

ETSI TS 125 331 V4.2.0 (2001-09)

Technical Specification

Universal Mobile Telecommunications System (UMTS); Radio Resource Control (RRC) protocol specification (3GPP TS 25.331 version 4.2.0 Release 4)



Reference

RTS/TSGR-0225331Uv4R2

Keywords

UMTS

ETSI

650 Route des Lucioles
F-06921 Sophia Antipolis Cedex - FRANCE

Tel.: +33 4 92 94 42 00 Fax: +33 4 93 65 47 16

Siret N° 348 623 562 00017 - NAF 742 C
Association à but non lucratif enregistrée à la
Sous-Préfecture de Grasse (06) N° 7803/88

Important notice

Individual copies of the present document can be downloaded from:

<http://www.etsi.org>

The present document may be made available in more than one electronic version or in print. In any case of existing or perceived difference in contents between such versions, the reference version is the Portable Document Format (PDF). In case of dispute, the reference shall be the printing on ETSI printers of the PDF version kept on a specific network drive within ETSI Secretariat.

Users of the present document should be aware that the document may be subject to revision or change of status. Information on the current status of this and other ETSI documents is available at

<http://portal.etsi.org/tb/status/status.asp>

If you find errors in the present document, send your comment to:

editor@etsi.fr

Copyright Notification

No part may be reproduced except as authorized by written permission.
The copyright and the foregoing restriction extend to reproduction in all media.

© European Telecommunications Standards Institute 2001.
All rights reserved.

Intellectual Property Rights

IPRs essential or potentially essential to the present document may have been declared to ETSI. The information pertaining to these essential IPRs, if any, is publicly available for **ETSI members and non-members**, and can be found in ETSI SR 000 314: "*Intellectual Property Rights (IPRs); Essential, or potentially Essential, IPRs notified to ETSI in respect of ETSI standards*", which is available from the ETSI Secretariat. Latest updates are available on the ETSI Web server (<http://www.etsi.org/legal/home.htm>).

Pursuant to the ETSI IPR Policy, no investigation, including IPR searches, has been carried out by ETSI. No guarantee can be given as to the existence of other IPRs not referenced in ETSI SR 000 314 (or the updates on the ETSI Web server) which are, or may be, or may become, essential to the present document.

Foreword

This Technical Specification (TS) has been produced by ETSI 3rd Generation Partnership Project (3GPP).

The present document may refer to technical specifications or reports using their 3GPP identities, UMTS identities or GSM identities. These should be interpreted as being references to the corresponding ETSI deliverables.

The cross reference between GSM, UMTS, 3GPP and ETSI identities can be found under www.etsi.org/key.

Contents

Intellectual Property Rights	2
Foreword.....	2
Foreword.....	24
1 Scope	25
2 References	25
3 Definitions and abbreviations.....	27
3.1 Definitions.....	27
3.2 Abbreviations	27
4 General	29
4.1 Overview of the specification	29
4.2 RRC Layer Model.....	30
4.3 Protocol specification principles	33
5 RRC Functions and Services provided to upper layers	33
5.1 RRC Functions.....	33
5.2 RRC Services provided to upper layers	33
5.3 Primitives between RRC and upper layers.....	34
6 Services expected from lower layers	34
6.1 Services expected from Layer 2.....	34
6.2 Services expected from Layer 1	34
6.3 Signalling Radio Bearers	34
7 Protocol states	35
7.1 Overview of RRC States and State Transitions including GSM.....	35
7.2 Processes in UE modes/states	35
7.2.1 UE Idle mode	35
7.2.2 UTRA RRC Connected mode	36
7.2.2.1 URA_PCH or CELL_PCH state	36
7.2.2.2 CELL_FACH state	36
7.2.2.3 CELL_DCH state	37
8 RRC procedures	37
8.1 RRC Connection Management Procedures.....	37
8.1.1 Broadcast of system information.....	37
8.1.1.1 General	38
8.1.1.1.1 System information structure.....	38
8.1.1.1.2 System information blocks	38
8.1.1.1.3 Segmentation and concatenation of system information blocks	43
8.1.1.1.4 Re-assembly of segments.....	44
8.1.1.1.5 Scheduling of system information	45
8.1.1.2 Initiation	45
8.1.1.3 Reception of SYSTEM INFORMATION messages by the UE.....	45
8.1.1.4 Reception of SYSTEM INFORMATION messages broadcast on a FACH transport channel.....	46
8.1.1.5 Actions upon reception of the Master Information Block and Scheduling Block(s).....	46
8.1.1.6 Actions upon reception of system information blocks	49
8.1.1.6.1 System Information Block type 1	50
8.1.1.6.2 System Information Block type 2	51
8.1.1.6.3 System Information Block type 3	51
8.1.1.6.4 System Information Block type 4	51
8.1.1.6.5 System Information Block type 5	51
8.1.1.6.6 System Information Block type 6	52
8.1.1.6.7 System Information Block type 7	52
8.1.1.6.8 System Information Block type 8	52
8.1.1.6.9 System Information Block type 9	52

8.1.1.6.10	System Information Block type 10	53
8.1.1.6.11	System Information Block type 11	53
8.1.1.6.12	System Information Block type 12	54
8.1.1.6.13	System Information Block type 13	55
8.1.1.6.14	System Information Block type 14	55
8.1.1.6.15	System Information Block type 15	56
8.1.1.6.16	System Information Block type 16	58
8.1.1.6.17	System Information Block type 17	59
8.1.1.6.18	System Information Block type 18	59
8.1.1.7	Modification of system information	59
8.1.1.7.1	Modification of system information blocks using a value tag	59
8.1.1.7.2	Synchronised modification of system information blocks	60
8.1.1.7.3	Actions upon system information change	60
8.1.1.7.4	Actions upon expiry of a system information expiry timer	61
8.1.2	Paging	61
8.1.2.1	General	61
8.1.2.2	Initiation	61
8.1.2.3	Reception of a PAGING TYPE 1 message by the UE	61
8.1.3	RRC connection establishment	62
8.1.3.1	General	63
8.1.3.2	Initiation	63
8.1.3.3	RRC CONNECTION REQUEST message contents to set	63
8.1.3.4	Reception of an RRC CONNECTION REQUEST message by the UTRAN	64
8.1.3.5	Cell re-selection or T300 timeout	64
8.1.3.6	Reception of an RRC CONNECTION SETUP message by the UE	65
8.1.3.7	Physical channel failure or cell re-selection	66
8.1.3.8	Invalid RRC CONNECTION SETUP message, unsupported configuration or invalid configuration	67
8.1.3.9	Reception of an RRC CONNECTION REJECT message by the UE	67
8.1.3.10	Invalid RRC CONNECTION REJECT message	69
8.1.4	RRC connection release	70
8.1.4.1	General	71
8.1.4.2	Initiation	71
8.1.4.3	Reception of an RRC CONNECTION RELEASE message by the UE	71
8.1.4.4	Invalid RRC CONNECTION RELEASE message	72
8.1.4.5	Cell re-selection or radio link failure	73
8.1.4.6	Expiry of timer T308, unacknowledged mode transmission	73
8.1.4.7	Void	73
8.1.4.8	Reception of an RRC CONNECTION RELEASE COMPLETE message by UTRAN	73
8.1.4.9	Unsuccessful transmission of the RRC CONNECTION RELEASE COMPLETE message, acknowledged mode transmission	74
8.1.4.10	Detection of loss of dedicated physical channel by UTRAN in CELL_DCH state	74
8.1.4.11	Failure to receive RRC CONNECTION RELEASE COMPLETE message by UTRAN	74
8.1.5	Void	74
8.1.6	Transmission of UE capability information	74
8.1.6.1	General	74
8.1.6.2	Initiation	75
8.1.6.3	Reception of an UE CAPABILITY INFORMATION message by the UTRAN	75
8.1.6.4	Reception of the UE CAPABILITY INFORMATION CONFIRM message by the UE	75
8.1.6.5	Invalid UE CAPABILITY INFORMATION CONFIRM message	76
8.1.6.6	T304 timeout	76
8.1.7	UE capability enquiry	76
8.1.7.1	General	77
8.1.7.2	Initiation	77
8.1.7.3	Reception of an UE CAPABILITY ENQUIRY message by the UE	77
8.1.7.4	Invalid UE CAPABILITY ENQUIRY message	77
8.1.8	Initial Direct transfer	77
8.1.8.1	General	77
8.1.8.2	Initiation of Initial direct transfer procedure in the UE	78
8.1.8.3	Reception of INITIAL DIRECT TRANSFER message by the UTRAN	79
8.1.9	Downlink Direct transfer	79
8.1.9.1	General	79
8.1.9.2	Initiation of downlink direct transfer procedure in the UTRAN	79

8.1.9.3	Reception of a DOWNLINK DIRECT TRANSFER message by the UE.....	80
8.1.9.3a	No signalling connection exists	80
8.1.9.4	Invalid DOWNLINK DIRECT TRANSFER message.....	80
8.1.10	Uplink Direct transfer.....	81
8.1.10.1	General.....	81
8.1.10.2	Initiation of uplink direct transfer procedure in the UE	81
8.1.10.3	Reception of UPLINK DIRECT TRANSFER message by the UTRAN.....	82
8.1.11	UE dedicated paging	82
8.1.11.1	General.....	82
8.1.11.2	Initiation.....	82
8.1.11.3	Reception of a PAGING TYPE 2 message by the UE.....	82
8.1.11.4	Invalid PAGING TYPE 2 message.....	82
8.1.12	Security mode control	83
8.1.12.1	General.....	83
8.1.12.2	Initiation.....	83
8.1.12.2.1	Ciphering configuration change.....	83
8.1.12.2.2	Integrity protection configuration change.....	84
8.1.12.3	Reception of SECURITY MODE COMMAND message by the UE	84
8.1.12.4	Void	87
8.1.12.4a	Incompatible simultaneous security reconfiguration	87
8.1.12.4b	Cell update procedure during security reconfiguration	87
8.1.12.4c	Invalid configuration.....	88
8.1.12.5	Reception of SECURITY MODE COMPLETE message by the UTRAN.....	89
8.1.12.6	Invalid SECURITY MODE COMMAND message	89
8.1.13	Signalling connection release procedure	90
8.1.13.1	General.....	90
8.1.13.2	Initiation of SIGNALLING CONNECTION RELEASE by the UTRAN.....	90
8.1.13.3	Reception of SIGNALLING CONNECTION RELEASE by the UE	90
8.1.13.4	Invalid SIGNALLING CONNECTION RELEASE message	90
8.1.13.5	Invalid configuration.....	91
8.1.14	Signalling connection release indication procedure	91
8.1.14.1	General.....	91
8.1.14.2	Initiation.....	91
8.1.14.3	Reception of SIGNALLING CONNECTION RELEASE INDICATION by the UTRAN.....	92
8.1.15	Counter check procedure.....	92
8.1.15.1	General.....	92
8.1.15.2	Initiation.....	92
8.1.15.3	Reception of a COUNTER CHECK message by the UE	92
8.1.15.4	Reception of the COUNTER CHECK RESPONSE message by UTRAN.....	93
8.1.15.5	Cell re-selection	93
8.1.15.6	Invalid COUNTER CHECK message	93
8.2	Radio Bearer control procedures.....	94
8.2.1	Radio bearer establishment.....	94
8.2.2	Reconfiguration procedures.....	94
8.2.2.1	General	96
8.2.2.2	Initiation	97
8.2.2.3	Reception of RADIO BEARER SETUP or RADIO BEARER RECONFIGURATION or RADIO BEARER RELEASE or TRANSPORT CHANNEL RECONFIGURATION or PHYSICAL CHANNEL RECONFIGURATION message by the UE	98
8.2.2.4	Transmission of a response message by the UE, normal case	102
8.2.2.5	Reception of a response message by the UTRAN, normal case.....	103
8.2.2.6	Unsupported configuration in the UE.....	104
8.2.2.7	Physical channel failure.....	104
8.2.2.8	Cell re-selection.....	105
8.2.2.9	Transmission of a response message by the UE, failure case.....	105
8.2.2.10	Reception of a response message by the UTRAN, failure case	106
8.2.2.11	Invalid configuration.....	106
8.2.2.12	Incompatible simultaneous reconfiguration.....	107
8.2.2.12a	Incompatible simultaneous security reconfiguration	107
8.2.2.12b	Cell update procedure during security reconfiguration.....	107
8.2.2.13	Invalid received message	108
8.2.3	Radio bearer release	108

8.2.4	Transport channel reconfiguration	108
8.2.5	Transport format combination control.....	109
8.2.5.1	General	109
8.2.5.2	Initiation	109
8.2.5.3	Reception of a TRANSPORT FORMAT COMBINATION CONTROL message by the UE	109
8.2.5.4	Invalid configuration	110
8.2.5.5	Invalid TRANSPORT FORMAT COMBINATION CONTROL message	111
8.2.6	Physical channel reconfiguration	111
8.2.7	Physical Shared Channel Allocation [TDD only]	111
8.2.7.1	General	111
8.2.7.2	Initiation	112
8.2.7.3	Reception of a PHYSICAL SHARED CHANNEL ALLOCATION message by the UE	112
8.2.7.4	Invalid PHYSICAL SHARED CHANNEL ALLOCATION message	114
8.2.8	PUSCH capacity request [TDD only]	114
8.2.8.1	General	114
8.2.8.2	Initiation	114
8.2.8.3	PUSCH CAPACITY REQUEST message contents to set	115
8.2.8.4	Reception of a PUSCH CAPACITY REQUEST message by the UTRAN	116
8.2.8.5	T310 expiry	116
8.2.9	Void.....	116
8.2.10	Uplink Physical Channel Control [TDD only]	116
8.2.10.1	General.....	116
8.2.10.2	Initiation.....	117
8.2.10.3	Reception of UPLINK PHYSICAL CHANNEL CONTROL message by the UE.....	117
8.2.10.4	Invalid UPLINK PHYSICAL CHANNEL CONTROL message.....	117
8.2.11	Physical channel reconfiguration failure	118
8.2.11.1	General.....	118
8.2.11.2	Runtime error due to overlapping compressed mode configurations.....	118
8.2.11.3	Runtime error due to overlapping compressed mode configuration and PDSCH reception.....	118
8.3	RRC connection mobility procedures	119
8.3.1	Cell and URA update procedures	119
8.3.1.1	General	120
8.3.1.2	Initiation	121
8.3.1.3	CELL UPDATE / URA UPDATE message contents to set.....	124
8.3.1.4	T305 expiry and the UE detects "out of service area"	125
8.3.1.4.1	Re-entering "in service area"	125
8.3.1.4.2	Expiry of timer T307	126
8.3.1.5	Reception of an CELL UPDATE/URA UPDATE message by the UTRAN	126
8.3.1.6	Reception of the CELL UPDATE CONFIRM/URA UPDATE CONFIRM message by the UE	127
8.3.1.7	Transmission of a response message to UTRAN	131
8.3.1.7a	Physical channel failure	134
8.3.1.8	Unsupported configuration by the UE.....	135
8.3.1.9	Invalid configuration	136
8.3.1.9a	Incompatible simultaneous reconfiguration.....	137
8.3.1.10	Confirmation error of URA ID list	139
8.3.1.11	Invalid CELL UPDATE CONFIRM/URA UPDATE CONFIRM message.....	140
8.3.1.12	T302 expiry or cell reselection	140
8.3.1.13	T314 expiry.....	143
8.3.1.14	T315 expiry.....	144
8.3.1.15	Reception of the UTRAN MOBILITY INFORMATION CONFIRM message by the UTRAN	144
8.3.2	URA update.....	144
8.3.3	UTRAN mobility information.....	145
8.3.3.1	General	145
8.3.3.2	Initiation	145
8.3.3.3	Reception of UTRAN MOBILITY INFORMATION message by the UE	145
8.3.3.4	Reception of an UTRAN MOBILITY INFORMATION CONFIRM message by the UTRAN	147
8.3.3.5	Cell re-selection.....	147
8.3.3.5a	Incompatible simultaneous security reconfiguration	147
8.3.3.6	Invalid UTRAN MOBILITY INFORMATION message	148
8.3.4	Active set update	148
8.3.4.1	General	148
8.3.4.2	Initiation	149

8.3.4.3	Reception of an ACTIVE SET UPDATE message by the UE.....	149
8.3.4.4	Unsupported configuration in the UE.....	150
8.3.4.5	Invalid configuration	151
8.3.4.5a	Incompatible simultaneous reconfiguration.....	151
8.3.4.6	Reception of the ACTIVE SET UPDATE COMPLETE message by the UTRAN	152
8.3.4.7	Reception of the ACTIVE SET UPDATE FAILURE message by the UTRAN.....	152
8.3.4.8	Invalid ACTIVE SET UPDATE message.....	152
8.3.4.9	Reception of an ACTIVE SET UPDATE message in wrong state	153
8.3.5	Hard handover	153
8.3.5.1	Timing re-initialised hard handover	153
8.3.5.1.1	General.....	153
8.3.5.1.2	Initiation.....	153
8.3.5.2	Timing-maintained hard handover	154
8.3.5.2.1	General.....	154
8.3.5.2.2	Initiation.....	154
8.3.6	Inter-RAT handover to UTRAN	155
8.3.6.1	General	155
8.3.6.2	Initiation	155
8.3.6.3	Reception of HANDOVER TO UTRAN COMMAND message by the UE	156
8.3.6.4	Invalid Handover to UTRAN command message	158
8.3.6.4a	Unsupported configuration in HANDOVER TO UTRAN COMMAND message	158
8.3.6.5	UE fails to perform handover	158
8.3.6.6	Reception of message HANDOVER TO UTRAN COMPLETE by the UTRAN	158
8.3.7	Inter-RAT handover from UTRAN.....	159
8.3.7.1	General	159
8.3.7.2	Initiation	159
8.3.7.3	Reception of a HANDOVER FROM UTRAN COMMAND message by the UE.....	159
8.3.7.4	Successful completion of the inter-RAT handover	160
8.3.7.5	UE fails to complete requested handover	160
8.3.7.6	Invalid HANDOVER FROM UTRAN COMMAND message.....	161
8.3.7.7	Reception of an HANDOVER FROM UTRAN FAILURE message by UTRAN.....	161
8.3.7.8	Unsupported configuration in HANDOVER FROM UTRAN COMMAND message.....	162
8.3.7.8a	Reception of HANDOVER FROM UTRAN COMMAND message by UE in CELL_FACH	162
8.3.8	Inter-RAT cell reselection to UTRAN	162
8.3.8.1	General	162
8.3.8.2	Initiation	163
8.3.8.3	UE fails to complete an inter-RAT cell reselection.....	163
8.3.9	Inter-RAT cell reselection from UTRAN.....	163
8.3.9.1	General	163
8.3.9.2	Initiation	163
8.3.9.3	Successful cell reselection.....	163
8.3.9.4	Expiry of timer T309.....	163
8.3.10	Inter-RAT cell change order to UTRAN	164
8.3.10.1	General.....	164
8.3.10.2	Initiation.....	164
8.3.10.3	UE fails to complete an inter-RAT cell change order	164
8.3.11	Inter-RAT cell change order from UTRAN	164
8.3.11.1	General.....	165
8.3.11.2	Initiation.....	165
8.3.11.3	Reception of an CELL CHANGE ORDER FROM UTRAN message by the UE.....	165
8.3.11.4	Successful completion of the cell change order.....	165
8.3.11.5	Expiry of timer T309 or UE fails to complete requested cell change order.....	165
8.3.11.6	Unsupported configuration in CELL CHANGE ORDER FROM UTRAN message	167
8.3.11.7	Invalid CELL CHANGE ORDER FROM UTRAN message.....	167
8.4	Measurement procedures	167
8.4.0	Measurement related definitions	167
8.4.1	Measurement control.....	169
8.4.1.1	General	169
8.4.1.2	Initiation	169
8.4.1.3	Reception of MEASUREMENT CONTROL by the UE	169
8.4.1.4	Unsupported measurement in the UE.....	171
8.4.1.4a	Configuration Incomplete	171

8.4.1.5	Invalid MEASUREMENT CONTROL message	172
8.4.1.6	Measurements after transition from CELL_DCH to CELL_FACH/CELL_PCH/URA_PCH state.....	172
8.4.1.6.1	Intra-frequency measurement	172
8.4.1.6.2	Inter-frequency measurement	173
8.4.1.6.3	Inter-RAT measurement	173
8.4.1.6.4	Quality measurement	173
8.4.1.6.5	UE internal measurement.....	174
8.4.1.6.6	Traffic volume measurement	174
8.4.1.6.7	UE positioning measurement.....	174
8.4.1.6a	Actions in CELL_FACH/CELL_PCH/URA_PCH state upon cell re-selection.....	174
8.4.1.7	Measurements after transition from CELL_FACH to CELL_DCH state	174
8.4.1.7.1	Intra-frequency measurement	175
8.4.1.7.2	Inter-frequency measurement	175
8.4.1.7.3	Inter-RAT measurement	175
8.4.1.7.4	Traffic volume measurement	175
8.4.1.8	Measurements after transition from idle mode to CELL_DCH state	176
8.4.1.8.1	Intra-frequency measurement	176
8.4.1.8.2	Inter-frequency measurement	176
8.4.1.8.3	Inter-RAT measurement	176
8.4.1.8.4	Traffic volume measurement	176
8.4.1.9	Measurements after transition from idle mode to CELL_FACH state	177
8.4.1.9.1	Intra-frequency measurement	177
8.4.1.9.2	Inter-frequency measurement	177
8.4.1.9.3	Inter-RAT measurement	177
8.4.1.9.4	Traffic volume measurement	177
8.4.1.9a	Measurements after transition from connected mode to idle mode	177
8.4.1.9a.1	Intra-frequency measurement	177
8.4.1.9a.2	Inter-frequency measurement	178
8.4.1.9a.3	Inter-RAT measurement	178
8.4.1.10	Measurements when measurement object is no longer valid.....	178
8.4.1.10.1	Traffic volume measurement	178
8.4.2	Measurement report.....	178
8.4.2.1	General	178
8.4.2.2	Initiation	178
8.4.3	Assistance Data Delivery	180
8.4.3.1	General	180
8.4.3.2	Initiation	180
8.4.3.3	Reception of ASSISTANCE DATA DELIVERY message by the UE	180
8.4.3.4	Invalid ASSISTANCE DATA DELIVERY message	180
8.5	General procedures	181
8.5.1	Selection of initial UE identity	181
8.5.2	Actions when entering idle mode from connected mode	181
8.5.3	Open loop power control upon establishment of DPCCH.....	182
8.5.4	Physical channel establishment criteria.....	182
8.5.5	Actions in "out of service area" and "in service area"	182
8.5.5.1	Detection of "out of service" area.....	182
8.5.5.1.1	Actions following detection of "out of service" area in URA_PCH or CELL_PCH state.....	182
8.5.5.1.2	Actions following detection of "out of service" area in CELL_FACH state	182
8.5.5.2	Detection of "in service" area.....	183
8.5.5.2.1	Actions following Re-entry into "in service area" in URA_PCH or CELL_PCH state.....	183
8.5.5.2.2	Actions following re-entry into "in service area" in CELL_FACH state.....	183
8.5.5.3	T316 expiry	183
8.5.5.4	T317 expiry	183
8.5.6	Radio link failure criteria and actions upon radio link failure	184
8.5.7	Open loop power control.....	184
8.5.8	Maintenance of Hyper Frame Numbers	186
8.5.9	START value calculation	187
8.5.10	Integrity protection.....	187
8.5.10.1	Integrity protection in downlink	188
8.5.10.2	Integrity protection in uplink	189
8.5.10.3	Calculation of message authentication code	189
8.5.11	FACH measurement occasion calculation.....	190

8.5.12	Establishment of Access Service Classes	190
8.5.13	Mapping of Access Classes to Access Service Classes	191
8.5.14	PLMN Type Selection	191
8.5.14a	Neighbour cells list narrowing for cell reselection	191
8.5.15	CFN calculation	192
8.5.15.1	Initialisation for CELL_DCH state after state transition	192
8.5.15.2	Initialisation in CELL_DCH state at hard handover	192
8.5.15.3	Initialisation for CELL_FACH	192
8.5.15.4	Initialisation after intersystem handover to UTRAN	192
8.5.16	Configuration of CTCH occasions	193
8.5.17	PRACH selection	193
8.5.18	Selection of RACH TTI	194
8.5.18.1	FDD Mode	194
8.5.18.2	1.28 Mcps TDD	195
8.5.19	Secondary CCPCCH selection	195
8.6	Generic actions on receipt and absence of an information element	196
8.6.1	CN information elements	196
8.6.1.1	Void	196
8.6.1.2	CN information info	196
8.6.1.3	Signalling connection release indication	196
8.6.2	UTRAN mobility information elements	197
8.6.2.1	URA identity	197
8.6.2.2	Mapping info	197
8.6.3	UE information elements	197
8.6.3.1	Activation time	197
8.6.3.1a	CN domain specific DRX cycle length coefficient	198
8.6.3.2	UTRAN DRX Cycle length coefficient	198
8.6.3.3	Generic state transition rules depending on received information elements	199
8.6.3.4	Ciphering mode info	199
8.6.3.5	Integrity protection mode info	201
8.6.3.6	Void	204
8.6.3.7	Void	204
8.6.3.8	Integrity check info	204
8.6.3.9	New C-RNTI	204
8.6.3.10	New U-RNTI	204
8.6.3.11	RRC transaction identifier	204
8.6.3.12	Capability Update Requirement	207
8.6.4	Radio bearer information elements	208
8.6.4.1	Signalling RB information to setup list	208
8.6.4.2	RAB information for setup	209
8.6.4.2a	RAB information to reconfigure	210
8.6.4.3	RB information to setup	210
8.6.4.4	RB information to be affected	211
8.6.4.5	RB information to reconfigure	211
8.6.4.6	RB information to release	212
8.6.4.7	RB with PDCP information	212
8.6.4.8	RB mapping info	212
8.6.4.9	RLC Info	215
8.6.4.10	PDCP Info	215
8.6.4.11	PDCP SN Info	216
8.6.4.12	NAS Synchronisation Indicator	216
8.6.5	Transport channel information elements	216
8.6.5.1	Transport Format Set	216
8.6.5.2	Transport format combination set	218
8.6.5.3	Transport format combination subset	220
8.6.5.4	DCH quality target	221
8.6.5.5	Added or Reconfigured UL TrCH information	221
8.6.5.6	Added or Reconfigured DL TrCH information	221
8.6.5.7	Deleted UL TrCH information	221
8.6.5.8	Deleted DL TrCH information	222
8.6.5.9	UL Transport channel information common for all transport channels	222
8.6.5.10	DL Transport channel information common for all transport channels	222

8.6.5.11	DRAC static information	223
8.6.5.12	TFCS Reconfiguration/Addition Information	223
8.6.5.13	TFCS Removal Information	223
8.6.5.14	TFCI Field 2 Information	223
8.6.5.15	TFCS Explicit Configuration	224
8.6.6	Physical channel information elements	224
8.6.6.1	Frequency info	224
8.6.6.2	Void	225
8.6.6.2a	PNBSCH allocation	225
8.6.6.3	Void	225
8.6.6.4	Downlink information for each radio link	225
8.6.6.5	Void	226
8.6.6.6	Uplink DPCH info	226
8.6.6.7	Void	226
8.6.6.8	Maximum allowed UL TX power	226
8.6.6.9	PDSCH with SHO DCH Info (FDD only)	226
8.6.6.10	PDSCH code mapping (FDD only)	226
8.6.6.11	Uplink DPCH power control info	228
8.6.6.12	Secondary CPICH info	229
8.6.6.13	Primary CPICH usage for channel estimation	229
8.6.6.14	DPCH frame offset	229
8.6.6.15	DPCH Compressed mode info	230
8.6.6.16	Repetition period, Repetition length, Offset (TDD only)	231
8.6.6.17	Primary CCPCH info	232
8.6.6.18	Primary CPICH info	232
8.6.6.19	CPCH SET Info (FDD only)	232
8.6.6.20	CPCH set ID (FDD only)	232
8.6.6.21	Default DPCH Offset Value	233
8.6.6.22	Secondary Scrambling Code, Code Number	233
8.6.6.23	PDSCH Power Control info	233
8.6.6.24	Tx Diversity Mode	233
8.6.6.25	SSDT Information	233
8.6.6.26	UL Timing Advance Control (TDD only)	234
8.6.6.26a	Uplink synchronisation parameters	234
8.6.6.27	Downlink information common for all radio links	234
8.6.6.28	Downlink DPCH info common for all radio links	235
8.6.6.29	ASC setting	235
8.6.6.30	SRB delay, PC preamble (FDD only)	237
8.6.6.31	FPACH/PRACH Selection (1.28 Mcps TDD only)	237
8.6.7	Measurement information elements	238
8.6.7.1	Measurement validity	238
8.6.7.2	Filter coefficient	238
8.6.7.3	Intra-frequency/Inter-frequency/Inter-RAT cell info list	239
8.6.7.4	Intra-frequency measurement quantity	244
8.6.7.5	Inter-RAT measurement quantity	244
8.6.7.6	Inter-RAT reporting quantity	245
8.6.7.7	Cell Reporting Quantities	245
8.6.7.8	Periodical Reporting Criteria	246
8.6.7.9	Reporting Cell Status	247
8.6.7.10	Traffic Volume Measurement	247
8.6.7.11	Traffic Volume Measurement Reporting Criteria	248
8.6.7.12	FACH measurement occasion info	248
8.6.7.13	Measurement Reporting Mode	249
8.6.7.14	Inter-frequency measurement	249
8.6.7.15	Inter-RAT measurement	250
8.6.7.16	Intra-frequency measurement	250
8.6.7.17	Quality measurement	250
8.6.7.18	UE internal measurement	250
8.6.7.19	UE positioning	250
8.6.7.19.1	UE positioning reporting quantity	250
8.6.7.19.2	UE positioning OTDOA assistance data	252
8.6.7.19.3	UE positioning GPS assistance data	253

8.6.7.20	Void	254
8.6.8	Void.....	254
9	Handling of unknown, unforeseen and erroneous protocol data	254
9.1	General.....	254
9.2	ASN.1 violation or encoding error.....	255
9.3	Unknown or unforeseen message type.....	255
9.3a	Unsolicited received message.....	256
9.3b	Unexpected critical message extension	256
9.4	Unknown or unforeseen information element value, mandatory information element	256
9.5	Conditional information element error.....	257
9.6	Unknown or unforeseen information element value, conditional information element	258
9.7	Unknown or unforeseen information element value, optional information element	258
9.8	Unexpected non-critical message extension.....	259
10	Message and information element functional definition and content.....	260
10.1	General	260
10.1.1	Protocol extensions.....	261
10.1.1.1	Non-critical extensions	264
10.1.1.1.1	Extension of an information element with additional values or choices.....	264
10.1.1.1.2	Extension of a message with additional information elements	264
10.1.1.2	Critical extensions	264
10.1.1.2.1	Extension of an information element with additional values or choices.....	264
10.1.1.2.2	Extension of a message with additional information elements	264
10.2	Radio Resource Control messages	264
10.2.1	ACTIVE SET UPDATE	264
10.2.2	ACTIVE SET UPDATE COMPLETE.....	267
10.2.3	ACTIVE SET UPDATE FAILURE.....	267
10.2.4	ASSISTANCE DATA DELIVERY	268
10.2.5	CELL CHANGE ORDER FROM UTRAN	268
10.2.6	CELL CHANGE ORDER FROM UTRAN FAILURE	269
10.2.7	CELL UPDATE	270
10.2.8	CELL UPDATE CONFIRM	271
10.2.9	COUNTER CHECK.....	274
10.2.10	COUNTER CHECK RESPONSE.....	275
10.2.11	DOWNLINK DIRECT TRANSFER	275
10.2.12	HANDOVER TO UTRAN COMMAND	276
10.2.13	HANDOVER TO UTRAN COMPLETE.....	279
10.2.14	INITIAL DIRECT TRANSFER.....	279
10.2.15	HANDOVER FROM UTRAN COMMAND	280
10.2.16	HANDOVER FROM UTRAN FAILURE.....	282
10.2.17	MEASUREMENT CONTROL.....	282
10.2.18	MEASUREMENT CONTROL FAILURE	284
10.2.19	MEASUREMENT REPORT	284
10.2.20	PAGING TYPE 1.....	285
10.2.21	PAGING TYPE 2.....	285
10.2.22	PHYSICAL CHANNEL RECONFIGURATION.....	286
10.2.23	PHYSICAL CHANNEL RECONFIGURATION COMPLETE.....	288
10.2.24	PHYSICAL CHANNEL RECONFIGURATION FAILURE	289
10.2.25	PHYSICAL SHARED CHANNEL ALLOCATION	290
10.2.26	PUSCH CAPACITY REQUEST	291
10.2.27	RADIO BEARER RECONFIGURATION.....	292
10.2.28	RADIO BEARER RECONFIGURATION COMPLETE.....	295
10.2.29	RADIO BEARER RECONFIGURATION FAILURE	296
10.2.30	RADIO BEARER RELEASE	297
10.2.31	RADIO BEARER RELEASE COMPLETE	300
10.2.32	RADIO BEARER RELEASE FAILURE	302
10.2.33	RADIO BEARER SETUP	302
10.2.34	RADIO BEARER SETUP COMPLETE	305
10.2.35	RADIO BEARER SETUP FAILURE.....	307
10.2.36	RRC CONNECTION REJECT	307
10.2.37	RRC CONNECTION RELEASE.....	308

10.2.38	RRC CONNECTION RELEASE COMPLETE.....	309
10.2.39	RRC CONNECTION REQUEST	309
10.2.40	RRC CONNECTION SETUP	310
10.2.41	RRC CONNECTION SETUP COMPLETE	312
10.2.42	RRC STATUS	313
10.2.43	SECURITY MODE COMMAND	314
10.2.44	SECURITY MODE COMPLETE.....	315
10.2.45	SECURITY MODE FAILURE	316
10.2.46	SIGNALLING CONNECTION RELEASE	316
10.2.47	SIGNALLING CONNECTION RELEASE INDICATION	317
10.2.48	SYSTEM INFORMATION	318
10.2.48.1	First Segment	319
10.2.48.2	First Segment (short)	319
10.2.48.3	Subsequent Segment	320
10.2.48.4	Last Segment	320
10.2.48.5	Last Segment (short).....	320
10.2.48.6	Complete SIB.....	321
10.2.48.7	Complete SIB (short).....	321
10.2.48.8	System Information Blocks	321
10.2.48.8.1	Master Information Block	322
10.2.48.8.2	Scheduling Block 1	322
10.2.48.8.3	Scheduling Block 2	322
10.2.48.8.4	System Information Block type 1.....	323
10.2.48.8.5	System Information Block type 2.....	323
10.2.48.8.6	System Information Block type 3.....	323
10.2.48.8.7	System Information Block type 4.....	324
10.2.48.8.8	System Information Block type 5.....	324
10.2.48.8.9	System Information Block type 6.....	325
10.2.48.8.10	System Information Block type 7.....	326
10.2.48.8.11	System Information Block type 8.....	327
10.2.48.8.12	System Information Block type 9.....	327
10.2.48.8.13	System Information Block type 10.....	328
10.2.48.8.14	System Information Block type 11.....	328
10.2.48.8.15	System Information Block type 12.....	328
10.2.48.8.16	System Information Block type 13.....	329
10.2.48.8.16.1	System Information Block type 13.1.....	329
10.2.48.8.16.2	System Information Block type 13.2.....	329
10.2.48.8.16.3	System Information Block type 13.3.....	330
10.2.48.8.16.4	System Information Block type 13.4.....	330
10.2.48.8.17	System Information Block type 14.....	330
10.2.48.8.18	System Information Block type 15.....	330
10.2.48.8.18.1	System Information Block type 15.1.....	331
10.2.48.8.18.2	System Information Block type 15.2.....	331
10.2.48.8.18.3	System Information Block type 15.3.....	332
10.2.48.8.18.4	System Information Block type 15.4.....	332
10.2.48.8.19	System Information Block type 16.....	332
10.2.48.8.20	System Information Block type 17.....	333
10.2.48.8.21	System Information Block type 18.....	333
10.2.49	SYSTEM INFORMATION CHANGE INDICATION	333
10.2.50	TRANSPORT CHANNEL RECONFIGURATION	334
10.2.51	TRANSPORT CHANNEL RECONFIGURATION COMPLETE	337
10.2.52	TRANSPORT CHANNEL RECONFIGURATION FAILURE	338
10.2.53	TRANSPORT FORMAT COMBINATION CONTROL	339
10.2.54	TRANSPORT FORMAT COMBINATION CONTROL FAILURE	340
10.2.55	UE CAPABILITY ENQUIRY	341
10.2.56	UE CAPABILITY INFORMATION	341
10.2.57	UE CAPABILITY INFORMATION CONFIRM	342
10.2.58	UPLINK DIRECT TRANSFER.....	342
10.2.59	UPLINK PHYSICAL CHANNEL CONTROL	343
10.2.60	URA UPDATE.....	345
10.2.61	URA UPDATE CONFIRM.....	345
10.2.62	UTRAN MOBILITY INFORMATION	346

10.2.63	UTRAN MOBILITY INFORMATION CONFIRM	347
10.2.64	UTRAN MOBILITY INFORMATION FAILURE	348
10.3	Information element functional definitions	349
10.3.1	CN Information elements	349
10.3.1.1	CN domain identity	349
10.3.1.2	CN Domain System Information	349
10.3.1.3	CN Information info	350
10.3.1.3a	CN Information info full	350
10.3.1.4	IMEI	350
10.3.1.5	IMSI (GSM-MAP)	351
10.3.1.6	Intra Domain NAS Node Selector	351
10.3.1.7	Location Area Identification	353
10.3.1.8	NAS message	353
10.3.1.9	NAS system information (GSM-MAP)	353
10.3.1.10	Paging record type identifier	354
10.3.1.11	PLMN identity	354
10.3.1.12	PLMN Type	354
10.3.1.13	P-TMSI (GSM-MAP)	354
10.3.1.14	RAB identity	355
10.3.1.15	Routing Area Code	355
10.3.1.16	Routing Area Identification	355
10.3.1.17	TMSI (GSM-MAP)	355
10.3.2	UTRAN mobility Information elements	356
10.3.2.1	Cell Access Restriction	356
10.3.2.2	Cell identity	356
10.3.2.3	Cell selection and re-selection info for SIB3/4	357
10.3.2.4	Cell selection and re-selection info for SIB11/12	359
10.3.2.5	Mapping Info	360
10.3.2.6	URA identity	361
10.3.3	UE Information elements	361
10.3.3.1	Activation time	361
10.3.3.2	Capability Update Requirement	361
10.3.3.3	Cell update cause	362
10.3.3.4	Ciphering Algorithm	362
10.3.3.5	Ciphering mode info	362
10.3.3.6	CN domain specific DRX cycle length coefficient	363
10.3.3.7	CPCH Parameters	363
10.3.3.8	C-RNTI	365
10.3.3.9	DRAC system information	365
10.3.3.10	RRC State Indicator	365
10.3.3.11	Establishment cause	365
10.3.3.12	Expiration Time Factor	367
10.3.3.13	Failure cause	367
10.3.3.14	Failure cause and error information	367
10.3.3.15	Initial UE identity	368
10.3.3.16	Integrity check info	369
10.3.3.17	Integrity protection activation info	369
10.3.3.18	Integrity protection Algorithm	370
10.3.3.19	Integrity protection mode info	370
10.3.3.20	Maximum bit rate	370
10.3.3.21	Measurement capability	371
10.3.3.21a	Measurement capability extension	372
10.3.3.22	Paging cause	374
10.3.3.23	Paging record	375
10.3.3.24	PDCP capability	375
10.3.3.25	Physical channel capability	377
10.3.3.26	Protocol error cause	379
10.3.3.27	Protocol error indicator	380
10.3.3.28	RB timer indicator	380
10.3.3.29	Redirection info	380
10.3.3.30	Re-establishment timer	380
10.3.3.31	Rejection cause	380

10.3.3.32	Release cause	381
10.3.3.33	RF capability FDD	381
10.3.3.33a	RF capability FDD extension	381
10.3.3.33b	RF capability TDD	382
10.3.3.34	RLC capability	382
10.3.3.35	RLC re-establish indicator	382
10.3.3.36	RRC transaction identifier	382
10.3.3.37	Security capability	383
10.3.3.38	START	383
10.3.3.39	Transmission probability	383
10.3.3.40	Transport channel capability	384
10.3.3.41	UE multi-mode/multi-RAT capability	385
10.3.3.42	UE radio access capability	386
10.3.3.42a	UE radio access capability extension	387
10.3.3.43	UE Timers and Constants in connected mode	387
10.3.3.44	UE Timers and Constants in idle mode	389
10.3.3.45	UE positioning capability	390
10.3.3.46	URA update cause	390
10.3.3.47	U-RNTI	390
10.3.3.48	U-RNTI Short	390
10.3.3.49	UTRAN DRX cycle length coefficient	391
10.3.3.50	Wait time	391
10.3.4	Radio Bearer Information elements	391
10.3.4.0	Default configuration identity	391
10.3.4.1	Downlink RLC STATUS info	391
10.3.4.2	PDCP info	392
10.3.4.3	PDCP SN info	395
10.3.4.4	Polling info	395
10.3.4.5	Predefined configuration identity	395
10.3.4.6	Predefined configuration value tag	395
10.3.4.7	Predefined RB configuration	396
10.3.4.8	RAB info	396
10.3.4.9	RAB info Post	396
10.3.4.10	RAB information for setup	397
10.3.4.11	RAB information to reconfigure	397
10.3.4.12	NAS Synchronization indicator	397
10.3.4.13	RB activation time info	397
10.3.4.14	RB COUNT-C MSB information	398
10.3.4.15	RB COUNT-C information	398
10.3.4.16	RB identity	398
10.3.4.17	RB information to be affected	398
10.3.4.18	RB information to reconfigure	399
10.3.4.19	RB information to release	399
10.3.4.20	RB information to setup	399
10.3.4.21	RB mapping info	399
10.3.4.22	RB with PDCP information	401
10.3.4.23	RLC info	402
10.3.4.24	Signalling RB information to setup	403
10.3.4.25	Transmission RLC Discard	404
10.3.5	Transport CH Information elements	405
10.3.5.1	Added or Reconfigured DL TrCH information	405
10.3.5.2	Added or Reconfigured UL TrCH information	406
10.3.5.3	CPCH set ID	406
10.3.5.4	Deleted DL TrCH information	406
10.3.5.5	Deleted UL TrCH information	406
10.3.5.6	DL Transport channel information common for all transport channels	407
10.3.5.7	DRAC Static Information	407
10.3.5.8	Power Offset Information	408
10.3.5.9	Predefined TrCH configuration	408
10.3.5.10	Quality Target	409
10.3.5.11	Semi-static Transport Format Information	410
10.3.5.12	TFCI Field 2 Information	410

10.3.5.13	TFCS Explicit Configuration.....	411
10.3.5.14	TFCS Information for DSCH (TFCI range method).....	411
10.3.5.15	TFCS Reconfiguration/Addition Information.....	411
10.3.5.16	TFCS Removal Information	413
10.3.5.17	Transparent mode signalling info	413
10.3.5.18	Transport channel identity	413
10.3.5.19	Transport Format Combination (TFC).....	413
10.3.5.20	Transport Format Combination Set	413
10.3.5.21	Transport Format Combination Set Identity	414
10.3.5.22	Transport Format Combination Subset.....	415
10.3.5.23	Transport Format Set	416
10.3.5.24	UL Transport channel information common for all transport channels.....	418
10.3.6	Physical CH Information elements.....	418
10.3.6.1	AC-to-ASC mapping	418
10.3.6.2	AICH Info	418
10.3.6.3	AICH Power offset	419
10.3.6.4	Allocation period info.....	419
10.3.6.5	Alpha	419
10.3.6.6	ASC setting.....	420
10.3.6.7	Block STTD indicator.....	421
10.3.6.8	CCTrCH power control info	421
10.3.6.8a	Cell and Channel Identity info.....	421
10.3.6.9	Cell parameters Id.....	422
10.3.6.10	Common timeslot info	422
10.3.6.11	Constant value	422
10.3.6.12	CPCH persistence levels	423
10.3.6.13	CPCH set info.....	423
10.3.6.14	CPCH Status Indication mode	426
10.3.6.15	CSICH Power offset	426
10.3.6.16	Default DPCH Offset Value	426
10.3.6.17	Downlink channelisation codes	427
10.3.6.18	Downlink DPCH info common for all RL.....	428
10.3.6.19	Downlink DPCH info common for all RL Post.....	428
10.3.6.20	Downlink DPCH info common for all RL Pre.....	429
10.3.6.21	Downlink DPCH info for each RL	430
10.3.6.22	Downlink DPCH info for each RL Post.....	431
10.3.6.23	Downlink DPCH power control information.....	432
10.3.6.24	Downlink information common for all radio links	432
10.3.6.25	Downlink information common for all radio links Post	432
10.3.6.26	Downlink information common for all radio links Pre	433
10.3.6.27	Downlink information for each radio link	433
10.3.6.28	Downlink information for each radio link Post.....	433
10.3.6.29	Void	434
10.3.6.30	Downlink PDSCH information.....	434
10.3.6.31	Downlink rate matching restriction information.....	434
10.3.6.32	Downlink Timeslots and Codes	434
10.3.6.33	DPCH compressed mode info.....	435
10.3.6.34	DPCH Compressed Mode Status Info	438
10.3.6.35	Dynamic persistence level	439
10.3.6.35a	FPACH info.....	439
10.3.6.36	Frequency info	440
10.3.6.37	Individual timeslot info.....	440
10.3.6.38	Individual Timeslot interference.....	440
10.3.6.39	Maximum allowed UL TX power.....	440
10.3.6.40	Void	441
10.3.6.41	Midamble shift and burst type	441
10.3.6.42	PDSCH Capacity Allocation info	442
10.3.6.43	PDSCH code mapping.....	443
10.3.6.44	PDSCH info	445
10.3.6.45	PDSCH Power Control info.....	445
10.3.6.46	PDSCH system information.....	445
10.3.6.47	PDSCH with SHO DCH Info	446

10.3.6.48	Persistence scaling factors	446
10.3.6.49	PICH Info	448
10.3.6.50	PICH Power offset	449
10.3.6.51	PRACH Channelisation Code List	449
10.3.6.51a	PRACH Channelisation Code 1.28 Mcps TDD	449
10.3.6.52	PRACH info (for RACH)	450
10.3.6.53	PRACH partitioning	451
10.3.6.54	PRACH power offset	451
10.3.6.55	PRACH system information list	452
10.3.6.56	Predefined PhyCH configuration	453
10.3.6.57	Primary CCPCH info	453
10.3.6.58	Primary CCPCH info post	453
10.3.6.59	Primary CCPCH TX Power	454
10.3.6.60	Primary CPICH info	454
10.3.6.61	Primary CPICH Tx power	454
10.3.6.62	Primary CPICH usage for channel estimation	454
10.3.6.63	PUSCH info	455
10.3.6.64	PUSCH Capacity Allocation info	455
10.3.6.65	PUSCH power control info	455
10.3.6.66	PUSCH system information	456
10.3.6.67	RACH transmission parameters	456
10.3.6.68	Radio link addition information	457
10.3.6.69	Radio link removal information	457
10.3.6.70	SCCPCH Information for FACH	458
10.3.6.71	Secondary CCPCH info	459
10.3.6.72	Secondary CCPCH system information	460
10.3.6.73	Secondary CPICH info	460
10.3.6.74	Secondary scrambling code	460
10.3.6.75	SFN Time info	461
10.3.6.75a	Special Burst Scheduling	461
10.3.6.76	SSDT cell identity	461
10.3.6.77	SSDT information	461
10.3.6.78	STTD indicator	461
10.3.6.78a	SYNC_UL info	462
10.3.6.79	TDD open loop power control	462
10.3.6.80	TFC Control duration	463
10.3.6.81	TFCI Combining Indicator	463
10.3.6.82	TGPSI	463
10.3.6.83	Time info	464
10.3.6.84	Timeslot number	464
10.3.6.85	TPC combination index	464
10.3.6.85a	TSTD indicator	464
10.3.6.86	TX Diversity Mode	464
10.3.6.87	UL interference	465
10.3.6.88	Uplink DPCH info	466
10.3.6.89	Uplink DPCH info Post	467
10.3.6.90	Uplink DPCH info Pre	467
10.3.6.91	Uplink DPCH power control info	467
10.3.6.92	Uplink DPCH power control info Post	468
10.3.6.93	Uplink DPCH power control info Pre	469
10.3.6.94	Uplink Timeslots and Codes	469
10.3.6.95	Uplink Timing Advance	470
10.3.6.96	Uplink Timing Advance Control	471
10.3.7	Measurement Information elements	473
10.3.7.1	Additional measurements list	473
10.3.7.2	Cell info	473
10.3.7.3	Cell measured results	475
10.3.7.4	Cell measurement event results	475
10.3.7.5	Cell reporting quantities	476
10.3.7.6	Cell synchronisation information	476
10.3.7.7	Event results	478
10.3.7.8	FACH measurement occasion info	478

10.3.7.9	Filter coefficient.....	479
10.3.7.10	HCS Cell re-selection information.....	479
10.3.7.11	HCS neighbouring cell information.....	480
10.3.7.12	HCS Serving cell information.....	480
10.3.7.13	Inter-frequency cell info list.....	480
10.3.7.14	Inter-frequency event identity.....	481
10.3.7.15	Inter-frequency measured results list.....	482
10.3.7.16	Inter-frequency measurement.....	483
10.3.7.17	Inter-frequency measurement event results.....	483
10.3.7.18	Inter-frequency measurement quantity.....	484
10.3.7.19	Inter-frequency measurement reporting criteria.....	484
10.3.7.20	Inter-frequency measurement system information.....	486
10.3.7.21	Inter-frequency reporting quantity.....	486
10.3.7.22	Inter-frequency SET UPDATE.....	486
10.3.7.23	Inter-RAT cell info list.....	487
10.3.7.24	Inter-RAT event identity.....	488
10.3.7.25	Inter-RAT info.....	488
10.3.7.26	Inter-RAT measured results list.....	488
10.3.7.27	Inter-RAT measurement.....	489
10.3.7.28	Inter-RAT measurement event results.....	489
10.3.7.29	Inter-RAT measurement quantity.....	490
10.3.7.30	Inter-RAT measurement reporting criteria.....	490
10.3.7.31	Inter-RAT measurement system information.....	491
10.3.7.32	Inter-RAT reporting quantity.....	491
10.3.7.33	Intra-frequency cell info list.....	491
10.3.7.34	Intra-frequency event identity.....	492
10.3.7.35	Intra-frequency measured results list.....	492
10.3.7.36	Intra-frequency measurement.....	493
10.3.7.37	Intra-frequency measurement event results.....	493
10.3.7.38	Intra-frequency measurement quantity.....	494
10.3.7.39	Intra-frequency measurement reporting criteria.....	494
10.3.7.40	Intra-frequency measurement system information.....	497
10.3.7.41	Intra-frequency reporting quantity.....	497
10.3.7.42	Intra-frequency reporting quantity for RACH reporting.....	497
10.3.7.43	Maximum number of reported cells on RACH.....	498
10.3.7.44	Measured results.....	498
10.3.7.45	Measured results on RACH.....	499
10.3.7.46	Measurement Command.....	501
10.3.7.47	Measurement control system information.....	501
10.3.7.48	Measurement Identity.....	501
10.3.7.49	Measurement reporting mode.....	502
10.3.7.50	Measurement Type.....	502
10.3.7.51	Measurement validity.....	502
10.3.7.52	Observed time difference to GSM cell.....	502
10.3.7.53	Periodical reporting criteria.....	503
10.3.7.53a	PLMN identities of neighbour cells.....	503
10.3.7.54	Primary CCPCH RSCP info.....	504
10.3.7.54a	Qhcs.....	505
10.3.7.55	Quality measured results list.....	506
10.3.7.56	Quality measurement.....	507
10.3.7.57	Quality measurement event results.....	507
10.3.7.58	Quality measurement reporting criteria.....	507
10.3.7.59	Quality reporting quantity.....	508
10.3.7.60	Reference time difference to cell.....	508
10.3.7.61	Reporting Cell Status.....	508
10.3.7.62	Reporting information for state CELL_DCH.....	511
10.3.7.63	SFN-SFN observed time difference.....	511
10.3.7.64	Time to trigger.....	511
10.3.7.65	Timeslot ISCP info.....	511
10.3.7.66	Traffic volume event identity.....	512
10.3.7.67	Traffic volume measured results list.....	512
10.3.7.68	Traffic volume measurement.....	513

10.3.7.69	Traffic volume measurement event results	513
10.3.7.70	Traffic volume measurement object	514
10.3.7.71	Traffic volume measurement quantity	514
10.3.7.72	Traffic volume measurement reporting criteria	514
10.3.7.73	Traffic volume measurement system information	515
10.3.7.74	Traffic volume reporting quantity	516
10.3.7.75	UE internal event identity	516
10.3.7.76	UE internal measured results	517
10.3.7.77	UE internal measurement	518
10.3.7.78	UE internal measurement event results	518
10.3.7.79	UE internal measurement quantity	518
10.3.7.80	UE internal measurement reporting criteria	519
10.3.7.81	UE internal measurement system information	520
10.3.7.82	UE Internal reporting quantity	520
10.3.7.83	UE Rx-Tx time difference type 1	521
10.3.7.84	UE Rx-Tx time difference type 2	521
10.3.7.85	UE Transmitted Power info	521
10.3.7.86	UE positioning Ciphering info	521
10.3.7.87	UE positioning Error	522
10.3.7.88	UE positioning GPS acquisition assistance	522
10.3.7.88a	UE positioning GPS Additional Assistance Data Request	524
10.3.7.89	UE positioning GPS almanac	524
10.3.7.90	UE positioning GPS assistance data	525
10.3.7.90a	Void	526
10.3.7.91	UE positioning GPS DGPS corrections	526
10.3.7.91a	UE positioning GPS Ephemeris and Clock Correction parameters	528
10.3.7.92	UE positioning GPS ionospheric model	530
10.3.7.93	UE positioning GPS measured results	530
10.3.7.94	UE positioning GPS navigation model	532
10.3.7.95	UE positioning GPS real-time integrity	532
10.3.7.96	UE positioning GPS reference time	533
10.3.7.97	UE positioning GPS UTC model	533
10.3.7.98	UE positioning IPDL parameters	534
10.3.7.99	UE positioning measured results	535
10.3.7.100	UE positioning measurement	535
10.3.7.101	UE positioning measurement event results	536
10.3.7.102	Void	536
10.3.7.103	UE positioning OTDOA assistance data	536
10.3.7.104	Void	536
10.3.7.105	UE positioning OTDOA measurement	537
10.3.7.106	UE positioning OTDOA neighbour cell info	538
10.3.7.107	UE positioning OTDOA quality	540
10.3.7.108	UE positioning OTDOA reference cell info	541
10.3.7.109	UE positioning position estimate info	541
10.3.7.110	UE positioning reporting criteria	542
10.3.7.111	UE positioning reporting quantity	543
10.3.7.112	T _{ADV} info	545
10.3.8	Other Information elements	545
10.3.8.1	BCCH modification info	545
10.3.8.2	BSIC	545
10.3.8.3	CBS DRX Level 1 information	545
10.3.8.4	Cell Value tag	545
10.3.8.4a	Ellipsoid point	546
10.3.8.4b	Ellipsoid point with Altitude	546
10.3.8.4c	Ellipsoid point with Altitude and uncertainty ellipsoid	546
10.3.8.4d	Ellipsoid point with uncertainty Circle	547
10.3.8.4e	Ellipsoid point with uncertainty Ellipse	548
10.3.8.5	Inter-RAT change failure	548
10.3.8.6	Inter-RAT handover failure	549
10.3.8.7	Inter-RAT UE radio access capability	549
10.3.8.8	Void	550

10.3.8.8a	Inter-RAT UE security capability	550
10.3.8.9	MIB Value tag	550
10.3.8.10	PLMN Value tag	550
10.3.8.10a	PNBSCH allocation	550
10.3.8.11	Predefined configuration identity and value tag	551
10.3.8.12	Protocol error information	551
10.3.8.13	References to other system information blocks	551
10.3.8.14	References to other system information blocks and scheduling blocks	552
10.3.8.15	Rplmn information	552
10.3.8.16	Scheduling information	554
10.3.8.17	SEG COUNT	555
10.3.8.18	Segment index	555
10.3.8.19	SIB data fixed	555
10.3.8.20	SIB data variable	555
10.3.8.20a	SIB occurrence identity	555
10.3.8.20b	SIB occurrence identity and value tag	556
10.3.8.20c	SIB occurrence value tag	556
10.3.8.21	SIB type	556
10.3.8.22	SIB type SIBs only	557
10.3.9	ANSI-41 Information elements	558
10.3.9.1	ANSI 41 Core Network Information	558
10.3.9.2	ANSI-41 Global Service Redirection information	558
10.3.9.3	ANSI-41 NAS parameter	558
10.3.9.4	ANSI-41 NAS system information	559
10.3.9.5	ANSI-41 Private Neighbour List information	559
10.3.9.6	ANSI-41 RAND information	559
10.3.9.7	ANSI-41 User Zone Identification information	559
10.3.9.8	MIN_P_REV	559
10.3.9.9	NID	559
10.3.9.10	P_REV	560
10.3.9.11	SID	560
10.3.10	Multiplicity values and type constraint values	560
11	Message and Information element abstract syntax (with ASN.1)	563
11.0	General	563
11.1	General message structure	563
11.2	PDU definitions	567
11.3	Information element definitions	594
11.4	Constant definitions	684
11.5	RRC information between network nodes	685
11.6	RRC information between UE and other RATs	689
12	Message transfer syntax	690
12.1	Structure of encoded RRC messages	690
12.1.1	Basic production	691
12.1.2	Extension	691
12.1.3	Padding	691
12.2	ECN link module for RRC	693
12.3	ECN modules for RRC	693
13	Protocol timers, counters, other parameters and default configurations	694
13.1	Timers for UE	695
13.2	Counters for UE	696
13.3	UE constants and parameters	697
13.4	UE variables	697
13.4.0	CELL INFO LIST	697
13.4.00	Void	698
13.4.0a	CELL_UPDATE_STARTED	698
13.4.1	CIPHERING_STATUS	699
13.4.2	Void	699
13.4.2a	CONFIGURATION_INCOMPLETE	699
13.4.3	C_RNTI	699
13.4.4	DOFF	700

13.4.5	ESTABLISHED_RABS.....	700
13.4.5a	ESTABLISHED_SIGNALLING_CONNECTIONS.....	700
13.4.6	ESTABLISHMENT_CAUSE.....	701
13.4.7	FAILURE_CAUSE.....	701
13.4.8	FAILURE_INDICATOR.....	701
13.4.8a	INCOMPATIBLE_SECURITY_RECONFIGURATION.....	701
13.4.9	INITIAL_UE_IDENTITY.....	702
13.4.9a	INTEGRITY_PROTECTION_ACTIVATION_INFO.....	702
13.4.10	INTEGRITY_PROTECTION_INFO.....	702
13.4.11	INVALID_CONFIGURATION.....	703
13.4.11a	LATEST_CONFIGURED_CN_DOMAIN.....	703
13.4.12	MEASUREMENT_IDENTITY.....	704
13.4.13	Void.....	704
13.4.14	ORDERED_RECONFIGURATION.....	704
13.4.15	PDCP_SN_INFO.....	704
13.4.16	PROTOCOL_ERROR_INDICATOR.....	704
13.4.17	PROTOCOL_ERROR_INFORMATION.....	705
13.4.18	PROTOCOL_ERROR_REJECT.....	705
13.4.19	RB_TIMER_INDICATOR.....	705
13.4.20	RB_UPLINK_CIPHERING_ACTIVATION_TIME_INFO.....	705
13.4.21	SELECTED_PLMN.....	705
13.4.22	START_THRESHOLD.....	706
13.4.23	START_VALUE_TO_TRANSMIT.....	706
13.4.24	TFC_SUBSET.....	706
13.4.25	TGPS_IDENTITY.....	707
13.4.26	TGSN_REPORTED.....	708
13.4.26a	TIMERS_AND_CONSTANTS.....	708
13.4.27	TRANSACTIONS.....	708
13.4.27a	TRIGGERED_1A_EVENT.....	709
13.4.27b	TRIGGERED_1B_EVENT.....	709
13.4.27c	TRIGGERED_1C_EVENT.....	710
13.4.27d	BEST_CELL_1D_EVENT.....	710
13.4.27e	TRIGGERED_1E_EVENT.....	710
13.4.27f	TRIGGERED_1F_EVENT.....	711
13.4.27f1	TRIGGERED_1G_EVENT.....	711
13.4.27f2	TRIGGERED_1H_EVENT.....	711
13.4.27f3	TRIGGERED_1I_EVENT.....	712
13.4.27f4	BEST_FREQUENCY_2A_EVENT.....	712
13.4.27f5	TRIGGERED_2B_EVENT.....	712
13.4.27f6	TRIGGERED_2C_EVENT.....	712
13.4.27f7	TRIGGERED_2D_EVENT.....	713
13.4.27f8	TRIGGERED_2E_EVENT.....	713
13.4.27f9	TRIGGERED_2F_EVENT.....	713
13.4.27f10	TRIGGERED_3A_EVENT.....	713
13.4.27f11	TRIGGERED_3B_EVENT.....	714
13.4.27f12	TRIGGERED_3C_EVENT.....	714
13.4.27f13	BEST_CELL_3D_EVENT.....	715
13.4.27g	UE_CAPABILITY_REQUESTED.....	715
13.4.28	UE_CAPABILITY_TRANSFERRED.....	715
13.4.28a	UE_POSITIONING_GPS_DATA.....	717
13.4.28b	UE_POSITIONING_OTDOA_DATA.....	718
13.4.29	UNSUPPORTED_CONFIGURATION.....	718
13.4.30	URA_IDENTITY.....	718
13.4.31	U_RNTI.....	718
13.4.32	VALUE_TAG.....	719
13.5	UE RRC Procedure Performance.....	721
13.5.1	Definitions.....	721
13.5.2	RRC procedure performance values.....	721
13.6	RB information parameters for signalling radio bearer RB 0.....	726
13.6a	RB information parameters for SHCCH.....	727
13.6b	RB information parameters for BCCH mapped to FACH.....	727
13.6c	RB information parameters for PCCH mapped to PCH.....	727

13.6d	Parameters for BCCH mapped to BCH.....	728
13.7	Parameter values for default radio configurations.....	728
14	Specific functions.....	743
14.1	Intra-frequency measurements	743
14.1.1	Intra-frequency measurement quantities	743
14.1.2	Intra-frequency reporting events for FDD.....	744
14.1.2.1	Reporting event 1A: A Primary CPICH enters the reporting range.....	744
14.1.2.2	Reporting event 1B: A primary CPICH leaves the reporting range.....	746
14.1.2.3	Reporting event 1C: A non-active primary CPICH becomes better than an active primary CPICH.....	747
14.1.2.4	Reporting event 1D: Change of best cell	749
14.1.2.5	Reporting event 1E: A Primary CPICH becomes better than an absolute threshold	750
14.1.2.6	Reporting event 1F: A Primary CPICH becomes worse than an absolute threshold	752
14.1.3	Intra-frequency reporting events for TDD.....	753
14.1.3.1	Reporting event 1G: Change of best cell (TDD)	753
14.1.3.2	Reporting event 1H: Timeslot ISCP below a certain threshold (TDD).....	755
14.1.3.3	Reporting event 1I: Timeslot ISCP above a certain threshold (TDD)	756
14.1.4	Event-triggered periodic intra-frequency measurement reports (informative).....	757
14.1.4.1	Cell addition failure (FDD only).....	757
14.1.4.2	Cell replacement failure (FDD only)	758
14.1.5	Mechanisms available for modifying intra-frequency measurement reporting behaviour (informative).....	758
14.1.5.1	Hysteresis.....	758
14.1.5.2	Time-to-trigger	759
14.1.5.3	Cell individual offsets.....	760
14.1.5.4	Forbid a Primary CPICH to affect the reporting range (FDD only)	761
14.1.6	Report quantities in intra-frequency measurements	762
14.2	Inter-frequency measurements	763
14.2.0a	Inter-frequency measurement quantities	763
14.2.0b	Frequency quality estimate.....	763
14.2.0b.1	FDD cells.....	763
14.2.0b.2	TDD cells.....	764
14.2.0c	Inter-frequency reporting quantities	764
14.2.1	Inter-frequency reporting events	764
14.2.1.1	Event 2a: Change of best frequency.	765
14.2.1.2	Event 2b: The estimated quality of the currently used frequency is below a certain threshold and the estimated quality of a non-used frequency is above a certain threshold.	765
14.2.1.3	Event 2c: The estimated quality of a non-used frequency is above a certain threshold.....	767
14.2.1.4	Event 2d: The estimated quality of the currently used frequency is below a certain threshold	768
14.2.1.5	Event 2e: The estimated quality of a non-used frequency is below a certain threshold.....	769
14.2.1.6	Event 2 f: The estimated quality of the currently used frequency is above a certain threshold	770
14.3	Inter-RAT measurements	770
14.3.0a	Inter-RAT measurement quantities	770
14.3.0b	Frequency quality estimate of the UTRAN frequency	771
14.3.0c	Inter-RAT reporting quantities	771
14.3.1	Inter-RAT reporting events	771
14.3.1.1	Event 3a: The estimated quality of the currently used UTRAN frequency is below a certain threshold and the estimated quality of the other system is above a certain threshold.....	772
14.3.1.2	Event 3b: The estimated quality of other system is below a certain threshold	774
14.3.1.3	Event 3c: The estimated quality of other system is above a certain threshold.....	775
14.3.1.4	Event 3d: Change of best cell in other system	776
14.3.2	GSM measurements in compressed mode.....	777
14.3.2.1	GSM RSSI measurements	777
14.3.2.2	Initial BSIC identification.....	778
14.3.2.3	BSIC re-confirmation	778
14.4	Traffic Volume Measurements.....	778
14.4.1	Traffic Volume Measurement Quantity	778
14.4.2	Traffic Volume reporting triggers	778
14.4.2.1	Reporting event 4 A: Transport Channel Traffic Volume exceeds an absolute threshold.....	779
14.4.2.2	Reporting event 4 B: Transport Channel Traffic Volume becomes smaller than an absolute threshold ..	779
14.4.3	Traffic volume reporting mechanisms.....	779
14.4.3.1	Pending time after trigger	780
14.4.4	Interruption of user data transmission	780

14.5	Quality Measurements.....	780
14.5.1	Quality reporting measurement quantities.....	780
14.5.2	Quality reporting events	781
14.5.2.1	Reporting event 5A: A predefined number of bad CRCs is exceeded.....	781
14.6	UE internal measurements.....	781
14.6.1	UE internal measurement quantities.....	781
14.6.2	UE internal measurement reporting events	781
14.6.2.1	Reporting event 6A: The UE Tx power becomes larger than an absolute threshold	782
14.6.2.2	Reporting event 6B: The UE Tx power becomes less than an absolute threshold.....	782
14.6.2.3	Reporting event 6C: The UE Tx power reaches its minimum value.....	782
14.6.2.4	Reporting event 6D: The UE Tx power reaches its maximum value.....	783
14.6.2.5	Reporting event 6E: The UE RSSI reaches the UE's dynamic receiver range.....	783
14.6.2.6	Reporting event 6F (FDD): The UE Rx-Tx time difference for a RL included in the active set becomes larger than an absolute threshold.....	783
14.6.2.6a	Reporting event 6F (1.28 Mcps TDD): The time difference indicated by T_{ADV} becomes larger than an absolute threshold.....	783
14.6.2.7	Reporting event 6G: The UE Rx-Tx time difference for a RL included in the active set becomes less than an absolute threshold	783
14.7	UE positioning measurements.....	783
14.7.1	UE positioning measurement quantities	783
14.7.2	Void.....	784
14.7.3	UE positioning reporting events	784
14.7.3.1	Reporting Event 7a: The UE position changes more than an absolute threshold	784
14.7.3.2	Reporting Event 7b: SFN-SFN measurement changes more than an absolute threshold	784
14.7.3.3	Reporting Event 7c: GPS time and SFN time have drifted apart more than an absolute threshold	784
14.8	Dynamic Resource Allocation Control of Uplink DCH (FDD only)	784
14.9	Downlink power control.....	785
14.9.1	Generalities.....	785
14.9.2	Downlink power control in compressed mode	785
14.10	Calculated Transport Format Combination	786
14.11	UE autonomous update of virtual active set on non-used frequency (FDD only).....	786
14.11.1	Initial virtual active set.....	787
14.11.2	Virtual active set update during an inter-frequency measurement	790
14.12	Provision and reception of RRC information between network nodes.....	792
14.12.0	General	792
14.12.0a	General error handling for RRC information containers	793
14.12.1	RRC Information to target RNC.....	793
14.12.2	RRC information, target RNC to source RNC	794
14.12.3	RRC information, target RNC to source system	795
14.12.4	RRC information containers exchanged between network nodes	795
14.12.4.1	HANDOVER TO UTRAN INFO.....	795
14.12.4.2	SRNS RELOCATION INFO.....	796
14.12.4.3	RRC INFORMATION CONTAINER FAILURE INFO	804
14.13	RRC information transferred between UE and other systems	804
14.13.0	General	804
14.13.1	RRC information, another RAT to UE.....	805
14.13.1.1	Void	805
14.13.2	RRC information, UE to another RAT	805
14.13.2.1	UE capability information	805
14.13.2.2	UE security information.....	805
14.13.2.3	Pre-defined configuration status information.....	805
14.13.2.4	Void	806
14.14	Versatile Channel Assignment Mode (VCAM) mapping rule (FDD only).....	806
Annex A (informative): USIM parameters		807
A.1	Introduction.....	807
A.2	Ciphering information.....	807
A.3	Frequency information.....	807
A.4	Multiplicity values and type constraint values	808
Annex B (informative): Description of RRC state transitions.....		809
B.1	RRC states and state transitions including GSM.....	809

B.2	Transition from Idle Mode to UTRA RRC Connected Mode	809
B.2.1	Transitions for Emergency Calls	809
B.3	UTRA RRC Connected Mode States and Transitions	809
B.3.1	CELL_DCH state	809
B.3.1.1	Transition from CELL_DCH to Idle Mode	810
B.3.1.2	Transition from CELL_DCH to CELL_FACH state	810
B.3.1.3	Transition from CELL_DCH to CELL_PCH state	810
B.3.1.4	Transition from CELL_DCH to URA_PCH state	810
B.3.1.5	Radio Resource Allocation tasks (CELL_DCH)	810
B.3.1.6	RRC Connection mobility tasks (CELL_DCH)	810
B.3.1.7	UE Measurements (CELL_DCH)	811
B.3.1.8	Acquisition of system information (CELL_DCH)	811
B.3.2	CELL_FACH state	811
B.3.2.1	Transition from CELL_FACH to CELL_DCH state	811
B.3.2.2	Transition from CELL_FACH to CELL_PCH state	811
B.3.2.3	Transition from CELL_FACH to Idle Mode	811
B.3.2.4	Transition from CELL_FACH to URA_PCH State	811
B.3.2.5	Radio Resource Allocation Tasks (CELL_FACH)	811
B.3.2.6	RRC Connection mobility tasks (CELL_FACH)	812
B.3.2.7	UE Measurements (CELL_FACH)	812
B.3.2.8	Transfer and update of system information (CELL_FACH)	812
B.3.3	CELL_PCH state	813
B.3.3.1	Transition from CELL_PCH to CELL_FACH state	813
B.3.3.2	Radio Resource Allocation Tasks (CELL_PCH)	813
B.3.3.3	RRC Connection mobility tasks (CELL_PCH)	813
B.3.3.4	UE Measurements (CELL_PCH)	813
B.3.3.5	Transfer and update of system information (CELL_PCH)	813
B.3.4	URA_PCH State	814
B.3.4.1	Transition from URA_PCH State to CELL_FACH State (URA_PCH)	814
B.3.4.2	Radio Resource Allocation Tasks (URA_PCH)	814
B.3.4.3	RRC Connection mobility tasks (URA_PCH)	814
B.3.4.4	UE Measurements (URA_PCH)	814
B.3.4.5	Transfer and update of system information (URA_PCH)	815
B.3.5	States and Transitions for Cell Reselection in URA_PCH, CELL_PCH, and CELL_FACH	815
B.4	Inter-RAT handover with CS domain services	815
B.5	Inter-RAT handover with PS domain services	816
B.6	Inter-RAT handover with simultaneous PS and CS domain services	816
B.6.1	Inter-RAT handover UTRAN to GSM / BSS	816
B.6.2	Inter-RAT handover GSM / BSS to UTRAN	816
Annex C (informative): Change history		817
History		830

Foreword

This Technical Specification has been produced by the 3rd Generation Partnership Project (3GPP).

The contents of the present document are subject to continuing work within the TSG and may change following formal TSG approval. Should the TSG modify the contents of the present document, it will be re-released by the TSG with an identifying change of release date and an increase in version number as follows:

Version x.y.z

where:

- x the first digit:
 - 1 presented to TSG for information;
 - 2 presented to TSG for approval;
 - 3 or greater indicates TSG approved document under change control.
- y the second digit is incremented for all changes of substance, i.e. technical enhancements, corrections, updates, etc.
- z the third digit is incremented when editorial only changes have been incorporated in the document.

1 Scope

The present document specifies the Radio Resource Control protocol for the UE-UTRAN radio interface.

The scope of this specification also includes:

- the information to be transported in a transparent container between source RNC and target RNC in connection with SRNC relocation;
- the information to be transported in a transparent container between a target RNC and another system.

2 References

The following documents contain provisions which, through reference in this text, constitute provisions of the present document.

- References are either specific (identified by date of publication, edition number, version number, etc.) or non-specific.
- For a specific reference, subsequent revisions do not apply.
- For a non-specific reference, the latest version applies. In the case of a reference to a 3GPP document (including a GSM document), a non-specific reference implicitly refers to the latest version of that document *in the same Release as the present document*.

- [1] 3GPP TR 21.905: "Vocabulary for 3GPP Specifications".
- [2] 3GPP TS 25.301: "Radio Interface Protocol Architecture".
- [3] 3GPP TS 25.303: "Interlayer Procedures in Connected Mode".
- [4] 3GPP TS 25.304: "UE Procedures in Idle Mode and Procedures for Cell Reselection in Connected Mode".
- [5] 3GPP TS 24.008: "Mobile radio interface layer 3 specification, Core Network Protocols - Stage 3".
- [6] 3GPP TS 25.103: "RF Parameters in Support of RRM".
- [7] 3GPP TS 25.215: "Physical layer – Measurements (FDD)".
- [8] 3GPP TS 25.225: "Physical layer – Measurements (TDD)".
- [9] 3GPP TS 25.401: "UTRAN overall description".
- [10] 3GPP TS 25.402: "Synchronization in UTRAN, stage 2".
- [11] 3GPP TS 23.003: "Numbering, addressing and identification".
- [12] ICD-GPS-200: "Navstar GPS Space Segment/Navigation User Interface".
- [13] RTCM-SC104: "RTCM Recommended Standards for Differential GNSS Service (v.2.2)".
- [14] 3GPP TR 25.921: "Guidelines and Principles for protocol description and error handling".
- [15] 3GPP TS 25.321: "MAC protocol specification".
- [16] 3GPP TS 25.322: "RLC Protocol Specification".
- [17] 3GPP TS 24.007: "Mobile radio interface signalling layer 3" General Aspects.
- [18] 3GPP TS 25.305: "Stage 2 Functional Specification of Location Services in UTRAN".
- [19] 3GPP TS 25.133: "Requirements for Support of Radio Resource Management (FDD)".

- [20] 3GPP TS 25.123: "Requirements for Support of Radio Resource Management (TDD)".
- [21] 3GPP TS 25.101: "UE Radio Transmission and Reception (FDD)".
- [22] 3GPP TS 25.102: "UE Radio Transmission and Reception (TDD)".
- [23] 3GPP TS 23.060: "General Packet Radio Service (GPRS), Service description, Stage 2".
- [24] 3GPP TS 23.032: "Universal Geographical Area Description (GAD)".
- [25] 3GPP TS 23.122: "NAS Functions related to Mobile Station (MS) in idle mode".
- [26] 3GPP TS 25.211: "Physical channels and mapping of transport channels onto physical channels (FDD)".
- [27] 3GPP TS 25.212: "Multiplexing and channel coding (FDD)".
- [28] 3GPP TS 25.213: "Spreading and modulation (FDD)".
- [29] 3GPP TS 25.214: "Physical layer procedures (FDD)".
- [30] 3GPP TS 25.221: "Physical channels and mapping of transport channels onto physical channels (TDD)".
- [31] 3GPP TS 25.222: "Multiplexing and channel coding (TDD)".
- [32] 3GPP TS 25.223: "Spreading and modulation (TDD)".
- [33] 3GPP TS 25.224: "Physical Layer Procedures (TDD)".
- [34] 3GPP TS 25.302: "Services provided by the physical layer".
- [35] 3GPP TS 25.306 "UE Radio Access Capabilities".
- [36] 3GPP TS 25.323: "Packet Data Convergence Protocol (PDCP) Specification".
- [37] 3GPP TS 25.324: "Broadcast/Multicast Control BMC".
- [38] 3GPP TR 25.922: "Radio resource management strategies".
- [39] 3GPP TR 25.925: "Radio interface for broadcast/multicast services".
- [40] 3GPP TS 33.102: "Security Architecture".
- [41] 3GPP TS 34.108: "Common Test Environments for User Equipment (UE) Conformance Testing".
- [42] 3GPP TS 34.123-2: "User Equipment (UE) conformance specification; Part 2: Implementation Conformance Statement (ICS) proforma specification".
- [43] 3GPP TS 04.18: "Mobile radio interface layer 3 specification, Radio Resource Control Protocol".
- [44] 3GPP TS 04.60: "General Packet Radio Service (GPRS), MS-BSS interface; RLC/MAC".
- [45] 3GPP TS 05.05: "Radio transmission and reception".
- [46] 3GPP TS 05.08: "Radio subsystem link control".
- [47] ITU-T Recommendation X.680, (12/97) "Information Technology - Abstract Syntax Notation One (ASN.1): Specification of basic notation".
- [48] ITU-T Recommendation X.681, (12/97) "Information Technology - Abstract Syntax Notation One (ASN.1): Information object specification".
- [49] ITU-T Recommendation X.691, (12/97) "Information technology - ASN.1 encoding rules - Specification of Packed Encoding Rules (PER)".
- [50] 3GPP TS 31.102: "Characteristics of the USIM Application".

3 Definitions and abbreviations

3.1 Definitions

For the purposes of the present document, the terms and definitions given in [1] apply.

3.2 Abbreviations

For the purposes of the present document, the following abbreviations apply:

ACK	Acknowledgement
AICH	Acquisition Indicator CHannel
AM	Acknowledged Mode
AS	Access Stratum
ASC	Access Service Class
ASN.1	Abstract Syntax Notation.1
BCCH	Broadcast Control Channel
BCFE	Broadcast Control Functional Entity
BER	Bit Error Rate
BLER	BLock Error Rate
BSS	Base Station Sub-system
CH	Conditional on history
CV	Conditional on value
CCPCH	Common Control Physical CHannel
CCCH	Common Control Channel
CN	Core Network
CM	Connection Management
CPCH	Common Packet CHannel
C-RNTI	Cell RNTI
CTCH	Common Traffic CHannel
CTFC	Calculated Transport Format Combination
DCA	Dynamic Channel Allocation
DCCH	Dedicated Control Channel
DCFE	Dedicated Control Functional Entity
DCH	Dedicated Channel
DC-SAP	Dedicated Control SAP
DGPS	Differential Global Positioning System
DL	Downlink
DRAC	Dynamic Resource Allocation Control
DSCH	Downlink Shared Channel
DTCH	Dedicated Traffic Channel
FACH	Forward Access Channel
FDD	Frequency Division Duplex
FFS	For Further Study
GC-SAP	General Control SAP
HCS	Hierarchical Cell Structure
HFN	Hyper Frame Number
ID	Identifier
IDNNS	Intra Domain NAS Node Selector
IETF	Internet Engineering Task Force
IMEI	International Mobile Equipment Identity
IMSI	International Mobile Subscriber Identity
IE	Information element
IP	Internet Protocol
ISCP	Interference on Signal Code Power
LAI	Location Area Identity
L1	Layer 1
L2	Layer 2
L3	Layer 3

MD	Mandatory default
MP	Mandatory present
MAC	Media Access Control
MCC	Mobile Country Code
MM	Mobility Management
MNC	Mobile Network Code
NAS	Non Access Stratum
Nt-SAP	Notification SAP
NW	Network
OP	Optional
PCCH	Paging Control Channel
PCH	Paging Channel
PDCP	Packet Data Convergence Protocol
PDSCH	Physical Downlink Shared Channel
PDU	Protocol Data Unit
PLMN	Public Land Mobile Network
PNFE	Paging and Notification Control Functional Entity
PRACH	Physical Random Access Channel
P-TMSI	Packet Temporary Mobile Subscriber Identity
PUSCH	Physical Uplink Shared Channel
QoS	Quality of Service
RAB	Radio access bearer
RAT	Radio Access Technology
RAI	Routing Area Identity
RACH	Random Access Channel
RB	Radio Bearer
RFE	Routing Functional Entity
RL	Radio Link
RLC	Radio Link Control
RNTI	Radio Network Temporary Identifier
RNC	Radio Network Controller
RRC	Radio Resource Control
RSCP	Received Signal Code Power
RSSI	Received Signal Strength Indicator
SAP	Service Access Point
SCFE	Shared Control Function Entity
SF	Spreading Factor
SHCCH	Shared Control Channel
SIR	Signal to Interference Ratio
SSDT	Site Selection Diversity Transmission
S-RNTI	SRNC - RNTI
TDD	Time Division Duplex
TF	Transport Format
TFCS	Transport Format Combination Set
TFS	Transport Format Set
TM	Transparent Mode
TME	Transfer Mode Entity
TMSI	Temporary Mobile Subscriber Identity
Tr	Transparent
Tx	Transmission
UE	User Equipment
UL	Uplink
UM	Unacknowledged Mode
URA	UTRAN Registration Area
U-RNTI	UTRAN-RNTI
USCH	Uplink Shared Channel
UTRAN	Universal Terrestrial Radio Access Network

4 General

If not specified differently, descriptions are relevant for both FDD and TDD. Descriptions for TDD only are relevant for both 1.28 Mcps TDD and 3.84 Mcps TDD if not specified differently.

4.1 Overview of the specification

This specification is organised as follows:

- Subclause 4.2 contains the description of the model of the RRC protocol layer;
- Clause 5 lists the RRC functions and the services provided to upper layers;
- Clause 6 lists the services expected from the lower layers and specifies the radio bearers available for usage by the RRC messages;
- Clause 7 specifies the UE states for the Access Stratum, and also specifies the processes running in the UE in the respective states;
- Clause 8 specifies RRC procedures, including UE state transitions;
- Clause 9 specifies the procedures for the handling of unknown, unforeseen, and erroneous protocol data by the receiving entity;
- Clause 10 describes the message in a Tabular format; these messages descriptions are referenced in clause 8;
- Clause 11 specifies the encoding of the messages of the RRC protocol. This is based on the Tabular description in clause 10.
- Clause 12 specifies the transfer syntax for RRC PDUs derived from the encoding definition;
- Clause 13 lists the protocol timers, counters, constants and variables to be used by the UE;
- Clause 14 specifies some of the processes applicable in UTRA RRC connected mode e.g. measurement processes, and also the RRC information to be transferred between network nodes. Note that not all the processes applicable in UTRA RRC connected mode are specified here i.e. some UTRA RRC connected mode processes are described in [4] e.g. cell re-selection; Annex A contains recommendations about the network parameters to be stored on the USIM;

Annex B contains informative Stage 2 description of the RRC protocol states and state transitions.

The following figure summarises the mapping of UE states, including states in GSM, to the appropriate UTRA and GSM specifications that specify the UE behaviour.

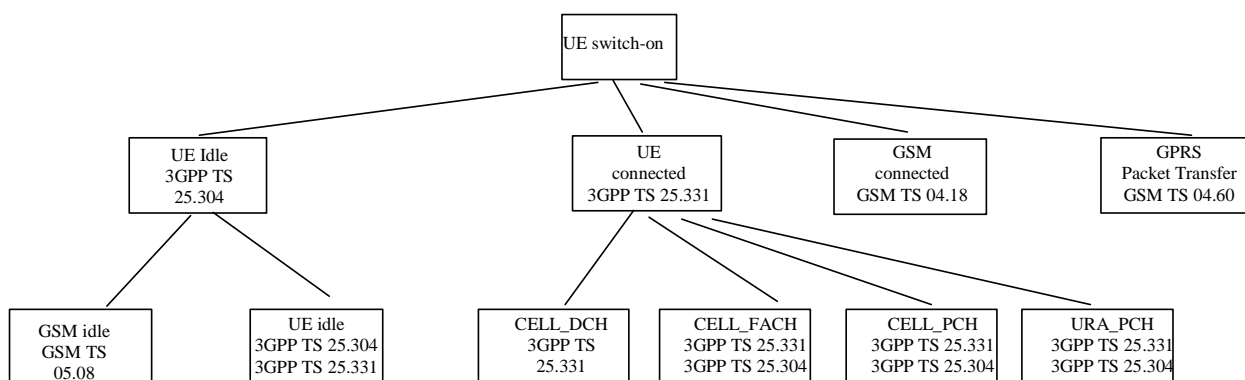

Figure 1: Mapping of UE state to 3GPP Specifications

4.2 RRC Layer Model

The functional entities of the RRC layer are described below:

- Routing of higher layer messages to different MM/CM entities (UE side) or different core network domains (UTRAN side) is handled by the Routing Function Entity (**RFE**)
- Broadcast functions are handled in the broadcast control function entity (**BCFE**). The BCFE is used to deliver the RRC services, which are required at the GC-SAP. The BCFE can use the lower layer services provided by the Tr-SAP and UM-SAP.
- Paging of UEs that do not have an RRC connection is controlled by the paging and notification control function entity (**PNFE**). The PNFE is used to deliver the RRC services that are required at the Nt-SAP. The PNFE can use the lower layer services provided by the Tr-SAP and UM-SAP.
- The Dedicated Control Function Entity (**DCFE**) handles all functions specific to one UE. The DCFE is used to deliver the RRC services that are required at the DC-SAP and can use lower layer services of UM/AM-SAP and Tr-SAP depending on the message to be sent and on the current UE service state.
- In TDD mode, the DCFE is assisted by the Shared Control Function Entity (SCFE) location in the C-RNC, which controls the allocation of the PDSCH and PUSCH using lower layers services of UM-SAP and Tr-SAP.
- The Transfer Mode Entity (TME) handles the mapping between the different entities inside the RRC layer and the SAPs provided by RLC.

NOTE: Logical information exchange is necessary also between the RRC sublayer functional entities. Most of that is implementation dependent and not necessary to present in detail in a specification.

Figure 2 shows the RRC model for the UE and Figure 3 and Figure 4 show the RRC model for the UTRAN.

NOTE: The figure shows only the types of SAPs that are used. Multiple instances of Tr-SAP, UM-SAP and AM-SAP are possible. Especially, different functional entities usually use different instances of SAP types.

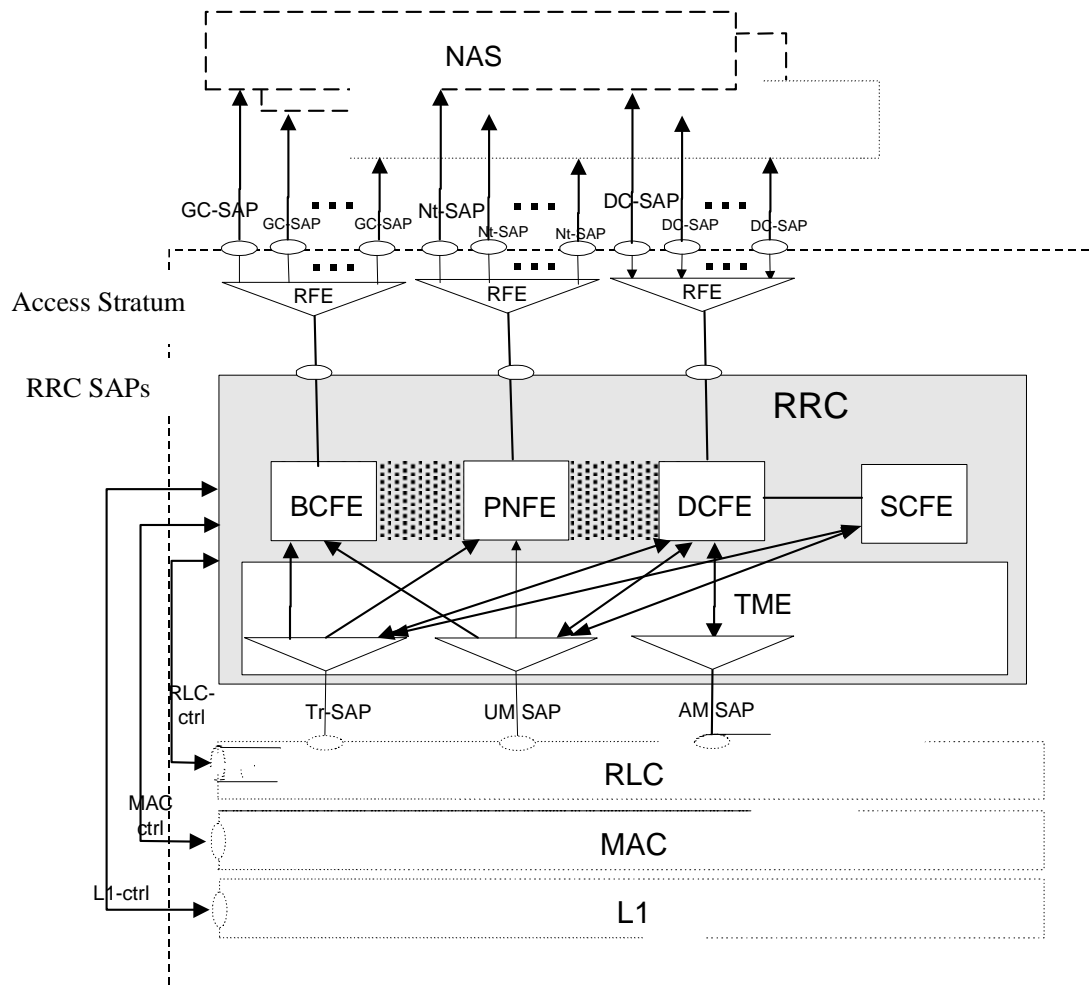

Figure 2: UE side model of RRC

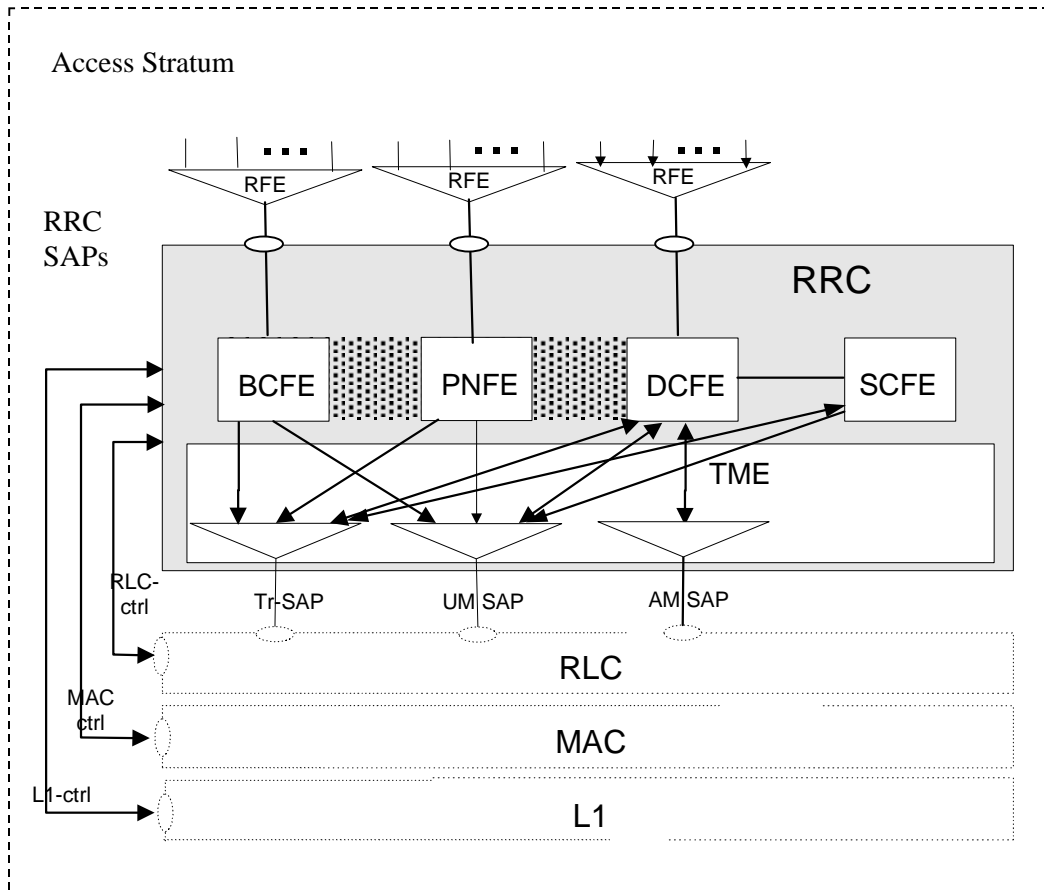

Figure 3: UTRAN side RRC model (DS-MAP system)

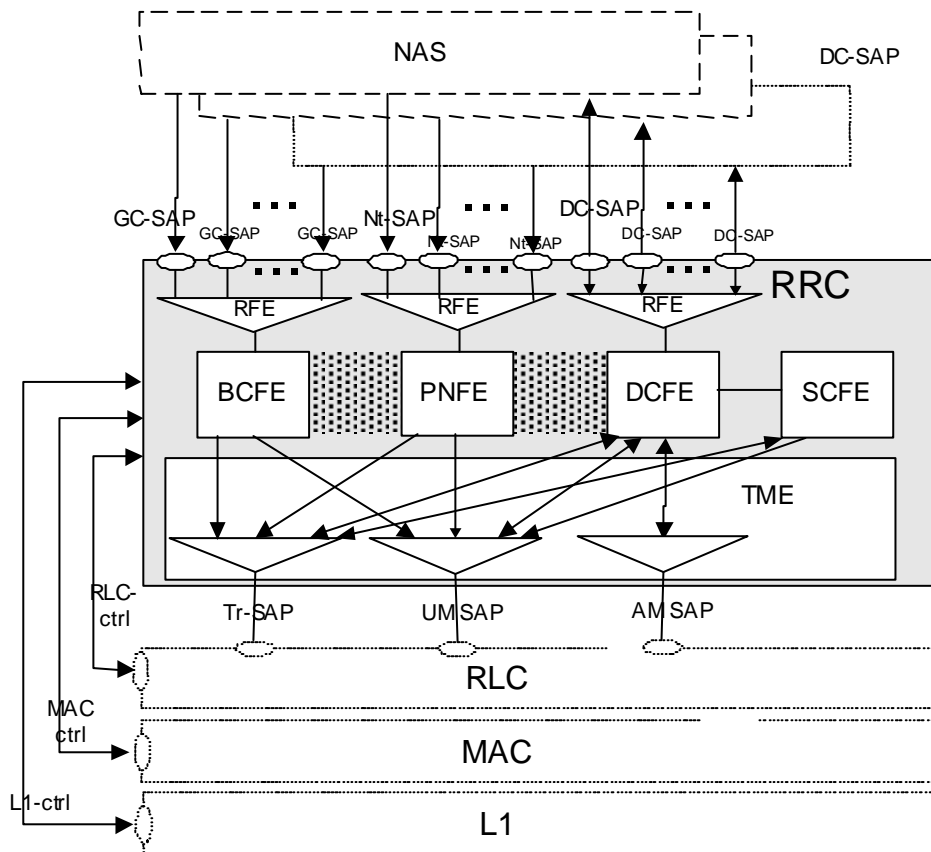

Figure 4: UTRAN side RRC model (DS-41 System)

4.3 Protocol specification principles

This protocol specification is based on the applicable general guidelines given in [14].

In this specification, a notation of variables is used. The variables are defined in subclause 13.4. Variables are typically used to represent a status or a result of an action, such as reception of an information element in a message, which is used to specify a behaviour somewhere else in the specification, such as when setting the value of an information element in a transmitted message. The variables only serve the purpose of specifying the protocol, and do not therefore impose any particular implementation.

When specifying the UE behaviour at reception of messages, the behaviour that is tied to reception or non-reception of individual information elements, and in some cases combinations of information elements, is specified in one location (subclause 8.6).

5 RRC Functions and Services provided to upper layers

5.1 RRC Functions

The RRC performs the functions listed below. A more detailed description of these functions is provided in [2]:

- Broadcast of information related to the non-access stratum (Core Network);
- Broadcast of information related to the access stratum;
- Establishment, maintenance and release of an RRC connection between the UE and UTRAN;
- Establishment, reconfiguration and release of Radio Bearers;
- Assignment, reconfiguration and release of radio resources for the RRC connection;
- RRC connection mobility functions;
- Control of requested QoS;
- UE measurement reporting and control of the reporting;
- Outer loop power control;
- Control of ciphering;
- Slow DCA (TDD mode);
- Paging;
- Initial cell selection and cell re-selection;
- Arbitration of radio resources on uplink DCH;
- RRC message integrity protection;
- Timing advance (TDD mode);
- CBS control.

5.2 RRC Services provided to upper layers

The RRC offers the following services to upper layers, a description and primitives of these services are provided in [2], [17].

- General Control;

- Notification;
- Dedicated control.

The RRC layer provides the UE-UTRAN portion of signalling connections to the upper layers to support the exchange of upper layer's information flow. The signalling connection is used between the user equipment and the core network to transfer upper layer information. For each core network domain, at most one signalling connection may exist at the same time. The RRC layer maps the signalling connections for one UE on a single RRC connection. For the upper layer data transfer on signalling connections, the RRC layer supports the discrimination between two different classes, named "High priority" (corresponding to "SAPI 0" for a GSM-MAP based core network) and "Low priority" (corresponding to "SAPI 3" for a GSM-MAP based core network).

5.3 Primitives between RRC and upper layers

The primitives between RRC and the upper layers are described in [17].

6 Services expected from lower layers

6.1 Services expected from Layer 2

The services provided by layer 2 are described in [2], [15] and [16].

6.2 Services expected from Layer 1

The services provided by layer 1 are described in [2].

6.3 Signalling Radio Bearers

The Radio Bearers (RB) available for transmission of RRC messages are defined as "signalling radio bearers" and are specified in the following. The UE and UTRAN shall select the signalling radio bearers for RRC messages using RLC-TM, RLC-UM or RLC-AM on the DCCH and CCCH, according to the following:

- Signalling radio bearer RB0 shall be used for all messages sent on the CCCH (UL: RLC-TM, DL: RLC-UM).
- Signalling radio bearer RB1 shall be used for all messages sent on the DCCH, when using RLC unacknowledged mode (RLC-UM).
- Signalling radio bearer RB2 shall be used for all messages sent on the DCCH, when using RLC acknowledged mode (RLC-AM), except for the RRC messages carrying higher layer (NAS) signalling.
- Signalling radio bearer RB3 and optionally Signalling radio bearer RB4 shall be used for the RRC messages carrying higher layer (NAS) signalling and sent on the DCCH in RLC acknowledged mode (RLC-AM), as specified in subclauses 8.1.8., 8.1.9 and 8.1.10.
- Additionally, RBs whose identities shall be set between 5 and 32 may be used as signalling radio bearer for the RRC messages on the DCCH sent in RLC transparent mode (RLC-TM).
- RRC messages on the SHCCH are mapped either on RACH or on the USCH in the uplink using TM and either on FACH or on the DSCH using RLC-UM. These messages are only specified for TDD mode.

The Radio Bearer configuration for signalling radio bearer RB0, SHCCH, BCCH on FACH and PCCH on PCH are specified in subclauses 13.6, 13.6a, 13.6b and 13.6c.

When an RRC message is transmitted in DL on CCCH or SHCCH using RLC UM, RRC should indicate to RLC that a special RLC length indicator should be used [16]. The UE shall assume that this indication has been given. The special length indicator indicates that an RLC SDU begins in the beginning of an RLC PDU.

7 Protocol states

7.1 Overview of RRC States and State Transitions including GSM

Figure 5 shows the RRC states in UTRA RRC Connected Mode, including transitions between UTRA RRC connected mode and GSM connected mode for CS domain services, and between UTRA RRC connected mode and GSM/GPRS packet modes for PS domain services. It also shows the transitions between Idle Mode and UTRA RRC Connected Mode and furthermore the transitions within UTRA RRC connected mode.

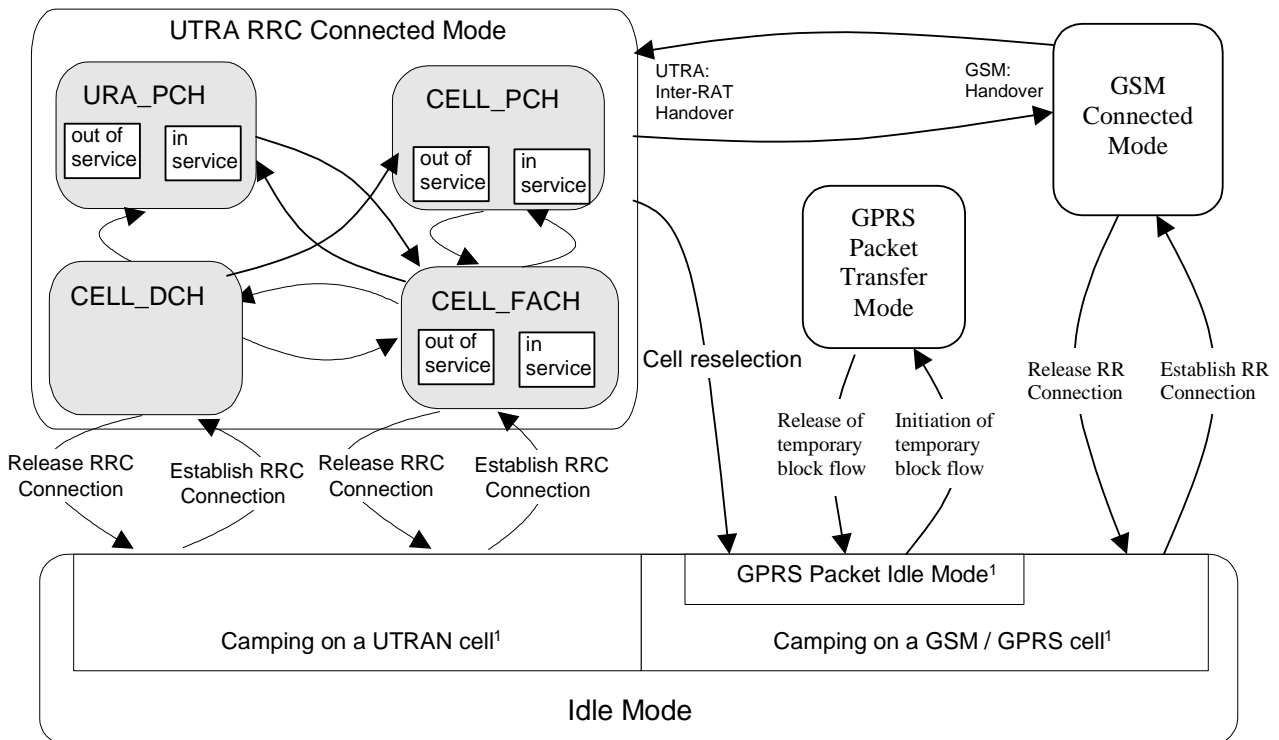

Figure 5: RRC States and State Transitions including GSM

[¹: The indicated division within Idle Mode is only included for clarification and shall not be interpreted as states.]

The RRC connection is defined as a point-to-point bi-directional connection between RRC peer entities in the UE and the UTRAN characterised by the allocation of a U-RNTI. A UE has either zero or one RRC connection.

NOTE: The state transitions are specified in clause 8.

7.2 Processes in UE modes/states

NOTE: This subclause specifies what processes shall be active in the UE in the different RRC modes/states. The related procedures and the conditions on which they are triggered are specified either in clause 8 or elsewhere in the relevant process definition.

7.2.1 UE Idle mode

UE processes that are active in UE Idle mode are specified in [4].

The UE shall perform a periodic search for higher priority PLMNs as specified in [25]

7.2.2 UTRA RRC Connected mode

In this specification unless otherwise mentioned "connected mode" shall refer to "UTRA RRC connected mode".

7.2.2.1 URA_PCH or CELL_PCH state

In the URA_PCH or CELL_PCH state the UE shall perform the following actions:

NOTE: Neither DCCH nor DTCH are available in these states.

- if the UE is "in service area":
 - maintain up-to-date system information as broadcast by the serving cell as specified in the sub-clause 8.1.1;
 - perform cell reselection process as specified in [4];
 - perform a periodic search for higher priority PLMNs as specified in [25];
 - monitor the paging occasions and PICH monitoring occasions determined according to subclause 8.6.3.1a and 8.6.3.2 and receive paging information on the PCH mapped on the S-CCPCH selected by the UE according to the procedure in subclause 8.5.19;
 - act on RRC messages received on PCCH and BCCH;
 - perform measurements process according to measurement control information as specified in subclause 8.4 and in subclause 14.4;
 - maintain up-to-date BMC data if it supports Cell Broadcast Service (CBS) as specified in [37];
 - run timer T305 for periodical URA update if the UE is in URA_PCH or for periodical cell update if the UE is in CELL_PCH;
- if the UE is "out of service area":
 - perform cell reselection process as specified in [4];
 - run timer T316;
 - run timer T305

7.2.2.2 CELL_FACH state

In the CELL_FACH state the UE shall perform the following actions:

NOTE: DCCH and, if configured, DTCH are available in this state.

- if the UE is "in service area":
 - maintain up-to-date system information as broadcast by the serving cell as specified in subclause 8.1.1;
 - perform cell reselection process as specified in [4];
 - perform measurements process according to measurement control information as specified in subclause 8.4 and in subclause 14.4;
 - run timer T305 (periodical cell update);
 - listen to all FACH transport channels mapped on the S-CCPCH selected by the UE according to the procedure in subclause 8.5.19;
 - act on RRC messages received on BCCH, CCCH and DCCH;
 - act on RRC messages received on, if available, SHCCH (TDD only);
- if the UE is "out of service area":

- perform cell reselection process as specified in [4];
- run timers T305 (periodical cell update), and T317 (cell update when re-entering "in service") or T307 (transition to Idle mode)

7.2.2.3 CELL_DCH state

In the CELL_DCH state the UE shall perform the following actions:

NOTE: DCCH and, if configured, DTCH are available in this state.

- read system information broadcast on FACH as specified in subclause 8.1.1.3 (applicable only to UEs with certain capabilities and in FDD mode);
- read the system information as specified in subclause 8.1.1 (for UEs in TDD mode);
- perform measurements process according to measurement control information as specified in subclause 8.4 and in clause 14;
- act on RRC messages received on DCCH;
- act on RRC messages received on BCCH (applicable only to UEs with certain capabilities and in FDD mode);
- act on RRC messages received on BCCH (TDD only) and, if available, SHCCH (TDD only).

8 RRC procedures

The UE shall be able to process several simultaneous RRC procedures. After the reception of a message which invoked a procedure, the UE shall be prepared to receive and act on another message which may invoke a second procedure. Whether this second invocation of a procedure (transaction) is accepted or rejected by the UE is specified in the subclauses of this clause, and in particular in subclause 8.6.3.11 (RRC transaction identifier).

On receiving a message the UE shall first apply integrity check as appropriate and then proceed with error handling as specified in clause 9 before continuing on with the procedure as specified in the relevant subclause. The RRC entity in the UE shall consider PDUs to have been transmitted when they are submitted to the lower layers. If the RRC entity in the UE submits a message for transmission using AM RLC, it shall consider the message successfully transmitted when UTRAN reception of all relevant PDUs is acknowledged by RLC. In the UE, timers are started when the PDUs are sent on the radio interface in the case of the transmission using the CCCH.

8.1 RRC Connection Management Procedures

8.1.1 Broadcast of system information

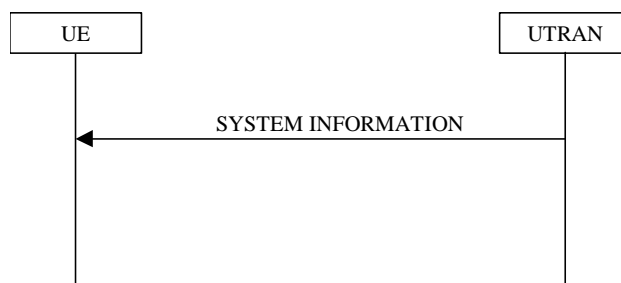

Figure 6: Broadcast of system information

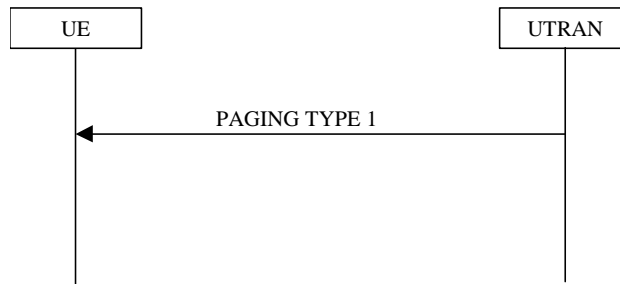

Figure 6a: Notification of system information modification for UEs in idle mode, CELL_PCH state and URA_PCH state

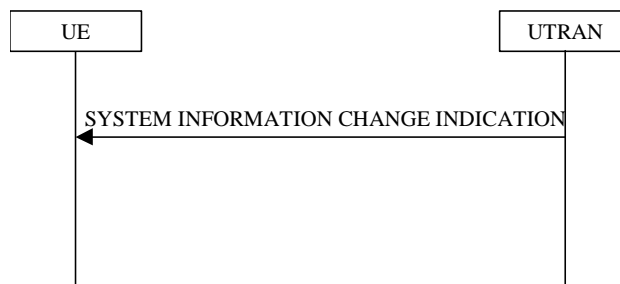

Figure 6b: Notification of system information modification for UEs in CELL_FACH state

8.1.1.1 General

The purpose of this procedure is to broadcast system information from the UTRAN to UEs in a cell.

8.1.1.1.1 System information structure

The system information elements are broadcast in *system information blocks*. A system information block groups together system information elements of the same nature. Different system information blocks may have different characteristics, e.g. regarding their repetition rate and the requirements on UEs to re-read the system information blocks.

The system information is organised as a tree. A *master information block* gives references and scheduling information to a number of system information blocks in a cell. The system information blocks contain the actual system information. The master information block may optionally also contain reference and scheduling information to one or two *scheduling blocks*, which give references and scheduling information for additional system information blocks. Scheduling information for a system information block may only be included in either the master information block or one of the scheduling blocks.

For all system information blocks except System Information Block types 15.2, 15.3 and 16, the content is the same in each occurrence for system information blocks using value tag. System Information Block types 15.2, 15.3 and 16 may occur more than once with different content. In this case scheduling information is provided for each such occurrence of the system information block. System information blocks that do not use value tag may have different content for each occurrence.

8.1.1.1.2 System information blocks

Table 8.1.1 specifies all system information blocks and their characteristics.

The *area scope column* in table 8.1.1 specifies the area where a system information block's value tag is valid. If the area scope is *cell*, the UE shall consider the system information block to be valid only in the cell in which it was read. If system information blocks have been previously stored for this cell, the UE shall check whether the value tag for the system information block in the entered cell is different compared to the stored value tag. If the area scope is *PLMN*, the UE shall check the value tag for the system information block when a new cell is selected. If the value tag for the system information block in the new cell is different compared to the value tag for the system information block stored in the UE, the UE shall re-read the system information block.

For System information block types 15.2, 15.3 and 16, which may have multiple occurrences, each occurrence has its own independent value tag. The UE shall re-read a particular occurrence if the value tag of this occurrence has changed compared to that stored in the UE.

The *UE mode/state column when block is valid* in Table 8.1.1 specifies in which UE mode or UE state the IEs in a system information block shall be regarded as valid by the UE. In other words, the indicated system information block becomes invalid upon change to a mode/state that is not included in this column. In some cases, the states are inserted in brackets to indicate that the validity is dependent on the broadcast of the associated System Information Blocks by the network as explained in the relevant procedure section.

The *UE mode/state column when block is read* in Table 8.1.1 specifies in which UE mode or UE state the IEs in a system information block may be read by the UE. The UE shall have the necessary information prior to execution of any procedure requiring information to be obtained from the appropriate system information block. The requirements on the UE in terms of when to read the system information may therefore be derived from the procedure specifications that specify which IEs are required in the different UE modes/states in conjunction with the different performance requirements that are specified. System Information Block type 10 shall only be read by the UE while in CELL_DCH.

NOTE: There are a number of system information blocks that include the same IEs while the UE mode/state in which the information is valid differs. This approach is intended to allow the use of different IE values in different UE mode/states.

The *Scheduling information* column in Table 8.1.1 specifies the position and repetition period for the SIB.

The *modification of system information* column in Table 8.1.1 specifies the update mechanisms applicable for a certain system information block. For system information blocks with a value tag, the UE shall update the information according to subclause 8.1.1.7.1 or 8.1.1.7.2. For system information blocks with an expiration timer, the UE shall, when the timer expires, perform an update of the information according to subclause 8.1.1.7.4.

Table 8.1.1: Specification of system information block characteristics

System information block	Area scope	UE mode/state when block is valid	UE mode/state when block is read	Scheduling information	Modification of system information	Additional comment
Master information block	Cell	Idle mode, CELL_FACH, CELL_PCH, URA_PCH	Idle mode, CELL_FACH, CELL_PCH, URA_PCH	SIB_POS = 0 SIB_REP = 8 (FDD) SIB_REP = 8, 16, 32 (TDD) SIB_OFF=2	Value tag	
Scheduling block 1	Cell	Idle mode, CELL_FACH, CELL_PCH, URA_PCH	Idle mode, CELL_FACH, CELL_PCH, URA_PCH	Specified by the IE "Scheduling information" in MIB	Value tag	
Scheduling block 2	Cell	Idle mode, CELL_FACH, CELL_PCH, URA_PCH	Idle mode, CELL_FACH, CELL_PCH, URA_PCH	Specified by the IE "Scheduling information" in MIB	Value tag	
System information block type 1	PLMN	Idle mode, CELL_FACH, CELL_PCH, URA_PCH, CELL_DCH	Idle, CELL_FACH, CELL_PCH, URA_PCH	Specified by the IE "Scheduling information"	Value tag	
System information block type 2	Cell	URA_PCH	URA_PCH	Specified by the IE "Scheduling information"	Value tag	
System information block type 3	Cell	Idle mode, (CELL_FACH, CELL_PCH, URA_PCH)	Idle mode, (CELL_FACH, CELL_PCH, URA_PCH)	Specified by the IE "Scheduling information"	Value tag	
System information block type 4	Cell	CELL_FACH, CELL_PCH, URA_PCH	CELL_FACH, CELL_PCH, URA_PCH	Specified by the IE "Scheduling information"	Value tag	If System information block type 4 is not broadcast in a cell, the connected mode UE shall apply information in System information block type 3 in connected mode.
System information block type 5	Cell	Idle mode, (CELL_FACH, CELL_PCH, URA_PCH, CELL_DCH (TDD only))	Idle mode, (CELL_FACH, CELL_PCH, URA_PCH, CELL_DCH (TDD only))	Specified by the IE "Scheduling information"	Value tag	

System information block type 6	Cell	CELL_FACH, CELL_PCH, URA_PCH, CELL_DCH (TDD only)	CELL_FACH, CELL_PCH, URA_PCH, CELL_DCH (TDD only)	Specified by the IE "Scheduling information"	Value tag	<p>If system information block type 6 is not broadcast in a cell, the connected mode UE shall read System information block type 5.</p> <p>If some of the optional IEs are not included in System information block type 6, the UE shall read the corresponding IEs in System information block type 5</p> <p>In TDD mode system information block 6 shall only be read in CELL_DCH if required for open loop power control as specified in subclause 8.5.7 and/or if shared transport channels are assigned to the UE. If in these cases system information block type 6 is not broadcast the UE shall read system information block type 5.</p>
System information block type 7	Cell	Idle mode, CELL_FACH, CELL_PCH, URA_PCH, CELL_DCH (TDD only)	Idle mode, CELL_FACH, CELL_PCH, URA_PCH, CELL_DCH (TDD only)	Specified by the IE "Scheduling information"	Expiration timer = MAX(320 ms,SIB_REP * ExpirationTimeFactor)	In TDD mode system information block type 7 shall only be read in CELL_DCH if shared transport channels are assigned to the UE.
System information block type 8	Cell	CELL_FACH, CELL_PCH, URA_PCH	CELL_FACH, CELL_PCH, URA_PCH	Specified by the IE "Scheduling information"	Value tag	
System information block type 9	Cell	CELL_FACH, CELL_PCH, URA_PCH	CELL_FACH, CELL_PCH, URA_PCH	Specified by the IE "Scheduling information"	Expiration timer = SIB_REP	
System information block type 10	Cell	CELL_DCH	CELL_DCH	Specified by the IE "Scheduling information"	Expiration timer = SIB_REP	
System information block type 11	Cell	Idle mode (CELL_FACH, CELL_PCH, URA_PCH, CELL_DCH)	Idle mode (CELL_FACH, CELL_PCH, URA_PCH)	Specified by the IE "Scheduling information"	Value tag	

System information block type 12	Cell	CELL_FACH, CELL_PCH, URA_PCH, CELL_DCH	CELL_FACH, CELL_PCH, URA_PCH	Specified by the IE "Scheduling information"	Value tag	If system information block type 12 is not broadcast in a cell, the connected mode UE shall read System information block type 11. If some of the optional IEs are not included in System information block type 12, the UE shall read the corresponding IEs in System information block type 11.
System information block type 13	Cell	Idle Mode, CELL_FACH, CELL_PCH, URA_PCH	Idle Mode, CELL_FACH, CELL_PCH, URA_PCH	Specified by the IE "Scheduling information"	Value tag	
System information block type 13.1	Cell	Idle Mode, CELL_FACH, CELL_PCH, URA_PCH	Idle Mode, CELL_FACH, CELL_PCH, URA_PCH	Specified by the IE "Scheduling information"	Value tag	
System information block type 13.2	Cell	Idle Mode, CELL_FACH, CELL_PCH, URA_PCH	Idle Mode, CELL_FACH, CELL_PCH, URA_PCH	Specified by the IE "Scheduling information"	Value tag	
System information block type 13.3	Cell	Idle Mode, CELL_FACH, CELL_PCH, URA_PCH	Idle Mode, CELL_FACH, CELL_PCH, URA_PCH	Specified by the IE "Scheduling information"	Value tag	
System information block type 13.4	Cell	Idle Mode, CELL_FACH, CELL_PCH, URA_PCH	Idle Mode, CELL_FACH, CELL_PCH, URA_PCH	Specified by the IE "Scheduling information"	Value tag	
System information block type 14	Cell	Idle Mode, CELL_FACH, CELL_PCH, URA_PCH, CELL_DCH	Idle Mode, CELL_FACH, CELL_PCH, URA_PCH, CELL_DCH	Specified by the IE "Scheduling information"	Expiration timer = MAX([320 ms], SIB_REP * ExpirationTimeFactor)	This system information block is used in TDD mode only. System information block type 14 shall only be read in CELL_DCH if required for open loop power control as specified in subclause 8.5.7.
System information block type 15	Cell	Idle Mode, CELL_FACH, CELL_PCH, URA_PCH	Idle Mode, CELL_FACH, CELL_PCH, URA_PCH	Specified by the IE "Scheduling information"	Value tag	
System information block type 15.1	Cell	Idle Mode, CELL_FACH, CELL_PCH, URA_PCH	Idle Mode, CELL_FACH, CELL_PCH, URA_PCH	Specified by the IE "Scheduling information"	Value tag	
System information block type 15.2	Cell	Idle Mode, CELL_FACH, CELL_PCH, URA_PCH	Idle Mode, CELL_FACH, CELL_PCH, URA_PCH	Specified by the IE "Scheduling information"	Value tag	For this system information block there may be multiple occurrences
System information block type 15.3	PLMN	Idle Mode, CELL_FACH, CELL_PCH, URA_PCH	Idle Mode, CELL_FACH, CELL_PCH, URA_PCH	Specified by the IE "Scheduling information"	Value tag	For this system information block there may be multiple occurrences
System information block type 15.4	Cell	Idle Mode, CELL_FACH, CELL_PCH, URA_PCH	Idle Mode, CELL_FACH, CELL_PCH, URA_PCH	Specified by the IE "Scheduling information"	Value tag	

System information block type 16	PLMN	Idle Mode, CELL_FACH, CELL_PCH, URA_PCH	Idle Mode, CELL_FACH, CELL_PCH, URA_PCH	Specified by the IE "Scheduling information"	Value tag	For this system information block there may be multiple occurrences
System information block type 17	Cell	CELL_FACH, CELL_PCH, URA_PCH, CELL_DCH	CELL_FACH, CELL_PCH, URA_PCH, CELL_DCH	Specified by the IE "Scheduling information"	Expiration timer = SIB_REP	This system information block is used in TDD mode only. System information block type 17 shall only be read if shared transport channels are assigned to the UE.
System Information Block type 18	Cell	Idle mode, CELL_FACH, CELL_PCH, URA_PCH, CELL_DCH	Idle mode, CELL_FACH, CELL_PCH, URA_PCH	Specified by the IE "Scheduling information"	Value tag	

The UE shall acquire all system information blocks except system information block type 10 on BCH. System Information Block type 10 shall be acquired on the FACH and only by UEs with support for simultaneous reception of one SCCPCH and one DPCH. If System Information Block type 10 is not broadcast in a cell, the DRAC procedures do not apply in this cell. System Information Block type 10 is used in FDD mode only.

8.1.1.1.3 Segmentation and concatenation of system information blocks

A generic SYSTEM INFORMATION message is used to convey the system information blocks on the BCCH. A given BCCH may be mapped onto either a BCH or a FACH transport channel according to subclause 8.1.1.1.2. The size of the SYSTEM INFORMATION message shall fit the size of a BCH or a FACH transport block.

The RRC layer in UTRAN performs segmentation and concatenation of encoded system information blocks. If the encoded system information block is larger than the size of a SYSTEM INFORMATION message, it will be segmented and transmitted in several messages. If the encoded system information block is smaller than a SYSTEM INFORMATION message, UTRAN may concatenate several system information blocks, or the first segment or the last segment into the same message as specified in the remainder of this clause.

Four different segment types are defined:

- First segment;
- Subsequent segment;
- Last segment;
- Complete.

Each of the types - *First*, *Subsequent* and *Last segment* - is used to transfer segments of a master information block, scheduling block or a system information block. The segment type, *Complete*, is used to transfer a complete master information block, complete scheduling block or a complete system information block.

Each segment consists of a header and a data field. The data field carries the encoded system information elements. The header contains the following parameters:

- The number of segments in the system information block (SEG_COUNT). This parameter is only included in the header if the segment type is "First segment".
- SIB type. The SIB type uniquely identifies the master information block, scheduling block or a system information block.
- Segment index. This parameter is only included in the header if the segment type is "Subsequent segment" or "Last segment".

UTRAN may combine one or several segments of variable length in the same SYSTEM INFORMATION message. The following combinations are allowed:

1. No segment;

2. First segment;
3. Subsequent segment;
4. Last segment;
5. Last segment + First segment;
6. Last segment + one or several Complete;
7. Last segment + one or several Complete + First segment;
8. One or several Complete;
9. One or several Complete + First segment;
10. One Complete of size 215 to 226;
11. Last segment of size 215 to 222.

The "No segment" combination is used when there is no master information block, scheduling block or system information block scheduled for a specific BCH transport block.

UEs are not required to support the reception of multiple occurrences of the same system information block type within one SYSTEM INFORMATION message.

NOTE: Since the SIB type is the same for each occurrence of the system information block, the UE does not know the order in which the occurrences, scheduled for this SYSTEM INFORMATION message, appear. Therefore, the UE is unable to determine which scheduling information, e.g., value tag relates to which occurrence of the system information block.

8.1.1.1.4 Re-assembly of segments

The RRC layer in the UE shall perform re-assembly of segments. All segments belonging to the same master information block, scheduling block or system information block shall be assembled in ascending order with respect to the segment index. When all segments of the master information block, scheduling block or a system information block have been received, the UE shall perform decoding of the complete master information block, scheduling block or system information block. For System Information Block type 16 which may have multiple occurrences, each occurrence shall be re-assembled independently.

The UE shall discard system information blocks of which segments were missing, of which segments were received out of sequence and/or for which duplicate segments were received. The only valid sequence is an ascending one with the sequence starting with the First Segment of the associated System Information Block.

If the UE receives a Subsequent segment or Last segment where the index in IE "Segment index" is equal to or larger than the number of segments stated in IE "SEG_COUNT" in the scheduling information for that scheduling block or system information block,

- the UE may
 - read all the segments to create a system information block as defined by the scheduling information read by the UE;
 - store the content of the system information block with a value tag set to the value NULL; and
 - consider the content of the scheduling block or system information block as valid,
 - until it receives the same type of scheduling block or system information block in a position according to its scheduling information or
 - at most for 6 hours after reception.
- and the UE shall:
 - re-read scheduling information for that scheduling block or system information block.

If the UE receives a Subsequent segment or Last segment where the index in IE "Segment index" is equal to or larger than the number of segments stated in IE "SEG_COUNT" in the First segment, the UE shall

- discard all segments for that master information block, scheduling block or system information block and
- re-read the scheduling information for that system information block.
- then re-read all segments for that system information block.

8.1.1.1.5 Scheduling of system information

Scheduling of system information blocks is performed by the RRC layer in UTRAN. If segmentation is used, it should be possible to schedule each segment separately.

To allow the mixing of system information blocks with short repetition period and system information blocks with segmentation over many frames, UTRAN may multiplex segments from different system information blocks. Multiplexing and de-multiplexing is performed by the RRC layer.

The scheduling of each system information block broadcast on a BCH transport channel is defined by the following parameters:

- the number of segments (SEG_COUNT);
- the repetition period (SIB_REP). The same value applies to all segments;
- the position (phase) of the first segment within one cycle of the Cell System Frame Number (SIB_POS(0)). Since system information blocks are repeated with period SIB_REP, the value of SIB_POS(i), $i = 0, 1, 2, \dots, \text{SEG_COUNT}-1$ must be less than SIB_REP for all segments;
- the offset of the subsequent segments in ascending index order (SIB_OFF(i), $i = 1, 2, \dots, \text{SEG_COUNT}-1$). The position of the subsequent segments is calculated using the following: $\text{SIB_POS}(i) = \text{SIB_POS}(i-1) + \text{SIB_OFF}(i)$.

The scheduling is based on the Cell System Frame Number (SFN). The SFN of a frame at which a particular segment, i , with $i = 0, 1, 2, \dots, \text{SEG_COUNT}-1$ of a system information block occurs, fulfils the following relation:

$$\text{SFN mod SIB_REP} = \text{SIB_POS}(i)$$

In FDD and TDD the scheduling of the master information block is fixed as defined in Table 8.1.1. For TDD, UTRAN may apply one of the values allowed for the master information block's repetition period. The value that UTRAN is using in TDD is not signalled; UEs have to determine it by trial and error.

8.1.1.2 Initiation

The system information is continuously broadcast on a regular basis in accordance with the scheduling defined for each system information block.

8.1.1.3 Reception of SYSTEM INFORMATION messages by the UE

The UE shall read SYSTEM INFORMATION messages broadcast on a BCH transport channel in idle mode and in the connected mode in states CELL_FACH, CELL_PCH, URA_PCH and CELL_DCH (TDD only). In addition, UEs in FDD mode which support simultaneous reception of one SCCPCH and one DPCH shall read system information on a FACH transport channel when in CELL_DCH state.

In idle mode and connected mode different combinations of system information blocks are valid. The UE shall acquire the system information blocks that are needed according to Table 8.1.1.

The UE may store system information blocks with cell or PLMN area scope (including their value tag if applicable) for different cells and different PLMNs, to be used if the UE returns to these cells.

The UE shall consider all stored system information blocks as invalid after it has been switched off. Some information obtained from system information may be stored by the UE or in the USIM for use in a stored information cell selection.

When selecting a new cell within the currently used PLMN, the UE shall consider all current system information blocks with area scope cell to be invalid. If the UE has stored valid system information blocks for the newly selected cell, the UE may set those as current system information blocks.

After selecting a new PLMN, the UE shall consider all current system information blocks to be invalid. If the UE has previously stored valid system information blocks for the selected cell of the new PLMN, the UE may set those as current system information blocks. Upon selection of a new PLMN the UE shall store all information elements specified within variable `SELECTED_PLMN` for the new PLMN within this variable.

8.1.1.4 Reception of SYSTEM INFORMATION messages broadcast on a FACH transport channel

System information block type 10 may be broadcast on FACH, as specified in subclause 8.1.1.1.2.

When reading system information blocks on FACH, the UE shall perform the actions as defined in subclause 8.1.1.6.

8.1.1.5 Actions upon reception of the Master Information Block and Scheduling Block(s)

When selecting a new cell, the UE shall read the master information block. The UE may use the pre-defined scheduling information to locate the master information block in the cell.

Upon reception of the master information block, the UE shall:

- if the "PLMN type" in the variable `SELECTED_PLMN` has the value "GSM-MAP" and the IE "PLMN Type" has the value "GSM-MAP" or "GSM-MAP and ANSI-41":
 - check the IE "PLMN identity" in the master information block and verify that it is the selected PLMN, stored as "PLMN identity" in the variable `SELECTED_PLMN`;
- if the "PLMN type" in the variable `SELECTED_PLMN` has the value "ANSI-41" and the IE "PLMN Type" has the value "ANSI-41" or "GSM-MAP and ANSI-41":
 - store the ANSI-41 Information elements contained in the master information block and perform initial process for ANSI-41;
- compare the value tag in the master information block with the value tag stored for this cell and this PLMN in the variable `VALUE_TAG`;
- if the value tags differ, or if no IEs for the master information block are stored:
 - store the value tag into the variable `VALUE_TAG` for the master information block;
 - read and store scheduling information included in the master information block;
- if the value tags are the same the UE may use stored system information blocks and scheduling blocks using value tag that were stored for this cell and this PLMN as valid system information.

For all system information blocks or scheduling blocks that are supported by the UE referenced in the master information block or the scheduling blocks, the UE shall perform the following actions:

- for all system information blocks with area scope "PLMN" that use value tags:
 - compare the value tag read in scheduling information for that system information block with the value stored within the variable `VALUE_TAG` for that system information block;
 - if the value tags differ, or if no IEs for the corresponding system information block are stored:
 - store the value tag read in scheduling information for that system information block into the variable `VALUE_TAG`;
 - read and store the IEs of that system information block;
 - if the value tags are the same the UE may use stored system information blocks using value tag that were stored in this PLMN as valid system information;

- for all system information blocks or scheduling blocks with area scope cell that use value tags:
 - compare the value tag read in scheduling information for that system information block or scheduling block with the value stored within the variable VALUE_TAG for that system information block or scheduling block;
 - if the value tags differ, or if no IEs for the corresponding system information block or scheduling block are stored:
 - store the value tag read in scheduling information for that system information block or scheduling block into the variable VALUE_TAG;
 - read and store the IEs of that system information block or scheduling block;
 - if the value tags are the same the UE may use stored system information blocks using value tags that were stored for this cell and this PLMN as valid system information;
- for system information blocks which may have multiple occurrences:
 - compare the value tag and the configuration or multiple occurrence identity for the occurrence of the system information blocks read in scheduling information with the value tag and configuration or multiple occurrence identity stored within the variable VALUE_TAG;
 - if the value tags differ, or if no IEs from the occurrence with that configuration or multiple occurrence identity of the system information block are stored:
 - store the value tag read in scheduling information for that system information block and the occurrence with that configuration or multiple occurrence identity into the variable VALUE_TAG;
 - read and store the IEs of that system information block;
 - if the value tags and the configuration or multiple occurrence identity are identical to those stored, the UE may use stored occurrences of system information blocks that were stored for this cell and this PLMN as valid system information.

For system information blocks, not supported by the UE, but referenced either in the master information block or in the scheduling blocks, the UE may:

- skip reading this system information block;
- skip monitoring changes to this system information block.

If the UE:

- receives a scheduling block at a position different from its position according to the scheduling information for the scheduling block; or
- receives a scheduling block for which scheduling information has not been received:

the UE may:

- store the content of the scheduling block with a value tag set to the value NULL; and
- consider the content of the scheduling block as valid until it receives the same type of scheduling block in a position according to its scheduling information or at most for 6 hours after reception.

If the UE does not find a scheduling block in a position where it should be according to its scheduling information, but a transport block with correct CRC was found at that position, the UE shall:

- read the scheduling information for this scheduling block.

If the UE does not find the master information block in a position fulfilling

$$\text{SFN mod } 32 = 0$$

but a transport block with correct CRC was found at that position), the UE shall:

- consider the master information block as not found; and
- consider the cell to be barred according to [4]; and
- consider the barred cell as using the value "allowed" in the IE "Intra-frequency cell re-selection indicator", and the maximum value in the IE " T_{barred} ".

NOTE: This permits a different repetition for the MIB in later versions for FDD. In TDD it allows for a variable SIB_REP in this and future releases.

If system information block type 1 is not scheduled on BCH, and system information block type 13 is not scheduled on BCH, the UE shall:

- consider the cell to be barred according to [4]; and
- consider the barred cell as using the value "allowed" in the IE "Intra-frequency cell re-selection indicator", and the maximum value in the IE " T_{barred} ".

If the UE only supports GSM-MAP but finds a cell that broadcasts System Information Block type 13 but not System Information Block type 1, the UE shall:

- consider the cell barred.

If

- system information block type 1 is not scheduled on BCH; and
- the "PLMN Type" in the variable SELECTED_PLMN has the value "GSM-MAP"; and
- the IE "PLMN type" in the Master Information Block has the value "GSM-MAP" or "GSM-MAP and ANSI-41":

the UE shall:

- indicate to upper layers that no CN system information is available.

If in idle mode and System Information Block type 3 is not scheduled on BCH, the UE shall:

- consider the cell to be barred according to [4]; and
- consider the barred cell as using the value "allowed" in the IE "Intra-frequency cell re-selection indicator", and the maximum value in the IE " T_{barred} ".

If in connected mode and System Information Block type 3 is not scheduled on BCH, and System Information Block type 4 is not scheduled on BCH, the UE shall:

- consider the cell to be barred according to [4]; and
- consider the barred cell as using the value "allowed" in the IE "Intra-frequency cell re-selection indicator", and the maximum value in the IE " T_{barred} ".

If in idle mode and System Information Block type 5 is not scheduled on BCH or System Information Block type 5 is scheduled but IE "AICH info" (FDD) or IE "PICH info" is not present, the UE shall:

- consider the cell to be barred according to [4]; and
- consider the barred cell as using the value "allowed" in the IE "Intra-frequency cell re-selection indicator", and the maximum value in the IE " T_{barred} ".

If in connected mode and System Information Block type 5 is not scheduled on BCH, and System Information Block type 6 is not scheduled on BCH, or any of System Information Block type 5 or type 6 is scheduled but IE "AICH info" (FDD) or IE "PICH info" is not present, the UE shall:

- consider the cell to be barred according to [4]; and
- consider the barred cell as using the value "allowed" in the IE "Intra-frequency cell re-selection indicator", and the maximum value in the IE " T_{barred} ".

If System Information Block type 7 is not scheduled on BCH, the UE shall:

- consider the cell to be barred according to [4]; and
- consider the barred cell as using the value "allowed" in the IE "Intra-frequency cell re-selection indicator", and the maximum value in the IE " T_{barred} ".

In 3.84 Mcps TDD, if System Information Block type 14 is not scheduled on BCH, the UE shall:

- consider the cell to be barred according to [4]; and
- consider the barred cell as using the value "allowed" in the IE "Intra-frequency cell re-selection indicator", and the maximum value in the IE " T_{barred} ".

8.1.1.6 Actions upon reception of system information blocks

The UE may use the scheduling information included within the master information block and the scheduling blocks to locate each system information block to be acquired.

The UE should only expect one occurrence of the scheduling information for a system information block in the master information block and any of the scheduling blocks except for System Information Block type 16, System Information Block type 15.2 and System Information Block type 15.3, which may have multiple occurrences. However, to enable future introduction of new system information blocks, the UE shall also be able to receive system information blocks other than the ones indicated within the scheduling information. The UE may ignore contents of such system information block.

If the UE

- receives a system information block in a position according to the scheduling information for the system information block; and
- this system information block uses a value tag; or
- this system information block uses a value tag and configuration or multiple occurrence identity:

the UE shall:

- store the content of the system information block together with the value of its value tag or the values of configuration and multiple occurrence identity and the associated value tag in the scheduling information for the system information block; and
- consider the content of the system information block valid until, if used, the value tag in the scheduling information for the system information block is changed or at most for 6 hours after reception.

If the UE

- receives a system information block in a position according to the scheduling information for the system information block; and
- this system information block does not use a value tag according to the system information block type:

the UE shall:

- store the content of the system information block; and
- start an expiration timer using a value as defined in Table 8.1.1 for that system information block type; and
- consider the content of the system information block valid until, the expiration timer expires.

If the UE

- receives a system information block at a position different from its position according to the scheduling information for the system information block; or
- receives a system information block for which scheduling information has not been received; and
- this system information block uses a value tag:

the UE may:

- store the content of the system information block with a value tag set to the value NULL; and
- consider the content of the system information block as valid until it receives the same type of system information block in a position according to its scheduling information or at most for 6 hours after reception.

If the UE

- receives a system information block with multiple occurrences at a position different from its position according to the scheduling information for the system information block; or
- receives a system information block with multiple occurrences for which scheduling information has not been received; and
- this system information block uses a value tag and configuration or multiple occurrence identity:

the UE shall:

- ignore this information.

If the UE does not find a system information block in a position where it should be according to its scheduling information, but a transport block with correct CRC was found at that position, the UE shall read the scheduling information for this system information block.

The UE shall act upon all received information elements as specified in subclause 8.6 unless specified otherwise in the following subclauses.

8.1.1.6.1 System Information Block type 1

The UE should store all relevant IEs included in this system information block if the "PLMN Type" in the variable `SELECTED_PLMN` has the value "GSM-MAP" and the IE "PLMN type" in the Master Information Block has the value "GSM-MAP" or "GSM-MAP and ANSI-41". The UE shall also:

- check that the cell, according to information included in IE "CN common GSM-MAP NAS system information", is suitable [4];
- if in connected mode:
 - not forward the content of the IE "CN common GSM-MAP NAS system information" to upper layers;
- if in idle mode:
 - forward the content of the IE "CN common GSM-MAP NAS system information" to upper layers;
- for the IE "CN domain system information list":
 - for each IE "CN domain system information" that is present:
 - check that the cell, according to information included in IE "CN domain specific NAS system information", is suitable [4];
 - if in connected mode:
 - not forward the content of the IE "CN common GSM-MAP NAS system information" to upper layers;
 - if in idle mode:
 - forward the content of the IE "CN domain specific NAS system information" and the IE "CN domain identity" to upper layers;
 - use the IE "CN domain specific DRX cycle length coefficient" to calculate frame number for the Paging Occasions as specified in [4];
 - if an IE "CN domain system information" is not present for a particular CN domain:
 - indicate to upper layers that no CN system information is available for that CN domain;

- use the values in the IE "UE Timers and constants in idle mode" for the relevant timers and constants;
- store the values of the IE "UE Timers and constants in connected mode" in the variable TIMERS_AND_CONSTANTS.

8.1.1.6.2 System Information Block type 2

If in connected mode the UE should store all relevant IEs included in this system information block. The UE shall:

- if in state URA_PCH, start to perform URA updates using the information in the IE "URA identity".

If in idle mode, the UE shall not use the values of the IEs in this system information block.

8.1.1.6.3 System Information Block type 3

The UE should store all relevant IEs included in this system information block. The UE shall:

- if in connected mode, and System Information Block 4 is indicated as used in the cell:
 - read and act on information sent in that block.

8.1.1.6.4 System Information Block type 4

If in connected mode, the UE should store all relevant IEs included in this system information block.

If in idle mode, the UE shall not use the values of the IEs included in this system information block.

8.1.1.6.5 System Information Block type 5

The UE should store all relevant IEs included in this system information block. The UE shall:

- if in connected mode, and System Information Block type 6 is indicated as used in the cell:
 - read and act on information sent in System Information Block type 6.
- replace the TFS of the RACH with the one stored in the UE if any;
- let the physical channel(s) of type PRACH given by the IE(s) "PRACH info" be the default in uplink for the PRACH if UE is in CELL_FACH state;
- start to receive the physical channel of type AICH using the parameters given by the IE "AICH info" (FDD only) when given allocated PRACH is used;
- use the first instance of the list of transport formats as in the IE "RACH TFS" for the used RACH received in the IE "PRACH system information list" when using the CCCH;
- replace the TFS of the FACH/PCH with the one stored in the UE if any;
- select a Secondary CCPCH as specified in [4] and in subclause 8.5.19, and start to receive the physical channel of type PICH associated with the PCH carried by the selected Secondary CCPCH using the parameters given by the IE "PICH info" if UE is in Idle mode or in CELL_PCH or URA_PCH state;
- start to monitor its paging occasions on the selected PICH if UE is in Idle mode or in CELL_PCH or URA_PCH state;
- start to receive the selected physical channel of type Secondary CCPCH using the parameters given by the IE(s) "Secondary CCPCH info" if UE is in CELL_FACH state;
- in 3.84 Mcps TDD:
 - use the IE "TDD open loop power control" as defined in subclause 8.5.7 when allocated PRACH is used;
- in TDD:
 - if the IE "PDSCH system information" and/or the IE "PUSCH system information" is included:

- store each of the configurations given there with the associated identity given in the IE "PDSCH Identity" and/or "PUSCH Identity" respectively. For every configuration, for which the IE "SFN Time info" is included, the information shall be stored for the duration given there.

8.1.1.6.6 System Information Block type 6

If in connected mode, the UE should store all relevant IEs included in this system information block. The UE shall:

- replace the TFS of the RACH with the one stored in the UE if any;
- let the physical channel(s) of type PRACH given by the IE(s) "PRACH info" be the default in uplink if UE is in CELL_FACH state. If the IE "PRACH info" is not included, the UE shall read the corresponding IE(s) in System Information Block type 5 and use that information to configure the PRACH;
- start to receive the physical channel of type AICH using the parameters given by the IE "AICH info" when associated PRACH is used. If the IE "AICH info" is not included, the UE shall read the corresponding IE in System Information Block type 5 and use that information (FDD only);
- replace the TFS of the FACH/PCH with the one stored in the UE if any;
- select a Secondary CCPCH as specified in [4] and in subclause 8.5.19, and start to receive the physical channel of type PICH associated with the PCH carried by the selected Secondary CCPCH using the parameters given by the IE "PICH info" if the UE is in CELL_PCH or URA_PCH state. If the IE "PICH info" is not included, the UE shall read the corresponding IE in System Information Block type 5 and use that information;
- start to monitor its paging occasions on the selected PICH if the UE is in CELL_PCH or URA_PCH state;
- start to receive the selected physical channel of type Secondary CCPCH using the parameters given by the IE(s) "Secondary CCPCH info" if the UE is in CELL_FACH state. If the IE "Secondary CCPCH info" is not included, the UE shall read the corresponding IE(s) in System Information Block type 5 and use that information;
- in 3.84 Mcps TDD: use the IE "TDD open loop power control" as defined in subclause 8.5.7;
- in TDD: if the IE "PDSCH system information" and/or the IE "PUSCH system information" is included, store each of the configurations given there with the associated identity given in the IE "PDSCH Identity" and/or "PUSCH Identity" respectively. For every configuration, for which the IE "SFN Time info" is included, the information shall be stored for the duration given there.

If in idle mode, the UE shall not use the values of the IEs in this system information block.

8.1.1.6.7 System Information Block type 7

The UE should store all relevant IEs included in this system information block.

8.1.1.6.8 System Information Block type 8

This system information block type is used only in FDD.

If in connected mode, the UE should store all relevant IEs included in this system information block.

If in idle mode, the UE shall not use the values of the IEs in this system information block.

8.1.1.6.9 System Information Block type 9

This system information block type is used only in FDD.

If in connected mode, the UE should store all relevant IEs included in the system information block. The UE shall:

- start a timer set to the value given by the repetition period (SIB_REP) for that system information block

If in idle mode, the UE shall not use the values of the IEs in this system information block.

8.1.1.6.10 System Information Block type 10

This system information block type is used only in FDD.

If in state CELL_DCH, the UE should store all relevant IEs included in this system information block. The UE shall:

- start a timer set to the value given by the repetition period (SIB_REP) for that system information block;
- perform actions defined in subclause 14.8.

If in idle mode, state CELL_FACH, state CELL_PCH or state URA_PCH, the UE shall not use the values of the IEs in this system information block.

8.1.1.6.11 System Information Block type 11

The UE should store all relevant IEs included in this system information block. The UE shall:

- if IE "FACH measurement occasion info" is included:
 - act as specified in subclause 8.6.7.
- else:
 - may perform inter-frequency/inter-RAT measurements or inter-frequency/inter-RAT cell re-selection evaluation, if the UE capabilities permit such measurements while simultaneously receiving the S-CCPCH of the serving cell;
- if in connected mode, and System Information Block type 12 is indicated as used in the cell:
 - read and act on information sent in System Information Block type 12;
- for each measurement type:
 - start a measurement using the set of IEs specified for that measurement type;
- associate each measurement with the identity number given by the IE "Measurement identity";
- clear the variable CELL_INFO_LIST;
- act upon the received IE "Intra-frequency/Inter-frequency/Inter-RAT cell info list" as described in subclause 8.6.7.3;
- if included, store the IE "Intra-frequency reporting quantity" and the IE "Intra-frequency measurement reporting criteria" or "Periodical reporting criteria" in order to activate reporting when state CELL_DCH is entered;
- if IE "Use of HCS" is set to "used", indicating that HCS is used, do the following:
 - if IE "HCS neighbouring cell information" is not included in the first occurrence of IE "Intra-frequency cell info list":
 - use the default values specified for the IE "HCS neighbouring cell information" for that cell;
 - if IE "HCS neighbouring cell information" is not included in other occurrence of IE "Intra-frequency cell info list":
 - for that cell use the same parameter values as used for the preceding IE "Intra-frequency cell info list";
 - if IE "HCS neighbouring cell information" is not included in the first occurrence of IE "Inter-frequency cell info list":
 - use the default values specified for the IE "HCS neighbouring cell information" for that cell;
 - if IE "HCS neighbouring cell information" is not included in other occurrence of IE "Inter-frequency cell info list":
 - for that cell use the same parameter values as used for the preceding IE "Inter-frequency cell info list";

- if IE "HCS neighbouring cell information" is not included in the first occurrence of IE "Inter-RAT Cell info list":
 - use the default values specified for the IE "HCS neighbouring cell information" for that cell;
- if IE "HCS neighbouring cell information" is not included in other occurrence of IE "Inter-RAT cell info list":
 - for that cell use the same parameter values as used for the preceding IE "Inter-RAT cell info list";
- if the value of the IE "Cell selection and reselection quality measure" is different from the value of the IE "Cell selection and reselection quality measure" obtained from System Information Block type 3 or System Information Block type 4:
 - use the value of the IE from this System Information Block and ignore the value obtained from System Information Block type 3 or System Information Block type 4.

8.1.1.6.12 System Information Block type 12

If in connected mode, the UE should store all relevant IEs included in this system information block. The UE shall:

- if IE "FACH measurement occasion info" is included:
 - act as specified in subclause 8.6.7.
- else:
 - perform neither inter-frequency/inter-RAT measurements nor inter-frequency/inter-RAT cell re-selection evaluation, independent of UE measurement capabilities;
- for each measurement type:
 - start (or continue) a measurement using the set of IEs specified for that measurement type;
- act upon the received IE "Intra-frequency/Inter-frequency/Inter-RAT cell info list" as described in subclause 8.6.7.3;
- if any of the IEs "Intra-frequency measurement quantity", "Intra-frequency reporting quantity for RACH reporting", "Maximum number of reported cells on RACH" or "Reporting information for state CELL_DCH" are not included in the system information block:
 - read the corresponding IE(s) in system information block type 11 and use that information for the intra-frequency measurement;
- if included in this system information block or in System Information Block type 11
 - store the IE "Intra-frequency reporting quantity" and the IE "Intra-frequency measurement reporting criteria" or "Periodical reporting criteria" in order to activate reporting when state CELL_DCH is entered;
- if the IE "Inter-frequency measurement quantity" is not included in the system information block:
 - read the corresponding IE in System Information Block type 11 and use that information for the inter-frequency measurement;
- if the IE "Inter-RAT measurement quantity" is not included in the system information block:
 - read the corresponding IE in System Information Block type 11 and use that information for the inter-RAT measurement;
- if in state CELL_FACH:
 - start traffic volume measurement reporting as specified in the IE "Traffic volume reporting quantity";
- associate each measurement with the identity number given by the IE "Measurement identity";
- if IE "Use of HCS" is set to "used", indicating that HCS is used, do the following:

- if IE "HCS neighbouring cell information" is not included in the first occurrence of IE "Intra-frequency cell info list":
 - use the default values specified for the IE "HCS neighbouring cell information" for that cell;
- if IE "HCS neighbouring cell information" is not included in other occurrence of IE "Intra-frequency cell info list":
 - for that cell use the same parameter values as used for the preceding IE "Intra-frequency cell info list";
- if IE "HCS neighbouring cell information" is not included in the first occurrence of IE "Inter-frequency cell info list":
 - use the default values specified for the IE "HCS neighbouring cell information" for that cell;
- if IE "HCS neighbouring cell information" is not included in other occurrence of IE "Inter-frequency cell info list":
 - for that cell use the same parameter values as used for the preceding IE "Inter-frequency cell info list";
- if IE "HCS neighbouring cell information" is not included in the first occurrence of IE "Inter-RAT cell info list":
 - use the default values specified for the IE "HCS neighbouring cell information" for that cell;
- if IE "HCS neighbouring cell information" is not included in other occurrence of IE "Inter-RAT cell info list":
 - for that cell use the same parameter values as used for the preceding IE "Inter-RAT cell info list".
- if the value of the IE "Cell selection and reselection quality measure" is different from the value of the IE "Cell selection and reselection quality measure" obtained from System Information Block type 3 or System Information Block type 4:
 - use the value of the IE from this System Information Block and ignore the value obtained from System Information Block type 3 or System Information Block type 4.

If in idle mode, the UE shall not use the values of the IEs in this system information block.

8.1.1.6.13 System Information Block type 13

If in idle or connected mode, the UE should store all relevant IEs included in this system information block except for the IEs "CN domain specific DRX cycle length coefficient", "UE timers and constants in idle mode" and "Capability update requirement" which shall be stored only in the idle mode case. The UE shall read System Information Block type 13 and the associated System Information Block types 13.1, 13.2, 13.3 and 13.4 only when the "PLMN Type" in the variable SELECTED_PLMN has the value "ANSI-41" and the IE "PLMN type" in the Master Information Block has the value "ANSI-41" or "GSM-MAP and ANSI-41". The UE shall also:

- forward the content of the IE "CN domain specific NAS system information" to the non-access stratum entity indicated by the IE "CN domain identity";
- use the IE "CN domain specific DRX cycle length coefficient" to calculate frame number for the Paging Occasions and Page indicator as specified in [4].

Refer to TIA/EIA/IS-2000.5-A for actions on information contained in System Information Block types 13.1, 13.2, 13.3 and 13.4.

8.1.1.6.14 System Information Block type 14

This system information block type is used only in TDD.

The UE should store all relevant IEs included in this system information block. The UE shall:

- use the IE "UL Timeslot Interference" to calculate PRACH, DPCH and PUSCH transmit power for TDD uplink open loop power control as defined in subclause 8.5.7.

8.1.1.6.15 System Information Block type 15

If the UE is in idle or connected mode, and supports GPS location services and/or OTDOA location services it should store all relevant IEs included in this system information block. The UE shall:

- if the IE "GPS Data ciphering info" is included, and the UE has a full or reduced complexity GPS receiver functionality (the UE will know that the broadcast GPS data is ciphered in accordance with the Data Assistance Ciphering Algorithm detailed in [18]):
 - store the parameters contained within this IE (see 10.3.7.86 for details) in the IE "GPS Data ciphering info" in variable UE_POSITIONING_GPS_DATA; and
 - use them to decipher the broadcast UE positioning GPS information contained within the System Information Block types 15.1, 15.2 and 15.3;
- store the IE "Reference position" in the IE "UE positioning GPS reference UE position" in variable UE_POSITIONING_GPS_DATA and use it as a priori knowledge of the approximate location of the UE;
- store the IE "GPS reference time" in the IE "UE positioning GPS reference time" in variable UE_POSITIONING_GPS_DATA and use it as a reference GPS time;
- use "GPS TOW msec" as GPS Time of Week in milliseconds;
- if the IE "GPS TOW rem usec" is included in the IE "GPS reference time":
 - store it in the IE "UE positioning GPS reference time" in variable UE_POSITIONING_GPS_DATA and may use it as GPS Time of Week in microseconds;
- if the IE "NODE B Clock Drift" is included in the IE "GPS reference time":
 - store it in the IE "UE positioning GPS reference time" in variable UE_POSITIONING_GPS_DATA and may use it as an estimate of the drift rate of the NODE B clock relative to GPS time;
- if the IE "NODE B Clock Drift" is not included in the IE "GPS reference time":
 - assume the value 0;
- if SFN is included in the IE "GPS reference time" and IE "Primary CPICH Info" for FDD or IE "cell parameters id" for TDD is not included:
 - store it in the IE "UE positioning GPS reference time" in variable UE_POSITIONING_GPS_DATA and may use it as the relationship between GPS time and air-interface timing of the NODE B transmission in the serving cell;
- if SFN is included in IE "GPS reference time" and IE "Primary CPICH Info" for FDD or IE "cell parameters id" for TDD is also included:
 - store it in the IE "UE positioning GPS reference time" in variable UE_POSITIONING_GPS_DATA and may use it as the relationship between GPS time and air-interface timing of the NODE B transmission in the cell indicated by "Primary CPICH info" or "cell parameters id";
- if IE "Satellite information" is included:
 - act as specified in subclause 8.6.7.19.3.6.

NOTE: For efficiency purposes, the UTRAN should broadcast System Information Block type 15 if it is broadcasting System Information Block type 15.2.

8.1.1.6.15.1 System Information Block type 15.1

The UE should store all the relevant IEs included in this system information block in variable UE_POSITIONING_GPS_DATA. The UE shall:

- use "Status/Health" in the IE "DGPS Corrections" to determine the status of the differential corrections;

- act on "DGPS information" in the IE "DGPS Corrections" in a similar manner as specified in [13] except that the scale factors for PRC and RRC are different. In addition, the IE group DGPS information also includes Delta PRC2 and Delta RRC2. Delta PRC2 is the difference in the pseudorange correction between the satellite's ephemeris identified by IODE and the previous ephemeris two issues ago IODE-2. Delta RRC2 is the difference in the pseudorange rate-of-change correction between the satellite's ephemeris identified by IODE and IODE-2. These two additional IEs can extend the life of the raw ephemeris data up to 6 hours. If the IEs "Delta PRC3" and "Delta RRC3" are included, UE may use them as appropriate e.g. to extend the life of the raw ephemeris data up to 8 hours;
- act upon the received IE "DGPS corrections" as specified in subclause 8.6.7.19.3.3.

8.1.1.6.15.2 System Information Block type 15.2

For System Information Block type 15.2 multiple occurrences may be used; one occurrence for one satellite. To identify the different occurrences, the scheduling information for System Information Block type 15.2 includes IE "SIB occurrence identity and value tag". The UE should store all the relevant IEs included in this system information block in variable UE_POSITIONING_GPS_DATA. The UE shall:

- compare for each occurrence the value tag of the stored occurrence, if any, with the occurrence value tag included in the IE "SIB occurrence identity and value tag" for the occurrence of the SIB with the same occurrence identity;
- in case the UE has no SIB occurrence stored with the same identity or in case the occurrence value tag is different:
 - store the occurrence information together with its identity and value tag for later use;
- in case an occurrence with the same identity but different value tag was stored:
 - overwrite this one with the new occurrence read via system information for later use;
- interpret IE "Transmission TOW" as a very coarse estimate of the current time, i.e., the approximate GPS time-of-week when the message is broadcast;
- interpret IE "SatID" as the satellite ID of the data from which this message was obtained;
- act upon the received IEs "Sat ID" and "GPS Ephemeris and Clock Corrections Parameter" as specified in subclause 8.6.7.19.3.4;
- act on the rest of the IEs in a manner similar to that specified in [12]. In addition, the UE can utilise these IEs for GPS time dissemination and sensitivity improvement.

The IE "Transmission TOW" may be different each time a particular SIB occurrence is transmitted. The UTRAN should not increment the value tag of the SIB occurrence if the IE "Transmission TOW" is the only IE that is changed.

The UE may not need to receive all occurrences before it can use the information from any one occurrence.

8.1.1.6.15.3 System Information Block type 15.3

For System Information Block type 15.3 multiple occurrences may be used; one occurrence for each set of satellite data. To identify the different occurrences, the scheduling information for System Information Block type 15.3 includes IE "SIB occurrence identity and value tag". The UE should store all the relevant IEs included in this system information block in variable UE_POSITIONING_GPS_DATA. The UE shall:

- compare for each occurrence the value tag of the stored occurrence, if any, with the occurrence value tag included in the IE "SIB occurrence identity and value tag" for the occurrence of the SIB with the same occurrence identity;
- in case the UE has no SIB occurrence stored with the same identity or in case the occurrence value tag is different:
 - store the occurrence information together with its identity and value tag for later use;
- in case an occurrence with the same identity but different value tag was stored:

- overwrite this one with the new occurrence read via system information for later use;
- interpret IE "Transmission TOW" as a very coarse estimate of the current time, i.e., the approximate GPS time-of-week when the message is broadcast;
- interpret IE "SatMask" as the satellites that contain the pages being broadcast in this message;
- interpret IE "LSB TOW" as the least significant 8 bits of the TOW ([12]);
- interpret "Data ID" in the IE "UE positioning GPS almanac" as the Data ID field contained in the indicated subframe, word 3, most significant 2 bits, as defined by [12];
- if the IE "GPS Almanac and Satellite Health" is included:
 - act as specified in subclause 8.6.7.19.3.2;
- act on the rest of the IEs in a similar manner as specified in [12]. In addition, the UE can utilise these IEs including non-information bits for GPS time dissemination and sensitivity improvement.

The IE "Transmission TOW" may be different each time a particular SIB occurrence is transmitted. The UTRAN should not increment the value tag of the SIB occurrence if the IE "Transmission TOW" is the only IE that is changed. One SIB occurrence value tag is assigned to the table of subclause 10.2.48.8.18.3.

The UE may not need to receive all occurrences before it can use the information for any one occurrence.

8.1.1.6.15.4 System Information Block type 15.4

If the UE is in idle or connected mode, and supports the UE-based OTDOA UE positioning method the UE shall:

- act as specified in subclause 8.6.7.19.3.2;
- store IE "OTDOA ciphering info" in OTDOA Data ciphering info in variable UE_POSITIONING_OTDOA_DATA if it is included.

8.1.1.6.16 System Information Block type 16

For System Information Block type 16 multiple occurrences may be used; one occurrence for each predefined configuration. To identify the different predefined configurations, the scheduling information for System Information Block type 16 includes IE "Predefined configuration identity and value tag".

The UE should store all relevant IEs included in this system information block. The UE shall:

- compare for each predefined configuration the value tag of the stored predefined configuration with the preconfiguration value tag included in the IE "Predefined configuration identity and value tag" for the occurrence of the SIB with the same predefined configuration identity;
- in case the UE has no predefined configuration stored with the same identity or in case the predefined configuration value tag is different:
 - store the predefined configuration information together with its identity and value tag for later use e.g. during handover to UTRAN;
- in case a predefined configuration with the same identity but different value tag was stored:
 - overwrite this one with the new configuration read via system information for later use e.g. during handover to UTRAN.

The above handling applies regardless of whether the previously stored predefined configuration information has been obtained via UTRA or via another RAT.

The UE is not required to complete reading of all occurrences of System Information Block type 16 before initiating RRC connection establishment.

The UE is not required to store more than maxPredefConfig preconfigurations even in the case of multiple equivalent PLMNs.

8.1.1.6.17 System Information Block type 17

This system information block type is used only for TDD.

If in connected mode, the UE should store all relevant IEs included in this system information block. The UE shall:

- if the IE "PDSCH system information" and/or the IE "PUSCH system information" is included, store each of the configurations given there with the associated identity given in the IE "PDSCH Identity" and/or "PUSCH Identity" respectively. This information shall become invalid after the time specified by the repetition period (SIB_REP) for this system information block.

If in idle mode, the UE shall not use the values of the IEs in this system information block.

8.1.1.6.18 System Information Block type 18

If the System Information Block type 18 is present, a UE may obtain knowledge of the PLMN identity of the neighbour cells to be considered for cell reselection, and may behave as specified in this subclause and in subclause 8.5.14a.

The UE should store all the relevant IEs included in this system information block.

A UE in idle mode shall act according to the following rules:

- any PLMN list of a given type (IEs "PLMNs of intra-frequency cells list", "PLMNs of inter-frequency cells list", "PLMNs of inter-RAT cell lists") included in the IE "Idle mode PLMN identities" is paired with the list of cells of the same type derived from System Information Block type 11;
- the PLMN identity located at a given rank in the PLMN list is that of the cell with the same ranking in the paired list of cells, the cells being considered in the increasing order of their associated identities ("Intra-frequency cell id", "Inter-frequency cell id", "Inter-RAT cell id");
- if the number of identities in a PLMN list exceeds the number of neighbour cells in the paired list (if any), the extra PLMN identities are considered as unnecessary and ignored;
- if the number of identities in a PLMN list (if any) is lower than the number of neighbour cells in the paired list, the missing PLMN identities are replaced by the last PLMN identity in the list if present, otherwise by the identity of the selected PLMN.

A UE in connected mode shall act in the same manner as a UE in idle mode with the following modifications:

- the PLMN lists to be considered are the ones included, when present, in the IE "Connected mode PLMN identities"; otherwise, the UE shall use, in place of any missing list, the corresponding one in the IE "Idle mode PLMN identities";
- the paired lists of cells are the ones derived from System Information Block type 11, and System Information Block type 12 if present.

8.1.1.7 Modification of system information

For System Information Block type 15.2, 15.3 and 16 that may have multiple occurrences, the UE shall handle each occurrence independently as specified in the previous; that is each occurrence is handled as a separate system information block.

NOTE: It should be noted that for the proper operation of the BCCH Modification Information sent on a PCH, the System Information should not be changed more frequently than can be accommodated by mobile stations operating at the maximum DRX cycle length supported by the UTRAN.

8.1.1.7.1 Modification of system information blocks using a value tag

Upon modifications of system information blocks using value tags, UTRAN should notify the new value tag for the master information block in the IE "BCCH modification info", transmitted in the following way:

- to reach UEs in idle mode, CELL_PCH state and URA_PCH state, the IE "BCCH modification info" is contained in a PAGING TYPE 1 message transmitted on the PCCH in all paging occasions in the cell;

- to reach UEs in CELL_FACH state or TDD UEs in CELL_DCH with S-CCPCH assigned, the IE "BCCH modification info" is contained in a SYSTEM INFORMATION CHANGE INDICATION message transmitted on the BCCH mapped on at least one FACH on every Secondary CCPCH in the cell.

Upon reception of a PAGING TYPE 1 message or a SYSTEM INFORMATION CHANGE INDICATION message containing the IE "BCCH modification info" containing the IE "MIB value tag" but not containing the IE "BCCH modification time", the UE shall perform actions as specified in subclause 8.1.1.7.3.

If the IE "BCCH modification time" is included the UE shall perform actions as specified in subclause 8.1.1.7.2.

8.1.1.7.2 Synchronised modification of system information blocks

For modification of some system information elements, e.g. reconfiguration of the channels, it is important for the UE to know exactly when a change occurs. In such cases, the UTRAN should notify the SFN when the change will occur as well as the new value tag for the master information block in the IE "BCCH modification info" transmitted in the following way:

- To reach UEs in idle mode, CELL_PCH state and URA_PCH state, the IE "BCCH modification info" is contained in a PAGING TYPE 1 message transmitted on the PCCH in all paging occasions in the cell;
- To reach UEs in CELL_FACH state, the IE "BCCH modification info" is contained in a SYSTEM INFORMATION CHANGE INDICATION message transmitted on the BCCH mapped on at least one FACH on every Secondary CCPCH in the cell.

Upon reception of a PAGING TYPE 1 message or a SYSTEM INFORMATION CHANGE INDICATION message containing the IE "BCCH modification info" containing the IE "MIB value tag" and containing the "IE BCCH modification time", the UE shall:

- perform the actions as specified in subclause 8.1.1.7.3 at the time, indicated in the IE "BCCH Modification Information".

8.1.1.7.3 Actions upon system information change

The UE shall:

- compare the value of IE "MIB value tag" in the IE "BCCH modification info" with the value tag stored for the master information block in variable VALUE_TAG.
- if the value tags differ:
 - read the master information block on BCH;
 - if the value tag of the master information block in the system information is the same as the value in IE "MIB value tag" in "BCCH modification info" but different from the value tag stored in the variable VALUE_TAG:
 - perform actions as specified in subclause 8.1.1.5;
 - if the value tag of the master information block in the system information is the same as the value tag stored in the variable VALUE_TAG:
 - for the next occurrence of the master information block:
 - perform actions as specified in subclause 8.1.1.7.3 again;
 - if the value tag of the master information block in the system information is different from the value tag stored in the variable VALUE_TAG, and is different from the value in IE "MIB value tag" in "BCCH modification info":
 - perform actions as specified in subclause 8.1.1.5;
 - if $(VTCI - VTMIB) \bmod 8 < 4$, where VTCI is the value tag in the IE "MIB value tag" in "BCCH modification info" and VTMIB is the value tag of the master information block in the system information:
 - for the next occurrence of the master information block:

- perform actions as specified in subclause 8.1.1.7.3 again.

8.1.1.7.4 Actions upon expiry of a system information expiry timer

When the expiry timer of a system information block not using a value tag expires

the UE shall:

consider the content of the system information block invalid;

- re-acquire the system information block again before the content can be used;

the UE may:

- postpone reading the system information block until the content is needed.

8.1.2 Paging

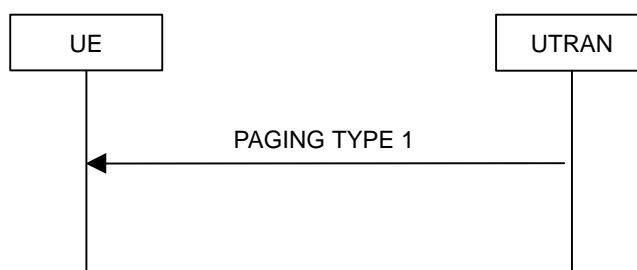

Figure 7: Paging

8.1.2.1 General

This procedure is used to transmit paging information to selected UEs in idle mode, CELL_PCH or URA_PCH state using the paging control channel (PCCH). Upper layers in the network may request paging, to e.g. establish a signalling connection. UTRAN may initiate paging for UEs in CELL_PCH or URA_PCH state to trigger a cell update procedure. In addition, UTRAN may initiate paging for UEs in idle mode, CELL_PCH and URA_PCH state to trigger reading of updated system information.

8.1.2.2 Initiation

UTRAN initiates the paging procedure by transmitting a PAGING TYPE 1 message on an appropriate paging occasion on the PCCH.

UTRAN may repeat transmission of a PAGING TYPE 1 message to a UE in several paging occasions to increase the probability of proper reception of a page.

UTRAN may page several UEs in the same paging occasion by including one IE "Paging record" for each UE in the PAGING TYPE 1 message.

For CN originated paging, UTRAN should set the IE "Paging cause" to the cause for paging received from upper layers. If no cause for paging is received from upper layers, UTRAN should set the value "Terminating – cause unknown".

UTRAN may also indicate that system information has been updated, by including the value tag of the master information block in the IE "BCCH modification information" in the PAGING TYPE 1 message. In this case, UTRAN may omit the IEs "Paging record".

8.1.2.3 Reception of a PAGING TYPE 1 message by the UE

A UE in idle mode, CELL_PCH state or URA_PCH state shall receive the paging information for all its monitored paging occasions. For an UE in idle mode, the paging occasions are specified in [4] and depend on the IE "CN domain specific DRX cycle length coefficient", as specified in subclause 8.6.3.1a. For a UE in CELL_PCH state or URA_PCH

state, the paging occasions depend also on the IE "UTRAN DRX cycle length coefficient" and the IE "RRC State Indicator", as specified in subclauses 8.6.3.2 and 8.6.3.3 respectively.

When the UE receives a PAGING TYPE 1 message, it shall perform the actions as specified below.

If the UE is in idle mode, for each occurrence of the IE "Paging record" included in the message the UE shall:

- if the IE "Used paging identity" is a CN identity:
 - compare the IE "UE identity" with all of its allocated CN UE identities:
 - if one match is found:
 - indicate reception of paging; and
 - forward the IE "CN domain identity", the IE "UE identity" and the IE "Paging cause" to the upper layers;
- otherwise:
 - ignore that paging record.

If the UE is in connected mode, for each occurrence of the IE "Paging record" included in the message the UE shall:

- if the IE "Used paging identity" is a UTRAN identity and if this U-RNTI is the same as the U-RNTI allocated to the UE:
 - if the optional IE "CN originated page to connected mode UE" is included:
 - indicate reception of paging; and
 - forward the IE "CN domain identity", the IE "Paging cause" and the IE "Paging record type identifier" to the upper layers;
 - otherwise:
 - perform a cell update procedure with cause "paging response" as specified in subclause 8.3.1.2;
- ignore any other remaining IE "Paging record" that may be present in the message;
- otherwise:
 - ignore that paging record.

If the IE "BCCH modification info" is included, any UE in idle mode, CELL_PCH or URA_PCH state shall perform the actions as specified in subclause 8.1.1 in addition to any actions caused by the IE "Paging record" occurrences in the message as specified above.

8.1.3 RRC connection establishment

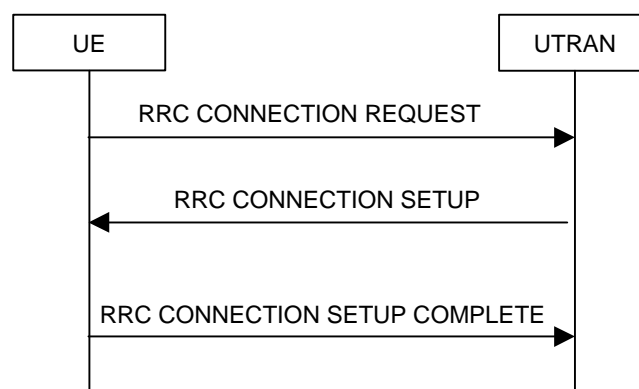

Figure 8: RRC Connection Establishment, network accepts RRC connection

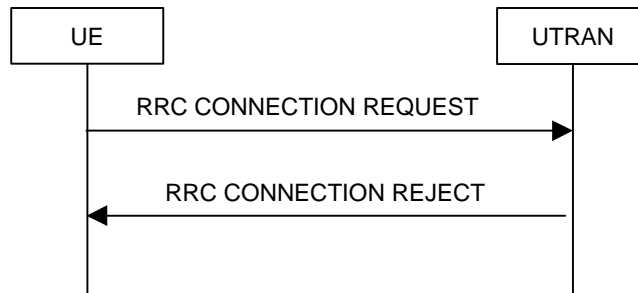

Figure 9: RRC Connection Establishment, network rejects RRC connection

8.1.3.1 General

The purpose of this procedure is to establish an RRC connection.

8.1.3.2 Initiation

The UE shall initiate the procedure when upper layers in the UE requests the establishment of a signalling connection and the UE is in idle mode (no RRC connection exists), as specified in subclause 8.1.8.

Upon initiation of the procedure, the UE shall:

- set the variable `PROTOCOL_ERROR_INDICATOR` to `FALSE`;
- if the USIM is present:
 - set the value of "THRESHOLD" in the variable "START_THRESHOLD" to the 20 MSBs of the value stored in the USIM [50] for the maximum value of START for each CN Domain;
- set the IE "Initial UE identity" in the variable `INITIAL_UE_IDENTITY` according to subclause 8.5.1;
- set the contents of the RRC CONNECTION REQUEST message according to subclause 8.1.3.3;
- set CFN in relation to SFN of current cell according to subclause 8.5.15;
- perform the mapping of the Access Class to an Access Service Class as specified in subclause 8.5.13, and apply the given Access Service Class when accessing the RACH;
- submit the RRC CONNECTION REQUEST message for transmission on the uplink CCCH;
- set counter V300 to 1; and
- start timer T300 when the MAC layer indicates success or failure to transmit the message;
- select a Secondary CCPCH according to [4];
- start receiving all FACH transport channels mapped on the selected Secondary CCPCH.

8.1.3.3 RRC CONNECTION REQUEST message contents to set

The UE shall, in the transmitted RRC CONNECTION REQUEST message:

- set the IE "Establishment cause" to the value of the variable `ESTABLISHMENT_CAUSE`;
- set the IE "Initial UE identity" to the value of the variable `INITIAL_UE_IDENTITY`;
- set the IE "Protocol error indicator" to the value of the variable `PROTOCOL_ERROR_INDICATOR`;
- include a measurement report in the IE "Measured results on RACH", as specified in the IE "Intra-frequency reporting quantity for RACH reporting" and the IE "Maximum number of reported cells on RACH" in System Information Block type 11; and

- include in the IE "Measured results on RACH" all requested reporting quantities for cells for which measurements are reported; and
- take care that the maximum allowed message size is not exceeded when forming the IE "Measured results on RACH".

8.1.3.4 Reception of an RRC CONNECTION REQUEST message by the UTRAN

Upon receiving an RRC CONNECTION REQUEST message, UTRAN should either:

- submit an RRC CONNECTION SETUP message to the lower layers for transmission on the downlink CCCH; or

NOTE: The RRC CONNECTION SETUP message always includes the IEs "Added or Reconfigured TrCH information list", both for uplink and downlink transport channels, even if UTRAN orders the UE to move to CELL_FACH and hence need not configure any transport channels. In these cases, UTRAN may include a configuration that adds little to the encoded message size e.g. a DCH with a single zero size transport format. At a later stage, UTRAN may either remove or reconfigure this configuration.

- submit an RRC CONNECTION REJECT message on the downlink CCCH. In the RRC CONNECTION REJECT message, the UTRAN may direct the UE to another UTRA carrier or to another system. After the RRC CONNECTION REJECT message has been sent, all context information for the UE may be deleted in UTRAN.

8.1.3.5 Cell re-selection or T300 timeout

- if the UE has not yet received an RRC CONNECTION SETUP message with the value of the IE "Initial UE identity" equal to the value of the variable INITIAL_UE_IDENTITY; and
- if cell re-selection or expiry of timer T300 occurs;

the UE shall:

- check the value of V300; and
 - if V300 is equal to or smaller than N300:
 - if cell re-selection occurred:
 - set CFN in relation to SFN of current cell according to subclause 8.5.15;
 - set the IEs in the RRC CONNECTION REQUEST message according to subclause 8.1.3.3;
 - perform the mapping of the Access Class to an Access Service Class as specified in subclause 8.5.13; and
 - apply the given Access Service Class when accessing the RACH;
 - submit a new RRC CONNECTION REQUEST message to lower layers for transmission on the uplink CCCH;
 - increment counter V300;
 - restart timer T300 when the MAC layer indicates success or failure to transmit the message;
 - if V300 is greater than N300:
 - enter idle mode.
 - consider the procedure to be unsuccessful;
 - Other actions the UE shall perform when entering idle mode from connected mode are specified in subclause 8.5.2;
 - the procedure ends.

8.1.3.6 Reception of an RRC CONNECTION SETUP message by the UE

The UE shall compare the value of the IE "Initial UE identity" in the received RRC CONNECTION SETUP message with the value of the variable INITIAL_UE_IDENTITY.

If the values are different, the UE shall:

- ignore the rest of the message;

If the values are identical, the UE shall:

- stop timer T300, and act upon all received information elements as specified in subclause 8.6, unless specified otherwise in the following;
- if the UE will be in the CELL_FACH state at the conclusion of this procedure:
 - if the IE "Frequency info" is included:
 - select a suitable UTRA cell according to [4] on that frequency;
 - select PRACH according to subclause 8.5.17;
 - select Secondary CCPCH according to subclause 8.5.19;
 - perform the physical layer synchronisation procedure as specified in [29];
 - enter a state according to subclause 8.6.3.3;
- submit an RRC CONNECTION SETUP COMPLETE message to the lower layers on the uplink DCCH after successful state transition per subclause 8.6.3.3, with the contents set as specified below:
 - set the IE "RRC transaction identifier" to
 - the value of "RRC transaction identifier" in the entry for the RRC CONNECTION SETUP message in the table "Accepted transactions" in the variable TRANSACTIONS; and
 - clear that entry.
 - if the USIM is present:
 - set the "START" for each CN domain in the IE "START list" in the RRC CONNECTION SETUP COMPLETE message with the corresponding START value that is stored in the USIM [50]; and then
 - set the START value stored in the USIM [50] for any CN domain to the value "THRESHOLD" of the variable START_THRESHOLD;
 - if the USIM is not present:
 - set the "START" for each CN domain in the IE "START list" in the RRC CONNECTION SETUP COMPLETE message to zero;
 - retrieve its UTRA UE radio access capability information elements from variable UE_CAPABILITY_REQUESTED; and then
 - include this in IE "UE radio access capability" and IE "UE radio access capability extension", provided this IE is included in variable UE_CAPABILITY_REQUESTED;
 - retrieve its inter-RAT-specific UE radio access capability information elements from variable UE_CAPABILITY_REQUESTED; and then
 - include this in IE "UE system specific capability".

When the RRC CONNECTION SETUP COMPLETE message has been submitted to lower layers for transmission the UE shall:

- if the UE has entered CELL_FACH state:

- start timer T305 using its initial value if periodical update has been configured by T305 in the IE "UE Timers and constants in connected mode" set to any other value than "infinity" in system information block type 1;
- store the contents of the variable UE_CAPABILITY_REQUESTED into the variable UE_CAPABILITY_TRANSFERRED;
- initialise variables upon entering UTRA RRC connected mode as specified in subclause 13.4;
- consider the procedure to be successful;

And the procedure ends.

8.1.3.7 Physical channel failure or cell re-selection

- If the UE failed to establish, per subclause 8.5.4, the physical channel(s) indicated in the RRC CONNECTION SETUP message; or
- if the UE performs cell re-selection; or
- if the UE will be in the CELL_FACH state at the conclusion of this procedure; and
 - if the received RRC CONNECTION SETUP message included the IE "Primary CPICH info" (for FDD) or "Primary CCPCH info" (for TDD), and the UE selected another cell than indicated by this IE; or
 - if the contents of the variable C_RNTI is empty
- after having received an RRC CONNECTION SETUP message with the value of the IE "Initial UE identity" equal to the value of the variable INITIAL_UE_IDENTITY; and
- before the RRC CONNECTION SETUP COMPLETE message is delivered to lower layers for transmission:

the UE shall:

- clear the entry for the RRC CONNECTION SETUP message in the table "Accepted transactions" in the variable TRANSACTIONS;
- check the value of V300, and:
 - if V300 is equal to or smaller than N300:
 - set CFN in relation to SFN of current cell according to subclause 8.5.15;
 - set the IEs in the RRC CONNECTION REQUEST message according to subclause 8.1.3.3;
 - perform the mapping of the Access Class to an Access Service Class as specified in subclause 8.5.13, and apply the given Access Service Class when accessing the RACH;
 - submit a new RRC CONNECTION REQUEST message to the lower layers for transmission on the uplink CCCH;
 - increment counter V300; and
 - restart timer T300 when the MAC layer indicates success or failure in transmitting the message;
 - if V300 is greater than N300:
 - enter idle mode;
 - perform the actions specified in subclause 8.5.2 when entering idle mode from connected mode;
 - consider the procedure to be successful;
 - the procedure ends.

8.1.3.8 Invalid RRC CONNECTION SETUP message, unsupported configuration or invalid configuration

If the UE receives an RRC CONNECTION SETUP message which contains an IE "Initial UE identity" with a value which is identical to the value of the variable INITIAL_UE_IDENTITY, but the RRC CONNECTION SETUP message contains a protocol error causing the variable PROTOCOL_ERROR_REJECT to be set to TRUE according to clause 9, the UE shall perform procedure specific error handling as follows. The UE shall:

- clear the entry for the RRC CONNECTION SETUP message in the table "Rejected transactions" in the variable TRANSACTIONS and proceed as below;

If the UE receives an RRC CONNECTION SETUP message which contains an IE "Initial UE identity" with a value which is identical to the value of the variable INITIAL_UE_IDENTITY; and

- the RRC CONNECTION SETUP message contained a configuration the UE does not support; and/or
- the variable UNSUPPORTED_CONFIGURATION becomes set to TRUE due to the received RRC CONNECTION SETUP message; and/or
- the variable INVALID_CONFIGURATION becomes set to TRUE due to the received RRC CONNECTION SETUP message;

the UE shall:

- clear the entry for the RRC CONNECTION SETUP message in the table "Accepted transactions" in the variable TRANSACTIONS and proceed as below;
- if V300 is equal to or smaller than N300:
 - set the variable PROTOCOL_ERROR_INDICATOR to TRUE;
 - set the IEs in the RRC CONNECTION REQUEST message according to subclause 8.1.3.3;
 - perform the mapping of the Access Class to an Access Service Class as specified in subclause 8.5.13; and
 - apply the given Access Service Class when accessing the RACH;
 - submit a new RRC CONNECTION REQUEST message to the lower layers for transmission on the uplink CCCH;
 - increment counter V300; and
 - restart timer T300 when the MAC layer indicates success or failure in transmitting the message;
- if V300 is greater than N300:
 - enter idle mode;
 - perform the actions specified in subclause 8.5.2 when entering idle mode from connected mode;
 - consider the procedure to be successful;
 - the procedure ends.

8.1.3.9 Reception of an RRC CONNECTION REJECT message by the UE

When the UE receives an RRC CONNECTION REJECT message on the downlink CCCH, it shall compare the value of the IE "Initial UE identity" in the received RRC CONNECTION REJECT message with the value of the variable INITIAL_UE_IDENTITY:

If the values are different, the UE shall ignore the rest of the message;

If the values are identical, the UE shall stop timer T300 and:

- if the IE "wait time" <> '0', and

- if the IE "frequency info" is present and:
 - if V300 is equal to or smaller than N300:
 - initiate cell selection on the designated UTRA carrier;
 - after having selected and camped on a cell:
 - set CFN in relation to SFN of current cell according to subclause 8.5.15;
 - set the contents of the RRC CONNECTION REQUEST message according to subclause 8.1.3.3;
 - perform the mapping of the Access Class to an Access Service Class as specified in subclause 8.5.13, and apply the given Access Service Class when accessing the RACH;
 - transmit an RRC CONNECTION REQUEST message on the uplink CCCH;
 - reset counter V300;
 - start timer T300 when the MAC layer indicates success or failure in transmitting the message;
 - disable cell reselection to original carrier until the time stated in the IE "wait time" has elapsed;
 - if a cell selection on the designated carrier fails:
 - wait for the time stated in the IE "wait time";
 - set CFN in relation to SFN of current cell according to subclause 8.5.15;
 - set the IEs in the RRC CONNECTION REQUEST message according to subclause 8.1.3.3;
 - perform the mapping of the Access Class to an Access Service Class as specified in subclause 8.5.13, and apply the given Access Service Class when accessing the RACH;
 - then submit a new RRC CONNECTION REQUEST message to the lower layers for transmission on the uplink CCCH of the original serving cell;
 - increment counter V300;
 - restart timer T300 when the MAC layer indicates success or failure to transmit the message;
- if V300 is greater than N300:
 - enter idle mode;
 - perform the actions specified in subclause 8.5.2 when entering idle mode from connected mode;
 - consider the procedure to be successful;
 - the procedure ends.
- if the IE "inter-RAT info" is present and:
 - if V300 is equal to or smaller than N300:
 - perform cell selection in the designated system;
 - delay cell reselection to the original system until the time stated in the IE "wait time" has elapsed.
 - if cell selection in the designated system fails:
 - wait at least the time stated in the IE "wait time";
 - set CFN in relation to SFN of current cell according to subclause 8.5.15;
 - set the IEs in the RRC CONNECTION REQUEST message according to subclause 8.1.3.2.
 - perform the mapping of the Access Class to an Access Service Class as specified in subclause 8.5.13, and apply the given Access Service Class when accessing the RACH;

- then submit a new RRC CONNECTION REQUEST message to the lower layers for transmission on the uplink CCCH;
- increment counter V300;
- restart timer T300 when the MAC layer indicates success or failure to transmit the message;
- if V300 is greater than N300:
 - enter idle mode;
 - perform the actions specified in subclause 8.5.2 when entering idle mode from connected mode;
 - consider the procedure to be successful;
 - the procedure ends.
- If neither the IEs "frequency info" nor "inter-RAT info" are present and:
 - if V300 is equal to or smaller than N300:
 - wait at least the time stated in the IE "wait time";
 - set the IEs in the RRC CONNECTION REQUEST message according to subclause 8.1.3.2;
 - perform the mapping of the Access Class to an Access Service Class as specified in subclause 8.5.13, and apply the given Access Service Class when accessing the RACH;
 - submit a new RRC CONNECTION REQUEST message to the lower layers for transmission on the uplink CCCH;
 - increment counter V300;
 - restart timer T300 when the MAC layer indicates success or failure to transmit the message;
 - if V300 is greater than N300:
 - enter idle mode;
 - perform the actions specified in subclause 8.5.2 when entering idle mode from connected mode;
 - consider the procedure to be successful;
 - the procedure ends.
- if the IE "wait time" = '0':
 - enter idle mode;
 - perform the actions specified in subclause 8.5.2 when entering idle mode from connected mode;
 - consider the procedure to be successful;
 - the procedure ends.

8.1.3.10 Invalid RRC CONNECTION REJECT message

If the UE receives an RRC CONNECTION REJECT message which contains an IE "Initial UE identity" with a value which is identical to the value of the IE "Initial UE identity" in the most recent RRC CONNECTION REQUEST message sent by the UE; but the RRC CONNECTION REJECT message contains a protocol error causing the variable PROTOCOL_ERROR_REJECT to be set to TRUE according to clause 9, the UE shall perform procedure specific error handling as follows:

The UE shall:

- if the IE "wait time" is ≤ 0 , and:

- if V300 is equal to or smaller than N300:
 - wait for the time stated in the IE "wait time";
 - set the variable `PROTOCOL_ERROR_INDICATOR` to `TRUE`;
 - set the IEs in the `RRC CONNECTION REQUEST` message according to subclause 8.1.3.3;
 - perform the mapping of the Access Class to an Access Service Class as specified in subclause 8.5.13, and apply the given Access Service Class when accessing the RACH;
 - submit a new `RRC CONNECTION REQUEST` message to the lower layers for transmission on the uplink CCCH;
 - increment counter V300;
 - restart timer T300 when the MAC layer indicates success or failure to transmit the message;
- if V300 is greater than N300:
 - enter idle mode;
 - perform the actions specified in subclause 8.5.2 when entering idle mode from connected mode;
 - consider the procedure to be successful;
 - the procedure ends.
- if the IE "wait time" is = 0:
 - enter idle mode;
 - perform the actions specified in subclause 8.5.2 when entering idle mode from connected mode;
 - consider the procedure to be successful;
 - the procedure ends.

8.1.4 RRC connection release

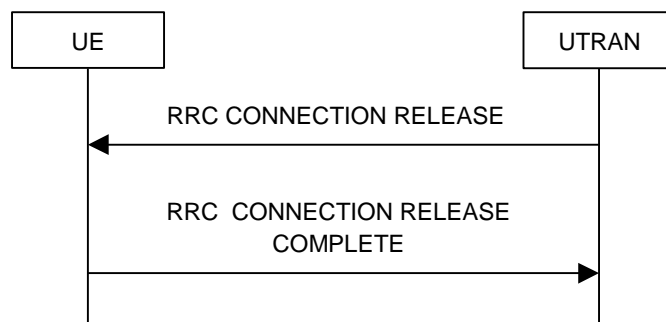

Figure 10: RRC Connection Release procedure on the DCCH



Figure 11: RRC Connection Release procedure on the CCCH

8.1.4.1 General

The purpose of this procedure is to release the RRC connection including all radio bearers and all signalling radio bearers between the UE and the UTRAN. By doing so, all established signalling connections will be released.

8.1.4.2 Initiation

When the UE is in state CELL_DCH or CELL_FACH, the UTRAN may at anytime initiate an RRC connection release by transmitting an RRC CONNECTION RELEASE message using UM RLC.

When UTRAN transmits an RRC CONNECTION RELEASE message the downlink DCCH should be used, if available. If the downlink DCCH is not available in UTRAN and the UE is in CELL_FACH state, the downlink CCCH may be used.

UTRAN may transmit several RRC CONNECTION RELEASE messages to increase the probability of proper reception of the message by the UE. In such a case, the RRC SN for these repeated messages shall be the same. This shall also apply to the RRC CONNECTION RELEASE COMPLETE message. The number of repeated messages and the interval between the messages is a network option.

8.1.4.3 Reception of an RRC CONNECTION RELEASE message by the UE

The UE shall receive and act on an RRC CONNECTION RELEASE message in states CELL_DCH and CELL_FACH. Furthermore this procedure can interrupt any ongoing procedures with the UE in the above listed states.

When the UE receives the first RRC CONNECTION RELEASE message, it shall:

- in state CELL_DCH:
 - initialise the counter V308 to zero;
 - set the IE "RRC transaction identifier" in the RRC CONNECTION RELEASE COMPLETE message to the value of "RRC transaction identifier" in the entry for the RRC CONNECTION RELEASE message in the table "Accepted transactions" in the variable TRANSACTIONS; and
 - clear that entry.
 - submit an RRC CONNECTION RELEASE COMPLETE message to the lower layers for transmission using UM RLC on the DCCH to the UTRAN;
 - if the IE "Rplmn information" is present:
 - the UE may:
 - store the IE on the ME together with the PLMN id for which it applies;
 - the UE may then:
 - utilise this information, typically indicating where a number of BCCH frequency ranges of a RAT may be expected to be found, during subsequent Rplmn selections of the indicated PLMN;
 - start timer T308 when the RRC CONNECTION RELEASE COMPLETE message is sent on the radio interface.
- in state CELL_FACH:
 - if the RRC CONNECTION RELEASE message was received on the DCCH:
 - set the IE "RRC transaction identifier" in the RRC CONNECTION RELEASE COMPLETE message to the value of "RRC transaction identifier" in the entry for the RRC CONNECTION RELEASE message in the table "Accepted transactions" in the variable TRANSACTIONS; and
 - clear that entry;
 - submit an RRC CONNECTION RELEASE COMPLETE message to the lower layers for transmission using AM RLC on the DCCH to the UTRAN.

- when the successful transmission of the RRC CONNECTION RELEASE COMPLETE message has been confirmed by the lower layers:
 - release all its radio resources; and
 - indicate the release of the established signalling connections (as stored in the variable ESTABLISHED_SIGNALLING_CONNECTIONS) and established radio access bearers (as stored in the variable ESTABLISHED_RABS) to upper layers; and
 - clear the variable ESTABLISHED_SIGNALLING_CONNECTIONS;
 - clear the variable ESTABLISHED_RABS;
 - pass the value of the IE "Release cause" received in the RRC CONNECTION RELEASE message to upper layers;
 - enter idle mode;
 - perform the actions specified in subclause 8.5.2 when entering idle mode;
- and the procedure ends.
- if the RRC CONNECTION RELEASE message was received on the CCCH:
 - release all its radio resources;
 - indicate the release of the established signalling connections (as stored in the variable ESTABLISHED_SIGNALLING_CONNECTIONS) and established radio access bearers (as stored in the variable ESTABLISHED_RABS) to the upper layers;
 - clear the variable ESTABLISHED_SIGNALLING_CONNECTIONS;
 - clear the variable ESTABLISHED_RABS;
 - pass the value of the IE "Release cause" received in the RRC CONNECTION RELEASE message to upper layers;
 - enter idle mode;
 - perform the actions specified in subclause 8.5.2 when entering idle mode;
 - and the procedure ends.

8.1.4.4 Invalid RRC CONNECTION RELEASE message

If the RRC CONNECTION RELEASE message contains a protocol error causing the variable PROTOCOL_ERROR_REJECT to be set to TRUE according to clause 9, and if the "protocol error cause" in PROTOCOL_ERROR_INFORMATION is set to any cause value except "ASN.1 violation or encoding error", the UE shall perform procedure specific error handling as follows:

The UE shall:

- ignore any IE(s) causing the error but treat the rest of the RRC CONNECTION RELEASE message as normal according to subclause 8.1.4.3, with an addition of the following actions;
- if the RRC CONNECTION RELEASE message was received on the DCCH:
 - set the IE "RRC transaction identifier" in the RRC CONNECTION RELEASE COMPLETE message to the value of "RRC transaction identifier" in the entry for the RRC CONNECTION RELEASE message in the table "Rejected transactions" in the variable TRANSACTIONS; and
 - clear that entry.
 - include the IE "Error indication" in the RRC CONNECTION RELEASE COMPLETE message with:
 - the IE "Failure cause" set to the cause value "Protocol error" and

- the IE "Protocol error information" set to the value of the variable PROTOCOL_ERROR_INFORMATION;

8.1.4.5 Cell re-selection or radio link failure

If the UE performs cell re-selection or the radio link failure criteria in subclause 8.5.6 is met at any time during the RRC connection release procedure and the UE has not yet entered idle mode, the UE shall:

- if cell re-selection occurred (CELL_FACH state):
 - perform a cell update procedure according to subclause 8.3.1 using the cause "Cell reselection";
- if radio link failure occurred (CELL_DCH state):
 - select a suitable UTRA cell according to [4];
 - perform a cell update procedure according to subclause 8.3.1 using the cause "radio link failure".

8.1.4.6 Expiry of timer T308, unacknowledged mode transmission

When in state CELL_DCH and the timer T308 expires, the UE shall:

- increment V308 by one;
- if V308 is equal to or smaller than N308:
 - retransmit the RRC CONNECTION RELEASE COMPLETE message, without incrementing "Uplink RRC Message sequence number" for signalling radio bearer RB1 in the variable INTEGRITY_PROTECTION_INFO;
- if V308 is greater than N308:
 - release all its radio resources;
 - indicate the release of the established signalling connections (as stored in the variable ESTABLISHED_SIGNALLING_CONNECTIONS) and established radio access bearers (as stored in the variable ESTABLISHED_RABS) to upper layers;
 - clear the variable ESTABLISHED_SIGNALLING_CONNECTIONS;
 - clear the variable ESTABLISHED_RABS;
 - enter idle mode;
 - perform the actions specified in subclause 8.5.2 when entering idle mode;
 - and the procedure ends.

8.1.4.7 Void

8.1.4.8 Reception of an RRC CONNECTION RELEASE COMPLETE message by UTRAN

When UTRAN receives an RRC CONNECTION RELEASE COMPLETE message from the UE, it should:

- release all UE dedicated resources and the procedure ends on the UTRAN side.

8.1.4.9 Unsuccessful transmission of the RRC CONNECTION RELEASE COMPLETE message, acknowledged mode transmission

When acknowledged mode was used and RLC does not succeed in transmitting the RRC CONNECTION RELEASE COMPLETE message, the UE shall:

- release all its radio resources;
- indicate the release of the established signalling connections (as stored in the variable ESTABLISHED_SIGNALLING_CONNECTIONS) and established radio access bearers (as stored in the variable ESTABLISHED_RABS) to upper layers;
- clear the variable ESTABLISHED_SIGNALLING_CONNECTIONS;
- clear the variable ESTABLISHED_RABS;
- enter idle mode;
- perform the actions specified in subclause 8.5.2 when entering idle mode;
- and the procedure ends.

8.1.4.10 Detection of loss of dedicated physical channel by UTRAN in CELL_DCH state

If the release is performed from the state CELL_DCH, and UTRAN detects loss of the dedicated physical channel according to subclause 8.5.6, UTRAN may release all UE dedicated resources, even if no RRC CONNECTION RELEASE COMPLETE message has been received.

8.1.4.11 Failure to receive RRC CONNECTION RELEASE COMPLETE message by UTRAN

If UTRAN does not receive any RRC CONNECTION RELEASE COMPLETE message, it should release all UE dedicated resources.

8.1.5 Void

8.1.6 Transmission of UE capability information

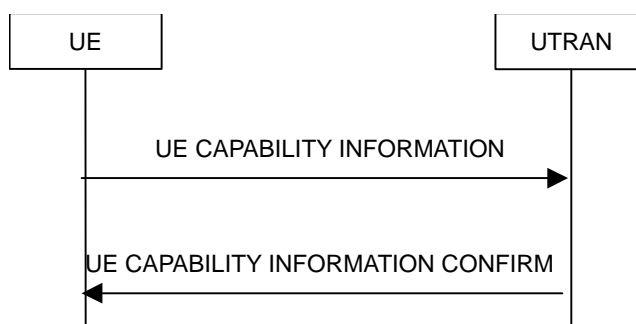

Figure 12: Transmission of UE capability information, normal flow

8.1.6.1 General

The UE capability update procedure is used by the UE to convey UE specific capability information to the UTRAN.

8.1.6.2 Initiation

The UE shall initiate the UE capability update procedure in the following situations:

- the UE receives a UE CAPABILITY ENQUIRY message from the UTRAN;
- while in connected mode the UE capabilities change compared to those stored in the variable UE_CAPABILITY_TRANSFERRED

If the UE CAPABILITY INFORMATION message is sent in response to a UE CAPABILITY ENQUIRY message, the UE shall:

- include the IE "RRC transaction identifier"; and
- set it to the value of "RRC transaction identifier" in the entry for the UE CAPABILITY ENQUIRY message in the table "Accepted transactions" in the variable TRANSACTIONS;
- retrieve its UTRA UE radio access capability information elements from variable UE_CAPABILITY_REQUESTED; and
- include this in IE "UE radio access capability" and in IE "UE radio access capability extension", provided this IE is included in variable UE_CAPABILITY_REQUESTED;
- retrieve its inter-RAT-specific UE radio access capability information elements from variable UE_CAPABILITY_REQUESTED; and
- include this in IE "UE system specific capability".

If the UE CAPABILITY INFORMATION message is sent because one or more of the UE capabilities change compared to those stored in the variable UE_CAPABILITY_TRANSFERRED while in connected state, the UE shall include the information elements associated with the capabilities that have changed in the UE CAPABILITY INFORMATION message.

If the UE is in CELL_PCH or URA_PCH state, it shall first perform a cell update procedure using the cause "uplink data transmission", see subclause 8.3.1.

The UE RRC shall submit the UE CAPABILITY INFORMATION message to the lower layers for transmission on the uplink DCCH using AM RLC. When the message has been delivered to lower layers for transmission the UE RRC shall start timer T304 and set counter V304 to 1.

8.1.6.3 Reception of an UE CAPABILITY INFORMATION message by the UTRAN

Upon reception of a UE CAPABILITY INFORMATION message, the UTRAN should transmit a UE CAPABILITY INFORMATION CONFIRM message on the downlink DCCH using UM or AM RLC. After the UE CAPABILITY INFORMATION CONFIRM message has been submitted to the lower layers for transmission, the procedure is complete.

8.1.6.4 Reception of the UE CAPABILITY INFORMATION CONFIRM message by the UE

Upon reception of a UE CAPABILITY INFORMATION CONFIRM message, the UE shall:

- stop timer T304;
- if there is an entry for the UE CAPABILITY ENQUIRY message is present in the table "Accepted transactions" in the variable TRANSACTIONS:
 - clear that entry;
- update its variable UE_CAPABILITY_TRANSFERRED with the UE capabilities it has last transmitted to the UTRAN during the current RRC connection;
- clear the variable UE_CAPABILITY_REQUESTED;
- and the procedure ends.

8.1.6.5 Invalid UE CAPABILITY INFORMATION CONFIRM message

If the UE receives a UE CAPABILITY INFORMATION CONFIRM message, which contains a protocol error causing the variable `PROTOCOL_ERROR_REJECT` to be set to `TRUE` according to clause 9, the UE shall perform procedure specific error handling as follows:

- stop timer T304;
- transmit an RRC STATUS message on the uplink DCCH using AM RLC;
- include the IE "Identification of received message"; and
- set the IE "Received message type" to UE CAPABILITY INFORMATION CONFIRM; and
- set the IE "RRC transaction identifier" to the value of "RRC transaction identifier" in the entry for the UE CAPABILITY INFORMATION CONFIRM message in the table "Rejected transactions" in the variable TRANSACTIONS; and
- clear that entry;
- include the IE "Protocol error information" with contents set to the value of the variable `PROTOCOL_ERROR_INFORMATION`;
- when the RRC STATUS message has been submitted to lower layers for transmission:
 - restart timer T304 and continue with any ongoing procedures or processes as if the invalid UE CAPABILITY INFORMATION CONFIRM message has not been received.

8.1.6.6 T304 timeout

Upon expiry of timer T304, the UE shall check the value of V304 and:

- if V304 is smaller than or equal to N304:
 - retransmit a UE CAPABILITY INFORMATION message with the IEs as set in the last unsuccessful attempt, without incrementing "Uplink RRC Message sequence number" for signalling radio bearer RB2 in the variable `INTEGRITY_PROTECTION_INFO`;
 - restart timer T304;
 - increment counter V304;
- if V304 is greater than N304:
 - initiate the Cell update procedure as specified in subclause 8.3.1, using the cause "Radio link failure".

8.1.7 UE capability enquiry

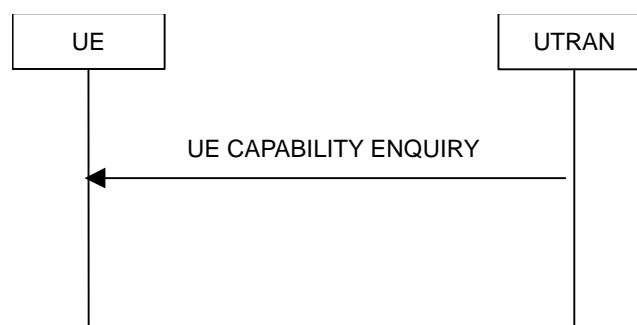

Figure 13: UE capability enquiry procedure, normal flow

8.1.7.1 General

The UE capability enquiry can be used to request the UE to transmit its capability information related to any radio access network that is supported by the UE.

8.1.7.2 Initiation

The UE capability enquiry procedure is initiated by the UTRAN by transmitting a UE CAPABILITY ENQUIRY message on the DCCH using UM or AM RLC.

8.1.7.3 Reception of an UE CAPABILITY ENQUIRY message by the UE

Upon reception of an UE CAPABILITY ENQUIRY message, the UE shall act on the received information elements as specified in subclause 8.6 and initiate the transmission of UE capability information procedure, which is specified in subclause 8.1.6.

8.1.7.4 Invalid UE CAPABILITY ENQUIRY message

If the UE receives a UE CAPABILITY ENQUIRY message, which contains a protocol error causing the variable `PROTOCOL_ERROR_REJECT` to be set to `TRUE` according to clause 9, the UE shall perform procedure specific error handling as follows:

- transmit an RRC STATUS message on the uplink DCCH using AM RLC;
- include the IE "Identification of received message"; and
- set the IE "Received message type" to UE CAPABILITY ENQUIRY; and
- set the IE "RRC transaction identifier" to the value of "RRC transaction identifier" in the entry for the UE CAPABILITY ENQUIRY message in the table "Rejected transactions" in the variable `TRANSACTIONS`; and
- clear that entry;
- include the IE "Protocol error information" with contents set to the value of the variable `PROTOCOL_ERROR_INFORMATION`;
- when the RRC STATUS message has been submitted to lower layers for transmission:
 - continue with the ongoing processes and procedures as if the invalid UE CAPABILITY ENQUIRY message has not been received.

8.1.8 Initial Direct transfer

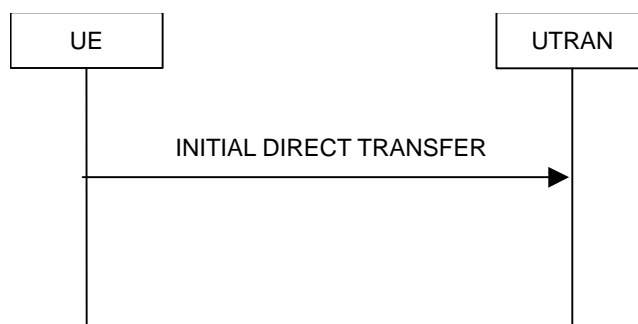

Figure 14: Initial Direct transfer in the uplink, normal flow

8.1.8.1 General

The initial direct transfer procedure is used in the uplink to establish a signalling connection. It is also used to carry an initial upper layer (NAS) message over the radio interface.

8.1.8.2 Initiation of Initial direct transfer procedure in the UE

In the UE, the initial direct transfer procedure shall be initiated, when the upper layers request establishment of a signalling connection. This request also includes a request for the transfer of a NAS message.

Upon initiation of the initial direct transfer procedure when the UE is in idle mode, the UE shall

- set the variable ESTABLISHMENT_CAUSE to the cause for establishment indicated by upper layers;
- perform an RRC connection establishment procedure, according to subclause 8.1.3;
- if the RRC connection establishment procedure was not successful:
 - indicate failure to establish the signalling connection to upper layers and end the procedure;
- when the RRC connection establishment procedure is completed successfully:
 - continue with the initial direct transfer procedure as below;

Upon initiation of the initial direct transfer procedure when the UE is in CELL_PCH or URA_PCH state, the UE shall:

- perform a cell update procedure, according to subclause 8.3.1, using the cause "uplink data transmission";
- when the cell update procedure completed successfully:
 - continue with the initial direct transfer procedure as below.

The UE shall, in the INITIAL DIRECT TRANSFER message:

- set the IE "NAS message" as received from upper layers; and
- set the IE "CN domain identity" as indicated by the upper layers; and
- set the IE "Intra Domain NAS Node Selector" as follows:
 - derive the IE "Intra Domain NAS Node Selector" from TMSI/PMTSI, IMSI, or IMEI; and
 - provide the coding of the IE "Intra Domain NAS Node Selector" according to the following priorities:
 1. derive the routing parameter for IDNNS from TMSI (CS domain) or PTMSI (PS domain) whenever a valid TMSI/PTMSI is available;
 2. base the routing parameter for IDNNS on IMSI when no valid TMSI/PTMSI is available;
 3. base the routing parameter for IDNNS on IMEI only if no (U)SIM is inserted in the UE.

In CELL_FACH state, the UE shall:

- include a measurement report in the IE "Measured results on RACH", as specified in the IE "Intra-frequency reporting quantity for RACH reporting" and the IE "Maximum number of reported cells on RACH" in System Information Block type 12 (or "System Information Block Type 11" if "System Information Block Type 12" is not being broadcast);
- include in the IE "Measured results on RACH" all requested reporting quantities for cells for which measurements are reported.

The UE shall:

- transmit the INITIAL DIRECT TRANSFER message on the uplink DCCH using AM RLC on signalling radio bearer RB3;
- when the INITIAL DIRECT TRANSFER message has been submitted to lower layers for transmission:
 - confirm the establishment of a signalling connection to upper layers; and
 - add the signalling connection with the identity indicated by the IE "CN domain identity" in the variable ESTABLISHED_SIGNALLING_CONNECTIONS; and

- the procedure ends.

When not stated otherwise elsewhere, the UE may also initiate the initial direct transfer procedure when another procedure is ongoing, and in that case the state of the latter procedure shall not be affected.

A new signalling connection request may be received from upper layers subsequent to the indication of the release of a previously established signalling connection to upper layers. From the time of the indication of release to upper layers until the UE has entered idle mode, any such upper layer request to establish a new signalling connection shall be queued. This request shall be processed after the UE has entered idle mode.

8.1.8.3 Reception of INITIAL DIRECT TRANSFER message by the UTRAN

On reception of the INITIAL DIRECT TRANSFER message the NAS message should be routed using the IE "CN Domain Identity". UTRAN may also use the IE "Intra Domain NAS Node Selector" for routing among the CN nodes for the addressed CN domain.

If no signalling connection exists towards the chosen node, then a signalling connection is established.

If the IE "Measured results on RACH" is present in the message, the UTRAN should extract the contents to be used for radio resource control.

When the UTRAN receives an INITIAL DIRECT TRANSFER message, it shall not affect the state of any other ongoing RRC procedures, when not stated otherwise elsewhere.

8.1.9 Downlink Direct transfer



Figure 15: Downlink Direct transfer, normal flow

8.1.9.1 General

The downlink direct transfer procedure is used in the downlink direction to carry upper layer (NAS) messages over the radio interface.

8.1.9.2 Initiation of downlink direct transfer procedure in the UTRAN

In the UTRAN, the direct transfer procedure is initiated when the upper layers request the transfer of a NAS message after the initial signalling connection is established. The UTRAN may also initiate the downlink direct transfer procedure when another RRC procedure is ongoing, and in that case the state of the latter procedure shall not be affected. The UTRAN shall transmit the DOWNLINK DIRECT TRANSFER message on the downlink DCCH using AM RLC on signalling radio bearer RB3 or signalling radio bearer RB4. The UTRAN should:

- if upper layers indicate "low priority" for this message:
 - select signalling radio bearer RB4, if available. Specifically, for a GSM-MAP based CN, signalling radio bearer RB4 should, if available, be selected when "SAPI 3" is requested;
 - select signalling radio bearer RB3 when signalling radio bearer RB4 is not available;
- if upper layers indicate "high priority" for this message:

- select signalling radio bearer RB3. Specifically, for a GSM-MAP based CN, signalling radio bearer RB3 should be selected when "SAPI 0" is requested.

The UTRAN sets the IE "CN Domain Identity" to indicate, which CN domain the NAS message is originated from.

8.1.9.3 Reception of a DOWNLINK DIRECT TRANSFER message by the UE

Upon reception of the DOWNLINK DIRECT TRANSFER message, the UE RRC shall, using the IE "CN Domain Identity", route the contents of the IE "NAS message" and the value of the IE "CN Domain Identity" to upper layers.

The UE shall clear the entry for the DOWNLINK DIRECT TRANSFER message in the table "Accepted transactions" in the variable TRANSACTIONS.

When the UE receives a DOWNLINK DIRECT TRANSFER message, it shall not affect the state of any other ongoing RRC procedures when not stated otherwise elsewhere.

8.1.9.3a No signalling connection exists

If the UE receives a DOWNLINK DIRECT TRANSFER message, and the signalling connection identified with the IE "CN domain identity" does not exist according to the variable ESTABLISHED_SIGNALLING_CONNECTIONS, the UE shall:

- ignore the content of the DOWNLINK DIRECT TRANSFER message;
- transmit an RRC STATUS message on the uplink DCCH using AM RLC;
- include the IE "Identification of received message"; and
- set the IE "Received message type" to DOWNLINK DIRECT TRANSFER; and
- set the IE "RRC transaction identifier" to the value of "RRC transaction identifier" in the entry for the DOWNLINK DIRECT TRANSFER message in the table "Accepted transactions" in the variable TRANSACTIONS; and
- clear that entry;
- include the IE "Protocol error information" with the IE "Protocol error cause" set to "Message not compatible with receiver state".

When the RRC STATUS message has been submitted to lower layers for transmission, the UE shall:

- continue with any ongoing processes and procedures as if the DOWNLINK DIRECT TRANSFER message has not been received.

8.1.9.4 Invalid DOWNLINK DIRECT TRANSFER message

If the UE receives a DOWNLINK DIRECT TRANSFER message, which contains a protocol error causing the variable PROTOCOL_ERROR_REJECT to be set to TRUE according to clause 9, the UE shall perform procedure specific error handling as follows:

- transmit an RRC STATUS message on the uplink DCCH using AM RLC;
- include the IE "Identification of received message"; and
- set the IE "Received message type" to DOWNLINK DIRECT TRANSFER; and
- set the IE "RRC transaction identifier" to the value of "RRC transaction identifier" in the entry for the DOWNLINK DIRECT TRANSFER message in the table "Rejected transactions" in the variable TRANSACTIONS; and
- clear that entry;
- include the IE "Protocol error information" with contents set to the value of the variable PROTOCOL_ERROR_INFORMATION.

When the RRC STATUS message has been submitted to lower layers for transmission, the UE shall:

- continue with any ongoing processes and procedures as if the invalid DOWNLINK DIRECT TRANSFER message has not been received.

8.1.10 Uplink Direct transfer

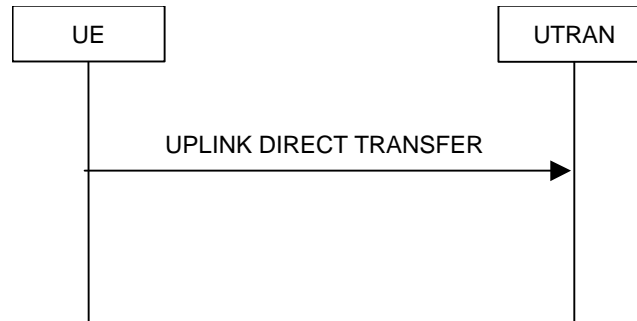

Figure 16: Uplink Direct transfer, normal flow

8.1.10.1 General

The uplink direct transfer procedure is used in the uplink direction to carry all subsequent upper layer (NAS) messages over the radio interface belonging to a signalling connection.

8.1.10.2 Initiation of uplink direct transfer procedure in the UE

In the UE, the uplink direct transfer procedure shall be initiated when the upper layers request a transfer of a NAS message on an existing signalling connection. When not stated otherwise elsewhere, the UE may initiate the uplink direct transfer procedure when another procedure is ongoing, and in that case the state of the latter procedure shall not be affected.

Upon initiation of the uplink direct transfer procedure in CELL_PCH or URA_PCH state, the UE shall:

- perform a cell update procedure, according to subclause 8.3.1, using the cause "uplink data transmission";
- when the cell update procedure has been completed successfully:
 - continue with the uplink direct transfer procedure as below.

The UE shall transmit the UPLINK DIRECT TRANSFER message on the uplink DCCH using AM RLC on signalling radio bearer RB3 or signalling radio bearer RB4. The UE shall:

- if upper layers indicate "low priority" for this message:
 - select signalling radio bearer RB4, if available. Specifically, for a GSM-MAP based CN, signalling radio bearer RB4 shall, if available, be selected when "SAPI 3" is requested;
 - select signalling radio bearer RB3 when signalling radio bearer RB4 is not available;
- if upper layers indicate "high priority" for this message:
 - select signalling radio bearer RB3. Specifically, for a GSM-MAP based CN, signalling radio bearer RB3 shall be selected when "SAPI 0" is requested.

The UE shall set the IE "NAS message" as received from upper layers and set the IE "CN domain identity" as indicated by the upper layers.

When the UPLINK DIRECT TRANSFER message has been submitted to lower layers for transmission the procedure ends.

8.1.10.3 Reception of UPLINK DIRECT TRANSFER message by the UTRAN

On reception of the UPLINK DIRECT TRANSFER message the NAS message should be routed using the value indicated in the IE "CN domain identity".

If the IE "Measured results on RACH" is present in the message, the UTRAN should extract the contents to be used for radio resource control.

When the UTRAN receives an UPLINK DIRECT TRANSFER message, it shall not affect the state of any other ongoing RRC procedures, when not stated otherwise elsewhere.

8.1.11 UE dedicated paging

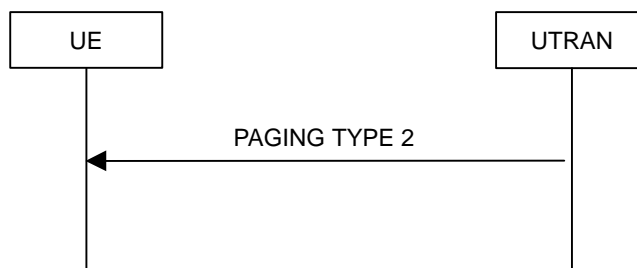

Figure 17: UE dedicated paging

8.1.11.1 General

This procedure is used to transmit dedicated paging information to one UE in connected mode in CELL_DCH or CELL_FACH state. Upper layers in the network may request initiation of paging.

8.1.11.2 Initiation

For a UE in CELL_DCH or CELL_FACH state, UTRAN initiates the procedure by transmitting a PAGING TYPE 2 message on the DCCH using AM RLC. When not stated otherwise elsewhere, the UTRAN may initiate the UE dedicated paging procedure also when another RRC procedure is ongoing, and in that case the state of the latter procedure shall not be affected.

UTRAN should set the IE "Paging cause" to the cause for paging received from upper layers. If no cause for paging is received from upper layers, UTRAN should set the value "Terminating – cause unknown".

8.1.11.3 Reception of a PAGING TYPE 2 message by the UE

When the UE receives a PAGING TYPE 2 message, it shall not affect the state of any other ongoing RRC procedures, when not stated otherwise elsewhere.

The UE shall:

- indicate reception of paging; and
- forward the IE "Paging cause" and the IE "Paging record type identifier" to upper layers.

The UE shall:

- clear the entry for the PAGING TYPE 2 message in the table "Accepted transactions" in the variable TRANSACTIONS.

8.1.11.4 Invalid PAGING TYPE 2 message

If the UE receives a PAGING TYPE 2 message, which contains a protocol error causing the variable PROTOCOL_ERROR_REJECT to be set to TRUE according to clause 9, the UE shall perform procedure specific error handling as follows:

- transmit an RRC STATUS message on the uplink DCCH using AM RLC;
- include the IE "Identification of received message"; and
- set the IE "Received message type" to PAGING TYPE 2; and
- set the IE "RRC transaction identifier" to the value of "RRC transaction identifier" in the entry for the PAGING TYPE 2 message in the table "Rejected transactions" in the variable TRANSACTIONS; and
- clear that entry;
- include the IE "Protocol error information" with contents set to the value of the variable PROTOCOL_ERROR_INFORMATION.
- when the RRC STATUS message has been submitted to lower layers for transmission:
 - continue with any ongoing processes and procedures as if the invalid PAGING TYPE 2 message has not been received.

8.1.12 Security mode control

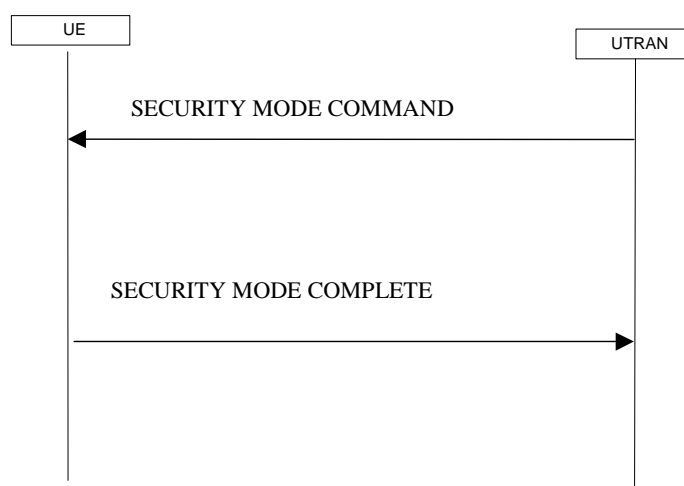

Figure 18: Security mode control procedure

8.1.12.1 General

The purpose of this procedure is to trigger the stop or start of ciphering or to command the restart of the ciphering with a new ciphering configuration, for all radio bearers and for all signalling radio bearers.

It is also used to start integrity protection or to modify the integrity protection configuration for all signalling radio bearers.

8.1.12.2 Initiation

8.1.12.2.1 Ciphering configuration change

To stop or start/restart ciphering, UTRAN sends a SECURITY MODE COMMAND message on the downlink DCCH in AM RLC using the most recent ciphering configuration. If no such ciphering configuration exists then the SECURITY MODE COMMAND is not ciphered.

Prior to sending the SECURITY MODE COMMAND, for the CN domain indicated in the IE "CN domain identity" in the SECURITY MODE COMMAND, UTRAN should:

- if this is the first SECURITY MODE COMMAND sent for this RRC connection:

- use the value "START" in the most recently received IE "START list" that belongs to the CN domain as indicated in the IE "CN domain identity" to initialise all hyper frame numbers for all the signalling radio bearers; while
 - setting the 20 most significant bits of the hyper frame numbers for all signalling radio bearers to the START for that CN domain;
 - setting the remaining bits of the hyper frame numbers equal to zero;
- suspend all radio bearers using RLC-AM and RLC-UM;
- suspend all signalling radio bearers using RLC-AM and RLC-UM, except the signalling radio bearer used to send the SECURITY MODE COMMAND message on the downlink DCCH in RLC-AM;
- set, for the signalling radio bearer used to send the SECURITY MODE COMMAND, the "RLC send sequence number" in IE "Radio bearer downlink ciphering activation time info" in the IE "Ciphering mode info", at which time the new ciphering configuration shall be applied;
- include "Ciphering activation time for DPCH" in IE "Ciphering mode info" when a DPCH exists and is used for radio bearers using transparent mode RLC, at which time the new ciphering configuration shall be applied;
- set, for each suspended radio bearer and signalling radio bearer that has no pending ciphering activation time set by a previous security mode control procedure, an "RLC send sequence number" in IE "Radio bearer downlink ciphering activation time info" in the IE "Ciphering mode info", at which time the new ciphering configuration shall be applied;
- set, for each suspended radio bearer and signalling radio bearer that has a pending ciphering activation time set by a previous security mode control procedure, the "RLC send sequence number" in IE "Radio bearer downlink ciphering activation time info" in the IE "Ciphering mode info" to the value used in the previous security mode control procedure, at which time the latest ciphering configuration shall be applied.

While suspended, radio bearers and signalling radio bearers shall not deliver RLC PDUs with sequence number greater than or equal to the number in IE "Radio bearer downlink ciphering activation time info".

When the successful delivery of the SECURITY MODE COMMAND has been confirmed by RLC, UTRAN shall:

- resume all the suspended radio bearers and signalling radio bearers. The old ciphering configuration shall be applied for the transmission of RLC PDUs with RLC sequence number less than the number indicated in the IE "Radio bearer downlink ciphering activation time info", as sent to the UE. The new ciphering configuration shall be applied for the transmission of RLC PDUs with RLC sequence number greater than or equal to the number indicated in IE "Radio bearer downlink ciphering activation time info", sent to the UE.

8.1.12.2.2 Integrity protection configuration change

To start or modify integrity protection, UTRAN sends a SECURITY MODE COMMAND message on the downlink DCCH in AM RLC using the new integrity protection configuration.

When the successful delivery of the SECURITY MODE COMMAND has been confirmed by RLC, UTRAN should:

- for the signalling radio bearers:
 - send an indication to upper layers that the new integrity protection configuration has been activated when the activation time has elapsed.

8.1.12.3 Reception of SECURITY MODE COMMAND message by the UE

Upon reception of the SECURITY MODE COMMAND message, the UE shall perform the actions for the received information elements according to subclause 8.6.

If the IE "Ciphering mode info" and the IE "Integrity protection mode info" are both not included in the SECURITY MODE COMMAND, the UE shall:

- set the variable INVALID_CONFIGURATION to TRUE.

If the IE "Security capability" is the same as indicated by variable UE_CAPABILITY_TRANSFERRED, and the IE "GSM security capability" (if included in the SECURITY MODE COMMAND) is the same as indicated by the variable UE_CAPABILITY_TRANSFERRED, the UE shall:

- set the variable LATEST_CONFIGURED_CN_DOMAIN equal to the IE "CN domain identity";
- if prior to the reception of SECURITY MODE COMMAND, the value of the IE "Status" in the variable "CIPHERING_STATUS" of the CN domain stored in the variable LATEST_CONFIGURED_CN_DOMAIN is "Not started" and the value of the IE "Historical status" in the variable "INTEGRITY_PROTECTION_INFO" is "Never been active":
 - use the value "START" in the most recently sent IE "START list" that belongs to the CN domain as indicated in the IE "CN domain identity" to initialise all hyper frame numbers for all the signalling radio bearers; while
 - setting the 20 most significant bits of the hyper frame numbers for all signalling radio bearers to the START for that CN domain;
 - setting the remaining bits of the hyper frame numbers equal to zero;
- suspend all radio bearers and signalling radio bearers (except the signalling radio bearer used to transmit the SECURITY MODE COMPLETE message on the uplink DCCH in RLC-AM) using RLC-AM or RLC-UM that belong to the CN domain indicated in the IE "CN domain identity"; and
- set the "RLC send sequence number" in IE "Radio bearer uplink ciphering activation time info", at which time the new ciphering configuration shall be applied;
- set the IE "RRC transaction identifier" in the SECURITY MODE COMPLETE message to the value of "RRC transaction identifier" in the entry for the SECURITY MODE COMMAND message in the table "Accepted transactions" in the variable TRANSACTIONS; and
- clear that entry;
- if the SECURITY MODE COMMAND message contained the IE "Ciphering mode info":
 - include and set the IE "Radio bearer uplink ciphering activation time info" to the value of the variable RB_UPLINK_CIPHERING_ACTIVATION_TIME_INFO, for the respective radio bearer and signalling radio bearer;
- if the SECURITY MODE COMMAND message contained the IE "Integrity protection mode info" with the IE "Integrity protection mode command" set to "Modify":
 - include and set the IE "Integrity protection activation info" to the value of the variable INTEGRITY_PROTECTION_ACTIVATION_INFO;
- for radio bearers using RLC-TM:
 - apply the old ciphering configuration for the receiving and transmission of RLC TrD PDUs with CFN less than the number indicated in the IE "Ciphering activation time for DPCH", as sent by the UTRAN;
 - apply the new ciphering configuration for the receiving and transmission of RLC TrD PDUs with CFN greater than or equal to the number indicated in IE "Ciphering activation time for DPCH", as sent by the UTRAN;
- when the radio bearers and signalling radio bearers using RLC-AM or RLC-UM have been suspended:
 - send a SECURITY MODE COMPLETE message on the uplink DCCH in AM RLC, using the old ciphering configurations;
 - if the IE "Integrity protection mode info" was present in the SECURITY MODE COMMAND message:
 - start applying the new integrity protection configuration in the uplink for signalling radio bearer RB2 from and including the transmitted SECURITY MODE COMPLETE message;
- when the successful delivery of the SECURITY MODE COMPLETE message has been confirmed by RLC:

- resume data transmission on any suspended radio bearer and signalling radio bearer mapped on RLC-AM or RLC-UM;
- if the SECURITY MODE COMMAND message contained the IE "Ciphering mode info":
 - set the IE "Reconfiguration" in the variable CIPHERING_STATUS to FALSE; and
 - clear the variable RB_UPLINK_CIPHERING_ACTIVATION_TIME_INFO;
- if the SECURITY MODE COMMAND message contained the IE "Integrity protection mode info":
 - set the IE "Reconfiguration" in the variable INTEGRITY_PROTECTION_INFO to FALSE; and
 - clear the variable INTEGRITY_PROTECTION_ACTIVATION_INFO;
- the procedure ends. If a RLC reset or re-establishment occurs after the SECURITY MODE COMPLETE message has been confirmed by RLC, but before the activation time for the new ciphering configuration has been reached, then the activation time shall be ignored and the new ciphering configuration shall be applied immediately after the RLC reset or RLC re-establishment;
- notify upper layers upon change of the security configuration;
- if a new security key set has been received for the CN domain as indicated in the variable LATEST_CONFIGURED_CN_DOMAIN:
 - set the START value for this CN domain to 0.

For radio bearers and signalling radio bearers used by the CN indicated in the IE "CN domain identity", the UE shall:

- if a new integrity protection key has been received:
 - in the downlink:
 - use the new key;
 - set the IE "Downlink RRC HFN" for all signalling radio bearers in the variable INTEGRITY_PROTECTION_INFO of the downlink COUNT-I to zero when the RRC sequence number in a received RRC message on the particular signalling radio bearer reaches the value for that signalling radio bearer indicated in IE "Downlink integrity protection activation info" included in the IE "Integrity protection mode info";
 - in the uplink:
 - use the new key;
 - set the IE "Uplink RRC HFN" for all signalling radio bearers in the variable INTEGRITY_PROTECTION_INFO of the uplink COUNT-I to zero when the RRC sequence number in a transmitted RRC message on the particular signalling radio bearer reaches the value for that signalling radio bearer indicated in IE "Uplink integrity protection activation info";
- if a new ciphering key is available:
 - for radio bearers using RLC-TM:
 - use the new key in uplink and downlink;
 - set the HFN component of the COUNT-C to zero at the CFN as indicated in the IE "Ciphering activation time for DPCH" in the IE "Ciphering mode info";
 - for radio bearers using RLC-AM and RLC-UM:
 - in the downlink, at and after the RLC sequence number indicated in IE "Radio bearer downlink ciphering activation time info" in the IE "Ciphering mode info":
 - use the new key;
 - set the HFN component of the downlink COUNT-C to zero;

- in the uplink, at and after the RLC sequence number indicated in IE "Radio bearer uplink ciphering activation time info":
 - use the new key;
 - set the HFN component of the uplink COUNT-C to zero.

If the IE "Security capability" is not the same as indicated by the variable UE_CAPABILITY_TRANSFERRED, or the IE "GSM security capability" (if included in the SECURITY MODE COMMAND) is not the same as indicated by the variable UE_CAPABILITY_TRANSFERRED, or if the IE "GSM security capability" is not included in the SECURITY MODE COMMAND and is included in the variable UE_CAPABILITY_TRANSFERRED, the UE shall:

- release all its radio resources;
- indicate the release of the established signalling connections (as stored in the variable ESTABLISHED_SIGNALLING_CONNECTIONS) and established radio access bearers (as stored in the variable ESTABLISHED_RABS) to upper layers;
- clear the variable ESTABLISHED_SIGNALLING_CONNECTIONS;
- clear the variable ESTABLISHED_RABS;
- enter idle mode;
- perform actions when entering idle mode as specified in subclause 8.5.2;
- and the procedure ends.

8.1.12.4 Void

8.1.12.4a Incompatible simultaneous security reconfiguration

If the variable INCOMPATIBLE_SECURITY_RECONFIGURATION becomes set to TRUE of the received SECURITY MODE COMMAND message, the UE shall:

- transmit a SECURITY MODE FAILURE message on the uplink DCCH using AM RLC, using the ciphering and integrity protection configurations prior to the reception of this SECURITY MODE COMMAND;
- set the IE "RRC transaction identifier" in the SECURITY MODE FAILURE message to the value of "RRC transaction identifier" in the entry for the SECURITY MODE COMMAND message in the table "Accepted transactions" in the variable TRANSACTIONS; and
- clear that entry;
- set the IE "failure cause" to the cause value "incompatible simultaneous reconfiguration";
- when the successful delivery of the SECURITY MODE FAILURE message has been confirmed by RLC:
 - set the variable INCOMPATIBLE_SECURITY_RECONFIGURATION to FALSE;
 - continue with any ongoing processes and procedures as if the invalid SECURITY MODE COMMAND message has not been received;
- and the procedure ends.

8.1.12.4b Cell update procedure during security reconfiguration

If:

- a cell update procedure according to subclause 8.3.1 is initiated; and
- the received SECURITY MODE COMMAND message causes either,

- the IE "Reconfiguration" in the variable CIPHERING_STATUS to be set to TRUE; and/or
- the IE "Reconfiguration" in the variable INTEGRITY_PROTECTION_INFO to be set to TRUE:

the UE shall:

- abort the ongoing integrity and/or ciphering reconfiguration;
- resume data transmission on any suspended radio bearer and signalling radio bearer mapped on RLC-AM or RLC-UM;
- transmit a SECURITY MODE FAILURE message on the uplink DCCH using AM RLC, using the ciphering and integrity protection configurations prior to the reception of this SECURITY MODE COMMAND;
- set the IE "RRC transaction identifier" in the SECURITY MODE FAILURE message to the value of "RRC transaction identifier" in the entry for the SECURITY MODE COMMAND message in the table "Accepted transactions" in the variable TRANSACTIONS; and
- clear that entry;
- set the IE "failure cause" to the cause value "cell update occurred";
- when the successful delivery of the SECURITY MODE FAILURE message has been confirmed by RLC:
 - if the SECURITY MODE COMMAND message contained the IE "Ciphering mode info":
 - set the IE "Reconfiguration" in the variable CIPHERING_STATUS to FALSE; and
 - clear the variable RB_UPLINK_CIPHERING_ACTIVATION_TIME_INFO;
 - if the SECURITY MODE COMMAND message contained the IE "Integrity protection mode info":
 - set the IE "Reconfiguration" in the variable INTEGRITY_PROTECTION_INFO to FALSE; and
 - clear the variable INTEGRITY_PROTECTION_ACTIVATION_INFO;
 - continue with any ongoing processes and procedures as if the invalid SECURITY MODE COMMAND message has not been received; and
 - the procedure ends.

8.1.12.4c Invalid configuration

If the variable INVALID_CONFIGURATION is set to TRUE due to the received SECURITY MODE COMMAND message, the UE shall:

- transmit a SECURITY MODE FAILURE message on the DCCH using AM RLC after setting the IEs as specified below;
 - set the IE "RRC transaction identifier" in the SECURITY MODE FAILURE message to the value of "RRC transaction identifier" in the entry for the SECURITY MODE COMMAND message in the table "Accepted transactions" in the variable TRANSACTIONS; and
 - clear that entry;
 - set the IE "failure cause" to the cause value "invalid configuration";
- when the successful delivery of the SECURITY MODE FAILURE message has been confirmed by RLC:
 - set the variable INVALID_CONFIGURATION to FALSE;
 - continue with any ongoing processes and procedures as if the invalid SECURITY MODE COMMAND message has not been received;
 - and the procedure ends.

8.1.12.5 Reception of SECURITY MODE COMPLETE message by the UTRAN

UTRAN should apply integrity protection on the received SECURITY MODE COMPLETE message and all subsequent messages with the new integrity protection configuration, if changed. When UTRAN has received a SECURITY MODE COMPLETE message and the integrity protection has successfully been applied, UTRAN shall:

- for radio bearers using RLC-AM or RLC-UM:
 - use the old ciphering configuration for received RLC PDUs with RLC sequence number less than the RLC sequence number indicated in the IE "Radio bearer uplink ciphering activation time info" sent by the UE;
 - use the new ciphering configuration for received RLC PDUs with RLC sequence number greater than or equal to the RLC sequence number indicated in the IE "Radio bearer uplink ciphering activation time info" sent by the UE;
 - if an RLC reset or re-establishment occurs after the SECURITY MODE COMPLETE message has been received by UTRAN before the activation time for the new ciphering configuration has been reached, ignore the activation time and apply the new ciphering configuration immediately after the RLC reset or RLC re-establishment;
- for radio bearers using RLC-TM:
 - use the old ciphering configuration for the received RLC PDUs before the CFN as indicated in the IE "Ciphering activation time for DPCH" in the IE "Ciphering mode info" as included in the SECURITY MODE COMMAND;
 - use the new ciphering configuration for the received RLC PDUs at the CFN as indicated in the IE "Ciphering activation time for DPCH" in the IE "Ciphering mode info" as included in the SECURITY MODE COMMAND;
- and the procedure ends.

8.1.12.6 Invalid SECURITY MODE COMMAND message

If the SECURITY MODE COMMAND message contains a protocol error causing the variable PROTOCOL_ERROR_REJECT to be set to TRUE according to clause 9, the UE shall perform procedure specific error handling as follows:

- transmit a SECURITY MODE FAILURE message on the uplink DCCH using AM RLC;
- set the IE "RRC transaction identifier" in the SECURITY MODE FAILURE message to the value of "RRC transaction identifier" in the entry for the SECURITY MODE COMMAND message in the table "Rejected transactions" in the variable TRANSACTIONS; and
- clear that entry;
- set the IE "failure cause" to the cause value "protocol error";
- include the IE "Protocol error information" with contents set to the value of the variable PROTOCOL_ERROR_INFORMATION.
- when the successful delivery of the SECURITY MODE FAILURE message has been confirmed by RLC:
 - continue with any ongoing processes and procedures as if the invalid SECURITY MODE COMMAND message has not been received;
 - and the procedure ends.

8.1.13 Signalling connection release procedure



Figure 19: Signalling connection release procedure, normal case

8.1.13.1 General

The signalling connection release procedure is used to notify to the UE that one of its ongoing signalling connections has been released. The procedure does not initiate the release of the RRC connection.

8.1.13.2 Initiation of SIGNALLING CONNECTION RELEASE by the UTRAN

To initiate the procedure, the UTRAN transmits a SIGNALLING CONNECTION RELEASE message on DCCH using AM RLC.

8.1.13.3 Reception of SIGNALLING CONNECTION RELEASE by the UE

Upon reception of a SIGNALLING CONNECTION RELEASE message, the UE shall:

- indicate the release of the signalling connection and pass the value of the IE "CN domain identity" to upper layers;
- remove the signalling connection with the identity indicated by the IE "CN domain identity" from the variable ESTABLISHED_SIGNALLING_CONNECTIONS;
- clear the entry for the SIGNALLING CONNECTION RELEASE message in the table "Accepted transactions" in the variable TRANSACTIONS;
- the procedure ends.

8.1.13.4 Invalid SIGNALLING CONNECTION RELEASE message

If the UE receives a SIGNALLING CONNECTION RELEASE message, which contains a protocol error causing the variable `PROTOCOL_ERROR_REJECT` to be set to `TRUE` according to clause 9, the UE shall perform procedure specific error handling as follows:

- include the IE "Identification of received message"; and
- set the IE "Received message type" to SIGNALLING CONNECTION RELEASE;
- set the IE "RRC transaction identifier" to the value of "RRC transaction identifier" in the entry for the SIGNALLING CONNECTION RELEASE message in the table "Rejected transactions" in the variable TRANSACTIONS; and
- clear that entry;
- include the IE "Protocol error information" with contents set to the value of the variable `PROTOCOL_ERROR_INFORMATION`;
- transmit an RRC STATUS message on the uplink DCCH using AM RLC

- when the RRC STATUS message has been submitted to lower layers for transmission:
 - continue with any ongoing processes and procedures as if the invalid SIGNALLING CONNECTION RELEASE message has not been received.

8.1.13.5 Invalid configuration

If radio access bearers for the CN domain indicated by the IE "CN domain identity" exist in the variable ESTABLISHED_RABS, the UE shall:

- transmit an RRC STATUS message on the uplink DCCH using AM RLC
- include the IE "Identification of received message"; and
- set the IE "Received message type" to SIGNALLING CONNECTION RELEASE; and
- set the IE "RRC transaction identifier" to the value of "RRC transaction identifier" in the entry for the SIGNALLING CONNECTION RELEASE message in the table "Accepted transactions" in the variable TRANSACTIONS and clear that entry;
- include the IE "Protocol error information" with contents set to the value "Message not compatible with receiver state";
- when the RRC STATUS message has been submitted to lower layers for transmission:
 - continue with any ongoing processes and procedures as if the invalid SIGNALLING CONNECTION RELEASE message has not been received.

8.1.14 Signalling connection release indication procedure

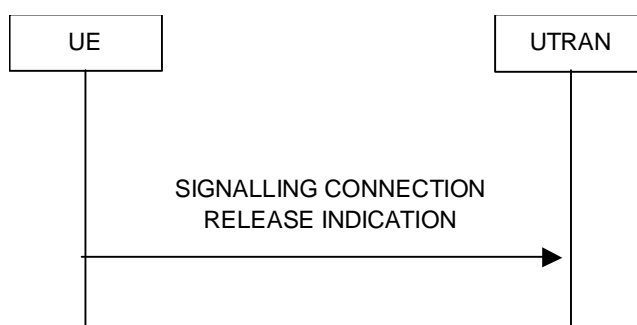

Figure 20: Signalling connection release indication procedure, normal case

8.1.14.1 General

The signalling connection release indication procedure is used by the UE to indicate to the UTRAN that one of its signalling connections has been released. The procedure may in turn initiate the RRC connection release procedure.

8.1.14.2 Initiation

The UE shall, on receiving a request to release (abort) the signalling connection from upper layers:

- initiate the signalling connection release indication procedure.

Upon initiation of the signalling connection release indication procedure in CELL_PCH or URA_PCH state, the UE shall:

- perform a cell update procedure, according to subclause 8.3.1, using the cause "uplink data transmission";
- when the cell update procedure completed successfully:
 - continue with the signalling connection release indication procedure as below;

The UE shall:

- set the IE "CN Domain Identity" to the value indicated by the upper layers. The value of the IE indicates the CN domain whose associated signalling connection the upper layers are indicating to be released;
- remove the signalling connection with the identity indicated by upper layers from the variable ESTABLISHED_SIGNALLING_CONNECTIONS;
- transmit a SIGNALLING CONNECTION RELEASE INDICATION message on DCCH using AM RLC.

When the SIGNALLING CONNECTION RELEASE INDICATION message has been submitted to lower layers for transmission the procedure ends.

8.1.14.3 Reception of SIGNALLING CONNECTION RELEASE INDICATION by the UTRAN

Upon reception of a SIGNALLING CONNECTION RELEASE INDICATION message, the UTRAN requests the release of the signalling connection from upper layers. Upper layers may then initiate the release of the signalling connection.

8.1.15 Counter check procedure

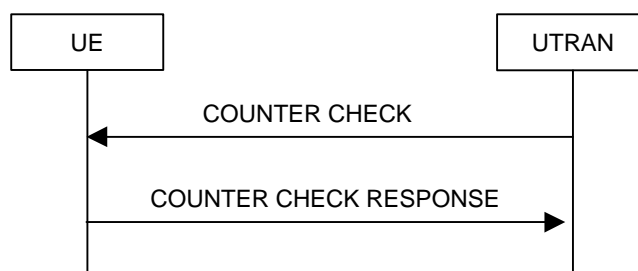

Figure 21: Counter check procedure

8.1.15.1 General

The counter check procedure is used by the UTRAN to perform a local authentication. The purpose of the procedure is to check that the amount of data sent in both directions (uplink and downlink) over the duration of the RRC connection is identical at the UTRAN and at the UE (to detect a possible intruder – a 'man-in-the-middle' – from operating). It should be noted that this requires that the COUNT-C values for each UL and DL radio bearer are maintained even if ciphering is not used. This procedure is only applicable to radio bearers using UM or AM mode of RLC. In this version, this procedure is not applied for radio bearers using transparent mode RLC.

8.1.15.2 Initiation

The UTRAN monitors the COUNT-C value associated with each radio bearer using UM or AM RLC. The procedure is triggered whenever any of these values reaches a critical checking value. The granularity of these checking values and the values themselves are defined to the UTRAN by the visited network. The UTRAN initiates the procedure by sending a COUNTER CHECK message on the downlink DCCH.

8.1.15.3 Reception of a COUNTER CHECK message by the UE

When the UE receives a COUNTER CHECK message it shall compare the COUNT-C MSB values received in the IE "RB COUNT-C MSB information" in the COUNTER CHECK message to the COUNT-C MSB values of the corresponding radio bearers.

The UE shall:

- set the IE "RRC transaction identifier" in the COUNTER CHECK RESPONSE message to the value of "RRC transaction identifier" in the entry for the COUNTER CHECK message in the table "Accepted transactions" in the variable TRANSACTIONS; and

- clear that entry.

If

- there is one or more radio bearer(s) using UM or AM RLC mode stored in the variable ESTABLISHED_RABS, which is (are) not included in the IE "RB COUNT-C MSB information"; or
- there is one or more radio bearer(s) included in the IE "RB COUNT-C MSB information", which is (are) not stored in the variable ESTABLISHED_RABS; or
- for any radio bearer (excluding signalling radio bearers) using UM or AM RLC mode stored in the variable ESTABLISHED_RABS and included in the IE "RB COUNT-C MSB information" with COUNT-C MSB values different from the MSB part of the COUNT-C values in the UE

the UE shall:

- include these radio bearers in the IE "RB COUNT-C information" in the COUNTER CHECK RESPONSE message. For any RB which is included in the IE "RB COUNT-C MSB information" in the COUNTER CHECK message but not stored in the variable ESTABLISHED_RABS in the UE, the MSB part of COUNT-C values in the COUNTER CHECK RESPONSE message shall be set identical to COUNT-C-MSB values in the COUNTER CHECK message. The LSB part shall be filled by 0s;

The UE shall:

- submit a COUNTER CHECK RESPONSE message to lower layers for transmission on the uplink DCCH using AM RLC.

When the COUNTER CHECK RESPONSE message has been submitted to lower layers for transmission the procedure ends.

8.1.15.4 Reception of the COUNTER CHECK RESPONSE message by UTRAN

If the UTRAN receives a COUNTER CHECK RESPONSE message that does not contain any COUNT-C values, the procedure ends.

If the UTRAN receives a COUNTER CHECK RESPONSE message that contains one or several COUNT-C values the UTRAN may release the RRC connection.

8.1.15.5 Cell re-selection

If the UE performs cell re-selection anytime during this procedure it shall, without interrupting the procedure:

- initiate the cell update procedure according to subclause 8.3.1.

8.1.15.6 Invalid COUNTER CHECK message

If the UE receives a COUNTER CHECK message, which contains a protocol error causing the variable PROTOCOL_ERROR_REJECT to be set to TRUE according to clause 9, the UE shall perform procedure specific error handling as follows. The UE shall:

- transmit an RRC STATUS message on the uplink DCCH using AM RLC;
- include the IE "Identification of received message"; and
- set the IE "Received message type" to COUNTER CHECK; and
- set the IE "RRC transaction identifier" to the value of "RRC transaction identifier" in the entry for the UE COUNTER CHECK message in the table "Rejected transactions" in the variable TRANSACTIONS; and
- clear that entry;
- include the IE "Protocol error information" with contents set to the value of the variable PROTOCOL_ERROR_INFORMATION;
- when the RRC STATUS message has been submitted to lower layers for transmission:

- continue with any ongoing processes and procedures as if the invalid COUNTER CHECK message has not been received.

8.2 Radio Bearer control procedures

8.2.1 Radio bearer establishment

See subclause 8.2.2 Reconfiguration procedures.

8.2.2 Reconfiguration procedures

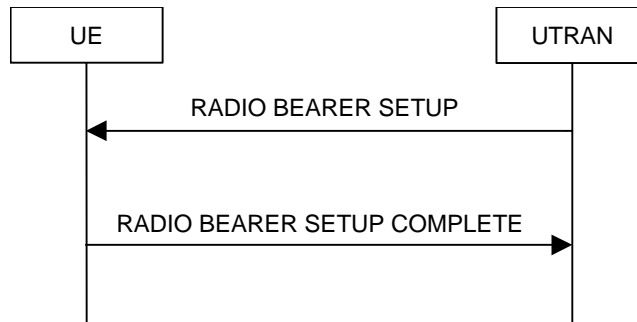

Figure 22: Radio Bearer Establishment, normal case

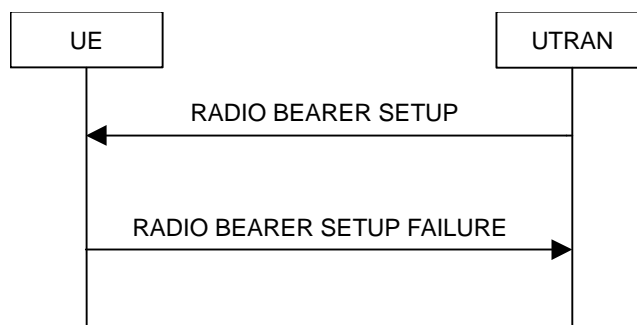

Figure 23: Radio Bearer Establishment, failure case

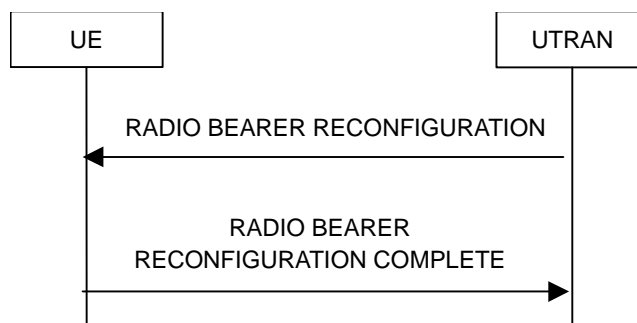

Figure 24: Radio bearer reconfiguration, normal flow

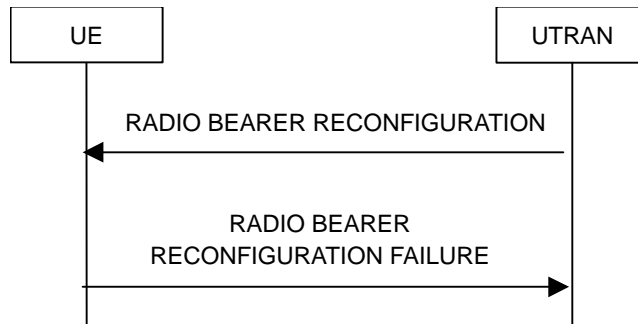

Figure 25: Radio bearer reconfiguration, failure case

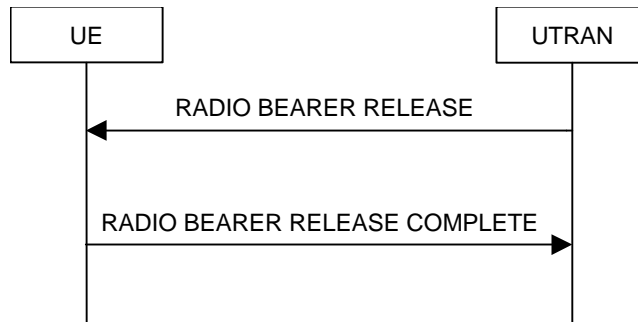

Figure 26: Radio Bearer Release, normal case

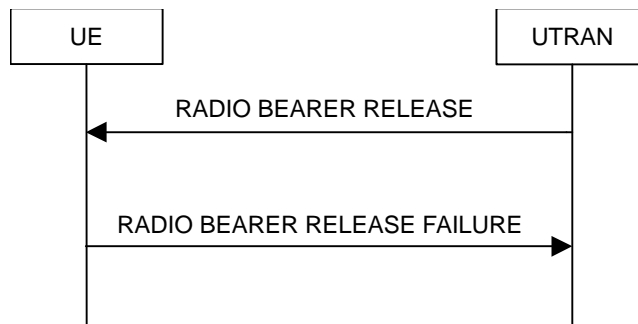

Figure 27: Radio Bearer Release, failure case

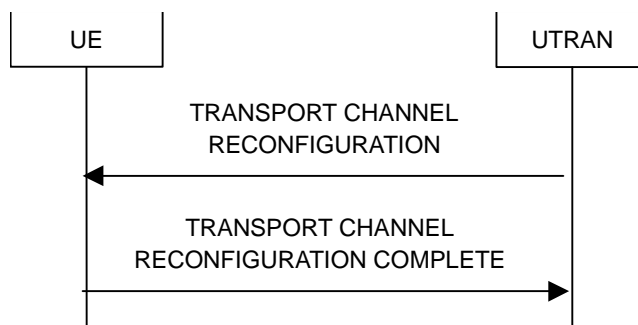

Figure 28: Transport channel reconfiguration, normal flow

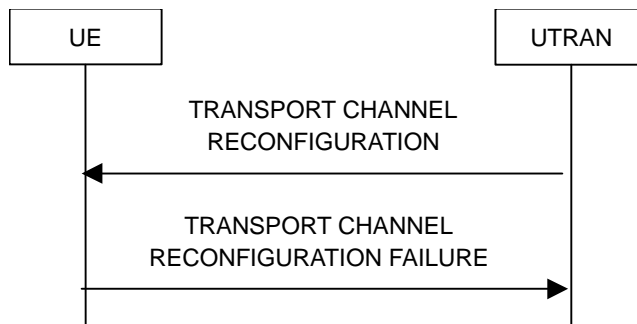

Figure 29: Transport channel reconfiguration, failure case

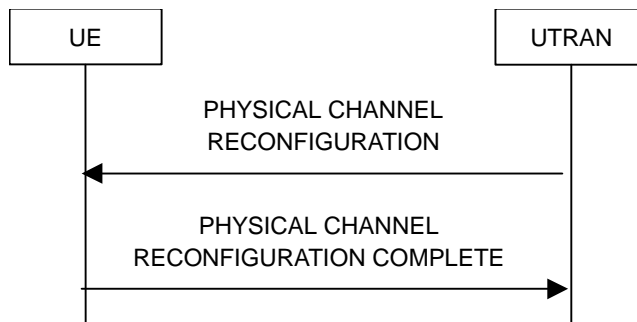

Figure 30: Physical channel reconfiguration, normal flow

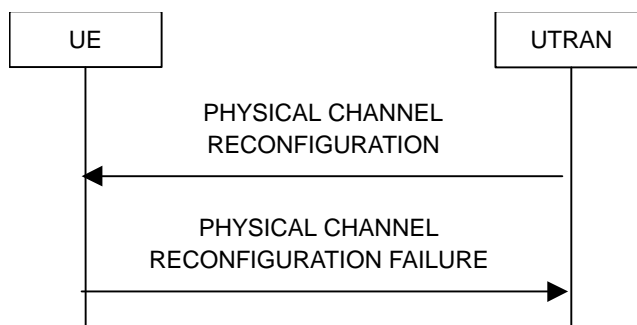

Figure 31: Physical channel reconfiguration, failure case

8.2.2.1 General

Reconfiguration procedures include the following procedures:

- the radio bearer establishment procedure;
- radio bearer reconfiguration procedure;
- the radio bearer release procedure;
- the transport channel reconfiguration procedure; and
- the physical channel reconfiguration procedure.

The radio bearer establishment procedure is used to establish new radio bearer(s).

The radio bearer reconfiguration procedure is used to reconfigure parameters for a radio bearer.

The radio bearer release procedure is used to release radio bearer(s).

The transport channel reconfiguration procedure is used to reconfigure transport channel parameters.

The physical channel reconfiguration procedure is used to establish, reconfigure and release physical channels.

While performing any of the above procedures, these procedures may perform a hard handover - see subclause 8.3.5.

8.2.2.2 Initiation

To initiate any one of the reconfiguration procedures, UTRAN should:

- configure new radio links in any new physical channel configuration;
- start transmission and reception on the new radio links;
- for a radio bearer establishment procedure:
 - transmit a RADIO BEARER SETUP message on the downlink DCCH using AM or UM RLC;
- for a radio bearer reconfiguration procedure:
 - transmit a RADIO BEARER RECONFIGURATION message on the downlink DCCH using AM or UM RLC;
- for a radio bearer release procedure:
 - transmit a RADIO BEARER RELEASE message on the downlink DCCH using AM or UM RLC;
- for a transport channel reconfiguration procedure:
 - transmit a TRANSPORT CHANNEL RECONFIGURATION message on the downlink DCCH using AM or UM RLC;
- for a physical channel reconfiguration procedure:
 - transmit a PHYSICAL CHANNEL RECONFIGURATION message on the downlink DCCH using AM or UM RLC;
- if the reconfiguration procedure is simultaneous with SRNS relocation procedure:
 - include the IE "Downlink counter synchronisation info"; and
 - if ciphering and/or integrity protection are activated:
 - include new ciphering and/or integrity protection configuration information to be used after reconfiguration;
 - use the downlink DCCH using AM RLC;
- if transport channels are added, reconfigured or deleted in uplink and/or downlink:
 - set TFCS according to the new transport channel(s).
- if transport channels are added or deleted in uplink and/or downlink, and RB Mapping Info applicable to the new configuration has not been previously provided to the UE, the UTRAN should:
 - send the RB Mapping Info for the new configuration.

In the Radio Bearer Reconfiguration procedure UTRAN may indicate that uplink transmission shall be stopped or continued on certain radio bearers. Uplink transmission on a signalling radio bearer used by the RRC signalling (signalling radio bearer RB1 or signalling radio bearer RB2) should not be stopped.

NOTE 1: The RADIO BEARER RECONFIGURATION message always includes the IE "RB information to reconfigure", even if UTRAN does not require the reconfiguration of any RB. In these cases, UTRAN may include only the IE "RB identity" within the IE "RB information to reconfigure".

NOTE 2: The RADIO BEARER RECONFIGURATION message always includes the IE "Downlink information per radio link list", even if UTRAN does not require the reconfiguration of any RL. In these cases, UTRAN may re-send the currently assigned values for the mandatory IEs included within the IE "Downlink information per radio link list ". Moreover, the RADIO BEARER RECONFIGURATION message always includes the IE "Primary CPICH Info" (FDD) or IE "Primary CCPCH Info" (TDD). This implies that in case UTRAN applies the RADIO BEARER RECONFIGURATION message to move the UE to CELL_FACH state, it has to indicate a cell. However, UTRAN may indicate any cell; the UE anyhow performs cell selection and notifies UTRAN if it selects another cell than indicated by UTRAN.

If the IE "Activation Time" is included, UTRAN should set it to a value taking the UE performance requirements into account.

UTRAN should take the UE capabilities into account when setting the new configuration.

If the message is used to initiate a transition from CELL_DCH to CELL_FACH state, the UTRAN may assign a common channel configuration of a given cell and C-RNTI to be used in that cell to the UE.

8.2.2.3 Reception of RADIO BEARER SETUP or RADIO BEARER RECONFIGURATION or RADIO BEARER RELEASE or TRANSPORT CHANNEL RECONFIGURATION or PHYSICAL CHANNEL RECONFIGURATION message by the UE

The UE shall be able to receive any of the following messages:

- RADIO BEARER SETUP message; or
- RADIO BEARER RECONFIGURATION message; or
- RADIO BEARER RELEASE message; or
- TRANSPORT CHANNEL RECONFIGURATION message; or
- PHYSICAL CHANNEL RECONFIGURATION message

and perform a hard handover, even if no prior UE measurements have been performed on the target cell and/or frequency.

If the UE receives:

- a RADIO BEARER SETUP message; or
- a RADIO BEARER RECONFIGURATION message; or
- a RADIO BEARER RELEASE message; or
- a TRANSPORT CHANNEL RECONFIGURATION message; or
- a PHYSICAL CHANNEL RECONFIGURATION message

it shall:

- set the variable ORDERED_RECONFIGURATION to TRUE;
- perform the physical layer synchronisation procedure as specified in [29];
- act upon all received information elements as specified in subclause 8.6, unless specified in the following and perform the actions below.

The UE may first release the physical channel configuration used at reception of the reconfiguration message. The UE shall then:

- in FDD, if the IE "PDSCH code mapping" is included but the IE "PDSCH with SHO DCH Info" is not included and if the DCH has only one link in its active set:
 - act upon the IE "PDSCH code mapping" as specified in subclause 8.6 and:

- infer that the PDSCH will be transmitted from the cell from which the downlink DPCH is transmitted;
- enter a state according to subclause 8.6.3.3.

In case the UE receives a RADIO BEARER RECONFIGURATION message including the IE "RB information to reconfigure" that only includes the IE "RB identity", the UE shall:

- handle the message as if IE "RB information to reconfigure" was absent.

NOTE: The RADIO BEARER RECONFIGURATION message always includes the IE "RB information to reconfigure". UTRAN has to include it even if it does not require the reconfiguration of any RB.

If after state transition the UE enters CELL_DCH state, the UE shall, after the state transition:

- remove any C-RNTI from MAC;
- clear the variable C_RNTI.

If the UE was in CELL_DCH state upon reception of the reconfiguration message and remains in CELL_DCH state, the UE shall:

- if the IE "UL DPCH Info" is absent, not change its current UL Physical channel configuration;
- if the IE "DL DPCH Info for each RL" is absent, not change its current DL Physical channel configuration.

If after state transition the UE enters CELL_FACH state, the UE shall, after the state transition:

- if the IE "Frequency info" is included in the received reconfiguration message:
 - select a suitable UTRA cell according to [4] on that frequency;
- if the IE "Frequency info" is not included in the received reconfiguration message:
 - select a suitable UTRA cell according to [4];
- if the received reconfiguration message included the IE "Primary CPICH info" (for FDD) or "Primary CCPCH info" (for TDD), and the UE selects another cell than indicated by this IE or the received reconfiguration message did not include the IE "Primary CPICH info" (for FDD) or "Primary CCPCH info" (for TDD):
 - initiate a cell update procedure according to subclause 8.3.1 using the cause "Cell reselection";
 - when the cell update procedure completed successfully:
 - if the UE is in CELL_PCH or URA_PCH state:
 - initiate a cell update procedure according to subclause 8.3.1 using the cause "Uplink data transmission";
 - proceed as below;
- start timer T305 using its initial value if timer T305 is not running and if periodical update has been configured by T305 in the IE "UE Timers and constants in connected mode" set to any other value than "infinity" in system information block type 1;
- select PRACH according to subclause 8.5.17;
- select Secondary CCPCH according to subclause 8.5.19;
- use the transport format set given in system information;
- if the IE "UTRAN DRX cycle length coefficient" is included in the same message:
 - ignore that IE and stop using DRX;
- if the contents of the variable C_RNTI is empty:
 - perform a cell update procedure according to subclause 8.3.1 using the cause "Cell reselection";

- when the cell update procedure completed successfully:
 - if the UE is in CELL_PCH or URA_PCH state:
 - initiate a cell update procedure according to subclause 8.3.1 using the cause "Uplink data transmission";
 - proceed as below;

The UE shall transmit a response message as specified in subclause 8.2.2.4, setting the information elements as specified below. The UE shall:

- if the received reconfiguration message included the IE "Downlink counter synchronisation info":
 - re-establish RB2;
 - increment by one the downlink and uplink HFN values for RB2;
 - calculate the START value according to subclause 8.5.9;
 - include the calculated START values for each CN domain in the IE "START list" in the IE "Uplink counter synchronisation info";
- if the received reconfiguration message did not include the IE "Downlink counter synchronisation info":
 - if the variable START_VALUE_TO_TRANSMIT is set:
 - include and set the IE "START" to the value of that variable;
 - if the variable START_VALUE_TO_TRANSMIT is not set and the IE "New U-RNTI" is included:
 - calculate the START value according to subclause 8.5.9;
 - include the calculated START values for each CN domain in the IE "START list" in the IE "Uplink counter synchronisation info";
- if the received reconfiguration message contained the IE "Ciphering mode info":
 - include and set the IE "Radio bearer uplink ciphering activation time info" to the value of the variable RB_UPLINK_CIPHERING_ACTIVATION_TIME_INFO;
- if the received reconfiguration message contained the IE "Integrity protection mode info" with the IE "Integrity protection mode command" set to "Modify":
 - include and set the IE "Integrity protection activation info" to the value of the variable INTEGRITY_PROTECTION_ACTIVATION_INFO;
- if the received reconfiguration message did not contain the IE "Ciphering activation time for DPCH" in IE "Ciphering mode info":
 - if prior to this procedure there exist no transparent mode RLC radio bearers:
 - if, at the conclusion of this procedure, the UE will be in CELL_DCH state; and
 - if, at the conclusion of this procedure, at least one transparent mode RLC radio bearer exists:
 - include the IE "COUNT-C activation time" and specify a CFN value other than the default, "Now", for this IE;
 - if prior to this procedure there exists at least one transparent mode RLC radio bearer:
 - if, at the conclusion of this procedure, no transparent mode RLC radio bearers exist:
 - include the IE "COUNT-C activation time" in the response message and specify a CFN value other than the default, "Now", for this IE;
- set the IE "RRC transaction identifier" to the value of "RRC transaction identifier" in the entry for the received message in the table "Accepted transactions" in the variable TRANSACTIONS; and

- clear that entry;
- if the variable PDCP_SN_INFO is not empty:
 - include the IE "RB with PDCP information list" and set it to the value of the variable PDCP_SN_INFO;
- in TDD, if the procedure is used to perform a handover to a cell where timing advance is enabled, and the UE can calculate the timing advance value in the new cell (i.e. in a synchronous TDD network):
 - set the IE "Uplink Timing Advance" according to subclause 8.6.6.26;
- if the IE "Integrity protection mode info" was present in the received reconfiguration message:
 - start applying the new integrity protection configuration in the uplink for signalling radio bearer RB2 from and including the transmitted response message;

If after state transition the UE enters CELL_PCH or URA_PCH state, the UE shall, after the state transition and transmission of the response message:

- if the IE "Frequency info" is included in the received reconfiguration message:
 - select a suitable UTRA cell according to [4] on that frequency;
- if the IE "Frequency info" is not included in the received reconfiguration message:
 - select a suitable UTRA cell according to [4];
- prohibit periodical status transmission in RLC;
- remove any C-RNTI from MAC;
- clear the variable C_RNTI;
- start timer T305 using its initial value if timer T305 is not running and if periodical update has been configured by T305 in the IE "UE Timers and constants in connected mode" set to any other value than "infinity" in system information block type 1;
- select Secondary CCPCH according to subclause 8.5.19;
- if the IE "UTRAN DRX cycle length coefficient" is included in the same message:
 - use the value in the IE "UTRAN DRX Cycle length coefficient" for calculating Paging occasion and PICH Monitoring Occasion as specified in subclause 8.6.3.2;
- if the UE enters CELL_PCH state from CELL_DCH state, and the received reconfiguration message included the IE "Primary CPICH info" (for FDD) or "Primary CCPCH info" (for TDD), and the UE selected another cell than indicated by this IE or the received reconfiguration message did not include the IE "Primary CPICH info" (for FDD) or "Primary CCPCH info" (for TDD):
 - initiate a cell update procedure according to subclause 8.3.1 using the cause "cell reselection";
 - when the cell update procedure completed successfully:
 - the procedure ends;
- if the UE enters CELL_PCH state from CELL_FACH state, and the received reconfiguration message included the IE "Primary CPICH info" (for FDD) or "Primary CCPCH info" (for TDD), and the UE selected another cell than indicated by this IE:
 - initiate a cell update procedure according to subclause 8.3.1 using the cause "cell reselection";
 - when the cell update procedure is successfully completed:
 - the procedure ends;
- if the UE enters URA_PCH state, and after cell selection the criteria for URA update caused by "URA reselection" according to subclause 8.3.1 is fulfilled:

- initiate a URA update procedure according to subclause 8.3.1 using the cause "URA reselection";
- when the URA update procedure is successfully completed:
 - the procedure ends.

8.2.2.4 Transmission of a response message by the UE, normal case

In case the procedure was triggered by reception of a RADIO BEARER SETUP message, the UE shall:

- transmit a RADIO BEARER SETUP COMPLETE as response message on the uplink DCCH using AM RLC;

In case the procedure was triggered by reception of a RADIO BEARER RECONFIGURATION message, the UE shall:

- transmit a RADIO BEARER RECONFIGURATION COMPLETE as response message on the uplink DCCH using AM RLC;

In case the procedure was triggered by reception of a RADIO BEARER RELEASE message, the UE shall:

- transmit a RADIO BEARER RELEASE COMPLETE as response message on the uplink DCCH using AM RLC;

In case the procedure was triggered by reception of a TRANSPORT CHANNEL RECONFIGURATION message, the UE shall:

- transmit a TRANSPORT CHANNEL RECONFIGURATION COMPLETE as response message on the uplink DCCH using AM RLC;

In case the procedure was triggered by reception of a PHYSICAL CHANNEL RECONFIGURATION message, the UE shall:

- transmit a PHYSICAL CHANNEL RECONFIGURATION COMPLETE as response message on the uplink DCCH using AM RLC;

If the new state is CELL_DCH or CELL_FACH, the response message shall be transmitted using the new configuration after the state transition, and the UE shall:

- if the IE "Downlink counter synchronization info" was included in the reconfiguration message:
 - when RLC has confirmed the successful transmission of the response message:
 - re-establish all AM and UM RLC entities with RB identities larger than 3 and set the first 20 bits of all their HFN values to the START value included in the response message for the corresponding CN domain;
 - re-establish the RLC entities with RB identities 1 and 3 and set the first 20 bits of all their HFN values to the START value included in the response message for the CN domain stored in the variable LATEST_CONFIGURED_CN_DOMAIN;
 - set the remaining bits of the HFN values of all AM and UM RLC entities with RB identities different from 2 to zero;
- if the variable PDCP_SN_INFO is empty:
 - if the received reconfiguration message contained the IE "Ciphering mode info":
 - when RLC has confirmed the successful transmission of the response message:
 - notify upper layers upon change of the security configuration;
 - perform the actions below;
 - if the received reconfiguration message did not contain the IE "Ciphering mode info":
 - when RLC has been requested to transmit the response message:
 - perform the actions below;

- if the variable PDCP_SN_INFO is non-empty:
 - when RLC has confirmed the successful transmission of the response message:
 - for each radio bearer in the variable PDCP_SN_INFO:
 - if the IE "RB started" in the variable ESTABLISHED_RABS is set to "started":
 - configure the RLC entity for that radio bearer to "continue";
 - perform the actions below.

If the new state is CELL_PCH or URA_PCH, the response message shall be transmitted using the old configuration before the state transition, but the new C-RNTI shall be used if the IE "New C-RNTI" was included in the received reconfiguration message, and the UE shall:

- when RLC has confirmed the successful transmission of the response message:
 - for each radio bearer in the variable PDCP_SN_INFO:
 - if the IE "RB started" in the variable ESTABLISHED_RABS is set to "started":
 - configure the RLC entity for that radio bearer to "continue";
 - enter the new state (CELL_PCH or URA_PCH, respectively);
 - perform the actions below.

The UE shall:

- set the variable ORDERED_RECONFIGURATION to FALSE;
- if the received reconfiguration message contained the IE "Ciphering mode info":
 - set the IE "Reconfiguration" in the variable CIPHERING_STATUS to FALSE; and
 - clear the variable RB_UPLINK_CIPHERING_ACTIVATION_TIME_INFO;
- if the received reconfiguration message contained the IE "Integrity protection mode info":
 - set the IE "Reconfiguration" in the variable INTEGRITY_PROTECTION_INFO to FALSE; and
 - clear the variable INTEGRITY_PROTECTION_ACTIVATION_INFO;
- clear the variable PDCP_SN_INFO;
- clear the variable START_VALUE_TO_TRANSMIT.

8.2.2.5 Reception of a response message by the UTRAN, normal case

When UTRAN has received

- the RADIO BEARER SETUP COMPLETE message; or
- the RADIO BEARER RECONFIGURATION COMPLETE message; or
- the RADIO BEARER RELEASE COMPLETE message; or
- the TRANSPORT CHANNEL RECONFIGURATION COMPLETE message; or
- the PHYSICAL CHANNEL RECONFIGURATION COMPLETE message;

UTRAN may:

- delete the old configuration.

If the procedure caused the UE to leave the CELL_FACH state, UTRAN may:

- delete the C-RNTI of the UE.

If the IE "UL Timing Advance" is included in TDD, UTRAN should:

- evaluate the timing advance value that the UE has to use in the new cell after handover.

If the IE "START" or the IE "START list " is included, UTRAN should:

- set the START value for each CN domain with the corresponding values as received in this response message;
- consequently, then use the START values to initialise the hyper frame numbers, in the same way as specified for the UE in subclause 8.2.2.3, for any new radio bearers that are established.

For radio bearers using RLC-AM or RLC-UM, UTRAN should:

- use the old ciphering configuration for received RLC PDUs with RLC sequence number less than the RLC sequence number indicated in the IE "Radio bearer uplink ciphering activation time info" sent by the UE;
- use the new ciphering configuration for received RLC PDUs with RLC sequence number greater than or equal to the RLC sequence number indicated in the IE "Radio bearer uplink ciphering activation time info" sent by the UE;
- if an RLC reset or re-establishment occurs after this response message has been received by UTRAN before the activation time for the new ciphering configuration has been reached:
 - ignore the activation time; and
 - apply the new ciphering configuration immediately after the RLC reset or RLC re-establishment.

For radio bearers using RLC-TM:

- use the new ciphering configuration and only begin incrementing the COUNT-C at the CFN as indicated in:
 - the IE "Ciphering activation time for DPCH" in the IE "Ciphering mode info", if included in the message that triggered the radio bearer control procedure; or
 - the IE "COUNT-C activation time", if included in the response message for this procedure.

The procedure ends on the UTRAN side.

8.2.2.6 Unsupported configuration in the UE

If the UTRAN instructs the UE to use a configuration, which it does not support and/or if the received message causes the variable UNSUPPORTED_CONFIGURATION to be set to TRUE, the UE shall:

- transmit a failure response as specified in subclause 8.2.2.9, setting the information elements as specified below:
 - include the IE "RRC transaction identifier"; and
 - set it to the value of "RRC transaction identifier" in the entry for the received message in the table "Accepted transactions" in the variable TRANSACTIONS; and
 - clear that entry;
 - set the IE "failure cause" to "configuration unsupported";
- set the variable UNSUPPORTED_CONFIGURATION to FALSE;
- continue with any ongoing processes and procedures as if the reconfiguration message was not received.

The procedure ends.

8.2.2.7 Physical channel failure

A physical channel failure occurs in case the criteria defined in subclause 8.5.4 are not fulfilled.

If the received message caused the UE to be in CELL_DCH state and the UE failed to establish the dedicated physical channel(s) indicated in the received message the UE shall:

- revert to the configuration prior to the reception of the message (old configuration);
- if the old configuration includes dedicated physical channels (CELL_DCH state) and the UE is unable to revert to the old configuration:
 - select a suitable UTRA cell according to [4];
 - initiate a cell update procedure according to subclause 8.3.1, using the cause "radio link failure";
 - after the cell update procedure has completed successfully:
 - proceed as below;
- if the old configuration does not include dedicated physical channels (CELL_FACH state):
 - select a suitable UTRA cell according to [4];
 - if the UE selects another cell than the cell the UE camped on upon reception of the reconfiguration message:
 - initiate a cell update procedure according to subclause 8.3.1, using the cause "Cell reselection";
 - after the cell update procedure has completed successfully:
 - proceed as below;
- transmit a failure response message as specified in subclause 8.2.2.9, setting the information elements as specified below:
 - include the IE "RRC transaction identifier"; and
 - set it to the value of "RRC transaction identifier" in the entry for the received message in the table "Accepted transactions" in the variable TRANSACTIONS; and
 - clear that entry;
 - set the IE "failure cause" to "physical channel failure";
- set the variable ORDERED_RECONFIGURATION to FALSE;
- continue with any ongoing processes and procedures as if the reconfiguration message was not received;

The procedure ends.

8.2.2.8 Cell re-selection

If the UE performs cell re-selection during the reconfiguration procedure, the UE shall:

- initiate a cell update procedure, as specified in subclause 8.3.1;
- continue with the reconfiguration procedure.

8.2.2.9 Transmission of a response message by the UE, failure case

The UE shall:

- in case of reception of a RADIO BEARER SETUP message:
 - if the radio bearer establishment procedure affects several radio bearers:
 - (may) include the identities of the radio bearers for which the procedure would have been successful into the RADIO BEARER SETUP FAILURE message;
 - transmit a RADIO BEARER SETUP FAILURE as response message on the DCCH using AM RLC;

- in case of reception of a RADIO BEARER RECONFIGURATION message:
 - if the radio bearer reconfiguration procedure affects several radio bearers:
 - (may) include the identities of the radio bearers for which the procedure would have been successful into the RADIO BEARER RECONFIGURATION FAILURE message;
 - transmit a RADIO BEARER RECONFIGURATION FAILURE as response message on the DCCH using AM RLC;
 - in case of reception of a RADIO BEARER RELEASE message:
 - if the radio bearer release procedure affects several radio bearers:
 - (may) include the identities of the radio bearers for which the procedure would have been successful into the RADIO BEARER RELEASE FAILURE message;
 - transmit a RADIO BEARER RELEASE FAILURE as response message on the DCCH using AM RLC;
- in case of reception of a TRANSPORT CHANNEL RECONFIGURATION message:
- transmit a TRANSPORT CHANNEL RECONFIGURATION FAILURE as response message on the DCCH using AM RLC;
- in case of reception of a PHYSICAL CHANNEL RECONFIGURATION message:
- transmit a PHYSICAL CHANNEL RECONFIGURATION FAILURE as response message on the DCCH using AM RLC;
- when the response message has been submitted to lower layers for transmission:
 - continue with any ongoing processes and procedures as if no reconfiguration attempt had occurred.

8.2.2.10 Reception of a response message by the UTRAN, failure case

When the UTRAN has received

- the RADIO BEARER SETUP FAILURE message; or
- the RADIO BEARER RECONFIGURATION FAILURE message; or
- the RADIO BEARER RELEASE FAILURE message; or
- the TRANSPORT CHANNEL RECONFIGURATION FAILURE message; or
- the PHYSICAL CHANNEL RECONFIGURATION FAILURE message;

the UTRAN may restore the old and delete the new configuration. Upper layers should be notified of the failure.

The procedure ends on the UTRAN side.

8.2.2.11 Invalid configuration

If the variable INVALID_CONFIGURATION is set to TRUE the UE shall:

- keep the configuration existing before the reception of the message;
- transmit a failure response message as specified in subclause 8.2.2.9, setting the information elements as specified below:
 - include the IE "RRC transaction identifier"; and
 - set it to the value of "RRC transaction identifier" in the entry for the received message in the table "Accepted transactions" in the variable TRANSACTIONS; and
 - clear that entry;

- set the IE "failure cause" to "invalid configuration";
- set the variable INVALID_CONFIGURATION to FALSE;
- continue with any ongoing processes and procedures as if the reconfiguration message was not received;

The procedure ends.

8.2.2.12 Incompatible simultaneous reconfiguration

If the table "Rejected transactions" in the variable TRANSACTIONS is set due to the received message and the variable PROTOCOL_ERROR_REJECT is set to FALSE, the UE shall:

- not apply the configuration contained in the received reconfiguration message;
- transmit a failure response message as specified in subclause 8.2.2.9, setting the information elements as specified below:
 - include the IE "RRC transaction identifier"; and
 - set it to the value of "RRC transaction identifier" in the entry for the received message in the table "Rejected transactions" in the variable TRANSACTIONS; and
 - clear that entry;
 - set the IE "failure cause" to "incompatible simultaneous reconfiguration";
- continue with any ongoing processes and procedures as if the reconfiguration message was not received;

The procedure ends.

8.2.2.12a Incompatible simultaneous security reconfiguration

If the variable INCOMPATIBLE_SECURITY_RECONFIGURATION is set to TRUE due to the received reconfiguration message, the UE shall:

- transmit a failure response message as specified in subclause 8.2.2.9, setting the information elements as specified below:
 - include the IE "RRC transaction identifier"; and
 - set it to the value of "RRC transaction identifier" in the entry for the received message in the table "Accepted transactions" in the variable TRANSACTIONS; and
 - clear that entry;
 - set the IE "failure cause" to the cause value "incompatible simultaneous reconfiguration";
- set the variable INCOMPATIBLE_SECURITY_RECONFIGURATION to FALSE;
- continue with any ongoing processes and procedures as if the reconfiguration message was not received.

The procedure ends.

8.2.2.12b Cell update procedure during security reconfiguration

If:

- a cell update procedure according to subclause 8.3.1 is initiated; and
- the received reconfiguration message causes either,
 - the IE "Reconfiguration" in the variable CIPHERING_STATUS to be set to TRUE; and/or
 - the IE "Reconfiguration" in the variable INTEGRITY_PROTECTION_INFO to be set to TRUE;

the UE shall:

- abort the ongoing integrity and/or ciphering reconfiguration;
- resume data transmission on any suspended radio bearer and signalling radio bearer mapped on RLC-AM or RLC-UM;
- transmit a failure response message as specified in subclause 8.2.2.9, setting the information elements as specified below:
 - include the IE "RRC transaction identifier"; and
 - set it to the value of "RRC transaction identifier" in the entry for the received message in the table "Accepted transactions" in the variable TRANSACTIONS; and
 - clear that entry;
 - set the IE "failure cause" to the cause value "cell update occurred";
 - if the received reconfiguration message contained the IE "Ciphering mode info":
 - set the IE "Reconfiguration" in the variable CIPHERING_STATUS to FALSE; and
 - clear the variable RB_UPLINK_CIPHERING_ACTIVATION_TIME_INFO;
 - if the received reconfiguration message contained the IE "Integrity protection mode info":
 - set the IE "Reconfiguration" in the variable INTEGRITY_PROTECTION_INFO to FALSE; and
 - clear the variable INTEGRITY_PROTECTION_ACTIVATION_INFO;
- continue with any ongoing processes and procedures as if the reconfiguration message was not received.

The procedure ends.

8.2.2.13 Invalid received message

If the received reconfiguration message contains a protocol error causing the variable PROTOCOL_ERROR_REJECT to be set to TRUE according to clause 9, the UE shall perform procedure specific error handling as follows. The UE shall:

- transmit a failure response message as specified in subclause 8.2.2.9, setting the information elements as specified below:
 - include the IE "RRC transaction identifier"; and
 - set it to the value of "RRC transaction identifier" in the entry for the received message in the table "Rejected transactions" in the variable TRANSACTIONS; and
 - clear that entry;
 - set the IE "failure cause" to the cause value "protocol error";
 - include the IE "Protocol error information" with contents set to the value of the variable PROTOCOL_ERROR_INFORMATION.

The procedure ends.

8.2.3 Radio bearer release

See subclause 8.2.2 (Reconfiguration procedures).

8.2.4 Transport channel reconfiguration

See subclause 8.2.2 (Reconfiguration procedures).

8.2.5 Transport format combination control

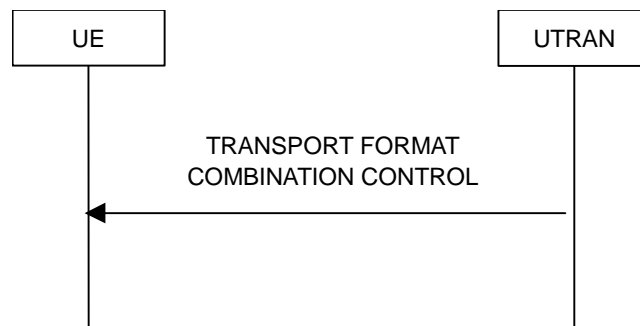

Figure 32: Transport format combination control, normal flow

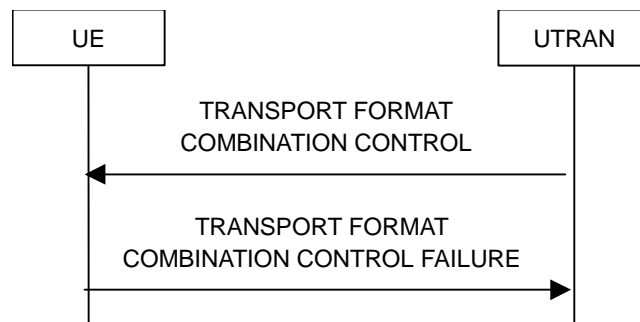

Figure 33: Transport format combination control, failure case

8.2.5.1 General

The transport format combination control procedure is used to control the allowed uplink transport format combinations within the transport format combination set.

8.2.5.2 Initiation

To initiate the transport format combination control procedure, the UTRAN transmits the TRANSPORT FORMAT COMBINATION CONTROL message on the downlink DCCH using AM, UM or TM RLC. When not stated otherwise elsewhere, the UE may initiate the transport format combination control procedure also when another procedure is ongoing, and in that case the state of the latter procedure shall not be affected.

To change the sub-set of allowed transport format combinations, the UTRAN shall:

- set the allowed TFCs in the IE "TFC subset". The network can optionally specify the duration for which a new TFC sub-set applies by using the IE "TFC Control duration" and independently can optionally specify the time at which a new TFC sub-set shall be applied using the IE "Activation Time".

To remove completely the previous restrictions of allowed transport format combinations, the UTRAN shall:

- set the "full transport format combination" in the IE "TFC subset".

8.2.5.3 Reception of a TRANSPORT FORMAT COMBINATION CONTROL message by the UE

Upon reception of the TRANSPORT FORMAT COMBINATION CONTROL message the UE shall:

- act upon all received information elements as specified in 8.6, unless specified otherwise in the following;
- perform the actions for the transport format combination subset specified in the IE "DPCH/PUSCH TFCS in uplink" according to subclause 8.6.5.3;
- if the variable INVALID_CONFIGURATION is set to FALSE:

- if the IE "TFC Control duration" is included in the message:
 - store the value of the IE "TFC Control duration" in the IE "Duration" in the variable TFC_SUBSET
 - set the IE "Current TFC subset" (or IE "TFCS Id" in case of TDD) in the variable TFC_SUBSET to the value of the IE "Transport format combination subset";
 - apply the transport format combination subset in the IE "Current TFC subset" stored in the variable TFC_SUBSET for the number of (10 ms) frames specified in the IE "TFC Control duration";
 - at the end of the time period defined by the IE "TFC control duration":
 - if the variable TFC_SUBSET has not subsequently been reset by another message:
 - go back to any previous restriction of the transport format combination set defined by the content of the IE "Default TFC subset" in the variable TFC_SUBSET;
 - set the value of the IE "Current TFC subset" in the variable TFC_SUBSET to the value of the IE "Default TFC subset" in the variable TFC_SUBSET;
 - clear the IE "Duration" in the variable TFC_SUBSET;
- if the IE "TFC Control duration" is not included in the message:
 - set both the IE "Current TFC subset" and the IE "Default TFC subset" (or IE "TFCS Id" in case of TDD) in the variable TFC_SUBSET to the value of the IE "Transport format combination subset";
- if the UE is unable to comply with the reconfiguration due to an invalid activation time:
 - set the variable INVALID_CONFIGURATION to TRUE.

The UE shall:

- clear the entry for the TRANSPORT FORMAT COMBINATION CONTROL message in the table "Accepted transactions" in the variable TRANSACTIONS;
- and the procedure ends.

8.2.5.4 Invalid configuration

If the variable INVALID_CONFIGURATION is set to TRUE due to the received TRANSPORT FORMAT COMBINATION CONTROL message the UE shall:

- if the TRANSPORT FORMAT COMBINATION CONTROL message was received on AM RLC:
 - keep the TFC subset existing before the TRANSPORT FORMAT COMBINATION CONTROL message was received;
 - transmit a TRANSPORT FORMAT COMBINATION CONTROL FAILURE message on the DCCH using AM RLC;
 - set the IE "RRC transaction identifier" in the TRANSPORT FORMAT COMBINATION CONTROL FAILURE message to the value of "RRC transaction identifier" in the entry for the TRANSPORT FORMAT COMBINATION CONTROL message in the table "Accepted transactions" in the variable TRANSACTIONS; and
 - clear that entry;
 - set the IE "failure cause" to "invalid configuration";
 - when the TRANSPORT FORMAT COMBINATION CONTROL FAILURE message has been submitted to lower layers for transmission the procedure ends.
- if the TRANSPORT FORMAT COMBINATION CONTROL message was received on UM RLC or TM RLC:
 - ignore the TRANSPORT FORMAT COMBINATION CONTROL message.

8.2.5.5 Invalid TRANSPORT FORMAT COMBINATION CONTROL message

If the TRANSPORT FORMAT COMBINATION CONTROL message was received on AM RLC or UM RLC and contains a protocol error causing the variable `PROTOCOL_ERROR_REJECT` to be set to `TRUE` according to clause 9, the UE shall perform procedure specific error handling as follows. The UE shall:

- transmit a TRANSPORT FORMAT COMBINATION CONTROL FAILURE message on the uplink DCCH using AM RLC setting the information elements as specified below;
 - set the IE "RRC transaction identifier" in the TRANSPORT FORMAT COMBINATION CONTROL FAILURE message to the value of "RRC transaction identifier" in the entry for the TRANSPORT FORMAT COMBINATION CONTROL message in the table "Rejected transactions" in the variable `TRANSACTIONS`; and
 - clear that entry;
 - set the IE "failure cause" to the cause value "protocol error";
 - include the IE "Protocol error information" with contents set to the value of the variable `PROTOCOL_ERROR_INFORMATION`;
- when the TRANSPORT FORMAT COMBINATION CONTROL FAILURE message has been submitted to lower layers for transmission:
 - continue with any ongoing processes and procedures as if the invalid TRANSPORT FORMAT COMBINATION CONTROL message has not been received;
 - and the procedure ends.

If the TRANSPORT FORMAT COMBINATION CONTROL message was received on TM RLC and contains a protocol error causing the variable `PROTOCOL_ERROR_REJECT` to be set to `TRUE` according to clause 9, the UE shall perform procedure specific error handling as follows. The UE shall:

- ignore the invalid TRANSPORT FORMAT COMBINATION CONTROL message as if it has not been received;
- the procedure ends.

8.2.6 Physical channel reconfiguration

See subclause 8.2.2 Reconfiguration procedures.

8.2.7 Physical Shared Channel Allocation [TDD only]



Figure 34: Physical Shared Channel Allocation

8.2.7.1 General

The purpose of this procedure is to allocate radio resources to USCH and/or DSCH transport channels in TDD mode, for use by a UE. This procedure can also be used to indicate to the UE, that a PUSCH allocation is pending, in order to prevent further capacity requests from the UE.

UEs are not required to receive FACH and DSCH simultaneously, i.e. if resources are allocated to DSCH the FACH reception may be suspended.

8.2.7.2 Initiation

To initiate the Physical Shared Channel Allocation procedure, the UTRAN sends the "PHYSICAL SHARED CHANNEL ALLOCATION" message on the downlink SHCCH or on the downlink DCCH using UM RLC. The C-RNTI shall be included for UE identification, if the message is sent on the SHCCH.

8.2.7.3 Reception of a PHYSICAL SHARED CHANNEL ALLOCATION message by the UE

Upon reception of a "PHYSICAL SHARED CHANNEL ALLOCATION" message, if the message is received on the downlink SHCCH the UE shall:

- check the C-RNTI to see if the UE is addressed by the message;
- if the UE is addressed by the message, or if the message is received on the downlink DCCH:
 - perform the following actions;
- otherwise:
 - ignore the message;
- act upon all received information elements as specified in subclause 8.6, unless specified otherwise in the following:
- if the IE "ISCP Timeslot list" is included:
 - store the timeslot numbers given there for future Timeslot ISCP measurements and reports;
- if the IE "PDSCH capacity allocation info" is included:
 - configure the physical resources used for the downlink CCTrCH given by the IE "TFCS ID" according to the following:
 - if the CHOICE "Configuration" has the value "Old configuration":
 - if the UE has stored a PDSCH configuration with the identity given by the IE "PDSCH Identity":
 - configure the physical resources according to that configuration;
 - otherwise:
 - ignore the IE "PDSCH capacity allocation info";
 - if the CHOICE "Configuration" has the value "New configuration":
 - configure the physical resources according to the information given in IE "PDSCH Info". If IE "Common timeslot info" or IE "PDSCH timeslots and codes" IE are not present in IE "PDSCH Info":
 - reuse the configuration specified in the previous "PHYSICAL SHARED CHANNEL ALLOCATION" message for this CCTrCH;
 - if the IE "PDSCH Identity" is included:
 - store the new configuration using that identity;
 - start using the new configuration at the CFN specified by the IE "Allocation activation time", and use that for the duration given by the IE "Allocation duration";
 - if the IE "Confirm request" has the value "Confirm PDSCH" and IE "PDSCH Identity" is included in IE "PDSCH capacity allocation info":
 - initiate the PUSCH CAPACITY REQUEST procedure as described in subclause 8.2.8.
 - if the IE "PUSCH capacity allocation info" is included:
 - stop the timer T310, if running;

- if the CHOICE "PUSCH allocation" has the value "PUSCH allocation pending":
 - start the timer T311;
- if the CHOICE "PUSCH allocation" has the value "PUSCH allocation assignment":
 - stop the timer T311, if running;
 - configure the physical resources used for the uplink CCTrCH given by the IE "TFCS ID" according to the following:
 - if the CHOICE "Configuration" has the value "Old configuration":
 - if the UE has stored a PUSCH configuration with the identity given by the IE "PUSCH Identity":
 - configure the physical resources according to that configuration;
 - otherwise:
 - ignore the IE "PUSCH capacity allocation info" ;
 - if the CHOICE "Configuration" has the value "New configuration", the UE shall:
 - configure the physical resources according to the information given in IE "PUSCH Info". If IE "Common timeslot info" or IE "PUSCH timeslots and codes" is not present in IE "PUSCH Info":
 - reuse the configuration specified in the previous "PHYSICAL SHARED CHANNEL ALLOCATION" message for this CCTrCH.
 - if the IE "PUSCH Identity" is included:
 - store the new configuration using that identity;
 - start using the new configuration at the CFN specified by the IE "Allocation activation time", and use that for the duration given by the IE "Allocation duration";
 - if the IE "Traffic volume report request " is included:
 - initiate the PUSCH CAPACITY REQUEST procedure as described in subclause 8.2.8 at the time indicated by the IE "Traffic volume report request";
 - if the IE "Confirm request" has the value "Confirm PUSCH" and IE "PUSCH Identity" is included in IE "PUSCH capacity allocation info":
 - initiate the PUSCH CAPACITY REQUEST procedure as described in subclause 8.2.8.
 - determine the TFCS subset and hence the TFCI values which are possible given the PUSCH allocation for that CCTrCH;
 - configure the MAC-c/sh in the UE with this TFCS restriction if necessary;
 - transmit USCH Transport Block Sets as required, within the TFCS limits given by the PUSCH allocation.

NOTE: If the UE has just entered a new cell and System Information Block Type 6 has not yet been scheduled, PUSCH/PDSCH information should be specified in the allocation message.

The UE shall:

- clear the entry for the PHYSICAL SHARED CHANNEL ALLOCATION message in the table "Accepted transactions" in the variable TRANSACTIONS;
- and the procedure ends.

8.2.7.4 Invalid PHYSICAL SHARED CHANNEL ALLOCATION message

If the UE receives a PHYSICAL SHARED CHANNEL ALLOCATION message, which contains a protocol error causing the variable `PROTOCOL_ERROR_REJECT` to be set to `TRUE` according to clause 9, the UE shall perform procedure specific error handling as follows. The UE shall:

- ignore the invalid PHYSICAL SHARED CHANNEL ALLOCATION message;
- submit the PUSCH CAPACITY REQUEST message for transmission on the uplink SHCCH, setting the information elements in the message as specified in subclause 8.2.8.3;
- reset counter V310;
- start timer T310;
- proceed as described in subclause 8.2.8.

8.2.8 PUSCH capacity request [TDD only]

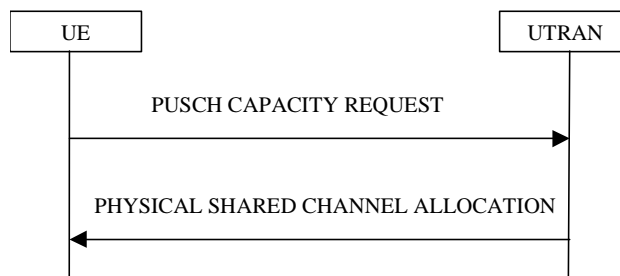

Figure 35: PUSCH Capacity request procedure

8.2.8.1 General

With this procedure, the UE transmits its request for PUSCH resources to the UTRAN. In the normal case, the UTRAN responds with a PHYSICAL SHARED CHANNEL ALLOCATION message, which either allocates the requested PUSCH resources, and/or allocates a PDSCH resource, or may just serve as an acknowledgement, indicating that PUSCH allocation is pending.

This procedure can also be used to acknowledge the reception of a PHYSICAL SHARED CHANNEL ALLOCATION message, or to indicate a protocol error in that message.

With the PUSCH CAPACITY REQUEST message, the UE can request capacity for one or more USCH.

8.2.8.2 Initiation

This procedure is initiated

- in the `CELL_FACH` or `CELL_DCH` state,
- and when at least one RB using USCH has been established,
- and when the UE sees the requirement to request physical resources (PUSCH) for an USCH channel or there is the need to reply to a PHYSICAL SHARED CHANNEL ALLOCATION message as described in clause 8.2.7 (i.e. to confirm the reception of a message, if requested to do so, or to indicate a protocol error).

The procedure can be initiated if:

- Timer T311 is not running.
- The timer T310 (capacity request repetition timer) is not running.

The UE shall:

- set the IEs in the PUSCH CAPACITY REQUEST message according to subclause 8.2.8.3;

- if the procedure is triggered to reply to a previous PHYSICAL SHARED CHANNEL ALLOCATION message by the IE "Confirm request" set to "Confirm PUSCH" and the IE "PUSCH capacity allocation info" is not present:
 - transmit the PUSCH CAPACITY REQUEST message on RACH;
- else:
 - transmit the PUSCH CAPACITY REQUEST message on the uplink SHCCH;
- set counter V310 to 1;
- start timer T310.

8.2.8.3 PUSCH CAPACITY REQUEST message contents to set

With one PUSCH CAPACITY REQUEST message, capacity for one or more USCH can be requested. It shall include these information elements:

- C-RNTI to be used as UE identity if the message is sent on RACH;
- Traffic volume measured results for each radio bearer satisfying the reporting criteria as specified in the MEASUREMENT CONTROL procedure (if no radio bearer satisfies the reporting criteria, traffic volume measured results shall not be included). These results shall include:
 - Radio Bearer ID of the Radio Bearer being reported;
 - RLC buffer payload for these radio bearers, as specified by the MEASUREMENT CONTROL procedure;

The UE shall:

- if the initiation of the procedure is triggered by the IE "Traffic volume report request" in a previously received PHYSICAL SHARED CHANNEL ALLOCATION message:
 - report the traffic volume measurement result for the radio bearer mapped on USCH transport channel specified in the received message. These results shall include:
 - Radio Bearer ID of the Radio Bearer being reported;
 - RLC buffer payload for this radio bearer;
- if the initiation of the procedure is triggered by the IE "Confirm request" set to "Confirm PDSCH" in a previously received PHYSICAL SHARED CHANNEL ALLOCATION message and the IE "PUSCH capacity allocation info" is present in this message:
 - set the CHOICE "Allocation confirmation" to "PDSCH Confirmation" with the value given in the IE "PDSCH Identity" in the received message;
- if the initiation of the procedure is triggered by the IE "Confirm request" set to "Confirm PUSCH" in a previously received PHYSICAL SHARED CHANNEL ALLOCATION message:
 - set the CHOICE "Allocation confirmation" to "PUSCH Confirmation" with the value given in the IE "PUSCH Identity" in the received message;
- if the variable `PROTOCOL_ERROR_REJECT` is set to TRUE:
 - include the IE "RRC transaction identifier" in the response message transmitted below; and
 - set it to the value of "RRC transaction identifier" in the entry for the PHYSICAL SHARED CHANNEL ALLOCATION message in the table "Rejected transactions" in the variable `TRANSACTIONS`; and
 - clear that entry;
 - set the IE "protocol error indicator" to TRUE;
 - include the IE "Protocol error information" with contents set to the value of the variable `PROTOCOL_ERROR_INFORMATION`;

- if the value of the variable `PROTOCOL_ERROR_REJECT` is `FALSE`;
- set the IE "Protocol error indicator" to `FALSE`;

As an option, the message may include IE "Timeslot ISCP" and IE "Primary CCPCH RSCP".

The timeslots for which "Timeslot ISCP" may be reported shall have been configured with a previous `PHYSICAL SHARED CHANNEL ALLOCATION` message.

"Primary CCPCH RSCP" is reported when requested with a previous `PHYSICAL SHARED CHANNEL ALLOCATION` message.

8.2.8.4 Reception of a PUSCH CAPACITY REQUEST message by the UTRAN

Upon receiving a `PUSCH CAPACITY REQUEST` message with traffic volume measurement included for at least one radio bearer, the UTRAN should initiate the `PHYSICAL SHARED CHANNEL ALLOCATION` procedure, either for allocating PUSCH or PDSCH resources as required, or just as an acknowledgement, indicating a pending PUSCH allocation, as described in subclause 8.2.7.

8.2.8.5 T310 expiry

Upon expiry of timer T310, the UE shall

- if V310 is smaller than N310:
 - transmit a new `PUSCH CAPACITY REQUEST` message on the Uplink SHCCH;
 - restart timer T310;
 - increment counter V310;
 - set the IEs in the `PUSCH CAPACITY REQUEST` message as specified in subclause 8.2.8.3;
- if V310 is greater than or equal to N310:
 - the procedure ends.

8.2.9 Void

8.2.10 Uplink Physical Channel Control [TDD only]

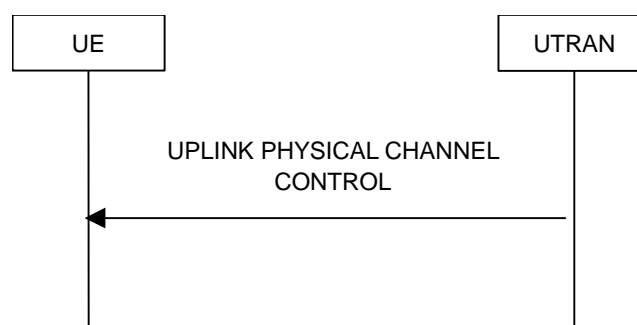

Figure 36: Uplink Physical Channel Control

8.2.10.1 General

The uplink physical channel control procedure is used in TDD to control the uplink outer loop power control and timing advance running in the UE.

8.2.10.2 Initiation

The UTRAN initiates the procedure by transmitting the UPLINK PHYSICAL CHANNEL CONTROL message on the downlink DCCH using AM or UM RLC in order to update parameters for uplink open loop power control in the UE for one CCTrCH or to inform the UE about a new timing advance value to be applied. Especially, uplink interference information measured by the UTRAN can be included for the uplink timeslots used for the CCTrCH.

8.2.10.3 Reception of UPLINK PHYSICAL CHANNEL CONTROL message by the UE

Upon reception of the UPLINK PHYSICAL CHANNEL CONTROL message, the UE shall:

- act upon all received information elements as specified in subclause 8.6.

In 3.84 Mcps TDD, if the IEs "Uplink DPCH Power Control Info", "Constant Value", "Alpha" or IE group "list of UL Timeslot Interference" are transmitted, this information shall be taken into account by the UE for uplink open loop power control as specified in subclause 8.5.7. If the UE is capable of using IPDLs for UE positioning, the IE "IPDL-Alpha" shall be used instead of the IE "Alpha". If the IE "IPDL-Alpha" parameter is not present, the UE shall use IE "Alpha".

If the IE Special Burst Scheduling is transmitted the UE shall:

- use the new value for the UL Special Burst generation period.

The UE shall:

- clear the entry for the UPLINK PHYSICAL CHANNEL CONTROL message in the table "Accepted transactions" in the variable TRANSACTIONS;
- and the procedure ends.

8.2.10.4 Invalid UPLINK PHYSICAL CHANNEL CONTROL message

If the UE receives a UPLINK PHYSICAL CHANNEL CONTROL message, which contains a protocol error causing the variable `PROTOCOL_ERROR_REJECT` to be set to TRUE according to clause 9, the UE shall perform procedure specific error handling as follows. The UE shall:

- transmit an RRC STATUS message on the uplink DCCH using AM RLC, setting the information elements as specified below:
 - include the IE "Identification of received message"; and
 - set the IE "Received message type" to UPLINK PHYSICAL CHANNEL CONTROL; and
 - set the IE "RRC transaction identifier" to the value of "RRC transaction identifier" in the entry for the UPLINK PHYSICAL CHANNEL CONTROL message in the table "Rejected transactions" in the variable TRANSACTIONS; and
 - clear that entry;
 - include the IE "Protocol error information" with contents set to the value of the variable `PROTOCOL_ERROR_INFORMATION`;
- when the RRC STATUS message has been submitted to lower layers for transmission:
 - continue with any ongoing processes and procedures as if the invalid UPLINK PHYSICAL CHANNEL CONTROL message has not been received.

8.2.11 Physical channel reconfiguration failure

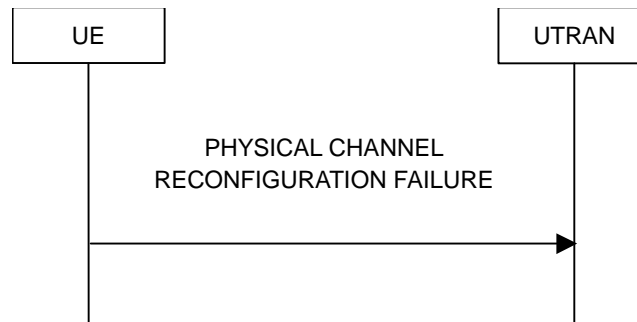

Figure 37: Physical channel reconfiguration failure in case of runtime configuration error

8.2.11.1 General

The physical channel reconfiguration failure procedure is used to indicate to the network a runtime configuration error in the UE.

8.2.11.2 Runtime error due to overlapping compressed mode configurations

When the UE has received from the UTRAN the configurations of several compressed mode transmission gap pattern sequences, and if several of these patterns are to be simultaneously active, the UE shall check to see if these simultaneously active transmission gap pattern sequences create transmission gaps in the same frame. An illegal overlap is created if two or more transmission gap pattern sequences create transmission gaps in the same frame, irrespective of the gaps are created in uplink or downlink.

If the parallel transmission gap pattern sequences create an illegal overlap, the UE shall:

- delete the overlapping transmission gap pattern sequence configuration stored in the variable TGPS_IDENTITY, which is associated with the highest value of IE "TGPSI";
- transmit a PHYSICAL CHANNEL RECONFIGURATION FAILURE message on the DCCH using AM RLC, setting the information elements as specified below:
 - not include the IE "RRC transaction identifier";
 - set the cause value in IE "failure cause" to value "compressed mode runtime error";
- terminate the inter-frequency and/or inter-RAT measurements corresponding to the deleted transmission gap pattern sequence;
- when the PHYSICAL CHANNEL RECONFIGURATION FAILURE message has been submitted to lower layers for transmission:
 - the procedure ends.

8.2.11.3 Runtime error due to overlapping compressed mode configuration and PDSCH reception

If UE is scheduled to receive a PDSCH frame at the same time instant as a compressed mode gap, UE shall perform the measurements according to the measurement purpose of the pattern sequence.

8.3 RRC connection mobility procedures

8.3.1 Cell and URA update procedures

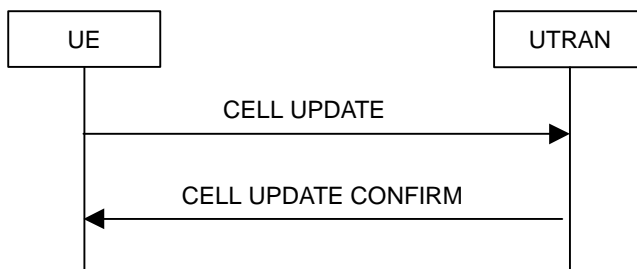

Figure 38: Cell update procedure, basic flow

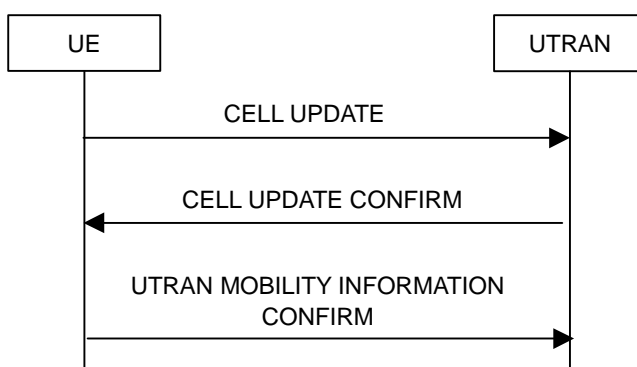

Figure 39: Cell update procedure with update of UTRAN mobility information

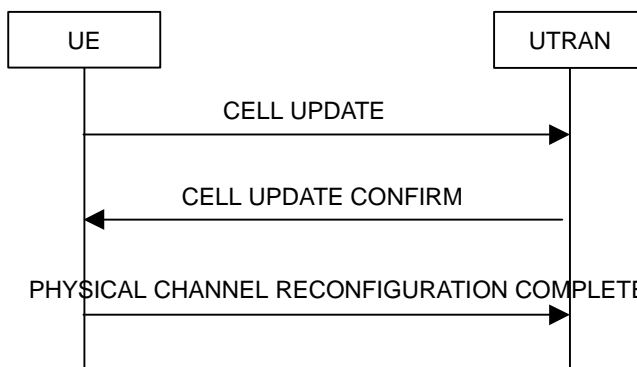

Figure 40: Cell update procedure with physical channel reconfiguration

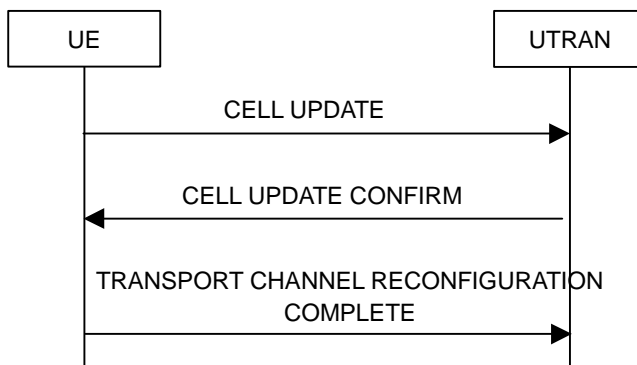

Figure 41: Cell update procedure with transport channel reconfiguration

Error! Objects cannot be created from editing field codes.

Figure 42: Cell update procedure with radio bearer release

Error! Objects cannot be created from editing field codes.

Figure 43: Cell update procedure with radio bearer reconfiguration

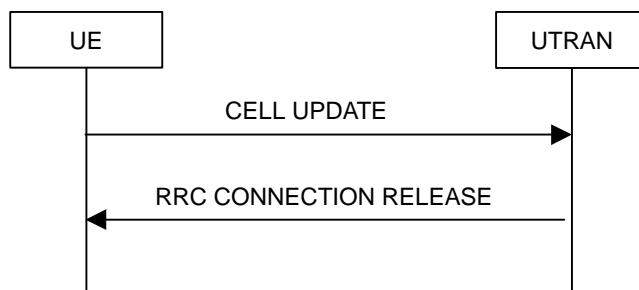

Figure 44: Cell update procedure, failure case

Error! Objects cannot be created from editing field codes.

Figure 45: URA update procedure, basic flow

Error! Objects cannot be created from editing field codes.

Figure 46: URA update procedure with update of UTRAN mobility information

Error! Objects cannot be created from editing field codes.

Figure 47: URA update procedure, failure case

8.3.1.1 General

The URA update and cell update procedures serve several main purposes:

- to notify UTRAN after re-entering service area in the URA_PCH or CELL_PCH state;
- to notify UTRAN of an RLC unrecoverable error [16] on an AM RLC entity;
- to be used as a supervision mechanism in the CELL_FACH, CELL_PCH, or URA_PCH state by means of periodical update;

In addition, the URA update procedure also serves the following purpose:

- to retrieve a new URA identity after cell re-selection to a cell not belonging to the current URA assigned to the UE in URA_PCH state;

In addition, the cell update procedure also serves the following purposes:

- to update UTRAN with the current cell the UE is camping on after cell reselection;
- to act on a radio link failure in the CELL_DCH state;
- when triggered in the URA_PCH or CELL_PCH state, to notify UTRAN of a transition to the CELL_FACH state due to the reception of UTRAN originated paging or due to a request to transmit uplink data.

The URA update and cell update procedures may:

- include an update of mobility related information in the UE;
- cause a state transition from the CELL_FACH state to the CELL_DCH, CELL_PCH or URA_PCH states or idle mode.

The cell update procedure may also include:

- a re-establish of AM RLC entities;
- a radio bearer release, radio bearer reconfiguration, transport channel reconfiguration or physical channel reconfiguration;

8.3.1.2 Initiation

A UE shall initiate the cell update procedure in the following cases:

- Uplink data transmission:
 - if the UE is in URA_PCH or CELL_PCH state; and
 - if the UE has uplink RLC data PDU or uplink RLC control PDU on RB1 or upwards to transmit:
 - perform cell update using the cause "uplink data transmission".
- Paging response:
 - if the criteria for performing cell update with the cause specified above in the current subclause is not met; and
 - if the UE in URA_PCH or CELL_PCH state, receives a PAGING TYPE 1 message fulfilling the conditions for initiating a cell update procedure specified in subclause 8.1.2.3:
 - perform cell update using the cause "paging response".
- Radio link failure:
 - if none of the criteria for performing cell update with the causes specified above in the current subclause is met; and
 - if the UE is in CELL_DCH state; and
 - if the criteria for radio link failure is met as specified in subclause 8.5.6:
 - perform cell update using the cause "radio link failure".
- Re-entering service area:
 - if none of the criteria for performing cell update with the causes specified above in the current subclause is met; and
 - if the UE is in CELL_FACH or CELL_PCH state; and
 - if the UE has been out of service area and re-enters service area before T307 or T317 expires:
 - perform cell update using the cause "re-entering service area".
- RLC unrecoverable error:
 - if none of the criteria for performing cell update with the causes specified above in the current subclause is met; and
 - if the UE detects RLC unrecoverable error [16] in an AM RLC entity:
 - perform cell update using the cause "RLC unrecoverable error".
- Cell reselection:
 - if none of the criteria for performing cell update with the causes specified above in the current subclause is met; and
 - if the UE is in CELL_FACH or CELL_PCH state; and

- if the UE performs cell re-selection or the variable C_RNTI is empty:
 - perform cell update using the cause "cell reselection".
- Periodical cell update:
 - if none of the criteria for performing cell update with the causes specified above in the current subclause is met; and
 - if the UE is in CELL_FACH or CELL_PCH state; and
 - if the timer T305 expires; and
 - if the criteria for "in service area" as specified in subclause 8.5.5.2 is fulfilled; and
 - if periodic updating has been configured by T305 in the IE "UE Timers and constants in connected mode" set to any other value than "infinity":
 - perform cell update using the cause "periodical cell update".

A UE in URA_PCH state shall initiate the URA update procedure in the following cases:

- URA reselection:
 - if the UE detects that the current URA assigned to the UE, stored in the variable URA_IDENTITY, is not present in the list of URA identities in system information block type 2; or
 - if the list of URA identities in system information block type 2 is empty; or
 - if the system information block type 2 can not be found:
 - perform URA update using the cause "change of URA".
- Periodic URA update:
 - if the criteria for performing URA update with the causes as specified above in the current subclause are not met; and
 - if the timer T305 expires while the UE is in the service area; and
 - if periodic updating has been configured by T305 in the IE "UE Timers and constants in connected mode" set to any other value than "infinity":
 - perform URA update using the cause "periodic URA update".

When initiating the URA update or cell update procedure, the UE shall:

- stop timer T305;
- if the UE is in CELL_DCH state:
 - in the variable RB_TIMER_INDICATOR, set the IE "T314 expired" and the IE "T315 expired" to FALSE;
 - if the stored values of the timer T314 and timer T315 are both equal to zero:
 - release all its radio resources;
 - indicate release (abort) of the established signalling connections (as stored in the variable ESTABLISHED_SIGNALLING_CONNECTIONS) and established radio access bearers (as stored in the variable ESTABLISHED_RABS) to upper layers;
 - clear the variable ESTABLISHED_SIGNALLING_CONNECTIONS;
 - clear the variable ESTABLISHED_RABS;
 - enter idle mode;
 - perform other actions when entering idle mode from connected mode as specified in subclause 8.5.2;

- and the procedure ends.
- if the stored value of the timer T314 is equal to zero:
 - release all radio bearers, associated with any radio access bearers for which in the variable ESTABLISHED_RABS the value of the IE "Re-establishment timer" is set to "useT314";
 - in the variable RB_TIMER_INDICATOR set the IE "T314 expired" to TRUE;
- if the stored value of the timer T315 is equal to zero:
 - release all radio bearers associated with any radio access bearers for which in the variable ESTABLISHED_RABS the value of the IE "Re-establishment timer" is set to "useT315";
 - in the variable RB_TIMER_INDICATOR set the IE "T315 expired" to TRUE;
- if the stored value of the timer T314 is greater than zero:
 - start timer T314;
- if the stored value of the timer T315 is greater than zero:
 - start timer T315;
- for the released radio bearer(s):
 - delete the information about the radio bearer from the variable ESTABLISHED_RABS;
 - when all radio bearers belonging to the same radio access bearer have been released:
 - indicate local end release of the radio access bearer to upper layers using the CN domain identity together with the RAB identity stored in the variable ESTABLISHED_RABS;
 - delete all information about the radio access bearer from the variable ESTABLISHED_RABS;
- set the variable ORDERED_RECONFIGURATION to FALSE;
- set the variables PROTOCOL_ERROR_INDICATOR, FAILURE_INDICATOR, UNSUPPORTED_CONFIGURATION and INVALID_CONFIGURATION to FALSE;
- set the variable CELL_UPDATE_STARTED to TRUE;
- move to CELL_FACH state, if not already in that state;
- if the UE performs cell re-selection:
 - clear the variable C_RNTI; and
 - stop using that C_RNTI just cleared from the variable C_RNTI in MAC;
- set CFN in relation to SFN of current cell according to subclause 8.5.15;
- in case of a cell update procedure:
 - set the contents of the CELL UPDATE message according to subclause 8.3.1.3;
 - submit the CELL UPDATE message for transmission on the uplink CCCH;
- in case of a URA update procedure:
 - set the contents of the URA UPDATE message according to subclause 8.3.1.3;
 - submit the URA UPDATE message for transmission on the uplink CCCH;
- set counter V302 to 1;
- start timer T302 when the MAC layer indicates success or failure in transmitting the message.

8.3.1.3 CELL UPDATE / URA UPDATE message contents to set

In case of cell update procedure the UE shall transmit a CELL UPDATE message.

In case of URA update procedure the UE shall transmit a URA UPDATE message.

The UE shall set the IEs in the CELL UPDATE message as follows:

- set the IE "Cell update cause" corresponding to the cause specified in subclause 8.3.1.2 that is valid when the CELL UPDATE message is submitted to lower layers for transmission;

NOTE: During the time period starting from when a cell update procedure is initiated by the UE until when the procedure ends, additional CELL UPDATE messages may be transmitted by the UE with different causes.

- set the IE "U-RNTI" to the value of the variable U_RNTI;
- if the value of the variable PROTOCOL_ERROR_INDICATOR is TRUE:
 - include the IE "RRC transaction identifier"; and
 - set it to the value of "RRC transaction identifier" in the entry for the CELL UPDATE CONFIRM message in the table "Rejected transactions" in the variable TRANSACTIONS;
 - include and set the IE "failure cause" to the cause value "protocol error";
 - set the IE "Protocol error information" set to the value of the variable PROTOCOL_ERROR_INFORMATION;
- if the value of the variable FAILURE_INDICATOR is TRUE:
 - include the IE "RRC transaction identifier"; and
 - set it to the value of "RRC transaction identifier" in the entry for the CELL UPDATE CONFIRM message in the table "Accepted transactions" in the variable TRANSACTIONS;
 - include and set the IE "failure cause" to the value of the variable FAILURE_CAUSE;
- include the START values for each CN domain, calculated according to subclause 8.5.9;
- if an unrecoverable error [16] in any of the AM RLC entities for the signalling radio bearers RB2, RB3 or RB4 is detected:
 - set the IE "AM_RLC error indication (RB2, RB3 or RB4)" to TRUE;
- otherwise:
 - set the IE "AM_RLC error indication (RB2, RB3 or RB4)" to FALSE;
- if an unrecoverable error [16] in any of the AM RLC entities for the RB5 or upward is detected:
 - set the IE "AM_RLC error indication (RB>4)" to TRUE;
- otherwise:
 - set the IE "AM_RLC error indication (RB>4)" to FALSE;
- set the IE "RB Timer indicator" to the value of the variable RB_TIMER_INDICATOR;
- include an intra-frequency measurement report in the IE "Measured results on RACH", as specified in the IE "Intra-frequency reporting quantity for RACH reporting" and the IE "Maximum number of reported cells on RACH" in system information block type 12 (or System Information Block type 11, if System Information Block type 12 is not being broadcast); and
- include in the IE "Measured results on RACH" all requested reporting quantities for all included measurement objects; and

- take care that the maximum allowed message size is not exceeded when forming the IE "Measured results on RACH".

The UE shall set the IEs in the URA UPDATE message as follows:

- set the IE "U-RNTI" to the value of the variable U_RNTI;
- set the IE "URA update cause" corresponding to which cause as specified in subclause 8.3.1.2 that is valid when the URA UPDATE message is submitted to lower layers for transmission;

NOTE: During the time period starting from when a URA update procedure is initiated by the UE until when the procedure ends, additional URA UPDATE messages may be transmitted by the UE with different causes, depending on which causes are valid for the respective URA UPDATE message.

- if the value of the variable PROTOCOL_ERROR_INDICATOR is TRUE:
 - include the IE "RRC transaction identifier"; and
 - set it to the value of "RRC transaction identifier" in the entry for the URA UPDATE CONFIRM message in the table "Rejected transactions" in the variable TRANSACTIONS;
 - set the IE "Protocol error indicator" to TRUE;
 - include the IE "Protocol error information" set to the value of the variable PROTOCOL_ERROR_INFORMATION.
- if the value of the variable PROTOCOL_ERROR_INDICATOR is FALSE:
 - if the value of the variable INVALID_CONFIGURATION is TRUE:
 - include the IE "RRC transaction identifier"; and
 - set it to the value of "RRC transaction identifier" in the entry for the URA UPDATE CONFIRM message in the table "Accepted transactions" in the variable TRANSACTIONS;
 - set the IE "Protocol error indicator" to TRUE;
 - include the IE "Protocol error information" set to "Information element value not comprehended";
 - if the value of the variable INVALID_CONFIGURATION is FALSE:
 - set the IE "Protocol error indicator" to FALSE.

8.3.1.4 T305 expiry and the UE detects "out of service area"

When the T305 expires and the UE detects that it is "out of service area" as specified in subclause 8.5.5.1, the UE shall

- start timer T307;
- re-select to a new cell, as described in [4].

8.3.1.4.1 Re-entering "in service area"

If the UE detects "in service area" according to subclause 8.5.5.2 and timer T307 or T317 is running, the UE shall:

- check the value of V302; and
- if V302 is equal to or smaller than N302:
 - in case of a cell update procedure:
 - set the contents of the CELL UPDATE message according to subclause 8.3.1.3;
 - submit the CELL UPDATE message for transmission on the uplink CCCH;
 - in case of a URA update procedure:

- set the contents of the URA UPDATE message according to subclause 8.3.1.3;
- submit the URA UPDATE message for transmission on the uplink CCCH;
- increment counter V302;
- restart timer T302 when the MAC layer indicates success or failure to transmit the message.
- if V302 is greater than N302:
 - clear the variable RB_UPLINK_CIPHERING_ACTIVATION_TIME_INFO;
 - clear the variable INTEGRITY_PROTECTION_ACTIVATION_INFO;
 - in case of a cell update procedure:
 - clear the entry for the CELL UPDATE CONFIRM message in the table "Rejected transactions" in the variable TRANSACTIONS;
 - in case of a URA update procedure:
 - clear the entry for the URA UPDATE CONFIRM message in the table "Rejected transactions" in the variable TRANSACTIONS;
 - release all its radio resources;
 - indicate release (abort) of the established signalling connections (as stored in the variable ESTABLISHED_SIGNALLING_CONNECTIONS) and established radio access bearers (as stored in the variable ESTABLISHED_RABS) to upper layers;
 - clear the variable ESTABLISHED_SIGNALLING_CONNECTIONS;
 - clear the variable ESTABLISHED_RABS;
 - enter idle mode;
 - perform other actions when entering idle mode from connected mode as specified in subclause 8.5.2;
 - and the procedure ends.

8.3.1.4.2 Expiry of timer T307

When the T307 expires, the UE shall:

- move to idle mode;
- release all dedicated resources;
- indicate release (abort) of the established signalling connections (as stored in the variable ESTABLISHED_SIGNALLING_CONNECTIONS) and established radio access bearers (as stored in the variable ESTABLISHED_RABS) to upper layers;
- clear the variable ESTABLISHED_SIGNALLING_CONNECTIONS;
- clear the variable ESTABLISHED_RABS;
- perform other actions when entering idle mode from connected mode as specified in subclause 8.5.2;
- and the procedure ends.

8.3.1.5 Reception of an CELL UPDATE/URA UPDATE message by the UTRAN

When the UTRAN receives a CELL UPDATE/URA UPDATE message, it may either:

- in case the procedure was triggered by reception of a CELL UPDATE:

- update the START value for each CN domain as maintained in UTRAN (refer to subclause 8.5.9) with "START" in the IE "START list" for the CN domain as indicated by "CN domain identity" in the IE "START list";
- if this procedure was triggered while the UE was not in CELL_DCH state, then for each CN domain as indicated by "CN domain identity" in the IE "START list":
 - set the 20 MSB of the MAC-d HFN with the corresponding START value in the IE "START list";
 - set the remaining LSB of the MAC-d HFN to zero;
- transmit a CELL UPDATE CONFIRM message on the downlink DCCH or optionally on the CCCH but only if ciphering is not required; and
- optionally include the IE "RLC re-establish indicator" to request a RLC re-establishment in the UE, in which case the corresponding RLC entities should also be re-established in UTRAN; or
- in case the procedure was triggered by reception of a URA UPDATE:
 - transmit a URA UPDATE CONFIRM message to the lower layers for transmission on the downlink CCCH or DCCH in which case the UTRAN should include the IE "URA identity" in the URA UPDATE CONFIRM message in a cell where multiple URA identifiers are broadcast; or
- initiate an RRC connection release procedure (see subclause 8.1.4) by transmitting an RRC CONNECTION RELEASE message on the downlink CCCH. In particular UTRAN should:
 - if the CELL UPDATE message was sent because of an unrecoverable error in RB2, RB3 or RB4:
 - initiate an RRC connection release procedure (subclause 8.1.4) by transmitting an RRC CONNECTION RELEASE message on the downlink CCCH.

8.3.1.6 Reception of the CELL UPDATE CONFIRM/URA UPDATE CONFIRM message by the UE

When the UE receives a CELL UPDATE CONFIRM/URA UPDATE CONFIRM message; and

- if the message is received on the CCCH, and IE "U-RNTI" is present and has the same value as the variable U_RNTI, or;
- if the message is received on DCCH;

the UE shall:

- stop timer T302;
- in case of a cell update procedure and the CELL UPDATE CONFIRM message:
 - includes "RB information elements"; and/or
 - includes "Transport channel information elements"; and/or
 - includes "Physical channel information elements"; and
 - if the variable ORDERED_RECONFIGURATION is set to FALSE:
 - set the variable ORDERED_RECONFIGURATION to TRUE;
- act upon all received information elements as specified in subclause 8.6, unless specified otherwise in the following:
 - use the transport channel(s) applicable for the physical channel types that is used; and
 - if the IE "TFS" is neither included nor previously stored in the UE for that transport channel(s):
 - use the TFS given in system information.
 - if none of the TFS stored is compatible with the physical channel:

- delete the stored TFS;
- use the TFS given in system information.
- perform the physical layer synchronisation procedure as specified in [29];
- if the CELL UPDATE CONFIRM message includes the IE "RLC re-establish indicator (RB2, RB3 and RB4)":
 - re-establish the RLC entities for signalling radio bearer RB2, signalling radio bearer RB3 and signalling radio bearer RB4 (if established);
 - if the value of the IE "Status" in the variable CIPHERING_STATUS of the CN domain stored in the variable LATEST_CONFIGURED_CN_DOMAIN is set to "Started":
 - set the HFN values for AM RLC entities with RB identity 2, RB identity 3 and RB identity 4 (if established) equal to the START value included in the latest transmitted CELL UPDATE message for the CN domain stored in the variable LATEST_CONFIGURED_CN_DOMAIN;
- if the CELL UPDATE CONFIRM message includes the IE "RLC re-establish indicator (RB>4)":
 - for radio bearers with RB identity larger than 4:
 - re-establish the AM RLC entities;
 - if the value of the IE "Status" in the variable CIPHERING_STATUS of the CN domain as indicated in the IE "CN domain identity" in the IE "RAB info" in the variable ESTABLISHED_RABS is set to "Started":
 - set the HFN values for AM RLC entities equal to the START value included in this CELL UPDATE message for the CN domain as indicated in the IE "CN domain identity" in the IE "RAB info" in the variable ESTABLISHED_RABS;
- enter a state according to subclause 8.6.3.3 applied on the CELL UPDATE CONFIRM / URA UPDATE CONFIRM message.

If the UE after state transition enters CELL_DCH state, it shall:

- not prohibit periodical status transmission in RLC.

If the UE after state transition remains in CELL_FACH state, it shall

- start the timer T305 using its initial value if timer T305 is not running and periodical cell update has been configured by T305 in the IE "UE Timers and constants in connected mode" set to any other value than "infinity";
- select PRACH according to subclause 8.5.17;
- select Secondary CCPCH according to subclause 8.5.19;
- not prohibit periodical status transmission in RLC;
- if the IE "UTRAN DRX cycle length coefficient" is included in the same message:
 - ignore that IE and stop using DRX;

If the UE after state transition enters URA_PCH or CELL_PCH state, it shall

- prohibit periodical status transmission in RLC;
- clear the variable C_RNTI;
- stop using that C_RNTI just cleared from the variable C_RNTI in MAC;
- start the timer T305 using its initial value if timer T305 is not running and periodical update has been configured by T305 in the IE "UE Timers and constants in connected mode" set to any other value than "infinity";

- select Secondary CCPCH according to subclause 8.5.19;
- if the IE "UTRAN DRX cycle length coefficient" is included in the same message:
 - use the value in the IE "UTRAN DRX Cycle length coefficient" for calculating Paging Occasion and PICH Monitoring Occasion as specified in subclause 8.6.3.2 in CELL_PCH state.

If the UE after the state transition remains in CELL_FACH state and;

- the contents of the variable C_RNTI are empty;

it shall check the value of V302 and

- If V302 is equal to or smaller than N302:
 - if, caused by the received CELL UPDATE CONFIRM or URA UPDATE CONFIRM message,
 - the IE "Reconfiguration" in the variable CIPHERING_STATUS is set to TRUE; and/or
 - the IE "Reconfiguration" in the variable INTEGRITY_PROTECTION_INFO is set to TRUE:
 - abort the ongoing integrity and/or ciphering reconfiguration;
 - if the received CELL UPDATE CONFIRM or URA UPDATE CONFIRM message contained the IE "Ciphering mode info":
 - set the IE "Reconfiguration" in the variable CIPHERING_STATUS to FALSE; and
 - clear the variable RB_UPLINK_CIPHERING_ACTIVATION_TIME_INFO;
 - if the received CELL UPDATE CONFIRM or URA UPDATE CONFIRM message contained the IE "Integrity protection mode info":
 - set the IE "Reconfiguration" in the variable INTEGRITY_PROTECTION_INFO to FALSE; and
 - clear the variable INTEGRITY_PROTECTION_ACTIVATION_INFO;
 - in case of a URA update procedure:
 - stop the URA update procedure; and
 - continue with a cell update procedure;
 - set the contents of the CELL UPDATE message according to subclause 8.3.1.3, except for the IE "Cell update cause" which shall be set to "cell reselection";
 - submit the CELL UPDATE message for transmission on the uplink CCCH;
 - increment counter V302;
 - restart timer T302 when the MAC layer indicates success or failure to transmit the message;
- If V302 is greater than N302:
 - clear the variable RB_UPLINK_CIPHERING_ACTIVATION_TIME_INFO;
 - clear the variable INTEGRITY_PROTECTION_ACTIVATION_INFO;
 - in case of a cell update procedure:
 - clear the entry for the CELL UPDATE CONFIRM message in the table "Rejected transactions" in the variable TRANSACTIONS;
 - in case of a URA update procedure:
 - clear the entry for the URA UPDATE CONFIRM message in the table "Rejected transactions" in the variable TRANSACTIONS;

- release all its radio resources;
- indicate release (abort) of the established signalling connections (as stored in the variable ESTABLISHED_SIGNALLING_CONNECTIONS) and established radio access bearers (as stored in the variable ESTABLISHED_RABS) to upper layers;
- clear the variable ESTABLISHED_SIGNALLING_CONNECTIONS;
- clear the variable ESTABLISHED_RABS;
- enter idle mode;
- other actions the UE shall perform when entering idle mode from connected mode are specified in subclause 8.5.2;
- and the procedure ends.

If the UE after the state transition remains in CELL_FACH state and

- a C-RNTI is stored in the variable C_RNTI;

or

the UE after the state transition moves to another state than the CELL_FACH state;

the UE shall:

- if the CELL UPDATE CONFIRM / URA UPDATE CONFIRM message contained the IE "Ciphering mode info":
 - include and set the IE "Radio bearer uplink ciphering activation time info" in any response message transmitted below to the value of the variable RB_UPLINK_CIPHERING_ACTIVATION_TIME_INFO.
- if the CELL UPDATE CONFIRM / URA UPDATE CONFIRM message contained the IE "Integrity protection mode info" with the IE "Integrity protection mode command" set to "Modify":
 - include and set the IE "Integrity protection activation info" in any response message transmitted below to the value of the variable INTEGRITY_PROTECTION_ACTIVATION_INFO;
- in case of a cell update procedure:
 - set the IE "RRC transaction identifier" in any response message transmitted below to the value of "RRC transaction identifier" in the entry for the CELL UPDATE CONFIRM message in the table "Accepted transactions" in the variable TRANSACTIONS; and
 - clear that entry.
- in case of a URA update procedure:
 - set the IE "RRC transaction identifier" in any response message transmitted below to the value of "RRC transaction identifier" in the entry for the URA UPDATE CONFIRM message in the table "Accepted transactions" in the variable TRANSACTIONS; and
 - clear that entry;
- if the variable PDCP_SN_INFO is non-empty:
 - include the IE "RB with PDCP information list" in any response message transmitted below and set it to the value of the variable PDCP_SN_INFO;
- if the received CELL UPDATE CONFIRM or URA UPDATE CONFIRM message included the IE "Downlink counter synchronisation info":
 - calculate the START value according to subclause 8.5.9;
 - include the calculated START values for each CN domain in the IE "START list" in the IE "Uplink counter synchronisation info" in any response message transmitted below;

- transmit a response message as specified in subclause 8.3.1.7;
- if the IE "Integrity protection mode info" was present in the CELL UPDATE CONFIRM or URA UPDATE CONFIRM message:
 - start applying the new integrity protection configuration in the uplink for signalling radio bearer RB2 from and including the transmitted response message;
- if the variable ORDERED_RECONFIGURATION is set to TRUE caused by the received CELL UPDATE CONFIRM message in case of a cell update procedure:
 - set the variable ORDERED_RECONFIGURATION to FALSE;
- clear the variable PDCP_SN_INFO;
- if the CELL UPDATE CONFIRM / URA UPDATE CONFIRM message contained the IE "Ciphering mode info":
 - set the IE "Reconfiguration" in the variable CIPHERING_STATUS to FALSE; and
 - clear the variable RB_UPLINK_CIPHERING_ACTIVATION_TIME_INFO;
- if the CELL UPDATE CONFIRM / URA UPDATE CONFIRM message contained the IE "Integrity protection mode info":
 - set the IE "Reconfiguration" in the variable INTEGRITY_PROTECTION_INFO to FALSE; and
 - clear the variable INTEGRITY_PROTECTION_ACTIVATION_INFO;
- in case of a cell update procedure:
 - clear the entry for the CELL UPDATE CONFIRM message in the table "Rejected transactions" in the variable TRANSACTIONS;
- in case of a URA update procedure:
 - clear the entry for the URA UPDATE CONFIRM message in the table "Rejected transactions" in the variable TRANSACTIONS;
- set the variable CELL_UPDATE_STARTED to FALSE;

The procedure ends.

8.3.1.7 Transmission of a response message to UTRAN

If the CELL UPDATE CONFIRM message

- includes the IE "RB information to release list":

the UE shall:

- transmit a RADIO BEARER RELEASE COMPLETE as response message using AM RLC.

If the CELL UPDATE CONFIRM message

- does not include the IE "RB information to release list"; and
- includes the IE "RB information to reconfigure list "; or
- includes the IE "RB information to be affected list ":

the UE shall:

- transmit a RADIO BEARER RECONFIGURATION COMPLETE as response message using AM RLC.

If the CELL UPDATE CONFIRM message

- does not include "RB information elements"; and
- includes "Transport channel information elements":

the UE shall:

- transmit a TRANSPORT CHANNEL RECONFIGURATION COMPLETE as response message using AM RLC.

If the CELL UPDATE CONFIRM message

- does not include "RB information elements"; and
- does not include "Transport channel information elements"; and
- includes "Physical channel information elements":

the UE shall:

- transmit a PHYSICAL CHANNEL RECONFIGURATION COMPLETE as response message using AM RLC.

If the CELL UPDATE CONFIRM message

- does not include "RB information elements"; and
- does not include "Transport channel information elements"; and
- does not include "Physical channel information elements"; and
- includes "CN information elements"; or
- includes the IE "Ciphering mode info"; or
- includes the IE "Integrity protection mode info"; or
- includes the IE "New C-RNTI"; or
- includes the IE "New U-RNTI":

the UE shall:

- transmit a UTRAN MOBILITY INFORMATION CONFIRM as response message using AM RLC.

If the CELL UPDATE CONFIRM message

- does not include "RB information elements"; and
- does not include "Transport channel information elements"; and
- does not include "Physical channel information elements"; and
- does not include "CN information elements"; and
- does not include the IE "Ciphering mode info"; and
- does not include the IE "Integrity protection mode info"; and
- does not include the IE "New C-RNTI"; and
- does not include the IE "New U-RNTI":

the UE shall:

- transmit no response message.

If the URA UPDATE CONFIRM message

- includes "CN information elements"; or

- includes the IE "Ciphering mode info"; or
- includes the IE "Integrity protection mode info"; or
- includes any one or both of the IEs "New C-RNTI" and "New U-RNTI":

the UE shall:

- transmit a UTRAN MOBILITY INFORMATION CONFIRM as response message using AM RLC.

If the URA UPDATE CONFIRM message

- does not include "CN information elements"; and
- does not include the IE "Ciphering mode info"; and
- does not include the IE "Integrity protection mode info"; and
- does not include the IE "New U-RNTI"; and
- does not include the IE "New C-RNTI":

the UE shall:

- transmit no response message.

If the new state is CELL_DCH or CELL_FACH, the response message shall be transmitted using the new configuration after the state transition., and the UE shall:

- if the variable PDCP_SN_INFO is empty:
 - if the CELL UPDATE CONFIRM or URA UPDATE CONFIRM message contained the IE "Ciphering mode info":
 - when RLC has confirmed the successful transmission of the response message:
 - continue with the remainder of the procedure;
 - if the CELL UPDATE CONFIRM or URA UPDATE CONFIRM message did not contain the IE "Ciphering mode info":
 - when RLC has been requested to transmit the response message,
 - continue with the remainder of the procedure;
- if the variable PDCP_SN_INFO non-empty:
 - when RLC has confirmed the successful transmission of the response message:
 - for each radio bearer in the variable PDCP_SN_INFO:
 - if the IE "RB started" in the variable ESTABLISHED_RABS is set to "started":
 - configure the RLC entity for that radio bearer to "continue";
 - continue with the remainder of the procedure;

If the new state is CELL_PCH or URA_PCH, the response message shall be transmitted in CELL_FACH state, and the UE shall:

- when RLC has confirmed the successful transmission of the response message:
 - for each radio bearer in the variable PDCP_SN_INFO:
 - if the IE "RB started" in the variable ESTABLISHED_RABS is set to "started":
 - configure the RLC entity for that radio bearer to "continue";
 - enter the new state (CELL_PCH or URA_PCH, respectively);

- continue with the remainder of the procedure.

8.3.1.7a Physical channel failure

If the received CELL UPDATE CONFIRM or URA UPDATE CONFIRM message would cause the UE to transit to CELL_DCH state; and

- in case of a received CELL UPDATE CONFIRM message:
 - if the UE failed to establish the physical channel(s) indicated in the received CELL UPDATE CONFIRM message according to the criteria defined in subclause 8.5.4 are not fulfilled; or
 - the received CELL UPDATE CONFIRM message does not contain dedicated physical channels;
- in case of the UE received a URA UPDATE CONFIRM message:

the UE shall:

- if, caused by the received CELL UPDATE CONFIRM or URA UPDATE CONFIRM message
 - the IE "Reconfiguration" in the variable CIPHERING_STATUS is set to TRUE; and/or
 - the IE "Reconfiguration" in the variable INTEGRITY_PROTECTION_INFO is set to TRUE:
 - abort the ongoing integrity and/or ciphering reconfiguration;
 - if the received CELL UPDATE CONFIRM or URA UPDATE CONFIRM message contained the IE "Ciphering mode info":
 - set the IE "Reconfiguration" in the variable CIPHERING_STATUS to FALSE; and
 - clear the variable RB_UPLINK_CIPHERING_ACTIVATION_TIME_INFO;
 - if the received CELL UPDATE CONFIRM or URA UPDATE CONFIRM message contained the IE "Integrity protection mode info":
 - set the IE "Reconfiguration" in the variable INTEGRITY_PROTECTION_INFO to FALSE; and
 - clear the variable INTEGRITY_PROTECTION_ACTIVATION_INFO;
- if the variable ORDERED_RECONFIGURATION is set to TRUE caused by the received CELL UPDATE CONFIRM message in case of a cell update procedure:
 - set the variable ORDERED_RECONFIGURATION to FALSE;
- if V302 is equal to or smaller than N302:
 - in case of a URA update procedure:
 - stop the URA update procedure; and
 - continue with a cell update procedure;
 - select a suitable UTRA cell according to [4];
 - set the contents of the CELL UPDATE message according to subclause 8.3.1.3, except for the IE "Cell update cause" which shall be set to "Radio link failure";
 - submit the CELL UPDATE message for transmission on the uplink CCCH;
 - increment counter V302;
 - restart timer T302 when the MAC layer indicates success or failure to transmit the message;
- if V302 is greater than N302:
 - clear the variable RB_UPLINK_CIPHERING_ACTIVATION_TIME_INFO;

- clear the variable INTEGRITY_PROTECTION_ACTIVATION_INFO;
- in case of a cell update procedure:
 - clear the entry for the CELL UPDATE CONFIRM message in the table "Rejected transactions" in the variable TRANSACTIONS;
- in case of a URA update procedure:
 - clear the entry for the URA UPDATE CONFIRM message in the table "Rejected transactions" in the variable TRANSACTIONS;
- release all its radio resources;
- indicate release (abort) of the established signalling connections (as stored in the variable ESTABLISHED_SIGNALLING_CONNECTIONS) and established radio access bearers (as stored in the variable ESTABLISHED_RABS) to upper layers;
- clear the variable ESTABLISHED_SIGNALLING_CONNECTIONS;
- clear the variable ESTABLISHED_RABS;
- set the variable CELL_UPDATE_STARTED to FALSE;
- enter idle mode.

8.3.1.8 Unsupported configuration by the UE

If the UE does not support the configuration in the CELL UPDATE CONFIRM message and/or the variable UNSUPPORTED_CONFIGURATION is set to TRUE, the UE shall:

- if V302 is equal to or smaller than N302, the UE shall:
 - if, caused by the received CELL UPDATE CONFIRM or URA UPDATE CONFIRM message
 - the IE "Reconfiguration" in the variable CIPHERING_STATUS is set to TRUE; and/or
 - the IE "Reconfiguration" in the variable INTEGRITY_PROTECTION_INFO is set to TRUE:
 - abort the ongoing integrity and/or ciphering reconfiguration;
 - if the received CELL UPDATE CONFIRM or URA UPDATE CONFIRM message contained the IE "Ciphering mode info":
 - set the IE "Reconfiguration" in the variable CIPHERING_STATUS to FALSE; and
 - clear the variable RB_UPLINK_CIPHERING_ACTIVATION_TIME_INFO;
 - if the received CELL UPDATE CONFIRM or URA UPDATE CONFIRM message contained the IE "Integrity protection mode info":
 - set the IE "Reconfiguration" in the variable INTEGRITY_PROTECTION_INFO to FALSE; and
 - clear the variable INTEGRITY_PROTECTION_ACTIVATION_INFO;
- if the variable ORDERED_RECONFIGURATION is set to TRUE caused by the received CELL UPDATE CONFIRM message in case of a cell update procedure:
 - set the variable ORDERED_RECONFIGURATION to FALSE;
- set the variable FAILURE_INDICATOR to TRUE;
- set the variable FAILURE_CAUSE to "Unsupported configuration";
- set the content of the CELL UPDATE message according to subclause 8.3.1.3;
- submit the CELL UPDATE message for transmission on the uplink CCCH;

- increment counter V302;
- restart timer T302 when the MAC layer indicates success or failure to transmit the message;
- if V302 is greater than N302, the UE shall:
 - clear the variable RB_UPLINK_CIPHERING_ACTIVATION_TIME_INFO;
 - clear the variable INTEGRITY_PROTECTION_ACTIVATION_INFO;
 - clear the variable PDCP_SN_INFO;
 - clear the entry for the CELL UPDATE CONFIRM message in the table "Rejected transactions" in the variable TRANSACTIONS;
 - release all its radio resources;
 - indicate release (abort) of the established signalling connections (as stored in the variable ESTABLISHED_SIGNALLING_CONNECTIONS) and established radio access bearers (as stored in the variable ESTABLISHED_RABS) to upper layers;
 - clear the variable ESTABLISHED_SIGNALLING_CONNECTIONS;
 - clear the variable ESTABLISHED_RABS;
 - set the variable CELL_UPDATE_STARTED to FALSE;
 - enter idle mode;
 - Other actions the UE shall perform when entering idle mode from connected mode are specified in subclause 8.5.2;
 - and the procedure ends.

8.3.1.9 Invalid configuration

If the variable INVALID_CONFIGURATION is set to TRUE, the UE shall:

- if V302 is equal to or smaller than N302:
 - if, caused by the received CELL UPDATE CONFIRM or URA UPDATE CONFIRM message
 - the IE "Reconfiguration" in the variable CIPHERING_STATUS is set to TRUE; and/or
 - the IE "Reconfiguration" in the variable INTEGRITY_PROTECTION_INFO is set to TRUE:
 - abort the ongoing integrity and/or ciphering reconfiguration;
 - if the received CELL UPDATE CONFIRM or URA UPDATE CONFIRM message contained the IE "Ciphering mode info":
 - set the IE "Reconfiguration" in the variable CIPHERING_STATUS to FALSE; and
 - clear the variable RB_UPLINK_CIPHERING_ACTIVATION_TIME_INFO;
 - if the received CELL UPDATE CONFIRM or URA UPDATE CONFIRM message contained the IE "Integrity protection mode info":
 - set the IE "Reconfiguration" in the variable INTEGRITY_PROTECTION_INFO to FALSE; and
 - clear the variable INTEGRITY_PROTECTION_ACTIVATION_INFO;
 - if the variable ORDERED_RECONFIGURATION is set to TRUE caused by the received CELL UPDATE CONFIRM message in case of a cell update procedure:
 - set the variable ORDERED_RECONFIGURATION to FALSE;

- in case of a cell update procedure:
 - set the variable FAILURE_INDICATOR to TRUE;
 - set the variable FAILURE_CAUSE to "Invalid configuration";
 - set the contents of the CELL UPDATE message according to subclause 8.3.1.3;
 - submit the CELL UPDATE message for transmission on the uplink CCCH;
- in case of a URA update procedure:
 - set the contents of the URA UPDATE message according to subclause 8.3.1.3;
 - submit the URA UPDATE message for transmission on the uplink CCCH;
- increment counter V302;
- restart timer T302 when the MAC layer indicates success or failure to transmit the message;
- if V302 is greater than N302:
 - clear the variable RB_UPLINK_CIPHERING_ACTIVATION_TIME_INFO;
 - clear the variable INTEGRITY_PROTECTION_ACTIVATION_INFO;
 - clear the variable PDCP_SN_INFO;
 - clear the entry for the CELL UPDATE CONFIRM message in the table "Rejected transactions" in the variable TRANSACTIONS;
 - release all its radio resources;
 - indicate release (abort) of the established signalling connections (as stored in the variable ESTABLISHED_SIGNALLING_CONNECTIONS) and established radio access bearers (as stored in the variable ESTABLISHED_RABS) to upper layers;
 - clear the variable ESTABLISHED_SIGNALLING_CONNECTIONS;
 - clear the variable ESTABLISHED_RABS;
 - set the variable CELL_UPDATE_STARTED to FALSE;
 - enter idle mode;
 - Other actions the UE shall perform when entering idle mode from connected mode are specified in subclause 8.5.2;
- the procedure ends.

8.3.1.9a Incompatible simultaneous reconfiguration

In case of a cell update procedure and if the received CELL UPDATE CONFIRM message

- includes "RB information elements"; and/or
- includes "Transport channel information elements"; and/or
- includes "Physical channel information elements"; and
- the variable ORDERED_RECONFIGURATION is set to TRUE because of an ongoing Reconfiguration procedure;

and/or

- if the variable INCOMPATIBLE_SECURITY_RECONFIGURATION becomes set to TRUE of the received CELL UPDATE CONFIRM message:

the UE shall:

- if V302 is equal to or smaller than N302:
 - if, caused by the received CELL UPDATE CONFIRM or URA UPDATE CONFIRM message
 - the IE "Reconfiguration" in the variable CIPHERING_STATUS is set to TRUE; and/or
 - the IE "Reconfiguration" in the variable INTEGRITY_PROTECTION_INFO is set to TRUE:
 - abort the ongoing integrity and/or ciphering reconfiguration;
 - if the received CELL UPDATE CONFIRM or URA UPDATE CONFIRM message contained the IE "Ciphering mode info":
 - set the IE "Reconfiguration" in the variable CIPHERING_STATUS to FALSE; and
 - clear the variable RB_UPLINK_CIPHERING_ACTIVATION_TIME_INFO;
 - if the received CELL UPDATE CONFIRM or URA UPDATE CONFIRM message contained the IE "Integrity protection mode info":
 - set the IE "Reconfiguration" in the variable INTEGRITY_PROTECTION_INFO to FALSE; and
 - clear the variable INTEGRITY_PROTECTION_ACTIVATION_INFO;
 - if the variable ORDERED_RECONFIGURATION is set to TRUE caused by the received CELL UPDATE CONFIRM message in case of a cell update procedure:
 - set the variable ORDERED_RECONFIGURATION to FALSE;
 - set the variable FAILURE_INDICATOR to TRUE;
 - set the variable FAILURE_CAUSE to "Incompatible simultaneous reconfiguration";
 - set the content of the CELL UPDATE message according to subclause 8.3.1.3;
 - submit the CELL UPDATE message for transmission on the uplink CCCH;
 - increment counter V302;
 - restart timer T302 when the MAC layer indicates success or failure to transmit the message;
- if V302 is greater than N302:
 - clear the variable RB_UPLINK_CIPHERING_ACTIVATION_TIME_INFO;
 - clear the variable INTEGRITY_PROTECTION_ACTIVATION_INFO;
 - clear the variable PDCP_SN_INFO;
 - set the variable INCOMPATIBLE_SECURITY_RECONFIGURATION to FALSE;
 - clear the entry for the CELL UPDATE CONFIRM message in the table "Rejected transactions" in the variable TRANSACTIONS;
 - release all its radio resources;
 - indicate release (abort) of the established signalling connections (as stored in the variable ESTABLISHED_SIGNALLING_CONNECTIONS) and established radio access bearers (as stored in the variable ESTABLISHED_RABS) to upper layers;
 - clear the variable ESTABLISHED_SIGNALLING_CONNECTIONS;
 - clear the variable ESTABLISHED_RABS;
 - set the variable CELL_UPDATE_STARTED to FALSE;

- enter idle mode;
- Other actions the UE shall perform when entering idle mode from connected mode are specified in subclause 8.5.2;
- the procedure ends.

8.3.1.10 Confirmation error of URA ID list

If the URA UPDATE CONFIRM message causes a confirmation error of URA identity list as specified in subclause 8.6.2.1 the UE shall:

- check the value of V302; and
- if V302 is smaller or equal than N302:
 - if, caused by the received CELL UPDATE CONFIRM or URA UPDATE CONFIRM message
 - the IE "Reconfiguration" in the variable CIPHERING_STATUS is set to TRUE; and/or
 - the IE "Reconfiguration" in the variable INTEGRITY_PROTECTION_INFO is set to TRUE:
 - abort the ongoing integrity and/or ciphering reconfiguration;
 - if the received CELL UPDATE CONFIRM or URA UPDATE CONFIRM message contained the IE "Ciphering mode info":
 - set the IE "Reconfiguration" in the variable CIPHERING_STATUS to FALSE; and
 - clear the variable RB_UPLINK_CIPHERING_ACTIVATION_TIME_INFO;
 - if the received CELL UPDATE CONFIRM or URA UPDATE CONFIRM message contained the IE "Integrity protection mode info"
 - set the IE "Reconfiguration" in the variable INTEGRITY_PROTECTION_INFO to FALSE; and
 - clear the variable INTEGRITY_PROTECTION_ACTIVATION_INFO;
 - set the IEs in the URA UPDATE message according to subclause 8.3.1.3;
 - submit the URA UPDATE message for transmission on the uplink CCCH;
 - increment counter V302;
 - restart timer T302 when the MAC layer indicates success or failure to transmit the message;
- if V302 is greater than N302:
 - release all its radio resources;
 - clear the variable RB_UPLINK_CIPHERING_ACTIVATION_TIME_INFO;
 - clear the variable INTEGRITY_PROTECTION_ACTIVATION_INFO;
 - clear the variable PDCP_SN_INFO;
 - indicate release (abort) of the established signalling connections (as stored in the variable ESTABLISHED_SIGNALLING_CONNECTIONS) and established radio access bearers (as stored in the variable ESTABLISHED_RABS) to upper layers;
 - clear the variable ESTABLISHED_SIGNALLING_CONNECTIONS;
 - clear the variable ESTABLISHED_RABS;
 - set the variable CELL_UPDATE_STARTED to FALSE;
 - enter idle mode;

- perform the actions specified in subclause 8.5.2 when entering idle mode from connected mode;
- the procedure ends.

8.3.1.11 Invalid CELL UPDATE CONFIRM/URA UPDATE CONFIRM message

If the UE receives an CELL UPDATE CONFIRM/URA UPDATE CONFIRM message, which contains a protocol error causing the variable `PROTOCOL_ERROR_REJECT` to be set to TRUE according to clause 9, the UE shall perform procedure specific error handling as follows:

- If V302 is equal to or smaller than N302, the UE shall:
 - set the variable `PROTOCOL_ERROR_INDICATOR` to TRUE;
 - in case of a cell update procedure:
 - set the contents of the CELL UPDATE message according to subclause 8.3.1.3;
 - submit the CELL UPDATE message for transmission on the uplink CCCH;
 - in case of a URA update procedure:
 - set the contents of the URA UPDATE message according to subclause 8.3.1.3;
 - submit the URA UPDATE message for transmission on the uplink CCCH;
 - increment counter V302;
 - restart timer T302 when the MAC layer indicates success or failure to transmit the message;
- if V302 is greater than N302, the UE shall:
 - clear the variable `RB_UPLINK_CIPHERING_ACTIVATION_TIME_INFO`;
 - in case of a cell update procedure:
 - clear the entry for the CELL UPDATE CONFIRM message in the table "Rejected transactions" in the variable `TRANSACTIONS`;
 - in case of a URA update procedure:
 - clear the entry for the URA UPDATE CONFIRM message in the table "Rejected transactions" in the variable `TRANSACTIONS`;
 - indicate release (abort) of the established signalling connections (as stored in the variable `ESTABLISHED_SIGNALLING_CONNECTIONS`) and established radio access bearers (as stored in the variable `ESTABLISHED_RABS`) to upper layers;
 - clear the variable `ESTABLISHED_SIGNALLING_CONNECTIONS`;
 - clear the variable `ESTABLISHED_RABS`;
 - set the variable `CELL_UPDATE_STARTED` to FALSE;
 - release all its radio resources;
 - enter idle mode;
 - Other actions the UE shall perform when entering idle mode from connected mode are specified in subclause 8.5.2;
- the procedure ends.

8.3.1.12 T302 expiry or cell reselection

If any or several of the following conditions are true:

- expiry of timer T302;
- reselection to another UTRA cell (including the previously serving cell) before completion of the cell update or URA update procedure;

the UE shall:

- stop T302 if it is running;
- if the UE was in CELL_DCH state prior to the initiation of the procedure; and
 - if timers T314 and T315 have elapsed while T302 was running:
 - enter idle mode.
 - indicate release (abort) of the established signalling connections (as stored in the variable ESTABLISHED_SIGNALLING_CONNECTIONS) and established radio access bearers (as stored in the variable ESTABLISHED_RABS) to upper layers. Other actions the UE shall perform when entering idle mode from connected mode are specified in subclause 8.5.2.
 - and the procedure ends.
 - if timer T314 has elapsed while T302 was running and,
 - if "T314 expired" in the variable RB_TIMER_INDICATOR is set to FALSE and
 - if T315 is still running:
 - release locally all radio bearers which are associated with any radio access bearers for which in the variable ESTABLISHED_RABS the value of the IE "Re-establishment timer" is set to "useT314";
 - indicate release of those radio access bearers to upper layers;
 - delete all information about those radio access bearers from the variable ESTABLISHED_RABS;
 - set "T314 expired" in the variable RB_TIMER_INDICATOR to TRUE;
 - if timer T315 has elapsed while T302 was running and,
 - if "T315 expired" in the variable RB_TIMER_INDICATOR is set to FALSE and,
 - if T314 is still running:
 - release locally all radio bearers which are associated with any radio access bearers for which in the variable ESTABLISHED_RABS the value of the IE "Re-establishment timer" is set to "useT315";
 - indicate release of those radio access bearers to upper layers;
 - delete all information about those radio access bearers from the variable ESTABLISHED_RABS;
 - set "T315 expired" in the variable RB_TIMER_INDICATOR to TRUE;
- check whether it is still in "in service area" (see subclause 8.5.5.2);
- if, caused by the received CELL UPDATE CONFIRM or URA UPDATE CONFIRM message the IE "Reconfiguration" in the variable CIPHERING_STATUS is set to TRUE and/or the IE "Reconfiguration" in the variable INTEGRITY_PROTECTION_INFO is set to TRUE:
 - abort the ongoing integrity and/or ciphering reconfiguration;
 - if the received CELL UPDATE CONFIRM or URA UPDATE CONFIRM message contained the IE "Ciphering mode info":
 - set the IE "Reconfiguration" in the variable CIPHERING_STATUS to FALSE; and
 - clear the variable RB_UPLINK_CIPHERING_ACTIVATION_TIME_INFO;

- if the received CELL UPDATE CONFIRM or URA UPDATE CONFIRM message contained the IE "Integrity protection mode info":
 - set the IE "Reconfiguration" in the variable INTEGRITY_PROTECTION_INFO to FALSE; and
 - clear the variable INTEGRITY_PROTECTION_ACTIVATION_INFO;
- if the variable ORDERED_RECONFIGURATION is set to TRUE caused by the received CELL UPDATE CONFIRM message in case of a cell update procedure:
 - set the variable ORDERED_RECONFIGURATION to FALSE;
- in case of a cell update procedure:
 - clear any entry for the CELL UPDATE CONFIRM message in the table "Accepted transactions" in the variable TRANSACTIONS;
- in case of a URA update procedure:
 - clear any entry for the URA UPDATE CONFIRM message in the table "Accepted transactions" in the variable TRANSACTIONS;

If the UE detects "in service area" if it has not entered idle mode, and:

- if V302 is equal to or smaller than N302, the UE shall:
 - if the UE performed cell re-selection:
 - delete its C-RNTI;
 - in case of a cell update procedure:
 - set the contents of the CELL UPDATE message according to subclause 8.3.1.3;
 - submit the CELL UPDATE message for transmission on the uplink CCCH;
 - in case of a URA update procedure:
 - set the contents of the URA UPDATE message according to subclause 8.3.1.3;
 - submit the URA UPDATE message for transmission on the uplink CCCH;
 - increment counter V302;
 - restart timer T302 when the MAC layer indicates success or failure to transmit the message;
- if V302 is greater than N302, the UE shall:
 - clear the variable RB_UPLINK_CIPHERING_ACTIVATION_TIME_INFO;
 - clear the variable INTEGRITY_PROTECTION_ACTIVATION_INFO;
 - clear the variable PDCP_SN_INFO;
 - in case of a cell update procedure:
 - clear the entry for the CELL UPDATE CONFIRM message in the table "Rejected transactions" in the variable TRANSACTIONS;
 - in case of a URA update procedure:
 - clear the entry for the URA UPDATE CONFIRM message in the table "Rejected transactions" in the variable TRANSACTIONS;
 - release all its radio resources;

- indicate release (abort) of the established signalling connections (as stored in the variable ESTABLISHED_SIGNALLING_CONNECTIONS) and established radio access bearers (as stored in the variable ESTABLISHED_RABS) to upper layers;
- clear the variable ESTABLISHED_SIGNALLING_CONNECTIONS;
- clear the variable ESTABLISHED_RABS;
- set the variable CELL_UPDATE_STARTED to FALSE;
- enter idle mode;
- other actions the UE shall perform when entering idle mode from connected mode are specified in subclause 8.5.2;
- and the procedure ends.

If the UE does not detect "in service area", it shall:

- continue searching for "in service area".

8.3.1.13 T314 expiry

Upon expiry of timer T314 the UE shall:

- if timer T302 is running:
 - continue awaiting response message from UTRAN;
- if timer T302 is not running and timer T315 is running:
 - set IE "T314 expired" in variable RB_TIMER_INDICATOR to TRUE;
 - release locally all radio bearers which are associated with any radio access bearers for which in the variable ESTABLISHED_RABS the value of the IE "Re-establishment timer" is set to "useT314";
 - indicate release of those radio access bearers to upper layers;
 - delete all information about those radio access bearers from the variable ESTABLISHED_RABS;
- if timers T302 and T315 are not running:
 - clear the variable RB_UPLINK_CIPHERING_ACTIVATION_TIME_INFO;
 - clear the variable INTEGRITY_PROTECTION_ACTIVATION_INFO;
 - clear the variable PDCP_SN_INFO;
 - clear the entry for the CELL UPDATE CONFIRM message in the table "Rejected transactions" in the variable TRANSACTIONS;
 - release all its radio resources;
 - indicate release (abort) of the established signalling connections (as stored in the variable ESTABLISHED_SIGNALLING_CONNECTIONS) and established radio access bearers (as stored in the variable ESTABLISHED_RABS) to upper layers;
 - clear the variable ESTABLISHED_SIGNALLING_CONNECTIONS;
 - clear the variable ESTABLISHED_RABS;
 - set the variable CELL_UPDATE_STARTED to FALSE;
 - enter idle mode;
 - other actions the UE shall perform when entering idle mode from connected mode are specified in subclause 8.5.2;

- and the procedure ends.

8.3.1.14 T315 expiry

Upon expiry of timer T315 the UE shall:

- if timer T302 is running:
 - continue awaiting response message from UTRAN;
- if timer T302 is not running and timer T314 is running:
 - set IE "T315 expired" in variable RB_TIMER_INDICATOR to TRUE;
 - release locally all radio bearers which are associated with any radio access bearers for which in the variable ESTABLISHED_RABS the value of the IE "Re-establishment timer" is set to "use T315";
 - indicate release of those radio access bearers to upper layers;
 - delete all information about those radio access bearers from the variable ESTABLISHED_RABS;
- if timers T302 and T314 are not running:
 - clear the variable RB_UPLINK_CIPHERING_ACTIVATION_TIME_INFO;
 - clear the variable INTEGRITY_PROTECTION_ACTIVATION_INFO;
 - clear the variable PDCP_SN_INFO;
 - clear the entry for the CELL UPDATE CONFIRM message in the table "Rejected transactions" in the variable TRANSACTIONS;
 - release all its radio resources;
 - indicate release (abort) of the established signalling connections (as stored in the variable ESTABLISHED_SIGNALLING_CONNECTIONS) and established radio access bearers (as stored in the variable ESTABLISHED_RABS) to upper layers;
 - clear the variable ESTABLISHED_SIGNALLING_CONNECTIONS;
 - clear the variable ESTABLISHED_RABS;
 - set the variable CELL_UPDATE_STARTED to FALSE;
 - enter idle mode;
 - other actions the UE shall perform when entering idle mode from connected mode are specified in subclause 8.5.2;
- and the procedure ends.

8.3.1.15 Reception of the UTRAN MOBILITY INFORMATION CONFIRM message by the UTRAN

See subclause 8.3.3.4.

8.3.2 URA update

See subclause 8.3.1.

8.3.3 UTRAN mobility information

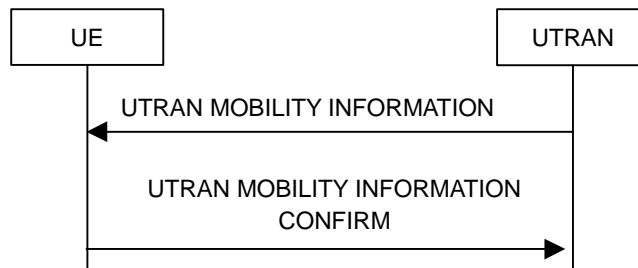

Figure 48: UTRAN mobility information procedure, normal flow

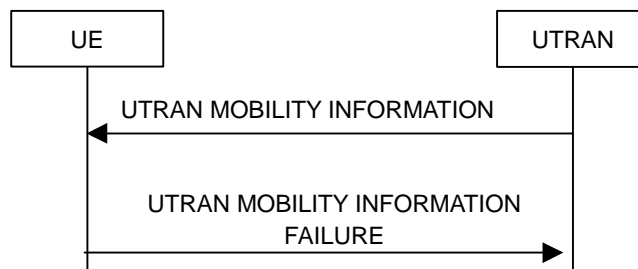

Figure 49: UTRAN mobility information procedure, failure case

8.3.3.1 General

The purpose of this procedure is to allocate any one or a combination of the following to a UE in connected mode:

- a new C-RNTI;
- a new U-RNTI;
- other mobility related information.

8.3.3.2 Initiation

To initiate the procedure UTRAN transmits a UTRAN MOBILITY INFORMATION message to the UE on the downlink DCCH.

8.3.3.3 Reception of UTRAN MOBILITY INFORMATION message by the UE

When the UE receives a UTRAN MOBILITY INFORMATION message, it shall:

- act on received information elements as specified in subclause 8.6;
- if the IE "UE Timers and constants in connected mode" is present:
 - store the values of the IE "UE Timers and constants in connected mode" in the variable TIMERS_AND_CONSTANTS, replacing any previously stored value for each timer and constant; and
 - for each updated timer value:
 - start using the new value next time the timer is started;
 - for each updated constant value:
 - start using the new value directly;
- set the IE "RRC transaction identifier" in the UTRAN MOBILITY INFORMATION CONFIRM message to the value of "RRC transaction identifier" in the entry for the UTRAN MOBILITY INFORMATION message in the table "Accepted transactions" in the variable TRANSACTIONS; and

- clear that entry;
- if the UTRAN MOBILITY INFORMATION message contained the IE "Ciphering mode info":
 - include and set the IE "Radio bearer uplink ciphering activation time info" to the value of the variable RB_UPLINK_CIPHERING_ACTIVATION_TIME_INFO;
- if the UTRAN MOBILITY INFORMATION message contained the IE "Integrity protection mode info" with the IE "Integrity protection mode command" set to "Modify":
 - include and set the IE "Integrity protection activation info" to the value of the variable INTEGRITY_PROTECTION_ACTIVATION_INFO;
- if the variable PDCP_SN_INFO is non-empty:
 - include the IE "RB with PDCP information list" in the UTRAN MOBILITY INFORMATION CONFIRM message and set it to the value of the variable PDCP_SN_INFO;
- if the received UTRAN MOBILITY INFORMATION message included the IE "Downlink counter synchronisation info":
 - calculate the START value according to subclause 8.5.9;
 - include the calculated START values for each CN domain in the IE "START list" in the IE "Uplink counter synchronisation info" in the UTRAN MOBILITY INFORMATION CONFIRM message;
- transmit a UTRAN MOBILITY INFORMATION CONFIRM message on the uplink DCCH using AM RLC;
- if the IE "Integrity protection mode info" was present in the UTRAN MOBILITY INFORMATION message:
 - start applying the new integrity protection configuration in the uplink for signalling radio bearer RB2 from and including the transmitted UTRAN MOBILITY INFORMATION CONFIRM message;
- if the variable PDCP_SN_INFO is empty; and
 - if the UTRAN MOBILITY INFORMATION message contained the IE "Ciphering mode info":
 - when RLC has confirmed the successful transmission of the UTRAN MOBILITY INFORMATION CONFIRM message, perform the actions below;
 - if the UTRAN MOBILITY INFORMATION message did not contain the IE "Ciphering mode info":
 - when RLC has been requested to transmit the UTRAN MOBILITY INFORMATION CONFIRM message, perform the actions below;
- if the variable PDCP_SN_INFO is non-empty:
 - when RLC has confirmed the successful transmission of the UTRAN MOBILITY INFORMATION CONFIRM message:
 - for each radio bearer in the variable PDCP_SN_INFO:
 - if the IE "RB started" in the variable ESTABLISHED_RABS is set to "started":
 - configure the RLC entity for that radio bearer to "continue";
 - clear the variable PDCP_SN_INFO;
- if the UTRAN MOBILITY INFORMATION message contained the IE "Ciphering mode info":
 - set the IE "Reconfiguration" in the variable CIPHERING_STATUS to FALSE; and
 - clear the variable RB_UPLINK_CIPHERING_ACTIVATION_TIME_INFO;
- if the UTRAN MOBILITY INFORMATION message contained the IE "Integrity protection mode info":
 - set the IE "Reconfiguration" in the variable INTEGRITY_PROTECTION_INFO to FALSE; and

- clear the variable INTEGRITY_PROTECTION_ACTIVATION_INFO;

The procedure ends.

8.3.3.4 Reception of an UTRAN MOBILITY INFORMATION CONFIRM message by the UTRAN

When the network receives UTRAN MOBILITY INFORMATION CONFIRM message, UTRAN may delete any old U-RNTI. The procedure ends.

8.3.3.5 Cell re-selection

If the UE performs cell re-selection, the UE shall:

- initiate a cell update procedure according to subclause 8.3.1;
- if the UTRAN MOBILITY INFORMATION message contains the IE "New C-RNTI"; and
- if the UE has not yet submitted the UTRAN MOBILITY INFORMATION CONFIRM message to lower layers for transmission;
 - transmit a UTRAN MOBILITY INFORMATION FAILURE message on the uplink DCCH using AM RLC;
 - set the IE "RRC transaction identifier" in the UTRAN MOBILITY INFORMATION FAILURE message to the value of "RRC transaction identifier" in the entry for the UTRAN MOBILITY INFORMATION message in the table "Accepted transactions" in the variable TRANSACTIONS; and
 - clear that entry.
 - set the IE "failure cause" to the cause value "cell update occurred";
 - when the UTRAN MOBILITY INFORMATION FAILURE message has been submitted to lower layers for transmission:
 - continue with any ongoing processes and procedures as if the invalid UTRAN MOBILITY INFORMATION message has not been received and the procedure ends.
- otherwise:
 - continue the procedure normally.

8.3.3.5a Incompatible simultaneous security reconfiguration

If the variable INCOMPATIBLE_SECURITY_RECONFIGURATION becomes set to TRUE of the received UTRAN MOBILITY INFORMATION message, the UE shall:

- transmit a UTRAN MOBILITY INFORMATION FAILURE message on the uplink DCCH using AM RLC;
- set the IE "RRC transaction identifier" in the UTRAN MOBILITY INFORMATION FAILURE message to the value of "RRC transaction identifier" in the entry for the UTRAN MOBILITY INFORMATION message in the table "Accepted transactions" in the variable TRANSACTIONS; and
- clear that entry;
- set the IE "failure cause" to the cause value "incompatible simultaneous reconfiguration";
- when the UTRAN MOBILITY INFORMATION FAILURE message has been delivered to lower layers for transmission:
 - set the variable INCOMPATIBLE_SECURITY_RECONFIGURATION to FALSE;
 - continue with any ongoing processes and procedures as if the UTRAN MOBILITY INFORMATION message has not been received;
 - and the procedure ends.

8.3.3.6 Invalid UTRAN MOBILITY INFORMATION message

If the UTRAN MOBILITY INFORMATION message contains a protocol error causing the variable `PROTOCOL_ERROR_REJECT` to be set to `TRUE` according to clause 9, the UE shall perform procedure specific error handling as follows. The UE shall:

- transmit a UTRAN MOBILITY INFORMATION FAILURE message on the uplink DCCH using AM RLC;
- set the IE "RRC transaction identifier" in the UTRAN MOBILITY INFORMATION FAILURE message to the value of "RRC transaction identifier" in the entry for the UTRAN MOBILITY INFORMATION message in the table "Rejected transactions" in the variable `TRANSACTIONS`, and;
- clear that entry.
- set the IE "failure cause" to the cause value "protocol error";
- include the IE "Protocol error information" with contents set to the value of the variable `PROTOCOL_ERROR_INFORMATION`;
- when the UTRAN MOBILITY INFORMATION FAILURE message has been submitted to lower layers for transmission:
 - continue with any ongoing processes and procedures as if the invalid UTRAN MOBILITY INFORMATION message has not been received;
 - and the procedure ends.

8.3.4 Active set update

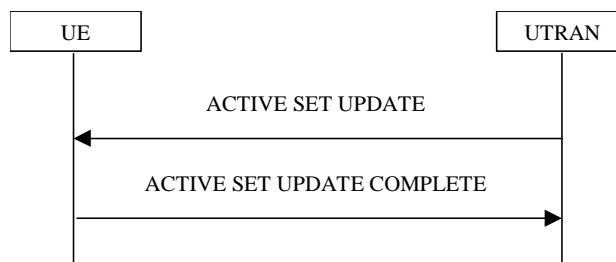

Figure 50: Active Set Update procedure, successful case

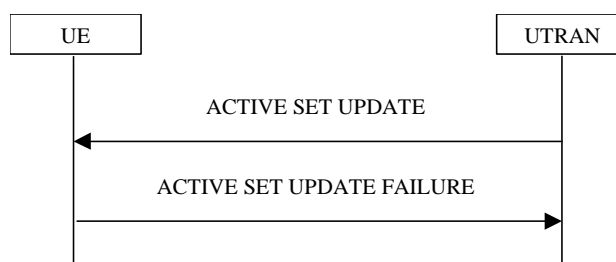

Figure 51: Active Set Update procedure, failure case

8.3.4.1 General

The purpose of the active set update procedure is to update the active set of the connection between the UE and UTRAN. This procedure shall be used in `CELL_DCH` state. The UE should keep on using the old RLs while configuring the new RLs. Also the UE should keep the transmitter turned on during the procedure. This procedure is only used in FDD mode.

8.3.4.2 Initiation

The procedure is initiated when UTRAN orders a UE in CELL_DCH state, to make the following modifications of the active set of the connection:

- a) Radio link addition;
- b) Radio link removal;
- c) Combined radio link addition and removal.

In case a) and c), UTRAN should:

- prepare new additional radio link(s) in the UTRAN prior to the command to the UE.

In all cases, UTRAN should:

- send an ACTIVE SET UPDATE message on downlink DCCH using AM or UM RLC.

UTRAN should include the following information:

- IE "Radio Link Addition Information": Downlink DPCH information and other optional parameters relevant for the radio links to be added along with the IE "Primary CPICH info" used for the reference ID to indicate which radio link to add. This IE is needed in cases a) and c) listed above;
- IE "Radio Link Removal Information": IE "Primary CPICH info" used for the reference ID to indicate which radio link to remove. This IE is needed in cases b) and c) listed above.

8.3.4.3 Reception of an ACTIVE SET UPDATE message by the UE

Upon reception of an ACTIVE SET UPDATE message the UE shall act upon all received information elements as specified in 8.6, unless specified otherwise in the following. The UE shall:

- first add the RLs indicated in the IE "Radio Link Addition Information";
- remove the RLs indicated in the IE "Radio Link Removal Information". If the UE active set is full or becomes full, an RL, which is included in the IE "Radio Link Removal Information" for removal, shall be removed before adding RL, which is included in the IE "Radio Link Addition Information" for addition;
- perform the physical layer synchronisation procedure as specified in [29];
- if the ACTIVE SET UPDATE message contained the IE "Ciphering mode info":
 - include and set the IE "Radio bearer uplink ciphering activation time info" to the value of the variable RB_UPLINK_CIPHERING_ACTIVATION_TIME_INFO;
- if the ACTIVE SET UPDATE message contained the IE "Integrity protection mode info" with the IE "Integrity protection mode command" set to "Modify":
 - include and set the IE "Integrity protection activation info" to the value of the variable INTEGRITY_PROTECTION_ACTIVATION_INFO;
- if the variable PDCP_SN_INFO is non-empty:
 - include the IE "RB with PDCP information list" in the ACTIVE SET UPDATE COMPLETE message; and
 - set it to the value of the variable PDCP_SN_INFO;
- if the IE "TFCI combining indicator" associated with a radio link to be added is set to TRUE:
 - if a DSCH transport channel is assigned and there is a 'hard' split in the TFCI field:
 - configure Layer 1 to soft-combine TFCI (field 2) of this new link with those links already in the TFCI (field 2) combining set;
- if the received ACTIVE SET UPDATE message included the IE "Downlink counter synchronisation info":

- calculate the START value according to subclause 8.5.9;
- include the calculated START values for each CN domain in the IE "START list" in the IE "Uplink counter synchronisation info" in the ACTIVE SET UPDATE COMPLETE message;
- set the IE "RRC transaction identifier" in the ACTIVE SET UPDATE COMPLETE message to the value of "RRC transaction identifier" in the entry for the ACTIVE SET UPDATE message in the table "Accepted transactions" in the variable TRANSACTIONS; and
- clear that entry;
- transmit an ACTIVE SET UPDATE COMPLETE message on the uplink DCCH using AM RLC without waiting for the Physical Layer synchronization;
- if the IE "Integrity protection mode info" was present in the ACTIVE SET UPDATE message:
 - start applying the new integrity protection configuration in the uplink for signalling radio bearer RB2 from and including the transmitted ACTIVE SET UPDATE COMPLETE message;
- if the variable PDCP_SN_INFO is empty:
 - if the ACTIVE SET UPDATE message contained the IE "Ciphering mode info":
 - when RLC has confirmed the successful transmission of the ACTIVE SET UPDATE COMPLETE message:
 - perform the actions below;
 - if the ACTIVE SET UPDATE message did not contain the IE "Ciphering mode info":
 - when RLC has been requested to transmit the ACTIVE SET UPDATE COMPLETE message:
 - perform the actions below;
- if the variable PDCP_SN_INFO is non-empty:
 - when RLC has confirmed the successful transmission of the ACTIVE SET UPDATE COMPLETE message:
 - for each radio bearer in the variable PDCP_SN_INFO:
 - if the IE "RB started" in the variable ESTABLISHED_RABS is set to "started":
 - configure the RLC entity for that radio bearer to "continue";
 - clear the variable PDCP_SN_INFO;
- if the ACTIVE SET UPDATE message contained the IE "Ciphering mode info":
 - set the IE "Reconfiguration" in the variable CIPHERING_STATUS to FALSE; and
 - clear the variable RB_UPLINK_CIPHERING_ACTIVATION_TIME_INFO;
- if the ACTIVE SET UPDATE message contained the IE "Integrity protection mode info":
 - set the IE "Reconfiguration" in the variable INTEGRITY_PROTECTION_INFO to FALSE; and
 - clear the variable INTEGRITY_PROTECTION_ACTIVATION_INFO;
- the procedure ends on the UE side.

8.3.4.4 Unsupported configuration in the UE

If UTRAN instructs the UE to use a configuration that it does not support, the UE shall:

- keep the active set as it was before the ACTIVE SET UPDATE message was received;
- transmit an ACTIVE SET UPDATE FAILURE message on the DCCH using AM RLC;

- set the IE "RRC transaction identifier" in the ACTIVE SET UPDATE FAILURE message to the value of "RRC transaction identifier" in the entry for the ACTIVE SET UPDATE message in the table "Accepted transactions" in the variable TRANSACTIONS; and
- clear that entry;
- set the IE "failure cause" to "configuration unsupported";
- when the ACTIVE SET UPDATE FAILURE message has been submitted to lower layers for transmission:
 - the procedure ends on the UE side.

8.3.4.5 Invalid configuration

If any of the following conditions are valid:

- a radio link indicated by the IE "Downlink DPCH info for each RL" in the IE "Radio link addition information" has a different spreading factor than the spreading factor for the radio links in the active set that will be established at the time indicated by the IE "Activation time"; and/or
- a radio link in the IE "Radio link addition information" is also present in the IE "Radio Link Removal Information"; and/or
- the IE "Radio Link Removal Information" contains all the radio links which are part of or will be part of the active set at the time indicated by the IE "Activation time"; and/or
- the variable INVALID_CONFIGURATION is set to TRUE:

the UE shall:

- keep the active set as it was before the ACTIVE SET UPDATE message was received;
- transmit an ACTIVE SET UPDATE FAILURE message on the DCCH using AM RLC;
- set the IE "RRC transaction identifier" in the ACTIVE SET UPDATE FAILURE message to the value of "RRC transaction identifier" in the entry for the ACTIVE SET UPDATE message in the table "Accepted transactions" in the variable TRANSACTIONS; and
- clear that entry;
- set the IE "failure cause" to "Invalid configuration";
- When the ACTIVE SET UPDATE FAILURE message has been submitted to lower layers for transmission:
 - the procedure ends on the UE side.

8.3.4.5a Incompatible simultaneous reconfiguration

If the variable INCOMPATIBLE_SECURITY_RECONFIGURATION becomes set to TRUE due to the received ACTIVE SET UPDATE message, the UE shall:

- transmit a ACTIVE SET UPDATE FAILURE message on the uplink DCCH using AM RLC;
- set the IE "RRC transaction identifier" in the ACTIVE SET UPDATE FAILURE message to the value of "RRC transaction identifier" in the entry for the ACTIVE SET UPDATE message in the table "Accepted transactions" in the variable TRANSACTIONS; and
- clear that entry;
- set the IE "failure cause" to the cause value "incompatible simultaneous reconfiguration";
- when the ACTIVE SET UPDATE FAILURE message has been delivered to lower layers for transmission:
 - set the variable INCOMPATIBLE_SECURITY_RECONFIGURATION to FALSE;

- continue with any ongoing processes and procedures as if the ACTIVE SET UPDATE message has not been received;
- and the procedure ends.

If the variable ORDERED_RECONFIGURATION is set to TRUE; and

- if the activation time for the procedure that has set variable ORDERED_RECONFIGURATION and the activation time for the Active Set Update procedure are within a time window of 5 frames, the UE may:
 - transmit a ACTIVE SET UPDATE FAILURE message on the uplink DCCH using AM RLC;
 - set the IE "RRC transaction identifier" in the ACTIVE SET UPDATE FAILURE message to the value of "RRC transaction identifier" in the entry for the ACTIVE SET UPDATE message in the table "Accepted transactions" in the variable TRANSACTIONS; and
 - clear that entry;
 - set the IE "failure cause" to the cause value "incompatible simultaneous reconfiguration";
- when the ACTIVE SET UPDATE FAILURE message has been delivered to lower layers for transmission:
 - continue with any ongoing processes and procedures as if the ACTIVE SET UPDATE message has not been received;
 - and the procedure ends.

8.3.4.6 Reception of the ACTIVE SET UPDATE COMPLETE message by the UTRAN

When the UTRAN has received the ACTIVE SET UPDATE COMPLETE message,

- the UTRAN may remove radio link(s) that are indicated to remove to the UE in case b) and c); and
- the procedure ends on the UTRAN side.

8.3.4.7 Reception of the ACTIVE SET UPDATE FAILURE message by the UTRAN

When the UTRAN has received the ACTIVE SET UPDATE FAILURE message, the UTRAN may delete radio links that were included in the IE "Radio Link Addition Information" for addition. The procedure ends on the UTRAN side.

8.3.4.8 Invalid ACTIVE SET UPDATE message

If the ACTIVE SET UPDATE message contains a protocol error causing the variable PROTOCOL_ERROR_REJECT to be set to TRUE according to clause 9, the UE shall perform procedure specific error handling as follows. The UE shall:

- transmit a ACTIVE SET UPDATE FAILURE message on the uplink DCCH using AM RLC;
- set the IE "RRC transaction identifier" in the ACTIVE SET UPDATE FAILURE message to the value of "RRC transaction identifier" in the entry for the ACTIVE SET UPDATE message in the table "Rejected transactions" in the variable TRANSACTIONS; and
- clear that entry;
- set the IE "failure cause" to the cause value "protocol error";
- include the IE "Protocol error information" with contents set to the value of the variable PROTOCOL_ERROR_INFORMATION;
- when the ACTIVE SET UPDATE FAILURE message has been delivered to lower layers for transmission:
 - continue with any ongoing processes and procedures as if the invalid ACTIVE SET UPDATE message has not been received;

- and the procedure ends.

8.3.4.9 Reception of an ACTIVE SET UPDATE message in wrong state

If the UE is in another state than CELL_DCH state upon reception of the ACTIVE SET UPDATE message, the UE shall perform procedure specific error handling as follows. The UE shall:

- transmit a ACTIVE SET UPDATE FAILURE message on the uplink DCCH using AM RLC;
- set the IE "RRC transaction identifier" in the ACTIVE SET UPDATE FAILURE message to the value of "RRC transaction identifier" in the entry for the ACTIVE SET UPDATE message in the table "Accepted transactions" in the variable TRANSACTIONS; and
- clear that entry;
- set the IE "failure cause" to the cause value "protocol error";
- include the IE "Protocol error information" with the IE "Protocol error cause" set to "Message not compatible with receiver state";
- when the ACTIVE SET UPDATE FAILURE message has been delivered to lower layers for transmission:
 - continue with any ongoing processes and procedures as if the ACTIVE SET UPDATE message has not been received;
 - and the procedure ends.

8.3.5 Hard handover

8.3.5.1 Timing re-initialised hard handover

8.3.5.1.1 General

The purpose of the timing re-initialised hard handover procedure is to remove all the RL(s) in the active set and establish new RL(s) along with a change in the UL transmission timing and the CFN in the UE according to the SFN of the target cell.(see subclause 8.5.15).

This procedure is initiated when UTRAN does not know the target SFN timing before hard handover.

8.3.5.1.2 Initiation

Timing re-initialised hard handover initiated by the UTRAN is normally performed by using the procedure "Physical channel reconfiguration" (subclause 8.2.6), but may also be performed by using either one of the following procedures:

- "radio bearer establishment" (subclause 8.2.1);
- "Radio bearer reconfiguration" (subclause 8.2.2);
- "Radio bearer release" (subclause 8.2.3); or
- "Transport channel reconfiguration" (subclause 8.2.4).

If IE "Timing indication" has the value "initialise", UE shall:

- execute the Timing Re-initialised hard handover procedure by following the procedure indicated in the subclause relevant to the procedure chosen by the UTRAN.

If the IE "Default DPCH Offset Value" is included:

- in FDD mode UTRAN should:
 - set "Default DPCH Offset Value" and "DPCH frame offset" respecting the following relation

$$(\text{Default DPCH Offset Value}) \bmod 38400 = \text{DPCH frame offset}$$

- where j indicates the first radio link listed in the message and the IE values used are the Actual Values of the IEs as defined in clause 11;
- in FDD mode the UE shall:
 - if the UE receives a message where the above relation between "Default DPCH Offset Value" and "DPCH frame offset" is not respected:
 - set the variable INVALID_CONFIGURATION to true.

If the IE "Default DPCH Offset Value" is not included:

- the UE shall:
 - use the previously received value stored in variable DOFF. If there is no previously received value stored in DOFF, the UE should use the value 0.
- in FDD mode UTRAN should:
 - set "DPCH frame offset" respecting the following relation
 - if UTRAN has previously sent Default DPCH Offset Value to the UE

$$(\text{previously sent Default DPCH Offset Value}) \bmod 38400 = \text{DPCH frame offset}_j$$
 - where j indicates the first radio link listed in the message and the IE values used are the Actual Values of the IEs as defined in clause 11.
 - if UTRAN has not previously sent Default DPCH Offset Value to the UE

$$\text{DPCH frame offset}_j = 0$$
 - where j indicates the first radio link listed in the message
- in FDD mode the UE shall:
 - if the UE receives a message where the above relations are not respected:
 - set the variable INVALID_CONFIGURATION to true.

8.3.5.2 Timing-maintained hard handover

8.3.5.2.1 General

The purpose of the Timing-maintained hard handover procedure is to remove all the RL(s) in the active set and establish new RL(s) while maintaining the UL transmission timing and the CFN in the UE.

This procedure can be initiated only if UTRAN knows the target SFN timing before hard handover. The target SFN timing can be known by UTRAN in the following 2 cases:

- UE reads SFN when measuring "Cell synchronisation information" and sends it to the UTRAN in MEASUREMENT REPORT message.
- UTRAN internally knows the time difference between the cells.

8.3.5.2.2 Initiation

Timing-maintained hard handover initiated by the network is normally performed by using the procedure "Physical channel reconfiguration" (subclause 8.2.6), but may also be performed by using either one of the following procedures:

- "radio bearer establishment" (subclause 8.2.1);
- "Radio bearer reconfiguration" (subclause 8.2.2);
- "Radio bearer release" (subclause 8.2.3); or

- "Transport channel reconfiguration" (subclause 8.2.4).

If IE "Timing indication" has the value "maintain", UE shall initiate the Timing-maintained hard handover procedure by following the procedure indicated in the subclause relevant to the procedure chosen by the UTRAN.

If the IE "Default DPCH Offset Value" is included:

- UTRAN should:
 - include the same value of IE "Default DPCH Offset Value" as the one currently being used by the UE.

NOTE: The first radio link listed in the message may not be the reference radio link.

- The UE shall:
 - on reception of a message where the value of IE "Default DPCH Offset Value" is not the same as the one currently being used by the UE:
 - set the variable INVALID_CONFIGURATION to true.

8.3.6 Inter-RAT handover to UTRAN

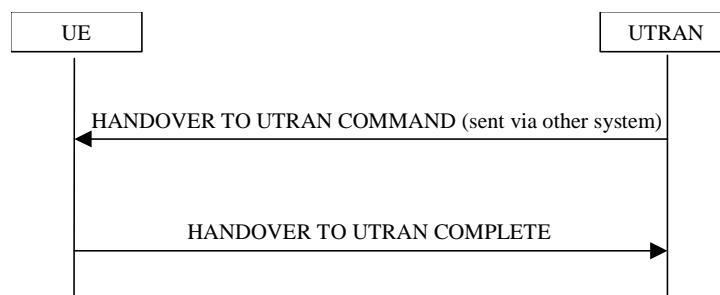

Figure 52: Inter-RAT handover to UTRAN, successful case

8.3.6.1 General

The purpose of the inter-RAT handover procedure is to, under the control of the network, transfer a connection between the UE and another radio access technology (e.g. GSM) to UTRAN.

8.3.6.2 Initiation

The procedure is initiated when a radio access technology other than UTRAN, e.g. GSM, using radio access technology-specific procedures, orders the UE to make a handover to UTRAN.

A HANDOVER TO UTRAN COMMAND message is sent to the UE via the radio access technology from which inter-RAT handover is performed.

In case UTRAN decides to use a predefined or default radio configuration that is stored in the UE, it should include the following information in the HANDOVER TO UTRAN COMMAND message.

- the IE "U-RNTI" to be assigned;
- the IE "Predefined configuration identity", to indicate which pre-defined configuration of RB, transport channel and physical channel parameters shall be used; or
- the IE "Default configuration mode" and IE "Default configuration identity", to indicate which default configuration of RB, transport channel and physical channel parameters shall be used;
- PhyCH information elements.

NOTE 1: When using a predefined or default configuration during handover to UTRAN, UTRAN can only assign values of IEs "U-RNTI" and "scrambling code" that are within the special subranges defined exclusively for this procedure. UTRAN may re-assign other values after completion of the handover procedure.

NOTE 2: When using a predefined or default configuration during handover to UTRAN, fewer IEs are signalled; when using this signalling option some parameters e.g. concerning compressed mode, DSCH, SSdT can not be configured. In this case, the corresponding functionality can not be activated immediately.

In case UTRAN does not use a predefined radio configuration that is stored in the UE, it should include the following information in the HANDOVER TO UTRAN COMMAND message.

- the IE "U-RNTI" to be assigned;
- the complete set of RB, TrCH and PhyCH information elements to be used.

8.3.6.3 Reception of HANDOVER TO UTRAN COMMAND message by the UE

The UE shall be able to receive a HANDOVER TO UTRAN COMMAND message and perform an inter-RAT handover, even if no prior UE measurements have been performed on the target UTRAN cell and/or frequency.

The UE shall act upon all received information elements as specified in subclause 8.6, unless specified otherwise in the following. The UE shall:

- store a U-RNTI value (32 bits), which is derived by the IEs "SRNC identity" (12 bits) and "S-RNTI 2" (10 bits) included in IE "U-RNTI-short". In order to produce a full size U-RNTI value, a full size "S-RNTI" (20 bits) shall be derived by padding the IE "S-RNTI 2" with 10 zero bits in the most significant positions; and
- initialise the variable ESTABLISHED_SIGNALLING_CONNECTIONS with the signalling connections that remains after the handover according to the specifications of the source RAT;
- initialise the variable UE_CAPABILITIES_TRANSFERRED with the UE capabilities that have been transferred to the network up to the point prior to the handover, if any;
- initialise the variable TIMERS_AND_CONSTANTS to the default values and start to use those timer and constants values;
- if IE "Specification mode" is set to "Preconfiguration" and IE "Preconfiguration mode" is set to "Predefined configuration":
 - initiate the radio bearer and transport channel configuration in accordance with the predefined parameters identified by the IE "Predefined configuration identity";
 - initiate the physical channels in accordance with the predefined parameters identified by the IE "Predefined radio configuration identity" and the received physical channel information elements;
 - store information about the established radio access bearers and radio bearers according to the IE "Predefined configuration identity"; and
 - set the IE "RAB Info Post" in the variable ESTABLISHED_RABS and the IE "Re-establishment timer" in the IE "RAB Info" in the variable ESTABLISHED_RABS to "useT314";
- if IE "Specification mode" is set to "Preconfiguration" and IE "Preconfiguration mode" is set to "Default configuration":
 - initiate the radio bearer and transport channel configuration in accordance with the default parameters identified by the IE "Default configuration mode" and IE "Default configuration identity";
 - initiate the physical channels in accordance with the default parameters identified by the IE "Default configuration mode" and IE "Default configuration identity" and the received physical channel information elements;

NOTE IE "Default configuration mode" specifies whether the FDD or TDD version of the default configuration shall be used

- set the IE "RAB Info Post" in the variable ESTABLISHED_RABS and the IE "Re-establishment timer" in the IE "RAB Info" in the variable ESTABLISHED_RABS to "useT314";
- if IE "Specification mode" is set to "Preconfiguration":
 - use the following values for parameters that are neither signalled within the HANDOVER TO UTRAN COMPLETE message nor included within pre-defined or default configuration:
 - 0 dB for the power offset $P_{\text{Pilot-DPDCH}}$ bearer in FDD;
 - calculate the Default DPCH Offset Value using the following formula:
 - in FDD:

$$\text{Default DPCH Offset Value} = (\text{SRNTI} \cdot 2 \bmod 600) * 512$$
 - in TDD:

$$\text{Default DPCH Offset Value} = (\text{SRNTI} \cdot 2 \bmod 7)$$
 - handle the above Default DPCH Offset Value as if an IE with that value was included in the message, as specified in subclause 8.6.6.21;
- if IE "Specification mode" is set to "Complete specification":
 - initiate the radio bearer, transport channel and physical channel configuration in accordance with the received radio bearer, transport channel and physical channel information elements;
 - perform an open loop estimation to determine the UL transmission power according to subclause 8.5.3;
 - if ciphering has been activated and ongoing in the radio access technology from which inter- RAT handover is performed:
 - for the CN domain as in the IE "CN domain identity" which is included in the IE "RAB info" of the IE "RAB information to setup":
 - set the HFN component of the COUNT-C variable for all UL and DL radio bearers and all UL and DL signalling radio bearers that use RLC-AM and RLC-UM to the START value as stored in the USIM for that CN domain; and
 - set the remaining LSBs of the HFN component of COUNT-C to zero;
 - set the HFN component of the COUNT-C variable for all UL and DL radio bearers and all UL and DL signalling radio bearers that use the transparent mode of RLC to zero, while not incrementing the value of the HFN component of the COUNT-C variable at each CFN cycle; and
 - set the CFN component of the COUNT-C variable to the value of the CFN as calculated in subclause 8.5.15;
 - set the IE "Status" in the variable CIPHERING_STATUS to "Started";
 - apply the same ciphering (ciphered/unciphered, algorithm) as prior to inter-RAT handover, unless a change of algorithm is requested by means of the IE "Ciphering algorithm";
 - apply ciphering immediately upon reception of the HANDOVER TO UTRAN COMMAND;

If the UE succeeds in establishing the connection to UTRAN, it shall:

- if the IE "Status" in the variable CIPHERING_STATUS of a CN domain is set to "Started" and transparent mode radio bearers have been established by this procedure for that CN domain:
 - include the IE "COUNT-C activation time" in the response message and specify a CFN value other than the default, "Now" for this IE;
 - at the CFN value as indicated in the response message in the IE "COUNT-C activation time":

- set the HFN component of the COUNT-C variable to the START value as indicated in the IE "START list" of the response message for the relevant CN domain; and
- set the remaining LSBs of the HFN component of COUNT-C to zero;
- increment the HFN component of the COUNT-C variable by one;
- set the CFN component of the COUNT-C to the value of the IE "COUNT-C activation time" of the response message. The HFN component and the CFN component completely initialise the COUNT-C variable;
- step the COUNT-C variable, as normal, at each CFN value. The HFN component is no longer fixed in value but incremented at each CFN cycle;
- transmit a HANOVER TO UTRAN COMPLETE message on the uplink DCCH, using the new ciphering configuration, only if ciphering has been started;
- when the HANOVER TO UTRAN COMPLETE message has been submitted to lower layers for transmission:
 - initialise variables upon entering UTRA RRC connected mode as specified in subclause 13.4;
- and the procedure ends.

8.3.6.4 Invalid Handover to UTRAN command message

If the UE receives a HANOVER TO UTRAN COMMAND message, which contains a protocol error causing the variable PROTOCOL_ERROR_REJECT to be set to TRUE according to clause 9, the UE shall perform procedure specific error handling according to the source radio access technology. The UE shall:

- if allowed by the source RAT:
 - transmit an RRC STATUS message to the source radio access technology; and
 - include the IE "Protocol error information" with contents set to the value of the variable PROTOCOL_ERROR_INFORMATION;
- Other details may be provided in the specifications related to the source radio access technology.

8.3.6.4a Unsupported configuration in HANOVER TO UTRAN COMMAND message

If the UE does not support the configuration included in the HANOVER TO UTRAN COMMAND message, e.g., the message includes a pre-defined configuration that the UE has not stored, the UE shall:

- continue the connection using the other radio access technology; and
- indicate the failure to the other radio access technology.

8.3.6.5 UE fails to perform handover

If the UE does not succeed in establishing the connection to UTRAN, it shall:

- terminate the procedure including release of the associated resources;
- resume the connection used before the handover; and
- indicate the failure to the other radio access technology.

Upon receiving an indication about the failure from the other radio access technology, UTRAN should release the associated resources and the context information concerning this UE.

8.3.6.6 Reception of message HANOVER TO UTRAN COMPLETE by the UTRAN

Upon receiving a HANOVER TO UTRAN COMPLETE message, UTRAN should consider the inter-RAT handover procedure as having been completed successfully and indicate this to the Core Network.

8.3.7 Inter-RAT handover from UTRAN

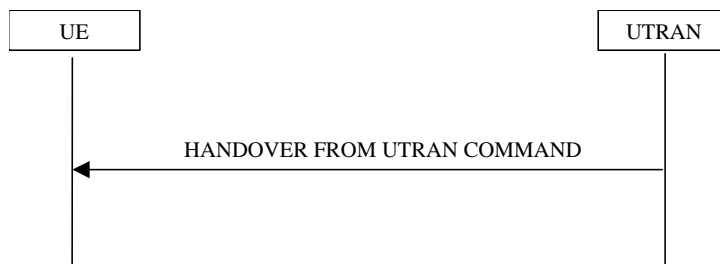

Figure 53: Inter-RAT handover from UTRAN, successful case

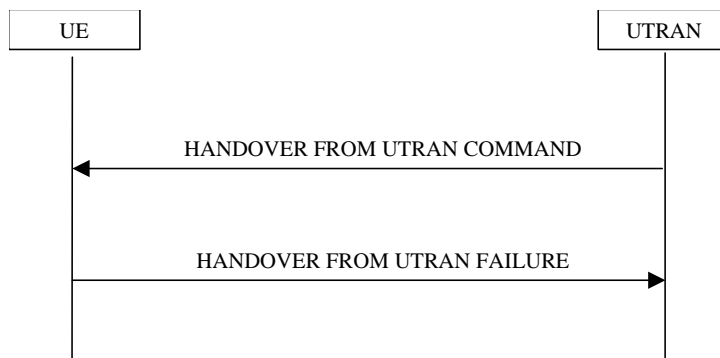

Figure 54: Inter-RAT handover from UTRAN, failure case

8.3.7.1 General

The purpose of the inter-RAT handover procedure is to, under the control of the network, transfer a connection between the UE and UTRAN to another radio access technology (e.g. GSM). This procedure may be used in CELL_DCH state.

NOTE: This procedure is applicable to CS domain service.

8.3.7.2 Initiation

The procedure is initiated when UTRAN orders a UE in CELL_DCH state, to make a handover to a radio access technology other than UTRAN, e.g. GSM.

To initiate the procedure, UTRAN sends a HANDOVER FROM UTRAN COMMAND message.

8.3.7.3 Reception of a HANDOVER FROM UTRAN COMMAND message by the UE

The UE shall be able to receive a HANDOVER FROM UTRAN COMMAND message and perform an inter-RAT handover, even if no prior UE measurements have been performed on the target cell.

The UE shall:

- establish the connection to the target radio access technology, by using the contents of the IE "Inter-RAT message". This IE contains a message specified in another standard, as indicated by the IE "System type", and carries information about the candidate/ target cell identifier(s) and radio parameters relevant for the target radio access technology. The correspondence between the value of the IE "System type", the standard to apply and the message contained within IE "Inter RAT message" is shown in the following:

Value of the IE "System type"	Standard to apply	Inter RAT Message
GSM	GSM TS 04.18, version 8.5.0 or later	HANDOVER COMMAND
cdma2000	TIA/EIA/IS-2000 or later, TIA/EIA/IS-833 or later, TIA/EIQ/IS-834 or later	

- if the IE "System type" has the value "GSM":
 - if the IE "Frequency band" has the value "GSM /DCS 1800 band used":
 - set the BAND_INDICATOR [26] to "ARFCN indicates 1800 band";
 - if the IE "Frequency band" has the value " GSM /PCS 1900 band used":
 - set the BAND_INDICATOR [26] to "ARFCN indicates 1900 band";
- apply the "Inter RAT Message" according to the "standard to apply" in the table above.
- in case one or more IEs "RAB info" is included in the HANOVER FROM UTRAN COMMAND message:
 - connect upper layer entities corresponding to indicated RABs to the radio resources indicated in the inter-RAT message;

NOTE: Requirements concerning the establishment of the radio connection towards the other radio access technology and the signalling procedure are outside the scope of this specification.

8.3.7.4 Successful completion of the inter-RAT handover

Upon successfully completing the handover, UTRAN should:

- release the radio connection; and
- remove all context information for the concerned UE.

Upon successfully completing the handover, the UE shall:

- if the USIM is present:
 - store the current START value for every CN domain in the USIM [50];
 - if the "START" stored in the USIM [50] for a CN domain is greater than the value "THRESHOLD" of the variable START_THRESHOLD:
 - delete the ciphering and integrity keys that are stored in the USIM for that CN domain;
 - inform the deletion of these keys to upper layers;
- clear or set variables upon leaving UTRA RRC connected mode as specified in subclause 13.4.

NOTE: The release of the UMTS radio resources is initiated from the target RAT.

8.3.7.5 UE fails to complete requested handover

If the UE does not succeed in establishing the connection to the target radio access technology, it shall:

- revert back to the UTRA configuration;
- establish the UTRA physical channel(s) used at the time for reception of HANOVER FROM UTRAN COMMAND;
- if the UE does not succeed to establish the UTRA physical channel(s):
 - select a suitable UTRA cell according to [4];
 - perform a cell update procedure according to subclause 8.3.1 with cause "Radio link failure";
 - when the cell update procedure has completed successfully:
 - proceed as below;
- transmit the HANOVER FROM UTRAN FAILURE message setting the information elements as specified below:

- include the IE "RRC transaction identifier"; and
- set it to the value of "RRC transaction identifier" in the entry for the HANOVER FROM UTRAN COMMAND message in the table "Accepted transactions" in the variable TRANSACTIONS; and
- clear that entry;
- set the IE "Inter-RAT change failure" to "physical channel failure";
- When the HANOVER FROM UTRAN FAILURE message has been submitted to lower layer for transmission:
 - the procedure ends.

8.3.7.6 Invalid HANOVER FROM UTRAN COMMAND message

If the IE "Inter-RAT message" received within the HANOVER FROM UTRAN COMMAND message does not include a valid inter RAT handover message in accordance with the protocol specifications for the target RAT, the UE shall perform procedure specific error handling as follows. The UE shall:

- set the IE "failure cause" to the cause value "Inter-RAT protocol error";
- include the IE "Inter-RAT message" in case the target RAT provides further details about the inter RAT protocol error;
- transmit a HANOVER FROM UTRAN FAILURE message on the uplink DCCH using AM RLC;
- when the transmission of the HANOVER FROM UTRAN FAILURE message has been confirmed by RLC:
 - continue with any ongoing processes and procedures as if the invalid HANOVER FROM UTRAN COMMAND message has not been received;
 - and the procedure ends.

If the HANOVER FROM UTRAN COMMAND message contains a protocol error causing the variable `PROTOCOL_ERROR_REJECT` to be set to TRUE according to clause 9, the UE shall perform procedure specific error handling as follows. The UE shall:

- set the IE "RRC transaction identifier" in the HANOVER FROM UTRAN FAILURE message to the value of "RRC transaction identifier" in the entry for the HANOVER FROM UTRAN COMMAND message in the table "Rejected transactions" in the variable TRANSACTIONS; and
- clear that entry;
- set the IE "failure cause" to the cause value "protocol error";
- include the IE "Protocol error information" with contents set to the value of the variable `PROTOCOL_ERROR_INFORMATION`;
- transmit a HANOVER FROM UTRAN FAILURE message on the uplink DCCH using AM RLC;
- when the HANOVER FROM UTRAN FAILURE message has been submitted to lower layers for transmission:
 - continue with any ongoing processes and procedures as if the invalid HANOVER FROM UTRAN COMMAND message has not been received;
 - and the procedure ends.

8.3.7.7 Reception of an HANOVER FROM UTRAN FAILURE message by UTRAN

Upon receiving an HANOVER FROM UTRAN FAILURE message, UTRAN may initiate the release the resources in the target radio access technology.

8.3.7.8 Unsupported configuration in HANDOVER FROM UTRAN COMMAND message

If the UTRAN instructs the UE to perform a non-supported handover scenario, e.g. multiple RAB or to use a non-supported configuration, the UE shall:

- transmit a HANDOVER FROM UTRAN FAILURE message, setting the information elements as specified below:
 - include the IE "RRC transaction identifier"; and
 - set it to the value of "RRC transaction identifier" in the entry for the HANDOVER FROM UTRAN COMMAND message in the table "Accepted transactions" in the variable TRANSACTIONS; and
 - clear that entry;
 - set the IE "Inter-RAT change failure" to "configuration unacceptable";
 - when the HANDOVER FROM UTRAN FAILURE message has been submitted to lower layers for transmission:
 - resume normal operation as if the invalid HANDOVER FROM UTRAN COMMAND message has not been received;
 - and the procedure ends.

8.3.7.8a Reception of HANDOVER FROM UTRAN COMMAND message by UE in CELL_FACH

If the UE receives HANDOVER FROM UTRAN COMMAND while in CELL_FACH, the UE shall:

- transmit a HANDOVER FROM UTRAN FAILURE message, setting the information elements as specified below:
 - include the IE "RRC transaction identifier"; and
 - set it to the value of "RRC transaction identifier" in the entry for the HANDOVER FROM UTRAN COMMAND message in the table "Accepted transactions" in the variable TRANSACTIONS; and
 - clear that entry;
 - set the IE "Inter-RAT change failure" to "protocol error", include IE "Protocol error information"; and
 - set the value of IE "Protocol error cause" to "Message not compatible with receiver state";
 - when the HANDOVER FROM UTRAN FAILURE message has been submitted to lower layers for transmission:
 - resume normal operation as if the invalid HANDOVER FROM UTRAN COMMAND message has not been received;
 - and the procedure ends.

8.3.8 Inter-RAT cell reselection to UTRAN

8.3.8.1 General

The purpose of the inter-RAT cell reselection procedure to UTRAN is to transfer, under the control of the UE and to some extent the source radio access technology, a connection between the UE and another radio access technology (e.g. GSM/GPRS, but not UTRAN) to UTRAN.

8.3.8.2 Initiation

When the UE makes an inter-RAT cell reselection to UTRAN according to the criteria specified in [4], it shall initiate this procedure. The inter-RAT cell reselection made by the UE may use system information broadcast from the source radio access technology or UE dedicated information.

The UE shall:

- set the variable ESTABLISHMENT_CAUSE to "Inter-RAT cell reselection";
- initiate an RRC connection establishment procedure as specified in subclause 8.1.3;
- after initiating an RRC connection establishment:
 - release all resources specific to the other radio access technology.

8.3.8.3 UE fails to complete an inter-RAT cell reselection

If the inter-RAT cell reselection fails before the UE has initiated the RRC connection establishment the UE may return back to the other radio access technology.

If the RRC connection establishment fails the UE shall enter idle mode.

8.3.9 Inter-RAT cell reselection from UTRAN

8.3.9.1 General

The purpose of the inter-RAT cell reselection procedure from UTRAN is to transfer, under the control of the UE and to some extent the UTRAN, a connection between the UE and UTRAN to another radio access technology (e.g. GSM/GPRS).

8.3.9.2 Initiation

This procedure is applicable in states CELL_FACH, CELL_PCH or URA_PCH.

When the UE based on received system information makes a cell reselection to a radio access technology other than UTRAN, e.g. GSM/GPRS, according to the criteria specified in [4], the UE shall.

- start timer T309;
- initiate the establishment of a connection to the target radio access technology according to its specifications.

8.3.9.3 Successful cell reselection

When the UE has succeeded in reselecting a cell in the target radio access technology and has initiated the establishment of a connection, it shall stop timer T309 and release all UTRAN specific resources.

UTRAN should release all UE dedicated resources upon indication that the UE has completed a connection establishment to the other radio access technology.

8.3.9.4 Expiry of timer T309

If the timer T309 expires before the UE succeeds in initiating the establishment of a connection to the other radio access technology, the UE shall:

- resume the connection to UTRAN using the resources used before initiating the inter-RAT cell reselection procedure.

8.3.10 Inter-RAT cell change order to UTRAN

8.3.10.1 General

The purpose of the inter-RAT cell change order to UTRAN procedure is to transfer, under the control of the source radio access technology, a connection between the UE and another radio access technology (e.g. GSM/GPRS) to UTRAN.

8.3.10.2 Initiation

The procedure is initiated when a radio access technology other than UTRAN, e.g. GSM/GPRS, using procedures specific for that RAT, orders the UE to change to a UTRAN cell.

NOTE: Within the message used to order the UE to change to a UTRAN cell, the source RAT should specify the identity of the target UTRAN cell as specified in the specifications for that RAT.

The UE shall:

- set the variable ESTABLISHMENT_CAUSE to "Inter-RAT cell reselection";
- initiate an RRC connection establishment procedure as specified in subclause 8.1.3.

8.3.10.3 UE fails to complete an inter-RAT cell change order

If the inter-RAT cell reselection fails the UE shall return to the other radio access technology and proceed as specified in the appropriate specifications for that RAT.

NOTE 3: The cell change was network ordered. Therefore, failure to change to the target cell should not cause the UE to move to UE- controlled cell selection.

8.3.11 Inter-RAT cell change order from UTRAN

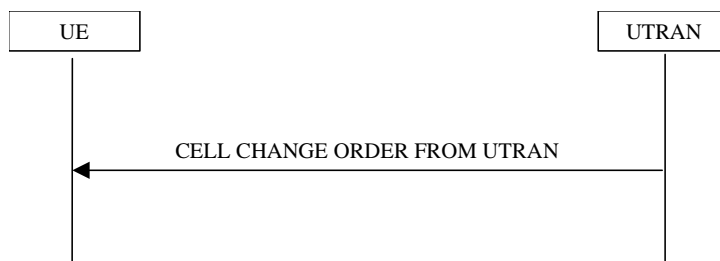

Figure 55: Inter-RAT cell change order from UTRAN

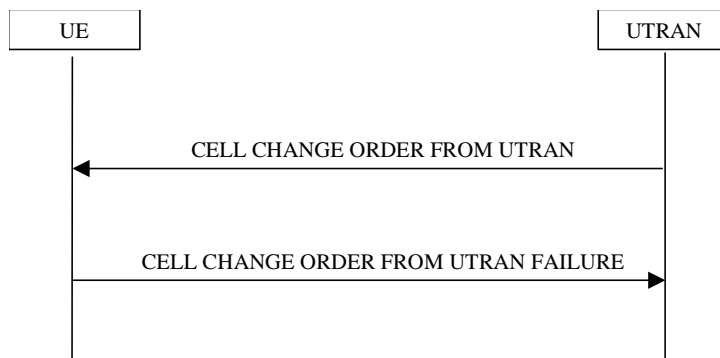

Figure 55a: Inter-RAT cell change order from UTRAN, failure case

8.3.11.1 General

The purpose of the inter-RAT cell change order procedure is to transfer, under the control of the network, a connection between the UE and UTRAN to another radio access technology (e.g. GSM). This procedure may be used in CELL_DCH and CELL_FACH state.

NOTE: This procedure is applicable for services in the PS domain.

8.3.11.2 Initiation

The procedure is initiated when UTRAN orders a UE in CELL_DCH or CELL_FACH state, to make a cell change to a radio access technology other than UTRAN, e.g. GSM.

To initiate the procedure, UTRAN sends a CELL CHANGE ORDER FROM UTRAN message.

8.3.11.3 Reception of an CELL CHANGE ORDER FROM UTRAN message by the UE

The UE shall be able to receive a CELL CHANGE ORDER FROM UTRAN message and perform a cell change order to another RAT, even if no prior UE measurements have been performed on the target cell.

The UE shall:

- start timer T309; and
- establish the connection to the other radio access technology, as specified within IE "Target cell info". This IE specifies the target cell identity, in accordance with the specifications for that other RAT. In case the target cell is a GSM/ GPRS cell, IE "Target cell info" may also include IE "NC mode", which specifies the cell selection mode to be applied in the target cell; and
- if IE "NC mode" is not included in the CELL CHANGE ORDER FROM UTRAN:
 - retrieve it from the target cell as specified in [43];
 - act upon IE "NC mode" as specified in [43].
- if one or more IEs "RAB info" are included in the CELL CHANGE ORDER FROM UTRAN message:
 - connect the upper layer entities corresponding to indicated RABs to the radio resources offered by the target RAT;

NOTE: Requirements concerning the establishment of the radio connection towards the other radio access technology and the signalling procedure are outside the scope of this specification. In case of GSM/GPRS proceed according to the procedure Network control cell reselection procedure as specified in [44].

8.3.11.4 Successful completion of the cell change order

Upon successful completion of the cell change order, the UE shall:

- stop timer T309;
- clear or set variables upon leaving UTRA RRC connected mode as specified in subclause 13.4.

Upon indication of the UE having successfully completed the cell change order, UTRAN should:

- release the radio connection; and
- remove all context information for the concerned UE.

NOTE: The release of the UMTS radio resources is initiated from another RAT.

8.3.11.5 Expiry of timer T309 or UE fails to complete requested cell change order

If:

- timer T309 expires prior to the successful establishment of a connection to the target RAT; or
- if the establishment of the connection to the other RAT failed due to other reasons e.g. (random) access failure, rejection due to lack of resources:

the UE shall:

- if it received the CELL CHANGE ORDER FROM UTRAN message in state CELL_DCH:
 - revert back to the UTRA configuration;
 - establish the UTRA physical channel(s) used at the time for reception of CELL CHANGE ORDER FROM UTRAN;
 - if the UE does not succeed in establishing the UTRA physical channel(s):
 - select a suitable UTRA cell according to [4];
 - perform a cell update procedure according to subclause 8.3.1 with cause "Radio link failure";
 - when the cell update procedure has completed successfully:
 - proceed as below;
 - transmit the CELL CHANGE ORDER FROM UTRAN FAILURE message setting the information elements as specified below:
 - include the IE "RRC transaction identifier"; and
 - set it to the value of "RRC transaction identifier" in the entry for the received message in the table "Accepted transactions" in the variable TRANSACTIONS; and
 - clear that entry;
 - set the IE "Inter-RAT change failure" to "physical channel failure";
 - When the CELL CHANGE ORDER FROM UTRAN FAILURE message has been submitted to lower layer for transmission, the procedure ends.
- if the UE receives the CELL CHANGE ORDER FROM UTRAN message in CELL_FACH state:
 - revert to the cell it was camped on at the reception of the CELL CHANGE ORDER FROM UTRAN message;
 - if the UE is unable to return to this cell:
 - select a suitable UTRA cell according to [4];
 - initiate the cell update procedure according to subclause 8.3.1 using the cause "cell re-selection";
 - when the cell update procedure completed successfully:
 - proceed as below;
 - transmit the CELL CHANGE ORDER FROM UTRAN FAILURE message setting the information elements as specified below:
 - include the IE "RRC transaction identifier"; and
 - set it to the value of "RRC transaction identifier" in the entry for the CELL CHANGE ORDER FROM UTRAN message in the table "Accepted transactions" in the variable TRANSACTIONS; and
 - clear that entry;
 - set the IE "Inter-RAT change failure" to "physical channel failure";
 - When the CELL CHANGE ORDER FROM UTRAN FAILURE message has been submitted to lower layer for transmission:

- the procedure ends.

8.3.11.6 Unsupported configuration in CELL CHANGE ORDER FROM UTRAN message

If the UTRAN instructs the UE to perform a non-supported cell change order scenario e.g. multiple RAB or to use a non-supported configuration, the UE shall:

- transmit a CELL CHANGE ORDER FROM UTRAN FAILURE message, setting the information elements as specified below:
 - include the IE "RRC transaction identifier"; and
 - set it to the value of "RRC transaction identifier" in the entry for the received message in the table "Accepted transactions" in the variable TRANSACTIONS; and
 - clear that entry;
 - set the IE "Inter-RAT change failure" to "configuration unacceptable";
 - when the CELL CHANGE ORDER FROM UTRAN FAILURE message has been submitted to lower layers for transmission:
 - resume normal operation as if the CELL CHANGE ORDER FROM UTRAN message has not been received;
 - and the procedure ends.

8.3.11.7 Invalid CELL CHANGE ORDER FROM UTRAN message

If the CELL CHANGE ORDER FROM UTRAN message contains a protocol error causing the variable `PROTOCOL_ERROR_REJECT` to be set to TRUE according to clause 9, the UE shall perform procedure specific error handling as follows. The UE shall:

- set the IE "RRC transaction identifier" in the CELL CHANGE ORDER FROM UTRAN FAILURE message to the value of "RRC transaction identifier" in the entry for the CELL CHANGE ORDER FROM UTRAN message in the table "Rejected transactions" in the variable TRANSACTIONS; and
- clear that entry;
- set the IE "failure cause" to the cause value "protocol error";
- include the IE "Protocol error information" with contents set to the value of the variable `PROTOCOL_ERROR_INFORMATION`;
- transmit a CELL CHANGE ORDER FROM UTRAN FAILURE message on the uplink DCCH using AM RLC;
- when the CELL CHANGE ORDER FROM UTRAN FAILURE message has been submitted to lower layers for transmission:
 - resume normal operation as if the invalid CELL CHANGE ORDER FROM UTRAN message has not been received;
- and the procedure ends.

8.4 Measurement procedures

8.4.0 Measurement related definitions

UTRAN may control a measurement in the UE either by broadcast of SYSTEM INFORMATION and/or by transmitting a MEASUREMENT CONTROL message.

The following information is used to control the UE measurements and the measurement results reporting:

1. **Measurement identity:** A reference number that should be used by the UTRAN when setting up, modifying or releasing the measurement and by the UE in the measurement report.
2. **Measurement command:** One out of three different measurement commands.
 - Setup: Setup a new measurement.
 - Modify: Modify a previously defined measurement, e.g. to change the reporting criteria.
 - Release: Stop a measurement and clear all information in the UE that are related to that measurement.
3. **Measurement type:** One of the types listed below describing what the UE shall measure.

Presence or absence of the following control information depends on the measurement type

4. **Measurement objects:** The objects on which the UE shall measure measurement quantities, and corresponding object information.
5. **Measurement quantity:** The quantity the UE shall measure on the measurement object. This also includes the filtering of the measurements.
6. **Reporting quantities:** The quantities the UE shall include in the report in addition to the quantities that are mandatory to report for the specific event.
7. **Measurement reporting criteria:** The triggering of the measurement report, e.g. periodical or event-triggered reporting.
8. **Measurement Validity:** Defines in which UE states the measurement is valid.
9. **Measurement reporting mode:** This specifies whether the UE shall transmit the measurement report using AM or UM RLC.
10. **Additional measurement identities:** A list of references to other measurements. When this measurement triggers a measurement report, the UE shall also include the reporting quantities for the measurements referenced by the additional measurement identities.

All these measurement parameters depend on the measurement type and are described in more detail in clause 14.

The different types of measurements are:

- **Intra-frequency measurements:** measurements on downlink physical channels at the same frequency as the active set. A measurement object corresponds to one cell. Detailed description is found in subclause 14.1.
- **Inter-frequency measurements:** measurements on downlink physical channels at frequencies that differ from the frequency of the active set. A measurement object corresponds to one cell. Detailed description is found in subclause 14.2.
- **Inter-RAT measurements:** measurements on downlink physical channels belonging to another radio access technology than UTRAN, e.g. GSM. A measurement object corresponds to one cell. Detailed description is found in subclause 14.3.
- **Traffic volume measurements:** measurements on uplink traffic volume. A measurement object corresponds to one cell. Detailed description is found in subclause 14.4.
- **Quality measurements:** Measurements of downlink quality parameters, e.g. downlink transport block error rate. A measurement object corresponds to one transport channel in case of BLER. A measurement object corresponds to one timeslot in case of SIR (TDD only). Detailed description is found in subclause 14.5.
- **UE-internal measurements:** Measurements of UE transmission power and UE received signal level. Detailed description is found in subclause 14.6.
- **UE positioning measurements:** Measurements of UE position. Detailed description is found in subclause 14.7.

The UE shall support a number of measurements running in parallel as specified in [19] and [20]. The UE shall also support that each measurement is controlled and reported independently of every other measurement.

Cells that the UE is monitoring are grouped in the UE into three different categories:

1. Cells, which belong to the **active set**. User information is sent from all these cells. In FDD, the cells in the active set are involved in soft handover. In TDD the active set always comprises one cell only.
2. Cells, which are not included in the active set, but are monitored according to a neighbour list assigned by the UTRAN belong to the **monitored set**.
3. Cells detected by the UE, which are neither included in the active set nor in the monitored set belong to the **detected set**. Reporting of measurements of the detected set is only applicable to intra-frequency measurements made by UEs in CELL_DCH state.

8.4.1 Measurement control



Figure 56: Measurement Control, normal case

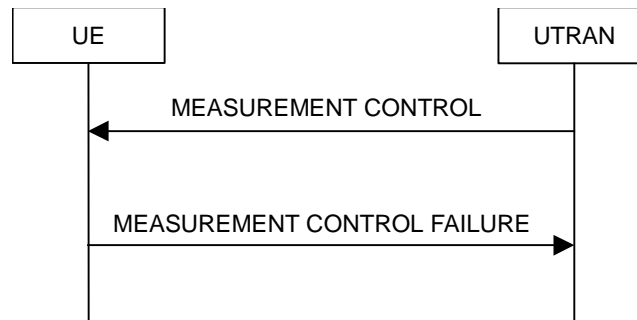

Figure 57: Measurement Control, failure case

8.4.1.1 General

The purpose of the measurement control procedure is to setup, modify or release a measurement in the UE.

8.4.1.2 Initiation

The UTRAN may request a measurement by the UE to be setup, modified or released with a MEASUREMENT CONTROL message, which is transmitted on the downlink DCCH using AM RLC.

The UTRAN should take the UE capabilities into account when a measurement is requested from the UE.

When a new measurement is created, UTRAN should set the IE "Measurement identity" to a value, which is not used for other measurements. UTRAN may use several "Measurement identity" for the same "Measurement type". In case of setting several "Measurement identity" within a same "Measurement type", the measurement object or the list of measurement objects can be set differently for each measurement with different "Measurement identity".

When a current measurement is modified or released, UTRAN should set the IE "Measurement identity" to the value, which is used for the measurement being modified or released. In case of modifying IEs within a "Measurement identity", it is not needed for UTRAN to indicate the IEs other than modified IEs, and the UE continues to use the current values of the IEs that are not modified.

8.4.1.3 Reception of MEASUREMENT CONTROL by the UE

Upon reception of a MEASUREMENT CONTROL message the UE shall perform actions specified in subclause 8.6 unless otherwise specified below.

The UE shall:

- read the IE "Measurement command";
- if the IE "Measurement command" has the value "setup":
 - store this measurement in the variable MEASUREMENT_IDENTITY according to the IE "measurement identity", possibly overwriting the measurement previously stored with that identity;
 - for measurement types "inter-RAT measurement" or "inter-frequency measurement":
 - if, according to its measurement capabilities, the UE requires compressed mode to perform the measurements and a compressed mode pattern sequence with an appropriate measurement purpose is simultaneously activated by the IE "DPCH compressed mode status info"; or
 - if, according to its measurement capabilities, the UE does not require compressed mode to perform the measurements:
 - if the measurement is valid in the current RRC state of the UE:
 - begin measurements according to the stored control information for this measurement identity;
 - for measurement type "UE positioning measurement":
 - if the IE "Positioning method" is set to "GPS" and UE has neither received nor stored sufficient assistance data in variable UE_POSITIONING_GPS_DATA to perform the requested measurements:
 - send a MEASUREMENT REPORT message to UTRAN, indicating the kind of assistance data which is necessary to fulfil the measurement request in the IE "UE positioning error";
 - for any other measurement type:
 - if the measurement is valid in the current RRC state of the UE:
 - begin measurements according to the stored control information for this measurement identity.
- if the IE "Measurement command" has the value "modify":
 - for all measurement control present in the MEASUREMENT CONTROL message:
 - if a measurement was stored in the variable MEASUREMENT_IDENTITY associated to the identity by the IE "measurement identity":
 - replace the corresponding information stored in variable MEASUREMENT_IDENTITY associated to the identity indicated by the IE "measurement identity";
 - resume the measurements according to the new stored measurement control information.
 - otherwise:
 - set the variable CONFIGURATION_INCOMPLETE to TRUE;
- if the IE "measurement command" has the value "release":
 - terminate the measurement associated with the identity given in the IE "measurement identity";
 - clear all stored measurement control information related associated to this measurement identity in variable MEASUREMENT_IDENTITY.
- if the IE "DPCH Compressed Mode Status Info" is present,
 - and if, as the result of this message, UE will have more than one transmission gap pattern sequence with the same measurement purpose active (according to IE "TGMP" in variable TGPS_IDENTITY):
 - set the variable CONFIGURATION_INCOMPLETE to TRUE;
 - if pattern sequence corresponding to IE "TGPSI" is already active (according to "TGPS Status Flag"):

- deactivate this pattern sequence at the beginning of the frame indicated by IE "TGPS reconfiguration CFN" received in the message;
- after the time indicated by IE "TGPS reconfiguration CFN" has elapsed:
 - activate the pattern sequence stored in the variable TGPS_IDENTITY corresponding to each IE "TGPSI" for which the "TGPS status flag" is set to "active" at the time indicated by IE "TGCFN"; and
 - begin the inter-frequency and/or inter-RAT measurements corresponding to the pattern sequence measurement purpose of each activated pattern sequence;
 - if the values of IE "TGPS reconfiguration CFN" and IE "TGCFN" are equal:
 - start the concerned pattern sequence immediately at that CFN;
 - not alter pattern sequences stored in variable TGPS_IDENTITY, but not identified in IE "TGPSI"
- if the UE in CELL_FACH state receives a MEASUREMENT CONTROL message, which indicates the same measurement identity as that stored in the variable MEASUREMENT_IDENTITY:
 - update the stored information with the traffic volume measurement control information in variable MEASUREMENT_IDENTITY; and
 - refrain from updating the traffic volume measurement control information associated with this measurement identity received in System Information Block type 12 (or System Information Block type 11, according to subclause 8.1.1.6.11) until this measurement is explicitly released with another MEASUREMENT CONTROL message;
- if the IE "Read SFN indicator" included in the IE "Cell info" of an inter-frequency cell is set to TRUE and the variable UE_CAPABILITY_TRANSFERRERED has the DL "Measurement capability" for "FDD measurements" set to TRUE (the UE requires DL compressed mode in order to perform measurements on FDD):
 - set the variable CONFIGURATION_INCOMPLETE to TRUE;
- clear the entry for the MEASUREMENT CONTROL message in the table "Accepted transactions" in the variable TRANSACTIONS;
- and the procedure ends.

8.4.1.4 Unsupported measurement in the UE

If UTRAN instructs the UE to perform a measurement that is not supported by the UE, the UE shall:

- retain the measurement configuration that was valid before the MEASUREMENT CONTROL message was received;
- set the IE "RRC transaction identifier" in the MEASUREMENT CONTROL FAILURE message to the value of "RRC transaction identifier" in the entry for the MEASUREMENT CONTROL message in the table "Accepted transactions" in the variable TRANSACTIONS; and
- clear that entry.
- set the cause value in IE "failure cause" to "unsupported measurement";
- submit the MEASUREMENT CONTROL FAILURE message to lower layers for transmission on the DCCH using AM RLC;
- continue with any ongoing processes and procedures as if the invalid MEASUREMENT CONTROL message has not been received;
- and the procedure ends.

8.4.1.4a Configuration Incomplete

If the variable CONFIGURATION_INCOMPLETE is set to TRUE, the UE shall:

- retain the measurement configuration that was valid before the MEASUREMENT CONTROL message was received;
- set the IE "RRC transaction identifier" in the MEASUREMENT CONTROL FAILURE message to the value of "RRC transaction identifier" in the entry for the MEASUREMENT CONTROL message in the table "Accepted transactions" in the variable TRANSACTIONS and clear that entry;
- clear the variable CONFIGURATION_INCOMPLETE;
- set the cause value in IE "failure cause" to "Configuration incomplete";
- submit the MEASUREMENT CONTROL FAILURE message to lower layers for transmission on the DCCH using AM RLC;
- continue with any ongoing processes and procedures as if the invalid MEASUREMENT CONTROL message has not been received;
- and the procedure ends.

8.4.1.5 Invalid MEASUREMENT CONTROL message

If the MEASUREMENT CONTROL message contains a protocol error causing the variable PROTOCOL_ERROR_REJECT to be set to TRUE according to clause 9, the UE shall perform procedure specific error handling as follows. The UE shall:

- set the IE "RRC transaction identifier" in the MEASUREMENT CONTROL FAILURE message to the value of "RRC transaction identifier" in the entry for the MEASUREMENT CONTROL message in the table "Rejected transactions" in the variable TRANSACTIONS; and
- clear that entry.
- set the IE "failure cause" to the cause value "protocol error";
- include the IE "Protocol error information" with contents set to the value of the variable PROTOCOL_ERROR_INFORMATION;
- submit the MEASUREMENT CONTROL FAILURE message to lower layers for transmission on the DCCH using AM RLC;
- continue with any ongoing processes and procedures as if the invalid MEASUREMENT CONTROL message has not been received;
- and the procedure ends.

8.4.1.6 Measurements after transition from CELL_DCH to CELL_FACH/CELL_PCH/URA_PCH state

The UE shall apply the following rules for different measurement types after transiting from CELL_DCH to CELL_FACH/CELL_PCH/URA_PCH state:

8.4.1.6.1 Intra-frequency measurement

Upon transition from CELL_DCH to CELL_FACH/CELL_PCH/URA_PCH state, the UE shall:

- stop intra-frequency type measurement reporting assigned in a MEASUREMENT CONTROL message;
- if the transition is due to a reconfiguration message which included the IE "Primary CPICH info" (for FDD) or "Primary CCPCH info" (for TDD), and the UE selects a cell other than that indicated by this IE; or
- if the transition is due to a reconfiguration message which does not include the IE "Primary CPICH info" (for FDD) or "Primary CCPCH info" (for TDD); or
- if the transition is not due to a reconfiguration message:
 - delete the measurements of type intra-frequency associated with the variable MEASUREMENT_IDENTITY;

- begin monitoring cells listed in the IE "intra-frequency cell info list" received in System Information Block type 12 (or System Information Block type 11, according to subclause 8.1.1.6.11);
- if the UE receives the IE "Intra-frequency reporting quantity for RACH Reporting" and the IE "Maximum number of Reported cells on RACH" IEs from System Information Block type 12 (or System Information Block type 11, according to subclause 8.1.1.6.11):
 - use this information for reporting measured results in RACH messages.

8.4.1.6.2 Inter-frequency measurement

Upon transition from CELL_DCH to CELL_FACH/ CELL_PCH/URA_PCH state, the UE shall:

- stop the inter-frequency type measurement reporting assigned in a MEASUREMENT CONTROL message;
- if the transition is due to a reconfiguration message which included the IE "Primary CPICH info" (for FDD) or "Primary CCPCH info" (for TDD), and the UE selects a cell other than that indicated by this IE; or
- if the transition is due to a reconfiguration message which does not include the IE "Primary CPICH info" (for FDD) or "Primary CCPCH info" (for TDD); or
- if the transition is not due to a reconfiguration message:
 - delete the measurements of type inter-frequency associated with the variable MEASUREMENT_IDENTITY;
- begin monitoring cells listed in the IE "inter-frequency cell info list" received in System Information Block type 12 (or System Information Block type 11, according to subclause 8.1.1.6.11);
- in CELL_FACH state:
 - perform measurements on other frequencies according to the IE "FACH measurement occasion info".

8.4.1.6.3 Inter-RAT measurement

Upon transition from CELL_DCH to CELL_FACH/CELL_PCH/URA_PCH state, the UE shall:

- stop the inter-RAT type measurement reporting assigned in a MEASUREMENT CONTROL message;
- if the transition is due to a reconfiguration message which included the IE "Primary CPICH info" (for FDD) or "Primary CCPCH info" (for TDD), and the UE selects another cell than indicated by this IE; or
- if the transition is due to a reconfiguration message which does not include the IE "Primary CPICH info" (for FDD) or "Primary CCPCH info" (for TDD); or
- if the transition is not due to a reconfiguration message:
 - delete the measurements of type inter-RAT associated with the variable MEASUREMENT_IDENTITY;
- begin monitoring cells listed in the IE "inter-RAT cell info list" received in System Information Block type 12 (or System Information Block type 11, according to subclause 8.1.1.6.11);
- in CELL_FACH state:
 - perform measurements on other systems according to the IE "FACH measurement occasion info".

8.4.1.6.4 Quality measurement

Upon transition from CELL_DCH to CELL_FACH/CELL_PCH/URA_PCH state, the UE shall:

- stop quality type measurement reporting;
- delete all measurement control information of measurement type "quality" stored in the variable MEASUREMENT_IDENTITY.

8.4.1.6.5 UE internal measurement

Upon transition from CELL_DCH to CELL_FACH/CELL_PCH/URA_PCH state, the UE shall:

- stop UE internal measurement type measurement reporting;
- delete all measurement control information of measurement type "UE internal" stored in the variable MEASUREMENT_IDENTITY.

8.4.1.6.6 Traffic volume measurement

Upon transition from CELL_DCH to CELL_FACH or CELL_PCH or URA_PCH state, the UE shall:

- retrieve each set of measurement control information of measurement type "traffic volume" stored in the variable MEASUREMENT_IDENTITY; and
- if the optional IE "measurement validity" for this measurement has not been included:
 - delete the measurement associated with the variable MEASUREMENT_IDENTITY;
- if the IE "measurement validity" for the measurement has been included, and the IE "UE state" has been assigned to value "CELL_DCH":
 - stop measurement reporting;
 - store the measurement associated with the variable MEASUREMENT_IDENTITY to be used after the next transition to CELL_DCH state;
- if the IE "measurement validity" for the measurement has been included, and the IE "UE state" has been assigned to value "all states":
 - continue measurement reporting;
- if the IE "measurement validity" has been included and the IE "UE state" has been assigned to value "all states except CELL_DCH":
 - resume this measurement and associated reporting;
- if no traffic volume type measurements valid in CELL_FACH or CELL_PCH or URA_PCH states are stored in the variable MEASUREMENT_IDENTITY:
 - store the measurement control information from the IE "Traffic volume measurement system information" received in System Information Block type 12 (or System Information Block type 11, according to subclause 8.1.1.6.11) in the variable MEASUREMENT_IDENTITY;
 - begin traffic volume measurement reporting according to the assigned information.

8.4.1.6.7 UE positioning measurement

FFS.

8.4.1.6a Actions in CELL_FACH/CELL_PCH/URA/PCH state upon cell re-selection

Upon cell reselection while in CELL_FACH/CELL_PCH/URA/PCH state and the cell reselection has occurred after the measurement control information was stored, the UE shall:

- delete the all measurements of type intra-frequency, inter-frequency, and inter-RAT associated with the variable MEASUREMENT_IDENTITY.

8.4.1.7 Measurements after transition from CELL_FACH to CELL_DCH state

The UE shall apply the following rules for different measurement types after transiting from CELL_FACH to CELL_DCH state:

8.4.1.7.1 Intra-frequency measurement

Upon transition from CELL_FACH to CELL_DCH state, the UE shall:

- retrieve each set of measurement control information of measurement type "intra-frequency" stored in the variable MEASUREMENT_IDENTITY;
- if the IE "measurement validity" for a measurement has been assigned the value "CELL_DCH":
 - resume the measurement reporting;
- if no intra-frequency measurements applicable to CELL_DCH state are stored in the variable MEASUREMENT_IDENTITY:
 - continue monitoring the list of neighbouring cells assigned in the IE "intra-frequency cell info list" in System Information Block type 12 (or System Information Block type 11, according to subclause 8.1.1.6.11);
 - if the IE "intra-frequency measurement reporting criteria" was included in System Information Block type 12 (or System Information Block type 11, according to subclause 8.1.1.6.11):
 - send the MEASUREMENT REPORT message when reporting criteria in IE "Reporting information for CELL_DCH" are fulfilled;

8.4.1.7.2 Inter-frequency measurement

Upon transition from CELL_FACH to CELL_DCH state, the UE shall:

- stop monitoring the list of cells assigned in the IE "inter-frequency cell info list" in System Information Block type 12 (or System Information Block type 11, according to subclause 8.1.1.6.11);
- retrieve each set of measurement control information of measurement type "inter-frequency" stored in the variable MEASUREMENT_IDENTITY; and
- if the IE "measurement validity" for a measurement has been assigned the value "CELL_DCH":
 - resume the measurement reporting.

8.4.1.7.3 Inter-RAT measurement

Upon transition from CELL_FACH to CELL_DCH state, the UE shall:

- stop monitoring the list of cells assigned in the IE "inter-RAT cell info list" in System Information Block type 12 (or System Information Block type 11, according to subclause 8.1.1.6.11);
- retrieve each set of measurement control information of measurement type "inter-RAT" stored in the variable MEASUREMENT_IDENTITY; and
- if the IE "measurement validity" for a measurement has been assigned the value "CELL_DCH":
 - resume the measurement reporting.

8.4.1.7.4 Traffic volume measurement

Upon transition from CELL_FACH to CELL_DCH state, the UE shall:

- retrieve each set of measurement control information of measurement type "traffic volume" stored in the variable MEASUREMENT_IDENTITY;
- if the optional IE "measurement validity" for this measurement has not been included:
 - delete the measurement associated with the variable MEASUREMENT_IDENTITY;
- if the IE "measurement validity" for the measurement has been included, and the IE "UE state" has been assigned to value "all states except CELL_DCH":
 - stop measurement reporting; and

- save the measurement associated with the variable MEASUREMENT_IDENTITY to be used after the next transition to CELL_FACH/CELL_PCH/URA_PCH state;
- if the IE "measurement validity" for the measurement has been included, and the IE "UE state" has been assigned to value "all states":
 - continue measurement reporting;
- if the IE "measurement validity" has been included and the IE "UE state" has been assigned to value "CELL_DCH":
 - resume this measurement and associated reporting;
- if no traffic volume type measurement has been assigned to the UE with a MEASUREMENT CONTROL message when transiting to CELL_DCH state:
 - continue an ongoing traffic volume type measurement, assigned in System Information Block type 11 (or System Information Block type 12, according to subclause 8.1.1.6.11);
- if the UE in CELL_DCH state receives a MEASUREMENT CONTROL message, which indicates the same measurement identity as that stored in variable MEASUREMENT_IDENTITY:
 - update the stored information with the traffic volume measurement control information in variable MEASUREMENT_IDENTITY.

8.4.1.8 Measurements after transition from idle mode to CELL_DCH state

The UE shall obey the following rules for different measurement types after transiting from idle mode to CELL_DCH state:

8.4.1.8.1 Intra-frequency measurement

Upon transition from idle mode to CELL_DCH state, the UE shall:

- begin or continue monitoring the list of cells assigned in the IE "intra-frequency cell info list" in System Information Block type 12 (or System Information Block type 11, according to subclause 8.1.1.6.11);
- if the "intra-frequency measurement reporting criteria" IE was included in System Information Block type 12 (or System Information Block type 11, according to subclause 8.1.1.6.11):
 - begin measurement reporting according to the IE.

8.4.1.8.2 Inter-frequency measurement

Upon transition from idle mode to CELL_DCH state, the UE shall:

- stop monitoring the list of cells assigned in the IE "inter-frequency cell info list" in System Information Block type 12 (or System Information Block type 11, according to subclause 8.1.1.6.11).

8.4.1.8.3 Inter-RAT measurement

Upon transition from idle mode to CELL_DCH state, the UE shall:

- stop monitoring the list of cells assigned in the IE "inter-RAT cell info list" in System Information Block type 12 (or System Information Block type 11, according to subclause 8.1.1.6.11).

8.4.1.8.4 Traffic volume measurement

Upon transition from idle mode to CELL_DCH state, the UE shall:

- begin a traffic volume type measurement, assigned in System Information Block type 11 (or System Information Block type 12, according to subclause 8.1.1.6.11).

8.4.1.9 Measurements after transition from idle mode to CELL_FACH state

The UE shall obey the follow rules for different measurement types after transiting from idle mode to CELL_FACH state:

8.4.1.9.1 Intra-frequency measurement

Upon transition from idle mode to CELL_FACH state, the UE shall:

- begin or continue monitoring cells listed in the IE "intra-frequency cell info list" received in System Information Block type 12 (or System Information Block type 11, according to subclause 8.1.1.6.11);
- if the UE receives the IE "Intra-frequency reporting quantity for RACH Reporting" and IE "Maximum number of Reported cells on RACH" from System Information Block type 12 (or System Information Block type 11, according to subclause 8.1.1.6.11):
 - use this information for reporting measured results in RACH messages.

8.4.1.9.2 Inter-frequency measurement

Upon transition from idle mode to CELL_FACH state, the UE shall:

- begin or continue monitoring cells listed in the IE "inter-frequency cell info list" received in System Information Block type 12 (or System Information Block type 11, according to subclause 8.1.1.6.11);
- perform measurements on other frequencies according to the IE "FACH measurement occasion info".

8.4.1.9.3 Inter-RAT measurement

Upon transition from idle mode to CELL_FACH state, the UE shall:

- begin or continue monitoring cells listed in the IE "inter-RAT cell info list" received in System Information Block type 12 (or System Information Block type 11, according to subclause 8.1.1.6.11);
- perform measurements on other systems according to the IE "FACH measurement occasion info".

8.4.1.9.4 Traffic volume measurement

Upon transition from idle mode to CELL_FACH state, the UE shall:

- store the measurement control information from the IE "Traffic volume measurements system information" received in System Information Block type 12 (or System Information Block type 11, according to subclause 8.1.1.6.11) in the variable MEASUREMENT_IDENTITY;
- begin traffic volume measurement reporting according to the assigned information.

8.4.1.9a Measurements after transition from connected mode to idle mode

Upon transition from connected mode to idle mode the UE shall:

- stop measurement reporting for all measurements stored in the variable MEASUREMENT_IDENTITY;
- clear the variable MEASUREMENT_IDENTITY;
- apply the following rules for different measurement types.

8.4.1.9a.1 Intra-frequency measurement

Upon transition from connected mode to idle mode, the UE shall:

- stop monitoring intra-frequency cells listed in the IE "intra-frequency cell info list" received in System Information Block type 12 (if System Information Block type 12 is transmitted in the cell, according to subclause 8.1.1.6.11);

- begin monitoring intra-frequency cells listed in the IE "intra-frequency cell info list" received in System Information Block type 11.

8.4.1.9a.2 Inter-frequency measurement

Upon transition from connected mode to idle mode, the UE shall:

- stop monitoring inter-frequency cells listed in the IE "inter-frequency cell info list" received in System Information Block type 12 (if System Information Block type 12 is transmitted in the cell, according to subclause 8.1.1.6.11);
- begin monitoring inter-frequency cells listed in the IE "inter-frequency cell info list" received in System Information Block type 11.

8.4.1.9a.3 Inter-RAT measurement

Upon transition from connected mode to idle mode, the UE shall:

- stop monitoring inter-RAT cells listed in the IE "inter-RAT cell info list" received in System Information Block type 12 (if System Information Block type 12 is transmitted in the cell, according to 8.1.1.6.11);
- begin monitoring inter-RAT cells listed in the IE "inter-RAT cell info list" received in System Information Block type 11.

8.4.1.10 Measurements when measurement object is no longer valid

8.4.1.10.1 Traffic volume measurement

If UE is no longer using the transport channel that is specified in the IE "Traffic volume measurement object", UE shall ignore any measurements that are assigned to that transport channel. If none of the transport channels that are specified in "traffic volume measurement object" is being used, UE shall delete that particular measurement and its measurement identity from the variable MEASUREMENT_IDENTITY.

8.4.2 Measurement report



Figure 58: Measurement report, normal case

8.4.2.1 General

The purpose of the measurement reporting procedure is to transfer measurement results from the UE to UTRAN.

8.4.2.2 Initiation

In CELL_DCH state, the UE shall transmit a MEASUREMENT REPORT message on the uplink DCCH when the reporting criteria stored in variable MEASUREMENT_IDENTITY are met for any ongoing measurements that are being performed in the UE.

In CELL_FACH state, the UE shall transmit a MEASUREMENT REPORT message on the uplink DCCH when the reporting criteria stored in variable MEASUREMENT_IDENTITY are met for any ongoing traffic volume measurement that is being performed in the UE.

In TDD, if the Radio Bearer associated with the MEASUREMENT_IDENTITY fulfilling the reporting criteria for an ongoing traffic volume measurement is mapped on transport channel of type USCH, the UE shall initiate the "PUSCH CAPACITY REQUEST" procedure instead of transmitting a MEASUREMENT REPORT (TDD Only).

In CELL_PCH or URA_PCH state, the UE shall first perform the cell update procedure according to subclause 8.3.1, using the cause "uplink data transmission", in order to transit to CELL_FACH state and then transmit a MEASUREMENT REPORT message on the uplink DCCH when the reporting criteria stored in variable MEASUREMENT_IDENTITY are fulfilled for any ongoing traffic volume measurement which is being performed in the UE.

The reporting criteria are fulfilled if either:

- the first measurement has been completed according to the requirements set in [19] or [20] for a newly initiated measurement with periodic reporting; or
- the time period indicated in the stored IE "Periodical reporting criteria" has elapsed since the last measurement report was submitted to lower layers for a given measurement; or
- an event in stored IE "Measurement reporting criteria" was triggered. Events and triggering of reports for different measurement types are described in detail in clause 14.

For the measurement, which triggered the MEASUREMENT REPORT message, the UE shall:

- set the IE "measurement identity" to the measurement identity, which is associated with that measurement in variable MEASUREMENT_IDENTITY;
- set the IE "measured results" to include measurements according to the IE "reporting quantity" of that measurement stored in variable MEASUREMENT_IDENTITY; and
 - if all the reporting quantities are set to "false":
 - not set the IE "measured results";
- set the IE "Measured results" in the IE "Additional measured results" according to the IE "reporting quantity" for all measurements associated with the measurement identities included in the IE "additional measurements" stored in variable MEASUREMENT_IDENTITY of the measurement that triggered the measurement report; and
 - if more than one additional measured results are to be included:
 - sort them in ascending order according to their IE "measurement identity" in the MEASUREMENT REPORT message;
- if the MEASUREMENT REPORT message was triggered by an event (i.e. not a periodical report):
 - set the IE "Event results" according to the event that triggered the report.

The UE shall:

- transmit the MEASUREMENT REPORT message on the uplink DCCH using either AM or UM RLC according to the stored IE "measurement reporting mode" associated with the measurement identity that triggered the report.

When the MEASUREMENT REPORT message has been submitted to lower layers for transmission:

- the procedure ends.

8.4.3 Assistance Data Delivery



Figure 59 Assistance Data Delivery

8.4.3.1 General

The purpose of the assistance data delivery procedure is to transfer UE positioning related assistance data from the UTRAN to the UE.

8.4.3.2 Initiation

The UTRAN may deliver UE positioning related assistance data with a ASSISTANCE DATA DELIVERY message, which is transmitted on the downlink DCCH using AM RLC

8.4.3.3 Reception of ASSISTANCE DATA DELIVERY message by the UE

Upon reception of a ASSISTANCE DATA DELIVERY message the UE shall:

- if IE "UE positioning OTDOA assistance data" is included:
 - store the OTDOA assistance data;
- if IE "UE positioning GPS assistance data" is included:
 - store the GPS assistance data.

8.4.3.4 Invalid ASSISTANCE DATA DELIVERY message

If the UE receives a ASSISTANCE DATA DELIVERY message, which contains a protocol error causing the variable `PROTOCOL_ERROR_REJECT` to be set to `TRUE` according to clause 9, the UE shall perform procedure specific error handling as follows. The UE shall:

- transmit an RRC STATUS message on the uplink DCCH using AM RLC;
- include the IE "Identification of received message"; and
- set the IE "Received message type" to ASSISTANCE DATA DELIVERY; and
- set the IE "RRC transaction identifier" to the value of "RRC transaction identifier" in the entry for the ASSISTANCE DATA DELIVERY message in the table "Rejected transactions" in the variable TRANSACTIONS; and
- clear that entry;
- include the IE "Protocol error information" with contents set to the value of the variable `PROTOCOL_ERROR_INFORMATION`.
- when the RRC STATUS message has been submitted to lower layers for transmission:
 - continue with any ongoing processes and procedures as if the invalid ASSISTANCE DATA DELIVERY message has not been received.

8.5 General procedures

8.5.1 Selection of initial UE identity

The purpose of the IE "Initial UE identity" is to provide a unique UE identification at the establishment of an RRC connection. The type of identity shall be selected by the UE according to the following.

Upper layers shall set the variable `SELECTED_PLMN`. If the variable `SELECTED_PLMN` in the UE indicates "GSM-MAP", the UE shall choose "UE id type" in the IE "Initial UE identity" with the following priority:

1. TMSI (GSM-MAP): The TMSI (GSM-MAP) shall be chosen if available. The IE "LAI" in the IE "Initial UE identity" shall also be present when TMSI (GSM-MAP) is used, for making it unique.
2. P-TMSI (GSM-MAP): The P-TMSI (GSM-MAP) shall be chosen if available and no TMSI (GSM-MAP) is available. The IE "RAI" in the IE "Initial UE identity" shall in this case also be present when P-TMSI (GSM-MAP) is used, for making it unique.
3. IMSI (GSM-MAP): The IMSI (GSM-MAP) shall be chosen if available and no TMSI (GSM-MAP) or P-TMSI is available.
4. IMEI: The IMEI shall be chosen when none of the above three conditions are fulfilled.

When being used, the IEs "TMSI (GSM-MAP)", "P-TMSI (GSM-MAP)", "IMSI (GSM-MAP)", "LAI" and "RAI" shall be set equal to the values of the corresponding identities stored in the USIM or SIM.

If the variable `SELECTED_PLMN` in the UE indicates "ANSI-41", the UE shall choose "UE id type" in the IE "Initial UE identity" according to the procedure specified in the 3GPP2 document "3GPP2 C.P0004-A".

8.5.2 Actions when entering idle mode from connected mode

When entering idle mode from connected mode, the UE shall:

- clear or set variables upon leaving UTRA RRC connected mode as specified in subclause 13.4;
- attempt to select a suitable cell to camp on.

When leaving connected mode according to [4], the UE shall:

- perform cell selection.

While camping on a cell, the UE shall:

- acquire system information according to the system information procedure in subclause 8.1;
- perform measurements according to the measurement control procedure specified in subclause 8.4; and
- if the UE is registered:
 - be prepared to receive paging messages according to the paging procedure in subclause 8.2.

If IE "PLMN identity" within variable `SELECTED_PLMN` has the value "GSM-MAP", the UE shall:

- delete any NAS system information received in connected mode;
- acquire the NAS system information in system information block type 1; and
- proceed according to subclause 8.6.1.2.

When entering idle mode, the UE shall:

- if the USIM is present:
 - store the current `START` value for every CN domain in the USIM [50];

- if the "START" stored in the USIM [50] for a CN domain is greater than the value "THRESHOLD" of the variable START_THRESHOLD:
 - delete the ciphering and integrity keys that are stored in the USIM for that CN domain;
 - inform the deletion of these keys to upper layers.

8.5.3 Open loop power control upon establishment of DPCCH

This procedure is used in FDD mode only.

When establishing the first DPCCH the UE shall start the UL inner loop power control at a power level according to:

- $DPCCH_Initial_power = DPCCH_Power_offset - CPICH_RSCP$

Where

DPCCH_Power_offset shall have the value of IE "DPCCH Power offset" in IE "Uplink DPCH power control info"

The value for the CPICH_RSCP shall be measured by the UE.

8.5.4 Physical channel establishment criteria

When a physical dedicated channel establishment is initiated by the UE, the UE shall start a timer T312 and wait for layer 1 to indicate N312 successive "in sync" indications. On receiving N312 successive "in sync" indications, the physical channel is considered established and the timer T312 is stopped and reset.

If the timer T312 expires before the physical channel is established, the UE shall consider this as a "physical channel establishment failure".

8.5.5 Actions in "out of service area" and "in service area"

This subclause specifies the general actions the UE shall perform when it detects "out of service" or "in service" area. The specific UE behaviour when it detects "out of service" or "in service area" and periodical update has been configured by T305 in the IE "UE Timers and constants in connected mode" set to any other value than "infinity" is specified in subclause 8.3.1.

8.5.5.1 Detection of "out of service" area

When a suitable cell is not found based on the description in [4], the UE considers it as having detected "out of service area".

8.5.5.1.1 Actions following detection of "out of service" area in URA_PCH or CELL_PCH state

If the UE detects the "out of service area" and the UE is in URA_PCH or CELL_PCH state it shall perform the following actions:

- start timer T316;
- perform processes described in subclause 7.2.2.

8.5.5.1.2 Actions following detection of "out of service" area in CELL_FACH state

If the UE detects the "out of service area" and the UE is in CELL_FACH state it shall perform the following actions. The UE shall:

- start timer T317 if not already running;
- perform processes described in subclause 7.2.2.

8.5.5.2 Detection of "in service" area

When a suitable cell is found based on the description in [4], the UE considers it as having detected "in service area".

8.5.5.2.1 Actions following Re-entry into "in service area" in URA_PCH or CELL_PCH state

If the UE re-enters "in service area" before T316 expiry the UE shall perform the following actions. The UE shall:

- stop T316;
- perform processes described in subclause 7.2.2.

8.5.5.2.2 Actions following re-entry into "in service area" in CELL_FACH state

If the UE detects "in service area" before T317 expiry the UE shall perform the following actions. If no cell update procedure or URA update procedure is ongoing, the UE shall:

- stop T317;
- initiate the cell update procedure using as cause "Re-entering service area" as specified in subclause 8.3.1;
- perform processes described in subclause 7.2.2.

If an cell update procedure or URA update procedure is ongoing, the UE shall:

- perform the actions as specified in 8.3.1.

8.5.5.3 T316 expiry

On T316 expiry the UE shall perform the following actions. The UE shall:

- if "out of service area" is detected:
 - start timer T317;
 - move to CELL_FACH state;
 - perform processes described in subclause 7.2.2;
- if "in service area" is detected:
 - initiate the cell update procedure using as cause "Re-entering service area" as specified in subclause 8.3.1;
 - perform processes described in subclause 7.2.2.

8.5.5.4 T317 expiry

When the T317 expires, the UE shall:

- move to idle mode;
- release all dedicated resources;
- indicate release (abort) of the established signalling connections (as stored in the variable ESTABLISHED_SIGNALLING_CONNECTIONS) and established radio access bearers (as stored in the variable ESTABLISHED_RABS) to upper layers;
- clear the variable ESTABLISHED_SIGNALLING_CONNECTIONS;
- clear the variable ESTABLISHED_RABS;
- perform actions specified in subclause 8.5.2 when entering idle mode from connected mode.

8.5.6 Radio link failure criteria and actions upon radio link failure

In CELL_DCH State, after receiving N313 consecutive "out of sync" indications from layer 1 for the established DPCH physical channel in FDD, and the DPCH associated with mapped DCCHs in TDD, the UE shall:

- start timer T313;
- upon receiving N315 successive "in sync" indications from layer 1 and upon change of UE state:
 - stop and reset timer T313;
- if T313 expires:
 - consider it as a "Radio link failure";

When a radio link failure occurs, the UE shall:

- clear the dedicated physical channel configuration;
- select a suitable UTRA cell according to [4];
- perform actions as specified for the ongoing procedure;
- if no procedure is ongoing or no actions are specified for the ongoing procedure:
 - select a suitable UTRA cell according to [4];
 - perform a cell update procedure according to subclause 8.3.1 using the cause "radio link failure".

8.5.7 Open loop power control

For FDD and prior to PRACH or PCPCH transmission the UE shall:

- read the IEs "Primary CPICH DL TX power", "UL interference" and "Constant value" in System Information Block type 6 (or System Information Block type 5, if system information block type 6 is not being broadcast) and System Information Block type 7;
- measure the value for the CPICH_RSCP;
- calculate the power for the first preamble as:

$$\text{Preamble_Initial_Power} = \text{Primary CPICH DL TX power} - \text{CPICH_RSCP} + \text{UL interference} + \text{Constant Value}$$

Where,

Primary CPICH DL TX power shall have the value of IE "Primary CPICH DL TX power",

UL interference shall have the value of IE "UL interference"; and

Constant Value shall have the value of IE "Constant Value".

- as long as the physical layer is configured for PRACH or PCPCH transmission:
 - continuously recalculate the Preamble_Initial_Power when any of the broadcast parameters used in the above formula changes; and
 - resubmit to the physical layer the new calculated Preamble_Initial_Power.

For 3.84 Mcps TDD the UE shall:

- if in the IE "Uplink DPCH Power Control info" the "CHOICE UL OL PC info" has the value "Broadcast UL OL PC info":
 - acquire Reference Power, Constant Values from System Information Block type 6 (or System Information Block type 5, according to subclause 8.1.1.6.5), and I_{BTS} for all active UL timeslots from System Information Block type 14 on the BCH;

- otherwise:
 - acquire Reference Power, Constant Values and I_{BTS} for all active UL timeslots from the IE "Uplink DPCH Power Control info".
- for PUSCH and PRACH power control:
 - acquire Reference Power, Constant Values and I_{BTS} for all active UL timeslots from System Information Block type 6 (or System Information Block type 5, according to subclause 8.1.1.6.5) and System Information Block type 14 on the BCH,

calculate the UL transmit power according to the following formula for the PRACH continuously while the physical channel is active:

$$P_{PRACH} = L_{PCCPCH} + I_{BTS} + RACH \text{ Constant value,}$$

- 3dB shall be added to RACH Constant Value in the above equation for the case where RACH Spreading Factor = 8
- calculate the UL transmit power according to the following formula for the DPCH continuously while the physical channel is active:

$$P_{DPCH} = \alpha L_{PCCPCH} + (1-\alpha)L_0 + I_{BTS} + SIR_{TARGET} + DPCH \text{ Constant value}$$

- calculate the UL transmit power according to the following formula for the PUSCH continuously while the physical channel is active:

$$P_{USCH} = \alpha L_{PCCPCH} + (1-\alpha)L_0 + I_{BTS} + SIR_{TARGET} + USCH \text{ Constant value}$$

Where, for all the above equations for TDD the following apply:

- P_{PRACH} , P_{DPCH} , & P_{USCH} : Transmitter power level in dBm;
- Pathloss values:
 - L_{PCCPCH} : Measurement representing path loss in dB based on beacon channels (the reference transmit power is signalled as the value of the IE "Primary CCPCH Tx Power" on BCH in System Information Block type 6 (or System Information Block type 5, according to subclause 8.1.1.6.5), or individually signalled in the IE "Uplink DPCH Power Control info").
 - L_0 : Long term average of path loss in dB;
 - If the midamble is used in the evaluation of L_{PCCPCH} and L_0 , and the Tx diversity scheme used for the P-CCPCH involves the transmission of different midambles from the diversity antennas, the received power of the different midambles from the different antennas shall be combined prior to evaluation of the variables.
- I_{BTS} : Interference signal power level at cell's receiver in dBm. I_{BTS} shall have the value of the IE "UL Timeslot Interference" (IE "UL Timeslot Interference" is broadcast on BCH in System Information Block type 14 or individually signalled to each UE in the IE "Uplink DPCH Power Control info" for each active uplink timeslot).
- α : α is a weighting parameter, which represents the quality of path loss measurements. α may be a function of the time delay between the uplink time slot and the most recent down link PCCPCH time slot. α is calculated at the UE. α shall be smaller or equal to the value of the IE "Alpha". If the IE "Alpha" is not explicitly signalled to the UE α shall be set to 1. If UE is capable of estimating its position by using the OTDOA IPDL method, the UE shall use the IPDL- α parameter.
- SIR_{TARGET} : Target SNR in dB. This value is individually signalled to UEs in IE "UL target SIR" in IE "UL DPCH Power Control Info" or in IE "PUSCH Power Control Info" respectively.
- RACH Constant value: RACH Constant value shall have the value of the IE "RACH Constant value".
- DPCH Constant value: DPCH Constant value shall have the value of the IE "DPCH Constant value".
- USCH Constant Value: USCH Constant value shall have the value of the IE "USCH Constant value".

- Values received by dedicated signalling shall take precedence over broadcast values.
- If IPDLs are applied, the UE may increase UL Tx power by the value given in the IE "Max power increase". This power increase is only allowed in the slots between an idle slot and the next beacon slot.

For 1.28 Mcps TDD the UE shall:

- calculate the UL transmit power according to the following formula for each UpPCH code transmission:

$$P_{\text{UpPCH}} = L_{\text{PCCPCH}} + \text{PRX}_{\text{UpPCHdes}} + i * P_{\text{wramp}}$$

- calculate the UL transmit power according to the following formula for each PRACH transmission:

$$P_{\text{PRACH}} = L_{\text{PCCPCH}} + \text{PRX}_{\text{PRACHdes}} + i * P_{\text{wramp}}$$

- calculate the initial UL transmit power according to the following formula for the PUSCH. Once the UE receives TPC bits relating to the PUSCH then it transitions to closed loop power control. If successive PUSCH resource allocations are contiguous then no return is made to open loop power control at the beginning of the succeeding resource allocation.

$$P_{\text{USCH}} = \text{SIR}_{\text{TARGET}} + L_{\text{PCCPCH}}$$

- calculate the initial UL transmit power according to the following formula for the DPCH. Once the UE receives TPC bits relating to the uplink DPCH then it transitions to closed loop power control.

$$P_{\text{DPCH}} = \text{SIR}_{\text{TARGET}} + L_{\text{PCCPCH}}$$

Where:

- P_{UpPCH} , P_{PRACH} , P_{DPCH} , & P_{USCH} : Transmitter power level in dBm,
- L_{PCCPCH} : Measurement representing path loss in dB (reference transmit power "Primary CCPCH Tx Power" is broadcast on BCH in System Information Block type 5 and System Information Block type 6, or individually signalled to each UE in the IE "Uplink DPCH Power Control info").
- $\text{SIR}_{\text{TARGET}}$: Target SIR in dB. This value is individually signalled to UEs in IEs "UL DPCH Power Control Info" and "PUSCH Power Control Info".
- i is the number of transmission attempts on UpPCH
- $\text{PRX}_{\text{PRACHdes}}$: Desired PRACH RX power at the cell's receiver in dBm signalled to the UE by the network in the FPACH response to the UE's successful SYNC_UL transmission.
- $\text{PRX}_{\text{UpPCHdes}}$: Desired UpPCH RX power at the cell's receiver in dBm. The value is broadcast in "PRX_{UpPCHdes}" in IE "SYNC_UL info" on BCH and shall be read on System Information Block type 5 and System Information Block type 6. It can also be signalled directly to the UE in a protocol message triggering a hard handover.
- P_{wramp} : The UE shall increase its transmission power by the value of the IE "Power Ramping step" by every UpPCH transmission.

8.5.8 Maintenance of Hyper Frame Numbers

The MSBs of both the ciphering sequence numbers (COUNT-C) and integrity sequence numbers (COUNT-I), for the ciphering and integrity protection algorithms, respectively [40], are called the Hyper Frame Numbers (HFN).

For integrity protection, the UE shall:

- maintain COUNT-I as specified in subclause 8.5.10.

The following hyper frame numbers types are defined:

MAC-d HFN:
24 MSB of COUNT-C for data sent over RLC TM

RLC UM HFN:
25 MSB of COUNT-C for data sent over RLC UM

RLC AM HFN:
20 MSB of COUNT-C for data sent over RLC AM

RRC HFN:
28 MSB of COUNT-I

For non-transparent mode RLC signalling radio bearers and radio bearers, the UE shall:

- maintain one uplink and one downlink COUNT-C per signalling radio bearer and per radio bearer and one uplink and one downlink COUNT-I per signalling radio bearer.

For all transparent mode RLC signalling radio bearers and radio bearers of each CN domain, the UE shall:

- maintain one COUNT-C, common for all signalling radio bearers and radio bearers in uplink and downlink;
- maintain one uplink and one downlink COUNT-I per signalling radio bearer.

NOTE: In this release of the specification there is only an uplink transparent mode COUNT-I, which is used for signalling radio bearer RB0.

COUNT-C and COUNT-I are defined in [40], with the following supplement for COUNT-C: for transparent mode RLC radio bearers with a transmission time interval of x radio frames ($x = 2, 4, 8$), the MAC PDU is carried by L1 in x consecutive radio frames due to radio frame segmentation. In this case, the CFN of the first segment of the MAC PDU is used as the CFN component of COUNT-C.

8.5.9 START value calculation

In connected mode, the START value for CN domain 'X' is calculated as

Let $START_X$ = the START value for CN domain 'X' prior to the calculation below:

$START_X' = MSB_{20} (MAX \{ COUNT-C, COUNT-I \} | \text{radio bearers and signalling radio bearers with the most recently configured } CK_X \text{ and } IK_X) + 1$.

- if $START_X' =$ the maximum value = 1048575 then $START_X = START_X'$;
- if the current $START_X < START_X'$ then $START_X = START_X'$, otherwise $START_X$ is unchanged.

8.5.10 Integrity protection

If the "Status" in the variable INTEGRITY_PROTECTION_INFO has the value "Started" then the UE and UTRAN shall:

- perform integrity protection (and integrity checking) on all RRC messages, with the following exceptions:

HANDOVER TO UTRAN COMPLETE

PAGING TYPE 1

PUSCH CAPACITY REQUEST

PHYSICAL SHARED CHANNEL ALLOCATION

RRC CONNECTION REQUEST

RRC CONNECTION SETUP

RRC CONNECTION SETUP COMPLETE

RRC CONNECTION REJECT

RRC CONNECTION RELEASE (CCCH only)

SYSTEM INFORMATION

SYSTEM INFORMATION CHANGE INDICATION

TRANSPORT FORMAT COMBINATION CONTROL (TM DCCH only)

If the "Status" in the variable INTEGRITY_PROTECTION_INFO has the value "Not started" then integrity protection (and integrity checking) shall not be performed on any RRC message.

For each signalling radio bearer, the UE shall use two RRC hyper frame numbers:

- "Uplink RRC HFN";
- "Downlink RRC HFN".

and two message sequence numbers:

- "Uplink RRC Message sequence number";
- "Downlink RRC Message sequence number".

The above information is stored in the variable INTEGRITY_PROTECTION_INFO per signalling radio bearer (RB0-RB4).

Upon the first activation of integrity protection for an RRC connection, UE and UTRAN initialise the "Uplink RRC Message sequence number" and "Downlink RRC Message sequence number" for all signalling radio bearers as specified in subclauses 8.6.3.5 and 8.5.10.1.

As a general rule, the RRC message sequence number (RRC SN) is incremented for every integrity protected RRC message. In cases when there are exceptions, these are stated for those procedures.

8.5.10.1 Integrity protection in downlink

If the UE receives an RRC message on signalling radio bearer with RB identity n, the "Status" in the variable INTEGRITY_PROTECTION_INFO has the value "Started" and the IE 'Integrity check info' is present the UE shall:

- perform the actions in subclause 8.6.3.5; and
- apply the new integrity protection configuration;
- check the value of the IE "RRC message sequence number" included in the IE "Integrity check info";
 - if the "Downlink RRC Message sequence number" is not present in the variable INTEGRITY_PROTECTION_INFO:
 - initialise the "Downlink RRC Message sequence number" in the variable INTEGRITY_PROTECTION_INFO with the value of the IE "RRC message sequence number" included in the IE "Integrity check info" of the received message;
 - if the "Downlink RRC Message sequence number" is present in the variable INTEGRITY_PROTECTION_INFO:
 - if the RRC message sequence number is lower than the "Downlink RRC Message sequence number" for signalling radio bearer RBn in the variable INTEGRITY_PROTECTION_INFO:
 - increment "Downlink RRC HFN" for signalling radio bearer RBn in the variable INTEGRITY_PROTECTION_INFO with one;
 - if the RRC message sequence number is equal to the "Downlink RRC Message sequence number" for signalling radio bearer RBn in the variable INTEGRITY_PROTECTION_INFO:
 - discard the message;
- calculate an expected message authentication code in accordance with subclause 8.5.10.3;
- compare the expected message authentication code with the value of the received IE "message authentication code" contained in the IE "Integrity check info";

- if the expected message authentication code and the received message authentication code are the same, the integrity check is successful:
 - update the "Downlink RRC Message sequence number" for signalling radio bearer RBn in the variable INTEGRITY_PROTECTION_INFO with the value of the IE "RRC message sequence number" included in the IE "Integrity check info" of the received RRC message;
- if the calculated expected message authentication code and the received message authentication code differ:
 - if the IE "RRC message sequence number" included in the IE "Integrity check info" is lower than the "Downlink RRC Message sequence number" for signalling radio bearer RBn in the variable INTEGRITY_PROTECTION_INFO (in this case the "Downlink RRC HFN" for signalling radio bearer RBn in the variable INTEGRITY_PROTECTION_INFO was incremented by one, as stated above):
 - decrement "Downlink RRC HFN" for signalling radio bearer RBn in the variable INTEGRITY_PROTECTION_INFO by one;
 - discard the message.

If the UE receives an RRC message on signalling radio bearer with identity n, the "Status" in the variable INTEGRITY_PROTECTION_INFO has the value "Started" and the IE 'Integrity check info' is not present the UE shall:

- discard the message.

8.5.10.2 Integrity protection in uplink

Upon transmitting an RRC message using the signalling radio bearer with radio bearer identity n, and the "Status" in the variable INTEGRITY_PROTECTION_INFO has the value "Started" the UE shall:

- increment "Uplink RRC Message sequence number" for signalling radio bearer RBn in the variable INTEGRITY_PROTECTION_INFO with 1. When "Uplink RRC Message sequence number" for signalling radio bearer RBn in the variable INTEGRITY_PROTECTION_INFO becomes 0, the UE shall increment "Uplink RRC HFN" for signalling radio bearer RBn in the variable INTEGRITY_PROTECTION_INFO with 1
- calculate the message authentication code in accordance with subclause 8.5.10.3
- replace the "Message authentication code" in the IE "Integrity check info" in the message with the calculated message authentication code.
- replace the "RRC Message sequence number" in the IE "Integrity check info" in the message with contents set to the new value of the "Uplink RRC Message sequence number" for signalling radio bearer RBn in the variable INTEGRITY_PROTECTION_INFO

During an ongoing reconfiguration of the integrity protection, UTRAN should, for all signalling radio bearers, apply the old configuration (that is, the configuration that was applied before the reconfiguration) for the integrity protection. In the response message for the procedure ordering the reconfiguration, the UE indicates the activation time, for each signalling radio bearer except RB2, when the new configuration is to be applied in uplink. UTRAN should then start to apply the new configuration according to the activation time for each signalling radio bearer (for signalling radio bearer RB2 the new configuration is applied starting from reception of the response message).

8.5.10.3 Calculation of message authentication code

The UE shall calculate the message authentication code in accordance with [40]. The input parameter MESSAGE [40] for the integrity algorithm shall be constructed by:

- setting the "Message authentication code" in the IE "Integrity check info" in the message to the radio bearer identity for the signalling radio bearer;
- setting the "RRC Message sequence number" in the IE "Integrity check info" in the message to zero;
- encoding the message;
- appending RRC padding (if any) as a bit string to the encoded bit string as the least significant bits.

For usage on an RRC message transmitted or received on the radio bearer with identity n, the UE shall:

- construct the input parameter COUNT-I [40] by appending the following IEs from the IE "Signalling radio bearer specific integrity protection information" for radio bearer n in the variable INTEGRITY_PROTECTION_INFO:
 - for uplink:
 - "Uplink RRC HFN", as the MSB, and "Uplink RRC Message sequence number", as LSB;
 - for downlink:
 - "Downlink RRC HFN", as the MSB, and the IE "RRC message sequence number" included in the IE "Integrity check info", as LSB.

8.5.11 FACH measurement occasion calculation

When in CELL_FACH state and when the variable C_RNTI is non-empty the UE in FDD mode shall perform inter-frequency and inter system measurements during the frame(s) with the SFN value fulfilling the following equation:

$$\text{SFN div } N = \text{C_RNTI mod } M_REP + n * M_REP$$

where

- N is the TTI (in number of 10ms frames) of the FACH having the largest TTI on the SCCPCH monitored by UE
- C_RNTI is the C-RNTI value of the UE stored in the variable C_RNTI
- M_REP is the Measurement Occasion cycle length. According to the equation above, a FACH Measurement Occasion of N frames will be repeated every $N * M_REP$ frame, and $M_REP = 2^k$.

where,

- k is the FACH Measurement occasion cycle length coefficient.
The value of the FACH Measurement occasion cycle length coefficient is read in system information in "System Information Block type 11" or "System Information Block type 12" in the IE "FACH measurement occasion info".
- $n = 0, 1, 2, \dots$ as long as SFN is below its maximum value

The UE is allowed to measure on other occasions in case the UE moves "out of service" area or in case it can simultaneously perform the ordered measurements.

A UE in TDD mode shall use the frame(s) with the SFN value fulfilling the above equation for neighbour cells measurements.

8.5.12 Establishment of Access Service Classes

The PRACH resources (i.e. access slots and preamble signatures for FDD), timeslot (with specific frame allocation and channelisation code for 3.84 Mcps TDD and SYNC_UL codes (with specific frame allocation) for 1.28 Mcps TDD) may be divided between different Access Service Classes in order to provide different priorities of RACH usage. It is possible for more than one ASC or for all ASCs to be assigned to the same access slot/signature space in FDD or frame allocation/channelisation codes in 3.84 Mcps TDD or frame allocation/SYNC_UL codes in 1.28 Mcps TDD.

Access Service Classes shall be numbered in the range $0 \leq i \leq \text{NumASC} \leq 7$ (i.e. the maximum number of ASCs is "NumASC+1" = 8). An ASC is defined by an identifier, i , that defines a certain partition of the PRACH resources (SYNC_UL resources in 1.28 Mcps TDD) and an associated persistence value P_i . A set of ASC parameters consists of "NumASC+1" such parameters (i, P_i), $i = 0, \dots, \text{NumASC}$.

PRACH partitions shall be established using the information element "PRACH partition". The persistence values P_i to be associated with each ASC shall be derived from the dynamic persistence level $N = 1, \dots, 8$ which is broadcast in SIB 7, and the persistence scaling factors s_i , broadcast in System Information Block Type 5 and possibly also in System Information Block Type 6, as follows:

$$P(N) = 2^{-(N-1)}$$

ASC # i	0	1	2	3	4	5	6	7
P_i	1	$P(N)$	$s_2 P(N)$	$s_3 P(N)$	$s_4 P(N)$	$s_5 P(N)$	$s_6 P(N)$	$s_7 P(N)$

Scaling factors s_i are provided optionally for $i = 2, \dots, \text{NumASC}$, where $\text{NumASC}+1$ is the number of ASCs as defined by PRACH partitioning. If no scaling factors are broadcast, default value 1 shall be used if $\text{NumASC} \geq 2$.

If $k \geq 1$ scaling factors are broadcast and $\text{NumASC} \geq k+2$ then the last scaling factor s_{k+1} shall be used as default for the ASCs where $i > k+1$.

The set of ASC parameters is provided to MAC with the CMAC-Config-REQ primitive (see [15]), the PRACH partitioning is provided to PHY using the CPHY-RL-Setup-REQ primitive (see [34]).

The ASC enumeration shall be such that it corresponds to the order of priority (ASC 0 = highest priority, ASC 7 = lowest priority). ASC 0 shall be used in case of Emergency Call or for reasons with equivalent priority.

At radio bearer setup/reconfiguration each involved logical channel is assigned a MAC Logical channel Priority (MLP) in the range 1, ..., 8. When the MAC sublayer is configured for RACH transmission in the UE, these MLP levels shall be employed for ASC selection on MAC.

8.5.13 Mapping of Access Classes to Access Service Classes

Access Classes shall only be applied at initial access, i.e. when sending an RRC CONNECTION REQUEST message. A mapping between Access Class (AC) and Access Service Class (ASC) shall be indicated by the information element "AC-to-ASC mapping" in System Information Block type 5. The correspondence between AC and ASC shall be indicated as follows.

AC	0 - 9	10	11	12	13	14	15
ASC	1 st IE	2 nd IE	3 rd IE	4 th IE	5 th IE	6 th IE	7 th IE

In the table, "nth IE" designates an ASC number i in the range 0 - 7 to AC.

For the random access, the parameters implied by the respective ASC shall be employed. In case the UE is member of several ACs it shall select the ASC for the highest AC number. In connected mode, AC shall not be applied.

8.5.14 PLMN Type Selection

The UE shall perform PLMN selection and reselection as stated in [4] and store the identifier of the chosen PLMN in the variable SELECTED_PLMN as follows. The UE shall:

- if a GSM-MAP type of PLMN is selected:
 - set the "PLMN Type" in the variable SELECTED_PLMN to "GSM-MAP";
 - and store the PLMN identity of that PLMN.
- if an ANSI-41 type of PLMN is selected:
 - set the "PLMN Type" in the variable SELECTED_PLMN to "ANSI-41";
 - and store the System identification (SID) of that PLMN.

8.5.14a Neighbour cells list narrowing for cell reselection

A UE having performed the PLMN identification of the neighbour cells as specified in 8.1.1.6.18 may narrow the cell list to be used for cell reselection ([4]) to those cells that do satisfy one of the following criteria:

- the PLMN identity of the neighbour cell is the identity of the selected PLMN;
- the PLMN identity of the neighbour cell is indicated by higher layers to be equivalent to the identity of the selected PLMN.

8.5.15 CFN calculation

8.5.15.1 Initialisation for CELL_DCH state after state transition

When the UE receives any of the messages causing the UE to perform a state transition to CELL_DCH, the UE shall set the CFN in relation to the SFN of the first radio link listed in the IE "Downlink information per radio link list" included in that message according to the following formula:

- for FDD:

$$\text{CFN} = ((\text{SFN} * 38400 - \text{DOFF}) \text{ div } 38400) \text{ mod } 256$$

- for TDD:

$$\text{CFN} = (\text{SFN} - \text{DOFF}) \text{ mod } 256$$

8.5.15.2 Initialisation in CELL_DCH state at hard handover

When the UE is in CELL_DCH state and receives any of the messages causing the UE to perform a hard handover, the UE shall check the IE "Timing indication" in that message and:

- if IE "Timing indication" has the value "initialise" (i.e. timing re-initialised hard handover):
 - read SFN on target cell identified by the first radio link listed in the IE "Downlink information per radio link list" included in that message;
 - set the CFN according to the following formula:
 - for FDD:
 - $\text{CFN} = ((\text{SFN} * 38400 - \text{DOFF}) \text{ div } 38400) \text{ mod } 256;$
 - for TDD:
 - $\text{CFN} = (\text{SFN} - \text{DOFF}) \text{ mod } 256;$
- if IE "Timing indication" has the value "maintain" (i.e. timing-maintained hard handover), the UE shall keep CFN with no change due to the hard handover, and only increase CFN (mod 256) by 1 every frame.

8.5.15.3 Initialisation for CELL_FACH

When the UE performs cell selection, re-selection or changes to CELL_FACH state the UE shall set CFN for all common or shared channels according to:

- $\text{CFN} = \text{SFN} \text{ mod } 256$

After the initialisation, the CFN in the UE is increased (mod 256) by 1 every frame.

8.5.15.4 Initialisation after intersystem handover to UTRAN

Upon inter RAT handover to UTRAN the UE shall, regardless of the value received within IE "Timing indication" (if received):

- read SFN on target cell and set the CFN according to the following formula:
 - for FDD:

$$\text{CFN} = ((\text{SFN} * 38400 - \text{DOFF}) \text{ div } 38400) \text{ mod } 256$$

- for TDD:

$$\text{CFN} = (\text{SFN} - \text{DOFF}) \text{ mod } 256$$

8.5.16 Configuration of CTCH occasions

The CTCH, carrying CBS data is mapped onto only one S-CCPCH. If more than one CTCH is defined, the first CTCH that is configured in the list of S-CCPCHs is the one that is used for CBS data.

The CTCH occasions are identified by the first radio frame of the TTI that can contain CTCH data. The CTCH occasions are fixed on the system frame number cycle 0 .. 4095 (i.e. no modulo calculation) and thus repeated cyclically.

The CTCH occasions are determined by a set of parameters.

M_{TTI} : number of radio frames within the TTI of the FACH used for CTCH

N: period of CTCH allocation on S-CCPCH, integer number of radio frames,
 $M_{TTI} \leq N \leq \text{MaxSFN} - K$, where N is a multiple of M_{TTI} (see [27] and [31]).

MaxSFN: maximum system frame number = 4095 (see [10]).

K: CBS frame offset, integer number of radio frames $0 \leq K \leq N-1$ where K is a multiple of M_{TTI} .

The CTCH occasions are calculated as follows:

$$\text{SFN} = (K + m N), m = 0, 1, \dots, M, \text{ with } M \text{ chosen that } K + MN \leq \text{MaxSFN}.$$

The parameters N and K are broadcast as system information.

8.5.17 PRACH selection

For this version of the specification, when a UE selects a cell, the uplink frequency to be used for the initial PRACH transmission shall have a default duplex frequency spacing offset from the downlink frequency that the cell was selected on. The default duplex frequency separation to be used by the UE is specified in [35] (for FDD only).

The UE shall select a "PRACH system information" according to the following rule. The UE shall:

- select a default "PRACH system information" from the ones indicated in the IE "PRACH system information list" in System Information Block type 5 (applicable in Idle Mode and Connected Mode) or System Information Block type 6 (applicable in Connected Mode only), as follows:
 - in FDD:
 - if both RACH with 10 ms and 20 ms TTI are indicated in System Information Block type 5 or System Information Block type 6:
 - select the appropriate TTI based on power requirements, as specified in subclause 8.5.18;
 - in 1.28 Mcps TDD:
 - if RACH with 5 ms, 10 ms and 20 ms TTI are indicated in System Information Block type 5 or System Information Block Type 6:
 - select the TTI according to 8.5.18.2;
- select a "PRACH system information" randomly from the ones listed in System Information Block type 5 or System Information Block type 6 as follows:

$$\text{"Index of selected PRACH"} = \text{floor}(\text{rand} * K)$$

where K is equal to the number of listed PRACH system informations that carry a RACH with the above selected TTI, "rand" is a random number uniformly distributed in the range 0, ..., 1, and "floor" refers to rounding down to nearest integer. PRACH system informations carrying RACHs with 10 and 20 ms TTI shall be counted separately. These PRACH system informations shall be indexed from 0 to K-1 in the order of their occurrence in System Information Block type 5 or System Information Block type 6. The random number generator is left to implementation. The scheme shall be implemented such that one of the available PRACH system informations is randomly selected with uniform probability. At start-up of

the random number generator in the UE the seed shall be dependent on the IMSI of the UE or time, thereby avoiding that all UEs select the same RACH;

- in Connected mode:
 - select the PRACH according to the following preference:
 - if System Information Block type 6 is defined and PRACH info is included:
 - select PRACH from the PRACHs listed in System Information Block type 6;
 - if System Information Block type 6 is defined and no PRACH info is included:
 - select PRACH from the PRACHs listed in System Information Block type 5;
 - if no System Information Block type 6 is defined:
 - select PRACH from the PRACHs listed in System Information Block type 5.
 - reselect the default PRACH system information when a new cell is selected. RACH reselection may also be performed after each transmission of a Transport Block Set on RACH;
- for emergency call, the UE is allowed to select any of the available PRACH system informations.

After selecting a PRACH system information, the RRC in the UE shall configure the MAC and the physical layer for the RACH access according to the parameters included in the selected "PRACH system information" IE.

8.5.18 Selection of RACH TTI

8.5.18.1 FDD Mode

In FDD mode, a RACH may employ either 10 or 20 ms TTI. The supported TTI is indicated as a semi-static parameter of the RACH Transport Format in system information. If in one cell RACHs for both 10 and 20 ms TTI are supported, the UE shall select an appropriate RACH according to the following rule:

The UE shall first check whether a RACH Transport Format is available which is suitable for the transmission of the current transport Block Set for both 10 and 20 ms TTI. The UE shall:

- if the required transport format is available only for one particular TTI:
 - select this TTI;
 - identify the corresponding RACHs;
 - proceed with RACH selection as specified in subclause 8.5.17.
- if the required transport format is available on both types of RACH, 10 and 20 ms TTI:
 - perform TTI selection as follows:
 - when the UE calculates the initial preamble transmit power ("Preamble_Initial_Power") as specified in subclause 8.5.7:
 - calculate a transmit power margin,

$$\text{Margin} = \{ \min(\text{Maximum allowed UL tx power, P_MAX}) - \max(\text{Preamble_Initial_Power, Preamble_Initial_Power} + \Delta P_{p-m} + 10 \cdot \log_{10}(1 + (\beta_d / \beta_c)^2)) \}$$

where "Maximum allowed UL tx power" is the maximum allowed uplink transmit power indicated in system information (in dBm), and P_MAX is the maximum RF output power of the UE (dBm). The margin shall be calculated for 10 ms TTI RACH message gain factors β_d and β_c .

NOTE: the expression $\text{Preamble_Initial_Power} + \Delta P_{p-m} + 10 \cdot \log_{10}(1 + (\beta_d / \beta_c)^2)$ represents the total RACH message power if the message would be sent after the initial preamble.

- if the value of "Margin" calculated for RACH with 10 ms TTI is less than 6 dB:
 - select RACH with 20 ms TTI, and proceed as specified in subclause 8.5.17.
- perform reselection of the RACH TTI only after successful transmission of one Transport Block Set. However in case L1 message transmission on PRACH has failed at least once while using 10 ms TTI, the UE may use the 20 ms TTI RACH for the retransmission. Handling of RACH Message transmission failure is part of general error handling procedure.

8.5.18.2 1.28 Mcps TDD

In 1.28 Mcps TDD, a RACH may be assigned a 5, 10 or 20 ms TTI. If, in one cell, more than one RACH is defined a UE shall select the RACH that is to be used for each transmission according to the following rule:

- if only one RACH is assigned a transport format that is suitable for the transmission of the transport block set:
 - select this RACH and the RACH's TTI;
- if more than one RACH is assigned a transport format that is suitable for the transmission of the transport block set:
 - select that which has the largest TTI.

8.5.19 Secondary CCPCH selection

In UTRAN Connected mode, the UE shall select the Secondary CCPCH according to the following rules:

- in Cell_DCH state:
 - select Secondary CCPCH according to subclause 8.6.6.4;
- in Cell_FACH state:
 - select an SCCPCH from the SCCPCHs listed in SIB 5 or SIB 6 based on U-RNTI as follows:

$$\text{"Index of selected SCCPCH"} = \text{U-RNTI mod K,}$$

where K is equal to the number of listed SCCPCHs that carry a FACH (i.e., SCCPCHs carrying PCH only shall not be counted). These SCCPCHs shall be indexed from 0 to K-1 in the order of their occurrence in SIB 5 or SIB 6. "Index of selected SCCPCH" identifies the selected SCCPCH.

 - if SIB 6 is defined and SCCPCH info is included:
 - select SCCPCH from the SCCPCHs listed in SIB 6;
 - if SIB 6 is defined and no SCCPCH info is included:
 - select SCCPCH from the SCCPCHs listed in SIB 5;
 - if no SIB 6 is defined:
 - select SCCPCH from the SCCPCHs listed in SIB 5.

- in Cell_PCH and URA_PCH states:
 - select an SCCPCH from the SCCPCHs listed in SIB 5 or SIB 6 based on U-RNTI as follows:

$$\text{"Index of selected SCCPCH"} = \text{U-RNTI mod K,}$$

where K is equal to the number of listed SCCPCHs that carry a PCH (i.e., SCCPCHs carrying FACH only shall not be counted). These SCCPCHs shall be indexed in the order of their occurrence in system information from 0 to K-1, and "Index of selected SCCPCH" identifies the selected SCCPCH.

 - if SIB 6 is defined and SCCPCH info is included:
 - select SCCPCH from the SCCPCHs listed in SIB 6;

- if SIB 6 is defined and no SCCPCH info is included:
 - select SCCPCH from the SCCPCHs listed in SIB 5;
- if no SIB 6 is defined:
 - select SCCPCH from the SCCPCHs listed in SIB 5.

UE shall set CFN in relation to SFN of current cell according to subclause 8.5.15.

The UE shall support reception of all transport formats on all FACHs multiplexed on the selected S-CCPCH.

8.6 Generic actions on receipt and absence of an information element

8.6.1 CN information elements

8.6.1.1 Void

8.6.1.2 CN information info

If the IE "CN information info" is present in a message, the UE shall:

- if present, forward the content of the IE "PLMN identity" to upper layers;
- if present, forward the content of the IE "CN common GSM-MAP NAS system information" to upper layers;
- if the IE "CN domain related information" is present:
 - forward each occurrence of the IE "CN domain specific GSM-MAP NAS system info" together with the IE "CN domain identity" to upper layers;
 - if an IE "CN domain specific GSM-MAP NAS system info" is not present for a particular CN domain:
 - indicate to upper layers that no CN system information is available for that CN domain.

8.6.1.3 Signalling connection release indication

If the IE "Signalling Connection release indication" is present in a message, the UE shall:

- if all radio access bearers for the CN domain identified with the value of the IE "Signalling Connection release indication" would have been released in the variable ESTABLISHED_RABS after processing of the received message:
 - indicate release of the signalling connection identified with the value of the IE "Signalling Connection release indication" to the upper layers;
 - remove the signalling connection identified with the value of the IE "Signalling Connection release indication" from the variable ESTABLISHED_SIGNALLING_CONNECTIONS;
- if radio access bearers for the CN domain identified with the value of the IE "Signalling Connection release indication" would remain in the variable ESTABLISHED_RABS after processing of the received message:
 - set the variable INVALID_CONFIGURATION to TRUE.

8.6.2 UTRAN mobility information elements

8.6.2.1 URA identity

The UE shall:

- if the IE "URA identity" is included in a received message:
 - if the IE "RRC State Indicator" is included and set to "URA_PCH":
 - store this URA identity in the variable URA_IDENTITY;
 - after sending a possible message to UTRAN and entering URA_PCH state as specified elsewhere, read system information block type 2 in the selected cell;
 - if the stored URA identity in the variable URA_IDENTITY is not included in the list of URA identities in System Information Block type 2 in the selected cell, the list of URA identities in system information block type 2 is empty or if the system information block type 2 can not be found, a confirmation error of URA identity list has occurred:
 - if no URA update procedure is ongoing:
 - initiate a URA update procedure after entering URA_PCH state; see subclause 8.3.1.2;
 - if a URA update procedure is ongoing:
 - take actions as specified in subclause 8.3.1.10;
 - if the IE "URA identity" is not included in a received message:
 - the IE "RRC State Indicator" is included and set to " URA_PCH":
 - after sending a possible message to UTRAN and entering URA_PCH state as specified elsewhere, read System Information Block type 2 in the selected cell;
 - if System Information Block type 2 in the selected cell contains a single URA identity:
 - store this URA identity in the variable URA_IDENTITY;
 - if System Information Block type 2 of the selected cell contains more than one URA identity, the list of URA identities in system information block type 2 is empty or if the system information block type 2 can not be found, a confirmation error of URA identity list has occurred:
 - if no URA update procedure is ongoing:
 - initiate a URA update procedure after entering URA_PCH state, see subclause 8.3.1.2;
 - if a URA update procedure is ongoing:
 - take actions as specified in subclause 8.3.1.10.

8.6.2.2 Mapping info

If the IE "Mapping info" is received, the UE shall in this version of the specification:

- ignore the contents of this IE.

8.6.3 UE information elements

8.6.3.1 Activation time

If the UE receives a message in which presence is needed for the IE "Activation time", and the value is other than the default value "Now", the UE shall:

- if the frame boundary immediately before the frame with the CFN (Connection Frame Number) value indicated by the IE "Activation Time" is at the TTI boundary common to all the transport channels that are multiplexed onto the same CCTrCh including any transport channel which is added, reconfigured or has been removed:
 - select that frame boundary as the activation time T;
- else:
 - select the next TTI boundary, which is common to all the transport channels that are multiplexed onto the same CCTrCh including any transport channel which is added, reconfigured or has been removed, after the frame with the CFN (Connection Frame Number) value indicated by the IE "Activation Time", as the activation time T;
- at the activation time T:
 - for a physical channel reconfiguration caused by the received message:
 - release the physical channel configuration, which was present before T;
 - initiate the establishment of the physical channel configuration as specified for the physical channel information elements in the received message as specified elsewhere;
 - for actions, other than a physical channel reconfiguration, caused by the received message:
 - perform the actions for the information elements in the received message as specified elsewhere.

If the UE receives a message in which presence is needed for the IE "Activation time", and the value is the default value "Now", the UE shall:

- choose an activation time T as soon as possible after the reception of the message, respecting the performance requirements in subclause 13.5;
- at the activation time T:
 - perform the actions for the information elements in the received message as specified elsewhere.

8.6.3.1a CN domain specific DRX cycle length coefficient

The UE updates CN domain specific DRX cycle length coefficient as specified in [4]. The UE shall use it to calculate the CN domain specific DRX cycle length, according to the following:

- set k to the value of the IE "CN domain specific DRX cycle length coefficient".
- store the result of $\text{MAX}(2^k, \text{PBP})$, where PBP is the Paging Block Periodicity, as the CN domain specific DRX cycle length for the CN domain indicated by the IE "CN domain identity". For FDD PBP=1.

The UE shall determine its idle mode paging occasions and PICH monitoring occasions for that CN domain, according to [4], based on the stored CN domain specific DRX cycle length, when using DRX in idle mode.

8.6.3.2 UTRAN DRX Cycle length coefficient

If the IE "UTRAN DRX cycle length coefficient" is present, the UE shall use it to calculate the UTRAN DRX cycle length, according to the following:

- set k to the value of the IE "UTRAN DRX cycle length coefficient";
- store the result of $\text{MAX}(2^k \cdot \text{PBP})$, where PBP is the Paging Block Periodicity, as the DRX cycle length.

The UE shall determine its connected mode paging occasions and PICH monitoring occasions in the same way as for idle mode, according to [4].

The DRX cycle length to use in connected mode is the shorter of the following two parameters:

- UTRAN DRX cycle length;

- CN domain specific DRX cycle length stored for any CN domain, when using Discontinuous Reception (DRX) in CELL_PCH and URA_PCH state.

The CN domain specific DRX cycle length stored for any CN domain is only used in Cell_PCH state and URA_PCH state if the UE is registered to that CN domain and no signalling connection stored in the variable ESTABLISHED_SIGNALLING_CONNECTIONS exists to that CN domain.

8.6.3.3 Generic state transition rules depending on received information elements

The IE "RRC State Indicator" indicates the state the UE shall enter. The UE shall enter the state indicated by the IE "RRC State Indicator" even if the received message includes other IEs relevant only for states other than indicated by the IE "RRC State Indicator". E.g. if the RRC state indicator is set to CELL_FACH while other IEs provide information about a configuration including dedicated channels, the UE shall enter CELL_FACH state. If however the UE has no information about the configuration corresponding to the state indicated by the IE "RRC State Indicator", it shall consider the requested configuration as invalid.

The UE shall, if the IE "RRC State Indicator" in the received message has the value:

- "CELL_FACH":
 - enter CELL_FACH state as dictated by the procedure governing the message received;
- "CELL_DCH":
 - if neither DPCH is assigned in the message nor is the UE in CELL_DCH:
 - set the variable INVALID_CONFIGURATION to TRUE;
 - else:
 - enter CELL_DCH state as dictated by the procedure governing the message received;
- "CELL_PCH":
 - if the received message is RRC CONNECTION SETUP and IE "RRC State Indicator" is set to CELL_PCH:
 - set the variable INVALID_CONFIGURATION to TRUE;
 - else:
 - enter CELL_PCH state as dictated by the procedure governing the message received;
- "URA_PCH":
 - if the received message is RRC CONNECTION SETUP and IE "RRC State Indicator" is set to URA_PCH:
 - set the variable INVALID_CONFIGURATION to TRUE;
 - else:
 - enter URA_PCH state as dictated by the procedure governing the message received.

8.6.3.4 Ciphering mode info

The IE "Ciphering mode info" defines the new ciphering configuration. At any given time, the UE needs to store at most two different ciphering configurations at any given time for all signalling radio bearers and radio bearers, the old and latest ciphering configurations, per CN domain. If the IE "Ciphering mode info" is present and if the IE "Reconfiguration" in the variable CIPHERING_STATUS is set to FALSE, the UE shall check the IE "Ciphering mode command" as part of the IE "Ciphering mode info", and perform the following. The UE shall:

- if the IE "Status" in the variable CIPHERING_STATUS of the CN domain
 - as indicated in the variable LATEST_CONFIGURED_CN_DOMAIN, if the variable LATEST_CONFIGURED_CN_DOMAIN has been initialised; or

- as indicated in the IE "CN domain identity", if the variable LATEST_CONFIGURED_CN_DOMAIN is not initialised
- has the value "Not Started", and if the IE "Ciphering mode command" has the value "stop":
- ignore this attempt to change the ciphering configuration; and
 - set the variable INVALID_CONFIGURATION to TRUE;
- else:
- set the IE "Reconfiguration" in the variable CIPHERING_STATUS to TRUE;
 - if IE "Ciphering mode command" has the value "start/restart":
 - start or restart ciphering in lower layers for all established radio bearers in the variable ESTABLISHED_RABS, using the ciphering algorithm (UEA [40]) indicated by the IE "Ciphering algorithm" as part of the new ciphering configuration. For each radio bearer, the value of the IE "RB identity" in the variable ESTABLISHED_RABS minus one shall be used as the value of BEARER in the ciphering algorithm. The new ciphering configuration shall be applied as specified below;
 - set the IE "Status" in the variable CIPHERING_STATUS of the CN domain
 - as indicated in the variable LATEST_CONFIGURED_CN_DOMAIN, if the variable LATEST_CONFIGURED_CN_DOMAIN has been initialised; or
 - as indicated in the IE "CN domain identity", if the variable LATEST_CONFIGURED_CN_DOMAIN is not initialised
 - if the IE "Ciphering mode command" has the value "stop", the UE shall:
 - stop ciphering and stop incrementing COUNT-C values for all UL and DL signalling radio bearers and also for UL and DL transparent RLC mode radio bearers, only at the new ciphering configuration that shall be applied as specified below;
 - set the IE "Status" in the variable CIPHERING_STATUS of the CN domain
 - as indicated in the variable LATEST_CONFIGURED_CN_DOMAIN, if the variable LATEST_CONFIGURED_CN_DOMAIN has been initialised; or
 - as indicated in the IE "CN domain identity", if the variable LATEST_CONFIGURED_CN_DOMAIN is not initialised
 - if the IE "Ciphering mode command" has the value "start/restart" or "stop", the new ciphering configuration shall be applied as follows:
 - store the (oldest currently used) ciphering configuration until activation times have elapsed for the new ciphering configuration to be applied on all signalling radio bearers and radio bearers;
 - if there are pending activation times set for ciphering by a previous procedure changing the ciphering configuration:
 - apply the ciphering configuration at this pending activation time as indicated in this procedure;
 - if the IE "Ciphering activation time for DPCH" is present in the IE "Ciphering mode info":
 - apply the new configuration at that time for radio bearers using RLC-TM. If the IE "Ciphering mode info" is present in a message reconfiguring RB, transport channel or physical channel, the indicated time in IE "Activation time for DPCH" corresponds to a CFN after that reconfiguration;
 - if the IE "Radio bearer downlink ciphering activation time info" is present in the IE "Ciphering mode info":

- apply the following procedure for each radio bearer using RLC-AM and RLC-UM indicated by the IE "RB identity":
- suspend data transmission on the radio bearer;
- select an "RLC send sequence number" at which (activation) time the new ciphering configuration shall be applied in uplink for that radio bearer according to the following:
 - for each radio bearer and signalling radio bearer that has no pending ciphering activation time as set by a previous procedure changing the security configuration:
 - set a suitable value that would ensure a minimised delay in the change to the latest security configuration;
 - for each radio bearer and signalling radio bearer that has a pending ciphering activation time as set by a previous procedure changing the security configuration:
 - set the same value as the pending ciphering activation time;
 - consider this activation time to be elapsed when the selected activation time (as above) is equal to the "RLC send sequence number";
- store the selected "RLC send sequence number" for that radio bearer in the entry for the radio bearer in the variable RB_UPLINK_CIPHERING_ACTIVATION_TIME_INFO;
- when the data transmission of that radio bearer is resumed:
 - switch to the new ciphering configuration according to the following:
 - use the old ciphering configuration for the transmitted and received RLC PDUs with RLC sequence numbers smaller than the corresponding RLC sequence numbers indicated in the IE "Radio bearer uplink ciphering activation time info" sent to UTRAN and in the received IE "Radio bearer downlink ciphering activation time info" received from UTRAN, respectively;
 - use the new ciphering configuration for the transmitted and received RLC PDUs with RLC sequence numbers greater than or equal to the corresponding RLC sequence numbers indicated in the IE "Radio bearer uplink ciphering activation time info" sent to UTRAN and in the received IE "Radio bearer downlink ciphering activation time info" received from UTRAN, respectively;
 - for a radio bearer using RLC-AM, when the RLC sequence number indicated in the IE "Radio bearer downlink ciphering activation time info" falls below the RLC receiving window and the RLC sequence number indicated in the IE "Radio bearer uplink ciphering activation time info" falls below the RLC transmission window, the UE may release the old ciphering configuration for that radio bearer;
 - if an RLC reset or re-establishment occurs before the activation time for the new ciphering configuration has been reached, ignore the activation time and apply the new ciphering configuration immediately after the RLC reset or RLC re-establishment.

If the IE "Ciphering mode info" is present and if the IE "Reconfiguration" in the variable CIPHERING_STATUS is set to TRUE, the UE shall:

- ignore this second attempt to change the ciphering configuration; and
- set the variable INCOMPATIBLE_SECURITY_RECONFIGURATION to TRUE.

If the IE "Ciphering mode info" is not present, the UE shall not change the ciphering configuration.

8.6.3.5 Integrity protection mode info

The IE "Integrity protection mode info" defines the new integrity protection configuration. At any given time, the UE needs to store at most two different integrity protection configurations for all signalling radio bearers, the old and newest integrity protection configurations, per CN domain. If the IE "Integrity protection mode info" is present and if the IE "Reconfiguration" in the variable INTEGRITY_PROTECTION_STATUS is set to FALSE, the UE shall check

the IE "Integrity protection mode command" as part of the IE "Integrity protection mode info", and perform the following. The UE shall:

- if the IE "Integrity protection mode command" has the value "Modify" and the IE "Status" in the variable INTEGRITY_PROTECTION_INFO has the value "Not Started":
 - ignore this attempt to change the integrity protection configuration; and
 - set the variable INVALID_CONFIGURATION to TRUE;
- else:
 - set the IE "Reconfiguration" in the variable INTEGRITY_PROTECTION_STATUS to TRUE;
 - if IE "Integrity protection mode command" has the value "start" and the IE "Status" in the variable INTEGRITY_PROTECTION_INFO has the value "Not started":
 - if the IE "Historical status" in the variable INTEGRITY_PROTECTION_INFO has the value "Never been active":
 - initialise the information for all signalling radio bearers in the variable INTEGRITY_PROTECTION_INFO according to the following:
 - initialise the 20 MSB of the "Uplink RRC HFN" and "Downlink RRC HFN" of COUNT-I for this signalling radio bearer with the START value included in the most recently transmitted IE "START list" for the CN domain:
 - as indicated in the variable LATEST_CONFIGURED_CN_DOMAIN, if the variable LATEST_CONFIGURED_CN_DOMAIN has been initialised; or
 - as indicated in the IE "CN domain identity", if the variable LATEST_CONFIGURED_CN_DOMAIN has not been initialised;
 - set the remaining LSB of the "Uplink RRC HFN" and "Downlink RRC HFN" to zero;
 - set the IE "Uplink RRC Message sequence number" to zero;
 - do not include the IE "Downlink RRC Message sequence number";
 - set the IE "Historical status" in the variable INTEGRITY_PROTECTION_INFO to the value "Has been active";
 - set the IE "Status" in the variable INTEGRITY_PROTECTION_INFO to the value "Started";
 - perform integrity protection on the received message as described in subclause 8.5.10.1;
 - use the algorithm (UIA [40]) indicated by the IE "Integrity protection algorithm" contained in the IE "Integrity protection mode info";
 - use the IE "Integrity protection initialisation number", contained in the IE "Integrity protection mode info" as the value of FRESH [40];
- if IE "Integrity protection mode command" has the value "start" and the IE "Status" in the variable INTEGRITY_PROTECTION_INFO has the value "Started":

NOTE: This case is used in SRNS relocation

- perform integrity protection on the received message as described in subclause 8.5.10.1;
- use the algorithm (UIA [40]) indicated by the IE "Integrity protection algorithm" contained in the IE "Integrity protection mode info";
- use the IE "Integrity protection initialisation number", contained in the IE "Integrity protection mode info" as the value of FRESH [40];
- if IE "Integrity protection mode command" has the value "modify" and the IE "Status" in the variable INTEGRITY_PROTECTION_INFO has the value "Started":

- store the (oldest currently used) integrity protection configuration until activation times have elapsed for the new integrity protection configuration to be applied on all signalling radio bearers;
- if there are pending activation times set for integrity protection by a previous procedure changing the integrity protection configuration:
 - apply the integrity protection configuration at this pending activation time as indicated in this procedure;
- start applying the new integrity protection configuration in the downlink at the RRC sequence number, for each signalling radio bearer n, indicated by the entry for signalling radio bearer n in the "RRC message sequence number list" in the IE "Downlink integrity protection activation info", included in the IE "Integrity protection mode info";
- perform integrity protection on the received message as described in subclause 8.5.10.1;
- if present, use the algorithm indicated by the IE "Integrity protection algorithm" (UIA [40]);
- set the content of the variable INTEGRITY_PROTECTION_ACTIVATION_INFO according to the following:
 - for each established signalling radio bearer, stored in the variable ESTABLISHED_RABS:
 - select a value of the RRC sequence number at which (activation) time the new integrity protection configuration shall be applied in uplink for that signalling radio bearer according to the following:
 - for each signalling radio bearer that has no pending activation time as set for integrity protection by a previous procedure changing the integrity protection configuration:
 - set a suitable value that would ensure a minimised delay in the change to the latest integrity protection configuration;
 - for signalling radio bearer that has a pending activation time as set for integrity protection by a previous procedure changing the integrity protection configuration:
 - set the same value as the pending activation time for integrity protection;
 - consider this activation time to be elapsed when the selected activation time (as above) is equal to the next RRC sequence number to be used;
 - for signalling radio bearer RB0:
 - set the value of the included RRC sequence number to greater than or equal to the current value of the RRC sequence number for signalling radio bearer RB0 in the variable INTEGRITY_PROTECTION_INFO, plus the value of the constant N302 plus one;
- let RB_m be the signalling radio bearer on which the message containing the IE "integrity protection mode info" was received;
- start applying the new integrity protection configuration in the uplink at the RRC sequence number, for each RB_n, except for signalling radio bearer RB_m, indicated by the entry for signalling radio bearer n in the "RRC message sequence number list" in the IE "Uplink integrity protection activation info", included in the variable INTEGRITY_PROTECTION_ACTIVATION_INFO;
- start applying the new integrity protection configuration in the uplink at the RRC sequence number for signalling radio bearer RB_m, as specified for the procedure initiating the integrity protection reconfiguration;

If the IE "Integrity protection mode info" is present and if the IE "Reconfiguration" in the variable INTEGRITY_PROTECTION_STATUS is set to TRUE, the UE shall:

- ignore this second attempt to change the integrity protection configuration; and
- set the variable INCOMPATIBLE_SECURITY_RECONFIGURATION to TRUE.

If the IE "Integrity protection mode info" is not present, the UE shall not change the integrity protection configuration.

8.6.3.6 Void

8.6.3.7 Void

8.6.3.8 Integrity check info

If the IE "Integrity check info" is present the UE shall:

- act as described in subclause 8.5.10.1.

8.6.3.9 New C-RNTI

If the IE "New C-RNTI" is included, the UE shall:

- store the value in the variable C_RNTI, replacing any old stored value;
- use that C-RNTI when using common transport channels of type RACH, FACH and CPCH in the current cell.

8.6.3.10 New U-RNTI

If the IE "New U-RNTI" is included in a received message, the UE shall:

- store the value in the variable U_RNTI, replacing any old stored value.

8.6.3.11 RRC transaction identifier

The IE "RRC transaction identifier" may be used, together with the message type, for identification of an invocation of a downlink procedure (transaction). The UE behaviour for accepting or rejecting transactions based on the message type and the IE "RRC transaction identifier" is specified below.

If the IE "RRC transaction identifier" is included in a received message, the UE shall perform the actions below. The UE shall:

If the received message is any of the messages:

- RADIO BEARER SETUP; or
- RADIO BEARER RECONFIGURATION; or
- RADIO BEARER RELEASE; or
- TRANSPORT CHANNEL RECONFIGURATION; or
- PHYSICAL CHANNEL RECONFIGURATION:

the UE shall:

- if the variable ORDERED_RECONFIGURATION is set to FALSE; and
- if the variable CELL_UPDATE_STARTED is set to FALSE; and
- if the received message does not contain a protocol error according to clause 9 and the variable PROTOCOL_ERROR_REJECT is set to FALSE:
 - accept the transaction; and
 - store the IE "Message type" and the IE "RRC transaction identifier" of the received message in the table "Accepted transactions" in the variable TRANSACTIONS;
- else:

- if the variable ORDERED_RECONFIGURATION is set to TRUE; or
- if the variable CELL_UPDATE_STARTED is set to TRUE; or
- if the table "Accepted transactions" in the variable TRANSACTIONS contains an entry with an IE "Message Type" set to ACTIVE SET UPDATE; or
- if the received message contains a protocol error according to clause 9 causing the variable PROTOCOL_ERROR_REJECT to be set to TRUE:
 - if the IE "RRC transaction identifier" of the received message is identical to the "RRC transaction identifier" stored for the same "Message Type" as the received message in the table "Accepted transactions" in the variable TRANSACTIONS:
 - ignore the transaction; and
 - continue with any ongoing processes and procedures as the message was not received;
 - and end the procedure;
 - else:
 - reject the transaction; and
 - if the IE "Message Type" of the received message is not present in the table "Rejected transactions" in the variable TRANSACTIONS:
 - store the IE "Message type" and the IE "RRC transaction identifier" of the received message in the table "Rejected transactions" in the variable TRANSACTIONS.

Else:

If the received message is any of the messages:

- RRC CONNECTION SETUP; or
- CELL UPDATE CONFIRM; or
- URA UPDATE CONFIRM; or
- UE CAPABILITY ENQUIRY:

the UE shall:

- if the IE "Message Type" of the received message is not present in the table "Accepted transactions" in the variable TRANSACTIONS:
 - if the received message does not contain a protocol error according to clause 9 and the variable PROTOCOL_ERROR_REJECT is set to FALSE:
 - accept the transaction; and
 - store the IE "Message type" and the IE "RRC transaction identifier" of the received message in the table "Accepted transactions" in the variable TRANSACTIONS;
 - else:
 - if the received message contains a protocol error according to clause 9 causing the variable PROTOCOL_ERROR_REJECT to be set to TRUE:
 - reject the transaction; and
 - if the IE "Message Type" of the received message is not present in the table "Rejected transactions" in the variable TRANSACTIONS:
 - store the IE "Message type" and the IE "RRC transaction identifier" of the received message in the table "Rejected transactions" in the variable TRANSACTIONS.

- else:
- if the IE "Message Type" of the received message is present in the table "Accepted transactions" in the variable TRANSACTIONS:
 - if the IE "RRC transaction identifier" of the received message is identical to the "RRC transaction identifier" stored for the "Message Type" in the table "Accepted transactions" in the variable TRANSACTIONS:
 - ignore the transaction; and
 - continue with any ongoing processes and procedures as the message was not received; and
 - end the procedure;
 - else:
 - if the IE "RRC transaction identifier" of the received message is different from the "RRC transaction identifier" stored for the "Message Type" in the table "Accepted transactions" in the variable TRANSACTIONS:
 - if the received message does not contain a protocol error according to clause 9 and the variable PROTOCOL_ERROR_REJECT is set to FALSE:
 - ignore the once accepted transaction and instead accept the new transaction; and
 - store the IE "Message type" and the IE "RRC transaction identifier" of the received message in the table "Accepted transactions" in the variable TRANSACTIONS, replacing the previous entry;

NOTE: The UE is expected to process the first RRC CONNECTION SETUP/CELL UPDATE CONFIRM/URA UPDATE CONFIRM message that it receives after transmitting an RRC CONNECTION REQUEST/CELL_UPDATE/URA_UPDATE message. If the UE receives further RRC CONNECTION SETUP/CELL UPDATE CONFIRM/URA UPDATE CONFIRM messages without having transmitted another RRC CONNECTION REQUEST/CELL_UPDATE/URA_UPDATE message, the UE is not required to process these messages.

- else:
- if the received message contains a protocol error according to clause 9 causing the variable PROTOCOL_ERROR_REJECT to be set to TRUE:
 - reject the transaction; and
 - if the IE "Message Type" of the received message is not present in the table "Rejected transactions" in the variable TRANSACTIONS:
 - store the IE "Message type" and the IE "RRC transaction identifier" of the received message in the table "Rejected transactions" in the variable TRANSACTIONS.

Else:

If the received message is any other message, the UE shall:

- if the IE "Message Type" of the received message is not present in the table "Accepted transactions" in the variable TRANSACTIONS:
 - if the received message does not contain a protocol error according to clause 9 and the variable PROTOCOL_ERROR_REJECT is set to FALSE:
 - accept the transaction; and
 - store the IE "Message type" and the IE "RRC transaction identifier" of the received message in the table "Accepted transactions" in the variable TRANSACTIONS;
 - else:
 - if the received message contains a protocol error according to clause 9 causing the variable PROTOCOL_ERROR_REJECT to be set to TRUE:

- reject the transaction; and
- store the IE "Message type" and the IE "RRC transaction identifier" of the received message in the table "Rejected transactions" in the variable TRANSACTIONS.
- else:
- if the IE "Message Type" of the received message is present in the table "Accepted transactions" in the variable TRANSACTIONS:
 - if the IE "RRC transaction identifier" of the received message is identical to the "RRC transaction identifier" stored in any entry for the "Message Type" in the table "Accepted transactions" in the variable TRANSACTIONS:
 - ignore the transaction; and
 - continue with any ongoing processes and procedures as the message was not received; and
 - end the procedure;
 - else:
 - if the IE "RRC transaction identifier" of the received message is different from the "RRC transaction identifier" stored in all entries for the "Message Type" in the table "Accepted transactions" in the variable TRANSACTIONS:
 - if the received message does not contain a protocol error according to clause 9 and the variable PROTOCOL_ERROR_REJECT is set to FALSE:
 - accept the additional transaction; and
 - store the IE "Message type" and the IE "RRC transaction identifier" of the received message in the table "Accepted transactions" in the variable TRANSACTIONS, in addition to the already existing entries;
 - else:
 - if the received message contains a protocol error according to clause 9 causing the variable PROTOCOL_ERROR_REJECT to be set to TRUE:
 - reject the transaction; and
 - store the IE "Message type" and the IE "RRC transaction identifier" of the received message in the table "Rejected transactions" in the variable TRANSACTIONS.

8.6.3.12 Capability Update Requirement

If the IE "Capability Update Requirement" is included the UE shall:

- if the IE "UE radio access FDD capability update requirement" has the value TRUE:
 - if the UE supports FDD mode:
 - store its UTRA FDD capabilities and its UTRA capabilities common to FDD and TDD in the IE "UE radio access capability" and the IE "UE radio access capability extension" in variable UE_CAPABILITY_REQUESTED as specified below:
 - if the UE supports multiple UTRA FDD Frequency Bands; or
 - if the UE supports a single UTRA FDD Frequency Band different from 2100 MHz:
 - store the IE "UE radio access capability", excluding IEs "RF capability FDD" and "Measurement capability";

- store the IE "UE radio access capability extension", including the IEs "RF capability FDD extension" and the "Measurement capability extension" associated with each supported UTRA FDD frequency band indicated in the IE "Frequency band";
- else:
 - store the IE "UE radio access capability", including the IEs "RF capability FDD" and "Measurement capability" associated with the 2100 MHz UTRA FDD frequency band;
- if the IE "UE radio access 3.84 Mcps TDD capability update requirement" has the value TRUE:
 - if the UE supports 3.84 Mcps TDD mode:
 - store its UTRAN-specific 3.84 Mcps TDD capabilities and its UTRAN-specific capabilities common to FDD and TDD in the variable UE_CAPABILITY_REQUESTED;
- if the IE "UE radio access 1.28 Mcps TDD capability update requirement" has the value TRUE:
 - if the UE supports 1.28 Mcps TDD mode:
 - store its UTRAN-specific 1.28 Mcps TDD capabilities and its UTRAN-specific capabilities common to FDD and TDD in the variable UE_CAPABILITY_REQUESTED;
- if the IE "System specific capability update requirement list" is present:
 - for each of the RAT requested in the IE "UE system specific capability"
 - if the UE supports the listed RAT:
 - include its inter-RAT radio access capabilities for the listed RAT in the IE "UE system specific capability" from the variable UE_CAPABILITY_REQUESTED.

If the IE " Capability update requirement " is not present, the UE shall:

- assume the default values as specified in subclause 10.3.3.2 and act in accordance with the above.

8.6.4 Radio bearer information elements

8.6.4.1 Signalling RB information to setup list

If the IE "Signalling RB information to setup list" is included the UE shall:

- use the same START value to initialise the COUNT-C and COUNT-I variables for all the signalling radio bearers in the list;
- for each occurrence of the IE "Signalling RB information to setup":
 - use the value of the IE "RB identity" as the identity of the signalling radio bearer to setup;
 - if the variable LATEST_CONFIGURED_CN_DOMAIN has been initialised and the value "STATUS" of the variable "CIPHERING_STATUS" of the CN domain stored in this variable is "Started":
 - if the IE "Uplink RLC mode" or the IE "Downlink RLC mode" in the IE "RLC info" is set to "AM RLC" or "UM RLC":
 - initialise the 20 MSB of the hyper frame number component of COUNT-C for this signalling radio bearer with the START value for the CN domain as indicated in the variable "LATEST_CONFIGURED_CN_DOMAIN";
 - set the remaining LSB of the hyper frame number component of COUNT-C for this signalling radio bearer to zero;
 - if the IE "Uplink RLC mode" and the IE "Downlink RLC mode" in the IE "RLC info" is set to "TM RLC":

- if no other transparent mode RLC radio bearers or signalling radio bearers in the variable "ESTABLISHED_RABS" exist:
 - initialise the 20 MSB of the hyper frame number component of COUNT-C for this signalling radio bearer with the START value for the CN domain as indicated in the variable LATEST_CONFIGURED_CN_DOMAIN;
 - set the remaining LSB of the hyper frame number component of COUNT-C for this signalling radio bearer to zero;
- if at least one transparent mode RLC radio bearers or signalling radio bearers in the variable "ESTABLISHED_RABS" exist:
 - use, for this signalling radio bearer, the COUNT-C for transparent mode radio bearers and signalling radio bearers that is common (refer to subclause 8.5.8), for the CN domain as indicated in the variable LATEST_CONFIGURED_CN_DOMAIN;
- if the variable LATEST_CONFIGURED_CN_DOMAIN has been initialised and the value "Status" of the variable "INTEGRITY_PROTECTION_INFO" of the CN domain stored in this variable is "Started":
 - initialise the 20 MSB of the hyper frame number component of COUNT-I for this signalling radio bearer with the START value for the CN domain as indicated in the variable LATEST_CONFIGURED_CN_DOMAIN;
 - set the remaining LSB of the hyper frame number component of COUNT-I for this signalling radio bearer to zero;
- perform the actions for the IE "RLC info" as specified in subclause 8.6.4.9, applied for that signalling radio bearer;
- perform the actions for the IE "RB mapping info" as specified in subclause 8.6.4.8, applied for that signalling radio bearer;
- apply a default value of the IE "RB identity" equal to 1 for the first IE "Signalling RB information to setup"; and
- increase the default value by 1 for each occurrence.

8.6.4.2 RAB information for setup

If the IE "RAB information for setup" is included, the procedure is used to establish radio bearers belonging to a radio access bearer, and the UE shall:

- if several IEs "RAB information for setup" are included and the included IEs "CN domain identity" in the IE "RAB info" does not all have the same value:
 - set the variable INVALID_CONFIGURATION to TRUE;
- if the radio access bearer identified with the IE "RAB info" does not exist in the variable ESTABLISHED_RABS:
 - create a new entry for the radio access bearer in the variable ESTABLISHED_RABS;
 - store the content of the IE "RAB info" in the entry for the radio access bearer in the variable ESTABLISHED_RABS;
 - indicate the establishment of the radio access bearer to the upper layer entity using the IE "CN domain identity", forwarding the content of the IE "RAB identity";
 - calculate the START value only once during this procedure (the same START value shall be used on all new radio bearers created for this radio access bearer) according to subclause 8.5.9 for the CN domain as indicated in the IE "CN domain identity" in the IE "RAB info" part of the IE "RAB information to setup";
 - store the calculated START value in the variable START_VALUE_TO_TRANSMIT;
- for each radio bearer in the IE "RB information to setup":

- if the radio bearer identified with the IE "RB identity" does not exist in the variable ESTABLISHED_RABS for another radio access bearer than the one identified with the IE "RAB info":
 - perform the actions specified in subclause 8.6.4.3;
 - store information about the new radio bearer in the entry for the radio access bearer identified by "RAB info" in the variable ESTABLISHED_RABS;
- if the radio bearer identified with the IE "RB identity" does not exist in the variable ESTABLISHED_RABS for the radio access bearer identified with the IE "RAB info":
 - create a new RAB subflow for the radio access bearer;
 - number the RAB subflow in ascending order, assigning the smallest number to the RAB subflow corresponding to the first radio bearer in the list;
 - if the IE "CN domain identity" in the IE "RAB info" is set to "PS domain" and the number of RAB subflows for the radio access bearer is greater than 1:
 - set the variable INVALID_CONFIGURATION to TRUE;
- if the radio bearer identified with the IE "RB identity" already exists in the variable ESTABLISHED_RABS for another radio access bearer than the one identified with the IE "RAB info":
 - set the variable INVALID_CONFIGURATION to TRUE.

8.6.4.2a RAB information to reconfigure

If the IE "RAB information to reconfigure" is included then the UE shall:

- if the entry for the radio access bearer identified by the IE "CN domain identity" together with the IE "RAB Identity" in the variable ESTABLISHED_RABS already exists:
 - perform the action for the IE "NAS Synchronization Indicator", according to subclause 8.6.4.12;
- else:
 - set the variable INVALID_CONFIGURATION to TRUE.

8.6.4.3 RB information to setup

If the IE "RB information to setup" is included, the UE shall apply the following actions on the radio bearer identified with the value of the IE "RB identity". The UE shall:

- use the same START value to initialise the hyper frame number components of COUNT-C and COUNT-I variables for all the new UL and DL radio bearers to setup;
- perform the actions for the IE "PDCP info", if present, according to subclause 8.6.4.10, applied for the radio bearer;
- perform the actions for the IE "RLC info", according to subclause 8.6.4.9, applied for the radio bearer;
- perform the actions for the IE "RB mapping info", according to subclause 8.6.4.8, applied for the radio bearer;
- if the IE "Downlink RLC mode" in the IE "RLC info" is set to "TM RLC":
 - configure delivery of erroneous SDUs in lower layers according to indication from upper layer [5].
- if the IE "Uplink RLC mode" or the IE "Downlink RLC mode" in the IE "RLC info" is set to "AM RLC" or "UM RLC":
 - initialise the 20 MSB of the hyper frame number component of COUNT-C for this radio bearer with the START value for the CN domain as indicated in the IE "CN domain identity" in the IE "RAB info" part of the IE "RAB information for setup";
 - set the remaining LSB of the hyper frame number component of COUNT-C for this radio bearer to zero;

- if the IE "Uplink RLC mode" and the IE "Downlink RLC mode" in the IE "RLC info" is set to "TM RLC":
 - if no other transparent mode RLC radio bearers and signalling radio bearers exist in the variable ESTABLISHED_RABS:
 - initialise the 20 MSB of the hyper frame number component of COUNT-C for this radio bearer with the START value for the CN domain as indicated in the IE "CN domain identity" in the IE "RAB info" part of the IE "RAB information for setup";
 - set the remaining LSB of the hyper frame number component of COUNT-C for this radio bearer to zero;
 - if at least one transparent mode RLC radio bearers or signalling radio bearers exist in the variable ESTABLISHED_RABS:
 - set the MAC-d HFN component of the COUNT-C for this radio bearer with the MAC-d HFN that is common (refer to subclause 8.5.8) for the CN domain as indicated in the IE "CN domain identity" in the IE "RAB info" part of the IE "RAB information for setup";
- if the IE "Status" in the variable CIPHERING_STATUS of the CN domain as indicated in the IE "CN domain identity" in the IE "RAB info" in the variable ESTABLISHED_RABS is set to "Started":
 - start to perform ciphering on the radio bearer in lower layers, using the value of the IE "RB identity" minus one as the value of BEARER in the ciphering algorithm.

NOTE: UTRAN should not use the IE "RB information to setup" to setup radio bearers with RB identity in the range 1-4.

8.6.4.4 RB information to be affected

If the IE "RB information to be affected" is included, the UE shall apply the following actions on the radio bearer identified with the value of the IE "RB identity". The UE shall:

- perform the actions for the IE "RB mapping info", according to subclause 8.6.4.8, applied for the radio bearer.

8.6.4.5 RB information to reconfigure

If the IE "RB information to reconfigure" is included, the UE shall apply the following actions on the radio bearer identified with the value of the IE "RB identity". The UE shall:

- perform the actions for the IE "PDCP info", if present, according to subclause 8.6.4.10, applied for the radio bearer;
- perform the actions for the IE "RLC info", according to subclause 8.6.4.9, applied for the radio bearer;
- perform the actions for the IE "RB mapping info", according to subclause 8.6.4.8, applied for the radio bearer;
- if the IE "Downlink RLC mode" in the IE "RLC info" is set to "TM RLC":
 - configure delivery of erroneous SDUs in lower layers according to indication from upper layer [5].
- if the IE "PDCP SN info" is included:
 - perform the actions as specified in subclause 8.6.4.11 applied for the radio bearer;
- if the IE "RB stop/continue" is included; and
 - if the "RB identity" has a value greater than 2; and
 - if the value of the IE "RB stop/continue" is "stop":
 - configure the RLC entity for the radio bearer to stop;
 - set the IE "RB started" in the variable ESTABLISHED_RABS to "stopped" for that radio bearer;
 - if the value of the IE "RB stop/continue" is "continue":

- configure the RLC entity for the radio bearer to continue;
- set the IE "RB started" in the variable ESTABLISHED_RABS to "started" for that radio bearer;
- if the IE "RB identity" is set to a value less than 2:
 - set the variable INVALID_CONFIGURATION to TRUE.

8.6.4.6 RB information to release

If the IE "RB information to release" is included, the UE shall apply the following actions on the radio bearer identified with the value of the IE "RB identity". The UE shall:

- release the PDCP and RLC entities dedicated for that radio bearer;
- if the information about the radio bearer is stored in the variable ESTABLISHED_RABS:
 - indicate release of the RAB subflow associated with the radio bearer to upper layers;
 - delete the information about the radio bearer from the variable ESTABLISHED_RABS;
- when all radio bearers belonging to the same radio access bearer have been released:
 - indicate release of the radio access bearer to upper layers providing the "CN domain identity" together with the "RAB identity" stored in the variable ESTABLISHED_RABS;
 - delete all information about the radio access bearer from the variable ESTABLISHED_RABS.

8.6.4.7 RB with PDCP information

If the IE "RB with PDCP information" is included, the UE shall apply the following actions on the radio bearer identified with the value of the IE "RB identity". The UE shall:

- for the IE "PDCP SN info":
 - perform the actions as specified in subclause 8.6.4.11.

8.6.4.8 RB mapping info

If the IE "RB mapping info" is included, the UE shall:

- for each multiplexing option of the RB:
 - if a transport channel that would not exist as a result of the message (i.e. removed in the same message in IE "Deleted DL TrCH information" and IE "Deleted UL TrCH information") is referred to:
 - set the variable INVALID_CONFIGURATION to TRUE;
 - if a multiplexing option that maps a logical channel corresponding to a TM-RLC entity onto RACH, CPCH, FACH or DSCH is included:
 - set the variable INVALID_CONFIGURATION to TRUE;
 - if the multiplexing option realises the radio bearer on the uplink (resp. on the downlink) using two logical channels with different values of the IE "Uplink transport channel type" (resp. of the IE "Downlink transport channel type"):
 - set the variable INVALID_CONFIGURATION to TRUE;
 - if that RB is using TM and the IE "Segmentation indication" is set to TRUE and, based on the multiplexing configuration resulting from this message, the logical channel corresponding to it is mapped onto the same transport channel as another logical channel:
 - set the variable INVALID_CONFIGURATION to TRUE;

- if the transport channel considered in that multiplexing option is different from RACH and if that RB is using AM and the set of RLC sizes applicable to the logical channel transferring data PDUs has more than one element:
 - set the variable INVALID_CONFIGURATION to TRUE;
- if that RB is using UM or TM and the multiplexing option realises it using two logical channels:
 - set the variable INVALID_CONFIGURATION to TRUE;
- for each logical channel in that multiplexing option:
 - if the value of the IE "RLC size list" is set to "Explicit list":
 - if a "Transport format set" for the transport channel this logical channel is mapped on in this multiplexing option is included in the same message, and the value (index) of any IE "RLC size index" in the IE "RLC size index list" does not correspond to an "RLC size" in the IE transport format set of that transport channel given in the message; or
 - if the transport channel this logical channel is mapped on in this multiplexing option is different from RACH, and if a "Transport format set" for that transport channel is not included in the same message, and the value (index) of any IE "RLC size index" in the IE "RLC size index list" does not correspond to an "RLC size" in the stored transport format set of that transport channel; or
 - if a "Transport format set" for the transport channel this logical channel is mapped on in this multiplexing option is included in the same message, and the value of any IE "Logical channel list" in the transport format set is not set to "Configured"; or
 - if a "Transport format set" for the transport channel this logical channel is mapped on in this multiplexing option is not included in the same message, and the value of any IE "Logical channel list" in the stored transport format set of that transport channel is not set to "Configured":
 - set the variable INVALID_CONFIGURATION to TRUE;
 - if the value of the IE "RLC size list" is set to "All":
 - if a "Transport format set" for the transport channel this logical channel is mapped on in this multiplexing option is included in the same message, and the value of any IE "Logical channel list" in the transport format set is not set to "Configured"; or
 - if a "Transport format set" for the transport channel this logical channel is mapped on in this multiplexing option is not included in the same message, and the value of any IE "Logical channel list" in the stored transport format set of that transport channel is not set to "Configured":
 - set the variable INVALID_CONFIGURATION to TRUE;
 - if the value of the IE "RLC size list" is set to "Configured":
 - if a "Transport format set" for the transport channel this logical channel is mapped on in this multiplexing option is included in the same message, and for none of the RLC sizes defined for that transport channel in the "Transport format set", the "Logical Channel List" is set to "All" or given as an "Explicit List" which contains this logical channel; or
 - if a "Transport format set" for the transport channel this logical channel is mapped on in this multiplexing option is not included in the same message, and for none of the RLC sizes defined in the transport format set stored for that transport channel, the "Logical Channel List" is set to "All" or given as an "Explicit List" which contains this logical channel:
 - set the variable INVALID_CONFIGURATION to TRUE;
- if, as a result of the message this IE is included in, several radio bearers can be mapped onto the same transport channel, and the IE "Logical Channel Identity" was not included in the RB mapping info of any of those radio bearers for a multiplexing option on that transport channel or the same "Logical Channel Identity" was used more than once in the RB mapping info of those radio bearers for the multiplexing options on that transport channel:

- set the variable INVALID_CONFIGURATION to TRUE;
- delete all previously stored multiplexing options for that radio bearer;
- store each new multiplexing option for that radio bearer;
- select and configure the multiplexing options applicable for the transport channels to be used;
- if the IE "Uplink transport channel type" is set to the value "RACH":
 - in FDD:
 - refer the IE "RLC size index" to the RACH Transport Format Set of the first PRACH received in the IE "PRACH system information list" received in SIB5 or SIB6;
 - in TDD:
 - use the first Transport Format of the PRACH of the IE "PRACH system information list" at the position equal to the value in the IE "RLC size index";
- determine the sets of RLC sizes that apply to the logical channels used by that RB, based on the IEs "RLC size list" and/or the IEs "Logical Channel List" included in the applicable "Transport format set" (either the ones received in the same message or the ones stored if none were received); and
- in case the selected multiplexing option is a multiplexing option on RACH:
 - ignore the RLC size indexes that do not correspond to any RLC size within the Transport Format Set stored for RACH;
- if RACH is the transport channel to be used on the uplink, if that RB has a multiplexing option on RACH and if it is using AM:
 - apply the largest size amongst the ones derived according to the previous bullet for the RLC size (or RLC sizes in case the RB is realised using two logical channels) for the corresponding RLC entity;
- if that RB is using AM and the RLC size applicable to the logical channel transporting data PDUs is different from the one derived from the previously stored configuration:
 - re-establish the corresponding RLC entity;
 - configure the corresponding RLC entity with the new RLC size;
- if the IE "Status" in the variable CIPHERING_STATUS of the CN domain as indicated in the IE "CN domain identity" in the IE "RAB info" in the variable ESTABLISHED_RABS is set to "Started":
 - if this IE was included in system information:
 - set the HFN values for the corresponding RLC entity equal to the value of the IE "START" for the CN domain stored in the variable LATEST_CONFIGURED_CN_DOMAIN that will be included in the CELL UPDATE message that will be sent before the next transmission;
 - if this IE was included in CELL UPDATE CONFIRM:
 - set the HFN values for the corresponding RLC entity equal to the value of the IE "START" included in the latest transmitted CELL UPDATE message for the CN domain stored in the variable LATEST_CONFIGURED_CN_DOMAIN;
 - if this IE was included in a reconfiguration message:
 - set the HFN values for the corresponding RLC entity equal to the value of the IE "START" that will be included in the reconfiguration complete message for the CN domain stored in the variable LATEST_CONFIGURED_CN_DOMAIN;
- if that RB is using UM:
 - indicate the largest applicable RLC size to the corresponding RLC entity;

- configure MAC multiplexing according to the selected multiplexing option (MAC multiplexing shall only be configured for a logical channel if the transport channel it is mapped on according to the selected multiplexing option is the same as the transport channel another logical channel is mapped on according to the multiplexing option selected for it);
- configure the MAC with the logical channel priorities according to selected multiplexing option;
- configure the MAC with the set of applicable RLC Sizes for each of the logical channels used for that RB;
- if there is no multiplexing option applicable for the transport channels to be used:
 - set the variable INVALID_CONFIGURATION to TRUE;
- if there is more than one multiplexing option applicable for the transport channels to be used:
 - set the variable INVALID_CONFIGURATION to TRUE.

In case IE "RB mapping info" includes IE "Downlink RLC logical channel info" but IE "Number of downlink RLC logical channels" is absent, the parameter values are exactly the same as for the corresponding UL logical channels. In case two multiplexing options are specified for the UL, the first options shall be used as default for the DL. As regards the IE "Channel type", the following rule should be applied to derive the DL channel type from the UL channel included in the IE:

Channel used in UL	DL channel type implied by "same as"
DCH	DCH
RACH	FACH
CPCH	FACH
USCH	DSCH

8.6.4.9 RLC Info

If the IE "RLC Info" is included, the UE shall:

- configure the transmitting and receiving RLC entities in the UE for that radio bearer accordingly.

If the IE "Transmission RLC discard" is not included for UM RLC or TM RLC, RLC discard procedure shall not be used for that radio bearer.

8.6.4.10 PDCP Info

For RFC 3095:

- the chosen MAX_CID shall not be greater than the value "Maximum number of ROHC context sessions" as indicated in the IE "PDCP Capability";
- the configuration for the PACKET_SIZES_ALLOWED is FFS.

If IE "PDCP info" is included, the UE shall:

- if the radio bearer is connected to a CS domain radio access bearer:
 - set the variable INVALID_CONFIGURATION to TRUE;
- if the IE "PDCP PDU header" is set to the value "absent":
 - if the IE "Support for lossless SRNS relocation" is true:
 - set the variable INVALID_CONFIGURATION to TRUE;
- if the IE "PDCP PDU header" is set to the value "present":
 - if the IE "Support for lossless SRNS relocation" is false:
 - if the IE "Header compression information" is absent:

- set the variable INVALID_CONFIGURATION to TRUE;
- configure the PDCP entity for that radio bearer accordingly;
- configure the RLC entity for that radio bearer according to the value of the IE "Support for lossless SRNS relocation".

8.6.4.11 PDCP SN Info

If the IE "PDCP SN Info" is included, the UE shall:

- transfer the sequence number to the PDCP entity for the radio bearer;
- configure the RLC entity for the radio bearer to stop;
- include the current PDCP receive sequence number and the radio bearer identity for the radio bearer in the variable PDCP_SN_INFO.

8.6.4.12 NAS Synchronisation Indicator

If the IE "NAS Synchronisation Indicator" is present in a message, the UE shall:

- forward the content to upper layers along with the IE "CN domain identity" of the associated RAB stored in the variable ESTABLISHED_RABS at the CFN indicated in the IE "Activation time" in order to synchronise actions in NAS and AS.

8.6.5 Transport channel information elements

8.6.5.1 Transport Format Set

If the IE "Transport format set" is included, the UE shall:

- if the transport format set is a RACH TFS received in System Information Block type 5 or 6, and CHOICE "Logical Channel List" has the value "Explicit List":
 - ignore that System Information Block;
- if the transport format set for a downlink transport channel is received in a System Information Block, and CHOICE "Logical Channel List" has a value different from 'ALL':
 - ignore that System Information Block;
- if the transport format set for a downlink transport channel is received in a message on a DCCH, and CHOICE "Logical Channel List" has a value different from 'ALL':
 - keep the transport format set if this exists for that transport channel;
 - set the variable INVALID_CONFIGURATION to TRUE;
- if the value of any IE "RB identity" (and "Logical Channel" for RBs using two UL logical channels) in the IE "Logical channel list" does not correspond to a logical channel indicated to be mapped onto this transport channel in any RB multiplexing option (either included in the same message or previously stored and not changed by this message); or
- if the "Logical Channel List" for any of the RLC sizes defined for that transport channel is set to "Configured" while it is set to "All" or given as an "Explicit List" for any other RLC size; or
- if the "Logical Channel List" for any of the RLC sizes defined for that transport channel is set to "All" and for any logical channel mapped to this transport channel, the value of the "RLC size list" (either provided in the IE "RB mapping info" if included in the same message, or stored) is not set to "Configured"; or
- if the "Logical Channel List" for any of the RLC sizes defined for that transport channel is given as an "Explicit List" that contains a logical channel for which the value of the "RLC size list" (either provided in the IE "RB mapping info" if included in the same message, or stored) is not set to "Configured"; or

- if the "Logical Channel List" for all the RLC sizes defined for that transport channel are given as "Explicit List" and if one of the logical channels mapped onto this transport channel is not included in any of those lists; or
- if the "Logical Channel List" for the RLC sizes defined for that transport channel is set to "Configured" and for any logical channel mapped onto that transport channel, the value of the "RLC size list" (either provided in the IE "RB mapping info" if included in the same message, or stored) is also set to "Configured"; or
- if the IE "Transport Format Set" was not received within the IE "PRACH system information list" and if the "Logical Channel List" for the RLC sizes defined for that transport channel is set to "Configured" and for any logical channel mapped onto that transport channel, the "RLC size list" (either provided in the IE "RB mapping info" if included in the same message, or stored) is given as an "Explicit List" that includes an "RLC size index" that does not correspond to any RLC size in this "Transport Format Set":
 - keep the transport format set if this exists for that transport channel;
 - set the variable INVALID_CONFIGURATION to TRUE;
- if the total number of configured transport formats for the transport channel exceeds maxTF:
 - keep the transport format set if this exists for that transport channel;
 - set the variable INVALID_CONFIGURATION to TRUE;
- if the IE "Transport format set" is considered as valid according to the rules above:
 - remove a previously stored transport format set if this exists for that transport channel;
 - store the transport format set for that transport channel;
 - consider the first instance of the parameter *Number of TBs and TTI List* within the *Dynamic transport format information* to correspond to transport format 0 for this transport channel, the second to transport format 1 and so on;
 - if the IE "Transport format Set" has the choice "Transport channel type" set to "Dedicated transport channel":
 - calculate the transport block size for all transport formats in the TFS using the following

$$\text{TB size} = \text{RLC size} + \text{MAC header size},$$
 where:
 - MAC header size is calculated according to [15] if MAC multiplexing is used. Otherwise it is 0 bits;
 - 'RLC size' reflects the RLC PDU size.
 - if the IE "Transport format Set" has the choice "Transport channel type" set to "Common transport channel":
 - calculate the transport block size for all transport formats in the TFS using the following:

$$\text{TB size} = \text{RLC size}$$
 - if the IE "Number of Transport blocks" $\neq 0$ and IE "RLC size" = 0, no RLC PDU data exists but only parity bits exist for that transport format;
 - if the IE "Number of Transport blocks" = 0, neither RLC PDU neither data nor parity bits exist for that transport format;
 - configure the MAC with the new transport format set (with computed transport block sizes) for that transport channel;
 - if the RB multiplexing option for a RB mapped onto that transport channel (based on the stored RB multiplexing option) is not modified by this message:
 - determine the sets of RLC sizes that apply to the logical channels used by that RB, based on the IE "Logical Channel List" and/or the IE "RLC Size List" from the previously stored RB multiplexing option;
 - if the IE "Transport Format Set" was received within the IE "PRACH system information list":

- ignore the RLC size indexes in the stored RB multiplexing option that do not correspond to any RLC size in the received Transport Format Set.
- if the IE "Transport Format Set" was received within the IE "PRACH system information list", if that RB is using AM and if RACH is the transport channel to be used on the uplink:
 - apply the largest size amongst the ones derived according to the previous bullet for the RLC size (or RLC sizes in case the RB is realised using two logical channels) for the corresponding RLC entity;
- if the IE "Transport Format Set" was not received within the IE "PRACH system information list", and if that RB is using AM and the set of RLC sizes applicable to the logical channel transferring data PDUs has more than one element:
 - set the variable INVALID_CONFIGURATION to true;
- if that RB is using AM and the RLC size applicable to the logical channel transporting data PDUs is different from the one derived from the previously stored configuration:
 - re-establish the corresponding RLC entity;
 - configure the corresponding RLC entity with the new RLC size;
 - if this IE was included in system information and if the IE "Status" in variable CIPHERING_STATUS of the CN domain as indicated in the IE "CN domain identity" in the IE "RAB info" in the variable ESTABLISHED_RABS is set to "Started":
 - set the HFN values for the corresponding RLC entity equal to the value of the IE "START" for the CN domain stored in the variable LATEST_CONFIGURED_CN_DOMAIN that will be included in the CELL UPDATE message that will be sent before the next transmission;
 - if this IE was included in CELL UPDATE CONFIRM and if the IE "Status" in the variable CIPHERING_STATUS of the CN domain as indicated in the IE "CN domain identity" in the IE "RAB info" in the variable ESTABLISHED_RABS is set to "Started":
 - set the HFN values for the corresponding RLC entity equal to the value of the IE "START" included in the latest transmitted CELL UPDATE message for the CN domain stored in the variable LATEST_CONFIGURED_CN_DOMAIN;
 - if this IE was included in a reconfiguration message and if the IE "Status" in the variable CIPHERING_STATUS of the CN domain as indicated in the IE "CN domain identity" in the IE "RAB info" in the variable ESTABLISHED_RABS is set to "Started":
 - set the HFN values for the corresponding RLC entity equal to the value of the IE "START" that will be included in the reconfiguration complete message for the CN domain stored in the variable LATEST_CONFIGURED_CN_DOMAIN;
 - if this IE was included in ACTIVE SET UPDATE and if the IE "Status" in the variable CIPHERING_STATUS of the CN domain as indicated in the IE "CN domain identity" in the IE "RAB info" in the variable ESTABLISHED_RABS is set to "Started":
 - set the HFN values for the corresponding RLC entity equal to the value of the IE "START" that will be included in the ACTIVE SET UPDATE COMPLETE message for the CN domain stored in the variable LATEST_CONFIGURED_CN_DOMAIN;
- if that RB is using UM:
 - indicate the largest applicable RLC size to the corresponding RLC entity;
 - configure MAC with the set of applicable RLC Sizes for each of the logical channels used for that RB.

For configuration restrictions on Blind Transport Format Detection, see [27].

8.6.5.2 Transport format combination set

If the IE "Transport format combination set" is included, the UE shall for that direction (uplink or downlink):

- store the new transport format combination set, or (if this exists) modify a previously stored transport format combination set according to IEs included in IE "Transport format combination set";
- start to respect those transport format combinations;
- if IE "Transport format combination subset" is received in this message:
 - perform the actions as specified in subsection 8.6.5.3;
- if IE "Transport format combination subset" is not received in this message:
 - clear the IE "Duration" in the variable TFC_SUBSET;
 - set both the IE "Current TFC subset" and the IE "Default TFC subset" in the variable TFC_SUBSET to the value indicating "full transport format combination set".

If the IE "Transport format combination set" is not included and if there is no addition, removal or reconfiguration of transport channels, the UE shall for that direction (uplink or downlink):

- use a previously stored transport format combination set if this exists.

If the IE "Transport format combination set" is not included; and

- if no transport format combination set is stored in the UE; or
- if transport channels are added or removed in the message; or
- if any transport channel is reconfigured in the message such that the size of the transport format set is changed:

the UE shall:

- set the variable INVALID_CONFIGURATION to TRUE.

In the uplink TFCS the UTRAN should include the following minimum set of TFCs:

- for each transport channel:
 - a TFC with one transport block for this transport channel and empty TFs (see [34]) for all the others;
- for each AM logical channel:
 - a TFC with a minimum size compatible TF for the corresponding transport channel and empty TFs for all other transport channels;
- for each TM logical channel and for each SDU size associated with it:
 - a TFC with a minimum size compatible TF for the corresponding transport channel and empty TFs for all other transport channels;
- an "empty" TFC (see [34]).

For TDD, the TFCS of a CCTrCH should include those of the above combinations, which include a TF with one transport block for a transport channel used in that CCTrCH, and the "empty" TFC should be included in the TFCS of every CCTrCH.

The UTRAN may decide not to include TFs and/or TFCs as specified above where they are not usable by a specific service.

For AM-RLC logical channels, the minimum size compatible TF includes one transport block with "Configured RLC Size" equal to the RLC PDU size. For non-segmented mode TM-RLC logical channels, the minimum size compatible TF includes one transport block with "Configured RLC Size" equal to the RLC SDU size considered. For segmented mode TM-RLC, the minimum size compatible TF is any TF such that the number of transport blocks multiplied by the "Configured RLC Size" is equal to the RLC SDU size considered.

NOTE: The "Configured RLC Size" is defined as the transport block size minus the MAC header size.

8.6.5.3 Transport format combination subset

If the IE "Transport format combination subset" ("TFC subset") is included, the UE shall:

- if the IE "Minimum allowed Transport format combination index" is included; and
 - if the value of the IE "Minimum allowed Transport format combination index" is greater than the highest TFCI value in the current transport format combination set:
 - consider the TFC subset to be incompatible with the current transport format combination set;
 - if the IE "Allowed transport format combination list" is included; and
 - if the value of any of the IEs "Allowed transport format combination" included in the IE "Allowed transport format combination list" does not match a TFCI value in the current transport format combination set:
 - consider the TFC subset to be incompatible with the current transport format combination set;
- if the IE "Non-allowed transport format combination list" is included; and
- if the value of any of the IEs "Non-allowed transport format combination" included in the IE "Non-allowed transport format combination list" does not match a TFCI value in the current transport format combination set:
 - consider the TFC subset to be incompatible with the current transport format combination set;
 - if the IE "Restricted TrCH information" is included:
 - if the value of any of the IEs "Uplink transport channel type" and "Restricted UL TrCH identity" included in the IE "Restricted TrCH information" do not correspond to any of the transport channels for which the current transport format combination set is valid:
 - consider the TFC subset to be incompatible with the current transport format combination set;
 - if the IE "Allowed TFIs" is included; and
 - if the value of each of the IEs "Allowed TFI" included in the IE "Allowed TFIs" corresponds to a transport format for that transport channel within the current transport format combination set:
 - allow all transport format combinations that include these transport formats for the transport channel;
 - restrict all other transport format combinations;
 - else
 - consider the TFC subset to be incompatible with the current transport format combination set;
 - if the IE "Allowed TFIs" is not included:
 - restrict all transport format combinations where the transport channel has a transport format of non-zero rate;
- if the UE considers the TFC subset to be incompatible with the current Transport format combination set according to the above:
- keep any previous restriction of the transport format combination set;
 - set the variable INVALID_CONFIGURATION to TRUE;
- if the UE does not consider the TFC subset to be incompatible with the current Transport format combination set according to the above:
- restrict the transport format combination set in the uplink to the value of the IE "Transport format combination subset" (in case of TDD for the uplink CCTrCH specified by the IE "TFCS Id");
 - clear the IE "Duration" in the variable TFC_SUBSET;
- if the transport format combination subset indicates the "full transport format combination set":

- any restriction on transport format combination set is released and the UE may use the full transport format combination set.

8.6.5.4 DCH quality target

At physical channel establishment, the UE sets an initial downlink target SIR value based on the received IEs "DCH quality target". The IE "DCH quality target" for a given DCH shall be used by the UE to set the target SIR for the downlink power control in case BLER measurement is possible for this DCH, i.e. CRC exists in all transport formats in downlink TFS.

8.6.5.5 Added or Reconfigured UL TrCH information

If the IE "Added or Reconfigured UL TrCH information" is included then the UE shall:

- for the transport channel identified by the IE "UL Transport Channel Identity":
 - perform the actions for the IE "Transport Format Set" as specified in subclause 8.6.5.1.

8.6.5.6 Added or Reconfigured DL TrCH information

If the IE "Added or Reconfigured DL TrCH information" is included then for the transport channel identified by the IE "DL Transport Channel Identity" the UE shall:

- if the choice "DL parameters" is set to 'independent':
 - perform the actions for the IE "Transport Format Set" as specified in subclause 8.6.5.1;
- if the choice "DL parameters" is set to 'same as uplink':
 - if the IE "UL Transport Channel Identity" indicates an existing or a new UL Transport Channel:
 - store as transport format for this transport channel the transport format associated with the transport channel identified by the IE "UL Transport Channel Identity";
 - else:
 - set the variable INVALID_CONFIGURATION to TRUE;
- if the IE "DCH quality target" is included:
 - perform the actions specified in subclause 8.6.5.4;
- if the IE "Transparent mode signalling info" is included:
 - consider the messages received on this transport channel to have the message type according to the value of the IE "Type of message";
 - if the choice "Transparent signalling mode" is set to "Mode 1":
 - consider the messages received on this transport channel affect all established DCHs;
 - if the choice "Transparent signalling mode" is set to "Mode 2":
 - consider the messages received on this transport channel affect the DCHs identified with the IE "UL controlled transport channels" in the IE "Controlled transport channels list";
 - if any of the DCHs identified with the IE "UL controlled transport channels" in the IE "Controlled transport channels list" does not exist:
 - set the variable INVALID_CONFIGURATION to TRUE.

8.6.5.7 Deleted UL TrCH information

If the IE "Deleted UL TrCH information" is included the UE shall:

- delete any information about the transport channel identified by the IE "UL TrCH identity".

8.6.5.8 Deleted DL TrCH information

If the IE "Deleted DL TrCH information" is included the UE shall:

- delete any information about the transport channel identified by the IE "DL TrCH identity".

8.6.5.9 UL Transport channel information common for all transport channels

If the IE "UL Transport channel information common for all transport channels" is included the UE shall:

- perform actions for the IE "TFC subset" as specified in subclause 8.6.5.3;
- if the IE "PRACH TFCS" is included:
 - set the variable INVALID_CONFIGURATION to TRUE;
- if the IE has the choice "mode" set to FDD:
 - perform actions for the IE "UL DCH TFCS" as specified in subclause 8.6.5.2;
- if the IE has the choice "mode" set to TDD:
 - if the IE "Individual UL CCTrCH information" is included:
 - for each TFCS identified by IE "UL TFCS id":
 - perform actions for the IE "UL TFCS" as specified in subclause 8.6.5.2.

8.6.5.10 DL Transport channel information common for all transport channels

If the IE "DL Transport channel information common for all transport channels" is included the UE shall:

- if the IE "SCCPCH TFCS" is included:
 - set the variable INVALID_CONFIGURATION to TRUE;
- if the IE choice "mode" is set to FDD:
 - if the choice "DL parameters" is set to 'Independent':
 - if the IE "DL DCH TFCS" is included:
 - if the IE "SCCPCH TFCS" is included and the state the UE enters after handling the received information is other than CELL_DCH:
 - ignore the received IE "DL DCH TFCS";

NOTE: the IE "DL Transport channel information common for all transport channels" always includes a DL DCH TFCS configuration, either by including the IE "DL DCH TFCS " or by specifying that the TFCS is the same as in UL. If UTRAN does not require the reconfiguration of the concerned parameters, UTRAN may replace one TFC with the value that is already assigned for this IE.

- else:
 - perform actions as specified in subclause 8.6.5.2;
- if the IE choice "mode" is set to TDD:
 - if the IE "Individual DL CCTrCH information" is included:
 - for each DL TFCS identified by the IE "DL TFCS identity":
 - if the IE choice "DL parameters" is set to 'independent':

- perform actions for the IE "DL TFCS" as specified in subclause 8.6.5.2;
- if the IE choice "DL parameters" is set to 'same as UL':
 - if the IE "UL DCH TFCS identity" indicates an existing or a new UL TFCS:
 - store for that DL TFCS the TFCS identified by the IE "UL DCH TFCS identity";
 - else:
 - set the variable INVALID_CONFIGURATION to TRUE.

8.6.5.11 DRAC static information

If the IE "DRAC static information" is included the UE shall:

- store the content of the IE "Transmission Time Validity";
- store the content of the IE "Time duration before retry";
- store the content of the IE "DRAC Class identity".

8.6.5.12 TFCS Reconfiguration/Addition Information

If the IE "TFCS Reconfiguration/Addition Information" is included the UE shall:

- store the TFCs to be reconfigured/added indicated in the IE "CTFC information" as specified below;
- if the IE "Power offset information" is included:
 - perform actions as specified in [29].

In order to identify the TFCs included in this IE the UE shall calculate the CTFC as specified in subclause 14.10 and

- if the IE "TFCS Reconfiguration/Addition Information" was included in the IE "TFCI Field 1 Information":
 - ignore for the CTFC calculation any DSCH transport channel that may be assigned;
- if the IE "TFCS Reconfiguration/Addition Information" was included in the IE "TFCI Field 2 Information":
 - ignore for the CTFC calculation any DCH transport channel that may be assigned.

If the IE "TFCS Reconfiguration/Addition Information" is used in case of TFCS "Complete reconfiguration" the UE shall:

- remove a previously stored transport format combination set if this exists;
- consider the first instance of the IE "CTFC information" as Transport Format Combination 0 in FDD (TFCI=0) and 1 in TDD (TFCI=1), the second instance as Transport Format Combination 1 in FDD (TFCI=1) and 2 in TDD (TFCI=2) and so on. In TDD the TFCI value = 0 is reserved for physical layer use.

If the IE "TFCS Reconfiguration/Addition Information" is used in case of TFCS "Addition" the UE shall insert the new additional(s) TFC into the first available position(s) in ascending TFCI order in the TFCS.

8.6.5.13 TFCS Removal Information

If the IE "TFCS Removal Information" is included the UE shall:

- remove the TFC indicated by the IE "TFCI" from the current TFCS, and regard this position (TFCI) in the TFCS as vacant.

8.6.5.14 TFCI Field 2 Information

If the IE "TFCI Field 2 Information" is included the UE shall:

- if the IE choice "Signalling method" is set to 'TFCI range':
 - for the first group in the IE "TFCI(field 2) range":
 - apply the Transport Format Combination indicated by the value of the IE "TFCS Information for DSCH (TFCI range method)" to the group of values of TFCI(field 2) between 0 and the IE "Max TFCI(field2) value";
 - for the following groups in the IE "TFCI(field 2) range":
 - apply the Transport Format Combination indicated by the value of the IE "TFCS Information for DSCH (TFCI range method)" to the group of values of TFCI(field 2) between the largest value reached in the previous group plus one and the IE "Max TFCI(field2) value";
- if the IE choice "Signalling method" is set to 'Explicit':
 - perform actions for the IE "TFCS explicit configuration" as specified in subclause 8.6.5.15.

8.6.5.15 TFCS Explicit Configuration

If the IE "TFCS Explicit Configuration" is included the UE shall:

- if the IE choice "TFCS representation" is set to 'complete reconfiguration':
 - perform the actions for the IE "TFCS Reconfiguration/Addition Information" as specified in subclause 8.6.5.12;
- if the IE choice "TFCS representation" is set to 'addition':
 - perform the actions for the IE "TFCS Reconfiguration/Addition Information" as specified in subclause 8.6.5.12;
- if the IE choice "TFCS representation" is set to 'removal':
 - perform the actions for the IE "TFCS Removal Information" as specified in subclause 8.6.5.13;
- if the IE choice "TFCS representation" is set to 'replace':
 - perform first the actions for the IE "TFCS Removal Information" as specified in subclause 8.6.5.13; and then
 - perform the actions for the IE "TFCS Reconfiguration/Addition Information" as specified in subclause 8.6.5.12.

8.6.6 Physical channel information elements

This section specifies the actions upon reception and/or non-reception of the physical channel information elements. The combination of the values of those information elements included in a given message shall follow the compatibility rules that are specified in the physical layer specifications. In case those rules are not followed, the UE shall set the variable INVALID_CONFIGURATION to TRUE.

8.6.6.1 Frequency info

If the IE "Frequency info" is included the UE shall:

- store that frequency as the active frequency; and
- tune to that frequency.

If the IE "Frequency info" is not included and the UE has a stored active frequency, the UE shall:

- continue to use the stored active frequency.

8.6.6.2 Void

8.6.6.2a PNBSCH allocation

The UE shall consider the frame numbers fulfilling the following equation as "PRACH blocked frames" as specified in [33].

$$- \text{SFN} = \lfloor k * \text{Repetition period} \rfloor$$

for an integer k with k ∈ {0, 1, 2, 3, 4, ... , value of IE "Number of repetitions per SFN period" - 1}, where:

Repetition period is: 4096 / value of IE "Number of repetitions per SFN period".

The UE shall configure the physical layer for the physical random access procedure accordingly.

8.6.6.3 Void

8.6.6.4 Downlink information for each radio link

If the IE "Downlink information for each radio link" is included in a received message, the UE shall:

- if the UE would enter CELL_DCH state according to subclause 8.6.3.3 applied on the received message:
 - if the IE "SCCPCH Information for FACH" is included; and
 - if the UE is in FDD mode and is not capable of simultaneous reception of DPCH and Secondary CCPCH:
 - set the variable UNSUPPORTED_CONFIGURATION to TRUE;
 - if the UE is in FDD mode and is capable of simultaneous reception of DPCH and SCCPCH:
 - start to receive the indicated Secondary CCPCH;
 - if the UE is in TDD mode and shared transport channels are assigned to the UE:
 - start to receive the indicated Secondary CCPCH;
 - if the UE is in TDD mode and no shared transport channels are assigned to the UE:
 - set the variable UNSUPPORTED_CONFIGURATION to TRUE;
- act on the other IEs contained in the IE "Downlink information for each radio link" as specified in subclause 8.6 applied on this radio link;
- if the UE would enter either the CELL_FACH, CELL_PCH or URA_PCH state according to subclause 8.6.3.3 applied on the received message:
 - if the received message is CELL UPDATE CONFIRM:
 - set the variable INVALID_CONFIGURATION to TRUE;
 - if the received message is any other message than CELL UPDATE CONFIRM; and
 - if IEs other than the IE "Primary CPICH info" (for FDD) or the IE "Primary CCPCH info" (for TDD) are included in the IE "Downlink information for each radio link":
 - ignore these IEs;
- act on the other IEs contained in the IE "Downlink information for each radio link" as specified in subclause 8.6 applied on this radio link.

8.6.6.5 Void

8.6.6.6 Uplink DPCH info

If the IE "Uplink DPCH info" is included, the UE shall:

- release any active uplink physical channels and activate the given physical channels.

8.6.6.7 Void

8.6.6.8 Maximum allowed UL TX power

If the IE "Maximum allowed UL TX power" is included, the UE shall:

- keep the UE uplink transmit power below the indicated power value;
- if the current UE uplink transmit power is above the indicated power value:
 - decrease the power to a level below the power value.

The maximum UE transmitter power is defined as the lower of the maximum output power of the UE power class and the maximum allowed UL TX power indicated in this IE. The maximum UE transmitter power shall not be exceeded.

8.6.6.9 PDSCH with SHO DCH Info (FDD only)

If the IE "PDSCH with SHO DCH Info" is included, the UE shall:

- configure itself to receive the PDSCH from the specified radio link within the active set identified by the IE "DSCH radio link identifier";
- if the TFCI has a 'hard' split:
 - if the IE "TFCI(field2) combining set" is included:
 - configure the Layer 1 to combine soft only the DPCCCH TFCI(field 2) of the radio links within the active set which are identified by the IE "Radio link identifier" in the IE "TFCI(field2) Combining set";
 - if the IE "TFCI combining set" is not included:
 - configure the L1 to combine soft the DPCCCH TFCI(field 2) of all radio links within the active set.

8.6.6.10 PDSCH code mapping (FDD only)

If the IE "PDSCH code mapping" is included, the UE shall:

- use the scrambling code defined by the IE "DL Scrambling Code" to receive the PDSCH;
- if the IE choice "signalling method" is set to 'code range':
 - map the TFCI(field2) values to PDSCH codes in the following way:
 - for the first group of the IE "PDSCH code mapping":
 - if the value of the IE "multi-code info" equals 1:
 - map the TFCI(field 2) = 0 to the PDSCH code specified by the IE "Spreading factor" and the code number given by the IE "Code number (for PDSCH code) start";
 - map TFCI(field 2) = 1 to the PDSCH code specified by the IE "Spreading factor" and the code number given by the IE "Code number (for PDSCH code) start"+1;

- continue this process with unit increments in the value of TFCI(field 2) mapped to unit increments in code number until the code number equals the value of the IE "Code number (for PDSCH code) stop";
- if the value of the IE "multi-code info" is greater than 1:
 - if the value of the difference between the IE "Code number (for PDSCH code) start" and the IE "Code number (for PDSCH code) stop" + 1 is not a multiple of the value of the IE "multi-code info":
 - set the variable INVALID_CONFIGURATION to TRUE;
 - map TFCI (field 2)=0 to a set of PDSCH contiguous codes. This code set is specified by the IE "Spreading factor" and code numbers between 'code number start' denoted by the IE "Code number (for PDSCH code) start" and 'code number stop' given by IE "Code number (for PDSCH code) start" - 1 + the value of the IE "multi-code info";
 - continue this process with unit increments in the value of TFCI(field 2) mapped to a set of contiguous codes. This code set is specified by the IE "Spreading factor" and code numbers between 'code number start' = 'code number stop' + 1 of the previous TFCI(field 2) and 'code number stop' = 'code number start' - 1 + the value of the IE "multi-code info";
 - stop this process when the 'code number stop' associated to the last TFCI(field 2) equals the value of the IE "Code number (for PDSCH code) stop";
- for each of the next groups included in the IE "PDSCH code mapping":
 - continue the process in the same way as for the first group with the TFCI(field 2) value used by the UE to construct its mapping table starting at the largest TFCI(field 2) value reached in the previous group plus one;
 - if the value of the IE "Code number (for PDSCH code) start" equals the value of the IE "Code number (for PDSCH code) stop" (as may occur when mapping the PDSCH root code to a TFCI (field 2) value):
 - consider this as defining the mapping between the channelisation code and a single TFCI (i.e., TFCI(field 2) shall not be incremented twice);
- if the IE choice "signalling method" is set to "TFCI range":
 - map the TFCI(field 2) values to PDSCH codes in the following way:
 - for the first group of the IE "DSCH mapping":
 - map each of the TFCI(field 2) between 0 and the value of the IE "Max TFCI(field 2)" to the PDSCH code specified by the IE "Spreading factor (for PDSCH code)" and the code number given by the IE "Code number (for PDSCH code)";
 - for each of the next groups included in the IE "DSCH mapping":
 - map each of the TFCI(field 2) between the IE "Max TFCI(field 2) value" specified in the last group plus one and the specified IE "Max TFCI(field 2)" in the current group to the PDSCH code specified by the IE "Spreading factor (for PDSCH code)" and the code number given by the IE "Code number (for PDSCH code)";
 - if the value of the IE "multi-code info" is greater than 1:
 - map each value of TFCI (field 2) to a set of PDSCH contiguous codes starting at the channelisation code denoted by the 'code number' parameter and including all codes with code numbers up to and including 'code number' - 1 + the value of the IE "multi-code info";
- if the IE choice "signalling method" is set to 'Explicit'
 - map the TFCI(field 2) values to PDSCH codes in the following way:
 - for the first instance on the IE "PDSCH code info":
 - apply the PDSCH code specified by the IE "Spreading factor (for PDSCH code)" and the code number given by the IE "Code number (for PDSCH code)" for TFCI(field 2)=0;

- for the second instance of the IE "PDSCH code info":
 - apply the PDSCH code specified by the IE "Spreading factor (for PDSCH code)" and the code number given by the IE "Code number (for PDSCH code)" for TFCI(field2)=1;
- continue in a similar way for each next instance of the IE "PDSCH code info";
- if the value of the IE "multi-code info" is greater than 1, then
 - map each value of TFCI (field 2) to a set of PDSCH contiguous codes starting at the channelisation code denoted by the 'code number' parameter and including all codes with code numbers up to and including 'code number' - 1 + the value of the IE "multi-code info";
- if the IE choice "signalling method" is set to 'Replace':
 - map the TFCI(field2) values to PDSCH codes in the following way:
 - for each instance of the IE "Replaced PDSCH code":
 - replace the corresponding PDSCH code for the TFCI(field2) identified by the IE "TFCI(field2)" with the new code specified by the IE "Spreading factor (for PDSCH code)" and the code number given by the IE "Code number (for PDSCH code)";
 - if the value of the IE "multi-code info" is greater than 1:
 - map each value of TFCI (field 2) to a set of PDSCH contiguous codes starting at the channelisation code denoted by the 'code number' parameter and including all codes with code numbers up to and including 'code number' - 1 + the value of the IE "multi-code info".

8.6.6.11 Uplink DPCH power control info

The UE shall:

- in FDD:
 - if the IE "Uplink DPCH power control info" is included:
 - if a synchronisation procedure is performed according to [29]:
 - calculate and set an initial uplink transmission power;
 - start inner loop power control as specified in subclause 8.5.3;
 - for the UL inner loop power control:
 - use the parameters specified in the IE;
 - else:
 - act on the IE "Power control algorithm" and the IE "TPC step size" if included and ignore any other IEs that are included;
- in 3.84 Mcps TDD:
 - if the IE "Uplink DPCH power control info" is included:
 - use the parameters specified in the IE for open loop power control as defined in subclause 8.5.7;
 - else:
 - use the current uplink transmission power;
- in 1.28 Mcps TDD:
 - if the IE "Uplink DPCH power control info" is included:
 - calculate and set an initial uplink transmission power;

- start inner loop power control;
- for the UL inner loop power control:
 - use the parameter specified in the IE;
- else:
 - use the current uplink transmission power;
- both in FDD and TDD;
- if the IE "Uplink DPCH power control info" is not included in a message used to enter CELL_DCH:
 - set the variable INVALID_CONFIGURATION to true.

8.6.6.12 Secondary CPICH info

If the IE Secondary CPICH info is included, the UE:

- may use the channelisation code according to IE "channelisation code", with scrambling code according to IE "DL scrambling code" in the IE "Secondary CPICH info", for channel estimation of that radio link;
- may use the pilot bits on DPCCH for channel estimation.

8.6.6.13 Primary CPICH usage for channel estimation

If the IE "Primary CPICH usage for channel estimation" is included and has the value "Primary CPICH may be used" the UE:

- may use the Primary CPICH for channel estimation;
- may use the pilot bits on DPCCH for channel estimation.

If the IE "Primary CPICH usage for channel estimation" is included and has the value "Primary CPICH shall not be used" the UE:

- shall not use the Primary CPICH for channel estimation;
- may use the Secondary CPICH for channel estimation;
- may use the pilot bits on DPCCH for channel estimation.

8.6.6.14 DPCH frame offset

If "DPCH frame offset" is included in a message that instructs the UE to enter CELL_DCH state:

- UTRAN should:
 - if only one Radio Link is included in the message:
 - set "Default DPCH Offset Value" and "DPCH frame offset" respecting the following relation:

$$(\text{Default DPCH Offset Value}) \bmod 38400 = \text{DPCH frame offset}$$
 - where the IE values used are the Actual Values of the IEs as defined in clause 11;
 - if more than one Radio Link are included in the message:
 - set "Default DPCH Offset Value" and "DPCH frame offset" respecting the following relation:

$$(\text{Default DPCH Offset Value}) \bmod 38400 = \text{DPCH frame offset};$$
 - where j indicates the first radio link listed in the message and the IE values used are the Actual Values of the IEs as defined in clause 11;

- The UE shall:
 - on reception of a message where the above relation between "Default DPCH Offset Value" and "DPCH frame offset" is not respected:
 - set the variable INVALID_CONFIGURATION to true.

If the IE "DPCH frame offset" is included the UE shall:

- use its value to determine the beginning of the DPCH frame.

8.6.6.15 DPCH Compressed mode info

If the IE "DPCH compressed mode info" is included, and if the IE group "transmission gap pattern sequence configuration parameters" is included, the UE shall for each transmission gap pattern sequence perform the following consistency checks:

- if UE, according to its measurement capabilities, and for the measurement purpose indicated by IE "TGMP", requires UL compressed mode for measurements on any of the cells to be measured according to UE variable CELL_INFO_LIST, and CHOICE 'UL/DL mode' indicates 'DL only':
 - set the variable INVALID_CONFIGURATION to TRUE;
- if UE, according to its measurement capabilities, and for the measurement purpose indicated by IE "TGMP", requires DL compressed mode for measurements on any of the cells to be measured according to UE variable CELL_INFO_LIST, and CHOICE 'UL/DL mode' indicates 'UL only':
 - set the variable INVALID_CONFIGURATION to TRUE;
- if UE already has an active transmission gap pattern sequence that, according to IE "TGMP", has the same measurement purpose, and both patterns will be active after the new configuration has been taken into use:
 - set the variable INVALID_CONFIGURATION to TRUE.

If variable INVALID_CONFIGURATION has value FALSE after UE has performed the checks above, the UE shall:

- if pattern sequence corresponding to IE "TGPSI" is already active (according to "TGPS Status Flag"):
 - deactivate this pattern sequence at the beginning of the frame, indicated by IE "Activation time"(see subclause 8.6.3.1) received in this message, when the new configuration received in this message is taken into use;
- update each pattern sequence to the variable TGPS_IDENTITY according to the IE "TGPSI";
- update into the variable TGPS_IDENTITY the configuration information defined by IE group "transmission gap pattern sequence configuration parameters";
- after the new configuration has been taken into use:
 - activate the stored pattern sequence corresponding to each IE "TGPSI" for which the "TGPS status flag" is set to "activate" at the time indicated by IE "TGCFN"; and
 - begin the inter-frequency and/or inter-RAT measurements corresponding to the pattern sequence measurement purpose of each activated pattern sequence;
 - if the new configuration is taken into use at the same CFN as indicated by IE "TGCFN":
 - start the concerned pattern sequence immediately at that CFN;
- monitor if the parallel transmission gap pattern sequences create an illegal overlap, and in case of overlap, take actions as specified in subclause 8.2.11.2;

If the IE "DPCH compressed mode info" is included, and if the IE group "transmission gap pattern sequence configuration parameters" is not included, the UE shall:

- if pattern sequence corresponding to IE "TGPSI" is already active (according to "TGPS Status Flag"):

- deactivate this pattern sequence at the beginning of the frame, indicated by IE "Activation time" (see subclause 8.6.3.1) received in this message, when the new configuration received in this message is taken into use;
- after the new configuration has been taken into use:
 - activate, at the time indicated by IE "TGCFN", the stored pattern sequence corresponding to each IE "TGPSI" for which the "TGPS status flag" is set to "activate"; and
 - begin the inter-frequency and/or inter-RAT measurements corresponding to the pattern sequence measurement purpose of each activated pattern sequence;
 - if the new configuration is taken into use at the same CFN as indicated by IE "TGCFN":
 - start the concerned pattern sequence immediately at that CFN;

For transmission gap pattern sequences stored in variable TGPS_IDENTITY, but not identified in IE "TGPSI", the UE shall:

- if the received message implies a timing re-initialised hard handover (see subclause 8.3.5.1):
 - deactivate such transmission gap pattern sequences at the beginning of the frame, indicated by IE "Activation time" (see subclause 8.6.3.1) received in this message; and
 - set IE "TGPS Status Flag" in corresponding UE variable TGPS_IDENTITY to 'inactive';
- if the received message not implies a timing re-initialised hard handover (see subclause 8.3.5.1):
 - continue such transmission gap pattern sequence according to IE "TGPS Status Flag" in corresponding UE variable TGPS_IDENTITY.

Uplink and downlink compressed mode methods are described in [27]. For UL "higher layer scheduling" compressed mode method and transport format combination selection, see [15].

8.6.6.16 Repetition period, Repetition length, Offset (TDD only)

In case the physical allocations of different channels overlap the following priority rules shall apply for common channels and shall be taken into account by the UE:

- PICH takes precedence over Primary CCPCH;
- PICH takes precedence over Secondary CCPCH;
- Secondary CCPCH takes precedence over Primary CCPCH.

The frame allocation can be derived by following rules:

If no IE "Offset" is explicitly given, the parameter "Offset" to be used is calculated by the following equation:

$$\text{Activation time mod Repetition period} = \text{Offset.}$$

Frames from CFN CFN_{off} to $CFN_{\text{off}} + \text{Repetition length}$ belong to the allocation with CFN_{off} fulfilling the following equation:

$$CFN_{\text{off}} \text{ mod Repetition period} = \text{Offset.}$$

Repetition length is always a multiple of the largest TTI within the CCTrCH fulfilling the following equation:

$$(\text{largest TTI within CCTrCH}) * X = \text{Repetition Length}$$

Example of usage:

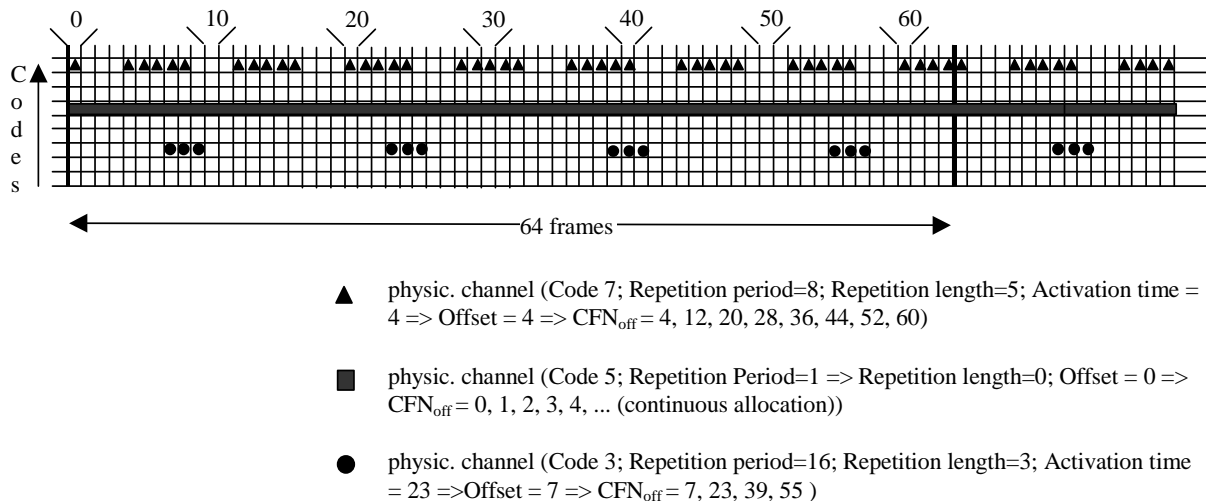

Figure 60: Examples for frame allocations in TDD

8.6.6.17 Primary CCPCH info

If the IE "Primary CCPCH info" is included, the UE shall:

- use the information elements in this IE.

8.6.6.18 Primary CPICH info

If the IE "Primary CPICH info" in FDD is included, the UE shall:

- use the value of this IE as the primary scrambling code for the downlink radio link.

8.6.6.19 CPCH SET Info (FDD only)

If the UE has the capability to use CPCH, the UE shall use the following general procedures:

- if an IE "CPCH SET Info" is included in a dedicated message:
 - read the "CPCH set ID" included in the IE;
 - store the IE using the "CPCH set ID" as an address tag;
 - release any active dedicated physical channels in the uplink;
 - let the PCPCHs listed in the CPCH set be the default in the uplink for CPCH;
- if an IE "CPCH SET Info" is included in a System Information message:
 - read the "CPCH set ID" included in the IE;
 - store the IE using the "CPCH set ID" as an address tag.

8.6.6.20 CPCH set ID (FDD only)

If the UE has the capability to use CPCH, the UE shall use the following general procedures. The UE shall:

- if an IE "CPCH set ID" is included in a dedicated message and not as part of IE "CPCH SET Info":
 - use the IE as an address tag to retrieve the corresponding stored "CPCH SET Info";
 - release any active dedicated physical channels in the uplink;
 - let the PCPCHs listed in the CPCH set be the default in the uplink for CPCH;

- if an IE "CPCH set ID" is included in a dedicated message and not as part of IE "CPCH SET Info", and if there is no corresponding stored "CPCH SET Info":
 - release any active dedicated physical channels in the uplink;
 - let the last assigned PRACH be the default in the uplink for RACH;
 - obtain current System Information on SCCPCH to obtain and store the "CPCH SET info" IE(s);
 - upon receipt of a "CPCH SET Info" which corresponds to the "CPCH set ID" IE:
 - let the PCPCHs listed in that CPCH set be the default in the uplink for CPCH.

8.6.6.21 Default DPCH Offset Value

The UE shall:

- if the IE "Default DPCH Offset Value" is included:
 - use its value to determine Frame Offset and Chip Offset from the SFN timing in a cell;
 - store the received value in variable DOFF;
- if the IE "Default DPCH Offset Value" is not included:
 - use the previously received value stored in variable DOFF. If there is no previously received value stored in DOFF, the UE should use the value 0.

After transition from CELL_DCH state to other states, the UE shall:

- erase the value stored in variable DOFF.

8.6.6.22 Secondary Scrambling Code, Code Number

The following description applies to FDD.

Code Number can be assigned by following rules:

- When more than one DL DPDCH is assigned per RL, the segmented physical channel shall be mapped on to DL DPDCHs according to [27]. When p number of DL DPDCHs are assigned to each RL, the first pair of Secondary Scrambling Code and Code Number corresponds to "PhCH number 1", the second to "PhCH number 2", and so on until the p th to "PhCH number p ".

8.6.6.23 PDSCH Power Control info

The UE shall:

- if the IE "PDSCH Power Control info" is included:
 - configure PDSCH power control with the received values;
- if the IE "PDSCH Power Control info" is not included:
 - continue to use the stored values.

8.6.6.24 Tx Diversity Mode

If the IE "Tx Diversity Mode" is included the UE shall:

- configure the Layer 1 to use the Tx diversity mode indicated in the IE.

8.6.6.25 SSDT Information

If the IE "SSDT Information" is included the UE shall:

- configure the size of the S-field in the FBI field on the uplink DPCH to the value indicated in the IE "S-field";
- use the length of the temporary cell ID code for SSST indicated in the IE "Code Word Length".

8.6.6.26 UL Timing Advance Control (TDD only)

If the IE "UL Timing Advance Control" is present, the UE shall:

- if IE "Uplink Timing Advance Control" has the value "disabled":
 - reset timing advance to 0;
 - disable calculated timing advance following handover;
 - in case of handover:
 - start uplink transmissions in the target cell without applying timing advance;
- if IE "Uplink Timing Advance Control" has the value "enabled":
 - in case of no cell change:
 - in 3.84 Mcps TDD:
 - evaluate and apply the timing advance value for uplink transmission as indicated in IE "Uplink Timing Advance" at the CFN indicated in the IE "Activation Time";
 - in 1.28 Mcps TDD:
 - continue to use the current uplink timing;
 - in case of cell change:
 - in 3.84 Mcps TDD
 - use the IE "Uplink Timing Advance" as TA_{old} and apply TA_{new} for uplink transmission in the target cell at the CFN indicated in the IE "Activation Time" as specified in [33];
 - include the value of the applied timing advance in the IE "Timing Advance" in the COMPLETE message;
 - in 1.28 Mcps TDD:
 - if the IE "Synchronization parameters" is included:
 - initiate SYNC_UL code transmissions as specified in [33] using the parameters as indicated in IE "Synchronization parameters";
 - if the IE "Synchronization parameters" is not included:
 - evaluate the timing for uplink transmissions as specified in [33].

8.6.6.26a Uplink synchronisation parameters

The UE shall apply uplink synchronisation using the values of the IEs "Uplink synchronisation step size" and "Uplink synchronisation frequency" as specified in [33].

8.6.6.27 Downlink information common for all radio links

If the IE "Downlink information common for all radio links " is included the UE shall:

- if the IE "Downlink DPCH info common for all radio links " is included:
 - perform actions as specified in subclause 8.6.6.28;
- if the IE choice "mode" is set to 'FDD':

- perform actions for the IE "DPCH compressed mode info" as specified in subclause 8.6.6.15;
- perform actions for the IE "Tx Diversity mode" as specified in subclause 8.6.6.24;
- if the IE "SSDT information" is included:
 - perform actions as specified in subclause 8.6.6.25;
- if the IE "Default DPCH Offset value" is included:
 - perform actions as specified in the subclause 8.6.6.21.

8.6.6.28 Downlink DPCH info common for all radio links

If the IE "Downlink DPCH info common for all radio links" is included the UE shall:

- perform actions for the IE "Timing indicator" as specified in subclause 8.5.15.2;
- ignore the value received in IE "CFN-targetSFN frame offset";
- if the IE "Downlink DPCH power control information" is included:
 - perform actions for the IE "DPC Mode" according to [29];
- if the IE choice "mode" is set to 'FDD':
 - if the IE "Downlink rate matching restriction information" is included:
 - perform downlink rate matching based on the TFCs composed of 'all the TFIs of the non-restricted Transport channel' and 'allowed TFIs in the restricted Transport channel' within given TFCS;
 - if the IE "Downlink rate matching restriction information" is not included:
 - cancel all the transport format restrictions if any and initiate the downlink rate matching based on all the TFCs in given TFCS;
 - perform actions for the IE "spreading factor";
 - perform actions for the IE "Fixed or Flexible position";
 - perform actions for the IE "TFCI existence";
 - if the IE choice "SF" is set to 256:
 - store the value of the IE "Number of bits for pilot bits";
 - if the IE choice "SF" set to 128:
 - store the value of the IE "Number of bits for pilot bits";
- if the IE choice "mode" is set to 'TDD':
 - perform actions for the IE "Common timeslot info".

If the IE "Downlink DPCH info common for all radio links" is included in a message used to perform a Timing re-initialised hard handover, and ciphering is active for any radio bearer using RLC-TM, the UE shall, after having activated the dedicated physical channels indicated by that IE:

- increment HFN for RLC-TM by '1'.

8.6.6.29 ASC setting

If the IE "ASC setting" is included, the UE shall:

- establish the available signatures for this ASC as specified in the following:

- renumber the list of available signatures specified in the IE "Available signature" included in the IE "PRACH info" from signature index 0 to signature index N-1, where N is the number of available signatures, starting with the lowest available signature number and continuing in sequence, in the order of increasing signature numbers;
- consider as available signatures for this ASC the signatures included in this renumbered list from the index specified by the IE "Available signature Start Index" to the index specified by the IE "Available signature End Index";
- establish the available access slot sub-channels for this ASC as specified in the following:
 - if the IE "AICH transmission timing" included in the IE "AICH Info" is set to '0':
 - ignore the leftmost (most significant) bit (bit b3) of the bit string specified by the IE "Assigned Sub-Channel Number";
 - repeat 4 times the 3 rightmost (least significant) bits (bits b2-b0) of the bit string specified by the IE "Assigned Sub-Channel Number" to form a resulting bit string 'b2 b1 b0 b2 b1 b0 b2 b1 b0 b2 b1 b0' of length 12 bits, where the leftmost bit is the most significant;
 - if the IE "AICH transmission timing" included in the IE "AICH Info" is set to '1':
 - repeat 3 times the bit string (bits b3-b0) specified by the IE "Assigned Sub-Channel Number" to form a bit string 'b3 b2 b1 b0 b3 b2 b1 b0 b3 b2 b1 b0' of length 12 bits, where the leftmost bit is the most significant;
 - perform in both cases, for the resulting bit string (that includes the repetitions) bit-wise logical AND operation with the IE "Available Sub Channel number" included in IE "PRACH info (for RACH)";
 - consider as available sub-channels for this ASC the available sub-channels indicated in the resulting bit string, after logical AND operation i.e. each bit set to 1 or 0 indicates availability or non-availability, respectively, of sub-channel number x , with x from 0 to 11, for the respective ASC.

NOTE 1: In FDD, the list of available signatures is renumbered from signature index 0 to signature index N-1, where N is the number of available signatures, starting with the lowest available signature number and continuing in sequence, in the order of increasing signature numbers.

- List of available signatures: 16 or fewer signatures are available.
- Example: only signatures 0, 5, 10 and 15 are available, then :
 - Signature 0 is: available signature index 0
 - Signature 5 is: available signature index 1
 - Signature 10 is: available signature index 2
 - Signature 15 is: available signature index 3

NOTE 2: In 3.84 Mcps TDD, the list of available channelisation codes (defined in PRACH info) is renumbered from channelisation code index 0 to channelisation code index N-1, where N is the number of available channelisation codes, starting with the lowest available channelisation code number and continuing in sequence, in the order of increasing channelisation code numbers

List of available channelisation codes : 8 or less channelisation codes are available.

The i-th bit of the bitmap defined in the IE "Available Channelisation Code indices" defines whether the channelisation code with the available channelisation code index i is to be used for this ASC (bit set means used, bit unset means not used). Only the low N bits shall be used in the bitmap, where N is the number of available channelisation codes defined in PRACH info.

Ex : spreading factor 16, channelisation codes 16/1, 16/2, 16/5, 16/10 are available :

Channelisation code 16/1 is: available channelisation code index 0
 Channelisation code 16/2 is: available channelisation code index 1
 Channelisation code 16/5 is: available channelisation code index 2
 Channelisation code 16/10 is: available channelisation code index 3

Available Channelisation Code indices has the value '00001100' means: Channelisation Codes 16/5 and 16/10 are available for this ASC.

NOTE 3: In TDD, the subchannel description is found in [33].

NOTE 4: In 1.28 Mcps TDD, the list of available SYNC_UL codes (defined in PRACH info) is numbered from SYNC_UL code index 0 to SYNC_UL code index N-1, where N is the number of available SYNC_UL codes, starting with the lowest available SYNC_UL code number and continuing in sequence, in the order of increasing SYNC_UL code numbers

The i-th bit of the bitmap defined in the IE "Available SYNC_UL codes indices" defines whether the SYNC_UL code with the available SYNC_UL code index i is to be used for this ASC (bit set means used, bit unset means not used). Only the low N bits shall be used in the bitmap, where N is the number of available SYNC_UL codes defined in PRACH info.

- List of available SYNC_UL codes: 8 or fewer SYNC_UL codes are available.

Example: only signatures 0, 5, 6 and 7 are available, then:

- SYNC_UL codes 0 is: available SYNC_UL codes index 0
 - SYNC_UL codes 5 is: available SYNC_UL codes index 1
 - SYNC_UL codes 6 is: available SYNC_UL codes index 2
 - SYNC_UL codes 7 is: available SYNC_UL codes index 3

Available SYNC_UL codes indices has the value '00001100' means: SYNC_UL codes 6 and 7 are available for this ASC.

8.6.6.30 SRB delay, PC preamble (FDD only)

When the IE "SRB delay" and IE "PC preamble" is received in a message that results in a configuration of uplink DPCH, the UE shall:

- after the establishment of the uplink physical channel, send DPCCCH and no DPDCH according to [26] during the number of frames indicated in the IE "PC preamble"; and
- then not send any data on signalling radio bearers RB0 to RB4 during the number of frames indicated in the IE "SRB delay".

8.6.6.31 FPACH/PRACH Selection (1.28 Mcps TDD only)

Where more than one FPACH is defined, the FPACH that a UE should receive following a UpPCH transmission is defined by the UpPCH signature (SYNC_UL) code that the UE used. The FPACH/PRACH number = $N \bmod M$ where N denotes the signature number (0..7) and M denotes the number of FPACH/PRACH combinations that have been

defined. The FPACH/PRACH number indicates the position of the FPACH/PRACH description in the IE "PRACH info".

The PRACH that should be used is selected out of the ones associated with the FPACH in the IE "PRACH info" according to [33].

8.6.7 Measurement information elements

8.6.7.1 Measurement validity

If the optional IE "measurement validity" for a given measurement has not been included in measurement control information, the UE shall delete the measurement associated with the variable MEASUREMENT_IDENTITY after the UE makes a transition to a new state.

If the IE "measurement validity" for this measurement has been included in measurement control information, the UE shall save the measurement associated with the variable MEASUREMENT_IDENTITY. The IE "UE state" defines the scope of resuming the measurement.

If the "UE state" is defined as "all states", the UE shall continue the measurement after making a transition to a new state. This scope is assigned only for traffic volume type measurements and can only be applied by the UE if the IE "traffic volume measurement object" has been included in measurement control information. If the IE "traffic volume measurement object" has not been included in measurement control information, the UE shall not save the measurement control information in variable MEASUREMENT_IDENTITY, but shall send a MEASUREMENT CONTROL FAILURE message to the UTRAN with failure cause "Configuration incomplete".

If the "UE state" is defined as "all states except CELL_DCH", the UE shall store the measurement to be resumed after a subsequent transition from CELL_DCH state to any of the other states in connected mode. This scope is assigned only for traffic volume type measurements.

If the "UE state" is defined as "CELL_DCH", the UE shall store the measurement to be resumed after a subsequent transition to CELL_DCH state. After cell re-selection, the UE shall delete any ongoing intra-frequency or inter-frequency and inter-RAT type measurement associated with the variable MEASUREMENT_IDENTITY. Other measurement types shall, however, be continued regardless of cell reselection.

8.6.7.2 Filter coefficient

If the IE "Filter coefficient" is received the UE shall apply filtering of the measurements for that measurement quantity according to the formula below. This filtering shall be performed by the UE before UE event evaluation. The UE shall also filter the measurements reported in the IE "Measured results". The filtering shall not be performed for the measurements reported in the IE "Measured results on RACH" and for cell-reselection in connected or idle mode.

The filtering shall be performed according to the following formula.

$$F_n = (1 - a) \cdot F_{n-1} + a \cdot M_n$$

The variables in the formula are defined as follows:

F_n is the updated filtered measurement result

F_{n-1} is the old filtered measurement result

M_n is the latest received measurement result from physical layer measurements, the unit used for M_n is the same unit as the reported unit in the MEASUREMENT REPORT message or the unit used in the event evaluation.

$a = 1/2^{(k/2)}$, where k is the parameter received in the IE "Filter coefficient".

NOTE: if k is set to 0 that will mean no layer 3 filtering.

In order to initialise the averaging filter, F_0 is set to M_1 when the first measurement result from the physical layer measurement is received.

The physical layer measurement results are sampled once every measurement period. The measurement period and the accuracy for a certain measurement is defined in [19] and [20].

8.6.7.3 Intra-frequency/Inter-frequency/Inter-RAT cell info list

If the IE "Intra-frequency cell info list" is received in System Information Block Type 11, the UE shall update the variable CELL_INFO_LIST accordingly and in the following order. The UE shall:

- if the IE "Removed Intra-frequency cells" is received:
 - ignore the IE;
- if the IE "Remove all intra-frequency cells" is received:
 - ignore the IE;
- if the IE "New Intra-frequency cells" is received, for each cell, and in the same order as the cells appear in the IE:
 - update the variable CELL_INFO_LIST as follows:
 - if the IE "Intra-frequency cell id" is received:
 - store received cell information at this position in the Intra-frequency cell info list in the variable CELL_INFO_LIST, possibly overwriting any existing information in this position; and
 - mark the position "occupied";
 - if the IE "Intra-frequency cell id" is not received:
 - store the received cell information at the first vacant position in ascending order in the Intra-frequency cell info list in the variable CELL_INFO_LIST; and
 - mark the position as "occupied";
- if the IE "Cells for measurement" is received:
 - ignore the IE.

If the IE "Intra-frequency cell info list" is received in System Information Block Type 12, the UE shall update the variable CELL_INFO_LIST accordingly and in the following order. The UE shall:

- if the IE "Removed Intra-frequency cells" is received:
 - at the position indicated by the IE "Intra-frequency cell id" clear the cell information stored in the variable CELL_INFO_LIST; and
 - mark the position "vacant";
- if the IE "Remove all intra-frequency cells" is received:
 - for each position referring to an intra frequency cell in the variable CELL_INFO_LIST:
 - mark the position "vacant";
- if the IE "New Intra-frequency cells" is received, for each cell, and in the same order as the cells appear in the IE:
 - update the variable CELL_INFO_LIST as follows:
 - if the IE "Intra-frequency cell id" is received:
 - store received cell information at this position in the Intra-frequency cell info list in the variable CELL_INFO_LIST, possibly overwriting any existing information in this position; and
 - mark the position "occupied";
 - if the IE "Intra-frequency cell id" is not received:
 - store the received cell information at the first vacant position in ascending order in the Intra-frequency cell info list in the variable CELL_INFO_LIST; and

- mark the position as "occupied";
- if the IE "Cells for measurement" is received:
 - ignore the IE.

If the IE "Intra-frequency cell info list" is received in a MEASUREMENT CONTROL message, the UE shall update the variable CELL_INFO_LIST accordingly and in the following order. The UE shall:

- if the IE "Removed Intra-frequency cells" is received, at the position indicated by the IE "Intra-frequency cell id":
 - clear the cell information stored in the variable CELL_INFO_LIST; and
 - mark the position "vacant";
- if the IE "Remove all intra-frequency cells" is received:
 - for each position referring to an intra frequency cell in the variable CELL_INFO_LIST:
 - mark the position "vacant";
- if the IE "New Intra-frequency cells" is received, for each cell, and in the same order as the cells appear in the IE:
 - update the variable CELL_INFO_LIST as follows:
 - if the IE "Intra-frequency cell id" is received:
 - store received cell information at this position in the Intra-frequency cell info list in the variable CELL_INFO_LIST, possibly overwriting any existing information in this position; and
 - mark the position "occupied";
 - if the IE "Intra-frequency cell id" is not received:
 - store the received cell information at the first vacant position in ascending order in the Intra-frequency cell info list in the variable CELL_INFO_LIST; and
 - mark the position as "occupied";
- if the IE "Cells for measurement" is received, in the measurement configured by this message only:
 - consider Intra-frequency cells whose cell information is stored at the position indicated by the IE "Intra-frequency cell id" in the variable CELL_INFO_LIST;
- if the IE "Cells for measurement" is not received, in the measurement configured by this message:
 - consider all Intra-frequency cells whose cell information is stored in CELL_INFO_LIST.

If the IE "Inter-frequency cell info list" is received in System Information Block Type 11 update the variable CELL_INFO_LIST accordingly and in the following order. The UE shall:

- if the IE "Removed Inter-frequency cells" is received:
 - ignore the IE;
- if the IE "Remove all inter-frequency cells" is received:
 - ignore the IE;
- if the IE "New Inter-frequency cells" is received, for each cell, and in the same order as the cells appear in the IE:
 - update the variable CELL_INFO_LIST as follows:
 - if the IE "Inter-frequency cell id" is received:

- store received cell information at this position in the Inter-frequency cell info list in the variable CELL_INFO_LIST, possibly overwriting any existing information in this position; and
- mark the position "occupied";
- if the IE "Inter-frequency cell id" is not received:
 - store the received cell information at the first vacant position in ascending order in the Inter-frequency cell info list in the variable CELL_INFO_LIST; and
 - mark the position as "occupied";
- if the IE "Cells for measurement" is received:
 - ignore the IE.

If the IE "Inter-frequency cell info list" is received in System Information Block Type 12, the UE shall update the variable CELL_INFO_LIST accordingly and in the following order. The UE shall:

- if the IE "Removed Inter-frequency cells" is received, at the position indicated by the IE "Inter-frequency cell id":
 - clear the cell information stored in the variable CELL_INFO_LIST; and
 - mark the position "vacant";
- if the IE "Remove all inter-frequency cells" is received:
 - for each position referring to an inter-frequency cell in the variable CELL_INFO_LIST:
 - clear the cell information stored in the variable CELL_INFO_LIST; and
 - mark the position "vacant";
- if the IE "New Inter-frequency cells" is received, for each cell, and in the same order as the cells appear in the IE:
 - update the variable CELL_INFO_LIST as follows:
 - if the IE "Inter-frequency cell id" is received:
 - store received cell information at this position in the Inter-frequency cell info list in the variable CELL_INFO_LIST, possibly overwriting any existing information in this position; and
 - mark the position "occupied";
 - if the IE "Inter-frequency cell id" is not received:
 - store the received cell information at the first vacant position in ascending order in the Inter-frequency cell info list in the variable CELL_INFO_LIST; and
 - mark the position as "occupied";
 - if the IE "Cells for measurement" is received:
 - ignore the IE.

If the IE "Inter-frequency cell info list" is received in a MEASUREMENT CONTROL message, the UE shall update the variable CELL_INFO_LIST accordingly and in the following order:

- if the IE "Removed Inter-frequency cells" is received, at the position indicated by the IE "Inter-frequency cell id":
 - clear the cell information stored in the variable CELL_INFO_LIST; and
 - mark the position "vacant";
- if the IE "Remove all inter-frequency cells" is received:

- for each position referring to an inter-frequency cell in the variable CELL_INFO_LIST:
 - clear the cell information stored in the variable CELL_INFO_LIST; and
 - mark the position "vacant";
- if the IE "New Inter-frequency cells" is received, for each cell, and in the same order as the cells appear in the IE:
 - update the variable CELL_INFO_LIST as follows:
 - if the IE "Inter-frequency cell id" is received:
 - store received cell information at this position in the Inter-frequency cell info list in the variable CELL_INFO_LIST, possibly overwriting any existing information in this position; and
 - mark the position "occupied";
 - if the IE "Inter-frequency cell id" is not received:
 - store the received cell information at the first vacant position in ascending order in the Inter-frequency cell info list in the variable CELL_INFO_LIST; and
 - mark the position as "occupied";
- if the IE "Cells for measurement" is received, in the measurement configured by this message only:
 - consider Inter-frequency cells whose cell information is stored at the position indicated by the IE "Inter-frequency cell id" in the variable CELL_INFO_LIST;
- if the IE "Cells for measurement" is not received, in the measurement configured by this message:
 - consider all Inter-frequency cells whose cell information is stored in CELL_INFO_LIST.

If the IE "Inter-RAT cell info list" is received in System Information Block Type 11, the UE shall update the variable CELL_INFO_LIST accordingly and in the following order. The UE shall:

- if the IE "Removed Inter-RAT cells" is received:
 - ignore the IE;
- if the IE "Remove all inter-RAT cells" is received:
 - ignore the IE;
- if the IE "New Inter-RAT cells" is received, for each cell, and in the same order as the cells appear in the IE:
 - update the variable CELL_INFO_LIST as follows:
 - if the IE "Inter-RAT cell id" is received:
 - store received cell information at this position in the Inter-RAT cell info list in the variable CELL_INFO_LIST, possibly overwriting any existing information in this position; and
 - mark the position "occupied";
 - if the IE "Inter-RAT cell id" is not received:
 - store the received cell information at the first vacant position in ascending order in the Inter-RAT cell info list in the variable CELL_INFO_LIST; and
 - mark the position as "occupied";
- if the IE "Cells for measurement" is received:
 - ignore the IE;

If the IE "Inter-RAT cell info list" is received in System Information Block Type 12, the UE shall update the variable CELL_INFO_LIST accordingly and in the following order. The UE shall:

- if the IE "Removed Inter-RAT cells" is received, at the position indicated by the IE "Inter-RAT cell id":
 - clear the cell information stored in the variable CELL_INFO_LIST; and
 - mark the position "vacant";
- if the IE "Remove all inter-RAT cells" is received:
 - for each position referring to an inter-RAT cell in the variable CELL_INFO_LIST:
 - clear the cell information stored in the variable CELL_INFO_LIST; and
 - mark the position "vacant";
- if the IE "New Inter-RAT cells" is received, for each cell, and in the same order as the cells appear in the IE:
 - update the variable CELL_INFO_LIST as follows:
 - if the IE "Inter-RAT cell id" is received:
 - store received cell information at this position in the Inter-RAT cell info list in the variable CELL_INFO_LIST, possibly overwriting any existing information in this position; and
 - mark the position "occupied";
 - if the IE "Inter-RAT cell id" is not received:
 - store the received cell information at the first vacant position in ascending order in the Inter-RAT cell info list in the variable CELL_INFO_LIST; and
 - mark the position as "occupied";
- if the IE "Cells for measurement" is received:
 - ignore the IE.

If the IE "Inter-RAT cell info list" is received in a MEASUREMENT CONTROL message, the UE shall update the variable CELL_INFO_LIST accordingly and in the following order. The UE shall:

- if the IE "Removed Inter-RAT cells" is received, at the position indicated by the IE "Inter-RAT cell id":
 - clear the cell information stored in the variable CELL_INFO_LIST; and
 - mark the position "vacant";
- if the IE "Remove all inter-RAT cells" is received:
 - for each position referring to an inter-RAT cell in the variable CELL_INFO_LIST:
 - clear the cell information stored in the variable CELL_INFO_LIST; and
 - mark the position "vacant";
- if the IE "New Inter-RAT cells" is received, for each cell, and in the same order as the cells appear in the IE:
 - update the variable CELL_INFO_LIST as follows:
 - if the IE "Inter-RAT cell id" is received:
 - store received cell information at this position in the Inter-RAT cell info list in the variable CELL_INFO_LIST, possibly overwriting any existing information in this position; and
 - mark the position "occupied";
 - if the IE "Inter-RAT cell id" is not received:

- store the received cell information at the first vacant position in ascending order in the Inter-RAT cell info list in the variable CELL_INFO_LIST; and
- mark the position as "occupied";
- if the IE "Cells for measurement" is received, in the measurement configured by this message only:
 - consider Inter-RAT cells whose cell information is stored at the position indicated by the IE "Inter-RAT cell id" in the variable CELL_INFO_LIST;
- if the IE "Cells for measurement" is not received, in the measurement configured by this message:
 - consider all Inter-RAT cells whose cell information is stored in CELL_INFO_LIST;
- if the IE "Cell selection and re-selection info for SIB11/12" is present:
 - ignore the IE.

8.6.7.4 Intra-frequency measurement quantity

If the IE "Intra-frequency measurement quantity" is received in a MEASUREMENT CONTROL message, the UE shall:

- if the IE "Measurement quantity" is set to "pathloss"; and
- for any intra-frequency cell indicated by the IE "Cells for measurement", the IE "Primary CPICH Tx power" in FDD or the IE "Primary CCPCH TX Power" in TDD in the intra frequency cell info list in the variable CELL_INFO_LIST is not present:
 - set the variable CONFIGURATION_INCOMPLETE to TRUE;
- else:
 - configure the measurement quantity accordingly.

8.6.7.5 Inter-RAT measurement quantity

If the IE "Inter-RAT measurement quantity" is received in a MEASUREMENT CONTROL message and CHOICE system is GSM, the UE shall:

- if IE "BSIC verification required" is set to "required", for cells that match any of the BCCH ARFCN and BSIC combinations in the list of inter-RAT cells that the UE has received in IE "Inter-RAT cell info list", and that has a "verified" BSIC:
 - report measurement quantities according to IE "inter-RAT reporting quantity" taking into account the restrictions defined in subclause 8.6.7.6;
 - trigger inter-RAT events according to IE "inter-RAT measurement reporting criteria"; and
 - perform event evaluation for event-triggered reporting after BSIC has been verified for a GSM cell as defined in [19]; and
 - trigger periodical reports according to the given "Reporting interval" even if the BSIC of GSM cell has not been verified; and
 - indicate non-verified BSIC for a GSM cell in the "Inter-RAT measured results list" IE as defined in subclause 8.6.7.6;
- if IE "BSIC verification required" is set to "not required", for cells that match any of the BCCH ARFCN in the list of inter-RAT cells that the UE has received in IE "Inter-RAT cell info list", regardless if the BSIC is "verified" or "non-verified":
 - report measurement quantities according to IE "inter-RAT reporting quantity";
 - trigger inter-RAT events according to IE "inter-RAT measurement reporting criteria";
- if the IE "Measurement quantity" is set to "pathloss":

- set the variable CONFIGURATION_INCOMPLETE to TRUE.

NOTE: The requirements for a cell to be considered "verified" or "non-verified" can be found in [19].

8.6.7.6 Inter-RAT reporting quantity

If the IE "Inter-RAT reporting quantity" is received by the UE, the UE shall:

- store the content of the IE to the variable MEASUREMENT_IDENTITY.

If the IE "Inter-RAT measurement quantity" is received and CHOICE system is GSM, the UE shall check each quantity in the GSM choice. The UE shall include measured results in MEASUREMENT REPORT as specified in the IE "Inter-RAT reporting quantity" with the following restrictions:

- if the UE has not confirmed the BSIC of the measured cell:
 - if no compressed mode pattern sequence specified with measurement purpose "Initial BSIC identification" is active, the UE is not required to include the "inter-RAT cell id" nor "Observed time difference to GSM cell" in the IE "Inter-RAT measured results list", when a MEASUREMENT REPORT is triggered.
- if the UE has confirmed the BSIC of the measured cell, then:
 - if no compressed mode pattern sequence specified with measurement purpose "Initial BSIC identification" nor "BSIC re-confirmation" is active, the UE is not required to include the "inter-RAT cell id" nor "Observed time difference to GSM cell" in the IE "Inter-RAT measured results", when a MEASUREMENT REPORT is triggered. If no compressed mode pattern sequence with measurement purpose "GSM carrier RSSI measurements" is active, the UE may include "inter-RAT cell id" or "Observed time difference to GSM cell" in MEASUREMENT REPORT without "GSM carrier RSSI" even if it is defined in the IE "Inter-RAT reporting quantity".
- if the IE "UTRAN estimated quantity" is set to "TRUE":
 - ignore that IE;
- if IE "Observed time difference to GSM cell" is set to "TRUE":
 - include optional IE "Observed time difference to GSM cell" with the value set to the time difference to that GSM cell for the GSM cells that have a BSIC that is "verified", and that match any of the BCCH ARFCN and BSIC combinations in the list of inter-RAT cells that the UE has received in IE "Inter-RAT cell info list". Observed time difference to GSM cells with "non-verified" BSIC shall not be included;
- if IE "GSM Carrier RSSI" is set to "TRUE":
 - include optional IE "GSM Carrier RSSI" with a value set to the measured RXLEV to that GSM cell in IE "Inter-RAT measured results list". If no compressed mode pattern sequence specified with measurement purpose "GSM carrier RSSI measurements" is active, the UE is not required to include the "GSM carrier RSSI" in the IE "Inter-RAT measured results list", when a MEASUREMENT REPORT is triggered;
- if the BSIC of reported GSM cell is "verified":
 - set the CHOICE BSIC to "Verified BSIC" and IE "inter-RAT cell id" to the value that GSM cell had in the IE "Inter-RAT cell info list";
- if the BSIC of reported GSM cell is "non-verified":
 - set the CHOICE BSIC to "Non verified BSIC" and the IE "BCCH ARFCN" to the value of that GSM cells ARFCN;

The requirements for a cell to be considered "verified" or "non-verified" can be found in [19].

8.6.7.7 Cell Reporting Quantities

If the IE "Cell Reporting Quantities" is received by the UE, the UE shall store the content of the IE "Cell Reporting Quantities" to the variable MEASUREMENT_IDENTITY.

The UE shall include measured results in MEASUREMENT REPORT as specified in the IE "Cell Reporting Quantities", except for the following cases:

If the IE "Cell Identity" is set to TRUE, the UE shall in this version of the specification:

- treat the IE as if the IE "Cell Identity" is set to FALSE.

If the IE "Cell synchronisation information reporting indicator" is set to TRUE, the UE shall:

- include the IE "Cell synchronisation information" in MEASUREMENT REPORT as specified in the IE "Cell Reporting Quantities":
 - if the measurement is performed on another frequency; or
 - if the IE "Read SFN indicator" included in the IE "Cell info" of the measured cell is set to FALSE:
 - the UE may omit the information group "COUNT-C-SFN frame difference" in the IE "Cell synchronisation information";
 - if the measurement is performed on the same frequency and no RLC Transparent Mode COUNT-C exists in the UE:
 - set the IE "COUNT-C-SFN high" to 0.
 - otherwise:
 - include the information group "COUNT-C-SFN frame difference".

If the IE "Proposed TGSN Reporting required" is set to TRUE, the UE shall:

- if compressed mode was used to monitor a TDD cell and the variable TGSN_REPORTED is set to FALSE:
 - report the IE "Proposed TGSN" indicating the TGSN that suits best to the measured cell;
 - set the variable TGSN_REPORTED to TRUE.
- otherwise
 - omit the IE "Proposed TGSN".

If the IE "SFN-SFN observed time difference reporting indicator" is set to "type 1" and the IE "Read SFN indicator" included in the IE "Cell info" of the measured cell is set to FALSE, the UE shall:

- set the SFN-SFN observed time difference type 1 for that cell to a value in the range (0..38399) (i.e. the UE shall assume that the SFN of the measured cell differs less than a frame with respect to the reference cell).

8.6.7.8 Periodical Reporting Criteria

If the IE "Periodical Reporting Criteria" is received by the UE, the UE shall:

- store the contents of the IE "Amount of Reporting" and IE "Reporting interval" in the variable MEASUREMENT_IDENTITY.

For the first MEASUREMENT REPORT message, the UE shall:

- send the MEASUREMENT REPORT at the end of the first reporting interval in which all requested reporting quantities are available according to the requirements and the measurement capabilities set in [19] and [20] for at least one measurement object stored in the variable MEASUREMENT_IDENTITY.

Following the first MEASUREMENT REPORT message, the UE shall:

- send subsequent MEASUREMENT REPORT message with intervals specified by the IE "Reporting interval";
- form the MEASUREMENT REPORT from the measurement objects stored in the variable MEASUREMENT_IDENTITY for which all requested reporting quantities are available according to the requirements and the measurement capabilities set in [19] and [20]; and

- omit measurement results that were reported in a previous MEASUREMENT REPORT and for which new measurement results are not available in the present reporting interval.

After the UE has sent a total number of MEASUREMENT REPORT messages, which equal the value indicated in the IE "Amount of reporting", the UE shall:

- terminate measurement reporting; and
- delete all measurement information linked with the "Measurement identity" of the ongoing measurement from the variable MEASUREMENT_IDENTITY.

8.6.7.9 Reporting Cell Status

If the IE "Reporting Cell Status" is received, the UE shall set the IE "Measured Results" in MEASUREMENT REPORT as follows. The UE shall:

- for intra-frequency measurement and inter-frequency measurement:
 - include the IE "Cell Measured Results" for cells that satisfy the condition (such as "Report cells within active set") specified in "Reporting Cell Status", in descending order by the measurement quantity;
 - the maximum number of the IE "Cell Measured Results" to be included in the IE "Measured Results" is the number specified in "Reporting Cell Status".

If the IE "Reporting Cell Status" is not received for intra-frequency, inter-frequency measurement, or inter-RAT measurement, the UE shall:

- exclude the IE "cell measured results" for any cell in MEASUREMENT REPORT.

8.6.7.10 Traffic Volume Measurement

If the IE "Traffic Volume Measurement" is received by the UE, the UE shall:

- store the content of the IE to the variable MEASUREMENT_IDENTITY.

If the IE "Traffic volume measurement Object" is not included, the UE shall:

- apply the measurement reporting criteria to all uplink transport channels.

If IE "Traffic volume measurement" is received by the UE in a MEASUREMENT CONTROL message, where IE "measurement command" has the value "setup", and if the IE "traffic volume reporting quantity" is included, the UE shall:

- report the measured quantities specified in the IE "traffic volume reporting quantity";
- if the parameter "Average of RLC Buffer Payload for each RB" or the parameter "Variance of RLC Buffer payload for each RB" is set:
 - if the IE "Traffic volume measurement quantity" is not included:
 - set the variable CONFIGURATION_INCOMPLETE to TRUE;
 - if the IE "Traffic volume measurement quantity" is included:
 - if the parameter "time interval to take an average or a variance" is included:
 - use the time specified in the parameter "time interval to take an average or a variance" to calculate the average and/or variance of RLC Buffer Payload according to the IE "traffic volume reporting quantity";
 - if the parameter "time interval to take an average or a variance" is not included:
 - set the variable CONFIGURATION_INCOMPLETE to TRUE.

If IE "Traffic volume measurement" is received by the UE in a MEASUREMENT CONTROL message, where IE "measurement command" has the value "setup", but IE "Traffic volume measurement quantity" or IE "Traffic volume reporting quantity" is not received, the UE shall:

- clear all stored measurement control information related associated to this measurement identity in variable MEASUREMENT_IDENTITY;
- set the variable CONFIGURATION_INCOMPLETE to TRUE.

8.6.7.11 Traffic Volume Measurement Reporting Criteria

If the IE "Traffic Volume Measurement Reporting Criteria" is received by the UE, the UE shall:

- store the content of the IE "Traffic Volume Measurement Reporting Criteria" to the variable MEASUREMENT_IDENTITY.

If the IE "UL transport channel id" is not included, the UE shall:

- apply the measurement reporting criteria to all uplink transport channels indicated in the IE "Traffic volume measurement object";
- if the UTRAN has not specified a traffic volume measurement object for a given measurement identity:
 - apply the measurement reporting criteria to all uplink transport channels that are configured for the current UE state.

If the IE "Tx interruption after trigger" is included, the UE shall:

- block DTCH transmissions on the RACH during the time specified in the IE after a measurement report is transmitted.

8.6.7.12 FACH measurement occasion info

IE "FACH measurement occasion info" is used to control UE measurement activities in inter-frequency and inter-RAT cells in CELL_FACH state.

If IE "FACH measurement occasion info" is received, UE shall, when in CELL_FACH state:

- if IE "FACH Measurement occasion length coefficient" is included:
 - if, according to its measurement capabilities, UE is not able to perform some of the indicated measurements in this IE simultaneously as receiving the SCCPCH of serving cell:
 - perform those measurements during FACH measurement occasions, see subclause 8.5.11;
 - if, according to its measurement capabilities, UE is able to perform some of the indicated measurements in this IE simultaneously as receiving the SCCPCH of serving cell:
 - UE may perform measurements also on other occasions;
 - if, according to its measurement capabilities, UE is able to perform the measurements and indicated in this IE simultaneously as receiving the SCCPCH of serving cell:
 - perform the measurements simultaneously as receiving the SCCPCH of serving cell;
- if IE "FACH Measurement occasion length coefficient" is not included:
 - perform those indicated measurements indicated in this IE that UE, according to its measurement capabilities, is able to perform simultaneously as receiving the SCCPCH of serving cell;
- if IE "Inter-frequency FDD measurement indicator" is set to TRUE:
 - perform measurements and evaluate cell re-selection criteria according to [4] on inter-frequency FDD cells listed in IE "Measurement control system information" in "System Information Block type 11" or "System Information Block type 12";

- if IE "Inter-frequency FDD measurement indicator" is set to FALSE:
 - neither perform measurements nor evaluate cell re-selection criteria on inter-frequency FDD cells;
- if IE "Inter-frequency TDD measurement indicator" is set to TRUE:
 - perform measurements and evaluate cell re-selection criteria according to [4] on inter-frequency TDD cells listed in IE "Measurement control system information" in "System Information Block type 11" or "System Information Block type 12";
- if IE "Inter-frequency TDD measurement indicator" is set to FALSE:
 - neither perform measurements nor evaluate cell re-selection criteria on inter-frequency TDD cells;
- if IE "Inter-RAT measurement indicators" is included:
 - perform measurements and evaluate cell re-selection criteria according to [4] on those cells of listed Inter-RAT types that are present in IE "Measurement control system information" in "System Information Block type 11" or "System Information Block type 12".

8.6.7.13 Measurement Reporting Mode

If IE "Measurement Reporting Mode" is received by the UE, the UE shall:

- store the contents of the IE "Measurement Report Transfer Mode" in the variable MEASUREMENT_IDENTITY;
- use the indicated RLC mode when sending MEASUREMENT REPORT message(s) related to this measurement;
- ignore IE "Periodical Reporting / Event Trigger Reporting Mode".

If IE "Measurement Reporting Mode" is not received by the UE in MEASUREMENT CONTROL message, where IE "measurement command" has the value "setup", the UE shall:

- clear all stored measurement control information related associated to this measurement identity in variable MEASUREMENT_IDENTITY;
- set the variable CONFIGURATION_INCOMPLETE to TRUE.

8.6.7.14 Inter-frequency measurement

If IE "Inter-frequency measurement" is received by the UE in a MEASUREMENT CONTROL message, where IE "measurement command" has the value "setup", but IE "Inter-frequency measurement quantity", IE "Inter-frequency reporting quantity" or "CHOICE Report criteria" is not received, the UE shall:

- clear all stored measurement control information related associated to this measurement identity in variable MEASUREMENT_IDENTITY;
- set the variable CONFIGURATION_INCOMPLETE to TRUE;
- in the case of an inter-frequency measurement for FDD:
 - if IE "Inter-frequency measurement" is received by the UE in a MEASUREMENT CONTROL message, where IE "measurement command" has the value "setup", if an inter-frequency event is configured that is different from event 2d or 2f, and if the IE "Inter-frequency SET UPDATE" is not received in that same message:
 - set the variable CONFIGURATION_INCOMPLETE to TRUE;
 - if the IE "Inter-frequency SET UPDATE" is received:
 - if the value of the IE "Autonomous Set Update" set to "Off" or "On":
 - if more than one frequency is included in the list of cells pointed at in the IE "cells for measurement" if also included in the same IE "Inter-frequency measurement", or otherwise included in the "Inter-frequency cell info" part of the variable CELL_INFO_LIST:

- set the variable INVALID_CONFIGURATION to TRUE.

If the variable CONFIGURATION_INCOMPLETE is set to TRUE, the UE shall:

- act as described in subclause 8.4.1.4a.

8.6.7.15 Inter-RAT measurement

If IE "Inter-RAT measurement" is received by the UE in a MEASUREMENT CONTROL message, where IE "measurement command" has the value "setup", but IE "Inter-RAT measurement quantity", IE "Inter-RAT reporting quantity" or "CHOICE Report criteria" is not received, the UE shall:

- clear all stored measurement control information related associated to this measurement identity in variable MEASUREMENT_IDENTITY;
- set the variable CONFIGURATION_INCOMPLETE to TRUE.

8.6.7.16 Intra-frequency measurement

If IE "Intra-frequency measurement" is received by the UE in a MEASUREMENT CONTROL message, where IE "measurement command" has the value "setup", but IE "Intra-frequency measurement quantity", IE "Intra-frequency reporting quantity" or "CHOICE Report criteria" is not received, the UE shall:

- clear all stored measurement control information related associated to this measurement identity in variable MEASUREMENT_IDENTITY;
- set the variable CONFIGURATION_INCOMPLETE to TRUE.

8.6.7.17 Quality measurement

If IE "Quality measurement" is received by the UE in a MEASUREMENT CONTROL message, where IE "measurement command" has the value "setup", but IE "Quality reporting quantity" is not received, the UE shall:

- clear all stored measurement control information related associated to this measurement identity in variable MEASUREMENT_IDENTITY;
- set the variable CONFIGURATION_INCOMPLETE to TRUE.

8.6.7.18 UE internal measurement

If IE "UE internal measurement" is received by the UE in a MEASUREMENT CONTROL message, where IE "measurement command" has the value "setup", but IE "UE internal measurement quantity" or IE "UE internal reporting quantity" is not received, the UE shall:

- clear all stored measurement control information related associated to this measurement identity in variable MEASUREMENT_IDENTITY;
- set the variable CONFIGURATION_INCOMPLETE to TRUE.

8.6.7.19 UE positioning

8.6.7.19.1 UE positioning reporting quantity

The UE shall:

- ignore IE "Multiple Sets";
- ignore IE "Response Time";
- if IE "Accuracy" is included:
 - should try to achieve the requested positioning accuracy with 67% confidence;

- if IE "Positioning Methods" is set to "Cell ID":
 - perform the Rx-Tx time difference type 2 measurement on the reference cell indicated in the OTDOA assistance data;
- if the IE "Method Type" is set to "UE based":
 - if the IE "Positioning Methods" is set to "GPS":
 - when a measurement report is triggered:
 - include the IE "UE positioning position estimate info" in the measurement report and set the contents of the IE as follows:
 - if the UE supports the capability to provide the GPS timing of the cell, and
 - if the IE "GPS timing of Cell wanted" is set to true:
 - include the IE "Primary CPICH Info" for FDD or the IE "cell parameters id" for TDD; and
 - include the IE "Reference SFN", the IE "GPS TOW msec"; and
 - the UE may include the IE "GPS TOW rem usec";
 - if the IE "Positioning Methods" is set to "OTDOA":
 - when a measurement report is triggered:
 - include the IE "UE positioning position estimate info" in the measurement report;
- if the IE "Method Type" is set to "UE assisted":
 - if the IE "Positioning Methods" is set to "GPS":
 - when a measurement report is triggered:
 - include the IE "UE positioning GPS measured results" in the measurement report and set the contents of the IE as follows:
 - if the UE supports the capability to provide the GPS timing of the cell, and
 - if the IE "GPS timing of Cell wanted" is set to true:
 - include the IE "Primary CPICH Info" for FDD or the IE "cell parameters id" for TDD; and
 - include the IE "Reference SFN", the IE "GPS TOW msec"; and
 - the UE may include the IE "GPS TOW rem usec";
 - if the UE does not support the capability to provide the GPS timing of the cell:
 - include the IE "GPS TOW msec";
 - if the IE "Positioning Methods" is set to "OTDOA":
 - when a measurement report is triggered:
 - include the IE "UE positioning OTDOA measured results" in the measurement report.

The UE shall perform the following consistency check:

- if UE, according to its capabilities, does not support UE based OTDOA and if IE "Positioning Methods" is set to "OTDOA" and if IE "Method Type" is set to "UE based":
 - act as specified in subclause 8.4.1.4;
- if UE, according to its capabilities, does not support UE based GPS and if IE "Positioning Methods" is set to "GPS" and if IE "Method Type" is set to "UE based":

- act as specified in subclause 8.4.1.4;
- if UE, according to its capabilities, does not support UE assisted GPS and if IE "Positioning Methods" is set to "GPS" and if IE "Method Type" is set to "UE assisted":
 - act as specified in subclause 8.4.1.4;
- if UE, according to its capabilities, does not support UE based positioning and if IE "Positioning Methods" is set to "OTDOAorGPS" and if IE "Method Type" is set to "UE based":
 - act as specified in subclause 8.4.1.4;
- if UE, according to its capabilities, does not support Rx-Tx time difference type 2 measurement and if IE "Positioning Methods" is set to "Cell ID":
 - act as specified in subclause 8.4.1.4.

8.6.7.19.2 UE positioning OTDOA assistance data

If IE "UE positioning OTDOA reference cell info" is received in System Information Block type 15.4 or in the MEASUREMENT CONTROL message, the UE shall update the variable UE_POSITIONING_OTDOA_DATA accordingly. The UE shall:

- store received cell information in the UE positioning reference cell info in the variable UE_POSITIONING_OTDOA_DATA, overwriting any existing information.

If IE "UE positioning OTDOA neighbour cell list" is received in System Information Block type 15.4 or in the MEASUREMENT CONTROL message, the UE shall update the variable UE_POSITIONING_OTDOA_DATA accordingly. The UE shall:

- store received cell information in the neighbour cell info list in the variable CELL_INFO_LIST, overwriting any existing information.

If, according to its capabilities, UE does not support IPDLs and if IE "IPDL parameters" is received for the reference or any of the neighbour cells, the UE shall:

- ignore this IE.

If IE "UE positioning measurement" is received in the MEASUREMENT CONTROL message, the UE shall also perform the following consistency checks:

- if IE "Positioning Methods" is set to "OTDOA" or "Cell ID":
 - if IE "UE positioning OTDOA reference cell info" is not included and if UE positioning OTDOA reference cell info in variable UE_POSITIONING_OTDOA_DATA is empty:
 - set the variable CONFIGURATION_INCOMPLETE to TRUE;
- if IE "Positioning Methods" is set to "OTDOA":
 - if IE "UE positioning OTDOA neighbour cell list" is not included and if less than two neighbour cells are stored in UE positioning OTDOA neighbour cell info list in variable UE_POSITIONING_OTDOA_DATA:
 - set the variable CONFIGURATION_INCOMPLETE to TRUE;
 - if IE "Method Type" is set to "UE based":
 - if IE "UE positioning OTDOA reference cell info" is included and if IE "Cell Position" for the reference cell is not included:
 - set the variable CONFIGURATION_INCOMPLETE to TRUE;
 - if the IE "UE positioning OTDOA neighbour cell list" is included and if cell position of less than two neighbour cells of the cells included in this IE and stored in variable UE_POSITIONING_OTDOA_DATA are different and if those cell positions are not different to the one of the reference cell stored in variable UE_POSITIONING_OTDOA_DATA:

- set the variable CONFIGURATION_INCOMPLETE to TRUE;
- if the IE "UE positioning OTDOA neighbouring cell list" is included and only two neighbour cells are included or stored in variable UE_POSITIONING_OTDOA_DATA and if the IE "Round Trip Time" is neither included for the neighbour cells nor for the reference cell info:
 - set the variable CONFIGURATION_INCOMPLETE to TRUE.

8.6.7.19.3 UE positioning GPS assistance data

8.6.7.19.3.1 UE positioning GPS acquisition assistance

If the IE "UE positioning GPS acquisition assistance" is included, the UE shall:

- store IE "GPS reference time" in the IE "UE positioning reference time" in UE_POSITIONING_GPS_DATA;
- for each satellite:
 - update the variable UE_POSITIONING_GPS_DATA as follows:
 - store received GPS acquisition assistance at the position indicated by the IE "Sat ID" in the IE "UE positioning GPS acquisition assistance" in the variable UE_POSITIONING_GPS_DATA, possibly overwriting any existing information in this position.

8.6.7.19.3.2 UE positioning GPS Almanac

If the IE "UE positioning GPS Almanac" is included, for each satellite, the UE shall:

- update the variable UE_POSITIONING_GPS_DATA as follows:
 - store received GPS almanac information at the position indicated by the IE "Sat ID" in the IE "UE positioning GPS Almanac" in the variable UE_POSITIONING_GPS_DATA, possibly overwriting any existing information in this position.

8.6.7.19.3.3 UE positioning D-GPS Corrections

If the IE "UE positioning GPS DGPS corrections" is included, the UE shall:

- delete all information currently stored in the IE "UE positioning GPS DGPS corrections" in the variable UE_POSITIONING_GPS_DATA;
- store the received DGPS corrections in the IE "UE positioning GPS DGPS corrections" in the variable UE_POSITIONING_GPS_DATA.

8.6.7.19.3.4 UE positioning GPS Ephemeris and Clock Correction Parameters

If the IE "UE positioning GPS Ephemeris and Clock Correction parameters" is included, for each satellite, the UE shall:

- update the variable UE_POSITIONING_GPS_DATA as follows:
 - store received GPS ephemeris information at the position indicated by the IE "Sat ID" in the IE "UE positioning GPS Navigation Model" in the variable UE_POSITIONING_GPS_DATA, possibly overwriting any existing information in this position.

8.6.7.19.3.5 UE positioning GPS ionospheric model

If IE "UE positioning GPS ionospheric model" is included, the UE shall:

- store this IE in the IE "UE positioning GPS ionospheric model" in variable UE_POSITIONING_GPS_DATA.

8.6.7.19.3.6 UE positioning GPS real-time integrity

The GPS real-time integrity information element specified in subclause 10.3.7.95 is primarily intended for non-differential applications. The real-time integrity of the satellite constellation is of importance as there is no differential

correction data by which the UE can determine the soundness of each satellite signal. The Real-Time GPS Satellite Integrity data communicates the health of the constellation to the mobile via a list of bad satellites. The UE shall consider the data associated with the satellites identified in this IE as invalid.

If this is included, for each satellite, the UE shall:

- add the Sat IDs that are not yet included in the list of satellites in the IE "UE positioning GPS real time integrity" in the variable UE_POSITIONING_GPS_DATA;
- remove all Sat IDs in the list of satellites in the IE "UE positioning GPS real time integrity" in the variable UE_POSITIONING_GPS_DATA that are not included in IE UE positioning GPS real time integrity.

8.6.7.19.3.7 UE positioning GPS reference time

If the IE "UE positioning GPS reference time" is included, the UE shall:

- store this IE in "UE positioning GPS reference time" in variable UE_POSITIONING_GPS_DATA;
- for each satellite:
 - store received GPS TOW assist at the position indicated by the IE "Sat ID" in the IE "UE positioning GPS reference time" in the variable UE_POSITIONING_GPS_DATA, possibly overwriting any existing information in this position.

8.6.7.19.3.8 UE positioning GPS reference UE position

If the IE "UE positioning GPS reference UE position" is included, the UE shall:

- store this IE in the IE "UE positioning GPS reference UE position" in variable UE_POSITIONING_GPS_DATA.

8.6.7.19.3.9 UE positioning UTC model

If the IE "UE positioning GPS UTC model" is included, the UE shall:

- store this IE in the IE "UE positioning GPS UTC model" in variable UE_POSITIONING_GPS_DATA.

8.6.7.20 Void

8.6.8 Void

9 Handling of unknown, unforeseen and erroneous protocol data

9.1 General

This subclause specifies procedures for the handling of unknown, unforeseen, and erroneous protocol data by the receiving entity. These procedures are called "error handling procedures", but in addition to provide recovery mechanisms for error situations they define a compatibility mechanism for future extensions of the protocol.

The error handling procedures specified in this subclause shall apply to all RRC messages. When there is a specific handling for messages received on different logical channels this is specified.

For system information received on the BCCH, the error handling procedures are applied on the BCCH message SYSTEM INFORMATION, the re-assembled system information segments as well as the system information blocks (including the master information block and the scheduling blocks), with specific error handling as specified below.

When the UE receives an RRC message, it shall set the variable `PROTOCOL_ERROR_REJECT` to `FALSE` and then perform the checks in the order as defined below.

The procedures specified in clause 8 are applied only for the messages passing the checks as defined below, except when procedure specific handling is used to recover from the error.

The error cases specified in the following include the handling upon reception of spare values. This behaviour also applies in case the actual value of the IE results from mapping the originally sent IE value. Moreover, in certain error cases, as specified in the following, default values apply. In this case, the default values specified within the ASN.1, the tabular and the procedure specifications apply.

9.2 ASN.1 violation or encoding error

If the UE receives an RRC message on the DCCH for which the encoded message does not result in any valid abstract syntax value [49] (or "encoding error"), it shall perform the following. The UE shall:

- set the variable `PROTOCOL_ERROR_REJECT` to `TRUE`;
- transmit an RRC STATUS message on the uplink DCCH. The IE "Protocol error information" shall contain an IE "Protocol error cause" set to "ASN.1 violation or encoding error";
- when RRC STATUS message has been submitted to lower layers for transmission:
 - continue with any ongoing processes and procedures as if the invalid message had not been received.

If the UE receives an RRC message sent to the UE in an RRC information container via a radio access technology other than UTRAN, for which the encoded message does not result in any valid abstract syntax, the UE shall:

- set the variable `PROTOCOL_ERROR_REJECT` to `TRUE`;
- set the IE "Protocol error cause" in the variable `PROTOCOL_ERROR_INFORMATION` to "ASN.1 violation or encoding error";
- perform procedure specific error handling according to clause 8.

If a reassembled set of system information segments received in messages on the BCCH does not result in any valid abstract syntax value, the UE shall:

- ignore the reassembled set of system information segments;
- treat the rest of each message containing the ignored system information segments as if those segments were not present.

If the UE receives an RRC message on the BCCH, PCCH, CCCH or SHCCH for which the encoded message does not result in any valid abstract syntax value, it shall ignore the message.

9.3 Unknown or unforeseen message type

If a UE receives an RRC message on the DCCH with a message type not defined for the DCCH it shall:

- set the variable `PROTOCOL_ERROR_REJECT` to `TRUE`;
- transmit an RRC STATUS message on the uplink DCCH. The IE "Protocol error information" shall contain an IE "Protocol error cause" set to "Message type non-existent or not implemented";
- when the RRC STATUS message has been submitted to lower layers for transmission:
 - continue with any ongoing processes and procedures as if the invalid message had not been received.

If the UE receives an RRC message on the BCCH, PCCH, CCCH or SHCCH with a message type not defined for the logical channel type the message was received on, it shall ignore the message.

9.3a Unsolicited received message

If the UE receives any of the following messages:

- an RRC CONNECTION SETUP message addressed to the UE on the CCCH; or
- an RRC CONNECTION REJECT message addressed to the UE on the CCCH; or
- a UE CAPABILITY INFORMATION CONFIRM message on the DCCH; or
- a CELL UPDATE CONFIRM message addressed to the UE on the CCCH or on the DCCH; or
- a URA UPDATE CONFIRM message addressed to the UE on the CCCH or on the DCCH

and no procedure is ongoing according to clause 8 which expects the message to be received:

the UE shall:

- ignore the received message.

9.3b Unexpected critical message extension

If the UE receives an RRC message on the DCCH, or addressed to the UE on the CCCH or on the SHCCH, or sent to the UE in an RRC information container via a radio access technology other than UTRAN, containing an undefined critical message extension, the UE shall:

- set the variable `PROTOCOL_ERROR_REJECT` to TRUE;
- set the IE "Protocol error cause" in the variable `PROTOCOL_ERROR_INFORMATION` to "Message extension not comprehended";
- if the IE "Message Type" of the received message is not present in the table "Rejected transactions" in the variable `TRANSACTIONS`:
 - store the IE "Message type" of the received message in the table "Rejected transactions" in the variable `TRANSACTIONS`; and
 - set the IE "RRC transaction identifier" to zero in that table entry;
- perform procedure specific error handling according to clause 8.

If the UE receives an RRC message on the BCCH or PCCH, containing an undefined critical message extension, the UE shall:

- ignore the message.

9.4 Unknown or unforeseen information element value, mandatory information element

If the UE receives an RRC message on the DCCH, or addressed to the UE on the CCCH or on the SHCCH, or sent to the UE in an RRC information container via a radio access technology other than UTRAN, with a mandatory IE having a value, including choice, reserved for future extension (spare), a value not used in this version of the specification or when the encoded IE does not result in any valid abstract syntax value [49] for this IE, the UE shall:

- if a default value of the IE is defined:
 - treat the rest of the message using the default value of the IE;
- if no default value of the IE is defined:

- set the variable `PROTOCOL_ERROR_REJECT` to `TRUE`;
- set the IE "Protocol error cause" in the variable `PROTOCOL_ERROR_INFORMATION` to "Information element value not comprehended";
- perform procedure specific error handling according to clause 8.

If the UE receives a system information block on the BCCH with a mandatory IE having a value reserved for future extension (spare), a value not used in this version of the specification or when the encoded IE does not result in any valid abstract syntax value for this IE, the UE shall:

- if a default value of the IE is defined:
 - treat the rest of the system information block using the default value of the IE;
- if no default value of the IE is defined:
 - ignore the system information block.

If the UE receives an RRC message on the BCCH or PCCH with a mandatory IE having a value reserved for future extension (spare), a value not used in this version of the specification or when the encoded IE does not result in any valid abstract syntax value for this IE, it shall

- if a default value of the IE is defined:
 - treat the rest of the message using the default value of the IE.
- if no default value of the IE is defined:
 - ignore the message.

9.5 Conditional information element error

If the UE receives an RRC message on the DCCH, BCCH, PCCH, or addressed to the UE on the CCCH or on the SHCCH, or sent to the UE in an RRC information container via a radio access technology other than UTRAN, for which the specified conditions for absence of a conditional IE are met and that IE is present, the UE shall:

- ignore the IE;
- treat the rest of the message as if the IE was not present.

If the UE receives an RRC message on the DCCH, or addressed to the UE on the CCCH or on the SHCCH, or sent to the UE via a radio access technology other than UTRAN, for which the specified conditions for presence of a conditional IE are met and that IE is absent, the UE shall:

- set the variable `PROTOCOL_ERROR_REJECT` to `TRUE`;
- set the IE "Protocol error cause" in the variable `PROTOCOL_ERROR_INFORMATION` to "Conditional information element error";
- perform procedure specific error handling according to clause 8.

If the UE receives a system information block on the BCCH for which the specified conditions for presence of a conditional IE are met and that IE is absent, the UE shall:

- ignore the system information block.

If the UE receives an RRC message on the BCCH or PCCH for which the specified conditions for presence of a conditional IE are met and that IE is absent, the UE shall:

- ignore the message.

9.6 Unknown or unforeseen information element value, conditional information element

If the UE receives an RRC message on the DCCH, or addressed to the UE on the CCCH or on the SHCCH, or sent to the UE in an RRC information container via a radio access technology other than UTRAN, for which the specified conditions for presence of a conditional IE are met, that IE is present, and that IE has a value, including choice, reserved for future extension (spare), a value not used in this version of the specification or when the encoded IE does not result in any valid abstract syntax value [49] for this IE, the UE shall:

- if a default value of the IE is defined:
 - treat the rest of the message using the default value of the IE;
- if no default value of the IE is defined:
 - set the variable `PROTOCOL_ERROR_REJECT` to `TRUE`;
 - set the IE "Protocol error cause" in the variable `PROTOCOL_ERROR_INFORMATION` to "Information element value not comprehended";
 - perform procedure specific error handling according to clause 8.

If the UE receives a system information block on the BCCH for which the specified conditions for presence of a conditional IE are met, that IE is present, and that IE has a value, including choice, reserved for future extension (spare), a value not used in this version of the specification or when the encoded IE does not result in any valid abstract syntax value for this IE, the UE shall:

- if a default value of the IE is defined:
 - treat the rest of the system information block using the default value of the IE;
- if no default value of the IE is defined:
 - ignore the system information block.

If the UE receives an RRC message on the BCCH or PCCH for which the specified conditions for presence of a conditional IE are met, that IE is present, and that IE has a value, including choice, reserved for future extension (spare), a value not used in this version of the specification or when the encoded IE does not result in any valid abstract syntax value for this IE, the UE shall:

- if a default value of the IE is defined:
 - treat the rest of the message using the default value of the IE;
- if no default value of the IE is defined:
 - ignore the message.

9.7 Unknown or unforeseen information element value, optional information element

If the UE receives an RRC message on the DCCH, or addressed to the UE on the CCCH or on the SHCCH, or sent to the UE in an RRC information container via a radio access technology other than UTRAN, with an optional IE having a value, including choice, reserved for future extension (spare), a value not used in this version of the specification or when the encoded IE does not result in any valid abstract syntax value [49] for this IE, it shall:

- ignore the value of the IE;
- treat the rest of the message as if the IE was not present.

If the UE receives a system information block on the BCCH with an optional IE having a value, including choice, reserved for future extension (spare), a value not used in this version of the specification or when the encoded IE does not result in any valid abstract syntax value for this IE, it shall:

- ignore the value of the IE;
- treat the rest of the system information block as if the IE was not present.

If the UE receives an RRC message on the BCCH or PCCH with an optional IE having a value, including choice, reserved for future extension (spare), a value not used in this version of the specification or when the encoded IE does not result in any valid abstract syntax value for this IE, it shall:

- ignore the value of the IE;
- treat the rest of the message as if the IE was not present.

9.8 Unexpected non-critical message extension

If the UE receives an RRC message on the DCCH, or addressed to the UE on the CCCH or on the SHCCH, or sent to the UE in an RRC information container via a radio access technology other than UTRAN, containing an undefined non-critical message extension, the UE shall:

- ignore the content of the extension and the message contents after the extension, but treat the parts of the message up to the extension normally.

If the UE receives a system information block on the BCCH containing an undefined non-critical message extension, the UE shall:

- ignore the content of the extension and the system information block contents after the extension, but treat the parts of the system information block up to the extension normally.

If the UE receives an RRC message on the BCCH or PCCH, containing an undefined non-critical message extension, the UE shall:

- ignore the content of the extension and the message contents after the extension, but treat the parts of the message up to the extension normally.

10 Message and information element functional definition and content

10.1 General

The function of each Radio Resource Control message together with message contents in the form of a list of information elements is defined in subclause 10.2.

Functional definitions of the information elements are then described in subclause 10.3.

Information elements are marked as either MP - Mandatory present, MD - Mandatory with default value, OP - Optional, CV - Conditional on value or CH - Conditional on history (see Table 10.1 with information extracted from [14]).

Table 10.1: Meaning of abbreviations used in RRC messages and information elements

Abbreviation	Meaning
MP	<p>Mandatory present</p> <p>A value for that information is always needed, and no information is provided about a particular default value. If ever the transfer syntax allows absence (e.g., due to extension), then absence leads to an error diagnosis.</p>
MD	<p>Mandatory with default value</p> <p>A value for that information is always needed, and a particular default value is mentioned (in the 'Semantical information' column). This opens the possibility for the transfer syntax to use absence or a special pattern to encode the default value.</p>
CV	<p>Conditional on value</p> <p>The need for a value for that information depends on the value of some other IE or IEs, and/or on the message flow (e.g., channel, SAP). The need is specified by means of a condition, the result of which may be that the information is mandatory present, mandatory with default value, not needed or optional.</p> <p>If one of the results of the condition is that the information is mandatory present, the transfer syntax must allow for the presence of the information. If in this case the information is absent an error is diagnosed.</p> <p>If one of the results of the condition is that the information is mandatory with default value, and a particular default value is mentioned (in the 'Semantical information' column), the transfer syntax may use absence or a special pattern to encode the default value.</p> <p>If one of the results of the condition is that the information is not needed, the transfer syntax must allow encoding the absence. If in this case the information is present, it will be ignored. In specific cases however, an error may be diagnosed instead.</p> <p>If one of the results of the condition is that the information is optional, the transfer syntax must allow for the presence of the information. In this case, neither absence nor presence of the information leads to an error diagnosis.</p>
CH	<p>Conditional on history</p> <p>The need for a value for that information depends on information obtained in the past (e.g., from messages received in the past from the peer). The need is specified by means of a condition, the result of which may be that the information is mandatory present, mandatory with default value, not needed or optional.</p> <p>The handling of the conditions is the same as described for CV.</p>
OP	<p>Optional</p> <p>The presence or absence is significant and modifies the behaviour of the receiver. However whether the information is present or not does not lead to an error diagnosis.</p>

10.1.1 Protocol extensions

RRC messages may be extended in future versions of this protocol, either by adding values for choices, enumerated and size constrained types or by adding information elements. An important aspect concerns the behaviour of a UE, conforming to this revision of the standard, upon receiving a not comprehended future extension. The details of this error handling behaviour are provided in clause 9.

NOTE 1: By avoiding the need for partial decoding (skipping uncomprehended IEs to continue decoding the remainder of the message), the RRC protocol extension mechanism also avoids the overhead of length determinants for extensions.

Two kinds of protocol extensions are distinguished: non-critical and critical extensions. In general, a receiver shall process a message including not comprehended non-critical extensions as if the extensions were absent. However, a receiver shall entirely reject a message including not comprehended critical extensions (there is no partial rejection) and notify the sender, as specified in clause 9.

The general mechanism for adding critical extensions is by defining a new version of the message, which is indicated at the beginning of the message.

The UE shall always comprehend the complete transfer syntax specified for the protocol version it supports; if the UE comprehends the transfer syntax defined within protocol version A for message 1, it shall also comprehend the transfer syntax defined within protocol version A for message 2.

The following table shows for which messages only non-critical extensions may be added while for others both critical and non-critical extensions may be added.

NOTE 2: Critical extensions can only be added to certain downlink messages.

Extensions	Message
Critical and non-critical extensions	ACTIVE SET UPDATE 10.2.1 ASSISTANCE DATA DELIVERY 10.2.4 CELL CHANGE ORDER FROM UTRAN 10.2.5 CELL UPDATE CONFIRM 10.2.8 COUNTER CHECK 10.2.9 DOWNLINK DIRECT TRANSFER 10.2.11 HANDOVER TO UTRAN COMMAND 10.2.12 HANDOVER FROM UTRAN COMMAND 10.2.15 MEASUREMENT CONTROL 10.2.17 PHYSICAL CHANNEL RECONFIGURATION 10.2.22 PHYSICAL SHARED CHANNEL ALLOCATION 10.2.25 RADIO BEARER RECONFIGURATION 10.2.27 RADIO BEARER RELEASE 10.2.30 RADIO BEARER SETUP 10.2.33 RRC CONNECTION REJECT 10.2.36 RRC CONNECTION RELEASE 10.2.37 RRC CONNECTION SETUP 10.2.40 SECURITY MODE COMMAND 10.2.43 SIGNALLING CONNECTION RELEASE 10.2.46 TRANSPORT CHANNEL RECONFIGURATION 10.2.50 UE CAPABILITY ENQUIRY 10.2.55 UE CAPABILITY INFORMATION CONFIRM 10.2.57 UPLINK PHYSICAL CHANNEL CONTROL 10.2.59 URA UPDATE CONFIRM 10.2.61 UTRAN MOBILITY INFORMATION 10.2.62
Non-critical extensions only	ACTIVE SET UPDATE COMPLETE 10.2.2 ACTIVE SET UPDATE FAILURE 10.2.3 CELL CHANGE ORDER FROM UTRAN FAILURE 10.2.6 CELL UPDATE 10.2.7 COUNTER CHECK RESPONSE 10.2.10 HANDOVER TO UTRAN COMPLETE 10.2.13 INITIAL DIRECT TRANSFER 10.2.14 HANDOVER FROM UTRAN FAILURE 10.2.16 MEASUREMENT CONTROL FAILURE 10.2.18 MEASUREMENT REPORT 10.2.19 PAGING TYPE 1 10.2.20 PAGING TYPE 2 10.2.21 PHYSICAL CHANNEL RECONFIGURATION COMPLETE 10.2.23 PHYSICAL CHANNEL RECONFIGURATION FAILURE 10.2.24 PUSCH CAPACITY REQUEST 10.2.26 RADIO BEARER RECONFIGURATION COMPLETE 10.2.28 RADIO BEARER RECONFIGURATION FAILURE 10.2.29 RADIO BEARER RELEASE COMPLETE 10.2.31 RADIO BEARER RELEASE FAILURE 10.2.32 RADIO BEARER SETUP COMPLETE 10.2.34 RADIO BEARER SETUP FAILURE 10.2.35 RRC CONNECTION RELEASE COMPLETE 10.2.38 RRC CONNECTION REQUEST 10.2.39 RRC CONNECTION SETUP COMPLETE 10.2.41 RRC STATUS 10.2.42 SECURITY MODE COMPLETE 10.2.44 SECURITY MODE FAILURE 10.2.45 SIGNALLING CONNECTION RELEASE INDICATION 10.2.47 Master Information Block 10.2.48.8.1 System Information Block type 1 to System Information Block type 17 10.2.48.8.2 to 10.2.48.8.19 SYSTEM INFORMATION CHANGE INDICATION 10.2.49 TRANSPORT CHANNEL RECONFIGURATION COMPLETE 10.2.51 TRANSPORT CHANNEL RECONFIGURATION FAILURE 10.2.52 TRANSPORT FORMAT COMBINATION CONTROL 10.2.53 TRANSPORT FORMAT COMBINATION CONTROL FAILURE 10.2.54 UE CAPABILITY INFORMATION 10.2.56 UPLINK DIRECT TRANSFER 10.2.58 URA UPDATE 10.2.60 UTRAN MOBILITY INFORMATION CONFIRM 10.2.63 UTRAN MOBILITY INFORMATION FAILURE 10.2.64
No extensions	SYSTEM INFORMATION 10.2.48

Extensions	Message
	First Segment 10.2.48.1 Subsequent or last Segment 10.2.48.3 Complete SIB 10.2.48.5 SIB content 10.2.48.8.1

NOTE: For the SYSTEM INFORMATION message protocol extensions are only possible at the level of system information blocks.

10.1.1.1 Non-critical extensions

10.1.1.1.1 Extension of an information element with additional values or choices

In future versions of this protocol, non-critical values may be added to choices, enumerated and size constrained types.

For choices, enumerated and size constrained types it is possible to indicate how many non-critical spare values need to be reserved for future extension. In this case, the tabular format should indicate the number of spare values that are needed. Within the ASN.1 spare values should only be used to increase the encoded size of an IE. This means that the ASN.1 should only include spares if the number of spare values that is needed exceeds the number of undefined code points that exist after encoding of the information element.

For downlink messages, spare values may be defined for non-critical information elements for which the need is specified to be MD or OP (or CV case leading to MD or OP). In this case, a receiver not comprehending the received spare value shall consider the information element to have the default value or consider it to be absent respectively.

For uplink messages spare values may be defined for all information elements, including those for which the need is specified to be MP (or CV case leading to MP).

In all cases at most one spare should be defined for choices. In this case, information elements applicable to the spare choices shall be added to the end of the message.

10.1.1.1.2 Extension of a message with additional information elements

In future versions of this protocol, non-critical information elements may be added to RRC messages. These additional information elements shall be appended at the end of the message; the transfer syntax specified in this revision of the standard facilitates this. A receiver conformant to this revision of the standard shall accept such extension, and proceed as if it was not included.

10.1.1.2 Critical extensions

10.1.1.2.1 Extension of an information element with additional values or choices

In versions of this protocol, choices, enumerated and size constrained types may be extended with critical values. For extension with critical values the general critical extension mechanism is used, i.e. for this no spare values are reserved since backward compatibility is not required.

10.1.1.2.2 Extension of a message with additional information elements

In future versions of this protocol, RRC messages may be extended with new information elements. Since messages including critical extensions are rejected by receivers not comprehending them, these messages may be modified completely, e.g. IEs may be inserted at any place and IEs may be removed or redefined.

10.2 Radio Resource Control messages

10.2.1 ACTIVE SET UPDATE

NOTE: Only for FDD.

This message is used by UTRAN to add, replace or delete radio links in the active set of the UE.

RLC-SAP: AM or UM

Logical channel: DCCH

Direction: UTRAN → UE

Information Element/Group name	Need	Multi	Type and reference	Semantics description
Message Type	MP		Message Type	
UE information elements				
RRC transaction identifier	MP		RRC transaction identifier 10.3.3.36	
Integrity check info	CH		Integrity check info 10.3.3.16	
Integrity protection mode info	OP		Integrity protection mode info 10.3.3.19	
Ciphering mode info	OP		Ciphering mode info 10.3.3.5	
Activation time	MD		Activation time 10.3.3.1	Default value is "now".
New U-RNTI	OP		U-RNTI 10.3.3.47	
CN information elements				
CN Information info	OP		CN Information info 10.3.1.3	
RB information elements				
Downlink counter synchronisation info	OP			
>RB with PDCP information list	OP	1 to <maxRBall RABs>		This IE is needed for each RB having PDCP in the case of lossless SRNS relocation
>>RB with PDCP information	MP		RB with PDCP information 10.3.4.22	
Phy CH information elements				
Uplink radio resources				
Maximum allowed UL TX power	MD		Maximum allowed UL TX power 10.3.6.39	Default value is the existing "maximum UL TX power."
Downlink radio resources				
Radio link addition information	OP	1 to <maxRL-1>		Radio link addition information required for each RL to add
>Radio link addition information	MP		Radio link addition information 10.3.6.68	
Radio link removal information	OP	1 to <maxRL>		Radio link removal information required for each RL to remove
>Radio link removal information	MP		Radio link removal information 10.3.6.69	
TX Diversity Mode	MD		TX Diversity Mode 10.3.6.86	Default value is the existing TX diversity mode.
SSDT information	OP		SSDT information 10.3.6.77	

10.2.2 ACTIVE SET UPDATE COMPLETE

NOTE: For FDD only.

This message is sent by UE when active set update has been completed.

RLC-SAP: AM

Logical channel: DCCH

Direction: UE→UTRAN

Information Element/Group name	Need	Multi	Type and reference	Semantics description
Message Type	MP		Message Type	
UE information elements				
RRC transaction identifier	MP		RRC transaction identifier 10.3.3.36	
Integrity check info	CH		Integrity check info 10.3.3.16	
Uplink integrity protection activation info	OP		Integrity protection activation info 10.3.3.17	
RB Information elements				
Radio bearer uplink ciphering activation time info	OP		RB activation time info 10.3.4.13	
Uplink counter synchronisation info	OP			
>RB with PDCP information list	OP	1 to <maxRBall RABs>		This IE is needed for each RB having PDCP in the case of lossless SRNS relocation
>>RB with PDCP information	MP		RB with PDCP information 10.3.4.22	
>START list	MP	1 to <maxCNdo mains>		START [40] values for all CN domains.
>>CN domain identity	MP		CN domain identity 10.3.1.1	
>>START	MP		START 10.3.3.38	START value to be used in this CN domain.

10.2.3 ACTIVE SET UPDATE FAILURE

NOTE: Only for FDD.

This message is sent by UE if the update of the active set has failed, e.g. because the radio link is not a part of the active set.

RLC-SAP: AM

Logical channel: DCCH

Direction: UE→UTRAN

Information Element/Group name	Need	Multi	Type and reference	Semantics description
Message Type	MP		Message Type	
UE information elements				
RRC transaction identifier	MP		RRC transaction identifier 10.3.3.36	
Integrity check info	CH		Integrity check info 10.3.3.16	
Failure cause	MP		Failure cause and error information 10.3.3.14	

10.2.4 ASSISTANCE DATA DELIVERY

This message is sent by UTRAN to convey UE positioning assistance data to the UE.

RLC-SAP: AM

Logical channel: DCCH

Direction: UTRAN→UE

Information Element/Group name	Need	Multi	Type and reference	Semantics description
Message Type	MP		Message Type	
UE information elements				
RRC transaction identifier	MP		RRC transaction identifier 10.3.3.36	
Integrity check info	CH		Integrity check info 10.3.3.16	
Measurement Information elements				
UE positioning OTDOA assistance data	OP		UE positioning OTDOA assistance data 10.3.7.103	
UE positioning GPS assistance data	OP		UE positioning GPS assistance data 10.3.7.90	

10.2.5 CELL CHANGE ORDER FROM UTRAN

This message is used to order a cell change from UTRA to another radio access technology, e.g., GSM.

RLC-SAP: AM

Logical channel: DCCH

Direction: UTRAN→UE

Information Element/Group name	Need	Multi	Type and reference	Semantics description
Message Type	MP		Message Type	
UE information elements				
RRC transaction identifier	MP		RRC transaction identifier 10.3.3.36	
Integrity check info	CH		Integrity check info 10.3.3.16	
Activation time	MD		Activation time 10.3.3.1	Default value is "now"
RB Information elements				
RAB information list	OP	1 to <maxRABs etup>		For each RAB to be handed over
>RAB info	MP		RAB info 10.3.4.8	
Other information elements				
Target cell description	MP			
>CHOICE <i>Radio Access Technology</i>	MP			At least one spare choice, Criticality: Reject, is needed.
>>GSM				
>>>BSIC	MP		BSIC 10.3.8.2	
>>>Band Indicator	MP		Enumerated (DCS 1800 band used, PCS 1900 band used)	Indicates how to interpret the BCCH ARFCN
>>>BCCH ARFCN	MP		Integer (0..1023)	[45]
>>>NC mode	OP		Bit string(3)	[43]
>>IS-2000				

10.2.6 CELL CHANGE ORDER FROM UTRAN FAILURE

This message is sent on the RRC connection used before the Cell change order from UTRAN was executed. The message indicates that the UE has failed to seize the new channel in the other radio access technology.

RLC-SAP: AM

Logical channel: DCCH

Direction: UE→UTRAN

Information Element/Group name	Need	Multi	Type and reference	Semantics description
Message Type	MP		Message Type	
UE information elements				
RRC transaction identifier	MP		RRC transaction identifier 10.3.3.36	
Integrity check info	CH		Integrity check info 10.3.3.16	
Other information elements				
Inter-RAT change failure	MP		Inter-RAT change failure 10.3.8.5	

10.2.7 CELL UPDATE

This message is used by the UE to initiate a cell update procedure.

RLC-SAP: TM

Logical channel: CCCH

Direction: UE→UTRAN

Information Element/Group name	Need	Multi	Type and reference	Semantics description
Message Type	MP		Message Type	
UE information elements				
U-RNTI	MP		U-RNTI 10.3.3.47	
RRC transaction identifier	<i>CV-Failure</i>		RRC transaction identifier 10.3.3.36	
Integrity check info	CH		Integrity check info 10.3.3.16	
START list	MP	1 to <maxCNdo mains>		START [40] values for all CN domains.
>CN domain identity	MP		CN domain identity 10.3.1.1	
>START	MP		START 10.3.3.38	START value to be used in this CN domain.
AM_RLC error indication(RB2, RB3 or RB4)	MP		Boolean	TRUE indicates AM_RLC unrecoverable error [16] occurred on RB2, RB3 or RB4 in the UE
AM_RLC error indication(RB>4)	MP		Boolean	TRUE indicates AM_RLC unrecoverable error [16] occurred on RB>4 in the UE
Cell update cause	MP		Cell update cause 10.3.3.3	
Failure cause	OP		Failure cause and error information 10.3.3.14	
RB timer indicator	MP		RB timer indicator 10.3.3.28	
Measurement information elements				
Measured results on RACH	OP		Measured results on RACH 10.3.7.45	

Condition	Explanation
<i>Failure</i>	This IE is mandatory present if the IE "Failure cause" is present and not needed otherwise.

10.2.8 CELL UPDATE CONFIRM

This message confirms the cell update procedure and can be used to reallocate new RNTI information for the UE valid in the new cell.

RLC-SAP: UM

Logical channel: CCCH or DCCH

Direction: UTRAN→UE

Information Element/Group name	Need	Multi	Type and reference	Semantics description
Message Type	MP		Message Type	
UE Information Elements				
U-RNTI	CV-CCCH		U-RNTI 10.3.3.47	
RRC transaction identifier	MP		RRC transaction identifier 10.3.3.36	
Integrity check info	CH		Integrity check info 10.3.3.16	
Integrity protection mode info	OP		Integrity protection mode info 10.3.3.19	
Ciphering mode info	OP		Ciphering mode info 10.3.3.5	
Activation time	MD		Activation time 10.3.3.1	Default value is "now"
New U-RNTI	OP		U-RNTI 10.3.3.47	
New C-RNTI	OP		C-RNTI 10.3.3.8	
RRC State Indicator	MP		RRC State Indicator 10.3.3.10	
UTRAN DRX cycle length coefficient	MD		UTRAN DRX cycle length coefficient 10.3.3.49	Default value is the existing DRX cycle length coefficient
RLC re-establish indicator (RB2, RB3 and RB4)	MP		RLC re-establish indicator 10.3.3.35	
RLC re-establish indicator (RB5 and upwards)	MP		RLC re-establish indicator 10.3.3.35	
CN Information Elements				
CN Information info	OP		CN Information info 10.3.1.3	
UTRAN Information Elements				
URA identity	OP		URA identity 10.3.2.6	
RB information elements				
RB information to release list	OP	1 to <maxRB>		
>RB information to release	MP		RB information to release 10.3.4.19	
RB information to reconfigure list	OP	1 to <maxRB>		
>RB information to reconfigure	MP		RB information to reconfigure 10.3.4.18	
RB information to be affected list	OP	1 to <maxRB>		
>RB information to be affected	MP		RB information	

Information Element/Group name	Need	Multi	Type and reference	Semantics description
			to be affected 10.3.4.17	
Downlink counter synchronisation info	OP			
>RB with PDCP information list	OP	1 to <maxRBall RABs>		This IE is needed for each RB having PDCP in the case of lossless SRNS relocation
>>RB with PDCP information	MP		RB with PDCP information 10.3.4.22	
TrCH Information Elements				
Uplink transport channels				
UL Transport channel information common for all transport channels	OP		UL Transport channel information common for all transport channels 10.3.5.24	
Deleted TrCH information list	OP	1 to <maxTrCH >		
>Deleted UL TrCH information	MP		Deleted UL TrCH information 10.3.5.5	
Added or Reconfigured TrCH information list	OP	1 to <maxTrCH >		
>Added or Reconfigured UL TrCH information	MP		Added or Reconfigured UL TrCH information 10.3.5.2	
CHOICE <i>mode</i>	MP			
>FDD				
>>CPCH set ID	OP		CPCH set ID 10.3.5.3	
>>Added or Reconfigured TrCH information for DRAC list	OP	1 to <maxTrCH >		
>>>DRAC static information	MP		DRAC static information 10.3.5.7	
>TDD				(no data)
Downlink transport channels				
DL Transport channel information common for all transport channels	OP		DL Transport channel information common for all transport channels 10.3.5.6	
Deleted TrCH information list	OP	1 to <maxTrCH >		
>Deleted DL TrCH information	MP		Deleted DL TrCH information 10.3.5.4	
Added or Reconfigured TrCH information list	OP	1 to <maxTrCH >		

Information Element/Group name	Need	Multi	Type and reference	Semantics description
>Added or Reconfigured DL TrCH information	MP		Added or Reconfigured DL TrCH information 10.3.5.1	
PhyCH information elements				
Frequency info	MD		Frequency info 10.3.6.36	Default value is the existing value of frequency information
Uplink radio resources				
Maximum allowed UL TX power	MD		Maximum allowed UL TX power 10.3.6.39	Default value is the existing maximum UL TX power
CHOICE channel requirement				
>Uplink DPCH info			Uplink DPCH info 10.3.6.88.	
>CPCH SET Info			CPCH SET Info 10.3.6.13	
Downlink radio resources				
CHOICE mode	MP			
>FDD				
>>Downlink PDSCH information	OP		Downlink PDSCH information 10.3.6.30	
>TDD				(no data)
Downlink information common for all radio links	OP		Downlink information common for all radio links 10.3.6.24	
Downlink information per radio link list	OP	1 to <maxRL>		Send downlink information for each radio link to be set-up
>Downlink information for each radio link	MP		Downlink information for each radio link 10.3.6.27	

Condition	Explanation
CCCH	This IE is mandatory present when CCCH is used and ciphering is not required and not needed otherwise.

10.2.9 COUNTER CHECK

This message is used by the UTRAN to indicate the current COUNT-C MSB values associated to each radio bearer utilising UM or AM RLC mode and to request the UE to compare these to its COUNT-C MSB values and to report the comparison results to UTRAN.

RLC-SAP: AM

Logical channel: DCCH

Direction: UTRAN→UE

Information Element/Group name	Presence	Multi	IE type and reference	Semantics description
Message Type	MP			
UE information elements				
RRC transaction identifier	MP		RRC transaction identifier 10.3.3.36	
Integrity check info	MP		Integrity check info 10.3.3.16	
RB information elements				
RB COUNT-C MSB information	MP	1 to < maxRBallR ABs >		For each RB (excluding signalling radio bearers) using UM or AM RLC.
>RB COUNT-C MSB information	MP		RB COUNT-C MSB information 10.3.4.14	

10.2.10 COUNTER CHECK RESPONSE

This message is used by the UE to respond to a COUNTER CHECK message.

RLC-SAP: AM

Logical channel: DCCH

Direction: UE→UTRAN

Information Element/Group name	Presence	Multi	IE type and reference	Semantics description
Message Type	MP			
UE information elements				
RRC transaction identifier	MP		RRC transaction identifier 10.3.3.36	
Integrity check info	MP		Integrity check info 10.3.3.16	
RB information elements				
RB COUNT-C information	OP	1 to < maxRBallR ABs >		
>RB COUNT-C information	MP		RB COUNT-C information 10.3.4.15	

10.2.11 DOWNLINK DIRECT TRANSFER

This message is sent by UTRAN to transfer higher layer messages.

RLC-SAP: AM

Logical channel: DCCH

Direction: UTRAN -> UE

Information Element/Group name	Need	Multi	Type and reference	Semantics description
Message Type	MP		Message Type	
UE information elements				
RRC transaction identifier	MP		RRC transaction identifier 10.3.3.36	
Integrity check info	CH		Integrity check info 10.3.3.16	
CN information elements				
CN Domain Identity	MP		Core Network Domain Identity 10.3.1.1	
NAS message	MP		NAS message 10.3.1.8	

10.2.12 HANDOVER TO UTRAN COMMAND

This message is sent to the UE via other system to make a handover to UTRAN.

RLC-SAP: N/A (Sent through a different RAT)

Logical channel: N/A (Sent through a different RAT)

Direction: UTRAN → UE

Information Element/Group name	Need	Multi	Type and reference	Semantics description
New U-RNTI	MP		U-RNTI Short 10.3.3.48	
Ciphering algorithm	OP		Ciphering algorithm 10.3.3.4	
CHOICE <i>specification mode</i>	MP			
>Complete specification				
RB information elements				
>>Signalling RB information to setup list	MP	1 to <maxSRBs etup>		For each signalling radio bearer established
>>>Signalling RB information to setup	MP		Signalling RB information to setup 10.3.4.24	
>>RAB information to setup list	OP	1 to <maxRABs etup>		For each RAB established
>>>RAB information for setup	MP		RAB information for setup 10.3.4.10	
Uplink transport channels				
>>UL Transport channel information common for all transport channels	MP		UL Transport channel information common for all transport channels 10.3.5.24	
>>Added or Reconfigured TrCH information	MP	1 to <maxTrCH >		
>>>Added or Reconfigured UL TrCH information	MP		Added or Reconfigured UL TrCH information 10.3.5.2	
Downlink transport channels				
>>DL Transport channel information common for all transport channels	MP		DL Transport channel information common for all transport channels 10.3.5.6	
>>Added or Reconfigured TrCH information	MP	1 to <maxTrCH >		
>>>Added or Reconfigured DL TrCH information	MP		Added or Reconfigured DL TrCH information 10.3.5.1	
Uplink radio resources				
>>Uplink DPCH info	MP		Uplink DPCH info 10.3.6.88	
>>CHOICE <i>mode</i>	MP			
>>>FDD				
>>>>CPCH SET Info	OP		CPCH SET Info 10.3.6.13	

Information Element/Group name	Need	Multi	Type and reference	Semantics description
Downlink radio resources				
>>>>Downlink PDSCH information	OP		Downlink PDSCH information 10.3.6.30	
>>>TDD				(no data)
>>Downlink information common for all radio links	MP		Downlink information common for all radio links 10.3.6.24	
>>Downlink information per radio link	MP	1 to <maxRL>		
>>>Downlink information for each radio link	MP		Downlink information for each radio link 10.3.6.27	
>Preconfiguration				
>>CHOICE <i>Preconfiguration mode</i>	MP			
>>>Predefined configuration	MP		Predefined configuration identity 10.3.4.5	
>>>Default configuration				
>>>>Default configuration mode	MP		Enumerated (FDD, TDD)	Indicates whether the FDD or TDD version of the default configuration shall be used
>>>>Default configuration identity	MP		Default configuration identity 10.3.4.0	
>>RAB info	OP		RAB info Post 10.3.4.9	One RAB is established
>>Uplink DPCH info	MP		Uplink DPCH info Post 10.3.6.89	
Downlink radio resources				
>>Downlink information common for all radio links	MP		Downlink information common for all radio links Post 10.3.6.25	
>>Downlink information per radio link	MP	1 to <maxRL>		Send downlink information for each radio link to be set-up. In TDD MaxRL is 1.
>>>Downlink information for each radio link	MP		Downlink information for each radio link Post 10.3.6.28	
>>CHOICE <i>mode</i>	MP			
>>>FDD				(no data)
>>>TDD				
>>>>Primary CCPCH Tx Power	MP		Primary CCPCH Tx Power 10.3.6.59	
Frequency info	MP		Frequency info	

Information Element/Group name	Need	Multi	Type and reference	Semantics description
Maximum allowed UL TX power	MP		10.3.6.36 Maximum allowed UL TX power 10.3.6.39	

10.2.13 HANDOVER TO UTRAN COMPLETE

This message is sent by the UE when a handover to UTRAN has been completed.

RLC-SAP: AM

Logical channel: DCCH

Direction: UE → UTRAN

Information Element/Group name	Need	Multi	Type and reference	Semantics description
Message Type	MP		Message Type	
UE Information elements				
START list	CH	1 to <maxCNdo mains>		START [40] values for all CN domains. The IE is mandatory if it has not been transferred prior to the handover.
>CN domain identity	MP		CN domain identity 10.3.1.1	
>START	MP		START 10.3.3.38	
RB Information elements				
COUNT-C activation time	OP		Activation time 10.3.3.1	Used for radio bearers mapped on RLC-TM.

10.2.14 INITIAL DIRECT TRANSFER

This message is used to initiate a signalling connection based on indication from the upper layers, and to transfer a NAS message.

RLC-SAP: AM

Logical channel: DCCH

Direction: UE → UTRAN

Information Element/Group name	Need	Multi	Type and reference	Semantics description
Message Type	MP		Message Type	
UE information elements				
Integrity check info	CH		Integrity check info 10.3.3.16	
CN information elements				
CN domain identity	MP		CN domain identity 10.3.1.1	
Intra Domain NAS Node Selector	MP		Intra Domain NAS Node Selector 10.3.1.6	
NAS message	MP		NAS message 10.3.1.8	
Measurement information elements				
Measured results on RACH	OP		Measured results on RACH 10.3.7.45	

10.2.15 HANDOVER FROM UTRAN COMMAND

This message is used for handover from UMTS to another system e.g. GSM. One or several messages from the other system can be included in the Inter-RAT message information element in this message. These messages are structured and coded according to that systems specification.

RLC-SAP: AM

Logical channel: DCCH

Direction: UTRAN→UE

Information Element/Group name	Need	Multi	Type and reference	Semantics description
Message Type	MP		Message Type	
UE information elements				
RRC transaction identifier	MP		RRC transaction identifier 10.3.3.36	
Integrity check info	CH		Integrity check info 10.3.3.16	
Activation time	MD		Activation time 10.3.3.1	Default value is "now"
RB information elements				
RAB information list	OP	1 to <maxRABs etup>		For each RAB to be handed over. In this version, the maximum size of the list of 1 shall be applied for all system types.
>RAB info	MP		RAB info 10.3.4.8	
Other information elements				
CHOICE <i>System type</i>	MP			This IE indicates which specification to apply, to decode the transported messages
>GSM				
>>Frequency band	MP		Enumerated (GSM/DCS 1800 band used), GSM/PCS 1900 band used)	
>>GSM message				
>>>Single GSM message	MP		Bit string (no explicit size constraint)	Formatted and coded according to GSM specifications The first bit of the bit string contains the first bit of the GSM message.
>>>GSM message List	MP	1.to.<maxl nterSysMe ssages>	Bit string (1..512)	Formatted and coded according to GSM specifications. The first bit of the bit string contains the first bit of the GSM message.
>cdma2000				
>>cdma2000MessageList	MP	1.to.<maxl nterSysMe ssages>		
>>>MSG_TYPE(s)	MP		Bit string (8)	Formatted and coded according to cdma2000 specifications. The MSG_TYPE bits are numbered b0 to b7, where b0 is the least significant bit.
>>>cdma2000Messagepayload(s)	MP		Bit string (1..512)	Formatted and coded according to cdma2000 specifications. The first bit of the bit string contains the first bit of the cdma2000 message.

10.2.16 HANDOVER FROM UTRAN FAILURE

This message is sent on the RRC connection used before the Inter-RAT Handover was executed. The message indicates that the UE has failed to seize the new channel in the other system.

RLC-SAP: AM

Logical channel: DCCH

Direction: UE→UTRAN

Information Element/Group name	Need	Multi	Type and reference	Semantics description
Message Type	MP		Message Type	
UE information elements				
RRC transaction identifier	MP		RRC transaction identifier 10.3.3.36	
Integrity check info	CH		Integrity check info 10.3.3.16	
Other information elements				
Inter-RAT handover failure	OP		Inter-RAT handover failure 10.3.8.6	
CHOICE <i>System type</i>	MP			This IE indicates which specification to apply to decode the transported messages
>GSM				
>GSM message List	MP	1.to.<maxInterSysMessages>	Bit string (1..512)	Formatted and coded according to GSM specifications. The first bit of the bit string contains the first bit of the GSM message.
>cdma2000				
>>cdma2000MessageList	MP	1.to.<maxInterSysMessages>		
>>>MSG_TYPE(s)	MP		Bit string (8)	Formatted and coded according to cdma2000 specifications. The MSG_TYPE bits are numbered b0 to b7, where b0 is the least significant bit.
>>>cdma2000Messagepayload(s)	MP		Bit string (1..512)	Formatted and coded according to cdma2000 specifications. The first bit of the bit string contains the first bit of the cdma2000 message.

10.2.17 MEASUREMENT CONTROL

This message is sent by UTRAN to setup, modify or release a measurement in the UE.

RLC-SAP: AM

Logical channel: DCCH

Direction: UTRAN→UE

Information Element/Group name	Need	Multi	Type and reference	Semantics description
Message Type	MP		Message Type	
UE information elements				
RRC transaction identifier	MP		RRC transaction identifier 10.3.3.36	
Integrity check info	CH		Integrity check info 10.3.3.16	
Measurement Information elements				
Measurement Identity	MP		Measurement Identity 10.3.7.48	
Measurement Command	MP		Measurement Command 10.3.7.46	
Measurement Reporting Mode	OP		Measurement Reporting Mode 10.3.7.49	
Additional measurements list	OP		Additional measurements list 10.3.7.1	
CHOICE <i>Measurement type</i>	<i>CV-command</i>			
>Intra-frequency measurement			Intra-frequency measurement 10.3.7.36	
>Inter-frequency measurement			Inter-frequency measurement 10.3.7.16	
>Inter-RAT measurement			Inter-RAT measurement 10.3.7.27	
>UE positioning measurement			UE positioning measurement 10.3.7.100	
>Traffic Volume measurement			Traffic Volume measurement 10.3.7.68	
>Quality measurement			Quality measurement 10.3.7.56	
>UE internal measurement			UE internal measurement 10.3.7.77	
Physical channel information elements				
DPCH compressed mode status info	OP		DPCH compressed mode status info 10.3.6.34	

Condition	Explanation
<i>Command</i>	The IE is mandatory present if the IE "Measurement command" is set to "Setup", optional if the IE "Measurement command" is set to "modify", otherwise the IE is not needed.

10.2.18 MEASUREMENT CONTROL FAILURE

This message is sent by UE, if it cannot initiate a measurement as instructed by UTRAN.

RLC-SAP: AM

Logical channel: DCCH

Direction: UE→UTRAN

Information Element/Group name	Need	Multi	Type and reference	Semantics description
Message Type	MP		Message Type	
UE information elements				
RRC transaction identifier	MP		RRC transaction identifier 10.3.3.36	
Integrity check info	CH		Integrity check info 10.3.3.16	
Failure cause	MP		Failure cause and error information 10.3.3.14	

10.2.19 MEASUREMENT REPORT

This message is used by UE to transfer measurement results to the UTRAN.

RLC-SAP: AM or UM

Logical channel: DCCH

Direction: UE→UTRAN

Information Element/Group name	Need	Multi	Type and reference	Semantics description
Message Type	MP		Message Type	
UE information elements				
Integrity check info	CH		Integrity check info 10.3.3.16	
Measurement Information Elements				
Measurement identity	MP		Measurement identity 10.3.7.48	
Measured Results	OP		Measured Results 10.3.7.44	
Measured Results on RACH	OP		Measured Results on RACH 10.3.7.45	
Additional Measured results	OP	1 to <maxAdditionalMeas>		
>Measured Results	MP		Measured Results 10.3.7.44	
Event results	OP		Event results 10.3.7.7	

10.2.20 PAGING TYPE 1

This message is used to send information on the paging channel. One or several UEs, in idle or connected mode, can be paged in one message, which also can contain other information.

RLC-SAP: TM

Logical channel: PCCH

Direction: UTRAN → UE

Information Element/Group name	Need	Multi	Type and reference	Semantics description
Message Type	MP		Message Type	
UE Information elements				
Paging record list	OP	1 to <maxPage 1>		
>Paging record	MP		Paging record 10.3.3.23	
Other information elements				
BCCH modification info	OP		BCCH modification info 10.3.8.1	

If the encoded message does not fill a transport block, the RRC layer shall add padding according to subclause 12.1.

10.2.21 PAGING TYPE 2

This message is used to page an UE in connected mode, when using the DCCH for CN originated paging.

RLC-SAP: AM

Logical channel: DCCH

Direction: UTRAN → UE

Information Element/Group name	Need	Multi	Type and reference	Semantics description
Message Type	MP		Message Type	
UE information elements				
RRC transaction identifier	MP		RRC transaction identifier 10.3.3.36	
Integrity check info	CH		Integrity check info 10.3.3.16	
Paging cause	MP		Paging cause 10.3.3.22	
CN Information elements				
CN domain identity	MP		CN domain identity 10.3.1.1	
Paging Record Type Identifier	MP		Paging Record Type Identifier 10.3.1.10	

10.2.22 PHYSICAL CHANNEL RECONFIGURATION

This message is used by UTRAN to assign, replace or release a set of physical channels used by a UE.

RLC-SAP: AM or UM

Logical channel: DCCH

Direction: UTRAN → UE

Information Element/Group name	Need	Multi	Type and reference	Semantics description
Message Type	MP		Message Type	
UE Information Elements				
RRC transaction identifier	MP		RRC transaction identifier 10.3.3.36	
Integrity check info	CH		Integrity check info 10.3.3.16	
Integrity protection mode info	OP		Integrity protection mode info 10.3.3.19	
Ciphering mode info	OP		Ciphering mode info 10.3.3.5	
Activation time	MD		Activation time 10.3.3.1	Default value is "now"
New U-RNTI	OP		U-RNTI 10.3.3.47	
New C-RNTI	OP		C-RNTI 10.3.3.8	
RRC State Indicator	MP		RRC State Indicator 10.3.3.10	
UTRAN DRX cycle length coefficient	MD		UTRAN DRX cycle length coefficient 10.3.3.49	Default value is the existing value of UTRAN DRX cycle length coefficient
CN Information Elements				
CN Information info	OP		CN Information info 10.3.1.3	
UTRAN mobility information elements				
URA identity	OP		URA identity 10.3.2.6	
RB information elements				
Downlink counter synchronisation info	OP			
>RB with PDCP information list	OP	1 to <maxRBall RABs>		This IE is needed for each RB having PDCP in the case of lossless SRNS relocation
>>RB with PDCP information	MP		RB with PDCP information 10.3.4.22	
PhyCH information elements				
Frequency info	MD		Frequency info 10.3.6.36	Default value is the existing value of frequency information
Uplink radio resources				
Maximum allowed UL TX power	MD		Maximum allowed UL TX power 10.3.6.39	Default value is the existing value of the maximum allowed UL TX power
<i>CHOICE channel requirement</i>				
>Uplink DPCH info			Uplink DPCH info 10.3.6.88	
>CPCH SET Info			CPCH SET Info 10.3.6.13	
>CPCH set ID			CPCH set ID	

Information Element/Group name	Need	Multi	Type and reference	Semantics description
			10.3.5.3	
Downlink radio resources				
CHOICE <i>mode</i>	MP			
>FDD				
>>Downlink PDSCH information	OP		Downlink PDSCH information 10.3.6.30	
>TDD				(no data)
Downlink information common for all radio links	OP		Downlink information common for all radio links 10.3.6.24	
Downlink information per radio link list	OP	1 to <maxRL>		Send downlink information for each radio link
>Downlink information for each radio link	MP		Downlink information for each radio link 10.3.6.27	

10.2.23 PHYSICAL CHANNEL RECONFIGURATION COMPLETE

This message is sent from the UE when a physical channel reconfiguration has been done.

RLC-SAP: AM

Logical channel: DCCH

Direction: UE → UTRAN

Information Element/Group name	Need	Multi	Type and reference	Semantics description	Version
Message Type	MP		Message Type		
UE information elements					
RRC transaction identifier	MP		RRC transaction identifier 10.3.3.36		
Integrity check info	CH		Integrity check info 10.3.3.16		
Uplink integrity protection activation info	OP		Integrity protection activation info 10.3.3.17		
CHOICE <i>mode</i>	MP				
>FDD				(no data)	
>TDD					
>>CHOICE <i>TDD option</i>	MP				REL-4
>>>3.84 Mcps TDD	MP				REL-4
>>>>Uplink Timing Advance	OP		Uplink Timing Advance 10.3.6.95		
>>>1.28 Mcps TDD				(no data)	REL-4
RB Information elements					
COUNT-C activation time	OP		Activation time 10.3.3.1	Used for radio bearers mapped on RLC-TM.	
Radio bearer uplink ciphering activation time info	OP		RB activation time info 10.3.4.13		
Uplink counter synchronisation info	OP				
>RB with PDCP information list	OP	1 to <maxRBall RABs>			
>>RB with PDCP information	MP		RB with PDCP information 10.3.4.22		
>START list	MP	1 to <maxCNdo mains>		START [40] values for all CN domains.	
>>CN domain identity	MP		CN domain identity 10.3.1.1		
>>>START	MP		START 10.3.3.38	START value to be used in this CN domain.	

10.2.24 PHYSICAL CHANNEL RECONFIGURATION FAILURE

This message is sent by UE if the configuration given by UTRAN is unacceptable or if the UE failed to assign, replace or release a set of physical channel(s).

RLC-SAP: AM

Logical channel: DCCH

Direction: UE→UTRAN

Information Element/Group name	Need	Multi	Type and reference	Semantics description
Message type	MP		Message type	
UE information elements				
RRC transaction identifier	OP		RRC transaction identifier 10.3.3.36	
Integrity check info	CH		Integrity check info 10.3.3.16	
Failure cause	MP		Failure cause and error information 10.3.3.14	

10.2.25 PHYSICAL SHARED CHANNEL ALLOCATION

NOTE: Only for TDD.

This message is used by UTRAN to assign physical resources to USCH/DSCH transport channels in TDD, for temporary usage by the UE.

RLC-SAP: UM on SHCCH, UM on DCCH

Logical channel: SHCCH or DCCH

Direction: UTRAN → UE

Information Element/Group name	Need	Multi	Type and reference	Semantics description
Message Type	MP		Message type	
C-RNTI	OP		C-RNTI 10.3.3.8	
RRC transaction identifier	MP		RRC transaction identifier 10.3.3.36	
Uplink timing advance Control	MD		Uplink Timing Advance Control 10.3.6.96	Default value is the existing value for uplink timing advance
PUSCH capacity allocation info	OP		PUSCH Capacity Allocation info 10.3.6.64	
PDSCH capacity allocation info	OP		PDSCH Capacity Allocation info 10.3.6.42	
Confirm request	MD		Enumerated(No Confirm, Confirm PDSCH, Confirm PUSCH)	Default value is No Confirm
Traffic volume report request	OP		Integer (0 .. 255)	Indicates the number of frames between start of the allocation period and sending measurement report. The value should be less than the value for Allocation Duration.
ISCP Timeslot list	OP	1 to maxTS		
>Timeslot number	MP		Timeslot number 10.3.6.84	Timeslot numbers, for which the UE shall report the timeslot ISCP in PUSCH CAPACITY REQUEST message.
Request P-CCPCH RSCP	MP		Boolean	TRUE indicates that a Primary CCPCH RSCP measurement shall be reported by the UE in PUSCH CAPACITY REQUEST message.

10.2.26 PUSCH CAPACITY REQUEST

NOTE: Only for TDD.

This message is used by the UE for request of PUSCH resources to the UTRAN.

RLC-SAP: TM

Logical channel: SHCCH

Direction: UE → UTRAN

Information Element/Group name	Need	Multi	Type and reference	Semantics description
Message Type	MP		Message Type	
C-RNTI	OP		C-RNTI 10.3.3.8	
RRC transaction identifier	CV-ProtErr		RRC transaction identifier 10.3.3.36	
Traffic Volume	OP		Traffic Volume, measured results list 10.3.7.67	
Timeslot list	OP	1 to maxTS		
>Timeslot number	MP		Timeslot number 10.3.6.84	
>Timeslot ISCP	MP		Timeslot ISCP info 10.3.7.65	
Primary CCPCH RSCP	OP		Primary CCPCH RSCP info 10.3.7.54	
CHOICE Allocation confirmation	OP			
>PDSCH Confirmation			Integer(1..hi PDSCHidentities)	
>PUSCH Confirmation			Integer(1..hi PUSCHidentities)	
Protocol error indicator	MD		Protocol error indicator 10.3.3.27	Default value is FALSE
Protocol error information	CV-ProtErr		Protocol error information 10.3.8.12	

Condition	Explanation
<i>ProtErr</i>	This IE is mandatory present if the IE "Protocol error indicator" has the value "TRUE". Otherwise it is not needed.

10.2.27 RADIO BEARER RECONFIGURATION

This message is sent from UTRAN to reconfigure parameters related to a change of QoS. This procedure can also change the multiplexing of MAC, reconfigure transport channels and physical channels.

RLC-SAP: AM or UM

Logical channel: DCCH

Direction: UTRAN → UE

Information Element/Group name	Need	Multi	Type and reference	Semantics description
Message Type	MP		Message Type	
UE Information elements				
RRC transaction identifier	MP		RRC transaction identifier 10.3.3.36	
Integrity check info	CH		Integrity check info 10.3.3.16	
Integrity protection mode info	OP		Integrity protection mode info 10.3.3.19	
Ciphering mode info	OP		Ciphering mode info 10.3.3.5	
Activation time	MD		Activation time 10.3.3.1	Default value is "now"
New U-RNTI	OP		U-RNTI 10.3.3.47	
New C-RNTI	OP		C-RNTI 10.3.3.8	
RRC State Indicator	MP		RRC State Indicator 10.3.3.10	
UTRAN DRX cycle length coefficient	MD		UTRAN DRX cycle length coefficient 10.3.3.49	Default value is the existing value of UTRAN DRX cycle length coefficient
CN information elements				
CN Information info	OP		CN Information info 10.3.1.3	
UTRAN mobility information elements				
URA identity	OP		URA identity 10.3.2.6	
RB information elements				
RAB information to reconfigure list	OP	1 to <maxRABse tup >		
>RAB information to reconfigure	MP		RAB information to reconfigure 10.3.4.11	
RB information to reconfigure list	MP	1to <maxRB>		Although this IE is not always required, need is MP to align with ASN.1
>RB information to reconfigure	MP		RB information to reconfigure 10.3.4.18	
RB information to be affected list	OP	1 to <maxRB>		
>RB information to be affected	MP		RB information to be affected 10.3.4.17	
TrCH Information Elements				
Uplink transport channels				
UL Transport channel	OP		UL Transport	

Information Element/Group name	Need	Multi	Type and reference	Semantics description
information common for all transport channels			channel information common for all transport channels 10.3.5.24	
Deleted TrCH information list	OP	1 to <maxTrCH >		
>Deleted UL TrCH information	MP		Deleted UL TrCH information 10.3.5.5	
Added or Reconfigured TrCH information list	OP	1 to <maxTrCH >		
>Added or Reconfigured UL TrCH information	MP		Added or Reconfigured UL TrCH information 10.3.5.2	
CHOICE mode	OP			
>FDD				
>>CPCH set ID	OP		CPCH set ID 10.3.5.3	
>>Added or Reconfigured TrCH information for DRAC list	OP	1 to <maxTrCH >		
>>>DRAC static information	MP		DRAC static information 10.3.5.7	
>TDD				(no data)
Downlink transport channels				
DL Transport channel information common for all transport channels	OP		DL Transport channel information common for all transport channels 10.3.5.6	
Deleted TrCH information list	OP	1 to <maxTrCH >		
>Deleted DL TrCH information	MP		Deleted DL TrCH information 10.3.5.4	
Added or Reconfigured TrCH information list	OP	1 to <maxTrCH >		
>Added or Reconfigured DL TrCH information	MP		Added or Reconfigured DL TrCH information 10.3.5.1	
PhyCH information elements				
Frequency info	MD		Frequency info 10.3.6.36	Default value is the existing value of frequency information
Uplink radio resources				
Maximum allowed UL TX power	MD		Maximum allowed UL TX power 10.3.6.39	Default value is the existing maximum UL TX power
CHOICE channel requirement	OP			

Information Element/Group name	Need	Multi	Type and reference	Semantics description
>Uplink DPCH info			Uplink DPCH info 10.3.6.88	
>CPCH SET Info			CPCH SET Info 10.3.6.13	
Downlink radio resources				
CHOICE <i>mode</i>	MP			
>FDD				
>>Downlink PDSCH information	OP		Downlink PDSCH information 10.3.6.30	
>TDD				(no data)
Downlink information common for all radio links	OP		Downlink information common for all radio links 10.3.6.24	
Downlink information per radio link list	MP	1 to <maxRL>		Although this IE is not always required, need is MP to align with ASN.1
>Downlink information for each radio link	MP		Downlink information for each radio link 10.3.6.27	

10.2.28 RADIO BEARER RECONFIGURATION COMPLETE

This message is sent from the UE when a RB and signalling link reconfiguration has been done.

RLC-SAP: AM

Logical channel: DCCH

Direction: UE → UTRAN

Information Element/Group name	Need	Multi	Type and reference	Semantics description	Version
Message Type	MP		Message Type		
UE information elements					
RRC transaction identifier	MP		RRC transaction identifier 10.3.3.36		
Integrity check info	CH		Integrity check info 10.3.3.16		
Uplink integrity protection activation info	OP		Integrity protection activation info 10.3.3.17		
CHOICE <i>mode</i>	MP				
>FDD				(no data)	
>TDD					
>>CHOICE <i>TDD option</i>	MP				REL-4
>>>3.84 Mcps TDD					REL-4
>>>>Uplink Timing Advance	OP		Uplink Timing Advance 10.3.6.95		
>>>1.28 Mcps TDD				(no data)	REL-4
RB Information elements					
COUNT-C activation time	OP		Activation time 10.3.3.1	Used for radio bearers mapped on RLC-TM.	
Radio bearer uplink ciphering activation time info	OP		RB activation time info 10.3.4.13		
Uplink counter synchronisation info	OP				
>RB with PDCP information list	OP	1 to <maxRBall RABs>			
>>RB with PDCP information	MP		RB with PDCP information 10.3.4.22		
>START list	MP	1 to <maxCNdo mains>		START [40] values for all CN domains.	
>>CN domain identity	MP		CN domain identity 10.3.1.1		
>>>START	MP		START 10.3.3.38	START value to be used in this CN domain.	

10.2.29 RADIO BEARER RECONFIGURATION FAILURE

This message is sent by UE if the configuration given by UTRAN is unacceptable or if the UE failed to establish the physical channel(s).

RLC-SAP: AM

Logical channel: DCCH

Direction: UE→UTRAN

Information Element/Group name	Need	Multi	Type and reference	Semantics description
Message Type	MP		Message Type	
UE information elements				
RRC transaction identifier	MP		RRC transaction identifier 10.3.3.36	
Integrity check info	CH		Integrity check info 10.3.3.16	
Failure cause	MP		Failure cause and error information 10.3.3.14	
RB information elements				
Radio bearers for which reconfiguration would have succeeded List	OP	1 to <maxRB>		
>Radio bearer for which reconfiguration would have succeeded	MP		RB identity, 10.3.4.16	

10.2.30 RADIO BEARER RELEASE

This message is used by UTRAN to release a radio bearer. It can also include modifications to the configurations of transport channels and/or physical channels. It can simultaneously indicate release of a signalling connection when UE is connected to more than one CN domain.

RLC-SAP: AM or UM

Logical channel: DCCH

Direction: UTRAN → UE

Information Element/Group name	Need	Multi	Type and reference	Semantics description
Message Type	MP		Message Type	
UE Information Elements				
RRC transaction identifier	MP		RRC transaction identifier 10.3.3.36	
Integrity check info	CH		Integrity check info 10.3.3.16	
Integrity protection mode info	OP		Integrity protection mode info 10.3.3.19	
Ciphering mode info	OP		Ciphering mode info 10.3.3.5	
Activation time	MD		Activation time 10.3.3.1	Default value is "now"
New U-RNTI	OP		U-RNTI 10.3.3.47	
New C-RNTI	OP		C-RNTI 10.3.3.8	
RRC State Indicator	MP		RRC State Indicator 10.3.3.10	
UTRAN DRX cycle length coefficient	MD		UTRAN DRX cycle length coefficient 10.3.3.49	Default value is the existing value of UTRAN DRX cycle length coefficient
CN Information Elements				
CN Information info	OP		CN Information info 10.3.1.3	
Signalling Connection release indication	OP		CN domain identity 10.3.1.1	
UTRAN mobility information elements				
URA identity	OP		URA identity 10.3.2.6	
RB Information Elements				
RAB information to reconfigure list	OP	1 to <maxRABse tup >		
>RAB information to reconfigure	MP		RAB information to reconfigure 10.3.4.11	
RB information to release list	MP	1 to <maxRB>		
>RB information to release	MP		RB information to release 10.3.4.19	
RB information to be affected list	OP	1 to <maxRB>		
>RB information to be affected	MP		RB information to be affected 10.3.4.17	
Downlink counter synchronisation info	OP			

Information Element/Group name	Need	Multi	Type and reference	Semantics description
>RB with PDCP information list	OP	1 to <maxRBall RABs>		This IE is needed for each RB having PDCP in the case of lossless SRNS relocation
>>RB with PDCP information	MP		RB with PDCP information 10.3.4.22	
TrCH Information Elements				
Uplink transport channels				
UL Transport channel information common for all transport channels	OP		UL Transport channel information common for all transport channels 10.3.5.24	
Deleted TrCH information list	OP	1 to <maxTrCH >		
>Deleted UL TrCH information	MP		Deleted UL TrCH information 10.3.5.5	
Added or Reconfigured TrCH information list	OP	1 to <maxTrCH >		
>Added or Reconfigured UL TrCH information	MP		Added or Reconfigured UL TrCH information 10.3.5.2	
CHOICE <i>mode</i>	OP			
>FDD				
>>CPCH set ID	OP		CPCH set ID 10.3.5.3	
>>Added or Reconfigured TrCH information for DRAC list	OP	1 to <maxTrCH >		
>>>DRAC static information	MP		DRAC static information 10.3.5.7	
>TDD				(no data)
Downlink transport channels				
DL Transport channel information common for all transport channels	OP		DL Transport channel information common for all transport channels 10.3.5.6	
Deleted TrCH information list	OP	1 to <maxTrCH >		
>Deleted DL TrCH information	MP		Deleted DL TrCH information 10.3.5.4	
Added or Reconfigured TrCH information list	OP	1 to <maxTrCH >		
>Added or Reconfigured DL TrCH information	MP		Added or Reconfigured DL TrCH information 10.3.5.1	

Information Element/Group name	Need	Multi	Type and reference	Semantics description
PhyCH information elements				
Frequency info	MD		Frequency info 10.3.6.36	Default value is the existing value of frequency information
Uplink radio resources				
Maximum allowed UL TX power	MD		Maximum allowed UL TX power 10.3.6.39	Default value is the existing maximum UL TX power
<i>CHOICE channel requirement</i>				
>Uplink DPCH info			Uplink DPCH info 10.3.6.88	
>CPCH SET Info			CPCH SET Info 10.3.6.13	
Downlink radio resources				
<i>CHOICE mode</i>				
>FDD	MP			
>>Downlink PDSCH information	OP		Downlink PDSCH information 10.3.6.30	
>TDD				(no data)
Downlink information common for all radio links	OP		Downlink information common for all radio links 10.3.6.24	
Downlink information per radio link list	OP	1 to <maxRL>		Send downlink information for each radio link to be set-up
>Downlink information for each radio link	MP		Downlink information for each radio link 10.3.6.27	

10.2.31 RADIO BEARER RELEASE COMPLETE

This message is sent from the UE when radio bearer release has been completed.

RLC-SAP: AM

Logical channel: DCCH

Direction: UE → UTRAN

Information Element/Group name	Need	Multi	Type and reference	Semantics description	Version
Message Type	MP		Message Type		
UE information elements					
RRC transaction identifier	MP		RRC transaction identifier 10.3.3.36		
Integrity check info	CH		Integrity check info 10.3.3.16	Integrity check info is included if integrity protection is applied	
Uplink integrity protection activation info	OP		Integrity protection activation info 10.3.3.17		
CHOICE mode	MP				
>FDD				(no data)	
>TDD					
>>CHOICE TDD option	MP				REL-4
>>>3.84 Mcps TDD					REL-4
>>>>Uplink Timing Advance	OP		Uplink Timing Advance 10.3.6.95	This information element shall be present in case of handover procedure if timing advance is enabled. Calculated timing advance value for the new cell after handover in a synchronous TDD network	
>>>1.28 Mcps TDD				(no data)	REL-4
RB Information elements					
COUNT-C activation time	OP		Activation time 10.3.3.1	Used for radio bearers mapped on RLC-TM.	
Radio bearer uplink ciphering activation time info	OP		RB activation time info 10.3.4.13		
Uplink counter synchronisation info	OP				
>RB with PDCP information list	OP	1 to <maxRBall RABs>		This IE is needed for each RB having PDCP in the case of lossless SRNS relocation	
>>RB with PDCP information	MP		RB with PDCP information 10.3.4.22		
>START list	MP	1 to <maxCNdo mains>		START [40] values for all CN domains.	
>>CN domain identity	MP		CN domain identity 10.3.1.1		
>>START	MP		START 10.3.3.38	START value to be used in this CN domain.	

10.2.32 RADIO BEARER RELEASE FAILURE

This message is sent by UE if the configuration given by UTRAN is unacceptable or if radio bearer cannot be released.

RLC-SAP: AM

Logical channel: DCCH

Direction: UE→UTRAN

Information Element/Group name	Need	Multi	Type and reference	Semantics description
Message Type	MP		Message Type	
UE information elements				
RRC transaction identifier	MP		RRC transaction identifier 10.3.3.36	
Integrity check info	CH		Integrity check info 10.3.3.16	
Failure cause	MP		Failure cause and error information 10.3.3.14	
RB information elements				
Radio bearers for which reconfiguration would have succeeded	OP	1 to <maxRB>		
>Radio bearer for which reconfiguration would have been succeeded	MP		RB identity, 10.3.4.16	

10.2.33 RADIO BEARER SETUP

This message is sent by UTRAN to the UE to establish new radio bearer(s). It can also include modifications to the configurations of transport channels and/or physical channels.

RLC-SAP: AM or UM

Logical channel: DCCH

Direction: UTRAN → UE

Information Element/Group name	Need	Multi	Type and reference	Semantics description
Message Type	MP		Message Type	
UE Information Elements				
RRC transaction identifier	MP		RRC transaction identifier 10.3.3.36	
Integrity check info	CH		Integrity check info 10.3.3.16	
Integrity protection mode info	OP		Integrity protection mode info 10.3.3.19	
Ciphering mode info	OP		Ciphering mode info 10.3.3.5	
Activation time	MD		Activation time 10.3.3.1	Default value is "now"
New U-RNTI	OP		U-RNTI 10.3.3.47	
New C-RNTI	OP		C-RNTI 10.3.3.8	
RRC State Indicator	MP		RRC State Indicator 10.3.3.10	
UTRAN DRX cycle length coefficient	MD		UTRAN DRX cycle length coefficient 10.3.3.49	Default value is the existing value of UTRAN DRX cycle length coefficient
CN Information Elements				
CN Information info	OP		CN Information info 10.3.1.3	
UTRAN mobility information elements				
URA identity	OP		URA identity 10.3.2.6	
RB Information Elements				
Signalling RB information to setup list	OP	1 to <maxSRBs etup>		For each signalling radio bearer established
>Signalling RB information to setup	MP		Signalling RB information to setup 10.3.4.24	
RAB information to setup list	OP	1 to <maxRABs etup>		For each RAB established
>RAB information for setup	MP		RAB information for setup 10.3.4.10	
RB information to be affected list	OP	1 to <maxRB>		
>RB information to be affected	MP		RB information to be affected 10.3.4.17	
Downlink counter synchronisation info	OP			
>RB with PDCP information list	OP	1 to <maxRBall		This IE is needed for each RB having PDCP in the case of

Information Element/Group name	Need	Multi	Type and reference	Semantics description
		RABs>		lossless SRNS relocation
>>RB with PDCP information	MP		RB with PDCP information 10.3.4.22	
TrCH Information Elements				
Uplink transport channels				
UL Transport channel information common for all transport channels	OP		UL Transport channel information common for all transport channels 10.3.5.24	
Deleted TrCH information list	OP	1 to <maxTrCH >		
>Deleted UL TrCH information	MP		Deleted UL TrCH information 10.3.5.5	
Added or Reconfigured TrCH information list	OP	1 to <maxTrCH >		
>Added or Reconfigured UL TrCH information	MP		Added or Reconfigured UL TrCH information 10.3.5.2	
CHOICE <i>mode</i>	OP			
>FDD				
>>CPCH set ID	OP		CPCH set ID 10.3.5.3	
>>Added or Reconfigured TrCH information for DRAC list	OP	1 to <maxTrCH >		
>>>DRAC static information	MP		DRAC static information 10.3.5.7	
>TDD				(no data)
Downlink transport channels				
DL Transport channel information common for all transport channels	OP		DL Transport channel information common for all transport channels 10.3.5.6	
Deleted TrCH information list	OP	1 to <maxTrCH >		
>Deleted DL TrCH information	MP		Deleted DL TrCH information 10.3.5.4	
Added or Reconfigured TrCH information list	OP	1 to <maxTrCH >		
>Added or Reconfigured DL TrCH information	MP		Added or Reconfigured DL TrCH information 10.3.5.1	
PhyCH information elements				
Frequency info	MD		Frequency	Default value is the existing

Information Element/Group name	Need	Multi	Type and reference	Semantics description
			info 10.3.6.36	value of frequency information
Uplink radio resources				
Maximum allowed UL TX power	MD		Maximum allowed UL TX power 10.3.6.39	Default value is the existing maximum UL TX power
CHOICE <i>channel requirement</i>	OP			
>Uplink DPCH info			Uplink DPCH info 10.3.6.88	
>CPCH SET Info			CPCH SET Info 10.3.6.13	
Downlink radio resources				
CHOICE <i>mode</i>	MP			
>FDD				
>>Downlink PDSCH information	OP		Downlink PDSCH information 10.3.6.30	
>TDD				(no data)
Downlink information common for all radio links	OP		Downlink information common for all radio links 10.3.6.24	
Downlink information per radio link list	OP	1 to <maxRL>		Send downlink information for each radio link
>Downlink information for each radio link	MP		Downlink information for each radio link 10.3.6.27	

10.2.34 RADIO BEARER SETUP COMPLETE

This message is sent by UE to confirm the establishment of the radio bearer.

RLC-SAP: AM

Logical channel: DCCH

Direction: UE → UTRAN

Information Element/Group name	Need	Multi	Type and reference	Semantics description	Version
Message Type	MP		Message Type		
UE information elements					
RRC transaction identifier	MP		RRC transaction identifier 10.3.3.36		
Integrity check info	CH		Integrity check info 10.3.3.16		
Uplink integrity protection activation info	OP		Integrity protection activation info 10.3.3.17		
CHOICE <i>mode</i>	OP				
>FDD				(no data)	
>TDD					
>>CHOICE <i>TDD option</i>	MP				REL-4
>>>3.84 Mcps TDD					REL-4
>>>>Uplink Timing Advance	OP		Uplink Timing Advance 10.3.6.95	This information element shall be present in case of handover procedure if timing advance is enabled. Calculated timing advance value for the new cell after handover in a synchronous TDD network	
>>>1.28 Mcps TDD				(No data)	REL-4
START	OP		START 10.3.3.38	This information element is not needed for transparent mode RBs	
RB Information elements					
COUNT-C activation time	OP		Activation time 10.3.3.1	Used for radio bearers mapped on RLC-TM.	
Radio bearer uplink ciphering activation time info	OP		RB activation time info 10.3.4.13		
Uplink counter synchronisation info	OP				
>RB with PDCP information list	OP	1 to <maxRBall RABs>		This IE is needed for each RB having PDCP in the case of lossless SRNS relocation	
>>RB with PDCP information	MP		RB with PDCP information 10.3.4.22		
>START list	MP	1 to <maxCNdo mains>		START [40] values for all CN domains.	
>>CN domain identity	MP		CN domain identity 10.3.1.1		

>>START	MP		START 10.3.3.38	START value to be used in this CN domain.	
---------	----	--	--------------------	-------------------------------------------------	--

10.2.35 RADIO BEARER SETUP FAILURE

This message is sent by UE, if it does not support the configuration given by UTRAN.

RLC-SAP: AM

Logical channel: DCCH

Direction: UE→UTRAN

Information Element/Group name	Need	Multi	Type and reference	Semantics description
Message Type	MP		Message Type	
UE information elements				
RRC transaction identifier	MP		RRC transaction identifier 10.3.3.36	
Integrity check info	CH		Integrity check info 10.3.3.16	
Failure cause	MP		Failure cause and error information 10.3.3.14	
RB information elements				
Radio bearers for which reconfiguration would have succeeded	OP	1 to <maxRB>		
>Radio bearer for which reconfiguration would have succeeded	MP		RB identity, 10.3.4.16	

10.2.36 RRC CONNECTION REJECT

The network transmits this message when the requested RRC connection cannot be accepted.

RLC-SAP: UM

Logical channel: CCCH

Direction: UTRAN → UE

Information Element/Group name	Need	Multi	Type and reference	Semantics description
Message Type	MP		Message Type	
UE information elements				
RRC transaction identifier	MP		RRC transaction identifier 10.3.3.36	
Initial UE identity	MP		Initial UE identity 10.3.3.15	
Rejection cause	MP		Rejection cause 10.3.3.31	
Wait time	MP		Wait time 10.3.3.50	
Redirection info	OP		Redirection info 10.3.3.29	

10.2.37 RRC CONNECTION RELEASE

This message is sent by UTRAN to release the RRC connection. The message also releases the signalling connection and all radio bearers between the UE and UTRAN.

RLC-SAP: UM

Logical channel: CCCH or DCCH

Direction: UTRAN→UE

Information Element/Group name	Need	Multi	Type and reference	Semantics description
Message Type	MP		Message Type	
UE information elements				
U-RNTI	<i>CV-CCCH</i>		U-RNTI 10.3.3.47	
RRC transaction identifier	MP		RRC transaction identifier 10.3.3.36	
Integrity check info	<i>CV-DCCH</i>		Integrity check info 10.3.3.16	Integrity check info is included if integrity protection is applied
N308	<i>CH-Cell_DCH</i>		Integer(1..8)	
Release cause	MP		Release cause 10.3.3.32	
Other information elements				
Rplmn information	OP		Rplmn information 10.3.8.15	

Condition	Explanation
<i>CCCH</i>	This IE is mandatory present when CCCH is used and not needed otherwise.
<i>DCCH</i>	This IE is mandatory present when DCCH is used and not needed otherwise.
<i>Cell_DCH</i>	This IE is mandatory present when UE is in CELL_DCH state and not needed otherwise.

10.2.38 RRC CONNECTION RELEASE COMPLETE

This message is sent by UE to confirm that the RRC connection has been released.

RLC-SAP: AM or UM

Logical channel: DCCH

Direction: UE → UTRAN

Information Element/Group name	Need	Multi	Type and reference	Semantics description
Message Type	MP		Message Type	
UE information elements				
RRC transaction identifier	MP		RRC transaction identifier 10.3.3.36	
Integrity check info	CH		Integrity check info 10.3.3.16	
Error indication	OP		Failure cause and error information 10.3.3.14	

10.2.39 RRC CONNECTION REQUEST

RRC Connection Request is the first message transmitted by the UE when setting up an RRC Connection to the network.

RLC-SAP: TM

Logical channel: CCCH

Direction: UE → UTRAN

Information Element/Group name	Need	Multi	Type and reference	Semantics description
Message Type	MP		Message Type	
UE information elements				
Initial UE identity	MP		Initial UE identity 10.3.3.15	
Establishment cause	MP		Establishment cause 10.3.3.11	
Protocol error indicator	MD		Protocol error indicator 10.3.3.27	Default value is FALSE
Measurement information elements				
Measured results on RACH	OP		Measured results on RACH 10.3.7.45	

If the encoded message does not fill a transport block, the RRC layer shall insert padding according to subclause 12.1.

10.2.40 RRC CONNECTION SETUP

This message is used by the network to accept the establishment of an RRC connection for an UE, including assignment of signalling link information, transport channel information and optionally physical channel information.

RLC-SAP: UM

Logical channel: CCCH

Direction: UTRAN → UE

Information Element/Group name	Need	Multi	Type and reference	Semantics description
Message Type	MP		Message Type	
UE Information Elements				
Initial UE identity	MP		Initial UE identity 10.3.3.15	
RRC transaction identifier	MP		RRC transaction identifier 10.3.3.36	
Activation time	MD		Activation time 10.3.3.1	Default value is "now"
New U-RNTI	MP		U-RNTI 10.3.3.47	
New C-RNTI	OP		C-RNTI 10.3.3.8	
RRC State Indicator	MP		RRC State Indicator 10.3.3.10	
UTRAN DRX cycle length coefficient	MP		UTRAN DRX cycle length coefficient 10.3.3.49	
Capability update requirement	MD		Capability update requirement 10.3.3.2	Default value is defined in subclause 10.3.3.2
RB Information Elements				
Signalling RB information to setup list	MP	3 to 4		
>Signalling RB information to setup	MP		Signalling RB information to setup 10.3.4.24	
TrCH Information Elements				
Uplink transport channels				
UL Transport channel information common for all transport channels	OP		UL Transport channel information common for all transport channels 10.3.5.24	
Added or Reconfigured TrCH information list	MP	1 to <maxTrCH >		Although this IE is not required when the IE "RRC state indicator" is set to "CELL_FACH", need is MP to align with ASN.1
>Added or Reconfigured UL TrCH information	MP		Added or Reconfigured UL TrCH information 10.3.5.2	
Downlink transport channels				
DL Transport channel information common for all transport channels	OP		DL Transport channel information common for all transport channels 10.3.5.6	
Added or Reconfigured TrCH information list	MP	1 to <maxTrCH >		Although this IE is not required when the IE "RRC state indicator" is set to

Information Element/Group name	Need	Multi	Type and reference	Semantics description
				"CELL_FACH", need is MP to align with ASN.1
>Added or Reconfigured DL TrCH information	MP		Added or Reconfigured DL TrCH information 10.3.5.1	
PhyCH information elements				
Frequency info	MD		Frequency info 10.3.6.36	Default value is the existing value of frequency information
Uplink radio resources				
Maximum allowed UL TX power	MD		Maximum allowed UL TX power 10.3.6.39	Default value is the existing maximum UL TX power
<i>CHOICE channel requirement</i>	OP			
>Uplink DPCH info			Uplink DPCH info 10.3.6.88	
>CPCH SET Info			CPCH SET Info 10.3.6.13	
Downlink radio resources				
Downlink information common for all radio links	OP		Downlink information common for all radio links 10.3.6.24	
Downlink information per radio link list	OP	1 to <MaxRL>		Send downlink information for each radio link to be set-up
>Downlink information for each radio link	MP		Downlink information for each radio link 10.3.6.27	

10.2.41 RRC CONNECTION SETUP COMPLETE

This message confirms the establishment of the RRC Connection by the UE.

RLC-SAP: AM

Logical channel: DCCH

Direction: UE → UTRAN

Information Element/Group name	Need	Multi	Type and reference	Semantics description
Message Type	MP		Message Type	
UE Information Elements				
RRC transaction identifier	MP		RRC transaction identifier 10.3.3.36	
START list	MP	1 to <maxCNdomains>		START [40] values for all CN domains.
>CN domain identity	MP		CN domain identity 10.3.1.1	
>START	MP		START 10.3.3.38	START value to be used in this CN domain.
UE radio access capability	OP		UE radio access capability 10.3.3.42	
UE radio access capability extension	OP		UE radio access capability extension 10.3.3.42a	
Other information elements				
UE system specific capability	OP	1 to <maxInterSysMessages>		
>Inter-RAT UE radio access capability	MP		Inter-RAT UE radio access capability 10.3.8.7	

10.2.42 RRC STATUS

This message is sent to indicate a protocol error.

RLC-SAP: AM

Logical channel: DCCH

Direction: UE→UTRAN

Information Element/Group name	Need	Multi	Type and reference	Semantics description
Message Type	MP		Message Type	
UE information elements				
Integrity check info	CH		Integrity check info 10.3.3.16	Integrity check info is included if integrity protection is applied
Identification of received message	CV- <i>Message identified</i>			
>Received message type	MP		Message Type	
>RRC transaction identifier	MP		RRC transaction identifier 10.3.3.36	
Other information elements				
Protocol error information	MP		Protocol error information 10.3.8.12	

Condition	Explanation
<i>Message identified</i>	This IE is mandatory present if the IE "Protocol error cause" in the IE "Protocol error information" has any other value than "ASN.1 violation or encoding error" or "Message type non-existent or not implemented" and not needed otherwise.

10.2.43 SECURITY MODE COMMAND

This message is sent by UTRAN to start or reconfigure ciphering and/or integrity protection parameters.

RLC-SAP: AM

Logical channel: DCCH

Direction: UTRAN to UE

Information Element/Group name	Need	Multi	Type and reference	Semantics description
Message Type	MP		Message Type	
UE information elements				
RRC transaction identifier	MP		RRC transaction identifier 10.3.3.36	
Integrity check info	MP		Integrity check info 10.3.3.16	
Security capability	MP		Security capability 10.3.3.37	
Ciphering mode info	OP		Ciphering mode info 10.3.3.5	Only present if ciphering shall be controlled
Integrity protection mode info	OP		Integrity protection mode info 10.3.3.19	Only present if integrity protection shall be controlled
CN Information elements				
CN domain identity	MP		CN domain identity 10.3.1.1	Indicates which cipher and integrity protection keys are applicable
Other information elements				
UE system specific security capability	CH	1 to <maxInter SysMessages>		This IE is included if the IE "Inter-RAT UE radio access capability" was included in RRC CONNECTION SETUP COMPLETE message
>Inter-RAT UE security capability	MP		Inter-RAT UE security capability 10.3.8.8a	

10.2.44 SECURITY MODE COMPLETE

This message is sent by UE to confirm the reconfiguration of ciphering and/or integrity protection.

RLC-SAP: AM

Logical channel: DCCH

Direction: UE to UTRAN

Information Element/Group name	Need	Multi	Type and reference	Semantics description
Message Type	MP		Message Type	
UE information elements				
RRC transaction identifier	MP		RRC transaction identifier 10.3.3.36	
Integrity check info	MP		Integrity check info 10.3.3.16	
Uplink integrity protection activation info	OP		Integrity protection activation info 10.3.3.17	
RB Information elements				
Radio bearer uplink ciphering activation time info	OP		RB activation time info 10.3.4.13	

10.2.45 SECURITY MODE FAILURE

This message is sent to indicate a failure to act on a received SECURITY MODE CONTROL message.

RLC-SAP: AM

Logical channel: DCCH

Direction: UE→UTRAN

Information Element/Group name	Need	Multi	Type and reference	Semantics description
Message Type	MP		Message Type	
UE information elements				
RRC transaction identifier	MP		RRC transaction identifier 10.3.3.36	
Integrity check info	CH		Integrity check info 10.3.3.16	
Failure cause	MP		Failure cause and error information 10.3.3.14	

10.2.46 SIGNALLING CONNECTION RELEASE

This message is used to notify the UE that its ongoing signalling connection to a CN domain has been released.

RLC-SAP: AM

Logical channel: DCCH

Direction: UTRAN→UE

Information Element/Group name	Need	Multi	Type and reference	Semantics description
Message Type	MP		Message Type	
UE information elements				
RRC transaction identifier	MP		RRC transaction identifier 10.3.3.36	
Integrity check info	CH		Integrity check info 10.3.3.16	Integrity check info is included if integrity protection is applied
CN information elements				
CN domain identity	MP		CN domain identity 10.3.1.1	

10.2.47 SIGNALLING CONNECTION RELEASE INDICATION

This message is used by the UE to indicate to UTRAN the release of an existing signalling connection.

RLC-SAP: AM

Logical channel: DCCH

Direction: UE→UTRAN

Information Element/Group name	Need	Multi	IE type and reference	Semantics description
Message Type	MP		Message type	
UE Information Elements				
Integrity check info	CH		Integrity check info 10.3.3.16	
CN information elements				
CN domain identity	MP		CN domain identity 10.3.1.1	

10.2.48 SYSTEM INFORMATION

Information Element/Group name	Need	Multi	Type and reference	Semantics description
Message type	CV- <i>channel1</i>		Message type	
SFNprime	CV- <i>channel2</i>		Integer(0..40 94 by step of 2)	SFN=SFNprime (for first 10ms frame of 20ms TTI), SFN=SFNprime+1 (for last 10ms frame of 20ms TTI)
<i>CHOICE Segment combination</i>	MP			
>Combination 1				(no data)
>Combination 2				
>>First Segment	MP		First Segment, 10.2.48.1	
>Combination 3				
>>Subsequent Segment	MP		Subsequent Segment, 10.2.48.3	
>Combination 4				
>>Last segment	MP		Last segment (short),10.2. 48.5	
>Combination 5				
>>Last segment	MP		Last Segment (short)10.2.4 8.5	
>>First Segment	MP		First Segment (short), 10.2.48.2	
>Combination 6				
>>Last Segment	MP		Last Segment (short), 10.2.48.5	
>>Complete list	MP	1 to maxSIBper Msg		Note 1
>>>Complete	MP		Complete SIB (short),10.2. 48.7	
>Combination 7				
>>Last Segment	MP		Last Segment (short), 10.2.48.5	
>>Complete list	MP	1..< maxSIBper Msg>		Note 1
>>>Complete	MP		Complete SIB (short),10.2. 48.7	
>>First Segment	MP		First Segment (short), 10.2.48.2	
>Combination 8				
>>Complete list	MP	1 to maxSIBper Msg		Note 1
>>>Complete	MP		Complete	

			SIB (short),10.2.48.7	
>Combination 9				
>>Complete list	MP	1..MaxSIB perMsg		Note 1
>>>Complete	MP		Complete SIB (short),10.2.48.7	
>>First Segment	MP		First Segment (short), 10.2.48.2	
>Combination 10				
>>>Complete SIB of size 215 to 226	MP		Complete SIB,10.2.48.6	
>Combination 11				
>>Last segment of size 215 to 222	MP		Last segment,10.2.48.4	

Condition	Explanation
<i>channel1</i>	The IE is mandatory present if the message is sent on the FACH and not needed otherwise.
<i>channel2</i>	This IE is mandatory present if the channel is BCH, otherwise it is not needed.

If the encoded message does not fill a transport block, the RRC layer shall insert padding according to subclause 12.1. Padding is needed e.g. if the remaining space is insufficient to start a new First Segment (which requires several bits for SIB type, SEG_COUNT and SIB data).

NOTE 1: If Combination 6 - 9 contains a Master information block Master information shall be located as the first IE in the list.

10.2.48.1 First Segment

This segment type is used to transfer the first segment of a segmented system information block. The IE is used when the first segment fills the entire transport block (Combination 2).

Information Element/Group name	Need	Multi	Type and reference	Semantics description
Other information elements				
SIB type	MP		SIB Type, 10.3.8.21	
SEG_COUNT	MP		SEG COUNT, 10.3.8.17	
SIB data fixed	MP		SIB data fixed, 10.3.8.19	

10.2.48.2 First Segment (short)

This segment type is used to transfer the first segment of a segmented system information block. The IE is used when the first segment is concatenated after other segments in a transport block (Combination 5, 7 and 9).

Information Element/Group name	Need	Multi	Type and reference	Semantics description
Other information elements				
SIB type	MP		SIB Type, 10.3.8.21	
SEG_COUNT	MP		SEG COUNT, 10.3.8.17	
SIB data variable	MP		SIB data variable, 10.3.8.20	

10.2.48.3 Subsequent Segment

This segment type is used to transfer a subsequent segment of a segmented system information block.

Information Element/Group name	Need	Multi	Type and reference	Semantics description
Other information elements				
SIB type	MP		SIB Type, 10.3.8.21	
Segment index	MP		Segment Index, 10.3.8.18	
SIB data fixed	MP		SIB data fixed, 10.3.8.19	

10.2.48.4 Last Segment

This segment type is used to transfer the last segment of a segmented system information block. The IE is used when the last segment has a length, excluding length denominator, from 215 through 222 (Combination 11).

Information Element/Group name	Need	Multi	Type and reference	Semantics description
Other information elements				
SIB type	MP		SIB Type, 10.3.8.21	
Segment index	MP		Segment Index, 10.3.8.18	
SIB data fixed	MP		SIB data fixed, 10.3.8.19	In case the SIB data is less than 222 bits, padding shall be used. The same padding bits shall be used as defined in clause 12.1

10.2.48.5 Last Segment (short)

This segment type is used to transfer the last segment of a segmented system information block. The IE is used when the last segment has a length, excluding length denominator, of upto 214 bits (Combination 4, 5, 6 and 7).

Information Element/Group name	Need	Multi	Type and reference	Semantics description
Other information elements				
SIB type	MP		SIB Type, 10.3.8.21	
Segment index	MP		Segment Index, 10.3.8.18	
SIB data variable	MP		SIB data variable, 10.3.8.20	

10.2.48.6 Complete SIB

This segment type is used to transfer a non-segmented system information block. The IE is used when the complete SIB has a length, excluding length denominator, from 215 through 226 (Combination 10).

Information Element/Group name	Need	Multi	Type and reference	Semantics description
Other information elements				
SIB type	MP		SIB Type, 10.3.8.21	
SIB data fixed	MP		Bit string (226)	In case the SIB data is less than 226 bits, padding shall be used. The same padding bits shall be used as defined in clause 12.1

10.2.48.7 Complete SIB (short)

This segment type is used to transfer a non-segmented system information block. The IE is used when the complete SIB has a length, excluding length denominator, of upto 214 bits (Combination 6, 7, 8 and 9).

Information Element/Group name	Need	Multi	Type and reference	Semantics description
Other information elements				
SIB type	MP		SIB Type, 10.3.8.21	
SIB data variable	MP		SIB data variable, 10.3.8.20	

10.2.48.8 System Information Blocks

The IE "SIB data" within the IEs, "First Segment", "Subsequent or last Segment" and "Complete SIB" contains either complete system information block or a segment of a system information block. The actual system information blocks are defined in the following clauses.

10.2.48.8.1 Master Information Block

Information Element/Group name	Need	Multi	Type and reference	Semantics description
Other information elements				
MIB Value tag	MP		MIB Value tag 10.3.8.9	
CN information elements				
Supported PLMN types	MP		PLMN Type 10.3.1.12	
PLMN Identity	CV-GSM		PLMN Identity 10.3.1.11	
ANSI-41 information elements				
ANSI-41 Core Network Information	CV-ANSI-41		ANSI-41 Core Network Information 10.3.9.1	
References to other system information blocks and scheduling blocks	MP		References to other system information blocks and scheduling blocks 10.3.8.14	

Condition	Explanation
<i>GSM</i>	The IE is mandatory present if the IE "Supported PLMN Types" is set to 'GSM-MAP' or 'GSM-MAP AND ANSI-41', and not needed otherwise
<i>ANSI-41</i>	The IE is mandatory present if the IE "Supported PLMN Types" is set to 'ANSI-41' or 'GSM-MAP AND ANSI-41', and not needed otherwise

10.2.48.8.2 Scheduling Block 1

Information Element/Group name	Need	Multi	Type and reference	Semantics description
References to other system information blocks	MP		References to other system information blocks 10.3.8.13	

10.2.48.8.3 Scheduling Block 2

Information Element/Group name	Need	Multi	Type and reference	Semantics description
References to other system information blocks	MP		References to other system information blocks 10.3.8.13	

10.2.48.8.4 System Information Block type 1

The system information block type 1 contains NAS system information as well as UE timers and counters to be used in idle mode and in connected mode.

Information Element/Group name	Need	Multi	Type and reference	Semantics description
CN information elements				
CN common GSM-MAP NAS system information	MP		NAS system information (GSM-MAP) 10.3.1.9	
CN domain system information list	MP	1 to <maxCNdomains>		Send CN information for each CN domain.
>CN domain system information	MP		CN domain system information 10.3.1.2	
UE information				
UE Timers and constants in idle mode	MD		UE Timers and constants in idle mode 10.3.3.44	Default value means that for all timers and constants - For parameters with need MD, the defaults specified in 10.3.3.44 apply and - For parameters with need OP, the parameters are absent
UE Timers and constants in connected mode	MD		UE Timers and constants in connected mode 10.3.3.43	Default value means that for all timers and constants - For parameters with need MD, the defaults specified in 10.3.3.43 apply and - For parameters with need OP, the parameters are absent

10.2.48.8.5 System Information Block type 2

The system information block type 2 contains the URA identity.

Information Element/Group name	Need	Multi	Type and reference	Semantics description
UTRAN mobility information elements				
URA identity list	MP	1 ..<maxURA>		
>URA identity	MP		URA identity 10.3.2.6	

10.2.48.8.6 System Information Block type 3

The system information block type 3 contains parameters for cell selection and re-selection.

Information Element/Group name	Need	Multi	Type and reference	Semantics description
SIB4 Indicator	MP		Boolean	TRUE indicates that SIB4 is broadcast in the cell.
UTRAN mobility information elements				
Cell identity	MP		Cell identity 10.3.2.2	
Cell selection and re-selection info	MP		Cell selection and re-selection info for SIB3/4 10.3.2.3	
Cell Access Restriction	MP		Cell Access Restriction 10.3.2.1	

10.2.48.8.7 System Information Block type 4

The system information block type 4 contains parameters for cell selection and re-selection to be used in connected mode.

Information Element/Group name	Need	Multi	Type and reference	Semantics description
UTRAN mobility information elements				
Cell identity	MP		Cell identity 10.3.2.2	
Cell selection and re-selection info	MP		Cell selection and re-selection info for SIB3/4 10.3.2.3	
Cell Access Restriction	MP		Cell Access Restriction 10.3.2.1	

10.2.48.8.8 System Information Block type 5

The system information block type 5 contains parameters for the configuration of the common physical channels in the cell.

Information Element/Group name	Need	Multi	Type and reference	Semantics description
SIB6 Indicator	MP		Boolean	TRUE indicates that SIB6 is broadcast in the cell.
PhyCH information elements				
PICH Power offset	MP		PICH Power offset 10.3.6.50	
CHOICE <i>mode</i>	MP			
>FDD				
>>AICH Power offset	MP		AICH Power offset 10.3.6.3	This AICH Power offset also indicates the power offset for AP-AICH and for CD/CA-ICH.
>TDD				
>>PUSCH system information	OP		PUSCH system information 10.3.6.66	
>>PDSCH system information	OP		PDSCH system information 10.3.6.46	
>>TDD open loop power control	MP		TDD open loop power control 10.3.6.79	
Primary CCPCH info	OP		Primary CCPCH info 10.3.6.57	Note 1
PRACH system information list	MP		PRACH system information list 10.3.6.55	
Secondary CCPCH system information	MP		Secondary CCPCH system information 10.3.6.72	
CBS DRX Level 1 information	CV-CTCH		CBS DRX Level 1 information 10.3.8.3	

NOTE 1: DL scrambling code of the Primary CCPCH is the same as the one for Primary CPICH (FDD only).

Condition	Explanation
CTCH	The IE is mandatory present if the IE "CTCH indicator" is equal to TRUE for at least one FACH, otherwise the IE is not needed in the message

10.2.48.8.9 System Information Block type 6

The system information block type 6 contains parameters for the configuration of the common and shared physical channels to be used in connected mode.

Information Element/Group name	Need	Multi	Type and reference	Semantics description
PhyCH information elements				
PICH Power offset	MP		PICH Power offset 10.3.6.50	
CHOICE <i>mode</i>	MP			
>FDD				
>>AICH Power offset	MP		AICH Power offset 10.3.6.3	This AICH Power offset also indicates the power offset for AP-AICH and for CD/CA-ICH.
>TDD				
>>PUSCH system information	OP		PUSCH system information 10.3.6.66	
>>PDSCH system information	OP		PDSCH system information 10.3.6.46	
>>TDD open loop power control	MP		TDD open loop power control 10.3.6.79	
Primary CCPCH info	OP		Primary CCPCH info 10.3.6.57	Note 1
PRACH system information list	OP		PRACH system information list 10.3.6.55	
Secondary CCPCH system information	OP		Secondary CCPCH system information 10.3.6.72	
CBS DRX Level 1 information	CV-CTCH		CBS DRX Level 1 information 10.3.8.3	

NOTE 1: DL scrambling code of the Primary CCPCH is the same as the one for Primary CPICH (FDD only).

Condition	Explanation
CTCH	The IE is mandatory present if the IE "CTCH indicator" is equal to TRUE for at least one FACH, otherwise the IE is not needed

10.2.48.8.10 System Information Block type 7

The system information block type 7 contains the fast changing parameters UL interference and Dynamic persistence level.

Information Element/Group name	Need	Multi	Type and reference	Semantics description
CHOICE <i>mode</i>	MP			
>FDD				
>>UL interference	MP		UL interference 10.3.6.87	
>TDD				(no data)
PhyCH information elements				
PRACHs listed in system information block type 5	MP	1 to <maxPRACH>		The order of the PRACHs is the same as in system information block type 5.
>Dynamic persistence level	MP		Dynamic persistence level 10.3.6.35	
PRACHs listed in system information block type 6	OP	1 to <maxPRA CH>		The order of the PRACHs is the same as in system information block type 6.
>Dynamic persistence level	MP		Dynamic persistence level 10.3.6.35	
Expiration Time Factor	MD		Expiration Time Factor 10.3.3.12	Default is 1.

10.2.48.8.11 System Information Block type 8

NOTE: Only for FDD.

The system information block type 8 contains static CPCH information to be used in the cell.

Information Element/Group name	Need	Multi	Type and reference	Semantics description
UE information				
CPCH parameters	MP		CPCH parameters 10.3.3.7	
PhyCH information elements				
CPCH set info list	MP	1 to <maxCPC Hsets>		
>CPCH set info	MP		CPCH set info 10.3.6.13	
CSICH Power offset	MP		CSICH Power offset 10.3.6.15	

10.2.48.8.12 System Information Block type 9

NOTE: Only for FDD.

The system information block type 9 contains CPCH information to be used in the cell.

Information Element/Group name	Need	Multi	Type and reference	Semantics description
PhyCH information elements				
CPCH set persistence levels list	MP	1 to <maxCPC Hsets>		
>CPCH set persistence levels	MP		CPCH persistence levels 10.3.6.12	

10.2.48.8.13 System Information Block type 10

NOTE: Only for FDD.

The system information block type 10 contains information to be used by UEs having their DCH controlled by a DRAC procedure.

Information Element/Group name	Need	Multi	Type and reference	Semantics description
UE information				
DRAC system information	MP		DRAC system information 10.3.3.9	DRAC information is sent for each class of terminal

10.2.48.8.14 System Information Block type 11

The system information block type 11 contains measurement control information to be used in the cell.

Information Element/Group name	Need	Multi	Type and reference	Semantics description
SIB12 Indicator	MP		Boolean	TRUE indicates that SIB12 is broadcast in the cell.
Measurement information elements				
FACH measurement occasion info	OP		FACH measurement occasion info 10.3.7.8	
Measurement control system information	MP		Measurement control system information 10.3.7.47	

10.2.48.8.15 System Information Block type 12

The system information block type 12 contains measurement control information to be used in connected mode.

Information Element/Group name	Need	Multi	Type and reference	Semantics description
Measurement information elements				
FACH measurement occasion info	OP		FACH measurement occasion info 10.3.7.8	
Measurement control system information	MP		Measurement control system information 10.3.7.47	

10.2.48.8.16 System Information Block type 13

The system information block type 13 contains ANSI-41 system information.

Information Element/Group name	Need	Multi	Type and reference	Semantics description
Other information elements				
CN Information Elements				
CN Domain system information list	MP	1 to <maxCNdo mains>		Send CN information for each CN domain.
>CN Domain system information	MP		CN Domain system information 10.3.1.2	
UE Information				
UE timers and constants in idle mode	MD		UE timers and constants in idle mode 10.3.3.44	Default value means that for all timers and constants - for parameters with need MD, the defaults specified in 10.3.3.44 apply; and - for parameters with need OP, the parameters are absent.
Capability update requirement	MD		Capability update requirement 10.3.3.2	Default value is defined in subclause 10.3.3.2

10.2.48.8.16.1 System Information Block type 13.1

The system information block type 13.1 contains the ANSI-41 RAND information.

Information Element/Group name	Need	Multi	Type and reference	Semantics description
ANSI-41 information elements				
ANSI-41 RAND information	MP		ANSI-41 RAND information 10.3.9.6	

10.2.48.8.16.2 System Information Block type 13.2

The system information block type 13.2 contains the ANSI-41 User Zone Identification information.

Information Element/Group name	Need	Multi	Type and reference	Semantics description
ANSI-41 information elements				
ANSI-41 User Zone Identification information	MP		ANSI-41 User Zone Identification information 10.3.9.7	

10.2.48.8.16.3 System Information Block type 13.3

The system information block type 13.3 contains the ANSI-41 Private Neighbour List information.

Information Element/Group name	Need	Multi	Type and reference	Semantics description
ANSI-41 information elements				
ANSI-41 Private Neighbour List information	MP		ANSI-41 Private Neighbour List information 10.3.9.5	

10.2.48.8.16.4 System Information Block type 13.4

The system information block type 13.4 contains the ANSI-41 Global Service Redirection information.

Information Element/Group name	Need	Multi	Type and reference	Semantics description
ANSI-41 information elements				
ANSI-41 Global Service Redirection information	MP		ANSI-41 Global Service Redirection information 10.3.9.2	

10.2.48.8.17 System Information Block type 14

NOTE: Only for TDD.

The system information block type 14 contains parameters for common and dedicated physical channel uplink outer loop power control information to be used in both idle and connected mode.

Information Element/Group name	Need	Multi	Type and reference	Semantics description
PhyCH information elements				
Individual Timeslot interference list	MP	1 to <maxTS>		
>Individual Timeslot interference	MP		Individual Timeslot interference 10.3.6.38	
Expiration Time Factor	MD		Expiration Time Factor 10.3.3.12	Default is 1.

10.2.48.8.18 System Information Block type 15

The system information block type 15 contains information useful for UE-based or UE-assisted positioning methods.

Information Element/Group name	Need	Multi	Type and Reference	Semantics description
GPS Data ciphering info	OP		UE positioning Cipher info 10.3.7.86	If this IE is present then the SIB types 15.1, 15.2 & 15.3 are ciphered in accordance with the Data Assistance Ciphering Algorithm specified in [18]
Reference position	MP		Ellipsoid point with altitude and uncertainty ellipsoid 10.3.8.4c	approximate position where the UE is located
GPS reference time	MP		UE positioning GPS reference time 10.3.7.96	
Satellite information	OP	1 to <maxSat>		This IE is present whenever bad (failed/failing) satellites are detected by UTRAN [18].
>BadSatID	MP		Enumerated(0..63)	

10.2.48.8.18.1 System Information Block type 15.1

The system information block type 15.1 contains information useful for UE positioning DGPS Corrections. The DGPS Corrections message contents are based on a Type-1 message of DGPS specified in [13].

Information Element/Group name	Need	Multi	Type and Reference	Semantics description
DGPS corrections	MP		UE positioning GPS DGPS corrections 10.3.7.91	

10.2.48.8.18.2 System Information Block type 15.2

The system information block type 15.2 contains information useful for GPS Navigation Model. These IE fields are based on information extracted from the subframes 1 to 3 of the GPS navigation message [12].

Information Element/Group name	Need	Multi	Type and Reference	Semantics description
Transmission TOW	MP		Integer (0..604799)	The approximate GPS time-of-week when the message is broadcast. in seconds
SatID	MP		Enumerated(0..63)	Satellite ID
GPS Ephemeris and Clock Correction Parameters	MP		UE positioning GPS Ephemeris and Clock Correction parameters 10.3.7.91a	

10.2.48.8.18.3 System Information Block type 15.3

The system information block type 15.3 contains information useful for ionospheric delay, UTC offset, and Almanac. These IEs contain information extracted from the subframes 4 and 5 of the GPS navigation message, [12].

Information Element/Group name	Need	Multi	Type and Reference	Semantics description
Transmission TOW	MP		Integer (0..604799)	The approximate GPS time-of-week when the message is broadcast. in seconds
GPS Almanac and Satellite Health	OP		UE positioning GPS almanac 10.3.7.89	
GPS ionospheric model	OP		UE positioning GPS ionospheric model 10.3.7.92	
GPS UTC model	OP		UE positioning GPS UTC model 10.3.7.97	
SatMask	CV- <i>Almanac</i>		Bit string(1..32)	indicates the satellites that contain the pages being broadcast in this data set
LSB TOW	CV- <i>Almanac</i>		Bit string(8)	

Condition	Explanation
<i>Almanac</i>	This IE is mandatory present if the IE "GPS Almanac and Satellite Health" is present

10.2.48.8.18.4 System Information Block type 15.4

The system information block type 15.4 contains information useful for OTDOA based UE Positioning method.

Information Element/Group name	Need	Multi	Type and Reference	Semantics description
OTDOA Data ciphering info	OP		UE positioning Ciphering info 10.3.7.86	If this IE is present then the IE "OTDOA Assistance Data" is ciphered in accordance with the Data Assistance Ciphering Algorithm specified in [18]
OTDOA assistance data	MP		UE positioning OTDOA assistance data 10.3.7.103	

10.2.48.8.19 System Information Block type 16

The system information block type 16 contains radio bearer, transport channel and physical channel parameters to be stored by UE in idle and connected mode for use during handover to UTRAN.

Information Element/Group name	Need	Multi	Type and Reference	Semantics description
RB information elements				
Predefined RB configuration	MP		Predefined RB configuration 10.3.4.7	
TrCH Information Elements				
Predefined TrCH configuration	MP		Predefined TrCH configuration 10.3.5.9	
PhyCH Information Elements				
Predefined PhyCH configuration	MP		Predefined PhyCH configuration 10.3.6.56	

10.2.48.8.20 System Information Block type 17

NOTE: Only for TDD.

The system information block type 17 contains fast changing parameters for the configuration of the shared physical channels to be used in connected mode.

Information Element/Group name	Need	Multi	Type and reference	Semantics description
PhyCH information elements				
PUSCH system information	OP		PUSCH system information 10.3.6.66	
PDSCH system information	OP		PDSCH system information 10.3.6.46	

10.2.48.8.21 System Information Block type 18

The System Information Block type 18 contains PLMN identities of neighbouring cells to be considered in idle mode as well as in connected mode.

Information Element/Group name	Need	Multi	Type and reference	Semantics description
Idle mode PLMN identities	OP		PLMN identities of neighbour cells 10.3.7.53a	
Connected mode PLMN identities	OP		PLMN identities of neighbour cells 10.3.7.53a	

10.2.49 SYSTEM INFORMATION CHANGE INDICATION

This message is used to send information on FACH to the UEs in state CELL_FACH about coming modification of the system information.

RLC-SAP: TM

Logical channel: BCCH

Direction: UTRAN → UE

Information Element/Group name	Need	Multi	Type and reference	Semantics description
Message Type	MP		Message Type	
Other information elements				
BCCH modification info	MP		BCCH modification info 10.3.8.1	

If the encoded message does not fill a transport block, the RRC layer shall insert padding according to subclause 12.1.

10.2.50 TRANSPORT CHANNEL RECONFIGURATION

This message is used by UTRAN to configure the transport channel of a UE. This also includes a possible reconfiguration of physical channels. The message can also be used to assign a TFC subset and reconfigure physical channel.

RLC-SAP: AM or UM

Logical channel: DCCH

Direction: UTRAN → UE

Information Element/Group name	Need	Multi	Type and reference	Semantics description
Message Type	MP		Message Type	
UE Information Elements				
RRC transaction identifier	MP		RRC transaction identifier 10.3.3.36	
Integrity check info	CH		Integrity check info 10.3.3.16	
Integrity protection mode info	OP		Integrity protection mode info 10.3.3.19	
Ciphering mode info	OP		Ciphering mode info 10.3.3.5	
Activation time	MD		Activation time 10.3.3.1	Default value is "now"
New U-RNTI	OP		U-RNTI 10.3.3.47	
New C-RNTI	OP		C-RNTI 10.3.3.8	
RRC State Indicator	MP		RRC State Indicator 10.3.3.10	
UTRAN DRX cycle length coefficient	MD		UTRAN DRX cycle length coefficient 10.3.3.49	Default value is the existing value of UTRAN DRX cycle length coefficient
CN Information Elements				
CN Information info	OP		CN Information info 10.3.1.3	
UTRAN mobility information elements				
URA identity	OP		URA identity 10.3.2.6	
RB information elements				
Downlink counter synchronisation info	OP			
>RB with PDCP information list	OP	1 to <maxRBall RABs>		This IE is needed for each RB having PDCP in the case of lossless SRNS relocation
>>RB with PDCP information	MP		RB with PDCP information 10.3.4.22	
TrCH Information Elements				
Uplink transport channels				
UL Transport channel information common for all transport channels	OP		UL Transport channel information common for all transport channels 10.3.5.24	
Added or Reconfigured TrCH information list	OP	1 to <maxTrCH >		
>Added or Reconfigured UL TrCH information	MP		Added or Reconfigured UL TrCH information 10.3.5.2	

Information Element/Group name	Need	Multi	Type and reference	Semantics description
CHOICE <i>mode</i>	OP			
>FDD				
>>CPCH set ID	OP		CPCH set ID 10.3.5.3	
>>>Added or Reconfigured TrCH information for DRAC list	OP	1 to <maxTrCH >		
>>>DRAC static information	MP		DRAC static information 10.3.5.7	
>TDD				(no data)
Downlink transport channels				
DL Transport channel information common for all transport channels	OP		DL Transport channel information common for all transport channels 10.3.5.6	
Added or Reconfigured TrCH information list	OP	1 to <maxTrCH >		
>Added or Reconfigured DL TrCH information	MP		Added or Reconfigured DL TrCH information 10.3.5.1	
PhyCH information elements				
Frequency info	MD		Frequency info 10.3.6.36	Default value is the existing value of frequency information
Uplink radio resources				
Maximum allowed UL TX power	MD		Maximum allowed UL TX power 10.3.6.39	Default value is the existing maximum UL TX power
CHOICE <i>channel requirement</i>	OP			
>Uplink DPCH info			Uplink DPCH info 10.3.6.88	
>CPCH SET Info			CPCH SET Info 10.3.6.13	
Downlink radio resources				
CHOICE <i>mode</i>	MP			
>FDD				
>>Downlink PDSCH information	OP		Downlink PDSCH information 10.3.6.30	
>TDD				(no data)
Downlink information common for all radio links	OP		Downlink information common for all radio links 10.3.6.24	
Downlink information per radio link list	OP	1 to <maxRL>		Send downlink information for each radio link
>Downlink information for each radio link	MP		Downlink information for each radio link 10.3.6.27	

10.2.51 TRANSPORT CHANNEL RECONFIGURATION COMPLETE

This message is sent from the UE when a transport channel reconfiguration has been done.

RLC-SAP: AM

Logical channel: DCCH

Direction: UE → UTRAN

Information Element/Group name	Need	Multi	Type and reference	Semantics description	Version
Message Type	MP		Message Type		
UE information elements					
RRC transaction identifier	MP		RRC transaction identifier 10.3.3.36		
Integrity check info	CH		Integrity check info 10.3.3.16		
Uplink integrity protection activation info	OP		Integrity protection activation info 10.3.3.17		
CHOICE <i>mode</i>	OP				
>FDD				(no data)	
>TDD					
>>CHOICE <i>TDD option</i>	MP				REL-4
>>>3.84 Mcps TDD					REL-4
>>>>Uplink Timing Advance	OP		Uplink Timing Advance 10.3.6.95		
>>>1.28 Mcps TDD				(no data)	REL-4
RB Information elements					
COUNT-C activation time	OP		Activation time 10.3.3.1	Used for radio bearers mapped on RLC-TM. Only applicable if the UE is moving to CELL_DCH state due to this procedure	
Radio bearer uplink ciphering activation time info	OP		RB activation time info 10.3.4.13		
Uplink counter synchronisation info	OP				
>RB with PDCP information list	OP	1 to <maxRBall RABs>			
>>RB with PDCP information	MP		RB with PDCP information 10.3.4.22		
>START list	MP	1 to <maxCNdo mains>		START [40] values for all CN domains.	
>>CN domain identity	MP		CN domain identity 10.3.1.1		
>>>START	MP		START 10.3.3.38	START value to be used in this CN domain.	

10.2.52 TRANSPORT CHANNEL RECONFIGURATION FAILURE

This message is sent by UE if the configuration given by UTRAN is unacceptable or if the UE failed to establish the physical channel(s).

RLC-SAP: AM

Logical channel: DCCH

Direction: UE→UTRAN

Information Element/Group name	Need	Multi	Type and reference	Semantics description
Message Type	MP		Message Type	
UE information elements				
RRC transaction identifier	MP		RRC transaction identifier 10.3.3.36	
Integrity check info	CH		Integrity check info 10.3.3.16	
Failure cause	MP		Failure cause and error information 10.3.3.14	

10.2.53 TRANSPORT FORMAT COMBINATION CONTROL

This message is sent by UTRAN to control the uplink transport format combination within the allowed transport format combination set.

RLC-SAP: TM, AM or UM

Logical channel: DCCH

Direction: UTRAN→UE

Information Element/Group name	Need	Multi	Type and reference	Semantics description
Message Type	<i>CV-notTM</i>		Message Type	
UE information elements				
RRC transaction identifier	<i>CV-notTM</i>		RRC transaction identifier 10.3.3.36	
Integrity check info	<i>CV-notTM</i>		Integrity check info 10.3.3.16	
TrCH information elements				
CHOICE <i>mode</i>	MP			
>FDD				(no data)
>TDD				
>>TFCS Id	OP		Transport Format Combination Set Identity 10.3.5.21	
DPCH/PUSCH TFCS in uplink	MP		Transport Format Combination subset 10.3.5.22	
Activation time for TFC subset	<i>CV-notTMMD</i>		Activation time 10.3.3.1	Default value is "now"
TFC Control duration	<i>CV-notTMopt</i>		TFC Control duration 10.3.6.80	

Condition	Explanation
<i>NotTM</i>	The message type is not needed when transmitting the message on the transparent mode signalling DCCH and mandatory present otherwise.
<i>NotTMopt</i>	The information element is not needed when transmitting the message on the transparent mode signalling DCCH and is optional otherwise.
<i>NotTMMD</i>	The information element is not needed when transmitting the message on the transparent mode signalling DCCH and is mandatory with default otherwise.

If transparent mode signalling is used and the encoded message does not fill a transport block, the RRC layer shall insert padding according to subclause 12.1.

10.2.54 TRANSPORT FORMAT COMBINATION CONTROL FAILURE

This message is sent to indicate that a received TRANSPORT FORMAT COMBINATION CONTROL message could not be handled by the UE.

RLC-SAP: AM

Logical channel: DCCH

Direction: UE→UTRAN

Information Element/Group name	Need	Multi	Type and reference	Semantics description
Message Type	MP		Message Type	
UE information elements				
RRC transaction identifier	MP		RRC transaction identifier 10.3.3.36	
Integrity check info	CH		Integrity check info 10.3.3.16	
Failure cause	MP		Failure cause and error information 10.3.3.14	

10.2.55 UE CAPABILITY ENQUIRY

The UE CAPABILITY ENQUIRY is used by the UTRAN to enquire inter-RAT classmarks from the UE.

RLC-SAP: AM or UM

Logical channel: DCCH

Direction: UTRAN → UE

Information Element/Group name	Need	Multi	Type and reference	Semantics description
Message Type	MP		Message Type	
UE information elements				
RRC transaction identifier	MP		RRC transaction identifier 10.3.3.36	
Integrity check info	CH		Integrity check info 10.3.3.16	Integrity check info is included if integrity protection is applied
Capability update requirement	MP		Capability update requirement 10.3.3.2	

10.2.56 UE CAPABILITY INFORMATION

This message is sent by UE to convey UE specific capability information to the UTRAN.

RLC-SAP: AM

Logical channel: DCCH

Direction: UE → UTRAN

Information Element/Group name	Need	Multi	Type and reference	Semantics description
Message Type	MP		Message Type	
UE information elements				
RRC transaction identifier	OP		RRC transaction identifier 10.3.3.36	
Integrity check info	CH		Integrity check info 10.3.3.16	Integrity check info is included if integrity protection is applied
UE radio access capability	OP		UE radio access capability 10.3.3.42	
UE radio access capability extension	OP		UE radio access capability extension 10.3.3.42a	
Other information elements				
UE system specific capability	OP	1 to <maxInter SysMessages>		
>Inter-RAT UE radio access capability	MP		Inter-RAT UE radio access capability 10.3.8.7	

10.2.57 UE CAPABILITY INFORMATION CONFIRM

This message is sent by UTRAN to confirm that UE capability information has been received.

RLC-SAP: AM or UM

Logical channel: DCCH

Direction: UTRAN → UE

Information Element/Group name	Need	Multi	Type and reference	Semantics description
Message Type	MP		Message Type	
UE information elements				
RRC transaction identifier	MP		RRC transaction identifier 10.3.3.36	
Integrity check info	CH		Integrity check info 10.3.3.16	Integrity check info is included if integrity protection is applied

10.2.58 UPLINK DIRECT TRANSFER

This message is used to transfer NAS messages for an existing signalling connection.

RLC-SAP: AM

Logical channel: DCCH

Direction: UE → UTRAN

Information Element/Group name	Need	Multi	Type and reference	Semantics description
Message Type	MP		Message Type	
UE information elements				
Integrity check info	CH		Integrity check info 10.3.3.16	Integrity check info is included if integrity protection is applied
CN information elements				
CN domain identity	MP		CN domain identity 10.3.1.1	
NAS message	MP		NAS message 10.3.1.8	
Measurement information elements				
Measured results on RACH	OP		Measured results on RACH 10.3.7.45	

10.2.59 UPLINK PHYSICAL CHANNEL CONTROL

NOTE: Only for TDD.

This message is used to transfer uplink physical channel parameters to the UE.

RLC-SAP: AM or UM

Logical channel: DCCH

Direction: UTRAN→UE

Information Element/Group name	Need	Multi	Type and Reference	Semantics description	Version
Message Type	MP		Message Type		
UE information elements					
RRC transaction identifier	MP		RRC transaction identifier 10.3.3.36		
Integrity check info	OP		Integrity check info 10.3.3.16		
PhyCH information elements					
CCTrCH power control info	OP		CCTrCH power control info 10.3.6.8	Power control information for one CCTrCH	
CHOICE <i>TDD option</i>	MP				REL-4
>3.84 Mcps TDD					REL-4
>>Alpha	OP		Alpha 10.3.6.5		
>>>Special Burst Scheduling	OP		Special Burst Scheduling 10.3.6.75a	UL Special Burst generation period in radio frames	
>>>Timing Advance Control	OP		UL Timing Advance Control 10.3.6.96		
>>>PRACH Constant Value	OP		Constant value 10.3.6.11	Operator controlled PRACH Margin	
>>>PUSCH Constant Value	OP		Constant value 10.3.6.11	Operator controlled PUSCH Margin	
>1.28 Mcps TDD					REL-4
>>Uplink synchronisation parameters	MD			Default: Uplink synchronisation step size 1. Uplink synchronisation frequency 1.	REL-4
>>>Uplink synchronisation step size	MP		Integer(1..8)	This parameter specifies the step size to be used for the adjustment of the uplink transmission timing	REL-4
>>>Uplink synchronisation frequency	MP		Integer(1..8)	This parameter specifies the frequency of the adjustment of the uplink transmission timing	REL-4
UE positioning related parameters	<i>CV-IPDLs</i>				REL-4
>IPDL-Alpha	MP		Alpha 10.3.6.5		REL-4
>Max power increase	MP		Integer (0..3)	In db	REL-4

Condition	Explanation
<i>IPDLs</i>	This IE is present only if idle periods are applied

10.2.60 URA UPDATE

This message is used by the UE to initiate a URA update procedure.

RLC-SAP: TM

Logical channel: CCCH

Direction: UE→UTRAN

Information Element/Group name	Need	Multi	Type and reference	Semantics description
Message Type	MP		Message Type	
UE information elements				
U-RNTI	MP		U-RNTI 10.3.3.47	
RRC transaction identifier	CV- <i>ProtErr</i>		RRC transaction identifier 10.3.3.36	
Integrity check info	CH		Integrity check info 10.3.3.16	
URA update cause	MP		URA update cause 10.3.3.46	
Protocol error indicator	MD		Protocol error indicator 10.3.3.27	Default value is FALSE
Other information elements				
Protocol error information	CV- <i>ProtErr</i>		Protocol error information 10.3.8.12	

Condition	Explanation
<i>ProtErr</i>	The IE is mandatory present if the IE "Protocol error indicator" has the value "TRUE" and not needed otherwise.

10.2.61 URA UPDATE CONFIRM

This message confirms the URA update procedure and can be used to reallocate new RNTI information for the UE valid after the URA update.

RLC-SAP: UM

Logical channel: CCCH or DCCH

Direction: UTRAN→UE

Information Element/Group name	Need	Multi	Type and reference	Semantics description
Message Type	MP		Message Type	
UE information elements				
U-RNTI	CV-CCCH		U-RNTI 10.3.3.47	
RRC transaction identifier	MP		RRC transaction identifier 10.3.3.36	
Integrity check info	CH		Integrity check info 10.3.3.16	Integrity check info is included if integrity protection is applied
Integrity protection mode info	OP		Integrity protection mode info 10.3.3.19	
Ciphering mode info	OP		Ciphering mode info 10.3.3.5	
New U-RNTI	OP		U-RNTI 10.3.3.47	
New C-RNTI	OP		C-RNTI 10.3.3.8	
RRC State Indicator	MP		RRC State Indicator 10.3.3.10	
UTRAN DRX cycle length coefficient	MD		UTRAN DRX cycle length coefficient 10.3.3.49	Default value is the existing value of UTRAN DRX cycle length coefficient
CN Information Elements				
CN Information info	OP		CN Information info 10.3.1.3	
UTRAN mobility information elements				
URA identity	OP		URA identity 10.3.2.6	
RB information elements				
Downlink counter synchronisation info	OP			
>RB with PDCP information list	OP	1 to <maxRBall RABs>		This IE is needed for each RB having PDCP in the case of lossless SRNS relocation
>>RB with PDCP information	MP		RB with PDCP information 10.3.4.22	

Condition	Explanation
CCCH	This IE is mandatory present when CCCH is used and not needed otherwise.

10.2.62 UTRAN MOBILITY INFORMATION

This message is used by UTRAN to allocate a new RNTI and to convey other UTRAN mobility related information to a UE.

RLC-SAP: AM or UM

Logical channel: DCCH

Direction: UTRAN→UE

Information Element/Group name	Need	Multi	Type and reference	Semantics description
Message Type	MP		Message Type	
UE Information Elements				
Integrity check info	CH		Integrity check info 10.3.3.16	
RRC transaction identifier	MP		RRC transaction identifier 10.3.3.36	
Integrity protection mode info	OP		Integrity protection mode info 10.3.3.19	
Ciphering mode info	OP		Ciphering mode info 10.3.3.5	
New U-RNTI	OP		U-RNTI 10.3.3.47	
New C-RNTI	OP		C-RNTI 10.3.3.8	
UE Timers and constants in connected mode	OP		UE Timers and constants in connected mode 10.3.3.43	
CN Information Elements				
CN Information info	OP		CN Information info full 10.3.1.3a	
UTRAN Information Elements				
URA identity	OP		URA identity 10.3.2.6	
RB Information elements				
Downlink counter synchronisation info	OP			
>RB with PDCP information list	OP	1 to <maxRBall RABs>		This IE is needed for each RB having PDCP in the case of lossless SRNS relocation
>>RB with PDCP information	MP		RB with PDCP information 10.3.4.22	

10.2.63 UTRAN MOBILITY INFORMATION CONFIRM

This message is used to confirm the new UTRAN mobility information for the UE.

RLC-SAP: AM

Logical channel: DCCH

Direction: UE→UTRAN

Information Element/Group name	Need	Multi	Type and reference	Semantics description
Message Type	MP		Message Type	
UE information elements				
RRC transaction identifier	MP		RRC transaction identifier 10.3.3.36	
Integrity check info	CH		Integrity check info 10.3.3.16	
Uplink integrity protection activation info	OP		Integrity protection activation info 10.3.3.17	
RB Information elements				
COUNT-C activation time	OP		Activation time 10.3.3.1	Used for radio bearers mapped on RLC-TM. Only applicable if the UE is moving to CELL_DCH state due to this procedure
Radio bearer uplink ciphering activation time info	OP		RB activation time info 10.3.4.13	
Uplink counter synchronisation info	OP			
>RB with PDCP information list	OP	1 to <maxRBall RABs>		This IE is needed for each RB having PDCP in the case of lossless SRNS relocation
>>RB with PDCP information	MP		RB with PDCP information 10.3.4.22	
>START list	MP	1 to <maxCNdo mains>		START [40] values for all CN domains.
>>CN domain identity	MP		CN domain identity 10.3.1.1	
>>START	MP		START 10.3.3.38	START value to be used in this CN domain.

10.2.64 UTRAN MOBILITY INFORMATION FAILURE

This message is sent to indicate a failure to act on a received UTRAN MOBILITY INFORMATION message.

RLC-SAP: AM

Logical channel: DCCH

Direction: UE→UTRAN

Information Element/Group name	Need	Multi	Type and reference	Semantics description
Message Type	MP		Message Type	
UE information elements				
RRC transaction identifier	MP		RRC transaction identifier 10.3.3.36	
Integrity check info	CH		Integrity check info 10.3.3.16	
Failure cause	MP		Failure cause and error information 10.3.3.14	

10.3 Information element functional definitions

10.3.1 CN Information elements

10.3.1.1 CN domain identity

Identifies the type of core network domain.

Information Element/Group name	Need	Multi	Type and reference	Semantics description
CN domain identity	MP		Enumerated (CS domain, PS domain)	

10.3.1.2 CN Domain System Information

Information Element/Group name	Need	Multi	Type and reference	Semantics description
CN domain identity	MP		CN domain identity 10.3.1.1	
<i>CHOICE CN Type</i>				
<i>>GSM-MAP</i>				
>>CN domain specific NAS system information	MP		NAS system information (GSM-MAP) 10.3.1.9	
<i>>ANSI-41</i>				
>>CN domain specific NAS system information	MP		ANSI-41 NAS system information, 10.3.9.4	
CN domain specific DRX cycle length coefficient	MP		CN domain specific DRX cycle length coefficient, 10.3.3.6	

10.3.1.3 CN Information info

Information Element/Group name	Need	Multi	Type and reference	Semantics description
PLMN identity	OP		PLMN identity 10.3.1.11	
CN common GSM-MAP NAS system information	OP		NAS system information (GSM-MAP) 10.3.1.9	
CN domain related information	OP	1 to <maxCNdomains>		
>CN domain identity	MP		CN domain identity 10.3.1.1	
>CN domain specific GSM-MAP NAS system info	MP		NAS system information (GSM-MAP) 10.3.1.9	

NOTE 1: Necessity of PLMN is FFS and for CN domain identity and NAS system information, the confirmation in SA WG2 is needed.

10.3.1.3a CN Information info full

Information Element/Group name	Need	Multi	Type and reference	Semantics description
PLMN identity	OP		PLMN identity 10.3.1.11	
CN common GSM-MAP NAS system information	OP		NAS system information (GSM-MAP) 10.3.1.9	
CN domain related information	OP	1 to <maxCNdomains>		
>CN domain identity	MP		CN domain identity 10.3.1.1	
>CN domain specific GSM-MAP NAS system info	MP		NAS system information (GSM-MAP) 10.3.1.9	
>CN domain specific DRX cycle length coefficient	MP		CN domain specific DRX cycle length coefficient, 10.3.3.6	

10.3.1.4 IMEI

This IE contains an International Mobile Equipment Identity. Setting specified in [11].

Information Element/Group name	Need	Multi	Type and reference	Semantics description
IMEI	MP	15		The first element contains the first IMEI digit, the second element the second IMEI digit and so on.
>IMEI digit	MP		INTEGER(0..15)	

10.3.1.5 IMSI (GSM-MAP)

This IE contains an International Mobile Subscriber Identity, used towards a GSM-MAP type of PLMN. Setting specified in [11].

Information Element/Group name	Need	Multi	Type and reference	Semantics description
IMSI	MP	6 to 15		The first element contains the first IMSI digit, the second element the second IMSI digit and so on.
>IMSI digit	MP		INTEGER(0..9)	

10.3.1.6 Intra Domain NAS Node Selector

This IE carries information to be used to route the establishment of a signalling connection to a CN node within a CN domain.

Information Element/Group name	Need	Multi	Type and reference	Semantics description
CHOICE <i>version</i>	MP			
>R99				
>>CHOICE <i>CN type</i>	MP			
>>>GSM-MAP				
>>>>CHOICE <i>Routing basis</i>	MP			
>>>>>local (P)TMSI				TMSI allocated in the current LA or PTMSI allocated in the current RA
>>>>>>Routing parameter	MP		Bit string (10)	The TMSI/ PTMSI consists of 4 octets (32bits). The bits are numbered from b0 to b31, with bit b0 being the least significant The "Routing parameter" bit string consists of bits b14 through b23 of the TMSI/ PTMSI where bit b14 is the least significant.
>>>>>(P)TMSI of same PLMN, different (RA)LA				TMSI allocated in another LA of this PLMN or PTMSI allocated in another RA this PLMN
>>>>>>Routing parameter	MP		Bit string (10)	The TMSI/ PTMSI consists of 4 octets (32bits). The bits are numbered from b0 to b31, with bit b0 being the least significant The "Routing parameter" bit string consists of bits b14 through b23 of the TMSI/ PTMSI where bit b14 is the least significant.
>>>>>(P)TMSI of different PLMN				TMSI or a PTMSI allocated in another PLMN
>>>>>>>Routing parameter	MP		Bit string (10)	The TMSI/ PTMSI consists of 4 octets (32bits). The bits are numbered from b0 to b31, with bit b0 being the least significant The "Routing parameter" bit string consists of bits b14 through b23 of the TMSI/ PTMSI where bit b14 is the least significant.
>>>>>>>IMSI(response to IMSI paging)				NAS identity is IMSI
>>>>>>>>Routing parameter	MP		Bit string (10)	The "Routing parameter" bit string consists of DecimalToBinary [(IMSI div 10) mod 1000]. The bits of the result are numbered from b0 to b9, with bit b0 being the least significant.
>>>>>>>>IMSI(cause UE initiated event)				NAS identity is IMSI
>>>>>>>>>Routing parameter	MP		Bit string (10)	The "Routing parameter" bit string consists of DecimalToBinary [(IMSI div 10) mod 1000]. The bits of the result are numbered from b0 to b9, with bit b0 being the least significant.
>>>>>>>>>>IMEI				NAS parameter is IMEI

>>>>>Routing parameter	MP		Bit string (10)	The "Routing parameter" bit string consists of DecimalToBinary [(IMEI div 10) mod 1000]. The bits of the result are numbered from b0 to b9, with bit b0 being the least significant.
>>>>>Spare 1			Bit string (10)	This choice shall not be used in this version
>>>>>Spare 2			Bit string (10)	This choice shall not be used in this version
>>>>Entered parameter	MP		Boolean	Entered parameter shall be set to TRUE if the most significant byte of the current LAI/RAI is different compared to the most significant byte of the LAI/RAI stored on the SIM; Entered parameter shall be set to FALSE otherwise
>>>ANSI-41			Bit string (14)	All bits shall be set to 0
>Later			Bit string(15)	This bit string shall not be sent by mobiles that are compliant to this version of the protocol.

10.3.1.7 Location Area Identification

Identifies uniquely a location area for a GSM-MAP type of PLMN. Setting specified in [5].

Information Element/Group name	Need	Multi	Type and reference	Semantics description
PLMN identity	MP		PLMN identity 10.3.1.11	
LAC	MP		Bit string(16)	The LAC bits are numbered b0-b15, where b0 is the least significant bit.

10.3.1.8 NAS message

A non-access stratum message to be transferred transparently through UTRAN.

Information Element/Group name	Need	Multi	Type and reference	Semantics description
NAS message	MP		Octet string (1..4095)	The first octet contains octet 1 [17] of the NAS message, the second octet contains octet 2 of the NAS message and so on.

10.3.1.9 NAS system information (GSM-MAP)

This information element contains system information that belongs to the non-access stratum for a GSM-MAP type of PLMN. This information is transparent to RRC. It may contain either information specific to one CN domain (CS or PS) or information common for both CN domains.

Information Element/Group name	Need	Multi	Type and reference	Semantics description
GSM-MAP NAS system information	MP		Octet string(1..8)	The first octet contains octet 1 [17] of the NAS system information element, the second octet contains octet 2 of the NAS system information element and so on.

10.3.1.10 Paging record type identifier

Information Element/Group name	Need	Multi	Type and reference	Semantics description
Paging record type identifier	MP		Enumerated (IMSI (GSM-MAP), TMSI (GSM-MAP)/ P-TMSI, IMSI (DS-41), TMSI (DS-41))	

10.3.1.11 PLMN identity

This information element identifies a Public Land Mobile Network for a GSM-MAP type of PLMN. Setting of digits is defined in [11].

Information Element/Group name	Need	Multi	Type and reference	Semantics description
MCC	MP	3		The first element contains the first MCC digit, the second element the second MCC digit and so on.
>MCC digit	MP		INTEGER(0..9)	
MNC	MP	2 to 3		The first element contains the first MNC digit, the second element the second MNC digit and so on.
>MNC digit	MP		INTEGER(0..9)	

10.3.1.12 PLMN Type

Identifies the type of Public Land Mobile Network (PLMN). This IE shall be used to control the interpretation of network dependent messages and information elements in the RRC protocol.

Information Element/Group name	Need	Multi	Type and reference	Semantics description
PLMN Type	MP		Enumerated (GSM-MAP, ANSI-41, GSM-MAP and ANSI-41)	

10.3.1.13 P-TMSI (GSM-MAP)

This IE contains a Packet Temporary Mobile Subscriber Identity, used towards a GSM-MAP type of PLMN.

Information Element/Group name	Need	Multi	Type and reference	Semantics description
P-TMSI	MP		Bit string (32)	Setting specified in [11]. The P-TMSI bits are numbered b0-b31, where b0 is the least significant bit.

10.3.1.14 RAB identity

This information element uniquely identifies a radio access bearer within a CN domain.

Information Element/Group name	Need	Multi	Type and reference	Semantics description
CHOICE <i>RAB identity type</i>	MP			
>RAB identity (GSM-MAP)			Bit string (8)	Formatted according to [5]. The bits are numbered b1-b8, where b1 is the least significant bit.
>RAB identity (ANSI-41)			Bit string (8)	The bits are numbered b1-b8, where b1 is the least significant bit.

CHOICE <i>NAS binding info type</i>	Condition under which the given <i>RAB identity type</i> is chosen
RAB identity (GSM-MAP)	PLMN is of type GSM-MAP
RAB identity (ANSI-41)	PLMN is of type ANSI-41

10.3.1.15 Routing Area Code

Identifies a routing area within a location area for a GSM-MAP type of PLMN.

Information Element/Group name	Need	Multi	Type and reference	Semantics description
Routing Area Code	MP		Bit string(8)	Setting specified in [11]. The Routing Area Code bits are numbered b0 to b7, where b0 is the least significant bit.

10.3.1.16 Routing Area Identification

Identifies uniquely a routing area for a GSM-MAP type of PLMN. Setting specified in [11].

Information Element/Group name	Need	Multi	Type and reference	Semantics description
LAI	MP		Location area identification 10.3.1.7	
RAC	MP		Routing area code 10.3.1.15	

10.3.1.17 TMSI (GSM-MAP)

This IE contains a Temporary Mobile Subscriber Identity, used towards a GSM-MAP type of PLMN.

Information Element/Group name	Need	Multi	Type and reference	Semantics description
TMSI (GSM-MAP)	MP		Bit string (32)	Setting specified in [11]. The TMSI bits are numbered b0-b31, where b0 is the least significant bit.

10.3.2 UTRAN mobility Information elements

10.3.2.1 Cell Access Restriction

Indicates the restrictions to cell access.

Information Element/Group name	Need	Multi	Type and reference	Semantics description
Cell Barred	MP		Enumerated(not barred, barred)	
Intra-frequency cell re-selection indicator	<i>CV-Barred</i>		Enumerated(not allowed, allowed)	
T_{barred}	<i>CV-Barred</i>		Integer (10,20,40,80,160,320,640,1280)	[4] [s]
Cell Reserved for operator use	MP		Enumerated(reserved, not reserved)	
Cell Reservation Extension	MP		Enumerated(reserved, not reserved)	
Access Class Barred list	MD	maxAC		Default is no access class barred is applied. The first instance of the parameter corresponds to Access Class 0, the second to Access Class 1 and so on up to Access Class 15. UE reads this IE of its access class stored in SIM.
>Access Class Barred	MP		Enumerated(not barred, barred)	

Condition	Explanation
<i>Barred</i>	The IE is mandatory present if the IE "Cell Barred" has the value "Barred"; otherwise the element is not needed in the message.

10.3.2.2 Cell identity

This information element identifies a cell unambiguously within a PLMN.

Information Element/Group name	Need	Multi	Type and reference	Semantics description
Cell identity	MP		bit string(28)	

10.3.2.3 Cell selection and re-selection info for SIB3/4

Information Element/Group name	Need	Multi	Type and reference	Semantics description
Mapping Info	OP		Mapping info 10.3.2.5	This IE should not be sent.
Cell_selection_and_reselection_quality_measure	MP		Enumerated (CPICH Ec/N0, CPICH RSCP)	Choice of measurement (CPICH Ec/N0 or CPICH RSCP) to use as quality measure Q for FDD cells. This IE is also sent to the UE in SIB11/12. Both occurrences of the IE should be set to the same value.
CHOICE mode	MP			
>FDD				
>>S _{intrasearch}	OP		Integer (-32..20 by step of 2)	If a negative value is received the UE shall consider the value to be 0. [4] [dB]
>>S _{intersearch}	OP		Integer (-32..20 by step of 2)	If a negative value is received the UE shall consider the value to be 0. [4] [dB]
>>S _{searchHCS}	OP		Integer (-105..91 by step of 2)	If a negative value is received the UE shall consider the value to be 0. [4] [dB]
>>RAT List	OP	1 to <maxOther RAT>		
>>>RAT identifier	MP		Enumerated (GSM, cdma2000)	
>>>S _{search,RAT}	MP		Integer (-32..20 by step of 2)	In case the value 20 is received the UE shall consider this IE as if it was absent according to [4] If a negative value is received the UE shall consider the value to be 0. [dB]
>>>S _{HCS,RAT}	OP		Integer (-105..91 by step of 2)	If a negative value is received the UE shall consider the value to be 0. [4] [dB]
>>>S _{limit,SearchRAT}	MP		Integer (-32..20 by step of 2)	If a negative value is received the UE shall consider the value to be 0. [4] [dB]
>>Q _{qualmin}	MP		Integer (-24..0)	Ec/N0, [dB]
>>Q _{rxlevmin}	MP		Integer (-115..-25 by step of 2)	RSCP, [dBm]
>TDD				
>>S _{intrasearch}	OP		Integer (-105..91 by step of 2)	If a negative value is received the UE shall consider the value to be 0. [4] [dB]
>>S _{intersearch}	OP		Integer (-	If a negative value is received

			105..91 by step of 2)	the UE shall consider the value to be 0. [4] [dB]
>>S _{searchHCS}	OP		Integer (-105..91 by step of 2)	If a negative value is received the UE shall consider the value to be 0. [4] [dB]
>>RAT List	OP	1 to <maxOther RAT>		
>>>RAT identifier	MP		Enumerated (GSM, cdma2000)	
>>>S _{search,RAT}	MP		Integer (-105..91 by step of 2)	In case the value 91 is received the UE shall consider this IE as if it was absent according to [4] If a negative value is received the UE shall consider the value to be 0. [dB]
>>>S _{HCS,RAT}	OP		Integer (-105..91 by step of 2)	If a negative value is received the UE shall consider the value to be 0. [4] [dB]
>>>S _{limit,SearchRAT}	MP		Integer (-105..91 by step of 2)	If a negative value is received the UE shall consider the value to be 0. [4] [dB]
>>Q _{rxlevmin}	MP		Integer (-115..-25 by step of 2)	RSCP, [dBm]
Q _{hyst1s}	MP		Integer (0..40 by step of 2)	[4] [dB]
Q _{hyst2s}	CV-FDD-Quality-Measure		Integer (0..40 by step of 2)	Default value is Q _{hyst1s} [4] [dB]
T _{reselections}	MP		Integer (0..31)	[s]
HCS Serving cell Information	OP		HCS Serving cell information 10.3.7.12	
Maximum allowed UL TX power	MP		Maximum allowed UL TX power 10.3.6.39	[dBm] UE_TXPWR_MAX_RACH in [4].

Condition	Explanation
FDD-Quality-Measure	The IE is not needed if the IE "Cell_selection_and_reselection_quality_measure" has the value CPICH RSCP, otherwise the IE is mandatory and has a default value.

10.3.2.4 Cell selection and re-selection info for SIB11/12

Information Element/Group name	Need	Multi	Type and reference	Semantics description
Qoffset1 _{s,n}	MD		Integer(-50..50)	Default value is 0. [dB]
Qoffset2 _{s,n}	CV-FDD-Quality-Measure		Integer(-50..50)	Default value is 0. [dB]
Maximum allowed UL TX power	MD		Maximum allowed UL TX power 10.3.6.39	[dBm] UE_TXPWR_MAX_RACH in [4]. Default is the Maximum allowed UL TX power for the serving cell
HCS neighbouring cell information	OP		HCS Neighbouring cell information 10.3.7.11	
CHOICE mode	MP			
>FDD				
>>Qqualmin	CV-FDD-Serving-Cell		Integer (-24..0)	Ec/NO, [dB] Default value is Qqualmin for the serving cell
>>Qrxlevmin	MD		Integer (-115..-25 by step of 2)	RSCP, [dBm] Default value is Qrxlevmin for the serving cell
>TDD				
>>Qrxlevmin	MD		Integer (-115..-25 by step of 2)	RSCP, [dBm] Default value is Qrxlevmin for the serving cell
>GSM				
>>Qrxlevmin	MD		Integer (-115..-25 by step of 2)	GSM RSSI, [dBm] Default value is Qrxlevmin for the serving cell

Condition	Explanation
FDD-Quality-Measure	This IE is mandatory and has a default value for Intra/Inter Frequency Cells if the IE "Cell_selection_and_reselection_quality_measure" has the value CPICH Ec/No. Otherwise the IE is optional
FDD-Serving-Cell	This IE is mandatory and has a default value if the serving cell is an FDD cell. Otherwise the IE is mandatory present.

10.3.2.5 Mapping Info

Information Element/Group name	Need	Multi	Type and Reference	Semantics description	Version
Mapping List	MP	1 to <MaxRAT>			
>RAT	MP		Enumerated (UTRA FDD, UTRA TDD 3.84 Mcps, UTRA TDD 1.28 Mcps, GSM, cdma2000)		UTRA TDD 1.28 Mcps is included for REL-4.
>Mapping Function Parameter List	MP	1 to <maxMeas Intervals>			
>>Function type	MP		Enumerated (linear, function type 2, function type 3, function type 4)	Type of the function within the interval.	
>>Map_parameter_1	MD		Integer (0..99)	Parameter describing the mapping function between the quality measurement and the representing quality value, see [4]. Default value is zero for the first interval or otherwise the value of Map_parameter_2 of the interval before.	
>>Map_parameter_2	MP		Integer (0..99)	Parameter describing the mapping function between the quality measurement and the representing quality value, see [4].	
>>Upper_limit	CV- <i>MaxInt</i>		Integer (1..MaxMeas)	Upper limit of interval for which the Map_parameter_1 and Map_parameter_2 are valid. MaxMeas = 25 if RAT = UTRA FDD / CPICH Ec/N0, MaxMeas = 91 if RAT = UTRA TDD 3.84 Mcps or if RAT = UTRA TDD 1.28 Mcps or if RAT = UTRA	UTRA TDD 1.28 Mcps is included for REL-4.

				FDD/ CPICH RSCP, MaxMeas = 63 if RAT = GSM.	
--	--	--	--	------------------------------------------------------	--

Condition	Explanation
<i>MaxInt</i>	This IE is mandatory present if Mapping Function Parameter List has not reached maxMeasIntervals and is not needed otherwise.

10.3.2.6 URA identity

Gives the identity of the UTRAN Registration Area. It can be used to indicate to the UE which URA it shall use in case of overlapping URAs.

Information Element/Group name	Need	Multi	Type and reference	Semantics description
URA identity	MP		bit string(16)	

10.3.3 UE Information elements

10.3.3.1 Activation time

Activation Time defines the frame number/time at which the operation/changes caused by the related message shall take effect. Values between 0 and 255 indicate the absolute value of CFN (Connection Frame Number) of that frame number/time.

Information Element/Group name	Need	Multi	Type and reference	Semantics description
Activation time	MP		Integer(0..255)	CFN [10]

10.3.3.2 Capability Update Requirement

This IE indicates to the UE which specific capabilities to transfer to the network.

Information Element/Group name	Need	Multi	Type and reference	Semantics description	Version
UE radio access FDD capability update requirement	MP		Boolean	TRUE indicates update required	
UE radio access 3.84 Mcps TDD capability update requirement	MP		Boolean	TRUE indicates update required	Name changed in REL-4
UE radio access 1.28 Mcps TDD capability update requirement	MP		Boolean	TRUE indicates update required	REL-4
System specific capability update requirement list	OP	1 to <maxSystemCapability>		In this version, a maximum size of 4 of the list shall be applied and any items after the 4 th item in the list shall be ignored.	
>System specific capability update requirement	MP		Enumerated (GSM)		

Default value is:

"UE radio capability FDD update requirement" = false

"UE radio capability 3.84 Mcps TDD update requirement" = false

"UE radio capability 1.28 Mcps TDD update requirement" = false

"System specific capability update requirement" not present.

10.3.3.3 Cell update cause

Indicates the cause for cell update.

Information Element/Group name	Need	Multi	Type and reference	Semantics description
Cell update cause	MP		Enumerated (cell reselection, periodical cell update, uplink data transmission, paging response, re-entered service area, radio link failure, RLC unrecoverable error)	At least one spare value needed.

10.3.3.4 Ciphering Algorithm

Information Element/Group name	Need	Multi	Type and reference	Semantics description
Ciphering algorithm	MP		Enumerated (UEA0, UEA1)	

10.3.3.5 Ciphering mode info

This information element contains the ciphering specific security mode control information.

Information Element/Group name	Need	Multi	Type and reference	Semantics description
Ciphering mode command	MP		Enumerated (start/restart, stop)	
Ciphering algorithm	CV- <i>notStop</i>		Ciphering algorithm 10.3.3.4	
Ciphering activation time for DPCH	OP		Activation time 10.3.3.1	Used for radio bearers mapped on RLC-TM. Only applicable if the UE is already in CELL_DCH state
Radio bearer downlink ciphering activation time info	OP		RB activation time info, 10.3.4.13	Used for radio bearers mapped on RLC-AM or RLC-UM

Condition	Explanation
<i>notStop</i>	The IE is mandatory present if the IE "Ciphering mode command" has the value "start/restart", otherwise the IE is not needed in the message.

10.3.3.6 CN domain specific DRX cycle length coefficient

A coefficient in the formula to count the paging occasions to be used by a specific UE (specified in [4]) .

Information Element/Group name	Need	Multi	Type and reference	Semantics description
CN domain specific DRX cycle length coefficient	MP		Integer(6...9)	Refers to 'k' in the formula as specified in [4], Discontinuous reception

10.3.3.7 CPCH Parameters

NOTE: Only for FDD.

These parameters are used by any UE using any CPCH set allocated to the cell that is broadcasting this system information.

Information Element/Group name	Need	Multi	Type and reference	Semantics description
Initial Priority Delay	OP	1 to maxASC		Initial delays for ASC priority.
>NS_IP	MP		Integer (0...28)	Number of slots for initial fixed delay for each ASC priority level
Backoff control parameters	MP			
>N_ap_retrans_max	MP		Integer (1...64)	Max number of AP transmissions without AP-AICH response, a PHY parameter.
>N_access_fails	MP		Integer (1...64)	Max number of preamble ramping cycles when NAK response received, a MAC parameter.
>NF_bo_no_aich	MP		Integer (0...31)	Number of frames for UE backoff after N _{ap_retrans_max} unsuccessful AP access attempts, a MAC parameter.
>NS_bo_busy	MP		Integer (0...63)	Number of slots for UE fixed backoff after access attempt to busy CPCH, a MAC parameter.
>NF_bo_all_busy	MP		Integer (0...31)	Max number of frames for UE backoff after access attempt to last busy CPCH, a MAC parameter. UE randomly selects backoff value from range (0..NF_bo_all_busy)
>NF_bo_mismatch	MP		Integer (0...127)	Max number of frames for the UE backoff after received mismatch on CD/CA-ICH, a MAC parameter. UE randomly selects backoff value from range (0..NF_bo_mismatch)
>T_CPCH	MP		Enumerated (0, 1)	CPCH channel timing used to determine Tau, a PHY parameter
Power Control Algorithm	MP		Enumerated (algorithm 1, algorithm 2)	Specifies algorithm to be used by UE to interpret TPC commands
TPC step size	CV- <i>algo</i>		Integer (1, 2)	In dB
DL DPCCH BER	MP		Integer (0..63)	The BER quality value shall be set in the range $0 \leq \text{DPCCH BER} \leq 1$ in the unit BER_dB where: BER_dB_0: DPCCH BER = 0 BER_dB_1: $-\infty < \text{Log}_{10}(\text{DPCCH BER}) < -4.03$ BER_dB_2: $-4.03 \leq \text{Log}_{10}(\text{DPCCH BER}) < -3.965$ BER_dB_3: $-3.965 \leq \text{Log}_{10}(\text{DPCCH BER}) < -3.9$... BER_dB_61: $-0.195 \leq \text{Log}_{10}(\text{DPCCH BER}) < -0.13$ BER_dB_62: $-0.13 \leq \text{Log}_{10}(\text{DPCCH BER}) < -0.065$ BER_dB_63: $-0.065 \leq \text{Log}_{10}(\text{DPCCH BER}) \leq 0$

Condition	Explanation
<i>algo</i>	The IE is mandatory present if "Power Control Algorithm" is set to "algorithm 1", otherwise the IE is not needed

10.3.3.8 C-RNTI

The cell RNTI (C-RNTI) identifies an UE having a RRC connection within a cell.

Information Element/Group name	Need	Multi	Type and reference	Semantics description
C-RNTI	MP		bit string(16)	

10.3.3.9 DRAC system information

Information element	Need	Multi	Type and reference	Semantics description
DRAC system information	MP	1 to <maxDRA Cclasses>		DRAC information is sent for each class of terminal
>Transmission probability	MP		Transmission probability 10.3.3.39	
>Maximum bit rate	MP		Maximum bit rate 10.3.3.20	

10.3.3.10 RRC State Indicator

Indicates to a UE the RRC state to be entered.

Information Element/Group name	Need	Multi	Type and reference	Semantics description
RRC State indicator	MP		Enumerated(CELL_DCH, CELL_FACH, CELL_PCH, URA_PCH)	

10.3.3.11 Establishment cause

Cause for an RRC connection establishment request.

Information Element/Group name	Need	Multi	Type and reference	Semantics description
Establishment cause	MP		Enumerated(Originating Conversational Call, Originating Streaming Call, Originating Interactive Call, Originating Background Call, Originating Subscribed traffic Call, Terminating Conversational Call, Terminating Streaming Call, Terminating Interactive Call, Terminating Background Call, Emergency Call, Inter-RAT cell re-selection, Inter-RAT cell change order, Registration, Detach, Originating High Priority Signalling, Originating Low Priority Signalling, Call re-establishment, Terminating High Priority Signalling, Terminating Low Priority Signalling, Terminating – cause unknown)	At least one spare value needed.

10.3.3.12 Expiration Time Factor

Information Element/Group name	Need	Multi	Type and reference	Semantics description
Expiration Time Factor	MP		Enumerated(2times, 4times, 8times, 16times, 32times, 64times, 128times, 256times)	

10.3.3.13 Failure cause

Cause for failure to perform the requested procedure.

Information Element/Group name	Need	Multi	Type and reference	Semantics description
Failure cause	MP		Enumerated (configuration unsupported, physical channel failure, incompatible simultaneous reconfiguration, protocol error, compressed mode runtime error, cell update occurred, invalid configuration, configuration incomplete, unsupported measurement)	At least one spare value needed.

10.3.3.14 Failure cause and error information

Cause for failure to perform the requested procedure.

Information Element/Group name	Need	Multi	Type and reference	Semantics description
Failure cause	MP		Failure cause 10.3.3.13	
Protocol error information	CV-ProtErr		Protocol error information 10.3.8.12	
Deleted TGPSI	CV-CompModeErr		TGPSI 10.3.6.82	

Condition	Explanation
<i>ProtErr</i>	The IE is mandatory present if the IE "Failure cause" has the value "Protocol error"; otherwise it is not needed in the message.
<i>CompModeErr</i>	The IE is mandatory present if the IE "Failure cause" has the value "Compressed mode runtime error"; otherwise it is not needed in the message.

10.3.3.15 Initial UE identity

This information element identifies the UE at a request of an RRC connection.

Information Element/Group name	Need	Multi	Type and reference	Semantics description
CHOICE <i>UE id type</i>	MP			
>IMSI (GSM-MAP)			IMSI (GSM-MAP) 10.3.1.5	
>TMSI and LAI (GSM-MAP)				
>>TMSI (GSM-MAP)	MP		TMSI (GSM-MAP) 10.3.1.17	
>>LAI (GSM-MAP)	MP		Location Area Identification 10.3.1.7	
>P-TMSI and RAI (GSM-MAP)				
>>P-TMSI (GSM-MAP)	MP		P-TMSI (GSM-MAP) 10.3.1.13	
>>RAI (GSM-MAP)	MP		Routing Area Identification 10.3.1.16	
>IMEI			IMEI 10.3.1.4	
>ESN (DS-41)			Bit string (SIZE (32))	TIA/EIA/IS-2000-4
>IMSI (DS-41)			Octet string (SIZE (5..7))	TIA/EIA/IS-2000-4
>IMSI and ESN (DS-41)				TIA/EIA/IS-2000-4
>>IMSI (DS-41)	MP		Octet string (SIZE (5..7))	TIA/EIA/IS-2000-4
>>ESN (DS-41)	MP		Bit string (SIZE (32))	TIA/EIA/IS-2000-4
>TMSI (DS-41)			Octet string (SIZE (2..12))	TIA/EIA/IS-2000-4

10.3.3.16 Integrity check info

The Integrity check info contains the RRC message sequence number needed in the calculation of XMAC-I [40] and the calculated MAC-I.

Information Element/Group name	Need	Multi	Type and reference	Semantics description
Message authentication code	MP		bit string(32)	MAC-I [40]. The Message Authentication Code bits are numbered b0-b31, where b0 is the least significant bit. The 27 MSB of the IE shall be set to zero and the 5 LSB of the IE shall be set to the used signalling radio bearer identity when the encoded RRC message is used as the MESSAGE parameter in the integrity protection algorithm.
RRC Message sequence number	MP		Integer (0..15)	The local RRC hyper frame number (RRC HFN) is concatenated with the RRC message sequence number to form the input parameter COUNT-I for the integrity protection algorithm. The IE value shall be set to zero when the encoded RRC message is used as the MESSAGE parameter in the integrity protection algorithm.

10.3.3.17 Integrity protection activation info

This IE contains the time, in terms of RRC sequence numbers, when a new integrity protection configuration shall be activated for the signalling radio bearers.

Information Element/Group name	Need	Multi	Type and reference	Semantics description
RRC message sequence number list	MP	4 to 5		The RRC sequence number when a new integrity protection configuration shall be applied, for CCCH (=RB0) and signalling radio bearers in the order RB0, RB1, RB2, RB3, RB4. The value for RB1 shall be ignored if this IE was included in a RRC message sent on RB1. The value for RB2 shall be ignored if this IE was included in a RRC message sent on RB2.
>RRC message sequence number	MP		Integer (0..15)	

10.3.3.18 Integrity protection Algorithm

Information Element/Group name	Need	Multi	Type and reference	Semantics description
Integrity protection algorithm	MP		Enumerated (UIA1)	

10.3.3.19 Integrity protection mode info

Information Element/Group name	Need	Multi	Type and reference	Semantics description
Integrity protection mode command	MP		Enumerated (start, modify)	
Downlink integrity protection activation info	<i>CV-modify</i>		Integrity protection activation info 10.3.3.17	
Integrity protection algorithm	OP		Integrity protection algorithm 10.3.3.18	
Integrity protection initialisation number	<i>CV-start</i>		Bit string(32)	FRESH [40]

Condition	Explanation
<i>Start</i>	The IE is mandatory present if the IE "Integrity protection mode command" has the value "start ", otherwise it is not needed in the message.
<i>Modify</i>	The IE is mandatory present if the IE "Integrity protection mode command" has the value "modify" and not needed otherwise.

10.3.3.20 Maximum bit rate

NOTE: Only for FDD.

Indicates the maximum user bit rate allowed on a DCH controlled by DRAC procedure for the transmission period (Transmission time validity).

Information Element/Group name	Need	Multi	Type and reference	Semantics description
Maximum bit rate	MP		integer(0..512 by step of 16)	=kbit/s

10.3.3.21 Measurement capability

Information Element/Group name	Need	Multi	Type and reference	Semantics description	Version
Need for downlink compressed mode					
FDD measurements	MP		Boolean	TRUE means that the UE requires DL compressed mode in order to perform measurements on FDD	
3.84 Mcps TDD measurements	CV- 3.84_Mcps _tdd_sup		Boolean	TRUE means that the UE requires DL compressed mode in order to perform measurements on 3.84 Mcps TDD	Name changed in REL-4
1.28 Mcps TDD measurements	CV- 1.28_Mcps _tdd_sup		Boolean	TRUE means that the UE requires DL compressed mode in order to perform measurements on 1.28 Mcps TDD	REL-4
GSM 900	CV- Gsm900_s upM		Boolean	TRUE means that the UE requires DL compressed mode in order to perform measurements on GSM 900	
DCS 1800	CV- Gsm1800_ sup		Boolean	TRUE means that the UE requires DL compressed mode in order to perform measurements on DCS 1800	
GSM 1900	CV- Gsm1900_ sup		Boolean	TRUE means that the UE requires DL compressed mode in order to perform measurements on GSM 1900	
Multi-carrier measurement	CV- mc_sup		Boolean	TRUE means that the UE requires DL compressed mode in order to perform measurements on multi-carrier	
Need for uplink compressed mode					
FDD measurements	MP		Boolean	TRUE means that the UE requires UL compressed mode in order to perform measurements on FDD	
3.84 Mcps TDD measurements	CV- 3.84_Mcps _tdd_sup		Boolean	TRUE means that the UE requires UL compressed mode in order to	Name changed in REL-4

				perform measurements on 3.84 Mcps TDD	
1.28 Mcps TDD measurements	CV- 1.28_Mcps _tdd_sup		Boolean	TRUE means that the UE requires DL compressed mode in order to perform measurements on 1.28 Mcps TDD	REL-4
GSM 900	CV- Gsm900_s up		Boolean	TRUE means that the UE requires UL compressed mode in order to perform measurements on GSM 900	
DCS 1800	CV- Gsm1800_ sup		Boolean	TRUE means that the UE requires UL compressed mode in order to perform measurements on DCS 1800	
GSM 1900	CV- Gsm1900_ sup		Boolean	TRUE means that the UE requires UL compressed mode in order to perform measurements on GSM 1900	
Multi-carrier measurement	CV- mc_sup		Boolean	TRUE means that the UE requires UL compressed mode in order to perform measurements on multi-carrier	

Condition	Explanation
<i>3.84_Mcps_tdd_sup</i>	The IE is mandatory present if an IE "TDD RF capability" is present with the IE "Chip rate capability" set to "3.84 Mcps". Otherwise this field is not needed in the message.
<i>1.28_Mcps_tdd_sup</i>	The IE is mandatory present if an IE "TDD RF capability" is present with the IE "Chip rate capability" set to "1.28 Mcps". Otherwise this field is not needed in the message.
<i>Gsm900_sup</i>	The IE is mandatory present if the IE "Inter-RAT UE radio access capability" indicates support for GSM900 and not needed otherwise.
<i>Gsm1800_sup</i>	The IE is mandatory present if the IE "Inter-RAT UE radio access capability" indicates support for GSM1800 and not needed otherwise.
<i>Gsm1900_sup</i>	The IE is mandatory present if the IE "Inter-RAT UE radio access capability" indicates support for GSM1900 and not needed otherwise.
<i>mc_sup</i>	The IE is mandatory present if the IE "Support of multi-carrier" has the value TRUE. Otherwise this field is not needed in the message.

10.3.3.21a Measurement capability extension

This IE may be used to replace the measurement capability information provided within IE "Measurement capability".

Information Element/Group name	Need	Multi	Type and reference	Semantics description
FDD measurements	MP	1 to <maxFreq BandsFDD >		
>FDD Frequency band	MD		Enumerated(FDD2100, FDD1900)	The default value is the same as indicated in the IE "Frequency band" included in the IE " UE radio access capability extension". At least one spare value is needed
>Need for DL compressed mode	MP		Boolean	TRUE means that the UE requires DL compressed mode in order to perform measurements on the FDD frequency band indicated by the IE "FDD Frequency band"
>Need for UL compressed mode	MP		Boolean	TRUE means that the UE requires UL compressed mode in order to perform measurements on the FDD frequency band indicated by the IE "FDD Frequency band"
TDD measurements	CV- <i>tdd_sup</i>	1 to <maxFreq BandsTDD >		
>TDD Frequency band	MP		Enumerated(a, b, c)	
>Need for DL compressed mode	MP		Boolean	TRUE means that the UE requires DL compressed mode in order to perform measurements on TDD frequency band indicated by the IE "TDD Frequency band"
>Need for UL compressed mode	MP		Boolean	TRUE means that the UE requires UL compressed mode in order to perform measurements on TDD frequency band indicated by the IE "TDD Frequency band"
GSM measurements	CV- <i>gsm_sup</i>	1 to <maxFreq BandsGS M>		
>GSM Frequency band	MP		Enumerated(GSM450, GSM480, GSM850, GSM900P, GSM900E, GSM1800, GSM1900)	as defined in [45] at least one spare value
>Need for DL compressed mode	MP		Boolean	TRUE means that the UE requires DL compressed mode in order to perform measurements on GSM frequency band indicated by the IE "GSM Frequency band"
>Need for UL compressed mode	MP		Boolean	TRUE means that the UE requires UL compressed mode in order to perform measurements on GSM frequency band indicated by the IE "GSM Frequency band"

Multi-carrier measurement	CV- <i>mc_sup</i>			
>Need for DL compressed mode	MP		Boolean	TRUE means that the UE requires DL compressed mode in order to perform measurements on multi-carrier
>Need for UL compressed mode	MP		Boolean	TRUE means that the UE requires UL compressed mode in order to perform measurements on multi-carrier

Condition	Explanation
<i>tdd_sup</i>	The IE is mandatory present if the IE "Multi-mode capability" has the value "TDD" or "FDD/TDD". Otherwise this field is not needed in the message.
<i>gsm_sup</i>	The IE is mandatory present if the IE "Support of GSM" has the value TRUE. Otherwise this field is not needed in the message.
<i>mc_sup</i>	The IE is mandatory present if the IE "Support of multi-carrier" has the value TRUE. Otherwise this field is not needed in the message.

10.3.3.22 Paging cause

Cause for a CN originated page.

Information Element/Group name	Need	Multi	Type and reference	Semantics description
Paging cause	MP		Enumerated(Terminating Conversational Call, Terminating Streaming Call, Terminating Interactive Call, Terminating Background Call, Terminating High Priority Signalling, Terminating Low Priority Signalling, Terminating – cause unknown)	

10.3.3.23 Paging record

Information Element/Group name	Need	Multi	Type and reference	Semantics description
CHOICE <i>Used paging identity</i>	MP			
>CN identity				
>>Paging cause	MP		Paging cause 10.3.3.22	
>>>CN domain identity	MP		CN domain identity 10.3.1.1	
>>>CHOICE <i>UE Identity</i>	MP			
>>>>IMSI (GSM-MAP)			IMSI (GSM-MAP) 10.3.1.5	
>>>>TMSI (GSM-MAP)			TMSI (GSM-MAP) 10.3.1.17	
>>>>P-TMSI (GSM-MAP)			P-TMSI (GSM-MAP) 10.3.1.13	
>>>>IMSI (DS-41)			TIA/EIA/IS-2000-4	
>>>>TMSI (DS-41)			TIA/EIA/IS-2000-4	
>UTRAN identity				
>>U-RNTI	MP		U-RNTI 10.3.3.47	
>>>CN originated page to connected mode UE	OP			
>>>>Paging cause	MP		Paging cause 10.3.3.22	
>>>>CN domain identity	MP		CN domain identity 10.3.1.1	
>>>>Paging record type identifier	MP		Paging record type identifier 10.3.1.10	

Condition	Explanation
CHOICE <i>Used paging identity</i>	Condition under which the given <i>used paging identity</i> is chosen
CN identity	For CN originating pages (for idle mode UEs)
UTRAN identity	For UTRAN originating pages (for connected mode UEs)

10.3.3.24 PDCP capability

Indicates which algorithms and which value range of their parameters are supported by the UE.

Information Element/Group name	Need	Multi	Type and reference	Semantics description	Version
Support for lossless SRNS relocation	MP		Boolean	TRUE means supported	
Support for RFC2507	MP		Boolean	TRUE means supported	
>Max HC context space			Integer(512, 1024, 2048, 4096, 8192)		
Support for RFC 3095	MP		Boolean	TRUE means supported	REL-4
>Maximum number of ROHC context sessions	MD		Integer(2, 4, 8, 12, 16, 24, 32, 48, 64, 128, 256, 512, 1024, 16384)	Default value is 16.	REL-4
>Reverse decompression depth	MD		Integer (0..65535)	Default value is 0 (reverse decompression shall not be used).	REL-4

10.3.3.25 Physical channel capability

Information Element/Group name	Need	Multi	Type and Reference	Semantics description	Version
Downlink physical channel capability information elements					
FDD downlink physical channel capability	CH- <i>fdd_req_su</i> <i>p</i>				
>Max no DPCH/PDSCH codes	MP		Integer (1..8)	Maximum number of DPCH/PDSCH codes to be simultaneously received	
>Max no physical channel bits received	MP		Integer (600, 1200, 2400, 3600, 4800, 7200, 9600, 14400, 19200, 28800, 38400, 48000, 57600, 67200, 76800)	Maximum number of physical channel bits received in any 10 ms interval (DPCH, PDSCH, S-CCPCH)	
>Support for SF 512	MP		Boolean	TRUE means supported	
>Support of PDSCH	MP		Boolean	TRUE means supported	
>Simultaneous reception of SCCPCH and DPCH	MP		Boolean	TRUE means supported	
>Simultaneous reception of SCCPCH, DPCH and PDSCH	CV- <i>if_sim_rec</i> <i>_pdsch</i> <i>_sup</i>		Boolean	TRUE means supported	
>Max no of S-CCPCH RL	CV- <i>if_sim_rec</i>		Integer(1)	Maximum number of simultaneous S-CCPCH radio links	
>Support of dedicated pilots for channel estimation	MD		Enumerated (true)	Presence of this element means supported and absence not supported. If the UE notifies support of this functionality, it should comply with the corresponding performance requirements. Note 1.	
3.84 Mcps TDD downlink physical channel capability	CH- <i>3.84_Mcps</i> <i>_tdd_req_s</i> <i>up</i>				Name changed in REL-4
>Maximum number of timeslots per frame	MP		Integer (1..14)		
>Maximum number of physical channels per frame	MP		Integer (1..224)		
>Minimum SF	MP		Integer (1, 16)		
>Support of PDSCH	MP		Boolean	TRUE means supported	
>Maximum number of physical	MP		Integer		

channels per timeslot			(1..16)		
1.28 Mcps TDD downlink physical channel capability	CH-1.28_Mcps_tdd_req_s_up				REL-4
>Maximum number of timeslots per subframe	MP		Integer (1..6)		REL-4
>Maximum number of physical channels per subframe	MP		Integer (1..96)		REL-4
>Minimum SF	MP		Integer (1, 16)		REL-4
>Support of PDSCH	MP		Boolean	TRUE means supported	REL-4
>Maximum number of physical channels per timeslot	MP		Integer (1..16)		REL-4
>Support of 8PSK	MP		Boolean	TRUE means supported	REL-4
Uplink physical channel capability information elements					
FDD uplink physical channel capability	CH-fdd_req_s_up				
>Maximum number of DPDCH bits transmitted per 10 ms	MP		Integer (600, 1200, 2400, 4800, 9600, 19200, 28800, 38400, 48000, 57600)		
>Support of PCPCH	MP		Boolean	TRUE means supported	
3.84 Mcps TDD uplink physical channel capability	CH-3.84_Mcps_tdd_req_s_up				Name changed in REL-4
>Maximum Number of timeslots per frame	MP		Integer (1..14)		
>Maximum number of physical channels per timeslot	MP		Integer (1, 2)		
>Minimum SF	MP		Integer (1, 2, 4, 8, 16)		
>Support of PUSCH	MP		Boolean	TRUE means supported	
1.28 Mcps TDD uplink physical channel capability	CH-1.28_Mcps_tdd_req_s_up				REL-4
>Maximum Number of timeslots per subframe	MP		Integer (1..6)		REL-4
>Maximum number of physical channels per timeslot	MP		Integer (1, 2)		REL-4
>Minimum SF	MP		Integer (1, 2, 4, 8, 16)		REL-4
>Support of PUSCH	MP		Boolean	TRUE means supported	REL-4
>Support of 8PSK	MP		Boolean	TRUE means supported	REL-4

Condition	Explanation
<i>if_sim_rec_pdsch_sup</i>	The IE is mandatory present if the IE "Simultaneous reception of SCCPCH and DPCH" = True and IE Support of PDSCH = True. Otherwise this field is not needed in the message.
<i>if_sim_rec</i>	The IE is mandatory present if the IE "capability Simultaneous reception of SCCPCH and DPCH" = True. Otherwise this field is not needed in the message.
<i>3.84_Mcps_tdd_req_sup</i>	The IE is mandatory present if the IE "TDD RF capability" is present with the IE "Chip rate capability" set to "3.84 Mcps" and a 3.84 Mcps TDD capability update has been requested in a previous message. Otherwise this field is not needed in the message.
<i>1.28_Mcps_tdd_req_sup</i>	The IE is mandatory present if the IE "TDD RF capability" is present with the IE "Chip rate capability" set to "1.28 Mcps" and a 1.28 Mcps TDD capability update has been requested in a previous message. Otherwise this field is not needed in the message.
<i>fdd_req_sup</i>	The IE is mandatory present if the IE "Multi-mode capability" has the value "FDD" or "FDD/TDD" and a FDD capability update has been requested in a previous message. Otherwise this field is not needed in the message.

NOTE 1: These performance requirements are defined in Release 5.

10.3.3.26 Protocol error cause

This IE indicates the cause for a message or information that was not comprehended.

Information Element/Group name	Need	Multi	Type and reference	Semantics description
Protocol error cause	MP		Enumerated (ASN.1 violation or encoding error, Message type non-existent or not implemented, Message not compatible with receiver state, Information element value not comprehended, Conditional information element error, Message extension not comprehended)	At least one spare value needed.

10.3.3.27 Protocol error indicator

This IE indicates whether a message was transmitted due to a protocol error or not.

Information Element/Group name	Need	Multi	Type and Reference	Semantics description
Protocol error indicator	MP		Boolean	TRUE means a protocol error occurred. FALSE means a protocol error did not occur.

10.3.3.28 RB timer indicator

This IE is used to indicate to UTRAN if the timers T314 or T315 has expired in the UE.

Information Element/Group name	Need	Multi	Type and reference	Semantics description
T314 expired	MP		Boolean	TRUE means that the timer has expired or the stored value is zero. FALSE means that the timer has not expired.
T315 expired	MP		Boolean	TRUE means that the timer has expired or the stored value is zero. FALSE means that the timer has not expired.

10.3.3.29 Redirection info

This IE is used to redirect the UE to another frequency or other system.

Information Element/Group name	Need	Multi	Type and reference	Semantics description
CHOICE <i>Redirection Information</i>	MP			
>Frequency info			Frequency info 10.3.6.36	
>Inter-RAT info			Inter-RAT info 10.3.7.25	

10.3.3.30 Re-establishment timer

This information element indicates which timer to associate with RAB.

Information Element/Group name	Need	Multi	Type and reference	Semantics description
Re-establishment timer	MP		Enumerated(useT314, useT315)	

10.3.3.31 Rejection cause

Cause for rejection of RRC connection establishment request.

Information Element/Group name	Need	Multi	Type and reference	Semantics description
Rejection cause	MP		Enumerated(congestion, unspecified)	

10.3.3.32 Release cause

Cause for release of RRC connection.

Information Element/Group name	Need	Multi	Type and reference	Semantics description
Release cause	MP		Enumerated (normal event, unspecified, pre-emptive release, congestion, re-establishment reject, user inactivity), directed signalling connection re-establishment)	

10.3.3.33 RF capability FDD

Information Element/Group name	Need	Multi	Type and Reference	Semantics description	Version
UE power class	MP		Enumerated(1..4)	as defined in [21]	
Tx/Rx frequency separation	MP		Enumerated(190, 174.8-205.2, 134.8-245.2)	In MHz as defined in [21]. NOTE: Not applicable if UE is not operating in frequency band a (as defined in [21]).	

10.3.3.33a RF capability FDD extension

Information Element/Group name	Need	Multi	Type and Reference	Semantics description
UE power class extension	MP		Enumerated(1..4)	as defined in [21]. At least one spare value is needed
Tx/Rx frequency separation	MP		Enumerated(190, 174.8-205.2, 134.8-245.2)	In MHz as defined in [21]. NOTE: Not applicable if UE is not operating in frequency band a (as defined in [21]).

10.3.3.33b RF capability TDD

Information Element/Group name	Need	Multi	Type and Reference	Semantics description
UE power class	MP		Enumerated (1..4)	as defined in [22]
Radio frequency bands	MP		Enumerated(a, b, c, a+b, a+c, b+c, a+b+c)	as defined in [22]
Chip rate capability	MP		Enumerated(3.84Mcps, 1.28Mcps)	as defined in [22]

10.3.3.34 RLC capability

Information Element/Group name	Need	Multi	Type and Reference	Semantics description
Total RLC AM buffer size	MP		Integer (2,10,50,100,150,500,1000)	Total receiving and transmitting RLC AM buffer capability in kBytes
Maximum RLC AM Window Size	MP		Integer(2047,4095)	Maximum supported RLC TX and RX window in UE
Maximum number of AM entities	MP		Integer (3,4,5,6,8,16,30)	

10.3.3.35 RLC re-establish indicator

This IE is used to re-configure AM RLC on c-plane and u-plane.

Information Element/Group name	Need	Multi	Type and reference	Semantics description
RLC re-establish indicator	MP		Boolean	TRUE means re-establish required FALSE means re-establish not required

10.3.3.36 RRC transaction identifier

This IE contains an identification of the RRC procedure transaction local for the type of the message this IE was included within.

Information Element/Group name	Need	Multi	Type and reference	Semantics description
RRC transaction identifier	MP		Integer (0..3)	

10.3.3.37 Security capability

Information Element/Group name	Need	Multi	Type and reference	Semantics description
Ciphering algorithm capability	MP			
>UEA0	MP		Boolean	The value TRUE means that an unciphered connection after the Security mode control procedure is accepted by the UE.
>UEA1	MP		Boolean	The value TRUE means that UEA1, Kasumi, is supported
>Spare	MP	14	Boolean	Shall be set to FALSE by UEs complying with this version of the protocol.
Integrity protection algorithm capability	MP			
>UIA1	MP		Boolean	The value TRUE means that UIA1, Kasumi, is supported
>Spare	MP	15	Boolean	Shall be set to FALSE by UEs complying with this version of the protocol.

NOTE: The UE shall support at least one UEAx other than UEA0 and one UIAx.

10.3.3.38 START

There is a START value per CN domain. The START is used to initialise the 20 MSBs of all hyper frame numbers (MAC-d HFN, RLC UM HFN, RLC AM HFN, RRC HFN) for a CN domain.

Information Element/Group name	Need	Multi	Type and Reference	Semantics description
START	MP		Bit string (20)	The START [40] bits are numbered b0-b19, where b0 is the least significant bit.

10.3.3.39 Transmission probability

NOTE: Only for FDD.

Indicates the probability for a mobile to be allowed to transmit on a DCH controlled by DRAC procedure.

Information Element/Group name	Need	Multi	Type and reference	Semantics description
Transmission probability	MP		Real(0.125..1.0 by step of 0.125)	probability

10.3.3.40 Transport channel capability

Information Element/Group name	Need	Multi	Type and Reference	Semantics description
Downlink transport channel capability information elements				
Max no of bits received	MP		Integer(640, 1280, 2560, 3840, 5120, 6400, 7680, 8960, 10240, 20480, 40960, 81920, 163840)	Maximum sum of number of bits of all transport blocks received at an arbitrary time instant
Max convolutionally coded bits received	MP		Integer(640, 1280, 2560, 3840, 5120, 6400, 7680, 8960, 10240, 20480, 40960, 81920, 163840)	Maximum sum of number of bits of all convolutionally coded transport blocks received at an arbitrary time instant
Max turbo coded bits received	CV-turbo_dec_sup		Integer(640, 1280, 2560, 3840, 5120, 6400, 7680, 8960, 10240, 20480, 40960, 81920, 163840)	Maximum sum of number of bits of all turbo coded transport blocks received at an arbitrary time instant
Maximum number of simultaneous transport channels	MP		Integer(4, 8, 16, 32)	
Maximum number of simultaneous CCTrCH	MP		Integer (1..8)	
Max no of received transport blocks	MP		Integer(4, 8, 16, 32, 48, 64, 96, 128, 256, 512)	Maximum total number of transport blocks received within TTIs that end at within the same 10ms interval
Maximum number of TFC in the TFCS	MP		Integer(16, 32, 48, 64, 96, 128, 256, 512, 1024)	
Maximum number of TF	MP		Integer(32, 64, 128, 256, 512, 1024)	
Support for turbo decoding	MP		Boolean	TRUE means supported
Uplink transport channel capability information elements				
Max no of bits transmitted	MP		Integer(640, 1280, 2560, 3840, 5120, 6400, 7680, 8960, 10240, 20480, 40960, 81920, 163840)	Maximum sum of number of bits of all transport blocks transmitted at an arbitrary time instant
Max convolutionally coded bits transmitted	MP		Integer(640, 1280, 2560, 3840, 5120, 6400, 7680, 8960, 10240, 20480,	Maximum sum of number of bits of all convolutionally coded transport blocks transmitted at an arbitrary time instant

			40960, 81920, 163840)	
Max turbo coded bits transmitted	CV- <i>turbo_enc_sup</i>		Integer(640, 1280, 2560, 3840, 5120, 6400, 7680, 8960, 10240, 20480, 40960, 81920, 163840)	Maximum sum of number of bits of all turbo coded transport blocks transmitted at an arbitrary time instant
Maximum number of simultaneous transport channels	MP		Integer(2, 4, 8, 16, 32)	
Maximum number of simultaneous CCTrCH of DCH type	CH- <i>tdd_req_sup</i>		Integer (1..8)	
Max no of transmitted transport blocks	MP		Integer(2, 4, 8, 16, 32, 48, 64, 96, 128, 256, 512)	Maximum total number of transport blocks transmitted within TTIs that start at the same time
Maximum number of TFC in the TFCS	MP		Integer(4, 8, 16, 32, 48, 64, 96, 128, 256, 512, 1024)	
Maximum number of TF	MP		Integer(32, 64, 128, 256, 512, 1024)	
Support for turbo encoding	MP		Boolean	TRUE means supported

Condition	Explanation
<i>turbo_dec_sup</i>	The IE is mandatory present if the IE "Support of turbo decoding" = True. Otherwise this field is not needed in the message.
<i>turbo_enc_sup</i>	The IE is mandatory present if the IE "Support of turbo encoding" = True. Otherwise this field is not needed in the message.
<i>tdd_req_sup</i>	The IE is mandatory present if the IE "Multi-mode capability" has the value "TDD" or "FDD/TDD" and a TDD capability update has been requested in a previous message. Otherwise this field is not needed in the message.

10.3.3.41 UE multi-mode/multi-RAT capability

Information Element/Group name	Need	Multi	Type and Reference	Semantics description
Multi-RAT capability				
Support of GSM	MP		Boolean	
Support of multi-carrier	MP		Boolean	
Multi-mode capability	MP		Enumerated (TDD, FDD, FDD/TDD)	

10.3.3.42 UE radio access capability

Information Element/Group name	Need	Multi	Type and reference	Semantics description	Version
ICS version	MP		Enumerated(R99, REL-4)	Indicates the release version of [42]-2 (Implementation Conformance Statement (ICS) proforma specification) that is applicable for the UE.	Value REL-4 added in REL-4
PDCP capability	MP		PDCP capability 10.3.3.24		
RLC capability	MP		RLC capability 10.3.3.34		
Transport channel capability	MP		Transport channel capability 10.3.3.40		
RF capability FDD	OP		RF capability FDD 10.3.3.33		
RF capability TDD	OP	1 to 2	RF capability TDD 10.3.3.33b	One "TDD RF capability" entity shall be included for every Chip rate capability supported.	Multi=2 is included in REL-4
Physical channel capability	MP		Physical channel capability 10.3.3.25		
UE multi-mode/multi-RAT capability	MP		UE multi-mode/multi-RAT capability 10.3.3.41		
Security capability	MP		Security capability 10.3.3.37		
UE positioning capability	MP		UE positioning capability 10.3.3.45		
Measurement capability	CH- <i>fdd_req_sup</i>		Measurement capability 10.3.3.21		

Condition	Explanation
<i>fdd_req_sup</i>	The IE is mandatory present if the IE "Multi-mode capability" has the value "FDD" or "FDD/TDD" and a FDD capability update has been requested in a previous message. Otherwise this field is not needed in the message.

10.3.3.42a UE radio access capability extension

Information Element/Group name	Need	Multi	Type and reference	Semantics description
Frequency band specific capability list	MP	1 to <maxFreqbandsFDD>		
>Frequency band	MP		Enumerated(FDD2100, FDD1900)	At least one spare value is needed
>RF capability FDD extension	MD		RF capability FDD extension 10.3.3.33a	the default values are the same values as in the immediately preceding IE "RF capability FDD extension"; the first occurrence is MP
>Measurement capability extension	MP		Measurement capability extension 10.3.3.21a	

10.3.3.43 UE Timers and Constants in connected mode

This information element specifies timer- and constants values used by the UE in connected mode.

Information Element/Group name	Need	Multi	Type and reference	Semantics description
T301	MD		Integer(100, 200 .. 2000 by step of 200, 3000, 4000, 6000, 8000)	Value in milliseconds. Default value is 2000. This IE should not be used by the UE in this release of the protocol.
N301	MD		Integer(0..7)	Default value is 2. This IE should not be used by the UE in this release of the protocol.
T302	MD		Integer(100, 200... 2000 by step of 200, 3000, 4000, 6000, 8000)	Value in milliseconds. Default value is 4000.
N302	MD		Integer(0..7)	Default value is 3.
T304	MD		Integer(100, 200, 400, 1000, 2000)	Value in milliseconds. Default value is 2000. At least one spare value is needed. Note 1.
N304	MD		Integer(0..7)	Default value is 2. Note 1.
T305	MD		Integer(5, 10, 30, 60, 120, 360, 720, infinity)	Value in minutes. Default value is 30. Infinity means no update
T307	MD		Integer(5, 10, 15, 20, 30, 40, 50)	Value in seconds. Default value is 30.
T308	MD		Integer(40, 80, 160, 320)	Value in milliseconds. Default value is 160. Note 1.
T309	MD		Integer(1...8)	Value in seconds. Default value is 5. Note 1.
T310	MD		Integer(40 .. 320 by step of 40)	Value in milliseconds. Default value is 160. Note 1.
N310	MD		Integer(0 .. 7)	Default value is 4. Note 1.
T311	MD		Integer(250 .. 2000 by step of 250)	Value in milliseconds. Default value is 2000. Note 1.
T312	MD		Integer (0..15)	Value in seconds. Default value is 1. The value 0 is not used in this version of the specification.
N312	MD		Integer (1, 50, 100, 200, 400, 600, 800, 1000)	Default value is 1.
T313	MD		Integer (0..15)	Value in seconds. Default value is 3. Note 1.
N313	MD		Integer (1, 2, 4, 10, 20, 50, 100, 200)	Default value is 20. Note 1.
T314	MD		Integer(0, 2, 4, 6, 8, 12, 16, 20)	Value in seconds. Default value is 12. Note 1.
T315	MD		Integer (0,10, 30, 60, 180, 600, 1200, 1800)	Value in seconds. Default value is 180. Note 1.
N315	MD		Integer (1, 50, 100, 200, 400, 600, 800, 1000)	Default value is 1. Note 1.
T316	MD		Integer(0,	Value in seconds. Default

			10, 20, 30, 40, 50, infinity)	value is 30.
T317	MD		Integer (0, 10, 30, 60, 180, 600, 1200, 1800)	Value in seconds Default value is 180.

NOTE 1: If the value of SIB1 changes, the UE shall re-read SIB1 and use the new value of the parameter, if modified.

10.3.3.44 UE Timers and Constants in idle mode

This information element specifies timer- and constant values used by the UE in idle mode.

Information Element/Group name	Need	Multi	Type and reference	Semantics description
T300	MP		Integer(100, 200... 2000 by step of 200, 3000, 4000, 6000, 8000)	Value in milliseconds. Default value is 1000. Use of Default is described in 10.2.48.8.4 and in 10.2.48.8.16.
N300	MP		Integer(0..7)	Default value is 3. Use of Default is described in 10.2.48.8.4 and in 10.2.48.8.16.
T312	MP		Integer(0 .. 15)	Value in seconds. Default value is 1. Use of Default is described in 10.2.48.8.4 and in 10.2.48.8.16. The value 0 is not used in this version of the specification.
N312	MP		Integer (1, 50, 100, 200, 400, 600, 800, 1000)	Default value is 1. Use of Default is described in 10.2.48.8.4 and in 10.2.48.8.16.

10.3.3.45 UE positioning capability

Information Element/Group name	Need	Multi	Type and reference	Semantics description
Standalone location method(s) supported	MP		Boolean	Defines if a UE can measure its location by some means unrelated to UTRAN TRUE means supported
UE based OTDOA supported	MP		Boolean	TRUE means supported
Network Assisted GPS support	MP		Enumerated ('Network based', 'UE based', 'Both', 'None')	Defines if the UE supports network based or UE based GPS methods.
GPS reference time capable	MP		Boolean	Defines if a UE has the capability to measure GPS reference time as defined in [7]. TRUE means capable
Support for IPDL	MP		Boolean	Defines if a UE has the capability to use IPDL to enhance its 'SFN-SFN observed time difference –type 2' measurement. TRUE means supported
Support for Rx-Tx time difference type2 measurement	MP		Boolean	TRUE means supported

10.3.3.46 URA update cause

Indicates the cause for s URA update.

Information Element/Group name	Need	Multi	Type and reference	Semantics description
URA update cause	MP		Enumerated(change of URA, periodic URA update)	At least one spare value needed.

10.3.3.47 U-RNTI

The U-RNTI (UTRAN Radio Network Temporary Identity) is allocated to an UE having a RRC connection and identifies the UE within UTRAN.

Information Element/Group name	Need	Multi	Type and reference	Semantics description
SRNC identity	MP		bit string(12)	
S-RNTI	MP		bit string(20)	

10.3.3.48 U-RNTI Short

The U-RNTI (UTRAN Radio Network Temporary Identity) is allocated to an UE having a RRC connection and identifies the UE within UTRAN.

Information Element/Group name	Need	Multi	Type and reference	Semantics description
SRNC identity	MP		bit string(12)	
S-RNTI 2	MP		bit string(10)	

10.3.3.49 UTRAN DRX cycle length coefficient

A coefficient in the formula to count the paging occasions to be used by a specific UE (specified in [4]).

Information Element/Group name	Need	Multi	Type and reference	Semantics description
DRX cycle length coefficient	MP		Integer(3..9)	Refers to 'k' in the formula as specified in [4], Discontinuous reception

10.3.3.50 Wait time

Wait time defines the time period the UE has to wait before repeating the rejected procedure.

Information Element/Group name	Need	Multi	Type and reference	Semantics description
Wait time	MP		Integer(0..15)	Wait time in seconds The value 0 indicates that repetition is not allowed.

10.3.4 Radio Bearer Information elements

10.3.4.0 Default configuration identity

This information element identifies a default radio parameter configuration.

Information Element/Group name	Need	Multi	Type and reference	Semantics description
Default configuration identity	MP		Integer (0..9)	The corresponding default configurations are specified in 13.7

10.3.4.1 Downlink RLC STATUS info

Information Element/Group name	Need	Multi	Type and reference	Semantics description
Timer_Status_Prohibit	OP		Integer(10..50 by step of 10, 550..1000 by step of 50)	Minimum time in ms between STATUS reports
Timer_EPC	OP		Integer(50, 60, 70, 80, 90, 100, 120, 140, 160, 180, 200, 300, 400, 500, 700, 900)	Time in ms
Missing PDU Indicator	MP		Boolean	Value true indicates that UE should send a STATUS report for each missing PDU that is detected
Timer_STATUS_periodic	OP		Integer(100, 200, 300, 400, 500, 750, 1000, 2000)	Time in milliseconds

10.3.4.2 PDCP info

The purpose of the PDCP info IE is to indicate which algorithms shall be established and to configure the parameters of each of the algorithms.

Information Element/Group name	Need	Multi	Type and reference	Semantics description	Version
Support for lossless SRNS relocation	CV- <i>LosslessCriteria</i>		Boolean	TRUE means support	
Max PDCP SN window size	CV- <i>Lossless</i>		Enumerated(sn255, sn65535)	Maximum PDCP sequence number window size. The handling of sequence number when the Max PDCP SN window size is 255 is specified in [23].	
PDCP PDU header	MD		Enumerated (present, absent)	Whether a PDCP PDU header is existent or not. Default value is "present"	
Header compression information	OP	1 to <maxPDC PAlgoType >			
>CHOICE <i>algorithm type</i>	MP				
>>RFC 2507				Header compression according to IETF standard RFC 2507	
>>>F_MAX_PERIOD	MD		Integer (1..65535)	Largest number of compressed non-TCP headers that may be sent without sending a full header. Default value is 256.	
>>>F_MAX_TIME	MD		Integer (1..255)	Compressed headers may not be sent more than F_MAX_TIME seconds after sending last full header. Default value is 5.	
>>>MAX_HEADER	MD		Integer (60..65535)	The largest header size in octets that may be compressed. Default value is 168.	
>>>TCP_SPACE	MD		Integer (3..255)	Maximum CID value for TCP connections. Default value is 15.	
>>>NON_TCP_SPACE	MD		Integer (3..65535)	Maximum CID value for non-TCP connections. Default value is 15.	
>>>EXPECT_REORDERING	MD		Enumerated (reordering not expected, reordering expected)	Whether the algorithm shall reorder PDCP SDUs or not. Default value is "reordering not expected".	

>>RFC 3095				Header compression according to IETF standard RFC 3095	REL-4
>>>CID inclusion info	MP		Enumerated (PDCP header, RFC3095 packet format)	Configures which method shall be used to carry RFC3095 CID values.	REL-4
>>>Max_CID	MD		Integer (1..16383)	Highest context ID number to be used by the compressor. Default value is 15.	REL-4
>>>Profiles	MP	1 to <maxROHC-Profiles>		Profiles supported by the decompressor.	REL-4
>>>>Profile instance	MP		Integer(1 .. 3)	Supported profile types. At least four spare values.	REL-4
>>>MRRU	MD		Integer (0 .. 65535)	Maximum reconstructed reception unit. Default value is 0 (no segmentation).	REL-4
>>>Packet_Sizes_Allowed	OP	1 to <maxROHC-PacketSizes>		List of packet sizes that are allowed to be produced by RFC 3095.	REL-4
>>>>Packet size	MP		Integer (2 .. 1500)	Packet size as defined in RFC 3095.	REL-4
>>>>Reverse-Decompression_Depth	MD		Integer (0..65535)	Determines whether reverse decompression should be used or not and the maximum number of packets that can be reverse decompressed by the decompressor. Default value is 0 (reverse decompression shall not be used).	REL-4

Condition	Explanation
<i>LosslessCriteria</i>	This IE is mandatory present if the IE "RLC mode" is "Acknowledged", the IE "In-sequence delivery" is "True" and the IE "SDU Discard Mode" is "No discard" and not needed otherwise.
<i>Lossless</i>	This IE is mandatory present if the IE "Support for lossless SRNS relocation" Is TRUE, otherwise it is not needed.

10.3.4.3 PDCP SN info

Information Element/Group name	Need	Multi	Type and Reference	Semantics description
Receive PDCP sequence number	MP		Integer(0..65535)	The PDCP sequence number, which the sender of the message is expecting next to be received.

10.3.4.4 Polling info

Information Element/Group name	Need	Multi	Type and reference	Semantics description
Timer_poll_prohibit	OP		Integer(10..550 by step of 10, 600..1000 by step of 50)	Minimum time between polls in ms
Timer_poll	OP		Integer(10..550 by step of 10, 600..1000 by step of 50)	Time in ms.
Poll_PDU	OP		Integer(1,2,4,8,16,32,64,128)	Number of PDUs, interval between pollings
Poll_SDU	OP		Integer(1,4,16,64)	Number of SDUs, interval between pollings
Last transmission PDU poll	MP		Boolean	TRUE indicates that poll is made at last PDU in transmission buffer
Last retransmission PDU poll	MP		Boolean	TRUE indicates that poll is made at last PDU in retransmission buffer
Poll_Window	OP		Integer(50,60,70,80,85,90,95,99)	Percentage of transmission window, threshold for polling
Timer_poll_periodic	OP		Integer(100, 200, 300, 400, 500, 750, 1000, 2000)	Time in milliseconds Timer for periodic polling.

10.3.4.5 Predefined configuration identity

This information element identifies a pre- defined radio parameter configuration.

Information Element/Group name	Need	Multi	Type and reference	Semantics description
Predefined radio configuration identity	MP		Integer (0..15)	

10.3.4.6 Predefined configuration value tag

This information element is used to identify different versions of a radio bearer configuration as may be used within one PLMN e.g. to support different UTRAN implementations.

Information Element/Group name	Need	Multi	Type and Reference	Semantics description
Predefined configuration value tag	MP		Integer(0..15)	

10.3.4.7 Predefined RB configuration

This information element concerns a pre- defined configuration of radio bearer parameters

Information Element/Group name	Need	Multi	Type and Reference	Semantics description
UE information elements				
Re-establishment timer	MP		Re-establishment timer 10.3.3.30	Only one RAB supported
Signalling radio bearer information				
Signalling RB information to setup List	MP	1 to <maxSRBs etup>		For each signalling radio bearer
>Signalling RB information to setup	MP		Signalling RB information to setup 10.3.4.24	
RB information				
RB information to setup list	MP	1 to <maxRBperRAB>		Only one RAB supported
>RB information to setup	MP		RB information to setup 10.3.4.20	

10.3.4.8 RAB info

This IE contains information used to uniquely identify a radio access bearer.

Information Element/Group name	Need	Multi	Type and reference	Semantics description
RAB identity	MP		RAB identity 10.3.1.14	
CN domain identity	MP		CN domain identity 10.3.1.1	
NAS Synchronization Indicator	OP		NAS Synchronization indicator 10.3.4.12	
Re-establishment timer	MP		Re-establishment timer 10.3.3.30	

10.3.4.9 RAB info Post

This IE contains information used to uniquely identify a radio access bearer.

Information Element/Group name	Need	Multi	Type and reference	Semantics description
RAB identity	MP		RAB identity 10.3.1.14	
CN domain identity	MP		CN domain identity 10.3.1.1	
NAS Synchronization Indicator	OP		NAS Synchronization indicator 10.3.4.12	

10.3.4.10 RAB information for setup

Information Element/Group name	Need	Multi	Type and reference	Semantics description
RAB info	MP		RAB info 10.3.4.8	
RB information to setup list	MP	1 to <maxRBpe rRAB>		
>RB information to setup	MP		RB information to setup 10.3.4.20	

10.3.4.11 RAB information to reconfigure

Information Element/Group name	Need	Multi	Type and reference	Semantics description
RAB identity	MP		RAB Identity 10.3.1.14	
CN domain identity	MP		CN domain identity 10.3.1.1	
NAS synchronization indicator	MP		NAS Synchronization info 10.3.4.12	

10.3.4.12 NAS Synchronization indicator

A container for non-access stratum information to be transferred transparently through UTRAN.

Information Element/Group name	Need	Multi	Type and reference	Semantics description
NAS Synchronization indicator	MP		Bit string(4)	The bits are numbered b1-b4, where b1 is the least significant bit.

10.3.4.13 RB activation time info

This IE contains the time, in terms of RLC sequence numbers, when a certain configuration shall be activated, for a number of radio bearers.

Information Element/Group name	Need	Multi	Type and reference	Semantics description
Radio bearer activation time	MP	1 to <maxRB>		
>RB identity	MP		RB identity 10.3.4.16	
>RLC sequence number	MP		Integer (0..4095)	RLC SN [16] . Used for radio bearers mapped on RLC AM and UM

10.3.4.14 RB COUNT-C MSB information

The MSB of the COUNT-C values of the radio bearer.

Information Element/Group name	Needed	Multi	Type and reference	Semantics description
RB identity	MP		RB identity 10.3.4.16	
COUNT-C-MSB-uplink	MP		Integer (0.. $2^{25}-1$)	25 MSBs from COUNT-C associated to this RB
COUNT-C-MSB-downlink	MP		Integer (0.. $2^{25}-1$)	25 MSBs from COUNT-C associated to this RB

10.3.4.15 RB COUNT-C information

The COUNT-C values of the radio bearer.

Information Element/Group name	Needed	Multi	Type and reference	Semantics description
RB identity	MP		RB identity 10.3.4.16	
COUNT-C-uplink	MP		Integer (0.. $2^{32}-1$)	
COUNT-C-downlink	MP		Integer (0.. $2^{32}-1$)	

10.3.4.16 RB identity

An identification number for the radio bearer affected by a certain message.

Information Element/Group name	Need	Multi	Type and reference	Semantics description
RB identity	MP		Integer(1..32)	Values 1-4 shall only be used for signalling radio bearers. The IE value minus one shall be used as BEARER in the ciphering algorithm.

10.3.4.17 RB information to be affected

Information Element/Group name	Need	Multi	Type and reference	Semantics description
RB identity	MP		RB identity 10.3.4.16	
RB mapping info	MP		RB mapping info 10.3.4.21	

10.3.4.18 RB information to reconfigure

Information Element/Group name	Need	Multi	Type and reference	Semantics description
RB identity	MP		RB identity 10.3.4.16	
PDCP info	OP		PDCP info 10.3.4.2	
PDCP SN info	OP		PDCP SN info 10.3.4.3	PDCP sequence number info from the network. Present only in case of lossless SRNS relocation.
RLC info	OP		RLC info 10.3.4.23	
RB mapping info	OP		RB mapping info 10.3.4.21	
RB stop/continue	OP		Enumerated(stop, continue)	

10.3.4.19 RB information to release

Information Element/Group name	Need	Multi	Type and reference	Semantics description
RB identity	MP		RB identity 10.3.4.16	

10.3.4.20 RB information to setup

Information Element/Group name	Need	Multi	Type and reference	Semantics description
RB identity	MP		RB identity 10.3.4.16	
PDCP info	OP		PDCP info 10.3.4.2	
CHOICE <i>RLC info type</i>	MP			
>RLC info			RLC info 10.3.4.23	
>Same as RB			RB identity 10.3.4.16	Identity of RB with exactly the same RLC info IE values
RB mapping info	MP		RB mapping info 10.3.4.21	

NOTE This information element is included within IE "Predefined RB configuration"

10.3.4.21 RB mapping info

A multiplexing option for each possible transport channel this RB can be multiplexed on.

Information Element/Group name	Need	Multi	Type and reference	Semantics description
Information for each multiplexing option	MP	1 to <maxRBMuxOptions>		
>RLC logical channel mapping indicator	CV-UL-RLCLogicalChannels		Boolean	TRUE indicates that the first logical channel shall be used for data PDUs and the second logical channel shall be used for control PDUs. FALSE indicates that control and data PDUs can be sent on either of the two logical channels. This parameter is not used in this release and shall be set to TRUE.
>Number of uplink RLC logical channels	CV-UL-RLC info	1 to MaxLoCHperRLC		1 or 2 logical channels per RLC entity or radio bearer RLC [16]
>>Uplink transport channel type	MP		Enumerated(DCH,RACH, CPCH,USCH)	CPCH is FDD only USCH is TDD only
>>UL Transport channel identity	CV-UL-DCH/USCH		Transport channel identity 10.3.5.18	This is the ID of a DCH or USCH (TDD only) that this RB could be mapped onto.
>>Logical channel identity	OP		Integer(1..15)	This parameter is used to distinguish logical channels multiplexed by MAC on a transport channel.
>>CHOICE RLC size list	MP			The RLC sizes that are allowed for this logical channel For radio bearers mapped to RACH, "Explicit list" is the only valid choice. The UE shall regard all other choices as undefined IE values and handle these as specified in clause 9.
>>>All			Null	All RLC sizes listed in the <i>Transport Format Set</i> . 10.3.5.23
>>>Configured			Null	The RLC sizes configured for this logical channel in the <i>Transport Format Set</i> . 10.3.5.23 if present in this message or in the previously stored configuration otherwise
>>>Explicit List		1 to <maxTF>		Lists the RLC sizes that are valid for the logical channel.
>>>>RLC size index	MP		Integer(1..maxTF)	The integer number is a reference to the <i>RLC size</i> which arrived at that position in the <i>Transport Format Set</i> 10.3.5.23
>>MAC logical channel priority	MP		Integer(1..8)	This is priority between a user's different RBs (or logical channels). [15]
>Downlink RLC logical channel info	CV-DL-RLC info			
>>Number of downlink RLC logical channels	MD	1 to MaxLoCHperRLC		1 or 2 logical channels per RLC entity or radio bearer RLC [16] Default value is that parameter values for DL are exactly the same as for corresponding UL

				logical channel. In case two multiplexing options are specified for the UL, the first options shall be used as default for the DL. As regards to the IE "Channel type", rule is specified in 8.6.4.8.
>>>Downlink transport channel type	MP		Enumerated(DCH,FACH, DSCH,DCH+DSCH)	
>>>DL DCH Transport channel identity	CV-DL-DCH		Transport channel identity 10.3.5.18	
>>>DL DSCH Transport channel identity	CV-DL-DSCH		Transport channel identity 10.3.5.18	
>>>Logical channel identity	OP		Integer(1..15)	16 is reserved

Condition	Explanation
<i>UL-RLC info</i>	If "CHOICE <i>Uplink RLC mode</i> " in the IE "RLC info" that applies for that RB (i.e. either the one stored or received in the same message for the RB for which the "RB mapping info" was received, or the one stored or received in the same message for the RB pointed at in the IE "Same as RB" in the IE "RB information to setup" stored or received in the same message) is present this IE is mandatory present. Otherwise the IE is not needed.
<i>DL-RLC info</i>	If "CHOICE <i>Downlink RLC mode</i> " in the IE "RLC info" that applies for that RB (i.e. either the one stored or received in the same message for the RB for which the "RB mapping info" was received, or the one stored or received in the same message for the RB pointed at in the IE "Same as RB" in the IE "RB information to setup" stored or received in the same message) is present this IE is mandatory present. Otherwise the IE is not needed.
<i>UL-RLCLogicalChannels</i>	If "Number of uplink RLC logical channels" in IE "RB mapping info" is 2, then this IE is mandatory present. Otherwise this IE is not needed.
<i>UL-DCH/USCH</i>	If IE "Uplink transport channel type" is equal to "DCH" or "USCH" (TDD only) this IE is mandatory present. Otherwise the IE is not needed.
<i>DL-DCH</i>	If IE "Downlink transport channel type" is equal to "DCH" or "DCH+DSCH" this IE is mandatory present. Otherwise the IE is not needed.
<i>DL-DSCH</i>	If IE "Downlink transport channel type" is equal to "DSCH" or "DCH+DSCH" this IE is mandatory present. Otherwise the IE is not needed.

10.3.4.22 RB with PDCP information

Information Element/Group name	Need	Multi	Type and reference	Semantics description
RB identity	MP		RB identity 10.3.4.16	
PDCP SN info	MP		PDCP SN info 10.3.4.3	PDCP sequence number info from the sender of the message for lossless SRNS relocation.

10.3.4.23 RLC info

Information Element/Group name	Need	Multi	Type and reference	Semantics description
CHOICE <i>Uplink RLC mode</i>	OP			Indicates if Acknowledged, Unacknowledged or Transparent mode RLC shall be used.
>AM RLC				
>>Transmission RLC discard	MP		Transmission RLC discard 10.3.4.25	
>>Transmission window size	MP		Integer(1,8,16,32,64,128,256,512,768,1024,1536,2047,2560,3072,3584,4095)	Maximum number of RLC PUs sent without getting them acknowledged. This parameter is needed if acknowledged mode is used. UE shall also assume that the UTRAN receiver window is equal to this value.
>>Timer_RST	MP		Integer(50,100,150,200,250,300,350,400,450,500,550,600,700,800,900,1000)	Elapsed time in milliseconds. It is used to trigger the retransmission of RESET PDU.
>>Max_RST	MP		Integer(1,4,6,8,12,16,24,32)	Defined in [16]
>>Polling info	OP		Polling info 10.3.4.4	
>UM RLC				
>>Transmission RLC discard	OP		Transmission RLC discard 10.3.4.25	
>TM RLC				
>>Transmission RLC discard	OP		Transmission RLC discard 10.3.4.25	
>>Segmentation indication	MP		Boolean	TRUE indicates that segmentation is performed.
CHOICE <i>Downlink RLC mode</i>	OP			Indicates if Acknowledged, Unacknowledged or Transparent mode RLC shall be used
>AM RLC				
>>In-sequence delivery	MP		Boolean	TRUE indicates that RLC shall preserve the order of higher layer PDUs when these are delivered. FALSE indicates that receiving RLC entity could allow SDUs to be delivered to the higher layer in different order than submitted to RLC sublayer at the transmitting side.
>>Receiving window size	MP		Integer(1,8,16,32,64,128,256,512,768,1024,1536,2047,2560,3072,3584,4095)	Maximum number of RLC PUs allowed to be received. This parameter is needed if acknowledged mode is used. UE shall also assume that the

			72,3584,409 5)	UTRAN transmitter window is equal to this value
>>Downlink RLC status Info	MP		Downlink RLC status info 10.3.4.1	
>UM RLC				(No data)
>TM RLC				
>>Segmentation indication	MP		Boolean	TRUE indicates that segmentation is performed.

NOTE This information element is included within IE "Predefined RB configuration"

10.3.4.24 Signalling RB information to setup

Information Element/Group name	Need	Multi	Type and reference	Semantics description
RB identity	MD		RB identity 10.3.4.16	Default value is specified in subclause 8.6.4.1
CHOICE <i>RLC info type</i>	MP			
>RLC info			RLC info 10.3.4.23	
>Same as RB			RB identity 10.3.4.16	Identity of RB with exactly the same RLC info IE values
RB mapping info	MP		RB mapping info 10.3.4.21	

NOTE This information element is included within IE "Predefined RB configuration"

10.3.4.25 Transmission RLC Discard

Information Element/Group name	Need	Multi	Type and reference	Semantics description
CHOICE <i>SDU Discard Mode</i>	MP			Different modes for discharge the RLC buffer on the transmitter side; "Timer based with explicit signalling", "Timer based without explicit signalling", "Discard after Max_DAT retransmissions" or "No_discard". For unacknowledged mode and transparent mode, only Timer based without explicit signalling is applicable. If "No_discard" is used, reset procedure shall be done after Max_DAT retransmissions
>Timer based explicit				
>>Timer_MRW	MP		Integer(50,60, 70, 80, 90, 100, 120, 140, 160, 180, 200, 300, 400, 500, 700, 900)	Elapsed time in milliseconds. It is used to trigger the retransmission of a STATUS PDU containing an MRW SUFI field
>>Timer_discard	MP		Integer(100, 250, 500, 750, 1000, 1250, 1500, 1750, 2000, 2500, 3000, 3500, 4000, 4500, 5000, 7500)	Elapsed time in milliseconds before a SDU is discarded.
>>MaxMRW	MP		Integer(1, 4, 6, 8, 12, 16, 24, 32)	Defined in [16]
>Timer based no explicit				
>>Timer_discard	MP		Integer(10,20,30,40,50,60,70,80,90,100)	Elapsed time in milliseconds before a SDU is discarded.
>Max DAT retransmissions				
>>Max_DAT	MP		Integer(1, 2, 3, 4, 5, 6, 7, 8, 9, 10, 15, 20, 25, 30, 35, 40)	Defined in [16]
>>Timer_MRW	MP		Integer(50, 60, 70, 80, 90, 100, 120, 140, 160, 180, 200, 300, 400, 500, 700, 900)	Elapsed time in milliseconds. It is used to trigger the retransmission of a STATUS PDU containing an MRW SUFI field
>>MaxMRW	MP		Integer(1, 4, 6, 8, 12, 16, 24, 32)	Defined in [16]
>No discard				
>>Max_DAT	MP		Integer(1, 2, 3, 4, 5, 6, 7, 8, 9, 10, 15, 20, 25, 30,	Defined in [16]

			35, 40)	
--	--	--	---------	--

CHOICE SDU Discard Mode	Condition under which the given SDU Discard Mode is chosen
Timer based explicit	If the modes for discharge of the RLC buffer on the transmitter side is "Timer based with explicit signalling"
Timer based no explicit	If the modes for discharge of the RLC buffer on the transmitter side is "Timer based without explicit signalling" For unacknowledged mode, only Timer based without explicit signalling is applicable.
Max DAT retransmissions	If the modes for discharge of the RLC buffer on the transmitter side is "Discard after Max_DAT retransmissions"
No discard	If the modes for discharge the of RLC buffer on the transmitter side is "Reset procedure shall be done after Max_DAT retransmissions"

10.3.5 Transport CH Information elements

10.3.5.1 Added or Reconfigured DL TrCH information

Information Element/Group name	Need	Multi	Type and reference	Semantics description
Downlink transport channel type	MP		Enumerated(DCH,DSCH)	
DL Transport channel identity	MP		Transport channel identity 10.3.5.18	
CHOICE DL parameters				
>Explicit				
>>TFS	MP		Transport Format Set 10.3.5.23	
>SameAsUL				
>>Uplink transport channel type	MP		Enumerated(DCH,USCH)	USCH is TDD only
>>UL TrCH identity	MP		Transport channel identity 10.3.5.18	Same TFS applies as specified for indicated UL TrCH
DCH quality target	OP		Quality target 10.3.5.10	
Transparent mode signalling info	CV- MessageType		Transparent mode signalling info 10.3.5.17	This IE is not used in RB RELEASE message nor RB RECONFIGURATION message

Condition	Explanation
<i>MessageType</i>	This IE is not needed in Radio Bearer Release message and Radio Bearer Reconfiguration message. Otherwise it is optional.

10.3.5.2 Added or Reconfigured UL TrCH information

Information Element/Group name	Need	Multi	Type and reference	Semantics description
Uplink transport channel type	MP		Enumerated(DCH,USCH)	USCH is TDD only
UL Transport channel identity	MP		Transport channel identity 10.3.5.18	
TFS	MP		Transport Format Set 10.3.5.23	

NOTE This information element is included within IE "Predefined RB configuration"

10.3.5.3 CPCH set ID

NOTE: Only for FDD.

This information element indicates that this transport channel may use any of the Physical CPCH channels defined in the CPCH set info, which contains the same CPCH set ID. The CPCH set ID associates the transport channel with a set of PCPCH channels defined in a CPCH set info IE and a set of CPCH persistency values. The CPCH set info IE(s) and the CPCH persistency values IE(s) each include the CPCH set ID and are part of the SYSTEM INFORMATION message

Information Element/Group name	Need	Multi	Type and reference	Semantics description
CPCH set ID	MP		Integer(1...maxCPCHsets)	Identifier for CPCH set info and CPCH persistency value messages

10.3.5.4 Deleted DL TrCH information

Information Element/Group name	Need	Multi	Type and reference	Semantics description
Downlink transport channel type	MP		Enumerated(DCH,DSCH)	
DL Transport channel identity	MP		Transport channel identity 10.3.5.18	

10.3.5.5 Deleted UL TrCH information

Information Element/Group name	Need	Multi	Type and reference	Semantics description
Uplink transport channel type	MP		Enumerated(DCH,USCH)	USCH is TDD only
UL Transport channel identity	MP		Transport channel identity 10.3.5.18	

10.3.5.6 DL Transport channel information common for all transport channels

Information Element/Group name	Need	Multi	Type and reference	Semantics description
SCCPCH TFCS	OP		Transport Format Combination Set 10.3.5.20	This IE should not be included in this version of the protocol.
CHOICE <i>mode</i>	MP			Although this IE is not always required, need is MP to align with ASN.1
>FDD				
>>CHOICE <i>DL parameters</i>	OP			
>>>Explicit				
>>>>DL DCH TFCS	MP		Transport Format Combination Set 10.3.5.20	Although this IE is not always required, need is MP to align with ASN.1
>>>>SameAsUL				(no data)
>TDD				
>>Individual DL CCTrCH information	OP	1 to <maxCCTrCH>		
>>>DL TFCS Identity	MP		Transport format combination set identity 10.3.5.21	Identifies a special CCTrCH for shared or dedicated channels.
>>>>CHOICE <i>DL parameters</i>	MP			
>>>>>Independent				
>>>>>>DL TFCS	MP		Transport format combination set 10.3.5.20	
>>>>>>>SameAsUL				
>>>>>>>>UL DCH TFCS Identity	MP		Transport format combination set identity 10.3.5.21	Same TFCS applies as specified for the indicated UL DCH TFCS identity except for information applicable for UL only

NOTE This information element is included within IE "Predefined TrCh configuration"

10.3.5.7 DRAC Static Information

NOTE: Only for FDD.

Contains static parameters used by the DRAC procedure. Meaning and use is described in subclause 14.8.

Information Element/Group name	Need	Multi	Type and reference	Semantics description
Transmission Time Validity	MP		Integer(1..256)	number of frames
Time duration before retry	MP		Integer(1..256)	number of frames
DRAC Class Identity	MP		Integer(1..maxDRACclasses)	Indicates the class of DRAC parameters to use in SIB10 message

10.3.5.8 Power Offset Information

Information Element/Group name	Need	Multi	Type and reference	Semantics description
CHOICE <i>Gain Factors</i>	MP			
>Signalled Gain Factors				
>>CHOICE <i>mode</i>				
>>>FDD				
>>>>Gain Factor β_c	MP		Integer (0.. 15)	For UL DPCCH or control part of PRACH or PCPCH
>>>TDD				(no data)
>>Gain Factor β_d	MP		Integer (0..15)	For UL DPDCH or data part of PRACH or PCPCH in FDD and all uplink channels in TDD
>>Reference TFC ID	OP		Integer (0..3)	If this TFC is a reference TFC, indicates the reference ID.
>Computed Gain Factors				
>>Reference TFC ID	MP		Integer (0.. 3)	Indicates the reference TFC Id of the TFC to be used to calculate the gain factors for this TFC. In case of using computed gain factors, at least one signalled gain factor is necessary for reference.
CHOICE <i>mode</i>	MP			
>FDD				
>>Power offset P _{p-m}	OP		Integer(-5..10)	In dB. Power offset between the last transmitted preamble and the control part of the message (added to the preamble power to receive the power of the message control part) Needed only for PRACH
>TDD				(no data)

CHOICE <i>Gain Factors</i>	Condition under which the way to signal the <i>Gain Factors</i> is chosen
<i>Signalled Gain Factors</i>	The values for gain factors β_c (only in FDD mode) and β_d are signalled directly for a TFC.
<i>Computed Gain Factors</i>	The gain factors β_c (only in FDD mode) and β_d are computed for a TFC, based on the signalled settings for the associated reference TFC.

10.3.5.9 Predefined TrCH configuration

This information element concerns a pre- defined configuration of transport channel parameters.

Information Element/Group name	Need	Multi	Type and Reference	Semantics description
UL Transport channel information common for all transport channels	MP		UL Transport channel information common for all transport channels 10.3.5.24	
Added or Reconfigured TrCH information				
Added or Reconfigured UL TrCH information	MP	1 to <maxTrCH preconf>		
>Added or Reconfigured UL TrCH information	MP		Added or Reconfigured UL TrCH information 10.3.5.2	
DL Transport channel information common for all transport channels	MP		DL Transport channel information common for all transport channels 10.3.5.6	
Downlink transport channels				
Added or Reconfigured DL TrCH information	MP	1 to <maxTrCH preconf>		
>Added or Reconfigured DL TrCH information	MP		Added or Reconfigured DL TrCH information 10.3.5.1	

10.3.5.10 Quality Target

Information Element/Group name	Need	Multi	Type and reference	Semantics description
BLER Quality value	MP		Real(-6.3 ..0 by step of 0.1)	Signalled value is Log10(Transport channel BLER quality target)

10.3.5.11 Semi-static Transport Format Information

Information Element/Group name	Need	Multi	Type and reference	Semantics description	Version
Transmission time interval	MP		Integer(5, 10, 20, 40, 80, dynamic)	In ms. The value dynamic is only used in TDD mode. 5 is only applicable for the RACH in 1.28 Mcps TDD	REL-4
Type of channel coding	MP		Enumerated(No coding, Convolutional, Turbo)		
Coding Rate	<i>CV-Coding</i>		Enumerated(1/2, 1/3)		
Rate matching attribute	MP		Integer(1..hi RM)		
CRC size	MP		Integer(0, 8, 12, 16, 24)	in bits	

Condition	Explanation
<i>Coding</i>	This IE is mandatory present if IE "Type of channel coding" is "Convolutional" and not needed otherwise.

10.3.5.12 TFCI Field 2 Information

This IE is used for signalling the mapping between TFCI (field 2) values and the corresponding TFC.

Information Element/Group name	Need	Multi	IE type and reference	Semantics description
CHOICE <i>Signalling method</i>	MP			
>TFCI range				
>>TFCI(field 2) range	MP	1 to <maxPDS CH-TFCI groups>		
>>>Max TFCI(field2) value	MP		Integer(1..1023)	This is the Maximum value in the range of TFCI(field2) values for which the specified CTFC(field2) applies
>>>TFCS Information for DSCH (TFCI range method)	MP		TFCS Information for DSCH (TFCI range method) 10.3.5.14	
>Explicit				
>>TFCS explicit configuration	MP		TFCS explicit configuration 10.3.5.13	

10.3.5.13 TFCS Explicit Configuration

Information Element/Group name	Need	Multi	IE type and reference	Semantics description
CHOICE <i>TFCS representation</i>	MP			
>Complete reconfiguration				
>>TFCS complete reconfiguration information	MP		TFCS Reconfiguration/Addition information 10.3.5.15	
>Addition				
>>TFCS addition information	MP		TFCS Reconfiguration/Addition information 10.3.5.15	
>Removal				
>>TFCS removal information	MP		TFCS Removal Information 10.3.5.16	
>Replace				
>>TFCS removal information	MP		TFCS Removal Information 10.3.5.16	
>>TFCS addition information	MP		TFCS Reconfiguration/Addition information 10.3.5.15	

10.3.5.14 TFCS Information for DSCH (TFCI range method)

Information Element/Group name	Need	Multi	IE type and reference	Semantics description
CHOICE <i>CTFC Size</i>	MP			
>2 bit CTFC				
>>2bit CTFC	MP		Integer(0..3)	
>4 bit CTFC				
>>4bit CTFC	MP		Integer(0..15)	
>6 bit CTFC				
>>6 bit CTFC	MP		Integer(0..63)	
>8 bit CTFC				
>>8 bit CTFC	MP		Integer(0..255)	
>12 bit CTFC				
>>12 bit CTFC	MP		Integer(0..4095)	
>16 bit CTFC				
>>16 bit CTFC	MP		Integer(0..65535)	
>24 bit CTFC				
>>24 bit CTFC	MP		Integer(0..16777215)	

10.3.5.15 TFCS Reconfiguration/Addition Information

Information Element/Group name	Need	Multi	IE type and reference	Semantics description
CHOICE CTFC Size	MP			
>2 bit CTFC				
>>CTFC information	MP	1 to <maxTFC>		
>>>2bit CTFC	MP		Integer(0..3)	
>>>Power offset Information	OP		Power Offset Information 10.3.5.8	Needed only for uplink physical channels.
>4 bit CTFC				
>>CTFC information	MP	1 to <maxTFC>		
>>>4bit CTFC	MP		Integer(0..15)	
>>>Power offset Information	OP		Power Offset Information 10.3.5.8	Needed only for uplink physical channels.
>6 bit CTFC				
>>CTFC information	MP	1 to <maxTFC>		
>>>6 bit CTFC	MP		Integer(0..63)	
>>>Power offset Information	OP		Power Offset Information 10.3.5.8	Needed only for uplink physical channels.
>8 bit CTFC				
>>CTFC information	MP	1 to <MaxTFC>		
>>>8 bit CTFC	MP		Integer(0..255)	
>>>Power offset Information	OP		Power Offset Information 10.3.5.8	Needed only for uplink physical channels.
>12 bit CTFC				
>>CTFC information	MP	1 to <maxTFC>		
>>>12 bit CTFC	MP		Integer(0..4095)	
>>>Power offset Information	OP		Power Offset Information 10.3.5.8	Needed only for uplink physical channels.
>16 bit CTFC				
>>CTFC information	MP	1 to <maxTFC>		
>>>16 bit CTFC	MP		Integer(0..65535)	
>>>Power offset Information	OP		Power Offset Information 10.3.5.8	Needed only for uplink physical channels.
>24 bit CTFC				
>>CTFC information	MP	1 to <MaxTFC>		
>>>24 bit CTFC	MP		Integer(0..16777215)	
>>>Power offset Information	OP		Power Offset Information 10.3.5.8	Needed only for uplink physical channels.

10.3.5.16 TFCS Removal Information

Information Element/Group name	Need	Multi	IE type and reference	Semantics description
Removal TFCI information	MP	1 to <maxTFC>		
>TFCI	MP		Transport Format Combination (TFC) 10.3.5.19	In TDD 0 is a reserved value

10.3.5.17 Transparent mode signalling info

Information Element	Need	Multi	Type and reference	Semantics description
Type of message	MP		Enumerated (TRANSPORT FORMAT COMBINATION CONTROL)	Indicates which type of message sent on the transparent mode signalling DCCH
CHOICE <i>Transparent signalling mode</i>	MP			
>Mode 1				(no data)
>Mode 2				
>>Controlled transport channels list	MP	1 to <maxTrCH >		The transport channels that are effected by the rate control commands sent on this transparent mode DCCH
>>>UL Controlled transport channels	MP		Transport channel identity, 10.3.5.18	transport channel type = DCH

10.3.5.18 Transport channel identity

This information element is used to distinguish transport channels. Transport channels of different type (RACH, CPCH, USCH, FACH/PCH, DSCH or DCH) have separate series of identities. This also holds for uplink and downlink transport channel identities (i.e. for DCH). Depending on in which context a transport channel identity n that is sent, it will have different meaning

Information Element/Group name	Need	Multi	Type and reference	Semantics description
Transport channel identity	MP		Integer(1..32)	

10.3.5.19 Transport Format Combination (TFC)

Information Element/Group name	Need	Multi	Type and reference	Semantics description
Transport format combination	MP		Integer (0..1023)	

10.3.5.20 Transport Format Combination Set

Indicates the allowed combinations of already defined Transport formats and the mapping between these allowed TFCs and the corresponding TFCI values.

For TDD, different coded composite transport channels have independent transport format combination sets and thus independent TFCI values.

For FDD, Where the UE is assigned access to one or more DSCH transport channels, a TFCI(field2) is used to signal the transport format combination for the DSCH. The following two cases exist:

- Case 1:
Using one TFCI-word on the physical layer. A logical split determines the available number of transport format combinations for DCH and DSCH.
- Case 2:
Using split TFCI on the physical layer. Two TFCI-words, each having a static length of five bits, are used.

Information Element/Group name	Need	Multi	IE type and reference	Semantics description
CHOICE <i>TFCI signalling</i>	MP			'Normal' : meaning no split in the TFCI field (either 'Logical' or 'Hard') 'Split' : meaning there is a split in the TFCI field (either 'Logical' or 'Hard'). This value is only valid for FDD downlink when using DSCH.
>Normal				
>>TFCI Field 1 Information	MP		TFCS explicit Configuration 10.3.5.13	
>Split				
>>Split type	OP		Enumerated ('Hard', 'Logical')	'Hard' : meaning that TFCI (field 1) and TFCI (field 2) are each 5 bits long and each field is block coded separately. 'Logical' : meaning that on the physical layer TFCI (field 1) and TFCI (field 2) are concatenated, field 1 taking the most significant bits and field 2 taking the least significant bits). The whole is then encoded with a single block code.
>>Length of TFCI(field2)	OP		Integer (1..10)	This IE indicates the length measured in number of bits of TFCI(field2)
>>TFCI Field 1 Information	OP		TFCS explicit Configuration 10.3.5.13	
>>TFCI Field 2 Information	OP		TFCI field 2 information 10.3.5.12	

CHOICE <i>TFCI signalling</i>	Condition under which <i>TFCI signalling type</i> is chosen
Normal	It is chosen when no split in the TFCI field.
Split	It is chosen when split in the TFCI field. This value is only valid for FDD downlink when using DSCH.

10.3.5.21 Transport Format Combination Set Identity

NOTE: Only for TDD.

Information Element/Group name	Need	Multi	Type and reference	Semantics description
TFCS ID	MD		Integer (1..8)	Indicates the identity of every TFCS within a UE. Default value is 1.
Shared Channel Indicator	MP		Boolean	TRUE indicates the use of shared channels. Default is false.

10.3.5.22 Transport Format Combination Subset

Indicates which Transport format combinations in the already defined Transport format combination set are allowed.

Information Element/Group name	Need	Multi	Type and reference	Semantics description
<i>CHOICE Subset representation</i>	MP			
>Minimum allowed Transport format combination index			Transport format combination 10.3.5.19	
>Allowed transport format combination list		1 to <maxTFC>		
>>Allowed transport format combination	MP		Transport format combination 10.3.5.19	
>Non-allowed transport format combination list		1 to <maxTFC>		
>>Non-allowed transport format combination	MP		Transport format combination 10.3.5.19	
>Restricted TrCH information		1 to <maxTrCH >		
>>Uplink transport channel type	MP		Enumerated(DCH, USCH)	USCH is TDD only
>>Restricted UL TrCH identity	MP		Transport channel identity 10.3.5.18	
>>Allowed TFIs	OP	1 to <maxTF>		
>>>Allowed TFI	MP		Integer(0..31)	
>Full transport format combination set				(No data)

10.3.5.23 Transport Format Set

Information Element/Group name	Need	Multi	Type and reference	Semantics description
CHOICE <i>Transport channel type</i> >Dedicated transport channels	MP			The transport channel that is configured with this TFS is of type DCH
>>Dynamic Transport Format Information	MP	1 to <maxTF>		
>>>RLC Size	MP		Integer(0..4992)	Unit is bits
>>>Number of TBs and TTI List	MP	1 to <maxTF>		Present for every valid number of TB's (and TTI) for this RLC Size.
>>>>Transmission Time Interval	CV- <i>dynamicTTI</i>		Integer(10,20,40,80)	Unit is ms.
>>>>Number of Transport blocks	MP		Integer(0..512)	
>>>>CHOICE <i>Logical Channel List</i>	MP			The logical channels that are allowed to use this RLC Size
>>>>ALL			Null	All logical channels mapped to this transport channel.
>>>>Configured			Null	The logical channels configured to use this RLC size in the <i>RB mapping info</i> . 10.3.4.21 if present in this message or in the previously stored configuration otherwise
>>>>Explicit List		1 to 15		Lists the logical channels that are allowed to use this RLC size.
>>>>>RB Identity	MP		RB identity 10.3.4.16	
>>>>>LogicalChannel	CH-UL- <i>RLCLogicalChannels</i>		Integer(0..1)	Indicates the relevant UL logical channel for this RB. "0" corresponds to the first, "1" corresponds to the second UL logical channel configured for this RB in the IE "RB mapping info".
>>Semi-static Transport Format Information	MP		Semi-static Transport Format Information 10.3.5.11	
>Common transport channels				The transport channel that is configured with this TFS is of a type not equal to DCH
>>Dynamic Transport Format Information	MP	1 to <maxTF>		Note
>>>RLC Size	MP		Integer(0..4992)	Unit is bits
>>>Number of TBs and TTI List	MP	1 to <maxTF>		Present for every valid number of TB's (and TTI) for this RLC Size.
>>>>Number of Transport blocks	MP		Integer(0..512)	
>>>>CHOICE <i>mode</i>	MP			
>>>>>FDD				(no data)
>>>>>TDD				
>>>>>>Transmission Time Interval	CV- <i>dynamicTTI</i>		Integer(10,20,40,80)	Unit is ms.

Information Element/Group name	Need	Multi	Type and reference	Semantics description
	/			
>>>CHOICE <i>Logical Channel List</i>	MP			The logical channels that are allowed to use this RLC Size. For radio bearers mapped to RACH, the UE shall regard "Explicit list" as an undefined IE value and handle these as specified in clause 9.
>>>>ALL			Null	All logical channels mapped to this transport channel.
>>>>Configured			Null	The logical channels configured to use this RLC size in the <i>RB mapping info</i> . 10.3.4.21 if present in this message or in the previously stored configuration otherwise
>>>>Explicit List		1 to 15		Lists the logical channels that are allowed to use this RLC size.
>>>>RB Identity	MP		RB identity 10.3.4.16	
>>>>LogicalChannel	<i>CV-UL-RLCLogicalChannels</i>		Integer(0..1)	Indicates the relevant UL logical channel for this RB. "0" corresponds to the first, "1" corresponds to the second UL logical channel configured for this RB in the IE "RB mapping info".
>>Semi-static Transport Format Information	MP		Semi-static Transport Format Information 10.3.5.11	

Condition	Explanation
<i>dynamicTTI</i>	This IE is mandatory present if dynamic TTI usage is indicated in IE Transmission Time Interval in Semi-static Transport Format Information. Otherwise it is not needed.
<i>UL-RLCLogicalChannels</i>	If "Number of uplink RLC logical channels" in IE "RB mapping info" in this message is 2 or the IE "RB mapping info" is not present in this message and 2 UL logical channels are configured for this RB, then this IE is mandatory present. Otherwise this IE is not needed.

NOTE: The parameter "rate matching attribute" is in line with the RAN WG1 specifications. However, it is not currently in line with the description in [34].

10.3.5.24 UL Transport channel information common for all transport channels

Information Element/Group name	Need	Multi	Type and reference	Semantics description
PRACH TFCS	OP		Transport format combination set 10.3.5.20	This IE should not be included in this version of the protocol.
CHOICE <i>mode</i> >FDD	OP			
>>TFC subset	MD		Transport Format Combination Subset 10.3.5.22	Default value is the complete existing set of transport format combinations
>>UL DCH TFCS	MP		Transport formation combination set 10.3.5.20	
>TDD				
>>Individual UL CCTrCH information	OP	1 to <maxCCTrCH>		
>>>UL TFCS Identity	MP		Transport format combination set identity 10.3.5.21	Identifies a special CCTrCH for shared or dedicated channels.
>>>UL TFCS	MP		Transport format combination set 10.3.5.20	
>>>TFC subset	MD		Transport Format Combination Subset 10.3.5.22	Default value is the complete existing set of transport format combinations

NOTE This information element is included within IE "Predefined TrCh configuration"

10.3.6 Physical CH Information elements

10.3.6.1 AC-to-ASC mapping

Information Element/Group name	Need	Multi	Type and reference	Semantics description
AC-to-ASC mapping table	MP	maxASCmap		
>AC-to-ASC mapping	MP		Integer(0..7)	Mapping of Access Classes to Access Service Classes (see subclause 8.5.13.)

10.3.6.2 AICH Info

NOTE: Only for FDD.

Information Element/Group name	Need	Multi	Type and reference	Semantics description
Channelisation code	MP		Integer(0..255)	SF is fixed and equal to 256
STTD indicator	MP		STTD Indicator 10.3.6.78	
AICH transmission timing	MP		Enumerated (0, 1)	See parameter AICH_Transmission_Timing in [26]

10.3.6.3 AICH Power offset

NOTE: Only for FDD.

This parameter is used to indicate the power level of AICH, AP-AICH and CD/CA-ICH channels. This is the power per transmitted Acquisition Indicator, AP Acquisition Indicator or CD/CA Indicator minus power of the Primary CPICH.

Information Element/Group name	Need	Multi	Type and reference	Semantics description
AICH Power offset	MP		Integer(-22..+5)	Offset in dB

10.3.6.4 Allocation period info

NOTE: Only for TDD.

Parameters used by UE to determine period of shared channel allocation.

Information Element/Group name	Need	Multi	Type and reference	Semantics description
Allocation Activation Time	MP		Integer (0..255)	Start the allocation period at the given CFN.
Allocation Duration	MP		Integer (1..256)	Total number of frames for the allocation period.

10.3.6.5 Alpha

Information Element/Group name	Need	Multi	Type and reference	Semantics description
Alpha Value	MP		Enumerated(0, 1/8, 2/8, 3/8, 4/8, 5/8, 6/8, 7/8, 1)	

10.3.6.6 ASC setting

Information Element/Group name	Need	Multi	Type and reference	Semantics description	Version
CHOICE <i>mode</i>	MP				
>FDD					
>>Available signature Start Index	MP		Integer(0..15)		
>>Available signature End Index	MP		Integer(0..15)		
>>Assigned Sub-Channel Number	MP		Bit string(4)	This IE defines the subchannel assignment as specified in 8.6.6.29. The bits are numbered b0 to b3, where b0 is the least significant bit.	
>TDD					
>>CHOICE <i>TDD option</i>	MP				REL-4
>>>3.84 Mcps TDD					REL-4
>>>>Available Channelisation codes indices	MD		Bit string(8)	Each bit indicates availability of a channelisation code index, where the channelisation code indices are numbered "channelisation code index 0" to "channelisation code index 7". The value 1 of a bit indicates that the channelisation code index is available for the ASC this IE is associated to. The value 0 of a bit indicates that the channelisation code index is not available for the ASC this IE is associated to. Default is that all channelisation codes defined in PRACH Info are available.	
>>>1.28 Mcps TDD					REL-4
>>>>Available SYNC_UL codes indices	MD		Bit string(8)	Each bit indicates availability of a SYNC_UL code index, where the SYNC_UL code indices are numbered "SYNC_UL code index 0" to "SYNC_UL code index 7". The value 1 of a bit indicates that the	REL-4

				SYNC_UL code index is available for the ASC this IE is associated to. The value 0 of a bit indicates that the SYNC_UL code index is not available for the ASC this IE is associated to. Default is that all SYNC_UL codes defined in SYNC_UL Info are available.	
>>CHOICE <i>subchannel size</i>	MP				
>>>Size1					
>>>>Available Subchannels	MP		null	Indicates that all Subchannels are available	
>>>Size2					
>>>>Available Subchannels	MD		Bit string (2)	NOTE 1	
>>>Size4					
>>>>Available Subchannels	MD		Bit string (4)	NOTE 1	
>>>Size8					
>>>>Available Subchannels	MD		Bit string (8)	NOTE 1	

NOTE 1: Each bit indicates availability of a subchannel, where the subchannels are numbered subchannel 0, subchannel 1 etc. The value 1 of a bit indicates that the subchannel is available for the ASC this IE is associated with. The value 0 of a bit indicates that the subchannel is not available for the ASC this IE is associated with. Default value of the IE is that all subchannels within the size are available for the ASC this IE is associated with.

10.3.6.7 Block STTD indicator

NOTE: Only for TDD

Information Element/Group name	Need	Multi	Type and reference	Semantics description
Block STTD indicator	MP		Boolean	TRUE indicates that block STTD is used

10.3.6.8 CCTrCH power control info

Parameters used by UE to set the SIR target value for uplink open loop power control in TDD.

Information Element/Group name	Need	Multi	Type and Reference	Semantics description
TFCS Identity	OP		Transport Format Combination Set Identity 10.3.5.21	TFCS Identity of this CCTrCH. Default value is 1.
Uplink DPCH power control info	MP		Uplink DPCH power control info 10.3.6.91	

10.3.6.8a Cell and Channel Identity info

NOTE: Only for TDD.

Information Element/Group name	Need	Multi	Type and Reference	Semantics description
Burst type	MP		Enumerated (Type1, Type2)	Identifies the channel in combination with the Midamble shift and slot number
Midamble Shift	MP		Integer (0...15)	
Time Slot	OP		Timeslot number 10.3.6.84	This IE is present only if no IPDL scheme is configured in the reference cell. Otherwise the slot is defined by the IPDL configuration.
Cell parameters ID	MP		Cell parameters ID 10.3.6.9	Identifies the cell

10.3.6.9 Cell parameters Id

Information Element/Group name	Need	Multi	Type and Reference	Semantics description
Cell parameter Id	MP		Integer(0..127)	

10.3.6.10 Common timeslot info

Information Element/Group name	Need	Multi	Type and reference	Semantics description
2 nd interleaving mode	MD		Enumerated (Frame, Timeslot)	Frame timeslot related interleaving. Default value is "Frame"
TFCI coding	MD		Integer(4,8,16,32)	Describes the amount of bits for the TFCI bits code word as described in [31]. Defaults is no TFCI bit: In case of 8 PSK in 1.28Mcps TDD: 4 corresponds to 6 TFCI code word bits. 8 corresponds to 12 TFCI code word bits. 16 corresponds to 24 TFCI code word bits. 32 corresponds to 48 TFCI code word bits.
Puncturing limit	MP		Real(0.40..1.0 by step of 0.04)	
Repetition period	MD		Integer(1, 2,4,8,16,32,64)	Default is continuous allocation. Value 1 indicate continuous
Repetition length	MP		Integer(1..Repetition period -1)	Note that this is empty if repetition period is set to 1

10.3.6.11 Constant value

This constant value is used by the UE to calculate the initial output power on PRACH according to the Open loop power control procedure. In TDD constant values are used for open loop power control of PRACH, USCH and UL DPCH as defined in subclause 8.5.7.

Information Element/Group name	Need	Multi	Type and reference	Semantics description
Constant value	MP		Integer (-35..-10)	

10.3.6.12 CPCH persistence levels

NOTE: Only for FDD.

This IE is dynamic and is used by RNC for load balancing and congestion control. This is broadcast often in the system information message.

Information Element/Group name	Need	Multi	Type and reference	Semantics description
CPCH set ID	MP		Integer (1 .. <maxCPCHs ets>)	Identifier for CPCH set info.
Dynamic persistence level	MP	1 to <maxTF-CPCH>		
>Dynamic persistence level	MP		Dynamic persistence level 10.3.6.35	Persistence level for transport format.

10.3.6.13 CPCH set info

NOTE: Only for FDD.

This IE may be broadcast in the System Information message or assigned by SRNC. It is pseudo-static in a cell.

Information Element/Group name	Need	Multi	Type and reference	Semantics description
CPCH set ID	MP		CPCH set ID 10.3.5.3	Indicates the ID number for a particular CPCH set allocated to a cell.
TFS	MP		Transport Format Set 10.3.5.23	Transport Format Set Information allocated to this CPCH set.
TFCS	MP		Transport Format Combination Set 10.3.5.20	Transport Format Set Information allocated to this CPCH set
AP preamble scrambling code	MP		Integer (0..79)	Preamble scrambling code for AP in UL
AP-AICH channelisation code	MP		Integer(0..255)	Channelisation code for AP-AICH in DL
CD preamble scrambling code	MP		Integer (0..79)	Preamble scrambling code for CD in UL
CD/CA-ICH channelisation code	MP		Integer (0..255)	Channelisation code for CD/CA-ICH in DL
Available CD access slot subchannel	CV- <i>CDSigPresent</i>	1 to <maxPCP CH- CDsubCh>		Lists the set of subchannels to be used for CD access preambles. Note: if not present, all subchannels are to be used without access delays.
>CD access slot subchannel	MP		Integer (0..11)	
Available CD signatures	OP	1 to <maxPCP CH-CDsig>		Signatures for CD preamble in UL. Note: if not present, all signatures are available for use.
>CD signatures	MP		Integer (0..15)	
DeltaPp-m	MP		Integer (-10..10)	In dB. Power offset between the transmitted CD preamble and UL DPCCH of the power control preamble or message part (added to the preamble power to calculate the power of the UL DPCCH)
UL DPCCH Slot Format	MP		Enumerated (0,1,2)	Slot format for UL DPCCH in power control preamble and in message part
N_start_message	MP		Integer (1..8)	Number of Frames for start of message indication
N_EOT	MP		Integer(0..7)	Actual number of appended EOT indicators is $T_{EOT} = N_{TTI} * \text{ceil}(N_{EOT}/N_{TTI})$, where N_{TTI} is the number of frames per TTI and "ceil" refers to rounding up to nearest integer.
Channel Assignment Active	OP		Boolean	When present, indicates that Node B send a CA message and VCAM mapping rule (14.11) shall be used.
CPCH status indication mode	MP		CPCH status indication mode 10.3.6.14	
PCPCH Channel Info.	MP	1 to <maxPCP CHs>		
>UL scrambling code	MP		Integer (0..79)	For PCPCH message part

>DL channelisation code	MP		Integer (0...511)	For DL DPCCH for PCPCH message part
>DL scrambling code	MD		Secondary Scrambling Code 10.3.6.74	Default is the same scrambling code as for the primary CPICH.
>PCP length	MP		Enumerated (0, 8)	Indicates length of power control preamble, 0slots (no preamble used) or 8 slots
>UCSM Info	CV-NCAA			
>>Minimum Spreading Factor	MP		Integer (4,8,16,32,64,128,256)	The UE may use this PCPCH at any Spreading Factor equal to or greater than the indicated minimum Spreading Factor. The Spreading Factor for initial access is the minimum Spreading Factor.
>>NF_max	MP		Integer (1...64)	Maximum number of frames for PCPCH message part
>>Channel request parameters for UCSM	MP			Required in UE channel selection mode.
>>>Available AP signature	MP	1 to <maxPCP CH-APsig>		AP preamble signature codes for selection of this PCPCH channel.
>>>>AP signature	MP		Integer (0..15)	
>>>Available AP access slot subchannel	OP	1 to <maxPCP CH-APsubCh>		Lists the set of subchannels to be used for AP access preambles in combination with the above AP signature(s). Note: if not present, all subchannels are to be used without access delays.
>>>>AP access slot subchannel	MP		Integer (0..11)	
VCAM info	CV-CAA			
>Available Minimum Spreading Factor	MP	1 to <maxPCP CH-SF>		
>>Minimum Spreading Factor	MP		Enumerated (4,8,16,32,64,128,256)	
>>NF_max	MP		Integer (1..64)	Maximum number of frames for PCPCH message part
>>Maximum available number of PCPCH	MP		Integer (1..64)	Maximum available number of PCPCH for the indicated Spreading Factor.
>>Available AP signatures	MP	1 to <maxPCP CH-APsig>		Signatures for AP preamble in UL.
>>>AP signature			Integer (0..15)	
>>Available AP sub-channel	OP	1 to <maxPCP CH-APsubCh>		AP sub-channels for the given AP signature in UL. Note: if not present, all subchannels are to be used without access delays.
>>>AP sub-channel	MP		Integer (0..11)	

Condition	Explanation
<i>CDSigPresent</i>	This IE is optional if IE "Available CD signatures" is present and not needed otherwise.
<i>NCAA</i>	This IE is mandatory present if IE "Channel Assignment Active" is not present and not needed otherwise.
<i>CAA</i>	This IE is mandatory present if IE "Channel Assignment Active" is present and not needed otherwise.

10.3.6.14 CPCH Status Indication mode

NOTE: Only for FDD.

Information Element/Group name	Need	Multi	Type and reference	Semantics description
CPCH Status Indication mode	MP		Enumerated (PA mode, PAMASF mode)	Defines the status information type broadcast on the CPCH Status Indication Channel (CSICH)

CPCH Status Indication mode defines the structure of the CSICH information that is broadcast by Node B on the CSICH channel. CSICH mode can take 2 values: PCPCH Availability (PA) mode and PCPCH Availability with Minimum Available Spreading Factor (PAMASF) mode. PAMASF mode is used when Channel Assignment is active. PA mode is used when Channel Assignment is not active (UE Channel Selection is active). [26] defines the structure of the CSICH information for both CSICH modes.

10.3.6.15 CSICH Power offset

NOTE: Only for FDD.

This is the power per transmitted CSICH Indicator minus power of the Primary CPICH.

Information Element/Group name	Need	Multi	Type and reference	Semantics description
CSICH Power offset	MP		Integer(-10..+5)	Offset in dB, granularity of 1 dB

10.3.6.16 Default DPCH Offset Value

Indicates the default offset value within interleaving size at a resolution of 512chip (1/5 slot) in FDD and a resolution of one frame in TDD to offset CFN in the UE. This is used to distribute discontinuous transmission periods in time and also to distribute NodeB-RNC transmission traffics in time. Even though the CFN is offset by DOFF, the start timing of the interleaving will be the timing that "CFN mod (interleaving size)"=0 (e.g. interleaving size: 2,4,8) in both UE and SRNC.

Information Element/Group name	Need	Multi	Type and reference	Semantics description
CHOICE <i>mode</i>				
>FDD				
>>Default DPCH Offset Value (DOFF)	MP		Integer (0..306688 by step of 512)	Number of chips=. 0 to 599 time 512 chips, see [10].
>TDD				
>>Default DPCH Offset Value (DOFF)	MP		Integer(0..7)	Number of frames; See [10]

10.3.6.17 Downlink channelisation codes

NOTE: Only for TDD

Information Element/Group name	Need	Multi	Type and reference	Semantics description
CHOICE <i>codes representation</i>	MP			
>Consecutive codes				
>>First channelisation code	MP		Enumerated ((16/1)...(16/16))	The codes from First channelisation code to Last channelisation code shall be used in that order by the physical layer in this timeslot. If a TFCI exists in this timeslot, it is mapped in the First channelisation code.
>>>Last channelisation code	MP		Enumerated ((16/1)...(16/16))	If this is the same as First channelisation code, only one code is used by the physical layer.
>Bitmap				
>>Channelisation codes bitmap	MP		Bit string(16)	Each bit indicates the availability of a channelisation code for SF16, where the channelisation codes are numbered as channelisation code 1 (SF16) to channelisation code 16 (SF16). (For SF 16, a 1 in the bitmap means that the corresponding code is used, a 0 means that the corresponding code is not used.) If all bits are set to zero, SF 1 shall be used.

10.3.6.18 Downlink DPCH info common for all RL

Information Element/Group name	Need	Multi	Type and reference	Semantics description
Timing Indication	MP		Enumerated(Initialise, Maintain)	Note 1
CFN-targetSFN frame offset	CV- <i>TimInd</i>		Integer(0..255)	In frame
Downlink DPCH power control information	OP		Downlink DPCH power control information 10.3.6.23	
CHOICE <i>mode</i>	MP			
>FDD				
>>Power offset $P_{\text{Pilot-DPCH}}$	MP		Integer(0..24)	Power offset equals $P_{\text{Pilot}} - P_{\text{DPDCH}}$, range 0..6 dB, in steps of 0.25 dB
>>>Downlink rate matching restriction information	OP		Downlink rate matching restriction information 10.3.6.31	If this IE is set to "absent", no Transport CH is restricted in TFI.
>>>Spreading factor	MP		Integer(4, 8, 16, 32, 64, 128, 256, 512)	
>>>Fixed or Flexible Position	MP		Enumerated (Fixed, Flexible)	
>>TFCI existence	MP		Boolean	TRUE indicates that TFCI exists
>>CHOICE <i>SF</i>	MP			
>>>SF = 256				
>>>>Number of bits for Pilot bits	MP		Integer (2,4,8)	In bits
>>>>SF = 128				
>>>>Number of bits for Pilot bits	MP		Integer(4,8)	In bits
>>>>Otherwise				(no data). In ASN.1 choice "Otherwise" is not explicitly available as all values are available, it is implied by the use of any value other than 128 or 256.
>TDD				(no data)

CHOICE <i>SF</i>	Condition under which the given <i>SF</i> is chosen
SF=128	"Spreading factor" is set to 128
SF=256	"Spreading factor" is set to 256
Otherwise	"Spreading factor" is set to a value distinct from 128 and 256

Condition	Explanation
<i>TimInd</i>	This IE is optional if the IE "Timing Indication" is set to "Initialise". Otherwise it is not needed.

NOTE 1: Within the HANDOVER TO UTRAN COMMAND message, only value "initialise" is applicable.

10.3.6.19 Downlink DPCH info common for all RL Post

Information Element/Group name	Need	Multi	Type and reference	Semantics description
Downlink DPCH power control information	OP		Downlink DPCH power control information 10.3.6.23	

10.3.6.20 Downlink DPCH info common for all RL Pre

Information Element/Group name	Need	Multi	Type and reference	Semantics description
CHOICE <i>mode</i>	MP			
>FDD				
>>Spreading factor	MP		Integer(4, 8, 16, 32, 64, 128, 256, 512)	Defined in CHOICE SF512-Andpilot with "number of its for pilot bits" in ASN.1
>>Fixed or Flexible Position	MP		Enumerated (Fixed, Flexible)	
>>TFCI existence	MP		Boolean	TRUE indicates that TFCI exists
>>CHOICE <i>SF</i>	MP			
>>>SF = 256				
>>>>Number of bits for Pilot bits	MP		Integer (2,4,8)	In bits
>>>>SF = 128				
>>>>Number of bits for Pilot bits	MP		Integer(4,8)	In bits
>>>Otherwise				(no data)
>TDD				
>>Common timeslot info	MP		Common Timeslot Info 10.3.6.10	

CHOICE <i>SF</i>	Condition under which the given <i>SF</i> is chosen
SF=128	"Spreading factor" is set to 128
SF=256	"Spreading factor" is set to 256
Otherwise	"Spreading factor" is set to a value distinct from 128 and 256

10.3.6.21 Downlink DPCH info for each RL

Information Element/Group name	Need	Multi	Type and reference	Semantics description
CHOICE <i>mode</i>	MP			
>FDD				
>>Primary CPICH usage for channel estimation	MP		Primary CPICH usage for channel estimation 10.3.6.62	
>>DPCH frame offset	MP		Integer(0..38144 by step of 256)	Offset (in number of chips) between the beginning of the P-CCPCH frame and the beginning of the DPCH frame This is called $\tau_{DPCH,n}$ in [26]
>>Secondary CPICH info	OP		Secondary CPICH info 10.3.6.73	
>>DL channelisation code	MP	1 to <maxDPC H-DLchan>		For the purpose of physical channel mapping [27] the DPCHs are numbered, starting from DPCH number 1, according to the order that they are contained in this IE.
>>>Secondary scrambling code	MD		Secondary scrambling code 10.3.6.74	Default is the same scrambling code as for the Primary CPICH
>>>Spreading factor	MP		Integer(4, 8, 16, 32, 64, 128, 256, 512)	Defined in CHOICE SF512-AndCodenum with "code number" in ASN.1
>>>Code number	MP		Integer(0..Spreading factor - 1)	
>>>Scrambling code change	CH-SF/2		Enumerated (code change, no code change)	Indicates whether the alternative scrambling code is used for compressed mode method 'SF/2'.
>>TPC combination index	MP		TPC combination index 10.3.6.85	
>>SSDT Cell Identity	OP		SSDT Cell Identity 10.3.6.76	
>>Closed loop timing adjustment mode	CH-TxDiversity Mode		Integer(1, 2)	It is present if current TX Diversity Mode in UE is "closed loop mode 1" or "closed loop mode 2". Value in slots
>TDD				
>>DL CCTrCh List	MP	1..<maxCC TrCH>		
>>>TFCS ID	MD		Integer(1..8)	Identity of this CCTrCh. Default value is 1
>>>Time info	MP		Time Info 10.3.6.83	
>>>Common timeslot info	MD		Common Timeslot Info 10.3.6.10	Default is the current Common timeslot info
>>>Downlink DPCH timeslots and codes	MD		Downlink Timeslots and Codes 10.3.6.32	Default is to use the old timeslots and codes.
>>>UL CCTrCH TPC List	MD	0..<maxCC TrCH>		UL CCTrCH identities for TPC commands associated

Information Element/Group name	Need	Multi	Type and reference	Semantics description
				with this DL CCTrCH. Default is previous list or all defined UL CCTrCHs
>>>UL TPC TFCS Identity	MP		Transport Format Combination Set Identity 10.3.5.21	

Condition	Explanation
<i>SF/2</i>	The information element is mandatory present if the UE has an active compressed mode pattern sequence, which is using compressed mode method "SF/2". Otherwise the IE is not needed.
<i>TxDiversity Mode</i>	This IE is mandatory present if current TX Diversity Mode in UE is "closed loop mode 1" or "closed loop mode 2". Otherwise the IE is not needed.

10.3.6.22 Downlink DPCH info for each RL Post

Information Element/Group name	Need	Multi	Type and reference	Semantics description
CHOICE <i>mode</i>	MP			
>FDD				
>>Primary CPICH usage for channel estimation	MP		Primary CPICH usage for channel estimation 10.3.6.62	
>>>Secondary scrambling code	MD		Secondary scrambling code 10.3.6.74	Default is the same scrambling code as for the Primary CPICH
>>>CHOICE <i>Spreading factor</i>	MP		Integer(4, 8, 16, 32, 64, 128, 256, 512)	Defined in CHOICE SF512-AndCodenumbr with "code number" in ASN.1
>>>Code number	MP		Integer(0.. Spreading factor - 1)	
>>>Scrambling code change	CH-SF/2		Enumerated (code change, no code change)	Indicates whether the alternative scrambling code is used for compressed mode method 'SF/2'.
>>>>TPC combination index	MP		TPC combination index 10.3.6.85	
>TDD				
>>>Downlink DPCH timeslots and codes	MP		Downlink Timeslots and Codes 10.3.6.32	

10.3.6.23 Downlink DPCH power control information

Information Element/Group name	Need	Multi	Type and reference	Semantics description
CHOICE <i>mode</i>	MP			
>FDD				
>>DPC Mode	MP		Enumerated (Single TPC, TPC triplet in soft)	"Single TPC" is DPC_Mode=0 and "TPC triplet in soft" is DPC_mode=1 in [29].
>TDD				
>>TPC Step Size	OP		Integer (1, 2, 3)	In dB

10.3.6.24 Downlink information common for all radio links

Information Element/Group name	Need	Multi	Type and reference	Semantics description	Version
Downlink DPCH info common for all RL	OP		Downlink DPCH info common for all RL 10.3.6.18		
CHOICE <i>mode</i>	MP				
>FDD					
>>DPCH compressed mode info	MD		DPCH compressed mode info 10.3.6.33	Default value is the existing value of DPCH compressed mode information	
>>TX Diversity Mode	MD		TX Diversity Mode 10.3.6.86	Default value is the existing value of TX Diversity mode	
>>SSDT information	OP		SSDT information 10.3.6.77		
>TDD				(no data)	
>>CHOICE <i>TDD option</i>	MP				REL-4
>>>3.84 Mcps TDD				(no data)	REL-4
>>>1.28 Mcps TDD					REL-4
>>>>TSTD indicator	MP		TSTD indicator 10.3.6.85a		REL-4
Default DPCH Offset Value	OP		Default DPCH Offset Value, 10.3.6.16		

10.3.6.25 Downlink information common for all radio links Post

Information Element/Group name	Need	Multi	Type and reference	Semantics description
Downlink DPCH info common for all RL	MP		Downlink DPCH info common for all RL Post 10.3.6.19	

10.3.6.26 Downlink information common for all radio links Pre

Information Element/Group name	Need	Multi	Type and reference	Semantics description
Downlink DPCH info common for all RL	MP		Downlink DPCH info common for all RL Pre 10.3.6.20	

10.3.6.27 Downlink information for each radio link

Information Element/Group name	Need	Multi	Type and reference	Semantics description
Choice mode	MP			
>FDD				
>>Primary CPICH info	MP		Primary CPICH info 10.3.6.60	
>>PDSCH with SHO DCH Info	OP		PDSCH with SHO DCH Info 10.3.6.47	
>>PDSCH code mapping	OP		PDSCH code mapping 10.3.6.43	
>TDD				
>>Primary CCPCH info	MP		Primary CCPCH info 10.3.6.57	
Downlink DPCH info for each RL	OP		Downlink DPCH info for each RL 10.3.6.21	
SCCPCH Information for FACH	OP		SCCPCH Information for FACH 10.3.6.70	

10.3.6.28 Downlink information for each radio link Post

Information Element/Group name	Need	Multi	Type and reference	Semantics description
Choice mode	MP			
>FDD				
>>Primary CPICH info	MP		Primary CPICH info 10.3.6.60	
>TDD				
>>Primary CCPCH info	MP		Primary CCPCH info post 10.3.6.58	
Downlink DPCH info for each RL	MP		Downlink DPCH info for each RL Post 10.3.6.22	

10.3.6.29 Void

10.3.6.30 Downlink PDSCH information

NOTE: Only for FDD.

Information Element/Group name	Need	Multi	Type and reference	Semantics description
PDSCH with SHO DCH Info	OP		PDSCH with SHO DCH Info 10.3.6.47	
PDSCH code mapping	OP		PDSCH code mapping 10.3.6.43	

10.3.6.31 Downlink rate matching restriction information

This IE indicates which TrCH is restricted in TFI.

Information Element/Group name	Need	Multi	Type and reference	Semantics description
Restricted TrCH information	OP	1 to <maxTrCH >		
>Downlink transport channel type	MP		Enumerated(DCH,DSCH)	
>Restricted DL TrCH identity	MP		Transport channel identity 10.3.5.18	
>Allowed TFIs	MP	1 to <maxTF>		
>>Allowed TFI	MP		Integer(0..31)	

10.3.6.32 Downlink Timeslots and Codes

NOTE: Only for TDD

Information Element/Group name	Need	Multi	Type and reference	Semantics description
First Individual timeslot info	MP		Individual timeslot info 10.3.6.37	Individual timeslot info for the first timeslot used by the physical layer.
First timeslot channelisation codes	MP		Downlink channelisation codes 10.3.6.17	These codes shall be used by the physical layer in the timeslot given in First Individual timeslot info.
CHOICE <i>more timeslots</i>	MP			
>No more timeslots				(no data)
>Consecutive timeslots				
>>Number of additional timeslots	MP		Integer(1..maxTS-1)	The timeslots used by the physical layer shall be timeslots: N mod maxTS (N+1) mod maxTS ... (N+k) mod maxTS in that order, where N is the timeslot number in the First individual timeslot info and k the Number of additional timeslots. The additional timeslots shall use the same parameters (e.g. channelisation codes, midamble shifts etc.) as the first timeslot.
>Timeslot list				
>>Additional timeslot list	MP	1 to <maxTS-1>		The first instance of this parameter corresponds to the timeslot that shall be used second by the physical layer, the second to the timeslot that shall be used third and so on.
>>>CHOICE <i>parameters</i>	MP			
>>>>Same as last				
>>>>>Timeslot number	MP		Timeslot Number 10.3.6.84	The physical layer shall use the same parameters (e.g. channelisation codes, midamble shifts etc.) for this timeslot as for the last one.
>>>>>New parameters				
>>>>>Individual timeslot info	MP		Individual timeslot info 10.3.6.37	
>>>>>Channelisation codes	MP		Downlink channelisation codes 10.3.6.17	

10.3.6.33 DPCH compressed mode info

NOTE: Only for FDD.

This information element indicates the parameters of the compressed mode to be used by the UE in order to perform inter-frequency and inter-RAT measurements.

Information Element/Group name	Need	Multi	Type and reference	Semantics description
Transmission gap pattern sequence	MP	1 to <maxTGPS>		
>TGPSI	MP		TGPSI 10.3.6.82	

Information Element/Group name	Need	Multi	Type and reference	Semantics description
>TGPS Status Flag	MP		Enumerated(active, inactive)	This flag indicates the current status of the Transmission Gap Pattern Sequence, whether it shall be activated or deactivated.
>TGCFN	CV-Active		Integer (0..255)	Connection Frame Number of the first frame of the first pattern within the Transmission Gap Pattern Sequence.
>Transmission gap pattern sequence configuration parameters	OP			
>>TGMP	MP		Enumerated(TDD measurement, FDD measurement, GSM carrier RSSI measurement, GSM Initial BSIC identification, GSM BSIC re-confirmation, Multi-carrier measurement)	Transmission Gap pattern sequence Measurement Purpose.
>>TGPRC	MP		Integer (1..511, Infinity)	The number of transmission gap patterns within the Transmission Gap Pattern Sequence.
>>TGSN	MP		Integer (0..14)	Transmission Gap Starting Slot Number The slot number of the first transmission gap slot within the TGCFN.

Information Element/Group name	Need	Multi	Type and reference	Semantics description
>>TGL1	MP		Integer(1..14)	The length of the first Transmission Gap within the transmission gap pattern expressed in number of slots
>>TGL2	MD		Integer (1..14)	The length of the second Transmission Gap within the transmission gap pattern. If omitted, then TGL2=TGL1.
>>TGD	MP		Integer(15..269, undefined)	Transmission gap distance indicates the number of slots between starting slots of two consecutive transmission gaps within a transmission gap pattern. If there is only one transmission gap in the transmission gap pattern, this parameter shall be set to zero.
>>TGPL1	MP		Integer (1..144)	The duration of transmission gap pattern 1.
>>TGPL2	MD		Integer (1..144)	The duration of transmission gap pattern 2. If omitted, then TGPL2=TGPL1.
>>RPP	MP		Enumerated (mode 0, mode 1).	Recovery Period Power control mode during the frame after the transmission gap within the compressed frame. Indicates whether normal PC mode or compressed PC mode is applied
>>ITP	MP		Enumerated (mode 0, mode 1).	Initial Transmit Power is the uplink power control method to be used to compute the initial transmit power after the compressed mode gap.
>>CHOICE <i>UL/DL mode</i>	MP			
>>>DL only				Compressed mode used in DL only
>>>>Downlink compressed mode method	MP		Enumerated (puncturing, SF/2, higher layer scheduling)	Method for generating downlink compressed mode gap
>>>UL only				Compressed mode used in UL only
>>>>Uplink compressed mode method	MP		Enumerated (SF/2, higher layer scheduling)	Method for generating uplink compressed mode gap
>>>UL and DL				Compressed mode used in UL and DL
>>>>Downlink compressed mode method	MP		Enumerated (puncturing, SF/2, higher layer scheduling)	Method for generating downlink compressed mode gap
>>>>Uplink compressed mode method	MP		Enumerated (SF/2, higher layer scheduling)	Method for generating uplink compressed mode gap
>>Downlink frame type	MP		Enumerated (A, B)	
>>DeltaSIR1	MP		Real(0..3 by step of 0.1)	Delta in DL SIR target value to be set in the UE during the frame containing the start of the first transmission gap in

Information Element/Group name	Need	Multi	Type and reference	Semantics description
				the transmission gap pattern (without including the effect of the bit-rate increase)
>>DeltaSIRafter1	MP		Real(0..3 by step of 0.1)	Delta in DL SIR target value to be set in the UE one frame after the frame containing the start of the first transmission gap in the transmission gap pattern.
>>DeltaSIR2	OP		Real(0..3 by step of 0.1)	Delta in DL SIR target value to be set in the UE during the frame containing the start of the second transmission gap in the transmission gap pattern (without including the effect of the bit-rate increase) When omitted, DeltaSIR2 = DeltaSIR1.
>>DeltaSIRafter2	OP		Real(0..3 by step of 0.1)	Delta in DL SIR target value to be set in the UE one frame after the frame containing the start of the second transmission gap in the transmission gap pattern. When omitted, DeltaSIRafter2 = DeltaSIRafter1.
>>N Identify abort	CV-Initial BSIC		Integer(1..128)	Indicates the maximum number of repeats of patterns that the UE shall use to attempt to decode the unknown BSIC of the GSM cell in the initial BSIC identification procedure
>>T Reconfirm abort	CV-Re-confirm BSIC		Real(0.5..10.0 by step of 0.5)	Indicates the maximum time allowed for the re-confirmation of the BSIC of one GSM cell in the BSIC re-confirmation procedure. The time is given in steps of 0.5 seconds.

Condition	Explanation
Active	This IE is mandatory present when the value of the IE "TGPS Status Flag" is "Active" and not needed otherwise.
Initial BSIC	This IE is mandatory present when the value of the IE "TGMP" is set to "GSM Initial BSIC identification" and not needed otherwise.
Re-confirm BSIC	This IE is mandatory present when the value of the IE "TGMP" is set to "GSM BSIC re-confirmation" and not needed otherwise.

10.3.6.34 DPCH Compressed Mode Status Info

This information element indicates status information of the compressed mode used by the UE in order to perform inter-frequency and inter-RAT measurements.

Information Element/Group name	Need	Multi	Type and reference	Semantics description
TGPS reconfiguration CFN	MP		Integer (0..255)	Connection Frame Number of the frame where already active Transmission Gap Pattern Sequences shall be deactivated

Information Element/Group name	Need	Multi	Type and reference	Semantics description
Transmission gap pattern sequence	MP	1 to <maxTGP S>		
>TGPSI	MP		TGPSI 10.3.6.82	Transmission Gap Pattern Sequence Identifier
>TGPS Status Flag	MP		Enumerated(active, inactive)	This flag indicates the current status of the Transmission Gap Pattern Sequence, whether it shall be active or inactive.
>TGCFN	CV-Active		Integer (0..255)	Connection Frame Number of the first frame of the first pattern within the Transmission Gap Pattern Sequence.

Condition	Explanation
Active	This IE is mandatory present when the value of the IE "TGPS Status Flag" is "Active" and not needed otherwise.

10.3.6.35 Dynamic persistence level

Information Element/Group name	Need	Multi	Type and reference	Semantics description
Dynamic persistence level	MP		Integer(1..8)	Level shall be mapped to a dynamic persistence value in the range 0 .. 1.

10.3.6.35a FPACH info

NOTE: Only for 1.28 Mcps TDD.

Information Element/Group name	Need	Multi	Type and reference	Semantics description	Version
Timeslot number	MP		Integer(1..6)		REL-4
Channelisation code	MP		Enumerated((16/1)..(16/1 6)		REL-4
Midamble Shift and burst type	MP		Midamble shift and burst type 10.3.6.41		REL-4
WT	MP		Integer(1..4)	The number of sub-frames, following the sub-frame in which the SYNC UL is transmitted, in which the FPACH can be transmitted.	REL-4

10.3.6.36 Frequency info

Information Element/Group name	Need	Multi	Type and reference	Semantics description
CHOICE <i>mode</i>	MP			
>FDD				
>>UARFCN uplink (Nu)	OP		Integer(0..16383)	[21] If IE not present, default duplex distance of 190 MHz shall be used.
>>UARFCN downlink (Nd)	MP		Integer(0 .. 16383)	[21]
>TDD				
>>UARFCN (Nt)	MP		Integer(0 .. 16383)	[22]

10.3.6.37 Individual timeslot info

Information Element/Group name	Need	Multi	Type and reference	Semantics description	Version
Timeslot number	MP		Timeslot number 10.3.6.84	Timeslot within a frame	
TFCI existence	MP		Boolean	TRUE indicates that the TFCI exists. It shall be coded in the first physical channel of this timeslot.	
Midamble Shift and burst type	MP		Midamble shift and burst type 10.3.6.41		
CHOICE <i>TDD option</i>	MP				REL-4
>3.84 Mcps TDD				(no data)	REL-4
>1.28 Mcps TDD					REL-4
>>Modulation	MP		Enumerated(QPSK, 8PSK)		REL-4
>>SS-TPC Symbols	MP		Enumerated(0, 1, 16/SF)	Denotes amount of SS and TPC bits send in this timeslot	REL-4

10.3.6.38 Individual Timeslot interference

Parameters used by the UE for uplink open loop power control in TDD.

Information element	Need	Multi	Type and reference	Semantics description
Timeslot number	MP		Timeslot number 10.3.6.84	
UL Timeslot Interference	MP		UL Interference 10.3.6.87	

10.3.6.39 Maximum allowed UL TX power

This information element indicates the maximum allowed uplink transmit power.

Information Element	Need	Multi	Type and reference	Semantics description
Maximum allowed UL TX power	MP		Integer(-50..33)	In dBm

10.3.6.40 Void

10.3.6.41 Midamble shift and burst type

NOTE: Only for TDD.

This information element indicates burst type and midamble allocation. Three different midamble allocation schemes exist:

- Default midamble: the midamble shift is selected by layer 1 depending on the associated channelisation code (DL and UL)
- Common midamble: the midamble shift is chosen by layer 1 depending on the number of channelisation codes (possible in DL only)
- UE specific midamble: a UE specific midamble is explicitly assigned (DL and UL).

Information Element/Group name	Need	Multi	Type and reference	Semantics description	Version
CHOICE <i>TDD option</i>	MP				REL-4
>3.84 Mcps TDD					REL-4
>>CHOICE <i>Burst Type</i>	MP				
>>>Type 1					
>>>>Midamble Allocation Mode	MP		Enumerated (Default midamble, Common midamble, UE specific midamble)		
>>>>Midamble configuration burst type 1 and 3	MP		Integer(4, 8, 16)	As defined in [30]	
>>>>Midamble Shift	CV-UE		Integer(0..15)		
>>>Type 2					
>>>>Midamble Allocation Mode	MP		Enumerated (Default midamble, Common midamble, UE specific midamble)		
>>>>Midamble configuration burst type 2	MP		Integer(3, 6)	As defined in [30]	
>>>>Midamble Shift	CV-UE		Integer(0..5)		
>>>Type 3					
>>>>Midamble Allocation Mode	MP		Enumerated (Default midamble, UE specific midamble)		
>>>>Midamble configuration burst type 1 and 3	MP		Integer(4, 8, 16)	As defined in [30]	
>>>>Midamble Shift	CV-UE		Integer (0..15)	NOTE: Burst Type 3 is only used in uplink.	
>1.28 Mcps TDD					REL-4
>>Midamble Allocation Mode	MP		Enumerated (Default midamble, Common midamble, UE specific midamble)		REL-4
>>Midamble configuration	MP		Integer(2, 4, 6, 8, 10, 12, 14, 16)	As defined in [30]	REL-4
>>Midamble Shift	CV-UE		Integer (0..15)		REL-4

Condition	Explanation
UE	This IE is mandatory present when the value of the IE "Midamble Allocation Mode" is "UE-specific midamble" and not needed otherwise.

10.3.6.42 PDSCH Capacity Allocation info

NOTE: Only for TDD.

Information Element/Group name	Need	Multi	Type and reference	Semantics description
PDSCH allocation period info	MP		Allocation Period Info 10.3.6.4	
TFCS ID	MD		Integer(1..8)	Default is 1.
CHOICE <i>Configuration</i>	MP			
>Old configuration				
>>PDSCH Identity	MP		Integer(1..hi PDSCHidentities)	
>New configuration				
>>PDSCH Info	MP		PDSCH Info 10.3.6.44	
>>PDSCH Identity	OP		Integer(1..hi PDSCHidentities)	
>>PDSCH power control info	OP		PDSCH power control info 10.3.6.45	

10.3.6.43 PDSCH code mapping

NOTE: Only for FDD.

This IE indicates the association between each possible value of TFCI(field 2) and the corresponding PDSCH channelisation code(s). The following signalling methods are specified:

- 'code range': the mapping is described in terms of a number of groups, each group associated with a given spreading factor;
- 'TFCI range': the mapping is described in terms of a number of groups, each group corresponding to a given PDSCH channelisation code;
- 'Explicit': the mapping between TFCI(field 2) value and PDSCH channelisation code is spelt out explicitly for each value of TFCI (field2);
- 'Removal': replace individual entries in the TFCI(field 2) to PDSCH code mapping table with new PDSCH code values.

Information Element/Group name	Need	Multi	Type and reference	Semantics description
DL Scrambling Code	MD		Secondary scrambling code 10.3.6.74	Scrambling code on which PDSCH is transmitted. Default is the same scrambling code as for the Primary CPICH
<i>Choice signalling method</i>	MP			
>code range				
>>PDSCH code mapping	MP	1 to < maxPDSC H-TFCIgroups >		
>>>Spreading factor	MP		Integer(4, 8, 16, 32, 64, 128, 256)	
>>>multi-code info	MP		Integer(1..16)	
>>>Code number (for PDSCH code) start	MP		Integer(0..Spreading factor-1)	
>>>Code number (for PDSCH code) stop	MP		Integer(0..Spreading factor-1)	
>TFCI range				
>>DSCH mapping	MP	1 to < maxPDSC H-TFCIgroups >		
>>>Max TFCI(field2) value	MP		Integer(1..1023)	This is the maximum value in the range of TFCI(field 2) values for which the specified PDSCH code applies
>>>Spreading factor (for PDSCH code)	MP		Integer(4, 8, 16, 32, 64, 128, 256)	
>>>Code number (for PDSCH code)	MP		Integer(0..Spreading factor-1)	
>>>multi-code info	MP		Integer(1..16)	
>Explicit				
>>PDSCH code info	MP	1 to < maxTFCI-2-Combs >		The first instance of the parameter <i>PDSCH code</i> corresponds to TFCI (field2) = 0, the second to TFCI(field 2) = 1 and so on.
>>>Spreading factor (for PDSCH code)	MP		Integer(4, 8, 16, 32, 64, 128, 256)	
>>>Code number (for PDSCH code)	MP		Integer(0..Spreading factor-1)	
>>>multi-code info	MP		Integer(1..16)	
>Replace				This choice is made if the PDSCH code(s) associated with a given value of TFCI(field 2) is to be replaced.
>>Replaced PDSCH code	MP	1 to < maxTFCI-2-Combs >		Identity of the PDSCH code(s) to be used for the specified value of TFCI(field 2). These code identity(s) replace any that had been specified before
>>>TFCI (field 2)	MP		Integer	Value of TFCI(field 2) for

Information Element/Group name	Need	Multi	Type and reference	Semantics description
			(0..1023)	which PDSCH code mapping will be changed
>>>Spreading factor (for PDSCH code)	MP		Integer(4, 8, 16, 32, 64, 128, 256)	
>>>Code number (for PDSCH code)	MP		Integer(0..Spreading factor-1)	
>>>multi-code info	MP		Integer(1..16)	

10.3.6.44 PDSCH info

NOTE: Only for TDD.

Information Element/Group name	Need	Multi	Type and reference	Semantics description
TFCS ID	MD		Integer(1..8)	TFCS to be used. Default value is 1.
Common timeslot info	OP		Common timeslot info 10.3.6.10	
PDSCH timeslots and codes	OP		Downlink Timeslots and Codes 10.3.6.32	Default is to use the old timeslots and codes.

10.3.6.45 PDSCH Power Control info

NOTE: Only for TDD.

Information Element/Group name	Need	Multi	Type and reference	Semantics description
TPC Step Size	OP		Integer (1, 2, 3)	In dB
UL CCTrCH TPC List	OP	1..<maxCC TrCH>		UL CCTrCH identities for TPC commands associated with this DL CCTrCH
>UL TPC TFCS Identity	MP		Transport Format Combination Set Identity 10.3.5.21	

10.3.6.46 PDSCH system information

NOTE: Only for TDD.

Information Element/Group name	Need	Multi	Type and reference	Semantics description
PDSCH information	MP	1 to <maxPDSCH>		
>PDSCH Identity	MP		Integer(1..hi PDSCHidentities)	
>PDSCH info	MP		PDSCH info 10.3.6.44	
>SFN Time Info	CH-Block17		SFN Time Info 10.3.6.75	
>DSCH TFS	OP		Transport format set 10.3.5.23	
>DSCH TFCS	OP		Transport Format Combination Set 10.3.5.20	

Condition	Explanation
Block17	This IE is not needed in System Information Block 17. Otherwise it is optional.

10.3.6.47 PDSCH with SHO DCH Info

NOTE: Only for FDD

Information Element/Group name	Need	Multi	Type and reference	Semantics description
DSCH radio link identifier	MP		Primary CPICH info 10.3.6.60	This parameter indicates on which radio link the user will be allocated resource on the DSCH.
TFCI(field2) Combining set	OP	1 to <maxRL>		This is used to indicate which of the downlink TFCI(field 2) transmissions made on the DPCCs within the active set should be soft combined on the physical layer. This parameter may only be sent if there is a 'hard' split of the TFCI field and in this case the sending of the parameter is optional.
>Radio link identifier	MP		Primary CPICH info 10.3.6.60	

10.3.6.48 Persistence scaling factors

This IE defines scaling factors associated with ASC 2 – ASC 7 to be applied to the dynamic persistence value.

Information Element/Group name	Need	Multi	Type and reference	Semantics description
Access Service Class	MP	1 to maxASCpersist		multiplicity corresponds to the number of PRACH partitions minus 2
>Persistence scaling factor	MP		Real(0.9..0.2 , by step of 0.1)	Scaling factors in the range 0,...,1

10.3.6.49 PICH Info

Information Element/Group name	Need	Multi	Type and reference	Semantics description	Version
CHOICE <i>mode</i>	MP				
>FDD					
>>Channelisation code	MP		Integer(0..255)	SF is fixed and equal to 256	
>>Number of PI per frame	MP		Integer (18, 36, 72, 144)		
>>STTD indicator	MP		STTD Indicator 10.3.6.78		
>TDD					
>>Timeslot number	MD		Timeslot number 10.3.6.84	Default value is the timeslot used by the SCCPCH carrying the associated PCH.	
>>Midamble shift and burst type	MP		Midamble shift and burst type 10.3.6.41		
>>>>CHOICE <i>TDD option</i>	MP				REL-4
>>>>>3.84 Mcps TDD					REL-4
>>>>>>Channelisation code	MD		Enumerated ((16/1)...(16/16))	Default value is the channelisation code used by the SCCPCH carrying the associated PCH.	
>>>>1.28 Mcps TDD					REL-4
>>>>>Codes list	MP	1..2			REL-4
>>>>>>Channelisation code	MP		Enumerated ((16/1)...(16/16))		REL-4
>>Repetition period/length	MD		Enumerated((4/2),(8/2), (8/4),(16/2), (16/4), (32/2),(32/4), (64/2),(64/4))	Default value is "(64/2)".	
>>Offset	MP		Integer (0...Repetition period -1)	SFN mod Repetitionperiod = Offset.	
>>Paging indicator length	MD		Integer (4, 8, 16)	Indicates the length of one paging indicator in Bits. Default value is 4.	
>>N _{GAP}	MD		Integer(2, 4, 8)	Number of frames between the last frame carrying PICH for this Paging Occasion and the first frame carrying paging messages for this Paging Occasion. Default value is 4.	
>>N _{PCH}	MD		Integer(1 .. 8)	Number of paging groups. Default value is 2.	

10.3.6.50 PICH Power offset

This is the power transmitted on the PICH minus power of the Primary CPICH in FDD and Primary CCPCCH Tx Power in TDD.

Information Element/Group name	Need	Multi	Type and reference	Semantics description
PICH Power offset	MP		Integer(-10 .. +5)	Offset in dB

10.3.6.51 PRACH Channelisation Code List

NOTE: Only for 3.84 Mcps TDD.

Information Element/Group name	Need	Multi	Type and reference	Semantics description	Version
CHOICE SF	MP				
>SF16					
>>Channelisation Code List	MP	1 to 8			
>>>Channelisation code	MP		Enumerated ((16/1)..(16/16))	1:1 mapping between spreading code and midamble shift	
>SF8					
>>Channelisation Code List	MP	1 to 8			
>>>Channelisation Code	MP		Enumerated((8/1)..(8/8))		

10.3.6.51a PRACH Channelisation Code 1.28 Mcps TDD

NOTE: Only for 1.28 Mcps TDD.

Information Element/Group name	Need	Multi	Type and reference	Semantics description	Version
Channelisation Code List	MP	1 to 4			REL-4
>Channelisation Code	MP		Enumerated((4/1)..(4/4),(8/1)..(8/8),(16/1)..(16/16))		REL-4

10.3.6.52 PRACH info (for RACH)

Information Element/Group name	Need	Multi	Type and reference	Semantics description	Version
CHOICE <i>mode</i>	MP				
>FDD					
>>Available Signature	MP		Bit string(16)	Each bit indicates availability for a signature, where the signatures are numbered "signature 0" up to "signature 15". The value 1 of a bit indicates that the corresponding signature is available and the value 0 that it is not available.	
>>Available SF	MP		Integer (32,64,128,256)	In chips per symbol Defines the minimum allowed SF (i.e. the maximum rate)	
>>Preamble scrambling code number	MP		Integer (0 .. 15)	Identification of scrambling code see [28]	
>>Puncturing Limit	MP		Real(0.40..1.00 by step of 0.04)		
>>Available Sub Channel Number	MP		Bit string(12)	Each bit indicates availability for a subchannel, where the subchannels are numbered "subchannel 0" to "subchannel 11". The value 1 of a bit indicates that the corresponding subchannel is available and the value 0 indicates that it is not available.	
>TDD					
>>CHOICE <i>TDD option</i>	MP				REL-4
>>>3.84 Mcps TDD					REL-4
>>>>Timeslot number	MP		Timeslot number 10.3.6.84		
>>>>PRACH Channelisation Code List	MP		PRACH Channelisation Code List 10.3.6.51		
>>>>PRACH Midamble	MP		Enumerated (Direct, Direct/Inverted)	Direct or direct and inverted midamble are used for PRACH	
>>>1.28 Mcps TDD					REL-4
>>>>SYNC_UL info	MP		SYNC_UL info 10.3.6.78a		REL-4
>>>>PRACH Definition	MP	1..<maxPR			REL-4

Information Element/Group name	Need	Multi	Type and reference	Semantics description	Version
		ACH_FPA CH>			
>>>>>Timeslot number	MP		Timeslot number 10.3.6.84		REL-4
>>>>>PRACH Channelisation Code	MP		PRACH Channelisation Code 1.28 Mcps TDD 10.3.6.51a		REL-4
>>>>>Midamble Shift and burst type	MP		Midamble shift and burst type 10.3.6.41		REL-4
>>>>>FPACH info	MP		FPACH info 10.3.6.35a		REL-4
>>PNBSCH allocation	OP		PNBSCH allocation 10.3.8.10a	Identifies frames used for cell synchronisation purposes	REL-4

10.3.6.53 PRACH partitioning

Information Element/Group name	Need	Multi	Type and reference	Semantics description
Access Service class	MP	1 to maxASC		
ASC Setting	MD		ASC setting 10.3.6.6	The default values are same as the previous ASC. If the "default" is used for the first ASC, the default values are all available signatures and "all available sub-channels" for FDD and "all available channelisation codes" and "all available subchannels" with "subchannel size=Size 1" in TDD.

10.3.6.54 PRACH power offset

NOTE: Only for FDD.

Information Element/Group name	Need	Multi	Type and reference	Semantics description
Power Ramp Step	MP		Integer (1..8)	Power step when no acquisition indicator is received in dB
Preamble Retrans Max	MP		Integer (1..64)	Maximum number of preambles in one preamble ramping cycle

10.3.6.55 PRACH system information list

Information element	Need	Multi	Type and reference	Semantics description
PRACH system information	MP	1 .. <maxPRA CH>		
>PRACH info	MP		PRACH info (for RACH) 10.3.6.52	
>Transport channel identity	MP		Transport channel identity 10.3.5.18	
>RACH TFS	MD		Transport format set 10.3.5.23	Default value is the value of "RACH TFS" for the previous PRACH in the list NOTE: The first occurrence is then MP) NOTE: For TDD in this release there is a single TF within the RACH TFS.
>RACH TFCS	MD		Transport Format Combination Set 10.3.5.20	Default value is the value of "RACH TFCS" for the previous PRACH in the list. NOTE: The first occurrence is then MP). NOTE: For TDD in this release there is no TFCS required.
>PRACH partitioning	MD		PRACH partitioning 10.3.6.53	Default value is the value of "PRACH partitioning" for the previous PRACH in the list (note : the first occurrence is then MP)
>Persistence scaling factors	OP		Persistence scaling factors 10.3.6.48	This IE shall not be present if only ASC 0 and ASC 1 are defined. If this IE is absent, value is the value of "Persistence scaling factors" for the previous PRACH in the list if value exists
>AC-to-ASC mapping	OP		AC-to-ASC mapping 10.3.6.1	Only present in SIB 5 If this IE is absent, value is the value of "AC-to-ASC mapping" for the previous PRACH in the list if value exists
>CHOICE <i>mode</i>	MP			
>>FDD				
>>>Primary CPICH TX power	MD		Primary CPICH TX power 10.3.6.61	Default value is the value of "Primary CPICH TX power" for the previous PRACH in the list (note : the first occurrence is then MP)
>>>Constant value	MD		Constant value 10.3.6.11	Default value is the value of "Constant value" for the previous PRACH in the list (note : the first occurrence is then MP)
>>>PRACH power offset	MD		PRACH power offset 10.3.6.54	Default value is the value of "PRACH power offset" for the previous PRACH in the list (note : the first occurrence is then MP)
>>>RACH transmission parameters	MD		RACH transmission parameters	Default value is the value of "RACH transmission parameters" for the previous

			10.3.6.67	PRACH in the list (note : the first occurrence is then MP)
>>>AICH info	MD		AICH info 10.3.6.2	Default value is the value of "AICH info" for the previous PRACH in the list (note : the first occurrence is then MP)
>>TDD				(no data)

NOTE: If the setting of the PRACH information results in that a combination of a signature, preamble scrambling code and subchannel corresponds to a RACH with different TFS and/or TFCS, then for that combination only the TFS/TFCS of the PRACH listed first is valid, where PRACHs listed in System Information Block type 5 shall be counted first.

10.3.6.56 Predefined PhyCH configuration

This information element concerns a pre- defined configuration of physical channel parameters.

Information Element/Group name	Need	Multi	Type and Reference	Semantics description
Uplink radio resources				
Uplink DPCH info	MP		Uplink DPCH info Pre 10.3.6.90	
Downlink radio resources				
Downlink information common for all radio links	OP		Downlink information common for all radio links Pre 10.3.6.26	

10.3.6.57 Primary CCPCH info

Information Element/Group name	Need	Multi	Type and reference	Semantics description	Version
CHOICE <i>mode</i>	MP				
>FDD					
>>TX Diversity indicator	MP		Boolean		
>TDD					
>>CHOICE <i>TDD option</i>	MP				REL-4
>>>3.84 Mcps TDD					REL-4
>>>>CHOICE <i>SyncCase</i>	OP				
>>>>>Sync Case 1					
>>>>>Timeslot	MP		Integer (0...14)	PCCPCH timeslot	
>>>>>Sync Case 2					
>>>>>Timeslot	MP		Integer(0..6)		
>>>1.28 Mcps TDD					REL-4
>>>>TSTD indicator	MP		TSTD indicator 10.3.6.85a		REL-4
>>Cell parameters ID	OP		Cell parameters Id 10.3.6.9	The Cell parameters ID is described in [32].	
>>Block STTD indicator	MP		Block STTD indicator 10.3.6.7		

10.3.6.58 Primary CCPCH info post

NOTE: Only for TDD

Information Element/Group name	Need	Multi	Type and reference	Semantics description	Version
CHOICE <i>TDD option</i>	MP				REL-4
>3.84 Mcps TDD					REL-4
>>CHOICE <i>SyncCase</i>	MP				
>>>Sync Case 1					
>>>>Timeslot	MP		Integer (0..14)	PCCPCH timeslot	
>>>>Sync Case 2					
>>>>Timeslot	MP		Integer(0..6)		
>1.28 Mcps TDD					REL-4
>>TSTD indicator	MP		TSTD indicator 10.3.6.85a		REL-4
Cell parameters ID	MP		Cell parameters Id 10.3.6.9	The Cell parameters ID is described in [32].	
Block STTD indicator	MP		Block STTD indicator 10.3.6.7		

10.3.6.59 Primary CCPCH TX Power

NOTE: Only for TDD.

Information Element/group name	Need	Multi	Type and reference	Semantics description
Primary CCPCH Tx Power	MP		Integer(6..43)	In dBm

10.3.6.60 Primary CPICH info

NOTE: Only for FDD.

Information Element/Group name	Need	Multi	Type and reference	Semantics description
Primary scrambling code	MP		Integer(0..511)	

10.3.6.61 Primary CPICH Tx power

NOTE: Only for FDD.

Information Element/Group name	Need	Multi	Type and reference	Semantics description
Primary CPICH Tx Power	MP		Integer(-10..50)	Power in dBm.

10.3.6.62 Primary CPICH usage for channel estimation

NOTE: Only for FDD.

Information Element/Group name	Need	Multi	Type and Reference	Semantics description
Primary CPICH usage for channel estimation	MP		Enumerated(Primary CPICH may be used, Primary CPICH shall not be used)	

10.3.6.63 PUSCH info

NOTE: Only for TDD.

Information Element/Group name	Need	Multi	Type and reference	Semantics description
TFCS ID	MD		Integer(1..8)	Default value is 1
Common timeslot info	OP		Common timeslot info 10.3.6.10	
PUSCH timeslots and codes	OP		Uplink Timeslots and Codes 10.3.6.94	

10.3.6.64 PUSCH Capacity Allocation info

NOTE: Only for TDD.

Information Element/Group name	Need	Multi	Type and reference	Semantics description
CHOICE <i>PUSCH allocation</i>	MP			
>PUSCH allocation pending				(no data)
>PUSCH allocation assignment				
>>PUSCH allocation period info	MP		Allocation Period Info 10.3.6.4	
>>PUSCH power control info	OP		PUSCH power control info 10.3.6.65	
>>TFCS ID	MD		Integer(1..8)	Default is 1.
>>CHOICE <i>Configuration</i>	MP			
>>>Old configuration				
>>>>PUSCH Identity	MP		Integer(1..hi PUSCHidentities)	
>>>New configuration				
>>>>PUSCH info	MP		PUSCH info 10.3.6.63	
>>>>PUSCH Identity	OP		Integer(1..hiPUSCHidentities)	

10.3.6.65 PUSCH power control info

NOTE: Only for TDD.

Interference level measured for a frequency at the UTRAN access point used by UE to set PUSCH output power.

Information Element/Group name	Need	Multi	Type and reference	Semantics description	Version
UL target SIR	MP		Real (-11 .. 20 by step of 0.5)	in dB	
CHOICE <i>TDD option</i>	MP				REL-4
>3.84 Mcps TDD				(no data)	REL-4
>1.28 Mcps TDD					REL-4
>>TPC Step Size	OP		Integer (1, 2, 3)	In dB	REL-4
>>DL CCTrCH TPC List	OP	0..<maxCC TrCH>		DL CCTrCH identities for TPC commands associated with this UL CCTrCH	REL-4
>>>DL TPC TFCS Identity	MP		Transport Format Combination Set Identity 10.3.5.21		REL-4

10.3.6.66 PUSCH system information

NOTE: Only for TDD.

Information Element/Group name	Need	Multi	Type and reference	Semantics description
PUSCH information	MP	1 to <maxPUSCH>		
>PUSCH Identity	MP		Integer(1..hi PUSCHidentities)	
>PUSCH info	MP		PUSCH info 10.3.6.63	
>SFN Time Info	CH-Block17		SFN Time Info 10.3.6.75	
>USCH TFS	OP		Transport format set 10.3.5.23	
>USCH TFCS	OP		Transport Format Combination Set 10.3.5.20	

Condition	Explanation
<i>Block17</i>	This IE is not needed in System Information Block 17. Otherwise it is optional.

10.3.6.67 RACH transmission parameters

NOTE: Only for FDD.

Information Element/Group name	Need	Multi	Type and reference	Semantics description
Mmax	MP		Integer(1..32)	Maximum number of preamble cycles
NB01min	MP		Integer(0..50)	Sets lower bound for random back-off
NB01max	MP		Integer(0..50)	Sets upper bound for random back-off

10.3.6.68 Radio link addition information

Information Element/Group name	Need	Multi	Type and reference	Semantics description
Primary CPICH info	MP		Primary CPICH info 10.3.6.60	
Downlink DPCH info for each RL	MP		Downlink DPCH info for each RL 10.3.6.21	
TFCI combining indicator	MP		TFCI combining indicator 10.3.6.81	
SCCPCH Information for FACH	OP		SCCPCH Information for FACH 10.3.6.70	Note 1

NOTE 1: These IEs are present when the UE needs to listen to system information on FACH in CELL_DCH state.

10.3.6.69 Radio link removal information

Information Element/Group name	Need	Multi	Type and reference	Semantics description
Primary CPICH info	MP		Primary CPICH info 10.3.6.60	

10.3.6.70 SCCPCH Information for FACH

Information Element/Group name	Need	Multi	Type and reference	Semantics description
Secondary CCPCH info	MP		Secondary CCPCH info 10.3.6.71	
TFCS	MP		Transport format combination set 10.3.5.20	For FACHs and PCH
FACH/PCH information	MP	1 to <maxFACH/HPCH>		
>TFS	MP		Transport format set 10.3.5.23	For each FACHs and PCH
>Transport channel identity	MP		Transport channel identity 10.3.5.18	
>CTCH indicator	MP		Boolean	The value "TRUE" indicates that a CTCH is mapped on the FACH, and "FALSE" that no CTCH is mapped.
CHOICE mode				
>FDD				
>>References to system information blocks	MP	1 to <maxSIB-FACH>		
>>>Scheduling information	MP		Scheduling information 10.3.8.16	
>>>SIB type SIBs only	MP		SIB Type SIBs only, 10.3.8.22	
>TDD				(No data)

NOTE: TFS for PCH shall be the first "FACH/PCH information" in the list if a PCH exists for the respective secondary CCPCH.

10.3.6.71 Secondary CCPCH info

Information Element/Group name	Need	Multi	Type and reference	Semantics description
CHOICE <i>mode</i>	MP			
>FDD				
>>Secondary scrambling code	OP		Secondary scrambling code 10.3.6.74	May only be sent for SCCPCH channels not carrying the PCH.
>>STTD indicator	MD		STTD Indicator 10.3.6.78	Default value is "TRUE"
>>>Spreading factor	MP		Integer(4, 8, 16, 32, 64, 128, 256)	
>>>Code number	MP		Integer(0..Spreading factor - 1)	
>>>Pilot symbol existence	MD		Boolean	TRUE means the existence. Default value is "TRUE"
>>>TFCI existence	MD		Boolean	TRUE means the existence. Default value is "TRUE"
>>>Fixed or Flexible Position	MD		Enumerated (Fixed, Flexible)	Default value is "Flexible"
>>>Timing Offset	MD		Integer(0..38144 by step of 256)	Chip Delay of the Secondary CCPCH relative to the Primary CCPCH. Default value is 0.
>TDD				
>>>Offset	MP		Integer (0..Repetition Period -1)	SFN modulo Repetition period = offset. Repetition period is the one indicated in the accompanying Common timeslot info IE
>>>Common timeslot info	MP		Common timeslot info 10.3.6.10	
>>>Individual timeslot info	MP		Individual timeslot info 10.3.6.37	
>>>Code List	MP	1 to 16		
>>>>Channelisation Code	MP		Enumerated((16/1)..(16/16))	

10.3.6.72 Secondary CCPCH system information

Information element	Need	Multi	Type and reference	Semantics description
Secondary CCPCH system information	MP	1 to <maxSCC PCH>		
>Secondary CCPCH info	MP		Secondary CCPCH info 10.3.6.71	Note 1
>TFCS	MD		Transport format combination set 10.3.5.20	For FACHs and PCH Default value is the value of "TFCS" for the previous SCCPCH in the list (note : the first occurrence is then MP)
>FACH/PCH information	MD	1 to <maxFACH PCH>		Default value is the value of "FACH/PCH" for the previous SCCPCH in the list (note : the first occurrence is then MP)
>>TFS	MP		Transport format set 10.3.5.23	For each FACH and PCH Note 2
>>Transport channel identity	MP		Transport channel identity 10.3.5.18	
>>CTCH indicator	MP		Boolean	The value "TRUE" indicates that a CTCH is mapped on the FACH, and "FALSE" that no CTCH is mapped.
>PICH info	OP		PICH info 10.3.6.49	PICH info is present only when PCH is multiplexed on Secondary CCPCH

NOTE 1: The secondary CCPCHs carrying a PCH shall be listed first.

NOTE 2: TFS for PCH shall be the first "FACH/PCH information" in the list if a PCH exists for the respective secondary CCPCH.

10.3.6.73 Secondary CPICH info

NOTE: Only for FDD.

Information Element/Group name	Need	Multi	Type and reference	Semantics description
Secondary scrambling code	MD		Secondary scrambling code 10.3.6.74	Default is the same scrambling code as for the Primary CPICH
Channelisation code	MP		Integer(0..255)	SF=256

10.3.6.74 Secondary scrambling code

Information Element/Group name	Need	Multi	Type and reference	Semantics description
Secondary scrambling code	MP		Integer(1..15)	

10.3.6.75 SFN Time info

Information Element/Group name	Need	Multi	Type and reference	Semantics description
Activation time SFN	MP		Integer (0..4095)	System frame number start of the physical channel existence.
Duration	MP		Integer(1..4096)	Total number of frames the physical channel will exist.

10.3.6.75a Special Burst Scheduling

NOTE: Only for TDD.

Information Element/Group name	Need	Multi	Type and reference	Semantics description
Special Burst Generation Period	MP		Integer (2, 4, 8, 16, 32, 64, 128, 256)	Value in radio frames

10.3.6.76 SSdT cell identity

NOTE: Only for FDD.

This IE is used to associate a cell identity with a given radio link.

Information Element/Group name	Need	Multi	Type and reference	Semantics description
SSdT cell id	MP		Enumerated (a, b, c, d, e, f, g, h)	

10.3.6.77 SSdT information

NOTE: Only for FDD.

This information element indicates the status (e.g. initiated/terminated) of the Site Selection.

Diversity Transmit power control (SSdT). It is used to change the SSdT status. The parameter 'code word set' indicates how cell identities are coded (using many bits or few, values are long, medium, or short).

Information Element/Group name	Need	Multi	Type and reference	Semantics description	Version
S field	MP		Integer (1, 2)	In bits	
Code Word Set	MP		Enumerated (long, medium, shortSSdT off)		
SSdT UL	OP		Enumerated (UL, ULandDL)		REL-4

NOTE: These parameters shall be set optionally associated with DL DPCH info but not for each RL.

10.3.6.78 STTD indicator

Indicates whether STTD is used or not.

Information Element/Group name	Need	Multi	Type and reference	Semantics description
STTD Indicator	MP		Boolean	TRUE means that STTD is used

10.3.6.78a SYNC_UL info

NOTE: Only for 1.28 Mcps TDD.

Information Element/ Group name	Need	Multi	Type and reference	Semantics description	Version
SYNC_UL codes bitmap	MP		Bitstring(8)	Each bit indicates availability of a SYNC_UL code, where the SYNC_UL codes are numbered "code 0" to "code 7". The value 1 of a bit indicates that the corresponding SYNC_UL code can be used. The value 0 of a bit indicates that the corresponding SYNC_UL code can not be used.	REL-4
PRX _{UpPCHdes}	MP		Real(-11 .. 20 by step of 0.5)	In dB	REL-4
Power Ramping Step	MP		Integer(0,1,2,3)	In dB	REL-4
Max SYNC_UL Transmissions	MP		Integer(1,2,4,8)	Maximum numbers of SYNC_UL transmissions in a power ramping sequence.	REL-4
Mmax	MP		Integer(1..32)	Maximum number of synchronisation attempts.	REL-4

10.3.6.79 TDD open loop power control

This information element contains parameters for open loop power control setting for TDD.

Information Element/Group name	Need	Multi	Type and reference	Semantics description	Version
Primary CCPCH Tx Power	MP		Primary CCPCH Tx Power 10.3.6.59	For path loss calculation	
CHOICE <i>TDD option</i>	MP				REL-4
>3.84 Mcps TDD					REL-4
>>Alpha	OP		Alpha 10.3.6.5		
>>PRACH Constant Value	MP		Constant Value 10.3.6.11	Operator controlled PRACH Margin	
>>DPCH Constant Value	MP		Constant Value 10.3.6.11	Operator controlled UL DPCH Margin	
>>PUSCH Constant Value	OP		Constant Value 10.3.6.11	Operator controlled PUSCH Margin	
>>UE positioning related parameters	CV- <i>IPDLs</i>				REL-4
>>>IPDL-Alpha	MP		Alpha 10.3.6.5		REL-4
>>>Max power increase	MP		Integer (0..3)	In db	REL-4
>1.28 Mcps TDD				(no data)	REL-4

Condition	Explanation
<i>IPDLs</i>	This IE is present only if idle periods are applied

10.3.6.80 TFC Control duration

Information Element/Group name	Need	Multi	Type and reference	Semantics description
TFC Control duration	MP		Integer (1, 2, 4, 8, 16, 24, 32, 48, 64, 128, 192, 256, 512)	Defines the period in multiples of 10 ms frames for which the defined TFC sub-set is to be applied.

10.3.6.81 TFCI Combining Indicator

NOTE: Only for FDD.

This IE indicates whether the TFCI (field 2), which will be transmitted on the DPCCH of a newly added radio link, should be soft-combined with the others in the TFCI (field 2) combining set. This IE is relevant only when the UE is in CELL_DCH state with a DSCH transport channel assigned and when there is a 'hard' split in the TFCI field (such that TFCI1 and TFCI2 have their own separate block coding).

Information Element/Group name	Need	Multi	Type and reference	Semantics description
TFCI combining indicator	MP		Boolean	TRUE means that TFCI is combined, FALSE means that TFCI is not combined or that this IE is not applicable to the added radio link.

10.3.6.82 TGPSI

Information Element/Group name	Need	Multi	Type and reference	Semantics description
TGPSI	MP		Integer(1..M)	Transmission Gap Pattern

Information Element/Group name	Need	Multi	Type and reference	Semantics description
			axTGPS)	Sequence Identifier Establish a reference to the compressed mode pattern sequence. Up to <MaxTGPS> simultaneous compressed mode pattern sequences can be used.

10.3.6.83 Time info

Information Element/Group name	Need	Multi	Type and reference	Semantics description
Activation time	MD		Activation time 10.3.3.1	Frame number start of the physical channel existence. Default value is "Now"
Duration	MD		Integer(1..40 96, infinite)	Total number of frames the physical channel will exist. Default value is "infinite".

10.3.6.84 Timeslot number

Information Element/Group name	Need	Multi	Type and reference	Semantics description	Version
CHOICE <i>TDD option</i>	MP				REL-4
>3.84 Mcps TDD					REL-4
>>Timeslot number	MP		Integer(0..14)	Timeslot within a frame	
>1.28 Mcps TDD					REL-4
>>Timeslot number	MP		Integer(0..6)	Timeslot within a subframe	REL-4

10.3.6.85 TPC combination index

NOTE: Only for FDD.

Information Element/Group name	Need	Multi	Type and reference	Semantics description
TPC combination index	MP		Integer(0..5)	Radio links with the same index have TPC bits, which for the UE are known to be the same.

10.3.6.85a TSTD indicator

NOTE: Only for 1.28 Mcps TDD.

Information Element/Group name	Need	Multi	Type and reference	Semantics description	Version
TSTD indicator	MD		Boolean	Default value is "TRUE"	REL-4

10.3.6.86 TX Diversity Mode

NOTE: Only for FDD.

Information Element/Group name	Need	Multi	Type and reference	Semantics description
Tx diversity Mode	MP		Enumerated (none, STTD, closed loop mode1, closed loop mode2)	

10.3.6.87 UL interference

Information Element/Group name	Need	Multi	Type and reference	Semantics description
UL interference	MP		Integer (-110..-70)	In dBm

NOTE: In TDD, this IE is a timeslot specific value.

10.3.6.88 Uplink DPCH info

Information Element/Group name	Need	Multi	Type and reference	Semantics description
Uplink DPCH power control info	OP		Uplink DPCH power control info 10.3.6.91	
<i>CHOICE mode</i>	MP			
>FDD				
>>Scrambling code type	MP		Enumerated(short, long)	
>>Scrambling code number	MP		Integer(0..16 777215)	
>>Number of DPDCH	MD		Integer(2..maxDPDCH)	Default value is 1. Number of DPDCH is 1 in HANDOVER TO UTRAN COMMAND
>>Spreading factor	MP		Integer(4, 8, 16, 32, 64, 128, 256)	Minimum allowed SF of the channelisation code for data part
>>TFCI existence	MD		Boolean	TRUE means existence. Default value is "TRUE"
>>Number of FBI bits	CH		Integer (1, 2)	In bits. Number of FBI bits is needed if SSdT or FB Mode Transmit Signalling is supported.
>>Puncturing Limit	MP		Real(0.40 ..1 by step of 0.04)	
>TDD				
>>Uplink Timing Advance Control	OP		Uplink Timing Advance Control 10.3.6.96	
>>UL CCTrCH List	MP	1 to <maxCCTrCH>		
>>>TFCS ID	MD		Integer(1..8)	Default value is 1.
>>>UL target SIR	MP		Real (-11 .. 20 by step of 0.5dB)	In dB
>>>Time info	MP		Time info 10.3.6.83	
>>>Common timeslot info	MD		Common timeslot info 10.3.6.10	Default is the current Common timeslot info
>>>Uplink DPCH timeslots and codes	MD		Uplink Timeslots and Codes 10.3.6.94	Default is to use the old timeslots and codes.

Condition	Explanation
<i>Single</i>	This IE is mandatory present if the IE "Number of DPDCH" is "1" and not needed otherwise.

10.3.6.89 Uplink DPCH info Post

Information Element/Group name	Need	Multi	Type and reference	Semantics description
Uplink DPCH power control info	MP		Uplink DPCH power control info Post 10.3.6.92	
CHOICE <i>mode</i>	MP			
>FDD				
>>Scrambling code type	MP		Enumerated(short, long)	
>>>Reduced scrambling code number	MP		Integer(0..8191)	Sub-range of values for initial use upon handover to UTRAN.
>>>Spreading factor	MP		Integer(4, 8, 16, 32, 64, 128, 256)	SF of the channelisation code for data part There is only one DPDCH for this case
>TDD				
>>Uplink Timing Advance Control	OP		Uplink Timing Advance Control 10.3.6.96	
>>Uplink DPCH timeslots and codes	MP		Uplink Timeslots and Codes 10.3.6.94	

10.3.6.90 Uplink DPCH info Pre

Information Element/Group name	Need	Multi	Type and reference	Semantics description
Uplink DPCH power control info	OP		Uplink DPCH power control info Pre 10.3.6.93	
CHOICE <i>mode</i>	MP			
>FDD				
>>TFCI existence	MP		Boolean	TRUE means existence. Default value is "TRUE"
>>>Puncturing Limit	MP		Real(0.40 ..1 by step of 0.04)	
>TDD				
>>Common timeslot info	MP		Common Timeslot Info 10.3.6.10	

Condition	Explanation
<i>Single</i>	This IE is mandatory present if the IE "Number of DPDCH" is "1" and not needed otherwise.

10.3.6.91 Uplink DPCH power control info

Parameters used by UE to set DPCH initial output power and to use for closed-loop power control in FDD and 1.28 Mcps TDD and parameters for uplink open loop power control in 3.84 Mcps TDD.

Information Element/Group name	Need	Multi	Type and reference	Semantics description	Version
CHOICE <i>mode</i>	MP				
>FDD					
>>DPCCH Power offset	MP		Integer(-164,...-6 by step of 2)	In dB	
>>PC Preamble	MP		Integer (0..7)	In number of frames	
>>SRB delay	MP		Integer(0..7)	In number of frames	
>>Power Control Algorithm	MP		Enumerated (algorithm 1, algorithm 2)	Specifies algorithm to be used by UE to interpret TPC commands	
>>TPC step size	<i>CV-algo</i>		Integer (1, 2)	In dB	
>TDD					
>>UL target SIR	OP		Real (-11 .. 20 by step of 0.5dB)	In dB	
>>CHOICE <i>UL OL PC info</i>	MP				
>>>Broadcast UL OL PC info			Null	No data	
>>>Individually Signalled	OP				
>>>>CHOICE <i>TDD option</i>	MP				REL-4
>>>>>3.84 Mcps TDD					REL-4
>>>>>>Individual timeslot interference info	MP	1 to <maxTS>			
>>>>>>>Individual timeslot interference	MP		Individual timeslot interference 10.3.6.38		
>>>>>>>DPCH Constant Value	OP		Constant Value 10.3.6.11	Quality Margin	
>>>>>>>1.28 Mcps TDD					REL-4
>>>>>>>TPC step size	MP		Integer(1,2,3)		REL-4
>>>>>Primary CCPCH Tx Power	OP		Primary CCPCH Tx Power 10.3.6.59	For Pathloss Calculation	

Condition	Explanation
<i>algo</i>	The IE is mandatory present if the IE "Power Control Algorithm" is set to "algorithm 1", otherwise the IE is not needed

10.3.6.92 Uplink DPCH power control info Post

Parameters used by UE to set DPCH initial output power and to use for closed-loop power control.

Information Element/Group name	Need	Multi	Type and reference	Semantics description	Version
CHOICE <i>mode</i>	MP				
>FDD					
>>DPCCH Power offset	MP		Integer(-110..-50 by step of 4)	In dB	
>>PC Preamble	MP		Integer (0..7)	in number of frames	
>>SRB delay	MP		Integer (0..7)	In number of frames	
>TDD					
>>UL target SIR	MP		Real (-11 .. 20 by step of 0.5dB)	In dB	
>>CHOICE <i>TDD option</i>	MP				REL-4
>>>3.84 Mcps TDD					REL-4
>>>>UL Timeslot Interference	MP		UL Interference 10.3.6.87		
>>>1.28 Mcps TDD				(no data)	REL-4

Condition	Explanation
<i>algo</i>	The IE is mandatory present if the IE "Power Control Algorithm" is set to "algorithm 1", otherwise the IE is not needed

10.3.6.93 Uplink DPCH power control info Pre

Parameters used by UE to set DPCH initial output power and to use for closed-loop power control in FDD and parameters for uplink open loop power control in 3.84 Mcps TDD.

Information Element/Group name	Need	Multi	Type and reference	Semantics description	Version
CHOICE <i>mode</i>	MP				
>FDD					
>>Power Control Algorithm	MP		Enumerated (algorithm 1, algorithm 2)	Specifies algorithm to be used by UE to interpret TPC commands	
>>TPC step size	<i>CV-algo</i>		Integer (1, 2)	In dB	
>TDD				(No data)	
>>CHOICE <i>TDD option</i>	MP				REL-4
>>>3.84 Mcps TDD					REL-4
>>DPCH Constant Value	MP		Constant Value 10.3.6.11	Quality Margin	
>>>1.28 Mcps TDD				(no data)	REL-4

Condition	Explanation
<i>Algo</i>	The IE is mandatory present if the IE "Power Control Algorithm" is set to "algorithm 1", otherwise the IE is not needed

10.3.6.94 Uplink Timeslots and Codes

NOTE: Only for TDD

Information Element/Group name	Need	Multi	Type and reference	Semantics description
Dynamic SF usage	MP		Boolean	
First Individual timeslot info	MP		Individual timeslot info 10.3.6.37	Individual timeslot info for the first timeslot used by the physical layer.
First timeslot Code List	MP	1..2		Code list used in the timeslot. given in First individual timeslot info.
>Channelisation Code	MP		Enumerated((1/1),(2/1),(2/2),(4/1)..(4/4),(8/1)..(8/8),(16/1)..(16/16))	
CHOICE <i>more timeslots</i>	MP			
>No more timeslots				(no data)
>Consecutive timeslots				
>>Number of additional timeslots	MP		Integer(1..maxTS-1)	The timeslots used by the physical layer shall be timeslots: N mod maxTS (N+1) mod maxTS ... (N+k) mod maxTS in that order, where N is the timeslot number in the First individual timeslot info and k the Number of additional timeslots. The additional timeslots shall use the same parameters (e.g. channelisation codes, midamble shifts etc.) as the first timeslot.
>Timeslot list				
>>Additional timeslot list	MP	1 to <maxTS-1>		The first instance of this parameter corresponds to the timeslot that shall be used second by the physical layer, the second to the timeslot that shall be used third and so on.
>>>CHOICE <i>parameters</i>	MP			
>>>>Same as last				
>>>>>Timeslot number	MP		Timeslot Number 10.3.6.84	This physical layer shall use the same parameters (e.g. channelisation codes, midamble shifts etc.) for this timeslot as for the last one.
>>>>>New parameters				
>>>>>Individual timeslot info	MP		Individual timeslot info 10.3.6.37	
>>>>>Code List	MP	1..2		
>>>>>>Channelisation Code	MP		Enumerated((1/1),(2/1),(2/2),(4/1)..(4/4),(8/1)..(8/8),(16/1)..(16/16))	

10.3.6.95 Uplink Timing Advance

NOTE: Only for 3.84 Mcps TDD.

Information Element/Group name	Need	Multi	Type and reference	Semantics description	Version
UL Timing Advance	MP		Integer (0..63)	Absolute timing advance value to be used to avoid large delay spread at the NodeB	

10.3.6.96 Uplink Timing Advance Control

NOTE: Only for TDD

Information Element/Group name	Need	Multi	Type and reference	Semantics description	Version
CHOICE <i>Timing Advance</i>	MP				
>Disabled			Null	Indicates that no timing advance is applied	
>Enabled					
>>CHOICE <i>TDD option</i>	MP				REL-4
>>>3.84 Mcps TDD					REL-4
>>>>UL Timing Advance	MD		Uplink Timing Advance 10.3.6.95	Absolute timing advance value to be used to avoid large delay spread at the NodeB. Default value is the existing value for uplink timing advance.	
>>>>Activation Time	OP		Activation Time 10.3.3.1	Frame number timing advance is to be applied. This IE is required when a new UL Timing Advance adjustment is specified and Activation Time is not otherwise specified in the RRC message.	
>>1.28 Mcps TDD				(no data)	REL-4
>>>Uplink synchronisation parameters	MD			Default: Uplink synchronisation step size is 1. Uplink synchronisation frequency is 1.	REL-4
>>>>Uplink synchronisation step size	MP		Integer(1..8)	This parameter specifies the step size to be used for the adjustment of the uplink transmission timing	REL-4
>>>>Uplink synchronisation frequency	MP		Integer(1..8)	This parameter specifies the frequency of the adjustment of the uplink transmission timing	REL-4
>>>Synchronization parameters	OP				
>>>>SYNC_UL codes bitmap	MD		Bitstring(8)	Each bit indicates availability of a SYNC_UL code, where the SYNC_UL codes are numbered "code 0" to "code 7". The value 1 of a bit indicates that the corresponding SYNC_UL code can be used. The value 0 of a bit indicates that the corresponding	REL-4

				SYNC_UL code can not be used.	
>>>>FPACH info	MP		FPACH info 10.3.6.35a		REL-4
>>>>SYNC_UL procedure	MD			Default is: Max SYNC_UL Transmission is 2. Power Ramping Step is 2.	REL-4
>>>>>Max SYNC_UL Transmissions	MP		Integer(1,2,4,8)	Maximum numbers of SYNC_UL transmissions in a power ramping sequence.	REL-4
>>>>>Power Ramping Step	MP		Integer(0,1,2,3)	In dB	REL-4

10.3.7 Measurement Information elements

10.3.7.1 Additional measurements list

Information Element/Group name	Need	Multi	Type and reference	Semantics description
Additional measurements	MP	1 to <MaxAdditionalMeas>		
>Additional measurement identity	MP		Measurement identity 10.3.7.48	

10.3.7.2 Cell info

Includes non-frequency related cell info used in the IE "inter-frequency cell info list" and "intra frequency cell info list".

Information Element/Group name	Need	Multi	Type and reference	Semantics description	Version
Cell individual offset	MD		Real(-10..10 by step of 0.5)	In dB Default value is 0 dB Used to offset measured quantity value	
Reference time difference to cell	OP		Reference time difference to cell 10.3.7.60	In chips. This IE is absent for serving cell.	
Read SFN indicator	MP		Boolean	TRUE indicates that read of SFN is requested for the target cell	
CHOICE <i>mode</i>	MP				
>FDD					
>>Primary CPICH info	OP		Primary CPICH info 10.3.6.60	This IE is absent only if measuring RSSI only (broadband measurement.)	
>>Primary CPICH Tx power	OP		Primary CPICH Tx power 10.3.6.61	Required if calculating pathloss.	
>>TX Diversity Indicator	MP		Boolean		
>TDD					
>>Primary CCPCH info	MP		Primary CCPCH info 10.3.6.57		
>>Primary CCPCH TX power	OP		Primary CCPCH TX power 10.3.6.59		
>>Timeslot list	OP	1 to <maxTS>		The UE shall report Timeslot ISCP values according the order of the listed Timeslot numbers	
>>>CHOICE <i>TDD option</i>	MP				REL-4
>>>>3.84 Mcps TDD					REL-4
>>>>>Timeslot number	MP		Integer (0...14)	Timeslot numbers, for which the UE shall report Timeslot ISCP	
>>>>>Burst Type	MD		Enumerated (Type1, Type2)	Use for Timeslot ISCP measurements only. Default value is "Type1"	
>>>>>1.28 Mcps TDD					REL-4
>>>>>>Timeslot number	MP		Integer (1...6)	Timeslot numbers, for which the UE shall report Timeslot ISCP	REL-4
Cell Selection and Re-selection Info	CV- <i>BCHopt</i>		Cell Selection and Re-selection for SIB11/12Info 10.3.2.4	This IE is absent for serving cell. For neighbouring cell, if HCS is not used and all the parameters in cell	

Information Element/Group name	Need	Multi	Type and reference	Semantics description	Version
				selection and re-selection info are default value, this IE is absent.	

Condition	Explanation
<i>BCHopt</i>	This IE is Optional when sent in SYSTEM INFORMATION, Otherwise, the IE is not needed

10.3.7.3 Cell measured results

Includes non-frequency related measured results for a cell.

Information Element/Group name	Need	Multi	Type and reference	Semantics description
Cell Identity	OP		Cell Identity 10.3.2.2	
SFN-SFN observed time difference	OP		SFN-SFN observed time difference 10.3.7.63	
Cell synchronisation information	OP		Cell synchronisation information 10.3.7.6	
CHOICE <i>mode</i>	MP			
>FDD				
>>Primary CPICH info	MP		Primary CPICH info 10.3.6.60	
>>CPICH Ec/N0	OP		Integer(0..49)	According to CPICH_Ec/No in [19] and [20]
>>CPICH RSCP	OP		Integer(0..91)	According to CPICH_RSCP in [19] and [20]
>>Pathloss	OP		Integer(46..158)	In dB
>TDD				
>>Cell parameters Id	MP		Cell parameters Id 10.3.6.9	
>>Proposed TGSN	OP		Integer (0..14)	Proposal for the next TGSN
>>Primary CCPCH RSCP	OP		Primary CCPCH RSCP info 10.3.7.54	
>>Pathloss	OP		Integer(46..158)	In dB
>>Timeslot list	OP	1 to <maxTS>		
>>>Timeslot ISCP	MP		Timeslot ISCP Info 10.3.7.65	The UE shall report the Timeslot ISCP in the same order as indicated in the cell info

10.3.7.4 Cell measurement event results

Includes non-frequency related cell reporting quantities.

Information Element/Group name	Need	Multi	Type and reference	Semantics description
CHOICE <i>mode</i>	MP			
>FDD				
>>Primary CPICH info	MP	1 to <maxCellIM eas>	Primary CPICH info 10.3.6.60	
>TDD				
>>Primary CCPCH info	MP	1 to <maxCellIM eas>	Primary CCPCH info 10.3.6.57	

10.3.7.5 Cell reporting quantities

Includes non-frequency related cell reporting quantities.

For all boolean types TRUE means inclusion in the report is requested.

Information Element/Group name	Need	Multi	Type and reference	Semantics description
SFN-SFN observed time difference reporting indicator	MP		Enumerated(No report, type 1, type 2)	
Cell synchronisation information reporting indicator	MP		Boolean	
Cell Identity reporting indicator	MP		Boolean	
CHOICE <i>mode</i>	MP			
>FDD				
>>CPICH Ec/N0 reporting indicator	MP		Boolean	
>>CPICH RSCP reporting indicator	MP		Boolean	
>>Pathloss reporting indicator	MP		Boolean	
>TDD				
>>Timeslot ISCP reporting indicator	MP		Boolean	
>>Proposed TGSN Reporting required	MP		Boolean	
>>Primary CCPCH RSCP reporting indicator	MP		Boolean	
>>Pathloss reporting indicator	MP		Boolean	

10.3.7.6 Cell synchronisation information

The IE "Cell synchronisation information" contains the OFF and Tm as defined in [7] and [8] and the four most significant bits of the difference between the 12 least significant bits of the RLC Transparent Mode COUNT-C in the UE and the SFN of the measured cell. It is notified to SRNC by Measurement Report message or Measurement Information Element in other RRC messages

Information Element/Group name	Need	Multi	Type and reference	Semantics description
CHOICE <i>mode</i>	MP			
>FDD				
>>COUNT-C-SFN frame difference	OP			
>>>COUNT-C-SFN high	MP		Integer(0..3840 by step of 256)	in frames
>>>OFF	MP		Integer(0..255)	in frames
>>Tm	MP		Integer(0..38399)	in chips
>TDD				
>>COUNT-C-SFN frame difference	OP			
>>>COUNT-C-SFN high	MP		Integer(0..3840 by step of 256)	in frames
>>>OFF	MP		Integer(0..255)	in frames

NOTE: This measurement is only used in TDD when cells are not SFN synchronised

10.3.7.7 Event results

Information Element/Group name	Need	Multi	Type and reference	Semantics description
CHOICE <i>event result</i>	MP			
>Intra-frequency measurement event results			Intra-frequency measurement event results 10.3.7.37	
>Inter-frequency measurement event results			Inter-frequency measurement event results 10.3.7.17	
>Inter-RAT measurement event results			Inter-RAT measurement event results 10.3.7.28	For IS-2000 results, include fields of the <i>Pilot Strength Measurement Message</i> from subclause 2.7.2.3.2.5 of TIA/EIA/IS-2000.5
>Traffic volume measurement event results			Traffic volume measurement event results 10.3.7.69	
>Quality measurement event results			Quality measurement event results 10.3.7.57	
>UE internal measurement event results			UE internal measurement event results 10.3.7.78	
>UE positioning measurement event results			UE positioning measurement event results 10.3.7.101	

CHOICE <i>event result</i>	Condition under which the given <i>event result</i> is chosen
Intra-frequency measurement event results	If measurement type = intra-frequency measurement
Inter-frequency measurement event results	If measurement type = inter-frequency measurement
Inter-RAT measurement event results	If measurement type = inter-RAT measurement
Traffic volume measurement event results	If measurement type = traffic volume measurement
Quality measurement event results	If measurement type = Quality measurement
UE internal measurement event results	If measurement type = UE internal measurement
UE positioning measurement event results	If measurement type = UE positioning measurement

10.3.7.8 FACH measurement occasion info

Information Element/Group name	Need	Multi	Type and reference	Semantics description	Version
FACH Measurement occasion cycle length coefficient	OP		Integer(1..12)		
Inter-frequency FDD measurement indicator	MP		Boolean	TRUE means that measurements are required	
Inter-frequency TDD 3.84 Mcps measurement indicator	MP		Boolean	TRUE means that measurements are required	REL-4
Inter-frequency TDD 1.28 Mcps measurement indicator	MP		Boolean	TRUE means that measurements are required	REL-4
Inter-RAT measurement indicators	OP	1 to <maxOther RAT>			
>RAT type	MP		Enumerated(GSM, IS2000)		

10.3.7.9 Filter coefficient

Information Element/Group name	Need	Multi	Type and reference	Semantics description
Filter coefficient	MD		Integer(0, 1, 2, 3, 4, 5, 6, 7, 8, 9, 11, 13, 15, 17, 19)	Default value is 0

10.3.7.10 HCS Cell re-selection information

Information Element/Group name	Need	Multi	Type and reference	Semantics description
Penalty_time	MD		Integer(0, 10, 20, 30, 40, 50, 60)	Default value is 0 which means = not used In seconds
Temporary_offsets	<i>CV-Penalty used</i>			
>Temporary_offset1	MP		Integer(3, 6, 9, 12, 15, 18, 21, inf)	[dB]
>Temporary_offset2	<i>CV-FDD-Quality-Measure</i>		Integer(2, 3, 4, 6, 8, 10, 12, inf)	[dB]

Condition	Explanation
<i>Penalty used</i>	This IE is not needed if the IE "Penalty time" equals "not used", else it is mandatory present.
<i>FDD-Quality-Measure</i>	This IE is not needed if the IE "Cell_selection_and_reselection_quality_measure" has the value CPICH RSCP, otherwise the IE is mandatory present. This conditional presence is implemented in ASN.1 by the use of a specific RSCP and EcN0 variant of 10.3.7.10.

10.3.7.11 HCS neighbouring cell information

Information Element/Group name	Need	Multi	Type and reference	Semantics description
HCS_PRIO	MD		Integer (0..7)	Default value = 0
Qhcs	MD		Qhcs 10.3.7.54a	Default value = 0
HCS Cell Re-selection Information	MP		HCS Cell Re-selection Information 10.3.7.10	

10.3.7.12 HCS Serving cell information

Information Element/Group name	Need	Multi	Type and Reference	Semantics description
HCS_PRIO	MD		Integer (0..7)	Default value = 0
Qhcs	MD		Qhcs 10.3.7.54a	Default value = 0
T _{CRmax}	MD		Enumerated(not used, 30, 60, 120, 180, 240)	[s] Default value is not used
N _{CR}	<i>CV-UE speed detector</i>		Integer(1..16)	Default value = 8
T _{CRmaxHyst}	<i>CV-UE speed detector</i>		Enumerated(not used, 10, 20, 30, 40, 50, 60, 70)	[s]

Condition	Explanation
<i>UE Speed detector</i>	This IE is not needed if T _{CRmax} equals 'not used', else it is mandatory present.

10.3.7.13 Inter-frequency cell info list

Contains the information for the list of measurement objects for an inter-frequency measurement.

Information Element/Group name	Need	Multi	Type and reference	Semantics description
CHOICE <i>Inter-frequency cell removal</i>	OP			
>Remove all inter-frequency cells				No data
>Remove some inter-frequency cells				
>>Removed inter-frequency cells	MP	1 .. <maxCellMeas>		
>>>Inter-frequency cell id	MP		Integer(0 .. <maxCellMeas>-1)	
>No inter-frequency cells removed				No data
New inter-frequency cells	OP	1 to <maxCellMeas>		
>Inter-frequency cell id	MD		Integer(0 .. <maxCellMeas>-1)	
>Frequency info	MD		Frequency info 10.3.6.36	Default value is the value of the previous "frequency info" in the list (note : the first occurrence is then MP)
>Cell info	MP		Cell info 10.3.7.2	
Cell for measurement	CV- <i>BCHopt</i>	1 to <maxCellMeas>		
>Inter-frequency cell id	MP		Integer(0 .. <maxCellMeas>-1)	

Condition	Explanation
<i>BCHopt</i>	This IE is not needed when sent in SYSTEM INFORMATION. Otherwise, the IE is Optional

10.3.7.14 Inter-frequency event identity

Information Element/Group name	Need	Multi	Type and reference	Semantics description
Inter-frequency event identity	MP		Enumerated(2a, 2b, 2c, 2d, 2e, 2f)	

10.3.7.15 Inter-frequency measured results list

Information Element/Group name	Need	Multi	Type and reference	Semantics description
Inter-frequency measurement results	OP	1 to <maxFreq>		
>Frequency info	MD		Frequency info 10.3.6.36	Default value is the value of the previous "frequency info" in the list (note : the first occurrence is then MP)
>UTRA carrier RSSI	OP		Integer(0..76)	According to UTRA_carrier_RSSI_LEV in [19] and [20]
>Inter-frequency cell measurement results	OP	1 to <maxCellMeas>		
>>Cell measured results	MP		Cell measured results 10.3.7.3	

10.3.7.16 Inter-frequency measurement

Information Element/Group name	Need	Multi	Type and reference	Semantics description
Inter-frequency measurement objects list	MP		Inter-frequency cell info list 10.3.7.13	
Inter-frequency measurement quantity	OP		Inter-frequency measurement quantity 10.3.7.18	
Inter-frequency reporting quantity	OP		Inter-frequency reporting quantity 10.3.7.21	
Reporting cell status	CV- <i>reporting</i>		Reporting cell status 10.3.7.61	
Measurement validity	OP		Measurement validity 10.3.7.51	
Inter-frequency set update	OP		Inter-frequency set update 10.3.7.22	
<i>CHOICE report criteria</i>	MP			
>Intra-frequency measurement reporting criteria			Intra-frequency measurement reporting criteria 10.3.7.39	
>Inter-frequency measurement reporting criteria			Inter-frequency measurement reporting criteria 10.3.7.19	
>Periodical reporting criteria			Periodical reporting criteria 10.3.7.53	
>No reporting				(no data) Chosen when this measurement only is used as additional measurement to another measurement

Condition	Explanation
<i>reporting</i>	This IE is optional if the CHOICE " <i>report criteria</i> " is equal to "periodical reporting criteria" or "No reporting", otherwise the IE is not needed

10.3.7.17 Inter-frequency measurement event results

This IE contains the measurement event results that are reported to UTRAN for inter-frequency measurements.

Information Element/Group name	Need	Multi	Type and reference	Semantics description
Inter-frequency event identity	MP		Inter-frequency event identity 10.3.7.14	
Inter-frequency cells	OP	1 to <maxFreq>		
>Frequency info	MP		Frequency info 10.3.6.36	
>Non frequency related measurement event results	MP		Cell measurement event results 10.3.7.4	

10.3.7.18 Inter-frequency measurement quantity

The quantity the UE shall measure in case of inter-frequency measurement. It also includes the filtering of the measurements.

Information Element/Group name	Need	Multi	Type and reference	Semantics description
CHOICE <i>reporting criteria</i>	MP			
>Intra-frequency reporting criteria				
>>Intra-frequency measurement quantity	MP		Intra-frequency measurement quantity 10.3.7.38	
>Inter-frequency reporting criteria				
>>Filter coefficient	MP		Filter coefficient 10.3.7.9	
>>CHOICE <i>mode</i>	MP			
>>>FDD				
>>>>Measurement quantity for frequency quality estimate	MP		Enumerated(CPICH Ec/N0, CPICH RSCP)	
>>>TDD				
>>>>Measurement quantity for frequency quality estimate	MP		Enumerated(Primary CCPCH RSCP)	

10.3.7.19 Inter-frequency measurement reporting criteria

The triggering of the event-triggered reporting for an inter-frequency measurements. All events concerning inter-frequency measurements are labelled 2x where x is a,b,c..

Event 2a: Change of best frequency.

Event 2b: The estimated quality of the currently used frequency is below a certain threshold **and** the estimated quality of a non-used frequency is above a certain threshold.

Event 2c: The estimated quality of a non-used frequency is above a certain threshold.

Event 2d: The estimated quality of the currently used frequency is below a certain threshold.

Event 2e: The estimated quality of a non-used frequency is below a certain threshold.

Event 2f: The estimated quality of the currently used frequency is above a certain threshold.

Information Element/Group name	Need	Multi	Type and reference	Semantics description
Parameters required for each event	OP	1 to <maxMeas Event>		
>Inter-frequency event identity	MP		Inter-frequency event identity 10.3.7.14	
>Threshold used frequency	CV-clause 0		Integer(-115..0)	Ranges used depend on measurement quantity. CPICH Ec/No -24..0dB CPICH/Primary CCPCH RSCP -115..-25dBm
>W used frequency	CV-clause 2		Real(0, 0.1..2.0 by step of 0.1)	
>Hysteresis	MP		Real(0, 0.5..14.5 by step of 0.5)	In event 2a, 2b, 2c, 2d, 2e, 2f
>Time to trigger	MP		Time to trigger 10.3.7.64	Indicates the period of time between the timing of event detection and the timing of sending Measurement Report. Time in ms.
>Reporting cell status	OP		Reporting cell status 10.3.7.61	
>Parameters required for each non-used frequency	OP	1 to <maxFreq >		
>>Threshold non used frequency	CV-clause 1		Integer(-115..0)	Ranges used depend on measurement quantity. CPICH Ec/No -24..0dB CPICH/Primary CCPCH RSCP -115..-25dBm. This IE is not needed if the IE "Inter-frequency event identity" is set to 2a. However, it is specified to be mandatory to align with the ASN.1.
>>W non-used frequency	CV-clause 1		Real(0, 0.1..2.0 by step of 0.1)	

Condition	Explanation
Clause 0	This IE is mandatory present if the IE "Inter frequency event identity" is set to 2b, 2d, or 2f, otherwise the IE is not needed.
Clause 1	This IE is mandatory present if the IE "Inter frequency event identity" is set to 2a, 2b, 2c or 2e, otherwise the IE is not needed
Clause 2	This IE is mandatory present if the IE "Inter-frequency event identity" is set to 2a, 2b, 2d or 2f, otherwise the IE is not needed.

10.3.7.20 Inter-frequency measurement system information

Information Element/Group name	Need	Multi	Type and reference	Semantics description
Inter-frequency cell info list	OP		Inter-frequency cell info list 10.3.7.13	

10.3.7.21 Inter-frequency reporting quantity

Information Element/Group name	Need	Multi	Type and reference	Semantics description
UTRA Carrier RSSI	MP		Boolean	TRUE means report is requested.
Frequency quality estimate	MP		Boolean	TRUE means that report is requested. This parameter is not used in this release and should be set to FALSE. It shall be ignored by the UE.
Non frequency related cell reporting quantities	MP		Cell reporting quantities 10.3.7.5	

10.3.7.22 Inter-frequency SET UPDATE

NOTE: Only for FDD.

Contains the changes of the virtual active set associated with a non-used frequency. This information makes it possible to use events defined for Intra-frequency measurement within the same non-used frequency for Inter-frequency measurement reporting criteria. This information also controls if the UE should use autonomous updating of the virtual active set associated with a non-used frequency.

Information Element/group name	Need	Multi	Type and reference	Semantics description
UE autonomous update mode	MP		Enumerated (On, On with no reporting, Off)	
Non autonomous update mode	<i>CV-Update</i>			
>Radio link addition information	OP	1 to <maxRL>		Radio link addition information required for each RL to add
>>Primary CPICH info	MP		Primary CPICH info 10.3.6.60	Note 1
>Radio link removal information	OP	1 to <MaxRL>		Radio link removal information required for each RL to remove
>>Primary CPICH info	MP		Primary CPICH info 10.3.6.60	Note 1

Condition	Explanation
<i>Update</i>	The IE is mandatory present if the IE "UE autonomous update mode" is set to "Off", otherwise the IE is not needed.

NOTE 1: If it is assumed that CPICH downlink scrambling code is always allocated with sufficient reuse distances, CPICH downlink scrambling code will be enough for designating the different radio links.

10.3.7.23 Inter-RAT cell info list

Contains the information for the list of measurement objects for an inter-RAT measurement.

Information Element/Group name	Need	Multi	Type and reference	Semantics description
CHOICE <i>Inter-RAT cell removal</i>	MP			
>Remove all inter-RAT cells				No data
>Remove some inter-RAT cells				
>>Removed inter-RAT cells	MP	1 to <maxCellMeas>		
>>>Inter-RAT cell id	MP		Integer(0 .. <maxCellMeas> - 1)	
>Remove no inter-RAT cells				
New inter-RAT cells	OP	1 to <maxCellMeas>		
>Inter-RAT cell id	OP		Integer(0 .. <maxCellMeas> - 1)	
>CHOICE <i>Radio Access Technology</i>	MP			
>>GSM				
>>>Cell individual offset	MP		Integer (-50..50)	In dB Used to offset measured quantity value
>>>Cell selection and re-selection info	OP		Cell selection and re-selection info for SIB11/12 10.3.2.4	see 8.6.7.3 If HCS is not used and all the parameters in cell selection and re-selection info are default values, this IE is absent.
>>>BSIC	MP		BSIC 10.3.8.2	
>>>Band indicator	MP		Enumerated (DCS 1800 band used, PCS 1900 band used)	Indicates how to interpret the BCCH ARFCN
>>>BCCH ARFCN	MP		Integer (0..1023)	[45]
>>IS-2000				
>>>System specific measurement info			enumerated (frequency, timeslot, colour code, output power, PN offset)	For IS-2000, use fields from TIA/EIA/IS-2000.5, Subclause 3.7.3.3.2.27, <i>Candidate Frequency Neighbour List Message</i>
Cell for measurement	OP	1 to <maxCellMeas>		
>Inter-RAT cell id	MP		Integer(0 .. <maxCellMeas>-1)	

10.3.7.24 Inter-RAT event identity

Information Element/Group name	Need	Multi	Type and reference	Semantics description
Inter-RAT event identity	MP		Enumerated (3a, 3b, 3c, 3d)	

10.3.7.25 Inter-RAT info

Inter-RAT info defines the target system for redirected cell selection.

Information Element/Group name	Need	Multi	Type and reference	Semantics description
Inter-RAT info	MP		Enumerated (GSM)	

10.3.7.26 Inter-RAT measured results list

Information Element/Group name	Need	Multi	Type and reference	Semantics description
Inter-RAT measurement results	OP	1 to <maxOther RAT>		
>CHOICE <i>system</i>	MP			At least one spare value needed
>>GSM				
>>>Measured GSM cells	MP	1 to <maxReportedGSMCells>		
>>>>GSM carrier RSSI	OP		bit string(6)	RXLEV, [46]. The RSSI bits are numbered b0 to b5, where b0 is the least significant bit.
>>>>CHOICE <i>BSIC</i>	MP			
>>>>>Verified BSIC				
>>>>>>inter-RAT cell id	MP		Integer(0..<maxCellMeasurements>-1)	
>>>>>>Non verified BSIC				
>>>>>>>BCCH ARFCN	MP		Integer (0..1023)	[45]
>>>>>>>>Observed time difference to GSM cell	OP		Observed time difference to GSM cell 10.3.7.52	

10.3.7.27 Inter-RAT measurement

Information Element/Group name	Need	Multi	Type and reference	Semantics description
Inter-RAT measurement objects list	OP		Inter-RAT cell info list 10.3.7.23	
Inter-RAT measurement quantity	OP		Inter-RAT measurement quantity 10.3.7.29	
Inter-RAT reporting quantity	OP		Inter-RAT reporting quantity 10.3.7.32	
Reporting cell status	CV-reporting		Reporting cell status 10.3.7.61	
CHOICE <i>report criteria</i>	MP			
>Inter-RAT measurement reporting criteria			Inter-RAT measurement reporting criteria 10.3.7.30	
>Periodical reporting criteria			Periodical reporting criteria 10.3.7.53	
>No reporting				(no data) Chosen when this measurement only is used as additional measurement to another measurement

Condition	Explanation
<i>reporting</i>	This IE is optional if the CHOICE " <i>report criteria</i> " is equal to "periodical reporting criteria" or "No reporting", otherwise the IE is not needed

10.3.7.28 Inter-RAT measurement event results

This IE contains the measurement event results that are reported to UTRAN for inter-RAT measurements.

Information Element/Group name	Need	Multi	Type and reference	Semantics description
Inter-RAT event identity	MP		Inter-RAT event identity 10.3.7.24	
Cells to report	MP	1 to <maxCellMeas>		
>CHOICE <i>BSIC</i>	MP			
>>Verified <i>BSIC</i>				
>>>inter-RAT cell id	MP		Integer(0..<maxCellMeas>-1)	
>>Non verified <i>BSIC</i>				
>>>BCCH ARFCN	MP		Integer (0..1023)	[45]

10.3.7.29 Inter-RAT measurement quantity

The quantity the UE shall measure in case of inter-RAT measurement. It also includes the filtering of the measurements.

Information Element/Group name	Need	Multi	Type and reference	Semantics description
Measurement quantity for UTRAN quality estimate	OP		Intra-frequency measurement quantity 10.3.7.38	
CHOICE <i>system</i>	MP			
>GSM				
>>Measurement quantity	MP		Enumerated(GSM Carrier RSSI)	
>>Filter coefficient	MP		Filter coefficient 10.3.7.9	
>>BSIC verification required	MP		Enumerated(required, not required)	
>IS2000				
>>TADD E_c/I_0	MP		Integer(0..63)	Admission criteria for neighbours, see subclause 2.6.6.2.6 of TIA/EIA/IS-2000.5
>>TCOMP E_c/I_0	MP		Integer(0..15)	Admission criteria for neighbours, see subclause 2.6.6.2.5.2 of TIA/EIA/IS-2000.5
>>SOFT SLOPE	OP		Integer(0..63)	Admission criteria for neighbours, see subclause 2.6.6.2.3 and 2.6.6.2.5.2 of TIA/EIA/IS-2000.5
>>ADD_INTERCEPT	OP		Integer(0..63)	Admission criteria for neighbours, see subclause 2.6.6.2.5.2 of TIA/EIA/IS-2000.5

The IE "BSIC verification required" must be set to "required" if IE "Observed time difference to GSM cell" in IE "Inter-RAT reporting quantity" is set to "true".

10.3.7.30 Inter-RAT measurement reporting criteria

The triggering of the event-triggered reporting for an inter-RAT measurement. All events concerning inter-RAT measurements are labelled 3x where x is a,b,c..

Event 3a: The estimated quality of the currently used UTRAN frequency is below a certain threshold **and** the estimated quality of the other system is above a certain threshold.

Event 3b: The estimated quality of other system is below a certain threshold.

Event 3c: The estimated quality of other system is above a certain threshold.

Event 3d: Change of best cell in other system.

Information Element/Group name	Need	Multi	Type and reference	Semantics description
Parameters required for each event	OP	1 to <maxMeas Event>		
>Inter-RAT event identity	MP		Inter-RAT event identity 10.3.7.24	
>Threshold own system	CV-clause 0		Integer (-115..0)	
>W	CV-clause 0		Real(0, 0.1..2.0 by step of 0.1)	In event 3a
>Threshold other system	CV-clause 1		Integer (-115..0)	In event 3a, 3b, 3c
>Hysteresis	MP		Real(0..7.5 by step of 0.5)	
>Time to trigger	MP		Time to trigger 10.3.7.64	Indicates the period of time between the timing of event detection and the timing of sending Measurement Report.
>Reporting cell status	OP		Reporting cell status 10.3.7.61	

Condition	Explanation
Clause 0	The IE is mandatory present if the IE "Inter-RAT event identity" is set to "3a", otherwise the IE is not needed
Clause 1	The IE is mandatory present if the IE "Inter-RAT event identity" is set to 3a, 3b or 3c, otherwise the IE is not needed

10.3.7.31 Inter-RAT measurement system information

Information Element/Group name	Need	Multi	Type and reference	Semantics description
Inter-RAT cell info list	OP		Inter-RAT cell info list 10.3.7.23	

10.3.7.32 Inter-RAT reporting quantity

For all boolean types TRUE means inclusion in the report is requested.

Information Element/Group name	Need	Multi	Type and reference	Semantics description
UTRAN estimated quality	MP		Boolean	This parameter is not used in this release and should be set to FALSE.
CHOICE <i>system</i>	MP			
>GSM				
>>Observed time difference to GSM cell	MP		Boolean	
>>>GSM Carrier RSSI	MP		Boolean	

10.3.7.33 Intra-frequency cell info list

Contains the information for the list of measurement objects for an intra-frequency measurement.

Information Element/Group name	Need	Multi	Type and reference	Semantics description
CHOICE <i>Intra-frequency cell removal</i>	OP			Absence of this IE is equivalent to choice "Remove no intra-frequency cells".
>Remove all intra-frequency cells				No data
>Remove some intra-frequency cells				
>>Removed intra-frequency cells	MP	1 to <maxCellMeas>		
>>>Intra-frequency cell id	MP		Integer(0 .. <maxCellMeas> - 1)	
>Remove no intra-frequency cells				
New intra-frequency cell	OP	1 to <maxCellMeas>		This information element must be present when "Intra-frequency cell info list" is included in the system information
>Intra-frequency cell id	OP		Integer(0 .. <maxCellMeas> - 1)	
>Cell info	MP		Cell info 10.3.7.2	
Cells for measurement	CV- <i>BCHopt</i>	1 to <maxCellMeas>		
>Intra-frequency cell id	MP		Integer(0 .. <maxCellMeas>-1)	

Condition	Explanation
<i>BCHopt</i>	This IE is not needed when sent in SYSTEM INFORMATION. Otherwise, the IE is Optional

10.3.7.34 Intra-frequency event identity

Information Element/Group name	Need	Multi	Type and reference	Semantics description
Intra-frequency event identity	MP		Enumerated (1a,1b,1c,1d,1e,1f,1g,1h,1i)	

10.3.7.35 Intra-frequency measured results list

Information Element/Group name	Need	Multi	Type and reference	Semantics description
Intra-frequency measurement results	OP	1 to <maxCellMeas>		
>Cell measured results	MP		Cell measured results 10.3.7.3	

10.3.7.36 Intra-frequency measurement

Information Element/Group name	Need	Multi	Type and reference	Semantics description
Intra-frequency measurement objects list	OP		Intra-frequency cell info list 10.3.7.33	
Intra-frequency measurement quantity	OP		Intra-frequency measurement quantity 10.3.7.38	
Intra-frequency reporting quantity	OP		Intra-frequency reporting quantity 10.3.7.41	
Reporting cell status	CV-reporting		Reporting cell status 10.3.7.61	
Measurement validity	OP		Measurement validity 10.3.7.51	
<i>CHOICE report criteria</i>	OP			
>Intra-frequency measurement reporting criteria			Intra-frequency measurement reporting criteria 10.3.7.39	
>Periodical reporting criteria			Periodical reporting criteria 10.3.7.53	
>No reporting				(no data) Chosen when this measurement only is used as additional measurement to another measurement

Condition	Explanation
<i>reporting</i>	This IE is optional if the CHOICE " <i>report criteria</i> " is equal to "periodical reporting criteria" or "No reporting", otherwise the IE is not needed

10.3.7.37 Intra-frequency measurement event results

This IE contains the measurement event results that are reported to UTRAN for intra-frequency measurements.

Information Element/Group name	Need	Multi	Type and reference	Semantics description
Intra-frequency event identity	MP		Intra-frequency event identity 10.3.7.34	
Cell measurement event results	MP		Cell measurement event results 10.3.7.4	

10.3.7.38 Intra-frequency measurement quantity

The quantity the UE shall measure in case of intra-frequency measurement. It also includes the filtering of the measurements.

Information Element/Group name	Need	Multi	Type and reference	Semantics description
Filter coefficient	MP		Filter coefficient 10.3.7.9	
CHOICE <i>mode</i>	MP			
>FDD				
>>Measurement quantity	MP		Enumerated(CPICH Ec/N0, CPICH RSCP, Pathloss, UTRA Carrier RSSI)	
>TDD				
>>Measurement quantity list	MP	1 to 4		
>>>Measurement quantity	MP		Enumerated(Primary CCPCH RSCP, Pathloss, Timeslot ISCP, UTRA Carrier RSSI)	

10.3.7.39 Intra-frequency measurement reporting criteria

The triggering of the event-triggered reporting for an intra-frequency measurement. All events concerning intra-frequency measurements are labelled 1x where x is a, b, c....

Event 1a: A Primary CPICH enters the Reporting Range (FDD only).

Event 1b: A Primary CPICH leaves the Reporting Range (FDD only).

Event 1c: A Non-active Primary CPICH becomes better than an active Primary CPICH (FDD only).

Event 1d: Change of best cell (FDD only).

Event 1e: A Primary CPICH becomes better than an absolute threshold (FDD only).

Event 1f: A Primary CPICH becomes worse than an absolute threshold (FDD only).

Event 1g: Change of best cell in TDD.

Event 1h: Timeslot ISCP below a certain threshold (TDD only).

Event 1i: Timeslot ISCP above a certain threshold (TDD only).

Information Element/Group name	Need	Multi	Type and reference	Semantics description
Parameters required for each event	OP	1 to <maxMeas Event>		
>Intra-frequency event identity	MP		Intra-frequency event identity 10.3.7.34	
>Triggering condition 1	CV-clause 0		Enumerated(Active set cells, Monitored set cells, Active set cells and monitored set cells)	Indicates which cells can trigger the event
>Triggering condition 2	CV-clause 6		Enumerated(Active set cells, Monitored set cells, Active set cells and monitored set cells, Detected set cells, Detected set cells and monitored set cells)	Indicates which cells can trigger the event
>Reporting Range Constant	CV-clause 2		Real(0..14.5 by step of 0.5)	In dB. In event 1a,1b.
>Cells forbidden to affect Reporting range	CV-clause 1	1 to <maxCellMeas>		In event 1a,1b
>>CHOICE mode	MP			
>>>FDD				
>>>>Primary CPICH info	MP		Primary CPICH info 10.3.6.60	
>>>>TDD				
>>>>Primary CCPCH info	MP		Primary CCPCH info 10.3.6.57	
>W	CV-clause 2		Real(0.0..2.0 by step of 0.1)	
>Hysteresis	MP		Real(0..7.5 by step of 0.5)	In dB.
>Threshold used frequency	CV-clause 3		Integer (-115..165)	Range used depend on measurement quantity. CPICH RSCP -115..-25 dBm CPICH Ec/No -24..0 dB Pathloss 30..165dB ISCP -115..-25 dBm
>Reporting deactivation threshold	CV-clause 4		Integer(0, 1, 2, 3, 4, 5, 6, 7)	In event 1a Indicates the maximum number of cells allowed in the active set in order for event 1a to occur. 0 means not applicable

Information Element/Group name	Need	Multi	Type and reference	Semantics description
>Replacement activation threshold	CV-clause 5		Integer(0, 1, 2, 3, 4, 5, 6, 7)	In event 1c Indicates the minimum number of cells allowed in the active set in order for event 1c to occur. 0 means not applicable
>Time to trigger	MP		Time to trigger 10.3.7.64	Indicates the period of time between the timing of event detection and the timing of sending Measurement Report. Time in ms
>Amount of reporting	CV-clause 7		Integer(1, 2, 4, 8, 16, 32, 64, Infinity)	In case the IE "Intra-frequency reporting criteria" is included in the IE "Inter-frequency measurement", this IE is not needed.
>Reporting interval	CV-clause 7		Integer(0, 250, 500, 1000, 2000, 4000, 8000, 16000)	Indicates the interval of periodical reporting when such reporting is triggered by an event. Interval in milliseconds. 0 means no periodical reporting. In case the IE "Intra-frequency reporting criteria" is included in the IE "Inter-frequency measurement", this IE is not needed.
>Reporting cell status	OP		Reporting cell status 10.3.7.61	

Condition	Explanation
Clause 0	The IE is mandatory present if the IE "Intra-frequency event identity" is set to "1b" or "1f", otherwise the IE is not needed.
Clause 1	The IE is optional if the IE "Intra-frequency event identity" is set to "1a" or "1b", otherwise the IE is not needed.
Clause 2	The IE is mandatory present if the IE "Intra-frequency event identity" is set to "1a" or "1b", otherwise the IE is not needed.
Clause 3	The IE is mandatory present if the IE "Intra-frequency event identity" is set to , "1e", "1f", "1h" or "1i", otherwise the IE is not needed.
Clause 4	The IE is mandatory present if the IE "Intra-frequency event identity" is set to "1a", otherwise the IE is not needed.
Clause 5	The IE is mandatory present if the IE "Intra-frequency event identity" is set to "1c", otherwise the IE is not needed.
Clause 6	The IE is mandatory present if the IE "Intra-frequency event identity" is set to "1a" or "1e", otherwise the IE is not needed.
Clause 7	The IE is mandatory present if the IE "Intra-frequency event identity" is set to "1a" or "1c", otherwise the IE is not needed.

10.3.7.40 Intra-frequency measurement system information

Information Element/Group name	Need	Multi	Type and reference	Semantics description
Intra-frequency measurement identity	MD		Measurement identity 10.3.7.48	The intra-frequency measurement identity has default value 1.
Intra-frequency cell info list	OP		Intra-frequency cell info list 10.3.7.33	
Intra-frequency measurement quantity	OP		Intra-frequency measurement quantity 10.3.7.38	
Intra-frequency reporting quantity for RACH Reporting	OP		Intra-frequency reporting quantity for RACH Reporting 10.3.7.42	
Maximum number of reported cells on RACH	OP		Maximum number of reported cells on RACH 10.3.7.43	
Reporting information for state CELL_DCH	OP		Reporting information for state CELL_DCH 10.3.7.62	Note 1

NOTE 1: The reporting of intra-frequency measurements is activated when state CELL_DCH is entered.

10.3.7.41 Intra-frequency reporting quantity

Contains the reporting quantity information for an intra-frequency measurement.

Information Element/Group name	Need	Multi	Type and reference	Semantics description
Reporting quantities for active set cells	MP		Cell reporting quantities 10.3.7.5	
Reporting quantities for monitored set cells	MP		Cell reporting quantities 10.3.7.5	
Reporting quantities for detected set cells	OP		Cell reporting quantities 10.3.7.5	

10.3.7.42 Intra-frequency reporting quantity for RACH reporting

Contains the reporting quantity information for an intra-frequency measurement report, which is sent on the RACH.

Information Element/Group name	Need	Multi	Type and reference	Semantics description
SFN-SFN observed time difference reporting indicator	MP		Enumerated(No report, type 1, type 2)	
CHOICE <i>mode</i>	MP			
>FDD				
>>Reporting quantity	MP		Enumerated(CPICH Ec/No, CPICH RSCP, Pathloss, No report)	
>TDD				
>>Reporting quantity list	MP	1 to 2		
>>>Reporting quantity	MP		Enumerated(Timeslot ISCP, Primary CCPCH RSCP, No report)	

10.3.7.43 Maximum number of reported cells on RACH

Information Element/Group name	Need	Multi	Type and reference	Semantics description
Maximum number of reported cells	MP		Enumerated (no report, current cell, current cell + best neighbour, current cell+2 best neighbours, ..., current cell+6 best neighbours)	

10.3.7.44 Measured results

Contains the measured results of the quantity indicated optionally by Reporting Quantity in Measurement Control. "Measured results" can be used for both event trigger mode and periodical reporting mode. The list should be in the order of the value of the measurement quality (the first cell should be the best cell). The "best" FDD cell has the largest value when the measurement quantity is "Ec/No" or "RSCP". On the other hand, the "best" cell has the smallest value when the measurement quantity is "Pathloss". The "best" TDD cell has the largest value when measurement quantity is "Primary CCPCH RSCP".

Information Element/Group name	Need	Multi	Type and reference	Semantics description
CHOICE <i>Measurement</i>	MP			
>Intra-frequency measured results list			Intra-frequency measured results list 10.3.7.35	
>Inter-frequency measured results list			Inter-frequency measured results list 10.3.7.15	
>Inter-RAT measured results list			Inter-RAT measured results list 10.3.7.26	
>Traffic volume measured results list			Traffic volume measured results list 10.3.7.67	
>Quality measured results list			Quality measured results list 10.3.7.55	
>UE Internal measured results			UE Internal measured results 10.3.7.76	
>UE positioning measured results			UE positioning measured results 10.3.7.99	

10.3.7.45 Measured results on RACH

Contains the measured results on RACH of the quantity indicated optionally by Reporting Quantity in the system information broadcast on BCH. The list should be in the order of the value of the measurement quality (the first cell should be the best cell). The "best" FDD cell has the largest value when the measurement quantity is "Ec/No" or "RSCP". On the other hand, the "best" cell has the smallest value when the measurement quantity is "Pathloss". The "best" TDD cell has the largest value when measurement quantity is "Primary CCPCH RSCP".

Information Element/group name	Need	Multi	Type and reference	Semantics description	Version
Measurement result for current cell					
CHOICE <i>mode</i>	MP				
>FDD					
>>CHOICE <i>measurement quantity</i>	MP				
>>>CPICH Ec/N0			Integer(0..49)	In dB. According to CPICH_Ec/No in [19]	
>>>CPICH RSCP			Integer(0..91)	In dBm. According to CPICH_RSCP_LE V in [19]	
>>>Pathloss			Integer(46..158)	In dB	
>TDD					
>>CHOICE <i>TDD option</i>	MP				REL-4
>>>3.84 Mcps TDD					REL-4
>>>>Timeslot List	OP	1 to 14			
>>>>>Timeslot ISCP	MP		Timeslot ISCP info 10.3.7.65	The UE shall report the Timeslot ISCP in the same order as indicated in the cell info	
>>>>1.28 Mcps TDD					REL-4
>>>>>Timeslot List	OP	1 to 6			REL-4
>>>>>>Timeslot ISCP	MP		Timeslot ISCP info 10.3.7.65	The UE shall report the Timeslot ISCP in the same order as indicated in the cell info	REL-4
>>Primary CCPCH RSCP	OP		Primary CCPCH RSCP info 10.3.7.54		
Measurement results for monitored cells	OP	1 to 7			
>SFN-SFN observed time difference	OP		SFN-SFN observed time difference 10.3.7.63	It is absent for current cell	
>CHOICE <i>mode</i>	MP				
>>FDD					
>>>Primary CPICH info	MP		Primary CPICH info 10.3.6.60		
>>>CHOICE <i>measurement quantity</i>	OP			It is absent for current cell	
>>>>CPICH Ec/N0			Integer(0..49)	In dB. According to CPICH_Ec/No in [19].	
>>>>CPICH RSCP			Integer(0..91)	In dBm. According to CPICH_RSCP_LE V in [19].	
>>>>Pathloss			Integer(46..158)	In dB	
>>TDD					
>>>Cell parameters Id	MP		Cell parameters Id 10.3.6.9		
>>>Primary CCPCH RSCP	MP		Primary		

			CCPCH RSCP info 10.3.7.54		
--	--	--	---------------------------------	--	--

NOTE 1: Monitored cells consist of current cell and neighbouring cells.

10.3.7.46 Measurement Command

Information Element/Group name	Need	Multi	Type and reference	Semantics description
Measurement command	MP		Enumerated(Setup, Modify, Release)	

10.3.7.47 Measurement control system information

Information element/Group name	Need	Multi	Type and reference	Semantics description
Use of HCS	MP		Enumerated (Not used, used)	Indicates if the serving cell belongs to a HCS structure
Cell_selection_and_reselection_quality_measure	MP		Enumerated (CPICH Ec/N0, CPICH RSCP)	Choice of measurement (CPICH Ec/N0 or CPICH RSCP) to use as quality measure Q.
Intra-frequency measurement system information	OP		Intra-frequency measurement system information 10.3.7.40	
Inter-frequency measurement system information	OP		Inter-frequency measurement system information 10.3.7.20	
Inter-RAT measurement system information	OP		Inter-RAT measurement system information 10.3.7.31	
Traffic volume measurement system information	OP		Traffic volume measurement system information 10.3.7.73	
UE Internal measurement system information	OP		UE Internal measurement system information 10.3.7.81	

10.3.7.48 Measurement Identity

A reference number that is used by the UTRAN at modification and release of the measurement, and by the UE in the measurement report.

Information Element/Group name	Need	Multi	Type and reference	Semantics description
Measurement identity	MP		Integer(1..16)	

10.3.7.49 Measurement reporting mode

Contains the type of Measurement Report transfer mode and the indication of periodical/event trigger.

Information Element/Group name	Need	Multi	Type and reference	Semantics description
Measurement Report Transfer Mode	MP		enumerated (Acknowledged mode RLC, Unacknowledged mode RLC)	
Periodical Reporting / Event Trigger Reporting Mode	MP		Enumerated (Periodical reporting, Event trigger)	

10.3.7.50 Measurement Type

Information Element/Group name	Need	Multi	Type and reference	Semantics description
Measurement Type	MP		Enumerated (Intra-frequency, Inter-frequency, Inter-RAT, Traffic volume, Quality, UE internal, UE positioning)	

10.3.7.51 Measurement validity

Information Element/Group name	Need	Multi	Type and reference	Semantics description
UE state	MP		Enumerated (CELL_DCH, all states except CELL_DCH, all states)	Indicates the states, in which measurement reporting shall be conducted. The values 'all states except CELL_DCH' and 'all states' are used for measurement type 'traffic volume reporting'.

10.3.7.52 Observed time difference to GSM cell

Information Element/Group name	Need	Multi	Type and reference	Semantics description
Observed time difference to GSM cell	OP		Integer(0,4095)	According to GSM_TIME in [19] and [20]

10.3.7.53 Periodical reporting criteria

Contains the periodical reporting criteria information. It is necessary only in the periodical reporting mode.

Information Element/Group name	Need	Multi	Type and reference	Semantics description
Amount of reporting	MD		Integer(1, 2, 4, 8, 16, 32, 64, Infinity)	The default value is infinity.
Reporting interval	MP		Integer(250, 500, 1000, 2000, 3000, 4000, 6000, 8000, 12000, 16000, 20000, 24000, 28000, 32000, 64000)	Indicates the interval of periodical report. Interval in milliseconds

10.3.7.53a PLMN identities of neighbour cells

This IE contains the PLMN identities of neighbour cells.

Information Element/Group name	Need	Multi	Type and reference	Semantics description
PLMNs of intra-frequency cells list	OP	1 to <maxCellIM eas>		
>PLMN identity	MD		PLMN identity 10.3.1.11	Default value is the previous "PLMN identity" in the list. The default value for the first PLMN in the list is the identity of the selected PLMN if the "PLMN type" in the variable SELECTED_PLMN has the value "GSM-MAP"; otherwise, the first occurrence is MP.
PLMNs of inter-frequency cells list	OP	1 to <maxCellIM eas>		
>PLMN identity	MD		PLMN identity 10.3.1.11	Default value is the previous "PLMN identity" in the list. The default value for the first PLMN in the list is the identity of the selected PLMN if the "PLMN type" in the variable SELECTED_PLMN has the value "GSM-MAP"; otherwise, the first occurrence is MP.
PLMNs of inter-RAT cells list	OP	1 to <maxCellIM eas>		
>PLMN identity	MD		PLMN identity 10.3.1.11	Default value is the previous "PLMN identity" in the list. The default value for the first PLMN in the list is the identity of the selected PLMN if the "PLMN type" in the variable SELECTED_PLMN has the value "GSM-MAP"; otherwise, the first occurrence is MP.

10.3.7.54 Primary CCPCH RSCP info

NOTE: Only for TDD

Information Element/Group name	Need	Multi	IE type and reference	Semantics description
Primary CCPCH RSCP	MP		Integer(0..91)	According to P-CCPCH_RSCP_LEV in [19] and [20]

10.3.7.54a Qhcs

Information Element/Group name	Need	Multi	Type and Reference	Semantics description
Qhcs	MP		Integer(0..99)	Qhcs, mapped from CPICH Ec/No (FDD), see [4] [dB] 0: -24 1: -23.5 2: -23 3: -22.5 ... 45: -1.5 46: -1 47: -0.5 48: 0 49: (spare) ... 98: (spare) 99: (spare)
				Qhcs, mapped from CPICH RSCP (FDD), see [4] [dBm] 0: -115 1: -114 2: -113 : 88: -27 89: -26 90: -(spare) 91: -(spare) : 98: -(spare) 99: -(spare)
				Qhcs, mapped from PCCPCH RSCP (TDD), see [4] [dBm] 0: -115 1: -114 2: -113 : 88: -27 89: -26 90: -(spare) 91: -(spare) : 98: -(spare) 99: -(spare)

				Qhcs level, mapped from Averaged received signal level RSSI (GSM), see [4] [dBm] 0: -110 1: -109 2: -108 : 61: -49 62: -48 63: -47 64: -46 65: -45 66: -44 67: -43 68: -42 69: -41 70: -40 71: -39 72: -38 73: -37 74: -(spare) : 98: -(spare) 99: -(spare)
--	--	--	--	-------------------------------------------------------------------------------------------------------------------------------------------------------------------------------------------------------------------------------------------------------------------------------------------------------------------------------

10.3.7.55 Quality measured results list

Information Element/Group name	Need	Multi	Type and reference	Semantics description
BLER measurement results	OP	1 to <maxTrCH >		
>DL Transport channel identity	MP		Transport channel identity 10.3.5.18	transport channel type = DCH
>DL Transport Channel BLER	OP		Integer (0..63)	According to BLER_LOG in [19] and [20]
CHOICE <i>mode</i>	MP			
>FDD				No data
>TDD				
>>SIR measurement results	OP	1 to <MaxCCTrCH >		SIR measurements for DL CCTrCH
>>>TFCS ID	MP		Integer(1...8)	
>>>Timeslot list	MP	1 to <maxTS >		for all timeslot on which the CCTrCH is mapped on
>>>>SIR	MP		Integer(0..63)	According to UE_SIR in [20]

10.3.7.56 Quality measurement

Information Element/Group name	Need	Multi	Type and reference	Semantics description
Quality reporting quantity	OP		Quality reporting quantity 10.3.7.59	
<i>CHOICE report criteria</i>	MP			
>Quality measurement reporting criteria			Quality measurement reporting criteria 10.3.7.58	
>Periodical reporting criteria			Periodical reporting criteria 10.3.7.53	
>No reporting				(no data) Chosen when this measurement only is used as additional measurement to another measurement

10.3.7.57 Quality measurement event results

Information Element/Group name	Need	Multi	Type and reference	Semantics description
Transport channels causing the event	OP	1 to <maxTrCH >		
>DL Transport channel identity	MP		Transport channel identity 10.3.5.18	transport channel type = DCH

10.3.7.58 Quality measurement reporting criteria

Event 5a: Number of bad CRCs on a certain transport channel exceeds a threshold.

Information Element/Group name	Need	Multi	Type and reference	Semantics description
Parameters sent for each transport channel	OP	1 to <maxTrCH >		
>DL Transport channel identity	MP		Transport channel identity 10.3.5.18	transport channel type = DCH
>Total CRC	MP		Integer(1..512)	Number of CRCs
>Bad CRC	MP		Integer(1..512)	Number of CRCs
>Pending after trigger	MP		Integer(1..512)	Number of CRCs

10.3.7.59 Quality reporting quantity

Information Element/Group name	Need	Multi	Type and reference	Semantics description
DL Transport Channel BLER	MP		Boolean	TRUE means report requested
Transport channels for BLER reporting	<i>CV-BLER reporting</i>	1 to <maxTrCH >		The default, if no transport channel identities are present, is that the BLER is reported for all downlink transport channels
>DL Transport channel identity	MP		Transport channel identity 10.3.5.18	transport channel type = DCH
CHOICE <i>mode</i>	MP			
>FDD				No data
>TDD				
>>SIR measurement list	OP	1 to <maxCCTr CH>		SIR measurements shall be reported for all listed TFCS IDs
>>>TFCS ID	MP		Integer(1..8)	

Condition	Explanation
<i>BLER reporting</i>	This IE is not needed if the IE "DL Transport Channel BLER" is "False" and optional if the IE "DL Transport Channel BLER" is "True"

10.3.7.60 Reference time difference to cell

In the System Information message, the reference time difference to cell indicates the timing difference between the primary CCPCH of the current cell and the primary CCPCH of a neighbouring cell..

In the Measurement Control message, the reference time difference to cell indicates the timing difference between UE uplink transmission timing and the primary CCPCH of a neighbouring cell.

Information Element/Group name	Need	Multi	Type and reference	Semantics description
CHOICE <i>accuracy</i>	MP			
>40 chips				
>>Reference time difference	MP		Integer(0..38400 by step of 40)	In chips
>256 chips				
>>Reference time difference	MP		Integer(0..38400 by step of 256)	In chips
>2560 chips				
>>Reference time difference	MP		Integer(0..38400 by step of 2560)	In chips

10.3.7.61 Reporting Cell Status

Indicates maximum allowed number of cells to report and whether active set cells and/or virtual active set cells and/or monitored set cells on and/or detected set cells used frequency and/or monitored set cells on non used frequency should/should not be included in the IE "Measured results".

Information Element/Group name	Need	Multi	Type and reference	Semantics description
CHOICE <i>reported cell</i>	MP			
>Report cells within active set				This choice is not valid for inter-RAT measurements
>>Maximum number of reported cells	MP		Integer(1..6)	
>Report cells within monitored set cells on used frequency				This choice is not valid for inter-RAT measurements
>>Maximum number of reported cells	MP		Integer(1..6)	
>Report cells within active set and/or monitored set cells on used frequency				This choice is not valid for inter-RAT measurements
>>Maximum number of reported cells	MP		Integer(1..6)	
>Report cells within detected set on used frequency				This choice is not valid for inter-RAT measurements
>>Maximum number of reported cells	MP		Integer(1..6)	
>Report cells within monitored set and/or detected set on used frequency				This choice is not valid for inter-RAT measurements
>>Maximum number of reported cells	MP		Integer(1..6)	
>Report all active set cells + cells within monitored set on used frequency				This choice is not valid for inter-RAT measurements
>>Maximum number of reported cells	MP		Enumerated (virtual/active set cells+1, virtual/active set cells+2,, virtual/active set cells+6)	
>Report all active set cells + cells within detected set on used frequency				This choice is not valid for inter-RAT measurements
>>Maximum number of reported cells	MP		Enumerated (virtual/active set cells+1, virtual/active set cells+2,, virtual/active set cells+6)	
>Report all active set cells + cells within monitored set and/or detected set on used frequency				This choice is not valid for inter-RAT measurements
>>Maximum number of reported cells	MP		Enumerated (virtual/active set cells+1, virtual/active set cells+2,, virtual/active set cells+6)	

>Report cells within virtual active set				This choice is not valid for intra-frequency or inter-RAT measurements
>>Maximum number of reported cells per reported non-used frequency	MP		Integer(1..6)	
>Report cells within monitored set on non-used frequency				This choice is not valid for intra-frequency or inter-RAT measurements
>>Maximum number of reported cells per reported non-used frequency	MP		Integer(1..6)	
>Report cells within monitored and/or virtual active set on non-used frequency				This choice is not valid for intra-frequency or inter-RAT measurements
>>Maximum number of reported cells per reported non-used frequency	MP		Integer(1..6)	
>Report all virtual active set cells + cells within monitored set on non-used frequency				This choice is not valid for intra-frequency or inter-RAT measurements
>>Maximum number of reported cells per reported non-used frequency	MP		Enumerated (virtual/active set cells+1, virtual/active set cells+2,, virtual/active set cells+6)	
>Report cells within active set or within virtual active set or of the other RAT				
>>Maximum number of reported cells	MP		Integer (1..12)	
>Report cells within active and/or monitored set on used frequency or within virtual active and/or monitored set on non-used frequency				This choice is not valid for inter-RAT measurements
>>Maximum number of reported cells	MP		Integer(1..12)	

10.3.7.62 Reporting information for state CELL_DCH

Information Element/Group name	Need	Multi	Type and reference	Semantics description
Intra-frequency reporting quantity	MP		Intra-frequency reporting quantity 10.3.7.41	
Measurement Reporting Mode	MP		Measurement Reporting Mode 10.3.7.49	
<i>CHOICE report criteria</i>	MP			
>Intra-frequency measurement reporting criteria			Intra-frequency measurement reporting criteria 10.3.7.39	
>Periodical reporting criteria			Periodical reporting criteria 10.3.7.53	

10.3.7.63 SFN-SFN observed time difference

Information Element/Group name	Need	Multi	Type and reference	Semantics description
<i>CHOICE type</i>	MP			
>Type 1			Integer(0..9830399)	According to T1_SFN-SFN_TIME in [19] and [20]
>Type 2			Integer(0..40961)	According to T2_SFN-SFN_TIME in [19] and [20]

10.3.7.64 Time to trigger

Information Element/Group name	Need	Multi	Type and reference	Semantics description
Time to trigger	MP		Integer(0, 10, 20, 40, 60, 80, 100, 120, 160, 200, 240, 320, 640, 1280, 2560, 5000)	Time in ms

10.3.7.65 Timeslot ISCP info

NOTE: Only for TDD

Information Element/Group name	Need	Multi	IE type and reference	Semantics description
Timeslot ISCP	MP		Integer (0..91)	According to UE_TS_ISCP_LEV in [20]

10.3.7.66 Traffic volume event identity

Information Element/Group name	Need	Multi	Type and reference	Semantics description
Traffic volume event identity	MP		Enumerated(4a, 4b)	

10.3.7.67 Traffic volume measured results list

Information Element/Group name	Need	Multi	Type and reference	Semantics description
Traffic volume measurement results	OP	1 to <maxRB>		
>RB Identity	MP		RB Identity 10.3.4.16	
>RLC Buffers Payload	OP		Enumerated(0, 4, 8, 16, 32, 64, 128, 256, 512, 1024, 2K, 4K, 8K, 16K, 32K, 64K, 128K, 256K, 512K, 1024K)	In bytes And N Kbytes = N*1024 bytes
>Average of RLC Buffer Payload	OP		Enumerated(0, 4, 8, 16, 32, 64, 128, 256, 512, 1024, 2K, 4K, 8K, 16K, 32K, 64K, 128K, 256K, 512K, 1024K)	In bytes And N Kbytes = N*1024 bytes
>Variance of RLC Buffer Payload	OP		Enumerated(0, 4, 8, 16, 32, 64, 128, 256, 512, 1024, 2K, 4K, 8K, 16K)	In bytes And N Kbytes = N*1024 bytes

10.3.7.68 Traffic volume measurement

Information Element/Group name	Need	Multi	Type and reference	Semantics description
Traffic volume measurement Object	OP		Traffic volume measurement Object 10.3.7.70	
Traffic volume measurement quantity	OP		Traffic volume measurement quantity 10.3.7.71	
Traffic volume reporting quantity	OP		Traffic volume reporting quantity 10.3.7.74	
Measurement validity	OP		Measurement validity 10.3.7.51	
<i>CHOICE report criteria</i>	MP			
>Traffic volume measurement reporting criteria			Traffic volume measurement reporting criteria 10.3.7.72	
>Periodical reporting criteria			Periodical reporting criteria 10.3.7.53	
>No reporting				(no data) Chosen when this measurement only is used as additional measurement to another measurement

10.3.7.69 Traffic volume measurement event results

Contains the event result for a traffic volume measurement.

Information Element/Group name	Need	Multi	Type and reference	Semantics description
Uplink transport channel type causing the event	MP		Enumerated(DCH,RACHorCPCH,USCH)	USCH is TDD only. CPCH is FDD only. RACHorCPCH is the currently configured default in the uplink.
UL Transport Channel identity	<i>CV-UL-DCH/USCH</i>		Transport channel identity 10.3.5.18	
Traffic volume event identity	MP		Traffic volume event identity 10.3.7.66	

Condition	Explanation
<i>UL-DCH/USCH</i>	If IE "Uplink transport channel type" is equal to "DCH" or "USCH" (TDD only) this IE is mandatory present. Otherwise the IE is not needed.

10.3.7.70 Traffic volume measurement object

Contains the measurement object information for a traffic volume measurement.

Information Element/Group name	Need	Multi	Type and reference	Semantics description
Traffic volume measurement objects	MP	1 to <maxTrCH >		
>Uplink transport channel type	MP		Enumerated(DCH,RACHorCPCH,USCH)	USCH is TDD only. CPCH is FDD only. RACHorCPCH is the currently configured default in the uplink.
>UL Target Transport Channel ID	CV-UL-DCH/USCH		Transport channel identity 10.3.5.18	

Condition	Explanation
UL-DCH/USCH	If IE "Uplink transport channel type" is equal to "DCH" or "USCH" (TDD only) this IE is mandatory present. Otherwise the IE is not needed.

10.3.7.71 Traffic volume measurement quantity

Contains the measurement quantity information for a traffic volume measurement.

Information Element/Group name	Need	Multi	Type and reference	Semantics description
Measurement quantity	MP		Enumerated(RLC buffer payload, Average RLC buffer payload, Variance of RLC buffer payload)	The use of this parameter is described in section 8.6.7.10.
Time Interval to take an average or a variance	CV-A/V		Integer(20, 40, ..260, by steps of 20)	In ms

Condition	Explanation
A/V	This IE is mandatory present when "Average RLC buffer" or "Variance of RLC buffer payload" is chosen and not needed otherwise.

10.3.7.72 Traffic volume measurement reporting criteria

Contains the measurement reporting criteria information for a traffic volume measurement.

Event 4a: Transport Channel Traffic Volume [15] exceeds an absolute threshold.

Event 4b: Transport Channel Traffic Volume [15] becomes smaller than an absolute threshold.

Information Element/Group name	Need	Multi	Type and reference	Semantics description
Parameters sent for each transport channel	OP	1 to <maxTrCH >		
>Uplink transport channel type	OP		Enumerated(DCH,RACH or CPCH,USCH)	USCH is TDD only. CPCH is FDD only. RACH or CPCH is the currently configured default in the uplink.
>UL Transport Channel ID	CV-UL-DCH/USCH		Transport channel identity 10.3.5.18	
>Parameters required for each Event	OP	1 to <maxMeas perEvent>		
>>Traffic volume event identity	MP		Traffic volume event identity 10.3.7.66	
>>Reporting Threshold	MP		Enumerated(8,16,32,64,128,256,512,1024,2K,3K,4K,6K,8K,12K,16K,24K,32K,48K,64K,96K,128K,192K,256K,384K,512K,768K)	Threshold in bytes And N Kbytes = N*1024 bytes
>>Time to trigger	OP		Time to trigger 10.3.7.64	Indicates the period of time between the timing of event detection and the timing of sending Measurement Report. Time in ms
>>Pending time after trigger	OP		Integer(250, 500, 1000, 2000, 4000, 8000, 16000)	Indicates the period of time during which it is forbidden to send any new measurement reports with the same Traffic volume event identity even if the triggering condition is fulfilled. Time in milliseconds
>>Tx interruption after trigger	OP		Integer (250, 500, 1000, 2000, 4000, 8000, 16000)	Time in milliseconds. Indicates how long the UE shall block DTCH transmissions on the RACH after a measurement report is triggered.

Condition	Explanation
UL-DCH/USCH	If IE "Uplink transport channel type" is equal to "DCH" or "USCH" (TDD only) this IE is optional. Otherwise the IE is not needed.

10.3.7.73 Traffic volume measurement system information

Information Element/Group name	Need	Multi	Type and reference	Semantics description
Traffic volume measurement identity	MD		Measurement identity 10.3.7.48	The traffic volume measurement identity has default value 4.
Traffic volume measurement object	OP		Traffic volume	

			measurement object 10.3.7.70	
Traffic volume measurement quantity	OP		Traffic volume measurement quantity 10.3.7.71	
Traffic volume reporting quantity	OP		Traffic volume reporting quantity 10.3.7.74	
Measurement validity	OP		Measurement validity 10.3.7.51	
Measurement Reporting Mode	MP		Measurement Reporting Mode 10.3.7.49	
<i>CHOICE reporting criteria</i>	MP			
>Traffic volume measurement reporting criteria			Traffic volume measurement reporting criteria 10.3.7.72	
>Periodical reporting criteria			Periodical reporting criteria 10.3.7.53	

10.3.7.74 Traffic volume reporting quantity

Contains the reporting quantity information for a traffic volume measurement.

For all boolean types TRUE means inclusion in the report is requested.

Information Element/Group name	Need	Multi	Type and reference	Semantics description
RLC Buffer Payload for each RB	MP		Boolean	
Average of RLC Buffer Payload for each RB	MP		Boolean	
Variance of RLC Buffer Payload for each RB	MP		Boolean	

10.3.7.75 UE internal event identity

Information Element/Group name	Need	Multi	Type and reference	Semantics description
UE internal event identity	MP		Enumerated(6a,6b,6c,6d,6e, 6f, 6g)	

10.3.7.76 UE internal measured results

Information Element/Group name	Need	Multi	Type and reference	Semantics description	Version
CHOICE <i>mode</i>	MP				
>FDD					
>>UE Transmitted Power	OP		UE Transmitted Power info 10.3.7.85		
>>UE Rx-Tx report entries	OP	1 to <maxRL>			
>>>Primary CPICH info	MP		Primary CPICH info 10.3.6.60	Primary CPICH info for each cell included in the active set	
>>>UE Rx-Tx time difference type 1	MP		UE Rx-Tx time difference type 1 10.3.7.83	UE Rx-Tx time difference in chip for each RL included in the active set	
>TDD					
>>UE Transmitted Power list	OP	1 to <maxTS>		UE Transmitted Power for each used uplink timeslot in ascending timeslot number order	
>>>UE Transmitted Power	MP		UE Transmitted Power info 10.3.7.85		
>>CHOICE <i>TDD option</i>	MP				REL-4
>>>3.84 Mcps TDD					REL-4
>>>>Applied TA	OP		Uplink Timing Advance 10.3.6.95	Uplink timing advance applied by the UE	
>>>>1.28 Mcps TDD					REL-4
>>>>T _{ADV}	OP		T _{ADV} info 10.3.7.112		REL-4

10.3.7.77 UE internal measurement

Information Element/Group name	Need	Multi	Type and reference	Semantics description
UE internal measurement quantity	OP		UE internal measurement quantity 10.3.7.79	
UE internal reporting quantity	OP		UE internal reporting quantity 10.3.7.82	
CHOICE report criteria	MP			
>UE internal measurement reporting criteria			UE internal measurement reporting criteria 10.3.7.80	
>Periodical reporting criteria			Periodical reporting criteria 10.3.7.53	
>No reporting				(no data) Chosen when this measurement only is used as additional measurement to another measurement

CHOICE report criteria	Condition under which the given report criteria is chosen
UE internal measurement reporting criteria	Chosen when UE internal measurement event triggering is required
Periodical reporting criteria	Chosen when periodical reporting is required
No reporting	Chosen when this measurement only is used as additional measurement to another measurement

10.3.7.78 UE internal measurement event results

This IE contains the measurement event results that are reported to UTRAN for UE internal measurements.

Information Element/Group name	Need	Multi	Type and reference	Semantics description
UE internal event identity	MP		UE internal event identity 10.3.7.75	
CHOICE mode	MP			
>FDD				
>Primary CPICH info	<i>CV-clause 1</i>		Primary CPICH info 10.3.6.60	
>TDD				(no data)

Condition	Explanation
<i>Clause 1</i>	This IE is mandatory present if the IE "UE internal event identity" is set to "6f" or "6g", otherwise the IE is not needed.

10.3.7.79 UE internal measurement quantity

The quantity the UE shall measure in case of UE internal measurement.

Information Element/Group name	Need	Multi	Type and reference	Semantics description	Version
CHOICE <i>mode</i>	MP				
>FDD					
>>Measurement quantity	MP		Enumerated(UE Transmitted Power, UTRA Carrier RSSI, UE Rx-Tx time difference)		
>TDD					
>>Measurement quantity	MP		Enumerated(UE Transmitted Power, UTRA Carrier RSSI, T _{ADV})	Measurement on Timing Advance is for 1.28 Mcps TDD	REL-4
Filter coefficient	MP		Filter coefficient 10.3.7.9		

10.3.7.80 UE internal measurement reporting criteria

The triggering of the event-triggered reporting for a UE internal measurement. All events concerning UE internal measurements are labelled 6x where x is a, b, c.... In TDD, the events 6a - 6d are measured and reported on timeslot basis.

Event 6a: The UE Transmitted Power becomes larger than an absolute threshold

Event 6b: The UE Transmitted Power becomes less than an absolute threshold

Event 6c: The UE Transmitted Power reaches its minimum value

Event 6d: The UE Transmitted Power reaches its maximum value

Event 6e: The UE RSSI reaches the UEs dynamic receiver range

Event 6f (FDD): The UE Rx-Tx time difference for a RL included in the active set becomes larger than an absolute threshold

Event 6f (1.28 Mcps TDD): The time difference indicated by T_{ADV} becomes larger than an absolute threshold

Event 6g: The UE Rx-Tx time difference for a RL included in the active set becomes less than an absolute threshold

Information Element/Group name	Need	Multi	Type and reference	Semantics description	Version
Parameters sent for each UE internal measurement event	OP	1 to <maxMeas Event>			
>UE internal event identity	MP		UE internal event identity 10.3.7.75		
>Time-to-trigger	MP		Integer(0, 10, 20, 40, 60, 80, 100, 120, 160, 200, 240, 320, 640, 1280, 2560, 5000)	Time in ms. Indicates the period of time between the timing of event detection and the timing of sending Measurement Report.	
>UE Transmitted Power Tx power threshold	CV-clause 1		Integer(-50..33)	Power in dBm. In event 6a, 6b.	
>UE Rx-Tx time difference threshold	CV-clause 2		Integer(768..1280)	Time difference in chip. In event 6f, 6g.	
>T _{ADV} threshold	CV-clause 3		Real (0..63 step 0.125)	Time difference in chip. In event 6f	REL-4

Condition	Explanation
Clause 1	The IE is mandatory present if the IE "UE internal event identity" is set to "6a" or "6b", otherwise the IE is not needed.
Clause 2	In FDD, the IE is mandatory present if the IE "UE internal event identity" is set to "6f" or "6g", otherwise the IE is not needed.
Clause 3	In 1.28 Mcps TDD the IE is mandatory present if the IE "UE internal event identity" is set to "6f", otherwise the IE is not needed.

10.3.7.81 UE internal measurement system information

Information Element/Group name	Need	Multi	Type and reference	Semantics description
UE internal measurement identity	MD		Measurement identity 10.3.7.48	The UE internal measurement identity has default value 5.
UE internal measurement quantity	MP		UE internal measurement quantity 10.3.7.79	

10.3.7.82 UE Internal reporting quantity

For all boolean types TRUE means inclusion in the report is requested.

Information Element/Group name	Need	Multi	Type and reference	Semantics description	Version
UE Transmitted Power	MP		Boolean		
CHOICE <i>mode</i>	MP				
>FDD					
>>UE Rx-Tx time difference	MP		Boolean		
>TDD					
>>CHOICE <i>TDD option</i>					REL-4
>>>3.84 Mcps TDD				(no data)	REL-4
>>Applied TA	MP		Boolean		
>>>1.28 Mcps TDD					REL-4
>>>>T _{ADV} info	MP		Boolean		REL-4

10.3.7.83 UE Rx-Tx time difference type 1

The difference in time between the UE uplink DPCCH/DPDCH frame transmission and the first detected path (in time), of the downlink DPCH frame from the measured radio link. This measurement is for FDD only.

Information Element/Group name	Need	Multi	Type and reference	Semantics description
UE Rx-Tx time difference type 1	MP		Integer(768..1280)	In chips.

10.3.7.84 UE Rx-Tx time difference type 2

The difference in time between the UE uplink DPCCH/DPDCH frame transmission and the first detected path (in time), of the downlink DPCH frame from the measured radio link.

Information Element/Group name	Need	Multi	Type and reference	Semantics description
UE Rx-Tx time difference type 2	MP		Real(768.0..1279.9375 by step of 0.0625)	Resolution of 1/16 of a chip.

10.3.7.85 UE Transmitted Power info

Information Element/Group name	Need	Multi	IE type and reference	Semantics description
UE Transmitted Power	MP		Integer (0..104)	According to UE_TX_POWER in [19] and [20]

10.3.7.86 UE positioning Ciphering info

This IE contains information for the ciphering of UE positioning assistance data broadcast in System Information.

Information Element/Group name	Need	Multi	Type and Reference	Semantics description
Ciphering Key Flag	MP		Bit string(1)	See note 1
Ciphering Serial Number	MP		Integer(0..65535)	The serial number used in the DES ciphering algorithm

NOTE 1: The UE always receives two (2) cipher keys during the location update procedure. One of the keys is time-stamped to be current one and the other is time-stamped to be the next one. Thus, the UE always has two cipher keys in memory. The Cipher Key Change Indicator in this broadcast message instructs the UE whether to use current or next cipher key for deciphering the received broadcast message. The UE shall interpret this IE as follows:

- **Ciphering Key Flag**(previous message) = **Ciphering Key Flag**(this message) => Deciphering Key not changed
- **Ciphering Key Flag**(previous message) <> **Ciphering Key Flag**(this message) => Deciphering Key changed

10.3.7.87 UE positioning Error

Information Element/Group name	Need	Multi	Type and Reference	Semantics description
Error reason	MP		Enumerated(ER1, ER2, ER3, ER4, ER5, ER6, ER7, ER8)	Note 1
GPS Additional Assistance Data Request	OP		UE positioning GPS Additional Assistance Data Request 10.3.7.88a	

NOTE 1: The following table gives the mapping of the IE "Error reason"

Value	Indication
ER1	There were not enough cells to be received when performing mobile-based OTDOA-IPDL.
ER2	There were not enough GPS satellites to be received, when performing UE-based GPS location.
ER3	Location calculation assistance data missing.
ER4	Requested method not supported.
ER5	Undefined error.
ER6	Location request denied by the user.
ER7	Location request not processed by the user and timeout
ER8	Reference cell for GPS is not the serving cell

10.3.7.88 UE positioning GPS acquisition assistance

This IE contains parameters that enable fast acquisition of the GPS signals in UE-assisted GPS positioning.

Information Element/Group name	Need	Multi	Type and Reference	Semantics description
CHOICE <i>Reference Time</i>	MP			
>UTRAN reference time				GPS Time of Week counted in microseconds, given as GPS TOW in milliseconds and GPS TOW remainder in microseconds, UTRAN reference time = 1000 * GPS TOW msec + GPS TOW rem usec
>>GPS TOW msec	MP		Integer(0..6.048*10 ⁸ -1)	GPS Time of Week in milliseconds (rounded down to the nearest millisecond unit)
>>GPS TOW rem usec	MP		Integer(0..999)	GPS Time of Week in microseconds MOD 1000.
>>CHOICE <i>mode</i>				
>>>FDD				
>>>>Primary CPICH Info	OP		Primary CPICH Info 10.3.6.60	Identifies the reference cell for the GPS TOW-SFN relationship
>>>TDD				
>>>>cell parameters id	OP		Cell parameters id 10.3.6.9	Identifies the reference cell for the GPS TOW-SFN relationship
>>SFN	MP		Integer(0..4095)	
>GPS reference time only				
>>GPS TOW msec	MP		Integer(0..6.048*10 ⁸ -1)	GPS Time of Week in milliseconds (rounded down to the nearest millisecond unit).
Satellite information	MP	1 to <maxSat>		
>SatID	MP		Integer (0..63)	
>Doppler (0 th order term)	MP		Real(-5120..5117.5 by step of 2.5)	Hz
>Extra Doppler	OP			
>>Doppler (1 st order term)	MP		Real (-0.966..0.483 by step of 0.023)	Scaling factor 1/42
>>Doppler Uncertainty	MP		Enumerated (12.5,25,50,100,200)	Hz
>Code Phase	MP		Integer(0..1022)	Chips, specifies the centre of the search window
>Integer Code Phase	MP		Integer(0..19)	1023 chip segments
>GPS Bit number	MP		Integer(0..3)	Specifies GPS bit number (20 1023 chip segments)
>Code Phase Search Window	MP		Integer(1023,1,2,3,4,6,8,12,16,24,32,48,64,96,128,192)	Specifies the width of the search window.
>Azimuth and Elevation	OP			
>>Azimuth	MP		Real(0..348.75 by step of 11.25)	Degrees
>>Elevation	MP		Real(0..78.75 by step of 11.25)	Degrees

CHOICE Reference time	Condition under which the given reference time is chosen
UTRAN reference time	The reference time is relating GPS time to UTRAN time (SFN)
GPS reference time only	The time gives the time for which the location estimate is valid

10.3.7.88a UE positioning GPS Additional Assistance Data Request

Information Element/Group name	Need	Multi	Type and Reference	Semantics description
Almanac	MP		Boolean	TRUE means requested
UTC Model	MP		Boolean	TRUE means requested
Ionospheric model	MP		Boolean	TRUE means requested
Navigation Model	MP		Boolean	TRUE means requested
DGPS Corrections	MP		Boolean	TRUE means requested
Reference Location	MP		Boolean	TRUE means requested
Reference Time	MP		Boolean	TRUE means requested
Acquisition Assistance	MP		Boolean	TRUE means requested
Real-Time Integrity	MP		Boolean	TRUE means requested
Navigation Model Additional data	CV- <i>Navigation Model</i>			this IE is present only if "Navigation Model" is set to TRUE otherwise it is absent
>GPS Week	MP		Integer (0..1023)	
>GPS_Toe	MP		Integer (0..167)	GPS time of ephemeris in hours of the latest ephemeris set contained by the UE
>T-Toe limit	MP		Integer (0..10)	ephemeris age tolerance of the UE to UTRAN in hours
>Satellites list related data	MP	0 to <maxSat>		
>>SatID	MP		Integer (0..63)	
>>IODE	MP		Integer (0..255)	Issue of Data Ephemeris for SatID

10.3.7.89 UE positioning GPS almanac

This IE contains a reduced-precision subset of the ephemeris and clock correction parameters.

Information Element/Group name	Need	Multi	Type and Reference	Semantics description
WN _a	MP		Bit string(8)	
Satellite information	MP	1 to <maxSat>		
>DataID	MP		Integer(0..3)	See [12]
>SatID	MP		Enumerated(0..63)	Satellite ID
>e	MP		Bit string(16)	Eccentricity [12]
>t _{oa}	MP		Bit string(8)	Reference Time Ephemeris [12]
>δi	MP		Bit string(16)	
>OMEGADOT	MP		Bit string(16)	Longitude of Ascending Node of Orbit Plane at Weekly Epoch (semi-circles/sec) [12]
>SV Health	MP		Bit string(8)	
>A ^{1/2}	MP		Bit string(24)	Semi-Major Axis (meters) ^{1/2} [12]
>OMEGA ₀	MP		Bit string(24)	Longitude of Ascending Node of Orbit Plane at Weekly Epoch (semi-circles) [12]
>M ₀	MP		Bit string(24)	Mean Anomaly at Reference Time (semi-circles) [12]
>ω	MP		Bit string(24)	Argument of Perigee (semi-circles) [12]
>af ₀	MP		Bit string(11)	apparent clock correction [12]
>af ₁	MP		Bit string(11)	apparent clock correction [12]
SV Global Health	OP		Bit string(364)	This enables GPS time recovery and possibly extended GPS correlation intervals. It is specified in page 25 of subframes 4 and 5 [12]

10.3.7.90 UE positioning GPS assistance data

This IE contains GPS assistance data.

Information Element/Group name	Need	Multi	Type and Reference	Semantics description
UE positioning GPS reference time	OP		UE positioning GPS reference time 10.3.7.96	
UE positioning GPS reference UE position	OP		Ellipsoid point with altitude and uncertainty ellipsoid 10.3.8.4c	A priori knowledge of UE 3-D position.
UE positioning GPS DGPS corrections	OP		UE positioning GPS DGPS corrections 10.3.7.91	
UE positioning GPS navigation model	OP		UE positioning GPS navigation model 10.3.7.94	
UE positioning GPS ionospheric model	OP		UE positioning GPS ionospheric model 10.3.7.92	
UE positioning GPS UTC model	OP		UE positioning GPS UTC model 10.3.7.97	
UE positioning GPS almanac	OP		UE positioning GPS almanac 10.3.7.89	
UE positioning GPS acquisition assistance	OP		UE positioning GPS acquisition assistance 10.3.7.88	
UE positioning GPS real-time integrity	OP		UE positioning GPS real-time integrity 10.3.7.95	

10.3.7.90a Void

10.3.7.91 UE positioning GPS DGPS corrections

This IE contains DGPS corrections to be used by the UE.

Information Element/Group name	Need	Multi	Type and Reference	Semantics description
GPS TOW sec	MP		Integer(0..604799)	seconds GPS time-of-week when the DGPS corrections were calculated
Status/Health	MP		Enumerated(UDRE scale 1.0, UDRE scale 0.75, UDRE scale 0.5, UDRE scale 0.3, UDRE scale 0.2, UDRE scale 0.1, no data, invalid data)	
DPGS information	CV- Status/Health	1 to <maxSat>		If the Cipher information is included these fields are ciphered.
>SatID	MP		Enumerated (0...63)	
>IODE	MP		Integer(0..255)	
>UDRE	MP		Enumerated(UDRE ≤ 1.0 m, 1.0m < UDRE ≤ 4.0m, 4.0m < UDRE ≤ 8.0m, 8.0m < UDRE)	The value in this field shall be multiplied by the UDRE Scale Factor in the IE Status/Health to determine the final UDRE estimate for the particular satellite.
>PRC	MP		Real(-655.04..655.04 by step of 0.32)	meters (different from [13])
>RRC	MP		Real(-4.064..4.064 by step of 0.032)	meters/sec (different from [13])
>Delta PRC2	MP		Integer(-127..127)	meters
>Delta RRC2	MP		Real(-0.224..0.224 by step of 0.032)	meters/sec
>Delta PRC3	CV-DCCH		Integer(-127..127)	meters
>Delta RRC3	CV-DCCH		Real(-0.224..0.224 by step of 0.032)	meters/sec

Condition	Explanation
<i>Status/Health</i>	This IE is mandatory present if "status" is not equal to "no data" or "invalid data", otherwise the IE is not needed.
<i>DCCH</i>	This IE is mandatory present if the IE "UE positioning GPS DGPS corrections" it is included in the point-to-point message. It is optional if the IE "UE positioning GPS DGPS corrections" is included in the broadcast message. Otherwise it is not needed.

10.3.7.91a UE positioning GPS Ephemeris and Clock Correction parameters

This IE contains information for GPS ephemeris and clock correction.

Information Element/Group name	Need	Multi	Type and Reference	Semantics description
C/A or P on L2	MP		Bit string(2)	Code(s) on L2 Channel [12]
URA Index	MP		Bit string(4)	User Range Accuracy [12]
SV Health	MP		Bit string(6)	[12]
IODC	MP		Bit string(10)	Issue of Data, Clock [12]
L2 P Data Flag	MP		Bit string(1)	[12]
SF 1 Reserved	MP		Bit string(87)	[12]
TGD	MP		Bit string(8)	Estimated group delay differential [12]
t_{oc}	MP		Bit string(16)	apparent clock correction [12]
af_2	MP		Bit string(8)	apparent clock correction [12]
af_1	MP		Bit string(16)	apparent clock correction [12]
af_0	MP		Bit string(22)	apparent clock correction [12]
C_{rs}	MP		Bit string(16)	Amplitude of the Sine Harmonic Correction Term to the Orbit Radius (meters) [12]
Δn	MP		Bit string(16)	Mean Motion Difference From Computed Value (semi-circles/sec) [12]
M_0	MP		Bit string(32)	Mean Anomaly at Reference Time (semi-circles) [12]
C_{uc}	MP		Bit string(16)	Amplitude of the Cosine Harmonic Correction Term To The Argument Of Latitude (radians) [12]
e	MP		Bit string(32)	c
C_{us}	MP		Bit string(16)	Amplitude of the Sine Harmonic Correction Term To The Argument Of Latitude (radians) [12]
$(A)^{1/2}$	MP		Bit string(32)	Semi-Major Axis (meters) ^{1/2} [12]
t_{oe}	MP		Bit string(16)	Reference Time Ephemeris [12]
Fit Interval Flag	MP		Bit string(1)	[12]
AODO	MP		Bit string(5)	Age Of Data Offset [12]
C_{ic}	MP		Bit string(16)	Amplitude of the Cosine Harmonic Correction Term To The Angle Of Inclination (radians) [12]
$OMEGA_0$	MP		Bit string(32)	Longitude of Ascending Node of Orbit Plane at Weekly Epoch (semi-circles) [12]
C_{is}	MP		Bit string(16)	Amplitude of the Sine Harmonic Correction Term To The Angle Of Inclination (radians) [12]
i_0	MP		Bit string(32)	Inclination Angle at Reference Time (semi-circles) [12]
C_{rc}	MP		Bit string(16)	Amplitude of the Cosine Harmonic Correction Term to the Orbit Radius (meters) [12]
ω	MP		Bit string(32)	Argument of Perigee (semi-circles) [12]
$OMEGA_{dot}$	MP		Bit string(24)	Longitude of Ascending Node of Orbit Plane at Weekly Epoch (semi-circles/sec) [12]
$Idot$	MP		Bit string(14)	Rate of Inclination Angle (semi-circles/sec) [12]

10.3.7.92 UE positioning GPS ionospheric model

The IE contains fields needed to model the propagation delays of the GPS signals through the ionosphere.

Information Element/Group name	Need	Multi	Type and Reference	Semantics description
α_0	MP		Bit string(8)	Note 1
α_1	MP		Bit string(8)	Note 1
α_2	MP		Bit string(8)	Note 1
α_3	MP		Bit string(8)	Note 1
β_0	MP		Bit string(8)	Note 2
β_1	MP		Bit string(8)	Note 2
β_2	MP		Bit string(8)	Note 2
β_3	MP		Bit string(8)	Note 2

NOTE 1: The parameters α_n are the coefficients of a cubic equation representing the amplitude of the vertical delay [12].

NOTE 2: The parameters β_n are the coefficients of a cubic equation representing the period of the ionospheric model [12].

10.3.7.93 UE positioning GPS measured results

Information Element/Group name	Need	Multi	Type and Reference	Semantics description
CHOICE <i>mode</i>	OP			
>FDD				
>>Primary CPICH Info	MP		Primary CPICH Info 10.3.6.60	Identifies the reference cell for the GPS TOW-SFN relationship
>TDD				
>>cell parameters id	MP		Cell parameters id 10.3.6.9	Identifies the reference cell for the GPS TOW-SFN relationship
Reference SFN	OP		Integer(0..4095)	The SFN for which the location is valid
GPS TOW msec	MP		Integer(0..6.048*10 ⁸ -1)	GPS Time of Week in milliseconds (rounded down to the nearest millisecond unit). This time is the GPS TOW measured by the UE. If the Reference SFN field is present it is the ms flank closest to the beginning of that frame. GPS Time of Week in microseconds = 1000 * GPS TOW msec + GPS TOW rem usec
GPS TOW rem usec	OP		Integer(0..999)	GPS Time of Week in microseconds MOD 1000.
Measurement Parameters	MP	1 to <maxSat>		
>Satellite ID	MP		Enumerated(0..63)	
>C/N ₀	MP		Integer(0..63)	the estimate of the carrier-to-noise ratio of the received signal from the particular satellite used in the measurement. It is given in unites of dB-Hz (typical levels will be in the range of 20 – 50 dB-Hz).
>Doppler	MP		Integer(-32768..32768)	Hz, scale factor 0.2.
>Whole GPS Chips	MP		Integer(0..1023)	Unit in GPS chips
>Fractional GPS Chips	MP		Integer(0..(2 ¹⁰ -1))	Scale factor 2 ⁻¹⁰
>Multipath Indicator	MP		Enumerated(NM, low, medium, high)	See note 1
>Pseudorange RMS Error	MP		Enumerated(range index 0..range index 63)	See note 2

NOTE 1: The following table gives the mapping of the multipath indicator field.

Value	Multipath Indication
NM	Not measured
Low	MP error < 5m
Medium	5m < MP error < 43m
High	MP error > 43m

NOTE 2: The following table gives the bitmapping of the Pseudorange RMS Error field.

Range Index	Mantissa	Exponent	Floating-Point value, x_i	Pseudorange value, P
0	000	000	0.5	$P < 0.5$
1	001	000	0.5625	$0.5 \leq P < 0.5625$
I	X	Y	$0.5 * (1 + x/8) * 2^Y$	$x_{i-1} \leq P < x_i$
62	110	111	112	$104 \leq P < 112$
63	111	111	--	$112 \leq P$

10.3.7.94 UE positioning GPS navigation model

This IE contain information required to manage the transfer of precise navigation data to the GPS-capable UE.

Information Element/Group name	Need	Multi	Type and Reference	Semantics description
Satellite information	MP	1 to <maxSat>		
>SatID	MP		Enumerated(0..63)	Satellite ID
>Satellite Status	MP		Enumerated(NS_NN, ES_SN, ES_NN, REVD)	See note 1
>GPS Ephemeris and Clock Correction parameters	CV-Satellite status		UE positioning GPS Ephemeris and Clock Correction parameters 10.3.7.91a	

NOTE 1: The UE shall interpret enumerated symbols as follows.

Value	Indication
NS_NN	New satellite, new Navigation Model
ES_SN	Existing satellite, same Navigation Model
ES_NN	Existing satellite, new Navigation Model
REVD	Reserved

Condition	Explanation
<i>Satellite status</i>	The IE is not needed if the IE "Satellite status" is ES_SN and mandatory present otherwise.

10.3.7.95 UE positioning GPS real-time integrity

This IE contains parameters that describe the real-time status of the GPS constellation.

Information Element/Group name	Need	Multi	Type and Reference	Semantics description
Satellite information	MP	1 to <maxSat>		
>BadSatID	MP		Enumerated(0..63)	

10.3.7.96 UE positioning GPS reference time

Information Element/Group name	Need	Multi	Type and Reference	Semantics description
GPS Week	MP		Integer(0..1023)	
GPS TOW msec	MP		Integer(0..6.048*10 ⁸ -1)	GPS Time of Week in milliseconds (rounded down to the nearest millisecond unit).
GPS TOW rem usec	OP		Integer(0..999)	GPS Time of Week in microseconds MOD 1000. GPS Time of Week in microseconds = 1000 * GPS TOW msec + GPS TOW rem usec
CHOICE <i>mode</i>	OP			
>FDD				
>>Primary CPICH Info	MP		Primary CPICH Info 10.3.6.60	Identifies the reference cell for the GPS TOW-SFN relationship
>TDD				
>>cell parameters id	MP		Cell parameters id 10.3.6.9	Identifies the reference cell for the GPS TOW-SFN relationship
SFN	OP		Integer(0..4095)	The SFN which the GPS TOW time stamps. SFN and GPS TOW msec and GPS TOW rem usec are included if relation GPS TOW/SFN is known to at least 10 μs.
SFN-TOW Uncertainty	OP		Enumerated (lessThan10, moreThan10)	This field indicates the uncertainty of the relation GPS TOW/SFN. lessThan10 means the relation is accurate to at least 10 ms.
Node B Clock Drift	OP		Real(-0.09375..0.09375 by step of 0.0125)	μsec/sec (ppm)
GPS TOW Assist	OP	1 to <maxSat>		
>SatID	MP		Enumerated(0..63)	
>TLM Message	MP		Bit string(14)	
>TLM Reserved	MP		Bit string(2)	
>Alert	MP		Boolean	
>Anti-Spoof	MP		Boolean	

10.3.7.97 UE positioning GPS UTC model

The UTC Model field contains a set of parameters needed to relate GPS time to Universal Time Coordinate (UTC).

Information Element/Group name	Need	Multi	Type and Reference	Semantics description
A ₁	MP		Bit string(24)	sec/sec [12]
A ₀	MP		Bit string(32)	seconds [12]
t _{ot}	MP		Bit string(8)	seconds [12]
WN _t	MP		Bit string(8)	weeks [12]
Δt _{LS}	MP		Bit string(8)	seconds [12]
WN _{LSF}	MP		Bit string(8)	weeks [12]
DN	MP		Bit string(8)	days [12]
Δt _{LSF}	MP		Bit string(8)	seconds [12]

10.3.7.98 UE positioning IPDL parameters

This IE contains parameters for the IPDL mode. The use of this parameters is described in [29].

Information Element/Group name	Need	Multi	Type and Reference	Semantics description	Version
CHOICE <i>mode</i>					REL-4
>FDD					REL-4
>>IP spacing	MP		Integer(5,7,10,15,20,30,40,50)	See [29]	
>>IP length	MP		Integer(5,10)	See [29]	
>>IP offset	MP		Integer(0..9)	Relates the BFN and SFN, should be same as T _{cell} defined in [10]; See [29]	
>>Seed	MP		Integer(0..63)	See [29]	
>TDD					REL-4
>>IP spacing	MP		Integer(30,40,50,70,100)	See [33]	REL-4
>>IP_Start	MP		Integer(0..4095)	See [33]	REL-4
>>IP_Slot	MP		Integer(0..14)	See [33]	REL-4
>>IP_PCCPCH	CV-channel		Boolean	See [33]	REL-4
Burst mode parameters	OP				
>Burst Start	MP		Integer(0..15)	See [29] and [33]	
>Burst Length	MP		Integer(10..25)	See [29] and [33]	
>Burst freq	MP		Integer(1..16)	See [29] and [33]	

Condition	Explanation
<i>channel</i>	This IE is present only if the idle slot carries the PCCPCH

10.3.7.99 UE positioning measured results

Information Element/Group name	Need	Multi	Type and reference	Semantics description
UE positioning OTDOA measured results	OP		UE positioning OTDOA measured results 10.3.7.105	
UE positioning Position estimate info	OP		UE positioning Position estimate info 10.3.7.109	
UE positioning GPS measured results	OP		UE positioning GPS measured results 10.3.7.93	
UE positioning error	OP		UE positioning error 10.3.7.87	Included if UE positioning error occurred

10.3.7.100 UE positioning measurement

Information Element/Group name	Need	Multi	Type and reference	Semantics description
UE positioning reporting quantity	MP		UE positioning reporting quantity 10.3.7.111	
<i>CHOICE reporting criteria</i>	MP			
>UE positioning reporting criteria			UE positioning reporting criteria 10.3.7.110	
>Periodical reporting criteria			Periodical reporting criteria 10.3.7.53	
>No reporting				(no data) Chosen when this measurement only is used as additional measurement to another measurement
UE positioning OTDOA assistance data	CV- OTDOA		UE positioning OTDOA assistance data 10.3.7.103	
UE positioning GPS assistance data	OP		UE positioning GPS assistance data 10.3.7.90	

Condition	Explanation
OTDOA	This IE is mandatory present if the IE "Positioning method" is set to "OTDOA" or "OTDOA or GPS" and not needed otherwise.

10.3.7.101 UE positioning measurement event results

This IE contains the measurement event results that are reported to UTRAN for UE positioning measurements.

Information Element/Group name	Need	Multi	Type and Reference	Semantics description
CHOICE <i>Event ID</i>	MP			
>7a				
>>UE positioning Position estimate info	MP		UE positioning Position estimate info 10.3.7.109	
>7b				
>>UE positioning OTDOA measurement	MP		UE positioning OTDOA measurement 10.3.7.105	
>7c				
>>UE positioning GPS measurement	MP		UE positioning GPS measurement 10.3.7.93	

10.3.7.102 Void

10.3.7.103 UE positioning OTDOA assistance data

Information Element/Group name	Need	Multi	Type and Reference	Semantics description
UE positioning OTDOA reference cell info	OP		UE positioning OTDOA reference cell info 10.3.7.108	
UE positioning OTDOA neighbour cell list	OP	1 to <maxCellMeas>		
>UE positioning OTDOA neighbour cell info	MP		UE positioning OTDOA neighbour cell info 10.3.7.106	

10.3.7.104 Void

10.3.7.105 UE positioning OTDOA measurement

The purpose of the OTDOA Measurement Information element is to provide OTDOA measurements of signals sent from the reference and neighbour cells.

Information Element/Group name	Need	Multi	Type and Reference	Semantics description
SFN	MP		Integer(0..4095)	SFN during which the last measurement was performed
CHOICE <i>mode</i>				
>FDD				
>>Reference cell id	MP		Primary CPICH info 10.3.6.60	
>>>UE Rx-Tx time difference type 2 info	MP			
>>>>UE Rx-Tx time difference type 2	MP		UE Rx-Tx time difference type 2 10.3.7.84	
>>>>UE positioning OTDOA quality	MP		UE positioning OTDOA quality 10.3.7.107	Quality of the UE Rx-Tx time difference type 2 measurement from the reference cell.
>TDD				(no data)
>>Reference cell id	MP		Cell parameters ID 10.3.6.9	
Neighbours	MP	0 to <maxCellMeas>		
>CHOICE <i>mode</i>	MP			
>>FDD				
>>>Neighbour Identity	MD		Primary CPICH info 10.3.6.60	Default value is the same as in the first set of multiple sets.
>>>>UE Rx-Tx time difference type 2 info	OP			Included if the neighbour is in the active set
>>>>>UE Rx-Tx time difference type 2	MP		UE Rx-Tx time difference type 2 10.3.7.84	
>>>>>UE positioning OTDOA quality	MP		UE positioning OTDOA quality 10.3.7.107	Quality of the UE Rx-Tx time difference type 2 measurement from the neighbour cell.
>>TDD				
>>>>Cell and Channel ID	MD		Cell and Channel Identity info 10.3.6.8a	Default value is the same as in the first set of multiple sets.
>UE positioning OTDOA quality	MP		UE positioning OTDOA quality 10.3.7.107	Quality of the SFN-SFN observed time difference type 2 measurement from the neighbour cell.
>SFN-SFN observed time difference type 2	MP		SFN-SFN observed time difference 10.3.7.63	Gives the timing relative to the reference cell. Only type 2 is allowed.

10.3.7.106 UE positioning OTDOA neighbour cell info

This IE gives approximate cell timing in order to decrease the search window, as well as the cell locations and fine cell timing for UE based OTDOA.

Information Element/Group name	Need	Multi	Type and Reference	Semantics description
CHOICE <i>mode</i>	MP			
>FDD				
>>Primary CPICH info	MP		Primary CPICH info 10.3.6.60	
>TDD				
>>cell and channel ID	MP		Cell and Channel Identity info 10.3.6.8a	Identifies the channel to be measured on.
Frequency info	MD		Frequency info 10.3.6.36	Default value is the existing value of frequency information
IPDL parameters	CV-IPDLs		UE positioning IPDL parameters 10.3.7.98	
SFN offset	CV-IPDLs		Integer (0 .. 4095)	Define Tref as the time of beginning of system frame number SFNref of the reference cell. Define Tnc as the beginning of a frame from the neighbour cell occurring immediately after the time Tref. Let the corresponding system frame number be SFNnc. Then SFNnc = SFNref-SFN offset modulo 4096.
SFN-SFN relative time difference	MP		Integer(0.. 38399)	Gives the relative timing compared to the reference cell Equal to $(T_{nc}-T_{ref})/(3.84 \cdot 10^6)$ where $\lfloor \cdot \rfloor$ denotes rounding to the nearest lower integer. in chips.
SFN-SFN drift	OP		Real(0,+0.33,+0.66,+1,+1.33,+1.66,+2,+2.5,+3,+4,+5,+7,+9,+11,+13,+15,-0.33,-0.66,-1,-1.33,-1.66,-2,-2.5,-3,-4,-5,-7,-9,-11,-13,-15)	meters/sec
Search Window Size	MP		Integer(20, 40, 80, 160, 320, 640, 1280, infinity)	in chips. If the value is X then the expected SFN-SFN observed time difference is in the range [RTD-X, RTD+X] where RTD is the value of the field SFN-SFN relative time difference. Infinity means that the uncertainty is larger than 1280 chips.
CHOICE <i>PositioningMode</i>	MP			
>UE based				
>>Cell Position	MD			Default is the same as previous cell
>>>Relative North	OP		Integer(-20000..20000)	Seconds, scale factor 0.03. Relative position compared to reference cell.

>>>Relative East	OP		Integer(-20000..20000)	Seconds, scale factor 0.03. Relative position compared to reference cell.
>>>Relative Altitude	OP		Integer(-4000..4000)	Relative altitude in meters compared to ref. cell.
>>Fine SFN-SFN	MP		Real(0..0.9375 in steps of 0.0625)	Gives finer resolution
>>Round Trip Time	OP		Real(876.00 .. 2923.875) in steps of 0.0625	In chips. Included if cell is in active set.
>UE assisted				(no data)

Condition	Explanation
IPDLs	This IE is mandatory present if IPDLs are applied and not needed otherwise.

10.3.7.107 UE positioning OTDOA quality

Information Element/Group name	Need	Multi	Type and Reference	Semantics description
Std Resolution	MP		Bit string(2)	Std Resolution field includes the resolution used in Std of OTDOA Measurements field. Encoding on two bits as follows: '00' 10 meters '01' 20 meters '10' 30 meters '11' Reserved
Number of OTDOA Measurements	MP		Bit string(3)	Number of measurements field is used together with Std of OTDOA Measurements field to define quality of a reported OTDOA measurement. The field indicates how many OTDOA measurements have been used in the UE to define the standard deviation of the measurements. Following 3 bit encoding is used: '000' 0-4 '001' 5-9 '010' 10-14 '011' 15-24 '100' 25-34 '101' 35-44 '110' 45-54 '111' 55 or more
Std of OTDOA Measurements	MP		Bit string(5)	Std of OTDOA Measurements field includes standard deviation of OTDOA measurements. Following linear 5 bit encoding is used: '00000' 0 - (R*1-1) meters '00001' R*1 - (R*2-1) meters '00010' R*2 - (R*3-1) meters ... '11111' R*31 meters or more where R is the resolution defined by Std Resolution field. E.g. R=20 m corresponds to 0-19 m, 20-39 m,...,620+ m.

10.3.7.108 UE positioning OTDOA reference cell info

This IE defines the cell used for time references in all OTDOA measurements.

Information Element/Group name	Need	Multi	Type and Reference	Semantics description
SFN	OP		Integer (0..4095)	Time stamp (SFN of Reference Cell) of the SFN-SFN relative time differences and SFN-SFN drift rates. Included if any SFN-SFN drift value is included in IE UE positioning OTDOA neighbour cell info.
CHOICE <i>mode</i>	MP			
>FDD				
>>Primary CPICH info	MP		Primary CPICH info 10.3.6.60	
>TDD				
>>cell and channel ID	MP		Cell and Channel Identity info 10.3.6.8a	Identifies the channel to be measured on.
Frequency info	MD		Frequency info 10.3.6.36	Default value is the existing value of frequency information.
CHOICE <i>PositioningMode</i>	MP			
>UE based				
>>CHOICE <i>Cell Position</i>	OP			The position of the antenna that defines the cell. Used for the UE based method.
>>>Ellipsoid				
>>>>Ellipsoid point	MP		Ellipsoid point 10.3.8.4a	
>>>Ellipsoid with altitude				
>>>>Ellipsoid point with altitude	MP		Ellipsoid point with altitude 10.3.8.4b	
>>Round Trip Time	OP		Real(876.00 .. 2923.875) in steps of 0.0625	In chips.
>UE assisted				(no data)
IPDL parameters	OP		UE positioning IPDL parameters 10.3.7.98	If this element is not included there are no idle periods present

10.3.7.109 UE positioning position estimate info

The purpose of this IE is to provide the position estimate from the UE to the network, if the UE is capable of determining its own position.

Information Element/Group name	Need	Multi	Type and Reference	Semantics description
CHOICE <i>mode</i>	OP			
>FDD				
>>Primary CPICH Info	MP		Primary CPICH Info 10.3.6.60	Identifies the reference cell for the GPS TOW-SFN relationship
>TDD				
>>cell parameters id	MP		Cell parameters id 10.3.6.9	Identifies the reference cell for the GPS TOW-SFN relationship
Reference SFN	OP		Integer(0..4095)	The SFN for which the location is valid
GPS TOW msec	OP		Integer(0..6.048*10 ⁸ -1)	GPS Time of Week in milliseconds (rounded down to the nearest millisecond unit). This time-stamps the beginning of the frame defined in Reference SFN GPS Time of Week in microseconds = 1000 * GPS TOW msec + GPS TOW rem usec
GPS TOW rem usec	OP		Integer(0..999)	GPS Time of Week in microseconds MOD 1000.
CHOICE <i>Position estimate</i>	MP			
>Ellipsoid Point			Ellipsoid Point; 10.3.8.4a	
>Ellipsoid point with uncertainty circle			Ellipsoid point with uncertainty circle 10.3.8.4d	
>Ellipsoid point with uncertainty ellipse			Ellipsoid point with uncertainty ellipse 10.3.8.4e	
>Ellipsoid point with altitude			Ellipsoid point with altitude 10.3.8.4b	
>Ellipsoid point with altitude and uncertainty ellipsoid			Ellipsoid point with altitude and uncertainty ellipsoid 10.3.8.4c	

10.3.7.110 UE positioning reporting criteria

The triggering of the event-triggered reporting for an UE positioning measurement.

Information Element/Group name	Need	Multi	Type and Reference	Semantics description
Parameters required for each event	OP	1 to <maxMeas Event>		
>Amount of reporting	MP		Integer(1, 2, 4, 8, 16, 32, 64,infinite)	
>Report first fix	MP		Boolean	If true the UE reports the position once the measurement control is received, and then each time an event is triggered.
>Measurement interval	MP		Integer(5,15, 60,300,900,1 800,3600,72 00)	Indicates how often the UE should make the measurement In seconds
>CHOICE <i>Event ID</i>	MP			
>>7a				
>>>Threshold Position Change	MP		Integer(10,2 0,30,40,50,1 00,200,300,5 00,1000,200 0,5000,1000 0,20000,500 00,100000)	Indicated how much the position should change compared to last reported position fix in order to trigger the event.
>>7b				
>>>Threshold SFN-SFN change	MP		Real(0.25,0. 5,1,2,3,4,5,1 0,20,50,100, 200,500,100 0,2000,5000)	Chips. Indicates how much the SFN-SFN measurement of ANY measured cell is allowed to change before the event is triggered.
>>7c				
>>>Threshold SFN-GPS TOW	MP		Integer(1,2,3 ,5,10,20,50,1 00)	Time in ms. When the GPS TOW and SFN timer has drifted apart more than the specified value the event is triggered)

10.3.7.111 UE positioning reporting quantity

The purpose of the element is to express the allowed/required location method(s), and to provide information required QoS.

Information Element/Group name	Need	Multi	Type and Reference	Semantics description
Method Type	MP		Enumerated(UE assisted, UE based, UE based is preferred but UE assisted is allowed, UE assisted is preferred but UE based is allowed)	
Positioning Methods	MP		Enumerated(OTDOA, GPS, OTDOA or GPS, Cell ID)	
Response Time	MP		Integer(1,2,4, 8, 16, 32, 64, 128)	in seconds
Accuracy	CV- <i>MethodType</i>		Bit string(7)	The uncertainty is derived from the "uncertainty code" k by $r = 10 \cdot (1.1^k - 1)$
GPS timing of Cell wanted	MP		Boolean	If true the SRNC wants the UE to report the SFN-GPS timing of the reference cell. This is however optional in the UE.
Multiple Sets	MP		Boolean	TRUE indicates that the UE is requested to send multiple <i>OTDOA/GPS Measurement Information Sets</i> . UE is expected to include the current measurement set.
Additional Assistance Data Request	MP		Boolean	TRUE indicates that the UE is requested to send the IE "Additional assistance Data Request" when the IE "UE positioning Error" is present in the UE positioning measured results.
Environment Characterisation	OP		Enumerated(possibly heavy multipath and NLOS conditions, no or light multipath and usually LOS conditions, not defined or mixed environment)	

Condition	Explanation
<i>Method Type</i>	The IE is optional if the IE "Method Type" is "UE assisted"; otherwise it is mandatory present.

10.3.7.112 T_{ADV} info

NOTE: Only for 1.28 Mcps TDD.

T_{ADV} indicates the difference between the Rx timing and Tx timing of a UE.

Information Element/group name	Need	Multi	Type and reference	Semantics description	Version
T_{ADV}	MP		Integer (0..2047)	As defined in [20].	REL-4
SFN	MP		Integer(0..4095)	SFN during which the T_{ADV} measurement was performed.	REL-4

10.3.8 Other Information elements

10.3.8.1 BCCH modification info

Indicates modification of the System Information on BCCH.

Information Element/Group name	Need	Multi	Type and reference	Semantics description
MIB Value tag	MP		MIB Value tag 10.3.8.9	
BCCH modification time	OP		Integer (0..4088 in step of 8)	All SFN values in which MIB may be mapped are allowed.

10.3.8.2 BSIC

Information Element/Group name	Need	Multi	Type and reference	Semantics description
Base transceiver Station Identity Code (BSIC)	MP			[11]
>Network Colour Code (NCC)	MP		bit string(3)	
>Base Station Colour Code (BCC)	MP		bit string(3)	

10.3.8.3 CBS DRX Level 1 information

This information element contains the CBS discontinuous reception information to be broadcast for CBS DRX Level 1 calculations in the UE.

Information Element/Group name	Need	Multi	Type and reference	Semantics description
Period of CTCH allocation (N)	MP		Integer (1..256)	$M_{TTI} \leq N \leq 4096 - K$, N multiple of M_{TTI}
CBS frame offset (K)	MP		Integer (0..255)	$0 \leq K \leq N-1$, K multiple of M_{TTI}

10.3.8.4 Cell Value tag

Information Element/Group name	Need	Multi	Type and reference	Semantics description
Cell Value tag	MP		Integer (1..4)	

10.3.8.4a Ellipsoid point

This IE contains the description of an ellipsoid point as in [24].

Information Element/Group name	Need	Multi	Type and Reference	Semantics description
Latitude sign	MP		Enumerated (North, South)	
Degrees Of Latitude	MP		Integer (0...2 ²³ -1)	The IE value (<i>N</i>) is derived by this formula: $N \leq 2^{23} X / 90 < N+1$ <i>X</i> being the latitude in degree (0°.. 90°)
Degrees Of Longitude	MP		Integer (-2 ²³ ...2 ²³ -1)	The IE value (<i>N</i>) is derived by this formula: $N \leq 2^{24} X / 360 < N+1$ <i>X</i> being the longitude in degree (-180°..+180°)

10.3.8.4b Ellipsoid point with Altitude

This IE contains the description of an ellipsoid point with altitude as in [24].

Information Element/Group name	Need	Multi	Type and Reference	Semantics description
Latitude sign	MP		Enumerated (North, South)	
Degrees Of Latitude	MP		Integer (0...2 ²³ -1)	The IE value (<i>N</i>) is derived by this formula: $N \leq 2^{23} X / 90 < N+1$ <i>X</i> being the latitude in degree (0°.. 90°)
Degrees Of Longitude	MP		Integer (-2 ²³ ...2 ²³ -1)	The IE value (<i>N</i>) is derived by this formula: $N \leq 2^{24} X / 360 < N+1$ <i>X</i> being the longitude in degree (-180°..+180°)
Altitude Direction	MP		Enumerated (Height, Depth)	
Altitude	MP		Integer (0..2 ¹⁵ -1)	The IE value (<i>N</i>) is derived by this formula: $N \leq a < N+1$ <i>a</i> being the altitude in metres

10.3.8.4c Ellipsoid point with Altitude and uncertainty ellipsoid

This IE contains the description of an ellipsoid point with altitude and uncertainty ellipsoid as in [24].

Information Element/Group name	Need	Multi	Type and Reference	Semantics description
Latitude sign	MP		Enumerated (North, South)	
Degrees Of Latitude	MP		Integer (0...2 ²³ -1)	The IE value (<i>N</i>) is derived by this formula: $N \leq 2^{23} X / 90 < N+1$ <i>X</i> being the latitude in degree (0°.. 90°)
Degrees Of Longitude	MP		Integer (-2 ²³ ...2 ²³ -1)	The IE value (<i>N</i>) is derived by this formula: $N \leq 2^{24} X / 360 < N+1$ <i>X</i> being the longitude in degree (-180°..+180°)
Altitude Direction	MP		Enumerated (Height, Depth)	
Altitude	MP		Integer (0..2 ¹⁵ -1)	The IE value (<i>N</i>) is derived by this formula: $N \leq a < N+1$ <i>a</i> being the altitude in metres
Uncertainty semi-major	MP		Integer (0...127)	The uncertainty <i>r</i> is derived from the "uncertainty code" <i>k</i> by $r = 10x(1.1^k - 1)$
Uncertainty semi-minor	MP		Integer (0...127)	The uncertainty <i>r</i> is derived from the "uncertainty code" <i>k</i> by $r = 10x(1.1^k - 1)$
Orientation of major axis	MP		Integer (0..179 by step of 2)	The IE value (<i>N</i>) is derived by this formula: $N \leq a / 2 < N+1$ <i>a</i> being the orientation in degree (0°.. 360°)
Uncertainty Altitude	MP		Integer(0..127)	The uncertainty in altitude, <i>h</i> , expressed in metres is mapped from the IE value (<i>K</i>), with the following formula: $h = C \left((1 + x)^K - 1 \right)$ with <i>C</i> = 45 and <i>x</i> = 0.025.
Confidence	MP		Integer (0..100)	in percentage

10.3.8.4d Ellipsoid point with uncertainty Circle

This IE contains the description of an ellipsoid point with an uncertainty circle as in [24].

Information Element/Group name	Need	Multi	Type and Reference	Semantics description
Latitude sign	MP		Enumerated (North, South)	
Degrees Of Latitude	MP		Integer (0...2 ²³ -1)	The IE value (N) is derived by this formula: $N \leq 2^{23} X / 90 < N+1$ X being the latitude in degree (0°.. 90°)
Degrees Of Longitude	MP		Integer (-2 ²³ ...2 ²³ -1)	The IE value (N) is derived by this formula: $N \leq 2^{24} X / 360 < N+1$ X being the longitude in degree (-180°..+180°)
Uncertainty Code	MP		Integer (0...127)	The uncertainty r is derived from the "uncertainty code" k by $r = 10x(1.1^k - 1)$

10.3.8.4e Ellipsoid point with uncertainty Ellipse

This IE contains the description of an ellipsoid point with an uncertainty ellipse as in [24].

Information Element/Group name	Need	Multi	Type and Reference	Semantics description
Latitude sign	MP		Enumerated (North, South)	
Degrees Of Latitude	MP		Integer (0...2 ²³ -1)	The IE value (N) is derived by this formula: $N \leq 2^{23} X / 90 < N+1$ X being the latitude in degree (0°.. 90°)
Degrees Of Longitude	MP		Integer (-2 ²³ ...2 ²³ -1)	The IE value (N) is derived by this formula: $N \leq 2^{24} X / 360 < N+1$ X being the longitude in degree (-180°..+180°)
Uncertainty semi-major	MP		Integer (0...127)	The uncertainty r is derived from the "uncertainty code" k by $r = 10x(1.1^k - 1)$
Uncertainty semi-minor	MP		Integer (0...127)	The uncertainty r is derived from the "uncertainty code" k by $r = 10x(1.1^k - 1)$
Orientation of major axis	MP		Integer (0..179 by step of 2)	The IE value (N) is derived by this formula: $N \leq a / 2 < N+1$ a being the orientation in degree (0°.. 360°)
Confidence	MP		Integer (0..100)	in percentage

10.3.8.5 Inter-RAT change failure

Information Element/Group name	Need	Multi	Type and reference	Semantics description
Inter-RAT change failure cause	MP		Enumerated(Configuratio	At least 3 spare values, criticality = default, are

			n unacceptable, physical channel failure, protocol error)	required
Protocol error information	<i>CV-ProtErr</i>		Protocol error information 10.3.8.12	

Condition	Explanation
<i>ProtErr</i>	The IE is mandatory present if the IE "Inter-RAT handover failure cause" has the value "Protocol error" and not needed otherwise.

10.3.8.6 Inter-RAT handover failure

Information Element/Group name	Need	Multi	Type and reference	Semantics description
Inter-RAT handover failure cause	MD		Enumerated(Configuration unacceptable, physical channel failure, protocol error, inter-RAT protocol error, unspecified)	Default value is "unspecified". At least one spare value needed
Protocol error information	<i>CV-ProtErr</i>		Protocol error information 10.3.8.12	

Condition	Explanation
<i>ProtErr</i>	The IE is mandatory present if the IE "Inter-RAT handover failure cause" has the value "Protocol error" and not needed otherwise.

10.3.8.7 Inter-RAT UE radio access capability

This Information Element contains the inter-RAT UE radio access capability that is structured and coded according to the specification used for the corresponding system type.

Information Element/Group name	Need	Multi	Type and reference	Semantics description
CHOICE <i>system</i>	MP			
>GSM				
>>Mobile Station Classmark 2	MP		Octet string (5)	Defined in [5]
>>Mobile Station Classmark 3	MP		Octet string (1..32)	Defined in [5]
>cdma2000				
>>cdma2000Message	MP	1.to.<maxl nterSysMe ssages>		
>>>MSG_TYPE(s)	MP		Bit string (8)	Formatted and coded according to cdma2000 specifications
>>>cdma2000Messagepayload(s)	MP		Bit string (1..512)	Formatted and coded according to cdma2000 specifications

10.3.8.8 Void

10.3.8.8a Inter-RAT UE security capability

Information Element/Group name	Need	Multi	Type and reference	Semantics description
CHOICE <i>system</i>	MP			
>GSM				
>>GSM security capability	MP			The value TRUE means that the indicated ciphering algorithm is supported.
>>>A5/7 supported	MP		Boolean	
>>>A5/6 supported	MP		Boolean	
>>>A5/5 supported	MP		Boolean	
>>>A5/4 supported	MP		Boolean	
>>>A5/3 supported	MP		Boolean	
>>>A5/2 supported	MP		Boolean	
>>>A5/1 supported	MP		Boolean	

10.3.8.9 MIB Value tag

Information Element/Group name	Need	Multi	Type and reference	Semantics description
MIB Value tag	MP		Integer (1..8)	

10.3.8.10 PLMN Value tag

Information Element/Group name	Need	Multi	Type and reference	Semantics description
PLMN Value tag	MP		Integer (1..256)	

10.3.8.10a PNBSCH allocation

UTRAN may use this IE to provide silent periods in the cell that may be used for cell synchronisation purposes.

Information Element/Group name	Need	Multi	Type and reference	Semantics description	Version
Number of repetitions per SFN period	MP		Integer(2, 3, 4, 5, 6, 7, 8, 9, 10, 12, 14, 16, 18, 20, 24, 28, 32, 36, 40, 48, 56, 64, 72, 80)		REL-4

10.3.8.11 Predefined configuration identity and value tag

Information Element/Group name	Need	Multi	Type and reference	Semantics description
Predefined configuration identity	MP		Predefined configuration identity 10.3.4.5	
Predefined configuration value tag	MP		Predefined configuration value tag 10.3.4.6	

10.3.8.12 Protocol error information

This information element contains diagnostics information returned by the receiver of a message that was not completely understood.

Information Element/Group name	Need	Multi	Type and reference	Semantics description
CHOICE <i>diagnostics type</i>	MP			At least one spare choice is needed.
>Protocol error cause			Protocol error cause 10.3.3.26	

10.3.8.13 References to other system information blocks

Information element/Group name	Need	Multi	Type and reference	Semantics description
References to other system information blocks	MP	1 to <maxSIB>		System information blocks for which multiple occurrences are used, may appear more than once in this list
>Scheduling information	MP		Scheduling information, 10.3.8.16	
>SIB type SIBs only	MP		SIB Type SIBs only, 10.3.8.22	

10.3.8.14 References to other system information blocks and scheduling blocks

Information element/Group name	Need	Multi	Type and reference	Semantics description
References to other system information blocks	MP	1 to <maxSIB>		System information blocks for which multiple occurrences are used, may appear more than once in this list
>Scheduling information	MP		Scheduling information, 10.3.8.16	
>SIB type	MP		SIB Type, 10.3.8.21	

10.3.8.15 Rplmn information

Contains information to provide faster RPLMN selection in the UE.

Information Element/Group name	Need	Multi	Type and reference	Semantics description	Version
GSM BA Range	OP	1 to maxNumGSMFreqRanges		GSM BA Range	
>GSM Lower Range (UARFCN)	MP		Integer(0..16383)	Lower bound for range of GSM BA freqs	
>GSM Upper Range (UARFCN)	MP		Integer(0..16383)	Upper bound for range of GSM BA freqs	
FDD UMTS Frequency list	OP	1 to maxNumFDDFreqs			
>UARFCN (Nlow)	MP		Integer(0..16383)	[21]	
>UARFCN (Nupper)	OP		Integer(0..16383)	[21] This IE is only needed when the FDD frequency list is specifying a range.	
3.84 Mcps TDD UMTS Frequency list	OP	1 to maxNumTDDFreqs			
>UARFCN	MP		Integer(0..16383)	[22]	
1.28 Mcps TDD UMTS Frequency list	OP	1 to maxNumTDDFreqs			REL-4
>UARFCN	MP		Integer(0..16383)	[22]	REL-4
CDMA2000 UMTS Frequency list	OP	1 to maxNumCDMA2000Freqs			
>BAND_CLASS	MP		Bit string(5 bits)	TIA/EIA/IS-2000 The BAND_CLASS bits are numbered b0 to b4, where b0 is the least significant bit.	
>CDMA_FREQ	MP		Bit string (11 bits)	TIA/EIA/IS-2000 The CDMA_FREQ bits are numbered b0 to b10, where b0 is the least significant bit.	

10.3.8.16 Scheduling information

Information Element/Group name	Need	Multi	Type and reference	Semantics description
CHOICE Value tag	OP			
>PLMN Value tag			PLMN Value tag 10.3.8.10	This IE is included if the following conditions are fulfilled: the area scope for the system information block is set to "PLMN" in table 8.1.1. a value tag is used to indicate changes in the system information block. the SIB type does not equal system information block type 16
>Predefined configuration identity and value tag			Predefined configuration identity and value tag 10.3.8.11	This IE is included if the following conditions are fulfilled: the SIB type equals system information block type 16
>Cell Value tag			Cell Value tag 10.3.8.4	This IE is included if the following conditions are fulfilled: the area scope for the system information block is set to "cell" in table 8.1.1. a value tag is used to indicate changes in the system information block.
>SIB occurrence identity and value tag			SIB occurrence identity and value tag 10.3.8.20b	This IE is included if the following conditions are fulfilled: the SIB type equals system information block types 15.2 and 15.3
Scheduling	MP			
>SEG_COUNT	MD		SEG COUNT 10.3.8.17	Default value is 1
>SIB_REP	MP		Integer (4, 8, 16, 32, 64, 128, 256, 512, 1024, 2048, 4096)	Repetition period for the SIB in frames
>SIB_POS	MP		Integer (0 ..Rep-2 by step of 2)	Position of the first segment Rep is the value of the SIB_REP IE
>SIB_POS offset info	MD	1..15		see below for default value
>>SIB_OFF	MP		Integer(2..32 by step of 2)	Offset of subsequent segments

Field	Default value
SIB_POS offset info	The default value is that all segments are consecutive, i.e., that the SIB_OFF = 2 for all segments except when MIB segment/complete MIB is scheduled to be transmitted in between segments from same SIB. In that case, SIB_OFF=4 in between segments which are scheduled to be transmitted at SFNprime = 8 *n-2 and 8*n + 2, and SIB_OFF=2 for the rest of the segments.

10.3.8.17 SEG COUNT

Information Element/Group name	Need	Multi	Type and reference	Semantics description
SEG_COUNT	MP		Integer (1..16)	Number of segments in the system information block

10.3.8.18 Segment index

Each system information segment has an individual segment index.

Information Element/Group name	Need	Multi	Type and reference	Semantics description
Segment index	MP		Integer (1..15)	Segments of a system information block are numbered starting with 0 for the first segment and 1 for the next segment, which can be the first subsequent segment or a last segment.

10.3.8.19 SIB data fixed

Contains the result of a master information block or a system information block after encoding and segmentation. The IE is used for segments with fixed length (segments filling an entire transport block).

Information Element/Group name	Need	Multi	Type and reference	Semantics description
SIB data fixed	MP		Bit string (222)	The first bit contains the first bit of the segment.

10.3.8.20 SIB data variable

Contains either a complete system information block or a segment of a system information block. Contains the result of a master information block or a system information block after encoding and segmentation. The IE is used for segments with variable length. The system information blocks are defined in clauses 10.2.48.8.1 to 10.2.48.8.18.

Information Element/Group name	Need	Multi	Type and reference	Semantics description
SIB data variable	MP		Bit string (1..214)	The first bit contains the first bit of the segment.

10.3.8.20a SIB occurrence identity

This information element identifies a SIB occurrence for System Information Block types 15.2 and 15.3. For System Information Block type 15.2, this identity is assigned to the visible satellite only. Unused identities are claimed by newly rising satellites.

Information Element/Group name	Need	Multi	Type and reference	Semantics description
SIB occurrence identity	MP		Integer (0..15)	

10.3.8.20b SIB occurrence identity and value tag

Information Element/Group name	Need	Multi	Type and reference	Semantics description
SIB occurrence identity	MP		SIB occurrence identity 10.3.8.20a	
SIB occurrence value tag	MP		SIB occurrence value tag 10.3.8.20c	

10.3.8.20c SIB occurrence value tag

This information element is used to identify different versions of SIB occurrence for System Information Block types 15.2 and 15.3.

Information Element/Group name	Need	Multi	Type and Reference	Semantics description
SIB occurrence value tag	MP		Integer(0..15)	

10.3.8.21 SIB type

The SIB type identifies a specific system information block.

Information Element/Group name	Need	Multi	Type and reference	Semantics description
SIB type	MP		Enumerated, see below	

The list of values to encode is:

- Master information block,
- System Information Type 1,
- System Information Type 2,
- System Information Type 3,
- System Information Type 4,
- System Information Type 5,
- System Information Type 6,
- System Information Type 7,
- System Information Type 8,
- System Information Type 9,
- System Information Type 10,
- System Information Type 11,
- System Information Type 12,
- System Information Type 13,
- System Information Type 13.1,

System Information Type 13.2,
 System Information Type 13.3,
 System Information Type 13.4,
 System Information Type 14,
 System Information Type 15,
 System Information Type 15.1,
 System Information Type 15.2,
 System Information Type 15.3,
 System Information Type 15.4,
 System Information Type 16,
 System Information Type 17,
 System Information Type 18,
 Scheduling Block 1,
 Scheduling Block 2.

In addition, at least one spare value, criticality: ignore, is needed.

10.3.8.22 SIB type SIBs only

The SIB type identifies a specific system information block.

Information Element/Group name	Need	Multi	Type and reference	Semantics description
SIB type SIBs only	MP		Enumerated, see below	

The list of values to encode is:

System Information Type 1,
 System Information Type 2,
 System Information Type 3,
 System Information Type 4,
 System Information Type 5,
 System Information Type 6,
 System Information Type 7,
 System Information Type 8,
 System Information Type 9,
 System Information Type 10,
 System Information Type 11,
 System Information Type 12,
 System Information Type 13,

System Information Type 13.1,
 System Information Type 13.2,
 System Information Type 13.3,
 System Information Type 13.4,
 System Information Type 14,
 System Information Type 15,
 System Information Type 15.1,
 System Information Type 15.2,
 System Information Type 15.3,
 System Information Type 15.4,
 System Information Type 16,
 System Information Type 17,
 System Information Type 18.

In addition, at least one spare value, criticality: ignore, is needed.

10.3.9 ANSI-41 Information elements

10.3.9.1 ANSI 41 Core Network Information

Information element/Group name	Need	Multi	Type and reference	Semantics description
P_REV	MP		P_REV 10.3.9.10	
MIN_P_REV	MP		MIN_P_REV 10.3.9.8	
SID	MP		SID 10.3.9.11	
NID	MP		NID 10.3.9.9	

10.3.9.2 ANSI-41 Global Service Redirection information

This Information Element contains ANSI-41 Global Service Redirection information.

Information Element/Group name	Need	Multi	Type and reference	Semantics description
ANSI-41 Global Service Redirection information	MP		ANSI-41 NAS parameter, 10.3.9.3	Formatted and coded according to the 3GPP2 document "G3G CDMA DS on ANSI-41"

10.3.9.3 ANSI-41 NAS parameter

This Information Element contains ANSI-41 User Zone Identification information.

Information Element/Group name	Need	Multi	Type and reference	Semantics description
ANSI-41 NAS parameter	MP		Bit string (size (1..2048))	The first bit contains the first bit of the ANSI-41 information.

10.3.9.4 ANSI-41 NAS system information

This Information Element contains ANSI-41 system information.

Information Element/Group name	Need	Multi	Type and reference	Semantics description
NAS (ANSI-41) system information	MP		ANSI-41 NAS parameter, 10.3.9.3	Formatted and coded according to the 3GPP2 document "G3G CDMA DS on ANSI-41"

10.3.9.5 ANSI-41 Private Neighbour List information

This Information Element contains ANSI-41 Private Neighbour List information.

Information Element/Group name	Need	Multi	Type and reference	Semantics description
ANSI-41 Private Neighbour List information	MP		ANSI-41 NAS parameter, 10.3.9.3	Formatted and coded according to the 3GPP2 document "G3G CDMA DS on ANSI-41"

10.3.9.6 ANSI-41 RAND information

This Information Element contains ANSI-41 RAND information.

Information Element/Group name	Need	Multi	Type and reference	Semantics description
ANSI-41 RAND information	MP		ANSI-41 NAS parameter, 10.3.9.3	Formatted and coded according to the 3GPP2 document "G3G CDMA DS on ANSI-41"

10.3.9.7 ANSI-41 User Zone Identification information

This Information Element contains ANSI-41 User Zone Identification information.

Information Element/Group name	Need	Multi	Type and reference	Semantics description
ANSI-41 User Zone Identification information	MP		ANSI-41 NAS parameter, 10.3.9.3	Formatted and coded according to the 3GPP2 document "G3G CDMA DS on ANSI-41"

10.3.9.8 MIN_P_REV

This Information Element contains minimum protocol revision level.

Information Element/Group name	Need	Multi	Type and reference	Semantics description
MIN_P_REV	MP		Bit string (8)	Minimum protocol revision level. The MIN_P_REV bits are numbered b0 to b7, where b0 is the least significant bit.

10.3.9.9 NID

This Information Element contains Network identification.

Information Element/Group name	Need	Multi	Type and reference	Semantics description
NID	MP		Bit string (16)	Network identification. The NID bits are numbered b0 to b15, where b0 is the least significant bit.

10.3.9.10 P_REV

This Information Element contains protocol revision level.

Information Element/Group name	Need	Multi	Type and reference	Semantics description
P_REV	MP		Bit string (8)	Protocol revision level. The P_REV bits are numbered b0 to b7, where b0 is the least significant bit.

10.3.9.11 SID

This Information Element contains System identification.

Information Element/Group name	Need	Multi	Type and reference	Semantics description
SID	MP		Bit string (15)	System identification. The SID bits are numbered b0 to b14, where b0 is the least significant bit.

10.3.10 Multiplicity values and type constraint values

The following table includes constants that are either used as multi bounds (name starting with "max") or as high or low value in a type specification (name starting with "lo" or "hi"). Constants are specified only for values appearing more than once in the RRC specification. In case a constant is related to one or more other constants, an expression is included in the "value" column instead of the actual value.

Constant	Explanation	Value
CN information		
maxCNdomains	Maximum number of CN domains	4
UTRAN mobility information		
maxRAT	Maximum number of Radio Access Technologies	maxOtherRAT + 1
maxOtherRAT	Maximum number of other Radio Access Technologies	15
maxURA	Maximum number of URAs in a cell	8
maxInterSysMessages	Maximum number of Inter System Messages	4
maxRABsetup	Maximum number of RABs to be established	16
UE information		
maxtransactions	Maximum number of parallel RRC transactions in downlink	25
maxPDCPalgoType	Maximum number of PDCP algorithm types	8
maxDRACclasses	Maximum number of UE classes which would require different DRAC parameters	8
maxFreqBandsFDD	Maximum number of frequency bands supported by the UE as defined in [21]	8
maxFreqBandsTDD	Maximum number of frequency bands supported by the UE as defined in [22]	4
maxFreqBandsGSM	Maximum number of frequency bands supported by the UE as defined in [45]	16
maxPage1	Number of UEs paged in the Paging Type 1 message	8
maxSystemCapability	Maximum number of system specific capabilities that can be requested in one message.	16
RB information		
maxPredefConfig	Maximum number of predefined configurations	16
maxRB	Maximum number of RBs	32
maxSRBsetup	Maximum number of signalling RBs to be established	8
maxRBperRAB	Maximum number of RBs per RAB	8
maxRBallRABs	Maximum number of non signalling RBs	27
maxRBMuxOptions	Maximum number of RB multiplexing options	8
maxLoCHperRLC	Maximum number of logical channels per RLC entity	2
MaxROHC-PacketSizes	Maximum number of packet sizes that are allowed to be produced by ROHC.	16
MaxROHC-Profiles	Maximum number of profiles supported by ROHC on a given RB.	8
TrCH information		
maxTrCH	Maximum number of transport channels used in one direction (UL or DL)	32
maxTrCHpreconf	Maximum number of preconfigured Transport channels, per direction	16
maxCCTrCH	Maximum number of CCTrCHs	8
maxTF	Maximum number of different transport formats that can be included in the Transport format set for one transport channel	32
maxTF-CPCH	Maximum number of TFs in a CPCH set	16
maxTFC	Maximum number of Transport Format Combinations	1024
maxTFCl-1-Combs	Maximum number of TFCI (field 1) combinations	512
maxTFCl-2-Combs	Maximum number of TFCI (field 2) combinations	512
maxCPCHsets	Maximum number of CPCH sets per cell	16
maxSIBperMsg	Maximum number of complete system information blocks per SYSTEM INFORMATION message	16
maxSIB	Maximum number of references to other system information blocks.	32
maxSIB-FACH	Maximum number of references to system information blocks on the FACH	8
PhyCH information		
maxPCPCH-APsubCH	Maximum number of available sub-channels for AP signature on PCPCH	12
maxPCPCH-CDsubCH	Maximum number of available sub-channels for CD signature on PCPCH	12
maxPCPCH-APsig	Maximum number of available signatures for AP on PCPCH	16
maxPCPCH-CDsig	Maximum number of available signatures for CD on PCPCH	16
maxAC	Maximum number of access classes	16
maxASC	Maximum number of access service classes	8

maxASCmap	Maximum number of access class to access service classes mappings	7
maxASCpersist	Maximum number of access service classes for which persistence scaling factors are specified	6
maxPRACH	Maximum number of PRACHs in a cell	16
MaxPRACH_FPACH	Maximum number of PRACH / FPACH pairs in a cell (1.28 Mcps TDD)	8
maxFACHPCH	Maximum number of FACHs and PCHs mapped onto one secondary CCPCHs	8
maxRL	Maximum number of radio links	8
maxSCCPCH	Maximum number of secondary CCPCHs per cell	16
maxDPDCH-UL	Maximum number of DPDCHs per cell	6
maxDPCH-DLchan	Maximum number of channelisation codes used for DL DPCH	8
maxPUSCH	Maximum number of PUSCHs	(8)
maxPDSCH	Maximum number of PDSCHs	8
maxPDSCHcodes	Maximum number of codes for PDSCH	16
maxPDSCH-TFCIgroups	Maximum number of TFCI groups for PDSCH	256
maxPDSCHcodeGroups	Maximum number of code groups for PDSCH	256
maxPCPCHs	Maximum number of PCPCH channels in a CPCH Set	64
maxPCPCH-SF	Maximum number of available SFs on PCPCH	7
maxTS	Maximum number of timeslots used in one direction (UL or DL)	6 (1.28 Mcps TDD) 14 (3.84 Mcps TDD)
hiPUSCHidentities	Maximum number of PUSCH Identities	64
hiPDSCHidentities	Maximum number of PDSCH Identities	64
Measurement information		
maxTGPS	Maximum number of transmission gap pattern sequences	6
maxAdditionalMeas	Maximum number of additional measurements for a given measurement identity	4
maxMeasEvent	Maximum number of events that can be listed in measurement reporting criteria	8
maxMeasParEvent	Maximum number of measurement parameters (e.g. thresholds) per event	2
maxMeasIntervals	Maximum number of intervals that define the mapping function between the measurements for the cell quality Q of a cell and the representing quality value	1
maxCellMeas	Maximum number of cells to measure	32
maxReportedGSMCells	Maximum number of GSM cells to be reported	6
maxFreq	Maximum number of frequencies to measure	8
maxSat	Maximum number of satellites to measure	16
HiRM	Maximum number that could be set as rate matching attribute for a transport channel	256
Frequency information		
maxFDDFreqList	Maximum number of FDD carrier frequencies to be stored in USIM	4
maxTDDFreqList	Maximum number of TDD carrier frequencies to be stored in USIM	4
maxFDDFreqCellList	Maximum number of neighbouring FDD cells to be stored in USIM	32
maxTDDFreqCellList	Maximum number of neighbouring TDD cells to be stored in USIM	32
maxGSMCellList	Maximum number of GSM cells to be stored in USIM	32
Other information		
maxNumGSMFreqRanges	Maximum number of GSM Frequency Ranges to store	32
maxNumFDDFreqs	Maximum number of FDD centre frequencies to store	8
maxNumTDDFreqs	Maximum number of TDD centre frequencies to store	8
maxNumCDMA200Freqs	Maximum number of CDMA2000 centre frequencies to store	8

11 Message and Information element abstract syntax (with ASN.1)

This clause contains definitions for RRC PDUs and IEs using a subset of ASN.1 as specified in [14]. PDU and IE definitions are grouped into separate ASN.1 modules.

11.0 General

Some messages and/or IEs may include one or more IEs with name "dummy" that are included only in the ASN.1. The UE should avoid sending information elements that are named "dummy" to UTRAN. Likewise, UTRAN should avoid sending IEs with name "dummy" to the UE. If the UE anyhow receives an information element named "dummy", it shall ignore the IE and process the rest of the message as if the IE was not included.

NOTE: An IE with name "dummy" concerns an information element that was (erroneously) included in a previous version of the specification and has been removed by replacing it with a dummy with same type.

If the abstract syntax of an IE is defined using the ASN.1 type "BIT STRING", and this IE corresponds to a functional IE definition in tabular format, in which the significance of bits is semantically defined, the following general rule shall be applied:

The bits in the ASN.1 bit string shall represent the semantics of the functional IE definition in decreasing order of bit significance;

- with the first (or leftmost) bit in the bit string representing the most significant bit; and
- with the last (or rightmost) bit in the bit string representing the least significant bit.

11.1 General message structure

```
Class-definitions DEFINITIONS AUTOMATIC TAGS ::=
```

```
BEGIN
```

```
IMPORTS
```

```
    ActiveSetUpdate,  
    ActiveSetUpdateComplete,  
    ActiveSetUpdateFailure,  
    AssistanceDataDelivery,  
    CellChangeOrderFromUTRAN,  
    CellChangeOrderFromUTRANFailure,  
    CellUpdate,  
    CellUpdateConfirm-CCCH,  
    CellUpdateConfirm,  
    CounterCheck,  
    CounterCheckResponse,  
    DownlinkDirectTransfer,  
    HandoverToUTRANComplete,  
    InitialDirectTransfer,  
    HandoverFromUTRANCommand-GSM,  
    HandoverFromUTRANCommand-CDMA2000,  
    HandoverFromUTRANFailure,  
    MeasurementControl,  
    MeasurementControlFailure,  
    MeasurementReport,  
    PagingType1,  
    PagingType2,  
    PhysicalChannelReconfiguration,  
    PhysicalChannelReconfigurationComplete,  
    PhysicalChannelReconfigurationFailure,  
    PhysicalSharedChannelAllocation,  
    PUSCHCapacityRequest,  
    RadioBearerReconfiguration,  
    RadioBearerReconfigurationComplete,  
    RadioBearerReconfigurationFailure,  
    RadioBearerRelease,
```

```

RadioBearerReleaseComplete,
RadioBearerReleaseFailure,
RadioBearerSetup,
RadioBearerSetupComplete,
RadioBearerSetupFailure,
RRCConnectionReject,
RRCConnectionRelease,
RRCConnectionRelease-CCCH,
RRCConnectionReleaseComplete,
RRCConnectionRequest,
RRCConnectionSetup,
RRCConnectionSetupComplete,
RRCStatus,
SecurityModeCommand,
SecurityModeComplete,
SecurityModeFailure,
SignallingConnectionRelease,
SignallingConnectionReleaseIndication,
SystemInformation-BCH,
SystemInformation-FACH,
SystemInformationChangeIndication,
TransportChannelReconfiguration,
TransportChannelReconfigurationComplete,
TransportChannelReconfigurationFailure,
TransportFormatCombinationControl,
TransportFormatCombinationControlFailure,
UECapabilityEnquiry,
UECapabilityInformation,
UECapabilityInformationConfirm,
UplinkDirectTransfer,
UplinkPhysicalChannelControl,
URAUpdate,
URAUpdateConfirm,
URAUpdateConfirm-CCCH,
UTRANMobilityInformation,
UTRANMobilityInformationConfirm,
UTRANMobilityInformationFailure
FROM PDU-definitions

-- User Equipment IEs :
  IntegrityCheckInfo
FROM InformationElements;

--*****
--
-- Downlink DCCH messages
--
--*****

DL-DCCH-Message ::= SEQUENCE {
    integrityCheckInfo      IntegrityCheckInfo      OPTIONAL,
    message                  DL-DCCH-MessageType
}

DL-DCCH-MessageType ::= CHOICE {
    activeSetUpdate           ActiveSetUpdate,
    assistanceDataDelivery    AssistanceDataDelivery,
    cellChangeOrderFromUTRAN CellChangeOrderFromUTRAN,
    cellUpdateConfirm         CellUpdateConfirm,
    counterCheck              CounterCheck,
    downlinkDirectTransfer    DownlinkDirectTransfer,
    handoverFromUTRANCommand-GSM HandoverFromUTRANCommand-GSM,
    handoverFromUTRANCommand-CDMA2000 HandoverFromUTRANCommand-CDMA2000,
    measurementControl        MeasurementControl,
    pagingType2               PagingType2,
    physicalChannelReconfiguration PhysicalChannelReconfiguration,
    physicalSharedChannelAllocation PhysicalSharedChannelAllocation,
    radioBearerReconfiguration RadioBearerReconfiguration,
    radioBearerRelease        RadioBearerRelease,
    radioBearerSetup          RadioBearerSetup,
    rrcConnectionRelease      RRCConnectionRelease,
    securityModeCommand       SecurityModeCommand,
    signallingConnectionRelease SignallingConnectionRelease,
    transportChannelReconfiguration TransportChannelReconfiguration,
    transportFormatCombinationControl TransportFormatCombinationControl,
    ueCapabilityEnquiry        UECapabilityEnquiry,
    ueCapabilityInformationConfirm UECapabilityInformationConfirm,
    uplinkPhysicalChannelControl UplinkPhysicalChannelControl,

```

```

    uraUpdateConfirm                URAUpdateConfirm,
    utranMobilityInformation        UTRANMobilityInformation,
    extension                       NULL
}

--*****
--
-- Uplink DCCH messages
--
--*****

UL-DCCH-Message ::= SEQUENCE {
    integrityCheckInfo      IntegrityCheckInfo      OPTIONAL,
    message                 UL-DCCH-MessageType
}

UL-DCCH-MessageType ::= CHOICE {
    activeSetUpdateComplete      ActiveSetUpdateComplete,
    activeSetUpdateFailure      ActiveSetUpdateFailure,
    cellChangeOrderFromUTRANFailure CellChangeOrderFromUTRANFailure,
    counterCheckResponse        CounterCheckResponse,
    handoverToUTRANComplete     HandoverToUTRANComplete,
    initialDirectTransfer       InitialDirectTransfer,
    handoverFromUTRANFailure    HandoverFromUTRANFailure,
    measurementControlFailure   MeasurementControlFailure,
    measurementReport           MeasurementReport,
    physicalChannelReconfigurationComplete PhysicalChannelReconfigurationComplete,
    physicalChannelReconfigurationFailure PhysicalChannelReconfigurationFailure,
    radioBearerReconfigurationComplete RadioBearerReconfigurationComplete,
    radioBearerReconfigurationFailure RadioBearerReconfigurationFailure,
    radioBearerReleaseComplete  RadioBearerReleaseComplete,
    radioBearerReleaseFailure   RadioBearerReleaseFailure,
    radioBearerSetupComplete    RadioBearerSetupComplete,
    radioBearerSetupFailure     RadioBearerSetupFailure,
    rrcConnectionReleaseComplete RRCConnectionReleaseComplete,
    rrcConnectionSetupComplete  RRCConnectionSetupComplete,
    rrcStatus                   RRCStatus,
    securityModeComplete        SecurityModeComplete,
    securityModeFailure         SecurityModeFailure,
    signallingConnectionReleaseIndication SignallingConnectionReleaseIndication,
    transportChannelReconfigurationComplete TransportChannelReconfigurationComplete,
    transportChannelReconfigurationFailure TransportChannelReconfigurationFailure,
    transportFormatCombinationControlFailure TransportFormatCombinationControlFailure,
    ueCapabilityInformation      UECapabilityInformation,
    uplinkDirectTransfer         UplinkDirectTransfer,
    utranMobilityInformationConfirm UTRANMobilityInformationConfirm,
    utranMobilityInformationFailure UTRANMobilityInformationFailure,
    extension                   NULL
}

--*****
--
-- Downlink CCCH messages
--
--*****

DL-CCCH-Message ::= SEQUENCE {
    integrityCheckInfo      IntegrityCheckInfo      OPTIONAL,
    message                 DL-CCCH-MessageType
}

DL-CCCH-MessageType ::= CHOICE {
    cellUpdateConfirm          CellUpdateConfirm-CCCH,
    rrcConnectionReject        RRCConnectionReject,
    rrcConnectionRelease      RRCConnectionRelease-CCCH,
    rrcConnectionSetup        RRCConnectionSetup,
    uraUpdateConfirm          URAUpdateConfirm-CCCH,
    extension                 NULL
}

--*****
--

```

```

-- Uplink CCCH messages
--
--*****
UL-CCCH-Message ::= SEQUENCE {
    integrityCheckInfo IntegrityCheckInfo OPTIONAL,
    message              UL-CCCH-MessageType
}

UL-CCCH-MessageType ::= CHOICE {
    cellUpdate           CellUpdate,
    rrcConnectionRequest RRCConnectionRequest,
    uraUpdate           URAUpdate,
    extension            NULL
}

--*****
--
-- PCCH messages
--
--*****

PCCH-Message ::= SEQUENCE {
    message              PCCH-MessageType
}

PCCH-MessageType ::= CHOICE {
    pagingType1         PagingType1,
    extension            NULL
}

--*****
--
-- Downlink SHCCH messages
--
--*****

DL-SHCCH-Message ::= SEQUENCE {
    message              DL-SHCCH-MessageType
}

DL-SHCCH-MessageType ::= CHOICE {
    physicalSharedChannelAllocation PhysicalSharedChannelAllocation,
    extension                NULL
}

--*****
--
-- Uplink SHCCH messages
--
--*****

UL-SHCCH-Message ::= SEQUENCE {
    message              UL-SHCCH-MessageType
}

UL-SHCCH-MessageType ::= CHOICE {
    puschCapacityRequest PUSCHCapacityRequest,
    extension            NULL
}

--*****
--
-- BCCH messages sent on FACH
--
--*****

BCCH-FACH-Message ::= SEQUENCE {
    message              BCCH-FACH-MessageType
}

BCCH-FACH-MessageType ::= CHOICE {
    systemInformation           SystemInformation-FACH,
    systemInformationChangeIndication SystemInformationChangeIndication,
    extension                    NULL
}

```

```

--*****
--
-- BCCH messages sent on BCH
--
--*****

BCCH-BCH-Message ::= SEQUENCE {
    message          SystemInformation-BCH
}

END

```

11.2 PDU definitions

```

--*****
--
-- TABULAR: The message type and integrity check info are not
-- visible in this module as they are defined in the class module.
-- Also, all FDD/TDD specific choices have the FDD option first
-- and TDD second, just for consistency.
--
--*****

PDU-definitions DEFINITIONS AUTOMATIC TAGS ::=

BEGIN

--*****
--
-- IE parameter types from other modules
--
--*****

IMPORTS

-- Core Network IEs :
    CN-DomainIdentity,
    CN-InformationInfo,
    CN-InformationInfoFull,
    NAS-Message,
    PagingRecordTypeID,
-- UTRAN Mobility IEs :
    URA-Identity,
-- User Equipment IEs :
    ActivationTime,
    C-RNTI,
    CapabilityUpdateRequirement,
    CellUpdateCause,
    CipheringAlgorithm,
    CipheringModeInfo,
    EstablishmentCause,
    FailureCauseWithProtErr,
    FailureCauseWithProtErrTrId,
    InitialUE-Identity,
    IntegrityProtActivationInfo,
    IntegrityProtectionModeInfo,
    N-308,
    PagingCause,
    PagingRecordList,
    ProtocolErrorIndicator,
    ProtocolErrorIndicatorWithMoreInfo,
    Rb-timer-indicator,
    RedirectionInfo,
    RejectionCause,
    ReleaseCause,
    RRC-StateIndicator,
    RRC-TransactionIdentifier,
    SecurityCapability,
    START-Value,
    STARTList,
    U-RNTI,
    U-RNTI-Short,
    UE-RadioAccessCapability,
    UE-RadioAccessCapability-v370ext,
    UE-RadioAccessCapability-v380ext,
    DL-PhysChCapabilityFDD-v380ext,
    UE-ConnTimersAndConstants,

```



```
    URA-UpdateCause,
    UTRAN-DRX-CycleLengthCoefficient,
    WaitTime,
-- Radio Bearer IEs :
    DefaultConfigIdentity,
    DefaultConfigMode,
    DL-CounterSynchronisationInfo,
    PredefinedConfigIdentity,
    RAB-Info,
    RAB-Info-Post,
    RAB-InformationList,
    RAB-InformationReconfigList,
    RAB-InformationSetupList,
    RB-ActivationTimeInfoList,
    RB-COUNT-C-InformationList,
    RB-COUNT-C-MSB-InformationList,
    RB-IdentityList,
    RB-InformationAffectedList,
    RB-InformationReconfigList,
    RB-InformationReleaseList,
    SRB-InformationSetupList,
    SRB-InformationSetupList2,
    UL-CounterSynchronisationInfo,
-- Transport Channel IEs:
    CPCH-SetID,
    DL-AddReconfTransChInfo2List,
    DL-AddReconfTransChInfoList,
    DL-CommonTransChInfo,
    DL-DeletedTransChInfoList,
    DRAC-StaticInformationList,
    TFC-Subset,
    TFCS-Identity,
    UL-AddReconfTransChInfoList,
    UL-CommonTransChInfo,
    UL-DeletedTransChInfoList,
-- Physical Channel IEs :
    Alpha,
    CCTrCH-PowerControlInfo,
    ConstantValue,
    CPCH-SetInfo,
    DL-CommonInformation,
    DL-CommonInformationPost,
    DL-InformationPerRL,
    DL-InformationPerRL-List,
    DL-InformationPerRL-ListPostFDD,
    DL-InformationPerRL-PostTDD,
    DL-PDSCH-Information,
    DPCH-CompressedModeStatusInfo,
    FrequencyInfo,
    FrequencyInfoFDD,
    FrequencyInfoTDD,
    MaxAllowedUL-TX-Power,
    PDSCH-CapacityAllocationInfo,
    PDSCH-Identity,
    PrimaryCCPCH-TX-Power,
    PUSCH-CapacityAllocationInfo,
    PUSCH-Identity,
    RL-AdditionInformationList,
    RL-RemovalInformationList,
    SpecialBurstScheduling,
    SSDT-Information,
    TFC-ControlDuration,
    TimeslotList,
    TX-DiversityMode,
    UL-ChannelRequirement,
    UL-ChannelRequirementWithCPCH-SetID,
    UL-DPCH-Info,
    UL-DPCH-InfoPostFDD,
    UL-DPCH-InfoPostTDD,
    UL-TimingAdvance,
    UL-TimingAdvanceControl,
-- Measurement IEs :
    AdditionalMeasurementID-List,
    Frequency-Band,
    EventResults,
    InterRAT-TargetCellDescription,
    MeasuredResults,
    MeasuredResultsList,
```

```

    MeasuredResultsOnRACH,
    MeasurementCommand,
    MeasurementIdentity,
    MeasurementReportingMode,
    PrimaryCCPCH-RSCP,
    TimeslotListWithISCP,
    TrafficVolumeMeasuredResultsList,
    UE-Positioning-GPS-AssistanceData,
    UE-Positioning-OTDOA-AssistanceData,
-- Other IEs :
    BCCH-ModificationInfo,
    CDMA2000-MessageList,
    GSM-MessageList,
    InterRAT-ChangeFailureCause,
    InterRAT-HO-FailureCause,
    InterRAT-UE-RadioAccessCapabilityList,
    InterRAT-UE-SecurityCapList,
    IntraDomainNasNodeSelector,
    ProtocolErrorMoreInformation,
    Rplmn-Information,
    SegCount,
    SegmentIndex,
    SFN-Prime,
    SIB-Data-fixed,
    SIB-Data-variable,
    SIB-Type
FROM InformationElements

    maxSIBperMsg
FROM Constant-definitions;

-- *****
--
-- ACTIVE SET UPDATE (FDD only)
--
-- *****

ActiveSetUpdate ::= CHOICE {
    r3                               SEQUENCE {
        activeSetUpdate-r3           ActiveSetUpdate-r3-IEs,
        nonCriticalExtensions         SEQUENCE {} OPTIONAL
    },
    later-than-r3                    SEQUENCE {
        rrc-TransactionIdentifier     RRC-TransactionIdentifier,
        criticalExtensions             SEQUENCE {}
    }
}

ActiveSetUpdate-r3-IEs ::= SEQUENCE {
-- User equipment IEs
    rrc-TransactionIdentifier         RRC-TransactionIdentifier,
    integrityProtectionModeInfo      IntegrityProtectionModeInfo    OPTIONAL,
    cipheringModeInfo                CipheringModeInfo              OPTIONAL,
    activationTime                    ActivationTime                    OPTIONAL,
    newU-RNTI                         U-RNTI                          OPTIONAL,
-- Core network IEs
    cn-InformationInfo                CN-InformationInfo            OPTIONAL,
-- Radio bearer IEs
    dl-CounterSynchronisationInfo     DL-CounterSynchronisationInfo   OPTIONAL,
-- Physical channel IEs
    maxAllowedUL-TX-Power              MaxAllowedUL-TX-Power          OPTIONAL,
    rl-AdditionInformationList         RL-AdditionInformationList     OPTIONAL,
    rl-RemovalInformationList         RL-RemovalInformationList     OPTIONAL,
    tx-DiversityMode                  TX-DiversityMode              OPTIONAL,
    ssdt-Information                  SSDT-Information              OPTIONAL
}

-- *****
--
-- ACTIVE SET UPDATE COMPLETE (FDD only)
--
-- *****

ActiveSetUpdateComplete ::= SEQUENCE {
-- User equipment IEs
    rrc-TransactionIdentifier         RRC-TransactionIdentifier,
    ul-IntegProtActivationInfo        IntegrityProtActivationInfo     OPTIONAL,
-- Radio bearer IEs
    rb-UL-CiphActivationTimeInfo      RB-ActivationTimeInfoList     OPTIONAL,

```

```

        ul-CounterSynchronisationInfo    UL-CounterSynchronisationInfo    OPTIONAL,
-- Extension mechanism for non- release99 information
        nonCriticalExtensions            SEQUENCE {} OPTIONAL
    }
-- *****
--
-- ACTIVE SET UPDATE FAILURE (FDD only)
--
-- *****

ActiveSetUpdateFailure ::= SEQUENCE {
    -- User equipment IEs
    rrc-TransactionIdentifier            RRC-TransactionIdentifier,
    failureCause                         FailureCauseWithProtErr,
    -- Extension mechanism for non- release99 information
    nonCriticalExtensions                SEQUENCE {} OPTIONAL
}
-- *****
--
-- Assistance Data Delivery
--
-- *****

AssistanceDataDelivery ::= CHOICE {
    r3                                    SEQUENCE {
        assistanceDataDelivery-r3        AssistanceDataDelivery-r3-IEs,
        nonCriticalExtensions            SEQUENCE {} OPTIONAL
    },
    later-than-r3                        SEQUENCE {
        rrc-TransactionIdentifier        RRC-TransactionIdentifier,
        criticalExtensions                SEQUENCE {}
    }
}

AssistanceDataDelivery-r3-IEs ::= SEQUENCE {
    -- User equipment IEs
    rrc-TransactionIdentifier            RRC-TransactionIdentifier,
    -- Measurement Information Elements
    ue-positioning-GPS-AssistanceData    UE-Positioning-GPS-AssistanceData
    OPTIONAL,
    ue-positioning-OTDOA-AssistanceData  UE-Positioning-OTDOA-AssistanceData    OPTIONAL
}
-- *****
--
-- CELL CHANGE ORDER FROM UTRAN
--
-- *****

CellChangeOrderFromUTRAN ::= CHOICE {
    r3                                    SEQUENCE {
        cellChangeOrderFromUTRAN-IEs    CellChangeOrderFromUTRAN-r3-IEs,
        nonCriticalExtensions            SEQUENCE {} OPTIONAL
    },
    later-than-r3                        SEQUENCE {
        rrc-TransactionIdentifier        RRC-TransactionIdentifier,
        criticalExtensions                SEQUENCE {}
    }
}

CellChangeOrderFromUTRAN-r3-IEs ::= SEQUENCE {
    -- User equipment IEs
    rrc-TransactionIdentifier            RRC-TransactionIdentifier,
    -- not used in this release of the specification
    dummy                                IntegrityProtectionModeInfo    OPTIONAL,
    activationTime                       ActivationTime                OPTIONAL,
    rab-InformationList                  RAB-InformationList          OPTIONAL,
    interRAT-TargetCellDescription      InterRAT-TargetCellDescription
}
-- *****
--
-- CELL CHANGE ORDER FROM UTRAN FAILURE
--
-- *****

```

```

CellChangeOrderFromUTRANFailure ::= CHOICE {
  r3
    SEQUENCE {
      cellChangeOrderFromUTRANFailure-r3
      nonCriticalExtensions
    },
  dummy
    SEQUENCE {
      rrc-TransactionIdentifier
      criticalExtensions
    }
}

CellChangeOrderFromUTRANFailure-r3-IEs ::= SEQUENCE {
  -- User equipment IEs
  rrc-TransactionIdentifier
  -- not used in this release of the specification
  dummy
  interRAT-ChangeFailureCause
}

-- *****
--
-- CELL UPDATE
--
-- *****

CellUpdate ::= SEQUENCE {
  -- User equipment IEs
  u-RNTI
  startList
  am-RLC-ErrorIndicationRb2-3or4
  am-RLC-ErrorIndicationRb5orAbove
  cellUpdateCause
  failureCause
  -- TABULAR: RRC transaction identifier is nested in FailureCauseWithProtErrTrId
  rb-timer-indicator
  -- Measurement IEs
  measuredResultsOnRACH
  -- Extension mechanism for non- release99 information
  nonCriticalExtensions
}

-- *****
--
-- CELL UPDATE CONFIRM
--
-- *****

CellUpdateConfirm ::= CHOICE {
  r3
    SEQUENCE {
      cellUpdateConfirm-r3
      nonCriticalExtensions
    },
  later-than-r3
    SEQUENCE {
      rrc-TransactionIdentifier
      criticalExtensions
    }
}

CellUpdateConfirm-r3-IEs ::= SEQUENCE {
  -- User equipment IEs
  rrc-TransactionIdentifier
  integrityProtectionModeInfo
  cipheringModeInfo
  activationTime
  new-U-RNTI
  new-C-RNTI
  rrc-StateIndicator
  utran-DRX-CycleLengthCoeff
  rlc-Re-establishIndicatorRb2-3or4
  rlc-Re-establishIndicatorRb5orAbove
  -- CN information elements
  cn-InformationInfo
  -- UTRAN mobility IEs
  ura-Identity
  -- Radio bearer IEs
  rb-InformationReleaseList
}

```

```

        rb-InformationReconfigList      RB-InformationReconfigList      OPTIONAL,
        rb-InformationAffectedList      RB-InformationAffectedList      OPTIONAL,
        dl-CounterSynchronisationInfo  DL-CounterSynchronisationInfo  OPTIONAL,
-- Transport channel IEs
        ul-CommonTransChInfo           UL-CommonTransChInfo           OPTIONAL,
        ul-deletedTransChInfoList      UL-DeletedTransChInfoList      OPTIONAL,
        ul-AddReconfTransChInfoList    UL-AddReconfTransChInfoList    OPTIONAL,
        modeSpecificTransChInfo        CHOICE {
            fdd                         SEQUENCE {
                cpch-SetID              CPCH-SetID                      OPTIONAL,
                addReconfTransChDRAC-Info DRAC-StaticInformationList    OPTIONAL
            },
            tdd                          NULL
        },
        dl-CommonTransChInfo           DL-CommonTransChInfo           OPTIONAL,
        dl-DeletedTransChInfoList      DL-DeletedTransChInfoList      OPTIONAL,
        dl-AddReconfTransChInfoList    DL-AddReconfTransChInfoList    OPTIONAL,
-- Physical channel IEs
        frequencyInfo                  FrequencyInfo                    OPTIONAL,
        maxAllowedUL-TX-Power           MaxAllowedUL-TX-Power          OPTIONAL,
        ul-ChannelRequirement           UL-ChannelRequirement          OPTIONAL,
        modeSpecificPhysChInfo         CHOICE {
            fdd                         SEQUENCE {
                dl-PDSCH-Information    DL-PDSCH-Information            OPTIONAL
            },
            tdd                          NULL
        },
        dl-CommonInformation            DL-CommonInformation           OPTIONAL,
        dl-InformationPerRL-List        DL-InformationPerRL-List       OPTIONAL
    }
}

```

```

-- *****
--
-- CELL UPDATE CONFIRM for CCCH
--
-- *****

```

```

CellUpdateConfirm-CCCH ::= CHOICE {
    r3                               SEQUENCE {
        -- User equipment IEs
        u-RNTI                        U-RNTI,
        -- The rest of the message is identical to the one sent on DCCH.

        cellUpdateConfirm-r3          CellUpdateConfirm-r3-IEs,
        nonCriticalExtensions          SEQUENCE {} OPTIONAL
    },
    later-than-r3                    SEQUENCE {
        rrc-TransactionIdentifier      RRC-TransactionIdentifier,
        criticalExtensions              SEQUENCE {}
    }
}

```

```

-- *****
--
-- COUNTER CHECK
--
-- *****

```

```

CounterCheck ::= CHOICE {
    r3                               SEQUENCE {
        counterCheck-r3               CounterCheck-r3-IEs,
        nonCriticalExtensions          SEQUENCE {} OPTIONAL
    },
    later-than-r3                    SEQUENCE {
        rrc-TransactionIdentifier      RRC-TransactionIdentifier,
        criticalExtensions              SEQUENCE {}
    }
}

```

```

CounterCheck-r3-IEs ::= SEQUENCE {
    -- User equipment IEs
    rrc-TransactionIdentifier          RRC-TransactionIdentifier,
    -- Radio bearer IEs
    rb-COUNT-C-MSB-InformationList     RB-COUNT-C-MSB-InformationList
}

```

```

-- *****
--

```

```

-- COUNTER CHECK RESPONSE
--
-- *****

CounterCheckResponse ::= SEQUENCE {
  -- User equipment IEs
  rrc-TransactionIdentifier      RRC-TransactionIdentifier,
  -- Radio bearer IEs
  rb-COUNT-C-InformationList     RB-COUNT-C-InformationList      OPTIONAL,
  -- Extension mechanism for non- release99 information
  nonCriticalExtensions          SEQUENCE {} OPTIONAL
}

-- *****
--
-- DOWNLINK DIRECT TRANSFER
--
-- *****

DownlinkDirectTransfer ::= CHOICE {
  r3                             SEQUENCE {
    downlinkDirectTransfer-r3    DownlinkDirectTransfer-r3-IEs,
    nonCriticalExtensions        SEQUENCE {} OPTIONAL
  },
  later-than-r3                 SEQUENCE {
    rrc-TransactionIdentifier     RRC-TransactionIdentifier,
    criticalExtensions           SEQUENCE {}
  }
}

DownlinkDirectTransfer-r3-IEs ::= SEQUENCE {
  -- User equipment IEs
  rrc-TransactionIdentifier      RRC-TransactionIdentifier,
  -- Core network IEs
  cn-DomainIdentity             CN-DomainIdentity,
  nas-Message                   NAS-Message
}

-- *****
--
-- HANDOVER TO UTRAN COMMAND
--
-- *****

HandoverToUTRANCommand ::= CHOICE {
  r3                             SEQUENCE {
    handoverToUTRANCommand-r3    HandoverToUTRANCommand-r3-IEs,
    nonCriticalExtensions        SEQUENCE {} OPTIONAL
  },
  criticalExtensions            SEQUENCE {}
}

HandoverToUTRANCommand-r3-IEs ::= SEQUENCE {
  -- User equipment IEs
  new-U-RNTI                    U-RNTI-Short,
  -- Activation time is not used in this version of specification.
  dummy                          ActivationTime                OPTIONAL,
  cipheringAlgorithm             CipheringAlgorithm           OPTIONAL,
  -- Radio bearer IEs
  -- Specification mode information
  specificationMode              CHOICE {
    complete                     SEQUENCE {
      srb-InformationSetupList    SRB-InformationSetupList,
      rab-InformationSetupList    RAB-InformationSetupList      OPTIONAL,
      ul-CommonTransChInfo       UL-CommonTransChInfo,
      ul-AddReconfTransChInfoList UL-AddReconfTransChInfoList,
      dl-CommonTransChInfo       DL-CommonTransChInfo,
      dl-AddReconfTransChInfoList DL-AddReconfTransChInfoList,
      ul-DPCH-Info               UL-DPCH-Info,
      modeSpecificInfo           CHOICE {
        fdd                       SEQUENCE {
          dl-PDSCH-Information    DL-PDSCH-Information OPTIONAL,
          cpch-SetInfo            CPCH-SetInfo          OPTIONAL
        },
        tdd                       NULL
      },
      dl-CommonInformation       DL-CommonInformation,
    },
  },
  dl-CommonInformation           DL-CommonInformation,
}

```

```

        dl-InformationPerRL-List      DL-InformationPerRL-List,
        frequencyInfo                FrequencyInfo
    },
    preconfiguration                  SEQUENCE {
-- All IEs that include an FDD/TDD choice are split in two IEs for this message,
-- one for the FDD only elements and one for the TDD only elements, so that one
-- FDD/TDD choice in this level is sufficient.
        preConfigMode                CHOICE {
            predefinedConfigIdentity  PredefinedConfigIdentity,
            defaultConfig              SEQUENCE {
                defaultConfigMode     DefaultConfigMode,
                defaultConfigIdentity DefaultConfigIdentity
            }
        },
        rab-Info                      RAB-Info-Post      OPTIONAL,
        modeSpecificInfo              CHOICE {
            fdd                        SEQUENCE {
                ul-DPCH-Info           UL-DPCH-InfoPostFDD,
                dl-CommonInformationPost DL-CommonInformationPost,
                dl-InformationPerRL-List DL-InformationPerRL-ListPostFDD,
                frequencyInfo          FrequencyInfoFDD
            },
            tdd                        SEQUENCE {
                ul-DPCH-Info           UL-DPCH-InfoPostTDD,
                dl-CommonInformationPost DL-CommonInformationPost,
                dl-InformationPerRL     DL-InformationPerRL-PostTDD,
                frequencyInfo          FrequencyInfoTDD,
                primaryCCPCH-TX-Power  PrimaryCCPCH-TX-Power
            }
        }
    }
},
-- Physical channel IEs
    maxAllowedUL-TX-Power            MaxAllowedUL-TX-Power
}

-- *****
--
-- HANDOVER TO UTRAN COMPLETE
--
-- *****

HandoverToUTRANComplete ::= SEQUENCE {
--TABULAR: Integrity protection shall not be performed on this message.
-- User equipment IEs
-- TABULAR: the IE below is conditional on history.
    startList                        STARTList                OPTIONAL,
-- Radio bearer IEs
    count-C-ActivationTime           ActivationTime         OPTIONAL,
-- Extension mechanism for non- release99 information
    nonCriticalExtensions             SEQUENCE {}          OPTIONAL
}

-- *****
--
-- INITIAL DIRECT TRANSFER
--
-- *****

InitialDirectTransfer ::= SEQUENCE {
-- Core network IEs
    cn-DomainIdentity                CN-DomainIdentity,
    intraDomainNasNodeSelector       IntraDomainNasNodeSelector,
    nas-Message                       NAS-Message,
-- Measurement IEs
    measuredResultsOnRACH             MeasuredResultsOnRACH    OPTIONAL,
-- Extension mechanism for non- release99 information
    nonCriticalExtensions             SEQUENCE {}          OPTIONAL
}

-- *****
--
-- HANDOVER FROM UTRAN COMMAND
--
-- *****

HandoverFromUTRANCommand-GSM ::= CHOICE {

```

```

r3
  SEQUENCE {
    handoverFromUTRANCommand-GSM-r3
    nonCriticalExtensions
  },
  later-than-r3
    SEQUENCE {
      rrc-TransactionIdentifier
      criticalExtensions
    }
}

HandoverFromUTRANCommand-GSM-r3-IEs ::= SEQUENCE {
  -- User equipment IEs
  rrc-TransactionIdentifier
  activationTime
  -- Radio bearer IEs
  toHandoverRAB-Info
  -- Measurement IEs
  frequency-band
  -- Other IEs
  gsm-message
    CHOICE {
      single-GSM-Message
      -- In this case, what follows the basic production is a variable length bit string
      -- with no length field, containing the GSM message including GSM padding up to end
      -- of container, to be analysed according to GSM specifications
      gsm-MessageList
      gsm-Messages
    }
}

HandoverFromUTRANCommand-CDMA2000 ::= CHOICE {
  r3
    SEQUENCE {
      handoverFromUTRANCommand-CDMA2000-r3
      nonCriticalExtensions
    },
  later-than-r3
    SEQUENCE {
      rrc-TransactionIdentifier
      criticalExtensions
    }
}

HandoverFromUTRANCommand-CDMA2000-r3-IEs ::= SEQUENCE {
  -- User equipment IEs
  rrc-TransactionIdentifier
  activationTime
  -- Radio bearer IEs
  toHandoverRAB-Info
  -- Other IEs
  cdma2000-MessageList
}

-- *****
--
-- HANDOVER FROM UTRAN FAILURE
--
-- *****

HandoverFromUTRANFailure ::= SEQUENCE {
  -- User equipment IEs
  rrc-TransactionIdentifier
  -- Other IEs
  interRAT-HO-FailureCause
  interRATMessage
    CHOICE {
      gsm
        SEQUENCE {
          gsm-MessageList
        },
      cdma2000
        SEQUENCE {
          cdma2000-MessageList
        }
    }
  },
  nonCriticalExtensions
}

-- *****
--

```



```

-- MEASUREMENT CONTROL
--
-- *****

MeasurementControl ::= CHOICE {
  r3
    measurementControl-r3      SEQUENCE {
      measurementControl-r3-IEs,
      nonCriticalExtensions     SEQUENCE {} OPTIONAL
    },
  later-than-r3
    rrc-TransactionIdentifier   SEQUENCE {
      RRC-TransactionIdentifier,
      criticalExtensions        SEQUENCE {}
    }
}

MeasurementControl-r3-IEs ::= SEQUENCE {
  -- User equipment IEs
  rrc-TransactionIdentifier     RRC-TransactionIdentifier,
  -- Measurement IEs
  measurementIdentity          MeasurementIdentity,
  measurementCommand           MeasurementCommand,
  -- TABULAR: The measurement type is included in MeasurementCommand.
  measurementReportingMode     MeasurementReportingMode OPTIONAL,
  additionalMeasurementList    AdditionalMeasurementID-List OPTIONAL,
  -- Physical channel IEs
  dpch-CompressedModeStatusInfo DPCH-CompressedModeStatusInfo OPTIONAL
}

-- *****
--
-- MEASUREMENT CONTROL FAILURE
--
-- *****

MeasurementControlFailure ::= SEQUENCE {
  -- User equipment IEs
  rrc-TransactionIdentifier     RRC-TransactionIdentifier,
  failureCause                 FailureCauseWithProtErr,
  -- Extension mechanism for non- release99 information
  nonCriticalExtensions        SEQUENCE {} OPTIONAL
}

-- *****
--
-- MEASUREMENT REPORT
--
-- *****

MeasurementReport ::= SEQUENCE {
  -- Measurement IEs
  measurementIdentity          MeasurementIdentity,
  measuredResults              MeasuredResults OPTIONAL,
  measuredResultsOnRACH       MeasuredResultsOnRACH OPTIONAL,
  additionalMeasuredResults    MeasuredResultsList OPTIONAL,
  eventResults                 EventResults OPTIONAL,
  -- Extension mechanism for non- release99 information
  nonCriticalExtensions        SEQUENCE {} OPTIONAL
}

-- *****
--
-- PAGING TYPE 1
--
-- *****

PagingType1 ::= SEQUENCE {
  -- User equipment IEs
  pagingRecordList             PagingRecordList OPTIONAL,
  -- Other IEs
  bcch-ModificationInfo       BCCH-ModificationInfo OPTIONAL,
  -- Extension mechanism for non- release99 information
  nonCriticalExtensions        SEQUENCE {} OPTIONAL
}

-- *****
--
-- PAGING TYPE 2
--

```

```

-- *****
PagingType2 ::= SEQUENCE {
  -- User equipment IEs
  rrc-TransactionIdentifier      RRC-TransactionIdentifier,
  pagingCause                    PagingCause,
  -- Core network IEs
  cn-DomainIdentity              CN-DomainIdentity,
  pagingRecordTypeID             PagingRecordTypeID,
  -- Extension mechanism for non- release99 information
  nonCriticalExtensions          SEQUENCE {} OPTIONAL
}

-- *****
--
-- PHYSICAL CHANNEL RECONFIGURATION
--
-- *****

PhysicalChannelReconfiguration ::= CHOICE {
  r3                             SEQUENCE {
    physicalChannelReconfiguration-r3
    nonCriticalExtensions        SEQUENCE {} OPTIONAL
  },
  later-than-r3                 SEQUENCE {
    rrc-TransactionIdentifier    RRC-TransactionIdentifier,
    criticalExtensions           SEQUENCE {}
  }
}

PhysicalChannelReconfiguration-r3-IEs ::= SEQUENCE {
  -- User equipment IEs
  rrc-TransactionIdentifier      RRC-TransactionIdentifier,
  integrityProtectionModeInfo   IntegrityProtectionModeInfo      OPTIONAL,
  cipheringModeInfo             CipheringModeInfo                OPTIONAL,
  activationTime                 ActivationTime                    OPTIONAL,
  new-U-RNTI                    U-RNTI                          OPTIONAL,
  new-C-RNTI                    C-RNTI                          OPTIONAL,
  rrc-StateIndicator            RRC-StateIndicator,
  utran-DRX-CycleLengthCoeff    UTRAN-DRX-CycleLengthCoefficient  OPTIONAL,
  -- Core network IEs
  cn-InformationInfo            CN-InformationInfo                OPTIONAL,
  -- UTRAN mobility IEs
  ura-Identity                  URA-Identity                    OPTIONAL,
  -- Radio bearer IEs
  dl-CounterSynchronisationInfo DL-CounterSynchronisationInfo  OPTIONAL,
  -- Physical channel IEs
  frequencyInfo                 FrequencyInfo                  OPTIONAL,
  maxAllowedUL-TX-Power         MaxAllowedUL-TX-Power          OPTIONAL,
  ul-ChannelRequirement         UL-ChannelRequirementWithCPCH-SetID  OPTIONAL,
  -- TABULAR: UL-ChannelRequirementWithCPCH-SetID contains the choice
  -- between UL DPCH info, CPCH SET info and CPCH set ID.
  modeSpecificInfo              CHOICE {
    fdd                          SEQUENCE {
      dl-PDSCH-Information      DL-PDSCH-Information      OPTIONAL
    },
    tdd                          NULL
  },
  dl-CommonInformation          DL-CommonInformation          OPTIONAL,
  dl-InformationPerRL-List     DL-InformationPerRL-List     OPTIONAL
}

-- *****
--
-- PHYSICAL CHANNEL RECONFIGURATION COMPLETE
--
-- *****

PhysicalChannelReconfigurationComplete ::= SEQUENCE {
  -- User equipment IEs
  rrc-TransactionIdentifier      RRC-TransactionIdentifier,
  ul-IntegProtActivationInfo     IntegrityProtActivationInfo      OPTIONAL,
  -- TABULAR: UL-TimingAdvance is applicable for TDD mode only.
  ul-TimingAdvance              UL-TimingAdvance                OPTIONAL,
  -- Radio bearer IEs
  count-C-ActivationTime        ActivationTime                    OPTIONAL,
  rb-UL-CiphActivationTimeInfo  RB-ActivationTimeInfoList      OPTIONAL,
}

```

```

        ul-CounterSynchronisationInfo  UL-CounterSynchronisationInfo      OPTIONAL,
-- Extension mechanism for non- release99 information
        nonCriticalExtensions          SEQUENCE {}      OPTIONAL
    }
-- *****
--
-- PHYSICAL CHANNEL RECONFIGURATION FAILURE
--
-- *****

PhysicalChannelReconfigurationFailure ::= SEQUENCE {
-- User equipment IEs
    rrc-TransactionIdentifier          RRC-TransactionIdentifier          OPTIONAL,
    failureCause                       FailureCauseWithProtErr,
-- Extension mechanism for non- release99 information
    nonCriticalExtensions              SEQUENCE {}      OPTIONAL
}
-- *****
--
-- PHYSICAL SHARED CHANNEL ALLOCATION (TDD only)
--
-- *****

PhysicalSharedChannelAllocation ::= CHOICE {
    r3                                  SEQUENCE {
        physicalSharedChannelAllocation-r3
        PhysicalSharedChannelAllocation-r3-IEs,
        nonCriticalExtensions          SEQUENCE {}      OPTIONAL
    },
    later-than-r3                       SEQUENCE {
        rrc-TransactionIdentifier      RRC-TransactionIdentifier,
        criticalExtensions              SEQUENCE {}
    }
}

PhysicalSharedChannelAllocation-r3-IEs ::= SEQUENCE {
-- TABULAR: Integrity protection shall not be performed on this message.
-- User equipment IEs
    c-RNTI                             C-RNTI                             OPTIONAL,
    rrc-TransactionIdentifier            RRC-TransactionIdentifier,
-- Physical channel IEs
    ul-TimingAdvance                    UL-TimingAdvanceControl             OPTIONAL,
    pusch-CapacityAllocationInfo         PUSCH-CapacityAllocationInfo       OPTIONAL,
    pdsch-CapacityAllocationInfo         PDSCH-CapacityAllocationInfo       OPTIONAL,
    confirmRequest                       ENUMERATED {
        confirmPDSCH, confirmPUSCH }  OPTIONAL,
-- TABULAR: If the above value is not present, the default value "No Confirm"
-- shall be used as specified in 10.2.25.
    trafficVolumeReportRequest          INTEGER (0..255)                    OPTIONAL,
    iscpTimeslotList                    TimeslotList                        OPTIONAL,
    requestPCCPCHRSCP                   BOOLEAN
}
-- *****
--
-- PUSCH CAPACITY REQUEST (TDD only)
--
-- *****

PUSCHCapacityRequest ::= SEQUENCE {
-- User equipment IEs
    c-RNTI                             C-RNTI                             OPTIONAL,
-- Measurement IEs
    trafficVolume                        TrafficVolumeMeasuredResultsList    OPTIONAL,
    timeslotListWithISCP                 TimeslotListWithISCP                OPTIONAL,
    primaryCCPCH-RSCP                   PrimaryCCPCH-RSCP                   OPTIONAL,
    allocationConfirmation               CHOICE {
        pdschConfirmation              PDSCH-Identity,
        puschConfirmation               PUSCH-Identity
    }                                  OPTIONAL,
    protocolErrorIndicator                ProtocolErrorIndicatorWithMoreInfo,
-- Extension mechanism for non- release99 information
    nonCriticalExtensions                SEQUENCE {}      OPTIONAL
}
-- *****

```

```

--
-- RADIO BEARER RECONFIGURATION
--
-- *****

RadioBearerReconfiguration ::= CHOICE {
  r3                               SEQUENCE {
    radioBearerReconfiguration-r3  RadioBearerReconfiguration-r3-IEs,
    nonCriticalExtensions           SEQUENCE {} OPTIONAL
  },
  later-than-r3                   SEQUENCE {
    rrc-TransactionIdentifier      RRC-TransactionIdentifier,
    criticalExtensions             SEQUENCE {}
  }
}

RadioBearerReconfiguration-r3-IEs ::= SEQUENCE {
  -- User equipment IES
  rrc-TransactionIdentifier      RRC-TransactionIdentifier,
  integrityProtectionModeInfo    IntegrityProtectionModeInfo      OPTIONAL,
  cipheringModeInfo             CipheringModeInfo                OPTIONAL,
  activationTime                 ActivationTime                  OPTIONAL,
  new-U-RNTI                     U-RNTI                         OPTIONAL,
  new-C-RNTI                     C-RNTI                         OPTIONAL,
  rrc-StateIndicator             RRC-StateIndicator,
  utran-DRX-CycleLengthCoeff    UTRAN-DRX-CycleLengthCoefficient  OPTIONAL,
  -- Core network IES
  cn-InformationInfo             CN-InformationInfo              OPTIONAL,
  -- UTRAN mobility IES
  ura-Identity                   URA-Identity                    OPTIONAL,
  -- Radio bearer IES
  rab-InformationReconfigList    RAB-InformationReconfigList  OPTIONAL,
  rb-InformationReconfigList     RB-InformationReconfigList,
  -- NOTE: IE rb-InformationReconfigList should be optional in later versions of this message
  rb-InformationAffectedList     RB-InformationAffectedList   OPTIONAL,
  -- Transport channel IES
  ul-CommonTransChInfo          UL-CommonTransChInfo        OPTIONAL,
  ul-deletedTransChInfoList     UL-DeletedTransChInfoList   OPTIONAL,
  ul-AddReconfTransChInfoList   UL-AddReconfTransChInfoList  OPTIONAL,
  modeSpecificTransChInfo       CHOICE {
    fdd                           SEQUENCE {
      cpch-SetID                  CPCH-SetID                  OPTIONAL,
      addReconfTransChDRAC-Info   DRAC-StaticInformationList  OPTIONAL
    },
    tdd                            NULL
  } OPTIONAL,
  dl-CommonTransChInfo          DL-CommonTransChInfo        OPTIONAL,
  dl-DeletedTransChInfoList     DL-DeletedTransChInfoList   OPTIONAL,
  dl-AddReconfTransChInfoList   DL-AddReconfTransChInfo2List  OPTIONAL,
  -- Physical channel IES
  frequencyInfo                 FrequencyInfo                OPTIONAL,
  maxAllowedUL-TX-Power         MaxAllowedUL-TX-Power      OPTIONAL,
  ul-ChannelRequirement         UL-ChannelRequirement      OPTIONAL,
  modeSpecificPhysChInfo        CHOICE {
    fdd                           SEQUENCE {
      dl-PDSCH-Information        DL-PDSCH-Information        OPTIONAL
    },
    tdd                            NULL
  },
  dl-CommonInformation          DL-CommonInformation        OPTIONAL,
  dl-InformationPerRL-List      DL-InformationPerRL-List
  -- NOTE: IE dl-InformationPerRL-List should be optional in later versions of this message
}

-- *****
--
-- RADIO BEARER RECONFIGURATION COMPLETE
--
-- *****

RadioBearerReconfigurationComplete ::= SEQUENCE {
  -- User equipment IES
  rrc-TransactionIdentifier      RRC-TransactionIdentifier,
  ul-IntegProtActivationInfo     IntegrityProtActivationInfo  OPTIONAL,
  -- TABULAR: UL-TimingAdvance is applicable for TDD mode only.
  ul-TimingAdvance              UL-TimingAdvance              OPTIONAL,
  -- Radio bearer IES
  count-C-ActivationTime        ActivationTime                OPTIONAL,
}

```

```

        rb-UL-CiphActivationTimeInfo    RB-ActivationTimeInfoList    OPTIONAL,
        ul-CounterSynchronisationInfo  UL-CounterSynchronisationInfo  OPTIONAL,
-- Extension mechanism for non- release99 information
        nonCriticalExtensions          SEQUENCE {} OPTIONAL
    }
-- *****
--
-- RADIO BEARER RECONFIGURATION FAILURE
--
-- *****

RadioBearerReconfigurationFailure ::= SEQUENCE {
-- User equipment IES
    rrc-TransactionIdentifier          RRC-TransactionIdentifier,
    failureCause                       FailureCauseWithProtErr,
-- Radio bearer IES
    potentiallySuccessfulBearerList    RB-IdentityList                OPTIONAL,
-- Extension mechanism for non- release99 information
    nonCriticalExtensions              SEQUENCE {} OPTIONAL
}
-- *****
--
-- RADIO BEARER RELEASE
--
-- *****

RadioBearerRelease ::= CHOICE {
    r3                                  SEQUENCE {
        radioBearerRelease-r3          RadioBearerRelease-r3-IEs,
        nonCriticalExtensions          SEQUENCE {} OPTIONAL
    },
    later-than-r3                       SEQUENCE {
        rrc-TransactionIdentifier      RRC-TransactionIdentifier,
        criticalExtensions              SEQUENCE {}
    }
}

RadioBearerRelease-r3-IEs ::= SEQUENCE {
-- User equipment IES
    rrc-TransactionIdentifier          RRC-TransactionIdentifier,
    integrityProtectionModeInfo       IntegrityProtectionModeInfo    OPTIONAL,
    cipheringModeInfo                 CipheringModeInfo              OPTIONAL,
    activationTime                     ActivationTime                  OPTIONAL,
    new-U-RNTI                         U-RNTI                        OPTIONAL,
    new-C-RNTI                         C-RNTI                        OPTIONAL,
    rrc-StateIndicator                 RRC-StateIndicator,
    utran-DRX-CycleLengthCoeff         UTRAN-DRX-CycleLengthCoefficient OPTIONAL,
-- Core network IES
    cn-InformationInfo                 CN-InformationInfo            OPTIONAL,
    signallingConnectionRelIndication  CN-DomainIdentity            OPTIONAL,
-- UTRAN mobility IES
    ura-Identity                       URA-Identity                  OPTIONAL,
-- Radio bearer IES
    rab-InformationReconfigList        RAB-InformationReconfigList    OPTIONAL,
    rb-InformationReleaseList          RB-InformationReleaseList,
    rb-InformationAffectedList         RB-InformationAffectedList     OPTIONAL,
    dl-CounterSynchronisationInfo      DL-CounterSynchronisationInfo  OPTIONAL,
-- Transport channel IES
    ul-CommonTransChInfo              UL-CommonTransChInfo          OPTIONAL,
    ul-deletedTransChInfoList          UL-DeletedTransChInfoList     OPTIONAL,
    ul-AddReconfTransChInfoList        UL-AddReconfTransChInfoList   OPTIONAL,
    modeSpecificTransChInfo            CHOICE {
        fdd                             SEQUENCE {
            cpch-SetID                  CPCH-SetID                    OPTIONAL,
            addReconfTransChDRAC-Info    DRAC-StaticInformationList    OPTIONAL
        },
        tdd                             NULL
    }
    dl-CommonTransChInfo              DL-CommonTransChInfo          OPTIONAL,
    dl-DeletedTransChInfoList          DL-DeletedTransChInfoList     OPTIONAL,
    dl-AddReconfTransChInfoList        DL-AddReconfTransChInfo2List  OPTIONAL,
-- Physical channel IES
    frequencyInfo                      FrequencyInfo                   OPTIONAL,
    maxAllowedUL-TX-Power              MaxAllowedUL-TX-Power         OPTIONAL,
    ul-ChannelRequirement              UL-ChannelRequirement         OPTIONAL,
    modeSpecificPhysChInfo             CHOICE {

```

```

        fdd                SEQUENCE {
            dl-PDSCH-Information    DL-PDSCH-Information    OPTIONAL
        },
        tdd                NULL
    },
    dl-CommonInformation    DL-CommonInformation    OPTIONAL,
    dl-InformationPerRL-List    DL-InformationPerRL-List    OPTIONAL
}

```

```

-- *****
--
-- RADIO BEARER RELEASE COMPLETE
--
-- *****

```

```

RadioBearerReleaseComplete ::= SEQUENCE {
    -- User equipment IEs
    rrc-TransactionIdentifier    RRC-TransactionIdentifier,
    ul-IntegProtActivationInfo    IntegrityProtActivationInfo    OPTIONAL,
    -- TABULAR: UL-TimingAdvance is applicable for TDD mode only.
    ul-TimingAdvance            UL-TimingAdvance    OPTIONAL,
    -- Radio bearer IEs
    count-C-ActivationTime        ActivationTime    OPTIONAL,
    rb-UL-CiphActivationTimeInfo    RB-ActivationTimeInfoList    OPTIONAL,
    ul-CounterSynchronisationInfo    UL-CounterSynchronisationInfo    OPTIONAL,
    -- Extension mechanism for non- release99 information
    nonCriticalExtensions        SEQUENCE {}    OPTIONAL
}

```

```

-- *****
--
-- RADIO BEARER RELEASE FAILURE
--
-- *****

```

```

RadioBearerReleaseFailure ::= SEQUENCE {
    -- User equipment IEs
    rrc-TransactionIdentifier    RRC-TransactionIdentifier,
    failureCause                FailureCauseWithProtErr,
    -- Radio bearer IEs
    potentiallySuccessfulBearerList    RB-IdentityList    OPTIONAL,
    -- Extension mechanism for non- release99 information
    nonCriticalExtensions        SEQUENCE {}    OPTIONAL
}

```

```

-- *****
--
-- RADIO BEARER SETUP
--
-- *****

```

```

RadioBearerSetup ::= CHOICE {
    r3                SEQUENCE {
        radioBearerSetup-r3        RadioBearerSetup-r3-IEs,
        nonCriticalExtensions        SEQUENCE {}    OPTIONAL
    },
    later-than-r3        SEQUENCE {
        rrc-TransactionIdentifier    RRC-TransactionIdentifier,
        criticalExtensions        SEQUENCE {}
    }
}

```

```

RadioBearerSetup-r3-IEs ::= SEQUENCE {
    -- User equipment IEs
    rrc-TransactionIdentifier    RRC-TransactionIdentifier,
    integrityProtectionModeInfo    IntegrityProtectionModeInfo    OPTIONAL,
    cipheringModeInfo            CipheringModeInfo    OPTIONAL,
    activationTime                ActivationTime    OPTIONAL,
    new-U-RNTI                    U-RNTI    OPTIONAL,
    new-C-RNTI                    C-RNTI    OPTIONAL,
    rrc-StateIndicator            RRC-StateIndicator,
    utran-DRX-CycleLengthCoeff    UTRAN-DRX-CycleLengthCoefficient    OPTIONAL,
    -- UTRAN mobility IEs
    ura-Identity                URA-Identity    OPTIONAL,
    -- Core network IEs
    cn-InformationInfo            CN-InformationInfo    OPTIONAL,
    -- Radio bearer IEs
    srb-InformationSetupList        SRB-InformationSetupList    OPTIONAL,
}

```

```

    rab-InformationSetupList      RAB-InformationSetupList      OPTIONAL,
    rb-InformationAffectedList    RB-InformationAffectedList    OPTIONAL,
    dl-CounterSynchronisationInfo DL-CounterSynchronisationInfo OPTIONAL,
-- Transport channel IEs
    ul-CommonTransChInfo        UL-CommonTransChInfo        OPTIONAL,
    ul-deletedTransChInfoList    UL-DeletedTransChInfoList    OPTIONAL,
    ul-AddReconfTransChInfoList  UL-AddReconfTransChInfoList  OPTIONAL,
    modeSpecificTransChInfo      CHOICE {
        fdd                      SEQUENCE {
            cpch-SetID           CPCH-SetID                   OPTIONAL,
            addReconfTransChDRAC-Info DRAC-StaticInformationList OPTIONAL
        },
        tdd                      NULL
    }
    dl-CommonTransChInfo        DL-CommonTransChInfo        OPTIONAL,
    dl-DeletedTransChInfoList    DL-DeletedTransChInfoList    OPTIONAL,
    dl-AddReconfTransChInfoList  DL-AddReconfTransChInfoList  OPTIONAL,
-- Physical channel IEs
    frequencyInfo               FrequencyInfo                 OPTIONAL,
    maxAllowedUL-TX-Power        MaxAllowedUL-TX-Power        OPTIONAL,
    ul-ChannelRequirement        UL-ChannelRequirement        OPTIONAL,
    modeSpecificPhysChInfo      CHOICE {
        fdd                      SEQUENCE {
            dl-PDSCH-Information DL-PDSCH-Information        OPTIONAL
        },
        tdd                      NULL
    },
    dl-CommonInformation        DL-CommonInformation        OPTIONAL,
    dl-InformationPerRL-List     DL-InformationPerRL-List     OPTIONAL
}

-- *****
--
-- RADIO BEARER SETUP COMPLETE
--
-- *****

RadioBearerSetupComplete ::= SEQUENCE {
-- User equipment IEs
    rrc-TransactionIdentifier    RRC-TransactionIdentifier,
    ul-IntegProtActivationInfo    IntegrityProtActivationInfo    OPTIONAL,
-- TABULAR: UL-TimingAdvance is applicable for TDD mode only.
    ul-TimingAdvance            UL-TimingAdvance              OPTIONAL,
    start-Value                 START-Value                   OPTIONAL,
-- Radio bearer IEs
    count-C-ActivationTime       ActivationTime                 OPTIONAL,
    rb-UL-CiphActivationTimeInfo  RB-ActivationTimeInfoList     OPTIONAL,
    ul-CounterSynchronisationInfo UL-CounterSynchronisationInfo OPTIONAL,
-- Extension mechanism for non- release99 information
    nonCriticalExtensions        SEQUENCE {}                   OPTIONAL
}

-- *****
--
-- RADIO BEARER SETUP FAILURE
--
-- *****

RadioBearerSetupFailure ::= SEQUENCE {
-- User equipment IEs
    rrc-TransactionIdentifier    RRC-TransactionIdentifier,
    failureCause                 FailureCauseWithProtErr,
-- Radio bearer IEs
    potentiallySuccessfulBearerList RB-IdentityList              OPTIONAL,
-- Extension mechanism for non- release99 information
    nonCriticalExtensions        SEQUENCE {}                   OPTIONAL
}

-- *****
--
-- RRC CONNECTION REJECT
--
-- *****

RRCConnectionReject ::= CHOICE {
    r3                            SEQUENCE {
        rrcConnectionReject-r3    RRCConnectionReject-r3-IEs,
        nonCriticalExtensions      SEQUENCE {}                   OPTIONAL
    }
}

```

```

    },
    later-than-r3          SEQUENCE {
        rrc-TransactionIdentifier  RRC-TransactionIdentifier,
        criticalExtensions          SEQUENCE {}
    }
}

RRCCConnectionReject-r3-IEs ::= SEQUENCE {
    -- TABULAR: Integrity protection shall not be performed on this message.
    -- User equipment IEs
        initialUE-Identity          InitialUE-Identity,
        rrc-TransactionIdentifier    RRC-TransactionIdentifier,
        rejectionCause              RejectionCause,
        waitTime                    WaitTime,
        redirectionInfo              RedirectionInfo              OPTIONAL
}

-- *****
--
-- RRC CONNECTION RELEASE
--
-- *****

RRCCConnectionRelease ::= CHOICE {
    r3          SEQUENCE {
        rrcConnectionRelease-r3          RRCCConnectionRelease-r3-IEs,
        nonCriticalExtensions             SEQUENCE {} OPTIONAL
    },
    later-than-r3          SEQUENCE {
        rrc-TransactionIdentifier    RRC-TransactionIdentifier,
        criticalExtensions            SEQUENCE {}
    }
}

RRCCConnectionRelease-r3-IEs ::= SEQUENCE {
    -- User equipment IEs
        rrc-TransactionIdentifier    RRC-TransactionIdentifier,
        n-308                        N-308                                OPTIONAL,
        -- The IE above is conditional on the UE state.
        releaseCause                 ReleaseCause,
        rplmn-information              Rplmn-Information              OPTIONAL
}

-- *****
--
-- RRC CONNECTION RELEASE for CCCH
--
-- *****

RRCCConnectionRelease-CCCH ::= CHOICE {
    r3          SEQUENCE {
        rrcConnectionRelease-CCCH-r3    RRCCConnectionRelease-CCCH-r3-IEs,
        nonCriticalExtensions             SEQUENCE {} OPTIONAL
    },
    later-than-r3          SEQUENCE {
        rrc-TransactionIdentifier    RRC-TransactionIdentifier,
        criticalExtensions            SEQUENCE {}
    }
}

RRCCConnectionRelease-CCCH-r3-IEs ::= SEQUENCE {
    -- User equipment IEs
        u-RNTI                        U-RNTI,
        -- The rest of the message is identical to the one sent on DCCH.
        rrcConnectionRelease          RRCCConnectionRelease-r3-IEs
}

-- *****
--
-- RRC CONNECTION RELEASE COMPLETE
--
-- *****

RRCCConnectionReleaseComplete ::= SEQUENCE {
    -- User equipment IEs
        rrc-TransactionIdentifier    RRC-TransactionIdentifier,
        errorIndication              FailureCauseWithProtErr        OPTIONAL,
        -- Extension mechanism for non- release99 information
}

```



```

        nonCriticalExtensions          SEQUENCE {}          OPTIONAL
    }
-- *****
--
-- RRC CONNECTION REQUEST
--
-- *****

RRCConnectionRequest ::= SEQUENCE {
    -- TABULAR: Integrity protection shall not be performed on this message.
    -- User equipment IEs
    initialUE-Identity                InitialUE-Identity,
    establishmentCause                EstablishmentCause,
    protocolErrorIndicator            ProtocolErrorIndicator,
    -- The IE above is MD, but for compactness reasons no default value
    -- has been assigned to it.
    -- Measurement IEs
    measuredResultsOnRACH              MeasuredResultsOnRACH          OPTIONAL,
    -- Extension mechanism for non- release99 information
    nonCriticalExtensions              SEQUENCE {}          OPTIONAL
}
-- *****
--
-- RRC CONNECTION SETUP
--
-- *****

RRCConnectionSetup ::= CHOICE {
    r3                                 SEQUENCE {
        rrcConnectionSetup-r3         RRCConnectionSetup-r3-IEs,
        nonCriticalExtensions          SEQUENCE {}          OPTIONAL
    },
    later-than-r3                      SEQUENCE {
        rrc-TransactionIdentifier      RRC-TransactionIdentifier,
        criticalExtensions              SEQUENCE {}
    }
}

RRCConnectionSetup-r3-IEs ::= SEQUENCE {
    -- TABULAR: Integrity protection shall not be performed on this message.
    -- User equipment IEs
    initialUE-Identity                InitialUE-Identity,
    rrc-TransactionIdentifier          RRC-TransactionIdentifier,
    activationTime                     ActivationTime          OPTIONAL,
    new-U-RNTI                         U-RNTI,
    new-c-RNTI                         C-RNTI          OPTIONAL,
    rrc-StateIndicator                 RRC-StateIndicator,
    utran-DRX-CycleLengthCoeff        UTRAN-DRX-CycleLengthCoefficient,
    capabilityUpdateRequirement        CapabilityUpdateRequirement OPTIONAL,
    -- TABULAR: If the IE is not present, the default value defined in 10.3.3.2 shall
    -- be used.
    -- Radio bearer IEs
    srb-InformationSetupList           SRB-InformationSetupList2,
    -- Transport channel IEs
    ul-CommonTransChInfo              UL-CommonTransChInfo          OPTIONAL,
    ul-AddReconfTransChInfoList       UL-AddReconfTransChInfoList,
    -- NOTE: IE ul-AddReconfTransChInfoList should be optional in later versions of this message
    dl-CommonTransChInfo              DL-CommonTransChInfo          OPTIONAL,
    dl-AddReconfTransChInfoList       DL-AddReconfTransChInfoList,
    -- NOTE: IE dl-AddReconfTransChInfoList should be optional in later versions of this message
    -- Physical channel IEs
    frequencyInfo                     FrequencyInfo          OPTIONAL,
    maxAllowedUL-TX-Power              MaxAllowedUL-TX-Power          OPTIONAL,
    ul-ChannelRequirement              UL-ChannelRequirement          OPTIONAL,
    dl-CommonInformation               DL-CommonInformation          OPTIONAL,
    dl-InformationPerRL-List           DL-InformationPerRL-List          OPTIONAL
}
-- *****
--
-- RRC CONNECTION SETUP COMPLETE
--
-- *****

RRCConnectionSetupComplete ::= SEQUENCE {
    -- TABULAR: Integrity protection shall not be performed on this message.

```

```

-- User equipment IEs
  rrc-TransactionIdentifier      RRC-TransactionIdentifier,
  startList                      STARTList,
  ue-RadioAccessCapability      UE-RadioAccessCapability          OPTIONAL,
-- Other IEs
  ue-RATSpecificCapability      InterRAT-UE-RadioAccessCapabilityList  OPTIONAL,
-- Non critical extensions
  v370NonCriticalExtensions      SEQUENCE {
    rrcConnectionSetupComplete-v370ext  RRCConnectionSetupComplete-v370ext,
    v380NonCriticalExtensions          SEQUENCE {
      rrcConnectionSetupComplete-v380ext  RRCConnectionSetupComplete-v380ext-IEs,
      -- Reserved for future non critical extension
      nonCriticalExtensions              SEQUENCE {}          OPTIONAL
    }
  }
}

RRCConnectionSetupComplete-v370ext ::= SEQUENCE {
  -- User equipment IEs
  ue-RadioAccessCapability-v370ext  UE-RadioAccessCapability-v370ext  OPTIONAL
}

RRCConnectionSetupComplete-v380ext-IEs ::= SEQUENCE {
  -- User equipment IEs
  ue-RadioAccessCapability-v380ext  UE-RadioAccessCapability-v380ext  OPTIONAL,
  dl-PhysChCapabilityFDD-v380ext    DL-PhysChCapabilityFDD-v380ext
}

-- *****
--
-- RRC STATUS
--
-- *****

RRCStatus ::= SEQUENCE {
  -- Other IEs
  protocolErrorInformation          ProtocolErrorMoreInformation,
  -- TABULAR: Identification of received message is nested in
  -- ProtocolErrorMoreInformation
  -- Extension mechanism for non- release99 information
  nonCriticalExtensions              SEQUENCE {}          OPTIONAL
}

-- *****
--
-- SECURITY MODE COMMAND
--
-- *****

SecurityModeCommand ::= CHOICE {
  r3                                  SEQUENCE {
    securityModeCommand-r3          SecurityModeCommand-r3-IEs,
    nonCriticalExtensions            SEQUENCE {}          OPTIONAL
  },
  later-than-r3                      SEQUENCE {
    rrc-TransactionIdentifier        RRC-TransactionIdentifier,
    criticalExtensions               SEQUENCE {}
  }
}

SecurityModeCommand-r3-IEs ::= SEQUENCE {
-- TABULAR: Integrity protection shall always be performed on this message.
  -- User equipment IEs
  rrc-TransactionIdentifier          RRC-TransactionIdentifier,
  securityCapability                 SecurityCapability,
  cipheringModeInfo                 CipheringModeInfo          OPTIONAL,
  integrityProtectionModeInfo        IntegrityProtectionModeInfo  OPTIONAL,
-- Core network IEs
  cn-DomainIdentity                 CN-DomainIdentity,
-- Other IEs
  ue-SystemSpecificSecurityCap      InterRAT-UE-SecurityCapList  OPTIONAL
}

-- *****
--
-- SECURITY MODE COMPLETE
--
-- *****

```

```

SecurityModeComplete ::= SEQUENCE {
-- TABULAR: Integrity protection shall always be performed on this message.

-- User equipment IEs
   rrc-TransactionIdentifier      RRC-TransactionIdentifier,
   ul-IntegProtActivationInfo     IntegrityProtActivationInfo      OPTIONAL,
-- Radio bearer IEs
   rb-UL-CiphActivationTimeInfo  RB-ActivationTimeInfoList      OPTIONAL,
-- Extension mechanism for non- release99 information
   nonCriticalExtensions         SEQUENCE {}          OPTIONAL
}

-- *****
--
-- SECURITY MODE FAILURE
--
-- *****

SecurityModeFailure ::= SEQUENCE {
-- User equipment IEs
   rrc-TransactionIdentifier      RRC-TransactionIdentifier,
   failureCause                  FailureCauseWithProtErr,
-- Extension mechanism for non- release99 information
   nonCriticalExtensions         SEQUENCE {}          OPTIONAL
}

-- *****
--
-- SIGNALLING CONNECTION RELEASE
--
-- *****

SignallingConnectionRelease ::= CHOICE {
   r3                             SEQUENCE {
      signallingConnectionRelease-r3 SignallingConnectionRelease-r3-IEs,
      nonCriticalExtensions         SEQUENCE {}          OPTIONAL
   },
   later-than-r3                  SEQUENCE {
      rrc-TransactionIdentifier      RRC-TransactionIdentifier,
      criticalExtensions             SEQUENCE {}
   }
}

SignallingConnectionRelease-r3-IEs ::= SEQUENCE {
-- User equipment IEs
   rrc-TransactionIdentifier      RRC-TransactionIdentifier,
-- Core network IEs
   cn-DomainIdentity             CN-DomainIdentity
}

-- *****
--
-- SIGNALLING CONNECTION RELEASE INDICATION
--
-- *****

SignallingConnectionReleaseIndication ::= SEQUENCE {
-- Core network IEs
   cn-DomainIdentity             CN-DomainIdentity,
-- Extension mechanism for non- release99 information
   nonCriticalExtensions         SEQUENCE {}          OPTIONAL
}

-- *****
--
-- SYSTEM INFORMATION for BCH
--
-- *****

SystemInformation-BCH ::= SEQUENCE {
-- Other information elements
   sfn-Prime                     SFN-Prime,
   payload                       CHOICE {
      noSegment                   NULL,
      firstSegment                FirstSegment,
      subsequentSegment           SubsequentSegment,
      lastSegmentShort            LastSegmentShort,
}

```

```

    lastAndFirst          SEQUENCE {
        lastSegmentShort  LastSegmentShort,
        firstSegment      FirstSegmentShort
    },
    lastAndComplete       SEQUENCE {
        lastSegmentShort  LastSegmentShort,
        completeSIB-List  CompleteSIB-List
    },
    lastAndCompleteAndFirst SEQUENCE {
        lastSegmentShort  LastSegmentShort,
        completeSIB-List  CompleteSIB-List,
        firstSegment      FirstSegmentShort
    },
    completeSIB-List      CompleteSIB-List,
    completeAndFirst      SEQUENCE {
        completeSIB-List  CompleteSIB-List,
        firstSegment      FirstSegmentShort
    },
    completeSIB           CompleteSIB,
    lastSegment           LastSegment
}
}

```

```

-- *****
--
-- SYSTEM INFORMATION for FACH
--
-- *****

```

```

SystemInformation-FACH ::= SEQUENCE {
    -- Other information elements
    payload                CHOICE {
        noSegment          NULL,
        firstSegment       FirstSegment,
        subsequentSegment  SubsequentSegment,
        lastSegmentShort   LastSegmentShort,
        lastAndFirst       SEQUENCE {
            lastSegmentShort LastSegmentShort,
            firstSegment      FirstSegmentShort
        },
        lastAndComplete    SEQUENCE {
            lastSegmentShort LastSegmentShort,
            completeSIB-List CompleteSIB-List
        },
        lastAndCompleteAndFirst SEQUENCE {
            lastSegmentShort LastSegmentShort,
            completeSIB-List CompleteSIB-List,
            firstSegment      FirstSegmentShort
        },
        completeSIB-List   CompleteSIB-List,
        completeAndFirst   SEQUENCE {
            completeSIB-List CompleteSIB-List,
            firstSegment     FirstSegmentShort
        },
        completeSIB        CompleteSIB,
        lastSegment        LastSegment
    }
}

```

```

-- *****
--
-- First segment
--
-- *****

```

```

FirstSegment ::= SEQUENCE {
    -- Other information elements
    sib-Type          SIB-Type,
    seg-Count         SegCount,
    sib-Data-fixed    SIB-Data-fixed
}

```

```

-- *****
--
-- First segment (short)
--
-- *****

```

```

FirstSegmentShort ::=          SEQUENCE {
    -- Other information elements
        sib-Type                SIB-Type,
        seg-Count               SegCount,
        sib-Data-variable       SIB-Data-variable
    }

-- *****
--
-- Subsequent segment
--
-- *****

SubsequentSegment ::=          SEQUENCE {
    -- Other information elements
        sib-Type                SIB-Type,
        segmentIndex            SegmentIndex,
        sib-Data-fixed          SIB-Data-fixed
    }

-- *****
--
-- Last segment
--
-- *****

LastSegment ::=                SEQUENCE {
    -- Other information elements
        sib-Type                SIB-Type,
        segmentIndex            SegmentIndex,
        sib-Data-fixed          SIB-Data-fixed
    -- In case the SIB data is less than 222 bits, padding shall be used
    -- The same padding bits shall be used as defined in clause 12.1
    }

LastSegmentShort ::=          SEQUENCE {
    -- Other information elements
        sib-Type                SIB-Type,
        segmentIndex            SegmentIndex,
        sib-Data-variable       SIB-Data-variable
    }

-- *****
--
-- Complete SIB
--
-- *****

CompleteSIB-List ::=          SEQUENCE (SIZE (1..maxSIBperMsg)) OF
                                CompleteSIBshort

CompleteSIB ::=                SEQUENCE {
    -- Other information elements
        sib-Type                SIB-Type,
        sib-Data-fixed          BIT STRING (SIZE (226))
    -- In case the SIB data is less than 226 bits, padding shall be used
    -- The same padding bits shall be used as defined in clause 12.1
    }

CompleteSIBshort ::=          SEQUENCE {
    -- Other information elements
        sib-Type                SIB-Type,
        sib-Data-variable       SIB-Data-variable
    }

-- *****
--
-- SYSTEM INFORMATION CHANGE INDICATION
--
-- *****

SystemInformationChangeIndication ::= SEQUENCE {
    -- Other IEs
        bcch-ModificationInfo   BCCH-ModificationInfo,
    -- Extension mechanism for non- release99 information
        nonCriticalExtensions    SEQUENCE {} OPTIONAL
    }

```

```

-- *****
--
-- TRANSPORT CHANNEL RECONFIGURATION
--
-- *****

TransportChannelReconfiguration ::= CHOICE {
  r3                               SEQUENCE {
    transportChannelReconfiguration-r3
    nonCriticalExtensions           TransportChannelReconfiguration-r3-IEs,
    },
  later-than-r3                   SEQUENCE {
    rrc-TransactionIdentifier      RRC-TransactionIdentifier,
    criticalExtensions             SEQUENCE {}
  }
}

TransportChannelReconfiguration-r3-IEs ::= SEQUENCE {
  -- User equipment IES
  rrc-TransactionIdentifier      RRC-TransactionIdentifier,
  integrityProtectionModeInfo   IntegrityProtectionModeInfo   OPTIONAL,
  cipheringModeInfo             CipheringModeInfo             OPTIONAL,
  activationTime                 ActivationTime                 OPTIONAL,
  new-U-RNTI                    U-RNTI                       OPTIONAL,
  new-C-RNTI                    C-RNTI                       OPTIONAL,
  rrc-StateIndicator            RRC-StateIndicator,
  utran-DRX-CycleLengthCoeff    UTRAN-DRX-CycleLengthCoefficient OPTIONAL,
  -- Core network IES
  cn-InformationInfo            CN-InformationInfo            OPTIONAL,
  -- UTRAN mobility IES
  ura-Identity                  URA-Identity                  OPTIONAL,
  -- Radio bearer IES
  dl-CounterSynchronisationInfo DL-CounterSynchronisationInfo OPTIONAL,
  -- Transport channel IES
  ul-CommonTransChInfo         UL-CommonTransChInfo         OPTIONAL,
  ul-AddReconfTransChInfoList  UL-AddReconfTransChInfoList  OPTIONAL,
  modeSpecificTransChInfo      CHOICE {
    fdd                          SEQUENCE {
      cpch-SetID                 CPCH-SetID                 OPTIONAL,
      addReconfTransChDRAC-Info  DRAC-StaticInformationList OPTIONAL
    },
    tdd                          NULL
  } OPTIONAL,
  dl-CommonTransChInfo         DL-CommonTransChInfo         OPTIONAL,
  dl-AddReconfTransChInfoList  DL-AddReconfTransChInfoList  OPTIONAL,
  -- Physical channel IES
  frequencyInfo                FrequencyInfo                OPTIONAL,
  maxAllowedUL-TX-Power        MaxAllowedUL-TX-Power        OPTIONAL,
  ul-ChannelRequirement        UL-ChannelRequirement        OPTIONAL,
  modeSpecificPhysChInfo      CHOICE {
    fdd                          SEQUENCE {
      dl-PDSCH-Information       DL-PDSCH-Information       OPTIONAL
    },
    tdd                          NULL
  },
  dl-CommonInformation         DL-CommonInformation         OPTIONAL,
  dl-InformationPerRL-List     DL-InformationPerRL-List     OPTIONAL
}

-- *****
--
-- TRANSPORT CHANNEL RECONFIGURATION COMPLETE
--
-- *****

TransportChannelReconfigurationComplete ::= SEQUENCE {
  -- User equipment IES
  rrc-TransactionIdentifier      RRC-TransactionIdentifier,
  ul-IntegProtActivationInfo     IntegrityProtActivationInfo   OPTIONAL,
  -- TABULAR: UL-TimingAdvance is applicable for TDD mode only.
  ul-TimingAdvance              UL-TimingAdvance              OPTIONAL,
  -- Radio bearer IES
  count-C-ActivationTime        ActivationTime                OPTIONAL,
  rb-UL-CiphActivationTimeInfo  RB-ActivationTimeInfoList    OPTIONAL,
  ul-CounterSynchronisationInfo UL-CounterSynchronisationInfo OPTIONAL,
  -- Extension mechanism for non- release99 information
  nonCriticalExtensions         SEQUENCE {} OPTIONAL
}

```

```

}
-- *****
--
-- TRANSPORT CHANNEL RECONFIGURATION FAILURE
--
-- *****

TransportChannelReconfigurationFailure ::= SEQUENCE {
    -- User equipment IEs
    rrc-TransactionIdentifier    RRC-TransactionIdentifier,
    failureCause                 FailureCauseWithProtErr,
    -- Extension mechanism for non- release99 information
    nonCriticalExtensions        SEQUENCE {}    OPTIONAL
}

-- *****
--
-- TRANSPORT FORMAT COMBINATION CONTROL
--
-- *****

TransportFormatCombinationControl ::= SEQUENCE {
    -- TABULAR: Integrity protection shall not be performed on this message when transmitting this
    message
    -- on the transparent mode signalling DCCH.
    rrc-TransactionIdentifier    RRC-TransactionIdentifier    OPTIONAL,
    -- The information element is not included when transmitting the message
    -- on the transparent mode signalling DCCH
    modeSpecificInfo            CHOICE {
        fdd                     NULL,
        tdd                     SEQUENCE {
            tfcs-ID             TFCS-Identity    OPTIONAL
        }
    },
    dpch-TFCS-InUplink          TFC-Subset,
    activationTimeForTFCSubset  ActivationTime            OPTIONAL,
    tfc-ControlDuration         TFC-ControlDuration        OPTIONAL,
    -- The information element is not included when transmitting the message
    -- on the transparent mode signalling DCCH and is optional otherwise
    -- Extension mechanism for non- release99 information
    nonCriticalExtensions        SEQUENCE {}    OPTIONAL
}

-- *****
--
-- TRANSPORT FORMAT COMBINATION CONTROL FAILURE
--
-- *****

TransportFormatCombinationControlFailure ::= SEQUENCE {
    -- User equipment IEs
    rrc-TransactionIdentifier    RRC-TransactionIdentifier,
    failureCause                 FailureCauseWithProtErr,
    -- Extension mechanism for non- release99 information
    nonCriticalExtensions        SEQUENCE {}    OPTIONAL
}

-- *****
--
-- UE CAPABILITY ENQUIRY
--
-- *****

UECapabilityEnquiry ::= CHOICE {
    r3                          SEQUENCE {
        ueCapabilityEnquiry-r3  UECapabilityEnquiry-r3-IEs,
        nonCriticalExtensions    SEQUENCE {}    OPTIONAL
    },
    later-than-r3               SEQUENCE {
        rrc-TransactionIdentifier RRC-TransactionIdentifier,
        criticalExtensions        SEQUENCE {}
    }
}

UECapabilityEnquiry-r3-IEs ::= SEQUENCE {
    -- User equipment IEs
    rrc-TransactionIdentifier    RRC-TransactionIdentifier,

```

```

        capabilityUpdateRequirement      CapabilityUpdateRequirement
    }
-- *****
--
-- UE CAPABILITY INFORMATION
--
-- *****
UECapabilityInformation ::= SEQUENCE {
    -- User equipment IEs
    rrc-TransactionIdentifier            RRC-TransactionIdentifier            OPTIONAL,
    ue-RadioAccessCapability             UE-RadioAccessCapability             OPTIONAL,
    -- Other IEs
    ue-RATSpecificCapability             InterRAT-UE-RadioAccessCapabilityList
    OPTIONAL,
    -- Non critical extensions
    v370NonCriticalExtensions            SEQUENCE {
        ueCapabilityInformation-v370ext  UECapabilityInformation-v370ext,
        v380NonCriticalExtensions        SEQUENCE {
            ueCapabilityInformation-v380ext  UECapabilityInformation-v380ext-IEs,
            -- Reserved for future non critical extension
            nonCriticalExtensions          SEQUENCE {}          OPTIONAL
        }
        OPTIONAL
    }
    OPTIONAL
}

UECapabilityInformation-v370ext ::= SEQUENCE {
    -- User equipment IEs
    ue-RadioAccessCapability-v370ext     UE-RadioAccessCapability-v370ext     OPTIONAL
}

UECapabilityInformation-v380ext-IEs ::= SEQUENCE {
    -- User equipment IEs
    ue-RadioAccessCapability-v380ext     UE-RadioAccessCapability-v380ext     OPTIONAL,
    dl-PhysChCapabilityFDD-v380ext       DL-PhysChCapabilityFDD-v380ext
}

-- *****
--
-- UE CAPABILITY INFORMATION CONFIRM
--
-- *****
UECapabilityInformationConfirm ::= CHOICE {
    r3                                     SEQUENCE {
        ueCapabilityInformationConfirm-r3
        nonCriticalExtensions             SEQUENCE {}          OPTIONAL
    },
    later-than-r3                         SEQUENCE {
        rrc-TransactionIdentifier         RRC-TransactionIdentifier,
        criticalExtensions                 SEQUENCE {}
    }
}

UECapabilityInformationConfirm-r3-IEs ::= SEQUENCE {
    -- User equipment IEs
    rrc-TransactionIdentifier            RRC-TransactionIdentifier
}

-- *****
--
-- UPLINK DIRECT TRANSFER
--
-- *****
UplinkDirectTransfer ::= SEQUENCE {
    -- Core network IEs
    cn-DomainIdentity                   CN-DomainIdentity,
    nas-Message                          NAS-Message,
    -- Measurement IEs
    measuredResultsOnRACH                MeasuredResultsOnRACH                OPTIONAL,
    -- Extension mechanism for non- release99 information
    nonCriticalExtensions                SEQUENCE {}          OPTIONAL
}

-- *****

```



```

--
-- UPLINK PHYSICAL CHANNEL CONTROL
--
-- *****

UplinkPhysicalChannelControl ::= CHOICE {
    r3                SEQUENCE {
        uplinkPhysicalChannelControl-r3 UplinkPhysicalChannelControl-r3-IEs,
        nonCriticalExtensions            SEQUENCE {} OPTIONAL
    },
    later-than-r3     SEQUENCE {
        rrc-TransactionIdentifier        RRC-TransactionIdentifier,
        criticalExtensions                SEQUENCE {}
    }
}

UplinkPhysicalChannelControl-r3-IEs ::= SEQUENCE {
    -- User equipment IEs
    rrc-TransactionIdentifier        RRC-TransactionIdentifier,
    -- Physical channel IEs
    ccTrCH-PowerControlInfo        CcTrCH-PowerControlInfo            OPTIONAL,
    timingAdvance                   UL-TimingAdvanceControl          OPTIONAL,
    alpha                            Alpha                            OPTIONAL,
    specialBurstScheduling           SpecialBurstScheduling          OPTIONAL,
    prach-ConstantValue              ConstantValue                  OPTIONAL,
    pusch-ConstantValue              ConstantValue                  OPTIONAL
}

-- *****
--
-- URA UPDATE
--
-- *****

URAUUpdate ::= SEQUENCE {
    -- User equipment IEs
    u-RNTI                          U-RNTI,
    ura-UpdateCause                  URA-UpdateCause,
    protocolErrorIndicator            ProtocolErrorIndicatorWithMoreInfo,
    -- Extension mechanism for non- release99 information
    nonCriticalExtensions            SEQUENCE {} OPTIONAL
}

-- *****
--
-- URA UPDATE CONFIRM
--
-- *****

URAUUpdateConfirm ::= CHOICE {
    r3                SEQUENCE {
        uraUpdateConfirm-r3          URAUpdateConfirm-r3-IEs,
        nonCriticalExtensions        SEQUENCE {} OPTIONAL
    },
    later-than-r3     SEQUENCE {
        rrc-TransactionIdentifier        RRC-TransactionIdentifier,
        criticalExtensions                SEQUENCE {}
    }
}

URAUUpdateConfirm-r3-IEs ::= SEQUENCE {
    -- User equipment IEs
    rrc-TransactionIdentifier        RRC-TransactionIdentifier,
    integrityProtectionModeInfo      IntegrityProtectionModeInfo    OPTIONAL,
    cipheringModeInfo                CipheringModeInfo              OPTIONAL,
    new-U-RNTI                        U-RNTI                          OPTIONAL,
    new-C-RNTI                        C-RNTI                          OPTIONAL,
    rrc-StateIndicator                RRC-StateIndicator,
    utran-DRX-CycleLengthCoeff        UTRAN-DRX-CycleLengthCoefficient OPTIONAL,
    -- CN information elements
    cn-InformationInfo                CN-InformationInfo            OPTIONAL,
    -- UTRAN mobility IEs
    ura-Identity                       URA-Identity                    OPTIONAL,
    -- Radio bearer IEs
    dl-CounterSynchronisationInfo     DL-CounterSynchronisationInfo    OPTIONAL
}

```

```

-- *****
--
-- URA UPDATE CONFIRM for CCCH
--
-- *****

URAUUpdateConfirm-CCCH ::= CHOICE {
  r3          SEQUENCE {
    uraUpdateConfirm-CCCH-r3      URAUpdateConfirm-CCCH-r3-IEs,
    nonCriticalExtensions          SEQUENCE {} OPTIONAL
  },
  later-than-r3          SEQUENCE {
    rrc-TransactionIdentifier      RRC-TransactionIdentifier,
    criticalExtensions             SEQUENCE {}
  }
}

URAUUpdateConfirm-CCCH-r3-IEs ::= SEQUENCE {
  -- User equipment IEs
  u-RNTI          U-RNTI,
  -- The rest of the message is identical to the one sent on DCCH.
  uraUpdateConfirm      URAUpdateConfirm-r3-IEs
}

-- *****
--
-- UTRAN MOBILITY INFORMATION
--
-- *****

UTRANMobilityInformation ::= CHOICE {
  r3          SEQUENCE {
    utranMobilityInformation-r3      UTRANMobilityInformation-r3-IEs,
    nonCriticalExtensions            SEQUENCE {} OPTIONAL
  },
  later-than-r3          SEQUENCE {
    rrc-TransactionIdentifier      RRC-TransactionIdentifier,
    criticalExtensions             SEQUENCE {}
  }
}

UTRANMobilityInformation-r3-IEs ::= SEQUENCE {
  -- User equipment IEs
  rrc-TransactionIdentifier      RRC-TransactionIdentifier,
  integrityProtectionModeInfo    IntegrityProtectionModeInfo      OPTIONAL,
  cipheringModeInfo              CipheringModeInfo                OPTIONAL,
  new-U-RNTI                      U-RNTI                          OPTIONAL,
  new-C-RNTI                      C-RNTI                          OPTIONAL,
  ue-ConnTimersAndConstants       UE-ConnTimersAndConstants      OPTIONAL,
  -- CN information elements
  cn-InformationInfo              CN-InformationInfoFull          OPTIONAL,
  -- UTRAN mobility IEs
  ura-Identity                    URA-Identity                    OPTIONAL,
  -- Radio bearer IEs
  dl-CounterSynchronisationInfo    DL-CounterSynchronisationInfo    OPTIONAL,
  -- Extension mechanism for non- release99 information
  nonCriticalExtensions            SEQUENCE {} OPTIONAL
}

-- *****
--
-- UTRAN MOBILITY INFORMATION CONFIRM
--
-- *****

UTRANMobilityInformationConfirm ::= SEQUENCE {
  -- User equipment IEs
  rrc-TransactionIdentifier      RRC-TransactionIdentifier,
  ul-IntegProtActivationInfo      IntegrityProtActivationInfo      OPTIONAL,
  -- Radio bearer IEs
  count-C-ActivationTime          ActivationTime                    OPTIONAL,
  rb-UL-CiphActivationTimeInfo     RB-ActivationTimeInfoList        OPTIONAL,
  ul-CounterSynchronisationInfo    UL-CounterSynchronisationInfo    OPTIONAL,
  -- Extension mechanism for non- release99 information
  nonCriticalExtensions            SEQUENCE {} OPTIONAL
}

-- *****

```

```

--
-- UTRAN MOBILITY INFORMATION FAILURE
--
-- *****
UTRANMobilityInformationFailure ::= SEQUENCE {
    -- UE information elements
    rrc-TransactionIdentifier      RRC-TransactionIdentifier,
    failureCause                   FailureCauseWithProtErr,
    -- Extension mechanism for non- release99 information
    nonCriticalExtensions          SEQUENCE {} OPTIONAL
}
END

```

11.3 Information element definitions

```

InformationElements DEFINITIONS AUTOMATIC TAGS ::=
-- *****
--
-- CORE NETWORK INFORMATION ELEMENTS (10.3.1)
--
-- *****
BEGIN
IMPORTS
    hipDSCHidentities,
    hiPUSCHidentities,
    hiRM,
    maxAC,
    maxAdditionalMeas,
    maxASC,
    maxASCmap,
    maxASCPersist,
    maxCCTrCH,
    maxCellMeas,
    maxCellMeas-1,
    maxCNdomains,
    maxCPCHsets,
    maxDPCH-DLchan,
    maxDPDCH-UL,
    maxDRACclasses,
    maxFACHPCH,
    maxFreq,
    maxFreqBandsFDD,
    maxFreqBandsTDD,
    maxFreqBandsGSM,
    maxInterSysMessages,
    maxLoCHperRLC,
    maxMeasEvent,
    maxMeasIntervals,
    maxMeasParEvent,
    maxNumCDMA2000Freqs,
    maxNumFDDFreqs,
    maxNumGSMFreqRanges,
    maxNumTDDFreqs,
    maxOtherRAT,
    maxPage1,
    maxPCPCH-APsig,
    maxPCPCH-APsubCh,
    maxPCPCH-CDsig,
    maxPCPCH-CDSUBch,
    maxPCPCH-SF,
    maxPCPCHs,
    maxPDCPAlgoType,
    maxPDSCH,
    maxPDSCH-TFCIgroups,
    maxPRACH,
    maxPUSCH,
    maxRABsetup,
    maxRAT,
    maxRB,
    maxRBallRABs,
    maxRBMuxOptions,
    maxRBperRAB,

```

```

maxReportedGSMCells,
maxSRBsetup,
maxRL,
maxRL-1,
maxSCCPCH,
maxSat,
maxSIB,
maxSIB-FACH,
maxSystemCapability,
maxTF,
maxTF-CPCH,
maxTFC,
maxTFCl-2-Combs,
maxTGPS,
maxTrCH,
maxTrCHpreconf,
maxTS,
maxTS-1,
maxURA
FROM Constant-definitions;

Ansi-41-IDNNS ::=                                BIT STRING (SIZE (14))

CN-DomainIdentity ::=                           ENUMERATED {
                                                cs-domain,
                                                ps-domain }

CN-DomainInformation ::=                        SEQUENCE {
  cn-DomainIdentity                            CN-DomainIdentity,
  cn-DomainSpecificNAS-Info                    NAS-SystemInformationGSM-MAP
}

CN-DomainInformationFull ::=                   SEQUENCE {
  cn-DomainIdentity                            CN-DomainIdentity,
  cn-DomainSpecificNAS-Info                    NAS-SystemInformationGSM-MAP,
  cn-DRX-CycleLengthCoeff                     CN-DRX-CycleLengthCoefficient
}

CN-DomainInformationList ::=                   SEQUENCE (SIZE (1..maxCNdomains)) OF
  CN-DomainInformation

CN-DomainInformationListFull ::=               SEQUENCE (SIZE (1..maxCNdomains)) OF
  CN-DomainInformationFull

CN-DomainSysInfo ::=                           SEQUENCE {
  cn-DomainIdentity                            CN-DomainIdentity,
  cn-Type                                       CHOICE {
    gsm-MAP                                     NAS-SystemInformationGSM-MAP,
    ansi-41                                     NAS-SystemInformationANSI-41
  },
  cn-DRX-CycleLengthCoeff                     CN-DRX-CycleLengthCoefficient
}

CN-DomainSysInfoList ::=                       SEQUENCE (SIZE (1..maxCNdomains)) OF
  CN-DomainSysInfo

CN-InformationInfo ::=                         SEQUENCE {
  plmn-Identity                                PLMN-Identity                                OPTIONAL,
  cn-CommonGSM-MAP-NAS-SysInfo                NAS-SystemInformationGSM-MAP                OPTIONAL,
  cn-DomainInformationList                    CN-DomainInformationList                    OPTIONAL
}

CN-InformationInfoFull ::=                     SEQUENCE {
  plmn-Identity                                PLMN-Identity                                OPTIONAL,
  cn-CommonGSM-MAP-NAS-SysInfo                NAS-SystemInformationGSM-MAP                OPTIONAL,
  cn-DomainInformationListFull                 CN-DomainInformationListFull                OPTIONAL
}

Digit ::=                                     INTEGER (0..9)

Gsm-map-IDNNS ::=                              SEQUENCE {
  routingbasis                                 CHOICE {
    localPTMSI                                  SEQUENCE {
      routingparameter                          RoutingParameter
    },
    tMSIofsamePLMN                             SEQUENCE {
      routingparameter                          RoutingParameter
    },
  },

```

```

    tMSIofdifferentPLMN
      routingparameter
    },
    iMSIresponsetopaging
      routingparameter
    },
    iMSIcauseUEinitiatedEvent
      routingparameter
    },
    iMEI
      routingparameter
    },
    spare1
      routingparameter
    },
    spare2
      routingparameter
  },
  enteredparameter
}

IMEI ::=
SEQUENCE (SIZE (15)) OF
  IMEI-Digit

IMEI-Digit ::=
INTEGER (0..15)

IMSI-GSM-MAP ::=
SEQUENCE (SIZE (6..15)) OF
  Digit

IntraDomainNasNodeSelector ::=
  version
    release99
      cn-Type
        gsm-Map-IDNNS
        ansi-41-IDNNS
      },
    later
      futurecoding
  }
}

LAI ::=
SEQUENCE {
  plmn-Identity
  lac
}

MCC ::=
SEQUENCE (SIZE (3)) OF
  Digit

MNC ::=
SEQUENCE (SIZE (2..3)) OF
  Digit

NAS-Message ::=
OCTET STRING (SIZE (1..4095))

NAS-Synchronisation-Indicator ::=
BIT STRING(SIZE(4))

NAS-SystemInformationGSM-MAP ::=
OCTET STRING (SIZE (1..8))

P-TMSI-GSM-MAP ::=
BIT STRING (SIZE (32))

PagingRecordTypeID ::=
ENUMERATED {
  imsi-GSM-MAP,
  tmsi-GSM-MAP-P-TMSI,
  imsi-DS-41,
  tmsi-DS-41 }

PLMN-Identity ::=
SEQUENCE {
  mcc
  mnc
}

PLMN-Type ::=
CHOICE {
  gsm-MAP
  plmn-Identity
},

```

```

ansi-41                               SEQUENCE {
  p-REV                               P-REV,
  min-P-REV                           Min-P-REV,
  sid                                  SID,
  nid                                  NID
},
gsm-MAP-and-ANSI-41                  SEQUENCE {
  plmn-Identity                       PLMN-Identity,
  p-REV                               P-REV,
  min-P-REV                           Min-P-REV,
  sid                                  SID,
  nid                                  NID
}
}

RAB-Identity ::=                      CHOICE {
  gsm-MAP-RAB-Identity                BIT STRING (SIZE (8)),
  ansi-41-RAB-Identity                BIT STRING (SIZE (8))
}

RAI ::=                               SEQUENCE {
  lai                                  LAI,
  rac                                  RoutingAreaCode
}

RoutingAreaCode ::=                  BIT STRING (SIZE (8))

RoutingParameter ::=                 BIT STRING (SIZE (10))

TMSI-GSM-MAP ::=                     BIT STRING (SIZE (32))

-- *****
--
--   UTRAN MOBILITY INFORMATION ELEMENTS (10.3.2)
--
-- *****

AccessClassBarred ::=                ENUMERATED {
  barred, notBarred }

AccessClassBarredList ::=            SEQUENCE (SIZE (maxAC)) OF
  AccessClassBarred

AllowedIndicator ::=                  ENUMERATED {
  allowed, notAllowed }

CellAccessRestriction ::=            SEQUENCE {
  cellBarred                          CellBarred,
  cellReservedForOperatorUse           ReservedIndicator,
  cellReservationExtension             ReservedIndicator,
  accessClassBarredList               AccessClassBarredList           OPTIONAL
}

CellBarred ::=                       CHOICE {
  barred                               SEQUENCE {
    intraFreqCellReselectionInd       AllowedIndicator,
    t-Barred                           T-Barred
  },
  notBarred                            NULL
}

CellIdentity ::=                     BIT STRING (SIZE (28))

CellSelectReselectInfoSIB-3-4 ::=    SEQUENCE {
  mappingInfo                          MappingInfo           OPTIONAL,
  cellSelectQualityMeasure             CHOICE {
    cpich-Ec-N0                       SEQUENCE {
      q-HYST-2-S                       Q-Hyst-S           OPTIONAL
      -- Default value for q-HYST-2-S is q-HYST-1-S
    },
    cpich-RSCP                         NULL
  },
  modeSpecificInfo                     CHOICE {
    fdd                                SEQUENCE {
      s-Intrasearch                    S-SearchQual      OPTIONAL,
      s-Intersearch                    S-SearchQual      OPTIONAL,
      s-SearchHCS                      S-SearchRXLEV     OPTIONAL,
      rat-List                          RAT-FDD-InfoList   OPTIONAL,

```

```

        q-QualMin                Q-QualMin,
        q-RxlevMin              Q-RxlevMin
    },
    tdd                          SEQUENCE {
        s-Intrasearch            S-SearchRXLEV                OPTIONAL,
        s-Intersearch           S-SearchRXLEV                OPTIONAL,
        s-SearchHCS             S-SearchRXLEV                OPTIONAL,
        rat-List                 RAT-TDD-InfoList              OPTIONAL,
        q-RxlevMin              Q-RxlevMin
    }
},
q-Hyst-l-S                      Q-Hyst-S,
t-Reselection-S                T-Reselection-S,
hcs-ServingCellInformation     HCS-ServingCellInformation    OPTIONAL,
maxAllowedUL-TX-Power         MaxAllowedUL-TX-Power
}

MapParameter ::=                INTEGER (0..99)

Mapping ::=                      SEQUENCE {
    rat                          RAT,
    mappingFunctionParameterList MappingFunctionParameterList
}

MappingFunctionParameter ::=    SEQUENCE {
    functionType                 MappingFunctionType,
    mapParameter1                MapParameter                OPTIONAL,
    mapParameter2                MapParameter,
    upperLimit                   UpperLimit                OPTIONAL
    -- The parameter is conditional on the number of repetition
}

MappingFunctionParameterList ::= SEQUENCE (SIZE (1..maxMeasIntervals)) OF
    MappingFunctionParameter

MappingFunctionType ::=         ENUMERATED {
    linear,
    functionType2,
    functionType3,
    functionType4 }

MappingInfo ::=                 SEQUENCE (SIZE (1..maxRAT)) OF
    Mapping

-- Actual value = IE value * 2
Q-Hyst-S ::=                    INTEGER (0..20)

RAT ::=                          ENUMERATED {
    ultra-FDD,
    ultra-TDD,
    gsm,
    cdma2000 }

RAT-FDD-Info ::=                SEQUENCE {
    rat-Identifier               RAT-Identifier,
    s-SearchRAT                 S-SearchQual,
    s-HCS-RAT                    S-SearchRXLEV                OPTIONAL,
    s-Limit-SearchRAT           S-SearchQual
}

RAT-FDD-InfoList ::=            SEQUENCE (SIZE (1..maxOtherRAT)) OF
    RAT-FDD-Info

RAT-Identifier ::=              ENUMERATED {
    gsm, cdma2000 }

RAT-TDD-Info ::=                SEQUENCE {
    rat-Identifier               RAT-Identifier,
    s-SearchRAT                 S-SearchRXLEV,
    s-HCS-RAT                    S-SearchRXLEV                OPTIONAL,
    s-Limit-SearchRAT           S-SearchRXLEV
}

RAT-TDD-InfoList ::=            SEQUENCE (SIZE (1..maxOtherRAT)) OF
    RAT-TDD-Info

ReservedIndicator ::=           ENUMERATED {
    reserved,

```

```

notReserved }

-- Actual value = IE value * 2
S-SearchQual ::= INTEGER (-16..10)

-- Actual value = (IE value * 2) + 1
S-SearchRXLEV ::= INTEGER (-53..45)

T-Barred ::= ENUMERATED {
    s10, s20, s40, s80,
    s160, s320, s640, s1280 }

T-Reselection-S ::= INTEGER (0..31)

-- The used range depends on the RAT used.
UpperLimit ::= INTEGER (1..91)

URA-Identity ::= BIT STRING (SIZE (16))

URA-IdentityList ::= SEQUENCE (SIZE (1..maxURA)) OF
    URA-Identity

-- *****
--
-- USER EQUIPMENT INFORMATION ELEMENTS (10.3.3)
--
-- *****

ActivationTime ::= INTEGER (0..255)
-- TABULAR : value 'now' always appear as default, and is encoded by absence of the field

BackoffControlParams ::= SEQUENCE {
    n-AP-RetransMax N-AP-RetransMax,
    n-AccessFails N-AccessFails,
    nf-BO-NoAICH NF-BO-NoAICH,
    ns-BO-Busy NS-BO-Busy,
    nf-BO-AllBusy NF-BO-AllBusy,
    nf-BO-Mismatch NF-BO-Mismatch,
    t-CPCH T-CPCH
}

C-RNTI ::= BIT STRING (SIZE (16))

CapabilityUpdateRequirement ::= SEQUENCE {
    ue-RadioCapabilityFDDUpdateRequirement BOOLEAN,
    ue-RadioCapabilityTDDUpdateRequirement BOOLEAN,
    systemSpecificCapUpdateReqList SystemSpecificCapUpdateReqList OPTIONAL
}

CellUpdateCause ::= ENUMERATED {
    cellReselection,
    periodicalCellUpdate,
    uplinkDataTransmission,
    utran-pagingResponse,
    re-enteredServiceArea,
    radiolinkFailure,
    rlc-unrecoverableError,
    spare1 }

ChipRateCapability ::= ENUMERATED {
    mcps3-84, mcps1-28 }

CipheringAlgorithm ::= ENUMERATED {
    uea0, uea1 }

CipheringModeCommand ::= CHOICE {
    startRestart CipheringAlgorithm,
    stopCiphering NULL
}

CipheringModeInfo ::= SEQUENCE {
    cipheringModeCommand CipheringModeCommand,
    -- TABULAR: The ciphering algorithm is included in
    -- the CipheringModeCommand.
    activationTimeForDPCH ActivationTime OPTIONAL,
    rb-DL-CiphActivationTimeInfo RB-ActivationTimeInfoList OPTIONAL
}

```



```

CN-DRX-CycleLengthCoefficient ::= INTEGER (6..9)

CN-PagedUE-Identity ::= CHOICE {
    imsi-GSM-MAP          IMSI-GSM-MAP,
    tmsi-GSM-MAP          TMSI-GSM-MAP,
    p-TMSI-GSM-MAP       P-TMSI-GSM-MAP,
    imsi-DS-41           IMSI-DS-41,
    tmsi-DS-41           TMSI-DS-41
}

CompressedModeMeasCapability ::= SEQUENCE {
    fdd-Measurements      BOOLEAN,
    -- TABULAR: The IEs below are made optional since they are conditional based
    -- on another information element. Their absence corresponds to the case where
    -- the condition is not true.
    tdd-Measurements      BOOLEAN                                OPTIONAL,
    gsm-Measurements      GSM-Measurements                     OPTIONAL,
    multiCarrierMeasurements  BOOLEAN                            OPTIONAL
}

CompressedModeMeasCapabFDDList ::= SEQUENCE (SIZE (1..maxFreqBandsFDD)) OF
    CompressedModeMeasCapabFDD

CompressedModeMeasCapabFDD ::= SEQUENCE {
    radioFrequencyBandFDD  RadioFrequencyBandFDD  OPTIONAL,
    dl-MeasurementsFDD     BOOLEAN,
    ul-MeasurementsFDD     BOOLEAN
}

CompressedModeMeasCapabTDDList ::= SEQUENCE (SIZE (1..maxFreqBandsTDD)) OF
    CompressedModeMeasCapabTDD

CompressedModeMeasCapabTDD ::= SEQUENCE {
    radioFrequencyBandTDD  RadioFrequencyBandTDD,
    dl-MeasurementsTDD     BOOLEAN,
    ul-MeasurementsTDD     BOOLEAN
}

CompressedModeMeasCapabGSMList ::= SEQUENCE (SIZE (1..maxFreqBandsGSM)) OF
    CompressedModeMeasCapabGSM

CompressedModeMeasCapabGSM ::= SEQUENCE {
    radioFrequencyBandGSM  RadioFrequencyBandGSM,
    dl-MeasurementsGSM     BOOLEAN,
    ul-MeasurementsGSM     BOOLEAN
}

CompressedModeMeasCapabMC ::= SEQUENCE {
    dl-MeasurementsMC      BOOLEAN,
    ul-MeasurementsMC      BOOLEAN
}

CPCH-Parameters ::= SEQUENCE {
    initialPriorityDelayList  InitialPriorityDelayList  OPTIONAL,
    backoffControlParams      BackoffControlParams,
    powerControlAlgorithm     PowerControlAlgorithm,
    -- TABULAR: TPC step size nested inside PowerControlAlgorithm
    dl-DPCCH-BER             DL-DPCCH-BER
}

DL-DPCCH-BER ::= INTEGER (0..63)

DL-PhysChCapabilityFDD ::= SEQUENCE {
    maxNoDPCH-PDSCH-Codes    INTEGER (1..8),
    maxNoPhysChBitsReceived  MaxNoPhysChBitsReceived,
    supportForSF-512         BOOLEAN,
    supportOfPDSCH           BOOLEAN,
    simultaneousSCCPCH-DPCH-Reception  SimultaneousSCCPCH-DPCH-Reception
}

DL-PhysChCapabilityFDD-v380ext ::= SEQUENCE {
    supportOfDedicatedPilotsForChEstimation  SupportOfDedicatedPilotsForChEstimation  OPTIONAL
}

SupportOfDedicatedPilotsForChEstimation ::= ENUMERATED { true }

DL-PhysChCapabilityTDD ::= SEQUENCE {
    maxTS-PerFrame          MaxTS-PerFrame,

```

```

    maxPhysChPerFrame           MaxPhysChPerFrame,
    minimumSF                   MinimumSF-DL,
    supportOfPDSCH              BOOLEAN,
    maxPhysChPerTS             MaxPhysChPerTS
}

DL-TransChCapability ::=
    maxNoBitsReceived           MaxNoBits,
    maxConvCodeBitsReceived     MaxNoBits,
    turboDecodingSupport       TurboSupport,
    maxSimultaneousTransChs    MaxSimultaneousTransChsDL,
    maxSimultaneousCCTrCH-Count MaxSimultaneousCCTrCH-Count,
    maxReceivedTransportBlocks MaxTransportBlocksDL,
    maxNumberOfTFC-InTFCS     MaxNumberOfTFC-InTFCS-DL,
    maxNumberOfTF              MaxNumberOfTF
}

DRAC-SysInfo ::=
    transmissionProbability     TransmissionProbability,
    maximumBitRate              MaximumBitRate
}

DRAC-SysInfoList ::=
    SEQUENCE (SIZE (1..maxDRACclasses)) OF
        DRAC-SysInfo

ESN-DS-41 ::=
    BIT STRING (SIZE (32))

EstablishmentCause ::=
    ENUMERATED {
        originatingConversationalCall,
        originatingStreamingCall,
        originatingInteractiveCall,
        originatingBackgroundCall,
        originatingSubscribedTrafficCall,
        terminatingConversationalCall,
        terminatingStreamingCall,
        terminatingInteractiveCall,
        terminatingBackgroundCall,
        emergencyCall,
        interRAT-CellReselection,
        interRAT-CellChangeOrder,
        registration,
        detach,
        originatingHighPrioritySignalling,
        originatingLowPrioritySignalling,
        callRe-establishment,
        terminatingHighPrioritySignalling,
        terminatingLowPrioritySignalling,
        terminatingCauseUnknown,
        spare1 }

FailureCauseWithProtErr ::=
    CHOICE {
        configurationUnsupported     NULL,
        physicalChannelFailure      NULL,
        incompatibleSimultaneousReconfiguration
            NULL,
        compressedModeRuntimeError  TGPSI,
        protocolError               ProtocolErrorInformation,
        cellUpdateOccurred          NULL,
        invalidConfiguration        NULL,
        configurationIncomplete     NULL,
        unsupportedMeasurement      NULL,
        spare1                      NULL,
        spare2                      NULL,
        spare3                      NULL,
        spare4                      NULL,
        spare5                      NULL,
        spare6                      NULL,
        spare7                      NULL
    }

FailureCauseWithProtErrTrId ::=
    SEQUENCE {
        rrc-TransactionIdentifier    RRC-TransactionIdentifier,
        failureCause                 FailureCauseWithProtErr
    }

GSM-Measurements ::=
    SEQUENCE {
        gsm900                      BOOLEAN,
        dcs1800                     BOOLEAN,

```

```

    gsm1900                                BOOLEAN
}

ICS-Version ::=                             ENUMERATED {
    r99 }

IMSI-and-ESN-DS-41 ::=                     SEQUENCE {
    imsi-DS-41                               IMSI-DS-41,
    esn-DS-41                               ESN-DS-41
}

IMSI-DS-41 ::=                             OCTET STRING (SIZE (5..7))

InitialPriorityDelayList ::=               SEQUENCE (SIZE (1..maxASC)) OF
    NS-IP

InitialUE-Identity ::=                   CHOICE {
    imsi                                     IMSI-GSM-MAP,
    tmsi-and-LAI                           TMSI-and-LAI-GSM-MAP,
    p-TMSI-and-RAI                         P-TMSI-and-RAI-GSM-MAP,
    imei                                    IMEI,
    esn-DS-41                              ESN-DS-41,
    imsi-DS-41                             IMSI-DS-41,
    imsi-and-ESN-DS-41                    IMSI-and-ESN-DS-41,
    tmsi-DS-41                             TMSI-DS-41
}

IntegrityCheckInfo ::=                   SEQUENCE {
    messageAuthenticationCode              MessageAuthenticationCode,
    rrc-MessageSequenceNumber             RRC-MessageSequenceNumber
}

IntegrityProtActivationInfo ::=          SEQUENCE {
    rrc-MessageSequenceNumberList         RRC-MessageSequenceNumberList
}

IntegrityProtectionAlgorithm ::=        ENUMERATED {
    uial }

IntegrityProtectionModeCommand ::=      CHOICE {
    startIntegrityProtection              SEQUENCE {
        integrityProtInitNumber          IntegrityProtInitNumber
    },
    modify                                SEQUENCE {
        dl-IntegrityProtActivationInfo  IntegrityProtActivationInfo
    }
}

IntegrityProtectionModeInfo ::=         SEQUENCE {
    integrityProtectionModeCommand        IntegrityProtectionModeCommand,
    -- TABULAR: DL integrity protection activation info and Integrity
    -- protection intialisation number have been nested inside
    -- IntegrityProtectionModeCommand.
    integrityProtectionAlgorithm          IntegrityProtectionAlgorithm    OPTIONAL
}

IntegrityProtInitNumber ::=             BIT STRING (SIZE (32))

MaxHcContextSpace ::=                  ENUMERATED {
    by512, by1024, by2048, by4096,
    by8192 }

MaximumAM-EntityNumberRLC-Cap ::=      ENUMERATED {
    am3, am4, am5, am6,
    am8, am16, am30 }

-- Actual value = IE value * 16
MaximumBitRate ::=                     INTEGER (0..32)

MaximumRLC-WindowSize ::=              ENUMERATED { mws2047, mws4095 }

MaxNoDPDCH-BitsTransmitted ::=         ENUMERATED {
    b600, b1200, b2400, b4800,
    b9600, b19200, b28800, b38400,
    b48000, b57600 }

```

```

MaxNoBits ::=
    ENUMERATED {
        b640, b1280, b2560, b3840, b5120,
        b6400, b7680, b8960, b10240,
        b20480, b40960, b81920, b163840 }

MaxNoPhysChBitsReceived ::=
    ENUMERATED {
        b600, b1200, b2400, b3600,
        b4800, b7200, b9600, b14400,
        b19200, b28800, b38400, b48000,
        b57600, b67200, b76800 }

MaxNoSCCPCH-RL ::=
    ENUMERATED {
        r11 }

MaxNumberOfTF ::=
    ENUMERATED {
        tf32, tf64, tf128, tf256,
        tf512, tf1024 }

MaxNumberOfTFC-InTFCS-DL ::=
    ENUMERATED {
        tfc16, tfc32, tfc48, tfc64, tfc96,
        tfc128, tfc256, tfc512, tfc1024 }

MaxNumberOfTFC-InTFCS-UL ::=
    ENUMERATED {
        tfc4, tfc8, tfc16, tfc32, tfc48, tfc64,
        tfc96, tfc128, tfc256, tfc512, tfc1024 }

MaxPhysChPerFrame ::=
    INTEGER (1..224)

MaxPhysChPerTimeslot ::=
    ENUMERATED {
        ts1, ts2 }

MaxPhysChPerTS ::=
    INTEGER (1..16)

MaxSimultaneousCCTrCH-Count ::=
    INTEGER (1..8)

MaxSimultaneousTransChsDL ::=
    ENUMERATED {
        e4, e8, e16, e32 }

MaxSimultaneousTransChsUL ::=
    ENUMERATED {
        e2, e4, e8, e16, e32 }

MaxTransportBlocksDL ::=
    ENUMERATED {
        tb4, tb8, tb16, tb32, tb48,
        tb64, tb96, tb128, tb256, tb512 }

MaxTransportBlocksUL ::=
    ENUMERATED {
        tb2, tb4, tb8, tb16, tb32, tb48,
        tb64, tb96, tb128, tb256, tb512 }

MaxTS-PerFrame ::=
    INTEGER (1..14)

-- TABULAR: This IE contains dependencies to UE-MultiModeRAT-Capability,
-- the conditional fields have been left mandatory for now.
MeasurementCapability ::=
    SEQUENCE {
        downlinkCompressedMode          CompressedModeMeasCapability,
        uplinkCompressedMode            CompressedModeMeasCapability
    }

MeasurementCapabilityExt ::=
    SEQUENCE {
        compressedModeMeasCapabFDDList  CompressedModeMeasCapabFDDList,
        compressedModeMeasCapabTDDList  CompressedModeMeasCapabTDDList OPTIONAL,
        compressedModeMeasCapabGSMList  CompressedModeMeasCapabGSMList OPTIONAL,
        compressedModeMeasCapabMC       CompressedModeMeasCapabMC       OPTIONAL
    }

MessageAuthenticationCode ::=
    BIT STRING (SIZE (32))

MinimumSF-DL ::=
    ENUMERATED {
        sf1, sf16 }

MinimumSF-UL ::=
    ENUMERATED {
        sf1, sf2, sf4, sf8, sf16 }

MultiModeCapability ::=
    ENUMERATED {
        tdd, fdd, fdd-tdd }

MultiRAT-Capability ::=
    SEQUENCE {

```

```

    supportOfGSM                BOOLEAN,
    supportOfMulticarrier       BOOLEAN
}

N-300 ::=                       INTEGER (0..7)
N-301 ::=                       INTEGER (0..7)
N-302 ::=                       INTEGER (0..7)
N-304 ::=                       INTEGER (0..7)
N-308 ::=                       INTEGER (1..8)
N-310 ::=                       INTEGER (0..7)
N-312 ::=                       ENUMERATED {
                                s1, s50, s100, s200, s400,
                                s600, s800, s1000 }
N-313 ::=                       ENUMERATED {
                                s1, s2, s4, s10, s20,
                                s50, s100, s200 }
N-315 ::=                       ENUMERATED {
                                s1, s50, s100, s200, s400,
                                s600, s800, s1000 }

N-AccessFails ::=              INTEGER (1..64)
N-AP-RetransMax ::=            INTEGER (1..64)
NetworkAssistedGPS-Supported ::= ENUMERATED {
                                networkBased,
                                ue-Based,
                                bothNetworkAndUE-Based,
                                noNetworkAssistedGPS }

NF-BO-AllBusy ::=              INTEGER (0..31)
NF-BO-NoAICH ::=               INTEGER (0..31)
NF-BO-Mismatch ::=             INTEGER (0..127)
NS-BO-Busy ::=                  INTEGER (0..63)
NS-IP ::=                       INTEGER (0..28)

P-TMSI-and-RAI-GSM-MAP ::=     SEQUENCE {
    p-TMSI                       P-TMSI-GSM-MAP,
    rai                           RAI
}

PagingCause ::=                ENUMERATED {
                                terminatingConversationalCall,
                                terminatingStreamingCall,
                                terminatingInteractiveCall,
                                terminatingBackgroundCall,
                                terminatingHighPrioritySignalling,
                                terminatingLowPrioritySignalling,
                                terminatingCauseUnknown
}

PagingRecord ::=               CHOICE {
    cn-Identity                   SEQUENCE {
        pagingCause               PagingCause,
        cn-DomainIdentity         CN-DomainIdentity,
        cn-pagedUE-Identity       CN-PagedUE-Identity
    },
    utran-Identity                SEQUENCE {
        u-RNTI                     U-RNTI,
        cn-OriginatedPage-connectedMode-UE SEQUENCE {
            pagingCause           PagingCause,
            cn-DomainIdentity     CN-DomainIdentity,
            pagingRecordTypeID    PagingRecordTypeID
        }
    }
}
}
}
OPTIONAL

```

```

PagingRecordList ::=                               SEQUENCE (SIZE (1..maxPage1)) OF
                                                    PagingRecord

PDCP-Capability ::=                               SEQUENCE {
  losslessSRNS-RelocationSupport                 BOOLEAN,
  supportForRfc2507                               CHOICE {
    notSupported                                  NULL,
    supported                                     MaxHcContextSpace
  }
}

PhysicalChannelCapability ::=                     SEQUENCE {
  fddPhysChCapability                             SEQUENCE {
    downlinkPhysChCapability                       DL-PhysChCapabilityFDD,
    uplinkPhysChCapability                         UL-PhysChCapabilityFDD
  } OPTIONAL,
  tddPhysChCapability                             SEQUENCE {
    downlinkPhysChCapability                       DL-PhysChCapabilityTDD,
    uplinkPhysChCapability                         UL-PhysChCapabilityTDD
  } OPTIONAL
}

ProtocolErrorCause ::=                           ENUMERATED {
  asn1-ViolationOrEncodingError,
  messageTypeNonexistent,
  messageNotCompatibleWithReceiverState,
  ie-ValueNotComprehended,
  conditionalInformationElementError,
  messageExtensionNotComprehended,
  spare1, spare2
}

ProtocolErrorIndicator ::=                       ENUMERATED {
  noError, errorOccurred
}

ProtocolErrorIndicatorWithMoreInfo ::=           CHOICE {
  noError                                          NULL,
  errorOccurred                                   SEQUENCE {
    rrc-TransactionIdentifier                     RRC-TransactionIdentifier,
    protocolErrorInformation                     ProtocolErrorInformation
  }
}

ProtocolErrorMoreInformation ::=                 SEQUENCE {
  diagnosticsType                                 CHOICE {
    type1                                         CHOICE {
      asn1-ViolationOrEncodingError              NULL,
      messageTypeNonexistent                     NULL,
      messageNotCompatibleWithReceiverState
    }
    ie-ValueNotComprehended                       IdentificationOfReceivedMessage,
    conditionalInformationElementError            IdentificationOfReceivedMessage,
    messageExtensionNotComprehended              IdentificationOfReceivedMessage,
    spare1                                        NULL,
    spare2                                        NULL
  },
  spare                                           NULL
}

RadioFrequencyBandFDD ::=                       ENUMERATED {
  fdd2100,
  fdd1900,
  spare1, spare2, spare3, spare4, spare5, spare6
}

RadioFrequencyBandTDDList ::=                   ENUMERATED {
  a, b, c, ab, ac, bc, abc
}

RadioFrequencyBandTDD ::=                       ENUMERATED {a, b, c, spare}

RadioFrequencyBandGSM ::=                       ENUMERATED {
  gsm450,
  gsm480,
  gsm850,
  gsm900P,
  gsm900E,
  gsm1800,
}

```

```

        gsm1900,
        spare1, spare2, spare3, spare4, spare5,
        spare6, spare7, spare8, spare9}

Rb-timer-indicator ::=
    t314-expired
    t315-expired
SEQUENCE {
    BOOLEAN,
    BOOLEAN }

Re-EstablishmentTimer ::=
}
ENUMERATED {
    useT314, useT315

RedirectionInfo ::=
    frequencyInfo
    interRATInfo
CHOICE {
    FrequencyInfo,
    InterRATInfo

RejectionCause ::=
ENUMERATED {
    congestion,
    unspecified }

ReleaseCause ::=
ENUMERATED {
    normalEvent,
    unspecified,
    pre-emptiveRelease,
    congestion,
    re-establishmentReject,
    directedsignallingconnectionre-establishment,
    userInactivity }

RF-Capability ::=
    fddRF-Capability
        ue-PowerClass
        txRxFrequencySeparation
    }
    tddRF-Capability
        ue-PowerClass
        radioFrequencyTDDBandList
        chipRateCapability
    }
SEQUENCE {
    SEQUENCE {
        UE-PowerClass,
        TxRxFrequencySeparation
    }
    OPTIONAL,
    SEQUENCE {
        UE-PowerClass,
        RadioFrequencyBandTDDList,
        ChipRateCapability
    }
    OPTIONAL

}

RLC-Capability ::=
    totalRLC-AM-BufferSize
    maximumRLC-WindowSize
    maximumAM-EntityNumber
SEQUENCE {
    TotalRLC-AM-BufferSize,
    MaximumRLC-WindowSize,
    MaximumAM-EntityNumberRLC-Cap

}

RRC-MessageSequenceNumber ::=
INTEGER (0..15)

RRC-MessageSequenceNumberList ::=
SEQUENCE (SIZE (4..5)) OF
RRC-MessageSequenceNumber

RRC-StateIndicator ::=
ENUMERATED {
    cell-DCH, cell-FACH, cell-PCH, ura-PCH }

RRC-TransactionIdentifier ::=
INTEGER (0..3)

S-RNTI ::=
BIT STRING (SIZE (20))

S-RNTI-2 ::=
BIT STRING (SIZE (10))

SecurityCapability ::=
    cipheringAlgorithmCap
SEQUENCE {
    BIT STRING {
        spare15(0),
        spare14(1),
        spare13(2),
        spare12(3),
        spare11(4),
        spare10(5),
        spare9(6),
        spare8(7),
        spare7(8),
        spare6(9),
        spare5(10),
        spare4(11),

```

```

        spare3(12),
        spare2(13),
        uea1(14),
        uea0(15)
    } (SIZE (16)),
integrityProtectionAlgorithmCap BIT STRING {
    spare15(0),
    spare14(1),
    spare13(2),
    spare12(3),
    spare11(4),
    spare10(5),
    spare9(6),
    spare8(7),
    spare7(8),
    spare6(9),
    spare5(10),
    spare4(11),
    spare3(12),
    spare2(13),
    uia1(14),
    spare0(15)
} (SIZE (16))
}

SimultaneousSCCPCH-DPCH-Reception ::= CHOICE {
    notSupported          NULL,
    supported              SEQUENCE {
        maxNoSCCPCH-RL    MaxNoSCCPCH-RL,
        simultaneousSCCPCH-DPCH-DPDCH-Reception
                            BOOLEAN
        -- The IE above is applicable only if IE Support of PDSCH = TRUE
    }
}

SRNC-Identity ::=          BIT STRING (SIZE (12))

START-Value ::=           BIT STRING (SIZE (20))

STARTList ::=             SEQUENCE (SIZE (1..maxCNdomains)) OF
                            STARTSingle

STARTSingle ::=           SEQUENCE {
    cn-DomainIdentity      CN-DomainIdentity,
    start-Value            START-Value
}

SystemSpecificCapUpdateReq ::= ENUMERATED {
    gsm }

SystemSpecificCapUpdateReqList ::= SEQUENCE (SIZE (1..maxSystemCapability)) OF
    SystemSpecificCapUpdateReq

T-300 ::=                ENUMERATED {
    ms100, ms200, ms400, ms600, ms800,
    ms1000, ms1200, ms1400, ms1600,
    ms1800, ms2000, ms3000, ms4000,
    ms6000, ms8000 }

T-301 ::=                ENUMERATED {
    ms100, ms200, ms400, ms600, ms800,
    ms1000, ms1200, ms1400, ms1600,
    ms1800, ms2000, ms3000, ms4000,
    ms6000, ms8000 }

T-302 ::=                ENUMERATED {
    ms100, ms200, ms400, ms600, ms800,
    ms1000, ms1200, ms1400, ms1600,
    ms1800, ms2000, ms3000, ms4000,
    ms6000, ms8000 }

T-304 ::=                ENUMERATED {
    ms100, ms200, ms400,
    ms1000, ms2000, spare1, spare2, spare3 }

T-305 ::=                ENUMERATED {

```



```

        noUpdate, m5, m10, m30,
        m60, m120, m360, m720 }

T-307 ::=          ENUMERATED {
                    s5, s10, s15, s20,
                    s30, s40, s50 }

T-308 ::=          ENUMERATED {
                    ms40, ms80, ms160, ms320 }

T-309 ::=          INTEGER (1..8)

T-310 ::=          ENUMERATED {
                    ms40, ms80, ms120, ms160,
                    ms200, ms240, ms280, ms320 }

T-311 ::=          ENUMERATED {
                    ms250, ms500, ms750, ms1000,
                    ms1250, ms1500, ms1750, ms2000 }

T-312 ::=          INTEGER (0..15)
-- The value 0 for T-312 is not used in this version of the specification

T-313 ::=          INTEGER (0..15)

T-314 ::=          ENUMERATED {
                    s0, s2, s4, s6, s8,
                    s12, s16, s20 }

T-315 ::=          ENUMERATED {
                    s0, s10, s30, s60, s180,
                    s600, s1200, s1800 }

T-316 ::=          ENUMERATED {
                    s0, s10, s20, s30, s40,
                    s50, s-inf }

T-317 ::=          ENUMERATED {
                    s0, s10, s30, s60, s180,
                    s600, s1200, s1800 }

T-CPCH ::=         ENUMERATED {
                    ct0, ct1 }

TMSI-and-LAI-GSM-MAP ::= SEQUENCE {
    tmsi          TMSI-GSM-MAP,
    lai          LAI
}

TMSI-DS-41 ::=     OCTET STRING (SIZE (2..12))

TotalRLC-AM-BufferSize ::= ENUMERATED {
    kb2, kb10, kb50, kb100,
    kb150, kb500, kb1000 }

-- Actual value = IE value * 0.125
TransmissionProbability ::= INTEGER (1..8)

TransportChannelCapability ::= SEQUENCE {
    dl-TransChCapability  DL-TransChCapability,
    ul-TransChCapability  UL-TransChCapability
}

TurboSupport ::=   CHOICE {
    notSupported
    supported
    MaxNoBits
}

TxRxFrequencySeparation ::= ENUMERATED {
    mhz190, mhz174-8-205-2,
    mhz134-8-245-2 }

U-RNTI ::=         SEQUENCE {
    srnc-Identity  SRNC-Identity,
    s-RNTI        S-RNTI
}

U-RNTI-Short ::=   SEQUENCE {

```

```

    srnc-Identity          SRNC-Identity,
    s-RNTI-2              S-RNTI-2
}

UE-ConnTimersAndConstants ::= SEQUENCE {
-- Optional is used also for parameters for which the default value is the last one read in SIB1
-- t-301 and n-301 should not be used by the UE in this release of the protocol
    t-301                  T-301                DEFAULT ms2000,
    n-301                  N-301                DEFAULT 2,
    t-302                  T-302                DEFAULT ms4000,
    n-302                  N-302                DEFAULT 3,
    t-304                  T-304                DEFAULT ms2000,
    n-304                  N-304                DEFAULT 2,
    t-305                  T-305                DEFAULT m30,
    t-307                  T-307                DEFAULT s30,
    t-308                  T-308                DEFAULT ms160,
    t-309                  T-309                DEFAULT 5,
    t-310                  T-310                DEFAULT ms160,
    n-310                  N-310                DEFAULT 4,
    t-311                  T-311                DEFAULT ms2000,
    t-312                  T-312                DEFAULT 1,
    n-312                  N-312                DEFAULT s1,
    t-313                  T-313                DEFAULT 3,
    n-313                  N-313                DEFAULT s20,
    t-314                  T-314                DEFAULT s12,
    t-315                  T-315                DEFAULT s180,
    n-315                  N-315                DEFAULT s1,
    t-316                  T-316                DEFAULT s30,
    t-317                  T-317                DEFAULT s180
}

UE-IdleTimersAndConstants ::= SEQUENCE {
    t-300                  T-300,
    n-300                  N-300,
    t-312                  T-312,
    n-312                  N-312
}

UE-MultiModeRAT-Capability ::= SEQUENCE {
    multiRAT-CapabilityList MultiRAT-Capability,
    multiModeCapability      MultiModeCapability
}

UE-PowerClass ::= INTEGER (1..4)

UE-PowerClassExt ::= ENUMERATED {class1, class2, class3, class4, spare1, spare2,
    spare3, spare4}

UE-RadioAccessCapability ::= SEQUENCE {
    ics-Version            ICS-Version,
    pdcp-Capability        PDCP-Capability,
    rlc-Capability          RLC-Capability,
    transportChannelCapability TransportChannelCapability,
    rf-Capability          RF-Capability,
    physicalChannelCapability PhysicalChannelCapability,
    ue-MultiModeRAT-Capability UE-MultiModeRAT-Capability,
    securityCapability      SecurityCapability,
    ue-positioning-Capability UE-Positioning-Capability,
    measurementCapability   MeasurementCapability OPTIONAL
}

UE-RadioAccessCapability-v370ext ::= SEQUENCE {
    ue-RadioAccessCapabBandFDDList UE-RadioAccessCapabBandFDDList
}

UE-RadioAccessCapability-v380ext ::= SEQUENCE {
    ue-PositioningCapabilityExt UE-PositioningCapabilityExt
}

UE-PositioningCapabilityExt ::= SEQUENCE {
    rx-tx-TimeDifferenceType2Capable BOOLEAN
}

UE-RadioAccessCapabBandFDDList ::= SEQUENCE (SIZE (1..maxFreqBandsFDD)) OF
    UE-RadioAccessCapabBandFDD

```

```

UE-RadioAccessCapabBandFDD ::= SEQUENCE {
    radioFrequencyBandFDD      RadioFrequencyBandFDD,
    fddRF-Capability           SEQUENCE {
        ue-PowerClass          UE-PowerClassExt,
        txRxFrequencySeparation TxRxFrequencySeparation
    }
    measurementCapability      MeasurementCapabilityExt OPTIONAL,
}

UL-PhysChCapabilityFDD ::= SEQUENCE {
    maxNoDPDCH-BitsTransmitted MaxNoDPDCH-BitsTransmitted,
    supportOfPCPCH             BOOLEAN
}

UL-PhysChCapabilityTDD ::= SEQUENCE {
    maxTS-PerFrame             MaxTS-PerFrame,
    maxPhysChPerTimeslot       MaxPhysChPerTimeslot,
    minimumSF                   MinimumSF-UL,
    supportOfPUSCH             BOOLEAN
}

UL-TransChCapability ::= SEQUENCE {
    maxNoBitsTransmitted        MaxNoBits,
    maxConvCodeBitsTransmitted MaxNoBits,
    turboDecodingSupport        TurboSupport,
    maxSimultaneousTransChs     MaxSimultaneousTransChsUL,
    modeSpecificInfo            CHOICE {
        fdd                      NULL,
        tdd                      SEQUENCE {
            maxSimultaneousCCTrCH-Count MaxSimultaneousCCTrCH-Count
        }
    },
    maxTransmittedBlocks        MaxTransportBlocksUL,
    maxNumberOfTFC-InTFCS       MaxNumberOfTFC-InTFCS-UL,
    maxNumberOfTF               MaxNumberOfTF
}

UE-Positioning-Capability ::= SEQUENCE {
    standaloneLocMethodsSupported BOOLEAN,
    ue-BasedOTDOA-Supported      BOOLEAN,
    networkAssistedGPS-Supported NetworkAssistedGPS-Supported,
    gps-ReferenceTimeCapable     BOOLEAN,
    supportForIPDL               BOOLEAN
}

URA-UpdateCause ::= ENUMERATED {
    changeOfURA,
    periodicURAUpdate,
    dummy,
    spare1 }

UTRAN-DRX-CycleLengthCoefficient ::= INTEGER (3..9)

WaitTime ::= INTEGER (0..15)

-- *****
--
-- RADIO BEARER INFORMATION ELEMENTS (10.3.4)
--
-- *****

AlgorithmSpecificInfo ::= CHOICE {
    rfc2507-Info          RFC2507-Info
}

-- Upper limit is 2^32 - 1
COUNT-C ::= INTEGER (0..4294967295)

-- Upper limit is 2^25 - 1
COUNT-C-MSB ::= INTEGER (0..33554431)

DefaultConfigIdentity ::= INTEGER (0..9)

DefaultConfigMode ::= ENUMERATED {
    fdd,
    tdd }

DL-AM-RLC-Mode ::= SEQUENCE {

```

```

    inSequenceDelivery                BOOLEAN,
    receivingWindowSize              ReceivingWindowSize,
    dl-RLC-StatusInfo                DL-RLC-StatusInfo
}

DL-CounterSynchronisationInfo ::= SEQUENCE {
    rB-WithPDCP-InfoList             RB-WithPDCP-InfoList    OPTIONAL
}

DL-LogicalChannelMapping ::= SEQUENCE {
    -- TABULAR: DL-TransportChannelType contains TransportChannelIdentity as well.
    dl-TransportChannelType          DL-TransportChannelType,
    logicalChannelIdentity           LogicalChannelIdentity    OPTIONAL
}

DL-LogicalChannelMappingList ::= SEQUENCE (SIZE (1..maxLoCHperRLC)) OF
    DL-LogicalChannelMapping

DL-RLC-Mode ::= CHOICE {
    dl-AM-RLC-Mode                   DL-AM-RLC-Mode,
    dl-UM-RLC-Mode                   NULL,
    dl-TM-RLC-Mode                   DL-TM-RLC-Mode
}

DL-RLC-StatusInfo ::= SEQUENCE {
    timerStatusProhibit              TimerStatusProhibit    OPTIONAL,
    timerEPC                          TimerEPC                OPTIONAL,
    missingPDU-Indicator              BOOLEAN,
    timerStatusPeriodic              TimerStatusPeriodic    OPTIONAL
}

DL-TM-RLC-Mode ::= SEQUENCE {
    segmentationIndication           BOOLEAN
}

DL-TransportChannelType ::= CHOICE {
    dch                               TransportChannelIdentity,
    fach                              NULL,
    dsch                              TransportChannelIdentity,
    dch-and-dsch                      TransportChannelIdentityDCHandDSCH
}

ExpectReordering ::= ENUMERATED {
    reorderingNotExpected,
    reorderingExpected }

ExplicitDiscard ::= SEQUENCE {
    timerMRW                          TimerMRW,
    timerDiscard                      TimerDiscard,
    maxMRW                            MaxMRW
}

HeaderCompressionInfo ::= SEQUENCE {
    algorithmSpecificInfo            AlgorithmSpecificInfo
}

HeaderCompressionInfoList ::= SEQUENCE (SIZE (1..maxPDCPALgoType)) OF
    HeaderCompressionInfo

LogicalChannelIdentity ::= INTEGER (1..15)

LosslessSRNS-RelocSupport ::= CHOICE {
    supported                         MaxPDCP-SN-WindowSize,
    notSupported                      NULL
}

MAC-LogicalChannelPriority ::= INTEGER (1..8)

MaxDAT ::= ENUMERATED {
    dat1, dat2, dat3, dat4, dat5, dat6,
    dat7, dat8, dat9, dat10, dat15, dat20,
    dat25, dat30, dat35, dat40 }

MaxDAT-Retransmissions ::= SEQUENCE {
    maxDAT                            MaxDAT,
    timerMRW                          TimerMRW,
    maxMRW                            MaxMRW
}

```

```

}

MaxMRW ::= ENUMERATED {
    mm1, mm4, mm6, mm8, mm12, mm16,
    mm24, mm32 }

MaxPDCP-SN-WindowSize ::= ENUMERATED {
    sn255, sn65535 }

MaxRST ::= ENUMERATED {
    rst1, rst4, rst6, rst8, rst12,
    rst16, rst24, rst32 }

NoExplicitDiscard ::= ENUMERATED {
    dt10, dt20, dt30, dt40, dt50,
    dt60, dt70, dt80, dt90, dt100 }

PDCP-Info ::= SEQUENCE {
    losslessSRNS-RelocSupport LosslessSRNS-RelocSupport OPTIONAL,
    pdcp-PDU-Header PDCP-PDU-Header,
    -- TABULAR: The IE above is MD in the tabular format and it can be encoded
    -- in one bit, so the OPTIONAL is removed for compactness.
    headerCompressionInfoList HeaderCompressionInfoList OPTIONAL
}

PDCP-InfoReconfig ::= SEQUENCE {
    pdcp-Info PDCP-Info,
    -- dummy is not used in this version of the protocol
    dummy INTEGER (0..65535)
}

PDCP-PDU-Header ::= ENUMERATED {
    present, absent }

PDCP-SN-Info ::= INTEGER (0..65535)

Poll-PDU ::= ENUMERATED {
    pdu1, pdu2, pdu4, pdu8, pdu16,
    pdu32, pdu64, pdu128 }

Poll-SDU ::= ENUMERATED {
    sdu1, sdu4, sdu16, sdu64 }

PollingInfo ::= SEQUENCE {
    timerPollProhibit TimerPollProhibit OPTIONAL,
    timerPoll TimerPoll OPTIONAL,
    poll-PDU Poll-PDU OPTIONAL,
    poll-SDU Poll-SDU OPTIONAL,
    lastTransmissionPDU-Poll BOOLEAN,
    lastRetransmissionPDU-Poll BOOLEAN,
    pollWindow PollWindow OPTIONAL,
    timerPollPeriodic TimerPollPeriodic OPTIONAL
}

PollWindow ::= ENUMERATED {
    pw50, pw60, pw70, pw80, pw85,
    pw90, pw95, pw99 }

PredefinedConfigIdentity ::= INTEGER (0..15)

PredefinedConfigValueTag ::= INTEGER (0..15)

PredefinedRB-Configuration ::= SEQUENCE {
    re-EstablishmentTimer Re-EstablishmentTimer,
    srb-InformationList SRB-InformationSetupList,
    rb-InformationList RB-InformationSetupList
}

PreDefRadioConfiguration ::= SEQUENCE {
    -- Radio bearer IEs
    predefinedRB-Configuration PredefinedRB-Configuration,
    -- Transport channel IEs
    preDefTransChConfiguration PreDefTransChConfiguration,
    -- Physical channel IEs
    preDefPhyChConfiguration PreDefPhyChConfiguration
}

RAB-Info ::= SEQUENCE {

```

```

    rab-Identity                RAB-Identity,
    cn-DomainIdentity           CN-DomainIdentity,
    nas-Synchronisation-Indicator NAS-Synchronisation-Indicator OPTIONAL,
    re-EstablishmentTimer      Re-EstablishmentTimer
}
RAB-InformationList ::= SEQUENCE (SIZE (1..maxRABsetup)) OF
    RAB-Info

RAB-InformationReconfigList ::= SEQUENCE (SIZE (1.. maxRABsetup)) OF
    RAB-InformationReconfig

RAB-InformationReconfig ::= SEQUENCE {
    rab-Identity                RAB-Identity,
    cn-DomainIdentity           CN-DomainIdentity,
    nas-Synchronisation-Indicator NAS-Synchronisation-Indicator
}

RAB-Info-Post ::= SEQUENCE {
    rab-Identity                RAB-Identity,
    cn-DomainIdentity           CN-DomainIdentity,
    nas-Synchronisation-Indicator NAS-Synchronisation-Indicator OPTIONAL
}

RAB-InformationSetup ::= SEQUENCE {
    rab-Info                    RAB-Info,
    rb-InformationSetupList     RB-InformationSetupList
}

RAB-InformationSetupList ::= SEQUENCE (SIZE (1..maxRABsetup)) OF
    RAB-InformationSetup

RB-ActivationTimeInfo ::= SEQUENCE {
    rb-Identity                 RB-Identity,
    rlc-SequenceNumber         RLC-SequenceNumber
}

RB-ActivationTimeInfoList ::= SEQUENCE (SIZE (1..maxRB)) OF
    RB-ActivationTimeInfo

RB-COUNT-C-Information ::= SEQUENCE {
    rb-Identity                 RB-Identity,
    count-C-UL                  COUNT-C,
    count-C-DL                  COUNT-C
}

RB-COUNT-C-InformationList ::= SEQUENCE (SIZE (1..maxRBallRABs)) OF
    RB-COUNT-C-Information

RB-COUNT-C-MSB-Information ::= SEQUENCE {
    rb-Identity                 RB-Identity,
    count-C-MSB-UL              COUNT-C-MSB,
    count-C-MSB-DL              COUNT-C-MSB
}

RB-COUNT-C-MSB-InformationList ::= SEQUENCE (SIZE (1..maxRBallRABs)) OF
    RB-COUNT-C-MSB-Information

RB-Identity ::= INTEGER (1..32)

RB-IdentityList ::= SEQUENCE (SIZE (1..maxRB)) OF
    RB-Identity

RB-InformationAffected ::= SEQUENCE {
    rb-Identity                 RB-Identity,
    rb-MappingInfo             RB-MappingInfo
}

RB-InformationAffectedList ::= SEQUENCE (SIZE (1..maxRB)) OF
    RB-InformationAffected

RB-InformationReconfig ::= SEQUENCE {
    rab-Identity                RAB-Identity,
    pdcp-Info                   PDCP-InfoReconfig OPTIONAL,
    pdcp-SN-Info                PDCP-SN-Info OPTIONAL,
    rlc-Info                     RLC-Info OPTIONAL,
    rb-MappingInfo              RB-MappingInfo OPTIONAL,
    rb-StopContinue             RB-StopContinue OPTIONAL
}

```

```

RB-InformationReconfigList ::= SEQUENCE (SIZE (1..maxRB)) OF
    RB-InformationReconfig

RB-InformationReleaseList ::= SEQUENCE (SIZE (1..maxRB)) OF
    RB-Identity

RB-InformationSetup ::= SEQUENCE {
    rb-Identity RB-Identity,
    pdcp-Info PDCP-Info OPTIONAL,
    rlc-InfoChoice RLC-InfoChoice,
    rb-MappingInfo RB-MappingInfo
}

RB-InformationSetupList ::= SEQUENCE (SIZE (1..maxRBperRAB)) OF
    RB-InformationSetup

RB-MappingInfo ::= SEQUENCE (SIZE (1..maxRBMuxOptions)) OF
    RB-MappingOption

RB-MappingOption ::= SEQUENCE {
    ul-LogicalChannelMappings UL-LogicalChannelMappings OPTIONAL,
    dl-LogicalChannelMappingList DL-LogicalChannelMappingList OPTIONAL
}

RB-StopContinue ::= ENUMERATED {
    stopRB, continueRB }

RB-WithPDCP-Info ::= SEQUENCE {
    rb-Identity RB-Identity,
    pdcp-SN-Info PDCP-SN-Info
}

RB-WithPDCP-InfoList ::= SEQUENCE (SIZE (1..maxRBallRABs)) OF
    RB-WithPDCP-Info

ReceivingWindowSize ::= ENUMERATED {
    rw1, rw8, rw16, rw32, rw64, rw128, rw256,
    rw512, rw768, rw1024, rw1536, rw2047,
    rw2560, rw3072, rw3584, rw4095 }

RFC2507-Info ::= SEQUENCE {
    f-MAX-PERIOD INTEGER (1..65535) DEFAULT 256,
    f-MAX-TIME INTEGER (1..255) DEFAULT 5,
    max-HEADER INTEGER (60..65535) DEFAULT 168,
    tcp-SPACE INTEGER (3..255) DEFAULT 15,
    non-TCP-SPACE INTEGER (3..65535) DEFAULT 15,
    expectReordering ExpectReordering
    -- TABULAR: The IE above has only two possible values, so using Optional or Default
    -- would be wasteful
}

RLC-Info ::= SEQUENCE {
    ul-RLC-Mode UL-RLC-Mode OPTIONAL,
    dl-RLC-Mode DL-RLC-Mode OPTIONAL
}

RLC-InfoChoice ::= CHOICE {
    rlc-Info RLC-Info,
    same-as-RB RB-Identity
}

RLC-SequenceNumber ::= INTEGER (0..4095)

RLC-SizeInfo ::= SEQUENCE {
    rlc-SizeIndex INTEGER (1..maxTF)
}

RLC-SizeExplicitList ::= SEQUENCE (SIZE (1..maxTF)) OF
    RLC-SizeInfo

SRB-InformationSetup ::= SEQUENCE {
    rb-Identity RB-Identity OPTIONAL,
    -- The default value for the IE above is the smallest value not used yet.
    rlc-InfoChoice RLC-InfoChoice,
    rb-MappingInfo RB-MappingInfo
}

```

```

SRB-InformationSetupList ::= SEQUENCE (SIZE (1..maxSRBsetup)) OF
                               SRB-InformationSetup

SRB-InformationSetupList2 ::= SEQUENCE (SIZE (3..4)) OF
                               SRB-InformationSetup

TimerDiscard ::= ENUMERATED {
                    td0-1, td0-25, td0-5, td0-75,
                    td1, td1-25, td1-5, td1-75,
                    td2, td2-5, td3, td3-5, td4,
                    td4-5, td5, td7-5 }

TimerEPC ::= ENUMERATED {
               te50, te60, te70, te80, te90,
               te100, te120, te140, te160, te180,
               te200, te300, te400, te500, te700,
               te900 }

TimerMRW ::= ENUMERATED {
               te50, te60, te70, te80, te90, te100,
               te120, te140, te160, te180, te200,
               te300, te400, te500, te700, te900 }

TimerPoll ::= ENUMERATED {
                tp10, tp20, tp30, tp40, tp50,
                tp60, tp70, tp80, tp90, tp100,
                tp110, tp120, tp130, tp140, tp150,
                tp160, tp170, tp180, tp190, tp200,
                tp210, tp220, tp230, tp240, tp250,
                tp260, tp270, tp280, tp290, tp300,
                tp310, tp320, tp330, tp340, tp350,
                tp360, tp370, tp380, tp390, tp400,
                tp410, tp420, tp430, tp440, tp450,
                tp460, tp470, tp480, tp490, tp500,
                tp510, tp520, tp530, tp540, tp550,
                tp600, tp650, tp700, tp750, tp800,
                tp850, tp900, tp950, tp1000 }

TimerPollPeriodic ::= ENUMERATED {
                        tper100, tper200, tper300, tper400,
                        tper500, tper750, tper1000, tper2000 }

TimerPollProhibit ::= ENUMERATED {
                        tpp10, tpp20, tpp30, tpp40, tpp50,
                        tpp60, tpp70, tpp80, tpp90, tpp100,
                        tpp110, tpp120, tpp130, tpp140, tpp150,
                        tpp160, tpp170, tpp180, tpp190, tpp200,
                        tpp210, tpp220, tpp230, tpp240, tpp250,
                        tpp260, tpp270, tpp280, tpp290, tpp300,
                        tpp310, tpp320, tpp330, tpp340, tpp350,
                        tpp360, tpp370, tpp380, tpp390, tpp400,
                        tpp410, tpp420, tpp430, tpp440, tpp450,
                        tpp460, tpp470, tpp480, tpp490, tpp500,
                        tpp510, tpp520, tpp530, tpp540, tpp550,
                        tpp600, tpp650, tpp700, tpp750, tpp800,
                        tpp850, tpp900, tpp950, tpp1000 }

TimerRST ::= ENUMERATED {
               tr50, tr100, tr150, tr200, tr250, tr300,
               tr350, tr400, tr450, tr500, tr550,
               tr600, tr700, tr800, tr900, tr1000 }

TimerStatusPeriodic ::= ENUMERATED {
                        tsp100, tsp200, tsp300, tsp400, tsp500,
                        tsp750, tsp1000, tsp2000 }

TimerStatusProhibit ::= ENUMERATED {
                        tsp10, tsp20, tsp30, tsp40, tsp50,
                        tsp60, tsp70, tsp80, tsp90, tsp100,
                        tsp110, tsp120, tsp130, tsp140, tsp150,
                        tsp160, tsp170, tsp180, tsp190, tsp200,
                        tsp210, tsp220, tsp230, tsp240, tsp250,
                        tsp260, tsp270, tsp280, tsp290, tsp300,
                        tsp310, tsp320, tsp330, tsp340, tsp350,
                        tsp360, tsp370, tsp380, tsp390, tsp400,
                        tsp410, tsp420, tsp430, tsp440, tsp450,
                        tsp460, tsp470, tsp480, tsp490, tsp500,
                        tsp510, tsp520, tsp530, tsp540, tsp550,

```



```

tsp600,tsp650,tsp700,tsp750,tsp800,
tsp850,tsp900,tsp950,tsp1000 }

TransmissionRLC-Discard ::= CHOICE {
    timerBasedExplicit      ExplicitDiscard,
    timerBasedNoExplicit    NoExplicitDiscard,
    maxDAT-Retransmissions  MaxDAT-Retransmissions,
    noDiscard               MaxDAT
}

TransmissionWindowSize ::= ENUMERATED {
    tw1, tw8, tw16, tw32, tw64, tw128, tw256,
    tw512, tw768, tw1024, tw1536, tw2047,
    tw2560, tw3072, tw3584, tw4095 }

UL-AM-RLC-Mode ::= SEQUENCE {
    transmissionRLC-Discard      TransmissionRLC-Discard,
    transmissionWindowSize      TransmissionWindowSize,
    timerRST                     TimerRST,
    max-RST                      MaxRST,
    pollingInfo                  PollingInfo OPTIONAL
}

UL-CounterSynchronisationInfo ::= SEQUENCE {
    rB-WithPDCP-InfoList        RB-WithPDCP-InfoList OPTIONAL,
    startList                   STARTList
}

UL-LogicalChannelMapping ::= SEQUENCE {
    -- TABULAR: UL-TransportChannelType contains TransportChannelIdentity as well.
    ul-TransportChannelType      UL-TransportChannelType,
    logicalChannelIdentity        LogicalChannelIdentity OPTIONAL,
    rlc-SizeList                 CHOICE {
        allSizes                 NULL,
        configured               NULL,
        explicitList             RLC-SizeExplicitList
    },
    mac-LogicalChannelPriority    MAC-LogicalChannelPriority
}

UL-LogicalChannelMappingList ::= SEQUENCE {
    rlc-LogicalChannelMappingIndicator  BOOLEAN, -- NOTE: This parameter shall be set to TRUE in
this release
    ul-LogicalChannelMapping           SEQUENCE (SIZE (maxLoCHperRLC)) OF
UL-LogicalChannelMapping
}

UL-LogicalChannelMappings ::= CHOICE {
    oneLogicalChannel             UL-LogicalChannelMapping,
    twoLogicalChannels            UL-LogicalChannelMappingList
}

UL-RLC-Mode ::= CHOICE {
    ul-AM-RLC-Mode               UL-AM-RLC-Mode,
    ul-UM-RLC-Mode               UL-UM-RLC-Mode,
    ul-TM-RLC-Mode               UL-TM-RLC-Mode,
    spare                         NULL
}

UL-TM-RLC-Mode ::= SEQUENCE {
    transmissionRLC-Discard      TransmissionRLC-Discard OPTIONAL,
    segmentationIndication      BOOLEAN
}

UL-UM-RLC-Mode ::= SEQUENCE {
    transmissionRLC-Discard      TransmissionRLC-Discard OPTIONAL
}

UL-TransportChannelType ::= CHOICE {
    dch                           TransportChannelIdentity,
    rach                           NULL,
    cpch                           NULL,
    usch                           TransportChannelIdentity
}

-- *****
--

```

```

--      TRANSPORT CHANNEL INFORMATION ELEMENTS (10.3.5)
--
-- *****

AllowedTFC-List ::=
    SEQUENCE (SIZE (1..maxTFC)) OF
        TFC-Value

AllowedTFI-List ::=
    SEQUENCE (SIZE (1..maxTF)) OF
        INTEGER (0..31)

BitModeRLC-SizeInfo ::=
    CHOICE {
        sizeType1
            INTEGER (0..127),
        sizeType2
            SEQUENCE {
                part1
                    INTEGER (0..15),
                part2
                    INTEGER (1..7)
            }
            -- Actual size = (part1 * 8) + 128 + part2
            OPTIONAL
        },
        sizeType3
            SEQUENCE {
                part1
                    INTEGER (0..47),
                part2
                    INTEGER (1..15)
            }
            -- Actual size = (part1 * 16) + 256 + part2
            OPTIONAL
        },
        sizeType4
            SEQUENCE {
                part1
                    INTEGER (0..62),
                part2
                    INTEGER (1..63)
            }
            -- Actual size = (part1 * 64) + 1024 + part2
            OPTIONAL
        }
    }
-- Actual value = IE value * 0.1
BLER-QualityValue ::=
    INTEGER (-63..0)

ChannelCodingType ::=
    CHOICE {
        noCoding
            NULL,
        convolutional
            CodingRate,
        turbo
            NULL
    }

CodingRate ::=
    ENUMERATED {
        half,
        third }

CommonDynamicTF-Info ::=
    SEQUENCE {
        rlc-Size
            CHOICE {
                fdd
                    SEQUENCE {
                        octetModeRLC-SizeInfoType2
                            OctetModeRLC-SizeInfoType2
                    },
                tdd
                    SEQUENCE {
                        commonTDD-Choice
                            CHOICE {
                                bitModeRLC-SizeInfo
                                    BitModeRLC-SizeInfo,
                                octetModeRLC-SizeInfoType1
                                    OctetModeRLC-SizeInfoType1
                            }
                    }
            },
        numberOfTbSizeList
            SEQUENCE (SIZE (1..maxTF)) OF
                NumberOfTransportBlocks,
        logicalChannelList
            LogicalChannelList
    }

CommonDynamicTF-Info-DynamicTTI ::= SEQUENCE {
        commonTDD-Choice
            CHOICE {
                bitModeRLC-SizeInfo
                    BitModeRLC-SizeInfo,
                octetModeRLC-SizeInfoType1
                    OctetModeRLC-SizeInfoType1
            },
        numberOfTbSizeAndTTIList
            NumberOfTbSizeAndTTIList,
        logicalChannelList
            LogicalChannelList
    }

CommonDynamicTF-InfoList ::=
    SEQUENCE (SIZE (1..maxTF)) OF
        CommonDynamicTF-Info

CommonDynamicTF-InfoList-DynamicTTI ::= SEQUENCE (SIZE (1..maxTF)) OF
        CommonDynamicTF-Info-DynamicTTI

CommonTransChTFS ::=
    SEQUENCE {
        tti
            CHOICE {
                tti10
                    CommonDynamicTF-InfoList,
                tti20
                    CommonDynamicTF-InfoList,
                tti40
                    CommonDynamicTF-InfoList,
            }
    }

```

```

        tti80                CommonDynamicTF-InfoList,
        dynamic              CommonDynamicTF-InfoList-DynamicTTI
    },
    semistaticTF-Information SemistaticTF-Information
}

CPCH-SetID ::=
INTEGER (1..maxCPCHsets)

CRC-Size ::=
ENUMERATED {
    crc0, crc8, crc12, crc16, crc24 }

DedicatedDynamicTF-Info ::=
SEQUENCE {
    rlc-Size                CHOICE {
        bitMode             BitModeRLC-SizeInfo,
        octetModeType1     OctetModeRLC-SizeInfoType1
    },
    numberOfTbSizeList     SEQUENCE (SIZE (1..maxTF)) OF
    NumberOfTransportBlocks,
    logicalChannelList     LogicalChannelList
}

DedicatedDynamicTF-Info-DynamicTTI ::= SEQUENCE {
    rlc-Size                CHOICE {
        bitMode             BitModeRLC-SizeInfo,
        octetModeType1     OctetModeRLC-SizeInfoType1
    },
    numberOfTbSizeAndTTIList    NumberOfTbSizeAndTTIList,
    logicalChannelList     LogicalChannelList
}

DedicatedDynamicTF-InfoList ::= SEQUENCE (SIZE (1..maxTF)) OF
DedicatedDynamicTF-Info

DedicatedDynamicTF-InfoList-DynamicTTI ::= SEQUENCE (SIZE (1..maxTF)) OF
DedicatedDynamicTF-Info-DynamicTTI

DedicatedTransChTFS ::= SEQUENCE {
    tti                     CHOICE {
        tti10               DedicatedDynamicTF-InfoList,
        tti20               DedicatedDynamicTF-InfoList,
        tti40               DedicatedDynamicTF-InfoList,
        tti80               DedicatedDynamicTF-InfoList,
        dynamic             DedicatedDynamicTF-InfoList-DynamicTTI
    },
    semistaticTF-Information SemistaticTF-Information
}

-- The maximum allowed size of this sequence is 16
DL-AddReconfTransChInfo2List ::= SEQUENCE (SIZE (1..maxTrCHpreconf)) OF
DL-AddReconfTransChInformation2

-- The maximum allowed size of this sequence is 16
DL-AddReconfTransChInfoList ::= SEQUENCE (SIZE (1..maxTrCHpreconf)) OF
DL-AddReconfTransChInformation

-- ASN.1 for IE "Added or Reconfigured DL TrCH information"
-- in case of messages other than: Radio Bearer Release message and
-- Radio Bearer Reconfiguration message
DL-AddReconfTransChInformation ::= SEQUENCE {
    dl-TransportChannelType DL-TrCH-Type,
    dl-transportChannelIdentity TransportChannelIdentity,
    tfs-SignallingMode     CHOICE {
        explicit-config    TransportFormatSet,
        sameAsULTrCH      UL-TransportChannelIdentity
    },
    dch-QualityTarget     QualityTarget                OPTIONAL,
    tm-SignallingInfo     TM-SignallingInfo           OPTIONAL
}

-- ASN.1 for IE "Added or Reconfigured DL TrCH information"
-- in case of Radio Bearer Release message and
-- Radio Bearer Reconfiguration message
DL-AddReconfTransChInformation2 ::= SEQUENCE {
    dl-TransportChannelType DL-TrCH-Type,
    transportChannelIdentity TransportChannelIdentity,
    tfs-SignallingMode     CHOICE {
        explicit-config    TransportFormatSet,
        sameAsULTrCH      UL-TransportChannelIdentity
    }
}

```

```

    },
    qualityTarget          QualityTarget          OPTIONAL
  }

DL-CommonTransChInfo ::=          SEQUENCE {
  sccpch-TFCS              TFCS                  OPTIONAL,
  modeSpecificInfo         CHOICE {
    fdd                     SEQUENCE {
      dl-Parameters        CHOICE {
        dl-DCH-TFCS        TFCS,
        sameAsUL           NULL
      }
    }
    },
  tdd                      SEQUENCE {
    individualDL-CCTrCH-InfoList IndividualDL-CCTrCH-InfoList OPTIONAL
  }
}
-- NOTE: CHOICE modeSpecificInfo should be optional. A new version of this IE
-- should be defined to be used in later versions of messages using this IE
}

DL-DeletedTransChInfoList ::=      SEQUENCE (SIZE (1..maxTrCH)) OF
  DL-TransportChannelIdentity

DL-TransportChannelIdentity ::=    SEQUENCE {
  dl-TransportChannelType  DL-TrCH-Type,
  dl-TransportChannelIdentity TransportChannelIdentity
}

DL-TrCH-Type ::= ENUMERATED {dch, dsch}

DRAC-ClassIdentity ::=            INTEGER (1..maxDRACclasses)

DRAC-StaticInformation ::=        SEQUENCE {
  transmissionTimeValidity  TransmissionTimeValidity,
  timeDurationBeforeRetry  TimeDurationBeforeRetry,
  drac-ClassIdentity        DRAC-ClassIdentity
}

DRAC-StaticInformationList ::=    SEQUENCE (SIZE (1..maxTrCH)) OF
  DRAC-StaticInformation

ExplicitTFCS-Configuration ::=    CHOICE {
  complete                  TFCS-ReconfAdd,
  addition                  TFCS-ReconfAdd,
  removal                   TFCS-RemovalList,
  replacement               SEQUENCE {
    tfcsRemoval             TFCS-RemovalList,
    tfcsAdd                 TFCS-ReconfAdd
  }
}

GainFactor ::=                   INTEGER (0..15)

GainFactorInformation ::=        CHOICE {
  signalledGainFactors      SignalledGainFactors,
  computedGainFactors       ReferenceTFC-ID
}

IndividualDL-CCTrCH-Info ::=      SEQUENCE {
  dl-TFCS-Identity          TFCS-Identity,
  tfcs-SignallingMode       CHOICE {
    explicit-config         TFCS,
    sameAsUL                TFCS-Identity
  }
}

IndividualDL-CCTrCH-InfoList ::=  SEQUENCE (SIZE (1..maxCCTrCH)) OF
  IndividualDL-CCTrCH-Info

IndividualUL-CCTrCH-Info ::=      SEQUENCE {
  ul-TFCS-Identity          TFCS-Identity,
  ul-TFCS                   TFCS,
  tfc-Subset                TFC-Subset
}

IndividualUL-CCTrCH-InfoList ::=  SEQUENCE (SIZE (1..maxCCTrCH)) OF

```

```

IndividualUL-CCTrCH-Info

LogicalChannelByRB ::= SEQUENCE {
    rb-Identity
    logChOfRb
}
OPTIONAL

LogicalChannelList ::= CHOICE {
    allSizes
    configured
    explicitList
}

NumberOfTbSizeAndTTIList ::= SEQUENCE (SIZE (1..maxTF)) OF SEQUENCE {
    numberOfTransportBlocks
    transmissionTimeInterval
}

MessType ::= ENUMERATED {
    transportFormatCombinationControl
}

Non-allowedTFC-List ::= SEQUENCE (SIZE (1..maxTFC)) OF
    TFC-Value

NumberOfTransportBlocks ::= CHOICE {
    zero
    one
    small
    large
}

OctetModeRLC-SizeInfoType1 ::= CHOICE {
    sizeType1
        INTEGER (0..31),
        -- Actual size = (8 * sizeType1) + 16
    sizeType2
        SEQUENCE {
            part1
                INTEGER (0..23),
            part2
                INTEGER (1..3)
        },
        -- Actual size = (32 * part1) + 272 + (part2 * 8)
    sizeType3
        SEQUENCE {
            part1
                INTEGER (0..61),
            part2
                INTEGER (1..7)
        },
        -- Actual size = (64 * part1) + 1040 + (part2 * 8)
}
OPTIONAL

OctetModeRLC-SizeInfoType2 ::= CHOICE {
    sizeType1
        INTEGER (0..31),
        -- Actual size = (sizeType1 * 8) + 48
    sizeType2
        INTEGER (0..63),
        -- Actual size = (sizeType2 * 16) + 312
    sizeType3
        INTEGER (0..56)
        -- Actual size = (sizeType3 * 64) + 1384
}

PowerOffsetInformation ::= SEQUENCE {
    gainFactorInformation
        GainFactorInformation,
    -- PowerOffsetPp-m is always absent in TDD
    powerOffsetPp-m
        PowerOffsetPp-m
}
OPTIONAL

PowerOffsetPp-m ::= INTEGER (-5..10)

PreDefTransChConfiguration ::= SEQUENCE {
    ul-CommonTransChInfo
        UL-CommonTransChInfo,
    ul-AddReconfTrChInfoList
        UL-AddReconfTransChInfoList,
    dl-CommonTransChInfo
        DL-CommonTransChInfo,
    dl-TrChInfoList
        DL-AddReconfTransChInfoList
}

QualityTarget ::= SEQUENCE {
    bler-QualityValue
        BLER-QualityValue
}

RateMatchingAttribute ::= INTEGER (1..hiRM)

```

```

ReferenceTFC-ID ::= INTEGER (0..3)

RestrictedTrChInfo ::= SEQUENCE {
    ul-TransportChannelType      UL-TrCH-Type,
    restrictedTrChIdentity       TransportChannelIdentity,
    allowedTFI-List              AllowedTFI-List
}
                                                                    OPTIONAL

RestrictedTrChInfoList ::= SEQUENCE (SIZE (1..maxTrCH)) OF
    RestrictedTrChInfo

SemistaticTF-Information ::= SEQUENCE {
    -- TABULAR: Transmission time interval has been included in the IE CommonTransChTFS.
    channelCodingType           ChannelCodingType,
    rateMatchingAttribute       RateMatchingAttribute,
    crc-Size                    CRC-Size
}

SignalledGainFactors ::= SEQUENCE {
    modeSpecificInfo            CHOICE {
        fdd                     SEQUENCE {
            gainFactorBetaC
        },
        tdd                     NULL
    },
    gainFactorBetaD             GainFactor,
    referenceTFC-ID            ReferenceTFC-ID
}
                                                                    OPTIONAL

SplitTFCI-Signalling ::= SEQUENCE {
    splitType                   SplitType
                                                                    OPTIONAL,
    tfci-Field2-Length          INTEGER (1..10)
                                                                    OPTIONAL,
    tfci-Field1-Information     ExplicitTFCS-Configuration
                                                                    OPTIONAL,
    tfci-Field2-Information     TFCI-Field2-Information
                                                                    OPTIONAL
}

SplitType ::= ENUMERATED {
    hardSplit, logicalSplit }

TFC-Subset ::= CHOICE {
    minimumAllowedTFC-Number    TFC-Value,
    allowedTFC-List             AllowedTFC-List,
    non-allowedTFC-List         Non-allowedTFC-List,
    restrictedTrChInfoList      RestrictedTrChInfoList,
    fullTFCS                   NULL
}

TFC-Value ::= INTEGER (0..1023)

TFCI-Field2-Information ::= CHOICE {
    tfci-Range                  TFCI-RangeList,
    explicit-config              ExplicitTFCS-Configuration
}

TFCI-Range ::= SEQUENCE {
    maxTFCIField2Value          INTEGER (1..1023),
    tfcs-InfoForDSCH            TFCI-InfoForDSCH
}

TFCI-RangeList ::= SEQUENCE (SIZE (1..maxPDSCH-TFCIgroups)) OF
    TFCI-Range

TFCS ::= CHOICE {
    normalTFCI-Signalling       ExplicitTFCS-Configuration,
    splitTFCI-Signalling        SplitTFCI-Signalling
}

TFCS-Identity ::= SEQUENCE {
    tfcs-ID                    TFCI-IdentityPlain
                                                                    DEFAULT 1,
    sharedChannelIndicator      BOOLEAN
}

TFCS-IdentityPlain ::= INTEGER (1..8)

TFCS-InfoForDSCH ::= CHOICE {
    ctfc2bit                   INTEGER (0..3),
    ctfc4bit                   INTEGER (0..15),
    ctfc6bit                   INTEGER (0..63),
}

```

```

ctfc8bit          INTEGER (0..255),
ctfc12bit         INTEGER (0..4095),
ctfc16bit         INTEGER (0..65535),
ctfc24bit         INTEGER (0..16777215)
}

TFCS-ReconfAdd ::= SEQUENCE{
  ctfcSize        CHOICE{
    ctfc2Bit      SEQUENCE (SIZE (1..maxTFC)) OF SEQUENCE {
      ctfc2        INTEGER (0..3),
      powerOffsetInformation  OPTIONAL
    },
    ctfc4Bit      SEQUENCE (SIZE (1..maxTFC)) OF SEQUENCE {
      ctfc4        INTEGER (0..15),
      powerOffsetInformation  OPTIONAL
    },
    ctfc6Bit      SEQUENCE (SIZE (1..maxTFC)) OF SEQUENCE {
      ctfc6        INTEGER (0..63),
      powerOffsetInformation  OPTIONAL
    },
    ctfc8Bit      SEQUENCE (SIZE (1..maxTFC)) OF SEQUENCE {
      ctfc8        INTEGER (0..255),
      powerOffsetInformation  OPTIONAL
    },
    ctfc12Bit     SEQUENCE (SIZE(1..maxTFC)) OF SEQUENCE {
      ctfc12       INTEGER (0..4095),
      powerOffsetInformation  OPTIONAL
    },
    ctfc16Bit     SEQUENCE (SIZE (1..maxTFC)) OF SEQUENCE {
      ctfc16       INTEGER(0..65535),
      powerOffsetInformation  OPTIONAL
    },
    ctfc24Bit     SEQUENCE (SIZE (1..maxTFC)) OF SEQUENCE {
      ctfc24       INTEGER(0..16777215),
      powerOffsetInformation  OPTIONAL
    }
  }
}

TFCS-Removal ::= SEQUENCE {
  tfci            INTEGER (0..1023)
}

TFCS-RemovalList ::= SEQUENCE (SIZE (1..maxTFC)) OF
  TFCS-Removal

TimeDurationBeforeRetry ::= INTEGER (1..256)

TM-SignallingInfo ::= SEQUENCE {
  messType        MessType,
  tm-SignallingMode CHOICE {
    model         NULL,
    mode2         SEQUENCE {
      --TrCH-Type is always DCH
      ul-controlledTrChList  UL-ControlledTrChList
    }
  }
}

TransmissionTimeInterval ::= ENUMERATED {
  tti10, tti20, tti40, tti80 }

TransmissionTimeValidity ::= INTEGER (1..256)

TransportChannelIdentity ::= INTEGER (1..32)

TransportChannelIdentityDCHandDSCH ::= SEQUENCE {
  dch-transport-ch-id  TransportChannelIdentity,
  dsch-transport-ch-id TransportChannelIdentity
}

TransportFormatSet ::= CHOICE {
  dedicatedTransChTFS  DedicatedTransChTFS,
  commonTransChTFS    CommonTransChTFS
}

-- The maximum allowed size of this sequence is 16
UL-AddReconfTransChInfoList ::= SEQUENCE (SIZE (1..maxTrCHpreconf)) OF

```

UL-AddReconfTransChInformation

```

UL-AddReconfTransChInformation ::= SEQUENCE {
    ul-TransportChannelType      UL-TrCH-Type,
    transportChannelIdentity     TransportChannelIdentity,
    transportFormatSet          TransportFormatSet
}

UL-CommonTransChInfo ::=          SEQUENCE {
    tfc-Subset                    TFC-Subset                                OPTIONAL,
    -- TABULAR: this tfc-subset IE is applicable to FDD only, TDD specifies tfc-subset
    -- in individual CCTrCH Info.
    prach-TFCS                    TFCS                                OPTIONAL,
    modeSpecificInfo              CHOICE {
        fdd                        SEQUENCE {
            ul-TFCS                TFCS
        },
        tdd                        SEQUENCE {
            individualUL-CCTrCH-InfoList IndividualUL-CCTrCH-InfoList
        }
    }
}

-- TrCH-Type is always DCH
UL-ControlledTrChList ::=          SEQUENCE (SIZE (1..maxTrCH)) OF
    TransportChannelIdentity

UL-DeletedTransChInfoList ::=      SEQUENCE (SIZE (1..maxTrCH)) OF
    UL-TransportChannelIdentity

UL-TransportChannelIdentity ::=    SEQUENCE {
    ul-TransportChannelType      UL-TrCH-Type,
    ul-TransportChannelIdentity  TransportChannelIdentity
}

UL-TrCH-Type ::= ENUMERATED {dch, usch}

-- *****
--
--     PHYSICAL CHANNEL INFORMATION ELEMENTS (10.3.6)
--
-- *****

AC-To-ASC-Mapping ::=              INTEGER (0..7)

AC-To-ASC-MappingTable ::=         SEQUENCE (SIZE (maxASCMap)) OF
    AC-To-ASC-Mapping

AccessServiceClass-FDD ::=         SEQUENCE {
    availableSignatureStartIndex  INTEGER (0..15),
    availableSignatureEndIndex    INTEGER (0..15),

    assignedSubChannelNumber      BIT STRING {
        b3(0),
        b2(1),
        b1(2),
        b0(3)
    } (SIZE(4))
}

AccessServiceClass-TDD ::=         SEQUENCE {
    channelisationCodeIndices     BIT STRING {
        chCodeIndex7(0),
        chCodeIndex6(1),
        chCodeIndex5(2),
        chCodeIndex4(3),
        chCodeIndex3(4),
        chCodeIndex2(5),
        chCodeIndex1(6),
        chCodeIndex0(7)
    } (SIZE(8))                                OPTIONAL,
    subchannelSize                CHOICE {
        size1                      NULL,
        size2                      SEQUENCE {
            subchannels             ENUMERATED { subch0, subch1 } OPTIONAL
        }
    }
}

```



```

    },
    size4
        subchannels
        SEQUENCE {
            BIT STRING {
                subCh3(0),
                subCh2(1),
                subCh1(2),
                subCh0(3)
            } (SIZE(4)) OPTIONAL
        }
    },
    size8
        subchannels
        SEQUENCE {
            BIT STRING {
                subCh7(0),
                subCh6(1),
                subCh5(2),
                subCh4(3),
                subCh3(4),
                subCh2(5),
                subCh1(6),
                subCh0(7)
            } (SIZE(8)) OPTIONAL
        }
    }
}

AICH-Info ::=
    channelisationCode256
    sttd-Indicator
    aich-TransmissionTiming
    SEQUENCE {
        ChannelisationCode256,
        BOOLEAN,
        AICH-TransmissionTiming
    }

AICH-PowerOffset ::=
    INTEGER (-22..5)

AICH-TransmissionTiming ::=
    ENUMERATED {
        e0, e1
    }

AllocationPeriodInfo ::=
    allocationActivationTime
    allocationDuration
    SEQUENCE {
        INTEGER (0..255),
        INTEGER (1..256)
    }
-- Actual value = IE value * 0.125
Alpha ::=
    INTEGER (0..8)

AP-AICH-ChannelisationCode ::=
    INTEGER (0..255)

AP-PreambleScramblingCode ::=
    INTEGER (0..79)

AP-Signature ::=
    INTEGER (0..15)

AP-Signature-VCAM ::=
    ap-Signature
    availableAP-SubchannelList
    SEQUENCE {
        AP-Signature,
        AvailableAP-SubchannelList OPTIONAL
    }

AP-Subchannel ::=
    INTEGER (0..11)

ASCSetting-FDD ::=
    -- TABULAR: This is MD in tabular description
    -- Default value is previous ASC
    -- If this is the first ASC, the default value is all available signature and sub-channels
    accessServiceClass-FDD
    SEQUENCE {
        AccessServiceClass-FDD OPTIONAL
    }

ASCSetting-TDD ::=
    -- TABULAR: This is MD in tabular description
    -- Default value is previous ASC
    -- If this is the first ASC, the default value is all available channelisation codes and
    -- all available sub-channels with subchannelSize=size1.
    accessServiceClass-TDD
    SEQUENCE {
        AccessServiceClass-TDD OPTIONAL
    }

AvailableAP-Signature-VCAMList ::=
    SEQUENCE (SIZE (1..maxPCPCH-APsig)) OF
        AP-Signature-VCAM

AvailableAP-SignatureList ::=
    SEQUENCE (SIZE (1..maxPCPCH-APsig)) OF
        AP-Signature

AvailableAP-SubchannelList ::=
    SEQUENCE (SIZE (1..maxPCPCH-APsubCh)) OF
        AP-Subchannel

```

```

AvailableMinimumSF-ListVCAM ::= SEQUENCE (SIZE (1..maxPCPCH-SF)) OF
    AvailableMinimumSF-VCAM

AvailableMinimumSF-VCAM ::= SEQUENCE {
    minimumSpreadingFactor MinimumSpreadingFactor,
    nf-Max NF-Max,
    maxAvailablePCPCH-Number MaxAvailablePCPCH-Number,
    availableAP-Signature-VCAMList AvailableAP-Signature-VCAMList
}

AvailableSignatures ::= BIT STRING {
    signature15(0),
    signature14(1),
    signature13(2),
    signature12(3),
    signature11(4),
    signature10(5),
    signature9(6),
    signature8(7),
    signature7(8),
    signature6(9),
    signature5(10),
    signature4(11),
    signature3(12),
    signature2(13),
    signature1(14),
    signature0(15)
} (SIZE(16))

AvailableSubChannelNumbers ::= BIT STRING {
    subCh11(0),
    subCh10(1),
    subCh9(2),
    subCh8(3),
    subCh7(4),
    subCh6(5),
    subCh5(6),
    subCh4(7),
    subCh3(8),
    subCh2(9),
    subCh1(10),
    subCh0(11)
} (SIZE(12))

BurstType ::= ENUMERATED {
    type1, type2 }

CCTrCH-PowerControlInfo ::= SEQUENCE {
    tfcs-Identity TFCS-Identity OPTIONAL,
    ul-DPCH-PowerControlInfo UL-DPCH-PowerControlInfo
}

CD-AccessSlotSubchannel ::= INTEGER (0..11)

CD-AccessSlotSubchannelList ::= SEQUENCE (SIZE (1..maxPCPCH-CDsubCh)) OF
    CD-AccessSlotSubchannel

CD-CA-ICH-ChannelisationCode ::= INTEGER (0..255)

CD-PreambleScramblingCode ::= INTEGER (0..79)

CD-SignatureCode ::= INTEGER (0..15)

CD-SignatureCodeList ::= SEQUENCE (SIZE (1..maxPCPCH-CDsig)) OF
    CD-SignatureCode

CellAndChannelIdentity ::= SEQUENCE {
    burstType BurstType,
    midambleShift MidambleShiftLong,
    timeslot TimeslotNumber,
    cellParametersID CellParametersID
}

CellParametersID ::= INTEGER (0..127)

Cfntargetsfnsframeoffset ::= INTEGER(0..255)

```

```

ChannelAssignmentActive ::= CHOICE {
    notActive           NULL,
    isActive           AvailableMinimumSF-ListVCAM
}

ChannelisationCode256 ::= INTEGER (0..255)

ChannelReqParamsForUCSM ::= SEQUENCE {
    availableAP-SignatureList AvailableAP-SignatureList,
    availableAP-SubchannelList AvailableAP-SubchannelList OPTIONAL
}

ClosedLoopTimingAdjMode ::= ENUMERATED {
    slot1, slot2 }

CodeNumberDSCH ::= INTEGER (0..255)

CodeRange ::= SEQUENCE {
    pdsch-CodeMapList PDSCH-CodeMapList
}

CodeWordSet ::= ENUMERATED {
    longCWS,
    mediumCWS,
    shortCWS,
    ssdtOff }

CommonTimeslotInfo ::= SEQUENCE {
    -- TABULAR: The IE below is MD, but since it can be encoded in a single
    -- bit it is not defined as OPTIONAL.
    secondInterleavingMode SecondInterleavingMode,
    tfci-Coding TFCI-Coding OPTIONAL,
    puncturingLimit PuncturingLimit,
    repetitionPeriodAndLength RepetitionPeriodAndLength OPTIONAL
}

CommonTimeslotInfoSCCPCH ::= SEQUENCE {
    -- TABULAR: The IE below is MD, but since it can be encoded in a single
    -- bit it is not defined as OPTIONAL.
    secondInterleavingMode SecondInterleavingMode,
    tfci-Coding TFCI-Coding OPTIONAL,
    puncturingLimit PuncturingLimit,
    repetitionPeriodLengthAndOffset RepetitionPeriodLengthAndOffset OPTIONAL
}

ConstantValue ::= INTEGER (-35..-10)

CPCH-PersistenceLevels ::= SEQUENCE {
    cpch-SetID CPCH-SetID,
    dynamicPersistenceLevelTF-List DynamicPersistenceLevelTF-List
}

CPCH-PersistenceLevelsList ::= SEQUENCE (SIZE (1..maxCPCHsets)) OF
    CPCH-PersistenceLevels

CPCH-SetInfo ::= SEQUENCE {
    cpch-SetID CPCH-SetID,
    transportFormatSet TransportFormatSet,
    tfcs TFCS,
    ap-PreambleScramblingCode AP-PreambleScramblingCode,
    ap-AICH-ChannelisationCode AP-AICH-ChannelisationCode,
    cd-PreambleScramblingCode CD-PreambleScramblingCode,
    cd-CA-ICH-ChannelisationCode CD-CA-ICH-ChannelisationCode,
    cd-AccessSlotSubchannelList CD-AccessSlotSubchannelList OPTIONAL,
    cd-SignatureCodeList CD-SignatureCodeList OPTIONAL,
    deltaPp-m DeltaPp-m,
    ul-DPCCH-SlotFormat UL-DPCCH-SlotFormat,
    n-StartMessage N-StartMessage,
    n-EOT N-EOT,
    channelAssignmentActive ChannelAssignmentActive,
    -- TABULAR: VCAM info has been nested inside ChannelAssignmentActive,
    -- which in turn is mandatory since it's only a binary choice.
    cpch-StatusIndicationMode CPCH-StatusIndicationMode,
    pcpch-ChannelInfoList PCPCH-ChannelInfoList
}

CPCH-SetInfoList ::= SEQUENCE (SIZE (1..maxCPCHsets)) OF
    CPCH-SetInfo

```

```

CPCH-StatusIndicationMode ::=      ENUMERATED {
                                     pa-mode,
                                     pamsf-mode }

CSICH-PowerOffset ::=              INTEGER (-10..5)

-- DefaultDPCH-OffsetValueFDD and DefaultDPCH-OffsetValueTDD corresponds to
-- IE "Default DPCH Offset Value" depending on the mode.
-- Actual value = IE value * 512
DefaultDPCH-OffsetValueFDD ::=      INTEGER (0..599)

DefaultDPCH-OffsetValueTDD ::=      INTEGER (0..7)

DeltaPp-m ::=                      INTEGER (-10..10)

-- Actual value = IE value * 0.1
DeltaSIR ::=                       INTEGER (0..30)

DL-CCTrCh ::=                      SEQUENCE {
    tfcs-ID                          TFCS-IdentityPlain           DEFAULT 1,
    timeInfo                          TimeInfo,
    commonTimeslotInfo                 CommonTimeslotInfo         OPTIONAL,
    dl-CCTrCH-TimeslotsCodes           DownlinkTimeslotsCodes     OPTIONAL,
    ul-CCTrChTPCList                   UL-CCTrChTPCList           OPTIONAL
}

DL-CCTrChList ::=                  SEQUENCE (SIZE (1..maxCCTrCH)) OF
    DL-CCTrCh

DL-ChannelisationCode ::=          SEQUENCE {
    secondaryScramblingCode            SecondaryScramblingCode     OPTIONAL,
    sf-AndCodeNumber                  SF512-AndCodeNumber,
    scramblingCodeChange                ScramblingCodeChange       OPTIONAL
}

DL-ChannelisationCodeList ::=      SEQUENCE (SIZE (1..maxDPCH-DLchan)) OF
    DL-ChannelisationCode

DL-CommonInformation ::=          SEQUENCE {
    dl-DPCH-InfoCommon                DL-DPCH-InfoCommon        OPTIONAL,
    modeSpecificInfo                   CHOICE {
        fdd                            SEQUENCE {
            defaultDPCH-OffsetValue     DefaultDPCH-OffsetValueFDD  OPTIONAL,
            dpch-CompressedModeInfo     DPCH-CompressedModeInfo    OPTIONAL,
            tx-DiversityMode             TX-DiversityMode           OPTIONAL,
            ssdt-Information              SSDT-Information           OPTIONAL
        },
        tdd                            SEQUENCE {
            defaultDPCH-OffsetValue     DefaultDPCH-OffsetValueTDD  OPTIONAL
        }
    }
}

DL-CommonInformationPost ::=       SEQUENCE {
    dl-DPCH-InfoCommonPost             DL-DPCH-InfoCommonPost
}

DL-CommonInformationPredef ::=     SEQUENCE {
    dl-DPCH-InfoCommonPredef           DL-DPCH-InfoCommonPredef  OPTIONAL
}

DL-CompressedModeMethod ::=        ENUMERATED {
    puncturing, sf-2,
    higherLayerScheduling }

DL-DPCH-InfoCommon ::=            SEQUENCE {
    cfnHandling                         CHOICE {
        maintain                         NULL,
        initialise                        SEQUENCE {
            cfnTargetsfnframeoffset     CfnTargetsfnframeoffset    OPTIONAL
        }
    },
    modeSpecificInfo                   CHOICE {
        fdd                             SEQUENCE {
            dl-DPCH-PowerControlInfo     DL-DPCH-PowerControlInfo    OPTIONAL,
            powerOffsetPilot-pdpdch      PowerOffsetPilot-pdpdch,
            dl-rate-matching-restriction  Dl-rate-matching-restriction  OPTIONAL,
        }
    }
}

```

```

        spreadingFactorAndPilot          SF512-AndPilot,
-- TABULAR: The number of pilot bits is nested inside the spreading factor.
        positionFixedOrFlexible          PositionFixedOrFlexible,
        tfci-Existence                   BOOLEAN
    },
    tdd                                   SEQUENCE {
        dl-DPCH-PowerControlInfo         DL-DPCH-PowerControlInfo          OPTIONAL
    }
}

DL-DPCH-InfoCommonPost ::=              SEQUENCE {
    dl-DPCH-PowerControlInfo             DL-DPCH-PowerControlInfo          OPTIONAL
}

DL-DPCH-InfoCommonPredef ::=            SEQUENCE {
    modeSpecificInfo                     CHOICE {
        fdd                               SEQUENCE {
            spreadingFactorAndPilot       SF512-AndPilot,
-- TABULAR: The number of pilot bits is nested inside the spreading factor.
            positionFixedOrFlexible       PositionFixedOrFlexible,
            tfci-Existence                 BOOLEAN
        },
        tdd                               SEQUENCE {
            commonTimeslotInfo            CommonTimeslotInfo
        }
    }
}

DL-DPCH-InfoPerRL ::=                   CHOICE {
    fdd                                   SEQUENCE {
        pCPICH-UsageForChannelEst         PCPICH-UsageForChannelEst,
        dpch-FrameOffset                  DPCH-FrameOffset,
        secondaryCPICH-Info                SecondaryCPICH-Info              OPTIONAL,
        dl-ChannelisationCodeList         DL-ChannelisationCodeList,
        tpc-CombinationIndex               TPC-CombinationIndex,
        ssdt-CellIdentity                  SSDT-CellIdentity              OPTIONAL,
        closedLoopTimingAdjMode           ClosedLoopTimingAdjMode        OPTIONAL
    },
    tdd                                   DL-CCTrChList
}

DL-DPCH-InfoPerRL-PostFDD ::=            SEQUENCE {
    pCPICH-UsageForChannelEst             PCPICH-UsageForChannelEst,
    dl-ChannelisationCode                 DL-ChannelisationCode,
    tpc-CombinationIndex                   TPC-CombinationIndex
}

DL-DPCH-InfoPerRL-PostTDD ::=            SEQUENCE {
    dl-DPCH-TimeslotsCodes                DownlinkTimeslotsCodes
}

DL-DPCH-PowerControlInfo ::=             SEQUENCE {
    modeSpecificInfo                       CHOICE {
        fdd                               SEQUENCE {
            dpc-Mode                       DPC-Mode
        },
        tdd                               SEQUENCE {
            tpc-StepSizeTDD                 TPC-StepSizeTDD              OPTIONAL
        }
    }
}

DL-FrameType ::=                         ENUMERATED {
    dl-FrameTypeA, dl-FrameTypeB }

DL-InformationPerRL ::=                   SEQUENCE {
    modeSpecificInfo                       CHOICE {
        fdd                               SEQUENCE {
            primaryCPICH-Info              PrimaryCPICH-Info,
            pdsch-SHO-DCH-Info             PDSCH-SHO-DCH-Info           OPTIONAL,
            pdsch-CodeMapping              PDSCH-CodeMapping           OPTIONAL
        },
        tdd                               PrimaryCCPCH-Info
    },
    dl-DPCH-InfoPerRL                     DL-DPCH-InfoPerRL           OPTIONAL,
    sccpch-InfoForFACH                     SCCPCH-InfoForFACH          OPTIONAL
}

```

```

DL-InformationPerRL-List ::= SEQUENCE (SIZE (1..maxRL)) OF
                             DL-InformationPerRL

DL-InformationPerRL-ListPostFDD ::= SEQUENCE (SIZE (1..maxRL)) OF
                                     DL-InformationPerRL-PostFDD

DL-InformationPerRL-PostFDD ::= SEQUENCE {
    primaryCPICH-Info          PrimaryCPICH-Info,
    dl-DPCH-InfoPerRL         DL-DPCH-InfoPerRL-PostFDD
}

DL-InformationPerRL-PostTDD ::= SEQUENCE {
    primaryCCPCH-Info         PrimaryCCPCH-InfoPost,
    dl-DPCH-InfoPerRL         DL-DPCH-InfoPerRL-PostTDD
}

DL-PDSCH-Information ::= SEQUENCE {
    pdsch-SHO-DCH-Info        PDSCH-SHO-DCH-Info          OPTIONAL,
    pdsch-CodeMapping          PDSCH-CodeMapping            OPTIONAL
}

DL-rate-matching-restriction ::= SEQUENCE {
    restrictedTrCH-InfoList    RestrictedTrCH-InfoList      OPTIONAL
}

DL-TS-ChannelisationCode ::= ENUMERATED {
    cc16-1, cc16-2, cc16-3, cc16-4,
    cc16-5, cc16-6, cc16-7, cc16-8,
    cc16-9, cc16-10, cc16-11, cc16-12,
    cc16-13, cc16-14, cc16-15, cc16-16 }

DL-TS-ChannelisationCodesShort ::= SEQUENCE {
    codesRepresentation        CHOICE {
        consecutive            SEQUENCE {
            firstChannelisationCode DL-TS-ChannelisationCode,
            lastChannelisationCode  DL-TS-ChannelisationCode
        },
        bitmap                 BIT STRING {
            chCode16-SF16(0),
            chCode15-SF16(1),
            chCode14-SF16(2),
            chCode13-SF16(3),
            chCode12-SF16(4),
            chCode11-SF16(5),
            chCode10-SF16(6),
            chCode9-SF16(7),
            chCode8-SF16(8),
            chCode7-SF16(9),
            chCode6-SF16(10),
            chCode5-SF16(11),
            chCode4-SF16(12),
            chCode3-SF16(13),
            chCode2-SF16(14),
            chCode1-SF16(15)
        } (SIZE (16))
    }
}

DownlinkAdditionalTimeslots ::= SEQUENCE {
    parameters                CHOICE {
        sameAsLast            SEQUENCE {
            timeslotNumber    TimeslotNumber
        },
        newParameters         SEQUENCE {
            individualTimeslotInfo IndividualTimeslotInfo,
            dl-TS-ChannelisationCodesShort DL-TS-ChannelisationCodesShort
        }
    }
}

DownlinkTimeslotsCodes ::= SEQUENCE {
    firstIndividualTimeslotInfo IndividualTimeslotInfo,
    dl-TS-ChannelisationCodesShort DL-TS-ChannelisationCodesShort,
    moreTimeslots              CHOICE {
        noMore                 NULL,
        additionalTimeslots    CHOICE {
            consecutive        INTEGER (1..maxTS-1),

```

```

        timeslotList
    }
}

DPC-Mode ::=
    ENUMERATED {
        singleTPC,
        tpcTripletInSoft }

-- The actual value of DPCCH power offset is the value of this IE * 2.
DPCCH-PowerOffset ::=
    INTEGER (-82..-3)

-- The actual value of DPCCH power offset is the value of this (2 + IE * 4).
DPCCH-PowerOffset2 ::=
    INTEGER (-28..-13)

DPCH-CompressedModeInfo ::=
    SEQUENCE {
        tgp-SequenceList
    }

DPCH-CompressedModeStatusInfo ::=
    SEQUENCE {
        tgps-Reconfiguration-CFN
        tgp-SequenceShortList
    }

TGPS-Reconfiguration-CFN ::=
    INTEGER (0..255)

-- TABULAR: Actual value = IE value * 256
DPCH-FrameOffset ::=
    INTEGER (0..149)

DSCH-Mapping ::=
    SEQUENCE {
        maxTFCCI-Field2Value
        spreadingFactor
        codeNumber
        multiCodeInfo
    }

DSCH-MappingList ::=
    SEQUENCE (SIZE (1..maxPDSCH-TFCIgroups)) OF
        DSCH-Mapping

DSCH-RadioLinkIdentifier ::=
    INTEGER (0..511)

DurationTimeInfo ::=
    INTEGER (1..4096)

-- TABULAR : value [Duration = infinite] is the value by default,
-- and is encoded by absence of the full sequence. If the sequence is present,
-- thefield is absent, the default is respectivelyinfinite. Presence of the
-- field absent should not be used, but shall be understood as if the
-- sequence was absent.

DynamicPersistenceLevel ::=
    INTEGER (1..8)

DynamicPersistenceLevelList ::=
    SEQUENCE (SIZE (1..maxPRACH)) OF
        DynamicPersistenceLevel

DynamicPersistenceLevelTF-List ::= SEQUENCE (SIZE (1..maxTF-CPCH)) OF
        DynamicPersistenceLevel

FACH-PCH-Information ::=
    SEQUENCE {
        transportFormatSet
        transportChannelIdentity
        ctch-Indicator
    }

FACH-PCH-InformationList ::=
    SEQUENCE (SIZE (1..maxFACHPCH)) OF
        FACH-PCH-Information

FrequencyInfo ::=
    SEQUENCE {
        modeSpecificInfo
        fdd
        tdd
    }

FrequencyInfoFDD ::=
    SEQUENCE {
        uarfcn-UL
        uarfcn-DL
    }
    UARFCN
    UARFCN
    OPTIONAL,

```

```

}

FrequencyInfoTDD ::= SEQUENCE {
    uarfcn-Nt          UARFCN
}

IndividualTimeslotInfo ::= SEQUENCE {
    timeslotNumber    TimeslotNumber,
    tfci-Existence    BOOLEAN,
    midambleShiftAndBurstType MidambleShiftAndBurstType
}

IndividualTS-Interference ::= SEQUENCE {
    timeslot          TimeslotNumber,
    ul-TimeslotInterference UL-Interference
}

IndividualTS-InterferenceList ::= SEQUENCE (SIZE (1..maxTS)) OF
    IndividualTS-Interference

ITP ::= ENUMERATED {
    mode0, mode1 }

NidIdentifyAbort ::= INTEGER (1..128)

MaxAllowedUL-TX-Power ::= INTEGER (-50..33)

MaxAvailablePCPCH-Number ::= INTEGER (1..64)

MaxTFCI-Field2Value ::= INTEGER (1..1023)

MidambleConfigurationBurstTypePeland3 ::= ENUMERATED {ms4, ms8, ms16}

MidambleConfigurationBurstType2 ::= ENUMERATED {ms3, ms6}

MidambleShiftAndBurstType ::= SEQUENCE {
    burstType          CHOICE {
        type1          SEQUENCE {
            midambleConfigurationBurstTypePeland3 MidambleConfigurationBurstTypePeland3,
            midambleAllocationMode                CHOICE {
                defaultMidamble                NULL,
                commonMidamble                 NULL,
                ueSpecificMidamble             SEQUENCE {
                    midambleShift                MidambleShiftLong
                }
            }
        },
        type2          SEQUENCE {
            midambleConfigurationBurstType2      MidambleConfigurationBurstType2,
            midambleAllocationMode                CHOICE {
                defaultMidamble                NULL,
                commonMidamble                 NULL,
                ueSpecificMidamble             SEQUENCE {
                    midambleShift                MidambleShiftShort
                }
            }
        },
        type3          SEQUENCE {
            midambleConfigurationBurstTypePeland3 MidambleConfigurationBurstTypePeland3,
            midambleAllocationMode                CHOICE {
                defaultMidamble                NULL,
                ueSpecificMidamble             SEQUENCE {
                    midambleShift                MidambleShiftLong
                }
            }
        }
    }
}

MidambleShiftLong ::= INTEGER (0..15)

MidambleShiftShort ::= INTEGER (0..5)

MinimumSpreadingFactor ::= ENUMERATED {
    sf4, sf8, sf16, sf32,
    sf64, sf128, sf256 }

```



```

MultiCodeInfo ::= INTEGER (1..16)

N-EOT ::= INTEGER (0..7)

N-GAP ::= ENUMERATED {
    f2, f4, f8 }

N-PCH ::= INTEGER (1..8)

N-StartMessage ::= INTEGER (1..8)

NB01 ::= INTEGER (0..50)

NF-Max ::= INTEGER (1..64)

NumberOfDPDCH ::= INTEGER (1..maxDPDCH-UL)

NumberOfFBI-Bits ::= INTEGER (1..2)

OpenLoopPowerControl-TDD ::= SEQUENCE {
    primaryCCPCH-TX-Power PrimaryCCPCH-TX-Power,
    alpha Alpha, OPTIONAL,
    prach-ConstantValue ConstantValue,
    dpch-ConstantValue ConstantValue,
    pusoch-ConstantValue ConstantValue OPTIONAL
}

PagingIndicatorLength ::= ENUMERATED {
    pi4, pi8, pi16 }

PC-Preamble ::= INTEGER (0..7)

PCP-Length ::= ENUMERATED {
    as0, as8 }

PCPCH-ChannelInfo ::= SEQUENCE {
    pcpch-UL-ScramblingCode INTEGER (0..79),
    pcpch-DL-ChannelisationCode INTEGER (0..511),
    pcpch-DL-ScramblingCode SecondaryScramblingCode OPTIONAL,
    pcp-Length PCP-Length,
    ucsch-Info UCSCH-Info OPTIONAL
}

PCPCH-ChannelInfoList ::= SEQUENCE (SIZE (1..maxPCPCHs)) OF
    PCPCH-ChannelInfo

PCPICH-UsageForChannelEst ::= ENUMERATED {
    maybeUsed,
    shallNotBeUsed }

PDSCH-CapacityAllocationInfo ::= SEQUENCE {
    pdsch-PowerControlInfo PDSCH-PowerControlInfo OPTIONAL,
    -- pdsch-PowerControlInfo is conditional on new-configuration branch below, if this
    -- selected the IE is OPTIONAL otherwise it should not be sent
    pdsch-AllocationPeriodInfo AllocationPeriodInfo,
    tfcs-ID TFCS-IdentityPlain DEFAULT 1,
    configuration CHOICE {
        old-Configuration SEQUENCE {
            pdsch-Identity PDSCH-Identity
        },
        new-Configuration SEQUENCE {
            pdsch-Info PDSCH-Info,
            pdsch-Identity PDSCH-Identity OPTIONAL
        }
    }
}

PDSCH-CodeInfo ::= SEQUENCE {
    spreadingFactor SF-PDSCH,
    codeNumber CodeNumberDSCH,
    multiCodeInfo MultiCodeInfo
}

PDSCH-CodeInfoList ::= SEQUENCE (SIZE (1..maxTFCI-2-Combs)) OF
    PDSCH-CodeInfo

PDSCH-CodeMap ::= SEQUENCE {
    spreadingFactor SF-PDSCH,

```

```

multiCodeInfo          MultiCodeInfo,
codeNumberStart        CodeNumberDSCH,
codeNumberStop         CodeNumberDSCH
}

PDSCH-CodeMapList ::= SEQUENCE (SIZE (1..maxPDSCH-TFCIgroups)) OF
                      PDSCH-CodeMap

PDSCH-CodeMapping ::= SEQUENCE {
  dl-ScramblingCode      SecondaryScramblingCode          OPTIONAL,
  signallingMethod       CHOICE {
    codeRange            CodeRange,
    tfci-Range           DSCH-MappingList,
    explicit-config      PDSCH-CodeInfoList,
    replace              ReplacedPDSCH-CodeInfoList
  }
}

PDSCH-Identity ::= INTEGER (1..hiPDSCHidentities)

PDSCH-Info ::= SEQUENCE {
  tfcs-ID                TFCS-IdentityPlain          DEFAULT 1,
  commonTimeslotInfo     CommonTimeslotInfo          OPTIONAL,
  pdsch-TimeslotsCodes  DownlinkTimeslotsCodes      OPTIONAL
}

PDSCH-PowerControlInfo ::= SEQUENCE {
  tpc-StepSizeTDD        TPC-StepSizeTDD            OPTIONAL,
  ul-CCTrChTPCList      UL-CCTrChTPCList            OPTIONAL
}

PDSCH-SHO-DCH-Info ::= SEQUENCE {
  dsch-RadioLinkIdentifier DSCH-RadioLinkIdentifier,
  rl-IdentfierList        RL-IdentfierList          OPTIONAL
}

PDSCH-SysInfo ::= SEQUENCE {
  pdsch-Identity         PDSCH-Identity,
  pdsch-Info             PDSCH-Info,
  dsch-TFS               TransportFormatSet         OPTIONAL,
  dsch-TFCS              TFCS                      OPTIONAL
}

PDSCH-SysInfoList ::= SEQUENCE (SIZE (1..maxPDSCH)) OF
                      PDSCH-SysInfo

PDSCH-SysInfoList-SFN ::= SEQUENCE (SIZE (1..maxPDSCH)) OF
                          SEQUENCE {
  pdsch-SysInfo         PDSCH-SysInfo,
  sfn-TimeInfo          SFN-TimeInfo              OPTIONAL
}

PersistenceScalingFactor ::= ENUMERATED {
  psf0-9, psf0-8, psf0-7, psf0-6,
  psf0-5, psf0-4, psf0-3, psf0-2 }

PersistenceScalingFactorList ::= SEQUENCE (SIZE (1..maxASCPersist)) OF
                                 PersistenceScalingFactor

PI-CountPerFrame ::= ENUMERATED {
  e18, e36, e72, e144 }

PICH-Info ::= CHOICE {
  fdd SEQUENCE {
    channelisationCode256 ChannelisationCode256,
    pi-CountPerFrame      PI-CountPerFrame,
    sttd-Indicator        BOOLEAN
  },
  tdd SEQUENCE {
    channelisationCode      TDD-PICH-CCode          OPTIONAL,
    timeslot                TimeslotNumber          OPTIONAL,
    midambleShiftAndBurstType MidambleShiftAndBurstType,
    repetitionPeriodLengthOffset RepPerLengthOffset-PICH    OPTIONAL,
    pagingIndicatorLength   PagingIndicatorLength   DEFAULT pi4,
    n-GAP                   N-GAP                  DEFAULT f4,
    n-PCH                   N-PCH                   DEFAULT 2
  }
}

```

```

}

PICH-PowerOffset ::= INTEGER (-10..5)

PilotBits128 ::= ENUMERATED {
    pb4, pb8 }

PilotBits256 ::= ENUMERATED {
    pb2, pb4, pb8 }

PositionFixedOrFlexible ::= ENUMERATED {
    fixed,
    flexible }

PowerControlAlgorithm ::= CHOICE {
    algorithm1
    algorithm2
}

PowerOffsetPilot-pdpdch ::= INTEGER (0..24)

PowerRampStep ::= INTEGER (1..8)

PRACH-Midamble ::= ENUMERATED {
    direct,
    direct-Inverted }

PRACH-Partitioning ::= CHOICE {
    fdd SEQUENCE (SIZE (1..maxASC)) OF
        ASCSetting-FDD,
    tdd SEQUENCE (SIZE (1..maxASC)) OF
        ASCSetting-TDD
}

PRACH-PowerOffset ::= SEQUENCE {
    powerRampStep
    preambleRetransMax
}

PRACH-RACH-Info ::= SEQUENCE {
    modeSpecificInfo
    fdd CHOICE {
        SEQUENCE {
            availableSignatures AvailableSignatures,
            availableSF SF-PRACH,
            preambleScramblingCodeWordNumber PreambleScramblingCodeWordNumber,
            puncturingLimit PuncturingLimit,
            availableSubChannelNumbers AvailableSubChannelNumbers
        },
        tdd SEQUENCE {
            timeslot TimeslotNumber,
            channelisationCodeList TDD-PRACH-CCodeList,
            prach-Midamble PRACH-Midamble
        }
    }
}

PRACH-SystemInformation ::= SEQUENCE {
    prach-RACH-Info PRACH-RACH-Info,
    transportChannelIdentity TransportChannelIdentity,
    rach-TransportFormatSet TransportFormatSet OPTIONAL,
    rach-TFCS TFCS OPTIONAL,
    prach-Partitioning PRACH-Partitioning OPTIONAL,
    persistenceScalingFactorList PersistenceScalingFactorList OPTIONAL,
    ac-To-ASC-MappingTable AC-To-ASC-MappingTable OPTIONAL,
    modeSpecificInfo CHOICE {
        fdd SEQUENCE {
            primaryCPICH-TX-Power PrimaryCPICH-TX-Power OPTIONAL,
            constantValue ConstantValue OPTIONAL,
            prach-PowerOffset PRACH-PowerOffset OPTIONAL,
            rach-TransmissionParameters RACH-TransmissionParameters OPTIONAL,
            aich-Info AICH-Info OPTIONAL
        },
        tdd NULL
    }
}

PRACH-SystemInformationList ::= SEQUENCE (SIZE (1..maxPRACH)) OF
    PRACH-SystemInformation

```

```

PreambleRetransMax ::= INTEGER (1..64)

PreambleScramblingCodeWordNumber ::= INTEGER (0..15)

PreDefPhyChConfiguration ::= SEQUENCE {
    ul-DPCH-InfoPredef          UL-DPCH-InfoPredef,
    dl-CommonInformationPredef  DL-CommonInformationPredef  OPTIONAL
}

PrimaryCCPCH-Info ::= CHOICE {
    fdd                          SEQUENCE {
        tx-DiversityIndicator    BOOLEAN
    },
    tdd                          SEQUENCE {
        syncCase                 CHOICE {
            syncCase1            SEQUENCE {
                timeslot         TimeslotNumber
            },
            syncCase2            SEQUENCE {
                timeslotSync2    TimeslotSync2
            }
        }
        cellParametersID         CellParametersID          OPTIONAL,
        blockSTTD-Indicator      BOOLEAN                  OPTIONAL,
    }
}

PrimaryCCPCH-InfoPost ::= SEQUENCE {
    syncCase                     CHOICE {
        syncCase1                SEQUENCE {
            timeslot              TimeslotNumber
        },
        syncCase2                SEQUENCE {
            timeslotSync2        TimeslotSync2
        }
    },
    cellParametersID             CellParametersID,
    blockSTTD-Indicator          BOOLEAN
}

PrimaryCCPCH-TX-Power ::= INTEGER (6..43)

PrimaryCPICH-Info ::= SEQUENCE {
    primaryScramblingCode        PrimaryScramblingCode
}

PrimaryCPICH-TX-Power ::= INTEGER (-10..50)

PrimaryScramblingCode ::= INTEGER (0..511)

PuncturingLimit ::= ENUMERATED {
    p10-40, p10-44, p10-48, p10-52, p10-56,
    p10-60, p10-64, p10-68, p10-72, p10-76,
    p10-80, p10-84, p10-88, p10-92, p10-96, p11 }

PUSCH-CapacityAllocationInfo ::= SEQUENCE {
    pusch-Allocation             CHOICE {
        pusch-AllocationPending  NULL,
        pusch-AllocationAssignment SEQUENCE {
            pusch-AllocationPeriodInfo  AllocationPeriodInfo,
            pusch-PowerControlInfo       UL-TargetSIR          OPTIONAL,
            tfcs-ID                      TFCS-IdentityPlain   DEFAULT 1,
            configuration                 CHOICE {
                old-Configuration        SEQUENCE {
                    pusch-Identity       PUSCH-Identity
                },
                new-Configuration        SEQUENCE {
                    pusch-Info            PUSCH-Info,
                    pusch-Identity       PUSCH-Identity   OPTIONAL
                }
            }
        }
    }
}

PUSCH-Identity ::= INTEGER (1..hiPUSCHidentities)

```

```

PUSCH-Info ::=
    tfcs-ID
    commonTimeslotInfo
    pusch-TimeslotsCodes
}
SEQUENCE {
    TFCS-IdentityPlain
    CommonTimeslotInfo
    UplinkTimeslotsCodes
}
DEFAULT 1,
OPTIONAL,
OPTIONAL

PUSCH-SysInfo ::=
    pusch-Identity
    pusch-Info
    usch-TFS
    usch-TFCS
}
SEQUENCE {
    PUSCH-Identity,
    PUSCH-Info,
    TransportFormatSet
    TFCS
}
OPTIONAL,
OPTIONAL

PUSCH-SysInfoList ::=
SEQUENCE (SIZE (1..maxPUSCH)) OF
    PUSCH-SysInfo

PUSCH-SysInfoList-SFN ::=
SEQUENCE (SIZE (1..maxPUSCH)) OF
    SEQUENCE {
        pusch-SysInfo
        sfm-TimeInfo
    }
    PUSCH-SysInfo,
    SFN-TimeInfo
}
OPTIONAL

RACH-TransmissionParameters ::=
    mmax
    nb01Min
    nb01Max
}
SEQUENCE {
    INTEGER (1..32),
    NB01,
    NB01
}

ReducedScramblingCodeNumber ::=
    INTEGER (0..8191)

RepetitionPeriodAndLength ::=
    repetitionPeriod1
    repetitionPeriod2
    -- repetitionPeriod2 could just as well be NULL also.
    repetitionPeriod4
    repetitionPeriod8
    repetitionPeriod16
    repetitionPeriod32
    repetitionPeriod64
}
CHOICE {
    NULL,
    INTEGER (1..1),
    INTEGER (1..3),
    INTEGER (1..7),
    INTEGER (1..15),
    INTEGER (1..31),
    INTEGER (1..63)
}

RepetitionPeriodLengthAndOffset ::=
    repetitionPeriod1
    repetitionPeriod2
    length
    offset
    },
    repetitionPeriod4
    length
    offset
    },
    repetitionPeriod8
    length
    offset
    },
    repetitionPeriod16
    length
    offset
    },
    repetitionPeriod32
    length
    offset
    },
    repetitionPeriod64
    length
    offset
}
CHOICE {
    NULL,
    SEQUENCE {
        NULL,
        INTEGER (0..1)
    },
    SEQUENCE {
        INTEGER (1..3),
        INTEGER (0..3)
    },
    SEQUENCE {
        INTEGER (1..7),
        INTEGER (0..7)
    },
    SEQUENCE {
        INTEGER (1..15),
        INTEGER (0..15)
    },
    SEQUENCE {
        INTEGER (1..31),
        INTEGER (0..31)
    },
    SEQUENCE {
        INTEGER (1..63),
        INTEGER (0..63)
    }
}

ReplacedPDSCH-CodeInfo ::=
    tfci-Field2
    spreadingFactor
    codeNumber
    multiCodeInfo
}
SEQUENCE {
    MaxTFCI-Field2Value,
    SF-PDSCH,
    CodeNumberDSCH,
    MultiCodeInfo
}

ReplacedPDSCH-CodeInfoList ::=
SEQUENCE (SIZE (1..maxTFCI-2-Combs)) OF
    ReplacedPDSCH-CodeInfo

```

```

RepPerLengthOffset-PICH ::= CHOICE {
    rpp4-2          INTEGER (0..3),
    rpp8-2          INTEGER (0..7),
    rpp8-4          INTEGER (0..7),
    rpp16-2         INTEGER (0..15),
    rpp16-4         INTEGER (0..15),
    rpp32-2         INTEGER (0..31),
    rpp32-4         INTEGER (0..31),
    rpp64-2         INTEGER (0..63),
    rpp64-4         INTEGER (0..63)
}

RestrictedTrCH ::= SEQUENCE {
    dl-restrictedTrCh-Type DL-TrCH-Type,
    restrictedDL-TrCH-Identity TransportChannelIdentity,
    allowedTFILList AllowedTFI-List
}

RestrictedTrCH-InfoList ::= SEQUENCE (SIZE(1..maxTrCH)) OF
    RestrictedTrCH

RL-AdditionInformation ::= SEQUENCE {
    primaryCPICH-Info PrimaryCPICH-Info,
    dl-DPCH-InfoPerRL DL-DPCH-InfoPerRL,
    tfci-CombiningIndicator BOOLEAN,
    sccpch-InfoForFACH SCCPCH-InfoForFACH OPTIONAL
}

RL-AdditionInformationList ::= SEQUENCE (SIZE (1..maxRL-1)) OF
    RL-AdditionInformation

RL-IdentifierList ::= SEQUENCE (SIZE (1..maxRL)) OF
    PrimaryCPICH-Info

RL-RemovalInformationList ::= SEQUENCE (SIZE (1..maxRL)) OF
    PrimaryCPICH-Info

RPP ::= ENUMERATED {
    mode0, mode1 }

S-Field ::= ENUMERATED {
    e1bit, e2bits }

SCCPCH-ChannelisationCode ::= ENUMERATED {
    cc16-1, cc16-2, cc16-3, cc16-4,
    cc16-5, cc16-6, cc16-7, cc16-8,
    cc16-9, cc16-10, cc16-11, cc16-12,
    cc16-13, cc16-14, cc16-15, cc16-16 }

SCCPCH-ChannelisationCodeList ::= SEQUENCE (SIZE (1..16)) OF
    SCCPCH-ChannelisationCode

SCCPCH-InfoForFACH ::= SEQUENCE {
    secondaryCCPCH-Info SecondaryCCPCH-Info,
    tfcs TFCS,
    modeSpecificInfo CHOICE {
        fdd SEQUENCE {
            fach-PCH-InformationList FACH-PCH-InformationList,
            sib-ReferenceListFACH SIB-ReferenceListFACH
        },
        tdd SEQUENCE {
            fach-PCH-InformationList FACH-PCH-InformationList
        }
    }
}

SCCPCH-SystemInformation ::= SEQUENCE {
    secondaryCCPCH-Info SecondaryCCPCH-Info,
    tfcs TFCS OPTIONAL,
    fach-PCH-InformationList FACH-PCH-InformationList OPTIONAL,
    pich-Info PICH-Info OPTIONAL
}

SCCPCH-SystemInformationList ::= SEQUENCE (SIZE (1..maxSCCPCH)) OF
    SCCPCH-SystemInformation

ScramblingCodeChange ::= ENUMERATED {

```

```

        codeChange, noCodeChange }

ScramblingCodeType ::=
    ENUMERATED {
        shortSC,
        longSC }

SecondaryCCPCH-Info ::=
    modeSpecificInfo
    CHOICE {
        fdd
            SEQUENCE {
                -- This IE is not used in this version of the specification and should be ignored.
                dummy1
                    PCPICH-UsageForChannelEst,
                -- This IE is not used in this version of the specification. It should not
                -- be sent and if received it should be ignored.
                dummy2
                    SecondaryCPICH-Info
                    OPTIONAL,
                secondaryScramblingCode
                    SecondaryScramblingCode
                    OPTIONAL,
                sttd-Indicator
                    BOOLEAN,
                sf-AndCodeNumber
                    SF256-AndCodeNumber,
                pilotSymbolExistence
                    BOOLEAN,
                tfci-Existence
                    BOOLEAN,
                positionFixedOrFlexible
                    PositionFixedOrFlexible,
                timingOffset
                    TimingOffset
                    DEFAULT 0
            },
        tdd
            SEQUENCE {
                -- TABULAR: the offset is included in CommonTimeslotInfoSCCPCH
                commonTimeslotInfo
                    CommonTimeslotInfoSCCPCH,
                individualTimeslotInfo
                    IndividualTimeslotInfo,
                channelisationCode
                    SCCPCH-ChannelisationCodeList
            }
    }

SecondaryCPICH-Info ::=
    secondaryDL-ScramblingCode
    channelisationCode
    SEQUENCE {
        SecondaryScramblingCode
        ChannelisationCode256
    }
    OPTIONAL,

SecondaryScramblingCode ::=
    INTEGER (1..15)

SecondInterleavingMode ::=
    ENUMERATED {
        frameRelated, timeslotRelated }

-- SF256-AndCodeNumber encodes both "Spreading factor" and "Code Number"
SF256-AndCodeNumber ::=
    CHOICE {
        sf4
            INTEGER (0..3),
        sf8
            INTEGER (0..7),
        sf16
            INTEGER (0..15),
        sf32
            INTEGER (0..31),
        sf64
            INTEGER (0..63),
        sf128
            INTEGER (0..127),
        sf256
            INTEGER (0..255)
    }

-- SF512-AndCodeNumber encodes both "Spreading factor" and "Code Number"
SF512-AndCodeNumber ::=
    CHOICE {
        sf4
            INTEGER (0..3),
        sf8
            INTEGER (0..7),
        sf16
            INTEGER (0..15),
        sf32
            INTEGER (0..31),
        sf64
            INTEGER (0..63),
        sf128
            INTEGER (0..127),
        sf256
            INTEGER (0..255),
        sf512
            INTEGER (0..511)
    }

-- SF512-AndPilot encodes both "Spreading factor" and "Number of bits for Pilot bits"
SF512-AndPilot ::=
    CHOICE {
        sfd4
            NULL,
        sfd8
            NULL,
        sfd16
            NULL,
        sfd32
            NULL,
        sfd64
            NULL,
        sfd128
            PilotBits128,
        sfd256
            PilotBits256,
        sfd512
            NULL
    }

SF-PDSCH ::=
    ENUMERATED {
        sfp4, sfp8, sfp16, sfp32,
        sfp64, sfp128, sfp256 }

```

```

SF-PRACH ::=
    ENUMERATED {
        sfpr32, sfpr64, sfpr128, sfpr256 }

SFN-TimeInfo ::=
    SEQUENCE {
        activationTimesFN
        physChDuration
    }
    DurationTimeInfo

SpecialBurstScheduling ::=
    INTEGER (0..7)

SpreadingFactor ::=
    ENUMERATED {
        sf4, sf8, sf16, sf32,
        sf64, sf128, sf256 }

SRB-delay ::=
    INTEGER (0..7)

SSDT-CellIdentity ::=
    ENUMERATED {
        ssdt-id-a, ssdt-id-b, ssdt-id-c,
        ssdt-id-d, ssdt-id-e, ssdt-id-f,
        ssdt-id-g, ssdt-id-h }

SSDT-Information ::=
    SEQUENCE {
        s-Field
        codeWordSet
    }
    S-Field,
    CodeWordSet

TDD-PICH-CCode ::=
    ENUMERATED {
        cc16-1, cc16-2, cc16-3, cc16-4,
        cc16-5, cc16-6, cc16-7, cc16-8,
        cc16-9, cc16-10, cc16-11, cc16-12,
        cc16-13, cc16-14, cc16-15, cc16-16 }

TDD-PRACH-CCode8 ::=
    ENUMERATED {
        cc8-1, cc8-2, cc8-3, cc8-4,
        cc8-5, cc8-6, cc8-7, cc8-8 }

TDD-PRACH-CCode16 ::=
    ENUMERATED {
        cc16-1, cc16-2, cc16-3, cc16-4,
        cc16-5, cc16-6, cc16-7, cc16-8,
        cc16-9, cc16-10, cc16-11, cc16-12,
        cc16-13, cc16-14, cc16-15, cc16-16 }

TDD-PRACH-CCodeList ::=
    CHOICE {
        sf8
        SEQUENCE (SIZE (1..8)) OF
            TDD-PRACH-CCode8,
        sf16
        SEQUENCE (SIZE (1..8)) OF
            TDD-PRACH-CCode16
    }

TFC-ControlDuration ::=
    ENUMERATED {
        tfc-cd1, tfc-cd2, tfc-cd4, tfc-cd8,
        tfc-cd16, tfc-cd24, tfc-cd32,
        tfc-cd48, tfc-cd64, tfc-cd128,
        tfc-cd192, tfc-cd256, tfc-cd512 }

TF-CI-Coding ::=
    ENUMERATED {
        tfci-bits-4, tfci-bits-8,
        tfci-bits-16, tfci-bits-32 }

TGCFN ::=
    INTEGER (0..255)

-- The value 270 represents "undefined" in the tabular description.
TGD ::=
    INTEGER (15..270)

TGL ::=
    INTEGER (1..14)

TGMP ::=
    ENUMERATED {
        tdd-Measurement, fdd-Measurement,
        gsm-CarrierRSSIMeasurement,
        gsm-initialBSICIdentification, gsmBSICReconfirmation,
        multi-carrier }

TGP-Sequence ::=
    SEQUENCE {
        tgpsi
        tgps-Status
        activate
        tgcfm
    }
    TGPSI,
    CHOICE {
        SEQUENCE {
            TGCFN

```



```

    },
    deactivate                                NULL
  },
  tgps-ConfigurationParams                  TGPS-ConfigurationParams    OPTIONAL
}

TGP-SequenceList ::=                        SEQUENCE (SIZE (1..maxTGPS)) OF
                                           TGP-Sequence

TGP-SequenceShort ::=                      SEQUENCE {
  tgpsi                                     TGPSI,
  tgps-Status                               CHOICE {
    activate                                SEQUENCE {
      tgcfn                                TGCFN
    },
    deactivate                               NULL
  }
}

TGPL ::=                                    INTEGER (1..144)

-- TABULAR: The value 0 represents "infinity" in the tabular description.
TGPRC ::=                                    INTEGER (0..511)

TGPS-ConfigurationParams ::=              SEQUENCE {
  tgmp                                       TGMP,
  tgprc                                       TGPRC,
  tgsn                                       TGSN,
  tgl1                                       TGL,
  tgl2                                       TGL                                OPTIONAL,
  tgd                                       TGD,
  tgpl1                                       TGPL,
  tgpl2                                       TGPL                                OPTIONAL,
  rpp                                       RPP,
  itp                                       ITP,
  ul-DL-Mode                               UL-DL-Mode,
  -- TABULAR: Compressed mode method is nested inside UL-DL-Mode
  dl-FrameType                             DL-FrameType,
  deltaSIR1                                 DeltaSIR,
  deltaSIRAfter1                           DeltaSIR,
  deltaSIR2                                 DeltaSIR                                OPTIONAL,
  deltaSIRAfter2                           DeltaSIR                                OPTIONAL,
  nidentifyAbort                           NidentifyAbort                        OPTIONAL,
  treconfirmAbort                           TreconfirmAbort                       OPTIONAL
}

TGPSI ::=                                    INTEGER (1..maxTGPS)

TGSN ::=                                    INTEGER (0..14)

TimeInfo ::=                               SEQUENCE {
  activationTime                             ActivationTime                        OPTIONAL,
  durationTimeInfo                           DurationTimeInfo                      OPTIONAL
}

TimeslotList ::=                           SEQUENCE (SIZE (1..maxTS)) OF
                                           TimeslotNumber

TimeslotNumber ::=                         INTEGER (0..14)

TimeslotSync2 ::=                          INTEGER (0..6)

-- Actual value = IE value * 256
TimingOffset ::=                           INTEGER (0..149)

TPC-CombinationIndex ::=                   INTEGER (0..5)

TPC-StepSizeFDD ::=                        INTEGER (0..1)

-- Actual value = IE value + 1
TPC-StepSizeTDD ::=                       INTEGER (1..3)

-- Actual value = IE value * 0.5 seconds
TreconfirmAbort ::=                       INTEGER (1..20)

TX-DiversityMode ::=                       ENUMERATED {
  noDiversity,

```

```

        sttd,
        closedLoopModel,
        closedLoopMode2 }

UARFCN ::=
        INTEGER (0..16383)

UCSM-Info ::=
        SEQUENCE {
        minimumSpreadingFactor      MinimumSpreadingFactor,
        nf-Max                       NF-Max,
        channelReqParamsForUCSM     ChannelReqParamsForUCSM
        }

UL-CCTrCH ::=
        SEQUENCE {
        tfcs-ID                       TFCS-IdentityPlain           DEFAULT 1,
        ul-TargetSIR                  UL-TargetSIR,
        timeInfo                       TimeInfo,
        commonTimeslotInfo            CommonTimeslotInfo         OPTIONAL,
        ul-CCTrCH-TimeslotsCodes     UplinkTimeslotsCodes       OPTIONAL
        }

UL-CCTrCHList ::=
        SEQUENCE (SIZE (1..maxCCTrCH)) OF
        UL-CCTrCH

UL-CCTrChTPCLList ::=
        SEQUENCE (SIZE (0..maxCCTrCH)) OF
        TFCS-Identity

UL-ChannelRequirement ::=
        CHOICE {
        ul-DPCH-Info                  UL-DPCH-Info,
        cpch-SetInfo                  CPCH-SetInfo
        }

UL-ChannelRequirementWithCPCH-SetID ::= CHOICE {
        ul-DPCH-Info                  UL-DPCH-Info,
        cpch-SetInfo                  CPCH-SetInfo,
        cpch-SetID                    CPCH-SetID
        }

UL-CompressedModeMethod ::=
        ENUMERATED {
        sf-2,
        higherLayerScheduling }

UL-DL-Mode ::=
        CHOICE {
        ul                             UL-CompressedModeMethod,
        dl                             DL-CompressedModeMethod,
        ul-and-dl                       SEQUENCE {
                ul                     UL-CompressedModeMethod,
                dl                     DL-CompressedModeMethod
        }
        }

UL-DPCCH-SlotFormat ::=
        ENUMERATED {
        slf0, slf1, slf2 }

UL-DPCH-Info ::=
        SEQUENCE {
        ul-DPCH-PowerControlInfo      UL-DPCH-PowerControlInfo   OPTIONAL,
        modeSpecificInfo              CHOICE {
                fdd                    SEQUENCE {
                        scramblingCodeType      ScramblingCodeType,
                        scramblingCode          UL-ScramblingCode,
                        numberOfDPDCH          NumberOfDPDCH           DEFAULT 1,
                        spreadingFactor        SpreadingFactor,
                        tfci-Existence         BOOLEAN,
                        numberOfFBI-Bits      NumberOfFBI-Bits       OPTIONAL,
                        -- The IE above is conditional based on history
                        puncturingLimit       PuncturingLimit
                },
                tdd                    SEQUENCE {
                        ul-TimingAdvance       UL-TimingAdvanceControl  OPTIONAL,
                        ul-CCTrCHList         UL-CCTrCHList
                }
        }
        }

UL-DPCH-InfoPostFDD ::=
        SEQUENCE {
        ul-DPCH-PowerControlInfoPostFDD UL-DPCH-PowerControlInfoPostFDD,
        scramblingCodeType              ScramblingCodeType,
        reducedScramblingCodeNumber     ReducedScramblingCodeNumber,
        spreadingFactor                  SpreadingFactor
        }

```

```

}

UL-DPCH-InfoPostTDD ::= SEQUENCE {
    ul-DPCH-PowerControlInfo      UL-DPCH-PowerControlInfoPostTDD,
    ul-TimingAdvance              UL-TimingAdvanceControl           OPTIONAL,
    ul-CCTrCH-TimeslotsCodes      UplinkTimeslotsCodes
}

UL-DPCH-InfoPredef ::= SEQUENCE {
    ul-DPCH-PowerControlInfo      UL-DPCH-PowerControlInfoPredef,
    modeSpecificInfo              CHOICE {
        fdd                       SEQUENCE {
            tfci-Existence        BOOLEAN,
            puncturingLimit       PuncturingLimit
        },
        tdd                       SEQUENCE {
            commonTimeslotInfo    CommonTimeslotInfo
        }
    }
}

UL-DPCH-PowerControlInfo ::= CHOICE {
    fdd                           SEQUENCE {
        dpch-PowerOffset          DPCH-PowerOffset,
        pc-Preamble               PC-Preamble,
        srb-delay                 SRB-delay,
        powerControlAlgorithm     PowerControlAlgorithm
        -- TABULAR: TPC step size nested inside PowerControlAlgorithm
    },
    tdd                           SEQUENCE {
        ul-TargetSIR              UL-TargetSIR                OPTIONAL,
        ul-OL-PC-Signalling        CHOICE {
            broadcast-UL-OL-PC-info NULL,
            handoverGroup          SEQUENCE {
                individualTS-InterferenceList IndividualTS-InterferenceList,
                dpch-ConstantValue   ConstantValue,
                primaryCCPCH-TX-Power PrimaryCCPCH-TX-Power
            }
        }
    }
}

UL-DPCH-PowerControlInfoPostFDD ::= SEQUENCE {
    dpch-PowerOffset          DPCH-PowerOffset2, -- smaller range to save bits
    pc-Preamble               PC-Preamble,
    srb-delay                 SRB-delay
}

UL-DPCH-PowerControlInfoPostTDD ::= SEQUENCE {
    ul-TargetSIR              UL-TargetSIR,
    ul-TimeslotInterference    UL-Interference
}

UL-DPCH-PowerControlInfoPredef ::= CHOICE {
    fdd                       SEQUENCE {
        powerControlAlgorithm    PowerControlAlgorithm
        -- TABULAR: TPC step size nested inside PowerControlAlgorithm
    },
    tdd                       SEQUENCE {
        dpch-ConstantValue       ConstantValue
    }
}

UL-Interference ::= INTEGER (-110..-70)

UL-ScramblingCode ::= INTEGER (0..16777215)

-- Actual value = (IE value * 0.5) - 11
UL-TargetSIR ::= INTEGER (0..62)

UL-TimingAdvance ::= INTEGER (0..63)

UL-TimingAdvanceControl ::= CHOICE {
    disabled                  NULL,
    enabled                   SEQUENCE {
        ul-TimingAdvance        UL-TimingAdvance           OPTIONAL,
        activationTime          ActivationTime             OPTIONAL
    }
}

```

```

    }
}

UL-TS-ChannelisationCode ::=      ENUMERATED {
    cc1-1, cc2-1, cc2-2,
    cc4-1, cc4-2, cc4-3, cc4-4,
    cc8-1, cc8-2, cc8-3, cc8-4,
    cc8-5, cc8-6, cc8-7, cc8-8,
    cc16-1, cc16-2, cc16-3, cc16-4,
    cc16-5, cc16-6, cc16-7, cc16-8,
    cc16-9, cc16-10, cc16-11, cc16-12,
    cc16-13, cc16-14, cc16-15, cc16-16 }

UL-TS-ChannelisationCodeList ::= SEQUENCE (SIZE (1..2)) OF
    UL-TS-ChannelisationCode

UplinkAdditionalTimeslots ::=      SEQUENCE {
    parameters                       CHOICE {
        sameAsLast                   SEQUENCE {
            timeslotNumber           TimeslotNumber
        },
        newParameters                 SEQUENCE {
            individualTimeslotInfo    IndividualTimeslotInfo,
            ul-TS-ChannelisationCodeList UL-TS-ChannelisationCodeList
        }
    }
}

UplinkTimeslotsCodes ::=          SEQUENCE {
    dynamicSFusage                   BOOLEAN,
    firstIndividualTimeslotInfo       IndividualTimeslotInfo,
    ul-TS-ChannelisationCodeList      UL-TS-ChannelisationCodeList,
    moreTimeslots                     CHOICE {
        noMore                       NULL,
        additionalTimeslots           CHOICE {
            consecutive                SEQUENCE {
                numAdditionalTimeslots INTEGER (1..maxTS-1)
            }
        },
        timeslotList                  SEQUENCE (SIZE (1..maxTS-1)) OF
            UplinkAdditionalTimeslots
    }
}
}

-- *****
--
--      MEASUREMENT INFORMATION ELEMENTS (10.3.7)
--
-- *****

AcquisitionSatInfo ::=           SEQUENCE {
    satID                             SatID,
    -- Actual value = IE value * 2.5
    doppler0thOrder                   INTEGER (-2048..2047),
    extraDopplerInfo                  ExtraDopplerInfo                       OPTIONAL,
    codePhase                          INTEGER (0..1022),
    integerCodePhase                   INTEGER (0..19),
    gps-BitNumber                      INTEGER (0..3),
    codePhaseSearchWindow              CodePhaseSearchWindow,
    azimuthAndElevation                AzimuthAndElevation                       OPTIONAL
}

AcquisitionSatInfoList ::=       SEQUENCE (SIZE (1..maxSat)) OF
    AcquisitionSatInfo

AdditionalMeasurementID-List ::= SEQUENCE (SIZE (1..maxAdditionalMeas)) OF
    MeasurementIdentity

AlmanacSatInfo ::=              SEQUENCE {
    dataID                             INTEGER (0..3),
    satID                             SatID,
    e                                   BIT STRING (SIZE (16)),
    t-oa                               BIT STRING (SIZE (8)),
    deltaI                             BIT STRING (SIZE (16)),
    omegaDot                           BIT STRING (SIZE (16)),
    satHealth                          BIT STRING (SIZE (8)),
    a-Sqrt                             BIT STRING (SIZE (24)),
}

```

```

    omega0          BIT STRING (SIZE (24)),
    m0              BIT STRING (SIZE (24)),
    omega           BIT STRING (SIZE (24)),
    af0             BIT STRING (SIZE (11)),
    af1             BIT STRING (SIZE (11))
}

AlmanacSatInfoList ::= SEQUENCE (SIZE (1..maxSat)) OF
    AlmanacSatInfo

AverageRLC-BufferPayload ::= ENUMERATED {
    pla0, pla4, pla8, pla16, pla32,
    pla64, pla128, pla256, pla512,
    pla1024, pla2k, pla4k, pla8k, pla16k,
    pla32k, pla64k, pla128k, pla256k,
    pla512k, pla1024k }

AzimuthAndElevation ::= SEQUENCE {
    -- Actual value = IE value * 11.25
    azimuth          INTEGER (0..31),
    -- Actual value = IE value * 11.25
    elevation        INTEGER (0..7)
}

BadSatList ::= SEQUENCE (SIZE (1..maxSat)) OF
    INTEGER (0..63)

Frequency-Band ::= ENUMERATED {
    dcs1800BandUsed, pcs1900BandUsed }

BCCH-ARFCN ::= INTEGER (0..1023)

BLER-MeasurementResults ::= SEQUENCE {
    transportChannelIdentity TransportChannelIdentity,
    dl-TransportChannelBLER DL-TransportChannelBLER OPTIONAL
}

BLER-MeasurementResultsList ::= SEQUENCE (SIZE (1..maxTrCH)) OF
    BLER-MeasurementResults

BLER-TransChIdList ::= SEQUENCE (SIZE (1..maxTrCH)) OF
    TransportChannelIdentity

BSIC-VerificationRequired ::= ENUMERATED {
    required, notRequired }

BSICReported ::= CHOICE {
    -- Value maxCellMeas is not allowed for verifiedBSIC
    verifiedBSIC      INTEGER (0..maxCellMeas),
    nonVerifiedBSIC   BCCH-ARFCN
}

BurstModeParameters ::= SEQUENCE {
    burstStart        INTEGER (0..15),
    burstLength       INTEGER (10..25),
    burstFreq         INTEGER (1..16)
}

CellDCH-ReportCriteria ::= CHOICE {
    intraFreqReportingCriteria IntraFreqReportingCriteria,
    periodicalReportingCriteria PeriodicalReportingCriteria
}

-- Actual value = IE value * 0.5
CellIndividualOffset ::= INTEGER (-20..20)

CellInfo ::= SEQUENCE {
    cellIndividualOffset CellIndividualOffset DEFAULT 0,
    referenceTimeDifferenceToCell ReferenceTimeDifferenceToCell OPTIONAL,
    modeSpecificInfo     CHOICE {
        fdd              SEQUENCE {
            primaryCPICH-Info PrimaryCPICH-Info OPTIONAL,
            primaryCPICH-TX-Power PrimaryCPICH-TX-Power OPTIONAL,
            readSFN-Indicator BOOLEAN,
            tx-DiversityIndicator BOOLEAN
        },
        tdd              SEQUENCE {

```

<pre> primaryCCPCH-Info primaryCCPCH-TX-Power timeslotInfoList readSFN-Indicator } } } </pre>	<pre> PrimaryCCPCH-Info, PrimaryCCPCH-TX-Power TimeslotInfoList BOOLEAN </pre>	<pre> OPTIONAL, OPTIONAL, </pre>
<pre> CellInfoSI-RSCP ::= cellIndividualOffset referenceTimeDifferenceToCell modeSpecificInfo fdd primaryCPICH-Info primaryCPICH-TX-Power readSFN-Indicator tx-DiversityIndicator }, tdd primaryCCPCH-Info primaryCCPCH-TX-Power timeslotInfoList readSFN-Indicator } }, cellSelectionReselectionInfo } </pre>	<pre> SEQUENCE { CellIndividualOffset ReferenceTimeDifferenceToCell CHOICE { SEQUENCE { PrimaryCPICH-Info PrimaryCPICH-TX-Power BOOLEAN, BOOLEAN } SEQUENCE { PrimaryCCPCH-Info, PrimaryCCPCH-TX-Power TimeslotInfoList BOOLEAN } } } CellSelectReselectInfoSIB-11-12-RSCP </pre>	<pre> DEFAULT 0, OPTIONAL, OPTIONAL, OPTIONAL, OPTIONAL, OPTIONAL, OPTIONAL, OPTIONAL, OPTIONAL </pre>
<pre> CellInfoSI-ECN0 ::= cellIndividualOffset referenceTimeDifferenceToCell modeSpecificInfo fdd primaryCPICH-Info primaryCPICH-TX-Power readSFN-Indicator tx-DiversityIndicator }, tdd primaryCCPCH-Info primaryCCPCH-TX-Power timeslotInfoList readSFN-Indicator } }, cellSelectionReselectionInfo } </pre>	<pre> SEQUENCE { CellIndividualOffset ReferenceTimeDifferenceToCell CHOICE { SEQUENCE { PrimaryCPICH-Info PrimaryCPICH-TX-Power BOOLEAN, BOOLEAN } SEQUENCE { PrimaryCCPCH-Info, PrimaryCCPCH-TX-Power TimeslotInfoList BOOLEAN } } } CellSelectReselectInfoSIB-11-12-ECN0 </pre>	<pre> DEFAULT 0, OPTIONAL, OPTIONAL, OPTIONAL, OPTIONAL, OPTIONAL, OPTIONAL, OPTIONAL, OPTIONAL </pre>
<pre> CellInfoSI-HCS-RSCP ::= cellIndividualOffset referenceTimeDifferenceToCell modeSpecificInfo fdd primaryCPICH-Info primaryCPICH-TX-Power readSFN-Indicator tx-DiversityIndicator }, tdd primaryCCPCH-Info primaryCCPCH-TX-Power timeslotInfoList readSFN-Indicator } }, cellSelectionReselectionInfo } </pre>	<pre> SEQUENCE { CellIndividualOffset ReferenceTimeDifferenceToCell CHOICE { SEQUENCE { PrimaryCPICH-Info PrimaryCPICH-TX-Power BOOLEAN, BOOLEAN } SEQUENCE { PrimaryCCPCH-Info, PrimaryCCPCH-TX-Power TimeslotInfoList BOOLEAN } } } CellSelectReselectInfoSIB-11-12-HCS-RSCP </pre>	<pre> DEFAULT 0, OPTIONAL, OPTIONAL, OPTIONAL, OPTIONAL, OPTIONAL, OPTIONAL, OPTIONAL, OPTIONAL </pre>
<pre> CellInfoSI-HCS-ECN0 ::= cellIndividualOffset referenceTimeDifferenceToCell modeSpecificInfo fdd primaryCPICH-Info primaryCPICH-TX-Power readSFN-Indicator tx-DiversityIndicator }, </pre>	<pre> SEQUENCE { CellIndividualOffset ReferenceTimeDifferenceToCell CHOICE { SEQUENCE { PrimaryCPICH-Info PrimaryCPICH-TX-Power BOOLEAN, BOOLEAN } </pre>	<pre> DEFAULT 0, OPTIONAL, OPTIONAL, OPTIONAL, OPTIONAL, OPTIONAL, OPTIONAL, OPTIONAL, OPTIONAL </pre>

```

    tdd
        primaryCCPCH-Info
        primaryCCPCH-TX-Power
        timeslotInfoList
        readSFN-Indicator
    },
    cellSelectionReselectionInfo
}

CellMeasuredResults ::= SEQUENCE {
    cellIdentity
    sfn-SFN-ObsTimeDifference
    cellSynchronisationInfo
    modeSpecificInfo
        fdd
            primaryCPICH-Info
            cpich-Ec-N0
            cpich-RSCP
            pathloss
        },
        tdd
            cellParametersID
            proposedTGSN
            primaryCCPCH-RSCP
            pathloss
            timeslotISCP-List
    }
}

CellMeasurementEventResults ::= CHOICE {
    fdd
        SEQUENCE (SIZE (1..maxCellMeas)) OF
            PrimaryCPICH-Info,
    tdd
        SEQUENCE (SIZE (1..maxCellMeas)) OF
            PrimaryCCPCH-Info
}

CellReportingQuantities ::= SEQUENCE {
    sfn-SFN-OTD-Type
    cellIdentity-reportingIndicator
    cellSynchronisationInfoReportingIndicator
    modeSpecificInfo
        fdd
            cpich-Ec-N0-reportingIndicator
            cpich-RSCP-reportingIndicator
            pathloss-reportingIndicator
        },
        tdd
            timeslotISCP-reportingIndicator
            proposedTGSN-ReportingRequired
            primaryCCPCH-RSCP-reportingIndicator
            pathloss-reportingIndicator
    }
}

CellSelectReselectInfoSIB-11-12 ::= SEQUENCE {
    q-Offset1S-N
    q-Offset2S-N
    maxAllowedUL-TX-Power
    hcs-NeighbouringCellInformation-RSCP
    modeSpecificInfo
        fdd
            q-QualMin
            q-RxlevMin
        },
        tdd
            q-RxlevMin
    },
    gsm
        q-RxlevMin
    }
}

CellSelectReselectInfoSIB-11-12-RSCP ::= SEQUENCE {

```

```

q-OffsetS-N                Q-OffsetS-N                DEFAULT 0,
maxAllowedUL-TX-Power      MaxAllowedUL-TX-Power      OPTIONAL,
modeSpecificInfo          CHOICE {
  fdd                      SEQUENCE {
    q-QualMin              Q-QualMin                OPTIONAL,
    q-RxlevMin            Q-RxlevMin            OPTIONAL
  },
  tdd                      SEQUENCE {
    q-RxlevMin            Q-RxlevMin            OPTIONAL
  },
  gsm                      SEQUENCE {
    q-RxlevMin            Q-RxlevMin            OPTIONAL
  }
}
}

CellSelectReselectInfoSIB-11-12-ECNO ::= SEQUENCE {
  q-Offset1S-N              Q-OffsetS-N                DEFAULT 0,
  q-Offset2S-N              Q-OffsetS-N                DEFAULT 0,
  maxAllowedUL-TX-Power    MaxAllowedUL-TX-Power    OPTIONAL,
  modeSpecificInfo        CHOICE {
    fdd                    SEQUENCE {
      q-QualMin            Q-QualMin                OPTIONAL,
      q-RxlevMin          Q-RxlevMin            OPTIONAL
    },
    tdd                    SEQUENCE {
      q-RxlevMin          Q-RxlevMin            OPTIONAL
    },
    gsm                    SEQUENCE {
      q-RxlevMin          Q-RxlevMin            OPTIONAL
    }
  }
}

CellSelectReselectInfoSIB-11-12-HCS-RSCP ::= SEQUENCE {
  q-OffsetS-N              Q-OffsetS-N                DEFAULT 0,
  maxAllowedUL-TX-Power    MaxAllowedUL-TX-Power    OPTIONAL,
  hcs-NeighbouringCellInformation-RSCP HCS-NeighbouringCellInformation-RSCP
  OPTIONAL,
  modeSpecificInfo        CHOICE {
    fdd                    SEQUENCE {
      q-QualMin            Q-QualMin                OPTIONAL,
      q-RxlevMin          Q-RxlevMin            OPTIONAL
    },
    tdd                    SEQUENCE {
      q-RxlevMin          Q-RxlevMin            OPTIONAL
    },
    gsm                    SEQUENCE {
      q-RxlevMin          Q-RxlevMin            OPTIONAL
    }
  }
}

CellSelectReselectInfoSIB-11-12-HCS-ECNO ::= SEQUENCE {
  q-Offset1S-N              Q-OffsetS-N                DEFAULT 0,
  q-Offset2S-N              Q-OffsetS-N                DEFAULT 0,
  maxAllowedUL-TX-Power    MaxAllowedUL-TX-Power    OPTIONAL,
  hcs-NeighbouringCellInformation-ECNO HCS-NeighbouringCellInformation-ECNO
  OPTIONAL,
  modeSpecificInfo        CHOICE {
    fdd                    SEQUENCE {
      q-QualMin            Q-QualMin                OPTIONAL,
      q-RxlevMin          Q-RxlevMin            OPTIONAL
    },
    tdd                    SEQUENCE {
      q-RxlevMin          Q-RxlevMin            OPTIONAL
    },
    gsm                    SEQUENCE {
      q-RxlevMin          Q-RxlevMin            OPTIONAL
    }
  }
}

CellsForInterFreqMeasList ::= SEQUENCE (SIZE (1..maxCellMeas)) OF
  InterFreqCellID
CellsForInterRATMeasList ::= SEQUENCE (SIZE (1..maxCellMeas)) OF
  InterRATCellID
CellsForIntraFreqMeasList ::= SEQUENCE (SIZE (1..maxCellMeas)) OF

```



```

        IntraFreqCellID
CellSynchronisationInfo ::= SEQUENCE {
    modeSpecificInfo CHOICE {
        fdd SEQUENCE {
            countC-SFN-Frame-difference CountC-SFN-Frame-difference OPTIONAL,
            tm INTEGER(0..38399)
        },
        tdd SEQUENCE {
            countC-SFN-Frame-difference CountC-SFN-Frame-difference OPTIONAL
        }
    }
}

CellToReport ::= SEQUENCE {
    bsicReported BSICReported
}

CellToReportList ::= SEQUENCE (SIZE (1..maxCellMeas)) OF
    CellToReport

CodePhaseSearchWindow ::= ENUMERATED {
    w1023, w1, w2, w3, w4, w6, w8,
    w12, w16, w24, w32, w48, w64,
    w96, w128, w192 }

CountC-SFN-Frame-difference ::= SEQUENCE {
    countC-SFN-High INTEGER(0..15), -- Actual value = IE value * 256
    off INTEGER(0..255)
}

-- It is not allowed to send value 50 in this version of the specification
CPICH-Ec-NO ::= INTEGER (0..50)

CPICH-RSCP ::= INTEGER (0..91)

DeltaPRC ::= INTEGER (-127..127)

-- Actual value = IE value * 0.032
DeltaRRC ::= INTEGER (-7..7)

DGPS-CorrectionSatInfo ::= SEQUENCE {
    satID SatID,
    iode IODE,
    udre UDRE,
    prc PRC,
    rrc RRC,
    deltaPRC2 DeltaPRC,
    deltaRRC2 DeltaRRC,
    deltaPRC3 DeltaPRC OPTIONAL,
    deltaRRC3 DeltaRRC OPTIONAL
}

DGPS-CorrectionSatInfoList ::= SEQUENCE (SIZE (1..maxSat)) OF
    DGPS-CorrectionSatInfo

DiffCorrectionStatus ::= ENUMERATED {
    udre-1-0, udre-0-75, udre-0-5, udre-0-3,
    udre-0-2, udre-0-1, noData, invalidData }

DL-TransportChannelBLER ::= INTEGER (0..63)

DopplerUncertainty ::= ENUMERATED {
    hz12-5, hz25, hz50, hz100, hz200 }

EllipsoidPoint ::= SEQUENCE {
    latitudeSign ENUMERATED { north, south },
    latitude INTEGER (0..8388607),
    longitude INTEGER (-8388608..8388607)
}

EllipsoidPointAltitude ::= SEQUENCE {
    latitudeSign ENUMERATED { north, south },
    latitude INTEGER (0..8388607),
    longitude INTEGER (-8388608..8388607),
    altitudeDirection ENUMERATED { height, depth },

```

```

    altitude                INTEGER (0..32767)
  }

EllipsoidPointAltitudeEllipsoide ::= SEQUENCE {
    latitudeSign            ENUMERATED { north, south },
    latitude                INTEGER (0..8388607),
    longitude               INTEGER (-8388608..8388607),
    altitudeDirection      ENUMERATED {height, depth},
    altitude                INTEGER (0..32767),
    uncertaintySemiMajor    INTEGER (0..127),
    uncertaintySemiMinor    INTEGER (0..127),
    orientationMajorAxis    INTEGER (0..89),
    uncertaintyAltitude     INTEGER (0..127),
    confidence               INTEGER (0..100)
}

EllipsoidPointUncertCircle ::= SEQUENCE {
    latitudeSign            ENUMERATED { north, south },
    latitude                INTEGER (0..8388607),
    longitude               INTEGER (-8388608..8388607),
    uncertaintyCode         INTEGER (0..127)
}

EllipsoidPointUncertEllipse ::= SEQUENCE {
    latitudeSign            ENUMERATED { north, south },
    latitude                INTEGER (0..8388607),
    longitude               INTEGER (-8388608..8388607),
    uncertaintySemiMajor    INTEGER (0..127),
    uncertaintySemiMinor    INTEGER (0..127),
    orientationMajorAxis    INTEGER (0..89),
    confidence               INTEGER (0..100)
}

EnvironmentCharacterisation ::= ENUMERATED {
    possibleHeavyMultipathNLOS,
    lightMultipathLOS,
    notDefined }

Event1a ::= SEQUENCE {
    triggeringCondition      TriggeringCondition2,
    reportingRange           ReportingRange,
    forbiddenAffectCellList ForbiddenAffectCellList           OPTIONAL,
    w                         W,
    reportDeactivationThreshold ReportDeactivationThreshold,
    reportingAmount           ReportingAmount,
    reportingInterval         ReportingInterval
}

Event1b ::= SEQUENCE {
    triggeringCondition      TriggeringCondition1,
    reportingRange           ReportingRange,
    forbiddenAffectCellList ForbiddenAffectCellList           OPTIONAL,
    w                         W
}

Event1c ::= SEQUENCE {
    replacementActivationThreshold ReplacementActivationThreshold,
    reportingAmount           ReportingAmount,
    reportingInterval         ReportingInterval
}

Event1e ::= SEQUENCE {
    triggeringCondition      TriggeringCondition2,
    thresholdUsedFrequency   ThresholdUsedFrequency
}

Event1f ::= SEQUENCE {
    triggeringCondition      TriggeringCondition1,
    thresholdUsedFrequency   ThresholdUsedFrequency
}

Event2a ::= SEQUENCE {
    dummy                    Threshold,
    -- IE "dummy" shall not be sent and shall be ignored if received.
}

```

```

-- IE "dummy" should be removed in later versions of the message including this IE
usedFreqW                W,
hysteresis                HysteresisInterFreq,
timeToTrigger            TimeToTrigger,
reportingCellStatus      ReportingCellStatus      OPTIONAL,
nonUsedFreqParameterList NonUsedFreqParameterList  OPTIONAL
}

Event2b ::=                SEQUENCE {
    usedFreqThreshold      Threshold,
    usedFreqW              W,
    hysteresis              HysteresisInterFreq,
    timeToTrigger          TimeToTrigger,
    reportingCellStatus    ReportingCellStatus      OPTIONAL,
    nonUsedFreqParameterList NonUsedFreqParameterList  OPTIONAL
}

Event2c ::=                SEQUENCE {
    hysteresis              HysteresisInterFreq,
    timeToTrigger          TimeToTrigger,
    reportingCellStatus    ReportingCellStatus      OPTIONAL,
    nonUsedFreqParameterList NonUsedFreqParameterList  OPTIONAL
}

Event2d ::=                SEQUENCE {
    usedFreqThreshold      Threshold,
    usedFreqW              W,
    hysteresis              HysteresisInterFreq,
    timeToTrigger          TimeToTrigger,
    reportingCellStatus    ReportingCellStatus      OPTIONAL
}

Event2e ::=                SEQUENCE {
    hysteresis              HysteresisInterFreq,
    timeToTrigger          TimeToTrigger,
    reportingCellStatus    ReportingCellStatus      OPTIONAL,
    nonUsedFreqParameterList NonUsedFreqParameterList  OPTIONAL
}

Event2f ::=                SEQUENCE {
    usedFreqThreshold      Threshold,
    usedFreqW              W,
    hysteresis              HysteresisInterFreq,
    timeToTrigger          TimeToTrigger,
    reportingCellStatus    ReportingCellStatus      OPTIONAL
}

Event3a ::=                SEQUENCE {
    thresholdOwnSystem     Threshold,
    w                       W,
    thresholdOtherSystem   Threshold,
    hysteresis              Hysteresis,
    timeToTrigger          TimeToTrigger,
    reportingCellStatus    ReportingCellStatus      OPTIONAL
}

Event3b ::=                SEQUENCE {
    thresholdOtherSystem   Threshold,
    hysteresis              Hysteresis,
    timeToTrigger          TimeToTrigger,
    reportingCellStatus    ReportingCellStatus      OPTIONAL
}

Event3c ::=                SEQUENCE {
    thresholdOtherSystem   Threshold,
    hysteresis              Hysteresis,
    timeToTrigger          TimeToTrigger,
    reportingCellStatus    ReportingCellStatus      OPTIONAL
}

Event3d ::=                SEQUENCE {
    hysteresis              Hysteresis,
    timeToTrigger          TimeToTrigger,
    reportingCellStatus    ReportingCellStatus      OPTIONAL
}

EventIDInterFreq ::=      ENUMERATED {

```

```

        e2a, e2b, e2c, e2d, e2e, e2f }

EventIDInterRAT ::=          ENUMERATED {
        e3a, e3b, e3c, e3d }

EventIDIntraFreq ::=        ENUMERATED {
        e1a, e1b, e1c, e1d, e1e,
        e1f, e1g, e1h, e1i }

EventResults ::=            CHOICE {
        intraFreqEventResults      IntraFreqEventResults,
        interFreqEventResults      InterFreqEventResults,
        interRATEventResults       InterRATEventResults,
        trafficVolumeEventResults  TrafficVolumeEventResults,
        qualityEventResults         QualityEventResults,
        ue-InternalEventResults     UE-InternalEventResults,
        ue-positioning-MeasurementEventResults  UE-Positioning-MeasurementEventResults
}

ExtraDopplerInfo ::=        SEQUENCE {
        -- Actual value = IE value * 0.023
        doppler1stOrder             INTEGER (-42..21),
        dopplerUncertainty          DopplerUncertainty
}

FACH-MeasurementOccasionInfo ::= SEQUENCE {
        fACH-meas-occasion-coeff    INTEGER (1..12)                OPTIONAL,
        inter-freq-FDD-meas-ind     BOOLEAN,
        inter-freq-TDD-meas-ind     BOOLEAN,
        inter-RAT-meas-ind          SEQUENCE (SIZE (1..maxOtherRAT)) OF
        RAT-Type                    OPTIONAL
}

FilterCoefficient ::=       ENUMERATED {
        fc0, fc1, fc2, fc3, fc4, fc5,
        fc6, fc7, fc8, fc9, fc11, fc13,
        fc15, fc17, fc19, spare1 }

-- Actual value = IE value * 0.0625
FineSFN-SFN ::=            INTEGER (0..15)

ForbiddenAffectCell ::=     CHOICE {
        fdd                         PrimaryCPICH-Info,
        tdd                         PrimaryCCPCH-Info
}

ForbiddenAffectCellList ::= SEQUENCE (SIZE (1..maxCellMeas)) OF
        ForbiddenAffectCell

FreqQualityEstimateQuantity-FDD ::= ENUMERATED {
        cpich-Ec-N0,
        cpich-RSCP }

FreqQualityEstimateQuantity-TDD ::= ENUMERATED {
        primaryCCPCH-RSCP }

GPS-MeasurementParam ::=    SEQUENCE {
        satelliteID                 INTEGER (0..63),
        c-N0                        INTEGER (0..63),
        doppler                      INTEGER (-32768..32768),
        wholeGPS-Chips               INTEGER (0..1023),
        fractionalGPS-Chips          INTEGER (0..1023),
        multipathIndicator           MultipathIndicator,
        pseudorangeRMS-Error        INTEGER (0..63)
}

GPS-MeasurementParamList ::= SEQUENCE (SIZE (1..maxSat)) OF
        GPS-MeasurementParam

GSM-CarrierRSSI ::=        BIT STRING (SIZE (6))

GSM-MeasuredResults ::=    SEQUENCE {
        gsm-CarrierRSSI             GSM-CarrierRSSI                OPTIONAL,
        dummy                       INTEGER (46..158)                OPTIONAL,
        bsicReported                BSICReported,
        observedTimeDifferenceToGSM  ObservedTimeDifferenceToGSM  OPTIONAL
}

```

```

GSM-MeasuredResultsList ::= SEQUENCE (SIZE (1..maxReportedGSMCells)) OF
    GSM-MeasuredResults

GPS-TOW-1msec ::= INTEGER (0..604799999)

GPS-TOW-Assist ::= SEQUENCE {
    satID SatID,
    tlm-Message BIT STRING (SIZE (14)),
    tlm-Reserved BIT STRING (SIZE (2)),
    alert BOOLEAN,
    antiSpoof BOOLEAN
}

GPS-TOW-AssistList ::= SEQUENCE (SIZE (1..maxSat)) OF
    GPS-TOW-Assist

GPS-TOW-rem-usec ::= INTEGER (0..999)

HCS-CellReselectInformation-RSCP ::= SEQUENCE {
    penaltyTime PenaltyTime-RSCP
    -- TABULAR: The default value is "notUsed", temporary offset is nested inside PenaltyTime
}

HCS-CellReselectInformation-ECNO ::= SEQUENCE {
    penaltyTime PenaltyTime-ECNO
    -- TABULAR: The default value is "notUsed", temporary offset is nested inside PenaltyTime
}

HCS-NeighbouringCellInformation-RSCP ::= SEQUENCE {
    hcs-PRIO HCS-PRIO DEFAULT 0,
    q-HCS Q-HCS DEFAULT 0,
    hcs-CellReselectInformation HCS-CellReselectInformation-RSCP
}

HCS-NeighbouringCellInformation-ECNO ::= SEQUENCE {
    hcs-PRIO HCS-PRIO DEFAULT 0,
    q-HCS Q-HCS DEFAULT 0,
    hcs-CellReselectInformation HCS-CellReselectInformation-ECNO
}

HCS-PRIO ::= INTEGER (0..7)

HCS-ServingCellInformation ::= SEQUENCE {
    hcs-PRIO HCS-PRIO DEFAULT 0,
    q-HCS Q-HCS DEFAULT 0,
    t-CR-Max T-CRMax OPTIONAL
}

-- Actual value = IE value * 0.5
Hysteresis ::= INTEGER (0..15)

-- Actual value = IE value * 0.5
HysteresisInterFreq ::= INTEGER (0..29)

InterFreqCell ::= SEQUENCE {
    frequencyInfo FrequencyInfo,
    nonFreqRelatedEventResults CellMeasurementEventResults
}

InterFreqCellID ::= INTEGER (0..maxCellMeas-1)

InterFreqCellInfoList ::= SEQUENCE {
    removedInterFreqCellList RemovedInterFreqCellList OPTIONAL,
    newInterFreqCellList NewInterFreqCellList OPTIONAL,
    cellsForInterFreqMeasList CellsForInterFreqMeasList OPTIONAL
}

InterFreqCellInfoSI-List-RSCP ::= SEQUENCE {
    removedInterFreqCellList RemovedInterFreqCellList OPTIONAL,
    newInterFreqCellList NewInterFreqCellSI-List-RSCP OPTIONAL
}

InterFreqCellInfoSI-List-ECNO ::= SEQUENCE {
    removedInterFreqCellList RemovedInterFreqCellList OPTIONAL,
    newInterFreqCellList NewInterFreqCellSI-List-ECNO OPTIONAL
}

```

```

InterFreqCellInfoSI-List-HCS-RSCP ::= SEQUENCE {
    removedInterFreqCellList      RemovedInterFreqCellList      OPTIONAL,
    newInterFreqCellList           NewInterFreqCellSI-List-HCS-RSCP  OPTIONAL
}
InterFreqCellInfoSI-List-HCS-ECNO ::= SEQUENCE {
    removedInterFreqCellList      RemovedInterFreqCellList      OPTIONAL,
    newInterFreqCellList           NewInterFreqCellSI-List-HCS-ECNO  OPTIONAL
}

InterFreqCellList ::= SEQUENCE (SIZE (1..maxFreq)) OF
    InterFreqCell

InterFreqCellMeasuredResultsList ::= SEQUENCE (SIZE (1..maxCellMeas)) OF
    CellMeasuredResults

InterFreqEvent ::= CHOICE {
    event2a      Event2a,
    event2b      Event2b,
    event2c      Event2c,
    event2d      Event2d,
    event2e      Event2e,
    event2f      Event2f
}

InterFreqEventList ::= SEQUENCE (SIZE (1..maxMeasEvent)) OF
    InterFreqEvent

InterFreqEventResults ::= SEQUENCE {
    eventID      EventIDInterFreq,
    interFreqCellList      InterFreqCellList      OPTIONAL
}

InterFreqMeasQuantity ::= SEQUENCE {
    reportingCriteria      CHOICE {
        intraFreqReportingCriteria      SEQUENCE {
            intraFreqMeasQuantity      IntraFreqMeasQuantity
        },
        interFreqReportingCriteria      SEQUENCE {
            filterCoefficient      FilterCoefficient      DEFAULT fc0,
            modeSpecificInfo      CHOICE {
                fdd      SEQUENCE {
                    freqQualityEstimateQuantity-FDD      FreqQualityEstimateQuantity-FDD
                },
                tdd      SEQUENCE {
                    freqQualityEstimateQuantity-TDD      FreqQualityEstimateQuantity-TDD
                }
            }
        }
    }
}

InterFreqMeasuredResults ::= SEQUENCE {
    frequencyInfo      FrequencyInfo      OPTIONAL,
    ultra-CarrierRSSI      UTRA-CarrierRSSI      OPTIONAL,
    interFreqCellMeasuredResultsList      InterFreqCellMeasuredResultsList      OPTIONAL
}

InterFreqMeasuredResultsList ::= SEQUENCE (SIZE (1..maxFreq)) OF
    InterFreqMeasuredResults

InterFreqMeasurementSysInfo-RSCP ::= SEQUENCE {
    interFreqCellInfoSI-List      InterFreqCellInfoSI-List-RSCP      OPTIONAL
}

InterFreqMeasurementSysInfo-ECNO ::= SEQUENCE {
    interFreqCellInfoSI-List      InterFreqCellInfoSI-List-ECNO      OPTIONAL
}

InterFreqMeasurementSysInfo-HCS-RSCP ::= SEQUENCE {
    interFreqCellInfoSI-List      InterFreqCellInfoSI-List-HCS-RSCP      OPTIONAL
}

InterFreqMeasurementSysInfo-HCS-ECNO ::= SEQUENCE {
    interFreqCellInfoSI-List      InterFreqCellInfoSI-List-HCS-ECNO      OPTIONAL
}

```

```

InterFreqReportCriteria ::=          CHOICE {
    intraFreqReportingCriteria      IntraFreqReportingCriteria,
    interFreqReportingCriteria      InterFreqReportingCriteria,
    periodicalReportingCriteria     PeriodicalWithReportingCellStatus,
    noReporting                     ReportingCellStatusOpt
}

InterFreqReportingCriteria ::=      SEQUENCE {
    interFreqEventList              InterFreqEventList              OPTIONAL
}

InterFreqReportingQuantity ::=     SEQUENCE {
    ultra-Carrier-RSSI              BOOLEAN,
    frequencyQualityEstimate        BOOLEAN,
    nonFreqRelatedQuantities       CellReportingQuantities
}

InterFrequencyMeasurement ::=      SEQUENCE {
    interFreqCellInfoList           InterFreqCellInfoList,
    interFreqMeasQuantity           InterFreqMeasQuantity           OPTIONAL,
    interFreqReportingQuantity     InterFreqReportingQuantity     OPTIONAL,
    measurementValidity            MeasurementValidity           OPTIONAL,
    interFreqSetUpUpdate           UE-AutonomousUpdateMode       OPTIONAL,
    reportCriteria                 InterFreqReportCriteria
}

InterRAT-TargetCellDescription ::= SEQUENCE {
    technologySpecificInfo          CHOICE {
        gsm                        SEQUENCE {
            bsic                   BSIC,
            frequency-band         Frequency-Band,
            bcch-ARFCN            BCCH-ARFCN,
            ncMode                 NC-Mode                OPTIONAL
        },
        is-2000                    NULL,
        spare                       NULL
    }
}

InterRATCellID ::=                 INTEGER (0..maxCellMeas-1)

InterRATCellInfoList ::=           SEQUENCE {
    removedInterRATCellList        RemovedInterRATCellList,
    newInterRATCellList            NewInterRATCellList,
    cellsForInterRATMeasList       CellsForInterRATMeasList       OPTIONAL
}

InterRATCellInfoList-B ::=         SEQUENCE {
    removedInterRATCellList        RemovedInterRATCellList,
    newInterRATCellList            NewInterRATCellList-B
}

InterRATCellIndividualOffset ::=   INTEGER (-50..50)

InterRATEvent ::=                  CHOICE {
    event3a                        Event3a,
    event3b                        Event3b,
    event3c                        Event3c,
    event3d                        Event3d
}

InterRATEventList ::=              SEQUENCE (SIZE (1..maxMeasEvent)) OF
    InterRATEvent

InterRATEventResults ::=           SEQUENCE {
    eventID                        EventIDInterRAT,
    cellToReportList              CellToReportList
}

InterRATInfo ::=                   ENUMERATED {
    gsm
}

InterRATMeasQuantity ::=           SEQUENCE {
    measQuantityUTRAN-QualityEstimate IntraFreqMeasQuantity           OPTIONAL,
    ratSpecificInfo               CHOICE {
        gsm                        SEQUENCE {
            measurementQuantity    MeasurementQuantityGSM,
            filterCoefficient      FilterCoefficient           DEFAULT fc0,
        }
    }
}

```

```

        bsic-VerificationRequired          BSIC-VerificationRequired
    },
    is-2000                                SEQUENCE {
        tadd-EcIo                          INTEGER (0..63),
        tcomp-EcIo                        INTEGER (0..15),
        softSlope                          INTEGER (0..63)          OPTIONAL,
        addIntercept                       INTEGER (0..63)          OPTIONAL
    }
}

InterRATMeasuredResults ::= CHOICE {
    gsm          GSM-MeasuredResultsList,
    spare       NULL
}

InterRATMeasuredResultsList ::= SEQUENCE (SIZE (1..maxOtherRAT)) OF
    InterRATMeasuredResults

InterRATMeasurement ::= SEQUENCE {
    interRATCellInfoList      InterRATCellInfoList          OPTIONAL,
    interRATMeasQuantity      InterRATMeasQuantity          OPTIONAL,
    interRATReportingQuantity InterRATReportingQuantity     OPTIONAL,
    reportCriteria            InterRATReportCriteria
}

InterRATMeasurementSysInfo ::= SEQUENCE {
    interRATCellInfoList      InterRATCellInfoList          OPTIONAL
}

InterRATMeasurementSysInfo-B ::= SEQUENCE {
    interRATCellInfoList      InterRATCellInfoList-B        OPTIONAL
}

InterRATReportCriteria ::= CHOICE {
    interRATReportingCriteria      InterRATReportingCriteria,
    periodicalReportingCriteria    PeriodicalWithReportingCellStatus,
    noReporting                    ReportingCellStatusOpt
}

InterRATReportingCriteria ::= SEQUENCE {
    interRATEventList            InterRATEventList          OPTIONAL
}

InterRATReportingQuantity ::= SEQUENCE {
    utran-EstimatedQuality        BOOLEAN,
    ratSpecificInfo              CHOICE {
        gsm                      SEQUENCE {
            dummy                BOOLEAN,
            observedTimeDifferenceGSM    BOOLEAN,
            gsm-Carrier-RSSI      BOOLEAN
        }
    }
}

IntraFreqCellID ::= INTEGER (0..maxCellMeas-1)

IntraFreqCellInfoList ::= SEQUENCE {
    removedIntraFreqCellList      RemovedIntraFreqCellList          OPTIONAL,
    newIntraFreqCellList          NewIntraFreqCellList            OPTIONAL,
    cellsForIntraFreqMeasList     CellsForIntraFreqMeasList        OPTIONAL
}

IntraFreqCellInfoSI-List-RSCP ::= SEQUENCE {
    removedIntraFreqCellList      RemovedIntraFreqCellList          OPTIONAL,
    newIntraFreqCellList          NewIntraFreqCellSI-List-RSCP
}

IntraFreqCellInfoSI-List-ECNO ::= SEQUENCE {
    removedIntraFreqCellList      RemovedIntraFreqCellList          OPTIONAL,
    newIntraFreqCellList          NewIntraFreqCellSI-List-ECNO
}

IntraFreqCellInfoSI-List-HCS-RSCP ::= SEQUENCE {
    removedIntraFreqCellList      RemovedIntraFreqCellList          OPTIONAL,
    newIntraFreqCellList          NewIntraFreqCellSI-List-HCS-RSCP
}

```



```

IntraFreqCellInfoSI-List-HCS-ECNO ::= SEQUENCE {
    removedIntraFreqCellList      RemovedIntraFreqCellList      OPTIONAL,
    newIntraFreqCellList          NewIntraFreqCellSI-List-HCS-ECNO
}

IntraFreqEvent ::= CHOICE {
    ela          Event1a,
    elb          Event1b,
    elc          Event1c,
    eld          NULL,
    ele          Event1e,
    elf          Event1f,
    elg          NULL,
    elh          ThresholdUsedFrequency,
    eli          ThresholdUsedFrequency
}

IntraFreqEventCriteria ::= SEQUENCE {
    event          IntraFreqEvent,
    hysteresis     Hysteresis,
    timeToTrigger TimeToTrigger,
    reportingCellStatus ReportingCellStatus      OPTIONAL
}

IntraFreqEventCriteriaList ::= SEQUENCE (SIZE (1..maxMeasEvent)) OF
    IntraFreqEventCriteria

IntraFreqEventResults ::= SEQUENCE {
    eventID      EventIDIntraFreq,
    cellMeasurementEventResults CellMeasurementEventResults
}

IntraFreqMeasQuantity ::= SEQUENCE {
    filterCoefficient      FilterCoefficient      DEFAULT fc0,
    modeSpecificInfo      CHOICE {
        fdd                SEQUENCE {
            intraFreqMeasQuantity-FDD      IntraFreqMeasQuantity-FDD
        },
        tdd                SEQUENCE {
            intraFreqMeasQuantity-TDDList  IntraFreqMeasQuantity-TDDList
        }
    }
}

IntraFreqMeasQuantity-FDD ::= ENUMERATED {
    cpich-Ec-N0,
    cpich-RSCP,
    pathloss,
    ultra-CarrierRSSI }
-- If used in InterRATMeasQuantity only cpich-Ec-N0 and cpich-RSCP is
-- allowed.
-- If used in InterFreqMeasQuantity ultra-CarrierRSSI is not allowed.
IntraFreqMeasQuantity-TDD ::= ENUMERATED {
    primaryCCPCH-RSCP,
    pathloss,
    timeslotISCP,
    ultra-CarrierRSSI }
-- If used in InterFreqMeasQuantity ultra-CarrierRSSI is not allowed.
IntraFreqMeasQuantity-TDDList ::= SEQUENCE (SIZE (1..4)) OF
    IntraFreqMeasQuantity-TDD

IntraFreqMeasuredResultsList ::= SEQUENCE (SIZE (1..maxCellMeas)) OF
    CellMeasuredResults

IntraFreqMeasurementSysInfo-RSCP ::= SEQUENCE {
    intraFreqMeasurementID      MeasurementIdentity      DEFAULT 1,
    intraFreqCellInfoSI-List    IntraFreqCellInfoSI-List-RSCP      OPTIONAL,
    intraFreqMeasQuantity       IntraFreqMeasQuantity      OPTIONAL,
    intraFreqReportingQuantityForRACH IntraFreqReportingQuantityForRACH      OPTIONAL,
    maxReportedCellsOnRACH      MaxReportedCellsOnRACH      OPTIONAL,
    reportingInfoForCellDCH      ReportingInfoForCellDCH      OPTIONAL
}

IntraFreqMeasurementSysInfo-ECNO ::= SEQUENCE {
    intraFreqMeasurementID      MeasurementIdentity      DEFAULT 1,
    intraFreqCellInfoSI-List    IntraFreqCellInfoSI-List-ECNO      OPTIONAL,
    intraFreqMeasQuantity       IntraFreqMeasQuantity      OPTIONAL,
    intraFreqReportingQuantityForRACH IntraFreqReportingQuantityForRACH      OPTIONAL,

```

```

maxReportedCellsOnRACH           MaxReportedCellsOnRACH           OPTIONAL,
reportingInfoForCellDCH          ReportingInfoForCellDCH           OPTIONAL
}

IntraFreqMeasurementSysInfo-HCS-RSCP ::= SEQUENCE {
  intraFreqMeasurementID          MeasurementIdentity             DEFAULT 1,
  intraFreqCellInfoSI-List        IntraFreqCellInfoSI-List-HCS-RSCP OPTIONAL,
  intraFreqMeasQuantity           IntraFreqMeasQuantity         OPTIONAL,
  intraFreqReportingQuantityForRACH IntraFreqReportingQuantityForRACH OPTIONAL,
  maxReportedCellsOnRACH          MaxReportedCellsOnRACH        OPTIONAL,
  reportingInfoForCellDCH          ReportingInfoForCellDCH        OPTIONAL
}

IntraFreqMeasurementSysInfo-HCS-ECNO ::= SEQUENCE {
  intraFreqMeasurementID          MeasurementIdentity             DEFAULT 1,
  intraFreqCellInfoSI-List        IntraFreqCellInfoSI-List-HCS-ECNO OPTIONAL,
  intraFreqMeasQuantity           IntraFreqMeasQuantity         OPTIONAL,
  intraFreqReportingQuantityForRACH IntraFreqReportingQuantityForRACH OPTIONAL,
  maxReportedCellsOnRACH          MaxReportedCellsOnRACH        OPTIONAL,
  reportingInfoForCellDCH          ReportingInfoForCellDCH        OPTIONAL
}

IntraFreqReportCriteria ::= CHOICE {
  intraFreqReportingCriteria      IntraFreqReportingCriteria,
  periodicalReportingCriteria     PeriodicalWithReportingCellStatus,
  noReporting                     ReportingCellStatusOpt
}

IntraFreqReportingCriteria ::= SEQUENCE {
  eventCriteriaList              IntraFreqEventCriteriaList    OPTIONAL
}

IntraFreqReportingQuantity ::= SEQUENCE {
  activeSetReportingQuantities    CellReportingQuantities,
  monitoredSetReportingQuantities CellReportingQuantities,
  detectedSetReportingQuantities  CellReportingQuantities        OPTIONAL
}

IntraFreqReportingQuantityForRACH ::= SEQUENCE {
  sfn-SFN-OTD-Type              SFN-SFN-OTD-Type,
  modeSpecificInfo              CHOICE {
    fdd                          SEQUENCE {
      intraFreqRepQuantityRACH-FDD IntraFreqRepQuantityRACH-FDD
    },
    tdd                          SEQUENCE {
      intraFreqRepQuantityRACH-TDDList IntraFreqRepQuantityRACH-TDDList
    }
  }
}

IntraFreqRepQuantityRACH-FDD ::= ENUMERATED {
  cpich-EcN0, cpich-RSCP,
  pathloss, noReport }

IntraFreqRepQuantityRACH-TDD ::= ENUMERATED {
  timeslotISCP,
  primaryCCPCH-RSCP,
  noReport }

IntraFreqRepQuantityRACH-TDDList ::= SEQUENCE (SIZE (1..2)) OF
  IntraFreqRepQuantityRACH-TDD

IntraFrequencyMeasurement ::= SEQUENCE {
  intraFreqCellInfoList          IntraFreqCellInfoList         OPTIONAL,
  intraFreqMeasQuantity           IntraFreqMeasQuantity         OPTIONAL,
  intraFreqReportingQuantity      IntraFreqReportingQuantity    OPTIONAL,
  measurementValidity             MeasurementValidity            OPTIONAL,
  reportCriteria                  IntraFreqReportCriteria       OPTIONAL
}

IODE ::= INTEGER (0..255)

IP-Length ::= ENUMERATED {
  ip15, ip110 }

IP-Spacing ::= ENUMERATED {
  e5, e7, e10, e15, e20,
  e30, e40, e50 }

```

```

IS-2000SpecificMeasInfo ::=          ENUMERATED {
                                        frequency, timeslot, colourcode,
                                        outputpower, pn-Offset }

MaxNumberOfReportingCellsType1 ::=   ENUMERATED {
                                        e1, e2, e3, e4, e5, e6}

MaxNumberOfReportingCellsType2 ::=   ENUMERATED {
                                        e1, e2, e3, e4, e5, e6, e7, e8, e9, e10, e11, e12}

MaxNumberOfReportingCellsType3 ::=   ENUMERATED {
                                        viactCellsPlus1,
                                        viactCellsPlus2,
                                        viactCellsPlus3,
                                        viactCellsPlus4,
                                        viactCellsPlus5,
                                        viactCellsPlus6 }

MaxReportedCellsOnRACH ::=          ENUMERATED {
                                        noReport,
                                        currentCell,
                                        currentAnd-1-BestNeighbour,
                                        currentAnd-2-BestNeighbour,
                                        currentAnd-3-BestNeighbour,
                                        currentAnd-4-BestNeighbour,
                                        currentAnd-5-BestNeighbour,
                                        currentAnd-6-BestNeighbour }

MeasuredResults ::=                  CHOICE {
    intraFreqMeasuredResultsList      IntraFreqMeasuredResultsList,
    interFreqMeasuredResultsList      InterFreqMeasuredResultsList,
    interRATMeasuredResultsList      InterRATMeasuredResultsList,
    trafficVolumeMeasuredResultsList  TrafficVolumeMeasuredResultsList,
    qualityMeasuredResults            QualityMeasuredResults,
    ue-InternalMeasuredResults        UE-InternalMeasuredResults,
    ue-positioning-MeasuredResults    UE-Positioning-MeasuredResults
}

MeasuredResultsList ::=              SEQUENCE (SIZE (1..maxAdditionalMeas)) OF
                                        MeasuredResults

MeasuredResultsOnRACH ::=            SEQUENCE {
    currentCell                        SEQUENCE {
        modeSpecificInfo              CHOICE {
            fdd                        SEQUENCE {
                measurementQuantity    CHOICE {
                    cpich-Ec-N0        CPICH-Ec-N0,
                    cpich-RSCP         CPICH-RSCP,
                    pathloss           Pathloss
                }
            },
            tdd                        SEQUENCE {
                timeslotISCP           TimeslotISCP-List      OPTIONAL,
                primaryCCPCH-RSCP     PrimaryCCPCH-RSCP    OPTIONAL
            }
        },
        monitoredCells                MonitoredCellRACH-List    OPTIONAL
    }

MeasurementCommand ::=              CHOICE {
    setup                              MeasurementType,
    modify                              SEQUENCE {
        measurementType              MeasurementType      OPTIONAL
    },
    release                              NULL
}

MeasurementControlSysInfo ::=       SEQUENCE {
    use-of-HCS                          CHOICE {
        hcs-not-used                  SEQUENCE {
            cellSelectQualityMeasure  CHOICE {
                cpich-RSCP            SEQUENCE {
                    intraFreqMeasurementSysInfo    IntraFreqMeasurementSysInfo-RSCP
                }
            },
            interFreqMeasurementSysInfo    InterFreqMeasurementSysInfo-RSCP    OPTIONAL
        },
    },
}

```

```

        cpich-Ec-NO          SEQUENCE {
OPTIONAL,      intraFreqMeasurementSysInfo      IntraFreqMeasurementSysInfo-ECNO
        },
        interFreqMeasurementSysInfo      InterFreqMeasurementSysInfo-ECNO      OPTIONAL
    },
    },
    interRATMeasurementSysInfo      InterRATMeasurementSysInfo-B      OPTIONAL
},
hcs-used
cellSelectQualityMeasure      SEQUENCE {
    cpich-RSCP          SEQUENCE {
OPTIONAL,      intraFreqMeasurementSysInfo      IntraFreqMeasurementSysInfo-HCS-RSCP
OPTIONAL      interFreqMeasurementSysInfo      InterFreqMeasurementSysInfo-HCS-RSCP
    },
    cpich-Ec-NO          SEQUENCE {
OPTIONAL,      intraFreqMeasurementSysInfo      IntraFreqMeasurementSysInfo-HCS-ECNO
OPTIONAL      interFreqMeasurementSysInfo      InterFreqMeasurementSysInfo-HCS-ECNO
    },
    interRATMeasurementSysInfo      InterRATMeasurementSysInfo      OPTIONAL
},
},
},
trafficVolumeMeasSysInfo      TrafficVolumeMeasSysInfo      OPTIONAL,
ue-InternalMeasurementSysInfo      UE-InternalMeasurementSysInfo      OPTIONAL
}

MeasurementIdentity ::=      INTEGER (1..16)

MeasurementQuantityGSM ::=      ENUMERATED {
    gsm-CarrierRSSI,
    dummy }

MeasurementReportingMode ::=      SEQUENCE {
    measurementReportTransferMode      TransferMode,
    periodicalOrEventTrigger          PeriodicalOrEventTrigger
}

MeasurementType ::=      CHOICE {
    intraFrequencyMeasurement          IntraFrequencyMeasurement,
    interFrequencyMeasurement          InterFrequencyMeasurement,
    interRATMeasurement                InterRATMeasurement,
    ue-positioning-Measurement          UE-Positioning-Measurement,
    trafficVolumeMeasurement           TrafficVolumeMeasurement,
    qualityMeasurement                 QualityMeasurement,
    ue-InternalMeasurement             UE-InternalMeasurement
}

MeasurementValidity ::=      SEQUENCE {
    ue-State                          ENUMERATED {
        cell-DCH, all-But-Cell-DCH, all-States }
}

MonitoredCellRACH-List ::=      SEQUENCE (SIZE (1..7)) OF
    MonitoredCellRACH-Result

MonitoredCellRACH-Result ::=      SEQUENCE {
    sfn-SFN-ObsTimeDifference          SFN-SFN-ObsTimeDifference      OPTIONAL,
    modeSpecificInfo                  CHOICE {
        fdd                          SEQUENCE {
            primaryCPICH-Info          PrimaryCPICH-Info,
            measurementQuantity        CHOICE {
                cpich-Ec-NO            CPICH-Ec-NO,
                cpich-RSCP            CPICH-RSCP,
                pathloss                Pathloss
            }
        },
        tdd                          SEQUENCE {
            cellParametersID            CellParametersID,
            primaryCCPCH-RSCP          PrimaryCCPCH-RSCP
        }
    }
}

MultipathIndicator ::=      ENUMERATED {

```

```

        nm,
        low,
        medium,
        high }

N-CR-T-CRMaxHyst ::= SEQUENCE {
    n-CR          INTEGER (1..16)          DEFAULT 8,
    t-CRMaxHyst   T-CRMaxHyst
}

NavigationModelSatInfo ::= SEQUENCE {
    satID          SatID,
    satelliteStatus SatelliteStatus,
    ephemerisParameter EphemerisParameter OPTIONAL
}

NavigationModelSatInfoList ::= SEQUENCE (SIZE (1..maxSat)) OF
    NavigationModelSatInfo

EphemerisParameter ::= SEQUENCE {
    codeOnL2       BIT STRING (SIZE (2)),
    uraIndex       BIT STRING (SIZE (4)),
    satHealth      BIT STRING (SIZE (6)),
    iodc           BIT STRING (SIZE (10)),
    l2Pflag        BIT STRING (SIZE (1)),
    sflRevd        SubFrameReserved,
    t-GD           BIT STRING (SIZE (8)),
    t-oc           BIT STRING (SIZE (16)),
    af2            BIT STRING (SIZE (8)),
    af1            BIT STRING (SIZE (16)),
    af0            BIT STRING (SIZE (22)),
    c-rs           BIT STRING (SIZE (16)),
    delta-n        BIT STRING (SIZE (16)),
    m0             BIT STRING (SIZE (32)),
    c-uc           BIT STRING (SIZE (16)),
    e              BIT STRING (SIZE (32)),
    c-us           BIT STRING (SIZE (16)),
    a-Sqrt         BIT STRING (SIZE (32)),
    t-oe           BIT STRING (SIZE (16)),
    fitInterval    BIT STRING (SIZE (1)),
    aodo           BIT STRING (SIZE (5)),
    c-ic           BIT STRING (SIZE (16)),
    omega0         BIT STRING (SIZE (32)),
    c-is           BIT STRING (SIZE (16)),
    i0             BIT STRING (SIZE (32)),
    c-rc           BIT STRING (SIZE (16)),
    omega          BIT STRING (SIZE (32)),
    omegaDot       BIT STRING (SIZE (24)),
    iDot          BIT STRING (SIZE (14))
}

NC-Mode ::= BIT STRING (SIZE (3))

Neighbour ::= SEQUENCE {
    modeSpecificInfo CHOICE {
        fdd SEQUENCE {
            neighbourIdentity PrimaryCPICH-Info OPTIONAL,
            ue-RX-TX-TimeDifferenceType2Info UE-RX-TX-TimeDifferenceType2Info OPTIONAL
        },
        tdd SEQUENCE {
            neighbourAndChannelIdentity CellAndChannelIdentity OPTIONAL
        }
    },
    neighbourQuality NeighbourQuality,
    sfn-SFN-ObsTimeDifference2 SFN-SFN-ObsTimeDifference2
}

NeighbourList ::= SEQUENCE (SIZE (1..maxCellMeas)) OF
    Neighbour

NeighbourQuality ::= SEQUENCE {
    ue-Positioning-OTDOA-Quality UE-Positioning-OTDOA-Quality
}

NewInterFreqCell ::= SEQUENCE {
    interFreqCellID InterFreqCellID OPTIONAL,
    frequencyInfo FrequencyInfo OPTIONAL,
    cellInfo CellInfo
}

```

```

NewInterFreqCellList ::=          SEQUENCE (SIZE (1..maxCellMeas)) OF
                                   NewInterFreqCell

NewInterFreqCellSI-RSCP ::=      SEQUENCE {
    interFreqCellID                InterFreqCellID                OPTIONAL,
    frequencyInfo                   FrequencyInfo                       OPTIONAL,
    cellInfo                         CellInfoSI-RSCP
}

NewInterFreqCellSI-ECN0 ::=      SEQUENCE {
    interFreqCellID                InterFreqCellID                OPTIONAL,
    frequencyInfo                   FrequencyInfo                       OPTIONAL,
    cellInfo                         CellInfoSI-ECN0
}

NewInterFreqCellSI-HCS-RSCP ::=  SEQUENCE {
    interFreqCellID                InterFreqCellID                OPTIONAL,
    frequencyInfo                   FrequencyInfo                       OPTIONAL,
    cellInfo                         CellInfoSI-HCS-RSCP
}

NewInterFreqCellSI-HCS-ECN0 ::=  SEQUENCE {
    interFreqCellID                InterFreqCellID                OPTIONAL,
    frequencyInfo                   FrequencyInfo                       OPTIONAL,
    cellInfo                         CellInfoSI-HCS-ECN0
}

NewInterFreqCellSI-List-ECN0 ::= SEQUENCE (SIZE (1..maxCellMeas)) OF
                                   NewInterFreqCellSI-ECN0

NewInterFreqCellSI-List-HCS-RSCP ::= SEQUENCE (SIZE (1..maxCellMeas)) OF
                                       NewInterFreqCellSI-HCS-RSCP

NewInterFreqCellSI-List-HCS-ECN0 ::= SEQUENCE (SIZE (1..maxCellMeas)) OF
                                       NewInterFreqCellSI-HCS-ECN0

NewInterFreqCellSI-List-RSCP ::=  SEQUENCE (SIZE (1..maxCellMeas)) OF
                                   NewInterFreqCellSI-RSCP

NewInterRATCell ::=              SEQUENCE {
    interRATCellID                  InterRATCellID                  OPTIONAL,
    technologySpecificInfo          CHOICE {
        gsm                         SEQUENCE {
            cellSelectionReselectionInfo CellSelectReselectInfoSIB-11-12 OPTIONAL,
            interRATCellIndividualOffset InterRATCellIndividualOffset,
            bsic                      BSIC,
            frequency-band             Frequency-Band,
            bcch-ARFCN                 BCCH-ARFCN,
            dummy                       NULL                               OPTIONAL
        },
        is-2000                      SEQUENCE {
            is-2000SpecificMeasInfo    IS-2000SpecificMeasInfo
        },
        spare1                         NULL,
        spare2                         NULL
    }
}

NewInterRATCell-B ::=           SEQUENCE {
    interRATCellID                  InterRATCellID                  OPTIONAL,
    technologySpecificInfo          CHOICE {
        gsm                         SEQUENCE {
            cellSelectionReselectionInfo CellSelectReselectInfoSIB-11-12 OPTIONAL,
            interRATCellIndividualOffset InterRATCellIndividualOffset,
            bsic                      BSIC,
            frequency-band             Frequency-Band,
            bcch-ARFCN                 BCCH-ARFCN,
            dummy                       NULL                               OPTIONAL
        },
        is-2000                      SEQUENCE {
            is-2000SpecificMeasInfo    IS-2000SpecificMeasInfo
        },
        spare1                         NULL,
        spare2                         NULL
    }
}

```

```

NewInterRATCellList ::=          SEQUENCE (SIZE (1..maxCellMeas)) OF
                                  NewInterRATCell

NewInterRATCellList-B ::=        SEQUENCE (SIZE (1..maxCellMeas)) OF
                                  NewInterRATCell-B

NewIntraFreqCell ::=             SEQUENCE {
    intraFreqCellID              IntraFreqCellID          OPTIONAL,
    cellInfo                      CellInfo
}

NewIntraFreqCellList ::=         SEQUENCE (SIZE (1..maxCellMeas)) OF
                                  NewIntraFreqCell

NewIntraFreqCellSI-RSCP ::=      SEQUENCE {
    intraFreqCellID              IntraFreqCellID          OPTIONAL,
    cellInfo                      CellInfoSI-RSCP
}

NewIntraFreqCellSI-ECN0 ::=      SEQUENCE {
    intraFreqCellID              IntraFreqCellID          OPTIONAL,
    cellInfo                      CellInfoSI-ECN0
}

NewIntraFreqCellSI-HCS-RSCP ::=  SEQUENCE {
    intraFreqCellID              IntraFreqCellID          OPTIONAL,
    cellInfo                      CellInfoSI-HCS-RSCP
}

NewIntraFreqCellSI-HCS-ECN0 ::= SEQUENCE {
    intraFreqCellID              IntraFreqCellID          OPTIONAL,
    cellInfo                      CellInfoSI-HCS-ECN0
}

NewIntraFreqCellSI-List-RSCP ::= SEQUENCE (SIZE (1..maxCellMeas)) OF
                                  NewIntraFreqCellSI-RSCP

NewIntraFreqCellSI-List-ECN0 ::= SEQUENCE (SIZE (1..maxCellMeas)) OF
                                  NewIntraFreqCellSI-ECN0

NewIntraFreqCellSI-List-HCS-RSCP ::= SEQUENCE (SIZE (1..maxCellMeas)) OF
                                  NewIntraFreqCellSI-HCS-RSCP

NewIntraFreqCellSI-List-HCS-ECN0 ::= SEQUENCE (SIZE (1..maxCellMeas)) OF
                                  NewIntraFreqCellSI-HCS-ECN0

-- Actual value = IE value * 0.0125 - 0.09375
NodeB-ClockDrift ::=            INTEGER (0..15)

NonUsedFreqParameter ::=        SEQUENCE {
    nonUsedFreqThreshold          Threshold,
    -- IE "nonUsedFreqThreshold" is not needed in case of event 2a
    -- In case of event 2a UTRAN should include value 0 within IE "nonUsedFreqThreshold"
    -- In case of event 2a, the UE shall be ignore IE "nonUsedFreqThreshold"
    -- In later versions of the message including this IE, a special version of
    -- IE "NonUsedFreqParameterList" may be defined for event 2a, namely a
    -- version not including IE "nonUsedFreqThreshold"
    nonUsedFreqW                  W
}

NonUsedFreqParameterList ::=    SEQUENCE (SIZE (1..maxFreq)) OF
                                  NonUsedFreqParameter

ObservedTimeDifferenceToGSM ::=  INTEGER (0..4095)

OTDOA-SearchWindowSize ::=      ENUMERATED {
    c20, c40, c80, c160, c320,
    c640, c1280, moreThan1280 }

Pathloss ::=                     INTEGER (46..158)

PenaltyTime-RSCP ::=            CHOICE {
    notUsed                       NULL,
    pt10                          TemporaryOffset1,
    pt20                          TemporaryOffset1,
    pt30                          TemporaryOffset1,
    pt40                          TemporaryOffset1,
    pt50                          TemporaryOffset1,
    pt60                          TemporaryOffset1
}

```

```

}

PenaltyTime-ECNO ::= CHOICE {
    notUsed
    pt10
    pt20
    pt30
    pt40
    pt50
    pt60
    TemporaryOffsetList
}

PendingTimeAfterTrigger ::= ENUMERATED {
    ptat0-25, ptat0-5, ptat1,
    ptat2, ptat4, ptat8, ptat16 }

PeriodicalOrEventTrigger ::= ENUMERATED {
    periodical,
    eventTrigger }

PeriodicalReportingCriteria ::= SEQUENCE {
    reportingAmount
    reportingInterval
    ReportingAmountLong
    ReportingIntervalLong
    ReportingAmount
    ReportingIntervalLong
    DEFAULT ra-Infinity,
}

PeriodicalWithReportingCellStatus ::= SEQUENCE {
    periodicalReportingCriteria
    reportingCellStatus
    PeriodicalReportingCriteria,
    ReportingCellStatus
    OPTIONAL
}

PLMNIdentitiesOfNeighbourCells ::= SEQUENCE {
    plmnsOfIntraFreqCellsList
    plmnsOfInterFreqCellsList
    plmnsOfInterRATCellsList
    PLMNsOfIntraFreqCellsList
    PLMNsOfInterFreqCellsList
    PLMNsOfInterRATCellsList
    OPTIONAL,
    OPTIONAL,
    OPTIONAL
}

PLMNsOfInterFreqCellsList ::= SEQUENCE (SIZE (1..maxCellMeas)) OF
    SEQUENCE {
        plmn-Identity
        PLMN-Identity
        OPTIONAL
    }

PLMNsOfIntraFreqCellsList ::= SEQUENCE (SIZE (1..maxCellMeas)) OF
    SEQUENCE {
        plmn-Identity
        PLMN-Identity
        OPTIONAL
    }

PLMNsOfInterRATCellsList ::= SEQUENCE (SIZE (1..maxCellMeas)) OF
    SEQUENCE {
        plmn-Identity
        PLMN-Identity
        OPTIONAL
    }

PositionEstimate ::= CHOICE {
    ellipsoidPoint
    ellipsoidPointUncertCircle
    ellipsoidPointUncertEllipse
    ellipsoidPointAltitude
    ellipsoidPointAltitudeEllipse
    EllipsoidPoint,
    EllipsoidPointUncertCircle,
    EllipsoidPointUncertEllipse,
    EllipsoidPointAltitude,
    EllipsoidPointAltitudeEllipsoide
}

PositioningMethod ::= ENUMERATED {
    otdoa,
    gps,
    otdoaOrGPS, cellID }

-- Actual value = IE value * 0.32
PRC ::= INTEGER (-2047..2047)

PrimaryCCPCH-RSCP ::= INTEGER (0..91)

Q-HCS ::= INTEGER (0..99)

Q-OffsetS-N ::= INTEGER (-50..50)

Q-QualMin ::= INTEGER (-24..0)

-- Actual value = (IE value * 2) + 1
Q-RxlevMin ::= INTEGER (-58..-13)

```



```

QualityEventResults ::= SEQUENCE (SIZE (1..maxTrCH)) OF
    TransportChannelIdentity

QualityMeasuredResults ::= SEQUENCE {
    blerMeasurementResultsList BLER-MeasurementResultsList OPTIONAL,
    modeSpecificInfo CHOICE {
        fdd NULL,
        tdd SEQUENCE {
            sir-MeasurementResults SIR-MeasurementList OPTIONAL
        }
    }
}

QualityMeasurement ::= SEQUENCE {
    qualityReportingQuantity QualityReportingQuantity OPTIONAL,
    reportCriteria QualityReportCriteria
}

QualityReportCriteria ::= CHOICE {
    qualityReportingCriteria QualityReportingCriteria,
    periodicalReportingCriteria PeriodicalReportingCriteria,
    noReporting NULL
}

QualityReportingCriteria ::= SEQUENCE (SIZE (1..maxTrCH)) OF
    QualityReportingCriteriaSingle

QualityReportingCriteriaSingle ::= SEQUENCE {
    transportChannelIdentity TransportChannelIdentity,
    totalCRC INTEGER (1..512),
    badCRC INTEGER (1..512),
    pendingAfterTrigger INTEGER (1..512)
}

QualityReportingQuantity ::= SEQUENCE {
    dl-TransChBLER BOOLEAN,
    bler-dl-TransChIdList BLER-TransChIdList OPTIONAL,
    modeSpecificInfo CHOICE {
        fdd NULL,
        tdd SEQUENCE {
            sir-TFCS-List SIR-TFCS-List OPTIONAL
        }
    }
}

RAT-Type ::= ENUMERATED {
    gsm, is2000 }

ReferenceCellPosition ::= CHOICE {
    ellipsoidPoint EllipsoidPoint,
    ellipsoidPointWithAltitude EllipsoidPointAltitude
}

-- As defined in 23.032
ReferenceLocation ::= SEQUENCE {
    ellipsoidPointAltitudeEllipsoide EllipsoidPointAltitudeEllipsoide
}

ReferenceSFN ::= INTEGER (0..4095)

ReferenceTimeDifferenceToCell ::= CHOICE {
    -- Actual value = IE value * 40
    accuracy40 INTEGER (0..960),
    -- Actual value = IE value * 256
    accuracy256 INTEGER (0..150),
    -- Actual value = IE value * 2560
    accuracy2560 INTEGER (0..15)
}

RemovedInterFreqCellList ::= CHOICE {
    removeAllInterFreqCells NULL,
    removeSomeInterFreqCells SEQUENCE (SIZE (1..maxCellMeas)) OF
        InterFreqCellID,
    removeNoInterFreqCells NULL
}

```

```

RemovedInterRATCellList ::= CHOICE {
    removeAllInterRATCells      NULL,
    removeSomeInterRATCells    SEQUENCE (SIZE (1..maxCellMeas)) OF
                                InterRATCellID,
    removeNoInterRATCells      NULL
}

RemovedIntraFreqCellList ::= CHOICE {
    removeAllIntraFreqCells     NULL,
    removeSomeIntraFreqCells   SEQUENCE (SIZE (1..maxCellMeas)) OF
                                IntraFreqCellID,
    removeNoIntraFreqCells     NULL
}

ReplacementActivationThreshold ::= ENUMERATED {
    notApplicable, t1, t2,
    t3, t4, t5, t6, t7 }

ReportDeactivationThreshold ::= ENUMERATED {
    notApplicable, t1, t2,
    t3, t4, t5, t6, t7 }

ReportingAmount ::= ENUMERATED {
    ra1, ra2, ra4, ra8, ra16, ra32,
    ra64, ra-Infinity }

ReportingCellStatus ::= CHOICE{
    withinActiveSet              MaxNumberOfReportingCellsType1,
    withinMonitoredSetUsedFreq   MaxNumberOfReportingCellsType1,
    withinActiveAndOrMonitoredUsedFreq MaxNumberOfReportingCellsType1,
    withinDetectedSetUsedFreq    MaxNumberOfReportingCellsType1,
    withinMonitoredAndOrDetectedUsedFreq
                                MaxNumberOfReportingCellsType1,
    allActiveplusMonitoredSet    MaxNumberOfReportingCellsType3,
    allActivePlusDetectedSet     MaxNumberOfReportingCellsType3,
    allActivePlusMonitoredAndOrDetectedSet
                                MaxNumberOfReportingCellsType3,
    withinVirtualActSet          MaxNumberOfReportingCellsType1,
    withinMonitoredSetNonUsedFreq MaxNumberOfReportingCellsType1,
    withinMonitoredAndOrVirtualActiveSetNonUsedFreq
                                MaxNumberOfReportingCellsType1,
    allVirtualActSetplusMonitoredSetNonUsedFreq
                                MaxNumberOfReportingCellsType3,
    withinActSetOrVirtualActSet-InterRATcells
                                MaxNumberOfReportingCellsType2,
    withinActSetAndOrMonitoredUsedFreqOrVirtualActSetAndOrMonitoredNonUsedFreq
                                MaxNumberOfReportingCellsType2
}

ReportingCellStatusOpt ::= SEQUENCE {
    reportingCellStatus          ReportingCellStatus          OPTIONAL
}

ReportingInfoForCellDCH ::= SEQUENCE {
    intraFreqReportingQuantity   IntraFreqReportingQuantity,
    measurementReportingMode     MeasurementReportingMode,
    reportCriteria               CellDCH-ReportCriteria
}

ReportingInterval ::= ENUMERATED {
    noPeriodicalreporting, ri0-25,
    ri0-5, ri1, ri2, ri4, ri8, ri16 }

ReportingIntervalLong ::= ENUMERATED {
    ril0, ril0-25, ril0-5, ril1,
    ril2, ril3, ril4, ril6, ril8,
    ril12, ril16, ril20, ril24,
    ril28, ril32, ril64 }

-- Actual value = IE value * 0.5
ReportingRange ::= INTEGER (0..29)

RL-AdditionInfoList ::= SEQUENCE (SIZE (1..maxRL)) OF
    PrimaryCPICH-Info

RL-InformationLists ::= SEQUENCE {
    rl-AdditionInfoList          RL-AdditionInfoList          OPTIONAL,

```

```

    rl-RemovalInformationList          RL-RemovalInformationList          OPTIONAL
  }

RLC-BuffersPayload ::=
    ENUMERATED {
        pl0, pl4, pl8, pl16, pl32, pl64, pl128,
        pl256, pl512, pl1024, pl2k, pl4k,
        pl8k, pl16k, pl32k, pl64k, pl128k,
        pl256k, pl512k, pl1024k }

-- Actual value = IE value * 0.032
RRC ::=
    INTEGER (-127..127)

SatData ::=
    SEQUENCE {
        satID          SatID,
        iode           IOE
    }

SatDataList ::=
    SEQUENCE (SIZE (0..maxSat)) OF
        SatData

SatelliteStatus ::=
    ENUMERATED {
        ns-NN-U,
        es-SN,
        es-NN-U,
        rev2,
        rev }

SatID ::=
    INTEGER (0..63)

SFN-SFN-Drift ::=
    ENUMERATED {
        no-drift, sfnsfndrift0-33, sfnsfndrift0-66,
        sfnsfndrift1, sfnsfndrift1-33, sfnsfndrift1-66,
        sfnsfndrift2, sfnsfndrift2-5, sfnsfndrift3,
        sfnsfndrift4, sfnsfndrift5, sfnsfndrift7,
        sfnsfndrift9, sfnsfndrift11, sfnsfndrift13,
        sfnsfndrift15, sfnsfndrift-0-33, sfnsfndrift-0-66,
        sfnsfndrift-1, sfnsfndrift-1-33, sfnsfndrift-1-66,
        sfnsfndrift-2, sfnsfndrift-2-5, sfnsfndrift-3,
        sfnsfndrift-4, sfnsfndrift-5, sfnsfndrift-7,
        sfnsfndrift-9, sfnsfndrift-11, sfnsfndrift-13,
        sfnsfndrift-15 }

SFN-SFN-ObsTimeDifference ::=
    CHOICE {
        type1          SFN-SFN-ObsTimeDifference1,
        type2          SFN-SFN-ObsTimeDifference2
    }

SFN-SFN-ObsTimeDifference1 ::=
    INTEGER (0..9830399)

SFN-SFN-ObsTimeDifference2 ::=
    INTEGER (0..40961)

SFN-SFN-OTD-Type ::=
    ENUMERATED {
        noReport,
        type1,
        type2 }

SFN-SFN-RelTimeDifference1 ::=
    SEQUENCE {
        sfn-Offset          INTEGER (0 .. 4095),
        sfn-sfn-ReltimeDifference
        INTEGER (0.. 38399)
    }

SFN-TOW-Uncertainty ::=
    ENUMERATED {
        lessThan10,
        moreThan10 }

SIR ::=
    INTEGER (0..63)

SIR-MeasurementList ::=
    SEQUENCE (SIZE (1..maxCCTrCH)) OF
        SIR-MeasurementResults

SIR-MeasurementResults ::=
    SEQUENCE {
        tfcs-ID          TFCS-IdentityPlain,
        sir-TimeslotList
        SIR-TimeslotList
    }

SIR-TFCS ::=
    TFCS-IdentityPlain

```

```

SIR-TFCS-List ::=                               SEQUENCE (SIZE (1..maxCCTrCH)) OF
                                                SIR-TFCS

SIR-TimeslotList ::=                           SEQUENCE (SIZE (1..maxTS)) OF
                                                SIR

-- Reserved bits in subframe 1 of the GPS navigation message
SubFrame1Reserved ::=                          SEQUENCE {
    reserved1                                BIT STRING (SIZE (23)),
    reserved2                                BIT STRING (SIZE (24)),
    reserved3                                BIT STRING (SIZE (24)),
    reserved4                                BIT STRING (SIZE (16))
}

T-CRMax ::=                                    CHOICE {
    notUsed                                  NULL,
    t30                                      N-CR-T-CRMaxHyst,
    t60                                      N-CR-T-CRMaxHyst,
    t120                                    N-CR-T-CRMaxHyst,
    t180                                    N-CR-T-CRMaxHyst,
    t240                                    N-CR-T-CRMaxHyst
}

T-CRMaxHyst ::=                                ENUMERATED {
    notUsed, t10, t20, t30,
    t40, t50, t60, t70 }

TemporaryOffset1 ::=                          ENUMERATED {
    to3, to6, to9, to12, to15,
    to18, to21, infinite }

TemporaryOffset2 ::=                          ENUMERATED {
    to2, to3, to4, to6, to8,
    to10, to12, infinite }

TemporaryOffsetList ::=                      SEQUENCE {
    temporaryOffset1
    temporaryOffset2
}

Threshold ::=                                 INTEGER (-115..0)

ThresholdPositionChange ::=                  ENUMERATED {
    pc10, pc20, pc30, pc40, pc50,
    pc100, pc200, pc300, pc500,
    pc1000, pc2000, pc5000, pc10000,
    pc20000, pc50000, pc100000 }

ThresholdSFN-GPS-TOW ::=                    ENUMERATED {
    ms1, ms2, ms3, ms5, ms10,
    ms20, ms50, ms100 }

ThresholdSFN-SFN-Change ::=                 ENUMERATED {
    c0-25, c0-5, c1, c2, c3, c4, c5,
    c10, c20, c50, c100, c200, c500,
    c1000, c2000, c5000 }

ThresholdUsedFrequency ::=                  INTEGER (-115..165)

-- Actual value = IE value * 20.
TimeInterval ::=                             INTEGER (1..13)

TimeslotInfo ::=                             SEQUENCE {
    timeslotNumber
    burstType
}

TimeslotInfoList ::=                        SEQUENCE (SIZE (1..maxTS)) OF
                                                TimeslotInfo

TimeslotISCP ::=                             INTEGER (0..91)

TimeslotISCP-List ::=                       SEQUENCE (SIZE (1..maxTS)) OF

```

```

TimeslotISCP

TimeslotListWithISCP ::= SEQUENCE (SIZE (1..maxTS)) OF
                          TimeslotWithISCP

TimeslotWithISCP ::= SEQUENCE {
  timeslot                TimeslotNumber,
  timeslotISCP            TimeslotISCP
}

TimeToTrigger ::= ENUMERATED {
  ttt0, ttt10, ttt20, ttt40, ttt60,
  ttt80, ttt100, ttt120, ttt160,
  ttt200, ttt240, ttt320, ttt640,
  ttt1280, ttt2560, ttt5000 }

TrafficVolumeEventParam ::= SEQUENCE {
  eventID                TrafficVolumeEventType,
  reportingThreshold     TrafficVolumeThreshold,
  timeToTrigger          TimeToTrigger                OPTIONAL,
  pendingTimeAfterTrigger PendingTimeAfterTrigger   OPTIONAL,
  tx-InterruptionAfterTrigger TX-InterruptionAfterTrigger OPTIONAL
}

TrafficVolumeEventResults ::= SEQUENCE {
  ul-transportChannelCausingEvent UL-TrCH-Identity,
  trafficVolumeEventIdentity     TrafficVolumeEventType
}

TrafficVolumeEventType ::= ENUMERATED {
  e4a,
  e4b }

TrafficVolumeMeasQuantity ::= CHOICE {
  rlc-BufferPayload      NULL,
  averageRLC-BufferPayload TimeInterval,
  varianceOfRLC-BufferPayload TimeInterval
}

TrafficVolumeMeasSysInfo ::= SEQUENCE {
  trafficVolumeMeasurementID MeasurementIdentity          DEFAULT 4,
  trafficVolumeMeasurementObjectList TrafficVolumeMeasurementObjectList OPTIONAL,
  trafficVolumeMeasQuantity TrafficVolumeMeasQuantity          OPTIONAL,
  trafficVolumeReportingQuantity TrafficVolumeReportingQuantity OPTIONAL,
  dummy                    TrafficVolumeReportingCriteria      OPTIONAL,
  -- Above IE is not used in this version of protocol
  measurementValidity      MeasurementValidity                OPTIONAL,
  measurementReportingMode MeasurementReportingMode,
  reportCriteriaSysInf     TrafficVolumeReportCriteriaSysInfo
}

TrafficVolumeMeasuredResults ::= SEQUENCE {
  rb-Identity            RB-Identity,
  rlc-BuffersPayload     RLC-BuffersPayload                OPTIONAL,
  averageRLC-BufferPayload AverageRLC-BufferPayload          OPTIONAL,
  varianceOfRLC-BufferPayload VarianceOfRLC-BufferPayload      OPTIONAL
}

TrafficVolumeMeasuredResultsList ::= SEQUENCE (SIZE (1..maxRB)) OF
  TrafficVolumeMeasuredResults

TrafficVolumeMeasurement ::= SEQUENCE {
  trafficVolumeMeasurementObjectList TrafficVolumeMeasurementObjectList OPTIONAL,
  trafficVolumeMeasQuantity          TrafficVolumeMeasQuantity          OPTIONAL,
  trafficVolumeReportingQuantity     TrafficVolumeReportingQuantity     OPTIONAL,
  measurementValidity                MeasurementValidity                OPTIONAL,
  reportCriteria                     TrafficVolumeReportCriteria
}

TrafficVolumeMeasurementObjectList ::= SEQUENCE (SIZE (1..maxTrCH)) OF
  UL-TrCH-Identity

TrafficVolumeReportCriteria ::= CHOICE {
  trafficVolumeReportingCriteria TrafficVolumeReportingCriteria,
  periodicalReportingCriteria    PeriodicalReportingCriteria,
  noReporting                     NULL
}

```

```

TrafficVolumeReportCriteriaSysInfo ::= CHOICE {
    trafficVolumeReportingCriteria    TrafficVolumeReportingCriteria,
    periodicalReportingCriteria       PeriodicalReportingCriteria
}

TrafficVolumeReportingCriteria ::= SEQUENCE {
    transChCriteriaList                TransChCriteriaList                OPTIONAL
}

TrafficVolumeReportingQuantity ::= SEQUENCE {
    rlc-RB-BufferPayload               BOOLEAN,
    rlc-RB-BufferPayloadAverage        BOOLEAN,
    rlc-RB-BufferPayloadVariance       BOOLEAN
}

TrafficVolumeThreshold ::=
    ENUMERATED {
        th8, th16, th32, th64, th128,
        th256, th512, th1024, th2k, th3k,
        th4k, th6k, th8k, th12k, th16k,
        th24k, th32k, th48k, th64k, th96k,
        th128k, th192k, th256k, th384k,
        th512k, th768k
    }

TransChCriteria ::=
    SEQUENCE {
        ul-transportChannelID          UL-TrCH-Identity                OPTIONAL,
        eventSpecificParameters        SEQUENCE (SIZE (1..maxMeasParEvent)) OF
                                         TrafficVolumeEventParam          OPTIONAL
    }

TransChCriteriaList ::=
    SEQUENCE (SIZE (1..maxTrCH)) OF
        TransChCriteria

TransferMode ::=
    ENUMERATED {
        acknowledgedModeRLC,
        unacknowledgedModeRLC
    }

TransmittedPowerThreshold ::=
    INTEGER (-50..33)

TriggeringCondition1 ::=
    ENUMERATED {
        activeSetCellsOnly,
        monitoredSetCellsOnly,
        activeSetAndMonitoredSetCells
    }

TriggeringCondition2 ::=
    ENUMERATED {
        activeSetCellsOnly,
        monitoredSetCellsOnly,
        activeSetAndMonitoredSetCells,
        detectedSetCellsOnly,
        detectedSetAndMonitoredSetCells
    }

TX-InterruptionAfterTrigger ::=
    ENUMERATED {
        txiat0-25, txiat0-5, txiat1,
        txiat2, txiat4, txiat8, txiat16
    }

UDRE ::=
    ENUMERATED {
        lessThan1,
        between1-and-4,
        between4-and-8,
        over8
    }

UE-6AB-Event ::=
    SEQUENCE {
        timeToTrigger                  TimeToTrigger,
        transmittedPowerThreshold       TransmittedPowerThreshold
    }

UE-6FG-Event ::=
    SEQUENCE {
        timeToTrigger                  TimeToTrigger,
        ue-RX-TX-TimeDifferenceThreshold UE-RX-TX-TimeDifferenceThreshold
    }

UE-AutonomousUpdateMode ::=
    CHOICE {
        on                             NULL,
        onWithNoReporting              NULL,
        off                             RL-InformationLists
    }

UE-InternalEventParam ::=
    CHOICE {

```

```

    event6a          UE-6AB-Event,
    event6b          UE-6AB-Event,
    event6c          TimeToTrigger,
    event6d          TimeToTrigger,
    event6e          TimeToTrigger,
    event6f          UE-6FG-Event,
    event6g          UE-6FG-Event
}

UE-InternalEventParamList ::= SEQUENCE (SIZE (1..maxMeasEvent)) OF
    UE-InternalEventParam

UE-InternalEventResults ::= CHOICE {
    event6a          NULL,
    event6b          NULL,
    event6c          NULL,
    event6d          NULL,
    event6e          NULL,
    event6f          PrimaryCPICH-Info,
    event6g          PrimaryCPICH-Info
}

UE-InternalMeasQuantity ::= SEQUENCE {
    measurementQuantity UE-MeasurementQuantity,
    filterCoefficient   FilterCoefficient           DEFAULT fc0
}

UE-InternalMeasuredResults ::= SEQUENCE {
    modeSpecificInfo CHOICE {
        fdd SEQUENCE {
            ue-TransmittedPowerFDD      UE-TransmittedPower      OPTIONAL,
            ue-RX-TX-ReportEntryList    UE-RX-TX-ReportEntryList  OPTIONAL
        },
        tdd SEQUENCE {
            ue-TransmittedPowerTDD-List  UE-TransmittedPowerTDD-List  OPTIONAL,
            appliedTA                     UL-TimingAdvance           OPTIONAL
        }
    }
}

UE-InternalMeasurement ::= SEQUENCE {
    ue-InternalMeasQuantity      UE-InternalMeasQuantity      OPTIONAL,
    ue-InternalReportingQuantity UE-InternalReportingQuantity  OPTIONAL,
    reportCriteria               UE-InternalReportCriteria
}

UE-InternalMeasurementSysInfo ::= SEQUENCE {
    ue-InternalMeasurementID      MeasurementIdentity          DEFAULT 5,
    ue-InternalMeasQuantity      UE-InternalMeasQuantity
}

UE-InternalReportCriteria ::= CHOICE {
    ue-InternalReportingCriteria  UE-InternalReportingCriteria,
    periodicalReportingCriteria  PeriodicalReportingCriteria,
    noReporting                   NULL
}

UE-InternalReportingCriteria ::= SEQUENCE {
    ue-InternalEventParamList    UE-InternalEventParamList    OPTIONAL
}

UE-InternalReportingQuantity ::= SEQUENCE {
    ue-TransmittedPower          BOOLEAN,
    modeSpecificInfo CHOICE {
        fdd SEQUENCE {
            ue-RX-TX-TimeDifference    BOOLEAN
        },
        tdd SEQUENCE {
            appliedTA                  BOOLEAN
        }
    }
}

-- TABULAR: For TDD only the first two values are used.
UE-MeasurementQuantity ::= ENUMERATED {
    ue-TransmittedPower,
    ultra-Carrier-RSSI,
    ue-RX-TX-TimeDifference }

```

```

UE-RX-TX-ReportEntry ::=          SEQUENCE {
    primaryCPICH-Info              PrimaryCPICH-Info,
    ue-RX-TX-TimeDifferenceType1   UE-RX-TX-TimeDifferenceType1
}

UE-RX-TX-ReportEntryList ::=      SEQUENCE (SIZE (1..maxRL)) OF
    UE-RX-TX-ReportEntry

UE-RX-TX-TimeDifferenceType1 ::=  INTEGER (768..1280)
-- Actual value = IE value * 0.0625 + 768
UE-RX-TX-TimeDifferenceType2 ::=  INTEGER (0..8191)

UE-RX-TX-TimeDifferenceType2Info ::= SEQUENCE {
    ue-RX-TX-TimeDifferenceType2   UE-RX-TX-TimeDifferenceType2,
    neighbourQuality               NeighbourQuality
}

UE-RX-TX-TimeDifferenceThreshold ::= INTEGER (768..1280)

UE-TransmittedPower ::=          INTEGER (0..104)

UE-TransmittedPowerTDD-List ::=  SEQUENCE (SIZE (1..maxTS)) OF
    UE-TransmittedPower

UL-TrCH-Identity ::=            CHOICE{
    dch                            TransportChannelIdentity,
    -- Default transport channel in the UL is either RACH or CPCH, but not both.
    rachorcpch                     NULL,
    usch                            TransportChannelIdentity
}

UE-Positioning-Accuracy ::=      BIT STRING (SIZE (7))

UE-Positioning-CipherParameters ::= SEQUENCE {
    cipheringKeyFlag               BIT STRING (SIZE (1)),
    cipheringSerialNumber          INTEGER (0..65535)
}

UE-Positioning-Error ::=        SEQUENCE {
    errorReason                    UE-Positioning-ErrorCause,
    ue-positioning-GPS-additionalAssistanceDataRequest  UE-Positioning-GPS-
AdditionalAssistanceDataRequest OPTIONAL
}

UE-Positioning-ErrorCause ::=    ENUMERATED {
    notEnoughOTDOA-Cells,
    notEnoughGPS-Satellites,
    assistanceDataMissing,
    methodNotSupported,
    undefinedError,
    requestDeniedByUser,
    notProcessedAndTimeout,
    referenceCellNotServingCell }

UE-Positioning-EventParam ::=    SEQUENCE {
    reportingAmount                ReportingAmount,
    reportFirstFix                 BOOLEAN,
    measurementInterval            UE-Positioning-MeasurementInterval,
    eventSpecificInfo              UE-Positioning-EventSpecificInfo
}

UE-Positioning-EventParamList ::= SEQUENCE (SIZE (1..maxMeasEvent)) OF
    UE-Positioning-EventParam

UE-Positioning-EventSpecificInfo ::= CHOICE {
    e7a                            ThresholdPositionChange,
    e7b                            ThresholdSFN-SFN-Change,
    e7c                            ThresholdSFN-GPS-TOW
}

UE-Positioning-GPS-AcquisitionAssistance ::= SEQUENCE {
    referenceTime                  CHOICE {
        utran-ReferenceTime        UTRAN-ReferenceTime,
        gps-ReferenceTimeOnly      INTEGER (0..604799999)
    },

```



```

    satelliteInformationList      AcquisitionSatInfoList
}

UE-Positioning-GPS-AdditionalAssistanceDataRequest ::= SEQUENCE {
    almanacRequest                BOOLEAN,
    utcModelRequest               BOOLEAN,
    ionosphericModelRequest       BOOLEAN,
    navigationModelRequest        BOOLEAN,
    dgpsCorrectionsRequest        BOOLEAN,
    referenceLocationRequest      BOOLEAN,
    referenceTimeRequest          BOOLEAN,
    aquisitionAssistanceRequest   BOOLEAN,
    realTimeIntegrityRequest      BOOLEAN,
    navModelAddDataRequest        UE-Positioning-GPS-NavModelAddDataReq  OPTIONAL
}

UE-Positioning-GPS-Almanac ::= SEQUENCE {
    wn-a                          BIT STRING (SIZE (8)),
    almanacSatInfoList           AlmanacSatInfoList,
    sv-GlobalHealth              BIT STRING (SIZE (364))  OPTIONAL
}

UE-Positioning-GPS-AssistanceData ::= SEQUENCE {
    ue-positioning-GPS-ReferenceTime      UE-Positioning-GPS-ReferenceTime
    OPTIONAL,
    ue-positioning-GPS-ReferenceLocation  ReferenceLocation  OPTIONAL,
    ue-positioning-GPS-DGPS-Corrections  UE-Positioning-GPS-DGPS-Corrections
    OPTIONAL,
    ue-positioning-GPS-NavigationModel    UE-Positioning-GPS-NavigationModel
    OPTIONAL,
    ue-positioning-GPS-IonosphericModel   UE-Positioning-GPS-IonosphericModel
    OPTIONAL,
    ue-positioning-GPS-UTC-Model          UE-Positioning-GPS-UTC-Model
    OPTIONAL,
    ue-positioning-GPS-Almanac            UE-Positioning-GPS-Almanac
    OPTIONAL,
    ue-positioning-GPS-AcquisitionAssistance  UE-Positioning-GPS-AcquisitionAssistance
    OPTIONAL,
    ue-positioning-GPS-Real-timeIntegrity  BadSatList  OPTIONAL
}

UE-Positioning-GPS-DGPS-Corrections ::= SEQUENCE {
    gps-TOW                        INTEGER (0..604799),
    statusHealth                   DiffCorrectionStatus,
    dgps-CorrectionSatInfoList    DGPS-CorrectionSatInfoList
}

UE-Positioning-GPS-IonosphericModel ::= SEQUENCE {
    alfa0                          BIT STRING (SIZE (8)),
    alfa1                          BIT STRING (SIZE (8)),
    alfa2                          BIT STRING (SIZE (8)),
    alfa3                          BIT STRING (SIZE (8)),
    beta0                          BIT STRING (SIZE (8)),
    beta1                          BIT STRING (SIZE (8)),
    beta2                          BIT STRING (SIZE (8)),
    beta3                          BIT STRING (SIZE (8))
}

UE-Positioning-GPS-MeasurementResults ::= SEQUENCE {
    modeSpecificInfo              CHOICE {
        fdd                       SEQUENCE {
            referenceIdentity      PrimaryCPICH-Info
        },
        tdd                       SEQUENCE {
            referenceIdentity      CellParametersID
        }
    }  OPTIONAL,
    referenceSFN                  ReferenceSFN  OPTIONAL,
    gps-TOW-lmsec                 GPS-TOW-lmsec,
    gps-TOW-rem-usec              GPS-TOW-rem-usec  OPTIONAL,
    gps-MeasurementParamList      GPS-MeasurementParamList
}

UE-Positioning-GPS-NavigationModel ::= SEQUENCE {
    navigationModelSatInfoList    NavigationModelSatInfoList
}

UE-Positioning-GPS-NavModelAddDataReq ::= SEQUENCE {

```

```

gps-Week                INTEGER (0..1023),
gps-Toe                 INTEGER (0..167),
tToeLimit               INTEGER (0..10),
satDataList             SatDataList
}

UE-Positioning-GPS-ReferenceTime ::=
    gps-Week                INTEGER (0..1023),
    gps-tow-lmsec          GPS-TOW-lmsec,
    gps-tow-rem-usec       GPS-TOW-rem-usec                OPTIONAL,
    modeSpecificInfo       CHOICE {
        fdd                 SEQUENCE {
            referenceIdentity PrimaryCPICH-Info
        },
        tdd                 SEQUENCE {
            referenceIdentity CellParametersID
        }
    }
    sfm                    INTEGER (0..4095)                OPTIONAL,
    sfm-tow-Uncertainty    SFN-TOW-Uncertainty              OPTIONAL,
    nodeBClockDrift        NodeB-ClockDrift                 OPTIONAL,
    gps-TOW-AssistList     GPS-TOW-AssistList                OPTIONAL
}

UE-Positioning-GPS-UTC-Model ::=
    a1                     BIT STRING (SIZE (24)),
    a0                     BIT STRING (SIZE (32)),
    t-ot                   BIT STRING (SIZE (8)),
    wn-t                   BIT STRING (SIZE (8)),
    delta-t-LS             BIT STRING (SIZE (8)),
    wn-lsf                 BIT STRING (SIZE (8)),
    dn                     BIT STRING (SIZE (8)),
    delta-t-LSF           BIT STRING (SIZE (8))
}

UE-Positioning-IPDL-Parameters ::=
    ip-Spacing             IP-Spacing,
    ip-Length              IP-Length,
    ip-Offset              INTEGER (0..9),
    seed                   INTEGER (0..63),
    burstModeParameters    BurstModeParameters            OPTIONAL
}

UE-Positioning-MeasuredResults ::=
    ue-positioning-OTDOA-Measurement UE-Positioning-OTDOA-Measurement
    OPTIONAL,
    ue-positioning-PositionEstimateInfo UE-Positioning-PositionEstimateInfo
    OPTIONAL,
    ue-positioning-GPS-Measurement UE-Positioning-GPS-MeasurementResults
    OPTIONAL,
    ue-positioning-Error           UE-Positioning-Error
    OPTIONAL
}

UE-Positioning-Measurement ::=
    ue-positioning-ReportingQuantity UE-Positioning-ReportingQuantity,
    reportCriteria                 UE-Positioning-ReportCriteria,
    ue-positioning-OTDOA-AssistanceData UE-Positioning-OTDOA-AssistanceData
    OPTIONAL,
    ue-positioning-GPS-AssistanceData   UE-Positioning-GPS-AssistanceData
    OPTIONAL
}

UE-Positioning-MeasurementEventResults ::=
    event7a                 UE-Positioning-PositionEstimateInfo,
    event7b                 UE-Positioning-OTDOA-Measurement,
    event7c                 UE-Positioning-GPS-MeasurementResults
}

UE-Positioning-MeasurementInterval ::=
    e5, e15, e60, e300,
    e900, e1800, e3600, e7200 }

UE-Positioning-MethodType ::=
    ue-Assisted,
    ue-Based,
    ue-BasedPreferred,
    ue-AssistedPreferred }

```

```

UE-Positioning-OTDOA-AssistanceData ::= SEQUENCE {
  ue-positioning-OTDOA-ReferenceCellInfo  UE-Positioning-OTDOA-ReferenceCellInfo
  OPTIONAL,
  ue-positioning-OTDOA-NeighbourCellList  UE-Positioning-OTDOA-NeighbourCellList
  OPTIONAL
}

UE-Positioning-OTDOA-Measurement ::= SEQUENCE {
  sfn  INTEGER (0..4095),
  modeSpecificInfo  CHOICE {
    fdd  SEQUENCE {
      referenceCellIdentity  PrimaryCPICH-Info,
      ue-RX-TX-TimeDifferenceType2Info  UE-RX-TX-TimeDifferenceType2Info
    },
    tdd  SEQUENCE {
      referenceCellIdentity  CellParametersID
    }
  },
  neighbourList  NeighbourList  OPTIONAL
}

UE-Positioning-OTDOA-NeighbourCellInfo ::= SEQUENCE {
  modeSpecificInfo  CHOICE {
    fdd  SEQUENCE {
      primaryCPICH-Info  PrimaryCPICH-Info
    },
    tdd  SEQUENCE {
      cellAndChannelIdentity  CellAndChannelIdentity
    }
  },
  frequencyInfo  FrequencyInfo  OPTIONAL,
  ue-positioning-IPDL-Parameters  UE-Positioning-IPDL-Parameters
  OPTIONAL,
  sfn-SFN-RelTimeDifference  SFN-SFN-RelTimeDifference,
  sfn-SFN-Drift  SFN-SFN-Drift  OPTIONAL,
  searchWindowSize  OTDOA-SearchWindowSize,
  positioningMode  CHOICE {
    ueBased  SEQUENCE {
      relativeNorth  INTEGER (-20000..20000)  OPTIONAL,
      relativeEast  INTEGER (-20000..20000)  OPTIONAL,
      relativeAltitude  INTEGER (-4000..4000)  OPTIONAL,
      fineSFN-SFN  FineSFN-SFN,
      -- actual value = (IE value * 0.0625) + 876
      roundTripTime  INTEGER (0.. 32766)  OPTIONAL
    },
    ueAssisted  SEQUENCE {}
  }
}

UE-Positioning-OTDOA-NeighbourCellList ::= SEQUENCE (SIZE (1..maxCellMeas)) OF
  UE-Positioning-OTDOA-NeighbourCellInfo

UE-Positioning-OTDOA-Quality ::= SEQUENCE {
  stdResolution  BIT STRING (SIZE (2)),
  numberOfOTDOA-Measurements  BIT STRING (SIZE (3)),
  stdOfOTDOA-Measurements  BIT STRING (SIZE (5))
}

UE-Positioning-OTDOA-ReferenceCellInfo ::= SEQUENCE {
  sfn  INTEGER (0..4095)
  OPTIONAL,
  modeSpecificInfo  CHOICE {
    fdd  SEQUENCE {
      primaryCPICH-Info  PrimaryCPICH-Info
    },
    tdd  SEQUENCE {
      cellAndChannelIdentity  CellAndChannelIdentity
    }
  },
  frequencyInfo  FrequencyInfo  OPTIONAL,
  positioningMode  CHOICE {
    ueBased  SEQUENCE {
      cellPosition  ReferenceCellPosition  OPTIONAL,
      -- actual value = (IE value * 0.0625) + 876
      roundTripTime  INTEGER (0..32766)  OPTIONAL
    },
    ueAssisted  SEQUENCE {}
  },
}

```

```

    ue-positioning-IPDL-Parameters                UE-Positioning-IPDL-Parameters  OPTIONAL
  }
UE-Positioning-PositionEstimateInfo ::=          SEQUENCE {
  modeSpecificInfo                               CHOICE {
    fdd                                           SEQUENCE {
      referenceIdentity                          PrimaryCPICH-Info
    },
    tdd                                           SEQUENCE {
      referenceIdentity                          CellParametersID
    }
  }
  referenceSFN                                   ReferenceSFN          OPTIONAL,
  gps-tow-lmsec                                  GPS-TOW-lmsec        OPTIONAL,
  gps-tow-rem-usec                              GPS-TOW-rem-usec     OPTIONAL,
  positionEstimate                              PositionEstimate
}

UE-Positioning-ReportCriteria ::=                CHOICE {
  ue-positioning-ReportingCriteria              UE-Positioning-EventParamList,
  periodicalReportingCriteria                  PeriodicalReportingCriteria,
  noReporting                                  NULL
}

UE-Positioning-ReportingQuantity ::=            SEQUENCE {
  methodType                                    UE-Positioning-MethodType,
  positioningMethod                            PositioningMethod,
  responseTime                                  UE-Positioning-ResponseTime,
  accuracy                                      UE-Positioning-Accuracy          OPTIONAL,
  gps-TimingOfCellWanted                       BOOLEAN,
  multipleSets                                  BOOLEAN,
  additionalAssistanceDataRequest              BOOLEAN,
  environmentCharacterisation                   EnvironmentCharacterisation      OPTIONAL
}

UE-Positioning-ResponseTime ::=                ENUMERATED {
  s1, s2, s4, s8, s16,
  s32, s64, s128 }

UTRA-CarrierRSSI ::=                           INTEGER (0..76)

UTRAN-ReferenceTime ::=                        SEQUENCE {
  gps-tow-lmsec                                  GPS-TOW-lmsec,
  gps-tow-rem-usec                              GPS-TOW-rem-usec,
  modeSpecificInfo                              CHOICE {
    fdd                                           SEQUENCE {
      referenceIdentity                          PrimaryCPICH-Info          OPTIONAL
    },
    tdd                                           SEQUENCE {
      referenceIdentity                          CellParametersID          OPTIONAL
    }
  },
  sfn                                           INTEGER (0..4095)
}

VarianceOfRLC-BufferPayload ::=                ENUMERATED {
  plv0, plv4, plv8, plv16, plv32, plv64,
  plv128, plv256, plv512, plv1024,
  plv2k, plv4k, plv8k, plv16k }

-- Actual value = IE value * 0.1
W ::=                                           INTEGER (0..20)

-- *****
--
--   OTHER INFORMATION ELEMENTS (10.3.8)
--
-- *****

BCC ::=                                         INTEGER (0..7)

BCCH-ModificationInfo ::=                      SEQUENCE {
  mib-ValueTag                                  MIB-ValueTag,
  bcch-ModificationTime                         BCCH-ModificationTime          OPTIONAL
}

-- Actual value = IE value * 8

```

```

BCCH-ModificationTime ::= INTEGER (0..511)

BSIC ::= SEQUENCE {
    ncc          NCC,
    bcc          BCC
}

CBS-DRX-Level1Information ::= SEQUENCE {
    ctch-AllocationPeriod  INTEGER (1..256),
    cbs-FrameOffset        INTEGER (0..255)
}

CDMA2000-Message ::= SEQUENCE {
    msg-Type          BIT STRING (SIZE (8)),
    payload           BIT STRING (SIZE (1..512))
}

CDMA2000-MessageList ::= SEQUENCE (SIZE (1..maxInterSysMessages)) OF
    CDMA2000-Message

CDMA2000-UMTS-Frequency-List ::= SEQUENCE (SIZE (1..maxNumCDMA2000Freqs)) OF
    FrequencyInfoCDMA2000

CellValueTag ::= INTEGER (1..4)

--Actual value = 2^(IE value)
ExpirationTimeFactor ::= INTEGER (1..8)

FDD-UMTS-Frequency-List ::= SEQUENCE (SIZE (1..maxNumFDDFreqs)) OF
    FrequencyInfoFDD

FrequencyInfoCDMA2000 ::= SEQUENCE {
    band-Class          BIT STRING (SIZE (5)),
    cdma-Freq           BIT STRING (SIZE(11))
}

GSM-BA-Range ::= SEQUENCE {
    gsmLowRangeUARFCN    UARFCN,
    gsmUpRangeUARFCN     UARFCN
}

GSM-BA-Range-List ::= SEQUENCE (SIZE (1..maxNumGSMFreqRanges)) OF
    GSM-BA-Range

GSM-Classmark2 ::= OCTET STRING (SIZE (5))

GSM-Classmark3 ::= OCTET STRING (SIZE (1..32))

GSM-MessageList ::= SEQUENCE (SIZE (1..maxInterSysMessages)) OF
    BIT STRING (SIZE (1..512))

GsmSecurityCapability ::= BIT STRING {
    a5-7(0),
    a5-6(1),
    a5-5(2),
    a5-4(3),
    a5-3(4),
    a5-2(5),
    a5-1(6)
} (SIZE (7))

IdentificationOfReceivedMessage ::= SEQUENCE {
    rrc-TransactionIdentifier  RRC-TransactionIdentifier,
    receivedMessageType        ReceivedMessageType
}

InterRAT-ChangeFailureCause ::= CHOICE {
    configurationUnacceptable    NULL,
    physicalChannelFailure       NULL,
    protocolError                 ProtocolErrorInformation,
    unspecified                   NULL,
    spare1                         NULL,
    spare2                         NULL,
    spare3                         NULL
}

InterRAT-UE-RadioAccessCapability ::= CHOICE {
    gsm                            SEQUENCE {

```

```

        gsm-Classmark2          GSM-Classmark2,
        gsm-Classmark3          GSM-Classmark3
    },
    cdma2000                     SEQUENCE {
        cdma2000-MessageList     CDMA2000-MessageList
    }
}

InterRAT-UE-RadioAccessCapabilityList ::= SEQUENCE (SIZE(1..maxInterSysMessages)) OF
InterRAT-UE-RadioAccessCapability

InterRAT-UE-SecurityCapability ::= CHOICE {
    gsm                           SEQUENCE {
        gsmSecurityCapability     GsmSecurityCapability
    }
}

InterRAT-UE-SecurityCapList ::= SEQUENCE (SIZE(1..maxInterSysMessages)) OF
InterRAT-UE-SecurityCapability

InterRAT-HO-FailureCause ::= CHOICE {
    configurationUnacceptable     NULL,
    physicalChannelFailure        NULL,
    protocolError                 ProtocolErrorInformation,
    interRAT-ProtocolError        NULL,
    unspecified                    NULL,
    spare1                         NULL,
    spare2                         NULL,
    spare3                         NULL,
    spare4                         NULL
}

MasterInformationBlock ::= SEQUENCE {
    mib-ValueTag                  MIB-ValueTag,
    plmn-Type                     PLMN-Type,
    -- TABULAR: The PLMN identity and ANSI-41 core network information
    -- are included in PLMN-Type.
    sibSb-ReferenceList           SIBSb-ReferenceList,
    -- Extension mechanism for non- release99 information
    nonCriticalExtensions         SEQUENCE {} OPTIONAL
}

MIB-ValueTag ::= INTEGER (1..8)

NCC ::= INTEGER (0..7)

PLMN-ValueTag ::= INTEGER (1..256)

PredefinedConfigIdentityAndValueTag ::= SEQUENCE {
    predefinedConfigIdentity       PredefinedConfigIdentity,
    predefinedConfigValueTag       PredefinedConfigValueTag
}

ProtocolErrorInformation ::= SEQUENCE {
    diagnosticsType               CHOICE {
        type1                      SEQUENCE {
            protocolErrorCause      ProtocolErrorCause
        },
        spare                       NULL
    }
}

ReceivedMessageType ::= ENUMERATED {
    activeSetUpdate,
    cellChangeOrderFromUTRAN,
    cellUpdateConfirm,
    counterCheck,
    downlinkDirectTransfer,
    interRATHandoverCommand,
    measurementControl,
    pagingType2,
    physicalChannelReconfiguration,
    physicalSharedChannelAllocation,
    radioBearerReconfiguration,
    radioBearerRelease,
    radioBearerSetup,
    rrcConnectionRelease,
}

```

```

rrcConnectionReject,
rrcConnectionSetup,
securityModeCommand,
signallingConnectionRelease,
transportChannelReconfiguration,
transportFormatCombinationControl,
ueCapabilityEnquiry,
ueCapabilityInformationConfirm,
uplinkPhysicalChannelControl,
uraUpdateConfirm,
utranMobilityInformation,
assistanceDataDelivery,
spare1, spare2, spare3, spare4,
spare5
}

Rplmn-Information ::= SEQUENCE {
    gsm-BA-Range-List      GSM-BA-Range-List  OPTIONAL,
    fdd-UMTS-Frequency-List FDD-UMTS-Frequency-List
    OPTIONAL,
    tdd-UMTS-Frequency-List FDD-UMTS-Frequency-List
    OPTIONAL,
    cdma2000-UMTS-Frequency-List  CDMA2000-UMTS-Frequency-
List  OPTIONAL
}

SchedulingInformation ::= SEQUENCE {
    scheduling SEQUENCE {
        segCount SegCount DEFAULT 1,
        sib-Pos CHOICE {
            -- The element name indicates the repetition period and the value
            -- (multiplied by two) indicates the position of the first segment.
            rep4 INTEGER (0..1),
            rep8 INTEGER (0..3),
            rep16 INTEGER (0..7),
            rep32 INTEGER (0..15),
            rep64 INTEGER (0..31),
            rep128 INTEGER (0..63),
            rep256 INTEGER (0..127),
            rep512 INTEGER (0..255),
            rep1024 INTEGER (0..511),
            rep2048 INTEGER (0..1023),
            rep4096 INTEGER (0..2047)
        },
        sib-PosOffsetInfo SibOFF-List OPTIONAL
    }
}

SchedulingInformationSIB ::= SEQUENCE {
    sib-Type SIB-TypeAndTag,
    scheduling SchedulingInformation
}

SchedulingInformationSIBSb ::= SEQUENCE {
    sibSb-Type SIBSb-TypeAndTag,
    scheduling SchedulingInformation
}

SegCount ::= INTEGER (1..16)

SegmentIndex ::= INTEGER (1..15)

-- Actual value = 2 * IE value
SFN-Prime ::= INTEGER (0..2047)

SIB-Data-fixed ::= BIT STRING (SIZE (222))

SIB-Data-variable ::= BIT STRING (SIZE (1..214))

SIBOccurIdentity ::= INTEGER (0..15)

SIBOccurrenceIdentityAndValueTag ::= SEQUENCE {
    sibOccurIdentity SIBOccurIdentity,
    sibOccurValueTag SIBOccurValueTag
}

```

```

SIBOccurValueTag ::=                INTEGER (0..15)

SIB-ReferenceList ::=                SEQUENCE (SIZE (1..maxSIB)) OF
                                      SchedulingInformationSIB

SIBSb-ReferenceList ::=              SEQUENCE (SIZE (1..maxSIB)) OF
                                      SchedulingInformationSIBSb

SIB-ReferenceListFACH ::=            SEQUENCE (SIZE (1..maxSIB-FACH)) OF
                                      SchedulingInformationSIB

SIB-Type ::=                          ENUMERATED {
                                      masterInformationBlock,
                                      systemInformationBlockType1,
                                      systemInformationBlockType2,
                                      systemInformationBlockType3,
                                      systemInformationBlockType4,
                                      systemInformationBlockType5,
                                      systemInformationBlockType6,
                                      systemInformationBlockType7,
                                      systemInformationBlockType8,
                                      systemInformationBlockType9,
                                      systemInformationBlockType10,
                                      systemInformationBlockType11,
                                      systemInformationBlockType12,
                                      systemInformationBlockType13,
                                      systemInformationBlockType13-1,
                                      systemInformationBlockType13-2,
                                      systemInformationBlockType13-3,
                                      systemInformationBlockType13-4,
                                      systemInformationBlockType14,
                                      systemInformationBlockType15,
                                      systemInformationBlockType15-1,
                                      systemInformationBlockType15-2,
                                      systemInformationBlockType15-3,
                                      systemInformationBlockType16,
                                      systemInformationBlockType17,
                                      systemInformationBlockType15-4,
                                      systemInformationBlockType18,
                                      schedulingBlock1,
                                      schedulingBlock2,
                                      spare1, spare2, spare3 }

SIB-TypeAndTag ::=                  CHOICE {
  sysInfoType1                       PLMN-ValueTag,
  sysInfoType2                       CellValueTag,
  sysInfoType3                       CellValueTag,
  sysInfoType4                       CellValueTag,
  sysInfoType5                       CellValueTag,
  sysInfoType6                       CellValueTag,
  sysInfoType7                       NULL,
  sysInfoType8                       CellValueTag,
  sysInfoType9                       NULL,
  sysInfoType10                      NULL,
  sysInfoType11                      CellValueTag,
  sysInfoType12                      CellValueTag,
  sysInfoType13                      CellValueTag,
  sysInfoType13-1                    CellValueTag,
  sysInfoType13-2                    CellValueTag,
  sysInfoType13-3                    CellValueTag,
  sysInfoType13-4                    CellValueTag,
  sysInfoType14                      NULL,
  sysInfoType15                      CellValueTag,
  sysInfoType16                      PredefinedConfigIdentityAndValueTag,
  sysInfoType17                      NULL,
  sysInfoType15-1                    CellValueTag,
  sysInfoType15-2                    SIBOccurrenceIdentityAndValueTag,
  sysInfoType15-3                    SIBOccurrenceIdentityAndValueTag,
  sysInfoType15-4                    CellValueTag,
  sysInfoType18                      CellValueTag
}

SIBSb-TypeAndTag ::=                CHOICE {
  sysInfoType1                       PLMN-ValueTag,
  sysInfoType2                       CellValueTag,
  sysInfoType3                       CellValueTag,
  sysInfoType4                       CellValueTag,
  sysInfoType5                       CellValueTag,

```



```

sysInfoType6          CellValueTag,
sysInfoType7          NULL,
sysInfoType8          CellValueTag,
sysInfoType9          NULL,
sysInfoType10         NULL,
sysInfoType11         CellValueTag,
sysInfoType12         CellValueTag,
sysInfoType13         CellValueTag,
sysInfoType13-1       CellValueTag,
sysInfoType13-2       CellValueTag,
sysInfoType13-3       CellValueTag,
sysInfoType13-4       CellValueTag,
sysInfoType14         NULL,
sysInfoType15         CellValueTag,
sysInfoType16         PredefinedConfigIdentityAndValueTag,
sysInfoType17         NULL,
sysInfoTypeSB1        CellValueTag,
sysInfoTypeSB2        CellValueTag,
sysInfoType15-1       CellValueTag,
sysInfoType15-2       SIBOccurrenceIdentityAndValueTag,
sysInfoType15-3       SIBOccurrenceIdentityAndValueTag,
sysInfoType15-4       CellValueTag,
sysInfoType18         CellValueTag
}

SibOFF ::=
    ENUMERATED {
        so2, so4, so6, so8, so10,
        so12, so14, so16, so18,
        so20, so22, so24, so26,
        so28, so30, so32 }

SibOFF-List ::=
    SEQUENCE (SIZE (1..15)) OF
        SibOFF

SysInfoType1 ::=
    SEQUENCE {
        -- Core network IEs
        cn-CommonGSM-MAP-NAS-SysInfo    NAS-SystemInformationGSM-MAP,
        cn-DomainSysInfoList            CN-DomainSysInfoList,
        -- User equipment IEs
        ue-ConnTimersAndConstants        UE-ConnTimersAndConstants    OPTIONAL,
        ue-IdleTimersAndConstants        UE-IdleTimersAndConstants    OPTIONAL,
        -- Extension mechanism for non- release99 information
        nonCriticalExtensions            SEQUENCE {}                    OPTIONAL
    }

SysInfoType2 ::=
    SEQUENCE {
        -- UTRAN mobility IEs
        ura-IdentityList                URA-IdentityList,
        -- Extension mechanism for non- release99 information
        nonCriticalExtensions            SEQUENCE {}                    OPTIONAL
    }

SysInfoType3 ::=
    SEQUENCE {
        sib4indicator                   BOOLEAN,
        -- UTRAN mobility IEs
        cellIdentity                    CellIdentity,
        cellSelectReselectInfo           CellSelectReselectInfoSIB-3-4,
        cellAccessRestriction           CellAccessRestriction,
        -- Extension mechanism for non- release99 information
        nonCriticalExtensions            SEQUENCE {}                    OPTIONAL
    }

SysInfoType4 ::=
    SEQUENCE {
        -- UTRAN mobility IEs
        cellIdentity                    CellIdentity,
        cellSelectReselectInfo           CellSelectReselectInfoSIB-3-4,
        cellAccessRestriction           CellAccessRestriction,
        -- Extension mechanism for non- release99 information
        nonCriticalExtensions            SEQUENCE {}                    OPTIONAL
    }

SysInfoType5 ::=
    SEQUENCE {
        sib6indicator                   BOOLEAN,
        -- Physical channel IEs
        pich-PowerOffset                 PICH-PowerOffset,
        modeSpecificInfo                 CHOICE {
            fdd                          SEQUENCE {
                aich-PowerOffset          AICH-PowerOffset
            }
        }
    }

```

```

    },
    tdd
        pusch-SysInfoList-SFN          PUSCH-SysInfoList-SFN          OPTIONAL,
        pdsch-SysInfoList-SFN          PDSCH-SysInfoList-SFN          OPTIONAL,
        openLoopPowerControl-TDD       OpenLoopPowerControl-TDD
    }
},
primaryCCPCH-Info                    PrimaryCCPCH-Info                    OPTIONAL,
prach-SystemInformationList           PRACH-SystemInformationList,
sCCPCH-SystemInformationList          SCCPCH-SystemInformationList,
cbs-DRX-Level1Information              CBS-DRX-Level1Information          OPTIONAL,
-- Conditional on any of the CTCH indicator IEs in
-- sCCPCH-SystemInformationList
-- Extension mechanism for non- release99 information
nonCriticalExtensions                 SEQUENCE {}                          OPTIONAL
}

SysInfoType6 ::=                      SEQUENCE {
-- Physical channel IEs
pich-PowerOffset                      PICH-PowerOffset,
modeSpecificInfo                       CHOICE {
    fdd
        aich-PowerOffset                AICH-PowerOffset,
        dummy                          CSICH-PowerOffset                OPTIONAL
    },
-- This parameter dummy is not to be sent in the current version of the
specification.
    tdd
        pusch-SysInfoList-SFN          PUSCH-SysInfoList-SFN          OPTIONAL,
        pdsch-SysInfoList-SFN          PDSCH-SysInfoList-SFN          OPTIONAL,
        openLoopPowerControl-TDD       OpenLoopPowerControl-TDD
    }
},
primaryCCPCH-Info                    PrimaryCCPCH-Info                    OPTIONAL,
prach-SystemInformationList           PRACH-SystemInformationList          OPTIONAL,
sCCPCH-SystemInformationList          SCCPCH-SystemInformationList          OPTIONAL,
cbs-DRX-Level1Information              CBS-DRX-Level1Information          OPTIONAL,
-- Conditional on any of the CTCH indicator IEs in
-- sCCPCH-SystemInformationList
-- Extension mechanism for non- release99 information
nonCriticalExtensions                 SEQUENCE {}                          OPTIONAL
}

SysInfoType7 ::=                      SEQUENCE {
-- Physical channel IEs
modeSpecificInfo                       CHOICE {
    fdd
        ul-Interference                 UL-Interference
    },
    tdd
        NULL
    },
prach-Information-SIB5-List           DynamicPersistenceLevelList,
prach-Information-SIB6-List           DynamicPersistenceLevelList          OPTIONAL,
expirationTimeFactor                  ExpirationTimeFactor                OPTIONAL,
-- Extension mechanism for non- release99 information
nonCriticalExtensions                 SEQUENCE {}                          OPTIONAL
}

SysInfoType8 ::=                      SEQUENCE {
-- User equipment IEs
cpch-Parameters                       CPCH-Parameters,
-- Physical channel IEs
cpch-SetInfoList                      CPCH-SetInfoList,
csich-PowerOffset                     CSICH-PowerOffset,
-- Extension mechanism for non- release99 information
nonCriticalExtensions                 SEQUENCE {}                          OPTIONAL
}

SysInfoType9 ::=                      SEQUENCE {
-- Physical channel IEs
cpch-PersistenceLevelsList            CPCH-PersistenceLevelsList,
-- Extension mechanism for non- release99 information
nonCriticalExtensions                 SEQUENCE {}                          OPTIONAL
}

SysInfoType10 ::=                     SEQUENCE {
-- User equipment IEs
drac-SysInfoList                      DRAC-SysInfoList,

```

```

-- Extension mechanism for non- release99 information
nonCriticalExtensions          SEQUENCE {}                                OPTIONAL
}

SysInfoType11 ::=
    SEQUENCE {
        sib12indicator           BOOLEAN,
        -- Measurement IEs
        fach-MeasurementOccasionInfo  FACH-MeasurementOccasionInfo  OPTIONAL,
        measurementControlSysInfo     MeasurementControlSysInfo,
        -- Extension mechanism for non- release99 information
        nonCriticalExtensions        SEQUENCE {}                                OPTIONAL
    }

SysInfoType12 ::=
    SEQUENCE {
        -- Measurement IEs
        fach-MeasurementOccasionInfo  FACH-MeasurementOccasionInfo  OPTIONAL,
        measurementControlSysInfo     MeasurementControlSysInfo,
        -- Extension mechanism for non- release99 information
        nonCriticalExtensions        SEQUENCE {}                                OPTIONAL
    }

SysInfoType13 ::=
    SEQUENCE {
        -- Core network IEs
        cn-DomainSysInfoList         CN-DomainSysInfoList,
        -- User equipment IEs
        ue-IdleTimersAndConstants     UE-IdleTimersAndConstants     OPTIONAL,
        capabilityUpdateRequirement   CapabilityUpdateRequirement   OPTIONAL,
        -- Extension mechanism for non- release99 information
        nonCriticalExtensions        SEQUENCE {}                                OPTIONAL
    }

SysInfoType13-1 ::=
    SEQUENCE {
        -- ANSI-41 IEs
        ansi-41-RAND-Information      ANSI-41-RAND-Information,
        -- Extension mechanism for non- release99 information
        nonCriticalExtensions        SEQUENCE {}                                OPTIONAL
    }

SysInfoType13-2 ::=
    SEQUENCE {
        -- ANSI-41 IEs
        ansi-41-UserZoneID-Information  ANSI-41-UserZoneID-Information,
        -- Extension mechanism for non- release99 information
        nonCriticalExtensions        SEQUENCE {}                                OPTIONAL
    }

SysInfoType13-3 ::=
    SEQUENCE {
        -- ANSI-41 IEs
        ansi-41-PrivateNeighbourListInfo  ANSI-41-PrivateNeighbourListInfo,
        -- Extension mechanism for non- release99 information
        nonCriticalExtensions        SEQUENCE {}                                OPTIONAL
    }

SysInfoType13-4 ::=
    SEQUENCE {
        -- ANSI-41 IEs
        ansi-41-GlobalServiceRedirectInfo  ANSI-41-GlobalServiceRedirectInfo,
        -- Extension mechanism for non- release99 information
        nonCriticalExtensions        SEQUENCE {}                                OPTIONAL
    }

SysInfoType14 ::=
    SEQUENCE {
        -- Physical channel IEs
        individualTS-InterferenceList  IndividualTS-InterferenceList,
        expirationTimeFactor           ExpirationTimeFactor           OPTIONAL,
        -- Extension mechanism for non- release99 information
        nonCriticalExtensions        SEQUENCE {}                                OPTIONAL
    }

SysInfoType15 ::=
    SEQUENCE {
        -- Measurement IEs

        ue-positioning-GPS-CipherParameters  UE-Positioning-CipherParameters  OPTIONAL,
        ue-positioning-GPS-ReferenceLocation  ReferenceLocation,
        ue-positioning-GPS-ReferenceTime     UE-Positioning-GPS-ReferenceTime,

        ue-positioning-GPS-Real-timeIntegrity  BadSatList                    OPTIONAL,
        -- Extension mechanism for non- release99 information
        nonCriticalExtensions        SEQUENCE {}                                OPTIONAL
    }

```

```

}

SysInfoType15-1 ::=                               SEQUENCE {
  -- DGPS corrections
  ue-positioning-GPS-DGPS-Corrections             UE-Positioning-GPS-DGPS-Corrections,

  -- Extension mechanism for non- release99 information
  nonCriticalExtensions                           SEQUENCE {}                OPTIONAL
}

SysInfoType15-2 ::=                               SEQUENCE {
  -- Ephemeris and clock corrections
  transmissionTOW                                 INTEGER (0..604799),
  satID                                           SatID,
  ephemerisParameter                             EphemerisParameter,
  -- Extension mechanism for non- release99 information
  nonCriticalExtensions                           SEQUENCE {}                OPTIONAL
}

SysInfoType15-3 ::=                               SEQUENCE {
  -- Almanac and other data
  transmissionTOW                                 INTEGER (0.. 604799),
  ue-positioning-GPS-Almanac                      UE-Positioning-GPS-Almanac
  OPTIONAL,
  ue-positioning-GPS-IonosphericModel            UE-Positioning-GPS-IonosphericModel
  OPTIONAL,
  ue-positioning-GPS-UTC-Model                    UE-Positioning-GPS-UTC-Model
  OPTIONAL,
  satMask                                         BIT STRING (SIZE (1..32))  OPTIONAL,
  lsbTOW                                          BIT STRING (SIZE (8))      OPTIONAL,
  -- Extension mechanism for non- release99 information
  nonCriticalExtensions                           SEQUENCE {}                OPTIONAL
}

SysInfoType15-4 ::=                               SEQUENCE {
  -- Measurement IEs
  ue-positioning-OTDOA-CipherParameters          UE-Positioning-CipherParameters    OPTIONAL,
  ue-positioning-OTDOA-AssistanceData            UE-Positioning-OTDOA-AssistanceData,
  -- Extension mechanism for non- release99 information
  nonCriticalExtensions                           SEQUENCE {}                OPTIONAL
}

SysInfoType16 ::=                               SEQUENCE {
  -- Radio bearer IEs
  preDefinedRadioConfiguration                  PreDefRadioConfiguration,
  -- Extension mechanism for non- release99 information
  nonCriticalExtensions                           SEQUENCE {}                OPTIONAL
}

SysInfoType17 ::=                               SEQUENCE {
  -- Physical channel IEs
  pusch-SysInfoList                             PUSCH-SysInfoList            OPTIONAL,
  pdsch-SysInfoList                             PDSCH-SysInfoList            OPTIONAL,
  -- Extension mechanism for non- release99 information
  nonCriticalExtensions                           SEQUENCE {}                OPTIONAL
}

SysInfoType18 ::=                               SEQUENCE {
  idleModePLMNIdentities                        PLMNIdentitiesOfNeighbourCells    OPTIONAL,
  connectedModePLMNIdentities                   PLMNIdentitiesOfNeighbourCells    OPTIONAL,
  -- Extension mechanism for non- release99 information
  nonCriticalExtensions                           SEQUENCE {}                OPTIONAL
}

SysInfoTypeSB1 ::=                              SEQUENCE {
  -- Other IEs
  sib-ReferenceList                             SIB-ReferenceList,
  -- Extension mechanism for non- release99 information
  nonCriticalExtensions                           SEQUENCE {}                OPTIONAL
}

SysInfoTypeSB2 ::=                              SEQUENCE {
  -- Other IEs
  sib-ReferenceList                             SIB-ReferenceList,
  -- Extension mechanism for non- release99 information
  nonCriticalExtensions                           SEQUENCE {}                OPTIONAL
}

TDD-UMTS-Frequency-List ::=                     SEQUENCE (SIZE (1..maxNumTDDFreqs)) OF

```

FrequencyInfoTDD

```

-- *****
--
--      ANSI-41 INFORMATION ELEMENTS (10.3.9)
--
-- *****

ANSI-41-GlobalServiceRedirectInfo ::= ANSI-41-NAS-Parameter
ANSI-41-PrivateNeighbourListInfo ::= ANSI-41-NAS-Parameter
ANSI-41-RAND-Information ::= ANSI-41-NAS-Parameter
ANSI-41-UserZoneID-Information ::= ANSI-41-NAS-Parameter
ANSI-41-NAS-Parameter ::= BIT STRING (SIZE (1..2048))

Min-P-REV ::= BIT STRING (SIZE (8))

NAS-SystemInformationANSI-41 ::= ANSI-41-NAS-Parameter
NID ::= BIT STRING (SIZE (16))

P-REV ::= BIT STRING (SIZE (8))

SID ::= BIT STRING (SIZE (15))

END

```

11.4 Constant definitions

```
Constant-definitions DEFINITIONS AUTOMATIC TAGS ::=
```

```
BEGIN
```

```

hiPDSCHidentities      INTEGER ::= 64
hiPUSCHidentities      INTEGER ::= 64
hiRM                    INTEGER ::= 256
maxAC                   INTEGER ::= 16
maxAdditionalMeas       INTEGER ::= 4
maxASC                  INTEGER ::= 8
maxASCmap               INTEGER ::= 7
maxASCpersist           INTEGER ::= 6
maxCCTrCH               INTEGER ::= 8
maxCellMeas             INTEGER ::= 32
maxCellMeas-1           INTEGER ::= 31
maxCNdomains            INTEGER ::= 4
maxCPCHsets             INTEGER ::= 16
maxDPCH-DLchan          INTEGER ::= 8
maxDPDCH-UL             INTEGER ::= 6
maxDRACclasses          INTEGER ::= 8
maxFACHPCH              INTEGER ::= 8
maxFreq                 INTEGER ::= 8
maxFreqBandsFDD         INTEGER ::= 8
maxFreqBandsTDD         INTEGER ::= 4
maxFreqBandsGSM         INTEGER ::= 16
maxInterSysMessages     INTEGER ::= 4
maxLoCHperRLC           INTEGER ::= 2
maxMeasEvent            INTEGER ::= 8
maxMeasIntervals        INTEGER ::= 3
maxMeasParEvent         INTEGER ::= 2
maxNumCDMA2000Freqs     INTEGER ::= 8
maxNumGSMFreqRanges     INTEGER ::= 32
maxNumFDDFreqs          INTEGER ::= 8
maxNumTDDFreqs          INTEGER ::= 8
maxNoOfMeas             INTEGER ::= 16
maxOtherRAT             INTEGER ::= 15
maxPagel                INTEGER ::= 8
maxPCPCH-APsig          INTEGER ::= 16
maxPCPCH-APsubCh        INTEGER ::= 12
maxPCPCH-CDsig          INTEGER ::= 16
maxPCPCH-CDsubCh        INTEGER ::= 12
maxPCPCH-SF             INTEGER ::= 7
maxPCPCHs               INTEGER ::= 64
maxPDCPAlgoType         INTEGER ::= 8
maxPDSCH                INTEGER ::= 8
maxPDSCH-TFCIgroups     INTEGER ::= 256
maxPRACH                INTEGER ::= 16
maxPredefConfig         INTEGER ::= 16
maxPUSCH                INTEGER ::= 8
maxRABsetup             INTEGER ::= 16

```

```

maxRAT                INTEGER ::= 16
maxRB                 INTEGER ::= 32
maxRBallRABs         INTEGER ::= 27
maxRBMuxOptions       INTEGER ::= 8
maxRBperRAB          INTEGER ::= 8
maxReportedGSMCells  INTEGER ::= 6
maxRL                 INTEGER ::= 8
maxRL-1              INTEGER ::= 7
maxSat                INTEGER ::= 16
maxSCCPCH             INTEGER ::= 16
maxSIB                INTEGER ::= 32
maxSIB-FACH           INTEGER ::= 8
maxSIBperMsg         INTEGER ::= 16
maxSRBsetup           INTEGER ::= 8
maxSystemCapability  INTEGER ::= 16
maxTF                 INTEGER ::= 32
maxTF-CPCH           INTEGER ::= 16
maxTFC                INTEGER ::= 1024
maxTFCI-2-Combs      INTEGER ::= 512
maxTGPS               INTEGER ::= 6
maxTrCH              INTEGER ::= 32
-- maxTrCHpreconf should be 16 but has been set to 32 for compatibility
maxTrCHpreconf       INTEGER ::= 32
maxTS                 INTEGER ::= 14
maxTS-1              INTEGER ::= 13
maxURA               INTEGER ::= 8

```

END

11.5 RRC information between network nodes

Internode-definitions DEFINITIONS AUTOMATIC TAGS ::=

BEGIN

IMPORTS

```

    HandoverToUTRANCommand,
    MeasurementReport,
    PhysicalChannelReconfiguration,
    RadioBearerReconfiguration,
    RadioBearerRelease,
    RadioBearerSetup,
    TransportChannelReconfiguration

```

FROM PDU-definitions

```

-- Core Network IEs :
    CN-DomainIdentity,
    CN-DomainInformationList,
    NAS-SystemInformationGSM-MAP,
-- UTRAN Mobility IEs :
    CellIdentity,
    URA-Identity,
-- User Equipment IEs :
    C-RNTI,
    FailureCauseWithProtErr,
    RRC-MessageSequenceNumber,
    STARTList,
    U-RNTI,
    UE-RadioAccessCapability,
    UE-RadioAccessCapability-v370ext,
-- Radio Bearer IEs :
    PredefinedConfigValueTag,
    RAB-InformationSetupList,
    SRB-InformationSetupList,
-- Transport Channel IEs :
    CPCH-SetID,
    DL-CommonTransChInfo,
    DL-AddReconfTransChInfoList,
    DRAC-StaticInformationList,
    UL-CommonTransChInfo,
    UL-AddReconfTransChInfoList,
-- Measurement IEs :
    MeasurementIdentity,
    MeasurementReportingMode,
    MeasurementType,
    AdditionalMeasurementID-List,

```

```

    PositionEstimate,
-- Other IEs :
    InterRAT-UE-RadioAccessCapabilityList
FROM InformationElements

    maxCNdomains,
    maxNoOfMeas,
    maxPredefConfig,
    maxRB,
    maxSRBsetup
FROM Constant-definitions

    UE-SecurityInformation
FROM UEtoOtherRAT-definitions;

-- Part 1: Class definitions similar to what has been defined in 11.1 for RRC messages
-- Information that is transferred in the same direction and across the same path is grouped
-- *****
--
-- RRC information, to target RNC
--
-- *****
-- RRC Information to target RNC sent either from source RNC or from another RAT

ToTargetRNC-Container ::= CHOICE {
    handoverToUTRAN          HandoverToUTRANInfo,
    srncRelocation          SRNC-RelocationInfo,
    extension                NULL
}

-- *****
--
-- RRC information, target RNC to source RNC
--
-- *****

TargetRNC-ToSourceRNC-Container ::= CHOICE {
    radioBearerSetup        RadioBearerSetup,
    radioBearerReconfiguration RadioBearerReconfiguration,
    radioBearerRelease      RadioBearerRelease,
    transportChannelReconfiguration TransportChannelReconfiguration,
    physicalChannelReconfiguration PhysicalChannelReconfiguration,
    rrc-InformationContainerFailureInfo RRC-InformationContainerFailureInfo,
    extension                NULL
}

-- *****
--
-- RRC information, target RNC to source RAT
--
-- *****

TargetRNC-ToSourceRAT-Container ::= CHOICE {
    handoverToUTRAN          HandoverToUTRANCommand,
    rrc-InformationContainerFailureInfo RRC-InformationContainerFailureInfo,
    extension                NULL
}

-- Part2: Container definitions, similar to the PDU definitions in 11.2 for RRC messages
-- In alphabetical order

-- *****
--
-- Handover to UTRAN information
--
-- *****

HandoverToUTRANInfo ::= CHOICE {
    r3                      SEQUENCE {
        handoverToUTRANInfo-r3 HandoverToUTRANInfo-r3-IEs,
        -- Non critical extensions
        v380NonCriticalExtensions SEQUENCE {
            handoverToUTRANInfo-v380ext HandoverToUTRANInfo-v380ext-IEs,
            -- Reserved for future non critical extension

```

```

        nonCriticalExtensions          SEQUENCE {} OPTIONAL
    },
    criticalExtensions                 SEQUENCE {}
}

HandoverToUTRANInfo-r3-IEs ::= SEQUENCE {
    -- User equipment IEs
    ue-RadioAccessCapability          UE-RadioAccessCapability          OPTIONAL,
    ue-SecurityInformation             UE-SecurityInformation          OPTIONAL,
    -- Other IEs
    ue-RATSpecificCapability           InterRAT-UE-RadioAccessCapabilityList OPTIONAL,
    predefinedConfigStatusList         PredefinedConfigStatusList     OPTIONAL
}

HandoverToUTRANInfo-v380ext-IEs ::= SEQUENCE {
    -- User equipment IEs
    ue-RadioAccessCapability-v370ext   UE-RadioAccessCapability-v370ext   OPTIONAL
}

-- *****
--
-- RRC information container failure info
--
-- *****

RRC-InformationContainerFailureInfo ::= CHOICE {
    r3                                  SEQUENCE {
        r3-InformationContainerFailureInfo-r3 RRC-InformationContainerFailureInfo-r3-IEs,
        nonCriticalExtensions                 SEQUENCE {} OPTIONAL
    },
    criticalExtensions                     SEQUENCE {}
}

RRC-InformationContainerFailureInfo-r3-IEs ::= SEQUENCE {
    -- Non-RRC IEs
    failureCauseWithProtErr              FailureCauseWithProtErr
}

-- *****
--
-- SRNC Relocation information
--
-- *****

SRNC-RelocationInfo ::= CHOICE {
    r3                                  SEQUENCE {
        sRNC-RelocationInfo-r3            SRNC-RelocationInfo-r3-IEs,
        v380NonCriticalExtensions          SEQUENCE {
            sRNC-RelocationInfo-v380ext   SRNC-RelocationInfo-v380ext-IEs,
            -- Reserved for future non critical extension
            nonCriticalExtensions          SEQUENCE {} OPTIONAL
        }
        OPTIONAL
    },
    criticalExtensions                     SEQUENCE {}
}

SRNC-RelocationInfo-r3-IEs ::= SEQUENCE {
    -- Non-RRC IEs
    stateOfRRC                            StateOfRRC,
    stateOfRRC-Procedure                   StateOfRRC-Procedure,
    -- Ciphering related information IEs
    -- If the extension v380 is included use the extension for the ciphering status per CN domain
    cipheringStatus                        CipheringStatus,
    calculationTimeForCiphering            CalculationTimeForCiphering          OPTIONAL,
    cipheringInfoPerRB-List                CipheringInfoPerRB-List             OPTIONAL,
    count-C-List                           COUNT-C-List                        OPTIONAL,
    integrityProtectionStatus              IntegrityProtectionStatus,
    srb-SpecificIntegrityProtInfo          SRB-SpecificIntegrityProtInfoList,
    implementationSpecificParams           ImplementationSpecificParams        OPTIONAL,
    -- User equipment IEs
    u-RNTI                                 U-RNTI,
    c-RNTI                                 C-RNTI                              OPTIONAL,
    ue-RadioAccessCapability               UE-RadioAccessCapability,
    ue-Positioning-LastKnownPos            UE-Positioning-LastKnownPos         OPTIONAL,
    -- Other IEs
    ue-RATSpecificCapability               InterRAT-UE-RadioAccessCapabilityList OPTIONAL,
    -- UTRAN mobility IEs

```



```

ura-Identity          URA-Identity          OPTIONAL,
-- Core network IEs
cn-CommonGSM-MAP-NAS-SysInfo  NAS-SystemInformationGSM-MAP,
cn-DomainInformationList      CN-DomainInformationList      OPTIONAL,
-- Measurement IEs
ongoingMeasRepList          OngoingMeasRepList          OPTIONAL,
-- Radio bearer IEs
predefinedConfigStatusList  PredefinedConfigStatusList,
srb-InformationList          SRB-InformationSetupList,
rab-InformationList          RAB-InformationSetupList      OPTIONAL,
-- Transport channel IEs
ul-CommonTransChInfo        UL-CommonTransChInfo        OPTIONAL,
ul-TransChInfoList          UL-AddReconfTransChInfoList  OPTIONAL,
modeSpecificInfo            CHOICE {
    fdd                        SEQUENCE {
        cpch-SetID            CPCH-SetID                  OPTIONAL,
        transChDRAC-Info      DRAC-StaticInformationList  OPTIONAL
    },
    tdd                        NULL
},
dl-CommonTransChInfo        DL-CommonTransChInfo        OPTIONAL,
dl-TransChInfoList          DL-AddReconfTransChInfoList  OPTIONAL,
-- Measurement report
measurementReport            MeasurementReport            OPTIONAL
}

SRNC-RelocationInfo-v380ext-IEs ::= SEQUENCE {
-- Ciphering related information IEs
cn-DomainIdentity            CN-DomainIdentity,
cipheringStatusList          CipheringStatusList
}

CipheringStatusList ::=          SEQUENCE (SIZE (1..maxCNdomains)) OF
                                CipheringStatusCNdomain

CipheringStatusCNdomain ::=     SEQUENCE {
    cn-DomainIdentity          CN-DomainIdentity,
    cipheringStatus            CipheringStatus
}

-- IE definitions

CalculationTimeForCiphering ::= SEQUENCE {
    cell-Id                    CellIdentity,
    sfn                         INTEGER (0..4095)
}

CipheringInfoPerRB ::=          SEQUENCE {
    dl-HFN                      BIT STRING (SIZE (20..25)),
    ul-HFN                      BIT STRING (SIZE (20..25))
}

-- TABULAR: Multiplicity value numberOfRadioBearers has been replaced
-- with maxRB.
CipheringInfoPerRB-List ::=     SEQUENCE (SIZE (1..maxRB)) OF
                                CipheringInfoPerRB

CipheringStatus ::=            ENUMERATED {
                                started, notStarted }

COUNT-C-List ::=              SEQUENCE (SIZE (1..maxCNdomains)) OF
                                COUNT-CSingle

COUNT-CSingle ::=             SEQUENCE {
    cn-DomainIdentity          CN-DomainIdentity,
    count-C                    BIT STRING (SIZE (32))
}

ImplementationSpecificParams ::= BIT STRING (SIZE (1..512))

IntegrityProtectionStatus ::=  ENUMERATED {
                                started, notStarted }

MeasurementCommandWithType ::= CHOICE {
    setup                      MeasurementType,
    modify                      NULL,
    release                     NULL
}

```

```

}

OngoingMeasRep ::= SEQUENCE {
    measurementIdentity MeasurementIdentity,
    measurementCommandWithType MeasurementCommandWithType,
    -- TABULAR: The CHOICE Measurement in the tabular description is included
    -- in the IE above.
    measurementReportingMode MeasurementReportingMode OPTIONAL,
    additionalMeasurementID-List AdditionalMeasurementID-List OPTIONAL
}

OngoingMeasRepList ::= SEQUENCE (SIZE (1..maxNoOfMeas)) OF
    OngoingMeasRep

PredefinedConfigStatusList ::= SEQUENCE (SIZE (maxPredefConfig)) OF
    PredefinedConfigStatusInfo

PredefinedConfigStatusInfo ::= SEQUENCE {
    predefinedConfigValueTag PredefinedConfigValueTag OPTIONAL
    -- Absence of the IE indicates that the UE has not stored the corresponding preconfiguration
}

SRB-SpecificIntegrityProtInfo ::= SEQUENCE {
    ul-RRC-HFN BIT STRING (SIZE (28)),
    dl-RRC-HFN BIT STRING (SIZE (28)),
    ul-RRC-SequenceNumber RRC-MessageSequenceNumber,
    dl-RRC-SequenceNumber RRC-MessageSequenceNumber
}

SRB-SpecificIntegrityProtInfoList ::= SEQUENCE (SIZE (4..maxSRBsetup)) OF
    SRB-SpecificIntegrityProtInfo

StateOfRRC ::= ENUMERATED {
    cell-DCH, cell-FACH,
    cell-PCH, ura-PCH }

StateOfRRC-Procedure ::= ENUMERATED {
    awaitNoRRC-Message,
    awaitRRC-ConnectionRe-establishmentComplete,
    awaitRB-SetupComplete,
    awaitRB-ReconfigurationComplete,
    awaitTransportCH-ReconfigurationComplete,
    awaitPhysicalCH-ReconfigurationComplete,
    awaitActiveSetUpdateComplete,
    awaitHandoverComplete,
    sendCellUpdateConfirm,
    sendUraUpdateConfirm,
    sendRrcConnectionReestablishment,
    otherStates
}

UE-Positioning-LastKnownPos ::= SEQUENCE {
    sfn INTEGER (0..4095),
    cell-id CellIdentity,
    positionEstimate PositionEstimate
}

END

```

11.6 RRC information between UE and other RATs

```

UEtoOtherRAT-definitions DEFINITIONS AUTOMATIC TAGS ::=

```

```

BEGIN

```

```

IMPORTS

```

```

-- User Equipment IEs :
    START-Value,
    UE-RadioAccessCapability,
    UE-RadioAccessCapability-v370ext,
    DL-PhysChCapabilityFDD-v380ext,
-- Radio Bearer IEs :
    PredefinedConfigValueTag
FROM InformationElements;

```

```

-- Part 1: Class definitions similar to what has been defined in 11.1 for RRC messages
-- Information that is tranferred in the same direction and across the same path is grouped
-- *****
--
-- RRC information, to target RNC
--
-- *****
-- RRC Information to target RNC sent either from source RNC or from another RAT
--
-- Currently not used
--
-- *****
--
-- RRC information, target RNC to source RNC
--
-- *****
--
-- Currently not used
--
-- *****
--
-- RRC information, target RNC to source RAT
--
-- *****
--
-- Currently not used
--
-- Part 2: Container definitions, similar to the PDU definitions in 11.2 for RRC messages
-- In alphabetical order
--
-- Currently not used
--
-- Part 3: Non- extensible IE definitions
-- In alphabetical order
UE-CapabilityInformation ::=          SEQUENCE {
    ue-RadioAccessCapability          UE-RadioAccessCapability,
    ue-RadioAccessCapabilityExt1     UE-RadioAccessCapability-v370ext
}
UE-SecurityInformation ::=          SEQUENCE {
    start-CS                          START-Value
}
END

```

12 Message transfer syntax

Transfer syntax for RRC PDUs is derived from their ASN.1 definitions by use of Packed Encoding Rules, unaligned as specified in X.691 [49], and with adapted final padding. If special encoding is used, it is indicated in the ECN module defined for each ASN.1 module. The use of special encoding is defined in [14].

12.1 Structure of encoded RRC messages

An RRC PDU, which is the bit string that is exchanged between peer entities/ across the radio interface, is the concatenation of a basic production, an extension and padding, in that order.

RRC PDUs shall be mapped to and from RLC SDUs upon transmission and reception as follows:

- when delivering an RRC PDU as an RLC SDU to the RLC layer for transmission, the first bit of the RRC PDU shall be represented as the first bit in the RLC SDU and onwards; and
- upon reception of an RLC SDU from the RLC layer, the first bit of the RLC SDU shall represent the first bit of the RRC PDU and onwards.

12.1.1 Basic production

The 'basic production' is obtained by applying UNALIGNED PER to the abstract syntax value (the ASN.1 description) as specified in X.691, except for the 0 to 7 bits added at the end to produce a multiple of 8 bits. The basic production can have any positive number of bits, not necessarily a multiple of 8 bits.

12.1.2 Extension

Emitters compliant with this version of the specification of the protocol shall, unless indicated otherwise on a PDU type basis, set the extension part empty. Emitters compliant with a later version might send non-empty extensions.

12.1.3 Padding

Emitters compliant with this version of the specification of the protocol shall, unless indicated otherwise on a PDU type basis, pad the basic production with the smallest number of bits required to meet the size constraints of the lower layers. Padding bits shall be set to 0.

Receivers compliant with this version of the specification have no need to distinguish the extension and padding parts, and shall, unless indicated otherwise on a PDU type basis, accept RRC PDUs with any bit string in the extension and padding parts.

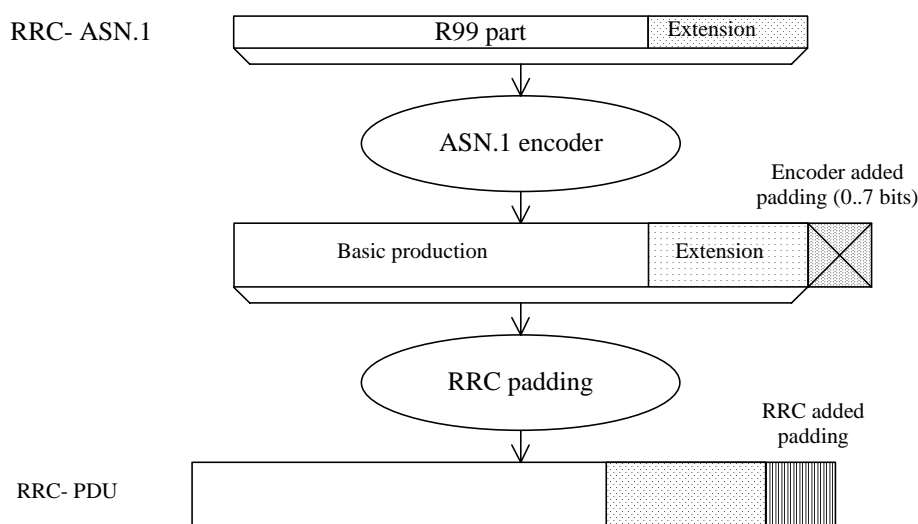

Figure 61: Padding

When using AM or UM mode, RLC requires that the RRC PDU length is a multiple of 8 bits.

When using Tr mode, RLC does neither impose size requirements nor perform padding. This implies that RRC has to take into account the transport format set defined for the transport channel across which the message is to be sent. RRC shall select the smallest transport format that fits the RRC PDU and shall add the lowest number of padding bits required to fit the size specified for the selected transport format.

For system information blocks, building the PDU involves two steps. The first step is the building of the SIBs, in which step padding is not applied (the rules for extension apply). The second step is the building of the RRC PDUs, involving segmentation and concatenation of SIBs, and then padding as described above for Tr mode. The procedure is shown by means of an example as described in Figure 62. The example includes two SIBs, SIB_n and SIB_{n+1}, of which only SIB_n includes a protocol extension. The two SIBs used in the example don't require segmentation and are concatenated into one SYSTEM INFORMATION message.

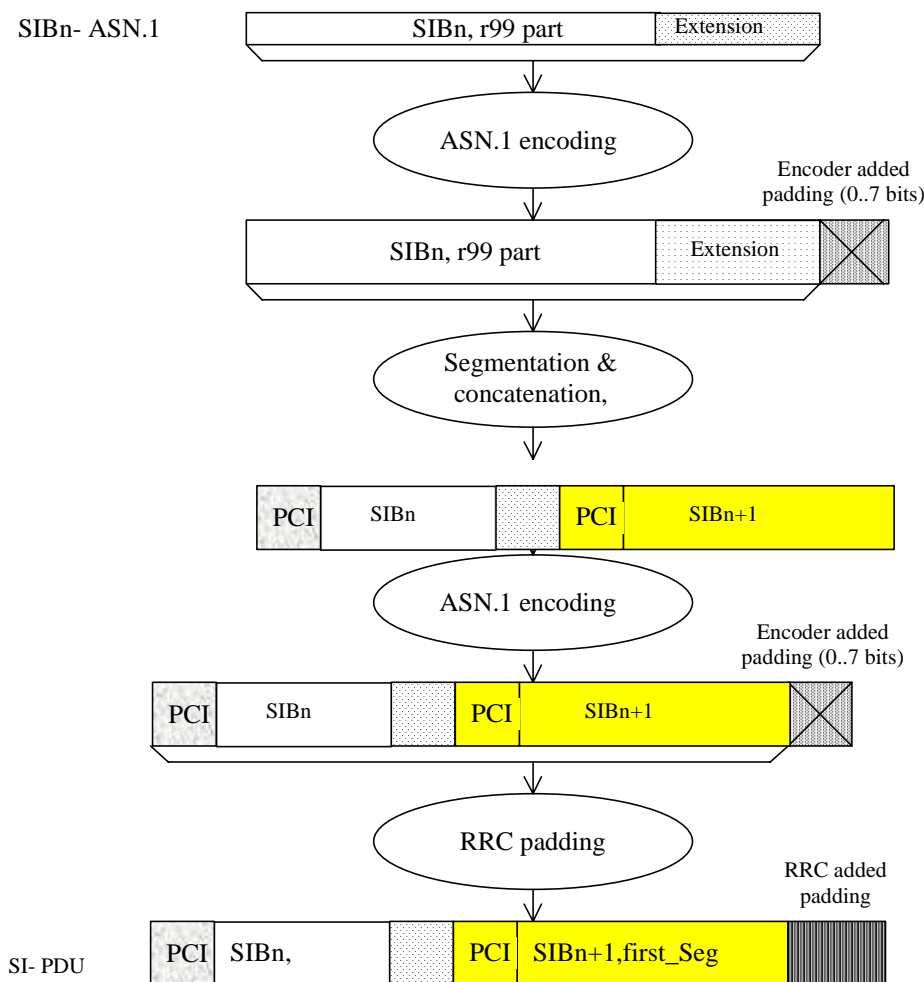

Figure 62: Padding for System Information

PCI: Protocol control information at SYSTEM INFORMATION message level

SI: SYSTEM INFORMATION message

For system information blocks, RRC may also add padding information at the end of IE "SIB data fixed", used both within IE "Last segment" and IE "Complete SIB". The IE "SIB data fixed" has a fixed length i.e. no length denominator used. In case the remaining amount of "SIB data" information is insufficient to fill the IE completely, RRC includes padding bits.

Since no length denominator is included, the receiving RRC cannot remove the padding added by the sender. However, since the padding used is the same as the padding added by the PER encoder to achieve octet alignment, the receiver can handle it.

NOTE 1 The mechanism described above implies that the PDU provided to the ASN.1 decoder may have more than 7 padding bits included. For a complete SIB of length 215 bits, 11 padding bits are added by RRC. Since the decoder requires an octet aligned input, 6 additional bits need to be added. In this (worst) case, a total of 17 padding bits is included.

NOTE 2 For the above cases, use of padding bits is possible and more efficient than including a length denominator.

When using the RRC padding described above, the segment has a fixed length, which completely fills the transport block. Therefore, in this case no RRC padding is added within the SYSTEM INFORMATION message. This is illustrated by means of the following figure.

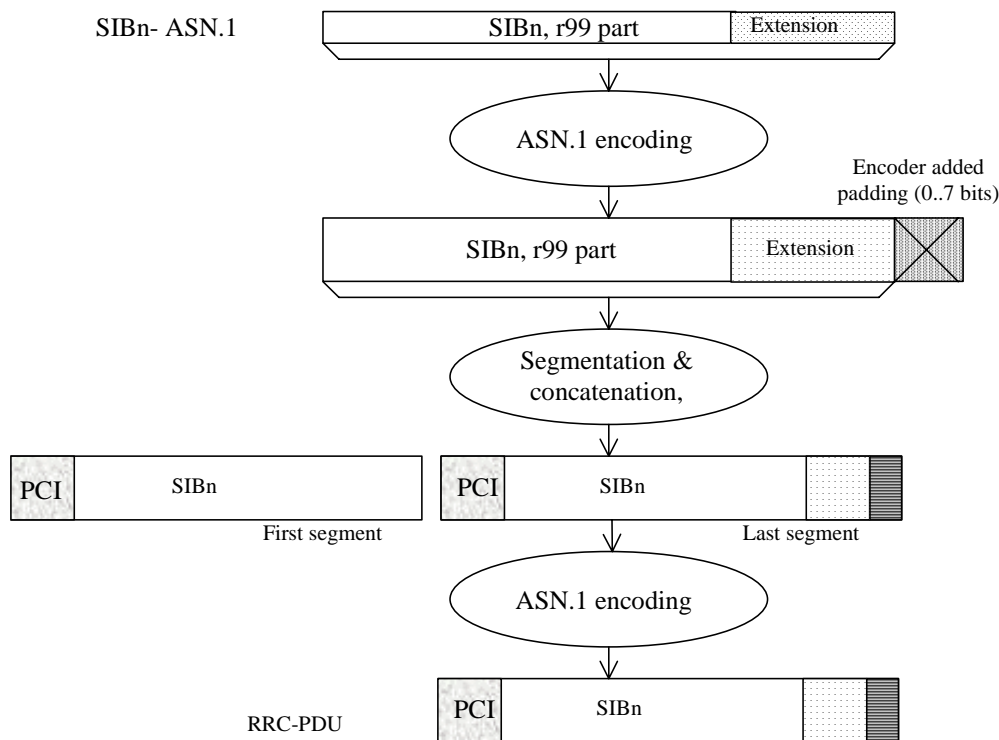

Figure 62a: No RRC padding for System Information

12.2 ECN link module for RRC

```

RRC-ECN-Link-Module LINK-DEFINITIONS ::=
BEGIN

IMPORTS
    RRC-encodings          -- Encoding objects for RRC messages
FROM RRC-Encoding-Definitions;

ENCODE Class-definitions
    WITH RRC-encodings
    COMPLETED BY PER-BASIC-UNALIGNED

ENCODE PDU-definitions
    WITH RRC-encodings
    COMPLETED BY PER-BASIC-UNALIGNED

ENCODE InformationElements
    WITH RRC-encodings
    COMPLETED BY PER-BASIC-UNALIGNED

ENCODE Internode-definitions
    WITH RRC-encodings
    COMPLETED BY PER-BASIC-UNALIGNED

END

```

12.3 ECN modules for RRC

The encoding definition module "RRC-Encoding-Definitions" contains definition of the encoding object set "RRC-encodings". The encoding object set contains all the specialized encoding for RRC.

```

RRC-Encoding-Definitions ENCODING-DEFINITIONS ::=
BEGIN
EXPORTS
  RRC-encodings;
RRC-encodings #ENCODINGS ::= {
  -- Trailing bits
  outer-encoding
}
--*****
--
-- The trailing bits in all RRC messages shall be ignored
-- (including unknown message contents & unknown extensions).
-- This overrides the default PER behaviour which pads the last
-- octet with zero bits.
--
--*****

outer-encoding #OUTER ::= {
  ENCODER-DECODER {
  }
  DECODE AS IF {
    POST-PADDING    encoder-option
  }
}

END

Class-definitions-ECN-Module ENCODING-DEFINITIONS ::=
BEGIN
END

PDU-definitions-ECN-Module ENCODING-DEFINITIONS ::=
BEGIN
END

InformationElements-ECN-Module ENCODING-DEFINITIONS ::=
BEGIN
END

Internode-definitions-ECN-Module ENCODING-DEFINITIONS ::=
BEGIN
END

```

13 Protocol timers, counters, other parameters and default configurations

The information provided in subclauses 13.1 and 13.2 shall be treated as informative. The normative text is specified in the relevant subclauses in clause 8 and clause 8 shall prevail.

13.1 Timers for UE

Timer	Start	Stop	At expiry
T300	Transmission of RRC CONNECTION REQUEST	Reception of RRC CONNECTION SETUP	Retransmit RRC CONNECTION REQUEST if V300 \leq N300, else go to Idle mode
T302	Transmission of CELL UPDATE/URA UPDATE	Reception of CELL UPDATE CONFIRM/URA UPDATE CONFIRM	Retransmit CELL UPDATE/URA UPDATE if V302 \leq N302, else, go to Idle mode
T304	Transmission of UE CAPABILITY INFORMATION	Reception of UE CAPABILITY INFORMATION CONFIRM	Retransmit UE CAPABILITY INFORMATION if V304 \leq N304, else initiate a cell update procedure
T305	Entering CELL_FACH or URA_PCH or CELL_PCH state. Reception of CELL UPDATE CONFIRM/URA UPDATE CONFIRM.	Entering another state.	Transmit CELL UPDATE if T307 is not activated and the UE detects "in service area". Otherwise, if T307 is not active, start T307.
T307	When the timer T305 has expired and the UE detects "out of service area".	When the UE detects "in service area".	Transit to idle mode
T308	Transmission of RRC CONNECTION RELEASE COMPLETE	Not stopped	Transmit RRC CONNECTION RELEASE COMPLETE if V308 \leq N308, else go to idle mode.
T309	Upon reselection of a cell belonging to another radio access system from connected mode, or reception of CELL CHANGE ORDER FROM UTRAN message	Successful establishment of a connection in the new cell	Resume the connection to UTRAN
T310	Transmission of PUSCH CAPACITY REQUEST	Reception of PHYSICAL SHARED CHANNEL ALLOCATION	Transmit PUSCH CAPACITY REQUEST if V310 \leq N310, else procedure stops.
T311	Reception of PHYSICAL SHARED CHANNEL ALLOCATION message with the CHOICE "PUSCH allocation" set to "PUSCH allocation pending".	Reception of PHYSICAL SHARED CHANNEL ALLOCATION message with CHOICE "PUSCH allocation" set to "PUSCH allocation assignment".	UE may initiate a PUSCH capacity request procedure.
T312	When the UE starts to establish dedicated CH	When the UE detects consecutive N312 "in sync" indication from L1.	The criteria for physical channel establishment failure is fulfilled
T313	When the UE detects consecutive N313 "out of sync" indication from L1.	When the UE detects consecutive N315 "in sync" indication from L1.	The criteria for Radio Link failure is fulfilled
T314	When the criteria for radio link failure are fulfilled. The timer is started only if radio bearer(s) that are associated with T314 exist.	When the Cell Update procedure has been completed.	See subclause 8.3.1.13

Timer	Start	Stop	At expiry
T315	When the criteria for radio link failure are fulfilled. The timer is started only if radio bearer(s) that are associated with T315 exist.	When the Cell Update procedure has been completed.	See subclause 8.3.1.14
T316	When the UE detects "out of service area" in URA_PCH or CELL_PCH state	When the UE detects "in service area".	Initiate cell update procedure if in service area is detected. Otherwise start timer T317, transit to CELL_FACH state and initiate cell update procedure when the UE detects "in service area".
T317	When the T316 expires or when in CELL_FACH state, the UE detects "out of service area".	When the UE detects "in service area".	Transit to idle mode

13.2 Counters for UE

Counter	Reset	Incremented	When reaching max value
V300	When initiating the procedure RRC connection establishment	Upon expiry of T300.	When V300 > N300, the UE enters idle mode.
V302	When initiating the procedure Cell update or URA update	Upon expiry of T302	When V302 > N302 the UE enters idle mode.
V304	When sending the first UE CAPABILITY INFORMATION message.	Upon expiry of T304	When V304 > N304 the UE initiates the Cell update procedure
V308	When sending the first RRC CONNECTION RELEASE COMPLETE message in a RRC connection release procedure.	Upon expiry of T308	When V308 > N308 the UE stops re-transmitting the RRC CONNECTION RELEASE COMPLETE message.
V310	When sending the first PUSCH CAPACITY REQUEST message in a PUSCH capacity request procedure	Upon expiry of T310	When V310 > N310 the UE stops re-transmitting the PUSCH CAPACITY REQUEST message.

13.3 UE constants and parameters

Constant	Usage
N300	Maximum number of retransmissions of the RRC CONNECTION REQUEST message
N302	Maximum number of retransmissions of the CELL UPDATE / URA UPDATE message
N304	Maximum number of retransmissions of the UE CAPABILITY INFORMATION message
N308	Maximum number of retransmissions of the RRC CONNECTION RELEASE COMPLETE message
N310	Maximum number of retransmission of the PUSCH CAPACITY REQUEST message
N312	Maximum number of successive "in sync" received from L1.
N313	Maximum number of successive "out of sync" received from L1.
N315	Maximum number of successive "in sync" received from L1 during T313 is activated.

13.4 UE variables

13.4.0 CELL INFO LIST

This variable contains cell information on intra-frequency, inter-frequency and inter-RAT cells, as received in messages System Information Block Type 11, System Information Block Type 12, and MEASUREMENT CONTROL.

The first position in Intra-frequency cell info list corresponds to Intra-frequency cell id 0, the second to Intra-frequency cell id 1, etc.

The first position in Inter-frequency cell info list corresponds to Inter-frequency cell id 0, the second to Inter-frequency cell id 1, etc.

The first position in Inter-RAT cell info list corresponds to Intra-frequency cell id 0, the second to Inter-RAT cell id 1, etc.

Information Element/Group name	Need	Multi	Type and reference	Semantics description
Intra-frequency cell info	OP	1..<maxCel IMeas>		Note
>CHOICE <i>position status</i>	MP			
>>Occupied				
>>>Cell info	MP		Cell info 10.3.7.2	
>>Vacant				No data
Inter-frequency cell info	OP	1..<maxCel IMeas>		Note
>CHOICE <i>position status</i>	MP			
>>Occupied				
>>>Frequency info	MP		Frequency info 10.3.6.36	
>>>Cell info	MP		Cell info 10.3.7.2	
>>Vacant				No data
Inter-RAT cell info	OP	1..<maxCel IMeas>		Note
>CHOICE <i>position status</i>	MP			
>>Occupied				
>>>CHOICE <i>Radio Access Technology</i>				
>>>>GSM				
>>>>>Cell selection and re- selection info	MP		Cell selection and re- selection info for SIB11/12 10.3.2.4	
>>>>>BSIC	MP		BSIC 10.3.8.2	
>>>>>BCCH ARFCN	MP		Integer (0..1023)	[43]
>>>>>IS-2000				
>>>>>>System specific measurement info			enumerated (frequency, timeslot, colour code, output power, PN offset)	For IS-2000, use fields from TIA/EIA/IS-2000.5, Subclause 3. 7.3.3.2.27, <i>Candidate Frequency Neighbour List Message</i>
>>Vacant				No data

NOTE: This IE shall be cleared when entering UTRA RRC connected mode, when leaving UTRA RRC connected mode, when switched off as well as at selection of a new PLMN.

13.4.00 Void

13.4.0a CELL_UPDATE_STARTED

This variable indicates whether a cell update or URA update procedure is in progress.

Information Element/Group name	Need	Multi	Type and reference	Semantics description
Cell update started	MP		Boolean	TRUE means a cell or URA update procedure is in progress. Set to FALSE when entering UTRA RRC connected mode. Set to FALSE when leaving UTRA RRC connected mode.

13.4.1 CIPHERING_STATUS

This variable contains information about the current status of ciphering in the UE.

Information Element/Group name	Need	Multi	Type and reference	Semantics description
Status for each CN domain	MP	<1 to maxCNDo mains>		
>CN domain identity	MP		CN domain identity 10.3.1.1	
>Status	MP		Enumerated(Not started, Started)	Set to "Not started" when entering UTRA RRC connected mode. Set to "Not started" when leaving UTRA RRC connected mode.
Reconfiguration	MP		Boolean	TRUE means an RRC procedure performing reconfiguration of ciphering is ongoing. Set to FALSE when entering UTRA RRC connected mode. Set to FALSE when leaving UTRA RRC connected mode.

13.4.2 Void

13.4.2a CONFIGURATION_INCOMPLETE

This variable indicates whether a received measurement control message contains invalid an incomplete measurement configuration.

Information Element/Group name	Need	Multi	Type and reference	Semantics description
Configuration incomplete	MP		Boolean	TRUE: An incomplete configuration has been detected. Set to FALSE when entering UTRA RRC connected mode. Set to FALSE when leaving UTRA RRC connected mode.

13.4.3 C_RNTI

This variable stores the assigned C-RNTI for this UE when in CELL_FACH state.

Information Element/Group name	Need	Multi	Type and reference	Semantics description
C-RNTI	OP		C-RNTI 10.3.3.8	Cleared when entering UTRA RRC connected mode when not otherwise stated in the procedure. Cleared when leaving UTRA RRC connected mode.

13.4.4 DOFF

This variable contains the default offset value in the UE. See [10] for details.

Information Element/Group name	Need	Multi	Type and reference	Semantics description
Default DPCH Offset Value (DOFF)	OP		Default DPCH Offset Value 10.3.6.16	Cleared when entering UTRA RRC connected mode when not otherwise stated in the procedure. Cleared when leaving UTRA RRC connected mode.

13.4.5 ESTABLISHED_RABS

This variable is used to store information about the established radio access bearers and signalling radio bearers in the UE.

Information Element/Group name	Need	Multi	Type and reference	Semantics description
RAB information	OP	1 to <maxRABs etup>		For each RAB established. Cleared when entering UTRA RRC connected mode when not otherwise stated in the procedure. Cleared when leaving UTRA RRC connected mode.
>RAB info	MP		RAB info 10.3.4.8	
>RB information	MP	1 to <maxRBper RAB>		For each RB belonging to the RAB
>>RB identity	MP		RB identity 10.3.4.16	
>>Subflow	MP		Integer(0..<maxSubflow count>)	Reference to the RAB subflow implemented by this RB
>>RB started	MD		Enumerated(stopped, started)	Default value is started
Signalling radio bearer information	OP	1 to <maxSRBsetup>		In the order of RB0 and upwards. Cleared when leaving UTRA RRC connected mode.
>RB started	MD		Enumerated(stopped, started)	Default value is started

13.4.5a ESTABLISHED_SIGNALLING_CONNECTIONS

This variable is used to store information about established signalling connections.

Information Element/Group name	Need	Multi	Type and reference	Semantics description
Signalling connection list	OP	1 to <maxCNdo mains>		For each established signalling connection. Cleared when entering UTRA RRC connected mode when not otherwise stated in the procedure. Cleared when leaving UTRA RRC connected mode.
>Signalling connection identity	MP		CN domain identity 10.3.1.1	

13.4.6 ESTABLISHMENT_CAUSE

This variable is used to store the cause for establishment of a signalling connection received by upper layers, to be used at RRC connection establishment.

Information Element/Group name	Need	Multi	Type and reference	Semantics description
Establishment cause	OP		Establishment cause 10.3.3.11	Cleared when leaving UTRA RRC connected mode.

13.4.7 FAILURE_CAUSE

This variable contains the cause for failure of a UE initiated procedure, to be reported in a retransmitted message.

Information Element/Group name	Need	Multi	Type and reference	Semantics description
Failure cause	OP		Failure cause 10.3.3.13	Cleared when entering UTRA RRC connected mode. Cleared when leaving UTRA RRC connected mode.

13.4.8 FAILURE_INDICATOR

This variable indicates whether the procedure has failed for a UE initiated procedure.

Information Element/Group name	Need	Multi	Type and reference	Semantics description
Failure indicator	MP		Boolean	TRUE: Procedure has failed. Set to FALSE when entering UTRA RRC connected mode. Set to FALSE when leaving UTRA RRC connected mode.

13.4.8a INCOMPATIBLE_SECURITY_RECONFIGURATION

This variable indicates whether an incompatible simultaneous reconfiguration of a security function has been received.

Information Element/Group name	Need	Multi	Type and reference	Semantics description
Incompatible security reconfiguration	MP		Boolean	TRUE: An incompatible simultaneous security reconfiguration has been detected. Set to FALSE when entering UTRA RRC connected mode. Set to FALSE when leaving UTRA RRC connected mode.

13.4.9 INITIAL_UE_IDENTITY

In this variable the identity used by the UE when establishing an RRC connection is stored.

Information Element/Group name	Need	Multi	Type and reference	Semantics description
Initial UE identity	OP		Initial UE identity 10.3.3.15	Cleared when leaving UTRA RRC connected mode.

13.4.9a INTEGRITY_PROTECTION_ACTIVATION_INFO

This variable contains information to be sent to UTRAN about when a new integrity protection configuration shall be activated in the uplink for signalling radio bearers in case of modification of integrity protection.

Information Element/Group name	Need	Multi	Type and reference	Semantics description
Uplink Integrity protection activation info	OP		Integrity protection activation info 10.3.3.17	Cleared when entering UTRA RRC connected mode. Cleared when leaving UTRA RRC connected mode.

13.4.10 INTEGRITY_PROTECTION_INFO

This variable contains information about the current status of the integrity protection in the UE.

Information Element/Group name	Need	Multi	Type and reference	Semantics description
Historical status	MP		Enumerated(Never been active, Has been active)	Set to "Never been active" when entering UTRA RRC connected mode.
Status	MP		Enumerated(Not started, Started)	Set to "Not started" when entering UTRA RRC connected mode. Set to "Not started" when leaving UTRA RRC connected mode.
Reconfiguration	MP		Boolean	TRUE means a reconfiguration of integrity protection is ongoing. Set to FALSE when entering UTRA RRC connected mode. Set to FALSE when leaving UTRA RRC connected mode.
Signalling radio bearer specific integrity protection information	OP	1 to <maxSRBs etup>		When integrity protection is started, status information for RB0- RB4 in that order. Cleared when entering UTRA RRC connected mode. Cleared when leaving UTRA RRC connected mode.
>Uplink RRC HFN	MP		Bit string (28)	
>Downlink RRC HFN	MP		Bit string (28)	
>Uplink RRC Message sequence number	MP		Integer (0.. 15)	
>Downlink RRC Message sequence number	OP		Integer (0.. 15)	

13.4.11 INVALID_CONFIGURATION

This variable indicates whether a received message contained an invalid configuration, by means of invalid values or invalid combinations of information elements.

Information Element/Group name	Need	Multi	Type and reference	Semantics description
Invalid configuration	MP		Boolean	TRUE: An invalid configuration has been detected. Set to FALSE when entering UTRA RRC connected mode. Set to FALSE when leaving UTRA RRC connected mode.

13.4.11a LATEST_CONFIGURED_CN_DOMAIN

This variable stores the CN-domain that was most recently configured to be used for ciphering and integrity protection.

Information Element/Group name	Need	Multi	Type and reference	Semantics description
Latest configured CN domain	OP		CN domain identity 10.3.1.1	Cleared when entering UTRA RRC connected mode when not stated otherwise in the procedure. Cleared when leaving UTRA RRC connected mode.

13.4.12 MEASUREMENT_IDENTITY

This variable stores the measurements configured in the UE. For each configured measurement, the information below shall be stored.

Information Element/Group name	Need	Multi	Type and reference	Semantics description
MEASUREMENT CONTROL	OP		MEASUREMENT CONTROL 10.2.17, System Information Block type 11 10.2.48.8.12, System Information Block type 12 10.2.48.8.13	Information as contained in these messages. Cleared when entering UTRA RRC connected mode when not stated otherwise in the procedure (8.4.1.8-8.4.1.9). Cleared when leaving UTRA RRC connected mode when not stated otherwise in the procedure (8.4.1.9a).

13.4.13 Void

13.4.14 ORDERED_RECONFIGURATION

This variable stores information about an ongoing Reconfiguration procedure.

Information Element/Group name	Need	Multi	Type and reference	Semantics description
Ordered reconfiguration	MP		Boolean	TRUE means that a Reconfiguration procedure is ongoing. Set to FALSE when entering UTRA RRC connected mode. Set to FALSE when leaving UTRA RRC connected mode.

13.4.15 PDCP_SN_INFO

This variable contains PDCP receive sequence numbers for one or several radio bearers to be included in a response message to UTRAN.

Information Element/Group name	Need	Multi	Type and reference	Semantics description
RB with PDCP information list	OP	1 to <maxRBall RABs>		Cleared when entering UTRA RRC connected mode. Cleared when leaving UTRA RRC connected mode.
>RB with PDCP information	MP		RB with PDCP information 10.3.4.22	

13.4.16 PROTOCOL_ERROR_INDICATOR

This variable indicates whether there exist a protocol error that is to be reported to UTRAN.

Information Element/Group name	Need	Multi	Type and reference	Semantics description
Protocol error indicator	MP		Protocol error indicator 10.3.3.27	Set to FALSE when entering UTRA RRC connected mode. Set to FALSE when leaving UTRA RRC connected mode.

13.4.17 PROTOCOL_ERROR_INFORMATION

This variable contains diagnostics to be reported to UTRAN for a message that was not completely understood.

Information Element/Group name	Need	Multi	Type and reference	Semantics description
Protocol error information	OP		Protocol error information 10.3.8.12	Cleared when entering UTRA RRC connected mode. Cleared when leaving UTRA RRC connected mode.

13.4.18 PROTOCOL_ERROR_REJECT

This variable indicates whether there has occurred a severe protocol error causing the ongoing procedure to fail.

Information Element/Group name	Need	Multi	Type and reference	Semantics description
Protocol error reject	MP		Boolean	TRUE: a severe protocol error has occurred. Set to FALSE when entering UTRA RRC connected mode. Set to FALSE when leaving UTRA RRC connected mode.

13.4.19 RB_TIMER_INDICATOR

This variable contains information to be sent to UTRAN if any of the timers T314 or T315 has expired when the UE sends a cell update with cause RL failure.

Information Element/Group name	Need	Multi	Type and reference	Semantics description
RB timer indicator	OP		RB timer indicator 10.3.3.28	Cleared when entering UTRA RRC connected mode. Cleared when leaving UTRA RRC connected mode.

13.4.20 RB_UPLINK_CIPHERING_ACTIVATION_TIME_INFO

This variable contains information to be sent to UTRAN about when a new ciphering configuration shall be activated in the uplink for radio bearers using RLC-AM or RLC-UM.

Information Element/Group name	Need	Multi	Type and reference	Semantics description
RB uplink ciphering activation time info	OP		RB activation time info 10.3.4.13	Cleared when entering UTRA RRC connected mode. Cleared when leaving UTRA RRC connected mode.

13.4.21 SELECTED_PLMN

This variable contains the type of and identity of the selected PLMN.

Information Element/Group name	Need	Multi	Type and reference	Semantics description
PLMN Type	MP		PLMN Type 10.3.1.12	
CHOICE <i>identity type</i>	MP			
>PLMN identity			PLMN identity 10.3.1.11	
>SID			SID 10.3.9.11	

CHOICE <i>identity type</i>	Condition under which the given <i>identity type</i> is chosen
PLMN identity	PLMN Type is "GSM-MAP"
SID	PLMN Type is "ANSI-41"

13.4.22 START_THRESHOLD

This variable contains information about the maximum allowed value of the START for a CN domain.

Information Element/Group name	Need	Multi	Type and reference	Semantics description
THRESHOLD	OP		Integer (0..1048576)	20 bits. Cleared when entering UTRA RRC connected mode when not stated otherwise in the procedure. Cleared when leaving UTRA RRC connected mode.

13.4.23 START_VALUE_TO_TRANSMIT

This variable contains the value of START for new radio bearer(s) to be transmitted in a response message.

Information Element/Group name	Need	Multi	Type and reference	Semantics description
START	OP		START 10.3.3.38	Cleared when entering UTRA RRC connected mode. Cleared when leaving UTRA RRC connected mode.

13.4.24 TFC_SUBSET

This variable contains information about the TFC subset currently applied.

Information Element/Group name	Need	Multi	Type and reference	Semantics description
CHOICE <i>mode</i>	MP			
>FDD				
>>Current TFC subset	MP		Transport Format Combination Subset 10.3.5.22	Set to "Full transport format set" when entering UTRA RRC connected mode when not stated otherwise in the procedure.
>>>Duration	OP		TFC Control duration 10.3.6.80	Cleared when entering UTRA RRC connected mode. Cleared when leaving UTRA RRC connected mode.
>>>>Default TFC subset	OP		Transport Format Combination Subset 10.3.5.22	The TFC subset to go back to when any temporary limitation is released. Cleared when entering UTRA RRC connected mode. Cleared when leaving UTRA RRC connected mode.
>TDD				
>>TFCS list	MP	1 to < maxCCTrC H >		One TFCS is created when entering UTRA RRC connected mode when not stated otherwise in the procedure.
>>>TFCS identity	MP		Transport Format Combination Set Identity 10.3.5.21	"TFCS ID" is set to 1 when entering UTRA RRC connected mode when not stated otherwise in the procedure. "Shared channel indicator" is set to FALSE when entering UTRA RRC connected mode when not stated otherwise in the procedure.
>>>>Current TFC subset	MP		Transport Format Combination Subset 10.3.5.22	Set to "Full transport format set" when entering UTRA RRC connected mode when not stated otherwise in the procedure.
>>>>>Duration	OP		TFC Control duration 10.3.6.80	Cleared when entering UTRA RRC connected mode. Cleared when leaving UTRA RRC connected mode.
>>>>>>Default TFC subset	OP		Transport Format Combination Subset 10.3.5.22	The TFC subset to go back to when any temporary limitation is released. Cleared when entering UTRA RRC connected mode. Cleared when leaving UTRA RRC connected mode.

13.4.25 TGPS_IDENTITY

This variable contains the configuration parameters of a compressed mode transmission gap pattern sequence

Information Element/Group name	Need	Multi	Type and reference	Semantics description
TGPS_IDENTITY	OP		DPCH compressed mode info 10.3.6.33	Information as contained in the IE group "Transmission gap pattern sequence configuration parameters". Cleared when entering UTRA RRC connected mode. Cleared when leaving UTRA RRC connected mode.
TGPS Status Flag	MP		Enumerated(active, inactive)	This flag indicates the current status of the Transmission Gap Pattern Sequence

13.4.26 TGSN_REPORTED

This variable specifies whether an IE "Proposed TGSN" was reported to the UTRAN

Information Element/Group name	Need	Multi	Type and reference	Semantics description
Proposed TGSN reported	MP		Boolean	Set to FALSE when entering UTRA RRC connected mode. Set to FALSE when leaving UTRA RRC connected mode.

13.4.26a TIMERS_AND_CONSTANTS

This variable contains the values for all timers and constants used in connected mode.

Information Element/Group name	Need	Multi	Type and reference	Semantics description
UE Timers and constants in connected mode	MD		UE Timers and constants in connected mode 10.3.3.43	Default value means that for all timers and constants - for parameters with need MD, the defaults specified in 10.3.3.43 apply and - for parameters with need OP, the parameters are absent. All parameters are set to the default value when leaving UTRA RRC connected mode to another RAT.

13.4.27 TRANSACTIONS

This variable stores the identifications of the ongoing RRC procedure transactions.

Information Element/Group name	Need	Multi	Type and reference	Semantics description
Accepted transactions	OP	1 to <maxtrans actions>		Cleared when leaving UTRA RRC connected mode.
>Message type	MP		Message Type	
>RRC transaction identifier	MP		RRC transaction identifier 10.3.3.36	
Rejected transactions	OP	1 to <maxtrans actions>		Cleared when leaving UTRA RRC connected mode.
>Message type	MP		Message Type	
>RRC transaction identifier	MP		RRC transaction identifier 10.3.3.36	

13.4.27a TRIGGERED_1A_EVENT

This variable contains information about a 1a event that has been triggered in the UE. There is one such variable per 1a event configured in the UE.

Information Element/Group name	Need	Multi	Type and reference	Semantics description
Cells triggered	OP	1 to <maxCellMeas>		Cleared when entering UTRA RRC connected mode. Cleared when leaving UTRA RRC connected mode.
>primary CPICH	MP		Primary CPICH info 10.3.6.60	
>sent reports	MP		Integer(1..Infinity)	Number of reports sent to UTRAN in case of event triggered periodical reporting
Cells recently triggered	OP	1 to <maxCellMeas>		
>primary CPICH	MP		Primary CPICH info 10.3.6.60	
>sent reports	MP		Integer(1..Infinity)	Number of reports sent to UTRAN in case of event triggered periodical reporting
Periodical reporting running	MP		Boolean	

13.4.27b TRIGGERED_1B_EVENT

This variable contains information about a 1b event that has been triggered in the UE. There is one such variable per 1b event configured in the UE.

Information Element/Group name	Need	Multi	Type and reference	Semantics description
Cells triggered	OP	1 to < maxCellMeas>		Cleared when entering UTRA RRC connected mode. Cleared when leaving UTRA RRC connected mode.
>primary CPICH	MP		Primary CPICH info 10.3.6.60	
Cells recently triggered	OP	1 to < maxCellMeas>		
>primary CPICH	MP		Primary CPICH info 10.3.6.60	

13.4.27c TRIGGERED_1C_EVENT

This variable contains information about a 1c event that has been triggered in the UE. There is one such variable per 1c event configured in the UE.

Information Element/Group name	Need	Multi	Type and reference	Semantics description
Cells triggered	OP	1 to < maxCellMeas>		Cleared when entering UTRA RRC connected mode. Cleared when leaving UTRA RRC connected mode.
>primary CPICH	MP		Primary CPICH info 10.3.6.60	
>sent reports	MP		Integer(1..Infinity)	Number of reports sent to UTRAN in case of event triggered periodical reporting
Cells recently triggered	OP	1 to < maxCellMeas>		
>primary CPICH	MP		Primary CPICH info 10.3.6.60	
>sent reports	MP		Integer(1..Infinity)	Number of reports sent to UTRAN in case of event triggered periodical reporting
Periodical reporting running	MP		Boolean	

13.4.27d BEST_CELL_1D_EVENT

This variable contains information about a 1d event that has been triggered in the UE. There is one such variable per 1d event configured in the UE.

Information Element/Group name	Need	Multi	Type and reference	Semantics description
Best cell	OP		Primary CPICH info 10.3.6.60	Cleared when entering UTRA RRC connected mode. Cleared when leaving UTRA RRC connected mode.

13.4.27e TRIGGERED_1E_EVENT

This variable contains information about a 1e event that has been triggered in the UE. There is one such variable per 1e event configured in the UE.

Information Element/Group name	Need	Multi	Type and reference	Semantics description
Cells triggered	OP	1 to < maxCellMeas>		Cleared when entering UTRA RRC connected mode. Cleared when leaving UTRA RRC connected mode.
>primary CPICH	MP		Primary CPICH info 10.3.6.60	
Cells recently triggered	OP	1 to < maxCellMeas>		
>primary CPICH	MP		Primary CPICH info 10.3.6.60	

13.4.27f TRIGGERED_1F_EVENT

This variable contains information about a 1f event that has been triggered in the UE. There is one such variable per 1f event configured in the UE.

Information Element/Group name	Need	Multi	Type and reference	Semantics description
Cells triggered	OP	1 to < maxCellMeas>		Cleared when entering UTRA RRC connected mode. Cleared when leaving UTRA RRC connected mode.
>primary CPICH	MP		Primary CPICH info 10.3.6.60	
Cells recently triggered	OP	1 to < maxCellMeas>		
>primary CPICH	MP		Primary CPICH info 10.3.6.60	

13.4.27f1 TRIGGERED_1G_EVENT

This variable contains information about a 1g event that has been triggered in the UE.

Information Element/Group name	Need	Multi	Type and reference	Semantics description
Cells triggered	OP	1 to < maxCellMeas>		
>Primary CCPCH info	MP		Primary CCPCH info 10.3.6.57	

13.4.27f2 TRIGGERED_1H_EVENT

This variable contains information about a 1h event that has been triggered in the UE.

Information Element/Group name	Need	Multi	Type and reference	Semantics description
Cells triggered	OP	1 to < maxCellMeas>		
>Primary CCPCH info	MP		Primary CCPCH info 10.3.6.57	

13.4.27f3 TRIGGERED_1I_EVENT

This variable contains information about a 1i event that has been triggered in the UE.

Information Element/Group name	Need	Multi	Type and reference	Semantics description
Cells triggered	OP	1 to < maxCellMeas>		
>Primary CCPCH info	MP		Primary CCPCH info 10.3.6.57	

13.4.27f4 BEST_FREQUENCY_2A_EVENT

This variable contains information about a 2a event that has been configured in the UE. There is one such variable per 2a event configured in the UE.

Information Element/Group name	Need	Multi	Type and reference	Semantics description
Best frequency	MP		Frequency info 10.3.6.36	

13.4.27f5 TRIGGERED_2B_EVENT

This variable contains information about a 2b event that has been configured in the UE. There is one such variable per 2b event configured in the UE.

Information Element/Group name	Need	Multi	Type and reference	Semantics description
Frequency triggered	OP	1 to < maxCellMeas>		
>Frequency	MP	Frequency info 10.3.6.36		

13.4.27f6 TRIGGERED_2C_EVENT

This variable contains information about a 2c event that has been configured in the UE. There is one such variable per 2c event configured in the UE.

Information Element/Group name	Need	Multi	Type and reference	Semantics description
Frequency triggered	OP	1 to < maxCellMeas>		
>Frequency	MP	Frequency info 10.3.6.36		

13.4.27f7 TRIGGERED_2D_EVENT

This variable contains information about a 2d event that has been configured in the UE. There is one such variable per 2d event configured in the UE.

Information Element/Group name	Need	Multi	Type and reference	Semantics description
Event triggered	OP		Boolean	

13.4.27f8 TRIGGERED_2E_EVENT

This variable contains information about a 2e event that has been configured in the UE. There is one such variable per 2e event configured in the UE.

Information Element/Group name	Need	Multi	Type and reference	Semantics description
Frequency triggered	OP	1 to < maxCellMeas>		
>Frequency	MP	Frequency info 10.3.6.36		

13.4.27f9 TRIGGERED_2F_EVENT

This variable contains information about a 2f event that have been configured in the UE. There is one such variable per 2f event configured in the UE.

Information Element/Group name	Need	Multi	Type and reference	Semantics description
Event triggered	OP		Boolean	

13.4.27f10 TRIGGERED_3A_EVENT

This variable contains information about a 3a event that has been configured in the UE. There is one such variable per event 3a configured in the UE.

Information Element/Group name	Need	Multi	Type and reference	Semantics description
CHOICE <i>system</i>	OP			
>GSM				
>>CHOICE <i>BSIC</i>	MP			
>>>Verified BSIC		0 to <maxCellMeas>		
>>>>Inter-RAT cell id	MP		Integer(0..<maxCellMeas>-1)	
>>>Non verified BSIC		0 to <maxCellMeas>		
>>>>BCCH ARFCN	MP		Integer (0..1023)	

13.4.27f11 TRIGGERED_3B_EVENT

This variable contains information about a 3b event that has been configured in the UE. There is one such variable per event 3b configured in the UE.

Information Element/Group name	Need	Multi	Type and reference	Semantics description
CHOICE <i>system</i>	OP			
>GSM				
>>CHOICE <i>BSIC</i>	MP			
>>>Verified BSIC		0 to <maxCellMeas>		
>>>>Inter-RAT cell id	MP		Integer(0..<maxCellMeas>-1)	
>>>Non verified BSIC		0 to <maxCellMeas>		
>>>>BCCH ARFCN	MP		Integer (0..1023)	

13.4.27f12 TRIGGERED_3C_EVENT

This variable contains information about a 3c event that has been configured in the UE. There is one such variable per event 3c configured in the UE.

Information Element/Group name	Need	Multi	Type and reference	Semantics description
CHOICE <i>system</i>	OP			
>GSM				
>>CHOICE <i>BSIC</i>	MP			
>>>Verified BSIC		0 to <maxCellMeas>		
>>>>Inter-RAT cell id	MP		Integer(0..<maxCellMeas>-1)	
>>>Non verified BSIC		0 to <maxCellMeas>		
>>>>BCCH ARFCN	MP		Integer (0..1023)	

13.4.27f13 BEST_CELL_3D_EVENT

This variable contains information about a 3d event that has been configured in the UE. There is one such variable per event 3a configured in the UE.

Information Element/Group name	Need	Multi	Type and reference	Semantics description
CHOICE <i>system</i>				
>GSM				
>>CHOICE <i>BSIC</i>	MP			
>>>Verified BSIC				
>>>>Inter-RAT cell id	MP		Integer(0..<maxCellMeas>-1)	
>>>Non verified BSIC				
>>>>BCCH ARFCN	MP		Integer (0..1023)	

13.4.27g UE_CAPABILITY_REQUESTED

This variable stores information about the UE capabilities that have been requested by UTRAN but that have not yet been transferred to UTRAN.

Information Element/Group name	Need	Multi	Type and reference	Semantics description
UE radio access capability	OP		UE radio access capability 10.3.3.42	Cleared when entering UTRA RRC connected mode. Cleared when leaving UTRA RRC connected mode.
UE radio access capability extension	OP		UE radio access capability extension 10.3.3.42a	Cleared when entering UTRA RRC connected mode. Cleared when leaving UTRA RRC connected mode.
UE system specific capability	OP	1 to <maxInterSystemMessages>	Inter-RAT UE radio access capability 10.3.8.7	Includes inter-RAT classmark. Cleared when entering UTRA RRC connected mode. Cleared when leaving UTRA RRC connected mode.
>Inter-RAT UE radio access capability	MP		Inter-RAT UE radio access capability 10.3.8.7	

13.4.28 UE_CAPABILITY_TRANSFERRED

This variable stores information about which UE capabilities that have been transferred to UTRAN.

Information Element/Group name	Need	Multi	Type and reference	Semantics description
UE radio access capability	OP		UE radio access capability 10.3.3.42	Cleared when entering UTRA RRC connected mode when not stated otherwise in the procedure. Cleared when leaving UTRA RRC connected mode.
UE radio access capability extension	OP		UE radio access capability extension 10.3.3.42a	Cleared when entering UTRA RRC connected mode when not stated otherwise in the procedure. Cleared when leaving UTRA RRC connected mode.
UE system specific capability	OP	1 to <maxSystemCapability>	Inter-RAT UE radio access capability 10.3.8.7	Includes inter-RAT classmark. Cleared when entering UTRA RRC connected mode when not stated otherwise in the procedure. Cleared when leaving UTRA RRC connected mode.
>Inter-RAT UE radio access capability	MP		Inter-RAT UE radio access capability 10.3.8.7	

13.4.28a UE_POSITIONING_GPS_DATA

Information Element/Group name	Need	Multi	Type and reference	Semantics description
GPS Data ciphering info	OP		UE positioning Cipher info 10.3.7.86	
UE positioning GPS reference time	OP		UE positioning GPS reference time 10.3.7.96	
UE positioning GPS reference UE position	OP		Ellipsoid point with altitude and uncertainty ellipsoid 10.3.8.4c	A priori knowledge of UE 3-D position.
UE positioning GPS DGPS corrections	OP		UE positioning GPS DGPS corrections 10.3.7.91	
UE positioning GPS navigation model	OP			
>SatID	MP		Enumerated(0..63)	Satellite ID
>GPS Ephemeris and Clock Correction parameters	MP		UE positioning GPS Ephemeris and Clock Correction parameters 10.3.7.91a	
UE positioning GPS ionospheric model	OP		UE positioning GPS ionospheric model 10.3.7.92	
UE positioning GPS UTC model	OP		UE positioning GPS UTC model 10.3.7.97	
UE positioning GPS almanac	OP		UE positioning GPS almanac 10.3.7.89	
UE positioning GPS acquisition assistance	OP		UE positioning GPS acquisition assistance 10.3.7.88	
UE positioning GPS real-time integrity	OP		UE positioning GPS real-time integrity 10.3.7.95	

13.4.28b UE_POSITIONING_OTDOA_DATA

Information Element/Group name	Need	Multi	Type and reference	Semantics description
OTDOA Data ciphering info	OP		UE positioning Ciphering info 10.3.7.86	
UE positioning OTDOA reference cell info	OP		UE positioning OTDOA reference cell info 10.3.7.108	
UE positioning OTDOA neighbour cell list	OP	1 to <maxCellMeas>		
>UE positioning OTDOA neighbour cell info	MP		UE positioning OTDOA neighbour cell info 10.3.7.106	

13.4.29 UNSUPPORTED_CONFIGURATION

This variable indicates whether a received message contained a configuration that is not supported by the UE.

Information Element/Group name	Need	Multi	Type and reference	Semantics description
Unsupported configuration	MP		Boolean	TRUE: An unsupported configuration has been detected. Set to FALSE when entering UTRA RRC connected mode. Set to FALSE when leaving UTRA RRC connected mode.

13.4.30 URA_IDENTITY

This variable stores the assigned URA identity for this UE when in URA_PCH state.

Information Element/Group name	Need	Multi	Type and reference	Semantics description
URA identity	OP		URA identity 10.3.2.6	Cleared when entering UTRA RRC connected mode. Cleared when leaving UTRA RRC connected mode.

13.4.31 U_RNTI

This variable stores the assigned U-RNTI for this UE.

Information Element/Group name	Need	Multi	Type and reference	Semantics description
U-RNTI	OP		U-RNTI 10.3.3.47	Cleared when leaving UTRA RRC connected mode.

13.4.32 VALUE_TAG

This variable contains information about the value tag for the last received system information block of a given type, for all system information blocks using value tags. The UE shall maintain one instance of this variable for the current selected cell. The UE may store several instances of this variable, one for each cell, to be used if the UE returns to these cells.

All IEs in this variable shall be cleared when switched off and as well as at selection of a new PLMN.

Information Element/Group name	Need	Multi	Type and reference	Semantics description
MIB value tag	OP		MIB value tag 10.3.8.9	Value tag for the master information block
SB 1 value tag	OP		Cell value tag 10.3.8.4	Value tag for the scheduling block type 1
SB 2 value tag	OP		Cell value tag 10.3.8.4	Value tag for the scheduling block type 2
SIB 1 value tag	CV-GSM		PLMN value tag 10.3.8.10	Value tag for the system information block type 1
SIB 2 value tag	OP		Cell value tag 10.3.8.4	Value tag for the system information block type 2
SIB 3 value tag	OP		Cell value tag 10.3.8.4	Value tag for the system information block type 3
SIB 4 value tag	OP		Cell value tag 10.3.8.4	Value tag for the system information block type 4
SIB 5 value tag	OP		Cell value tag 10.3.8.4	Value tag for the system information block type 5
SIB 6 value tag	OP		Cell value tag 10.3.8.4	Value tag for the system information block type 6
CHOICE mode	MP			
>FDD				
>>SIB 8 value tag	OP		Cell value tag 10.3.8.4	Value tag for the system information block type 8
>TDD				(no data)
SIB 11 value tag	OP		Cell value tag 10.3.8.4	Value tag for the system information block type 11
SIB 12 value tag	OP		Cell value tag 10.3.8.4	Value tag for the system information block type 12
SIB 13 value tag	CV-ANSI		Cell value tag 10.3.8.4	Value tag for the system information block type 13
SIB 13.1 value tag	CV-ANSI		Cell value tag 10.3.8.4	Value tag for the system information block type 13.1
SIB 13.2 value tag	CV-ANSI		Cell value tag 10.3.8.4	Value tag for the system information block type 13.2
SIB 13.3 value tag	CV-ANSI		Cell value tag 10.3.8.4	Value tag for the system information block type 13.3
SIB 13.4 value tag	CV-ANSI		Cell value tag 10.3.8.4	Value tag for the system information block type 13.4
SIB 15 value tag	OP		Cell value tag 10.3.8.4	Value tag for the system information block type 15
SIB 15.1 value tag	OP		Cell value tag 10.3.8.4	Value tag for the system information block type 15.1
SIB 15.2 value tag list	OP	1 to <maxSat>		List of value tags for all stored occurrences of system information block type 15.2
>SIB 15.2 value tag	MP		Cell value tag 10.3.8.4	
>SIB occurrence identity and value tag	MP		SIB occurrence identity and value tag 10.3.8.20b	
SIB 15.3 value tag list	OP	1 to <maxSat>		List of value tags for all stored occurrences of system information block type 15.3
>SIB 15.3 value tag	MP		PLMN value tag 10.3.8.10	Value tag for the system information block type 15.3
>SIB occurrence identity and value tag	MP		SIB occurrence identity and value tag 10.3.8.20b	
SIB 15.4 value tag	OP		Cell value tag 10.3.8.4	Value tag for the system information block type 15.4
SIB 16 value tag list	OP	1 to <maxPred		List of value tags for all stored occurrences of the system

		efConfig>		information block type 16
>Predefined configuration identity and value tag	MP		Predefined configuration identity and value tag 10.3.8.11	
SIB 18 value tag	OP		Cell value tag 10.3.8.4	Value tag for the system information block type 18

Condition	Explanation
<i>GSM</i>	This information is optional when the PLMN Type in the variable SELECTED_PLMN is "GSM-MAP" and never stored otherwise.
<i>ANSI</i>	This information is optional when the PLMN Type in the variable SELECTED_PLMN is "ANSI-41" and never stored otherwise.

13.5 UE RRC Procedure Performance

This subclause defines the performance requirements related to RRC procedures in the UE. Where the total delay is impacted by processing of variable length on the physical layer (e.g. physical layer synchronisation), references to appropriate specifications are given.

13.5.1 Definitions

The following definitions of N1 and N2 are valid only for this UE RRC Procedure Performance specification.

N1 = upper limit on the time required to execute modifications in UE after the reception of a UTRAN -> UE message has been completed. Where applicable (e.g. the physical layer transmission is impacted), the changes shall be adopted in the beginning of the next TTI starting after N1. N1 is specified as a multiple of 10 ms.

N2 = number of 10 ms radio frames from end of reception of UTRAN -> UE message on UE physical layer before the transmission of the UE -> UTRAN response message must be ready to start on a transport channel with no access delay other than the TTI alignment (e.g. DCH, therefore excluding delays caused by RACH procedure etc). The UE response message transmission from the physical layer shall begin at the latest $(N2 \cdot 10) + TTI$ ms after completion of the reception of the last TTI carrying the triggering UTRAN -> UE message. When Target State is CELL_DCH, the UE response message transmission from the physical layer may be additionally delayed by the value of IE "SRB delay".

N1 and N2 are independent (e.g. $N2 - N1$ is not restricted to being less than or equal to 10ms).

13.5.2 RRC procedure performance values

NOTE: Times indicated in the table do not include cell reselection.

Procedure title:	UTRAN -> UE	UE -> UTRAN	N1	N2	Notes
RRC Connection Management Procedures					
Broadcast of system information	SYSTEM INFORMATION				N2 is not applicable for any system information messages, because there is no response message from the UE.
Master Information Block	SYSTEM INFORMATION		5	NA	No system information data shall be lost due to processing of a MIB received with no detectable errors. This means that the UE shall buffer all system information data received after the MIB until the data can be processed according to the information in the MIB, unless the MIB was received erroneously.
System Information Block type 1	SYSTEM INFORMATION		10	NA	
System Information Block type 2	SYSTEM INFORMATION		10	NA	
System Information Block type 3	SYSTEM INFORMATION		10	NA	
System Information Block type 4	SYSTEM INFORMATION		10	NA	
System Information Block type 5	SYSTEM INFORMATION		10	NA	
System Information Block type 6	SYSTEM INFORMATION		10	NA	
System Information Block type 7	SYSTEM INFORMATION		5	NA	
System Information Block type 8	SYSTEM INFORMATION		10	NA	
System Information Block type 9	SYSTEM INFORMATION		5	NA	
System Information Block type 10	SYSTEM INFORMATION		5	NA	
System Information Block type 11	SYSTEM INFORMATION		10	NA	
System Information Block type 12	SYSTEM INFORMATION		10	NA	
System Information Block type 13	SYSTEM INFORMATION		10	NA	
System Information Block type 14	SYSTEM INFORMATION		10	NA	
System Information Block type 15	SYSTEM INFORMATION		10	NA	
System Information Block type 16	SYSTEM INFORMATION		10	NA	
System Information Block type 18	SYSTEM INFORMATION		10	NA	
RRC connection establishment <i>Target state CELL_DCH</i>	RRC CONNECTION SETUP	RRC CONNECTION SETUP COMPLETE	10	NA	N1 measures time to the start of tx / rx on DPCH. N2 cannot be specified, because RRC CONNECTION SETUP COMPLETE message is transmitted only after physical layer synchronisation, which also depends on the Node B. The performance of the physical layer synchronisation procedure is specified in [19] and [20]

RRC connection establishment <i>Target state CELL_FACH</i>	RRC CONNECTION SETUP	RRC CONNECTION SETUP COMPLETE	10	11	N1 and N2 applicable as defined (N2 can be tested from the initiation of the power ramp on RACH).
RRC connection release <i>From CELL_DCH state</i>	RRC CONNECTION RELEASE	RRC CONNECTION RELEASE COMPLETE	5	8	N1 sets the requirement for the time from the completion of the last repetition of the RRC CONNECTION RELEASE COMPLETE message to the release of the physical channel. N2 sets the requirement from the end of successful reception of the RRC CONNECTION RELEASE message to the start of the first transmission of the RRC CONNECTION RELEASE COMPLETE message.
RRC connection release <i>From CELL_FACH state</i>	RRC CONNECTION RELEASE	RRC CONNECTION RELEASE COMPLETE	NA	11	N1 represents UE internal configuration that cannot be externally observed.
Paging	PAGING TYPE 1	CELL UPDATE	10	11+ T	T is the repetition period of SIB7 (applicable for FDD) and SIB14 (applicable for TDD)
UE capability enquiry	UE CAPABILITY ENQUIRY	UE CAPABILITY INFORMATION	NA	8	N1 is not applicable because the UE configuration does not change.
Security mode control	SECURITY MODE COMMAND	SECURITY MODE COMPLETE	5	8	
Signalling connection release procedure	SIGNALLING CONNECTION RELEASE		5	NA	N2 is not applicable because there is no response message.
Counter check	COUNTER CHECK	COUNTER CHECK RESPONSE	NA	8	N1 is not applicable because the UE configuration does not change.
Radio Bearer control procedures					
Radio bearer establishment <i>Target state CELL_DCH</i>	RADIO BEARER SETUP	RADIO BEARER SETUP COMPLETE / FAILURE	10	NA	N2 cannot be specified, because the RADIO BEARER SETUP COMPLETE / FAILURE message is transmitted only after physical layer synchronisation, which depends also on Node B.
Radio bearer establishment <i>From state CELL_FACH to state CELL_FACH</i>	RADIO BEARER SETUP	RADIO BEARER SETUP COMPLETE / FAILURE	10	11	
Radio bearer establishment <i>From CELL_DCH to CELL_FACH</i>	RADIO BEARER SETUP	RADIO BEARER SETUP COMPLETE	NA	NA	N1 and N2 cannot be specified, because UE need to read SIBs on BCH before sending RADIO BEARER SETUP COMPLETE
Radio bearer reconfiguration <i>Target state CELL_DCH</i>	RADIO BEARER RECONFIGURATION	RADIO BEARER RECONFIGURATION COMPLETE / FAILURE	10	NA	N2 cannot be specified, because the RADIO BEARER RECONFIGURATION COMPLETE / FAILURE message is transmitted only after physical layer synchronisation, which depends also on Node B.

Radio bearer reconfiguration <i>From state CELL_FACH to state CELL_FACH</i>	RADIO BEARER RECONFIGURATION	RADIO BEARER RECONFIGURATION COMPLETE / FAILURE	10	11	
Radio bearer reconfiguration <i>From state CELL_DCH to state CELL_FACH</i>	RADIO BEARER RECONFIGURATION	RADIO BEARER RECONFIGURATION COMPLETE	NA	NA	N1 and N2 cannot be specified, because UE need to read SIBs on BCH before sending RADIO BEARER RECONFIGURATION COMPLETE
Radio bearer release <i>Target state CELL_DCH</i>	RADIO BEARER RELEASE	RADIO BEARER RELEASE COMPLETE / FAILURE	10	11	
Radio bearer release <i>From state CELL_FACH to state CELL_FACH</i>	RADIO BEARER RELEASE	RADIO BEARER RELEASE COMPLETE / FAILURE	10	11	
Radio bearer release <i>From state CELL_DCH to state CELL_FACH</i>	RADIO BEARER RELEASE	RADIO BEARER RELEASE COMPLETE	NA	NA	N1 and N2 cannot be specified, because UE need to read SIBs on BCH before sending RADIO BEARER RECONFIGURATION COMPLETE
Transport channel reconfiguration <i>Target state CELL_DCH</i>	TRANSPORT CHANNEL RECONFIGURATION	TRANSPORT CHANNEL RECONFIGURATION COMPLETE / FAILURE	10	NA	N2 cannot be specified, because the TRANSPORT CHANNEL RECONFIGURATION COMPLETE / FAILURE message is transmitted only after physical layer synchronisation, which depends also on Node B.
Transport channel reconfiguration <i>From state CELL_FACH to state CELL_FACH</i>	TRANSPORT CHANNEL RECONFIGURATION	TRANSPORT CHANNEL RECONFIGURATION COMPLETE / FAILURE	10	11	
Transport channel reconfiguration <i>From state CELL_DCH to state CELL_FACH</i>	TRANSPORT CHANNEL RECONFIGURATION	TRANSPORT CHANNEL RECONFIGURATION COMPLETE	NA	NA	N1 and N2 cannot be specified, because UE need to read SIBs on BCH before sending TRANSPORT CHANNEL RECONFIGURATION COMPLETE
Transport format combination control <i>AM or UM RLC mode</i>	TRANSPORT FORMAT COMBINATION CONTROL	TRANSPORT FORMAT COMBINATION CONTROL FAILURE	5	8	
Transport format combination control <i>Transparent mode</i>	TRANSPORT FORMAT COMBINATION CONTROL		5	NA	N2 is not applicable because no response message is defined.
Physical channel reconfiguration <i>Target state CELL_DCH</i>	PHYSICAL CHANNEL RECONFIGURATION	PHYSICAL CHANNEL RECONFIGURATION COMPLETE / FAILURE	8	NA	N2 cannot be specified, because the PHYSICAL CHANNEL RECONFIGURATION COMPLETE / FAILURE message is transmitted only after physical layer synchronisation, which depends also on Node B.

Physical channel reconfiguration <i>From state CELL_FACH to state CELL_FACH</i>	PHYSICAL CHANNEL RECONFIGURATION	PHYSICAL CHANNEL RECONFIGURATION COMPLETE / FAILURE	8	9	
Physical channel reconfiguration <i>From state CELL_DCH to state CELL_FACH</i>	PHYSICAL CHANNEL RECONFIGURATION	PHYSICAL CHANNEL RECONFIGURATION COMPLETE	NA	NA	N1 and N2 cannot be specified, because UE need to read SIBs on BCH before sending PHYSICAL CHANNEL RECONFIGURATION COMPLETE
Physical Shared Channel Allocation [TDD only]	PHYSICAL SHARED CHANNEL ALLOCATION		5	NA	N2 is not applicable because no response message is defined.
Uplink Physical Channel Control [TDD only]	UPLINK PHYSICAL CHANNEL CONTROL		NA	NA	Requirements for outer loop and timing advance adjustments are defined in [22] and [20].
RRC connection mobility procedures					
Cell update	CELL UPDATE CONFIRM	UTRAN MOBILITY INFORMATION CONFIRM	5	8	
		PHYSICAL CHANNEL RECONFIGURATION COMPLETE <i>Target state CELL_FACH</i>	8	9	
		PHYSICAL CHANNEL RECONFIGURATION COMPLETE <i>Target state CELL_DCH</i>	8	NA	N2 cannot be specified, because the PHYSICAL CHANNEL RECONFIGURATION COMPLETE / FAILURE message is transmitted only after physical layer synchronisation, which depends also on Node B.
		TRANSPORT CHANNEL RECONFIGURATION COMPLETE <i>Target state CELL_FACH</i>	10	11	
		TRANSPORT CHANNEL RECONFIGURATION COMPLETE <i>Target state CELL_DCH</i>	10	NA	N2 cannot be specified, because the PHYSICAL CHANNEL RECONFIGURATION COMPLETE / FAILURE message is transmitted only after physical layer synchronisation, which depends also on Node B.
		RADIO BEARER RECONFIGURATION COMPLETE <i>Target state CELL_FACH</i>	10	11	

		RADIO BEARER RECONFIGURATION COMPLETE <i>Target state</i> CELL_DCH	10	NA	N2 cannot be specified, because the PHYSICAL CHANNEL RECONFIGURATION COMPLETE / FAILURE message is transmitted only after physical layer synchronisation, which depends also on Node B.
		RADIO BEARER RELEASE COMPLETE <i>Target state</i> CELL_DCH	10	11	
URA update	URA UPDATE CONFIRM	UTRAN MOBILITY INFORMATION CONFIRM	5	8	
UTRAN mobility information	UTRAN MOBILITY INFORMATION	UTRAN MOBILITY INFORMATION CONFIRM / FAILURE	5	8	
Active set update	ACTIVE SET UPDATE	ACTIVE SET UPDATE COMPLETE / FAILURE	NA	8	The requirements on UE combining and power control performance for both UL and DL are specified by RAN WG4 in [21] and [19]. Also in case of branch addition the COMPLETE / FAILURE message is transmitted without waiting for the new branch to stabilise, therefore N2 is specified.
Inter-RAT handover to UTRAN	HANDOVER TO UTRAN COMMAND (other system)	HANDOVER TO UTRAN COMPLETE	NA	NA	The performance of this procedure is specified in 05.10.
Inter-RAT handover from UTRAN	HANDOVER FROM UTRAN COMMAND	HANDOVER FROM UTRAN FAILURE	NA	NA	The performance of this procedure is specified in [19] and [20].
Measurement procedures					
Measurement control	MEASUREMENT CONTROL	MEASUREMENT CONTROL FAILURE	5	8	Response to measurement inquiry depends on physical layer measurement. Response time is defined in [19] and [20]. N1 and N2 only define the processing of the message.

13.6 RB information parameters for signalling radio bearer RB 0

The following Radio Bearer parameter values apply for signalling radio bearer RB0:

Information element/ Group name	Value	Comment
RLC info		
>Uplink RLC mode	TM	
>>Transmission RLC discard	omitted	Neither discard is used, nor will there be a reset
>>Segmentation indication	FALSE	
>Downlink RLC mode	UM	
RB mapping info		Single multiplexing option
>Uplink mapping info		
>>UL transport channel	RACH	RACH corresponding with selected PRACH
>>RLC size list	N/A	The first TF defined in the Transport Format Set for the transport channel that is used
>>MAC logical channel priority	1	
>Downlink mapping info		
>>DL transport channel	FACH	

Procedure descriptions in subclause 8.6.4.8 shall not be applied for the IE "RB mapping info" that is used for signalling radio bearer RB0.

13.6a RB information parameters for SHCCH

The following Radio Bearer parameter values apply for SHCCH:

Information element/ Group name	Value	Comment
RLC info		
>Uplink RLC mode	TM	
>>Transmission RLC discard	omitted	Neither discard is used, nor will there be a reset
>>Segmentation indication	FALSE	
>Downlink RLC mode	UM	
RB mapping info		
>Uplink mapping info		Option 1
>>UL transport channel	RACH	RACH corresponding with selected PRACH
>>RLC size list	N/A	The first TFB defined in the Transport Format Set for the transport channel that is used
>>MAC logical channel priority	1	
>Downlink mapping info		
>>DL transport channel	FACH	
>Uplink mapping info		Option 2
>>UL transport channel	USCH	
>>UL Transport Channel Identity	1	
>>MAC logical channel priority	1	
>>RLC size list	N/A	The first TB defined in the Transport Format Set for the transport channel that is used
>Downlink mapping info		
>>DL transport channel	DSCH	
>>DL Transport Channel Identity	1	

13.6b RB information parameters for BCCH mapped to FACH

The following Radio Bearer parameter values apply for BCCH mapped to FACH:

Information element/ Group name	Value	Comment
Downlink RLC mode	TM	
Segmentation indication	FALSE	

13.6c RB information parameters for PCCH mapped to PCH

The following Radio Bearer parameter values apply for PCCH mapped to PCH:

Information element/ Group name	Value	Comment
Downlink RLC mode	TM	
Segmentation indication	FALSE	

13.6d Parameters for BCCH mapped to BCH

The transport format parameters for BCH are specified in [34].

13.7 Parameter values for default radio configurations

The UE shall support the use of the default radio configurations that are specified in the following.

NOTE 1: These configurations are based on [41] and cover a number of RAB and signalling connection configurations.

In the table that is used to specify the parameter values for these default configurations, the following principles are used:

- Optional IEs that are not used are omitted;
- In case no parameter value is specified in a column, this means the value given the previous (left side) column applies.

NOTE 2: If needed, signalling radio bearer RB4 is established after the completion of handover.

NOTE 3: For each default configuration, the value of FDD, 3.84 Mcps TDD and 1.28 Mcps TDD parameters are specified. All parameters apply to FDD, 3.84 Mcps TDD and 1.28 Mcps TDD modes, unless explicitly stated otherwise. It should be noted that in this respect default configurations differ from pre-defined configurations, which only include parameter values for one mode.

NOTE 4: The transport format sizes, indicated in the following table, concern the RLC PDU size, since all configurations concern dedicated channels. The transport block sizes indicated in TS 34.108 are different since these include the size of the MAC header.

Configuration	3.4 kbps signalling	13.6 kbps signalling	7.95 kbps speech + 3.4 kbps signalling	12.2 kbps speech + 3.4 kbps signalling
Ref 34.108	2	3	6	4
Default configuration identity	0	1	2	3
RB INFORMATION				
rb-Identity	RB1: 1, RB2: 2, RB3: 3	RB1: 1, RB2: 2, RB3: 3	RB1: 1, RB2: 2, RB3: 3, RB5: 5, RB6: 6	RB1: 1, RB2: 2, RB3: 3, RB5: 5, RB6: 6, RB7: 7
rlc-InfoChoice	Rlc-info	Rlc-info	Rlc-info	Rlc-info
>ul-RLC-Mode	RB1: UM RB2- RB3: AM	RB1: UM RB2- RB3: AM	RB1: UM RB2- RB3: AM RB5-RB6: TM	RB1: UM RB2- RB3: AM RB5-RB7: TM
>>transmissionRLC-DiscardMode	RB1: N/A RB2- RB3: NoDiscard	RB1: N/A RB2- RB3: NoDiscard	RB1: N/A RB2- RB3: NoDiscard RB5- RB6: N/A	RB1: N/A RB2- RB3: NoDiscard RB5- RB7: N/A
>>>maxDat	RB1: N/A RB2- RB3: 15	RB1: N/A RB2- RB3: 15	RB1: N/A RB2- RB3: 15 RB5- RB6: N/A	RB1: N/A RB2- RB3: 15 RB5- RB7: N/A
>>transmissionWindowSize	RB1: N/A RB2- RB3: 128	RB1: N/A RB2- RB3: 128	RB1: N/A RB2- RB3: 128 RB5- RB6: N/A	RB1: N/A RB2- RB3: 128 RB5- RB7: N/A
>>timerRST	RB1: N/A RB2- RB3: 300	RB1: N/A RB2- RB3: 300	RB1: N/A RB2- RB3: 300 RB5- RB6: N/A	RB1: N/A RB2- RB3: 300 RB5- RB7: N/A
>>max-RST	RB1: N/A RB2- RB3: 1	RB1: N/A RB2- RB3: 1	RB1: N/A RB2- RB3: 1 RB5- RB6: N/A	RB1: N/A RB2- RB3: 1 RB5- RB7: N/A
>>pollingInfo	RB1: N/A RB2- RB3: as below	RB1: N/A RB2- RB3: as below	RB1: N/A RB2- RB3: as below RB5- RB6: N/A	RB1: N/A RB2- RB3: as below RB5- RB7: N/A
>>>lastTransmissionPDU-Poll	RB2- RB3: FALSE	RB2- RB3: FALSE	RB2- RB3: FALSE	RB2- RB3: FALSE
>>>lastRetransmissionPDU-Poll	RB2- RB3: FALSE	RB2- RB3: FALSE	RB2- RB3: FALSE	RB2- RB3: FALSE
>>>timerPollPeriodic	RB2- RB3: 100	RB2- RB3: 100	RB2- RB3: 100	RB2- RB3: 100
>>segmentationIndication	RB1- RB3: N/A	RB1- RB3: N/A	RB1- RB3: N/A RB5- RB6: FALSE	RB1- RB3: N/A RB5- RB7: FALSE
>dl-RLC-Mode	RB1: UM RB2- RB3: AM	RB1: UM RB2- RB3: AM	RB1: UM RB2- RB3: AM RB5- RB6: TM	RB1: UM RB2- RB3: AM RB5- RB7: TM
>>inSequenceDelivery	RB1: N/A RB2- RB3: TRUE	RB1: N/A RB2- RB3: TRUE	RB1: N/A RB2- RB3: TRUE RB5- RB6: N/A	RB1: N/A RB2- RB3: TRUE RB5- RB7: N/A
>>receivingWindowSize	RB1: N/A RB2- RB3: 128	RB1: N/A RB2- RB3: 128	RB1: N/A RB2- RB3: 128 RB5- RB6: N/A	RB1: N/A RB2- RB3: 128 RB5- RB7: N/A
>>>dl-RLC-StatusInfo	RB1: N/A RB2- RB3: as below	RB1: N/A RB2- RB3: as below	RB1: N/A RB2- RB3: as below RB5- RB6: N/A	RB1: N/A RB2- RB3: as below RB5- RB7: N/A
>>>timerStatusProhibit	RB2- RB3: 100	RB2- RB3: 100	RB2- RB3: 100	RB2- RB3: 100
>>>missingPDU-Indicator	RB2- RB3: FALSE	RB2- RB3: FALSE	RB2- RB3: FALSE	RB2- RB3: FALSE
>>>timerStatusPeriodic	RB2- RB3: 100	RB2- RB3: 100	RB2- RB3: 100	RB2- RB3: 100
>>segmentationIndication	RB1- RB3: N/A	RB1- RB3: N/A	RB1- RB3: N/A RB5- RB6: FALSE	RB1- RB3: N/A RB5- RB7: FALSE
rb-MappingInfo				
>UL-LogicalChannelMappings	OneLogicalChannel	OneLogicalChannel	OneLogicalChannel	OneLogicalChannel
>>ul-TransportChannelType	Dch	Dch	Dch	Dch
>>>transportChannelIdentity	RB1- RB3: 1	RB1- RB3: 1	RB1- RB3: 3 RB5: 1, RB6: 2	RB1- RB3: 4 RB5: 1, RB6: 2, RB7: 3

>>logicalChannelIdentity	RB1: 1, RB2: 2, RB3: 3	RB1: 1, RB2: 2, RB3: 3	RB1: 1, RB2: 2, RB3: 3 RB5- RB6: N/A	RB1: 1, RB2: 2, RB3: 3 RB5- RB7: N/A
>>rlc-SizeList	RB1- RB3: all	RB1- RB3: all	RB1- RB3: all RB5- RB6: N/A	RB1- RB3: all RB5- RB7: N/A
>>mac-LogicalChannelPriority	RB1: 1, RB2: 2, RB3: 3	RB1: 1, RB2: 2, RB3: 3	RB1: 1, RB2: 2, RB3: 3 RB5- RB6: 5	RB1: 1, RB2: 2, RB3: 3 RB5- RB7: 5
>DL-logicalChannelMappingList				
>>Mapping option 1	One mapping option	One mapping option	One mapping option	One mapping option
>>>dl-TransportChannelType	Dch	Dch	Dch	Dch
>>>>transportChannelIdentity	RB1- RB3: 1	RB1- RB3: 1	RB1- RB3: 3 RB5: 1, RB6: 2	RB1- RB3: 4 RB5: 1, RB6: 2, RB7: 3
>>>>logicalChannelIdentity	RB1: 1, RB2: 2, RB3: 3	RB1: 1, RB2: 2, RB3: 3	RB1: 1, RB2: 2, RB3: 3 RB5- RB6: N/A	RB1: 1, RB2: 2, RB3: 3 RB5- RB7: N/A
TrCH INFORMATION PER TrCH				
UL-AddReconfTransChInfoList				
>Uplink transport channel type	dch	dch	dch	dch
>transportChannelIdentity	TrCH1: 1	TrCH1: 1	TrCH1: 1, TrCH2: 2, TrCH3: 3	TrCH1: 1, TrCH2: 2, TrCH3: 3, TrCH4: 4
>transportFormatSet	DedicatedTransChTFS	DedicatedTransChTFS	DedicatedTransChTFS	DedicatedTransChTFS
>>dynamicTF-information				
>>>>tf0/ tf0,1	TrCH1: (0x144, 1x144)	TrCH1: (0x144, 1x144)	TrCH1: (0x75) TrCH2: (0x 84 1x84) TrCH3: (0x144, 1x144)	TrCH1: (0x81) TrCH2: (0x 103, 1x103) TrCH3: (0x 60, 1x60) TrCH4: (0x144, 1x144)
>>>>>rlcSize	BitMode	BitMode	BitMode	BitMode
>>>>>>sizeType	TrCH1: type 2, part1= 2, part2= 0 (144)	TrCH1: type 2, part1= 2, part2= 0 (144)	TrCH1: type 1: 75 TrCH2: type 1: 84 TrCH3: 2: type 2, part1= 2, part2= 0 (144)	TrCH1: type 1: 81 TrCH2: type 1: 103 TrCH3: type 1: 60 TrCH4: 2: type 2, part1= 2, part2= 0 (144)
>>>>>numberOfTbSizeList	TrCH1: Zero, one	TrCH1: Zero, one	TrCH1: Zero TrCH2-3: Zero, one	TrCH1: Zero TrCH2-4: Zero, one
>>>>>logicalChannelList	All	All	All	All
>>>>>tf 1	N/A	N/A	TrCH1: (1x39) TrCH2- TrCH4: N/A	TrCH1: (1x39) TrCH2- TrCH4: N/A
>>>>>numberOfTransportBlocks			TrCH1: One	TrCH1: One
>>>>>rlc-Size			TrCH1: BitMode	TrCH1: BitMode
>>>>>>sizeType			TrCH1: 1: 39	TrCH1: 1: 39
>>>>>numberOfTbSizeList			TrCH1: One	TrCH1: One
>>>>>logicalChannelList			TrCH1: all	TrCH1: all
>>>>>tf 2	N/A	N/A	TrCH1: (1x75) TrCH2- TrCH3: N/A	TrCH1: (1x81) TrCH2- TrCH4: N/A
>>>>>numberOfTransportBlocks			TrCH1: Zero	TrCH1: Zero
>>>>>rlc-Size			TrCH1: BitMode	TrCH1: BitMode
>>>>>>sizeType			TrCH1: type 1: 75	TrCH1: type 1: 81
>>>>>numberOfTbSizeList			TrCH1: One	TrCH1: One
>>>>>logicalChannelList			TrCH1: all	TrCH1: all
>>semistaticTF-Information				
>>>>tti	TrCH1: 40	TrCH1: 10	TrCH1- TrCH2: 20 TrCH3: 40	TrCH1- TrCH3: 20 TrCH4: 40

>>>channelCodingType	Convolutional	Convolutional	Convolutional	Convolutional
>>>>codingRate	TrCH1: Third	TrCH1: Third	TrCH1- TrCH2: Third TrCH3: Third	TrCH1- TrCH2: Third TrCH3: Half TrCH4: Third
>>>rateMatchingAttribute	TrCH1: 160	TrCH1: 160	TrCH1: 200 TrCH2: 190 TrCH3: 160	TrCH1: 200 TrCH2: 190 TrCH3: 235 TrCH4: 160
>>>>crc-Size	TrCH1: 16	TrCH1: 16	TrCH1: 12 TrCH2: 0 TrCH3: 16	TrCH1: 12 TrCH2- TrCH3: 0 TrCH4: 16
DL-AddReconfTransChInfoList				
>Downlink transport channel type	dch	dch	dch	dch
>dl-TransportChannelIdentity (should be as for UL)	TrCH1: 1	TrCH1: 1	TrCH1: 1, TrCH2: 2, TrCH3: 3	TrCH1: 1, TrCH2: 2, TrCH3: 3, TrCH4: 4
>tfs-SignallingMode	SameAsUL	SameAsUL	Independent <Only tf0 on TrCH1 is different and shown below>	Independent <Only tf0 on TrCH1 is different and shown below>
>>transportFormatSet			DedicatedTransChTFS	DedicatedTransChTFS
>>>>dynamicTF-information				
>>>>>tf0/ tf0,1			TrCH1: (1x0)	TrCH1: (1x0)
>>>>>rlcSize			BitMode	bitMode
>>>>>>sizeType			TrCH1: type 1: 0	TrCH1: type 1: 0
>>>>>>numberOfTbSizeList			TrCH1: One	TrCH1: One
>>>>>>logicalChannelList			All	All
>>ULTrCH-Id	TrCH1: 1	TrCH1: 1	TrCH1: 1, TrCH2: 2, TrCH3: 3	TrCH1: 1, TrCH2: 2, TrCH3: 3, TrCH4: 4
>dch-QualityTarget				
>>bler-QualityValue	TrCH1: 5×10^{-2}	TrCH1: 5×10^{-2}	TrCH1: 7×10^{-3} TrCH2- TrCH3: Absent	TrCH1: 7×10^{-3} TrCH2- TrCH4: Absent
TrCH INFORMATION, COMMON				
ul-CommonTransChInfo				
>tfc-ID (TDD only)	1	1	1	1
>sharedChannelIndicator (TDD only)	FALSE	FALSE	FALSE	FALSE
>tfc-Subset	Absent, not required	Absent, not required	Absent, not required	Absent, not required
>ul-TFCS	Normal TFCI signalling	Normal TFCI signalling	Normal TFCI signalling	Normal TFCI signalling
>>explicitTFCS-ConfigurationMode	Complete	Complete	Complete	Complete
>>>>ctfcSize	Ctfc2Bit	Ctfc2Bit	Ctfc4Bit	Ctfc6Bit
>>>>>TFCS representation	Addition	Addition	Addition	Addition
>>>>>>TFCS list				
>>>>>>>TFCS 1	(TF0)	(TF0)	(TF0, TF0, TF0)	(TF0, TF0, TF0, TF0)
>>>>>>>>ctfc	0	0	0	0
>>>>>>>>>gainFactorInformation	Computed	Computed	Computed	Computed
>>>>>>>>>>referenceTFCId	0	0	0	0
>>>>>>>>>>>TFCS 2	(TF1)	(TF1)	(TF1, TF0, TF0)	(TF1, TF0, TF0, TF0)
>>>>>>>>>>>>ctfc	1	1	1	1
>>>>>>>>>>>>>gainFactorInformation	Signalled	Signalled	Computed	Computed
>>>>>>>>>>>>>>>βc (FDD only)	11	11	N/A	N/A
>>>>>>>>>>>>>>>>βd	15	15	N/A	N/A
>>>>>>>>>>>>>>>>>referenceTFCId	N/A	N/A	0	0

>>>>>TFCS 3			(TF2, TF1, TF0)	(TF2, TF1, TF1, TF0)
>>>>>>ctfc			5	11
>>>>>>gainFactorInformation			Computed	Computed
>>>>>>referenceTFCLd			0	0
>>>>>TFCS 4			(TF0, TF0, TF1)	(TF0, TF0, TF0, TF1)
>>>>>>ctfc			6	12
>>>>>>gainFactorInformation			Computed	Computed
>>>>>>> β c (FDD only)			N/A	N/A
>>>>>>> β d			N/A	N/A
>>>>>>>referenceTFCLd			0	0
>>>>>TFCS 5			(TF1, TF0, TF1)	(TF1, TF0, TF0, TF1)
>>>>>>ctfc			7	13
>>>>>>gainFactorInformation			Computed	Computed
>>>>>>>referenceTFCLd			0	0
>>>>>TFCS 6			(TF2, TF1, TF1)	(TF2, TF1, TF1, TF1)
>>>>>>ctfc			11	23
>>>>>>gainFactorInformation			Signalled	Signalled
>>>>>>> β c (FDD only)			11	11
>>>>>>> β d			15	15
>>>>>>>referenceTFCLd			0	0
dl-CommonTransChInfo				
>tfcs-SignallingMode	Same as UL	Same as UL	Same as UL	Same as UL
PhyCH INFORMATION FDD				
UL-DPCH-InfoPredef				
>ul-DPCH-PowerControlInfo				
>>powerControlAlgorithm	Algorithm 1	Algorithm 1	Algorithm 1	Algorithm 1
>>>tpcStepSize	1	1	1	1
>tfci-Existence	TRUE	TRUE	TRUE	TRUE
>puncturingLimit	1	1	1	0.88
DL-CommonInformationPredef				
>dl-DPCH-InfoCommon				
>>spreadingFactor	256	128	128	128
>>pilotBits	4	4	4	4
>>positionFixed	N/A	N/A	Fixed	Fixed
PhyCH INFORMATION 3.84 Mcps TDD				
UL-DPCH-InfoPredef				
>ul-DPCH-PowerControlInfo				
>>dpch-ConstantValue	-20	-20	-20	-20
>commonTimeslotInfo				
>>secondInterleavingMode	frameRelated	frameRelated	frameRelated	frameRelated
>>>tfci-Coding	4	4	16	16
>>puncturingLimit	1	0.92	0.52	0.88
>>repetitionPeriodAndLength	repetitionPeriod1	repetitionPeriod1	repetitionPeriod1	repetitionPeriod1
DL-CommonInformationPredef				
>dl-DPCH-InfoCommon				
>>commonTimeslotInfo				
>>>secondInterleavingMode	frameRelated	frameRelated	frameRelated	frameRelated

>>>tfc-Coding	4	4	16	16
>>>puncturingLimit	1	0.92	0.52	0.92
>>>repetitionPeriodAndLength	repetitionPeriod1	repetitionPeriod1	repetitionPeriod1	repetitionPeriod1
PhyCH INFORMATION 1.28 Mcps TDD				
UL-DPCH-InfoPredef				
>commonTimeslotInfo				
>>secondInterleavingMode	frameRelated	frameRelated	frameRelated	frameRelated
>>tfc-Coding	4	4	16	16
>>puncturingLimit	1	0.64	0.80	0.60
>>repetitionPeriodAndLength	repetitionPeriod1	repetitionPeriod1	repetitionPeriod1	repetitionPeriod1
DL- CommonInformationPredef				
>dl-DPCH-InfoCommon				
>>commonTimeslotInfo				
>>>secondInterleavingMode	frameRelated	frameRelated	frameRelated	frameRelated
>>>tfc-Coding	4	4	16	16
>>>puncturingLimit	1	0.64	0.80	0.60
>>>repetitionPeriodAndLength	repetitionPeriod1	repetitionPeriod1	repetitionPeriod1	repetitionPeriod1

Configuration	28.8 kbps conv. CS- data + 3.4 kbps signalling	32 kbps conv. CS- data + 3.4 kbps signalling	64kbps conv. CS- data + 3.4 kbps signalling	14.4 kbps streaming CS- data + 3.4 kbps signalling
Ref 34.108	12	14	13	15
Default configuration identity	4	5	6	7
RB INFORMATION				
rb-Identity	RB1: 1, RB2: 2, RB3: 3, RB5: 5	RB1: 1, RB2: 2, RB3: 3, RB5: 5	RB1: 1, RB2: 2, RB3: 3, RB5: 5	RB1: 1, RB2: 2, RB3: 3, RB5: 5
rlc-InfoChoice	Rlc-info	Rlc-info	Rlc-info	Rlc-info
>ul-RLC-Mode	RB1: UM RB2- RB3: AM RB5: TM	RB1: UM RB2- RB3: AM RB5: TM	RB1: UM RB2- RB3: AM RB5: TM	RB1: UM RB2- RB3: AM RB5: TM
>>transmissionRLC-DiscardMode	RB1: N/A RB2- RB3: NoDiscard RB5: N/A	RB1: N/A RB2- RB3: NoDiscard RB5: N/A	RB1: N/A RB2- RB3: NoDiscard RB5: N/A	RB1: N/A RB2- RB3: NoDiscard RB5: N/A
>>>maxDat	RB1: N/A RB2- RB3: 15 RB5: N/A	RB1: N/A RB2- RB3: 15 RB5: N/A	RB1: N/A RB2- RB3: 15 RB5: N/A	RB1: N/A RB2- RB3: 15 RB5: N/A
>>transmissionWindowSize	RB1: N/A RB2- RB3: 128 RB5: N/A	RB1: N/A RB2- RB3: 128 RB5: N/A	RB1: N/A RB2- RB3: 128 RB5: N/A	RB1: N/A RB2- RB3: 128 RB5: N/A
>>timerRST	RB1: N/A RB2- RB3: 300 RB5: N/A	RB1: N/A RB2- RB3: 300 RB5: N/A	RB1: N/A RB2- RB3: 300 RB5: N/A	RB1: N/A RB2- RB3: 300 RB5: N/A
>>max-RST	RB1: N/A RB2- RB3: 1 RB5: N/A	RB1: N/A RB2- RB3: 1 RB5: N/A	RB1: N/A RB2- RB3: 1 RB5: N/A	RB1: N/A RB2- RB3: 1 RB5: N/A
>>pollingInfo	RB1: N/A RB2- RB3: as below RB5: N/A	RB1: N/A RB2- RB3: as below RB5: N/A	RB1: N/A RB2- RB3: as below RB5: N/A	RB1: N/A RB2- RB3: as below RB5: N/A
>>>lastTransmissionPDU-Poll	RB2- RB3: FALSE	RB2- RB3: FALSE	RB2- RB3: FALSE	RB2- RB3: FALSE
>>>lastRetransmissionPDU-Poll	RB2- RB3: FALSE	RB2- RB3: FALSE	RB2- RB3: FALSE	RB2- RB3: FALSE
>>>timerPollPeriodic	RB2- RB3: 100	RB2- RB3: 100	RB2- RB3: 100	RB2- RB3: 100
>>segmentationIndication	RB1- RB3: N/A RB5: FALSE	RB1- RB3: N/A RB5: FALSE	RB1- RB3: N/A RB5: FALSE	RB1- RB3: N/A RB5: FALSE
>dl-RLC-Mode	RB1: UM RB2- RB3: AM RB5: TM	RB1: UM RB2- RB3: AM RB5: TM	RB1: UM RB2- RB3: AM RB5: TM	RB1: UM RB2- RB3: AM RB5: TM
>>inSequenceDelivery	RB1: N/A RB2- RB3: TRUE RB5: N/A	RB1: N/A RB2- RB3: TRUE RB5: N/A	RB1: N/A RB2- RB3: TRUE RB5: N/A	RB1: N/A RB2- RB3: TRUE RB5: N/A
>>receivingWindowSize	RB1: N/A RB2- RB3: 128 RB5: N/A	RB1: N/A RB2- RB3: 128 RB5: N/A	RB1: N/A RB2- RB3: 128 RB5: N/A	RB1: N/A RB2- RB3: 128 RB5: N/A
>>dl-RLC-StatusInfo	RB1: N/A RB2- RB3: as below RB5: N/A	RB1: N/A RB2- RB3: as below RB5: N/A	RB1: N/A RB2- RB3: as below RB5: N/A	RB1: N/A RB2- RB3: as below RB5: N/A
>>>timerStatusProhibit	RB2- RB3: 100	RB2- RB3: 100	RB2- RB3: 100	RB2- RB3: 100
>>>missingPDU-Indicator	RB2- RB3: FALSE	RB2- RB3: FALSE	RB2- RB3: FALSE	RB2- RB3: FALSE
>>>timerStatusPeriodic	RB2- RB3: 100	RB2- RB3: 100	RB2- RB3: 100	RB2- RB3: 100
>>segmentationIndication	RB1- RB3: N/A RB5: FALSE	RB1- RB3: N/A RB5: FALSE	RB1- RB3: N/A RB5: FALSE	RB1- RB3: N/A RB5: FALSE
rb-MappingInfo				
>UL-LogicalChannelMappings	OneLogicalChannel	OneLogicalChannel	OneLogicalChannel	OneLogicalChannel
>>ul-TransportChannelType	Dch	Dch	Dch	Dch
>>>transportChannelIdentity	RB1- RB3: 2 RB5: 1	RB1- RB3: 2 RB5: 1	RB1- RB3: 2 RB5: 1	RB1- RB3: 2 RB5: 1

>>logicalChannelIdentity	RB1: 1, RB2: 2, RB3: 3 RB5: N/A	RB1: 1, RB2: 2, RB3: 3 RB5: N/A	RB1: 1, RB2: 2, RB3: 3 RB5: N/A	RB1: 1, RB2: 2, RB3: 3 RB5: N/A
>>rlc-SizeList	RB1- RB3: all RB5: N/A	RB1- RB3: all RB5: N/A	RB1- RB3: all RB5: N/A	RB1- RB3: all RB5: N/A
>>mac-LogicalChannelPriority	RB1: 1, RB2: 2, RB3: 3 RB5: 5	RB1: 1, RB2: 2, RB3: 3 RB5: 5	RB1: 1, RB2: 2, RB3: 3 RB5: 5	RB1: 1, RB2: 2, RB3: 3 RB5: 5
>DL-logicalChannelMappingList				
>>Mapping option 1	One mapping option	One mapping option	One mapping option	One mapping option
>>>dl-TransportChannelType	Dch	Dch	Dch	Dch
>>>>transportChannelIdentity	RB1- RB3: 2 RB5: 1	RB1- RB3: 2 RB5: 1	RB1- RB3: 2 RB5: 1	RB1- RB3: 2 RB5: 1
>>>>logicalChannelIdentity	RB1: 1, RB2: 2, RB3: 3 RB5: N/A	RB1: 1, RB2: 2, RB3: 3 RB5: N/A	RB1: 1, RB2: 2, RB3: 3 RB5: N/A	RB1: 1, RB2: 2, RB3: 3 RB5: N/A
TrCH INFORMATION PER TrCH				
UL-AddReconfTransChInfoList				
>Uplink transport channel type	dch	dch	dch	dch
>transportChannelIdentity	TrCH1: 1, TrCH2: 2	TrCH1: 1, TrCH2: 2	TrCH1: 1, TrCH2: 2	TrCH1: 1, TrCH2: 2
>transportFormatSet	DedicatedTransChTFS	DedicatedTransChTFS	DedicatedTransChTFS	DedicatedTransChTFS
>>dynamicTF-information				
>>>>tf0/ tf0,1	TrCH1: (0x576, 1x576, 2x576) TrCH2: (0x144, 1x144)	TrCH1: (0x640, 1x640) TrCH2: (0x144, 1x144)	TrCH1: (0x640, 2x640) TrCH2: (0x144, 1x144)	TrCH1: (0x576, 1x576) TrCH2: (0x144, 1x144)
>>>>>rlcSize	TrCH1: OctetMode TrCH2:BitMode	TrCH1: OctetMode TrCH2:BitMode	TrCH1: OctetMode TrCH2:BitMode	TrCH1: OctetMode TrCH2:BitMode
>>>>>>sizeType	TrCH1: type 2, part1= 11, part2= 2 (576) TrCH2: type 2, part1= 2, part2= 0 (144)	TrCH1: type 2, part1= 11, part2= 2 (640) TrCH2: type 2, part1= 2, part2= 0 (144)	TrCH1: type 2, part1= 11, part2= 2 (640) TrCH2: type 2, part1= 2, part2= 0 (144)	TrCH1: type 2, part1= 9, part2= 2 (576) TrCH2: type 2, part1= 2, part2= 0 (144)
>>>>>numberOfTbSizeList	TrCH1: Zero,1, 2 (4) TrCH2: Zero, one	TrCH1: Zero, one TrCH2: Zero, one	TrCH1: Zero, 2 (4) TrCH2: Zero, one	TrCH1: Zero, one, TrCH2: Zero, one
>>>>>logicalChannelList	All	All	All	All
>>semiStaticTF-Information				
>>>>tti	TrCH1: 40 TrCH2: 40	TrCH1: 20 TrCH2: 40	TrCH1: 20 TrCH2: 40	TrCH1: 40 TrCH2: 40
>>>>channelCodingType	TrCH1: Turbo TrCH2: Convolutional	TrCH1: Turbo TrCH2: Convolutional	TrCH1: Turbo TrCH2: Convolutional	TrCH1: Turbo TrCH2: Convolutional
>>>>>codingRate	TrCH1: N/A TrCH2: Third	TrCH1: N/A TrCH2: Third	TrCH1: N/A TrCH2: Third	TrCH1: N/A TrCH2: Third
>>>>rateMatchingAttribute	TrCH1: 180 TrCH2: 160	TrCH1: 185 TrCH2: 160	TrCH1: 170 TrCH2: 160	TrCH1: 165 TrCH2: 160
>>>>crc-Size	TrCH1: 16 TrCH2: 16	TrCH1: 16 TrCH2: 16	TrCH1: 16 TrCH2: 16	TrCH1: 16 TrCH2: 16
DL-AddReconfTransChInfoList				
>Downlink transport channel type	dch	dch	dch	dch
>dl-TransportChannelIdentity (should be as for UL)	TrCH1: 1, TrCH2: 2	TrCH1: 1, TrCH2: 2	TrCH1: 1, TrCH2: 2	TrCH1: 1, TrCH2: 2
>tfs-SignallingMode	SameAsUL	SameAsUL	SameAsUL	SameAsUL

>>transportFormatSet				
>>>dynamicTF-information				
>>>>tf0/ tf0,1				
>>>>rlcSize				
>>>>>sizeType				
>>>>>numberOfTbSizeList				
>>>>>logicalChannelList				
>>ULTrCH-Id	TrCH1: 1, TrCH2: 2	TrCH1: 1, TrCH2: 2	TrCH1: 1, TrCH2: 2	TrCH1: 1, TrCH2: 2
>dch-QualityTarget				
>>bler-QualityValue	TrCH1: 2×10^{-3} TrCH2: Absent	TrCH1: 2×10^{-3} TrCH2: Absent	TrCH1: 2×10^{-3} TrCH2: Absent	TrCH1: 1×10^{-2} TrCH2: Absent
TrCH INFORMATION, COMMON				
ul-CommonTransChInfo				
>tfcs-ID (TDD only)	1	1	1	1
>sharedChannelIndicator (TDD only)	FALSE	FALSE	FALSE	FALSE
>tfcs-Subset	Absent, not required	Absent, not required	Absent, not required	Absent, not required
>ul-TFCS	Normal TFCS signalling	Normal TFCS signalling	Normal TFCS signalling	Normal TFCS signalling
>>explicitTFCS- ConfigurationMode	Complete	Complete	Complete	Complete
>>>ctfcSize	Ctfc2Bit	Ctfc2Bit	Ctfc2Bit	Ctfc4Bit
>>>>TFCS representation	Addition	Addition	Addition	Addition
>>>>>TFCS list				
>>>>>>TFCS 1	(TF0, TF0)	(TF0, TF0)	(TF0, TF0)	(TF0, TF0)
>>>>>>>ctfc	0	0	0	0
>>>>>>>>gainFactorInform ation	Computed	Computed	Computed	Computed
>>>>>>>>referenceTFCSId	0	0	0	0
>>>>>>>>TFCS 2	(TF1, TF0)	(TF1, TF0)	(TF1, TF0)	(TF1, TF0)
>>>>>>>>>ctfc	1	1	1	1
>>>>>>>>>gainFactorInform ation	Computed	Computed	Computed	Computed
>>>>>>>>>>βc (FDD only)	N/A	N/A	N/A	N/A
>>>>>>>>>>βd	N/A	N/A	N/A	N/A
>>>>>>>>>>referenceTFCSId	0	0	0	0
>>>>>>>>>>TFCS 3	(TF2, TF0)	(TF0, TF1)	(TF0, TF1)	(TF0, TF1)
>>>>>>>>>>>ctfc	2	2	2	2
>>>>>>>>>>>>gainFactorInform ation	Computed	Computed	Computed	Computed
>>>>>>>>>>>>referenceTFCSId	0	0	0	0
>>>>>>>>>>>>TFCS 4	(TF0, TF1)	(TF1, TF1)	(TF1, TF1)	(TF1, TF1)
>>>>>>>>>>>>>ctfc	3	3	3	3
>>>>>>>>>>>>>>gainFactorInform ation	Computed	Signalled	Signalled	Signalled
>>>>>>>>>>>>>>βc (FDD only)	N/A	8	8	11
>>>>>>>>>>>>>>βd	N/A	15	15	15
>>>>>>>>>>>>>>referenceTFCSId	N/A	N/A	N/A	N/A
>>>>>>>>>>>>>>TFCS 5	(TF1, TF1)	N/A	N/A	
>>>>>>>>>>>>>>>ctfc	4			
>>>>>>>>>>>>>>>>gainFactorInform ation	Computed			
>>>>>>>>>>>>>>>>referenceTFCSId	8			
>>>>>>>>>>>>>>>>TFCS 6	(TF2, TF1)	N/A	N/A	
>>>>>>>>>>>>>>>>>ctfc	5			
>>>>>>>>>>>>>>>>>>gainFactorInform ation	Signalled			
>>>>>>>>>>>>>>>>>>>βc (FDD only)	8			
>>>>>>>>>>>>>>>>>>>βd	15			
>>>>>>>>>>>>>>>>>>>>referenceTFCSId	N/A			
>>>>>>>>>>>>>>>>>>>>TFCS 7				
>>>>>>>>>>>>>>>>>>>>>ctfc				

>>>>>>gainFactorInformation				
>>>>>>referenceTFCId				
>>>>>>TFCS 8				
>>>>>>ctfc				
>>>>>>gainFactorInformation				
>>>>>>referenceTFCId				
>>>>>>TFCS 9				
>>>>>>ctfc				
>>>>>>gainFactorInformation				
>>>>>>referenceTFCId				
>>>>>>TFCS 10				
>>>>>>ctfc				
>>>>>>gainFactorInformation				
>>>>>> β c (FDD only)				
>>>>>> β d				
>>>>>>referenceTFCId				
>dl-CommonTransChInfo				
>tfc-SignallingMode	Same as UL	Same as UL	Same as UL	Same as UL
PhyCH INFORMATION FDD				
UL-DPCH-InfoPredef				
>ul-DPCH-PowerControlInfo				
>>powerControlAlgorithm	Algorithm 1	Algorithm 1	Algorithm 1	Algorithm 1
>>>tpcStepSize	1	1	1	1
>tfc-Existence	TRUE	TRUE	TRUE	TRUE
>puncturingLimit	0.92	0.8	0.92	1
DL-CommonInformationPredef				
>dl-DPCH-InfoCommon				
>>spreadingFactor	64	64	32	128
>>pilotBits	8	8	8	8
>>positionFixed	Flexible	Flexible	Flexible	Flexible
PhyCH INFORMATION 3.84 Mcps TDD				
UL-DPCH-InfoPredef				
>ul-DPCH-PowerControlInfo				
>>dpch-ConstantValue	-20	-20	-20	-20
>commonTimeslotInfo				
>>secondInterleavingMode	frameRelated	frameRelated	frameRelated	frameRelated
>>tfc-Coding	16	8	8	8
>>puncturingLimit	0.44	0.8	0.56	0.8
>>repetitionPeriodAndLength	repetitionPeriod1	repetitionPeriod1	repetitionPeriod1	repetitionPeriod1
DL-CommonInformationPredef				
>dl-DPCH-InfoCommon				
>>commonTimeslotInfo				
>>>secondInterleavingMode	frameRelated	frameRelated	frameRelated	frameRelated
>>>tfc-Coding	16	8	8	8
>>>puncturingLimit	0.44	0.64	0.56	0.8
>>>repetitionPeriodAndLength	repetitionPeriod1	repetitionPeriod1	repetitionPeriod1	repetitionPeriod1
PhyCH INFORMATION 1.28 Mcps TDD				

UL-DPCH-InfoPredef				
>commonTimeslotInfo				
>>secondInterleavingMode	frameRelated	frameRelated	frameRelated	frameRelated
>>tfc-Coding	16	8	8	8
>>puncturingLimit	0.64	0.60	0.64	1
>>repetitionPeriodAndLength	repetitionPeriod1	repetitionPeriod1	repetitionPeriod1	repetitionPeriod1
DL-CommonInformationPredef				
>dl-DPCH-InfoCommon				
>>commonTimeslotInfo				
>>>secondInterleavingMode	frameRelated	frameRelated	frameRelated	frameRelated
>>>tfc-Coding	16	8	8	8
>>>puncturingLimit	0.64	0.60	0.64	0.88
>>>repetitionPeriodAndLength	repetitionPeriod1	repetitionPeriod1	repetitionPeriod1	repetitionPeriod1

Configuration	28.8 kbps streaming CS- data + 3.4 kbps signalling	57.6 kbps streaming CS- data + 3.4 kbps signalling
Ref 34.108	16	17
Default configuration identity	8	9
RB INFORMATION		
rb-Identity	RB1: 1, RB2: 2, RB3: 3, RB5: 5	RB1: 1, RB2: 2, RB3: 3, RB5: 5
rlc-InfoChoice	Rlc-info	Rlc-info
>ul-RLC-Mode	RB1: UM RB2- RB3: AM RB5: TM	RB1: UM RB2- RB3: AM RB5: TM
>>transmissionRLC- DiscardMode	RB1: N/A RB2- RB3: NoDiscard RB5: N/A	RB1: N/A RB2- RB3: NoDiscard RB5: N/A
>>>maxDat	RB1: N/A RB2- RB3: 15 RB5: N/A	RB1: N/A RB2- RB3: 15 RB5: N/A
>>transmissionWindowSiz e	RB1: N/A RB2- RB3: 128 RB5: N/A	RB1: N/A RB2- RB3: 128 RB5: N/A
>>timerRST	RB1: N/A RB2- RB3: 300 RB5: N/A	RB1: N/A RB2- RB3: 300 RB5: N/A
>>max-RST	RB1: N/A RB2- RB3: 1 RB5: N/A	RB1: N/A RB2- RB3: 1 RB5: N/A
>>pollingInfo	RB1: N/A RB2- RB3: as below RB5: N/A	RB1: N/A RB2- RB3: as below RB5: N/A
>>>lastTransmissionPDU- Poll	RB2- RB3: FALSE	RB2- RB3: FALSE
>>>lastRetransmissionPD U-Poll	RB2- RB3: FALSE	RB2- RB3: FALSE
>>>timerPollPeriodic	RB2- RB3: 100	RB2- RB3: 100
>>segmentationIndication	RB1- RB3: N/A RB5: FALSE	RB1- RB3: N/A RB5: FALSE
>dl-RLC-Mode	RB1: UM RB2- RB3: AM RB5: TM	RB1: UM RB2- RB3: AM RB5: TM
>>inSequenceDelivery	RB1: N/A RB2- RB3: TRUE RB5: N/A	RB1: N/A RB2- RB3: TRUE RB5: N/A
>>receivingWindowSize	RB1: N/A RB2- RB3: 128 RB5: N/A	RB1: N/A RB2- RB3: 128 RB5: N/A
>>dl-RLC-StatusInfo	RB1: N/A RB2- RB3: as below RB5: N/A	RB1: N/A RB2- RB3: as below RB5: N/A
>>>timerStatusProhibit	RB2- RB3: 100	RB2- RB3: 100
>>>missingPDU-Indicator	RB2- RB3: FALSE	RB2- RB3: FALSE
>>>timerStatusPeriodic	RB2- RB3: 100	RB2- RB3: 100
>>segmentationIndication	RB1- RB3: N/A RB5: FALSE	RB1- RB3: N/A RB5: FALSE
rb-MappingInfo		
>UL- LogicalChannelMappings	OneLogicalChannel	OneLogicalChannel
>>ul- TransportChannelType	Dch	Dch
>>>transportChannelIdenti ty	RB1- RB3: 2 RB5: 1	RB1- RB3: 2 RB5: 1

>>logicalChannelIdentity	RB1: 1, RB2: 2, RB3: 3 RB5: N/A	RB1: 1, RB2: 2, RB3: 3 RB5: N/A
>>rlc-SizeList	RB1- RB3: all RB5: N/A	RB1- RB3: all RB5: N/A
>>mac-LogicalChannelPriority	RB1: 1, RB2: 2, RB3: 3 RB5: 5	RB1: 1, RB2: 2, RB3: 3 RB5: 5
>DL-logicalChannelMappingList		
>>Mapping option 1	One mapping option	One mapping option
>>>dl-TransportChannelType	Dch	Dch
>>>>transportChannelIdentity	RB1- RB3: 2 RB5: 1	RB1- RB3: 2 RB5: 1
>>>>logicalChannelIdentity	RB1: 1, RB2: 2, RB3: 3 RB5: N/A	RB1: 1, RB2: 2, RB3: 3 RB5: N/A
TrCH INFORMATION PER TrCH		
UL-AddReconfTransChInfoList		
>Uplink transport channel type	dch	dch
>transportChannelIdentity	TrCH1: 1, TrCH2: 2	TrCH1: 1, TrCH2: 2
>transportFormatSet	DedicatedTransChTFS	DedicatedTransChTFS
>>dynamicTF-information		
>>>tf0/ tf0,1	TrCH1: (0x576, 1x576, 2x576) TrCH2: (0x144, 1x144)	TrCH1: (0x576, 1x576, 2x576, 3x576, 4x576) TrCH2: (0x144, 1x144)
>>>>rlcSize	TrCH1: OctetMode TrCH2: BitMode	TrCH1: OctetMode TrCH2: BitMode
>>>>>sizeType	TrCH1: type 2, part1= 9, part2= 2 (576) TrCH2: type 2, part1= 2, part2= 0 (144)	TrCH1: type 2, part1= 9, part2= 2 (576) TrCH2: type 2, part1= 2, part2= 0 (144)
>>>>>numberOfTbSizeList	TrCH1: Zero, one, 2 TrCH2: Zero, one	TrCH1: Zero, one, 2, 3, 4 TrCH2: Zero, one
>>>>>logicalChannelList	All	All
>>semiStaticTF-Information		
>>>tti	TrCH1: 40 TrCH2: 40	TrCH1: 40 TrCH2: 40
>>>channelCodingType	TrCH1: Turbo TrCH2: Convolutional	TrCH1: Turbo TrCH2: Convolutional
>>>>codingRate	TrCH1: N/A TrCH2: Third	TrCH1: N/A TrCH2: Third
>>>rateMatchingAttribute	TrCH1: 155 TrCH2: 160	TrCH1: 145 TrCH2: 160
>>>crc-Size	TrCH1: 16 TrCH2: 16	TrCH1: 16 TrCH2: 16
DL-AddReconfTransChInfoList		
>Downlink transport channel type	dch	dch

>dl-TransportChannelIdentity (should be as for UL)	TrCH1: 1, TrCH2: 2	TrCH1: 1, TrCH2: 2
>tfs-SignallingMode	SameAsUL	SameAsUL
>>transportFormatSet		
>>>dynamicTF-information		
>>>>tf0/ tf0,1		
>>>>rlcSize		
>>>>>sizeType		
>>>>>numberOfTbSizeList		
>>>>>logicalChannelList		
>>ULTrCH-Id	TrCH1: 1, TrCH2: 2	TrCH1: 1, TrCH2: 2
>dch-QualityTarget		
>>bler-QualityValue	TrCH1: 1×10^{-2} TrCH2: Absent	TrCH1: 1×10^{-2} TrCH2: Absent
TrCH INFORMATION, COMMON		
ul-CommonTransChInfo		
>tfc-ID (TDD only)	1	1
>sharedChannelIndicator (TDD only)	FALSE	FALSE
>tfc-Subset	Absent, not required	Absent, not required
>ul-TFCS	Normal TFCI signalling	Normal TFCI signalling
>>explicitTFCS-ConfigurationMode	Complete	Complete
>>>ctfcSize	Ctfc4Bit	Ctfc4Bit
>>>>TFCS representation	Addition	Addition
>>>>>TFCS list		
>>>>>>TFCS 1	(TF0, TF0)	(TF0, TF0)
>>>>>>>ctfc	0	0
>>>>>>>>gainFactorInformation	Computed	Computed
>>>>>>>>>referenceTFClid	0	0
>>>>>>>>>TFCS 2	(TF1, TF0)	(TF1, TF0)
>>>>>>>>>ctfc	1	1
>>>>>>>>>>gainFactorInformation	Computed	Computed
>>>>>>>>>>> β_c (FDD only)	N/A	N/A
>>>>>>>>>>> β_d	N/A	N/A
>>>>>>>>>>>>referenceTFClid	0	0
>>>>>>>>>>>>>TFCS 3	(TF2, TF0)	(TF2, TF0)
>>>>>>>>>>>>>ctfc	2	2
>>>>>>>>>>>>>>gainFactorInformation	Computed	Computed
>>>>>>>>>>>>>>>referenceTFClid	0	0
>>>>>>>>>>>>>>>>TFCS 4	(TF0, TF1)	(TF3, TF0)
>>>>>>>>>>>>>>>>ctfc	3	3
>>>>>>>>>>>>>>>>>gainFactorInformation	Computed	Computed
>>>>>>>>>>>>>>>>>> β_c (FDD only)	N/A	N/A
>>>>>>>>>>>>>>>>>>> β_d	N/A	N/A
>>>>>>>>>>>>>>>>>>>>referenceTFClid	0	0
>>>>>>>>>>>>>>>>>>>>>>TFCS 5	(TF1, TF1)	(TF4, TF0)
>>>>>>>>>>>>>>>>>>>>>>ctfc	4	4
>>>>>>>>>>>>>>>>>>>>>>>gainFactorInformation	Computed	Computed
>>>>>>>>>>>>>>>>>>>>>>>>referenceTFClid	0	0
>>>>>>>>>>>>>>>>>>>>>>>>>>TFCS 6	(TF2, TF1)	(TF0, TF1)
>>>>>>>>>>>>>>>>>>>>>>>>>>ctfc	5	5
>>>>>>>>>>>>>>>>>>>>>>>>>>>>gainFactorInformation	Signalled	Computed
>>>>>>>>>>>>>>>>>>>>>>>>>>>>>> β_c (FDD only)	8	N/A

>>>>>>> β d	15	N/A
>>>>>>>referenceTFClId	N/A	0
>>>>>>>TFCS 7		(TF1, TF1)
>>>>>>>ctfc		6
>>>>>>>gainFactorInformation		Computed
>>>>>>>referenceTFClId		0
>>>>>>>TFCS 8		(TF2, TF1)
>>>>>>>ctfc		7
>>>>>>>gainFactorInformation		Computed
>>>>>>>referenceTFClId		0
>>>>>>>TFCS 9		(TF3, TF1)
>>>>>>>ctfc		8
>>>>>>>gainFactorInformation		Computed
>>>>>>>referenceTFClId		0
>>>>>>>TFCS 10		(TF4, TF1)
>>>>>>>ctfc		9
>>>>>>>gainFactorInformation		Signalled
>>>>>>> β c (FDD only)		8
>>>>>>> β d		15
>>>>>>>referenceTFClId		0
dl-CommonTransChInfo		
>tfcs-SignallingMode	Same as UL	Same as UL
PhyCH INFORMATION FDD		
UL-DPCH-InfoPredef		
>ul-DPCH-PowerControllInfo		
>>powerControlAlgorithm	Algorithm 1	Algorithm 1
>>>tpcStepSize	1	1
>tfci-Existence	TRUE	TRUE
>puncturingLimit	1	1
DL-CommonInformationPredef		
>dl-DPCH-InfoCommon		
>>spreadingFactor	64	32
>>pilotBits	8	8
>>positionFixed	Flexible	Flexible
PhyCH INFORMATION 3.84 Mcps TDD		
UL-DPCH-InfoPredef		
>ul-DPCH-PowerControllInfo		
>>dpch-ConstantValue	-20	-20
>commonTimeslotInfo		
>>secondInterleavingMode	frameRelated	frameRelated
>>>tfci-Coding	16	16
>>puncturingLimit	0.44	0.48
>>repetitionPeriodAndLength	repetitionPeriod1	repetitionPeriod1
DL-CommonInformationPredef		
>dl-DPCH-InfoCommon		
>>commonTimeslotInfo		
>>>secondInterleavingMode	frameRelated	frameRelated
>>>tfci-Coding	16	16
>>>puncturingLimit	0.44	0.48

>>>repetitionPeriodAndLength	repetitionPeriod1	repetitionPeriod1
PhyCH INFORMATION 1.28 Mcps TDD		
UL-DPCH-InfoPredef		
>commonTimeslotInfo		
>>secondInterleavingMode	frameRelated	frameRelated
>>tfc-Coding	16	16
>>puncturingLimit	0.64	0.72
>>repetitionPeriodAndLength	repetitionPeriod1	repetitionPeriod1
DL-CommonInformationPredef		
>dl-DPCH-InfoCommon		
>>commonTimeslotInfo		
>>>secondInterleavingMode	frameRelated	frameRelated
>>>tfc-Coding	16	16
>>>puncturingLimit	0.64	0.72
>>>repetitionPeriodAndLength	repetitionPeriod1	repetitionPeriod1

14 Specific functions

14.1 Intra-frequency measurements

14.1.1 Intra-frequency measurement quantities

A measurement quantity is used to evaluate whether an intra-frequency event has occurred or not. It can be:

- 1 Downlink E_c/N_0 .
- 2 Downlink path loss.

For FDD:

Pathloss in dB = Primary CPICH Tx power - CPICH RSCP.

For Primary CPICH Tx power the IE "Primary CPICH Tx power" shall be used. The unit is dBm.

CPICH RSCP is the result of the CPICH RSCP measurement. The unit is dBm.

For TDD:

Pathloss in dB = Primary CCPCH TX power - Primary CCPCH RSCP.

For Primary CCPCH TX power the IE "Primary CCPCH TX Power" shall be used. The unit is dBm.

Primary CCPCH RSCP is the result of the Primary CCPCH RSCP measurement. The unit is dBm.

If necessary Pathloss shall be rounded up to the next higher integer.

Results higher than 158 shall be reported as 158.

Results lower than 46 shall be reported as 46.

- 3 Downlink received signal code power (RSCP) after despreading.
- 4 ISCP measured on Timeslot basis.

A description of those values can be found in [7] and [8].

14.1.2 Intra-frequency reporting events for FDD

Within the measurement reporting criteria field in the Measurement Control message the UTRAN notifies the UE which events should trigger a measurement report. The listed events are the toolbox from which the UTRAN can choose the reporting events that are needed for the implemented handover evaluation function, or other radio network functions.

All the specified events are measured with respect to any of the measurement quantities given in subclause 14.1.1. The measurement quantities are measured on the monitored primary common pilot channels (CPICH) of the cell defined in the measurement object.

Special mechanisms for the events are illustrated in subclause 14.1.4 and 14.1.5.

NOTE: The events below are numbered 1A, 1B, 1C,... since all intra-frequency reporting events would be labelled 1X, inter-frequency reporting events would be labelled 2X, and so on for the other measurement types.

14.1.2.1 Reporting event 1A: A Primary CPICH enters the reporting range

When event 1A is configured in the UE, the UE shall:

- if "Measurement quantity" is "pathloss" and Equation 1 below is fulfilled for one or more primary CPICHs, or if "Measurement quantity" is "CPICH E_c/N_0 " or "CPICH RSCP", and Equation 2 below is fulfilled for one or more primary CPICHs, for each of these primary CPICHs:
 - if the equations have been fulfilled during the time "Time to trigger", and if that primary CPICH is part of cells allowed to trigger the event according to "Triggering condition 2", and if that primary CPICH is not included in the "cells triggered" in the variable TRIGGERED_1A_EVENT:
 - include that primary CPICH in the "cells recently triggered" in the variable TRIGGERED_1A_EVENT;
- if the value of "Reporting deactivations threshold" for this event is greater than or equal to the current number of cells in the active set or equal to 0 and any primary CPICHs are stored in the "cells recently triggered" in the variable TRIGGERED_1A_EVENT:
 - if "Reporting interval" for this event is not equal to 0:
 - if the IE "Periodical reporting running" in the variable TRIGGERED_1A_EVENT is set to FALSE:
 - start a timer with the value of "Reporting interval" for this event and set the IE "Periodical reporting running" in the variable TRIGGERED_1A_EVENT to TRUE;
 - set "sent reports" for the primary CPICHs in "cells recently triggered" in the variable TRIGGERED_1A_EVENT to 1;
 - send a measurement report with IEs set as below:
 - set in "intra-frequency measurement event results": "Intrafrequency event identity" to "1a"; and
 - include in "cell measurement event results" all entries of the "cells recently triggered" in the variable TRIGGERED_1A_EVENT that are not part of the active set in descending order according to the configured measurement quantity;
 - set the IE "measured results" and the IE "additional measured results" according to subclause 8.4.2;
 - move all entries from "cells recently triggered" to "cells triggered" in the variable TRIGGERED_1A_EVENT;
- if the timer for the periodical reporting has expired:
 - if any primary CPICH is included in the "cells triggered" in the variable TRIGGERED_1A_EVENT, and not included in the current active set:

- if "Reporting interval" for this event is not equal to 0, and if "Amount of reporting" is greater than "sent reports" stored for any of these primary CPICHs, in "cells triggered" in the variable TRIGGERED_1A_EVENT:
 - increment the stored counter "sent reports" for all CPICHs in "cell triggered" in variable TRIGGERED_1A_EVENT;
 - start a timer with the value of "Reporting interval" for this event;
 - send a measurement report with IEs set as below:
 - set in "intra-frequency measurement event results": "Intrafrequency event identity" to "1a"; and
 - include in "cell measurement event results" all entries of the variable TRIGGERED_1A_EVENT with value of IE "sent reports" smaller than value of "Amount of reporting" that are not part of the active set in descending order according to the configured measurement quantity;
 - set the IE "measured results" and the IE "additional measured results" according to subclause 8.4.2;
 - if "sent reports" in variable TRIGGERED_1A_EVENT is greater than "Amount of reporting" for all entries:
 - set the IE "Periodical Reporting running" in the variable TRIGGERED_1A_EVENT to FALSE and disable the timer for the periodical reporting;
- if "Measurement quantity" is "pathloss" and Equation 3 below is fulfilled for a primary CPICH, or if "Measurement quantity" is "CPICH Ec/N0" or "CPICH RSCP", and Equation 4 below is fulfilled for a primary CPICH:
 - if that primary CPICH is included in the "cells triggered" in the variable TRIGGERED_1A_EVENT:
 - remove the entry of that primary CPICH from "cells triggered" in the variable TRIGGERED_1A_EVENT;
 - if no entry in the variable TRIGGERED_1A_EVENT has a value of "sent reports" smaller than "Amount of reporting":
 - stop the reporting interval timer;
 - set the IE "Periodical reporting running" in the variable TRIGGERED_1A_EVENT to FALSE.

Upon transition to CELL_DCH the UE shall:

- Include the primary CPICH of all cells in the current active set into the "cells triggered" in the variable TRIGGERED_1A_EVENT.

Equation 1 (Triggering condition for pathloss)

$$10 \cdot \text{Log}M_{\text{New}} \leq W \cdot 10 \cdot \text{Log} \left(1 / \sum_{i=1}^{N_A} (1/M_i) \right) + (1-W) \cdot 10 \cdot \text{Log}M_{\text{Best}} + (R_{1a} - H_{1a} / 2),$$

Equation 2 (Triggering condition for all the other measurement quantities)

$$10 \cdot \text{Log}M_{\text{New}} \geq W \cdot 10 \cdot \text{Log} \left(\sum_{i=1}^{N_A} M_i \right) + (1-W) \cdot 10 \cdot \text{Log}M_{\text{Best}} - (R_{1a} - H_{1a} / 2),$$

Equation 3 (Leaving triggering condition for pathloss)

$$10 \cdot \text{Log}M_{\text{New}} > W \cdot 10 \cdot \text{Log} \left(1 / \sum_{i=1}^{N_A} (1/M_i) \right) + (1-W) \cdot 10 \cdot \text{Log}M_{\text{Best}} + (R_{1a} + H_{1a} / 2),$$

Equation 4 (Leaving triggering condition for all the other measurement quantities)

$$10 \cdot \text{Log} M_{New} < W \cdot 10 \cdot \text{Log} \left(\sum_{i=1}^{N_A} M_i \right) + (1-W) \cdot 10 \cdot \text{Log} M_{Best} - (R_{1a} + H_{1a} / 2),$$

The variables in the formula are defined as follows:

M_{New} is the measurement result of the cell entering the reporting range.

M_i is a measurement result of a cell in the active set.

N_A is the number of cells in the current active set.

For pathloss

M_{Best} is the measurement result of the cell in the active set with the lowest measurement result.

for other measurements quantities.

M_{Best} is the measurement result of the cell in the active set with the highest measurement result.

W is a parameter sent from UTRAN to UE.

R_{1a} is the reporting range constant.

H_{1a} is the hysteresis parameter for the event 1a.

If the measurement results are pathloss or CPICH-Ec/No then M_{New} , M_i and M_{Best} are expressed as ratios.

If the measurement result is CPICH-RSCP then M_{New} , M_i and M_{Best} are expressed in [mW].

14.1.2.2 Reporting event 1B: A primary CPICH leaves the reporting range

When event 1B is configured in the UE, the UE shall:

- if "Measurement quantity" is "pathloss" and Equation 1 below is fulfilled for one or more primary CPICHs, or if "Measurement quantity" is "CPICH Ec/No" or "CPICH RSCP", and Equation 2 below is fulfilled for one or more primary CPICHs, for each of these primary CPICHs:
 - if the equations have been fulfilled during the time "Time to trigger", and if that primary CPICH is part of cells allowed to trigger the event according to "Triggering condition 1", and if that primary CPICH is not included in the "cells triggered" in the variable TRIGGERED_1B_EVENT:
 - include that primary CPICH in the "cells recently triggered" in the variable TRIGGERED_1B_EVENT;
- if any primary CPICHs are stored in the "cells recently triggered" in the variable TRIGGERED_1B_EVENT:
 - send a measurement report with IEs set as below:
 - set in "intra-frequency measurement event results": "Intrafrequency event identity" to "1b"; and
 - include in "cell measurement event results" all entries of "cells recently triggered" in the variable TRIGGERED_1B_EVENT that are part of the active set;
 - set the IE "measured results" and the IE "additional measured results" according to subclause 8.4.2;
 - move all entries from IE "cells recently triggered" to "cells triggered" in the variable TRIGGERED_1B_EVENT;
- if "Measurement quantity" is "pathloss" and Equation 3 below is fulfilled for a primary CPICH, or if "Measurement quantity" is "CPICH Ec/No" or "CPICH RSCP", and Equation 4 below is fulfilled for a primary CPICH:
 - if that primary CPICH is included in the "cells triggered" in the variable TRIGGERED_1B_EVENT:
 - remove the entry of that primary CPICH from "cells triggered" in the variable TRIGGERED_1B_EVENT;

Equation 1 (Triggering condition for pathloss)

$$10 \cdot \text{Log}M_{Old} \geq W \cdot 10 \cdot \text{Log} \left(1 / \sum_{i=1}^{N_A} (1/M_i) \right) + (1-W) \cdot 10 \cdot \text{Log}M_{Best} + (R + H_{1b} / 2),$$

Equation 2 (Triggering condition for all the other measurement quantities)

$$10 \cdot \text{Log}M_{Old} \leq W \cdot 10 \cdot \text{Log} \left(\sum_{i=1}^{N_A} M_i \right) + (1-W) \cdot 10 \cdot \text{Log}M_{Best} - (R + H_{1b} / 2),$$

Equation 3 (Leaving triggering condition for pathloss)

$$10 \cdot \text{Log}M_{Old} < W \cdot 10 \cdot \text{Log} \left(1 / \sum_{i=1}^{N_A} (1/M_i) \right) + (1-W) \cdot 10 \cdot \text{Log}M_{Best} + (R - H_{1b} / 2),$$

Equation 4 (Leaving triggering condition for all the other measurement quantities)

$$10 \cdot \text{Log}M_{Old} > W \cdot 10 \cdot \text{Log} \left(\sum_{i=1}^{N_A} M_i \right) + (1-W) \cdot 10 \cdot \text{Log}M_{Best} - (R - H_{1b} / 2),$$

The variables in the formula are defined as follows:

M_{Old} is the measurement result of the cell leaving the reporting range.

M_i is a measurement result of a cell in the active set.

N_A is the number of cells in the current active set.

For pathloss

M_{Best} is the measurement result of the cell in the active set with the lowest measurement result.

for other measurements quantities.

M_{Best} is the measurement result of the cell in the active set with the highest measurement result.

W is a parameter sent from UTRAN to UE.

R_{1b} is the reporting range constant.

H_{1b} is the hysteresis parameter for the event 1b.

If the measurement results are pathloss or CPICH-Ec/No then M_{New} , M_i and M_{Best} are expressed as ratios.

If the measurement result is CPICH-RSCP then M_{New} , M_i and M_{Best} are expressed in [mW].

14.1.2.3 Reporting event 1C: A non-active primary CPICH becomes better than an active primary CPICH

When event 1C is configured in the UE, the UE shall:

- if "Measurement quantity" is "pathloss" and Equation 1 below is fulfilled for a primary CPICH, or if "Measurement quantity" is "CPICH Ec/No" or "CPICH RSCP", and Equation 2 below is fulfilled for one or more primary CPICHs, for each of these primary CPICHs:
 - if the equations have been fulfilled during the time "Time to trigger", and if the primary CPICH that is better is not included in the active set but the other primary CPICH is any of the primary CPICHs included in the active set, and if that primary CPICH is not included in the "cells triggered" in the variable TRIGGERED_1C_EVENT:
 - include that primary CPICH in the "cells recently triggered" in the variable TRIGGERED_1C_EVENT;

- if the value of "Replacement activation threshold" for this event is less than or equal to the current number of cells in the active set or equal to 0 and if any primary CPICHs are stored in the "cells recently triggered" in the variable TRIGGERED_1C_EVENT:
 - if "Reporting interval" for this event is not equal to 0:
 - if the IE "Periodical reporting running" in the variable TRIGGERED_1C_EVENT is set to FALSE:
 - start a timer for with the value of "Reporting interval" for this event and set the IE "Periodical reporting running" in the variable TRIGGERED_1C_EVENT to TRUE;
 - set "sent reports" for that primary CPICH in the variable TRIGGERED_1C_EVENT to 1;
 - send a measurement report with IEs set as below:
 - set in "intra-frequency measurement event results": "Intrafrequency event identity" to "1c"; and
 - include in "cell measurement event results" all entries of the "cells recently triggered" in the variable TRIGGERED_1C_EVENT not in the active set as well as the "primary CPICH info" of all the primary CPICHs in the active set for which the measured value is worse (i.e. greater for pathloss and less for the other measurement quantities) than the one of the entry in "cell recently triggered" that has the best measured value, ordering the "primary CPICH info" according to their measured value beginning with the best cell to the worst one;
 - set the IE "measured results" and the IE "additional measured results" according to subclause 8.4.2;
 - move all entries from "cells recently triggered" to "cells triggered" in the variable TRIGGERED_1C_EVENT;
- if the timer for the periodical reporting has expired:
 - if any primary CPICH is included in the "cells triggered" in the variable TRIGGERED_1C_EVENT, and not included in the current active set:
 - if "Reporting interval" for this event is not equal to 0, and if "Amount of reporting" is greater than "sent reports" stored for that primary CPICH, in "cells triggered" in the variable TRIGGERED_1C_EVENT:
 - increment the stored counter "sent reports" for all CPICH in "cell triggered" in variable TRIGGERED_1C_EVENT;
 - start a timer with the value of "Reporting interval" for this event;
 - send a measurement report with IEs set as below:
 - set in "intra-frequency measurement event results": "Intrafrequency event identity" to "1c"; and
 - include in "cell measurement event results" all entries of the variable TRIGGERED_1C_EVENT with value of IE "sent report" smaller than value of "Amount of reporting" and that are not part of the active set as well as the "primary CPICH info" of all the primary CPICHs in the active set for which the measured value is worse (i.e. greater for pathloss and less for the other measurement quantities) than the one of the entry in "cell recently triggered" that has the best measured value, ordering the "primary CPICH info" according to their measured value beginning with the best cell to the worst one;
 - set the IE "measured results" and the IE "additional measured results" according to subclause 8.4.2;
 - if "sent reports" in variable TRIGGERED_1C_EVENT is greater than "Amount of reporting" for all entries:
 - set the IE "Periodical Reporting running" in the variable TRIGGERED_1C_EVENT to FALSE and disable the timer for the periodical reporting;
- if "Measurement quantity" is "pathloss" and Equation 3 below is fulfilled for a primary CPICH, or if "Measurement quantity" is "CPICH E_c/N_0 " or "CPICH RSCP", and Equation 4 below is fulfilled for a primary CPICH:

- if that primary CPICH is included in the "cells triggered" in the variable TRIGGERED_1C_EVENT:
 - remove the entry of that primary CPICH from "cells triggered" in the variable TRIGGERED_1C_EVENT;
 - if no entry in the variable TRIGGERED_1C_EVENT has a value of "sent reports" smaller than "Amount of reporting":
 - stop the reporting interval timer;
 - set the IE "Periodical reporting running" in the variable TRIGGERED_1C_EVENT to FALSE.

Equation 1 (Triggering condition for pathloss)

$$M_{New} \leq M_{InAS} - H_{1c} / 2,$$

Equation 2 (Triggering condition for all the other measurement quantities)

$$M_{New} \geq M_{InAS} + H_{1c} / 2,$$

Equation 3 (Leaving triggering condition for pathloss)

$$M_{New} > M_{InAS} + H_{1c} / 2,$$

Equation 4 (Leaving triggering condition for all the other measurement quantities)

$$M_{New} < M_{InAS} - H_{1c} / 2,$$

The variables in the formula are defined as follows:

M_{New} is the measurement result of the cell not included in the active set.

M_{InAS} is the measurement result of a cell in the active set.

H_{1c} is the hysteresis parameter for the event 1c.

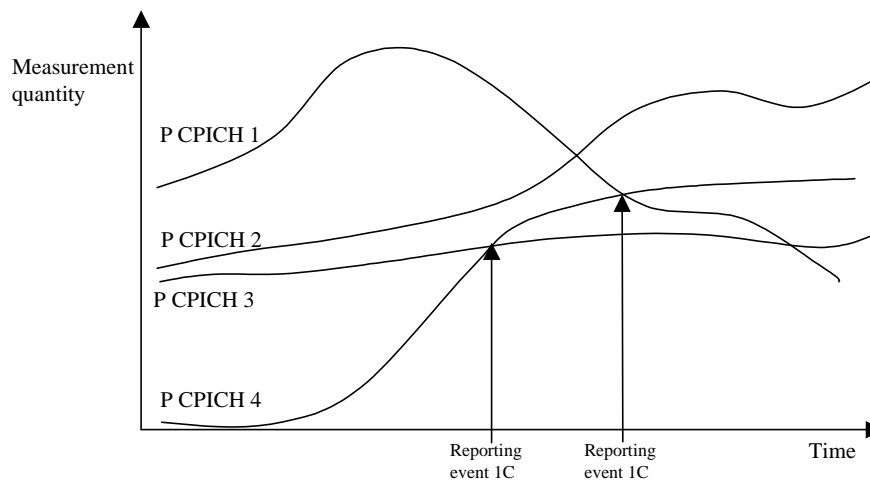

Figure 63: A primary CPICH that is not included in the active set becomes better than a primary CPICH that is in the active set

In this example the cells belonging to primary CPICH 1, 2 and 3 are supposed to be in the active set, but the cell transmitting primary CPICH 4 is not (yet) in the active set.

14.1.2.4 Reporting event 1D: Change of best cell

When event 1D is configured in the UE, the UE shall:

- if "Measurement quantity" is "pathloss" and Equation 1 below is fulfilled for a primary CPICH that is not stored in "Best cell" in variable BEST_CELL_1D_EVENT, or if "Measurement quantity" is "CPICH Ec/N0" or "CPICH RSCP", and Equation 2 below is fulfilled for a primary CPICH that is not stored in "Best cell" in variable BEST_CELL_1D_EVENT:
 - if the equations have been fulfilled during the time "Time to trigger":
 - set "best cell" in the variable BEST_CELL_1D_EVENT to that primary CPICH that triggered the event;
 - send a measurement report with IEs set as below:
 - set in "intra-frequency measurement event results"; "Intrafrequency event identity" to "1d" and "cell measurement event results" to the CPICH info of the primary CPICH that triggered the report.
 - set the IE "measured results" and the IE "additional measured results" according to subclause 8.4.2.

Upon transition to CELL_DCH the UE shall:

- set "best cell" in the variable BEST_CELL_1D_EVENT to the best cell of the primary CPICHs included in the active set.

Equation 1 (Triggering condition for pathloss)

$$M_{NotBest} \leq M_{Best} - H_{1d} / 2,$$

Equation 2 (Triggering condition for all the other measurement quantities)

$$M_{NotBest} \geq M_{Best} + H_{1d} / 2,$$

The variables in the formula are defined as follows:

$M_{NotBest}$ is the measurement result of a cell not stored in "best cell" in the variable BEST_CELL_1D_EVENT.

M_{Best} is the measurement result of the cell stored in "best cell" in variable BEST_CELL_1D_EVENT.

H_{1d} is the hysteresis parameter for the event 1d.

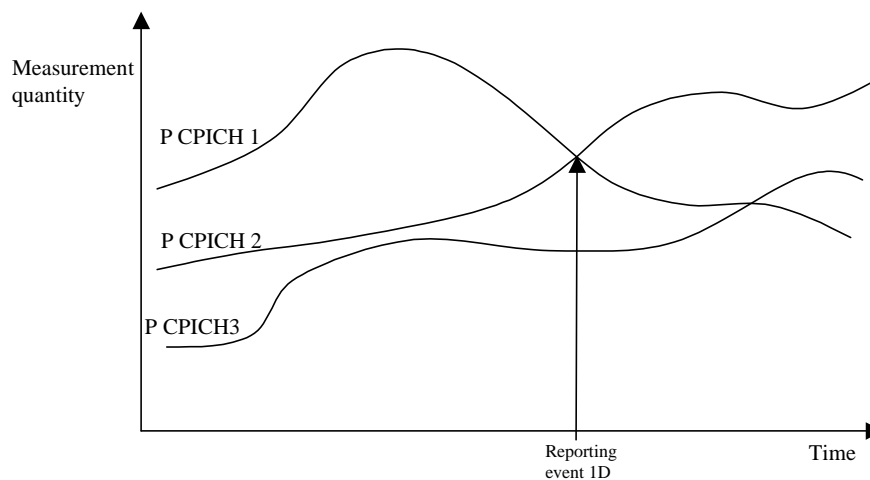

Figure 64: A primary CPICH becomes better than the previously best primary CPICH

14.1.2.5 Reporting event 1E: A Primary CPICH becomes better than an absolute threshold

When event 1E is configured in the UE, the UE shall:

- if "Measurement quantity" is "pathloss" and Equation 1 below is fulfilled for a primary CPICH, or if "Measurement quantity" is "CPICH Ec/N0" or "CPICH RSCP", and Equation 2 below is fulfilled for one or more primary CPICHs, for each of these primary CPICHs:

- if the equations have been fulfilled during the time "Time to trigger", and if that primary CPICH is part of cells allowed to trigger the event according to "Triggering condition 2", and that primary CPICH is not included in the "cells triggered" in the variable TRIGGERED_1E_EVENT:
 - include that primary CPICH in the "cells recently triggered" in the variable TRIGGERED_1E_EVENT;
- if any primary CPICHs are stored in the "cells recently triggered" in the variable TRIGGERED_1E_EVENT:
 - send a measurement report with IEs set as below:
 - set in "intra-frequency measurement event results": "Intrafrequency event identity" to "1e"; and
 - include in "cell measurement event results" all entries of the "cells recently triggered" in the variable TRIGGERED_1E_EVENT that are not part of the active set in descending order according to the configured measurement quantity;
 - set the IE "measured results" and the IE "additional measured results" according to subclause 8.4.2;
 - move all entries from "cells recently triggered" to "cells triggered" in the variable TRIGGERED_1E_EVENT;
- if "Measurement quantity" is "pathloss" and Equation 3 below is fulfilled for a primary CPICH, or if "Measurement quantity" is "CPICH Ec/N0" or "CPICH RSCP", and Equation 4 below is fulfilled for a primary CPICH:
 - if that primary CPICH is included in the "cells triggered" in the variable TRIGGERED_1E_EVENT:
 - remove that primary CPICH and sent reports from "cells triggered" in the variable TRIGGERED_1E_EVENT.

Upon transition to CELL_DCH the UE shall:

- include the primary CPICH of all cells in the current active set that fulfil the equations 1 or 2 according to the "Measurement quantity" of event 1e into the "cells triggered" in the variable TRIGGERED_1E_EVENT.

Equation 1 (Triggering condition for pathloss)

$$M_{New} \leq T_{1e} - H_{1e} / 2$$

Equation 2 (Triggering condition for all the other measurement quantities)

$$M_{New} \geq T_{1e} + H_{1e} / 2$$

Equation 3 (Leaving triggering condition for pathloss)

$$M_{New} > T_{1e} + H_{1e} / 2$$

Equation 4 (Leaving triggering condition for all the other measurement quantities)

$$M_{New} < T_{1e} - H_{1e} / 2$$

The variables in the formula are defined as follows:

M_{New} is the measurement result of a cell that becomes better than an absolute threshold.

T_{1e} is an absolute threshold.

H_{1e} is the hysteresis parameter for the event 1e.

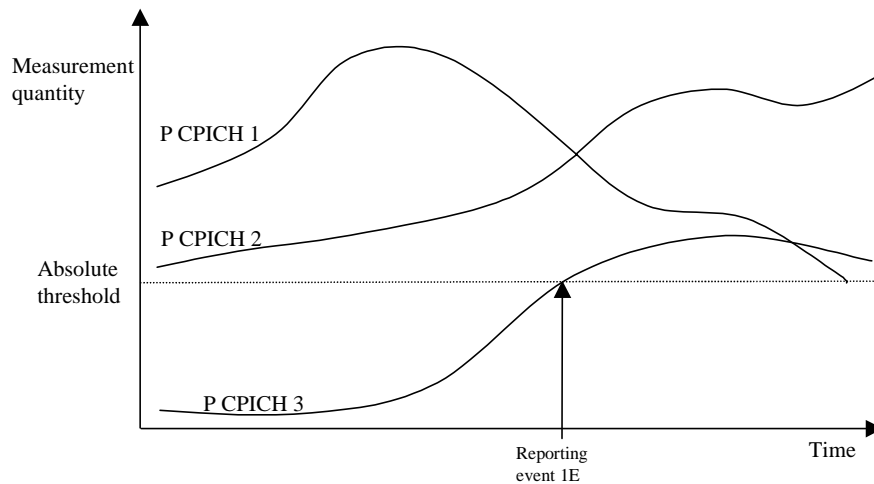

Figure 65: Event-triggered report when a Primary CPICH becomes better than an absolute threshold

14.1.2.6 Reporting event 1F: A Primary CPICH becomes worse than an absolute threshold

When event 1F is configured in the UE, the UE shall:

- if "Measurement quantity" is "pathloss" and Equation 1 below is fulfilled for one or more primary CPICHs, or if "Measurement quantity" is "CPICH Ec/N0" or "CPICH RSCP", and Equation 2 below is fulfilled for one or more primary CPICHs, for each of these primary CPICHs:
 - if the equations have been fulfilled during the time "Time to trigger", and if that primary CPICH is part of cells allowed to trigger the event according to "Triggering condition 1", and that primary CPICH is not included in the "cells triggered" in the variable TRIGGERED_1F_EVENT:
 - include that primary CPICH in the "cells recently triggered" in the variable TRIGGERED_1F_EVENT;
- if any primary CPICHs are stored in the "cells recently triggered" in the variable TRIGGERED_1F_EVENT:
 - send a measurement report with IEs set as below:
 - set in "intra-frequency event measurement results": "Intrafrequency event identity" to "1f"; and
 - include in "cell measurement event results" all entries of the "cells recently triggered" in the variable TRIGGERED_1F_EVENT that are part of the active set in descending order according to the configured measurement quantity;
 - set the IE "measured results" and the IE "additional measured results" according to subclause 8.4.2;
 - move all entries from "cells recently triggered" to "cells triggered" in the variable TRIGGERED_1F_EVENT
- if "Measurement quantity" is "pathloss" and Equation 3 below is fulfilled for a primary CPICH, or if "Measurement quantity" is "CPICH Ec/N0" or "CPICH RSCP", and Equation 4 below is fulfilled for a primary CPICH:
 - if that primary CPICH is included in the "cells triggered" in the variable TRIGGERED_1F_EVENT:
 - remove that primary CPICH from "cells triggered" in the variable TRIGGERED_1F_EVENT.

Upon transition to CELL_DCH the UE shall:

- include the primary CPICH of all cells that fulfil the equations 1 or 2 according to the "Measurement quantity" of event 1f into the "cells triggered" in the variable TRIGGERED_1F_EVENT.

Equation 1 (Triggering condition for pathloss)

$$M_{New} \geq T_{If} + H_{If} / 2$$

Equation 2 (Triggering condition for all the other measurement quantities)

$$M_{New} \leq T_{If} - H_{If} / 2$$

Equation 3 (Leaving triggering condition for pathloss)

$$M_{New} < T_{If} - H_{If} / 2$$

Equation 4 (Leaving triggering condition for all the other measurement quantities)

$$M_{New} > T_{If} + H_{If} / 2$$

The variables in the formula are defined as follows:

M_{New} is the measurement result of a cell that becomes worse than an absolute threshold

T_{If} is an absolute threshold

H_{If} is the hysteresis parameter for the event 1f.

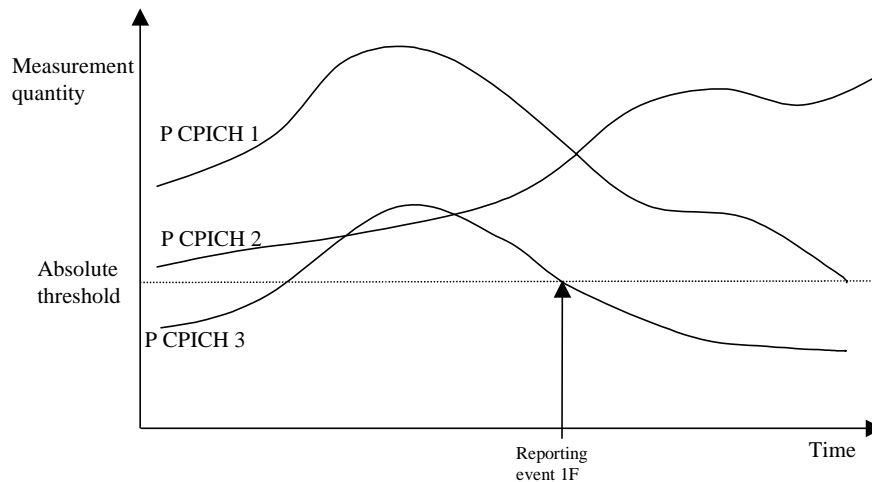

Figure 66: Event-triggered report when a Primary CPICH becomes worse than an absolute threshold

14.1.3 Intra-frequency reporting events for TDD

14.1.3.1 Reporting event 1G: Change of best cell (TDD)

When event 1G is configured in the UE, the UE shall:

- if the equation 1 is fulfilled for a P-CCPCHs during the time "Time to trigger" and if that P-CCPCH is not included in the "primary CCPCH info" in the variable TRIGGERED_1G_EVENT:
 - include that P-CCPCH in "cells triggered" in the variable TRIGGERED_1G_EVENT;
 - send a measurement report with IEs set as below:
 - set in "intra-frequency measurement event results": "Intrafrequency event identity" to "1g";
 - set the first entry in "cell measurement event results" to the "Cell parameters ID" of the P-CCPCH which was stored in the variable TRIGGERED_1G_EVENT;
 - include all entries in "cells triggered" in variable TRIGGERED_1G_EVENT in "cell measurement event results" in the measurement report in descending order according to:

$$10 \cdot \text{Log}M + O$$

where M is the P-CCPCH RSCP and O the individual offset of a cell;

- set the IE "measured results" and the IE "additional measured results" according to subclause 8.4.2;
- if Equation 2 below is fulfilled for a primary CCPCH:
 - if a primary CCPCH is included in the "cells triggered" in the variable TRIGGERED_1G_EVENT:
 - remove the entry of that primary CCPCH from "cells triggered" in the variable TRIGGERED_1G_EVENT;

The UE shall use the equations below for evaluation of reporting event 1g:

Equation 1

$$10 \cdot \text{Log}M_i + O_i - H_{1g} > 10 \cdot \text{Log}M_{previous_best} + O_{previous_best}$$

The variables in the formula are defined as follows:

$M_{previous_best}$ is the current P-CCPCH RSCP of the previous best cell expressed in [mW]

$O_{previous_best}$ is the cell individual offset of the previous best cell

M_i is the current P-CCPCH RSCP of the currently evaluated cell i expressed in [mW]

O_i is the cell individual offset of the currently evaluated cell i

H_{1g} is the hysteresis parameter for the event 1g.

Equation 2

$$10 \cdot \text{Log}M_i + O_i + H_{1g} < 10 \cdot \text{Log}M_{previous_best} + O_{previous_best}$$

The variables in the formula are defined as follows:

$M_{previous_best}$ is the current P-CCPCH RSCP of the previous best cell expressed in [mW]

$O_{previous_best}$ is the cell individual offset of the previous best cell

M_i is the current P-CCPCH RSCP of the currently evaluated cell i expressed in [mW]

O_i is the cell individual offset of the currently evaluated cell i

H_{1g} is the hysteresis parameter for the event 1g.

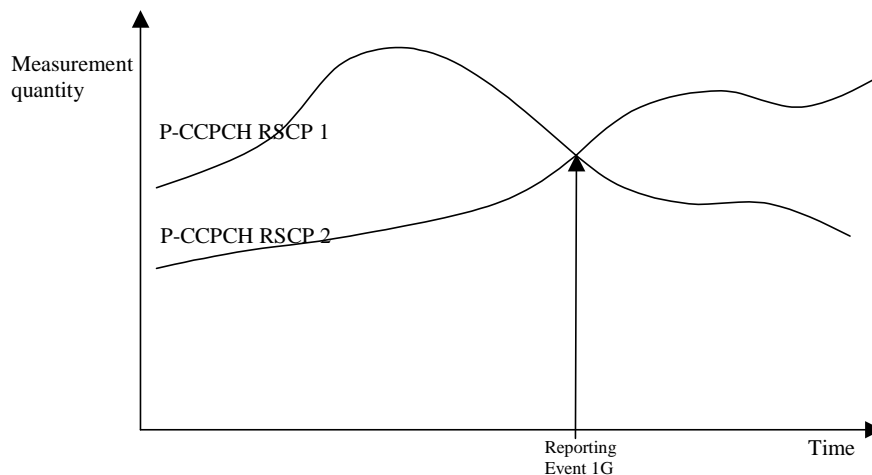

Figure 67: A P-CCPCH RSCP becomes better than the previous best P-CCPCH RSCP

14.1.3.2 Reporting event 1H: Timeslot ISCP below a certain threshold (TDD)

When event 1h is configured in the UE, the UE shall:

- if equation 1 is fulfilled during the time "Time to trigger" and if that P-CCPCH is not included in the IE "cells triggered" in the variable TRIGGERED_1H_EVENT:
 - include that P-CCPCH in the IE "cells triggered" in the variable TRIGGERED_1H_EVENT;
 - send a measurement report with the IEs set as below:
 - set in "intra-frequency measurement event results": "Intrafrequency event identity" to "1h" and in "cell measurement event results" the "Cell parameters ID" of the P-CCPCH that triggered the report;
 - include in "Cell measured results" the "Timeslot ISCP" of those cells that are included in the variable TRIGGERED_1H_EVENT;
- if a primary CCPCH is included in the "cells triggered" in the variable TRIGGERED_1H_EVENT:
 - increment the stored counter "sent reports" for that primary CCPCH in "cells triggered" in variable TRIGGERED_1H_EVENT;
 - send a measurement report with IEs set as below:
 - set in "intra-frequency measurement event results": "Intrafrequency event identity" to "1h" and "cell measurement event results" to the "Cell parameters ID" of the P-CCPCH that triggered the report;
 - set in "measured results" the "Timeslot ISCP" of those cells that are included in the variable TRIGGERED_1H_EVENT and "additional measured results" according to subclause 8.4.2;
- if Equation 2 below is fulfilled for a primary CCPCH:
 - if a primary CCPCH is included in the "cells triggered" in the variable TRIGGERED_1H_EVENT:
 - remove the entry of that primary CCPCH from "cells triggered" in the variable TRIGGERED_1H_EVENT;

The UE shall use the equations below for evaluation of reporting event 1h:

Equation 1

$$10 \cdot \text{Log}M_i + H_{1h} + O_i < T_{1h},$$

Equation 2

$$10 \cdot \text{Log}M_i - H_{1h} + O_i > T_{1h},$$

The variables in the formula are defined as follows:

M_i is the Timeslot ISCP of the currently evaluated cell i expressed in [mW]

O_i is the cell individual offset of the currently evaluated cell i

T_{1h} is the Threshold for event 1h

H_{1h} is the hysteresis parameter for the event 1h.

Before any evaluation is done, the Timeslot ISCP expressed in [mW] is filtered according to subclause 8.6.7.2.

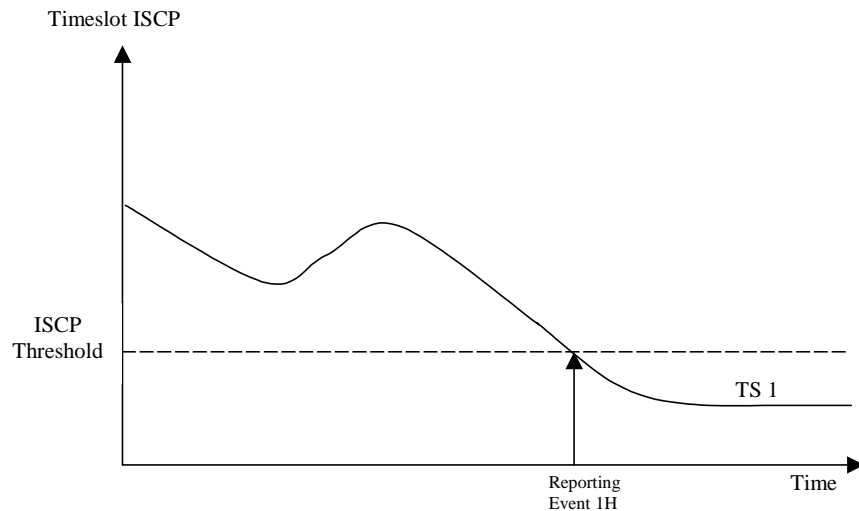

Figure 68: An ISCP value of a timeslot drops below an absolute threshold

14.1.3.3 Reporting event 1i: Timeslot ISCP above a certain threshold (TDD)

When event 1i is configured in the UE, the UE shall:

- if equation 1 is fulfilled during the time "Time to trigger" and if that P-CCPCH is not included in the IE "cells triggered" in the variable TRIGGERED_1I_EVENT:
 - include that P-CCPCH in the IE "cells triggered" in the variable TRIGGERED_1I_EVENT;
 - send a measurement report with the IEs set as below:
 - set in "intra-frequency measurement event results": "Intrafrequency event identity" to "1i" and in "cell measurement event results" to the "Cell parameters ID" of the P-CCPCH that triggered the report;
 - include in "measured results" the "Timeslot ISCP" of those cells that are included in the variable TRIGGERED_1I_EVENT and "additional measured results" according to 8.4.2;
- if a primary CCPCH is included in the "cells triggered" in the variable TRIGGERED_1I_EVENT:
 - if Equation 2 below is fulfilled for a primary CCPCH:
 - if a primary CCPCH is included in the "cells triggered" in the variable TRIGGERED_1I_EVENT:
 - remove the entry of that primary CCPCH from "cells triggered" in the variable TRIGGERED_1I_EVENT.

The UE shall use the equation below for evaluation of reporting event 1i:

Equation 1

$$10 \cdot \text{Log}M_i - H_{li} + O_i > T_{1i},$$

Equation 2

$$10 \cdot \text{Log}M_i + H_{li} + O_i < T_{1i},$$

The variables in the formula are defined as follows:

M_i is the Timeslot ISCP of the currently evaluated cell i expressed in [mW]

O_i is the cell individual offset of the currently evaluated cell i

T_{1i} is the Threshold for event 1i

H_{li} is the hysteresis parameter for the event li.

Before any evaluation is done, the Timeslot ISCP expressed in [mW] is filtered according to sub-clause 8.6.7.2.

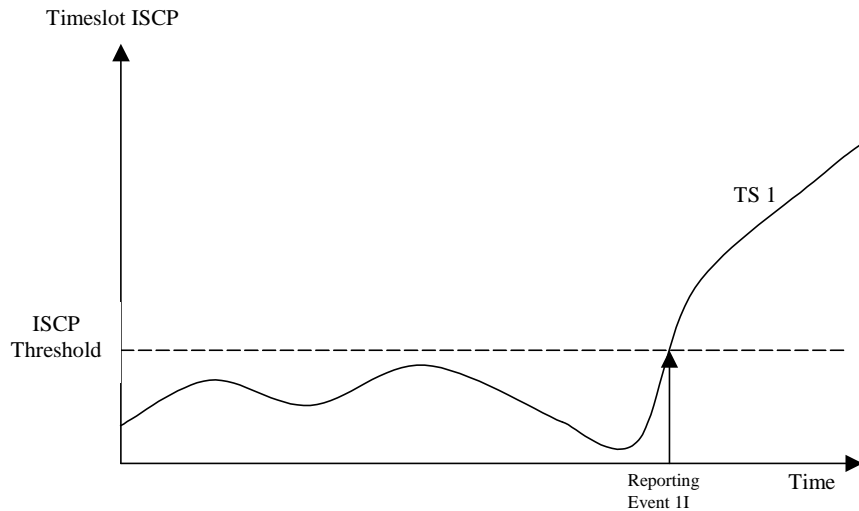

Figure 69: An ISCP value of a timeslot exceeds a certain threshold

14.1.4 Event-triggered periodic intra-frequency measurement reports (informative)

14.1.4.1 Cell addition failure (FDD only)

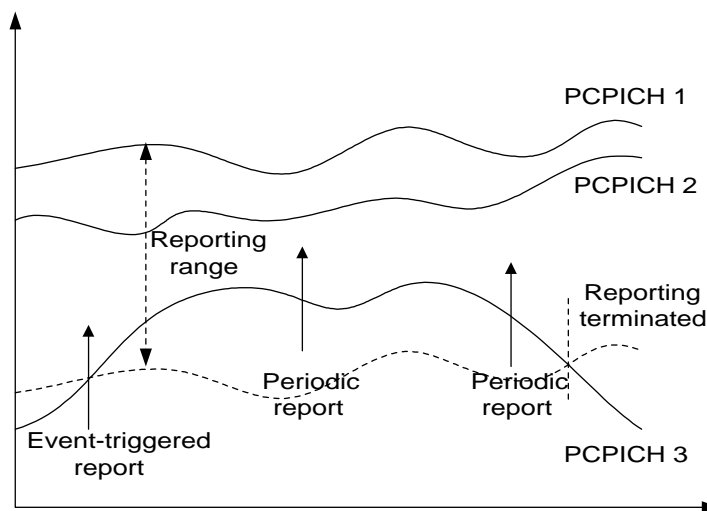

Figure 70: Periodic reporting triggered by event 1A

When a cell enters the reporting range and triggers event 1A, the UE shall transmit a MEASUREMENT REPORT to the UTRAN and typically this may result in an update of the active set. However, in some situations the UTRAN may be unable to add a strong cell to the active set typically due to capacity shortage for example.

The UE shall continue reporting after the initial report by reverting to periodical measurement reporting if the reported cell is not added to the active set. This is illustrated in Figure 70. During periodic reporting the UE shall transmit MEASUREMENT REPORT messages to the UTRAN at predefined intervals. The reports shall include reporting information of the cells in the current active set and of the monitored cell(s) in the reporting range.

Event-triggered periodic measurement reporting shall be terminated if:

- there are no longer any monitored cell(s) within the reporting range; or

- the UTRAN has added cells to the active set so that it includes the maximum number of cells (defined by the **reporting deactivation threshold** parameter), which are allowed for event 1A to be triggered; or
- the UE has sent the maximum number of MEASUREMENT REPORT messages (defined by the **amount of reporting** parameter).

The reporting period is assigned by the UTRAN (with the **Reporting interval** parameter). If the reporting interval is set to zero event-triggered measurement reporting shall not be applied.

14.1.4.2 Cell replacement failure (FDD only)

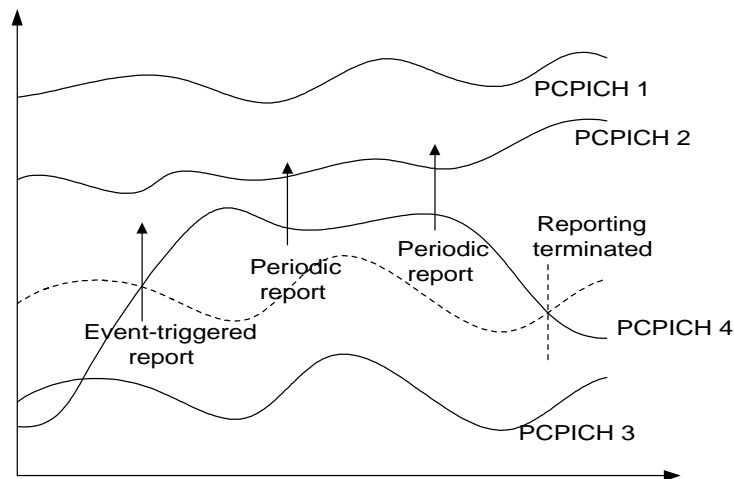

Figure 71: Periodic reporting triggered by event 1C

When a cell enters the replacement range and triggers event 1C, the UE shall transmit a MEASUREMENT REPORT to the UTRAN and typically this may result in the replacement of the weakest active cell. If the UTRAN is unable to replace the cell due to for example capacity shortage, it is beneficial to receive continuous reports in this case as well.

The UE shall revert to periodical measurement reporting if the UTRAN does not update the active set after the transmission of the measurement report. This is illustrated in Figure 71. During periodic reporting the UE shall transmit MEASUREMENT REPORT messages to the UTRAN at predefined intervals. The reports shall include reporting information of the cells in the current active set and of the monitored cell(s) in the replacement range.

Event-triggered periodic measurement reporting shall be terminated if:

- there are no longer any monitored cell(s) within the replacement range; or
- the UTRAN has removed cells from the active set so that there are no longer the minimum amount of active cells for event 1C to be triggered (as defined by the **replacement activation threshold** parameter); or
- the UE has sent the maximum number of MEASUREMENT REPORT messages (defined by the **amount of reporting** parameter).

The reporting period is assigned by the UTRAN (with the **Reporting interval** parameter). If the reporting interval is set to zero, event-triggered measurement reporting shall not be applied.

14.1.5 Mechanisms available for modifying intra-frequency measurement reporting behaviour (informative)

14.1.5.1 Hysteresis

To limit the amount of event-triggered reports, a hysteresis parameter may be connected with each reporting event given above. The value of the hysteresis is given to the UE in the Reporting criteria field of the Measurement Control message.

In the example in Figure 72, the hysteresis ensures that the event 1D (FDD) or IG(TDD) (primary CPICH(FDD)/CCPCH(TDD) 2 becomes the best cell) is not reported until the difference is equal to the hysteresis value. The fact that primary CPICH(FDD)/CCPCH(TDD) 1 becomes best afterwards is not reported at all in the example since the primary CPICH(FDD)/CCPCH(TDD) 1 does not become sufficiently better than the primary CPICH(FDD)/CCPCH(TDD) 2.

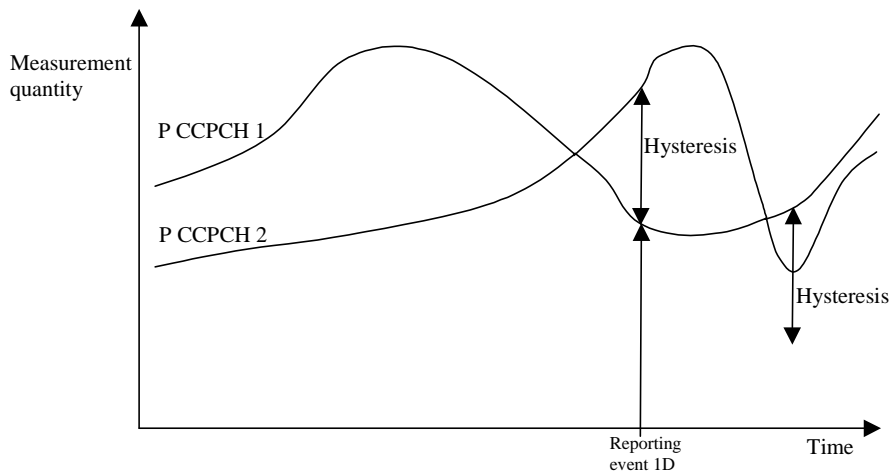

Figure 72: Hysteresis limits the amount of measurement reports

14.1.5.2 Time-to-trigger

To limit the measurement signalling load, a time-to-trigger parameter could be connected with each reporting event given above. The value of the time-to-trigger is given to the UE in the Reporting criteria field of the Measurement Control message.

The effect of the time-to-trigger is that the report is triggered only after the conditions for the event have existed for the specified time-to-trigger. In the following FDD example in Figure 73, the use of time-to-trigger means that the event (primary CPICH 3 enters the reporting range) is not reported until it has been within the range for the time given by the time-to-trigger parameter.

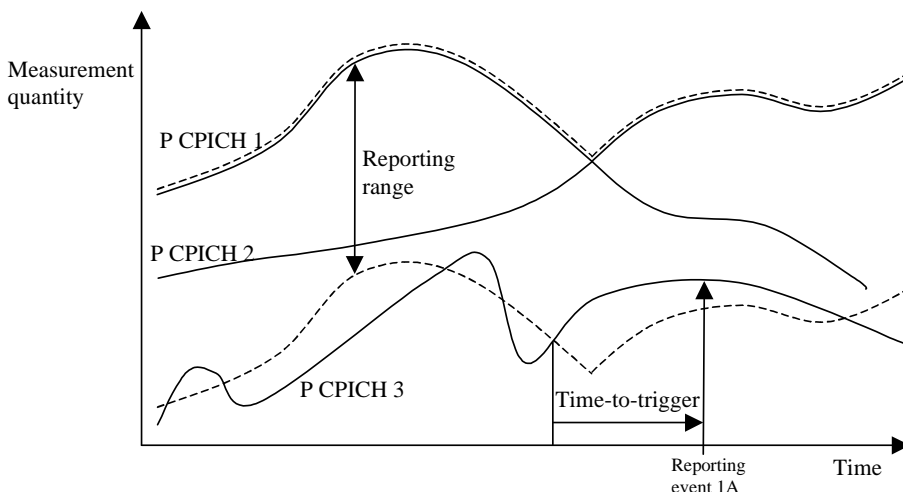

Figure 73: Time-to-trigger limits the amount of measurement reports

In the following TDD example in Figure 74, the use of time-to-trigger means that the event (Timeslot ISCP upon certain threshold) is not reported until it has been upon the threshold for the time given by the time-to trigger parameter.

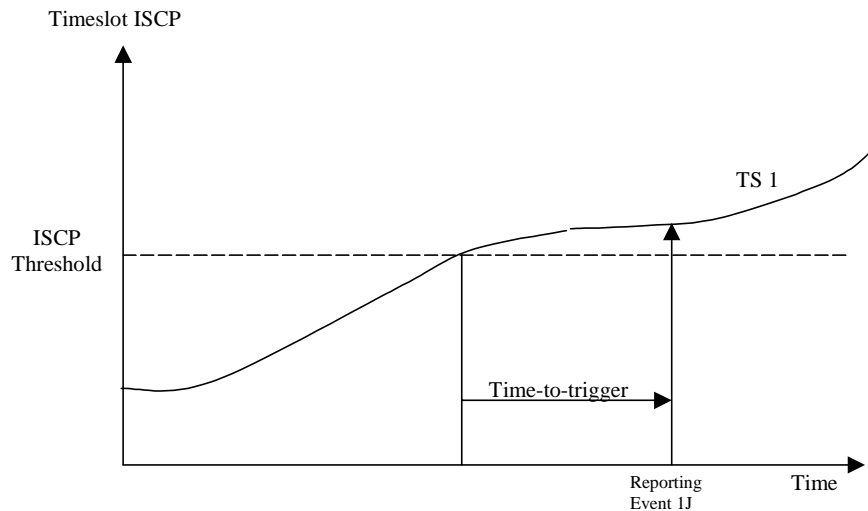

Figure 74: Time-to-trigger limits the amount of measurement reports

NOTE: The time-to-trigger could be combined with hysteresis, i.e. a hysteresis value is added to the measurement quantity before evaluating if the time-to-trigger timer should be started.

14.1.5.3 Cell individual offsets

For each cell that is monitored, an offset can be assigned with inband signalling. The offset can be either positive or negative. The offset is added to the measurement quantity before the UE evaluates if an event has occurred. The UE receives the cell individual offsets for each primary CPICH(FDD)/CCPCH(TDD) in the IE "Cell individual offset" included in the IE "Cell info" associated with each measurement object included in the MEASUREMENT CONTROL message.

For the FDD example, in Figure 75, since an offset is added to primary CPICH 3, it is the dotted curve that is used to evaluate if an event occurs. Hence, this means that measurement reports from UE to UTRAN are triggered when primary CPICH plus the corresponding offset, i.e. the dotted curve, leaves and enters the reporting range and when it gets better than primary CPICH 1 (if these events have been ordered by UTRAN). This offset mechanism provides the network with an efficient tool to change the reporting of an individual primary CPICH.

By applying a positive offset, as in Figure 75, the UE will send measurement reports as if the primary CPICH is offset x dB better than what it really is. This could be useful if the operator knows that a specific cell is interesting to monitor more carefully, even though it is not so good for the moment. In the example in Figure 75, the operator might know by experience that in this area primary CPICH 3 can become good very quickly (e.g. due to street corners) and therefore that it is worth reporting more intensively. Depending on the implemented handover evaluation algorithm, this may result in the cell with primary CPICH 3 being included in the active set earlier than would have been the case without the positive offset.

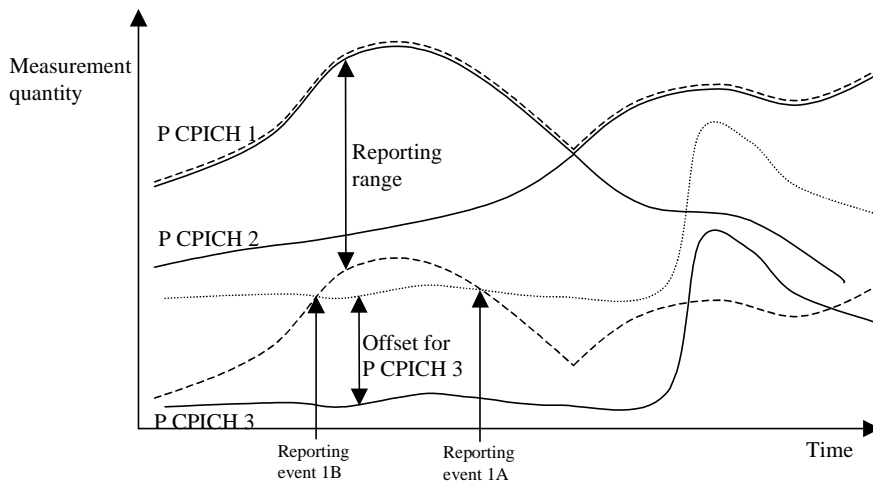

Figure 75: A positive offset is applied to primary CPICH 3 before event evaluation in the UE

For the TDD example, in Figure 76, an offset is added to primary CCPCH2, it is the dotted curve that is used to evaluate if the primary CCPCH2 becomes better than primary CCPCH1 (ordered by the UTRAN).

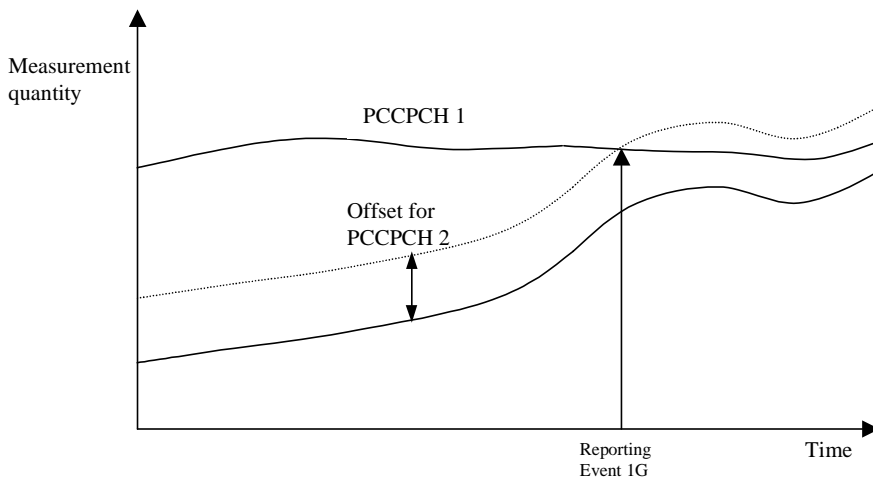

Figure 76: A positive offset is applied to primary CCPCH 2

Correspondingly, the operator can choose to apply a negative offset to a primary CCPCH. Then the reporting on that primary CCPCH is limited and the corresponding cell may be, at least temporarily excluded from the active set or as a target cell for handover.

The cell individual offset can be seen as a tool to move the cell border. It is important to note that the offset is added before triggering events, i.e. the offset is added by the UE before evaluating if a measurement report should be sent as opposed to offsets that are applied in the network and used for the actual handover evaluation.

14.1.5.4 Forbid a Primary CPICH to affect the reporting range (FDD only)

The reporting range affects the reporting events 1A and 1B presented above. The reporting range is defined as a function of all the Primary CPICHs in the active set (see 14.1.2.1 and 14.1.2.2). If the parameter W is set to 0, the reporting range is defined relative to the best Primary CPICH. However, there could be cases where it is good to forbid a specific Primary CPICH to affect the reporting range. For example in Figure 77 the network has requested the UE to not let Primary CPICH 3 affect the reporting range. This mechanism could be effective if the operator knows by experience that the quality of Primary CPICH 3 is very unstable in a specific area and therefore should not affect the reporting of the other Primary CPICHs.

The UE shall ignore that a Primary CPICH is forbidden to affect the reporting range if all of the following conditions are fulfilled:

- the Primary CPICH is included in active set; and
- all cells in active set are defined as Primary CPICHs forbidden to affect the reporting range.

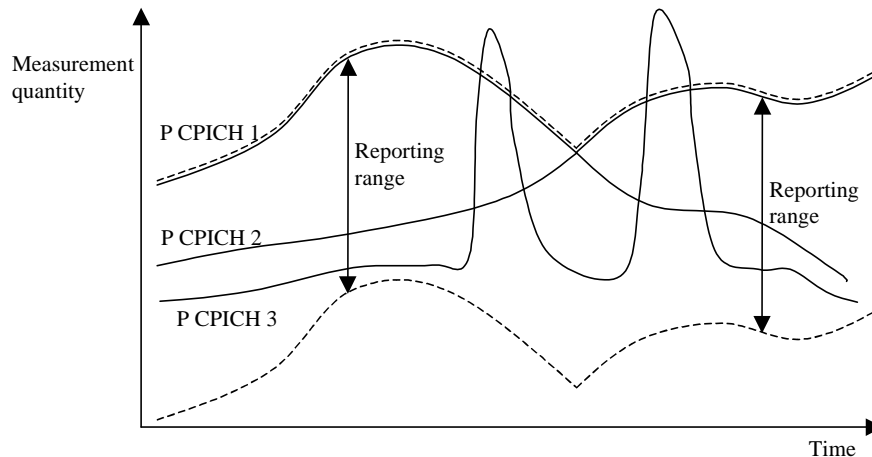

Figure 77: Primary CPICH 3 is forbidden to affect the reporting range

14.1.6 Report quantities in intra-frequency measurements

The quantities that the UE shall report to UTRAN when the event is triggered for an intra-frequency measurement are given by the IE "Intra-frequency reporting quantity" stored for this measurement and can be the following:

- 1 SFN-SFN observed time difference
- 2 Cell synchronisation information
- 3 Cell Identity
- 4 Downlink E_c/N_0 (FDD).
- 5 Downlink path loss.

For FDD:

$$\text{Pathloss in dB} = \text{Primary CPICH Tx power} - \text{CPICH RSCP.}$$

- For Primary CPICH Tx power the IE "Primary CPICH Tx power" shall be used. The unit is dBm.
- CPICH RSCP is the result of the CPICH RSCP measurement. The unit is dBm.

For TDD:

$$\text{Pathloss in dB} = \text{Primary CCPCH TX power} - \text{Primary CCPCH RSCP.}$$

- For Primary CCPCH TX power the IE "Primary CCPCH TX Power" shall be used. The unit is dBm.
- Primary CCPCH RSCP is the result of the Primary CCPCH RSCP measurement. The unit is dBm.

If necessary Pathloss shall be rounded up to the next higher integer.

Results higher than 158 shall be reported as 158.

Results lower than 46 shall be reported as 46.

- 6 Downlink received signal code power (RSCP) after despreading (of a primary CPICH for FDD, and of a primary CCPCH for TDD).
- 7 ISCP measured on Timeslot basis. (TDD)
- 8 Proposed TGSN (TDD)

A description of those values can be found in [7] and [8].

14.2 Inter-frequency measurements

14.2.0a Inter-frequency measurement quantities

The two first measurement quantities listed below are used by the UE to evaluate whether an inter-frequency measurement event has occurred or not, through the computation of a frequency quality estimate. The quantity to use to compute the frequency quality estimate for an inter-frequency measurement is given in the "Inter-frequency measurement quantity" stored for that measurement. In the FDD case, all three measurement quantities can be used for the update of the virtual active set of the non-used frequencies as described in subclause 14.11.

- 1 Downlink Ec/No
- 2 Downlink received signal code power (RSCP) after despreading.
- 3 Downlink path loss.

For FDD:

$$\text{Pathloss in dB} = \text{Primary CPICH Tx power} - \text{CPICH RSCP.}$$

- For Primary CPICH Tx power the IE "Primary CPICH Tx power" shall be used. The unit is dBm.
- CPICH RSCP is the result of the CPICH RSCP measurement. The unit is dBm.

A description of those values can be found in [7] and [8].

14.2.0b Frequency quality estimate

14.2.0b.1 FDD cells

The frequency quality estimate used in events 2a, 2b 2c, 2d, 2e and 2f is defined as:

$$Q_{carrier\ j} = 10 \cdot \text{Log}M_{carrier\ j} = W_j \cdot 10 \cdot \text{Log} \left(\sum_{i=1}^{N_{A\ j}} M_{i\ j} \right) + (1 - W_j) \cdot 10 \cdot \text{Log}M_{Best\ j} - H,$$

The variables in the formula are defined as follows ("the virtual active set on frequency j" should be understood as the active set if frequency j is the used frequency. If frequency j is a non-used frequency, the way the virtual active set is initiated and updated is described in subclause 14.11):

$Q_{frequency\ j}$ is the estimated quality of the virtual active set on frequency j.

$M_{frequency\ j}$ is the estimated quality of the virtual active set on frequency j.

$M_{i\ j}$ is a measurement result of cell i in the virtual active set on frequency j.

$N_{A\ j}$ is the number of cells in the virtual active set on frequency j.

$M_{Best\ j}$ is the measurement result of the cell in the virtual active set on frequency j with the highest measurement result.

W_j is a parameter sent from UTRAN to UE and used for frequency j.

If the measurement result is CPICH-Ec/No then $M_{Frequency}$, $M_{i\ j}$ and M_{Best} are expressed as ratios.

If the measurement result is CPICH-RSCP or PCCPCH-RSCP then $M_{Frequency}$, $M_{i\ j}$ and M_{Best} are expressed in [mW].

14.2.0b.2 TDD cells

$$Q_{i, \text{frequency } j} = 10 \cdot \text{Log} M_{i, \text{frequency } j} + O_{i,j}$$

$Q_{i, \text{frequency } j}$ is the estimated quality of cell i on frequency j .

$M_{\text{frequency } j}$ is the measurement result for Primary CCPCH RSCP of cell i on frequency j expressed in [mW].

$O_{i,j}$ is the cell individual offset of the currently evaluated cell i on frequency j . O_{ij} is set by IE "Cell individual offset"

14.2.0c Inter-frequency reporting quantities

The quantities that the UE shall report for each cell to UTRAN when the event is triggered for an inter-frequency measurement is given by the "Inter-frequency reporting quantity" IE stored for this measurement and can be the following, from 1 to 8. The quantity number 9 can be reported for each frequency that triggered the report.

- 1 Cell identity
- 2 SFN-SFN observed time difference
- 3 Cell synchronisation information
- 4 Downlink Ec/No (FDD)
- 5 Downlink path loss.

For FDD:

$$\text{Pathloss in dB} = \text{Primary CPICH Tx power} - \text{CPICH RSCP.}$$

- For Primary CPICH Tx power the IE "Primary CPICH Tx power" shall be used. The unit is dBm.
- CPICH RSCP is the result of the CPICH RSCP measurement. The unit is dBm.

For TDD:

$$\text{Pathloss in dB} = \text{Primary CCPCH TX power} - \text{Primary CCPCH RSCP.}$$

- For Primary CCPCH TX power the IE "Primary CCPCH TX Power" shall be used. The unit is dBm.
 - Primary CCPCH RSCP is the result of the Primary CCPCH RSCP measurement. The unit is dBm.
 - If necessary Pathloss shall be rounded up to the next higher integer.
Results higher than 158 shall be reported as 158.
Results lower than 46 shall be reported as 46.
- 6 Downlink received signal code power (RSCP) after despreading (of a primary CPICH for FDD, and of a primary CCPCH for TDD).
 - 7 ISCP measured on Timeslot basis. (TDD)
 - 8 Proposed TGSN (TDD)
 - 9 UTRA carrier RSSI

A description of those values can be found in [7] and [8].

14.2.1 Inter-frequency reporting events

Within the measurement reporting criteria field in the MEASUREMENT CONTROL message UTRAN notifies the UE which events should trigger the UE to send a MEASUREMENT REPORT message. The listed events are the toolbox from which the UTRAN can choose the reporting events that are needed for the implemented handover evaluation function, or other radio network functions.

All events are evaluated with respect to one of the measurement quantities given in subclause 14.2.0a. The measurement quantities are measured on the monitored primary common pilot channels (CPICH) in FDD mode and the monitored primary common control channels (PCCPCH) in TDD mode of the cell defined in the measurement object. A "non-used frequency" is a frequency that the UE has been ordered to measure upon but is not used for the connection. A "used frequency" is a frequency that the UE has been ordered to measure upon and is also currently used for the connection.

14.2.1.1 Event 2a: Change of best frequency.

When event 2a is configured in the UE within a measurement, the UE shall:

- when the measurement is initiated or resumed:
 - store the used frequency in the variable BEST_FREQUENCY_2A_EVENT;
- if equation 1 below has been fulfilled during the time "Time to trigger" for a frequency included for that event and which is not stored in the variable BEST_FREQUENCY_2A_EVENT:
 - send a measurement report with IEs set as below:
 - set in "inter-frequency measurement event results":
 - "inter-frequency event identity" to "2a"; and
 - "Frequency info" to the frequency that triggered the event; and
 - "Non frequency related measurement event results" to the "Primary CPICH info" of the best primary CPICH for FDD cells or "Primary CCPCH info" to the "Cells parameters ID" of the best primary CCPCH for TDD cells on that frequency;
 - set the IE "measured results" and the IE "additional measured results" according to subclause 8.4.2;
 - update the variable BEST_FREQUENCY_2A_EVENT with that frequency.

Equation 1:

$$Q_{NotBest} \geq Q_{Best} + H_{2a} / 2$$

The variables in the formula are defined as follows:

$Q_{NotBest}$ is the quality estimate of a frequency not stored the "best frequency" in the variable BEST_FREQUENCY_2A_EVENT.

Q_{Best} is the quality estimate of the frequency stored in "best frequency" in the variable BEST_FREQUENCY_2A_EVENT.

H_{2a} is the hysteresis parameter for the event 2a in that measurement.

14.2.1.2 Event 2b: The estimated quality of the currently used frequency is below a certain threshold **and** the estimated quality of a non-used frequency is above a certain threshold.

When an inter-frequency measurement configuring event 2b is set up, the UE shall:

- create a variable TRIGGERED_2B_EVENT related to that measurement, which shall initially be empty;
- delete this variable when the measurement is released.

When event 2b is configured in the UE within a measurement, the UE shall:

- if equations 1 and 2 below have been fulfilled during the time "Time to Trigger" from the same instant, respectively for one or several non-used frequencies included for that event and for the used frequency:
 - if any of those non-used frequency is not stored in the variable TRIGGERED_2B_EVENT:

- store the non-used frequencies that triggered the event and that were not previously stored in the variable TRIGGERED_2B_EVENT into that variable;
- send a measurement report with IEs set as below:
 - set in "inter-frequency measurement event results":
 - "inter-frequency event identity" to "2b"; and
 - for each non-used frequency that triggered the event, beginning with the best frequency:
 - "Frequency info" to that non-used frequency; and
 - "Non frequency related measurement event results" to the "Primary CPICH info" of the best primary CPICH for FDD cells or "Primary CCPCH info" to the "Cell parameters ID" of the best primary CCPCH for TDD cells on that non-used frequency;
 - set the IE "measured results" and the IE "additional measured results" according to subclause 8.4.2;
- if equation 3 below is fulfilled for a non-used frequency stored in the variable TRIGGERED_2B_EVENT:
 - remove that non-used frequency from the variable TRIGGERED_2B_EVENT;
- if equation 4 below is fulfilled for the used frequency:
 - clear the variable TRIGGERED_2B_EVENT.

Triggering conditions:

Equation 1:

$$Q_{Nonused} \geq T_{Nonused2b} + H_{2b}/2$$

The variables in the formula are defined as follows:

$Q_{Non used}$ is the quality estimate of a non-used frequency that becomes better than an absolute threshold.

$T_{Non used 2b}$ is the absolute threshold that applies for this non-used frequency in that measurement.

H_{2b} is the hysteresis parameter for the event 2b.

Equation 2:

$$Q_{Used} \leq T_{Used2b} - H_{2b}/2$$

The variables in the formula are defined as follows:

Q_{Used} is the quality estimate of the used frequency.

$T_{Used 2b}$ is the absolute threshold that applies for the used frequency in that measurement.

H_{2b} is the hysteresis parameter for the event 2b.

Leaving triggered state condition:

Equation 3:

$$Q_{Nonused} < T_{Nonused2b} - H_{2b}/2$$

The variables in the formula are defined as follows:

$Q_{Non used}$ is the quality estimate of a non-used frequency that is stored in the variable TRIGGERED_2B_EVENT.

$T_{Non used 2b}$ is the absolute threshold that applies for this non-used frequency in that measurement.

H_{2b} is the hysteresis parameter for the event 2b.

Equation 4:

$$Q_{Used} > T_{Used2b} + H_{2b}/2$$

The variables in the formula are defined as follows:

Q_{Used} is the quality estimate of the used frequency.

T_{Used2b} is the absolute threshold that applies for the used frequency in that measurement.

H_{2b} is the hysteresis parameter for the event 2b.

14.2.1.3 Event 2c: The estimated quality of a non-used frequency is above a certain threshold

When an inter-frequency measurement configuring event 2c is set up, the UE shall:

- create a variable TRIGGERED_2C_EVENT related to that measurement, which shall initially be empty;
- delete this variable when the measurement is released.

When event 2c is configured in the UE within a measurement, the UE shall:

- if equation 1 below has been fulfilled for one or several non-used frequencies included for that event during the time "Time to trigger":
 - if any of those non-used frequencies is not stored in the variable TRIGGERED_2C_EVENT:
 - store the non-used frequencies that triggered the event and that were not previously stored in the variable TRIGGERED_2C_EVENT into that variable;
 - send a measurement report with IEs set as below:
 - set in "inter-frequency measurement event results":
 - "inter-frequency event identity" to "2c"; and
 - for each non-used frequency that triggered the event, beginning with the best frequency:
 - "Frequency info" to that non-used frequency; and
 - "Non frequency related measurement event results" to the "Primary CPICH info" of the best primary CPICH for FDD cells or "Primary CCPCH info" to the "Cell parameters ID" of the best primary CCPCH for TDD cells on that non-used frequency;
 - if equation 2 below is fulfilled for a non-used frequency stored in the variable TRIGGERED_2C_EVENT:
 - remove that non-used frequency from the variable TRIGGERED_2C_EVENT.

Triggering condition:

Equation 1:

$$Q_{Nonused} \geq T_{Nonused2c} + H_{2c}/2$$

The variables in the formula are defined as follows:

$Q_{Nonused}$ is the quality estimate of a non-used frequency that becomes better than an absolute threshold.

$T_{Nonused2c}$ is the absolute threshold that applies for this non-used frequency in that measurement.

H_{2c} is the hysteresis parameter for the event 2c.

Leaving triggered state condition:

Equation 2:

$$Q_{Nonused} < T_{Nonused2c} - H_{2c} / 2$$

The variables in the formula are defined as follows:

$Q_{Nonused}$ is the quality estimate of a non-used frequency stored in the variable TRIGGERED_2C_EVENT.

$T_{Nonused2c}$ is the absolute threshold that applies for this non-used frequency in that measurement.

H_{2c} is the hysteresis parameter for the event 2c.

14.2.1.4 Event 2d: The estimated quality of the currently used frequency is below a certain threshold

When an inter-frequency measurement configuring event 2d is set up, the UE shall:

- create a variable TRIGGERED_2D_EVENT related to that measurement, which shall initially be set to FALSE;
- delete this variable when the measurement is released.

When event 2d is configured in the UE within a measurement, the UE shall:

- if equation 1 below has been fulfilled for the used frequency during the time "Time to trigger":
 - if the variable TRIGGERED_2D_EVENT is set to FALSE:
 - set the variable TRIGGERED_2D_EVENT to TRUE;
 - send a measurement report with IEs set as below:
 - set in "inter-frequency event results": "inter-frequency event identity" to "2d" and no IE "Inter-frequency cells";
 - set the IE "measured results" and the IE "additional measured results" according to 8.4.2;
 - if the variable TRIGGERED_2D_EVENT is set to TRUE and if equation 2 is fulfilled for the used frequency:
 - set the variable TRIGGERED_2D_EVENT to FALSE.

Triggering condition:

Equation 1:

$$Q_{Used} \leq T_{Used2d} - H_{2d} / 2$$

The variables in the formula are defined as follows:

Q_{Used} is the quality estimate of the used frequency.

T_{Used2d} is the absolute threshold that applies for the used frequency and event 2d.

H_{2d} is the hysteresis parameter for the event 2d.

Leaving triggered state condition:

Equation 2:

$$Q_{Used} > T_{Used2d} + H_{2d} / 2$$

The variables in the formula are defined as follows:

Q_{Used} is the quality estimate of the used frequency.

T_{Used2d} is the absolute threshold that applies for the used frequency and event 2d.

H_{2d} is the hysteresis parameter for the event 2d.

14.2.1.5 Event 2e: The estimated quality of a non-used frequency is below a certain threshold

When an inter-frequency measurement configuring event 2e is set up, the UE shall:

- create a variable TRIGGERED_2E_EVENT related to that measurement, which shall initially be empty;
- delete this variable when the measurement is released.

When event 2e is configured in the UE within a measurement, the UE shall:

- if equation 1 below has been fulfilled for one or several non-used frequencies included for that event during the time "Time to trigger":
 - if any of those non-used frequencies is not stored in the variable TRIGGERED_2E_EVENT:
 - store the non-used frequencies that triggered the event and that were not previously stored in the variable TRIGGERED_2E_EVENT into that variable;
 - send a measurement report with IEs set as below:
 - set in "inter-frequency measurement event results":
 - "inter-frequency event identity" to "2e"; and
 - for each non-used frequency that triggered the event, beginning with the best frequency:
 - "Frequency info" to that non-used frequency; and
 - "Non frequency related measurement event results" to the "Primary CPICH info" of the best primary CPICH for FDD cells or "Primary CCPCH info" to the "Cell parameters ID" of the best primary CCPCH for TDD cells on that non-used frequency;
 - set the IE "measured results" and the IE "additional measured results" according to 8.4.2;
 - if equation 2 below is fulfilled for a non-used frequency stored in the variable TRIGGERED_2E_EVENT:
 - remove that non-used frequency from the variable TRIGGERED_2E_EVENT.

Triggering condition:

Equation 1:

$$Q_{Non\ used} \leq T_{Nomse2e} - H_{2e} / 2$$

The variables in the formula are defined as follows:

$Q_{Non\ used}$ is the quality estimate of a non-used frequency that becomes worse than an absolute threshold.

$T_{Non\ used\ 2e}$ is the absolute threshold that applies for that non-used frequency for that event.

H_{2e} is the hysteresis parameter for the event 2e.

Leaving triggered state condition:

Equation 2:

$$Q_{Non\ used} > T_{Nomse2e} + H_{2e} / 2$$

The variables in the formula are defined as follows:

$Q_{Non\ used}$ is the quality estimate of a non-used frequency stored in the variable TRIGGERED_2E_EVENT.

$T_{Non\ used\ 2e}$ is the absolute threshold that applies for that non-used frequency for that event.

H_{2e} is the hysteresis parameter for the event 2e.

14.2.1.6 Event 2f: The estimated quality of the currently used frequency is above a certain threshold

When an inter-frequency measurement configuring event 2f is set up, the UE shall:

- create a variable TRIGGERED_2F_EVENT related to that measurement, which shall initially be set to FALSE;
- delete this variable when the measurement is released.

When event 2f is configured in the UE within a measurement, the UE shall:

- if equation 1 below has been fulfilled for the used frequency during the time "Time to trigger":
 - if the variable TRIGGERED_2F_EVENT is set to FALSE:
 - set the variable TRIGGERED_2F_EVENT to TRUE;
 - send a measurement report with IEs set as below:
 - set in "inter-frequency event results": "inter-frequency event identity" to "2f", and no IE "Inter-frequency cells";
 - set the IE "measured results" and the IE "additional measured results" according to 8.4.2;
 - if the variable TRIGGERED_2F_EVENT is set to TRUE and if equation 2 is fulfilled for the used frequency:
 - set the variable TRIGGERED_2F_EVENT to FALSE.

Triggering condition:

Equation 1:

$$Q_{Used} \geq T_{Used2f} + H_{2f} / 2$$

The variables in the formula are defined as follows:

Q_{Used} is the quality estimate of the used frequency.

T_{Used2f} is the absolute threshold that applies for the used frequency and event 2f.

H_{2f} is the hysteresis parameter for the event 2f.

Leaving triggered state condition:

Equation 2:

$$Q_{Used} < T_{Used2f} - H_{2f} / 2$$

The variables in the formula are defined as follows:

Q_{Used} is the quality estimate of the used frequency.

T_{Used2f} is the absolute threshold that applies for the used frequency and event 2f.

H_{2f} is the hysteresis parameter for the event 2f.

14.3 Inter-RAT measurements

14.3.0a Inter-RAT measurement quantities

A measurement quantity is used by the UE to evaluate whether an inter-RAT measurement event has occurred or not.

The measurement quantity for UTRAN is used to compute the frequency quality estimate for the active set, as described in the next section, and can be:

- 1 Downlink Ec/No.
- 2 Downlink received signal code power (RSCP) after despreading.

The measurement quantity for GSM can be:

- 1 GSM Carrier RSSI

A description of those values can be found in [7] and [8].

14.3.0b Frequency quality estimate of the UTRAN frequency

The estimated quality of the active set in UTRAN in event 3a is defined as:

$$Q_{UTRAN} = 10 \cdot \text{Log} M_{UTRAN} = W \cdot 10 \cdot \text{Log} \left(\sum_{i=1}^{N_A} M_i \right) + (1 - W) \cdot 10 \cdot \text{Log} M_{Best},$$

The variables in the formula are defined as follows:

Q_{UTRAN} is the estimated quality of the active set on the currently used UTRAN frequency.

M_{UTRAN} is the estimated quality of the active set on currently used UTRAN frequency expressed in another unit.

M_i is the measurement result of cell i in the active set, according to what is indicated in the IE "Measurement quantity for UTRAN quality estimate".

N_A is the number of cells in the active set.

M_{Best} is the measurement result of the cell in the active set with the highest measurement result.

W is a parameter sent from UTRAN to UE.

If the measurement result is CPICH-Ec/No M_{UTRAN} , M_i and M_{Best} are expressed as ratios.

If the measurement result is CPICH-RSCP or PCCPCH-RSCP, M_{UTRAN} , M_i and M_{Best} are expressed in [mW].

14.3.0c Inter-RAT reporting quantities

The quantities that the UE shall report to UTRAN when the event is triggered for an inter-RAT measurement are given by the IE "Inter-RAT reporting quantity" stored for that measurement, and can be the following:

In the case the other RAT is GSM:

- 1 Observed time difference to the GSM cell
- 2 GSM carrier RSSI

A description of those values can be found in [7] and [8].

14.3.1 Inter-RAT reporting events

Within the measurement reporting criteria field in the MEASUREMENT CONTROL message the UTRAN notifies the UE which events should trigger the UE to send a MEASUREMENT REPORT message. The listed events are the toolbox from which the UTRAN can choose the reporting events that are needed for the implemented handover evaluation function, or other radio network functions.

All events are measured with respect to one of the measurement quantities given in subclause 14.3.0a, and of the frequency quality estimate given in subclause 14.3.0b. For UTRAN the measurement quantities are measured on the monitored primary common pilot channels (CPICH) in FDD mode and the monitored primary common control channels (PCCPCH) in TDD mode of the cell defined in the measurement object. For other RATs the measurement quantities are system-specific. A "used UTRAN frequency" is a frequency that the UE have been ordered to measure upon and is also currently used for the connection to UTRAN. "Other system" is e.g. GSM.

In the text below describing the events:

- "The BCCH ARFCN and BSIC combinations considered in that inter-RAT measurement" shall be understood as the BCCH ARFCN and BSIC combinations of the inter-RAT cells pointed at in the IE "Cell for measurements" if it has been received for that inter-RAT measurement, or otherwise of the cells included in the "inter-RAT cell info" part of the variable CELL_INFO LIST.
- "The BCCH ARFCNs considered in that inter-RAT measurement" shall be understood as the BCCH ARFCNs of the inter-RAT cells pointed at in the IE "Cell for measurements" if it has been received for that inter-RAT measurement, or otherwise of the cells included in the "inter-RAT cell info" part of the variable CELL_INFO LIST.

14.3.1.1 Event 3a: The estimated quality of the currently used UTRAN frequency is below a certain threshold **and** the estimated quality of the other system is above a certain threshold.

When an inter-RAT measurement configuring event 3a is set up, the UE shall:

- create a variable TRIGGERED_3A_EVENT related to that measurement, which shall initially be empty;
- delete this variable when the measurement is released.

When event 3a is configured in the UE within a measurement, the UE shall:

- if the other RAT is GSM, and if IE "BSIC verification required" is set to "required":
 - If equations 1 and 2 below have both been fulfilled during the time "Time to trigger" from the same instant, respectively for the used UTRAN frequency and for one or several GSM cells that match any of the BCCH ARFCN and BSIC combinations considered in that inter-RAT measurement:
 - If the Inter-RAT cell id of any of those GSM cells is not stored in the variable TRIGGERED_3A_EVENT:
 - Store the Inter-RAT cell ids of the GSM cells that triggered the event and that were not previously stored in the variable TRIGGERED_3A_EVENT into that variable.
 - Send a measurement report with IEs set as below:
 - In "inter-RAT measurement event result": "inter-RAT event identity" to "3a", "CHOICE BSIC" to "verified BSIC" and "Inter-RAT cell id" to the GSM cells that triggered the event (best one first);
 - "measured results" and possible "additional measured results" according to 8.4.2;
 - If equation 4 is fulfilled for a GSM cell whose inter-RAT cell id is stored in the variable TRIGGERED_3A_EVENT:
 - Remove the inter-RAT cell id of that GSM cell from the variable TRIGGERED_3A_EVENT
- If equation 3 is fulfilled for the used frequency in UTRAN:
 - Clear the variable TRIGGERED_3A_EVENT
- If the other RAT is GSM, and if IE "BSIC verification required" is set to "not required":
 - If equations 1 and 2 below have been fulfilled during the time "Time to trigger" from the same instant, respectively for the used UTRAN frequency and for one or several BCCH ARFCNs considered in that inter-RAT measurement:
 - If any of those BCCH ARFCNs is not stored into the variable TRIGGERED_3A_EVENT:
 - Store the BCCH ARFCNs that triggered the event and that were not previously stored in the variable TRIGGERED_3A_EVENT into that variable;
 - Send a measurement report with IEs set as below:

- In "inter-RAT measurement event result": "inter-RAT event identity" to "3a", "CHOICE BSIC" to "non verified BSIC" and "BCCH ARFCN" to BCCH ARFCNs that triggered the event (best one first);
- "measured results" and possible "additional measured results" according to 8.4.2;
- If equation 4 is fulfilled for a BCCH ARFCN that is stored in the variable TRIGGERED_3A_EVENT:
 - Remove that BCCH ARFCN from the variable TRIGGERED_3A_EVENT;
- If equation 3 is fulfilled for the used frequency in UTRAN:
 - Clear the variable TRIGGERED_3A_EVENT

Triggering conditions:

Equation 1:

$$Q_{Used} \leq T_{Used} - H_{3a}/2$$

The variables in the formula are defined as follows:

Q_{Used} is the quality estimate of the used UTRAN frequency.

T_{Used} is the absolute threshold that applies for the used frequency in that measurement.

H_{3a} is the hysteresis parameter for event 3a.

Equation 2:

$$M_{Other RAT} \geq T_{Other RAT} + H_{3a}/2$$

The variables in the formula are defined as follows:

$M_{Other RAT}$ is the measurement quantity for the cell of the other system.

$T_{Other RAT}$ is the absolute threshold that applies for the other system in that measurement.

H_{3a} is the hysteresis parameter for event 3a.

Leaving triggered state conditions:

Equation 3:

$$Q_{Used} > T_{Used} + H_{3a}/2$$

The variables in the formula are defined as follows:

Q_{Used} is the quality estimate of the used UTRAN frequency.

T_{Used} is the absolute threshold that applies for the used frequency in that measurement.

H_{3a} is the hysteresis parameter for event 3a.

Equation 4:

$$M_{Other RAT} < T_{Other RAT} - H_{3a}/2$$

The variables in the formula are defined as follows:

$M_{Other RAT}$ is the measurement quantity for the cell of the other system.

$T_{Other RAT}$ is the absolute threshold that applies for the other system in that measurement.

H_{3a} is the hysteresis parameter for event 3a.

14.3.1.2 Event 3b: The estimated quality of other system is below a certain threshold

When an inter-RAT measurement configuring event 3b is set up, the UE shall:

- create a variable TRIGGERED_3B_EVENT related to that measurement, which shall initially be empty;
- delete this variable when the measurement is released.

When event 3b is configured in the UE within a measurement, the UE shall:

- if the other RAT is GSM, and if IE "BSIC verification required" is set to "required":
 - if equation 1 below has been fulfilled during the time "time to trigger" for one or several GSM cells that match any of the BCCH ARFCN and BSIC combinations considered in that inter-RAT measurement:
 - if the inter-RAT cell id of any of those GSM cell is not stored in the variable TRIGGERED_3B_EVENT:
 - store the inter-RAT cell ids of the GSM cells that triggered the event and that were not previously stored in the variable TRIGGERED_3B_EVENT into that variable;
 - send a measurement report with IEs set as below:
 - set in "inter-RAT measurement event result": "inter-RAT event identity" to "3b", "CHOICE BSIC" to "verified BSIC" and "Inter-RAT cell id" to the GSM cells that triggered the event (worst one first);
 - set the IE "measured results" and the IE "additional measured results" according to 8.4.2;
 - if equation 2 below is fulfilled for a GSM cell whose inter-RAT cell id is stored in the variable TRIGGERED_3B_EVENT:
 - remove the inter-RAT cell id of that GSM cell from the variable TRIGGERED_3B_EVENT;
- if the other RAT is GSM, and if IE "BSIC verification required" is set to "not required":
 - if equation 1 below has been fulfilled during the time "time to trigger" for one or several of the BCCH ARFCNs considered in that inter-RAT measurement:
 - if any of those BCCH ARFCN is not stored into the variable TRIGGERED_3B_EVENT:
 - store the BCCH ARFCNs that triggered the event and that were not previously stored in the variable TRIGGERED_3B_EVENT into that variable;
 - send a measurement report with IEs set as below:
 - set in "inter-RAT measurement event result": "inter-RAT event identity" to "3b", "CHOICE BSIC" to "non verified BSIC" and "BCCH ARFCN" to BCCH ARFCNs that triggered the event (worst one first);
 - set the IE "measured results" and the IE "additional measured results" according to 8.4.2;
 - if equation 2 below is fulfilled for a BCCH ARFCN that is stored in the variable TRIGGERED_3B_EVENT:
 - remove that BCCH ARFCN from the variable TRIGGERED_3B_EVENT.

Triggering condition:

Equation 1:

$$M_{Other\ RAT} \leq T_{Other\ RAT} - H_{3b} / 2$$

The variables in the formula are defined as follows:

$M_{Other\ RAT}$ is the measurement quantity for the cell of the other system.

$T_{Other\ RAT}$ is the absolute threshold that applies for the other system in that measurement.

H_{3b} is the hysteresis parameter for event 3b.

Leaving triggered state condition:

Equation 2:

$$M_{Other\ RAT} > T_{Other\ RAT} + H_{3b} / 2$$

The variables in the formula are defined as follows:

$M_{Other\ RAT}$ is the measurement quantity for the cell of the other system.

$T_{Other\ RAT}$ is the absolute threshold that applies for the other system in that measurement.

H_{3b} is the hysteresis parameter for event 3b.

14.3.1.3 Event 3c: The estimated quality of other system is above a certain threshold

When an inter-RAT measurement configuring event 3c is set up, the UE shall:

- create a variable TRIGGERED_3C_EVENT related to that measurement, which shall initially be empty;
- delete this variable when the measurement is released.

When event 3c is configured in the UE within a measurement, the UE shall:

- if the other RAT is GSM, and if IE "BSIC verification required" is set to "required":
 - if equation 1 below has been fulfilled during the time "time to trigger" for one or several GSM cells that match any of the BCCH ARFCN and BSIC combinations considered in that inter-RAT measurement:
 - if the inter-RAT cell id of any of those GSM cell is not stored in the variable TRIGGERED_3C_EVENT:
 - store the Inter-RAT cell ids of the GSM cells that triggered the event and that were not previously stored in the variable TRIGGERED_3C_EVENT into that variable;
 - send a measurement report with IEs set as below:
 - set in "inter-RAT measurement event result": "inter-RAT event identity" to "3c", "CHOICE BSIC" to "verified BSIC" and "Inter-RAT cell id" to the GSM cells that triggered the event (best one first);
 - set the IE "measured results" and the IE "additional measured results" according to 8.4.2;
 - if equation 2 below is fulfilled for a GSM cell whose inter-RAT cell id is stored in the variable TRIGGERED_3C_EVENT:
 - remove the inter-RAT cell id of that GSM cell from the variable TRIGGERED_3C_EVENT;
- if the other RAT is GSM, and if IE "BSIC verification required" is set to "not required":
 - if equation 1 below has been fulfilled during the time "time to trigger" for one or several of the BCCH ARFCNs considered in that inter-RAT measurement:
 - if any of those BCCH ARFCN is not stored into the variable TRIGGERED_3C_EVENT:
 - store the BCCH ARFCNs that triggered the event and that were not previously stored in the variable TRIGGERED_3C_EVENT into that variable;
 - send a measurement report with IEs set as below:

- set in "inter-RAT measurement event result": "inter-RAT event identity" to "3c", "CHOICE BSIC" to "non verified BSIC" and "BCCH ARFCN" to BCCH ARFCNs that triggered the event (best one first);
- set the IE "measured results" and the IE "additional measured results" according to 8.4.2;
- if equation 2 is fulfilled for a BCCH ARFCN that is stored in the variable TRIGGERED_3C_EVENT:
 - remove that BCCH ARFCN from the variable TRIGGERED_3C_EVENT.

Triggering condition:

Equation 1:

$$M_{Other\ RAT} \geq T_{Other\ RAT} + H_{3c}/2$$

The variables in the formula are defined as follows:

$M_{Other\ RAT}$ is the measurement quantity for the cell of the other system.

$T_{Other\ RAT}$ is the absolute threshold that applies for the other system in that measurement.

H_{3c} is the hysteresis parameter for event 3c.

Leaving triggered state condition:

Equation 2:

$$M_{Other\ RAT} < T_{Other\ RAT} - H_{3c}/2$$

The variables in the formula are defined as follows:

$M_{Other\ RAT}$ is the measurement quantity for the cell of the other system.

$T_{Other\ RAT}$ is the absolute threshold that applies for the other system in that measurement.

H_{3c} is the hysteresis parameter for event 3c.

14.3.1.4 Event 3d: Change of best cell in other system

When an inter-RAT measurement configuring event 3d is set up, the UE shall:

- create a variable BEST_CELL_3D_EVENT related to that measurement;
- delete this variable when the measurement is released.

When event 3d is configured in the UE within a measurement, the UE shall:

- if the other RAT is GSM, and if IE "BSIC verification required" is set to "required":
 - when the measurement is initiated or resumed:
 - store in the variable BEST_CELL_3D_EVENT the Inter-RAT cell id of the GSM cell that has the best measured quantity among the GSM cells that match any of the BCCH ARFCN and BSIC combinations considered in that inter-RAT measurement
 - send a measurement report with IE set as below:
 - set in "inter-RAT measurement event result": "inter-RAT event identity" to "3d", "CHOICE BSIC" to "verified BSIC" and "Inter-RAT cell id" to the GSM cell that is stored in the variable BEST_CELL_3D_EVENT;
 - set the IE "measured results" and the IE "additional measured results" according to 8.4.2;

- if equation 1 has been fulfilled during the time "time to trigger" for a GSM cell that is different from the one stored in BEST_CELL_3D_EVENT and that matches any of the BCCH ARFCN and BSIC combinations considered in that inter-RAT measurement:
 - store the Inter-RAT cell id of that GSM cell in the variable BEST_CELL_3D_EVENT;
 - send a measurement report with IEs set as below:
 - set in "inter-RAT measurement event result": "inter-RAT event identity" to "3d", "CHOICE BSIC" to "verified BSIC" and "Inter-RAT cell id" to the GSM cell is now stored in BEST_CELL_3D_EVENT;
 - set the IE "measured results" and the IE "additional measured results" according to 8.4.2;
- if the other RAT is GSM, and if IE "BSIC verification required" is set to "not required":
 - when the measurement is initiated or resumed:
 - store in the variable BEST_CELL_3D_EVENT the BCCH ARFCN of the GSM cell that has the best measured quantity among the BCCH ARFCNs considered in that inter-RAT measurement;
 - send a measurement report with IE set as below:
 - set in "inter-RAT measurement event result": "inter-RAT event identity" to "3d", "CHOICE BSIC" to "non verified BSIC" and "BCCH ARFCN" to the BCH ARFCN that is stored in the variable BEST_CELL_3D_EVENT;
 - set the IE "measured results" and the IE "additional measured results" according to 8.4.2;
 - if equation 1 below has been fulfilled during the time "time to trigger" for one of the BCCH ARFCNs considered in that inter-RAT measurement and different from the one stored in BEST_CELL_3D_EVENT:
 - store the BCCH ARFCN of that GSM cell in the variable BEST_CELL_3D_EVENT;
 - send a measurement report with IEs set as below:
 - set in "inter-RAT measurement event result": "inter-RAT event identity" to "3d", "CHOICE BSIC" to "non verified BSIC" and "BCCH ARFCN" to the BCCH ARFCN that is now stored in the variable BEST_CELL_3D_EVENT;
 - set the IE "measured results" and the IE "additional measured results" according to 8.4.2.

Equation 1:

$$M_{New} \geq M_{Best} + H_{3d} / 2$$

The variables in the formula are defined as follows:

M_{New} is the measurement quantity for a GSM cell that is not stored in the variable BEST_CELL_3D.

M_{Best} is the measurement quantity for a GSM cell that is stored in the variable BEST_CELL_3D.

H_{3d} is the hysteresis parameter for event 3d.

14.3.2 GSM measurements in compressed mode

14.3.2.1 GSM RSSI measurements

The UE shall perform GSM RSSI measurements in the gaps of compressed mode pattern sequence specified for GSM RSSI measurement purpose. The UE cannot be required to measure "Observed time difference to GSM" in gaps specified for this purpose.

14.3.2.2 Initial BSIC identification

The UE shall perform Initial BSIC identification in compressed mode pattern sequence specified for Initial BSIC identification measurement purpose.

The parameter "N identify abort" in the IE "DPCH compressed mode info" indicates the maximum number of patterns that the UE shall use to attempt to decode the unknown BSIC of the GSM cell in the initial BSIC identification procedure.

The UE shall be able to measure the "Observed time difference to GSM cell" during a compressed mode pattern sequence configured for this purpose.

The BSIC identification procedure is defined in detail in [19].

14.3.2.3 BSIC re-confirmation

The UE shall perform BSIC re-confirmation in compressed mode pattern sequence specified for BSIC re-confirmation measurement purpose.

The parameter "T reconfirm abort" in the IE "DPCH compressed mode info" indicates the maximum time allowed for the re-confirmation of the BSIC of one GSM cell in the BSIC re-confirmation procedure.

The UE shall be able to measure the "Observed time difference to GSM cell" during a compressed mode pattern sequence configured for this purpose.

The BSIC re-confirmation procedure is defined in detail in [19].

14.4 Traffic Volume Measurements

14.4.1 Traffic Volume Measurement Quantity

In order to support a large variation of bit rates and RLC buffer size capabilities, a non-linear scale is used. Since, for each RB, the expected traffic includes both new and retransmitted RLC PDUs and potentially existing Control PDUs, all these should be included in the Buffer Occupancy measure. It should also be noted that traffic volume measurements are only applicable for acknowledged and unacknowledged mode.

According to what is stated in the Measurement Control message, the UE should support reporting of RLC Buffer Payload, Average of RLC Buffer Payload, and Variance of RLC Buffer Payload for RBs multiplexed onto the same Transport channel. The Reporting Quantities (i.e. RLC Buffer Payload, Average of RLC Buffer Payload, and Variance of RLC Buffer Payload of each RB) are indicated in the measurement control message. If Average of RLC Buffer Payload or Variance of RLC Buffer Payload is included as Reporting Quantity, the time interval to take an average or a variance shall be used. When the RLC buffer payload, Average of RLC buffer payload or Variance of RLC buffer payload is reported, the measured quantity shall be rounded upwards to the closest higher value possible to report.

14.4.2 Traffic Volume reporting triggers

Traffic volume can be reported in two different ways, periodical and event triggered. The reporting criteria are specified in the measurement control message.

For periodical reporting the UE simply determines the Reporting Quantities in number of bytes for each RB mapped onto the indicated transport channels and reports the results at the time interval and for the number of times specified.

For traffic volume measurements in the UE only one quantity is compared with the thresholds. This quantity is Transport Channel Traffic Volume [15] (which equals the sum of Buffer Occupancies of RBs multiplexed onto a transport channel) in number of bytes. Event triggered reporting is performed when the Transport Channel Traffic Volume exceeds an upper threshold or becomes smaller than a lower threshold. Every TTI, UE measures the Transport Channel Traffic Volume for each transport channel and compares it with the configured thresholds. If the value is out of range, the UE determines the Reporting Quantities for the RBs mapped onto that transport channel and reports the results.

14.4.2.1 Reporting event 4 A: Transport Channel Traffic Volume exceeds an absolute threshold

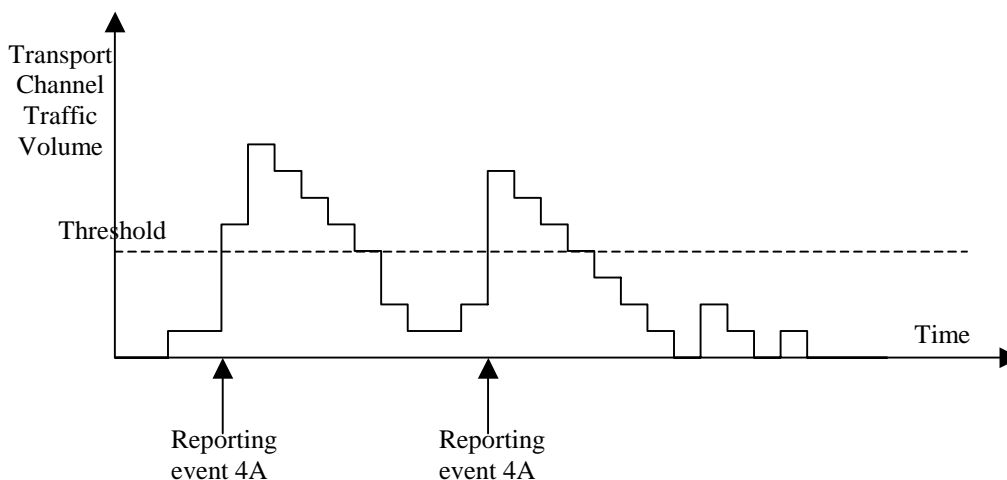

Figure 78: Event triggered report when Transport Channel Traffic Volume exceeds a certain threshold

If the monitored Transport Channel Traffic Volume [15] exceeds an absolute threshold, i.e. if $TCTF > \text{Reporting threshold}$, this is an event that could trigger a report. The corresponding report specifies at least which measurement ID the event that triggered the report belongs to.

14.4.2.2 Reporting event 4 B: Transport Channel Traffic Volume becomes smaller than an absolute threshold

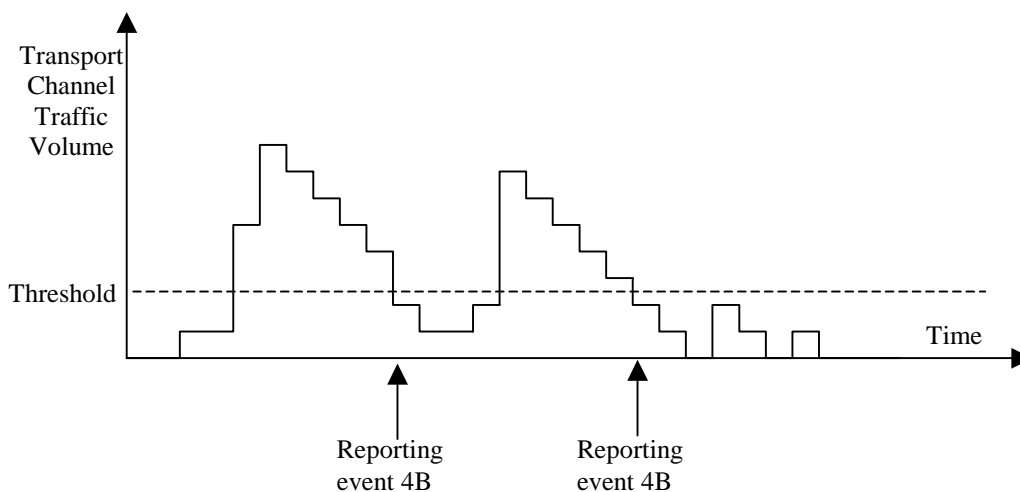

Figure 79: Event triggered report when Transport Channel Traffic Volume becomes smaller than certain threshold

If the monitored Transport Channel Traffic Volume [15] becomes smaller than an absolute threshold, i.e. if $TCTF < \text{Reporting threshold}$, this is an event that could trigger a report. The corresponding report specifies at least which measurement ID the event that triggered the report belongs to.

14.4.3 Traffic volume reporting mechanisms

Traffic volume measurement triggering could be associated with both a *time-to-trigger* and a *pending time after trigger*. The time-to-trigger is used to get time domain hysteresis, i.e. the condition must be fulfilled during the time-to-trigger time before a report is sent. Pending time after trigger is used to limit consecutive reports when one traffic volume measurement report already has been sent. This is described in detail below.

14.4.3.1 Pending time after trigger

This timer is started in the UE when a measurement report has been triggered. The UE is then forbidden to send any new measurement reports with the same measurement ID during this time period even when the triggering condition is fulfilled again. Instead the UE waits until the timer has suspended. If the Transport Channel Traffic Volume [15] is still above the threshold when the timer has expired the UE sends a new measurement report, and the timer is restarted. Otherwise it waits for a new triggering.

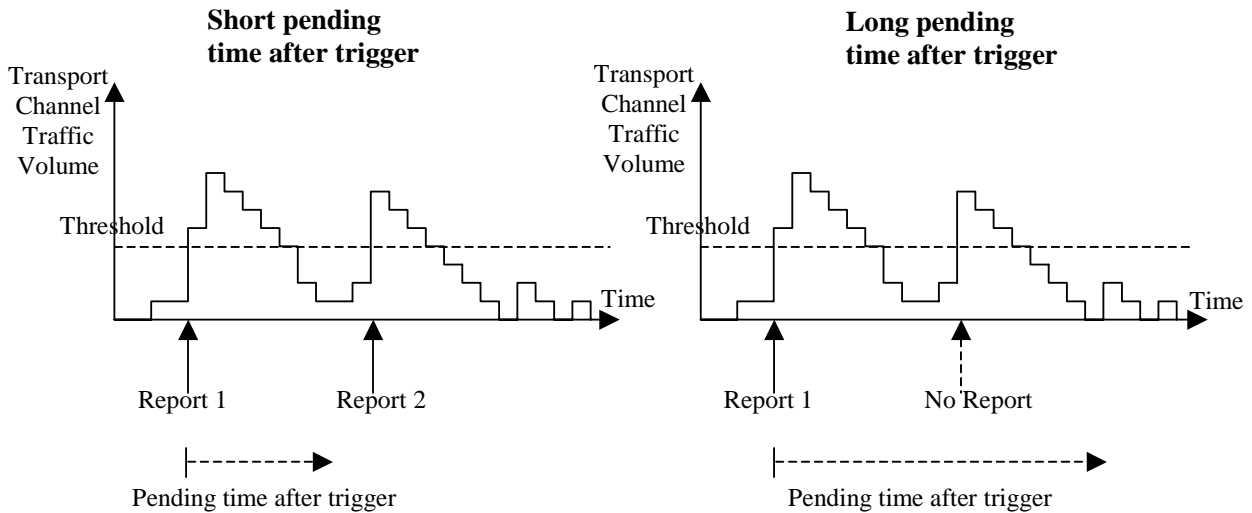

Figure 80: Pending time after trigger limits the amount of consecutive measurement reports

Figure 80 shows that by increasing the pending time after trigger a triggered second event does not result in a measurement report.

14.4.4 Interruption of user data transmission

A UE in CELL_FACH substate may be instructed by the UTRAN to cease transmission of user data on the RACH after a measurement report has been triggered. Before resuming transmission of user data,

- the UE shall receive from the UTRAN either a message allocating a dedicated physical channel, and make a transition to CELL_DCH state; or
- the UE shall receive an individually assigned measurement control message indicating that interruption of user data transmission is not be applied.

The transmission of signalling messages on the signalling bearer shall not be interrupted.

14.5 Quality Measurements

14.5.1 Quality reporting measurement quantities

For quality measurements, the following measurement quantities are used:

1. Downlink transport channel BLER
2. Timeslot SIR (TDD only)

14.5.2 Quality reporting events

14.5.2.1 Reporting event 5A: A predefined number of bad CRCs is exceeded

When this event is ordered by UTRAN in a measurement control message, the UE shall send a measurement report when the amount of bad CRCs during a predefined sliding window exceeds a predefined number.

The following three parameters are used in the scheme:

- **Total CRC** = the length of the sliding window over which the number of bad CRCs are counted.
- **Bad CRC** = the number of bad CRC that is required within the latest "Total CRC" received CRCs for the event to be triggered.
- **Pending after trigger** = a new event can not be triggered until "Pending after trigger" CRCs have been received,

When a DCH is established, the UE shall begin to count the number of bad CRCs within the last "Total CRC" received CRCs. No event can be triggered until at least "Total CRC" CRCs have been received. For each new received CRC, the UE shall compare the number of bad CRCs within the latest "Total CRC" received CRCs with the parameter "Bad CRC". An event shall be triggered if the number of bad CRCs is equal or larger than "Bad CRC".

At the time when the event is triggered a pending time after trigger timer is started with the length of "Pending after trigger" CRCs. A new event can not be triggered until "Pending after trigger" CRCs have been received. When "Pending after trigger" CRCs have been received the event evaluation start again and a new event can be triggered.

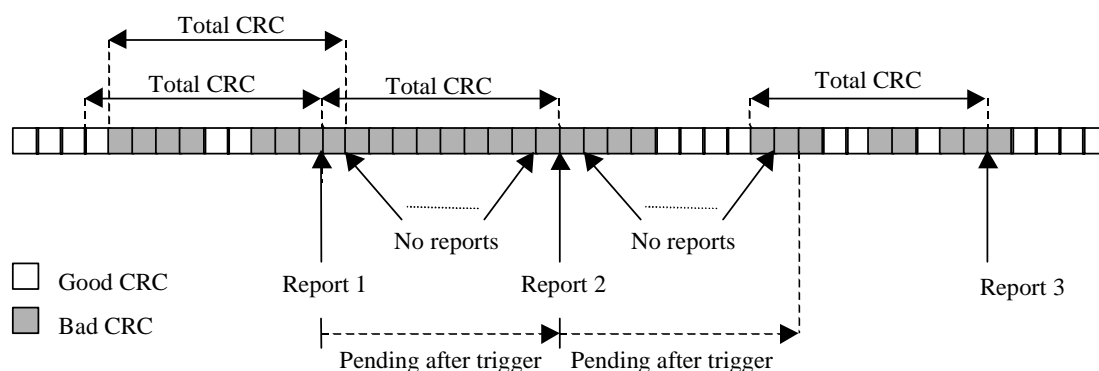

Figure 81: Event triggered CRC error reporting

14.6 UE internal measurements

14.6.1 UE internal measurement quantities

For UE internal measurements the following measurement quantities exist:

1. UE transmission (Tx) power, for TDD measured on a timeslot basis.
2. UE received signal strength power (RSSI).
3. UE Rx-Tx time difference (FDD only).
4. T_{ADV} (1.28 Mcps TDD)

14.6.2 UE internal measurement reporting events

In the Measurement reporting criteria field in the Measurement Control messages, the UTRAN notifies the UE of which events should trigger a measurement report. UE internal measurement reporting events that can trigger a report are given below. The reporting events are marked with vertical arrows in the figures below. All events can be combined with time-to-trigger. In that case, the measurement report is only sent if the condition for the event has been fulfilled for the time given by the time-to-trigger parameter.

NOTE: The reporting events are numbered 6A, 6B, 6C,.. where 6 denotes that the event belongs to the type UE internal measurements.

14.6.2.1 Reporting event 6A: The UE Tx power becomes larger than an absolute threshold

When this event is ordered by UTRAN in a measurement control message, the UE shall send a measurement report when the UE transmission power (for TDD within a single TS) becomes larger than a predefined threshold. The corresponding report identifies the threshold that was exceeded.

14.6.2.2 Reporting event 6B: The UE Tx power becomes less than an absolute threshold

When this event is ordered by UTRAN in a measurement control message, the UE shall send a measurement report when the UE transmission power (for TDD within a single TS) becomes less than a predefined threshold. The corresponding report identifies the threshold that the UE Tx power went below.

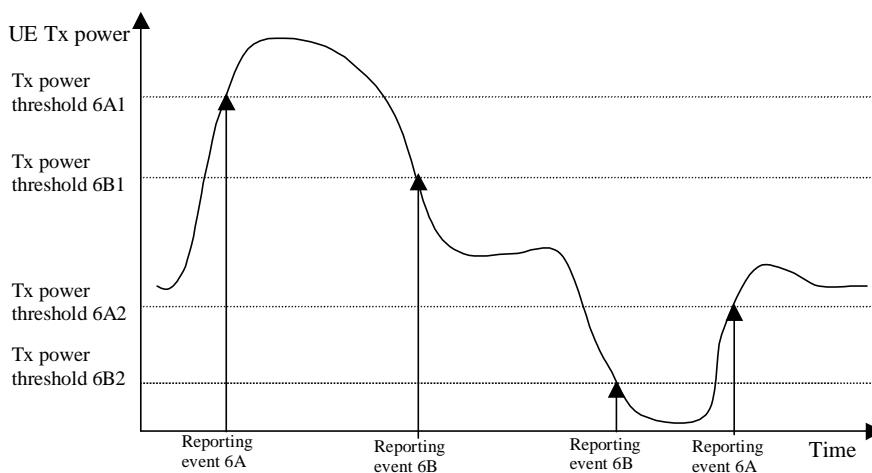

Figure 82: Event-triggered measurement reports when the UE Tx power becomes larger or less than absolute thresholds

14.6.2.3 Reporting event 6C: The UE Tx power reaches its minimum value

When this event is ordered by UTRAN in a measurement control message, the UE shall send a measurement report when the UE Tx power reaches its minimum value, for TDD its minimum value on a single timeslot.

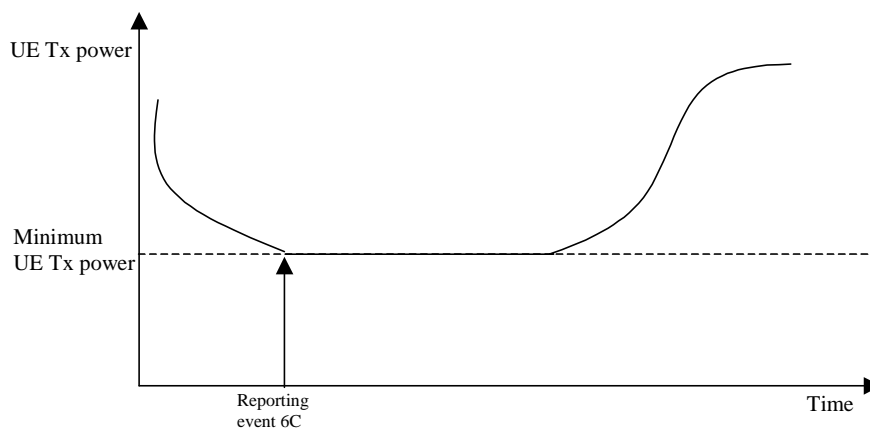

Figure 83: Event-triggered measurement report when the UE Tx power reaches its minimum value

14.6.2.4 Reporting event 6D: The UE Tx power reaches its maximum value

When this event is ordered by UTRAN in a measurement control message, the UE shall send a measurement report when the UE Tx power reaches its maximum value, for TDD its maximum value on a single timeslot.

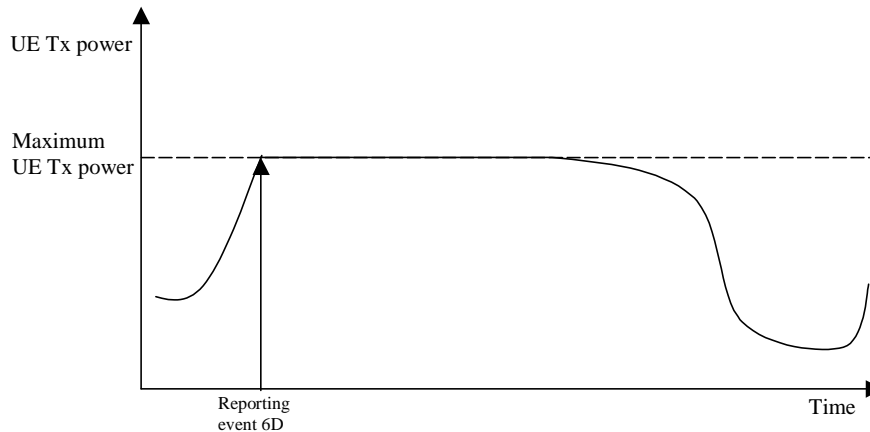

Figure 84: Event-triggered report when the UE Tx power reaches its maximum value

14.6.2.5 Reporting event 6E: The UE RSSI reaches the UE's dynamic receiver range

When this event is ordered by UTRAN in a measurement control message, the UE shall send a measurement report when the UE RSSI reaches the UE's dynamic receiver range.

14.6.2.6 Reporting event 6F (FDD): The UE Rx-Tx time difference for a RL included in the active set becomes larger than an absolute threshold

When this event is ordered by UTRAN in a MEASUREMENT CONTROL message, the UE shall send a MEASUREMENT REPORT message when the UE Rx-Tx time difference becomes larger than the threshold defined by the IE "UE Rx-Tx time difference threshold".

14.6.2.6a Reporting event 6F (1.28 Mcps TDD): The time difference indicated by T_{ADV} becomes larger than an absolute threshold

When this event is ordered by UTRAN in a MEASUREMENT CONTROL message, the UE shall send a MEASUREMENT REPORT message when the T_{ADV} changes compared to the last reported value more than a predefined threshold as configured with IE " T_{ADV} Threshold".

The UE shall set the IE " T_{ADV} " to the measured value and the IE "SFN" to the SFN during which the measurement was performed in the IE " T_{ADV} Info".

14.6.2.7 Reporting event 6G: The UE Rx-Tx time difference for a RL included in the active set becomes less than an absolute threshold

When this event is ordered by UTRAN in a MEASUREMENT CONTROL message, the UE shall send a MEASUREMENT REPORT when the UE Rx-Tx time difference becomes less than the threshold defined by the IE "UE Rx-Tx time difference threshold".

14.7 UE positioning measurements

14.7.1 UE positioning measurement quantities

The quantity to measure for UE positioning is dependent on the positioning method and the method type requested in the IE "UE positioning reporting quantity".

- 1 SFN-SFN observed time difference type 2, mandatory.
- 2 Rx-Tx time difference type 2, optional.
- 3 GPS timing of cell frames, optional.

The definition of other GPS measurements is not within the scope of this specification.

14.7.2 Void

14.7.3 UE positioning reporting events

In the UE positioning reporting criteria field in the Measurement Control messages, the UTRAN notifies the UE of which events should trigger a measurement report. UE positioning reporting events that can trigger a report are given below. The content of the measurement report is dependant on the location method and method type requested in the IE "UE positioning reporting quantity" of the Measurement Control message and is described in detail in [18].

14.7.3.1 Reporting Event 7a: The UE position changes more than an absolute threshold

When this event is ordered by UTRAN in a measurement control message, the UE shall send a measurement report when the UE changes its position compared to the last reported position more than a predefined threshold. This event is used for UE-based methods only.

14.7.3.2 Reporting Event 7b: SFN-SFN measurement changes more than an absolute threshold

When this event is ordered by UTRAN in a measurement control message, the UE shall send a measurement report when the SFN-SFN time difference measurement of any measured cell changes more than a predefined threshold. This event is primarily used for UE-assisted methods, but can be used also for UE-based methods.

14.7.3.3 Reporting Event 7c: GPS time and SFN time have drifted apart more than an absolute threshold

When this event is ordered by UTRAN in a measurement control message, the UE shall send a measurement report when the GPS Time Of Week and the SFN timer have drifted apart more than a predefined threshold. This event is primarily used for UE-assisted methods, but can be used also for UE-based methods.

14.8 Dynamic Resource Allocation Control of Uplink DCH (FDD only)

The network uses this procedure to dynamically control the allocation of resources on an uplink DCH.

This procedure shall be activated in the UE when it has been allocated an uplink DCH with DRAC static information elements. Such uplink DCHs can be established through RB establishment procedure, RB reconfiguration procedure, RB release procedure or Transport Channel Reconfiguration procedure by setting the DRAC static information elements to indicate that the DCH is controlled by the DRAC procedure.

The UE shall periodically listen to the SIB 10 of each cell in its Active Set. The scheduling information of SIB10 and the SCCPCH info on which the SIB10 is transmitted are provided to the UE when the DCH is set up and when a cell is added in its active set. In case several SIB10 messages from different cells are scheduled at the same time, the UE shall only listen to the SIB10 broadcast in the cell of its Active Set having the best CPICH measurements.

Upon reception of a SYSTEM INFORMATION message comprising a SIB10, the UE shall:

1. Determine and store the most stringent DRAC parameters from the last received values from each cell of its active set (i.e. select the lowest product p_{tr} *maximum bit rate corresponding to its DRAC class identity)

2. Determine the allowed subset of TFCS according to the selected maximum bit rate value, and store it for later usage.
The allowed subset of TFCS are the ones of the TFCS for which the sum of bit rates of the DCH controlled by DRAC is lower than Maximum Bit Rate IE, i.e.

$$\sum_{\text{DCHi controlled by DRAC}} TBSsize_i / TTI_i < MaximumBitRate$$

DCHi controlled by DRAC

After the first SIB10 has been received, the UE shall start the following process:

1. At the start of the next TTI, the UE shall randomly select $p \in [0,1]$.
2. If $p < ptr$, the UE shall transmit on the DCH controlled by DRAC during T_{validity} frames using the last stored allowed subset of TFCS and comes back to step 1, otherwise the UE shall stop transmission on these DCH during T_{retry} frames and then comes back to step 1.

Transmission time validity (T_{validity}) and Time duration before retry (T_{retry}) are indicated to the UE at the establishment of a DCH controlled by this procedure and may be changed through RB or transport channel reconfiguration. The UE shall always use the latest received DRAC static parameters.

A UE that supports the simultaneous reception of one SCCPCH and one DPCH shall support the DRAC procedure.

14.9 Downlink power control

14.9.1 Generalities

This function is implemented in the UE in order to set the SIR target value on each CCTrCH used for the downlink power control. This SIR value shall be adjusted according to an autonomous function in the UE in order to achieve the same measured quality as the quality target set by UTRAN. The quality target is set as the transport channel BLER value for each transport channel as signalled by UTRAN. For CPCH the quality target is set as the BER of the DL DPCCCH as signalled by UTRAN.

When transport channel BLER is used the UE shall run a quality target control loop such that the quality requirement is met for each transport channel, which has been assigned a BLER target.

When DL DPCCCH BER is used the UE shall run a quality target control loop such that the quality requirement is met for each CPCH transport channel, which has been assigned a DL DPCCCH BER target.

The UE shall set the SIR target when the physical channel has been set up or reconfigured. It shall not increase the SIR target value before the power control has converged on the current value. The UE may estimate whether the power control has converged on the current value, by comparing the averaged measured SIR to the SIR target value.

14.9.2 Downlink power control in compressed mode

In compressed mode, the target SIR needs to be changed in several frames compared to normal mode. For this purpose, four values DeltaSIR1, DeltaSIRafter1, DeltaSIR2 and DeltaSIRafter2 are signalled by the UTRAN to the UE (see subclause 10.2.9).

For each frame, the target SIR offset during compressed mode, compared to normal mode is:

$$\Delta SIR = \max(\Delta SIR1_{\text{compression}}, \dots, \Delta SIRn_{\text{compression}}) + \Delta SIR1_{\text{coding}} + \Delta SIR2_{\text{coding}}$$

where n is the number of TTI lengths for all TrChs of the CCTrCh, F_i is the length in number of frames of the i-th TTI and where $\Delta SIR_{\text{coding}}$ fulfils:

- $\Delta SIR1_{\text{coding}} = \text{DeltaSIR1}$ if the start of the first transmission gap in the transmission gap pattern is within the current frame.
- $\Delta SIR1_{\text{coding}} = \text{DeltaSIRafter1}$ if the current frame just follows a frame containing the start of the first transmission gap in the transmission gap pattern.

- $\Delta\text{SIR2_coding}$ = DeltaSIR2 if the start of the second transmission gap in the transmission gap pattern is within the current frame.
- $\Delta\text{SIR2_coding}$ = DeltaSIRafter2 if the current frame just follows a frame containing the start of the second transmission gap in the transmission gap pattern.
- $\Delta\text{SIR1_coding}$ = 0 and $\Delta\text{SIR2_coding}$ = 0 otherwise.

and ΔSIR_i _compression is defined by :

- ΔSIR_i _compression = 3 dB for downlink frames compressed by reducing the spreading factor by 2.
- ΔSIR_i _compression = $10 \log (15 \cdot F_i / (15 \cdot F_i - \text{TGL}_i))$ if there is a transmission gap created by puncturing method within the current TTI of length F_i frames, where TGL_i is the gap length in number of slots (either from one gap or a sum of gaps) in the current TTI of length F_i frames.
- ΔSIR_i _compression = 0 dB in all other cases.

Several compressed mode patterns applying to the same frames should be avoided as much as possible.

In particular; several simultaneous patterns by puncturing applying to the same frames shall be considered as a protocol error by the UE. The handling of this error is described in the procedure descriptions in clause 8

In case several compressed mode patterns are used simultaneously, a ΔSIR offset is computed for each compressed mode pattern and the sum of all ΔSIR offsets is applied to the frame.

14.10 Calculated Transport Format Combination

The Calculated Transport Format Combination (CTFC) is a tool for efficient signalling of transport format combinations.

Let I be the number of transport channels that are included in the transport format combination. Each transport channel TrCH_i , $i = 1, 2, \dots, I$, has L_i transport formats, i.e. the transport format indicator TFI_i can take L_i values, $\text{TFI}_i \in \{0, 1, 2, \dots, L_i - 1\}$.

Define $P_i = \prod_{j=0}^{i-1} L_j$, where $i = 1, 2, \dots, I$, and $L_0 = 1$.

Let $\text{TFC}(\text{TFI}_1, \text{TFI}_2, \dots, \text{TFI}_I)$ be the transport format combination for which TrCH_1 has transport format TFI_1 , TrCH_2 has transport format TFI_2 , etc. The corresponding $\text{CTFC}(\text{TFI}_1, \text{TFI}_2, \dots, \text{TFI}_I)$ is then computed as:

$$\text{CTFC}(\text{TFI}_1, \text{TFI}_2, \dots, \text{TFI}_I) = \sum_{i=1}^I \text{TFI}_i \cdot P_i.$$

For FACH and PCH transport channels, "TrCH₁" corresponds to the transport channel listed at the first position in IE "FACH/PCH information" in IE "Secondary CCPCH System Information", "TrCH₂" corresponds to the transport channel listed at the second position in IE "FACH/PCH information" and so on.

For all other transport channels in FDD and for all configured transport channels of the same transport channel type (i.e. DCH, DSCH, USCH) in TDD, "TrCH₁" corresponds to the transport channel having the lowest transport channel identity in the transport format combination mapped to the TFCI field. "TrCH₂" corresponds to the transport channel having the next lowest transport channel identity, and so on.

14.11 UE autonomous update of virtual active set on non-used frequency (FDD only)

In the text that follows:

- a "non-used frequency" is a frequency that the UE has been ordered to measure upon but is not used for the connection. A "used frequency" is a frequency that the UE has been ordered to measure upon and is also currently used for the connection;
- a "non-used frequency (resp. cell) considered in an inter-frequency measurement" shall be understood as a non-used frequency (resp. cell) included in the list of cells pointed at in the IE "cells for measurement" if it was received for that measurement, or otherwise as a non-used frequency (resp. cell) included in the "Inter-frequency cell info" part of the variable CELL_INFO_LIST.

For event-triggered inter frequency measurements it is possible to specify intra-frequency measurements reporting events for support of maintenance of an active set associated with a non-used frequency considered in that measurement, a "virtual active set" and used in the evaluation of the frequency quality estimates. The "initial virtual active set" for a frequency is the virtual active set that is associated to that frequency just after a message was received that sets up or modifies the inter-frequency measurement.

The way the virtual active sets are initiated and updated for the non-used frequencies considered in an inter-frequency measurement is described in the two subclauses below, and depends on whether the IE "intra-frequency reporting criteria" is stored for the inter-frequency measurement or not. In case that IE is not stored, the IE "intra-frequency measurement" stored in other measurements of type intra-frequency shall be used.

14.11.1 Initial virtual active set

The way the UE shall act when a MEASUREMENT CONTROL message is received that sets up or modifies an inter-frequency measurement, and that includes the IE "Inter-frequency set update" and/or the IE "Intra-Frequency measurement reporting quantity" is described below. The UE shall:

- if the IE "Intra-Frequency measurement reporting criteria" is included in the MEASUREMENT CONTROL message, or if it was previously stored and if the IE "Inter-frequency set update" was included in the MEASUREMENT CONTROL message:
- if the IE "UE autonomous update mode" received or previously stored is set to "on" or "on with no reporting":
- for each non-used frequency F_i considered in the measurement:
 - include in the initial virtual active set the N_i cells that have either the greatest downlink E_c/N_0 , the greatest downlink RSCP after despreading, or the lowest pathloss (depending on what is indicated in the IE "inter-frequency measurement quantity"), among the cells on frequency F_i considered in that inter-frequency measurement, where:
 - if event 1a is configured in the "Intra-Frequency measurement reporting criteria":

$$N_i = \min(N_{Ia}, N_{Cells Fi}) \text{ if } N_{Ia} \neq 0 \text{ and } N_i = N_{Cells Fi} \text{ otherwise.}$$

where:

N_{Ia} is the "Reporting deactivation threshold" included in the "Intra-Frequency measurement" IE received for that inter-frequency measurement for event 1a.

$N_{Cells Fi}$ is the number of cells on frequency F_i considered in that inter-frequency measurement.

- else, if event 1c is configured in the "Intra-Frequency measurement reporting criteria":

$$N_i = \min(N_{Ic}, N_{Cells Fi}) \text{ if } N_{Ic} \neq 0 \text{ and } N_i = N_{Cells Fi} \text{ otherwise.}$$

where:

N_{Ic} is the "Replacement activation threshold" included in the "Intra-Frequency measurement" IE received for that inter-frequency measurement for event 1c.

$N_{Cells Fi}$ is the number of cells on frequency F_i considered in that inter-frequency measurement.

- else:

$$N_i = N_{Cells F_i}$$

where:

$N_{Cells F_i}$ is the number of cells on frequency F_i considered in that inter-frequency measurement;

- if the IE "UE autonomous update mode" received or previously stored is set to "on":
 - if event 1a is configured in the "Intra-Frequency measurement reporting criteria":
 - send a MEASUREMENT REPORT with IEs set as follows:
 - set the Measurement identity to the identity of the inter-frequency measurement;
 - set the CHOICE event result in the IE Event results to Intra-frequency measurement event results, Intra-frequency event identity to 1a, and in "Cell measurement event results" the CPICH info of all the cells included in a virtual active set of the non-used frequency considered in the inter-frequency measurement;
 - do not include the IE "measured results".
 - else, if event 1c is configured in the "Intra-Frequency measurement reporting criteria":
 - send a measurement report with IEs set as follows:
 - set the Measurement identity to the identity of the inter-frequency measurement;
 - set the CHOICE event result in the IE Event results to Intra-frequency measurement event results, Intra-frequency event identity to 1c, and in "Cell measurement event results" the CPICH info of all the cells included in the virtual active set of the frequency considered in the inter-frequency measurement;
 - do not include the IE "measured results";
- if the IE "Inter-frequency set update" is included in the message and if the IE "UE autonomous update mode" is set to "Off":
 - if the IE "Measurement command" is set to "Modify", if the value previously stored for the IE "UE autonomous update set" was also "Off" and if the IE "Intra-frequency measurement reporting criteria" was not included in the message:
 - apply the modifications indicated in the "Inter-frequency set update" to the virtual active set that was valid before the message was received for the non-used frequency considered in that inter-frequency measurement.
 - otherwise:
 - remove the possibly existing virtual active set of the non-used frequency considered in that measurement; and
 - set the initial virtual active set for it according to the "Inter-frequency set update" included in the message;
- if the IE "Inter-frequency set update" is not included in the message and if the IE "UE autonomous update mode" stored for the inter-frequency measurement is set to "Off":
 - remove the possibly existing virtual active set of the non-used frequency considered in that measurement; and
 - consider the virtual active set for it as empty.
- if the IE "Intra-Frequency measurement reporting criteria" was not included in the MEASUREMENT CONTROL message:

- if the IE "UE autonomous update mode" is set to "on" or "on with no reporting":
 - for each non-used frequency F_i considered in the measurement:
 - include in the initial virtual active set the N_i cells that have either the greatest downlink E_c/N_0 or the greatest downlink RSCP after despreading or the lowest pathloss (depending on what is indicated in the IE "inter-frequency measurement quantity"), among the cells on frequency F_i considered in that inter-frequency measurement, where:
 - if event 1a is configured for the used frequency in an intra-frequency measurement; and
 - if the "Reporting deactivation threshold" is included:

$$N_i = \min(N_{1a}, N_{Cells\ F_i}) \text{ if } N_{1a} \neq 0 \text{ and } N_i = N_{Cells\ F_i} \text{ otherwise.}$$

where:

N_{1a} is the "Reporting deactivation threshold" included in the intra-frequency measurement for the first event 1a defined in the intra-frequency measurement with the lowest identity.

$N_{Cells\ F_i}$ is the number of cells on frequency F_i considered in that inter-frequency measurement.

- else, if event 1c is configured for the used frequency in an intra-frequency measurement:

$$N_i = \min(N_{1c}, N_{Cells\ F_i}) \text{ if } N_{1c} \neq 0 \text{ and } N_i = N_{Cells\ F_i} \text{ otherwise.}$$

where:

N_{1c} is the "Replacement activation threshold" included in the "Intra-Frequency measurement" for the first event 1c defined in the intra-frequency measurement with the lowest identity.

$N_{Cells\ F_i}$ is the number of cells on frequency F_i considered in that inter-frequency measurement.

- else:

$$N_i = N_{Cells\ F_i}$$

where:

$N_{Cells\ F_i}$ is the number of cells on frequency F_i considered in that inter-frequency measurement.

- if the IE "UE autonomous update mode" is set to "on":
 - if event 1a is configured for the used frequency in an intra-frequency measurement:
 - send a measurement report with IEs set as follows:
 - set the Measurement identity to the identity of the inter-frequency measurement;
 - set the CHOICE event result in the IE Event results to Intra-frequency measurement event results, Intra-frequency event identity to 1a, and in "Cell measurement event results" the CPICH info of all the cells included in the initial virtual active set of the non-used frequency considered in that measurement;
 - do not include the IE "measured results".
 - else, if event 1c is configured for the used frequency in an intra-frequency measurement:
 - send a measurement report with IEs set as follows:
 - set the Measurement identity to the identity of the inter-frequency measurement;
 - set the CHOICE event result in the IE Event results to Intra-frequency measurement event results, Intra-frequency event identity to 1c, and in "Cell measurement event results" the

CPICH info of all the cells included in the initial virtual active set of the non-used frequency considered in that measurement;

- do not include the IE "measured results".
- if the IE "UE autonomous update mode" is set to "off":
 - set the initial virtual active set of the non-used frequency considered in that inter-frequency measurement according to what is included in the IE "Inter-frequency set update" included in the message; and
 - if the IE "Inter-frequency set update" was not received:
 - set the initial virtual active set for the frequencies considered in that measurement to be empty.

14.11.2 Virtual active set update during an inter-frequency measurement

If the IE "Intra-frequency measurement reporting criteria" is stored for an inter-frequency measurement, the UE shall:

- if Event 1a is configured in that IE, when this event is triggered (according to the criteria described in subclause 14.2.1.1) by a cell allowed to affect the reporting range (i.e. not included in the IE "Cells forbidden to affect reporting range" if that IE is included) for a non-used frequency considered in that measurement:
 - if the "Reporting deactivation threshold" is equal to 0, or if the "Reporting deactivation threshold" is different from 0 and the number of cells included in the virtual active set for that frequency is less than the "Reporting deactivation threshold":
 - if the IE "UE autonomous update mode" is set to "on" or "on with no reporting":
 - add the primary CPICH that enters the reporting range to the "virtual active set";
 - if the IE "UE autonomous update mode" is set to "on" or "off":
 - send a measurement report with IEs set as below:
 - set the Measurement identity to the identity of the inter-frequency measurement;
 - set the CHOICE event result in the IE Event results to Intra-frequency measurement event results, Intra-frequency event identity to 1a, and in "Cell measurement event results" the CPICH info of the cell that triggered the event;
 - do not include the IE "measured results";
 - if Event 1b was configured, when this event is triggered (according to the criteria described in subclause 14.2.1.2) by a cell allowed to affect the reporting range (i.e. not included in the IE "Cells forbidden to affect reporting range" if that IE is included) for a non-used frequency considered in that measurement:
 - if the IE "UE autonomous update mode" is set to "on" or "on with no reporting" and if the number of cells included in the virtual active set is greater than 1:
 - remove the primary CPICH that leaves the reporting range from the "virtual active set";
 - if the IE "UE autonomous update mode" is set to "on" or "off":
 - send a measurement report with IEs set as below:
 - set the Measurement identity to the identity of the inter-frequency measurement;
 - set the CHOICE event result in the IE Event results to Intra-frequency measurement event results, Intra-frequency event identity to 1b, and in "Cell measurement event results" the CPICH info of the cell that triggered the event;
 - do not include the IE "measured results";
- if Event 1c was configured, when this event is triggered by a cell for a frequency considered in that measurement (according to the criteria described in subclause 14.2.1.3):

- if the "Reporting activation threshold" is equal to 0, or if the "Reporting activation threshold" is different from 0 and the number of cells included in the virtual active set for that frequency is greater than or equal to the "Reporting activation threshold":
 - if the IE "UE autonomous update mode" is set to "on" or "on with no reporting":
 - replace an active primary CPICH in the "virtual active set" with a non-active primary CPICH that has become better than the active primary CPICH;
 - if the IE "UE autonomous update mode" is set to "on" or "off":
 - send a measurement report with IEs set as below:
 - set the Measurement identity to the identity of the inter-frequency measurement;
 - set the CHOICE event result in the IE Event results to Intra-frequency measurement event results, Intra-frequency event identity to 1c, and in "Cell measurement event results" the first entry as the CPICH info of the cell that triggered the event, and the rest of the entries as the cells that were in the virtual active set before the event occurred and that are worse than the cell that triggered the event, in the order of their measured value (best one first);
 - do not include the IE "measured results".

If the IE "Intra-frequency measurement reporting criteria" is not stored for that inter-frequency measurement, the UE shall:

- apply the events of type 1a, 1b and 1c that were defined for the used frequency in other stored measurements of type "intra-frequency" at the time the inter-frequency measurement was set up; and
- update the virtual active set for the non-used frequencies considered in that measurement according to the following rules:
 - if several events of type 1a (resp. 1b,1c) were defined for the used frequency when the inter-frequency measurement was set up, only the first 1a event (resp 1b, 1c) that was defined in the measurement with the lowest measurement identity shall apply to the non-used frequencies;
 - all the cells considered in the inter-frequency measurements shall be able to affect the reporting range for event 1a and 1b. (i.e. the IE "Cells forbidden to affect reporting range" possibly stored for the intra-frequency measurements on the used frequency does not apply to the non-used frequencies considered in the inter-frequency measurement);
 - the IEs "amount of reporting" and "reporting interval" that were stored for the intra-frequency measurements on the used frequency shall not be considered if reports of the virtual active set updates are needed;
- if event 1a is applicable to the non-used frequencies considered in the inter-frequency measurement, when this event is triggered (according to the criteria described in subclause 14.2.1.1) by a cell for a non-used frequency considered in that measurement:
 - if the "Reporting deactivation threshold" is equal to 0, or if the "Reporting deactivation threshold" is different from 0 and the number of cells included in the virtual active set for that frequency is less than the "Reporting deactivation threshold":
 - if the IE "UE autonomous update mode" is set to "on" or "on with no reporting":
 - add the primary CPICH that enters the reporting range to the "virtual active set"
 - if the IE "UE autonomous update mode" is set to "on" or "off":
 - send a measurement report with IEs set as below:
 - set the Measurement identity to the identity of the inter-frequency measurement;
 - set the CHOICE event result in the IE Event results to Intra-frequency measurement event results, Intra-frequency event identity to 1a, and in "Cell measurement event results" the CPICH info of the cell that triggered the event;

- do not include the IE "measured results";
- if event 1b is applicable for the non-used frequencies considered in that inter-frequency measurement, when this event is triggered (according to the criteria described in subclause 14.2.1.2) by a cell for a non-used frequency considered in that measurement:
 - if the IE "UE autonomous update mode" is set to "on" or "on with no reporting" and if the number of cells included in the virtual active set is greater than 1:
 - remove the primary CPICH that leaves the reporting range from the "virtual active set"
 - if the IE "UE autonomous update mode" is set to "on" or "off", send a measurement report with IEs set as below:
 - set the Measurement identity to the identity of the inter-frequency measurement;
 - set the CHOICE event result in the IE Event results to Intra-frequency measurement event results, Intra-frequency event identity to 1b, and in "Cell measurement event results" the CPICH info of the cell that triggered the event;
 - do not include the IE "measured results";
- if event 1c is applicable for the non-used frequencies considered in that inter-frequency measurement, when this event is triggered (according to the criteria described in subclause 14.2.1.3) by a cell for a non-used frequency considered in that measurement:
 - if the "Reporting activation threshold" is equal to 0, or if the "Reporting activation threshold" is different from 0 and the number of cells included in the virtual active set for that frequency is greater than or equal to the "Reporting activation threshold":
 - if the IE "UE autonomous update mode" is set to "on" or "on with no reporting":
 - replace an active primary CPICH in the "virtual active set" with a non-active primary CPICH that has become better than the active primary CPICH;
 - if the IE "UE autonomous update mode" is set to "on" or "off":
 - send a measurement report with IEs set as below:
 - set the Measurement identity to the identity of the inter-frequency measurement.
 - set the CHOICE event result in the IE Event results to Intra-frequency measurement event results, Intra-frequency event identity to 1c, and in "Cell measurement event results" the first entry as the CPICH info of the cell that triggered the event, and the rest of the entries as the cells that were in the virtual active set before the event occurred and that are worse than the cell that triggered the event, in the order of their measured value (best one first);
 - do not include the IE "measured results".

14.12 Provision and reception of RRC information between network nodes

14.12.0 General

In certain cases, e.g., when performing handover to UTRAN or when performing SRNC relocation, RRC information may need to be transferred between other RATs and UTRAN or between UTRAN nodes within UTRAN. In the following, the details of the RRC information to be transferred are specified per direction.

In the following the RRC information exchanged between network nodes is sometimes referred to as RRC information containers. This term is used for information which handling resembles that of RRC messages rather than of RRC information elements.

In future versions of this specification, it is possible to extend the RRC information transferred between network nodes. For RRC information containers the same extension mechanism applies as defined for RRC messages, which is specified in subclause 10.1. For RRC information containers specified in the following, both critical and non-critical extensions may be added.

Like for the Uu interface, the transfer syntax for RRC transferred between UTRAN network nodes and/or between UTRAN and other RATs is derived from their ASN.1 definitions by use of Packed Encoding Rules, unaligned (X.691). It should be noted that the encoder adds final padding to achieve octet alignment. The resulting octet string is, carried in a container, transferred between the network nodes.

14.12.0a General error handling for RRC information containers

The handling of RRC messages that are terminated in the UE and transferred using RRC information containers is covered by clauses 8 and 9 of this specification.

The error handling for RRC information containers that are terminated in network nodes applies the same principles as defined for RRC messages, as specified in the following.

Although the same principles apply for network nodes receiving unknown, unforeseen and erroneous RRC information containers, although the notification of the error should be done in a different manner, as specified in the following:

The network node receiving an invalid RRC information container from another network node should:

- if the received RRC information container was unknown, unforeseen or erroneous:
 - prepare an RRC INFORMATION CONTAINER FAILURE INFO container, including the IE "Failure cause" set to "Protocol error" and the IE "Protocol error information" including an IE "Protocol error cause" which should be set as follows:
 - to "ASN.1 violation or encoding error" upon receiving an RRC information container for which the encoded message does not result in any valid abstract syntax value;
 - to "Message type non-existent or not implemented" upon receiving an unknown RRC information container type;
 - to "Message extension not comprehended" upon receiving an RRC information container including an undefined critical message extension;
 - to "Information element value not comprehended" upon receiving an RRC information container including an mandatory IE for which no default value is defined and for which either the value is set to spare or for which the encoded IE does not result in a valid transfer syntax. The same applies for conditional IEs, for which the conditions for presence are met, the IE is present but has a value set to spare or for which the encoded IE does not result in a valid transfer syntax;
 - to "Conditional information element error" upon receiving an RRC information container with an absent conditional IE for which the conditions for presence are met;
 - if there was another failure to perform the operation requested by the received RRC information container:
 - prepare an RRC INFORMATION CONTAINER FAILURE INFO container, including the IE "Failure cause" set to a value that reflects the failure cause;
- send the RRC INFORMATION CONTAINER FAILURE INFO container to the network node from which the invalid RRC protocol information was received.

NOTE: The RRC information container may be transferred across the network interfaces by means of a transparent container, if available.

14.12.1 RRC Information to target RNC

RRC Information to target RNC may either be sent from source RNC or from another RAT. In case of handover to UTRAN, this information originates from another RAT, while in case of SRNC relocation the RRC information originates from the source RNC. In case of SRNC information, the RRC information transferred specifies the configuration of RRC and the lower layers it controls, e.g., including the radio bearer and transport channel

configuration. It is used by the target RNC to initialise RRC and the lower layer protocols to facilitate SRNC relocation in a manner transparent to the UE.

Information Element/Group Name	Need	Multi	Type and reference	Semantics description
CHOICE case	MP			At least one spare choice, Criticality: Reject, is needed
>Handover to UTRAN			HANDOVER TO UTRAN INFO 14.12.4.1	
>SRNC relocation			SRNS RELOCATION INFO 14.12.4.2	

14.12.2 RRC information, target RNC to source RNC

There are 2 possible cases for RNC relocation:

1. The UE is already under control of target RNC; and
2. The SRNC Relocation with Hard Handover (UE still under control of SRNC), but UE is moving to a location controlled by the target RNC (based on measurement information).

In case 1 the relocation is transparent to the UE and there is no "reverse" direction container. The SRNC just assigns the 'serving' function to the target RNC, which then becomes the Serving RNC.

In case 2 the relocation is initiated by SRNC, which also provides the RRC Initialisation Information to the target RNC. Based on this information, the target RNC prepares the Hard Handover Message ("Physical channel reconfiguration" (subclause 8.2.6), "radio bearer establishment" (subclause 8.2.1), "Radio bearer reconfiguration" (subclause 8.2.2), "Radio bearer release" (subclause 8.2.3) or "Transport channel reconfiguration" (subclause 8.2.4).

The source RNC then transmits the Handover Message to the UE, which then performs the handover.

In the successful case, the UE transmits an XXX COMPLETE message, using the new configuration, to the target RNC.

In case of failure, the UE transmits an XXX FAILURE, using the old configuration, to the source RNC and the RRC context remains unchanged (has to be confirmed and checked with the SRNS relocation procedure).

Information Element/Group name	Need	Multi	Type and reference	Semantics description
CHOICE <i>RRC message</i>	MP			At least one spare choice, Criticality: Reject, is needed
>RADIO BEARER SETUP			RADIO BEARER SETUP 10.2.31	
>RADIO BEARER RECONFIGURATION			RADIO BEARER RECONFIGURATION 10.2.25	
>RADIO BEARER RELEASE			RADIO BEARER RELEASE 10.2.28	
>TRANSPORT CHANNEL RECONFIGURATION			TRANSPORT CHANNEL RECONFIGURATION 10.2.51	
>PHYSICAL CHANNEL RECONFIGURATION			PHYSICAL CHANNEL RECONFIGURATION 10.2.20	
>RRC INFORMATION CONTAINER FAILURE INFO			RRC INFORMATION CONTAINER FAILURE INFO 14.12.4.3	

14.12.3 RRC information, target RNC to source system

The RRC information, target RNC to source system is used to transfer information to another RAT, e.g., in case of handover to UTRAN. In this case, the RRC information concerns the "Handover To UTRAN Command" that is compiled by the target RNC but transferred via another RAT towards the UE, as specified in 8.3.6.

Information Element/Group name	Need	Multi	Type and reference	Semantics description
CHOICE <i>case</i>	MP			At least one spare choice, Criticality: Reject, is needed
>handover to UTRAN			HANDOVER TO UTRAN COMMAND 10.2.12	
>RRC INFORMATION CONTAINER FAILURE INFO			RRC INFORMATION CONTAINER FAILURE INFO 14.12.4.3	

14.12.4 RRC information containers exchanged between network nodes

14.12.4.1 HANDOVER TO UTRAN INFO

This RRC information container is sent between network nodes when preparing for an inter RAT handover to UTRAN.

Direction: source RAT→target RNC

Information Element/Group Name	Need	Multi	Type and reference	Semantics description
UE Information elements				
UE radio access capability	OP		UE radio access capability 10.3.3.42	
UE radio access capability extension	OP		UE radio access capability extension 10.3.3.42a	
Non RRC IEs				
UE system specific capability	OP		UE system specific capability 14.13.2.4	
UE security information	OP		UE security information 14.13.2.2	
Pre-defined configuration status information	OP		Pre-defined configuration status information 14.13.2.3	

14.12.4.2 SRNS RELOCATION INFO

This RRC information container is sent between network nodes when preparing for an SRNS relocation.

Direction: source RAT→target RNC

Information Element/Group Name	Need	Multi	Type and reference	Semantics description
Non RRC IEs				
>State of RRC	MP		RRC state indicator, 10.3.3.10	
>State of RRC procedure	MP		Enumerated (await no RRC message, Complete, await RB Setup Complete, await RB Reconfiguration Complete, await RB Release Complete, await Transport CH Reconfiguration Complete, await Physical CH Reconfiguration Complete, await Active Set Update Complete, await Handover Complete, send Cell Update Confirm, send URA Update Confirm, , others)	
Ciphering related information				
>Ciphering status for each CN domain	MP	<1 to maxCNDomains>		
>>CN domain identity	MP		CN domain identity 10.3.1.1	
>>Ciphering status	MP		Enumerated(Not started, Started)	
>Latest configured CN domain	MP		CN domain identity 10.3.1.1	Value contained in the variable of the same name.
>Calculation time for ciphering related information	CV- <i>Ciphering</i>			Time when the ciphering information of the message were calculated, relative to a cell of the target RNC
>>Cell Identity	MP		Cell Identity 10.3.2.2	Identity of one of the cells under the target RNC and included in the active set of the current call
>>SFN	MP		Integer(0..4095)	

Information Element/Group Name	Need	Multi	Type and reference	Semantics description
>COUNT-C list	CV- <i>Ciphering</i>	1 to <maxCNdo mains>		COUNT-C values for radio bearers using transparent mode RLC
>>CN domain identity	MP		CN domain identity 10.3.1.1	
>>COUNT-C	MP		Bit string(32)	
>Ciphering info per radio bearer	OP	1 to <maxRB>		For signalling radio bearers this IE is mandatory.
>>RB identity	MP		RB identity 10.3.4.16	
>>Downlink HFN	MP		Bit string(20..25)	This IE is either RLC AM HFN (20 bits) or RLC UM HFN (25 bits)
>>Uplink HFN	MP		Bit string(20..25)	This IE is either RLC AM HFN (20 bits) or RLC UM HFN (25 bits)
Integrity protection related information				
>Integrity protection status	MP		Enumerated(Not started, Started)	
>Signalling radio bearer specific integrity protection information	CV- <i>IP</i>	4 to <maxSRBs etup>		
>>Uplink RRC HFN	MP		Bit string (28)	
>>Downlink RRC HFN	MP		Bit string (28)	
>>Uplink RRC Message sequence number	MP		Integer (0..15)	
>>Downlink RRC Message sequence number	MP		Integer (0..15)	
>Implementation specific parameters	OP		Bit string (1..512)	
RRC IEs				
UE Information elements				
>U-RNTI	MP		U-RNTI 10.3.3.47	
>C-RNTI	OP		C-RNTI 10.3.3.8	
>UE radio access Capability	MP		UE radio access capability 10.3.3.42	
>UE radio access capability extension	OP		UE radio access capability extension 10.3.3.42a	
>Last known UE position	OP			
>>SFN	MP		Integer (0..4095)	Time when position was estimated
>>Cell ID	MP		Cell identity; 10.3.2.2	Indicates the cell, the SFN is valid for.
>>CHOICE <i>Position estimate</i>	MP			
>>>Ellipsoid Point			Ellipsoid Point; 10.3.8.4a	
>>>Ellipsoid point with uncertainty circle			Ellipsoid point with uncertainty circle 10.3.8.4d	
>>>Ellipsoid point with			Ellipsoid	

Information Element/Group Name	Need	Multi	Type and reference	Semantics description
uncertainty ellipse			point with uncertainty ellipse 10.3.8.4e	
>>>Ellipsoid point with altitude			Ellipsoid point with altitude 10.3.8.4b	
>>>Ellipsoid point with altitude and uncertainty ellipsoid			Ellipsoid point with altitude and uncertainty ellipsoid 10.3.8.4c	
Other Information elements				
>UE system specific capability	OP	1 to <maxSystemCapability>		
>>Inter-RAT UE radio access capability	MP		Inter-RAT UE radio access capability 10.3.8.7	
UTRAN Mobility Information elements				
>URA Identifier	OP		URA identity 10.3.2.6	
CN Information Elements				
>CN common GSM-MAP NAS system information	MP		NAS system information (GSM-MAP) 10.3.1.9	
>CN domain related information	OP	1 to <MaxCNdomains>		CN related information to be provided for each CN domain
>>CN domain identity	MP			
>>CN domain specific GSM-MAP NAS system info	MP		NAS system information (GSM-MAP) 10.3.1.9	
>>CN domain specific DRX cycle length coefficient	MP		CN domain specific DRX cycle length coefficient, 10.3.3.6	
Measurement Related Information elements				
>For each ongoing measurement reporting	OP	1 to <MaxNoOfMeas>		
>>Measurement Identity	MP		Measurement identity 10.3.7.48	
>>Measurement Command	MP		Measurement command 10.3.7.46	
>>Measurement Type	CV-Setup		Measurement type 10.3.7.50	
>>Measurement Reporting Mode	OP		Measurement reporting mode 10.3.7.49	
>>Additional Measurements list	OP		Additional	

Information Element/Group Name	Need	Multi	Type and reference	Semantics description
			measurements list 10.3.7.1	
>>CHOICE <i>Measurement</i>	OP			
>>>Intra-frequency				
>>>>Intra-frequency cell info	OP		Intra-frequency cell info list 10.3.7.33	
>>>>Intra-frequency measurement quantity	OP		Intra-frequency measurement quantity 10.3.7.38	
>>>>Intra-frequency reporting quantity	OP		Intra-frequency reporting quantity 10.3.7.41	
>>>>Reporting cell status	OP		Reporting cell status 10.3.7.61	
>>>>Measurement validity	OP		Measurement validity 10.3.7.51	
>>>>CHOICE <i>report criteria</i>	OP			
>>>>>Intra-frequency measurement reporting criteria			Intra-frequency measurement reporting criteria 10.3.7.39	
>>>>>Periodical reporting			Periodical reporting criteria 10.3.7.53	
>>>>>No reporting			NULL	
>>>Inter-frequency				
>>>>Inter-frequency cell info	OP		Inter-frequency cell info list 10.3.7.13	
>>>>Inter-frequency measurement quantity	OP		Inter-frequency measurement quantity 10.3.7.18	
>>>>Inter-frequency reporting quantity	OP		Inter-frequency reporting quantity 10.3.7.21	
>>>>Reporting cell status	OP		Reporting cell status 10.3.7.61	
>>>>Measurement validity	OP		Measurement validity 10.3.7.51	
>>>>CHOICE <i>report criteria</i>	OP			
>>>>>Inter-frequency measurement reporting criteria			Inter-frequency measurement reporting criteria 10.3.7.19	

Information Element/Group Name	Need	Multi	Type and reference	Semantics description
>>>>Periodical reporting			Periodical reporting criteria 10.3.7.53	
>>>>No reporting			NULL	
>>>Inter-RAT				
>>>>Inter-RAT cell info	OP		Inter-RAT cell info list 10.3.7.23	
>>>>Inter-RAT measurement quantity	OP		Inter-RAT measurement quantity 10.3.7.29	
>>>>Inter-RAT reporting quantity	OP		Inter-RAT reporting quantity 10.3.7.32	
>>>>Reporting cell status	OP		Reporting cell status 10.3.7.61	
>>>>Measurement validity	OP		Measurement validity 10.3.7.51	
>>>>CHOICE <i>report criteria</i>	OP			
>>>>>Inter-RAT measurement reporting criteria			Inter-RAT measurement reporting criteria 10.3.7.30	
>>>>>Periodical reporting			Periodical reporting criteria 10.3.7.53	
>>>>>No reporting			NULL	
>>>Traffic Volume				
>>>>Traffic volume measurement Object	OP		Traffic volume measurement object 10.3.7.70	
>>>>Traffic volume measurement quantity	OP		Traffic volume measurement quantity 10.3.7.71	
>>>>Traffic volume reporting quantity	OP		Traffic volume reporting quantity 10.3.7.74	
>>>>CHOICE <i>report criteria</i>	OP			
>>>>>Traffic volume measurement reporting criteria			Traffic volume measurement reporting criteria 10.3.7.72	
>>>>>Periodical reporting			Periodical reporting criteria 10.3.7.53	
>>>>>No reporting			NULL	
>>>Quality				
>>>>Quality measurement Object	OP		Quality measurement	

Information Element/Group Name	Need	Multi	Type and reference	Semantics description
			t object	
>>>>CHOICE <i>report criteria</i>	OP			
>>>>>Quality measurement reporting criteria			Quality measurement reporting criteria 10.3.7.58	
>>>>>Periodical reporting			Periodical reporting criteria 10.3.7.53	
>>>>>No reporting			NULL	
>>>UE internal				
>>>>UE internal measurement quantity	OP		UE internal measurement quantity 10.3.7.79	
>>>>UE internal reporting quantity	OP		UE internal reporting quantity 10.3.7.82	
>>>>CHOICE <i>report criteria</i>	OP			
>>>>>UE internal measurement reporting criteria			UE internal measurement reporting criteria 10.3.7.80	
>>>>>Periodical reporting			Periodical reporting criteria 10.3.7.53	
>>>>>No reporting			NULL	
>>>UE positioning				
>>>>LCS reporting quantity	OP		LCS reporting quantity 10.3.7.111	
>>>>CHOICE <i>report criteria</i>	OP			
>>>>>LCS reporting criteria			LCS reporting criteria 10.3.7.110	
>>>>>Periodical reporting			Periodical reporting criteria 10.3.7.53	
>>>>>No reporting				
Radio Bearer Information Elements				
>Pre-defined configuration status information	OP		Pre-defined configuration status information 14.13.2.3	
>Signalling RB information list	MP	1 to <maxSRBs etup>		For each signalling radio bearer
>>Signalling RB information	MP		Signalling RB information to setup 10.3.4.24	
>RAB information list	OP	1 to <maxRABs etup>		Information for each RAB

Information Element/Group Name	Need	Multi	Type and reference	Semantics description
>>RAB information	MP		RAB information to setup 10.3.4.10	
Transport Channel Information Elements				
Uplink transport channels				
>UL Transport channel information common for all transport channels	OP		UL Transport channel information common for all transport channels 10.3.5.24	
>UL transport channel information list	OP	1 to <MaxTrCH >		
>>UL transport channel information	MP		Added or reconfigured UL TrCH information 10.3.5.2	
>CHOICE mode	OP			
>>FDD				
>>>CPCH set ID	OP		CPCH set ID 10.3.5.5	
>>>>Transport channel information for DRAC list	OP	1 to <MaxTrCH >		
>>>>>DRAC static information	MP		DRAC static information 10.3.5.7	
>>TDD				(no data)
Downlink transport channels				
>DL Transport channel information common for all transport channels	OP		DL Transport channel information common for all transport channels 10.3.5.6	
>DL transport channel information list	OP	1 to <MaxTrCH >		
>>DL transport channel information	MP		Added or reconfigured DL TrCH information 10.3.5.1	
>Measurement report	OP		MEASUREMENT REPORT 10.2.17	

Multi Bound	Explanation
MaxNoOfMeas	Maximum number of active measurements, upper limit 16

Condition	Explanation
<i>Setup</i>	The IE is mandatory present when the IE Measurement command has the value "Setup", otherwise the IE is not needed.
<i>Ciphering</i>	The IE is mandatory present when the IE Ciphering Status has the value "started" and the ciphering counters need not be reinitialised, otherwise the IE is not needed.
<i>IP</i>	The IE is mandatory present when the IE Integrity protection status has the value "started" and the integrity protection counters need not be reinitialised, otherwise the IE is not needed.
<i>PDCP</i>	The IE is mandatory present when the PDCP Info IE is present, otherwise the IE is not needed.

14.12.4.3 RRC INFORMATION CONTAINER FAILURE INFO

This RRC information container is sent between network nodes to provide information about the cause for failure to perform the requested operation.

Direction: target RNC→source RNC, source RAT

Information Element/Group Name	Need	Multi	Type and reference	Semantics description
Other Information elements				
Failure cause	MP		Failure cause 10.3.3.13	
Protocol error information	<i>CV-ProtErr</i>		Protocol error information 10.3.8.12	

Condition	Explanation
<i>ProtErr</i>	Presence is mandatory if the IE "Failure cause" has the value "Protocol error"; otherwise the element is not needed in the message.

14.13 RRC information transferred between UE and other systems

14.13.0 General

This subclause specifies RRC information that is exchanged between other systems and the UE. This information is transferred via another RAT in accordance with the specifications applicable for those systems. This subclause specifies the UTRAN RRC information applicable for the different information flows.

NOTE: Currently RRC information containers, using the RRC protocol extension mechanism, are not used for information transferred between UE and another RAT

Like for the Uu interface, the transfer syntax for RRC transferred between UE and other RATs is derived from their ASN.1 definitions by use of Packed Encoding Rules, unaligned (X.691). It should be noted that the encoder adds final padding to achieve octet alignment. The resulting octet string is transferred across the other RAT as defined in the specifications applicable for that RAT.

14.13.1 RRC information, another RAT to UE

14.13.1.1 Void

14.13.2 RRC information, UE to another RAT

14.13.2.1 UE capability information

Upon receiving a UE information request from another system, the UE shall indicate the requested capabilities. The UE capability information includes the following RRC information.

Information Element/Group name	Need	Multi	Type and reference	Semantics description
UE information elements				
UE radio access capability	OP		UE radio access capability 10.3.3.42	
UE radio access capability extension	OP		UE radio access capability extension 10.3.3.42a	

14.13.2.2 UE security information

Upon receiving a UE information request from another system, the UE shall indicate the requested security information. The UE security information includes the following RRC information.

Information Element/Group name	Need	Multi	Type and reference	Semantics description
UE information elements				
START-CS	MP		START 10.3.3.38	START values to be used in this CN domain.

14.13.2.3 Pre-defined configuration status information

Another system may provide the UE with one or more pre-defined UTRAN configurations, comprising of radio bearer, transport channel and physical channel parameters. If requested, the UE shall indicate the configurations it has stored. The pre-defined configuration status information should include the following RRC information.

Information Element/Group name	Need	Multi	Type and reference	Semantics description
RB information elements				
Predefined configurations		maxPredef ConfigCou nt		The list is in order of preconfiguration identity
>Predefined configuration value tag	OP		Predefined configuration value tag 10.3.4.6	The UE shall include the value tag if it has stored the concerned configuration

Multi Bound	Explanation
MaxPredefConfigCount	Maximum number of predefined configurations

14.13.2.4 Void

14.14 Versatile Channel Assignment Mode (VCAM) mapping rule (FDD only)

When Versatile Channel Assignment Method (VCAM) is used in the CPCH procedure, the following mapping rules shall be used to specify one PCPCH.

If the number of PCPCHs is less than or equal to 16, there is a one to one mapping between the CA index and the PCPCH index. Thus a suitable AP signature (and/or AP sub-channel) number is transmitted for the required spreading factor based on the broadcast system information, and the assigned PCPCH index (having the requested spreading factor) corresponds to the received CA index.

When the number of PCPCHs is greater than 16, a combination of an AP signature (and/or AP sub-channel) number and a CA signature number specifies one PCPCH as follows:

In VCAM mapping rule, a combination of an AP signature (and/or AP sub-channel) number and a CA signature number specifies one PCPCH. In a CPCH set, there are K available PCPCHs which are numbered $k=0,1,\dots,K-1$, and there are R available Minimum Spreading Factor A_r , $r=0,1,\dots,R-1$, that a UE can request and use. The maximum available number of PCPCHs and the number of available AP signatures (and/or AP sub-channels) for A_r are denoted as P_{0r} and S_r , respectively, for $r=0,1,\dots,R-1$. Let P_r be equal to 16 if P_{0r} is less than 16 and to P_{0r} otherwise. T_r represents the number of CA signatures for A_r , which are needed for specifying PCPCH. The default value of T_r is 16.

S_r always satisfies $S_r \geq \min\{s : s \in N, s \times T_r \geq P_r\}$, where N is the set of positive integers.

The list of available AP signatures (and/or AP sub-channels) for each A_r is renumbered from signature index 0 to signature index $S_r - 1$, starting with the lowest AP signature (and/or AP sub-channel) number, and continuing in sequence, in the order of increasing signature numbers.

Then for given AP signature (and/or AP sub-channel) number and CA signature number, the number k that signifies the assigned PCPCH is obtained as:

$$k = \{[(i + n) \bmod S_r] + j \times S_r\} \bmod P_r,$$

where i ($i=0,1,\dots,S_r-1$) is the AP signature (and/or AP sub-channel) index for A_r , j ($j=0,1,\dots,\min(P_r,T_r)-1$) is the CA signature number for A_r , and n is a nonnegative integer which satisfies

$$n \times M_r \times S_r \leq i + j \times S_r < (n + 1) \times M_r \times S_r \text{ where } M_r = \min\{m : m \in N, (m \times S_r) \bmod P_r = 0\}.$$

An example of the above mapping rule is shown in [38].

Annex A (informative): USIM parameters

A.1 Introduction

This annex contains recommendations about the RRC parameters to be stored in the USIM.

A.2 Cipherring information

Information Element/Group name	Need	Multi	Type and reference	Semantics description
Cipher key for each CN domain	MP	<1 to maxCNDo mains>		Cipher key is described in [40].
>Old CK	MP		Bit string (128)	
>New CK	MP		Bit string (128)	
Integrity key for each CN domain	MP	<1 to maxCNDo mains>		Integrity key is described in [40].
>Old IK	MP		Bit string (128)	
>New IK	MP		Bit string (128)	
THRESHOLD	MP		Bit string (20)	
START value for each CN domain	MP	<1 to maxCNDo mains>		START value is described in [40].
>Old START	MP		Bit string (20)	
>New START	MP		Bit string (20)	
KSI, Key set identifier for each CN domain	MP	<1 to maxCNDo mains>		Key set identifier is described in [40].
>Old KSI	MP		Bit string (3)	
>New KSI	MP		Bit string (3)	

A.3 Frequency information

Neighbour cell list.

Information Element/Group name	Need	Multi	Type and reference	Semantics description	Version
FDD cell list	OP	<1 to maxFDDFr eqList>			
>UARFCN uplink (Nu)	OP		Integer(0..16383)	[21] If IE not present, default duplex distance of 190 MHz shall be used.	
>UARFCN downlink (Nd)	MP		Integer(0 .. 16383)	[21]	
>Primary scrambling code	OP	<1 to maxFDDFr eqCellList>	Primary CPICH info 10.3.6.60		
3.84 Mcps TDD cell list	OP	<1 to maxTDDFr eqList>			
>UARFCN (Nt)	MP		Integer(0 .. 16383)	[22]	
>Cell parameters ID	OP	<1 to maxTDDFr eqCellList>	Integer (0..127)	The Cell parameters ID is described in [32].	
1.28 Mcps TDD cell list	OP	<1 to maxTDDFr eqList>			REL-4
>UARFCN (Nt)	MP		Integer(0 .. 16383)	[22]	REL-4
>Cell parameters ID	OP	<1 to maxTDDFr eqCellList>	Integer (0..127)	The Cell parameters ID is described in [32].	REL-4
GSM Neighbour cell list	OP				
>GSM neighbour cell info	MP	<1 to maxGSMCellList>			
>>BSIC	MP				
>>BCCH ARFCN	MP				

A.4 Multiplicity values and type constraint values

Constant	Explanation	Value
Ciphering information		
maxCNDomains	Maximum number of CN domains	4
Frequency information		
maxFDDFreqList	Maximum number of FDD carrier frequencies to be stored in USIM	4
maxTDDFreqList	Maximum number of TDD carrier frequencies to be stored in USIM	4
maxFDDFreqCellList	Maximum number of neighbouring FDD cells on one carrier to be stored in USIM	32
maxTDDFreqCellList	Maximum number of neighbouring TDD cells on one carrier to be stored in USIM	32
maxGSMCellList	Maximum number of GSM cells to be stored in USIM	32

Annex B (informative): Description of RRC state transitions

This annex contains Stage 2 description of RRC states and state transitions.

B.1 RRC states and state transitions including GSM

After power on, the UE stays in Idle Mode until it transmits a request to establish an RRC Connection. In Idle Mode the connection of the UE is closed on all layers of the access stratum. In Idle Mode the UE is identified by non-access stratum identities such as IMSI, TMSI and P-TMSI. In addition, the UTRAN has no own information about the individual Idle Mode UEs, and it can only address e.g. all UEs in a cell or all UEs monitoring a paging occasion. The UE behaviour within this mode is described in [4].

The UTRA RRC Connected Mode is entered when the RRC Connection is established. The UE is assigned a radio network temporary identity (RNTI) to be used as UE identity on common transport channels.

The RRC states within UTRA RRC Connected Mode reflect the level of UE connection and which transport channels that can be used by the UE.

For inactive stationary data users the UE may fall back to PCH on both the Cell and URA levels. That is, upon the need for paging, the UTRAN checks the current level of connection of the given UE, and decides whether the paging message is sent within the URA, or should it be sent via a specific cell.

B.2 Transition from Idle Mode to UTRA RRC Connected Mode

The transition to the UTRA RRC Connected Mode from the Idle Mode can only be initiated by the UE by transmitting a request for an RRC Connection. The event is triggered either by a paging request from the network or by a request from upper layers in the UE.

When the UE receives a message from the network that confirms the RRC connection establishment, the UE enters the CELL_FACH or CELL_DCH state of UTRA RRC Connected Mode.

In the case of a failure to establish the RRC Connection the UE goes back to Idle Mode. Possible causes are radio link failure, a received reject response from the network or lack of response from the network (timeout).

B.2.1 Transitions for Emergency Calls

Refer to [4] for all states and procedures referred to in this subclause. When UE leaves idle mode from state *Camped on any cell* in order to make an emergency call, moving to state *Connected mode (emergency calls only)*, the UE shall attempt to access the current serving cell. If the access attempt to the serving cell fails the UE shall use the *Cell Reselection* procedure. If no acceptable cell is found, the UE shall use the *Any cell selection*. When returning to idle mode, the UE shall use the procedure *Cell selection when leaving connected mode* in order to find an acceptable cell to camp on, state *Camped on any cell*.

B.3 UTRA RRC Connected Mode States and Transitions

B.3.1 CELL_DCH state

The CELL_DCH state is characterised by

- A dedicated physical channel is allocated to the UE in uplink and downlink.
- The UE is known on cell level according to its current active set.
- Dedicated transport channels, downlink and uplink (TDD) shared transport channels, and a combination of these transport channels can be used by the UE.

The CELL_DCH-state is entered from the Idle Mode through the setup of an RRC connection, or by establishing a dedicated physical channel from the CELL_FACH state.

A PDSCH may be assigned to the UE in this state, to be used for a DSCH. In TDD a PUSCH may also be assigned to the UE in this state, to be used for a USCH. If PDSCH or PUSCH are used for TDD, a FACH transport channel may be assigned to the UE for reception of physical shared channel allocation messages.

B.3.1.1 Transition from CELL_DCH to Idle Mode

Transition to Idle Mode is realised through the release of the RRC connection.

B.3.1.2 Transition from CELL_DCH to CELL_FACH state

Transition to CELL_FACH state occurs when all dedicated channels have been released, which may be

- a) via explicit signalling (e.g. PHYSICAL CHANNEL RECONFIGURATION, RADIO BEARER RECONFIGURATION, RADIO BEARER RELEASE, RADIO BEARER SETUP, TRANSPORT CHANNEL RECONFIGURATION, etc.).

at the end of the time period for which the dedicated channel was allocated (TDD)

B.3.1.3 Transition from CELL_DCH to CELL_PCH state

Transition to CELL_PCH state occurs via explicit signalling (e.g. PHYSICAL CHANNEL RECONFIGURATION, RADIO BEARER RECONFIGURATION, RADIO BEARER RELEASE, RADIO BEARER SETUP, TRANSPORT CHANNEL RECONFIGURATION, etc.).

B.3.1.4 Transition from CELL_DCH to URA_PCH state

Transition to URA_PCH state occurs via explicit signalling (e.g. PHYSICAL CHANNEL RECONFIGURATION, RADIO BEARER RECONFIGURATION, RADIO BEARER RELEASE, RADIO BEARER SETUP, TRANSPORT CHANNEL RECONFIGURATION, etc.).

B.3.1.5 Radio Resource Allocation tasks (CELL_DCH)

For the DCH, several physical channel allocation strategies may be applied. The allocations can be either permanent (needing a DCH release message) or based on time or amount-of-data.

Resource allocation can be done separately for each packet burst with fast signalling on the DCH

For each radio frame the UE and the network indicate the current data rate (in uplink and downlink respectively) using the transport format combination indicator (TFCI). However, in TDD, DCH and DSCH or USCH may be mapped on different CCTrCHs, their TFCI are totally independent. DCH transmission is not modified by the simultaneous existence of DSCH/USCH. If the configured set of combinations (i.e. transport format set for one transport channel) are found to be insufficient to retain the QoS requirements for a transport channel, the network initiates a reconfiguration of the transport format set (TFS) for that transport channel. This reconfiguration can be done during or in between data transmission. Further, the network can reconfigure the physical channel allowing an increase or decrease of the peak data rate.

For the uplink data transmission, the UE reports the observed traffic volume to the network in order for the network to re-evaluate the current allocation of resources. This report contains e.g. the amount of data to be transmitted or the buffer status in the UE.

B.3.1.6 RRC Connection mobility tasks (CELL_DCH)

Depending on the amount and frequency of data macrodiversity (soft handover) may or may not be applied.

The RRC Connection mobility is handled by measurement reporting, soft handover and Timing re-initialised or Timing-maintained hard handover procedures.

B.3.1.7 UE Measurements (CELL_DCH)

The UE performs measurements and transmit measurement reports according to the measurement control information.

The UE uses the connected mode measurement control information received in other states until new measurement control information has been assigned to the UE.

B.3.1.8 Acquisition of system information (CELL_DCH)

FDD UEs with certain capabilities reads system information broadcast on FACH.

TDD UEs reads the BCH to acquire valid system information. For each acquisition, the UE may need different combinations of system information broadcast on BCH. The scheduling on the broadcast channel is done in such way that the UE knows when the requested information can be found.

B.3.2 CELL_FACH state

The CELL_FACH state is characterised by:

- No dedicated physical channel is allocated to the UE.
- The UE continuously monitors a FACH in the downlink.
- The UE is assigned a default common or shared transport channel in the uplink (e.g. RACH) that it can use anytime according to the access procedure for that transport channel.
- The position of the UE is known by UTRAN on cell level according to the cell where the UE last made a cell update.
- In TDD mode, one or several USCH or DSCH transport channels may have been established.

B.3.2.1 Transition from CELL_FACH to CELL_DCH state

A transition occurs, when a dedicated physical channel is established via explicit signalling (e.g. PHYSICAL CHANNEL RECONFIGURATION, RADIO BEARER RECONFIGURATION, RADIO BEARER RELEASE, RADIO BEARER SETUP, TRANSPORT CHANNEL RECONFIGURATION, etc.).

B.3.2.2 Transition from CELL_FACH to CELL_PCH state

The transition occurs when UTRAN orders the UE to move to CELL_PCH state, which is done via explicit signalling (e.g. CELL UPDATE CONFIRM, RADIO BEARER RECONFIGURATION, etc.).

B.3.2.3 Transition from CELL_FACH to Idle Mode

Upon release of the RRC connection, the UE moves to the idle mode.

B.3.2.4 Transition from CELL_FACH to URA_PCH State

The transition occurs when UTRAN orders the UE to move to URA_PCH state, which is done via explicit signalling (e.g. URA UPDATE CONFIRM, RADIO BEARER RECONFIGURATION, etc.).

B.3.2.5 Radio Resource Allocation Tasks (CELL_FACH)

In the CELL_FACH state the UE will monitor an FACH. It is enabled to transmit uplink control signals and it may be able to transmit small data packets on the RACH.

The network can assign the UE transport channel parameters (e.g. transport format sets) in advance, to be used when a DCH is used. Upon assignment of the physical channel for DCH, the UE moves to CELL_DCH state and uses the pre-assigned TFS for the DCH.

If no UE dedicated physical channel or transport channel configuration has been assigned, the UE uses the common physical channel and transport channel configuration according to the system information.

For the uplink data transmission, the UE reports the observed traffic volume to the network in order for the network to re-evaluate the current allocation of resources. This report contains e.g. the amount of data to be transmitted or the buffer status in the UE.

When there is either user or control data to transmit, a selection procedure determines whether the data should be transmitted on a common transport channel, or if a transition to CELL_DCH should be executed. The selection is dynamic and depends on e.g. traffic parameters (amount of data, packet burst frequency).

In FDD mode, the UTRAN can assign CPCH resources to the UE in CELL_FACH state. When CPCH resources are assigned, the UE will continue to monitor FACHs. When CPCH resources are assigned, the UE will use CPCH for all uplink traffic in accordance with RB mapping.

In FDD mode, UTRAN may configure the UE to provide CPCH measurement reports of traffic volume on each CPCH channel used. With these measures, the UTRAN can reallocate network resources on a periodic basis. The UTRAN allocates CPCH Sets to each cell and assigns UEs to one of the cell's CPCH Sets. The UEs can dynamically access the CPCH resources without further UTRAN control.

In the TDD mode, the UTRAN can assign USCH / DSCH resources to the UE in CELL_FACH state. When USCH / DSCH resources are assigned, the UE will continue to monitor FACHs, depending on the UE capability. The UE may use the USCH / DSCH to transmit signalling messages or user data in the uplink and / or the downlink using USCH and / or DSCH when resources are allocated to cell and UE is assigned use of those USCH / DSCH.

For the uplink data transmission on USCH the UE reports to the network the traffic volume (current size of RLC data buffers). The UTRAN can use these measurement reports to re-evaluate the current allocation of the USCH / DSCH resources.

B.3.2.6 RRC Connection mobility tasks (CELL_FACH)

In this state the location of the UE is known on cell level. A cell update procedure is used to report to the UTRAN, when the UE selects a new cell to observe the common downlink channels of a new cell. Downlink data transmission on the FACH can be started without prior paging.

The UE monitors the broadcast channel and system information on BCCH of its own and neighbour cells and from this the need for the updating of cell location is identified.

The UE performs cell reselection and upon selecting a new UTRA cell, it initiates a cell update procedure. Upon selecting a new cell belonging to another radio access system than UTRA, the UE enters idle mode and makes an access to that system according to its specifications.

B.3.2.7 UE Measurements (CELL_FACH)

The UE performs measurements and transmit measurement reports according to the measurement control information.

By default, the UE uses the measurement control information broadcast within the system information. However, for measurements for which the network also provides measurement control information within a MEASUREMENT CONTROL message, the latter information takes precedence.

B.3.2.8 Transfer and update of system information (CELL_FACH)

The UE reads the BCH to acquire valid system information. For each acquisition, the UE may need different combinations of system information broadcast on BCH. The scheduling on the broadcast channel is done in such way that the UE knows when the requested information can be found.

When the system information is modified, the scheduling information is updated to reflect the changes in system information transmitted on BCH. The new scheduling information is broadcast on FACH in order to inform UEs about the changes. If the changes are applicable for the UE, the modified system information is read on BCH.

B.3.3 CELL_PCH state

The CELL_PCH state is characterised by:

- No dedicated physical channel is allocated to the UE.
- The UE selects a PCH with the algorithm specified in subclause 8.5.19, and uses DRX for monitoring the selected PCH via an associated PICH.
- No uplink activity is possible.
- The position of the UE is known by UTRAN on cell level according to the cell where the UE last made a cell update in CELL_FACH state.

The DCCH logical channel cannot be used in this state. If the network wants to initiate any activity, it needs to make a paging request on the PCCH logical channel in the known cell to initiate any downlink activity.

B.3.3.1 Transition from CELL_PCH to CELL_FACH state

The UE is transferred to CELL_FACH state:

- a) by paging from UTRAN (PAGING TYPE1 message)
- b) through any uplink access

B.3.3.2 Radio Resource Allocation Tasks (CELL_PCH)

In CELL_PCH state no resources have been granted for data transmission. For this purpose, a transition to another state has to be executed.

The UE may use Discontinuous Reception (DRX) in order to reduce power consumption. When DRX is used the UE needs only to receive at one paging occasion per DRX cycle. The UE may be instructed to use a specific DRX cycle length by the network. The UE determines its paging occasions in the same way as for Idle Mode, see [4].

B.3.3.3 RRC Connection mobility tasks (CELL_PCH)

In the CELL_PCH state, the UE mobility is performed through cell reselection procedures, which may differ from the one defined in [4].

The UE performs cell reselection and upon selecting a new UTRA cell, it moves to CELL_FACH state and initiates a cell update procedure in the new cell. After the cell update procedure has been performed, the UE changes its state back to CELL_PCH state if neither the UE nor the network has any more data to transmit.

Upon selecting a new cell belonging to another radio access system than UTRA, the UE enters idle mode and make an access to that system according to its specifications.

In case of low UE activity, UTRAN may want to reduce the cell-updating overhead by ordering the UE to move to the URA_PCH State. This transition is made via the CELL_FACH state. UTRAN may apply an inactivity timer, and optionally, a counter, which counts the number of cell updates e.g. UTRAN orders the UE to move to URA_PCH when the number of cell updates has exceeded certain limits (network parameter).

B.3.3.4 UE Measurements (CELL_PCH)

The UE performs measurements and transmit measurement reports according to the measurement control information.

The UE uses the measurement control information according to the system information when no UE dedicated measurement control information has been assigned.

B.3.3.5 Transfer and update of system information (CELL_PCH)

The UE reads the BCH to acquire valid system information. For each acquisition, the UE may need different combinations of system information broadcast on BCH. The scheduling on the broadcast channel is done in such way that the UE knows when the requested information can be found.

B.3.4 URA_PCH State

The URA_PCH state is characterised by:

- No dedicated channel is allocated to the UE.
- The UE selects a PCH with the algorithm specified in subclause 8.5.19, and uses DRX for monitoring the selected PCH via an associated PICH.
- No uplink activity is possible.
- The location of the UE is known on UTRAN Registration area level according to the URA assigned to the UE during the last URA update in CELL_FACH state.

The DCCH logical channel cannot be used in this state. If the network wants to initiate any activity, it needs to make a paging request on the PCCH logical channel within the URA where the location of the UE is known. If the UE needs to transmit anything to the network, it goes to the CELL_FACH state. The transition to URA_PCH State can be controlled with an inactivity timer, and optionally, with a counter that counts the number of cell updates. When the number of cell updates has exceeded certain limits (a network parameter), then the UE changes to the URA_PCH State.

URA updating is initiated by the UE, which, upon the detection of the Registration area, sends the network the Registration area update information on the RACH of the new cell.

B.3.4.1 Transition from URA_PCH State to CELL_FACH State (URA_PCH)

Any activity causes the UE to be transferred to CELL_FACH State.

- a) Uplink access is performed by RACH.
- b) by paging from UTRAN (PAGING TYPE1 message).

NOTE: The release of an RRC connection is not possible in the URA_PCH State. The UE will first move to CELL_FACH State to perform the release signalling.

B.3.4.2 Radio Resource Allocation Tasks (URA_PCH)

In URA_PCH State no resources have been granted for data transmission. For this purpose, a transition to CELL_FACH State has to be executed.

The UE may use Discontinuous Reception (DRX) in order to reduce power consumption. When DRX is used the UE needs only to receive at one paging occasion per DRX cycle. The UE may be instructed to use a specific DRX cycle length by the network. The UE determines its paging occasions in the same way as for Idle Mode, see [4].

B.3.4.3 RRC Connection mobility tasks (URA_PCH)

In URA_PCH State the location of a UE is known on UTRAN Registration area level.

In this state, the UE mobility is performed through URA reselection procedures, which may differ from the definitions in [4]. The UE performs cell reselection and upon selecting a new UTRA cell belonging to a URA that does not match the URA used by the UE, the UE moves to CELL_FACH state and initiates a URA update towards the network. After the URA update procedure has been performed, the UE changes its state back to URA_PCH state if neither the UE nor the network has any more data to transmit.

Upon selecting a new cell belonging to another radio access system than UTRA, the UE enters idle mode and makes an access to that system according to its specifications (FFS).

B.3.4.4 UE Measurements (URA_PCH)

The UE performs measurements and transmit measurement reports according to the measurement control information.

The UE uses the measurement control information according to the system information when no UE dedicated measurement control information has been assigned.

B.3.4.5 Transfer and update of system information (URA_PCH)

The same mechanisms to transfer and update system information as for state CELL_PCH are applicable for UEs in URA_PCH state.

B.3.5 States and Transitions for Cell Reselection in URA_PCH, CELL_PCH, and CELL_FACH

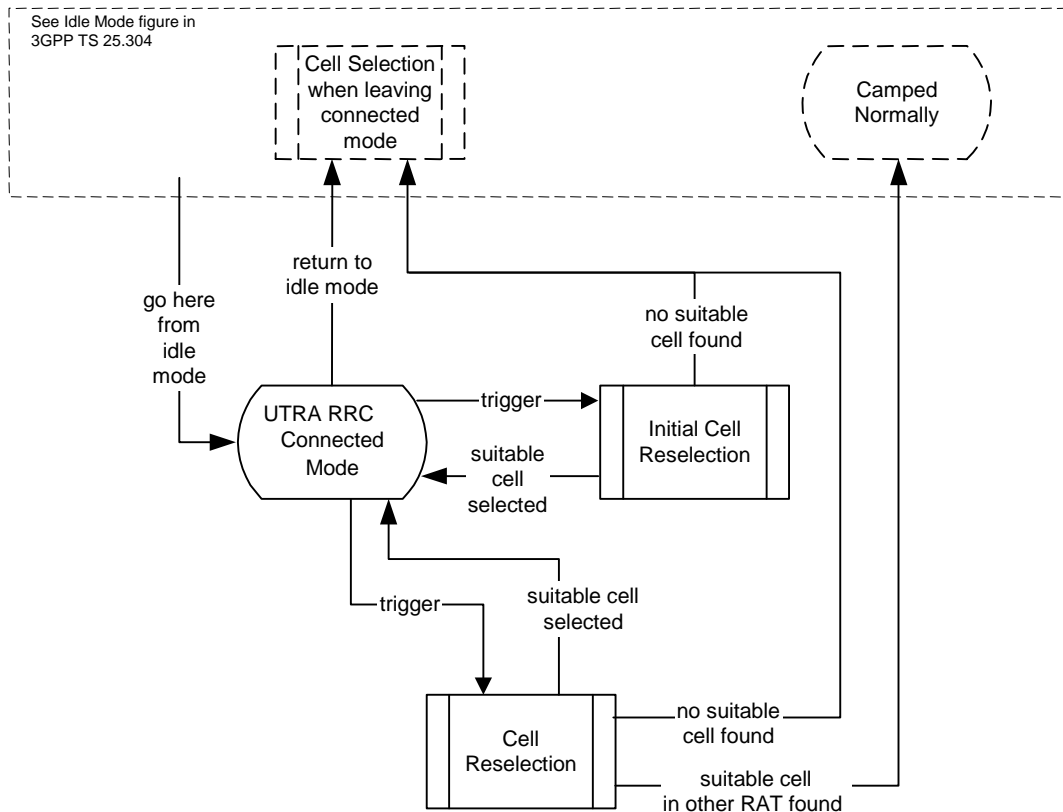

Figure 61: UTRA RRC Connected mode cell reselection for URA_PCH, CELL_PCH, and CELL_FACH

In some states the UE performs cell reselection procedures. The UE selects a suitable cell (defined in [4]) and radio access technology based on connected mode radio measurements and cell reselection criteria.

Figure 61 shows the states and procedures in the cell reselection process in connected mode.

When a cell reselection is triggered, the UE evaluates the cell reselection criteria based on radio measurements, and if a better cell is found that cell is selected, procedure Cell reselection (see [4]). If the change of cell implies a change of radio access technology, the RRC connection is released, and the UE enters idle mode of the other RAT. If no suitable cell is found in the cell reselection procedure, the UE eventually enters idle mode.

When an Initial cell reselection is triggered, the UE shall use the Initial cell reselection procedure (see [4]) to find a suitable cell. One example where this procedure is triggered is at radio link failure, where the UE may trigger an initial cell reselection in order to request re-establishment of the RRC connection. If the UE is unable to find a suitable cell, the UE eventually enters idle mode.

B.4 Inter-RAT handover with CS domain services

When using CS domain services, UTRAN is using an Inter-Radio access system Handover Procedure and GSM is using a Handover procedure for the transition from UTRA RRC Connected Mode to GSM Connected Mode.

B.5 Inter-RAT handover with PS domain services

When using PS domain services, the UE initiates cell reselection from a GSM/GPRS cell to a UTRAN cell and then uses the RRC Connection Establishment procedure for the transition to UTRA RRC Connected mode.

When the RRC Connection is established from Idle Mode (GPRS Packet Idle Mode) the RRC CONNECTION REQUEST message contains an indication, that UTRAN needs to continue an already established GPRS UE context from the CN. This indication allows UTRAN to e.g. prioritise the RRC CONNECTION REQUEST from the UE.

In UTRA RRC connected mode UTRAN is using UE or network initiated cell reselection to change from a UTRAN cell to a GSM/GPRS cell. If the cell reselection was successful the UE enters Idle Mode (GPRS Packet Idle Mode). The UE sends a packet channel request from Idle Mode (GPRS Packet Idle mode) to establish a Temporary Block flow and enter GPRS Packet Transfer Mode. In the GPRS Packet Transfer Mode the UE sends a RA Update request message. The RA Update Request message sent from the UE contains an indication that GSM/GPRS need to continue an already established UTRAN UE context from the CN. This means that the RA Update request is always sent for the transition from UTRA RRC Connected Mode to GSM/GPRS regardless if the RA is changed or not.

NOTE: The reason for using RA update instead of a new message is to reduce the impact on the existing GSM/GPRS specification.

B.6 Inter-RAT handover with simultaneous PS and CS domain services

NOTE: This is an initial assumption that needs to be seen by TSG-GERAN and requires checking by TSG-GERAN, when the work on this item has progressed.

B.6.1 Inter-RAT handover UTRAN to GSM / BSS

For a UE in CELL_DCH state using both CS and PS Domain services the Inter-RAT handover procedure is based on measurement reports from the UE but initiated from UTRAN.

The UE performs the Inter-RAT handover from UTRA RRC Connected Mode to GSM Connected Mode first. When the UE has sent handover complete message to GSM / BSS the UE initiates a temporary block flow towards GPRS and sends a RA update request.

If the Inter-RAT handover from UTRA RRC Connected Mode to GSM Connected Mode was successful the handover is considered as successful regardless if the UE was able to establish a temporary block flow or not towards GPRS.

In case of Inter-RAT handover failure the UE has the possibility to go back to UTRA RRC Connected Mode and re-establish the connection in the state it originated from without attempting to establish a temporary block flow. If the UE has the option to try to establish a temporary block flow towards GSM / GPRS after Inter-RAT handover failure is FFS.

B.6.2 Inter-RAT handover GSM / BSS to UTRAN

For a UE in GSM Connected Mode using both CS and PS domain services the Inter-RAT handover procedure is based on measurement reports from the UE but initiated from GSM / BSS.

The UE performs the Inter-RAT handover from GSM Connected Mode to UTRA RRC Connected Mode.

In UTRA RRC Connected Mode both services are established in parallel.

If the Inter-RAT handover from GSM Connected mode to UTRA RRC Connected Mode was successful the handover is considered as successful.

In case of Inter-RAT handover failure the UE has the possibility to go back to GSM Connected Mode and re-establish the connection in the state it originated from.

Annex C (informative): Change history

Change history							
Date	TSG #	TSG Doc.	CR	Rev	Subject/Comment	Old	New
10/1999	RP-05	RP-99524	-		Approved at TSG-RAN #5 and placed under Change Control	-	3.0.0
12/1999	RP-06	RP-99650	001		Modification of RRC procedure specifications	3.0.0	3.1.0
	RP-06	RP-99654	005	1	Introduction of Information Element for Power Control Algorithm	3.0.0	3.1.0
	RP-06	RP-99654	007	1	RRC parameters for SS DT	3.0.0	3.1.0
	RP-06	RP-99656	009	1	Inclusion of information elements for integrity protection	3.0.0	3.1.0
	RP-06	RP-99656	010	2	Security mode control procedure	3.0.0	3.1.0
	RP-06	RP-99656	011	3	Updates of the system information procedure	3.0.0	3.1.0
	RP-06	RP-99656	012	2	Inter-frequency measurements and reporting	3.0.0	3.1.0
	RP-06	RP-99656	013	1	Inter-system measurements and reporting	3.0.0	3.1.0
	RP-06	RP-99656	014	1	Additional measurements in RRC measurement messages	3.0.0	3.1.0
	RP-06	RP-99656	015	3	Value range for Measurement Information Elements	3.0.0	3.1.0
	RP-06	RP-99656	016	2	Message contents for inter system handover to UTRAN	3.0.0	3.1.0
	RP-06	RP-99652	017		Inclusion of ciphering information elements	3.0.0	3.1.0
	RP-06	RP-99651	018		Corrections and editorial changes	3.0.0	3.1.0
	RP-06	RP-99654	019	1	Algorithm for CTCF Calculation	3.0.0	3.1.0
	RP-06	RP-99651	025		Logical CH for RRC Connection Re-establishment (RRC Connection Re-establishment deleted in RAN_10, RP-000715)	3.0.0	3.1.0
	RP-06	RP-99719	026	1	Gain Factors	3.0.0	3.1.0
	RP-06	RP-99654	027	1	Parameters for CELL UPDATE CONFIRM message	3.0.0	3.1.0
	RP-06	RP-99651	028		Cell Update Cause	3.0.0	3.1.0
	RP-06	RP-99654	029	1	RRC Initialisation Information	3.0.0	3.1.0
	RP-06	RP-99656	034	1	Open loop power control for PRACH	3.0.0	3.1.0
	RP-06	RP-99652	038		Addition of the UE controlled AMR mode adaptation	3.0.0	3.1.0
	RP-06	RP-99651	039		Information elements for RLC reset	3.0.0	3.1.0
	RP-06	RP-99656	040		Support for DS-41 Initial UE Identity	3.0.0	3.1.0
	RP-06	RP-99656	042	2	Integration of Cell Broadcast Service (CBS)	3.0.0	3.1.0
	RP-06	RP-99654	044	1	Gated transmission of DPCH	3.0.0	3.1.0
	RP-06	RP-99656	045		Modification to the Transport Format Combination Control message	3.0.0	3.1.0
	RP-06	RP-99656	046		New Information elements and modifications to messages required in order to support configuration and re-configuration of the DSCH in FDD mode	3.0.0	3.1.0
	RP-06	RP-99654	047	1	Editorial Corrections and Alignments with Layer 1 specifications	3.0.0	3.1.0
	RP-06	RP-99654	048	1	Information elements for TDD shared channel operation	3.0.0	3.1.0
	RP-06	RP-99656	049		Description of CN dependent IEs in Master Information Block	3.0.0	3.1.0
	RP-06	RP-99650	050		UE capability information elements	3.0.0	3.1.0
	RP-06	RP-99656	051	1	UTRAN response time to uplink feedback commands of TX diversity control	3.0.0	3.1.0
	RP-06	RP-99654	052		New and corrected CPCH parameters	3.0.0	3.1.0
	RP-06	RP-99654	053	2	Compressed mode parameters without gating	3.0.0	3.1.0
	RP-06	RP-99654	054		Transport format combination set and transport format combination subset	3.0.0	3.1.0
	RP-06	RP-99656	055	1	Information elements for cell selection and reselection	3.0.0	3.1.0
	RP-06	RP-99654	056		Corrections and Alignments of the RRC to the L1 for TDD	3.0.0	3.1.0
	RP-06	RP-99656	057	1	Introduction of a SCCH procedure	3.0.0	3.1.0
	RP-06	RP-99656	061		Support for DS-41 Paging UE Identity	3.0.0	3.1.0
	RP-06	RP-99656	062	2	Support for cdma2000 Hard Handover	3.0.0	3.1.0
	RP-06	RP-99656	063	1	Provide necessary signalling to support FDD DSCH	3.0.0	3.1.0
	RP-06	RP-99654	064		RRC procedure interactions	3.0.0	3.1.0
	RP-06	RP-99654	066	1	Transfer of UE capabilities	3.0.0	3.1.0
	RP-06	RP-99654	067		Selection of initial UE identity	3.0.0	3.1.0
	RP-06	RP-99657	069		UE capability verification in the security mode control procedure	3.0.0	3.1.0
	RP-06	RP-99657	070	1	DPCH initial power	3.0.0	3.1.0
	RP-06	RP-99657	071		Actions when entering idle mode	3.0.0	3.1.0

Change history							
Date	TSG #	TSG Doc.	CR	Rev	Subject/Comment	Old	New
	RP-06	RP-99657	072		Specification of inter-frequency and inter-system reporting events for FDD	3.0.0	3.1.0
	RP-06	RP-99657	073	1	Signalling radio bearers	3.0.0	3.1.0
	RP-06	RP-99654	074		CN information elements	3.0.0	3.1.0
	RP-06	RP-99654	076		UE information elements	3.0.0	3.1.0
	RP-06	RP-99657	077	1	Radio bearer, transport channel and physical channel information elements	3.0.0	3.1.0
	RP-06	RP-99654	078		Other information elements	3.0.0	3.1.0
	RP-06	RP-99657	079	2	RRC signalling for PDCP	3.0.0	3.1.0
	RP-06	RP-99654	080		Content of Measurement Control Messages	3.0.0	3.1.0
	RP-06	RP-99654	081		RRC Information Elements to support Block STTD transmission diversity in TDD	3.0.0	3.1.0
	RP-06	RP-99657	082	1	Signalling connection release	3.0.0	3.1.0
	RP-06	RP-99657	083	1	Addition of cell access restriction information elements to System Information	3.0.0	3.1.0
	RP-06	RP-99655	085	1	RRC Connection Establishment parameters	3.0.0	3.1.0
	RP-06	RP-99657	092	1	Support of UE autonomous update of a active set on a non-used frequency	3.0.0	3.1.0
	RP-06	RP-99657	095	1	TPC combining for power control	3.0.0	3.1.0
	RP-06	RP-99653	096	1	Editorial Modification of IEs in RRC messages	3.0.0	3.1.0
	RP-06	RP-99655	097		Selection of SCCPCH	3.0.0	3.1.0
	RP-06	RP-99655	098	1	RRC Initialisation Information	3.0.0	3.1.0
	RP-06	RP-99657	100	1	Support of physical channel establishment and failure criteria in the UE	3.0.0	3.1.0
	RP-06	RP-99655	102	1	RRC Connection Re-establishment (Message deleted in RAN_10, RP-000715)	3.0.0	3.1.0
	RP-06	RP-99657	106	1	System information on FACH	3.0.0	3.1.0
	RP-06	RP-99657	108	1	SAPs and Primitives for DS-41 mode	3.0.0	3.1.0
	RP-06	RP-99655	109	1	TX Diversity Mode for Dedicated Channel	3.0.0	3.1.0
	RP-06	RP-99657	110	1	RACH message length signalling on System Information	3.0.0	3.1.0
	RP-06	RP-99657	113	1	Routing of NAS messages in UTRAN	3.0.0	3.1.0
	RP-06	RP-99655	116	3	TBS Identification in TFS	3.0.0	3.1.0
	RP-06	RP-99657	117	1	Merging the hard handover and some radio bearer control procedures	3.0.0	3.1.0
	RP-06	RP-99653	120	1	Selected RRC message transfer syntax	3.0.0	3.1.0
	RP-06	RP-99657	121		Efficient rate command signalling	3.0.0	3.1.0
03/2000	RP-07	RP-000043	122		TDD Mode BCH Reception in Cell DCH State	3.1.0	3.2.0
	RP-07	RP-000043	123		Uplink Outer Loop Power Control in TDD Mode	3.1.0	3.2.0
	RP-07	RP-000043	124	1	TFS TB Size Calculation with Bit Aligned TDD MAC Headers	3.1.0	3.2.0
	RP-07	RP-000043	125		Grouping of DRAC IEs, and detailed definitions of these IEs	3.1.0	3.2.0
	RP-07	RP-000043	126		Correction of specifications for the 'Dynamic Resource Allocation Control of Uplink DCH' Procedure	3.1.0	3.2.0
	RP-07	RP-000043	131	2	Clarification of PDCP info and PDCP capability IEs	3.1.0	3.2.0
	RP-07	RP-000043	132		Editorial change to "Specification of system information block characteristics"	3.1.0	3.2.0
	RP-07	RP-000043	133		Additions of CBS related Information Elements	3.1.0	3.2.0
	RP-07	RP-000043	134		Signalling for computed gain factors	3.1.0	3.2.0
	RP-07	RP-000043	137	1	General error handling procedures	3.1.0	3.2.0
	RP-07	RP-000043	138	1	RRC message extensions	3.1.0	3.2.0
	RP-07	RP-000043	139		Padding of RRC messages using RLC transparent mode	3.1.0	3.2.0
	RP-07	RP-000043	140	2	UE information elements	3.1.0	3.2.0
	RP-07	RP-000043	141		Other information elements	3.1.0	3.2.0
	RP-07	RP-000043	142	3	Integrity protection function	3.1.0	3.2.0
	RP-07	RP-000043	143	4	RAB-RB relations	3.1.0	3.2.0
	RP-07	RP-000043	144	1	Inter-system handover from UTRAN	3.1.0	3.2.0
	RP-07	RP-000043	145	3	Handover to UTRAN including procedure for pre- configuration	3.1.0	3.2.0
	RP-07	RP-000043	146	2	RRC measurement filtering parameters	3.1.0	3.2.0
	RP-07	RP-000043	147		New event "RL out of UE Rx window"	3.1.0	3.2.0
	RP-07	RP-000044	148	1	Access control on RACH	3.1.0	3.2.0
	RP-07	RP-000044	149	2	cdma2000 Hard Handover	3.1.0	3.2.0
	RP-07	RP-000044	150	1	CPCH parameters with corrections	3.1.0	3.2.0

Change history							
Date	TSG #	TSG Doc.	CR	Rev	Subject/Comment	Old	New
	RP-07	RP-000044	152		U-plane AM RLC reconfiguration by cell update procedure	3.1.0	3.2.0
	RP-07	RP-000044	154	3	CPCCH	3.1.0	3.2.0
	RP-07	RP-000044	155	1	Information elements for ASC in TDD	3.1.0	3.2.0
	RP-07	RP-000044	156		Addition of timing advance value in handover related messages	3.1.0	3.2.0
	RP-07	RP-000044	157	2	Physical channel description for TDD	3.1.0	3.2.0
	RP-07	RP-000044	159		Message contents for the intersystem command message to UTRAN operating in TDD mode	3.1.0	3.2.0
	RP-07	RP-000044	160		Corrections on use of PUSCH power control info and minor corrections	3.1.0	3.2.0
	RP-07	RP-000044	162	2	UE individual DRX cycles in CELL_PCH and URA_PCH states	3.1.0	3.2.0
	RP-07	RP-000044	163		Correction to Transport Format Combination Control procedure	3.1.0	3.2.0
	RP-07	RP-000044	164	3	Downlink outer loop power control	3.1.0	3.2.0
	RP-07	RP-000044	165	2	Redirection of RRC connection setup	3.1.0	3.2.0
	RP-07	RP-000044	166	2	Inter-frequency measurements in CELL_FACH state	3.1.0	3.2.0
	RP-07	RP-000044	167		List of found editorial mistakes in the Dec99 version of 25.331 (V3.1.0)	3.1.0	3.2.0
	RP-07	RP-000044	168	1	Transport block size	3.1.0	3.2.0
	RP-07	RP-000044	169	1	Cell Access Restriction	3.1.0	3.2.0
	RP-07	RP-000044	170		Editorial modification	3.1.0	3.2.0
	RP-07	RP-000044	171		Modification of DPCH info	3.1.0	3.2.0
	RP-07	RP-000045	172	1	Measurement control message	3.1.0	3.2.0
	RP-07	RP-000045	173	2	Reporting cell status	3.1.0	3.2.0
	RP-07	RP-000045	174		Additional IE for RB release	3.1.0	3.2.0
	RP-07	RP-000045	175		Available SF in PRACH info	3.1.0	3.2.0
	RP-07	RP-000045	176		Traffic volume measurement event	3.1.0	3.2.0
	RP-07	RP-000045	177		Report of multiple cells on an event result	3.1.0	3.2.0
	RP-07	RP-000045	178		Editorial modification on Direct Transfer	3.1.0	3.2.0
	RP-07	RP-000045	179		Correction of the Security Mode Control procedure	3.1.0	3.2.0
	RP-07	RP-000045	180	1	Maximum calculated Transport Format Combination	3.1.0	3.2.0
	RP-07	RP-000045	183		Additional DPCH IEs to align 25.331 with 25.214	3.1.0	3.2.0
	RP-07	RP-000045	184	1	RB – DCH mapping	3.1.0	3.2.0
	RP-07	RP-000045	188	1	Modifications related to FDD mode DSCH	3.1.0	3.2.0
	RP-07	RP-000045	189	1	Identification of Shared Channel Physical Configuration in TDD Mode	3.1.0	3.2.0
	RP-07	RP-000045	192	1	Uplink Outer Loop Power Control During Hard Handover	3.1.0	3.2.0
	RP-07	RP-000045	193		Support of Multiple CCTrCH's in TDD Mode	3.1.0	3.2.0
	RP-07	RP-000045	194	1	Uplink Physical Channel Control in TDD Mode	3.1.0	3.2.0
	RP-07	RP-000045	201	1	Transfer of initial information from UE to target RNC prior to handover to UTRAN	3.1.0	3.2.0
	RP-07	RP-000045	202	1	CN information elements	3.1.0	3.2.0
	RP-07	RP-000045	203		UTRAN mobility information elements	3.1.0	3.2.0
	RP-07	RP-000045	204	1	RB information elements	3.1.0	3.2.0
	RP-07	RP-000046	205	1	Physical channel information elements	3.1.0	3.2.0
	RP-07	RP-000046	206	1	UE capability information elements	3.1.0	3.2.0
	RP-07	RP-000046	207		UE variables	3.1.0	3.2.0
	RP-07	RP-000046	208	1	Actions when entering idle mode	3.1.0	3.2.0
	RP-07	RP-000046	209		Usage of pilot bits	3.1.0	3.2.0
	RP-07	RP-000046	210		System information procedure corrections	3.1.0	3.2.0
	RP-07	RP-000046	212		Reconfiguration of ciphering	3.1.0	3.2.0
	RP-07	RP-000046	213	1	Enhancements to RRC connection re-establishment procedure (Message subsequently deleted in RAN !), RP-000715)	3.1.0	3.2.0
	RP-07	RP-000046	215		Updates to RRC Initialisation Information transparent container and addition of reverse direction container description	3.1.0	3.2.0
	RP-07	RP-000046	220	1	Changes in RRC messages to support lossless SRNC relocation	3.1.0	3.2.0
	RP-07	RP-000046	229	1	Measurements of unlisted neighbouring cells	3.1.0	3.2.0
	RP-07	RP-000046	234	2	Inclusion of Location Services	3.1.0	3.2.0
	RP-07	RP-000046	236	1	Application of Access Service Classes and relation to Access Classes	3.1.0	3.2.0
	RP-07	RP-000046	252	1	DRX indicator presence and state entering mechanism at the end of a procedure	3.1.0	3.2.0

Change history							
Date	TSG #	TSG Doc.	CR	Rev	Subject/Comment	Old	New
	RP-07	RP-000046	254	1	Physical shared channel allocation procedure	3.1.0	3.2.0
	RP-07	RP-000046	255		Corrections to TDD specific parameters in PICH info	3.1.0	3.2.0
	RP-07	RP-000046	256		Editorial modifications	3.1.0	3.2.0
	RP-07	RP-000046	259	2	Introduction of mapping function information in Cell selection and	3.1.0	3.2.0
	RP-07	RP-000046	263		Ciphering and integrity HFN	3.1.0	3.2.0
	RP-07	RP-000046	267		New SIB for UP	3.1.0	3.2.0
	RP-07	RP-000047	268		Removal of synchronization Case 3	3.1.0	3.2.0
	RP-07	RP-000047	271		TX Diversity	3.1.0	3.2.0
	RP-07	RP-000047	272		Update of tabular format clause 10	3.1.0	3.2.0
	RP-07	RP-000047	273		ASN.1 description	3.1.0	3.2.0
06/2000	RP-08	RP-000222	228	5	Downlink power control in compressed mode	3.2.0	3.3.0
	RP-08	RP-000222	260	1	Clarification on physical channel allocations in TDD	3.2.0	3.3.0
	RP-08	RP-000222	261	4	TDD Measurements and Reporting	3.2.0	3.3.0
	RP-08	RP-000222	262	4	Signalling of IEs related to System Information on FACH	3.2.0	3.3.0
	RP-08	RP-000222	265	3	Transport Format Combination Control	3.2.0	3.3.0
	RP-08	RP-000222	269	1	Signalling of partial failure in radio bearer related procedures	3.2.0	3.3.0
	RP-08	RP-000222	275		Clarification on PDCP info	3.2.0	3.3.0
	RP-08	RP-000222	279		Editorial modification on Transport Ch capability	3.2.0	3.3.0
	RP-08	RP-000222	280		Editorial modification on CN IE	3.2.0	3.3.0
	RP-08	RP-000222	281	3	Editorial modification on Physical CH IE	3.2.0	3.3.0
	RP-08	RP-000222	282	1	Editorial modification on ASN.1 description	3.2.0	3.3.0
	RP-08	RP-000222	283	1	IEs on SIB5/6	3.2.0	3.3.0
	RP-08	RP-000222	285	2	Re-establishment timer	3.2.0	3.3.0
	RP-08	RP-000222	286	1	CN DRX cycle coefficient	3.2.0	3.3.0
	RP-08	RP-000222	287	1	Cell Access Restriction	3.2.0	3.3.0
	RP-08	RP-000222	288	1	Cell selection and re-selection parameters	3.2.0	3.3.0
	RP-08	RP-000222	289	2	Modification on Measurement IE	3.2.0	3.3.0
	RP-08	RP-000222	291	1	RACH Transmission parameters	3.2.0	3.3.0
	RP-08	RP-000222	292	1	SCCPCH System Info	3.2.0	3.3.0
	RP-08	RP-000222	293	1	Addition of HFN for RRC CONNECTION RE-ESTABLISHMENT COMPLETE	3.2.0	3.3.0
	RP-08	RP-000223	294	1	RLC reconfiguration indicator	3.2.0	3.3.0
	RP-08	RP-000223	296	3	RLC Info	3.2.0	3.3.0
	RP-08	RP-000223	297	1	Usage of Transport CH ID	3.2.0	3.3.0
	RP-08	RP-000223	298	2	Transport format combination set	3.2.0	3.3.0
	RP-08	RP-000223	300	1	Usage of U-RNTI and C-RNTI in DL DCCH message	3.2.0	3.3.0
	RP-08	RP-000223	301		Description of Cell Update Procedure	3.2.0	3.3.0
	RP-08	RP-000223	304	1	System information modification procedure	3.2.0	3.3.0
	RP-08	RP-000223	305		Functional descriptions of the RRC messages	3.2.0	3.3.0
	RP-08	RP-000223	306		Clarification of CTFC calculation	3.2.0	3.3.0
	RP-08	RP-000223	307	3	Compressed mode parameters	3.2.0	3.3.0
	RP-08	RP-000223	309	2	Signalling procedure for periodic local authentication	3.2.0	3.3.0
	RP-08	RP-000223	310	5	Editorial corrections on security	3.2.0	3.3.0
	RP-08	RP-000223	311	2	Security capability	3.2.0	3.3.0
	RP-08	RP-000223	312	1	Corrections on ASN.1 definitions	3.2.0	3.3.0
	RP-08	RP-000223	313	2	DRX cycle lower limit	3.2.0	3.3.0
	RP-08	RP-000223	314	1	Removal of CPICH SIR measurement quantity	3.2.0	3.3.0
	RP-08	RP-000223	315	1	Signalling connection release request	3.2.0	3.3.0
	RP-08	RP-000223	318	1	Change to IMEI coding from BCD to hexadecimal	3.2.0	3.3.0
	RP-08	RP-000223	319	1	Removal of RLC sequence numbers from RRC initialisation information	3.2.0	3.3.0
	RP-08	RP-000223	320	3	Addition of the length of PDCP sequence numbers into PDCP info	3.2.0	3.3.0
	RP-08	RP-000224	323	1	BSIC verification of GSM cells	3.2.0	3.3.0
	RP-08	RP-000224	324		Reporting cell status	3.2.0	3.3.0
	RP-08	RP-000224	325		RRC measurement filtering parameters	3.2.0	3.3.0
	RP-08	RP-000224	326		Cell-reselection parameter signalling	3.2.0	3.3.0
	RP-08	RP-000224	328	3	Multiplicity values	3.2.0	3.3.0

Change history							
Date	TSG #	TSG Doc.	CR	Rev	Subject/Comment	Old	New
	RP-08	RP-000224	329		Quality measurements	3.2.0	3.3.0
	RP-08	RP-000224	330	4	CPCH Status Indication mode correction	3.2.0	3.3.0
	RP-08	RP-000224	331	4	End of CPCH transmission	3.2.0	3.3.0
	RP-08	RP-000224	332		Handover to UTRAN procedure	3.2.0	3.3.0
	RP-08	RP-000224	333		Harmonization of access service classes in FDD and TDD	3.2.0	3.3.0
	RP-08	RP-000224	334	1	Correction to usage of primary CCPCH info and primary CPICH info	3.2.0	3.3.0
	RP-08	RP-000224	335		Corrections and clarifications on system information handling	3.2.0	3.3.0
	RP-08	RP-000224	336		Editorial corrections	3.2.0	3.3.0
	RP-08	RP-000224	337	1	Editorial corrections on uplink timing advance	3.2.0	3.3.0
	RP-08	RP-000224	339		Correction of Transport Format Combination tabular format and ASN.1	3.2.0	3.3.0
	RP-08	RP-000224	340	1	UE variables	3.2.0	3.3.0
	RP-08	RP-000224	342	1	General error handling	3.2.0	3.3.0
	RP-08	RP-000224	344	1	System Information extensibility in ASN.1 definitions	3.2.0	3.3.0
	RP-08	RP-000224	345		Usage of pilot bits	3.2.0	3.3.0
	RP-08	RP-000224	346	3	RRC connection release procedure	3.2.0	3.3.0
	RP-08	RP-000225	347	1	Alignment of Section 10.3 on methodology defined in 25.921	3.2.0	3.3.0
	RP-08	RP-000225	348		Modifications of cell (re)selection parameters	3.2.0	3.3.0
	RP-08	RP-000225	350	1	GPS time-of-week represented as seconds and fractions of seconds	3.2.0	3.3.0
	RP-08	RP-000225	351	2	CPCH corrections	3.2.0	3.3.0
	RP-08	RP-000225	352		PLMN type selection	3.2.0	3.3.0
	RP-08	RP-000225	353	3	Paging and establishment cause values	3.2.0	3.3.0
	RP-08	RP-000225	354		Common channel configurations	3.2.0	3.3.0
	RP-08	RP-000225	355	2	Clarification of prioritization of logical channels in UE	3.2.0	3.3.0
	RP-08	RP-000225	357	2	UE capability corrections	3.2.0	3.3.0
	RP-08	RP-000225	358	2	Clarification of HFN	3.2.0	3.3.0
	RP-08	RP-000225	359	3	Clarification of Integrity Protection	3.2.0	3.3.0
	RP-08	RP-000225	360	1	RRC message size optimization regarding TrCH parameters	3.2.0	3.3.0
	RP-08	RP-000225	361		Protocol extensions in ASN	3.2.0	3.3.0
	RP-08	RP-000225	362	1	Downloading of pre- defined configurations via SIB 16	3.2.0	3.3.0
	RP-08	RP-000225	363	1	Optimization of System Information	3.2.0	3.3.0
	RP-08	RP-000225	364	1	CPCH gain factor	3.2.0	3.3.0
	RP-08	RP-000225	368	2	SFN Transmission Rate in TDD Mode	3.2.0	3.3.0
	RP-08	RP-000225	371	1	Integrity Control	3.2.0	3.3.0
	RP-08	RP-000225	372		Modification to measurement event evaluation	3.2.0	3.3.0
	RP-08	RP-000225	373		System Information related parameters	3.2.0	3.3.0
	RP-08	RP-000226	375	1	Changes in RB mapping info	3.2.0	3.3.0
	RP-08	RP-000226	377		Editorial corrections to PRACH system information and Cell info	3.2.0	3.3.0
	RP-08	RP-000226	378		Editorial Corrections to 25.331 Procedures and Tabular Format	3.2.0	3.3.0
	RP-08	RP-000226	379	1	Corrections to figures and procedures for the failure cases	3.2.0	3.3.0
	RP-08	RP-000226	380		Corrections on use of ORDERED_CONFIG	3.2.0	3.3.0
	RP-08	RP-000226	382	1	Corrections to Transport Channel and RB Reconfiguration procedures	3.2.0	3.3.0
	RP-08	RP-000226	383	1	Corrections to INITIAL DIRECT TRANSFER and UE CAPABILITY INFORMATION CONFIRM procedures	3.2.0	3.3.0
	RP-08	RP-000226	384		Corrections to Transparent mode signalling info Tabular format and ASN.1	3.2.0	3.3.0
	RP-08	RP-000226	385		Corrections to Soft Handover messages and procedures	3.2.0	3.3.0
	RP-08	RP-000226	387		Corrections to RRC CONNECTION REJECT procedures	3.2.0	3.3.0
	RP-08	RP-000226	388	1	Transport format combination in TDD and Transport channel ID	3.2.0	3.3.0
	RP-08	RP-000226	389	1	Signalling for dynamic TTI in TDD	3.2.0	3.3.0
	RP-08	RP-000226	390	1	Usage of DCCH for Shared Channel Allocation message	3.2.0	3.3.0
	RP-08	RP-000226	391	1	Correction to physical channel IEs in TDD	3.2.0	3.3.0
	RP-08	RP-000226	392	1	TDD preconfiguration for Handover to UTRAN	3.2.0	3.3.0
	RP-08	RP-000226	393		Corrections to measurement control descriptions and messages	3.2.0	3.3.0
	RP-08	RP-000226	394	1	Corrections on ASN.1 definitions	3.2.0	3.3.0
	RP-08	RP-000226	395		Addition of the Segmentation indication field for transparent mode	3.2.0	3.3.0

Change history							
Date	TSG #	TSG Doc.	CR	Rev	Subject/Comment	Old	New
					RLC in the RLC Info		
	RP-08	RP-000226	396	1	Radio Bearer identity for CCCH	3.2.0	3.3.0
	RP-08	RP-000226	397	1	ASN.1 definitions for RRC information between network nodes	3.2.0	3.3.0
	RP-08	RP-000227	398	1	NAS Routing	3.2.0	3.3.0
	RP-08	RP-000227	399		DPCCH power control preamble	3.2.0	3.3.0
	RP-08	RP-000227	400	2	Modifications of Assisted GPS Messages	3.2.0	3.3.0
	RP-08	RP-000227	401		Choice of Initial UE Identity	3.2.0	3.3.0
	RP-08	RP-000227	402		ANSI-41 information elements	3.2.0	3.3.0
	RP-08	RP-000227	404	1	RLC value ranges	3.2.0	3.3.0
	RP-08	RP-000227	408	1	HFN Reset	3.2.0	3.3.0
	RP-08	RP-000227	409	1	Clarification on ciphering parameters and integrity protection procedure in case of SRNS relocation	3.2.0	3.3.0
	RP-08	RP-000227	410	1	Clarification of compressed mode activation and configuration failure	3.2.0	3.3.0
	RP-08	RP-000227	412	1	Modification of the RLC Size IE	3.2.0	3.3.0
	RP-08	RP-000227	414		CPCH DL Power control	3.2.0	3.3.0
	RP-08	RP-000227	415	1	SFN measurements in TDD	3.2.0	3.3.0
09/2000	RP-09	RP-000361	356	3	Clarification on multiplicity of PCH and PICH and S-CCPCH selection	3.3.0	3.4.0
	RP-09	RP-000361	403	3	Parameters to be stored in the USIM	3.3.0	3.4.0
	RP-09	RP-000361	413	3	Optimization of Inter-system handover message	3.3.0	3.4.0
	RP-09	RP-000361	416	2	Timing Advance in Handover Procedures	3.3.0	3.4.0
	RP-09	RP-000361	417	2	Synchronization of Timing Advance and Timing Deviation Measurement	3.3.0	3.4.0
	RP-09	RP-000361	418		Downlink Physical Channels Per Timeslot	3.3.0	3.4.0
	RP-09	RP-000361	419		TDD Mode DCH Reception in Cell DCH State	3.3.0	3.4.0
	RP-09	RP-000361	420	2	Downlink Power Control During DTX in TDD Mode	3.3.0	3.4.0
	RP-09	RP-000361	421	1	Paging Indicator Length Definition	3.3.0	3.4.0
	RP-09	RP-000361	422		Updating & alignment of RRC containers & handover to UTRAN information transfer	3.3.0	3.4.0
	RP-09	RP-000361	424		Default values for UE timers and counters	3.3.0	3.4.0
	RP-09	RP-000361	425	1	Security mode control	3.3.0	3.4.0
	RP-09	RP-000361	426	1	Corrections and Editorial updates to chapter 8	3.3.0	3.4.0
	RP-09	RP-000361	427		Corrections and editorial updates to chapter 10	3.3.0	3.4.0
	RP-09	RP-000361	428		Transition from CELL_DCH to CELL_PCH and URA_PCH state	3.3.0	3.4.0
	RP-09	RP-000361	430		Assisted GPS Messaging and Procedures	3.3.0	3.4.0
	RP-09	RP-000361	431	2	Corrections to Activation Time use	3.3.0	3.4.0
	RP-09	RP-000361	432		Editorial Corrections to measurement reporting range	3.3.0	3.4.0
	RP-09	RP-000361	434	4	Default DPCH offset value and DPCH offset	3.3.0	3.4.0
	RP-09	RP-000361	435	3	RLC info	3.3.0	3.4.0
	RP-09	RP-000362	437		Clarification of the description of IE semantics in "RB with PDCP information"	3.3.0	3.4.0
	RP-09	RP-000362	438	1	Editorial corrections on security	3.3.0	3.4.0
	RP-09	RP-000362	439		Editorial correction to RB mapping info	3.3.0	3.4.0
	RP-09	RP-000362	440	1	Compressed mode configuration failure	3.3.0	3.4.0
	RP-09	RP-000362	441		Gain factors for TDD	3.3.0	3.4.0
	RP-09	RP-000362	442		Introduction of Default DPCH Offset Value in TDD	3.3.0	3.4.0
	RP-09	RP-000362	444	1	Optimization of handover to UTRAN command	3.3.0	3.4.0
	RP-09	RP-000362	445		Editorial corrections	3.3.0	3.4.0
	RP-09	RP-000362	448	1	Mapping of channelisation code	3.3.0	3.4.0
	RP-09	RP-000362	449	2	DL TFCS Limitation	3.3.0	3.4.0
	RP-09	RP-000362	450		SIB offset	3.3.0	3.4.0
	RP-09	RP-000362	451		RRC CONNECTION RELEASE cause	3.3.0	3.4.0
	RP-09	RP-000362	452		Addition of RACH TFCS	3.3.0	3.4.0
	RP-09	RP-000362	453	2	Cell Identity	3.3.0	3.4.0
	RP-09	RP-000362	454		Editorial Modifications	3.3.0	3.4.0
	RP-09	RP-000362	455	1	TDD PRACH Power Control for Spreading Factor 8/16	3.3.0	3.4.0
	RP-09	RP-000362	456		TDD CCTrCH Repetition Length Definition	3.3.0	3.4.0
	RP-09	RP-000362	457	1	Reporting threshold of traffic volume measurements	3.3.0	3.4.0

Change history							
Date	TSG #	TSG Doc.	CR	Rev	Subject/Comment	Old	New
	RP-09	RP-000362	459	2	UP GPS assistance data for SIB	3.3.0	3.4.0
	RP-09	RP-000362	461	1	Support of cell update confirm on CCCH	3.3.0	3.4.0
	RP-09	RP-000363	462	1	Max Window Size in RLC capabilities	3.3.0	3.4.0
	RP-09	RP-000363	463	3	UE handling of CFN	3.3.0	3.4.0
	RP-09	RP-000363	464	1	Correction of padding description in clause 12	3.3.0	3.4.0
	RP-09	RP-000363	465	1	Window size in RLC info	3.3.0	3.4.0
	RP-09	RP-000363	466	1	TFC Control Duration	3.3.0	3.4.0
	RP-09	RP-000363	467		System Information Block Tabular Information	3.3.0	3.4.0
	RP-09	RP-000363	469	1	Frequency encoding in inter-system handover messages	3.3.0	3.4.0
	RP-09	RP-000363	470		RRC message size optimization regarding TFS parameters	3.3.0	3.4.0
	RP-09	RP-000363	471	2	RACH selection	3.3.0	3.4.0
	RP-09	RP-000363	472		DRX cycle lower limit	3.3.0	3.4.0
	RP-09	RP-000363	474		Rx window size in RLC info	3.3.0	3.4.0
	RP-09	RP-000363	476	1	Corrections & optimizations regarding system information blocks of length 215..221	3.3.0	3.4.0
	RP-09	RP-000363	477	1	Corrections on 8.1.1 resulting from RRC review at R2#14	3.3.0	3.4.0
	RP-09	RP-000363	478	1	Corrections to the RRC connection release procedure	3.3.0	3.4.0
	RP-09	RP-000363	479	1	New release cause for signalling connection re-establishment	3.3.0	3.4.0
	RP-09	RP-000363	480	1	Correction to IE midamble shift and burst type	3.3.0	3.4.0
	RP-09	RP-000363	481	1	Correction in RLC info	3.3.0	3.4.0
	RP-09	RP-000363	483		Description of CTCH occasions	3.3.0	3.4.0
	RP-09	RP-000363	485	1	TDD CCTrCH UL/DL Pairing for Inner Loop Power Control	3.3.0	3.4.0
	RP-09	RP-000363	486	1	DCCH and BCCH Signalling of TDD UL OL PC Information	3.3.0	3.4.0
	RP-09	RP-000364	487	1	Broadcast SIBs for TDD UL OL PC Information	3.3.0	3.4.0
	RP-09	RP-000364	490	1	CPCH corrections	3.3.0	3.4.0
	RP-09	RP-000364	492	3	Corrections to Security IEs	3.3.0	3.4.0
	RP-09	RP-000364	494	1	Corrections to parameters to be stored in the USIM	3.3.0	3.4.0
	RP-09	RP-000364	496		Editorial corrections	3.3.0	3.4.0
	RP-09	RP-000364	497	2	Physical Shared Channel Allocation procedure	3.3.0	3.4.0
	RP-09	RP-000364	498		Correction to Transport Format Combination Control Message	3.3.0	3.4.0
	RP-09	RP-000364	499	1	Usage of Cell Parameter ID	3.3.0	3.4.0
	RP-09	RP-000364	500		RB description for SHCCH	3.3.0	3.4.0
	RP-09	RP-000364	501	1	Use of LI in UM	3.3.0	3.4.0
	RP-09	RP-000364	502	1	Minor Corrections to RRC Protocol Specification	3.3.0	3.4.0
	RP-09	RP-000364	503	1	Correction to Cell Update Cause	3.3.0	3.4.0
	RP-09	RP-000364	504		Correction on T307 definition	3.3.0	3.4.0
	RP-09	RP-000364	505		Corrections to relative priorities in RRC Protocol	3.3.0	3.4.0
	RP-09	RP-000364	506		Unification of Reconfiguration Procedures	3.3.0	3.4.0
	RP-09	RP-000364	507	1	Changes to section 8.2 proposed at Paris RRC Ad Hoc	3.3.0	3.4.0
	RP-09	RP-000364	508		Establishment Cause	3.3.0	3.4.0
	RP-09	RP-000364	509	1	PRACH partitioning	3.3.0	3.4.0
	RP-09	RP-000364	510		Editorial Correction on Active Set Update	3.3.0	3.4.0
	RP-09	RP-000364	511		Editorial Correction regarding system information	3.3.0	3.4.0
	RP-09	RP-000365	512	1	Clarification on Reporting Cell Status	3.3.0	3.4.0
	RP-09	RP-000365	513	1	Editorial corrections on RRC Connection Establishment and Release procedures NOTE: In subclause 8.1.4.6, the change from "decrease" to "increase" for V308 was decided to be incorrect after discussion on the TSG-RAN WG2 reflector and was not implemented	3.3.0	3.4.0
	RP-09	RP-000365	514		Gated Transmission Control Info	3.3.0	3.4.0
	RP-09	RP-000365	515	1	Cell selection/reselection parameters for SIB 3/4	3.3.0	3.4.0
	RP-09	RP-000365	516		Implementation of Ec/N0 parameters and optimization of SIB 11/12	3.3.0	3.4.0
	RP-09	RP-000365	517		PRACH Info	3.3.0	3.4.0
	RP-09	RP-000365	518	1	Uplink DPCH power control info	3.3.0	3.4.0
	RP-09	RP-000365	519		AICH power offset value range	3.3.0	3.4.0
	RP-09	RP-000365	520		Direct paging of RRC connected UE in CELL_PCH/URA_PCH NOTE: This CR was postponed in TSG-RAN #9 and was wrongly included in v3.4.0. This was corrected in v3.4.1	3.3.0	3.4.0
	RP-09	RP-000365	521		Corrections to Sections 1-7	3.3.0	3.4.0

Change history							
Date	TSG #	TSG Doc.	CR	Rev	Subject/Comment	Old	New
	RP-09	RP-000365	522		Error handling for Uplink Physical Channel Control procedure	3.3.0	3.4.0
	RP-09	RP-000365	523		Corrections to downlink outer loop power control in compressed mode	3.3.0	3.4.0
	RP-09	RP-000365	524	1	Clarification on measurement procedure using compressed mode	3.3.0	3.4.0
	RP-09	RP-000365	525	1	Updates to cell and URA update procedures based on RRC Ad Hoc	3.3.0	3.4.0
	RP-09	RP-000365	526	1	Updates to RNTI allocation procedure based on RRC Ad Hoc	3.3.0	3.4.0
	RP-09	RP-000365	528		PRACH constant value	3.3.0	3.4.0
	RP-09	RP-000365	530	1	Corrections to the paging procedure	3.3.0	3.4.0
	RP-09	RP-000365	532	1	Moving of text from 25.304	3.3.0	3.4.0
	RP-09	RP-000365	533	1	Message extensibility	3.3.0	3.4.0
	RP-09	RP-000365	534	1	Additions to "State of RRC Procedure" in RRC Initialisation information, source RNC to target RNC	3.3.0	3.4.0
	RP-09	RP-000365	535	1	Support of codec negotiation	3.3.0	3.4.0
	-	-	-		Removal of contents of CR 520 from v3.4.0, because it was postponed at TSG-RAN #9 and by accident included anyway.	3.4.0	3.4.1
12/2000	RP-10	RP-000570	536		Downlink outer-loop power control in compressed mode	3.4.1	3.5.0
	RP-10	RP-000570	537	1	Correction in the use of "U-RNTI Short"	3.4.1	3.5.0
	RP-10	RP-000570	538		Corrections related to UE Timing	3.4.1	3.5.0
	RP-10	RP-000570	539		Corrections to SFN-SFN definition	3.4.1	3.5.0
	RP-10	RP-000570	541	1	Corrections to definition and use of Activation Time	3.4.1	3.5.0
	RP-10	RP-000570	542		Corrections to logical channel priorities	3.4.1	3.5.0
	RP-10	RP-000570	543	1	Correction to codec negotiation	3.4.1	3.5.0
	RP-10	RP-000570	544	1	CFN-SFN observed time difference measurement	3.4.1	3.5.0
	RP-10	RP-000570	545	1	Correction to timing indication for hard handover	3.4.1	3.5.0
	RP-10	RP-000570	546	1	UE Radio Access Capability Corrections	3.4.1	3.5.0
	RP-10	RP-000570	548	1	RRC establishment and paging causes for NAS signalling	3.4.1	3.5.0
	RP-10	RP-000570	549		Corrections to Intra-frequency measurements and Traffic volume measurements	3.4.1	3.5.0
	RP-10	RP-000570	551	1	PRACH/RACH System information	3.4.1	3.5.0
	RP-10	RP-000570	553	1	GSM Measurement reporting	3.4.1	3.5.0
	RP-10	RP-000570	554	1	BLER measurement and quality target	3.4.1	3.5.0
	RP-10	RP-000570	556	1	Clarification of PDCP sequence number window terminology	3.4.1	3.5.0
	RP-10	RP-000570	559	1	Clarification on Error Handling	3.4.1	3.5.0
	RP-10	RP-000570	560		Removal of compressed mode measurement purpose "other"	3.4.1	3.5.0
	RP-10	RP-000570	561		Clarification of compressed mode measurement purpose "GSM"	3.4.1	3.5.0
	RP-10	RP-000570	564	2	Reporting multiple GSM cells	3.4.1	3.5.0
	RP-10	RP-000571	566	1	Number of RLS that can be removed in Active Set update	3.4.1	3.5.0
	RP-10	RP-000571	568	1	Clarification on Segment Index	3.4.1	3.5.0
	RP-10	RP-000571	571	3	RRC procedure performance requirements	3.4.1	3.5.0
	RP-10	RP-000571	572	1	Correction of newInterSystemCellList and MeasurementControlSysInfo in ASN.1	3.4.1	3.5.0
	RP-10	RP-000571	573	4	Removal of Flow Id concept while maintaining lu interface flexibility	3.4.1	3.5.0
	RP-10	RP-000571	574	2	Ciphering and reset	3.4.1	3.5.0
	RP-10	RP-000571	575	1	Corrections and clarifications concerning inter-RAT change procedures	3.4.1	3.5.0
	RP-10	RP-000571	576	1	General Security Clarifications	3.4.1	3.5.0
	RP-10	RP-000571	577		Clarification on RB 0	3.4.1	3.5.0
	RP-10	RP-000571	578		Clarification on the transition of RRC state	3.4.1	3.5.0
	RP-10	RP-000571	580	1	UP measurements for RRC information to target RNC	3.4.1	3.5.0
	RP-10	RP-000571	581		Correction on LCS reporting criteria	3.4.1	3.5.0
	RP-10	RP-000574	583	1	CSICH Corrections	3.4.1	3.5.0
	RP-10	RP-000571	584	1	Clarification to handling of satellite health issues	3.4.1	3.5.0
	RP-10	RP-000571	585		Clarification on activation time	3.4.1	3.5.0
	RP-10	RP-000571	586		Clarification on activation time for ciphering in TM	3.4.1	3.5.0
	RP-10	RP-000571	587	2	Measurement procedures and messages	3.4.1	3.5.0
	RP-10	RP-000571	590	1	Inter-RAT UE radio access capability	3.4.1	3.5.0
	RP-10	RP-000571	592	1	Clarification on cell update/URA update procedures	3.4.1	3.5.0
	RP-10	RP-000571	595	4	Protocol States and Process	3.4.1	3.5.0

Change history							
Date	TSG #	TSG Doc.	CR	Rev	Subject/Comment	Old	New
	RP-10	RP-000571	596	1	System Information	3.4.1	3.5.0
	RP-10	RP-000715	597	5	RRC Connection Management Procedures, Generic procedures and actions	3.4.1	3.5.0
	RP-10	RP-000572	598	1	Paging Procedures	3.4.1	3.5.0
	RP-10	RP-000572	599		NAS signalling Procedures	3.4.1	3.5.0
	RP-10	RP-000572	600	3	Radio Bearer Control Procedures	3.4.1	3.5.0
	RP-10	RP-000572	601	1	Corrections to the Counter Check Procedure	3.4.1	3.5.0
	RP-10	RP-000572	602		Tabular Information and ASN.1	3.4.1	3.5.0
	RP-10	RP-000572	604	2	Corrections to Measurement Occasion concept	3.4.1	3.5.0
	RP-10	RP-000572	606		Corrections concerning optimisation of RB information	3.4.1	3.5.0
	RP-10	RP-000572	608	1	Corrections to security	3.4.1	3.5.0
	RP-10	RP-000572	609	1	Ciphering activation time for DPCH	3.4.1	3.5.0
	RP-10	RP-000572	610		Confirmation of signalling connection establishment	3.4.1	3.5.0
	RP-10	RP-000572	611	2	RACH Sub-channel signalling	3.4.1	3.5.0
	RP-10	RP-000572	613	2	Assistance data delivery for UP	3.4.1	3.5.0
	RP-10	RP-000572	614	1	Clarification of LCS measurements	3.4.1	3.5.0
	RP-10	RP-000572	615	2	Configuration of RLC PDU sizes for logical channels	3.4.1	3.5.0
	RP-10	RP-000574	616		PICH power offset for TDD	3.4.1	3.5.0
	RP-10	RP-000572	617		Correction for PDSCH power control for TDD	3.4.1	3.5.0
	RP-10	RP-000574	618		Usage of dynamic spreading factor in uplink	3.4.1	3.5.0
	RP-10	RP-000572	619		Correction of Midamble Shift for Burst Type 3	3.4.1	3.5.0
	RP-10	RP-000572	621		Correction of text concerning Scheduling of System Information	3.4.1	3.5.0
	RP-10	RP-000572	622	1	Alignment of GSM/99 BA Range concept and its inclusion in UTRA	3.4.1	3.5.0
	RP-10	RP-000572	623	1	Clarification of RB mapping info	3.4.1	3.5.0
	RP-10	RP-000572	624	1	Correction to UE multi-RAT capability	3.4.1	3.5.0
	RP-10	RP-000573	625		Correction to PDCP sequence number exchange during hard handover	3.4.1	3.5.0
	RP-10	RP-000573	628	2	DCH Quality Target	3.4.1	3.5.0
	RP-10	RP-000573	629	1	Simultaneous release of RBs and signalling connection	3.4.1	3.5.0
	RP-10	RP-000573	630		Correction on Transport Channel Reconfiguration	3.4.1	3.5.0
	RP-10	RP-000573	631		Limitation of DRX cycle length	3.4.1	3.5.0
	RP-10	RP-000574	632		Signalling of the alpha value in TDD for open loop power control	3.4.1	3.5.0
	RP-10	RP-000573	633		Support for improved compressed mode handling for TDD measurements	3.4.1	3.5.0
	RP-10	RP-000573	636		Usage of secondary CPICH and secondary scrambling code	3.4.1	3.5.0
	RP-10	RP-000573	639		Expiration time of SIB type 7, 14	3.4.1	3.5.0
	RP-10	RP-000573	640		Correction to integrity protection	3.4.1	3.5.0
	RP-10	RP-000684	641		Downlink Outer Loop Control	3.4.1	3.5.0
03/2001	RP-11	RP-010029	642	2	RL Failure in cell update procedure	3.5.0	3.6.0
	RP-11	RP-010029	645	1	Clarification on COUNTER CHECK	3.5.0	3.6.0
	RP-11	RP-010029	646	2	Traffic Volume Measurement corrections	3.5.0	3.6.0
	RP-11	RP-010029	650	2	Reserved TFCI for the TDD Special Burst	3.5.0	3.6.0
	RP-11	RP-010029	653		Correction to description of RRC state transitions	3.5.0	3.6.0
	RP-11	RP-010029	657		RLC re-establish correction	3.5.0	3.6.0
	RP-11	RP-010029	658	1	Removal of RLC logical channel mapping indicator	3.5.0	3.6.0
	RP-11	RP-010029	659		New paging and establishment cause "Unknown"	3.5.0	3.6.0
	RP-11	RP-010029	660	1	Miscellaneous procedure corrections	3.5.0	3.6.0
	RP-11	RP-010029	661		Corrections to compressed mode pattern sequence handling	3.5.0	3.6.0
	RP-11	RP-010029	662		Inter-system change clarifications	3.5.0	3.6.0
	RP-11	RP-010029	663	1	RLC status transmission in CELL_PCH and URA_PCH	3.5.0	3.6.0
	RP-11	RP-010029	665	1	Clarification of RB information parameter values for SRB0	3.5.0	3.6.0
	RP-11	RP-010029	666		Encoding for RRC- container	3.5.0	3.6.0
	RP-11	RP-010029	667	2	Update of message extension and encoding descriptions	3.5.0	3.6.0
	RP-11	RP-010032	668	4	Introduction of default pre-defined configurations	3.5.0	3.6.0
	RP-11	RP-010029	669	2	Security corrections	3.5.0	3.6.0
	RP-11	RP-010029	670		Clarifications on Blind Handover Support	3.5.0	3.6.0
	RP-11	RP-010029	671	1	Missing descriptions of UE actions	3.5.0	3.6.0
	RP-11	RP-010029	672	2	Corrections on UE Positioning information	3.5.0	3.6.0

Change history							
Date	TSG #	TSG Doc.	CR	Rev	Subject/Comment	Old	New
	RP-11	RP-010029	674	1	Security related corrections to SRNS	3.5.0	3.6.0
	RP-11	RP-010032	675	2	Downlink power offsets	3.5.0	3.6.0
	RP-11	RP-010274	676	2	Checking the integrity of UE security capabilities	3.5.0	3.6.0
	RP-11	RP-010030	678	1	Clarification to Secondary CCPCH info	3.5.0	3.6.0
	RP-11	RP-010030	679	1	Miscellaneous corrections	3.5.0	3.6.0
	RP-11	RP-010030	680		Removal of Layer 3 filtering for RACH	3.5.0	3.6.0
	RP-11	RP-010030	681	2	Correction of compressed mode parameters	3.5.0	3.6.0
	RP-11	RP-010030	682		Removal of immediate cell evaluation	3.5.0	3.6.0
	RP-11	RP-010030	684	2	Scheduling of SIB 15.2 and SIB 15.3	3.5.0	3.6.0
	RP-11	RP-010030	685	1	Correction to ECN modules	3.5.0	3.6.0
	RP-11	RP-010030	686	1	Improvement of the description of timing advance for TDD	3.5.0	3.6.0
	RP-11	RP-010030	687		Correction on timing advance and allocation for shared channels	3.5.0	3.6.0
	RP-11	RP-010030	688	1	Clarification on SF 1 signalling	3.5.0	3.6.0
	RP-11	RP-010030	689	1	Correction to power control in TDD	3.5.0	3.6.0
	RP-11	RP-010030	690		Midamble - Channelisation code association for TDD	3.5.0	3.6.0
	RP-11	RP-010030	691		Network requested reporting for physical shared channel allocation	3.5.0	3.6.0
	RP-11	RP-010030	693		System Information	3.5.0	3.6.0
	RP-11	RP-010030	694	1	Clarification on Transport Channel Identity	3.5.0	3.6.0
	RP-11	RP-010030	696	1	Editorial Correction	3.5.0	3.6.0
	RP-11	RP-010030	698	2	Correction to add coding of intra domain NAS node selector	3.5.0	3.6.0
	RP-11	RP-010030	700	1	Corrections to system information block characteristics in TDD	3.5.0	3.6.0
	RP-11	RP-010030	701	2	ASN.1 corrections	3.5.0	3.6.0
	RP-11	RP-010030	702	2	Measurement related corrections	3.5.0	3.6.0
	RP-11	RP-010031	703	1	Clarifications on TFC Control procedure	3.5.0	3.6.0
	RP-11	RP-010031	704	2	Association of PLMN ID to neighbour cells	3.5.0	3.6.0
	RP-11	RP-010031	705	1	TFCS Selection Guidelines	3.5.0	3.6.0
	RP-11	RP-010031	710		Special Burst Scheduling During DTX in TDD	3.5.0	3.6.0
	RP-11	RP-010031	711	1	Radio Link Failure Criteria in TDD	3.5.0	3.6.0
	RP-11	RP-010031	712	1	Correction & Clarification to TDD RACH Subchannels	3.5.0	3.6.0
	RP-11	RP-010031	713	1	Number of retransmission of RRC CONNECTION REQUEST	3.5.0	3.6.0
	RP-11	RP-010031	714		Uplink Frequency Notification	3.5.0	3.6.0
	RP-11	RP-010031	715		Clarification of Radio Bearer Mapping for DCH/DSCH Transport Channels	3.5.0	3.6.0
	RP-11	RP-010031	716		Correction of mismatches between tabular and ASN.1	3.5.0	3.6.0
	RP-11	RP-010031	717		Correction to discontinuous reception in TDD	3.5.0	3.6.0
	RP-11	RP-010031	718		Power control preamble	3.5.0	3.6.0
	RP-11	RP-010031	719		Maximum number of AM entity	3.5.0	3.6.0
	RP-11	RP-010031	720	1	Real-time Integrity Broadcast	3.5.0	3.6.0
	RP-11	RP-010031	721	3	Moving Real-time Integrity description to different chapter	3.5.0	3.6.0
	RP-11	RP-010031	723	1	Removal of the payload unit concept	3.5.0	3.6.0
	RP-11	RP-010031	724		Security related corrections to SRNS	3.5.0	3.6.0
	RP-11	RP-010031	725		Periodic PLMN selection correction	3.5.0	3.6.0
	RP-11	RP-010042	683	1	Modification of "SSDT Information" IE parameters to indicate if SSDT is used in the UL only	3.6.0	4.0.0
	RP-11	RP-010041	692	1	Idle allocation for Node B synchronisation	3.6.0	4.0.0
	RP-11	RP-010037	706	1	Physical channel configuration information elements for 1.28 Mcps TDD	3.6.0	4.0.0
	RP-11	RP-010037	707	2	Changes to Measurement Related Signalling and Introduction of Cell (Re)selection Parameters for 1.28Mcps TDD	3.6.0	4.0.0
	RP-11	RP-010037	708	1	Introduction of RACH Parameters for 1.28 Mcps TDD	3.6.0	4.0.0
	RP-11	RP-010037	709		Introduction of UE radio access capability Parameters for 1.28 Mcps TDD	3.6.0	4.0.0
	RP-11	RP-010040	722	1	Introduction of IPDLs for TDD	3.6.0	4.0.0
	RP-11	RP-010039	726	1	ROHC updates to RRC	3.6.0	4.0.0
06/2001	RP-12	RP-010311	731		Clarification of the IE 'spreading factor' in Uplink DPCH info for FDD mode	4.0.0	4.1.0
	RP-12	RP-010311	733		Correction of UE Radio Access Capability depending on UTRAN FDD bands	4.0.0	4.1.0
	RP-12	RP-010311	735		Clarification on Security mode control	4.0.0	4.1.0

Change history							
Date	TSG #	TSG Doc.	CR	Rev	Subject/Comment	Old	New
	RP-12	RP-010311	738		Correction of TrCH parameter handling	4.0.0	4.1.0
	RP-12	RP-010311	740		TFC Subsets in TDD	4.0.0	4.1.0
	RP-12	RP-010311	746		RRC containers	4.0.0	4.1.0
	RP-12	RP-010311	748		Various corrections	4.0.0	4.1.0
	RP-12	RP-010311	750		General error handling for system information	4.0.0	4.1.0
	RP-12	RP-010311	752		Order of elements in strings	4.0.0	4.1.0
	RP-12	RP-010311	754		Configuration consistency checks	4.0.0	4.1.0
	RP-12	RP-010312	756		Compressed mode corrections	4.0.0	4.1.0
	RP-12	RP-010312	758		Correction concerning inter-RAT procedures	4.0.0	4.1.0
	RP-12	RP-010312	762		Measurement corrections	4.0.0	4.1.0
	RP-12	RP-010312	764		RLC Tr Discard	4.0.0	4.1.0
	RP-12	RP-010312	766		Annex B CPCH Correction	4.0.0	4.1.0
	RP-12	RP-010312	768		SIB Correction for CSICH Power Offset	4.0.0	4.1.0
	RP-12	RP-010312	770		Transfer of Last known position in case of SRNS relocation	4.0.0	4.1.0
	RP-12	RP-010312	772		Corrections to UE Positioning measurements	4.0.0	4.1.0
	RP-12	RP-010312	779		GSM measurements in compressed mode	4.0.0	4.1.0
	RP-12	RP-010312	781		Correction of Activation Time in Inter-Rat HO Commands	4.0.0	4.1.0
	RP-12	RP-010313	785		Clarification of FRESH in SRNS relocation	4.0.0	4.1.0
	RP-12	RP-010313	789		Correction to UE timers and constants in idle mode	4.0.0	4.1.0
	RP-12	RP-010313	793		Clarification on multiframe allocation in TDD	4.0.0	4.1.0
	RP-12	RP-010313	795		Predefined parameters for logical channels	4.0.0	4.1.0
	RP-12	RP-010313	797		Pathloss calculation	4.0.0	4.1.0
	RP-12	RP-010313	799		Clarification on periodic measurement reporting	4.0.0	4.1.0
	RP-12	RP-010313	803	1	Handling of IE PRACH TFCS and Primary CPICH/Primary CCPCH info	4.0.0	4.1.0
	RP-12	RP-010313	805		Correction to FACH measurement occasion in TDD	4.0.0	4.1.0
	RP-12	RP-010313	807		Clarification of L1 synchronization procedures	4.0.0	4.1.0
	RP-12	RP-010313	809		Correction of Activation Time definition	4.0.0	4.1.0
	RP-12	RP-010314	813		Corrections to RRC procedure performance	4.0.0	4.1.0
	RP-12	RP-010314	815		Removal of mapping function	4.0.0	4.1.0
	RP-12	RP-010314	817		Security clarifications	4.0.0	4.1.0
	RP-12	RP-010314	819		Corrections to UE Positioning	4.0.0	4.1.0
	RP-12	RP-010314	825		Definition of DPCH numbering	4.0.0	4.1.0
	RP-12	RP-010314	827		Corrections to System Information Procedure	4.0.0	4.1.0
	RP-12	RP-010314	829		Relation between DOFF and DPCH Frame Offset	4.0.0	4.1.0
	RP-12	RP-010314	831		Procedures for "same as UL"	4.0.0	4.1.0
	RP-12	RP-010314	837		Editorial and minor corrections	4.0.0	4.1.0
	RP-12	RP-010314	839		Editorial Correction	4.0.0	4.1.0
	RP-12	RP-010315	843		Corrections on OTDOA-IPDL specific burst parameter semantic description	4.0.0	4.1.0
	RP-12	RP-010315	845		Error handling for messages sent from another RAT	4.0.0	4.1.0
	RP-12	RP-010315	849		Needed TFC in the TFCS for TDD	4.0.0	4.1.0
	RP-12	RP-010315	855		Clarification of TFCS selection guidelines	4.0.0	4.1.0
	RP-12	RP-010315	861		Clarification of Traffic Volume measurements	4.0.0	4.1.0
	RP-12	RP-010315	863		CFN synchronisation problems at timing re-initialised hard handover	4.0.0	4.1.0
	RP-12	RP-010315	866		Corrections on UP Assistance Message Descriptions	4.0.0	4.1.0
	RP-12	RP-010315	868		Correction on Area Scope of SIB 15.3	4.0.0	4.1.0
	RP-12	RP-010315	872		Correction to AICH power offset	4.0.0	4.1.0
	RP-12	RP-010316	875		Clarification on IE 'Downlink rate matching restriction information'	4.0.0	4.1.0
	RP-12	RP-010316	877		Corrections on Tabular/ASN.1	4.0.0	4.1.0
	RP-12	RP-010316	879		Corrections on Tabular and ASN.1 inconsistencies	4.0.0	4.1.0
	RP-12	RP-010316	881		Editorial corrections on Tabular and ASN.1 inconsistencies	4.0.0	4.1.0
	RP-12	RP-010316	883		UE Positioning corrections to ASN.1 and tabular	4.0.0	4.1.0
	RP-12	RP-010316	885		Corrections to resolve inconsistencies between Tabular and ASN.1	4.0.0	4.1.0
	RP-12	RP-010316	887		UE positioning OTDOA Neighbour Cell Info	4.0.0	4.1.0
	RP-12	RP-010316	889		DRAC corrections	4.0.0	4.1.0
	RP-12	RP-010316	893		ASN.1 Correction of IE TFCS ID	4.0.0	4.1.0

Change history							
Date	TSG #	TSG Doc.	CR	Rev	Subject/Comment	Old	New
	RP-12	RP-010316	895		Correction of IE IODE range in AGPS Positioning	4.0.0	4.1.0
	RP-12	RP-010317	897		Correction to BurstModeParameters in IPDL	4.0.0	4.1.0
	RP-12	RP-010317	899		Corrections on inconsistencies between Tabular and ASN.1	4.0.0	4.1.0
	RP-12	RP-010317	901		Naming of message abstract types in ASN.1	4.0.0	4.1.0
	RP-12	RP-010317	904		Information elements outside the extension container	4.0.0	4.1.0
	RP-12	RP-010317	906		Correction concerning DRX cycle upon inter-RAT change towards UTRAN	4.0.0	4.1.0
	RP-12	RP-010323	773		Corrections to IPDLs for TDD	4.0.0	4.1.0
	RP-12	RP-010323	850	2	Correction to 1.28Mcps TDD RACH parameters and operation	4.0.0	4.1.0
	RP-12	RP-010323	851		TFCI coding in case of 8PSK	4.0.0	4.1.0
	RP-12	RP-010323	902	1	Structure and naming of information elements	4.0.0	4.1.0
09/2001	RP-13	RP-010544	0870		UL Transport Channel Type Correction	4.1.0	4.2.0
	RP-13	RP-010544	0908		Guidelines concerning conditions, spares, defaults and correction of inconsistencies	4.1.0	4.2.0
	RP-13	RP-010544	0910		Correction to TDD DL DPCH Common Timeslot Info	4.1.0	4.2.0
	RP-13	RP-010544	0912		TDD System Information Update in Cell_DCH	4.1.0	4.2.0
	RP-13	RP-010544	0914		Editorial Corrections	4.1.0	4.2.0
	RP-13	RP-010544	0916		UL DPCH Power Control Info in TDD	4.1.0	4.2.0
	RP-13	RP-010544	0918		CN-originated paging in CELL_PCH and URA_PCH state	4.1.0	4.2.0
	RP-13	RP-010544	0920		Corrections to UE variable handling	4.1.0	4.2.0
	RP-13	RP-010544	0922		Inter-frequency measurements	4.1.0	4.2.0
	RP-13	RP-010544	0924		Inter-RAT measurements	4.1.0	4.2.0
	RP-13	RP-010671	0926	1	Intra-frequency measurements	4.1.0	4.2.0
	RP-13	RP-010545	0928		Multiplexing configuration corrections	4.1.0	4.2.0
	RP-13	RP-010545	0930		Reception of non-dedicated control channels mapped on FACH in CELL_FACH state	4.1.0	4.2.0
	RP-13	RP-010545	0932		Removal of C-RNTI when entering CELL_DCH	4.1.0	4.2.0
	RP-13	RP-010545	0935		TF and TFC set definition	4.1.0	4.2.0
	RP-13	RP-010545	0937		Correction of remaining ASN.1/Tabular inconsistencies	4.1.0	4.2.0
	RP-13	RP-010545	0939		CPICH Ec/N0 Range	4.1.0	4.2.0
	RP-13	RP-010545	0941		Priorities for IDNNS coding	4.1.0	4.2.0
	RP-13	RP-010545	0943		Dedicated pilots and S-CPICH specification related to UE specific beamforming	4.1.0	4.2.0
	RP-13	RP-010545	0945		Security corrections	4.1.0	4.2.0
	RP-13	RP-010546	0953		Intra-frequency measurement events for TDD corrections	4.1.0	4.2.0
	RP-13	RP-010546	0955		Inconsistencies between ASN.1 and tabular format	4.1.0	4.2.0
	RP-13	RP-010546	0957		TDD PICH corrections and clarifications	4.1.0	4.2.0
	RP-13	RP-010546	0959		Messages on CCCH	4.1.0	4.2.0
	RP-13	RP-010546	0961		Clarification of Parameter Values for Default Radio Configurations	4.1.0	4.2.0
	RP-13	RP-010546	0963		Clarification to usage of default values in "Cell Selection and Reselection for SIB11/12Info"	4.1.0	4.2.0
	RP-13	RP-010546	0965		Clarification of handling of System information block 14	4.1.0	4.2.0
	RP-13	RP-010546	0967		Description of UE behaviour when receiving UE positioning related information	4.1.0	4.2.0
	RP-13	RP-010546	0982		Clarification on periodic measurement reporting	4.1.0	4.2.0
	RP-13	RP-010546	0984		Corrections and clarifications on Measurement procedures description	4.1.0	4.2.0
	RP-13	RP-010547	0986		Lossless Criteria in PDCP Info	4.1.0	4.2.0
	RP-13	RP-010547	0988		Corrections to cell reselection parameter values	4.1.0	4.2.0
	RP-13	RP-010547	0990		Correction to signalling connection release	4.1.0	4.2.0
	RP-13	RP-010547	0992		Corrections to cell update procedures	4.1.0	4.2.0
	RP-13	RP-010547	0994		PDCP configuration and PS domain configuration checks	4.1.0	4.2.0
	RP-13	RP-010547	0996		Correction to handling of RRC transaction identifier for Cell Update, URA Update and RRC connection setup	4.1.0	4.2.0
	RP-13	RP-010547	0998	1	Correction of UE capabilities regarding Rx-Tx time difference type 2 measurement	4.1.0	4.2.0
	RP-13	RP-010547	1000		Correction to handling of IE 'Downlink info for each radio link'	4.1.0	4.2.0
	RP-13	RP-010547	1004		Redundant IE in Traffic volume measurement system information	4.1.0	4.2.0
	RP-13	RP-010547	1006		Editorial corrections	4.1.0	4.2.0
	RP-13	RP-010548	1008		MAC logical channel priority added to definition of RB0 and SHCCH	4.1.0	4.2.0

Change history							
Date	TSG #	TSG Doc.	CR	Rev	Subject/Comment	Old	New
	RP-13	RP-010548	1010		Control of primary CCPCH RSCP measurement in PUSCH CAPACITY REQUEST message	4.1.0	4.2.0
	RP-13	RP-010548	1014		Various minor corrections	4.1.0	4.2.0
	RP-13	RP-010548	1016		Range of T312	4.1.0	4.2.0
	RP-13	RP-010548	1018		Bitstring of channelisationCodeIndices	4.1.0	4.2.0
	RP-13	RP-010548	1020		Transmission of UE CAPABILITY INFORMATION message	4.1.0	4.2.0
	RP-13	RP-010548	1022		Multiple UE capabilities procedures	4.1.0	4.2.0
	RP-13	RP-010548	1024		Corrections to information elements outside the extension container	4.1.0	4.2.0
	RP-13	RP-010548	1026		SFN reporting	4.1.0	4.2.0
	RP-13	RP-010548	1028		TFCI combining indicator	4.1.0	4.2.0
	RP-13	RP-010549	1030		RLC reset on a Signalling Radio Bearer	4.1.0	4.2.0
	RP-13	RP-010549	1034		Quality Indication for UE Positioning Parameters	4.1.0	4.2.0
	RP-13	RP-010549	1036		Editorial Correction for UE Positioning	4.1.0	4.2.0
	RP-13	RP-010549	1038		Clarification on the current status of ciphering	4.1.0	4.2.0
	RP-13	RP-010549	1048		Clarification on HFN initialization at SRB and RB setup	4.1.0	4.2.0
	RP-13	RP-010549	1050		Clarification on Inter-RAT measurement	4.1.0	4.2.0
	RP-13	RP-010549	1052		Clarification on re-assembly of segments	4.1.0	4.2.0
	RP-13	RP-010549	1062		Minor Corrections	4.1.0	4.2.0
	RP-13	RP-010549	1066		Support of dedicated pilots for channel estimation	4.1.0	4.2.0
	RP-13	RP-010549	1068		Correction to SRNS relocation handling	4.1.0	4.2.0
	RP-13	RP-010550	1076		Correction to RLC state variables	4.1.0	4.2.0
	RP-13	RP-010550	1082		Reading of CN information in SIB 1 inRRC Connected Mode	4.1.0	4.2.0
	RP-13	RP-010550	1086		Restricting the maximum amount of preconfigurations in case of equivalent PLMNs	4.1.0	4.2.0
	RP-13	RP-010554	0933		Order of bits in bitstrings	4.1.0	4.2.0
	RP-13	RP-010554	0946		Selection of the RFC3095 CID transmission	4.1.0	4.2.0
	RP-13	RP-010554	0970		Correction of IPDL parameters for TDD enhancements in ASN.1 description	4.1.0	4.2.0
	RP-13	RP-010554	0971	1	1.28 Mcps TDD PICH, Midamble and UL timing advance control corrections	4.1.0	4.2.0
	RP-13	RP-010554	0972		Introduction of 1.28 Mcps TDD Mode in clause 13.7	4.1.0	4.2.0
	RP-13	RP-010554	0973		Tadv in 1.28 Mcps TDD	4.1.0	4.2.0
	RP-13	RP-010554	0974		Correction and clarification to PRACH in 1.28 Mcps TDD	4.1.0	4.2.0

History

Document history		
V4.0.0	April 2001	Publication
V4.1.0	July 2001	Publication
V4.2.0	September 2001	Publication