

ETSI TS 125 331 V12.14.0 (2017-10)



**Universal Mobile Telecommunications System (UMTS);
Radio Resource Control (RRC);
Protocol specification
(3GPP TS 25.331 version 12.14.0 Release 12)**



ReferenceRTS/TSGR-0625331vce0

KeywordsUMTS

ETSI

650 Route des Lucioles
F-06921 Sophia Antipolis Cedex - FRANCE

Tel.: +33 4 92 94 42 00 Fax: +33 4 93 65 47 16

Siret N° 348 623 562 00017 - NAF 742 C
Association à but non lucratif enregistrée à la
Sous-Préfecture de Grasse (06) N° 7803/88

Important notice

The present document can be downloaded from:

<http://www.etsi.org/standards-search>

The present document may be made available in electronic versions and/or in print. The content of any electronic and/or print versions of the present document shall not be modified without the prior written authorization of ETSI. In case of any existing or perceived difference in contents between such versions and/or in print, the only prevailing document is the print of the Portable Document Format (PDF) version kept on a specific network drive within ETSI Secretariat.

Users of the present document should be aware that the document may be subject to revision or change of status.

Information on the current status of this and other ETSI documents is available at

<https://portal.etsi.org/TB/ETSIDeliverableStatus.aspx>

If you find errors in the present document, please send your comment to one of the following services:

<https://portal.etsi.org/People/CommiteeSupportStaff.aspx>

Copyright Notification

No part may be reproduced or utilized in any form or by any means, electronic or mechanical, including photocopying and microfilm except as authorized by written permission of ETSI.

The content of the PDF version shall not be modified without the written authorization of ETSI.

The copyright and the foregoing restriction extend to reproduction in all media.

© ETSI 2017.

All rights reserved.

DECT™, **PLUGTESTS™**, **UMTS™** and the ETSI logo are trademarks of ETSI registered for the benefit of its Members.

3GPP™ and **LTE™** are trademarks of ETSI registered for the benefit of its Members and of the 3GPP Organizational Partners.

oneM2M logo is protected for the benefit of its Members.

GSM® and the GSM logo are trademarks registered and owned by the GSM Association.

Intellectual Property Rights

IPRs essential or potentially essential to the present document may have been declared to ETSI. The information pertaining to these essential IPRs, if any, is publicly available for **ETSI members and non-members**, and can be found in ETSI SR 000 314: "*Intellectual Property Rights (IPRs); Essential, or potentially Essential, IPRs notified to ETSI in respect of ETSI standards*", which is available from the ETSI Secretariat. Latest updates are available on the ETSI Web server (<https://ipr.etsi.org/>).

Pursuant to the ETSI IPR Policy, no investigation, including IPR searches, has been carried out by ETSI. No guarantee can be given as to the existence of other IPRs not referenced in ETSI SR 000 314 (or the updates on the ETSI Web server) which are, or may be, or may become, essential to the present document.

Foreword

This Technical Specification (TS) has been produced by ETSI 3rd Generation Partnership Project (3GPP).

The present document may refer to technical specifications or reports using their 3GPP identities, UMTS identities or GSM identities. These should be interpreted as being references to the corresponding ETSI deliverables.

The cross reference between GSM, UMTS, 3GPP and ETSI identities can be found under <http://webapp.etsi.org/key/queryform.asp>.

Modal verbs terminology

In the present document "**shall**", "**shall not**", "**should**", "**should not**", "**may**", "**need not**", "**will**", "**will not**", "**can**" and "**cannot**" are to be interpreted as described in clause 3.2 of the [ETSI Drafting Rules](#) (Verbal forms for the expression of provisions).

"**must**" and "**must not**" are **NOT** allowed in ETSI deliverables except when used in direct citation.

Contents

Intellectual Property Rights	2
Foreword.....	2
Modal verbs terminology.....	2
Foreword.....	40
1 Scope	41
2 References	41
3 Definitions and abbreviations.....	44
3.1 Definitions	44
3.2 Abbreviations	47
4 General	50
4.1 Overview of the specification.....	50
4.2 RRC Layer Model	51
4.3 Protocol specification principles	54
5 RRC Functions and Services provided to upper layers	54
5.1 RRC Functions	54
5.2 RRC Services provided to upper layers.....	55
5.3 Primitives between RRC and upper layers.....	55
6 Services expected from lower layers.....	55
6.1 Services expected from Layer 2	55
6.2 Services expected from Layer 1	55
6.3 Signalling Radio Bearers.....	55
7 Protocol states	56
7.1 Overview of RRC States and State Transitions including GSM and E-UTRA	56
7.2 Processes in UE modes/states.....	57
7.2.1 UE Idle mode.....	57
7.2.2 UTRA RRC Connected mode.....	57
7.2.2.1 URA_PCH or CELL_PCH state	57
7.2.2.2 CELL_FACH state.....	58
7.2.2.3 CELL_DCH state.....	60
8 RRC procedures	60
8.1 RRC Connection Management Procedures	61
8.1.1 Broadcast of system information	61
8.1.1.1 General	62
8.1.1.1.1 System information structure.....	62
8.1.1.1.2 System information blocks	62
8.1.1.1.3 Segmentation and concatenation of system information blocks.....	70
8.1.1.1.4 Re-assembly of segments	71
8.1.1.1.5 Scheduling of system information	72
8.1.1.2 Initiation.....	72
8.1.1.3 Reception of SYSTEM INFORMATION messages by the UE.....	72
8.1.1.4 Void.....	73
8.1.1.5 Actions upon reception of the Master Information Block and Scheduling Block(s).....	73
8.1.1.6 Actions upon reception of system information blocks	77
8.1.1.6.1 System Information Block type 1	80
8.1.1.6.2 System Information Block type 2	80
8.1.1.6.3 System Information Block type 3.....	81
8.1.1.6.4 System Information Block type 4.....	86
8.1.1.6.5 System Information Block type 5 and 5bis.....	86
8.1.1.6.6 System Information Block type 6.....	92
8.1.1.6.7 System Information Block type 7.....	95
8.1.1.6.8 Void.....	95

8.1.1.6.9	Void.....	95
8.1.1.6.10	Void.....	95
8.1.1.6.11	System Information Block type 11.....	95
8.1.1.6.11a	System Information Block type 11bis.....	97
8.1.1.6.11b	System Information Block type 11ter.....	97
8.1.1.6.12	System Information Block type 12.....	98
8.1.1.6.13	System Information Block type 13.....	99
8.1.1.6.14	System Information Block type 14.....	100
8.1.1.6.15	System Information Block type 15.....	100
8.1.1.6.15.0	System Information Block type 15bis.....	100
8.1.1.6.15.1	System Information Block type 15.1.....	100
8.1.1.6.15.1a	System Information Block type 15.1bis.....	101
8.1.1.6.15.1b	101
8.1.1.6.15.2	System Information Block type 15.2.....	101
8.1.1.6.15.2a	System Information Block type 15.2bis.....	101
8.1.1.6.15.2b	System Information Block type 15.2ter.....	102
8.1.1.6.15.3	System Information Block type 15.3.....	102
8.1.1.6.15.3a	System Information Block type 15.3bis.....	103
8.1.1.6.15.4	System Information Block type 15.4.....	104
8.1.1.6.15.5	System Information Block type 15.5.....	104
8.1.1.6.15.6	System Information Block type 15.6.....	104
8.1.1.6.15.7	System Information Block type 15.7.....	104
8.1.1.6.15.8	System Information Block type 15.8.....	104
8.1.1.6.16	System Information Block type 16.....	104
8.1.1.6.17	System Information Block type 17.....	105
8.1.1.6.18	System Information Block type 18.....	105
8.1.1.6.19	System Information Block type 19.....	107
8.1.1.6.20	System Information Block type 20.....	107
8.1.1.6.21	System Information Block type 21.....	107
8.1.1.6.22	System Information Block type 22.....	108
8.1.1.6.23	System Information Block type 23.....	108
8.1.1.6.24	System Information Block type 24.....	109
8.1.1.7	Modification of system information.....	109
8.1.1.7.1	Modification of system information blocks using a value tag.....	109
8.1.1.7.2	Synchronised modification of system information blocks.....	110
8.1.1.7.3	Actions upon system information change.....	110
8.1.1.7.4	Actions upon expiry of a system information expiry timer.....	111
8.1.1.8	Reception of System Information Container by the UE.....	112
8.1.2	Paging.....	112
8.1.2.1	General.....	112
8.1.2.2	Initiation.....	112
8.1.2.3	Reception of a PAGING TYPE 1 message by the UE.....	113
8.1.3	RRC connection establishment.....	115
8.1.3.1	General.....	115
8.1.3.2	Initiation.....	115
8.1.3.3	RRC CONNECTION REQUEST message contents to set.....	116
8.1.3.4	Reception of an RRC CONNECTION REQUEST message by the UTRAN.....	119
8.1.3.5	Cell re-selection, T300 or T318 timeout.....	120
8.1.3.5a	Abortion of RRC connection establishment.....	121
8.1.3.6	Reception of an RRC CONNECTION SETUP message by the UE.....	121
8.1.3.7	Physical channel failure or cell re-selection.....	127
8.1.3.8	Invalid RRC CONNECTION SETUP message, unsupported configuration or invalid configuration.....	128
8.1.3.9	Reception of an RRC CONNECTION REJECT message by the UE.....	129
8.1.3.10	Invalid RRC CONNECTION REJECT message.....	132
8.1.3.11	Logging of failed RRC Connection Establishment.....	133
8.1.4	RRC connection release.....	134
8.1.4.1	General.....	134
8.1.4.2	Initiation.....	134
8.1.4.3	Reception of an RRC CONNECTION RELEASE message by the UE.....	134
8.1.4.4	Invalid RRC CONNECTION RELEASE message.....	136
8.1.4.5	Cell re-selection or radio link failure.....	137

8.1.4.6	Expiry of timer T308, unacknowledged mode transmission.....	137
8.1.4.7	Void.....	138
8.1.4.8	Reception of an RRC CONNECTION RELEASE COMPLETE message by UTRAN	138
8.1.4.9	Unsuccessful transmission of the RRC CONNECTION RELEASE COMPLETE message, acknowledged mode transmission.....	138
8.1.4.10	Detection of loss of dedicated physical channel by UTRAN in CELL_DCH state	138
8.1.4.11	Failure to receive RRC CONNECTION RELEASE COMPLETE message by UTRAN.....	139
8.1.4a	RRC connection release requested by upper layers	139
8.1.4a.1	General	139
8.1.4a.2	Initiation.....	139
8.1.5	Void	139
8.1.6	Transmission of UE capability information.....	139
8.1.6.1	General	139
8.1.6.2	Initiation.....	140
8.1.6.3	Reception of a UE CAPABILITY INFORMATION message by the UTRAN.....	143
8.1.6.4	Reception of the UE CAPABILITY INFORMATION CONFIRM message by the UE	143
8.1.6.5	Invalid UE CAPABILITY INFORMATION CONFIRM message	144
8.1.6.6	T304 timeout.....	144
8.1.7	UE capability enquiry	145
8.1.7.1	General	145
8.1.7.2	Initiation.....	145
8.1.7.3	Reception of a UE CAPABILITY ENQUIRY message by the UE	145
8.1.7.4	Invalid UE CAPABILITY ENQUIRY message	145
8.1.8	Initial Direct transfer.....	146
8.1.8.1	General	146
8.1.8.2	Initiation of Initial direct transfer procedure in the UE	146
8.1.8.2a	RLC re-establishment or inter-RAT change	148
8.1.8.2ab	Inter-RAT handover from UTRAN to GERAN <i>Iu mode</i>	149
8.1.8.2b	Abortion of signalling connection establishment.....	149
8.1.8.2c	Inter-RAT handover from UTRAN to E-UTRAN	149
8.1.8.3	Reception of INITIAL DIRECT TRANSFER message by the UTRAN	149
8.1.9	Downlink Direct transfer	149
8.1.9.1	General	149
8.1.9.2	Initiation of downlink direct transfer procedure in the UTRAN	150
8.1.9.3	Reception of a DOWNLINK DIRECT TRANSFER message by the UE	150
8.1.9.3a	No signalling connection exists.....	150
8.1.9.4	Invalid DOWNLINK DIRECT TRANSFER message	151
8.1.10	Uplink Direct transfer	151
8.1.10.1	General	151
8.1.10.2	Initiation of uplink direct transfer procedure in the UE	151
8.1.10.2a	RLC re-establishment or inter-RAT change	152
8.1.10.2b	Inter-RAT handover from UTRAN to GERAN <i>Iu mode</i>	152
8.1.10.2c	Inter-RAT handover from UTRAN to E-UTRAN	152
8.1.10.3	Reception of UPLINK DIRECT TRANSFER message by the UTRAN	153
8.1.11	UE dedicated paging.....	153
8.1.11.1	General	153
8.1.11.2	Initiation.....	153
8.1.11.3	Reception of a PAGING TYPE 2 message by the UE.....	153
8.1.11.4	Invalid PAGING TYPE 2 message	153
8.1.12	Security mode control.....	154
8.1.12.1	General	154
8.1.12.2	Initiation.....	154
8.1.12.2.1	Ciphering configuration change	154
8.1.12.2.2	Integrity protection configuration change.....	155
8.1.12.3	Reception of SECURITY MODE COMMAND message by the UE	157
8.1.12.3.1	New ciphering and integrity protection keys.....	161
8.1.12.4	Void.....	163
8.1.12.4a	Incompatible simultaneous security reconfiguration.....	163
8.1.12.4b	Cell update procedure during security reconfiguration	163
8.1.12.4c	Invalid configuration.....	164
8.1.12.5	Reception of SECURITY MODE COMPLETE message by the UTRAN	165
8.1.12.6	Invalid SECURITY MODE COMMAND message.....	167

8.1.13	Signalling connection release procedure.....	167
8.1.13.1	General.....	167
8.1.13.2	Initiation of SIGNALLING CONNECTION RELEASE by the UTRAN.....	167
8.1.13.3	Reception of SIGNALLING CONNECTION RELEASE by the UE.....	168
8.1.13.4	Invalid SIGNALLING CONNECTION RELEASE message.....	168
8.1.13.5	Invalid configuration.....	168
8.1.14	Signalling connection release indication procedure.....	169
8.1.14.1	General.....	169
8.1.14.2	Initiation.....	169
8.1.14.2a	RLC re-establishment or inter-RAT change.....	171
8.1.14.3	Reception of SIGNALLING CONNECTION RELEASE INDICATION by the UTRAN.....	171
8.1.14.4	Expiry of timer T323.....	171
8.1.15	Counter check procedure.....	172
8.1.15.1	General.....	172
8.1.15.2	Initiation.....	172
8.1.15.3	Reception of a COUNTER CHECK message by the UE.....	172
8.1.15.4	Reception of the COUNTER CHECK RESPONSE message by UTRAN.....	173
8.1.15.5	Cell re-selection.....	173
8.1.15.6	Invalid COUNTER CHECK message.....	173
8.1.16	Inter RAT handover information transfer.....	174
8.1.16.1	General.....	174
8.1.16.2	Initiation.....	174
8.1.16.3	INTER RAT HANDOVER INFO message contents to set.....	174
8.1.17	ETWS primary notification with security procedure.....	176
8.1.17.1	General.....	176
8.1.17.2	Initiation.....	176
8.1.17.3	Void.....	177
8.1.17.4	Reception of the ETWS PRIMARY NOTIFICATION WITH SECURITY message.....	177
8.1.17.5	Forward of the ETWS primary notification to the upper layers.....	177
8.1.17.6	Void.....	177
8.2	Radio Bearer control procedures.....	177
8.2.1	Radio bearer establishment.....	177
8.2.2	Reconfiguration procedures.....	177
8.2.2.1	General.....	179
8.2.2.2	Initiation.....	180
8.2.2.2a	Initiation of handover from GERAN <i>Iu mode</i>	181
8.2.2.3	Reception of RADIO BEARER SETUP or RADIO BEARER RECONFIGURATION or RADIO BEARER RELEASE or TRANSPORT CHANNEL RECONFIGURATION or PHYSICAL CHANNEL RECONFIGURATION message, TTI switch HS-SCCH order or Target cell HS-SCCH order by the UE.....	182
8.2.2.3a	Reception of RADIO BEARER RECONFIGURATION message by the UE performing handover from GERAN <i>Iu mode</i>	202
8.2.2.4	Transmission of a response message by the UE, normal case.....	203
8.2.2.5	Reception of a response message by the UTRAN, normal case.....	205
8.2.2.5a	Rejection by the UE.....	206
8.2.2.6	Unsupported configuration in the UE.....	206
8.2.2.7	Physical channel failure.....	207
8.2.2.8	Cell re-selection.....	208
8.2.2.9	Transmission of a response message by the UE, failure case.....	208
8.2.2.10	Reception of a response message by the UTRAN, failure case.....	209
8.2.2.11	Invalid configuration.....	209
8.2.2.12	Incompatible simultaneous reconfiguration.....	209
8.2.2.12a	Incompatible simultaneous security reconfiguration.....	210
8.2.2.12b	Cell update procedure during security reconfiguration.....	210
8.2.2.13	Invalid received message.....	211
8.2.2.14	Radio link failure.....	211
8.2.3	Radio bearer release.....	212
8.2.4	Transport channel reconfiguration.....	212
8.2.5	Transport format combination control.....	213
8.2.5.1	General.....	213
8.2.5.2	Initiation.....	213
8.2.5.3	Reception of a TRANSPORT FORMAT COMBINATION CONTROL message by the UE.....	213

8.2.5.4	Invalid configuration.....	215
8.2.5.5	Invalid TRANSPORT FORMAT COMBINATION CONTROL message	216
8.2.6	Physical channel reconfiguration.....	216
8.2.7	Physical Shared Channel Allocation [TDD only].....	217
8.2.7.1	General.....	217
8.2.7.2	Initiation.....	217
8.2.7.3	Reception of a PHYSICAL SHARED CHANNEL ALLOCATION message by the UE.....	217
8.2.7.4	Invalid PHYSICAL SHARED CHANNEL ALLOCATION message.....	219
8.2.8	PUSCH capacity request [TDD only].....	220
8.2.8.1	General.....	220
8.2.8.2	Initiation.....	220
8.2.8.3	PUSCH CAPACITY REQUEST message contents to set.....	221
8.2.8.4	Reception of a PUSCH CAPACITY REQUEST message by the UTRAN.....	222
8.2.8.5	T310 expiry.....	222
8.2.9	Void.....	222
8.2.10	Uplink Physical Channel Control [TDD only].....	222
8.2.10.1	General.....	222
8.2.10.2	Initiation.....	222
8.2.10.3	Reception of UPLINK PHYSICAL CHANNEL CONTROL message by the UE.....	222
8.2.10.4	Invalid UPLINK PHYSICAL CHANNEL CONTROL message.....	223
8.2.11	Physical channel reconfiguration failure.....	223
8.2.11.1	General.....	224
8.2.11.2	Runtime error due to overlapping compressed mode configurations.....	224
8.2.11.3	Void.....	224
8.3	RRC connection mobility procedures.....	224
8.3.1	Cell and URA update procedures	224
8.3.1.1	General.....	227
8.3.1.2	Initiation.....	228
8.3.1.3	CELL UPDATE / URA UPDATE message contents to set.....	237
8.3.1.4	T305 expiry and the UE detects "out of service area".....	241
8.3.1.4.1	Re-entering "in service area".....	242
8.3.1.4.2	Expiry of timer T307.....	242
8.3.1.5	Reception of an CELL UPDATE/URA UPDATE message by the UTRAN.....	243
8.3.1.6	Reception of the CELL UPDATE CONFIRM/URA UPDATE CONFIRM message by the UE.....	243
8.3.1.7	Transmission of a response message to UTRAN.....	253
8.3.1.7a	Physical channel failure	257
8.3.1.8	Unsupported configuration by the UE	258
8.3.1.9	Invalid configuration.....	260
8.3.1.9a	Incompatible simultaneous reconfiguration.....	261
8.3.1.9b	Security reconfiguration during Cell update procedure	262
8.3.1.10	Confirmation error of URA ID list.....	262
8.3.1.11	Invalid CELL UPDATE CONFIRM/URA UPDATE CONFIRM message.....	263
8.3.1.12	T302 expiry or cell reselection.....	264
8.3.1.13	T314 expiry.....	268
8.3.1.14	T315 expiry.....	269
8.3.1.15	Reception of the UTRAN MOBILITY INFORMATION CONFIRM message by the UTRAN	270
8.3.1.16	T320 Expiry.....	270
8.3.2	URA update	270
8.3.3	UTRAN mobility information	270
8.3.3.1	General.....	270
8.3.3.2	Initiation.....	271
8.3.3.3	Reception of UTRAN MOBILITY INFORMATION message by the UE.....	271
8.3.3.4	Reception of an UTRAN MOBILITY INFORMATION CONFIRM message by the UTRAN.....	276
8.3.3.5	Cell re-selection	276
8.3.3.5a	Incompatible simultaneous security reconfiguration.....	276
8.3.3.6	Invalid UTRAN MOBILITY INFORMATION message.....	277
8.3.3.7	T322 expiry.....	277
8.3.4	Active set update.....	277
8.3.4.1	General.....	278
8.3.4.2	Initiation.....	278
8.3.4.3	Reception of an ACTIVE SET UPDATE message by the UE.....	279
8.3.4.3a	Handling of ACTIVE SET UPDATE message on secondary uplink frequency (FDD only).....	281

8.3.4.4	Unsupported configuration in the UE	283
8.3.4.5	Invalid configuration.....	283
8.3.4.5a	Void.....	284
8.3.4.5b	Incompatible simultaneous reconfiguration	284
8.3.4.6	Reception of the ACTIVE SET UPDATE COMPLETE message by the UTRAN	285
8.3.4.7	Reception of the ACTIVE SET UPDATE FAILURE message by the UTRAN	285
8.3.4.8	Invalid ACTIVE SET UPDATE message.....	285
8.3.4.9	Reception of an ACTIVE SET UPDATE message in wrong state	285
8.3.5	Hard handover	286
8.3.5.1	Timing re-initialised hard handover	286
8.3.5.1.1	General	286
8.3.5.1.2	Initiation (FDD only).....	286
8.3.5.2	Timing-maintained hard handover	287
8.3.5.2.1	General	287
8.3.5.2.2	Initiation (FDD only).....	288
8.3.6	Inter-RAT handover to UTRAN.....	288
8.3.6.1	General	288
8.3.6.2	Initiation.....	288
8.3.6.3	Reception of HANDOVER TO UTRAN COMMAND message by the UE	289
8.3.6.4	Invalid Handover to UTRAN command message.....	295
8.3.6.4a	Unsupported configuration in HANDOVER TO UTRAN COMMAND message.....	295
8.3.6.5	UE fails to perform handover.....	295
8.3.6.6	Reception of message HANDOVER TO UTRAN COMPLETE by the UTRAN	295
8.3.7	Inter-RAT handover from UTRAN	296
8.3.7.1	General	296
8.3.7.2	Initiation.....	296
8.3.7.3	Reception of a HANDOVER FROM UTRAN COMMAND message by the UE.....	297
8.3.7.4	Successful completion of the inter-RAT handover	298
8.3.7.5	UE fails to complete requested handover.....	299
8.3.7.6	Invalid HANDOVER FROM UTRAN COMMAND message	300
8.3.7.7	Reception of an HANDOVER FROM UTRAN FAILURE message by UTRAN	300
8.3.7.8	Unsupported configuration in HANDOVER FROM UTRAN COMMAND message.....	300
8.3.7.8a	Reception of HANDOVER FROM UTRAN COMMAND message by UE in CELL_FACH.....	301
8.3.8	Inter-RAT cell reselection to UTRAN.....	301
8.3.8.1	General	301
8.3.8.2	Initiation.....	302
8.3.8.2a	Initiation of inter-RAT cell reselection from GERAN <i>Iu mode</i>	302
8.3.8.3	UE fails to complete an inter-RAT cell reselection.....	303
8.3.8.3a	UE fails to complete an inter-RAT cell reselection from GERAN <i>Iu mode</i>	303
8.3.9	Inter-RAT cell reselection from UTRAN	303
8.3.9.1	General	303
8.3.9.2	Initiation.....	303
8.3.9.2a	Initiation of inter-RAT cell reselection to GERAN <i>Iu mode</i>	303
8.3.9.3	Successful cell reselection.....	303
8.3.9.4	UE fails to complete an inter-RAT cell reselection.....	304
8.3.10	Inter-RAT cell change order to UTRAN	304
8.3.10.1	General	304
8.3.10.2	Initiation.....	304
8.3.10.3	UE fails to complete an inter-RAT cell change order	304
8.3.11	Inter-RAT cell change order from UTRAN.....	304
8.3.11.1	General	305
8.3.11.2	Initiation.....	305
8.3.11.3	Reception of an CELL CHANGE ORDER FROM UTRAN message by the UE	305
8.3.11.4	Successful completion of the cell change order	306
8.3.11.5	Expiry of timer T309 or UE fails to complete requested cell change order	306
8.3.11.6	Unsupported configuration in CELL CHANGE ORDER FROM UTRAN message	308
8.3.11.7	Invalid CELL CHANGE ORDER FROM UTRAN message.....	308
8.4	Measurement procedures.....	309
8.4.0	Measurement related definitions.....	309
8.4.1	Measurement control	311
8.4.1.1	General	311
8.4.1.2	Initiation.....	311

8.4.1.3	Reception of MEASUREMENT CONTROL by the UE	311
8.4.1.4	Unsupported measurement in the UE.....	324
8.4.1.4a	Configuration Incomplete	324
8.4.1.5	Invalid MEASUREMENT CONTROL message.....	325
8.4.1.6	Measurements after transition from CELL_DCH to CELL_FACH/CELL_PCH/URA_PCH state ...	325
8.4.1.6.1	Intra-frequency measurement	325
8.4.1.6.2	Inter-frequency measurement	326
8.4.1.6.3	Inter-RAT measurement	327
8.4.1.6.4	Quality measurement.....	327
8.4.1.6.5	UE internal measurement	328
8.4.1.6.6	Traffic volume measurement.....	328
8.4.1.6.7	UE positioning measurement.....	329
8.4.1.6.8	CSG Proximity detection measurement.....	331
8.4.1.6a	Actions in CELL_FACH/CELL_PCH/URA/PCH state upon cell re-selection	331
8.4.1.7	Measurements after transition from CELL_FACH to CELL_DCH state	331
8.4.1.7.1	Intra-frequency measurement	331
8.4.1.7.2	Inter-frequency measurement	332
8.4.1.7.3	Inter-RAT measurement	332
8.4.1.7.4	Traffic volume measurement.....	332
8.4.1.7.5	UE positioning measurement.....	333
8.4.1.7.6	CSG Proximity detection measurement.....	333
8.4.1.7.7	E-UTRA measurement for CELL_FACH	334
8.4.1.8	Measurements after transition from idle mode to CELL_DCH state	334
8.4.1.8.1	Intra-frequency measurement	334
8.4.1.8.2	Inter-frequency measurement	334
8.4.1.8.3	Inter-RAT measurement	334
8.4.1.8.4	Traffic volume measurement.....	334
8.4.1.8.5	UE positioning measurement.....	334
8.4.1.9	Measurements after transition from idle mode to CELL_FACH state.....	335
8.4.1.9.1	Intra-frequency measurement	335
8.4.1.9.2	Inter-frequency measurement	335
8.4.1.9.3	Inter-RAT measurement.....	335
8.4.1.9.4	Traffic volume measurement.....	336
8.4.1.9.5	UE positioning measurement.....	336
8.4.1.9a	Measurements after transition from connected mode to idle mode.....	336
8.4.1.9a.1	Intra-frequency measurement	337
8.4.1.9a.2	Inter-frequency measurement	337
8.4.1.9a.3	Inter-RAT measurement	337
8.4.1.9a.4	UE positioning measurement.....	337
8.4.1.9b	Measurements after transition from CELL_FACH to CELL_PCH/URA_PCH.....	337
8.4.1.9b.1	Traffic volume measurement	337
8.4.1.9b.2	UE positioning measurement.....	338
8.4.1.9b.3	Inter-RAT measurement	338
8.4.1.9b.4	Intra-frequency measurement	338
8.4.1.9b.5	Inter-frequency measurement	338
8.4.1.9b.6	E-UTRA measurement for CELL_FACH	339
8.4.1.9c	Measurements after transition from CELL_PCH/URA_PCH to CELL_FACH	339
8.4.1.9c.1	Traffic volume measurement.....	339
8.4.1.9c.2	UE positioning measurement.....	339
8.4.1.9c.3	Inter-RAT measurement	339
8.4.1.10	Changes in measurement objects	340
8.4.1.10.1	Traffic volume measurement.....	340
8.4.1.10.2	Quality measurement.....	341
8.4.1.10.3	Intra-frequency, Inter-frequency and Inter-RAT measurements	341
8.4.1.11	Cell Reselection (FDD only and 1.28 Mcps TDD only).....	341
8.4.1.11.1	Traffic volume measurement.....	341
8.4.2	Measurement report	342
8.4.2.1	General	342
8.4.2.2	Initiation.....	342
8.4.3	Assistance Data Delivery	345
8.4.3.1	General	345
8.4.3.2	Initiation.....	345

8.4.3.3	Reception of ASSISTANCE DATA DELIVERY message by the UE.....	345
8.4.3.4	Invalid ASSISTANCE DATA DELIVERY message.....	345
8.5	General procedures.....	346
8.5.1	Selection of initial UE identity.....	346
8.5.2	Actions when entering idle mode from connected mode.....	346
8.5.3	Open loop power control upon establishment of DPCCCH.....	348
8.5.4	Physical channel establishment criteria in CELL_DCH state.....	349
8.5.4A	Physical channel establishment criteria for Enhanced Uplink in CELL_FACH state and Idle mode.....	349
8.5.4B	Physical channel establishment criteria in CELL_DCH state on the secondary uplink frequency (FDD only).....	349
8.5.5	Actions in "out of service area" and "in service area".....	350
8.5.5.1	Detection of "out of service" area.....	350
8.5.5.1.1	Actions following detection of "out of service" area in URA_PCH or CELL_PCH state.....	350
8.5.5.1.2	Actions following detection of "out of service" area in CELL_FACH state.....	350
8.5.5.1.3	Actions following detection of "out of service" area on transition from CELL_DCH to URA_PCH or CELL_PCH.....	350
8.5.5.1.4	Actions following detection of "out of service" area on transition from CELL_DCH to CELL_FACH.....	350
8.5.5.2	Detection of "in service" area.....	351
8.5.5.2.1	Actions following Re-entry into "in service area" in URA_PCH or CELL_PCH state.....	351
8.5.5.2.2	Actions following re-entry into "in service area" in CELL_FACH state.....	351
8.5.5.3	T316 expiry.....	351
8.5.5.4	T317 expiry.....	352
8.5.6	Radio link failure criteria and actions upon radio link failure.....	352
8.5.6a	Radio link failure criteria and actions upon radio link failure on the secondary uplink frequency (FDD only).....	353
8.5.7	Open loop power control.....	353
8.5.8	Maintenance of Hyper Frame Numbers.....	357
8.5.9	START value calculation.....	358
8.5.10	Integrity protection.....	359
8.5.10.1	Integrity protection in downlink.....	360
8.5.10.2	Integrity protection in uplink.....	361
8.5.10.3	Calculation of message authentication code.....	362
8.5.11	FACH measurement occasion calculation.....	362
8.5.11a	CELL_DCH measurement occasion calculation (1.28 Mcps TDD only).....	364
8.5.12	Establishment of Access Service Classes.....	364
8.5.13	Mapping of Access Classes to Access Service Classes.....	365
8.5.14	PLMN Type Selection.....	366
8.5.14a	Neighbour cells list narrowing for cell reselection.....	366
8.5.15	CFN calculation.....	366
8.5.15.1	Initialisation for CELL_DCH state after state transition.....	366
8.5.15.2	Initialisation in CELL_DCH state at hard handover.....	366
8.5.15.3	Initialisation for CELL_FACH.....	367
8.5.15.4	Initialisation after intersystem handover to UTRAN.....	367
8.5.15.5	Initialisation for MTCH and/or MSCH carried on S-CCPCH that may be soft combined.....	367
8.5.16	Configuration of CTCH occasions.....	367
8.5.17	PRACH selection.....	368
8.5.18	Selection of RACH TTI.....	369
8.5.18.1	FDD.....	369
8.5.18.2	1.28 Mcps TDD.....	370
8.5.19	Secondary CCPCH selection.....	370
8.5.19a	Secondary CCPCH and FACH selection for MCCH reception.....	371
8.5.20	Unsupported configuration.....	371
8.5.21	Actions related to Radio Bearer mapping.....	371
8.5.22	Actions when entering another RAT from connected mode.....	380
8.5.23	Measured results on RACH.....	380
8.5.24	Change of PLMN while in RRC connected mode.....	383
8.5.25	Actions related to HS_DSCH_RECEPTION variable.....	384
8.5.26	Service prioritisation.....	386
8.5.27	MBMS frequency selection.....	386
8.5.28	Actions related to E_DCH_TRANSMISSION variable.....	388
8.5.29	MBMS modification period identity calculation.....	391

8.5.30	Detecting MBMS service reception inability.....	391
8.5.31	Actions related to DEFERRED_MEASUREMENT_STATUS variable	392
8.5.32	Actions related to MIMO_PARAMS variable.....	392
8.5.33	Actions related to MIMO_STATUS variable	393
8.5.34	Actions related to DTX_DRX_STATUS variable (FDD only)	394
8.5.35	Actions related to HS_SCCH_LESS_STATUS variable (FDD only).....	395
8.5.36	Actions related to HS_DSCH_RECEPTION_CELL_FACH_STATE variable (FDD and 1.28 Mcps TDD only).....	396
8.5.37	Actions related to HS_DSCH_RECEPTION_OF_CCCH_ENABLED variable (FDD and 1.28 Mcps TDD only).....	398
8.5.37a	Actions related to HS_DSCH_RECEPTION_GENERAL	398
8.5.38	Common H-RNTI selection (FDD and 1.28 Mcps TDD only).....	399
8.5.39	PICH selection for HSDPA based paging (FDD and 1.28 Mcps TDD only)	399
8.5.40	HS_DSCH Reception in CELL_PCH and URA_PCH (FDD only)	400
8.5.40a	HS_DSCH Reception in CELL_PCH and URA_PCH (1.28 Mcps TDD only)	401
8.5.41	HS-PDSCH channelisation codes selection for paging reception (FDD and 1.28 Mcps TDD only)	402
8.5.42	Autonomous UTRAN DRX Cycle length coefficient change	403
8.5.43	Reception of MBMS from a cell operating in MBSFN mode	403
8.5.44	HS-DSCH CQI reporting tables.....	403
8.5.45	Enhanced Uplink in CELL_FACH state and Idle mode (FDD only)	403
8.5.45a	Enhanced Uplink in CELL_FACH state and Idle mode (1.28 Mcps TDD only)	406
8.5.46	Actions related to COMMON_E_DCH_TRANSMISSION variable (FDD and 1.28 Mcps TDD only).....	407
8.5.47	Actions related to READY_FOR_COMMON_EDCH variable (FDD and 1.28 Mcps TDD only)	409
8.5.48	Actions related to HS_DSCH_DRX_CELL_FACH_STATUS variable (FDD and 1.28 Mcps TDD only) and HS_DSCH_DRX_CELL_FACH_2CYCLE_STATUS variable (FDD only)	412
8.5.49	CELL_FACH HS-DSCH DRX operation (FDD only).....	413
8.5.49a	CELL_FACH HS-DSCH DRX operation (1.28Mcps TDD only).....	413
8.5.49b	CELL_FACH HS-DSCH DRX operation with second DRX cycle (FDD only).....	414
8.5.50	Common E-RNTI selection (1.28 Mcps TDD only).....	415
8.5.51	Actions related to SECONDARY_CELL_HS_DSCH_RECEPTION variable (FDD only).....	416
8.5.52	Actions related to TARGET_CELL_PRECONFIGURATION variable (FDD only)	418
8.5.53	Actions related to CONTROL_CHANNEL_DRX_STATUS variable (1.28 Mcps TDD only).....	418
8.5.54	Actions related to E_DCH_SPS_STATUS variable (1.28 Mcps TDD only)	419
8.5.55	Actions related to HS_DSCH_SPS_STATUS variable (1.28 Mcps TDD only)	419
8.5.56	Actions related to HSPA_RNTI_STORED_CELL_PCH variable (FDD and 1.28 Mcps TDD only)	420
8.5.57	Actions related to SECONDARY_CELL_MIMO_STATUS variable.....	421
8.5.58	Actions related to SECONDARY_CELL_E_DCH_TRANSMISSION variable (FDD only)	423
8.5.59	Actions related to reception of a HS-SCCH order for secondary uplink frequency activation/deactivation (FDD only)	425
8.5.60	Configuration of "TSN field extension" for MAC-ehs entity	425
8.5.61	Actions related to MU_MIMO_STATUS variable (1.28 Mcps TDD only).....	425
8.5.62	Actions related to MULTI_CARRIER_E_DCH_TRANSMISSION variable (1.28Mcps TDD only)....	426
8.5.63	Logged Measurements Configuration.....	427
8.5.63.1	General	427
8.5.63.2	Initiation.....	427
8.5.63.3	Reception of LOGGING MEASUREMENT CONFIGURATION by the UE	427
8.5.63.4	T326 Expiry	428
8.5.63.5	T327 Expiry	428
8.5.64	UE INFORMATION	429
8.5.64.1	General	429
8.5.64.2	Initiation.....	429
8.5.64.3	Reception of the UE INFORMATION REQUEST message by the UE.....	429
8.5.64.4	Reception of the UE INFORMATION RESPONSE message by the UTRAN	430
8.5.65	Measurements logging.....	430
8.5.65.1	General	430
8.5.65.2	Initiation.....	430
8.5.66	Release of Logged Measurements Configuration	431
8.5.66.1	General	431
8.5.66.2	Initiation.....	431
8.5.67	Measurements logging for ANR.....	432
8.5.67.1	General	432

8.5.67.2	Initiation.....	432
8.5.68	Release of ANR Logging Measurements Configuration	433
8.5.68.1	General.....	433
8.5.68.2	Initiation.....	434
8.5.69	Actions related to UPLINK_CLTD_TRANSMISSION variable (FDD only)	434
8.5.70	Actions related to UPLINK_OLTD_TRANSMISSION variable (FDD only)	435
8.5.71	Actions related to MULTIFLOW_STATUS variable (FDD only).....	435
8.5.72	Selection of common E-DCH TTI (FDD only)	436
8.5.73	PRACH preamble control parameters selection with Concurrent Deployment of 2ms and 10ms TTI (for Enhanced Uplink, FDD only)	437
8.5.74	PRACH preamble control parameters selection without Concurrent Deployment of 2ms and 10ms TTI (for Enhanced Uplink, FDD only)	439
8.5.75	Actions related to READY_FOR_COMMON_ERGCH variable (FDD only)	440
8.5.76	Actions related to FALLBACK_R99_PRACH_ENABLED variable (FDD only)	441
8.5.77	Actions related to READY_FOR_FALLBACK_R99_PRACH variable (FDD only)	441
8.5.78	Actions related to MIMO_MODE_WITH_FOUR_TRANSMIT_ANTENNAS_PARAMS variable (FDD only).....	442
8.5.79	Actions related to MIMO_MODE_WITH_FOUR_TRANSMIT_ANTENNAS_STATUS variable(FDD only).....	442
8.5.80	Actions related to SECONDARY_CELL_MIMO_MODE_WITH_FOUR_TRANSMIT_ANTENNAS_STATUS variable (FDD only).....	443
8.5.81	Actions related to UPLINK_MIMO_TRANSMISSION variable (FDD only)	445
8.5.82	Actions related to NON_RECTANGULAR_RESOURCE_ALLOCATION_STATUS variable (1.28 Mcps TDD only).....	446
8.5.83	Actions related to DPCCH2_TRANSMISSION variable (FDD only)	446
8.5.84	Actions related to DCH_ENHANCEMENTS_STATUS variable (FDD only).....	446
8.5.85	Actions related to IMPLICIT_GRANT variable (FDD only).....	447
8.5.86	Actions related to reception of a HS-SCCH order for TTI switching (FDD only)	448
8.6	Generic actions on receipt and absence of an information element.....	448
8.6.1	CN information elements.....	448
8.6.1.1	Void.....	448
8.6.1.2	CN information info	448
8.6.1.3	Signalling connection release indication.....	449
8.6.2	UTRAN mobility information elements	449
8.6.2.1	URA identity.....	449
8.6.2.2	Mapping info.....	450
8.6.2.3	RNC support for change of UE capability	450
8.6.2.4	CSG PSC Split Information	450
8.6.2.5	E-UTRA detection	451
8.6.3	UE information elements	451
8.6.3.1	Activation time.....	451
8.6.3.1a	CN domain specific DRX cycle length coefficient	452
8.6.3.1b	H-RNTI.....	452
8.6.3.2	UTRAN DRX Cycle length coefficient	453
8.6.3.3	Generic state transition rules depending on received information elements	454
8.6.3.4	Ciphering mode info	454
8.6.3.5	Integrity protection mode info.....	457
8.6.3.5.1	Initialisation of Integrity Protection.....	458
8.6.3.5.2	Integrity Protection Re-configuration for SRNS Relocation, intra-RAT SR-VCC and handover from GERAN Iu mode.....	459
8.6.3.5.3	Integrity Protection modification in case of new keys or initialisation of signalling connection ..	460
8.6.3.6	Void.....	461
8.6.3.7	Void.....	461
8.6.3.8	Integrity check info	461
8.6.3.9	New C-RNTI.....	461
8.6.3.9a	New DSCH-RNTI.....	461
8.6.3.10	New U-RNTI.....	462
8.6.3.11	RRC transaction identifier.....	462
8.6.3.12	Capability Update Requirement	467
8.6.3.13	Group release information.....	468
8.6.3.14	New E-RNTI.....	469

8.6.3.15	SR-VCC Info.....	470
8.6.3.16	rSR-VCC Info	470
8.6.3.17	Access Group identity	470
8.6.4	Radio bearer information elements	471
8.6.4.1	Signalling RB information to setup list.....	471
8.6.4.2	RAB information for setup.....	472
8.6.4.2a	RAB information to reconfigure	474
8.6.4.3	RB information to setup	474
8.6.4.4	RB information to be affected.....	476
8.6.4.4a	Void.....	476
8.6.4.5	RB information to reconfigure	477
8.6.4.6	RB information to release	477
8.6.4.7	RB with PDCP information	478
8.6.4.8	RB mapping info	478
8.6.4.9	RLC Info	481
8.6.4.10	PDCP Info.....	484
8.6.4.11	PDCP SN Info.....	486
8.6.4.12	NAS Synchronisation Indicator	486
8.6.4.13	PDCP context relocation info.....	486
8.6.4.14	RLC Info MBMS	486
8.6.4.15	RAB information for MBMS ptp bearer	487
8.6.5	Transport channel information elements.....	487
8.6.5.1	Transport Format Set.....	487
8.6.5.2	Transport format combination set	489
8.6.5.3	Transport format combination subset.....	490
8.6.5.4	DCH quality target	492
8.6.5.5	Added or Reconfigured UL TrCH information.....	492
8.6.5.5a	Added or reconfigured MAC-d flow.....	493
8.6.5.6	Added or Reconfigured DL TrCH information.....	494
8.6.5.6a	Void.....	495
8.6.5.6b	HARQ Info.....	495
8.6.5.6c	Void.....	497
8.6.5.7	Deleted UL TrCH information.....	497
8.6.5.8	Deleted DL TrCH information.....	497
8.6.5.9	UL Transport channel information common for all transport channels	498
8.6.5.10	DL Transport channel information common for all transport channels	498
8.6.5.11	Void.....	499
8.6.5.12	TFCS Reconfiguration/Addition Information	499
8.6.5.12a	Additional RACH TFCS for CCCH.....	500
8.6.5.13	TFCS Removal Information.....	500
8.6.5.14	Void.....	500
8.6.5.15	TFCS Explicit Configuration	500
8.6.5.16	E-DCH Transmission Time Interval (FDD only).....	500
8.6.5.17	HARQ Info for E-DCH	501
8.6.5.18	Added or reconfigured E-DCH MAC-d flow.....	501
8.6.5.19	SRB1 mapping info (FDD and 1.28 Mcps TDD only)	502
8.6.5.20	HARQ System Info (FDD and 1.28 Mcps TDD only).....	502
8.6.5.21	CCCH mapping info (FDD and 1.28 Mcps TDD only)	503
8.6.5.22	Common MAC-ehs reordering queue (FDD and 1.28 Mcps TDD only).....	503
8.6.5.23	Added or reconfigured MAC-ehs reordering queue.....	503
8.6.5.24	Common E-DCH MAC-d flows (FDD and 1.28 Mcps TDD only)	504
8.6.5.25	Early DCH quality target	504
8.6.6	Physical channel information elements.....	505
8.6.6.1	Frequency info	505
8.6.6.2	Void.....	506
8.6.6.2a	PNBSCH allocation	506
8.6.6.3	Void.....	506
8.6.6.3a	Downlink information per radio link list.....	506
8.6.6.3b	Downlink information per radio link list on secondary UL frequency (FDD only).....	507
8.6.6.4	Downlink information for each radio link.....	508
8.6.6.4a	Downlink information for each radio link on secondary UL frequency (FDD only).....	511
8.6.6.5	Void.....	512

8.6.6.6	Uplink DPCH info	512
8.6.6.7	Void.....	513
8.6.6.8	Maximum allowed UL TX power	513
8.6.6.9	Void.....	513
8.6.6.10	Void.....	513
8.6.6.11	Uplink DPCH power control info	514
8.6.6.12	Secondary CPICH info.....	515
8.6.6.13	Primary CPICH usage for channel estimation	515
8.6.6.14	DPCH frame offset (FDD Only)	516
8.6.6.15	DPCH Compressed mode info	517
8.6.6.16	Repetition period, Repetition length, Offset (TDD only).....	521
8.6.6.16a	Repetition period, Repetition length, Offset _{sub} (1.28 Mcps TDD only).....	521
8.6.6.17	Primary CCPCCH info	522
8.6.6.18	Primary CPICH info.....	522
8.6.6.19	Void.....	522
8.6.6.20	Void.....	522
8.6.6.21	Void.....	523
8.6.6.22	Secondary Scrambling Code, Code Number.....	523
8.6.6.23	PDSCH Power Control info	523
8.6.6.24	Tx Diversity Mode	523
8.6.6.25	Void.....	524
8.6.6.26	UL Timing Advance Control (TDD only)	524
8.6.6.26a	Uplink synchronisation parameters (TDD only)	525
8.6.6.27	Downlink information common for all radio links.....	525
8.6.6.28	Downlink DPCH info common for all radio links	526
8.6.6.28a	Downlink F-DPCH info common for all radio links	528
8.6.6.29	ASC setting	528
8.6.6.30	SRB delay, PC preamble (FDD only)	530
8.6.6.31	Void.....	530
8.6.6.32	Void.....	530
8.6.6.33	HS-SCCH Info	530
8.6.6.34	Measurement Feedback Info	532
8.6.6.35	DPC Mode.....	532
8.6.6.36	Downlink HS-PDSCH Information	532
8.6.6.36a	DL Multi-carrier information (1.28 Mcps TDD only)	533
8.6.6.37	E-DCH Info.....	534
8.6.6.38	DTX-DRX timing information (FDD only).....	535
8.6.6.39	DTX-DRX information (FDD only)	536
8.6.6.40	HS-SCCH less information (FDD only)	537
8.6.6.41	MIMO parameters.....	537
8.6.6.42	UL 16QAM settings.....	538
8.6.6.42b	UL 64QAM settings.....	538
8.6.6.43	Multi-frequency Info (1.28 Mcps TDD only)	538
8.6.6.44	Void.....	538
8.6.6.45	Downlink Secondary Cell Info FDD.....	538
8.6.6.46	Control Channel DRX information (1.28 Mcps TDD only)	540
8.6.6.47	SPS information (1.28 Mcps TDD only).....	540
8.6.6.48	Secondary cell MIMO parameters	542
8.6.6.49	Uplink Secondary Cell Info FDD (FDD only)	542
8.6.6.50	Additional downlink secondary cell info list FDD.....	543
8.6.6.51	MU-MIMO info (1.28 Mcps TDD only).....	543
8.6.6.52	Multi-carrier E-DCH Info for LCR TDD (1.28 Mcps TDD only)	543
8.6.6.53	Serving HS-DSCH cell information.....	544
8.6.6.54	E-DCH reconfiguration information	544
8.6.6.55	Additional downlink secondary cell info list FDD 2.....	545
8.6.6.56	Uplink CLTD info FDD.....	545
8.6.6.57	Uplink OLTLD info FDD.....	546
8.6.6.58	F-TPICH reconfiguration info.....	546
8.6.6.59	Common E-RGCH info FDD.....	546
8.6.6.60	MIMO_MODE_WITH_FOUR_TRANSMIT_ANTENNAS parameters (FDD only)	547
8.6.6.61	Secondary cell MIMO_MODE_WITH_FOUR_TRANSMIT_ANTENNAS parameters (FDD only)	548

8.6.6.62	Uplink MIMO info FDD	548
8.6.6.63	DPCCH2 info FDD	548
8.6.6.64	DCH Enhancements info FDD	549
8.6.6.65	Other TTI E-DCH Configuration Information	549
8.6.7	Measurement information elements	550
8.6.7.1	Measurement validity	550
8.6.7.2	Filter coefficient	550
8.6.7.3	Intra-frequency/Inter-frequency/Inter-RAT cell info list	552
8.6.7.3a	UTRA priority info list	561
8.6.7.3b	GSM priority info list	563
8.6.7.3c	E-UTRA frequency and priority info list	563
8.6.7.3d	E-UTRA frequency list	573
8.6.7.4	Intra-frequency measurement quantity	573
8.6.7.5	Inter-RAT measurement quantity	573
8.6.7.6	Inter-RAT reporting quantity	575
8.6.7.7	Cell Reporting Quantities	576
8.6.7.8	Periodical Reporting Criteria	576
8.6.7.9	Reporting Cell Status	577
8.6.7.10	Traffic Volume Measurement	578
8.6.7.11	Traffic Volume Measurement Reporting Criteria	579
8.6.7.12	FACH measurement occasion info	579
8.6.7.13	Measurement Reporting Mode	581
8.6.7.14	Inter-frequency measurement	581
8.6.7.15	Inter-RAT measurement	582
8.6.7.16	Intra-frequency measurement	583
8.6.7.17	Quality measurement	584
8.6.7.18	UE internal measurement	584
8.6.7.18a	Void	584
8.6.7.19	UE positioning	584
8.6.7.19.0	UE positioning reporting criteria	584
8.6.7.19.1	UE positioning reporting quantity	584
8.6.7.19.1a	UE positioning reporting for UE assisted methods	586
8.6.7.19.1b	UE positioning reporting for UE based methods	589
8.6.7.19.2	UE positioning OTDOA assistance data for UE-assisted	591
8.6.7.19.2a	UE positioning OTDOA assistance data for UE-based	592
8.6.7.19.3	UE positioning GPS assistance data	593
8.6.7.19.3.1	UE positioning GPS acquisition assistance	593
8.6.7.19.3.2	UE positioning GPS Almanac	594
8.6.7.19.3.3	UE positioning D-GPS Corrections	595
8.6.7.19.3.3a	UE positioning GPS Navigation Model	595
8.6.7.19.3.4	UE positioning GPS Ephemeris and Clock Correction Parameters	595
8.6.7.19.3.5	UE positioning GPS ionospheric model	595
8.6.7.19.3.6	UE positioning GPS real-time integrity	596
8.6.7.19.3.7	UE positioning GPS reference time	596
8.6.7.19.3.8	UE positioning GPS reference UE position	597
8.6.7.19.3.9	UE positioning UTC model	597
8.6.7.19.4	UE positioning Ciphering info	597
8.6.7.19.5	UE positioning Error	599
8.6.7.19.6	Void	600
8.6.7.19.7	UE positioning GANSS assistance data	600
8.6.7.19.7.1	UE positioning GANSS reference measurement information	600
8.6.7.19.7.2	UE positioning GANSS Almanac	601
8.6.7.19.7.3	UE positioning D-GANSS Corrections	601
8.6.7.19.7.4	UE positioning GANSS Navigation Model	601
8.6.7.19.7.4a	UE positioning GANSS Clock Model	601
8.6.7.19.7.4b	UE positioning GANSS Orbit Model	602
8.6.7.19.7.5	UE positioning GANSS ionospheric model	602
8.6.7.19.7.6	UE positioning GANSS real-time integrity	602
8.6.7.19.7.7	UE positioning GANSS reference time	602
8.6.7.19.7.8	UE positioning GANSS reference UE position	603
8.6.7.19.7.9	UE positioning GANSS time model	603
8.6.7.19.7.10	UE positioning GANSS UTC model	604

8.6.7.19.7.11	UE positioning GANSS data bit assistance	604
8.6.7.19.7.12	UE positioning GANSS additional ionospheric model	604
8.6.7.19.7.13	UE positioning GANSS Earth orientation parameters	604
8.6.7.19.7.14	UE positioning GANSS additional navigation models	604
8.6.7.19.7.14a	UE positioning GANSS additional clock models	604
8.6.7.19.7.14b	UE positioning GANSS additional orbit models	605
8.6.7.19.7.15	UE positioning GANSS additional UTC models	605
8.6.7.19.7.16	UE positioning GANSS auxiliary information	605
8.6.7.19.7.17	UE positioning DBDS corrections	605
8.6.7.19.7.18	UE positioning BDS Ionospheric Grid Model	606
8.6.7.20	Void	606
8.6.7.21	Intra-frequency reporting quantity for RACH reporting	606
8.6.7.22	Additional Measurement List	606
8.6.7.23	Dedicated Priority Information	607
8.6.7.24	Adjacent frequency index	608
8.6.7.24a	Inter-band frequency index	608
8.6.7.25	Idle Interval Information (TDD only)	609
8.6.7.26	CELL_DCH measurement occasion info LCR	609
8.6.7.27	Frequency index list for enhanced measurement	609
8.6.7.28	E-UTRA measurement for CELL_FACH	610
8.6.7.29	Dedicated WLAN Offload Information	611
8.6.7.30	T330 expiry	611
8.6.7.31	Filtered UE power headroom reporting information	611
8.6.8	Void	612
8.6.8a	Other Information elements	612
8.6.8a.1	ETWS information	612
8.6.9	MBMS specific information elements	612
8.6.9.1	Continue MCCH Reading	612
8.6.9.1a	MBMS dynamic persistence level	612
8.6.9.2	MBMS PL Service Restriction Information	612
8.6.9.3	MBMS L1 combining schedule	612
8.6.9.3a	MBMS Number of neighbour cells	613
8.6.9.4	MBMS Preferred frequency information	613
8.6.9.4a	Void	613
8.6.9.4b	MBMS p-t-m activation time	613
8.6.9.5	MBMS RB list released to change transfer mode	614
8.6.9.6	MBMS Required UE action	614
8.6.9.6a	MBMS re- acquire MCCH	615
8.6.9.7	MBMS Service transmissions info list	615
8.6.9.8	MBMS Short transmission ID	615
8.6.9.9	MBMS Transmission identity	616
8.6.9.9a	MBMS transmission time difference	616
8.6.9.9ab	MBSFN cluster frequency	616
8.6.9.9ac	MBSFN frequency list	617
8.6.9.9ad	MBSFN inter frequency neighbour list	617
8.6.9.9ae	MBSFN TDM Information	618
8.6.9.9b	MCCH configuration information	618
8.6.9.10	Next scheduling period	618
8.6.9.11	TDD MBSFN Information	618
8.6.9.12	Network Standard Time Information	619
8.7	MBMS specific procedures	619
8.7.1	Reception of MBMS control information	619
8.7.1.1	General	619
8.7.1.2	Initiation	620
8.7.1.3	UE requirements on reading of MCCH information	620
8.7.1.4	UE requirements on reading of MSCH information	621
8.7.2	MCCH acquisition	621
8.7.2.1	General	621
8.7.2.2	Initiation	622
8.7.2.3	MCCH information to be acquired by the UE	622
8.7.2.4	Reception of the MBMS MODIFIED SERVICES INFORMATION and the MBMS UNMODIFIED SERVICES INFORMATION by the UE	622

8.7.2.5	Reception of the other MBMS messages by the UE	623
8.7.3	MBMS Notification	623
8.7.3.1	General	624
8.7.3.2	Initiation	624
8.7.3.3	Receiving the MBMS Notification information	624
8.7.3.3.1	Reception via MCCH	624
8.7.3.3.2	Void	625
8.7.3.3.3	Reception via DCCH	625
8.7.3.4	UE action upon receiving MBMS MODIFIED SERVICES INFORMATION message	625
8.7.3.5	UE fails to receive MBMS Notification information	627
8.7.4	MBMS counting	627
8.7.4.1	General	627
8.7.4.2	Initiation	627
8.7.4.3	Reception of the MBMS ACCESS INFORMATION	627
8.7.4.4	Termination of the MBMS counting procedure	629
8.7.4.5	Failure of the counting response procedure	629
8.7.5	MBMS p-t-m radio bearer configuration	629
8.7.5.1	General	629
8.7.5.2	Initiation	629
8.7.5.3	Reception of the MBMS Current Cell PTM RB information	630
8.7.5.4	Reception of the MBMS Neighbouring Cell PTM RB information	630
8.7.6	MBMS modification request	630
8.7.6.1	General	630
8.7.6.2	Initiation	631
8.7.6.2a	MBMS MODIFICATION REQUEST message contents to set	631
8.7.6.3	Reception of a MBMS MODIFICATION REQUEST message by the UTRAN	632
8.7.7	MBMS service scheduling	632
8.7.7.1	General	632
8.7.7.2	Initiation	632
8.7.7.3	Reception of the MBMS scheduling information	632
9	Handling of unknown, unforeseen and erroneous protocol data	633
9.1	General	633
9.2	ASN.1 violation or encoding error	633
9.3	Unknown or unforeseen message type	634
9.3a	Unsolicited received message	634
9.3b	Unexpected critical message extension	634
9.4	Unknown or unforeseen information element value, mandatory information element	635
9.5	Conditional information element error	635
9.6	Unknown or unforeseen information element value, conditional information element	636
9.7	Unknown or unforeseen information element value, optional information element	637
9.8	Unexpected non-critical message extension	637
9.9	Handling of errors in nested information elements	637
10	Message and information element functional definition and content	638
10.1	General	638
10.1.1	Protocol extensions	639
10.1.1.1	Non-critical extensions	641
10.1.1.1.1	Extension of an information element with additional values or choices	641
10.1.1.1.2	Extension of a message with additional information elements	641
10.1.1.2	Critical extensions	642
10.1.1.2.1	Extension of an information element with additional values or choices	642
10.1.1.2.2	Extension of a message with additional information elements	642
10.2	Radio Resource Control messages	642
10.2.1	ACTIVE SET UPDATE	642
10.2.2	ACTIVE SET UPDATE COMPLETE	646
10.2.3	ACTIVE SET UPDATE FAILURE	646
10.2.4	ASSISTANCE DATA DELIVERY	647
10.2.5	CELL CHANGE ORDER FROM UTRAN	648
10.2.6	CELL CHANGE ORDER FROM UTRAN FAILURE	649
10.2.7	CELL UPDATE	649
10.2.7a	CELL UPDATE FDD	653

10.2.8	CELL UPDATE CONFIRM.....	655
10.2.9	COUNTER CHECK.....	661
10.2.10	COUNTER CHECK RESPONSE.....	661
10.2.11	DOWNLINK DIRECT TRANSFER.....	662
10.2.12	Void.....	662
10.2.12a	ETWS PRIMARY NOTIFICATION WITH SECURITY.....	662
10.2.13	Void.....	663
10.2.14	Void.....	663
10.2.15	HANDOVER FROM UTRAN COMMAND.....	663
10.2.16	HANDOVER FROM UTRAN FAILURE.....	666
10.2.16a	HANDOVER TO UTRAN COMMAND.....	667
10.2.16b	HANDOVER TO UTRAN COMPLETE.....	670
10.2.16c	INITIAL DIRECT TRANSFER.....	671
10.2.16d	INTER RAT HANDOVER INFO.....	673
10.2.16da	LOGGING MEASUREMENT CONFIGURATION.....	674
10.2.16e	MBMS ACCESS INFORMATION.....	675
10.2.16f	MBMS COMMON P-T-M RB INFORMATION.....	676
10.2.16g	MBMS CURRENT CELL P-T-M RB INFORMATION.....	678
10.2.16h	MBMS GENERAL INFORMATION.....	680
10.2.16i	MBMS MODIFICATION REQUEST.....	682
10.2.16j	MBMS MODIFIED SERVICES INFORMATION.....	682
10.2.16k	MBMS NEIGHBOURING CELL P-T-M RB INFORMATION.....	685
10.2.16L	MBMS SCHEDULING INFORMATION.....	688
10.2.16m	MBMS UNMODIFIED SERVICES INFORMATION.....	689
10.2.17	MEASUREMENT CONTROL.....	690
10.2.18	MEASUREMENT CONTROL FAILURE.....	692
10.2.19	MEASUREMENT REPORT.....	694
10.2.20	PAGING TYPE 1.....	696
10.2.21	PAGING TYPE 2.....	697
10.2.22	PHYSICAL CHANNEL RECONFIGURATION.....	697
10.2.23	PHYSICAL CHANNEL RECONFIGURATION COMPLETE.....	702
10.2.24	PHYSICAL CHANNEL RECONFIGURATION FAILURE.....	703
10.2.25	PHYSICAL SHARED CHANNEL ALLOCATION.....	704
10.2.26	PUSCH CAPACITY REQUEST.....	704
10.2.27	RADIO BEARER RECONFIGURATION.....	705
10.2.28	RADIO BEARER RECONFIGURATION COMPLETE.....	713
10.2.29	RADIO BEARER RECONFIGURATION FAILURE.....	714
10.2.30	RADIO BEARER RELEASE.....	715
10.2.31	RADIO BEARER RELEASE COMPLETE.....	720
10.2.32	RADIO BEARER RELEASE FAILURE.....	722
10.2.33	RADIO BEARER SETUP.....	722
10.2.34	RADIO BEARER SETUP COMPLETE.....	728
10.2.35	RADIO BEARER SETUP FAILURE.....	730
10.2.36	RRC CONNECTION REJECT.....	731
10.2.37	RRC CONNECTION RELEASE.....	732
10.2.38	RRC CONNECTION RELEASE COMPLETE.....	734
10.2.39	RRC CONNECTION REQUEST.....	734
10.2.40	RRC CONNECTION SETUP.....	739
10.2.41	RRC CONNECTION SETUP COMPLETE.....	743
10.2.41a	RRC FAILURE INFO.....	744
10.2.42	RRC STATUS.....	745
10.2.43	SECURITY MODE COMMAND.....	745
10.2.44	SECURITY MODE COMPLETE.....	746
10.2.45	SECURITY MODE FAILURE.....	747
10.2.46	SIGNALLING CONNECTION RELEASE.....	747
10.2.47	SIGNALLING CONNECTION RELEASE INDICATION.....	748
10.2.48	SYSTEM INFORMATION.....	749
10.2.48a	System Information Container.....	750
10.2.48b	SYSTEM INFORMATION 2.....	751
10.2.48.1	First Segment.....	753
10.2.48.1a	First Segment 2.....	753
10.2.48.2	First Segment (short).....	753

10.2.48.2a	First Segment (short) 2.....	754
10.2.48.3	Subsequent Segment	754
10.2.48.3a	Subsequent Segment 2	754
10.2.48.4	Last Segment.....	755
10.2.48.4a	Last Segment 2.....	755
10.2.48.5	Last Segment (short)	755
10.2.48.5a	Last Segment (short) 2	756
10.2.48.6	Complete SIB	756
10.2.48.6a	Complete SIB 2.....	756
10.2.48.7	Complete SIB (short)	757
10.2.48.7a	Complete SIB (short) 2	757
10.2.48.8	System Information Blocks.....	757
10.2.48.8.1	Master Information Block	758
10.2.48.8.2	Scheduling Block 1.....	758
10.2.48.8.3	Scheduling Block 2.....	759
10.2.48.8.3a	Scheduling Block 3.....	759
10.2.48.8.4	System Information Block type 1	759
10.2.48.8.5	System Information Block type 2.....	760
10.2.48.8.6	System Information Block type 3.....	760
10.2.48.8.7	System Information Block type 4.....	763
10.2.48.8.8	System Information Block type 5 and 5bis.....	764
10.2.48.8.9	System Information Block type 6.....	770
10.2.48.8.10	System Information Block type 7	772
10.2.48.8.11	Void.....	772
10.2.48.8.12	Void.....	772
10.2.48.8.13	Void.....	772
10.2.48.8.14	System Information Block type 11	772
10.2.48.8.14a	System Information Block type 11bis	773
10.2.48.8.14b	System Information Block type 11ter.....	774
10.2.48.8.15	System Information Block type 12.....	774
10.2.48.8.16	System Information Block type 13.....	774
10.2.48.8.16.1	System Information Block type 13.1	775
10.2.48.8.16.2	System Information Block type 13.2	775
10.2.48.8.16.3	System Information Block type 13.3	775
10.2.48.8.16.4	System Information Block type 13.4	776
10.2.48.8.17	System Information Block type 14.....	776
10.2.48.8.18	System Information Block type 15.....	776
10.2.48.8.18.0	System Information Block type 15bis.....	777
10.2.48.8.18.1a	System Information Block type 15.1bis.....	777
10.2.48.8.18.1b	System Information Block type 15.1ter.....	778
10.2.48.8.18.2	System Information Block type 15.2	778
10.2.48.8.18.2a	System Information Block type 15.2bis.....	778
10.2.48.8.18.2b	System Information Block type 15.2ter.....	779
10.2.48.8.18.3	System Information Block type 15.3	779
10.2.48.8.18.3a	System Information Block type 15.3bis.....	780
10.2.48.8.18.4	System Information Block type 15.4	780
10.2.48.8.18.4a	System Information Block type 15.5	780
10.2.48.8.18.5	System Information Block type 15.6.....	781
10.2.48.8.18.6	System Information Block type 15.7	781
10.2.48.8.18.7	System Information Block type 15.8	781
10.2.48.8.19	System Information Block type 16.....	782
10.2.48.8.20	System Information Block type 17.....	782
10.2.48.8.21	System Information Block type 18.....	783
10.2.48.8.22	System Information Block type 19.....	783
10.2.48.8.23	System Information Block type 20.....	785
10.2.48.8.24	System Information Block type 21.....	785
10.2.48.8.25	System Information Block type 22.....	786
10.2.48.8.26	System Information Block type 23.....	788
10.2.48.8.27	System Information Block type 24.....	789
10.2.49	SYSTEM INFORMATION CHANGE INDICATION.....	790
10.2.50	TRANSPORT CHANNEL RECONFIGURATION	790
10.2.51	TRANSPORT CHANNEL RECONFIGURATION COMPLETE	796

10.2.52	TRANSPORT CHANNEL RECONFIGURATION FAILURE.....	797
10.2.53	TRANSPORT FORMAT COMBINATION CONTROL.....	798
10.2.54	TRANSPORT FORMAT COMBINATION CONTROL FAILURE.....	799
10.2.55	UE CAPABILITY ENQUIRY	799
10.2.56	UE CAPABILITY INFORMATION.....	800
10.2.57	UE CAPABILITY INFORMATION CONFIRM	800
10.2.57a	UE INFORMATION REQUEST	801
10.2.57b	UE INFORMATION RESPONSE	801
10.2.58	UPLINK DIRECT TRANSFER	802
10.2.59	UPLINK PHYSICAL CHANNEL CONTROL.....	802
10.2.60	URA UPDATE	804
10.2.61	URA UPDATE CONFIRM	805
10.2.62	UTRAN MOBILITY INFORMATION	807
10.2.63	UTRAN MOBILITY INFORMATION CONFIRM	809
10.2.64	UTRAN MOBILITY INFORMATION FAILURE.....	810
10.3	Information element functional definitions	810
10.3.1	CN Information elements.....	810
10.3.1.1	CN domain identity	810
10.3.1.2	CN Domain System Information.....	810
10.3.1.3	CN Information info.....	811
10.3.1.3a	CN Information info full	812
10.3.1.3b	Domain Specific Access Restriction	812
10.3.1.3c	Domain Specific Access Restriction Parameters	813
10.3.1.3d	Domain Specific EAB Parameters	813
10.3.1.3e	EAB Configuration	813
10.3.1.4	IMEI	814
10.3.1.5	IMSI (GSM-MAP).....	814
10.3.1.6	Intra Domain NAS Node Selector.....	814
10.3.1.7	Location Area Identification	816
10.3.1.7oa	Location/Registration Parameters	817
10.3.1.7a	Multiple PLMN List.....	817
10.3.1.8	NAS message	817
10.3.1.9	NAS system information (GSM-MAP).....	818
10.3.1.10	Paging record type identifier	818
10.3.1.10a	Paging Permission with Access Control Parameters.....	818
10.3.1.11	PLMN identity	818
10.3.1.11a	PLMN identity with Optional MCC.....	819
10.3.1.12	PLMN Type	819
10.3.1.13	P-TMSI (GSM-MAP)	819
10.3.1.14	RAB identity	819
10.3.1.15	Routing Area Code.....	820
10.3.1.16	Routing Area Identification.....	820
10.3.1.17	TMSI (GSM-MAP).....	820
10.3.2	UTRAN mobility Information elements	821
10.3.2.1	Cell Access Restriction	821
10.3.2.2	Cell identity.....	821
10.3.2.3	Cell selection and re-selection info for SIB3/4	823
10.3.2.4	Cell selection and re-selection info for SIB11/12	828
10.3.2.5	Mapping Info.....	829
10.3.2.6	URA identity.....	831
10.3.2.7	Dedicated priority Information.....	831
10.3.2.8	CSG Identity	833
10.3.2.9	CSG PSC Split Information	833
10.3.2.10	Dedicated WLAN Offload Information	834
10.3.3	UE Information elements.....	834
10.3.3.1	Activation time.....	834
10.3.3.2	Capability Update Requirement	834
10.3.3.3	Cell update cause	835
10.3.3.4	Ciphering Algorithm	836
10.3.3.5	Ciphering mode info	836
10.3.3.6	CN domain specific DRX cycle length coefficient	836
10.3.3.7	Void.....	837

10.3.3.7a	Common E-RNTI info	837
10.3.3.8	C-RNTI	837
10.3.3.8a	CSG proximity indication capability	837
10.3.3.9	Void.....	838
10.3.3.9a	DSCH-RNTI	838
10.3.3.10	Void.....	838
10.3.3.10a	E-RNTI	838
10.3.3.11	Establishment cause	839
10.3.3.12	Expiration Time Factor	841
10.3.3.12a	Extended Wait Time	841
10.3.3.12b	Expiration Time Factor 2	841
10.3.3.13	Failure cause	841
10.3.3.14	Failure cause and error information	842
10.3.3.14o	Group release information.....	843
10.3.3.14a	H-RNTI.....	843
10.3.3.14b	IMS Voice capability	843
10.3.3.15	Initial UE identity.....	843
10.3.3.16	Integrity check info	844
10.3.3.17	Integrity protection activation info.....	845
10.3.3.18	Integrity protection Algorithm	845
10.3.3.19	Integrity protection mode info.....	845
10.3.3.19a	Void.....	846
10.3.3.20	Void.....	846
10.3.3.21	Measurement capability	847
10.3.3.21a	Measurement capability extension	852
10.3.3.21b	Measurement capability TDD	856
10.3.3.21ba	Multiflow capability.....	857
10.3.3.21bb	Multiflow per band capability	858
10.3.3.21c	Neighbour Cell SI acquisition capability	859
10.3.3.22	Paging cause.....	860
10.3.3.23	Paging record	860
10.3.3.24	PDCP capability	861
10.3.3.25	Physical channel capability	863
10.3.3.25a	Pre-redirectioin info	872
10.3.3.26	Protocol error cause.....	873
10.3.3.27	Protocol error indicator	873
10.3.3.28	RB timer indicator.....	873
10.3.3.29	Redirectioin info.....	874
10.3.3.30	Re-establishment timer.....	874
10.3.3.31	Rejection cause	874
10.3.3.32	Release cause	874
10.3.3.32a	RF Capability Compressed	875
10.3.3.33	RF capability FDD.....	875
10.3.3.33a	RF capability FDD extension	876
10.3.3.33b	RF capability TDD.....	877
10.3.3.33c	RF capability TDD 1.28 Mcps	877
10.3.3.34	RLC capability	878
10.3.3.35	RLC re-establish indicator	878
10.3.3.35a	RRC State Indicator	878
10.3.3.35o	RRC connection release information	879
10.3.3.36	RRC transaction identifier.....	879
10.3.3.36a	rSR-VCC Info	879
10.3.3.37	Security capability.....	880
10.3.3.37a	Signalling Connection Release Indication Cause.....	880
10.3.3.38	START	880
10.3.3.39	Void.....	881
10.3.3.40	Transport channel capability	881
10.3.3.41	UE multi-mode/multi-RAT capability	883
10.3.3.42	UE radio access capability	886
10.3.3.42o	UE radio access capability compressed.....	898
10.3.3.42oa	UE radio access capability comp 2	899
10.3.3.42ob	UE radio access capability comp for 1.28 Mcps TDD.....	902

10.3.3.42a	UE radio access capability extension	903
10.3.3.42b	UE security information	907
10.3.3.42c	UE security information2	907
10.3.3.43	UE Timers and Constants in connected mode	907
10.3.3.44	UE Timers and Constants in idle mode	909
10.3.3.45	UE positioning capability	910
10.3.3.45a	GANSS Signal Id	913
10.3.3.46	URA update cause	914
10.3.3.47	U-RNTI	914
10.3.3.47a	U-RNTI group	915
10.3.3.48	U-RNTI Short	916
10.3.3.49	UTRAN DRX cycle length coefficient	916
10.3.3.50	Wait time	916
10.3.3.51	UE Specific Behaviour Information 1 idle	917
10.3.3.52	UE Specific Behaviour Information 1 interRAT	917
10.3.3.53	UE based network performance measurements parameters	917
10.3.4	Radio Bearer Information elements	917
10.3.4.0a	Common RB mapping info	917
10.3.4.0	Default configuration identity	917
10.3.4.0a	Default configuration for CELL_FACH	918
10.3.4.1	Downlink RLC STATUS info	918
10.3.4.1a	PDCCP context relocation info	919
10.3.4.2	PDCCP info	919
10.3.4.2a	PDCCP ROHC target mode	922
10.3.4.3	PDCCP SN info	922
10.3.4.4	Polling info	922
10.3.4.5	Predefined configuration identity	922
10.3.4.5a	Predefined configuration status information	923
10.3.4.5b	Predefined configuration status information compressed	923
10.3.4.6	Predefined configuration value tag	924
10.3.4.7	Predefined RB configuration	925
10.3.4.8	RAB info	925
10.3.4.9	RAB info Post	926
10.3.4.9a	RAB information for MBMS ptp bearers	926
10.3.4.10	RAB information for setup	927
10.3.4.11	RAB information to reconfigure	928
10.3.4.11a	RAB info to replace	928
10.3.4.12	NAS Synchronization indicator	928
10.3.4.13	RB activation time info	929
10.3.4.14	RB COUNT-C MSB information	929
10.3.4.15	RB COUNT-C information	929
10.3.4.16	RB identity	929
10.3.4.17	RB information to be affected	930
10.3.4.18	RB information to reconfigure	930
10.3.4.19	RB information to release	930
10.3.4.20	RB information to setup	930
10.3.4.21	RB mapping info	931
10.3.4.22	RB with PDCCP information	935
10.3.4.23	RLC info	935
10.3.4.23a	RLC info MBMS	937
10.3.4.24	Signalling RB information to setup	938
10.3.4.24a	SR-VCC Info	938
10.3.4.25	Transmission RLC Discard	938
10.3.4.26	UM Duplication Avoidance and Reordering info	940
10.3.4.27	UM Out of sequence delivery info	940
10.3.5	Transport CH Information elements	940
10.3.5.1	Added or Reconfigured DL TrCH information	940
10.3.5.1a	Added or reconfigured MAC-d flow	941
10.3.5.1b	Added or reconfigured E-DCH MAC-d flow	942
10.3.5.1c	Added or reconfigured MAC-ehs reordering queue	944
10.3.5.2	Added or Reconfigured UL TrCH information	946
10.3.5.2a	Additional Dynamic Transport Format Information for CCCH	946

10.3.5.2b	Additional RACH TFCS for CCCH.....	947
10.3.5.3	Void.....	947
10.3.5.3a	Common MAC-ehs reordering queue list	947
10.3.5.3b	Common E-DCH MAC-d flows	947
10.3.5.4	Deleted DL TrCH information.....	949
10.3.5.5	Deleted UL TrCH information.....	949
10.3.5.6	DL Transport channel information common for all transport channels	950
10.3.5.7	Void.....	950
10.3.5.7a	HARQ Info.....	951
10.3.5.7b	Void.....	953
10.3.5.7c	MAC-d Flow Identity.....	953
10.3.5.7d	HARQ Info for E-DCH.....	953
10.3.5.7e	E-DCH MAC-d Flow Identity.....	954
10.3.5.7f	MAC-ehs Queue Id	954
10.3.5.8	Power Offset Information	954
10.3.5.9	Predefined TrCH configuration.....	956
10.3.5.10	Quality Target	956
10.3.5.11	Semi-static Transport Format Information.....	956
10.3.5.12	Void.....	957
10.3.5.13	TFCS Explicit Configuration	957
10.3.5.14	Void.....	957
10.3.5.15	TFCS Reconfiguration/Addition Information	958
10.3.5.16	TFCS Removal Information.....	961
10.3.5.17	Void.....	961
10.3.5.18	Transport channel identity.....	961
10.3.5.19	Transport Format Combination (TFC)	961
10.3.5.20	Transport Format Combination Set.....	961
10.3.5.21	Transport Format Combination Set Identity	961
10.3.5.22	Transport Format Combination Subset	962
10.3.5.23	Transport Format Set.....	962
10.3.5.24	UL Transport channel information common for all transport channels	964
10.3.5.25	Concurrent Deployment of 2ms and 10ms TTI.....	965
10.3.5.26	Common E-DCH MAC-d flow info for Concurrent TTI.....	966
10.3.5.27	Power Offset Information 10ms Mode.....	967
10.3.6	Physical CH Information elements	967
10.3.6.1	AC-to-ASC mapping.....	967
10.3.6.2	AICH Info	968
10.3.6.3	AICH Power offset.....	968
10.3.6.4	Allocation period info	968
10.3.6.5	Alpha.....	968
10.3.6.6	ASC setting	968
10.3.6.7	Void.....	971
10.3.6.8	CCTrCH power control info	971
10.3.6.8a	Cell and Channel Identity info	971
10.3.6.9	Cell parameters Id	972
10.3.6.9a	Common E-DCH system info	972
10.3.6.10	Common timeslot info.....	975
10.3.6.10a	Common timeslot info MBMS.....	976
10.3.6.11	Constant value.....	976
10.3.6.11a	Constant value TDD.....	976
10.3.6.12	Void.....	976
10.3.6.13	Void.....	976
10.3.6.14	Void.....	976
10.3.6.15	Void.....	977
10.3.6.16	Default DPCH Offset Value.....	977
10.3.6.17	Downlink channelisation codes.....	977
10.3.6.17a	Downlink channelisation codes VHCR.....	978
10.3.6.18	Downlink DPCH info common for all RL	979
10.3.6.19	Downlink DPCH info common for all RL Post	981
10.3.6.20	Downlink DPCH info common for all RL Pre.....	981
10.3.6.21	Downlink DPCH info for each RL.....	981
10.3.6.22	Downlink DPCH info for each RL Post.....	984

10.3.6.23	Downlink DPCH power control information	985
10.3.6.23oa	Downlink F-DPCH info common for all RL.....	985
10.3.6.23ob	Downlink F-DPCH info for each RL	986
10.3.6.23a	Downlink HS-PDSCH Information	987
10.3.6.24	Downlink information common for all radio links.....	990
10.3.6.25	Downlink information common for all radio links Post.....	991
10.3.6.26	Downlink information common for all radio links Pre	991
10.3.6.27	Downlink information for each radio link.....	992
10.3.6.28	Downlink information for each radio link Post.....	993
10.3.6.28a	DL Multi-Carrier Information (1.28 Mcps TDD only)	994
10.3.6.29	Void.....	996
10.3.6.30	Void.....	996
10.3.6.31	Downlink rate matching restriction information	996
10.3.6.31a	Downlink secondary cell info FDD	996
10.3.6.31b	Downlink secondary cell info FDD for Handover to UTRAN	998
10.3.6.32	Downlink Timeslots and Codes	999
10.3.6.32a	Downlink Timeslots and Codes VHCR.....	1000
10.3.6.33	DPCH compressed mode info	1000
10.3.6.34	DPCH Compressed Mode Status Info.....	1004
10.3.6.34a	DTX-DRX information.....	1004
10.3.6.34b	DTX-DRX timing information.....	1006
10.3.6.35	Dynamic persistence level.....	1007
10.3.6.35a	FPACH info	1007
10.3.6.35b	Frequency band indicator	1008
10.3.6.35c	Frequency band indicator 2	1008
10.3.6.35ca	Frequency band indicator 3	1008
10.3.6.35d	Frequency band indicator for TDD	1008
10.3.6.36	Frequency info	1009
10.3.6.36oo	HS-PDSCH Midamble Configuration.....	1009
10.3.6.36o	HS-PDSCH Timeslot Configuration	1009
10.3.6.36oa	HS-PDSCH Timeslot Configuration VHCR.....	1010
10.3.6.36a	HS-SCCH Info	1012
10.3.6.36ab	HS-SCCH less information	1017
10.3.6.36b	HS-SICH Power Control Info	1017
10.3.6.36c	HS-DSCH common system information.....	1018
10.3.6.36ca	HS-DSCH common system information 1.28Mcps TDD	1018
10.3.6.36d	HS-DSCH paging system information	1019
10.3.6.36da	HS-DSCH paging system information 1.28Mcps TDD	1020
10.3.6.36e	HS-SCCH system info	1022
10.3.6.36ea	HS-SCCH system info 1.28Mcps TDD	1022
10.3.6.36f	Void.....	1025
10.3.6.36g	HS-DSCH DRX in CELL_FACH information.....	1025
10.3.6.36h	HS-DSCH DRX in CELL_FACH information 1.28Mcps TDD	1026
10.3.6.37	Individual timeslot info	1027
10.3.6.38	Individual Timeslot interference	1027
10.3.6.39	Maximum allowed UL TX power.....	1027
10.3.6.39a	Multi-frequency Info (1.28 Mcps TDD only)	1028
10.3.6.40	Void.....	1028
10.3.6.40a	Measurement Feedback Info	1028
10.3.6.41	Midamble shift and burst type.....	1029
10.3.6.41a	MIMO parameters.....	1031
10.3.6.41b	MIMO pilot configuration.....	1032
10.3.6.41c	Non-scheduled transmission grant info (TDD only)	1033
10.3.6.42	PDSCH Capacity Allocation info	1036
10.3.6.43	Void.....	1036
10.3.6.44	PDSCH info	1036
10.3.6.45	PDSCH Power Control info	1037
10.3.6.46	PDSCH system information	1037
10.3.6.47	Void.....	1038
10.3.6.48	Persistence scaling factors.....	1038
10.3.6.49	PICH Info.....	1038
10.3.6.50	PICH Power offset	1040

10.3.6.50a	PLCCH Info	1040
10.3.6.51	PRACH Channelisation Code List.....	1040
10.3.6.51a	PRACH Channelisation Code 1.28 Mcps TDD	1041
10.3.6.51b	PRACH Channelisation Code List VHCR.....	1041
10.3.6.52	PRACH info (for RACH).....	1041
10.3.6.53	PRACH partitioning.....	1043
10.3.6.54	PRACH power offset	1043
10.3.6.54a	PRACH preamble control parameters (for Enhanced Uplink).....	1044
10.3.6.55	PRACH system information list.....	1047
10.3.6.56	Predefined PhyCH configuration	1048
10.3.6.57	Primary CCPCH info	1049
10.3.6.58	Primary CCPCH info post.....	1049
10.3.6.59	Primary CCPCH TX Power	1050
10.3.6.60	Primary CPICH info.....	1050
10.3.6.61	Primary CPICH Tx power.....	1050
10.3.6.62	Primary CPICH usage for channel estimation	1050
10.3.6.63	PUSCH info	1050
10.3.6.63a	PUSCH info VHCR	1050
10.3.6.64	PUSCH Capacity Allocation info	1051
10.3.6.65	PUSCH power control info	1051
10.3.6.66	PUSCH system information.....	1052
10.3.6.66a	PUSCH system information VHCR.....	1053
10.3.6.67	RACH transmission parameters.....	1054
10.3.6.68	Radio link addition information	1054
10.3.6.69	Radio link removal information	1055
10.3.6.69a	E-DCH reconfiguration information	1055
10.3.6.69b	E-DCH reconfiguration information same serving cell.....	1057
10.3.6.70	Void.....	1057
10.3.6.70a	SCTD indicator	1058
10.3.6.71	Secondary CCPCH info	1059
10.3.6.71a	Secondary CCPCH info MBMS	1062
10.3.6.71b	Secondary CCPCH info MBMS Diff.....	1065
10.3.6.72	Secondary CCPCH system information.....	1066
10.3.6.72a	Secondary CCPCH system information MBMS	1067
10.3.6.72b	Secondary cell MIMO parameters	1067
10.3.6.73	Secondary CPICH info.....	1067
10.3.6.74	Secondary scrambling code.....	1068
10.3.6.74a	Serving HS-DSCH cell information.....	1068
10.3.6.74b	Serving Cell Change Parameters.....	1068
10.3.6.75	SFN Time info	1069
10.3.6.75a	Special Burst Scheduling	1069
10.3.6.76	Void.....	1069
10.3.6.77	Void.....	1070
10.3.6.78	STTD indicator	1070
10.3.6.78o	SYNC_UL codes bitmap.....	1070
10.3.6.78a	SYNC_UL info	1070
10.3.6.78b	TDD MBSFN Information.....	1071
10.3.6.78c	LCR TDD MBSFN Information	1071
10.3.6.78d	SYNC_UL info for E-RUCCH	1071
10.3.6.79	TDD open loop power control	1072
10.3.6.79a	Target cell preconfiguration information	1074
10.3.6.80	TFC Control duration.....	1075
10.3.6.81	Void.....	1075
10.3.6.82	TGPSI	1075
10.3.6.83	Time info.....	1076
10.3.6.83a	Time Slot LCR Extension	1076
10.3.6.84	Timeslot number	1076
10.3.6.85	TPC combination index.....	1076
10.3.6.85a	TSTD indicator	1077
10.3.6.86	TX Diversity Mode	1077
10.3.6.86o	UL 16QAM configuration.....	1077
10.3.6.86a	UL 16QAM settings.....	1078

10.3.6.86b	UL 64QAM configuration.....	1078
10.3.6.86c	UL 64QAM settings.....	1079
10.3.6.87	UL interference	1079
10.3.6.87a	UL interference TDD	1079
10.3.6.87b	Uplink DPCH code info for Common E-DCH.....	1080
10.3.6.88	Uplink DPCH info	1081
10.3.6.89	Uplink DPCH info Post.....	1084
10.3.6.90	Uplink DPCH info Pre	1085
10.3.6.91	Uplink DPCH power control info	1085
10.3.6.91a	Uplink DPCH power control info for Common E-DCH.....	1087
10.3.6.92	Uplink DPCH power control info Post	1088
10.3.6.93	Uplink DPCH power control info Pre	1088
10.3.6.94	Uplink Timeslots and Codes	1089
10.3.6.94a	Uplink Timeslots and Codes LCR	1090
10.3.6.94b	Uplink Timeslots and Codes VHCR	1092
10.3.6.95	Uplink Timing Advance.....	1094
10.3.6.95a	Extended Uplink Timing Advance.....	1094
10.3.6.96	Uplink Timing Advance Control.....	1094
10.3.6.97	E-DCH Info.....	1097
10.3.6.97a	Multi-carrier E-DCH Info for LCR TDD.....	1100
10.3.6.98	E-DPCCH Info	1101
10.3.6.99	E-DPDCH Info.....	1102
10.3.6.100	E-AGCH Info.....	1103
10.3.6.100a	E-AGCH Info 1.28Mcps TDD	1106
10.3.6.101	E-HICH Info	1106
10.3.6.101a	E-HICH Info 1.28Mcps TDD.....	1108
10.3.6.102	E-RGCH Info (FDD only)	1108
10.3.6.103	E-RUCCH Info (TDD only).....	1110
10.3.6.103a	E-RUCCH Info 1.28Mcps TDD.....	1114
10.3.6.104	E-PUCH Info (TDD only).....	1117
10.3.6.104a	E-PUCH Info 1.28Mcps TDD.....	1121
10.3.6.104b	E-PUCH Info for multi-carrier E-DCH 1.28Mcps TDD.....	1123
10.3.6.105	E-TFCS info (TDD only).....	1124
10.3.6.106	E-TFC Boost Info.....	1124
10.3.6.107	Control Channel DRX information 1.28Mcps TDD	1124
10.3.6.108	HS-SCCH DRX information 1.28 Mcps TDD.....	1125
10.3.6.109	E-AGCH DRX information 1.28 Mcps TDD.....	1125
10.3.6.110	SPS information 1.28 Mcps TDD	1126
10.3.6.111	E-DCH SPS information 1.28 Mcps TDD	1126
10.3.6.112	HS-DSCH SPS information 1.28 Mcps TDD	1128
10.3.6.113	Downlink channelisation codes MBSFN IMB.....	1130
10.3.6.114	Secondary CCPCH frame type 2 info	1131
10.3.6.115	Uplink secondary cell info FDD	1131
10.3.6.116	Secondary serving E-DCH cell info.....	1131
10.3.6.117	Secondary E-DCH info common	1131
10.3.6.118	Downlink information per radio link list on secondary UL frequency	1134
10.3.6.119	Radio link addition information on secondary UL frequency	1135
10.3.6.120	Radio link removal information on secondary UL frequency	1135
10.3.6.121	E-DCH reconfiguration information on secondary UL frequency	1135
10.3.6.122	MU-MIMO info 1.28 Mcps TDD	1136
10.3.6.123	E-RGCH Info for Common E-DCH.....	1137
10.3.6.124	E-HICH Info for Common E-DCH.....	1137
10.3.6.125	Uplink CLTD info FDD.....	1138
10.3.6.126	Uplink OLTN info FDD.....	1139
10.3.6.127	F-TPICH info	1139
10.3.6.128	F-TPICH reconfiguration info.....	1139
10.3.6.129	Multiflow configuration info.....	1140
10.3.6.130	NodeB triggered HS-DPCCH Transmission.....	1140
10.3.6.131	Common E-DCH system info parameters for Concurrent TTI	1141
10.3.6.132	Uplink DPCH power control info for Concurrent TTI.....	1142
10.3.6.133	Measurement Feedback Info for Concurrent TTI	1143
10.3.6.134	PRACH preamble control parameters extension list (for Enhanced Uplink).....	1143

10.3.6.135	PRACH preamble control parameters extension list for Type 1 (for Enhanced Uplink)	1144
10.3.6.136	PRACH preamble control parameters extension (for Enhanced Uplink)	1144
10.3.6.137	AICH Info compressed	1145
10.3.6.138	Common E-RGCH info FDD	1145
10.3.6.139	HS-DSCH DRX in CELL_FACH with second DRX cycle information	1147
10.3.6.140	Common E-DCH Resource Configuration Information List Extension	1149
10.3.6.141	Fallback R99 PRACH info	1150
10.3.6.142	MIMO mode with four transmit antennas parameters	1151
10.3.6.143	MIMO mode with four transmit antennas pilot configuration	1151
10.3.6.144	Secondary cell MIMO mode with four transmit antennas parameters	1152
10.3.6.145	Uplink MIMO info FDD	1152
10.3.6.146	E-ROCH info FDD	1153
10.3.6.147	Radio Links without DPCH/F-DPCH info	1153
10.3.6.148	DPCCH2 info FDD	1153
10.3.6.149	DCH Enhancements info FDD	1154
10.3.6.150	Uplink Transmission Mode Switching Parameters	1156
10.3.6.151	DPCCH Power Reset after DTX on secondary uplink frequency	1156
10.3.6.152	Other TTI E-DCH Configuration Information	1157
10.3.7	Measurement Information elements	1157
10.3.7.1	Additional measurements list	1157
10.3.7.2	Cell info	1157
10.3.7.3	Cell measured results	1159
10.3.7.4	Cell measurement event results	1161
10.3.7.5	Cell reporting quantities	1161
10.3.7.6	Cell synchronisation information	1161
10.3.7.6a	E-UTRA event results	1162
10.3.7.6b	E-UTRA frequency list	1163
10.3.7.6c	E-UTRA measured results	1167
10.3.7.7	Event results	1169
10.3.7.8	FACH measurement occasion info	1170
10.3.7.9	Filter coefficient	1171
10.3.7.9a	GSM cell group	1171
10.3.7.10	HCS Cell re-selection information	1172
10.3.7.11	HCS neighbouring cell information	1172
10.3.7.12	HCS Serving cell information	1172
10.3.7.12a	Idle Interval Information	1173
10.3.7.13	Inter-frequency cell info list	1173
10.3.7.14	Inter-frequency event identity	1177
10.3.7.15	Inter-frequency measured results list	1177
10.3.7.16	Inter-frequency measurement	1177
10.3.7.17	Inter-frequency measurement event results	1179
10.3.7.18	Inter-frequency measurement quantity	1179
10.3.7.19	Inter-frequency measurement reporting criteria	1180
10.3.7.20	Inter-frequency measurement system information	1183
10.3.7.20a	Inter-frequency RACH reporting information	1183
10.3.7.21	Inter-frequency reporting quantity	1184
10.3.7.22	Inter-frequency SET UPDATE	1184
10.3.7.23	Inter-RAT cell info list	1184
10.3.7.24	Inter-RAT event identity	1186
10.3.7.25	Inter-RAT info	1186
10.3.7.26	Inter-RAT measured results list	1187
10.3.7.27	Inter-RAT measurement	1188
10.3.7.28	Inter-RAT measurement event results	1188
10.3.7.29	Inter-RAT measurement quantity	1189
10.3.7.30	Inter-RAT measurement reporting criteria	1190
10.3.7.31	Inter-RAT measurement system information	1191
10.3.7.32	Inter-RAT reporting quantity	1192
10.3.7.33	Intra-frequency cell info list	1192
10.3.7.34	Intra-frequency event identity	1194
10.3.7.36	Intra-frequency measurement	1194
10.3.7.37	Intra-frequency measurement event results	1195
10.3.7.38	Intra-frequency measurement quantity	1195

10.3.7.39	Intra-frequency measurement reporting criteria	1196
10.3.7.40	Intra-frequency measurement system information	1200
10.3.7.41	Intra-frequency reporting quantity	1200
10.3.7.42	Intra-frequency reporting quantity for RACH reporting	1201
10.3.7.42a	Logged ANR Configuration Info	1201
10.3.7.42b	Logged ANR Report Info.....	1203
10.3.7.43	Maximum number of reported cells on RACH	1205
10.3.7.43a	MBMS preferred frequency information	1206
10.3.7.43b	MBSFN inter frequency neighbour list.....	1206
10.3.7.44	Measured results	1206
10.3.7.45	Measured results on RACH	1207
10.3.7.45a	Measured results on RACH FDD.....	1211
10.3.7.46	Measurement Command	1214
10.3.7.46a	Measurement release enhancement	1215
10.3.7.46b	Release some measurements	1215
10.3.7.47	Measurement control system information.....	1216
10.3.7.47a	Measurement control system information extension.....	1217
10.3.7.47b	Inter-frequency cell info list extension.....	1221
10.3.7.48	Measurement Identity.....	1223
10.3.7.49	Measurement reporting mode.....	1224
10.3.7.50	Measurement Type.....	1224
10.3.7.51	Measurement validity.....	1224
10.3.7.52	Void.....	1224
10.3.7.53	Periodical reporting criteria.....	1225
10.3.7.53aa	Periodical reporting info-1b	1225
10.3.7.53a	PLMN identities of neighbour cells	1225
10.3.7.53b	PLMN identities of neighbour cells for SIB 11ter	1226
10.3.7.54	Primary CCPCH RSCP info.....	1227
10.3.7.54a	Qhcs	1227
10.3.7.55	Quality measured results list	1229
10.3.7.56	Quality measurement	1229
10.3.7.57	Quality measurement event results	1230
10.3.7.58	Quality measurement reporting criteria.....	1230
10.3.7.59	Quality reporting quantity	1230
10.3.7.60	Reference time difference to cell	1231
10.3.7.61	Reporting Cell Status	1231
10.3.7.62	Reporting information for state CELL_DCH.....	1234
10.3.7.63	SFN-SFN observed time difference	1234
10.3.7.64	Time to trigger	1234
10.3.7.65	Timeslot ISCP info.....	1234
10.3.7.66	Traffic volume event identity	1235
10.3.7.67	Traffic volume measured results list	1235
10.3.7.68	Traffic volume measurement	1236
10.3.7.69	Traffic volume measurement event results	1236
10.3.7.70	Traffic volume measurement object.....	1237
10.3.7.71	Traffic volume measurement quantity	1237
10.3.7.72	Traffic volume measurement reporting criteria.....	1238
10.3.7.73	Traffic volume measurement system information.....	1239
10.3.7.74	Traffic volume reporting quantity	1239
10.3.7.75	UE internal event identity	1240
10.3.7.76	UE internal measured results.....	1240
10.3.7.77	UE internal measurement	1241
10.3.7.78	UE internal measurement event results.....	1241
10.3.7.79	UE internal measurement quantity.....	1241
10.3.7.80	UE internal measurement reporting criteria	1242
10.3.7.81	Void.....	1243
10.3.7.82	UE Internal reporting quantity	1243
10.3.7.83	UE Rx-Tx time difference type 1	1243
10.3.7.84	UE Rx-Tx time difference type 2	1244
10.3.7.85	UE Transmitted Power info.....	1244
10.3.7.86	UE positioning Ciphering info	1244
10.3.7.87	UE positioning Error	1245

10.3.7.88	UE positioning GPS acquisition assistance.....	1246
10.3.7.88a	UE positioning GPS Additional Assistance Data Request.....	1248
10.3.7.88b	UE positioning GANSS reference measurement information.....	1250
10.3.7.88c	UE positioning GANSS additional assistance data request.....	1255
10.3.7.88d	DGANSS Signal Id.....	1260
10.3.7.89	UE positioning GPS almanac.....	1262
10.3.7.89a	UE positioning GANSS almanac.....	1263
10.3.7.90	UE positioning GPS assistance data.....	1267
10.3.7.90a	Void.....	1268
10.3.7.90b	UE positioning GANSS assistance data.....	1268
10.3.7.91	UE positioning GPS DGPS corrections.....	1271
10.3.7.91a	UE positioning GPS Ephemeris and Clock Correction parameters.....	1272
10.3.7.91b	UE positioning DGANSS corrections.....	1274
10.3.7.91c	UE positioning GANSS orbit model.....	1276
10.3.7.91d	UE positioning GANSS clock model.....	1278
10.3.7.91e	UE positioning GANSS additional orbit models.....	1278
10.3.7.91f	UE positioning GANSS additional clock models.....	1283
10.3.7.92	UE positioning GPS ionospheric model.....	1285
10.3.7.92a	UE positioning GANSS ionospheric model.....	1286
10.3.7.92b	UE positioning GANSS additional ionospheric model.....	1286
10.3.7.92c	UE positioning GANSS Earth orientation parameters.....	1287
10.3.7.92d	UE positioning BDS Ionospheric Grid Model.....	1287
10.3.7.92e	UE positioning DBDS corrections.....	1287
10.3.7.93	UE positioning GPS measured results.....	1288
10.3.7.93a	UE positioning GANSS measured results.....	1289
10.3.7.94	UE positioning GPS navigation model.....	1292
10.3.7.94a	UE positioning GANSS navigation model.....	1293
10.3.7.94b	UE positioning GANSS additional navigation models.....	1294
10.3.7.95	UE positioning GPS real-time integrity.....	1295
10.3.7.95a	Void.....	1295
10.3.7.95b	UE positioning GANSS real-time integrity.....	1295
10.3.7.96	UE positioning GPS reference time.....	1296
10.3.7.96o	UE positioning GANSS reference time.....	1297
10.3.7.96a	UE positioning GPS reference time uncertainty.....	1298
10.3.7.97	UE positioning GPS UTC model.....	1298
10.3.7.97a	UE positioning GANSS time model.....	1299
10.3.7.97b	UE positioning GANSS data bit assistance.....	1299
10.3.7.97c	UE positioning GANSS UTC model.....	1301
10.3.7.97d	UE positioning GANSS additional UTC models.....	1302
10.3.7.97e	UE positioning GANSS SBAS ID.....	1304
10.3.7.97f	UE positioning GANSS auxiliary information.....	1304
10.3.7.98	UE positioning IPDL parameters.....	1306
10.3.7.99	UE positioning measured results.....	1307
10.3.7.100	UE positioning measurement.....	1307
10.3.7.101	UE positioning measurement event results.....	1308
10.3.7.102	Void.....	1308
10.3.7.103	UE positioning OTDOA assistance data for UE-assisted.....	1309
10.3.7.103a	UE positioning OTDOA assistance data for UE-based.....	1309
10.3.7.104	Void.....	1309
10.3.7.105	UE positioning OTDOA measured results.....	1309
10.3.7.106	UE positioning OTDOA neighbour cell info.....	1310
10.3.7.106a	UE positioning OTDOA neighbour cell info for UE-based.....	1312
10.3.7.107	UE positioning OTDOA quality.....	1313
10.3.7.108	UE positioning OTDOA reference cell info.....	1314
10.3.7.108a	UE positioning OTDOA reference cell info for UE-based.....	1315
10.3.7.109	UE positioning position estimate info.....	1315
10.3.7.109a	UE positioning Relative Time Difference quality.....	1318
10.3.7.110	UE positioning reporting criteria.....	1318
10.3.7.111	UE positioning reporting quantity.....	1319
10.3.7.112	TADV info.....	1322
10.3.7.113	UTRA priority info list.....	1322

10.3.7.114	GSM priority info list.....	1324
10.3.7.115	E-UTRA frequency and priority info list	1324
10.3.7.116	Intra-frequency cell info list on secondary UL frequency.....	1329
10.3.7.117	Cell measurement event results on secondary UL frequency.....	1330
10.3.7.118	Measured results on secondary UL frequency	1331
10.3.7.119	Intra-frequency measurement reporting criteria on secondary UL frequency.....	1331
10.3.7.120	CSG Inter-frequency cell info	1333
10.3.7.121	CSG Intra-frequency cell info	1334
10.3.7.121a	CSG cell info.....	1334
10.3.7.122	CSG Proximity Indication.....	1334
10.3.7.123	CSG Proximity detection	1335
10.3.7.124	Inter-frequency SI Acquisition.....	1335
10.3.7.125	Intra-frequency SI Acquisition.....	1336
10.3.7.126	CELL_DCH measurement occasion info LCR	1336
10.3.7.127	E-UTRA SI Acquisition.....	1338
10.3.7.128	E-UTRA Results for SI Acquisition.....	1338
10.3.7.129	Logged Measurement Info-FDD.....	1339
10.3.7.129a	Logged Connection Establishment Failure Info-FDD	1344
10.3.7.130	Logged Measurement Info-TDD.....	1348
10.3.7.130a	Logged Connection Establishment Failure Info-TDD	1352
10.3.7.131	Logged Meas Report.....	1356
10.3.7.132	Logged Measurements Configuration Info	1356
10.3.7.132a	Connection Establishment Failure Report.....	1358
10.3.7.133	Trace Reference	1358
10.3.7.134	Trace Recording Session.....	1358
10.3.7.135	TCE Id.....	1358
10.3.7.136	Periodical reporting criteria on secondary UL frequency	1359
10.3.7.137	E-UTRA measurement for CELL_FACH.....	1359
10.3.7.138	E-UTRA results for CELL_FACH	1360
10.3.7.139	E-UTRA frequency RACH reporting information.....	1360
10.3.7.140	Filtered UE power headroom reporting information.....	1363
10.3.8	Other Information elements	1363
10.3.8.1	BCCH modification info	1363
10.3.8.2	BSIC.....	1363
10.3.8.3	CBS DRX Level 1 information.....	1364
10.3.8.4	Cell Value tag.....	1364
10.3.8.4o	Cell Value tag 2.....	1364
10.3.8.4a	Ellipsoid point.....	1364
10.3.8.4b	Ellipsoid point with Altitude	1364
10.3.8.4c	Ellipsoid point with Altitude and uncertainty ellipsoid.....	1365
10.3.8.4d	Ellipsoid point with uncertainty Circle	1366
10.3.8.4e	Ellipsoid point with uncertainty Ellipse	1366
10.3.8.4ea	ETWS information.....	1367
10.3.8.4eb	Void.....	1367
10.3.8.4f	GERAN system information	1367
10.3.8.4g	GSM Target Cell Info	1368
10.3.8.4h	Horizontal Velocity	1368
10.3.8.4i	Horizontal with Vertical Velocity	1368
10.3.8.4j	Horizontal Velocity with Uncertainty	1369
10.3.8.4k	Horizontal with Vertical Velocity and Uncertainty.....	1369
10.3.8.4L	E-UTRA Target Info	1370
10.3.8.4m	HNB Name.....	1371
10.3.8.5	Inter-RAT change failure	1371
10.3.8.6	Inter-RAT handover failure.....	1372
10.3.8.7	Inter-RAT UE radio access capability.....	1372
10.3.8.8	Void.....	1373
10.3.8.8a	Inter-RAT UE security capability	1373
10.3.8.9	MIB Value tag.....	1374
10.3.8.10	PLMN Value tag	1374
10.3.8.10a	PNBSCH allocation	1374
10.3.8.11	Predefined configuration identity and value tag.....	1374
10.3.8.12	Protocol error information.....	1374

10.3.8.13	References to other system information blocks.....	1376
10.3.8.13a	References to other system information blocks 2.....	1378
10.3.8.14	References to other system information blocks and scheduling blocks	1379
10.3.8.14a	SB3 information.....	1381
10.3.8.15	Rplmn information.....	1381
10.3.8.16	Scheduling information.....	1382
10.3.8.17	SEG COUNT	1383
10.3.8.18	Segment index.....	1383
10.3.8.18a	SIB and SB type.....	1384
10.3.8.18b	SIB type extension	1384
10.3.8.18c	SIB type extension2	1385
10.3.8.18ca	SIB type extension3	1385
10.3.8.18d	GANSS SIB type	1385
10.3.8.19	SIB data fixed.....	1386
10.3.8.19a	SIB data fixed 2.....	1386
10.3.8.20	SIB data variable.....	1386
10.3.8.20o	SIB data variable 2.....	1386
10.3.8.20a	SIB occurrence identity.....	1386
10.3.8.20b	SIB occurrence identity and value tag.....	1387
10.3.8.20c	SIB occurrence value tag	1387
10.3.8.21	SIB type	1387
10.3.8.22	SIB type SIBs only.....	1388
10.3.8.22ab	SIB and SB type 2.....	1389
10.3.8.22ac	SIB type SIBs only 2.....	1390
10.3.8.23	UE History Information	1392
10.3.8.24	Data volume history	1393
10.3.9	ANSI-41 Information elements.....	1393
10.3.9.1	ANSI-41 Core Network Information	1393
10.3.9.2	ANSI-41 Global Service Redirection information	1393
10.3.9.3	ANSI-41 NAS parameter	1394
10.3.9.4	ANSI-41 NAS system information	1394
10.3.9.5	ANSI-41 Private Neighbour List information.....	1394
10.3.9.6	ANSI-41 RAND information.....	1394
10.3.9.7	ANSI-41 User Zone Identification information.....	1394
10.3.9.8	MIN_P_REV.....	1395
10.3.9.9	NID	1395
10.3.9.10	P_REV	1395
10.3.9.11	SID	1395
10.3.9a	MBMS Information elements	1396
10.3.9a.1	MBMS Common CCTrCH identity	1396
10.3.9a.2	MBMS Common PhyCh identity.....	1396
10.3.9a.3	MBMS Common RB identity	1396
10.3.9a.4	MBMS Common TrCh identity	1396
10.3.9a.5	MBMS Current cell S-CCPCH identity.....	1396
10.3.9a.6	Void.....	1396
10.3.9a.7	MBMS L1 combining schedule	1397
10.3.9a.7o	MBMS p-t-m activation time	1397
10.3.9a.7a	MBMS p-t-m RB information.....	1398
10.3.9a.7b	MBMS Selected Service Info.....	1398
10.3.9a.7c	MBMS Selected Services Full	1399
10.3.9a.7d	MBMS Selected Services Short	1399
10.3.9a.8	MBMS Service identity.....	1399
10.3.9a.8a	MBMS Service ID	1400
10.3.9a.9	MBMS Session identity	1400
10.3.9a.10	MBMS Short transmission identity.....	1400
10.3.9a.10a	MBMS Soft Combining Timing Offset.....	1400
10.3.9a.11	MBMS specific timers and counters	1401
10.3.9a.12	MBMS Transmission identity.....	1401
10.3.9a.12a	MBSFN frequency list	1401
10.3.9a.12b	MBSFN TDM Information List	1402
10.3.9a.13	MCCH configuration information.....	1402
10.3.9a.14	MICH configuration information	1403

10.3.9a.15	MICH Power offset	1405
10.3.9a.16	MSCH configuration information	1406
10.3.9a.17	Network Standard Time Information	1406
10.3.9b	WLAN Information elements	1407
10.3.9b.1	WLAN Offload Configuration	1407
10.3.9b.2	WLAN Identifier	1409
10.3.9b.3	WLAN Offload Information	1409
10.3.9b.4	WLAN Threshold Backhaul Rate	1410
10.3.10	Multiplicity values and type constraint values	1410
10.3.11	Void	1416
11	Message and Information element abstract syntax (with ASN.1)	1416
11.0	General	1416
11.1	General message structure	1416
11.2	PDU definitions	1421
11.3	Information element definitions	1584
11.4	Constant definitions	1904
11.5	RRC information between network nodes	1907
12	Message transfer syntax	1935
12.1	Structure of encoded RRC messages	1935
12.1.1	Basic production	1935
12.1.2	Extension	1935
12.1.3	Padding	1936
12.2	ECN link module for RRC	1938
12.3	ECN modules for RRC	1939
12.4	RRC messages encoded otherwise	1939
12.4.1	Messages using tabular encoding specification	1939
12.4.1.1	TRANSPORT FORMAT COMBINATION CONTROL using transparent DCCH	1940
12.4.1.1.1	TRANSPORT FORMAT COMBINATION CONTROL, 3 bit format	1940
12.4.1.1.2	Void	1940
12.4.1.1.3	Void	1940
13	Protocol timers, counters, other parameters and default configurations	1941
13.1	Timers for UE	1941
13.2	Counters for UE	1945
13.3	UE constants and parameters	1946
13.4	UE variables	1946
13.4.ob	AM_RLC_ERROR_PENDING_RB234	1946
13.4.oc	AM_RLC_ERROR_PENDING_RB5_AND_UP	1946
13.4.0	CELL_INFO_LIST	1946
13.4.00	Void	1948
13.4.0a	CELL_UPDATE_STARTED	1948
13.4.1	CIPHERING_STATUS	1948
13.4.1a	COMMON_E_DCH_TRANSMISSION	1949
13.4.2	Void	1949
13.4.2a	CONFIGURATION_INCOMPLETE	1949
13.4.3	C_RNTI	1949
13.4.3a	DEFERRED_MEASUREMENT_STATUS	1950
13.4.3b	DTX_DRX_PARAMS	1950
13.4.3c	DTX_DRX_STATUS	1950
13.4.3d	DSAC_PARAM	1950
13.4.3e	DSCH_RNTI	1951
13.4.3f	DOWNLINK_SECONDARY_CELL_INFO	1951
13.4.3g	EAB_PARAM	1951
13.4.3h	DSAC_PARAM_2	1951
13.4.3i	CONNECTED_MODE_ACCESS_CONTROL	1952
13.4.4	Void	1952
13.4.4o	E_DCH_TRANSMISSION	1953
13.4.4a	E_RNTI	1953
13.4.5	ESTABLISHED_RABS	1953
13.4.5a	ESTABLISHED_SIGNALLING_CONNECTIONS	1954
13.4.6	ESTABLISHMENT_CAUSE	1954

13.4.6a	EUTRA_FREQUENCY_INFO_LIST.....	1954
13.4.6b	Void	1956
13.4.6c	ETWS_INFO_IN_PROGRESS	1956
13.4.7	FAILURE_CAUSE	1956
13.4.7a	FREQUENCY_BAND_INDICATOR_SUPPORT	1956
13.4.8	FAILURE_INDICATOR.....	1956
13.4.8o	H_RNTI.....	1957
13.4.8oo	HS_DSCH_RECEPTION.....	1957
13.4.8oa	HS_DSCH_RECEPTION_CELL_FACH_STATE.....	1957
13.4.8ob	HS_DSCH_RECEPTION_OF_CCCH_ENABLED	1958
13.4.8oc	HS_DSCH_RECEPTION_GENERAL	1958
13.4.8od	SECONDARY_CELL_HS_DSCH_RECEPTION.....	1959
13.4.8oe	HS_DSCH_DRX_CELL_FACH_STATUS.....	1959
13.4.8of	HS_DSCH_RECEPTION_OF_ETWS_ENABLED	1960
13.4.8ooo	HS_SCCH_LESS_PARAMS	1960
13.4.8oooo	HS_SCCH_LESS_STATUS	1960
13.4.8a	INCOMPATIBLE_SECURITY_RECONFIGURATION.....	1960
13.4.8b	Void	1961
13.4.8c	Void	1961
13.4.8d	HSPA_RNTI_STORED_CELL_PCH.....	1961
13.4.9	INITIAL_UE_IDENTITY.....	1961
13.4.9a	INTEGRITY_PROTECTION_ACTIVATION_INFO.....	1961
13.4.10	INTEGRITY_PROTECTION_INFO	1962
13.4.10a	INTER_RAT_HANDOVER_INFO_TRANSFERRED	1962
13.4.11	INVALID_CONFIGURATION	1964
13.4.11a	LATEST_CONFIGURED_CN_DOMAIN	1964
13.4.11b	LATEST_CONFIGURED_SRB_DELAY_AND_PC_PREAMBLE	1964
13.4.11c	MBMS_ACTIVATED_SERVICES.....	1964
13.4.11d	MBMS_PREV_FREQUENCY_INFO	1965
13.4.11e	MBMS_PL_SERVICE_RESTRICTION_INFO_DEDICATED	1965
13.4.12	MEASUREMENT_IDENTITY	1966
13.4.13	Void	1966
13.4.13a	MIMO_PARAMS.....	1966
13.4.13b	MIMO_STATUS.....	1967
13.4.14	ORDERED_RECONFIGURATION.....	1967
13.4.14o	OTHER_TTI_EDCH_CONFIGURATION	1967
13.4.14a	PDCP_ROHC_TARGET_MODE.....	1968
13.4.15	PDCP_SN_INFO.....	1968
13.4.15a	PHYSICAL_SHARED_CHANNEL_CONFIGURATION	1968
13.4.15b	PPAC_PARAM	1969
13.4.15c	PRIORITY_INFO_LIST	1970
13.4.15d	PPAC_PARAM_2.....	1973
13.4.16	PROTOCOL_ERROR_INDICATOR.....	1973
13.4.17	PROTOCOL_ERROR_INFORMATION	1973
13.4.18	PROTOCOL_ERROR_REJECT.....	1973
13.4.19	RB_TIMER_INDICATOR.....	1974
13.4.20	RB_UPLINK_CIPHERING_ACTIVATION_TIME_INFO.....	1974
13.4.20o	RNC_CAPABILITY_CHANGE_SUPPORT	1974
13.4.20oo	READY_FOR_COMMON_EDCH.....	1974
13.4.20a	SECURITY_MODIFICATION.....	1975
13.4.21	Void	1975
13.4.22	START_THRESHOLD	1975
13.4.23	START_VALUE_TO_TRANSMIT.....	1975
13.4.23a	TARGET_CELL_PRECONFIGURATION.....	1975
13.4.24	TFC_SUBSET	1976
13.4.25	TGPS_IDENTITY	1978
13.4.26	TGSN_REPORTED	1978
13.4.26a	TIMERS_AND_CONSTANTS.....	1978
13.4.27	TRANSACTIONS.....	1979
13.4.27o	Void	1980
13.4.27a	TRIGGERED_1A_EVENT.....	1980
13.4.27b	TRIGGERED_1B_EVENT.....	1980

13.4.27c	TRIGGERED_1C_EVENT	1981
13.4.27d	BEST_CELL_1D_EVENT	1981
13.4.27e	TRIGGERED_1E_EVENT	1982
13.4.27f	TRIGGERED_1F_EVENT	1982
13.4.27f1	TRIGGERED_1G_EVENT	1982
13.4.27f2	TRIGGERED_1H_EVENT	1983
13.4.27f3	TRIGGERED_1I_EVENT	1983
13.4.27f4	BEST_FREQUENCY_2A_EVENT	1983
13.4.27f5	TRIGGERED_2B_EVENT	1983
13.4.27f6	TRIGGERED_2C_EVENT	1984
13.4.27f7	TRIGGERED_2D_EVENT	1984
13.4.27f8	TRIGGERED_2E_EVENT	1984
13.4.27f9	TRIGGERED_2F_EVENT	1984
13.4.27f10	TRIGGERED_3A_EVENT	1984
13.4.27f11	TRIGGERED_3B_EVENT	1986
13.4.27f12	TRIGGERED_3C_EVENT	1986
13.4.27f13	BEST_CELL_3D_EVENT	1987
13.4.27f14	TRIGGERED_6A_EVENT	1988
13.4.27f15	TRIGGERED_6B_EVENT	1988
13.4.27f16	TRIGGERED_6C_EVENT	1988
13.4.27f17	TRIGGERED_6D_EVENT	1988
13.4.27f18	TRIGGERED_6E_EVENT	1989
13.4.27f19	TRIGGERED_6F_EVENT	1989
13.4.27f20	TRIGGERED_6G_EVENT	1989
13.4.27f21	TRIGGERED_1J_EVENT	1990
13.4.27f22	BEST_CELL_2G_EVENT	1990
13.4.27g	UE_CAPABILITY_REQUESTED	1990
13.4.28	UE_CAPABILITY_TRANSFERRED	1991
13.4.28a	UE_POSITIONING_GPS_DATA	1992
13.4.28b	UE_POSITIONING_OTDOA_DATA_UE_ASSISTED	1993
13.4.28c	UE_POSITIONING_OTDOA_DATA_UE_BASED	1994
13.4.28d	UE_POSITIONING_GANSS_DATA	1995
13.4.29	UNSUPPORTED_CONFIGURATION	1998
13.4.30	URA_IDENTITY	1998
13.4.31	U_RNTI	1998
13.4.32	VALUE_TAG	1998
13.4.33	CONTROL_CHANNEL_DRX_PARAMS	2002
13.4.34	CONTROL_CHANNEL_DRX_STATUS	2003
13.4.35	E_DCH_SPS_PARAMS	2003
13.4.36	E_DCH_SPS_STATUS	2003
13.4.37	HS_DSCH_SPS_PARAMS	2004
13.4.38	HS_DSCH_SPS_STATUS	2004
13.4.39	SECONDARY_CELL_MIMO_PARAMS	2004
13.4.40	SECONDARY_CELL_MIMO_STATUS	2005
13.4.41	SECONDARY_CELL_E_DCH_TRANSMISSION	2005
13.4.42	CELL_INFO_CSG_LIST	2005
13.4.43	DCH_MOPS_IDENTITY	2006
13.4.44	SYSTEM_INFORMATION_CONTAINER	2006
13.4.45	MU_MIMO_INFO	2006
13.4.46	MU_MIMO_STATUS	2006
13.4.47	MULTI_CARRIER_E_DCH_TRANSMISSION	2007
13.4.48	LOGGED_MEAS_CONFIG	2007
13.4.49	LOGGED_MEAS_REPORT_VARIABLE	2007
13.4.50	LOG_ANR_CONFIG	2008
13.4.51	LOG_ANR_REPORT_VARIABLE	2009
13.4.52	UPLINK_CLTD_TRANSMISSION	2009
13.4.53	UPLINK_OLTD_TRANSMISSION	2009
13.4.54	LOGGED_CONNECTION_ESTABLISHMENT_FAILURE	2010
13.4.55	MULTIFLOW_STATUS	2010
13.4.56	CELL_RESELECTION_INFO_LCRTDD	2010
13.4.57	EUTRA_FREQUENCY_INFO_LIST_FACH	2011
13.4.58	FALLBACK_R99_PRACH_ENABLED	2011

13.4.59	HS_DSCH_DRX_CELL_FACH_2CYCLE_STATUS.....	2011
13.4.60	READY_FOR_COMMON_ERGCH.....	2012
13.4.61	READY_FOR_FALLBACK_R99_PRACH.....	2012
13.4.62	MIMO_MODE_WITH_FOUR_TRANSMIT_ANTENNAS_PARAMS.....	2012
13.4.63	MIMO_MODE_WITH_FOUR_TRANSMIT_ANTENNAS_STATUS.....	2013
13.4.64	SECONDARY_CELL_MIMO_MODE_WITH_FOUR_TRANSMIT_ANTENNAS_PARAMS.....	2013
13.4.65	SECONDARY_CELL_MIMO_MODE_WITH_FOUR_TRANSMIT_ANTENNAS_STATUS.....	2013
13.4.66	UPLINK_MIMO_TRANSMISSION.....	2014
13.4.67	BCCH_MODIFICATION_ACCESS_PROHIBITION.....	2014
13.4.68	NON_RECTANGULAR_RESOURCE_ALLOCATION_STATUS.....	2014
13.4.69	WLAN_OFFLOAD_INFO.....	2015
13.4.70	SYSTEM_INFO_WLAN_OFFLOAD_INFO.....	2015
13.4.71	DPCCH2_TRANSMISSION.....	2015
13.4.72	DCH_ENHANCEMENTS_INFO.....	2016
13.4.73	DCH_ENHANCEMENTS_STATUS.....	2016
13.5	UE RRC Procedure Performance.....	2016
13.5.1	Definitions.....	2016
13.5.2	RRC procedure performance values.....	2016
13.6	RB information parameters for signalling radio bearer RB 0.....	2022
13.6a	RB information parameters for SHCCH.....	2022
13.6b	RB information parameters for BCCH mapped to FACH.....	2023
13.6c	RB information parameters for PCCH mapped to PCH.....	2023
13.6d	Parameters for BCCH mapped to BCH.....	2023
13.6e	RB information parameters for signalling radio bearer RB 0 mapped on HS-DSCH and RACH.....	2023
13.6f	RB information parameters for BCCH mapped to HS-DSCH.....	2024
13.6g	RB information parameters for PCCH mapped to HS-DSCH.....	2024
13.6h	RB information parameters for signalling radio bearer RB 0 mapped on HS-DSCH and common E-DCH.....	2024
13.6i	Parameters for BCCH mapped to BCH on SCCPCH.....	2025
13.7	Parameter values for default radio configurations.....	2025
13.7.1	Default configuration 3.4 kbps signalling.....	2026
13.7.2	Default configuration 13.6 kbps signalling.....	2029
13.7.3	Default configuration 12.2 kbps Speech & 3.4 kbps signalling.....	2032
13.7.4	Default configuration 28.8 kbps conv. CS- data & 3.4 kbps signalling.....	2035
13.7.5	Default configuration 32 kbps conversational CS- data & 3.4 kbps signalling.....	2039
13.7.6	Default configuration 64 kbps conversational CS- data & 3.4 kbps signalling.....	2042
13.7.7	Default configuration 14.4 kbps streaming CS- data & 3.4 kbps signalling.....	2046
13.7.8	Default configuration 28 kbps streaming CS- data & 3.4 kbps signalling.....	2049
13.7.9	Default configuration 57.6 kbps streaming CS- data & 3.4 kbps signalling.....	2054
13.7.10	Default configuration 12.2/7.95/5.9/4.75 kbps speech & 3.4 kbps signalling.....	2058
13.7.11	Default configuration 12.2/7.4/5.9/4.75 kbps speech & 3.4 kbps signalling (without SRB#5).....	2062
13.7.12	Default configuration 10.2/6.7/5.9/4.75 kbps speech & 3.4 kbps signalling & 0.15 kbps SRB#5.....	2068
13.7.13	Default configuration 7.4/6.7/5.9/4.75 kbps speech & 3.4 kbps signalling & 0.15 kbps SRB#5.....	2075
13.7.14	Default configuration 12.65/8.85/6.6 kbps speech & 3.4 kbps signalling & 0.15 kbps SRB#5.....	2082
13.7.15	Default configuration 12.2/7.4/5.9/4.75 kbps speech & 3.4 kbps signalling & 0.15 kbps SRB#5.....	2088
13.7.16	Default configuration 7.95 kbps speech & 3.4 kbps signalling.....	2093
13.7.17	Default configuration 12.65/8.85/6.6 kbps speech & 3.4 kbps signalling (without SRB#5).....	2098
13.7.18	Default configuration Signalling on E-DCH on UL depending based on minimum E-DCH UE category & Signalling on HS-DSCH based minimum HS-DSCH UE category.....	2103
13.7.19	Default configuration 12.2 kbps speech & 13.6 kbps signalling.....	2104
13.7.20	Default configuration 12.2/7.95/5.9/4.75 kbps speech & 13.6 kbps signalling.....	2108
13.7.21	Default configuration 64 kbps conversation CS-data & 13.6 kbps signalling.....	2113
13.7.22	Default configuration 12.65/8.85/6.6 kbps speech & 13.6 kbps signalling (without SRB#5).....	2119
13.7.23	Default configuration 13.6 kbps signalling.....	2125
13.7.24	Default configuration Signalling on E-DCH & HS-DSCH; Scheduled.....	2128
13.8	Parameter values for default radio configurations in CELL_FACH.....	2129
14	Specific functions.....	2131
14.1	Intra-frequency measurements.....	2131
14.1.1	Intra-frequency measurement quantities.....	2131
14.1.2	Intra-frequency reporting events for FDD.....	2132
14.1.2.1	Reporting event 1A: A Primary CPICH enters the reporting range.....	2132

14.1.2.2	Reporting event 1B: A primary CPICH leaves the reporting range	2135
14.1.2.3	Reporting event 1C: A non-active primary CPICH becomes better than an active primary CPICH	2137
14.1.2.4	Reporting event 1D: Change of best cell.....	2140
14.1.2.5	Reporting event 1E: A Primary CPICH becomes better than an absolute threshold.....	2142
14.1.2.6	Reporting event 1F: A Primary CPICH becomes worse than an absolute threshold	2144
14.1.2.7	Reporting event 1J: A non-active E-DCH but active DCH primary CPICH becomes better than an active E-DCH primary CPICH	2146
14.1.3	Intra-frequency reporting events for TDD	2149
14.1.3.1	Reporting event 1G: Change of best cell (TDD).....	2149
14.1.3.2	Reporting event 1H: Timeslot ISCP below a certain threshold (TDD).....	2150
14.1.3.3	Reporting event 1I: Timeslot ISCP above a certain threshold (TDD).....	2151
14.1.4	Event-triggered periodic intra-frequency measurement reports (informative)	2153
14.1.4.1	Cell addition failure (FDD only).....	2153
14.1.4.1a	Cell removal failure (FDD only).....	2154
14.1.4.2	Cell replacement failure (FDD only)	2155
14.1.5	Mechanisms available for modifying intra-frequency measurement reporting behaviour (informative)	2155
14.1.5.1	Hysteresis	2155
14.1.5.2	Time-to-trigger	2156
14.1.5.3	Cell individual offsets	2157
14.1.5.4	Forbid a Primary CPICH to affect the reporting range (FDD only).....	2158
14.1.6	Report quantities in intra-frequency measurements.....	2159
14.1.7	Intra-frequency Common E-RGCH RL Determination (FDD only)	2160
14.2	Inter-frequency measurements	2160
14.2.0a	Inter-frequency measurement quantities	2160
14.2.0b	Frequency quality estimate	2161
14.2.0b.1	FDD cells	2161
14.2.0b.2	TDD cells	2161
14.2.0c	Inter-frequency reporting quantities	2161
14.2.1	Inter-frequency reporting events.....	2162
14.2.1.1	Event 2a: Change of best frequency.....	2163
14.2.1.2	Event 2b: The estimated quality of the currently used frequency is below a certain threshold and the estimated quality of a non-used frequency is above a certain threshold.....	2164
14.2.1.3	Event 2c: The estimated quality of a non-used frequency is above a certain threshold	2166
14.2.1.4	Event 2d: The estimated quality of the currently used frequency is below a certain threshold.....	2167
14.2.1.5	Event 2e: The estimated quality of a non-used frequency is below a certain threshold	2168
14.2.1.6	Event 2 f: The estimated quality of the currently used frequency is above a certain threshold	2170
14.2.1.7	Event 2g: Change of best cell on a configured secondary downlink frequency (FDD only)	2171
14.3	Inter-RAT measurements	2172
14.3.0a	Inter-RAT measurement quantities.....	2172
14.3.0b	Frequency quality estimate of the UTRAN frequency	2173
14.3.0c	Inter-RAT reporting quantities	2173
14.3.1	Inter-RAT reporting events.....	2173
14.3.1.1	Event 3a: The estimated quality of the currently used UTRAN frequency is below a certain threshold and the estimated quality of the other system is above a certain threshold.....	2174
14.3.1.2	Event 3b: The estimated quality of other system is below a certain threshold.....	2176
14.3.1.3	Event 3c: The estimated quality of other system is above a certain threshold	2178
14.3.1.4	Event 3d: Change of best cell in other system	2179
14.3.2	GSM measurements in compressed mode	2181
14.3.2.1	GSM RSSI measurements.....	2181
14.3.2.2	Initial BSIC identification	2181
14.3.2.3	BSIC re-confirmation.....	2181
14.3.3	E-UTRA measurements in compressed mode	2182
14.3.3.1	E-UTRA RSRP measurements.....	2182
14.3.3.2	E-UTRA RSRQ measurements.....	2182
14.4	Traffic Volume Measurements.....	2182
14.4.1	Traffic Volume Measurement Quantity	2182
14.4.2	Traffic Volume reporting triggers.....	2182
14.4.2.1	Reporting event 4 A: Transport Channel Traffic Volume becomes larger than an absolute threshold.....	2187
14.4.2.2	Reporting event 4 B: Transport Channel Traffic Volume becomes smaller than an absolute threshold.....	2187

14.4.3	Traffic volume reporting mechanisms	2188
14.4.3.1	Pending time after trigger.....	2188
14.4.3.2	Time-to-trigger.....	2188
14.4.4	Interruption of user data transmission.....	2189
14.5	Quality Measurements.....	2189
14.5.1	Quality reporting measurement quantities	2189
14.5.2	Quality reporting events.....	2189
14.5.2.1	Reporting event 5A: A predefined number of bad CRCs is exceeded	2189
14.6	UE internal measurements.....	2190
14.6.1	UE internal measurement quantities	2190
14.6.2	UE internal measurement reporting events.....	2190
14.6.2.1	Reporting event 6A: The UE Tx power becomes larger than an absolute threshold.....	2190
14.6.2.2	Reporting event 6B: The UE Tx power becomes less than an absolute threshold	2191
14.6.2.3	Reporting event 6C: The UE Tx power reaches its minimum value	2192
14.6.2.4	Reporting event 6D: The UE Tx power reaches its maximum value.....	2193
14.6.2.5	Reporting event 6E: The UE RSSI reaches the UE's dynamic receiver range	2194
14.6.2.6	Reporting event 6F (FDD): The UE Rx-Tx time difference for a RL included in the active set becomes larger than an absolute threshold.....	2194
14.6.2.6a	Reporting event 6F (1.28 Mcps TDD): The time difference indicated by T _{ADV} becomes larger than an absolute threshold	2195
14.6.2.7	Reporting event 6G: The UE Rx-Tx time difference for a RL included in the active set becomes less than an absolute threshold	2195
14.7	UE positioning measurements	2196
14.7.1	UE positioning measurement quantities	2196
14.7.2	Void	2196
14.7.3	UE positioning reporting events	2196
14.7.3.1	Reporting Event 7a: The UE position changes more than an absolute threshold.....	2196
14.7.3.2	Reporting Event 7b: SFN-SFN measurement changes more than an absolute threshold.....	2197
14.7.3.3	Reporting Event 7c: GPS time and SFN time have drifted apart more than an absolute threshold ..	2197
14.7.3.4	Reporting Event 7d: GANSS time and SFN time have drifted apart more than an absolute threshold.....	2198
14.7a	Measurements related to CSG/Hybrid cells	2198
14.7a.1	Intra-frequency measurements for CSG/Hybrid cells.....	2198
14.7a.2	Inter-frequency measurements for CSG/Hybrid cells.....	2199
14.7a.3	CSG Proximity detection	2199
14.7a.4	CSG Proximity Indication	2199
14.7a.5	E-UTRA measurements for CSG/Hybrid cells	2200
14.8	Void.....	2200
14.9s	Downlink power control.....	2200
14.9.1	Generalities	2200
14.9.2	Downlink power control in compressed mode	2201
14.10	Calculated Transport Format Combination	2201
14.10.1	Default TFCS for MBMS	2202
14.10.1.1	S-CCPCH configuration including a FACH carrying MSCH.....	2202
14.10.1.2	S-CCPCH configuration not including a FACH carrying MSCH.....	2202
14.11	UE autonomous update of virtual active set on non-used frequency (FDD only).....	2203
14.11.1	Initial virtual active set	2203
14.11.2	Virtual active set update during an inter-frequency measurement.....	2204
14.12	Provision and reception of RRC information between network nodes.....	2206
14.12.0	General.....	2206
14.12.0a	General error handling for RRC messages exchanged between network nodes	2206
14.12.1	RRC Information to target RNC	2207
14.12.2	RRC information, target RNC to source RNC.....	2208
14.12.3	Void	2209
14.12.4	RRC messages exchanged between network nodes.....	2209
14.12.4.0	HANDOVER TO UTRAN COMMAND	2209
14.12.4.0a	INTER RAT HANDOVER INFO	2209
14.12.4.1	INTER RAT HANDOVER INFO WITH INTER RAT CAPABILITIES.....	2209
14.12.4.2	SRNS RELOCATION INFO	2211
14.12.4.3	Void.....	2225
14.12.4.4	RFC 3095 CONTEXT INFO	2225
14.13	Void.....	2228

14.14	Void.....	2229
14.15	E-UTRA measurement for CELL_FACH (FDD only)	2229
14.15.1	E-UTRA measurement for CELL_FACH measurement quantities (FDD only)	2229
14.15.2	E-UTRA measurement for CELL_FACH reporting (FDD only)	2229
Annex A (informative): USIM parameters		2230
A.1	Introduction	2230
A.2	Ciphering information	2230
A.3	Frequency information	2230
A.4	Multiplicity values and type constraint values	2231
Annex B (informative): Description of RRC state transitions including GSM and E-UTRA.....		2232
B.1	RRC states and state transitions	2232
B.2	Transition from Idle Mode to UTRA RRC Connected Mode	2232
B.2.1	Transitions for Emergency Calls	2232
B.3	UTRA RRC Connected Mode States and Transitions.....	2232
B.3.1	CELL_DCH state.....	2232
B.3.1.1	Transition from CELL_DCH to Idle Mode.....	2233
B.3.1.2	Transition from CELL_DCH to CELL_FACH state	2233
B.3.1.3	Transition from CELL_DCH to CELL_PCH state	2233
B.3.1.4	Transition from CELL_DCH to URA_PCH state.....	2233
B.3.1.5	Radio Resource Allocation tasks (CELL_DCH).....	2233
B.3.1.6	RRC Connection mobility tasks (CELL_DCH).....	2234
B.3.1.7	UE Measurements (CELL_DCH)	2234
B.3.1.8	Acquisition of system information (CELL_DCH)	2234
B.3.2	CELL_FACH state	2234
B.3.2.1	Transition from CELL_FACH to CELL_DCH state	2235
B.3.2.2	Transition from CELL_FACH to CELL_PCH state	2235
B.3.2.3	Transition from CELL_FACH to Idle Mode	2235
B.3.2.4	Transition from CELL_FACH to URA_PCH State.....	2235
B.3.2.5	Radio Resource Allocation Tasks (CELL_FACH)	2235
B.3.2.6	RRC Connection mobility tasks (CELL_FACH).....	2236
B.3.2.7	UE Measurements (CELL_FACH).....	2236
B.3.2.8	Transfer and update of system information (CELL_FACH).....	2236
B.3.3	CELL_PCH state	2236
B.3.3.1	Transition from CELL_PCH to CELL_FACH state	2237
B.3.3.2	Radio Resource Allocation Tasks (CELL_PCH).....	2237
B.3.3.3	RRC Connection mobility tasks (CELL_PCH).....	2237
B.3.3.4	UE Measurements (CELL_PCH).....	2237
B.3.3.5	Transfer and update of system information (CELL_PCH)	2237
B.3.4	URA_PCH State	2237
B.3.4.1	Transition from URA_PCH State to CELL_FACH State (URA_PCH)	2238
B.3.4.2	Radio Resource Allocation Tasks (URA_PCH).....	2238
B.3.4.3	RRC Connection mobility tasks (URA_PCH)	2238
B.3.4.4	UE Measurements (URA_PCH)	2238
B.3.4.5	Transfer and update of system information (URA_PCH).....	2238
B.3.5	States and Transitions for Cell Reselection in URA_PCH, CELL_PCH, and CELL_FACH	2239
B.4	Inter-RAT handover with CS domain services.....	2239
B.5	Inter-RAT handover with PS domain services	2240
B.6	Inter-RAT handover with simultaneous PS and CS domain services.....	2240
B.6.1	Inter-RAT handover UTRAN to GSM / BSS	2240
B.6.2	Inter-RAT handover GSM / BSS to UTRAN	2240
Annex C (informative): Description for the Compressed Coding of Pre-defined configurations included in the INTER RAT HANDOVER INFO message		2241
C.1	Definitions	2241
C.2	Examples of the methodology	2241
Annex D (Normative): Implementation of Domain Specific Access Control (DSAC) in UEs of 3GPP Release 5.....		2244

Annex E (Normative):	EUTRA Feature group indicators.....	2245
Annex F (Normative):	Support of Multiple Frequency Band Indicators (Multiple FBI) in UE.....	2247
Annex G (informative):	Signalling of Multiple Frequency Band Indicators (Multiple FBI).....	2248
G.1	Mapping between "Frequency band indicator", "Frequency band indicator 2" or "Frequency band indicator 3" and "Multiple Frequency Info list"	2248
G.2	Mapping between "New Inter-frequency cells" and "Multiple Frequency Info List FDD"	2248
G.3	Mapping between "E-UTRA frequency and priority" and "Multiple E-UTRA Frequency Info list" or "Multiple E-UTRA Frequency Info extension list"	2249
Annex H (informative):	Change history	2253
History		2300

Foreword

This Technical Specification has been produced by the 3rd Generation Partnership Project (3GPP).

The contents of the present document are subject to continuing work within the TSG and may change following formal TSG approval. Should the TSG modify the contents of the present document, it will be re-released by the TSG with an identifying change of release date and an increase in version number as follows:

Version x.y.z

where:

- x the first digit:
 - 1 presented to TSG for information;
 - 2 presented to TSG for approval;
 - 3 or greater indicates TSG approved document under change control.
- y the second digit is incremented for all changes of substance, i.e. technical enhancements, corrections, updates, etc.
- z the third digit is incremented when editorial only changes have been incorporated in the document.

1 Scope

The present document specifies the Radio Resource Control protocol for the UE-UTRAN radio interface.

The scope of the present document also includes:

- the information to be transported in a transparent container between source RNC and target RNC in connection with SRNC relocation;
- the information to be transported in a transparent container between a target RNC and another system.

2 References

The following documents contain provisions which, through reference in this text, constitute provisions of the present document.

- References are either specific (identified by date of publication, edition number, version number, etc.) or non-specific.
- For a specific reference, subsequent revisions do not apply.
- For a non-specific reference, the latest version applies. In the case of a reference to a 3GPP document (including a GSM document), a non-specific reference implicitly refers to the latest version of that document *in the same Release as the present document*.

- [1] 3GPP TR 21.905: "Vocabulary for 3GPP Specifications".
- [2] 3GPP TS 25.301: "Radio Interface Protocol Architecture".
- [3] 3GPP TS 25.303: "Interlayer Procedures in Connected Mode".
- [4] 3GPP TS 25.304: "UE Procedures in Idle Mode and Procedures for Cell Reselection in Connected Mode".
- [5] 3GPP TS 24.008: "Mobile radio interface layer 3 specification; Core Network Protocols; Stage 3".
- [6] 3GPP TS 25.103: "RF parameters in support of RRM".
- [7] 3GPP TS 25.215: "Physical layer – Measurements (FDD)".
- [8] 3GPP TS 25.225: "Physical layer – Measurements (TDD)".
- [9] 3GPP TS 25.401: "UTRAN overall description".
- [10] 3GPP TS 25.402: "Synchronization in UTRAN; Stage 2".
- [11] 3GPP TS 23.003: "Numbering, addressing and identification".
- [12] ICD-GPS-200: "Navstar GPS Space Segment/Navigation User Interface".
- [13] RTCM-SC104: "RTCM Recommended Standards for Differential GNSS Service (v.2.2)".
- [14] 3GPP TR 25.921: "Guidelines and principles for protocol description and error handling".
- [15] 3GPP TS 25.321: "Medium Access Control (MAC) protocol specification".
- [16] 3GPP TS 25.322: "Radio Link Control (RLC) protocol specification".
- [17] 3GPP TS 24.007: "Mobile radio interface signalling layer 3; General aspects".
- [18] 3GPP TS 25.305: "Stage 2 Functional Specification of UE Positioning in UTRAN".
- [19] 3GPP TS 25.133: "Requirements for Support of Radio Resource Management (FDD)".
- [20] 3GPP TS 25.123: "Requirements for Support of Radio Resource Management (TDD)".

- [21] 3GPP TS 25.101: "UE Radio Transmission and Reception (FDD)".
- [22] 3GPP TS 25.102: "UE Radio Transmission and Reception (TDD)".
- [23] 3GPP TS 23.060: "General Packet Radio Service (GPRS); Service description; Stage 2".
- [24] 3GPP TS 23.032: "Universal Geographical Area Description (GAD)".
- [25] 3GPP TS 23.122: "Non-Access-Stratum functions related to Mobile Station (MS) in idle mode".
- [26] 3GPP TS 25.211: "Physical channels and mapping of transport channels onto physical channels (FDD)".
- [27] 3GPP TS 25.212: "Multiplexing and channel coding (FDD)".
- [28] 3GPP TS 25.213: "Spreading and modulation (FDD)".
- [29] 3GPP TS 25.214: "Physical layer procedures (FDD)".
- [30] 3GPP TS 25.221: "Physical channels and mapping of transport channels onto physical channels (TDD)".
- [31] 3GPP TS 25.222: "Multiplexing and channel coding (TDD)".
- [32] 3GPP TS 25.223: "Spreading and modulation (TDD)".
- [33] 3GPP TS 25.224: "Physical Layer Procedures (TDD)".
- [34] 3GPP TS 25.302: "Services provided by the physical layer".
- [35] 3GPP TS 25.306 "UE Radio Access Capabilities".
- [36] 3GPP TS 25.323: "Packet Data Convergence Protocol (PDCP) Specification".
- [37] 3GPP TS 25.324: "Broadcast/Multicast Control BMC".
- [38] 3GPP TR 25.922: "Radio resource management strategies".
- [39] 3GPP TR 25.925: "Radio interface for broadcast/multicast services".
- [40] 3GPP TS 33.102: "3G Security; Security Architecture".
- [41] 3GPP TS 34.108: "Common Test Environments for User Equipment (UE) Conformance Testing".
- [42] 3GPP TS 34.123-2: "User Equipment (UE) conformance specification; Part 2: Implementation Conformance Statement (ICS) proforma specification".
- [43] 3GPP TS 44.018: "Mobile radio interface layer 3 specification; Radio Resource Control Protocol".
- [44] 3GPP TS 44.060: "General Packet Radio Service (GPRS); Mobile Station (MS) - Base Station System (BSS) interface; Radio Link Control/Medium Access Control (RLC/MAC) protocol".
- [45] 3GPP TS 45.005: "Radio transmission and reception".
- [46] 3GPP TS 45.008: "Radio subsystem link control".
- [47] ITU-T Recommendation X.680 (07/2002) "Information Technology - Abstract Syntax Notation One (ASN.1): Specification of basic notation".
- [48] ITU-T Recommendation X.681 (07/2002) "Information Technology - Abstract Syntax Notation One (ASN.1): Information object specification".
- [49] ITU-T Recommendation X.691 (07/2002) "Information technology - ASN.1 encoding rules: Specification of Packed Encoding Rules (PER)".
- [50] 3GPP TS 31.102: "Characteristics of the USIM Application".
- [51] 3GPP TS 25.308: "High Speed Downlink Packet Access (HSDPA): Overall Description; Stage 2".

- [52] IANA ROHC profile identifier definition (<http://www.iana.org/assignments/rohc-pro-ids>).
- [53] Void.
- [54] 3GPP TS 23.246: "Multimedia Broadcast Multicast Service; Architecture and Functional Description".
- [55] 3GPP TS 25.346: " Introduction of the Multimedia Broadcast Multicast Service (MBMS) in the Radio Access Network (Stage-2)".
- [56] 3GPP TR 25.992: "Multimedia Broadcast Multicast Service (MBMS); UTRAN/GERAN Requirements".
- [57] 3GPP TS 25.413: "UTRAN Iu Interface RANAP Signalling".
- [58] 3GPP TS 25.309: "FDD Enhanced Uplink; Overall Description; Stage 2".
- [59] 3GPP TS 25.319: "Enhanced Uplink; Overall Description; Stage 2".
- [60] 3GPP TR 25.827: "1.28Mcps TDD Enhanced Uplink; Physical Layer Aspects".
- [61] Galileo OS Signal in Space ICD (OS SIS ICD), Issue 1.2, February 2014, European Union.
- [62] 3GPP TS 26.101: "Adaptive Multi-Rate (AMR) speech codec frame structure".
- [63] 3GPP TS 26.201: "Adaptive Multi Rate – Wideband (AMR-WB) speech codec frame structure".
- [64] 3GPP TS 36.101: "Evolved Universal Terrestrial Radio Access (E-UTRA); User Equipment (UE) radio transmission and reception".
- [65] 3GPP TS 36.104: "Evolved Universal Terrestrial Radio Access (E-UTRA); Base Station (BS) radio transmission and reception".
- [66] 3GPP TS 36.304: "Evolved Universal Terrestrial Radio Access (E-UTRA); User Equipment (UE) procedures in idle mode".
- [67] 3GPP TS 36.331: "Evolved Universal Terrestrial Radio Access (E-UTRA); Radio Resource Control (RRC); Protocol Specification".
- [68] IS-GPS-200, Revision D, Navstar GPS Space Segment/Navigation User Interfaces, March 7th, 2006.
- [69] IS-GPS-705, Navstar GPS Space Segment/User Segment L5 Interfaces, September 22, 2005.
- [70] IS-GPS-800, Navstar GPS Space Segment/User Segment L1C Interfaces, March 31, 2008.
- [71] Specification for the Wide Area Augmentation System (WAAS), US Department of Transportation, Federal Aviation Administration, DTFA01-96-C-00025, 2001.
- [72] IS-QZSS, Quasi Zenith Satellite System Navigation Service Interface Specifications for QZSS, Ver.1.0, June 17, 2008.
- [73] Global Navigation Satellite System GLONASS Interface Control Document, Version 5.1, 2008.
- [74] 3GPP TS 36.133: "Evolved Universal Terrestrial Radio Access (E-UTRA); Requirements for support of radio resource management".
- [75] 3GPP TS 22.011: "Service accessibility".
- [76] 3GPP TS 23.003: "Numbering, addressing and identification".
- [77] 3GPP TS 23.041: "Technical realization of Cell Broadcast Service (CBS)".
- [78] 3GPP TS 33.401: "3GPP System Architecture Evolution (SAE): Security architecture".
- [79] 3GPP TS 24.301: " Non-Access-Stratum (NAS) protocol for Evolved Packet System (EPS)".

- [80] 3GPP TS 37.320: "Universal Terrestrial Radio Access (UTRA) and Evolved Universal Terrestrial Radio Access (E-UTRA); Radio measurement collection for Minimization of Drive Tests (MDT); Overall description; Stage 2".
- [81] 3GPP TS 32.422: "Telecommunication management; Subscriber and equipment trace; Trace control and configuration management".
- [82] 3GPP TS 22.368: "Service Requirements for Machine Type Communications; Stage 1".
- [83] RFC 3095: "RObust Header Compression (ROHC): Framework and four profiles".
- [84] RFC 4815: "RObust Header Compression (ROHC): Corrections and Clarifications to RFC 3095".
- [85] 3GPP TS 25.307: "Requirement on User Equipments (UEs) supporting a release-independent frequency band".
- [86] BDS-SIS-ICD-2.0: "BeiDou Navigation Satellite System Signal In Space Interface Control Document Open Service Signal (Version 2.0), December 2013".
- [87] IEEE 802.11-2012, Part 11: "Wireless LAN Medium Access Control (MAC) and Physical Layer (PHY) specifications, IEEE Std.".
- [88] 3GPP TS 24.312: "Access Network Discovery and Selection Function (ANDSF) Management Object (MO)".

3 Definitions and abbreviations

3.1 Definitions

For the purposes of the present document, the terms and definitions given in [1] apply, together as:

Activated uplink frequency (FDD only): For a specific UE, an uplink frequency is said to be activated if the UE is allowed to transmit on that frequency. The primary uplink frequency is always activated when configured while a secondary uplink frequency has to be activated by means of an HS-SCCH order in order to become activated.

Adjacent Frequency: A frequency whose centre is within 5 MHz of the centre of the currently used frequency and belongs to the same frequency band as that of the currently used frequency.

Assisting serving HS-DSCH Cell: In addition to the serving HS-DSCH cell, a cell in the same frequency, where the UE is configured to simultaneously monitor a HS-SCCH set and receive HS-DSCH if it is scheduled in that cell.

Assisting secondary serving HS-DSCH Cell: In addition to the serving HS-DSCH cell, a cell in the secondary downlink frequency, where the UE is configured to simultaneously monitor a HS-SCCH set and receive HS-DSCH if it is scheduled in that cell.

Common E-DCH resource: In FDD, common E-DCH resources are under direct control of the Node B and are shared by UEs in CELL_FACH state and IDLE mode. In 1.28 Mcps TDD, common E-DCH resources used by UEs in CELL_FACH and IDLE mode are under direct control of Node B and are shared by UEs in the CELL_DCH state.

Common E-RGCH RL: Cell which is not the serving E-DCH radio link and from which the UE can receive one Relative Grant in CELL_FACH state. The UE can have zero, one or up to 3 Common E-RGCH RL(s).

Configured Uplink Frequency (FDD only): For a specific UE, an uplink frequency is said to be configured if the UE has received all relevant information from RRC in order to perform transmission on that frequency.

CSG member cell: a cell broadcasting the identity of the selected PLMN, registered PLMN or equivalent PLMN and for which the CSG whitelist of the UE includes an entry comprising the cell's CSG ID and the respective PLMN identity.

Current Frequency (FDD only): The frequency that is currently used by the UE. In case of dual cell or dual band configured, the serving HS-DSCH cell frequency is treated as current frequency.

Data Description Indicator (DDI): MAC-e header field used to identify the logical channel, MAC-d flow and the size of the MAC-d PDUs concatenated into a MAC-es PDU.

Designated non-serving HS-DSCH cell: The non-serving HS-DSCH cell from which the UE estimates the F-DPCH quality for TPC derivation, when the UE is configured with DPCCH2 in the uplink or the E-DCH decoupling is configured. This TPC is transmitted on UL DPCCH.

E-DCH active set (FDD only): The set of cells on the primary uplink frequency which carry the E-DCH for one UE. Only radio links for which an E-HICH configuration is stored are considered part of the E-DCH active set.

Enhanced Uplink in CELL_FACH state and Idle mode: In FDD, combines the REL99 random access power ramping phase with E-DCH transmission. The procedure can be started in idle mode and RRC Connected mode, but not in CELL_DCH state. In 1.28 Mcps TDD, the REL7 enhanced random access procedure for E-DCH in CELL_DCH is used in idle mode and CELL_FACH state.

HARQ profile: One HARQ profile consists of a power offset attribute and maximum number of transmissions.

Implicit Grant handling: A scheduling scheme where a UE's Scheduling Grant on the Secondary Serving E-DCH cell may be revoked by means of an Absolute Grant addressed to another UE.

MBMS activated services: the MBMS multicast services the UE has joined as well as the broadcast services the UE is interested in.

MCCH acquisition: the procedure for acquiring all MCCH information relevant for the UE ie. includes reception of the RB information for the UE's MBMS activated services.

MBMS controlling cell: the cell from which the UE receives MCCH.

MBMS notification: a notification provided by UTRAN indicating a change in the provision of one or more MBMS services.

MBMS Selected Services: a subset of the MBMS activated services of the Broadcast type for which the UE applies RRC procedures to inform UTRAN that the service has been selected (by upper layers).

MBMS transmission: a possibly repeated session of an MBMS service. An MBMS transmission is uniquely identified by the combination of the MBMS service identity and the MBMS session identity.

MBSFN cluster: Set of cells operating in MBSFN mode providing only MBMS service in PtM mode and seen as one cell by a UE.

MBSFN mode: Transmission mode where a set of synchronized cells transmit exactly the same data for provision of MBMS service.

Multiflow (FDD only): A mode of operation with two simultaneous HS-DSCH transport channels per carrier frequency, where the HS-DSCH transport channels may belong to the same or different Node Bs.

NodeB triggered HS-DPCCH transmission: Transmission on a common E-DCH resource to provide HS-DPCCH feedback in CELL_FACH state, which is triggered by the reception of an HS-SCCH order as defined in [16].

Primary Absolute Grant (FDD only): Absolute Grant received with the primary E-RNTI.

Primary uplink frequency (FDD only): If a single uplink frequency is configured for the UE, then it is the primary uplink frequency. In case more than one uplink frequencies are configured for the UE, then the primary uplink frequency is the frequency on which E-DCH corresponding to the serving E-DCH cell associated with the serving HS-DSCH cell is transmitted. The association between a pair of uplink and downlink frequencies is indicated by higher layers.

Radio Links without DPCH/F-DPCH operation (FDD only): An operation mode in which UE supports to not receive both DPCH and F-DPCH downlink channels from the indicated Non-serving E-DCH cell(s).

Secondary Absolute Grant (FDD only): Absolute Grant received with the secondary E-RNTI.

Secondary E-DCH Active Set (FDD only): The set of cells on the secondary uplink frequency where E-DCH is carried for one UE. Only radio links for which an E-HICH configuration is stored are considered part of the secondary E-DCH active set. The secondary E-DCH active set and the active set on the secondary uplink frequency are always the same set of cells.

Secondary Serving E-DCH cell (FDD only): Cell from which the UE receives Absolute Grants from the Node-B scheduler on the downlink frequency associated with secondary uplink frequency. A UE has one Secondary Serving E-DCH cell on the secondary uplink frequency.

Secondary Serving E-DCH RLS or Secondary Serving RLS (FDD only): In Dual Cell E-DCH operation, the set of cells which contains at least the Secondary Serving E-DCH cell and from which the UE can receive and combine one Relative Grant. A UE can have zero or one Secondary Serving E-DCH RLS.

Secondary serving HS-DSCH cell(s): In addition to the serving HS-DSCH cell, the set of cells where the UE is configured to simultaneously monitor an HS-SCCH set and receive the HS-DSCH if it is scheduled in that cell. There can be up to 7 secondary serving HS-DSCH cells. If the UE is configured with two uplink frequencies, the first secondary serving HS-DSCH cell is the secondary serving HS-DSCH cell that is associated with the secondary uplink frequency.

Secondary Non-serving E-DCH RL or Secondary Non-serving RL (FDD only): In Dual Cell E-DCH operation, the cell which belongs to the Secondary E-DCH active set but does not belong to the Secondary Serving E-DCH RLS and from which the UE in CELL_DCH can receive one Relative Grant. The UE can have zero, one or several Secondary Non-serving E-DCH RL(s).

Secondary uplink frequency (FDD only): A secondary uplink frequency is a frequency on which an E-DCH corresponding to a serving E-DCH cell associated with a secondary serving HS-DSCH cell is transmitted. The association between a pair of uplink and downlink frequencies is indicated by higher layers.

Serving E-DCH cell: Cell from which the UE receives Absolute Grants from the Node-B scheduler. In TDD, a UE has one Serving E-DCH cell. In FDD, a UE has one Serving E-DCH cell on the primary uplink frequency.

Serving E-DCH cell decoupling (FDD only): An E-DCH operation mode in which the Serving HS-DSCH cell and the Serving E-DCH cell are different.

Serving E-DCH RLS or Serving RLS (FDD only): Set of cells which contains at least the Serving E-DCH cell and from which the UE can receive and combine one Relative Grant. In TDD, the UE has only one Serving E-DCH RLS. In FDD, a UE has one Serving E-DCH cell on the primary uplink frequency.

Non-serving E-DCH RL or Non-serving RL (FDD only): Cell which belongs to the E-DCH active set but does not belong to the Serving E-DCH RLS and from which the UE in CELL_DCH can receive one Relative Grant. In TDD, the UE can have zero, one or several Non-serving E-DCH RL(s). In FDD, the UE can have zero, one or several Non-serving E-DCH RL(s) on the primary uplink frequency.

SR-VCC: Single Radio Voice Call Continuity, Voice call or Voice and Video call continuity between IMS over PS access and CS access for calls that are anchored in IMS when the UE is capable of transmitting/receiving on only one of those access networks at a given time. Single Radio Voice Call Continuity between CS access and IMS over PS access is referred to as Reverse SRVCC (rSR-VCC).

Target Cell Pre-Configuration (FDD only): HS-DSCH Cell configuration provided to UE in Active Set Update for which HS-DSCH serving Cell Change may be initiated by HS-SCCH order sent from target cell.

Target cell HS-SCCH order: A HS-DSCH serving cell change command signaled to an UE by using HS-SCCH order in the target cell:

- for which a measurement report was triggered by an Event 1d intra frequency event; or

- for which a measurement report was triggered by an Event 1c intra frequency event on the primary frequency, which indicates the current serving HS-DSCH cell as the only active CPICH triggering this event 1c report, and the target cell is the best cell in the current active set reported in this Event 1c measurement report. If more than one cell in the active set share the same quality, the target cell will be the first one listed in the "Intra-frequency measured results list" in the Event 1c measurement report.

Primary E-DCH carrier (1.28Mcps TDD only): If a single E-DCH carrier is configured for the UE, then it is the primary E-DCH carrier. In case more than one E-DCH carriers are configured for the UE, then the primary E-DCH carrier is the carrier on which the E-RUCCH will be transmitted.

Additional E-DCH carrier (1.28Mcps TDD only): An additional E-DCH carrier is an E-DCH carrier other than the primary E-DCH carrier . The UE can have zero, one or several additional E-DCH carrier(s).

3.2 Abbreviations

For the purposes of the present document, the following abbreviations apply:

ACK	Acknowledgement
AG	Absolute Grant
AICH	Acquisition Indicator CHannel
AM	Acknowledged Mode
ANDSF	Access Network Discovery and Selection Function
ANR	Automatic Neighbour Relation
AS	Access Stratum
ASC	Access Service Class
ASN.1	Abstract Syntax Notation.1
BCCH	Broadcast Control Channel
BCD	Binary Coded Decimal
BCFE	Broadcast Control Functional Entity
BDS	BeiDou Navigation Satellite System
BER	Bit Error Rate
BLER	BLock Error Rate
BSS	Base Station Sub-system
CCCH	Common Control Channel
CCPCH	Common Control Physical CHannel
CH	Conditional on history
CLTD	Closed Loop Transmit Diversity
CM	Connection Management
CN	Core Network
C-RNTI	Cell RNTI
CSFB	CS Fallback
CSG	Closed Subscriber Group
CTCH	Common Traffic CHannel
CTFC	Calculated Transport Format Combination
CV	Conditional on value
DBDS	Differential BDS
DCA	Dynamic Channel Allocation
DCCH	Dedicated Control Channel
DCFE	Dedicated Control Functional Entity
DCH	Dedicated Channel
DC-SAP	Dedicated Control SAP
DDI	Data Description Indicator
DGANSS	Differential GANSS
DGPS	Differential Global Positioning System
DL	Downlink
DPCCH2	Dedicated Physical Control Channel 2
DSCH	Downlink Shared Channel
DTCH	Dedicated Traffic Channel
DTM	Dual Transfer Mode
EAB	Extended Access Barring
E-AGCH	E-DCH Absolute Grant Channel
ECEF	Earth-Centered, Earth-Fixed
ECI	Earth-Centered-Inertial
E-DCH	Enhanced uplink DCH
E-DPCCH	E-DCH Dedicated Physical Control Channel (FDD Only)
E-DPDCH	E-DCH Dedicated Physical Data Channel (FDD Only)
EGNOS	European Geostationary Navigation Overlay Service
E-HICH	E-DCH HARQ Acknowledgement Indicator Channel
E-PUCH	Enhanced Uplink Physical Channel (TDD only)
E-RGCH	E-DCH Relative Grant Channel (FDD only)
E-RNTI	E-DCH RNTI

E-ROCH	E-DCH Rank and Offset Channel (FDD only)
E-RUCCH	E-DCH Random Access Uplink Control Channel (TDD only)
E-TFCI	E-DCH Transport Format Combination Indicator
ETWS	Earthquake and Tsunami Warning System
E-UCCH	E-DCH Uplink Control Channel (TDD only)
E-UTRA	Evolved Universal Terrestrial Radio Access
E-UTRAN	Evolved Universal Terrestrial Radio Access Network
FACH	Forward Access Channel
FDD	Frequency Division Duplex
F-DPCH	Fractional DPCH
F-TPICH	Fractional Transmitted Precoding Indicator Channel
GAGAN	GPS Aided Geo Augmented Navigation
GANSS	Galileo and Additional Navigation Satellite Systems
GC-SAP	General Control SAP
GERAN	GSM/EDGE Radio Access Network
GLONASS	GLObal'naya NAVigatsionnaya Sputnikovaya Sistema (Engl.: Global Navigation Satellite System)
GNSS	Global Navigation Satellite System
GRA	GERAN Registration Area
G-RNTI	GERAN Radio Network Temporary Identity
HARQ	Hybrid Automatic Repeat Request
HCS	Hierarchical Cell Structure
HFN	Hyper Frame Number
H-RNTI	HS-DSCH RNTI
HS-DSCH	High Speed Downlink Shared Channel
ICD	Interface Control Document
ID	Identifier
IDNNS	Intra Domain NAS Node Selector
IE	Information element
IETF	Internet Engineering Task Force
IMB	Integrated Mobile Broadcast
IMEI	International Mobile Equipment Identity
IMSI	International Mobile Subscriber Identity
IP	Internet Protocol
ISCP	Interference on Signal Code Power
L1	Layer 1
L2	Layer 2
L3	Layer 3
LAI	Location Area Identity
MAC	Media Access Control
MBMS	Multimedia Broadcast Multicast Service
MBSFN	MBMS over a Single Frequency Network
MCC	Mobile Country Code
MCCH	MBMS point-to-multipoint Control Channel
MD	Mandatory default
MDT	Minimization of Drive Tests
MICH	MBMS notification Indicator Channel
MM	Mobility Management
MNC	Mobile Network Code
MP	Mandatory present
MTCH	MBMS point-to-multipoint Traffic Channel
MSAS	Multi-functional Satellite Augmentation System
MSCH	MBMS point-to-multipoint Scheduling Channel
NACC	Network Assisted Cell Change
NAS	Non Access Stratum
Nt-SAP	Notification SAP
NW	Network
OLTD	Open Loop Transmit Diversity
OP	Optional
PCCH	Paging Control Channel
PCH	Paging Channel
PDCP	Packet Data Convergence Protocol
PDSCH	Physical Downlink Shared Channel

PDU	Protocol Data Unit
PLMN	Public Land Mobile Network
PNFE	Paging and Notification Control Functional Entity
PRACH	Physical Random Access CHannel
PRN	Pseudo-Random Noise
PSI	Packet System Information
p-t-m	Point-to-Multipoint
P-TMSI	Packet Temporary Mobile Subscriber Identity
p-t-p	Point-to-Point
PUSCH	Physical Uplink Shared Channel
QoS	Quality of Service
QZSS	Quasi-Zenith Satellite System
RAB	Radio access bearer
RACH	Random Access CHannel
RAI	Routing Area Identity
RAT	Radio Access Technology
RB	Radio Bearer
RFE	Routing Functional Entity
RG	Relative Grant
RL	Radio Link
RLC	Radio Link Control
RLS	Radio Link Set
RNC	Radio Network Controller
ROHC	RObust Header Compression
RNTI	Radio Network Temporary Identifier
RRC	Radio Resource Control
RSCP	Received Signal Code Power
RSN	Retransmission Sequence Number
RSRP	Reference Signal Received Power
RSRQ	Reference Signal Received Quality
RSSI	Received Signal Strength Indicator
SAP	Service Access Point
SBAS	Satellite Based Augmentation System
SCFE	Shared Control Function Entity
SCTD	Space Code Transmit Diversity
SCTO	Soft Combining Timing Offset (MBMS)
S-DPCCH	Secondary Dedicated Physical Control Channel
S-E-DPCCH	Secondary E-DPCCH (FDD only)
S-E-DPDCH	Secondary E-DPDCH (FDD only)
SF	Spreading Factor
SG	Serving grant
SHCCH	Shared Control Channel
SI	System Information
SIR	Signal to Interference Ratio
SPS	Semi-Persistent Scheduling
S-RNTI	SRNC - RNTI
SV	Space Vehicle
TDD	Time Division Duplex
TF	Transport Format
TFCS	Transport Format Combination Set
TFS	Transport Format Set
TM	Transparent Mode
TME	Transfer Mode Entity
TMSI	Temporary Mobile Subscriber Identity
Tr	Transparent
TSN	Transmission Sequence Number
Tx	Transmission
UE	User Equipment
UL	Uplink
UM	Unacknowledged Mode
URA	UTRAN Registration Area
U-RNTI	UTRAN-RNTI

USCH	Uplink Shared Channel
UTC	Universal Coordinated Time
UTRAN	Universal Terrestrial Radio Access Network
WAAS	Wide Area Augmentation System
WGS-84	World Geodetic System 1984
WLAN	Wireless Local Area Network

4 General

If not specified differently, descriptions are relevant for both FDD and TDD. Descriptions for TDD only are relevant for both 1.28 Mcps TDD and 3.84 Mcps TDD and 7.68 Mcps TDD if not specified differently.

4.1 Overview of the specification

This specification is organised as follows:

- subclause 4.2 contains the description of the model of the RRC protocol layer;
- clause 5 lists the RRC functions and the services provided to upper layers;
- clause 6 lists the services expected from the lower layers and specifies the radio bearers available for usage by the RRC messages;
- clause 7 specifies the UE states for the Access Stratum, and also specifies the processes running in the UE in the respective states;
- clause 8 specifies RRC procedures, including UE state transitions;
- clause 9 specifies the procedures for the handling of unknown, unforeseen, and erroneous protocol data by the receiving entity;
- clause 10 describes the message in a Tabular format; these messages descriptions are referenced in clause 8;
- clause 11 specifies the encoding of the messages of the RRC protocol. This is based on the Tabular description in clause 10.
- clause 12 specifies the transfer syntax for RRC PDUs derived from the encoding definition;
- clause 13 lists the protocol timers, counters, constants and variables to be used by the UE;
- clause 14 specifies some of the processes applicable in UTRA RRC connected mode e.g. measurement processes, and also the RRC information to be transferred between network nodes. Note that not all the processes applicable in UTRA RRC connected mode are specified here i.e. some UTRA RRC connected mode processes are described in [4] e.g. cell re-selection;
- Annex A contains recommendations about the network parameters to be stored on the USIM;
- Annex B contains informative Stage 2 description of the RRC protocol states and state transitions.

The following figure summarises the mapping of UE states, including states in GSM and E-UTRA, to the appropriate UTRA, GSM and E-UTRA specifications that specify the UE behaviour.

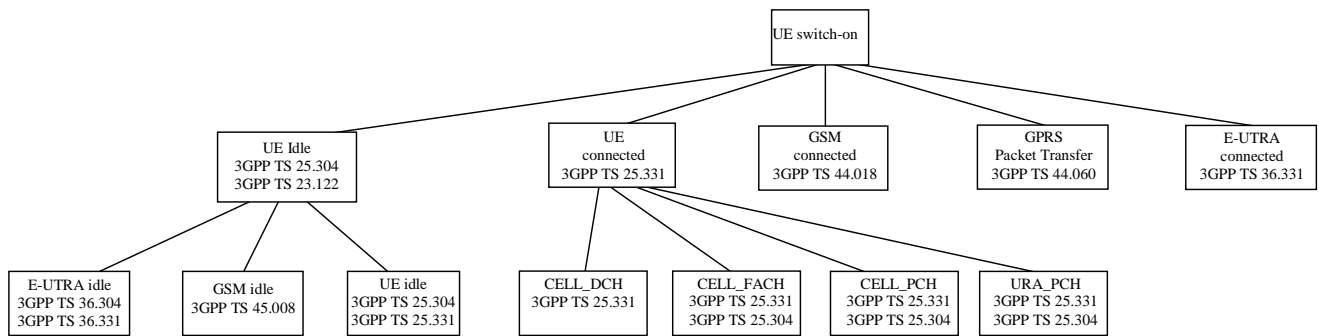

Figure 4.1-1: Mapping of UE state to 3GPP Specifications

4.2 RRC Layer Model

The functional entities of the RRC layer are described below:

- Routing of higher layer messages to different MM/CM entities (UE side) or different core network domains (UTRAN side) is handled by the Routing Function Entity (**RFE**).
- Broadcast functions are handled in the broadcast control function entity (**BCFE**). The BCFE is used to deliver the RRC services, which are required at the GC-SAP. The BCFE can use the lower layer services provided by the Tr-SAP and UM-SAP.
- Paging of UEs that do not have an RRC connection is controlled by the paging and notification control function entity (**PNFE**). The PNFE is used to deliver the RRC services that are required at the Nt-SAP. The PNFE can use the lower layer services provided by the Tr-SAP and UM-SAP.
- The Dedicated Control Function Entity (**DCFE**) handles all functions specific to one UE. The DCFE is used to deliver the RRC services that are required at the DC-SAP and can use lower layer services of UM/AM-SAP and Tr-SAP depending on the message to be sent and on the current UE service state.
- In TDD mode, the DCFE is assisted by the Shared Control Function Entity (SCFE) location in the C-RNC, which controls the allocation of the PDSCH and PUSCH using lower layers services of UM-SAP and Tr-SAP.
- The Transfer Mode Entity (TME) handles the mapping between the different entities inside the RRC layer and the SAPs provided by RLC.

NOTE 1: Logical information exchange is necessary also between the RRC sublayer functional entities. Most of that is implementation dependent and not necessary to present in detail in a specification.

Figure 4.2-1 shows the RRC model for the UE and Figure 4.2-2 and Figure 4.2-3 show the RRC model for the UTRAN.

NOTE 2: The figure shows only the types of SAPs that are used. Multiple instances of Tr-SAP, UM-SAP and AM-SAP are possible. Especially, different functional entities usually use different instances of SAP types.

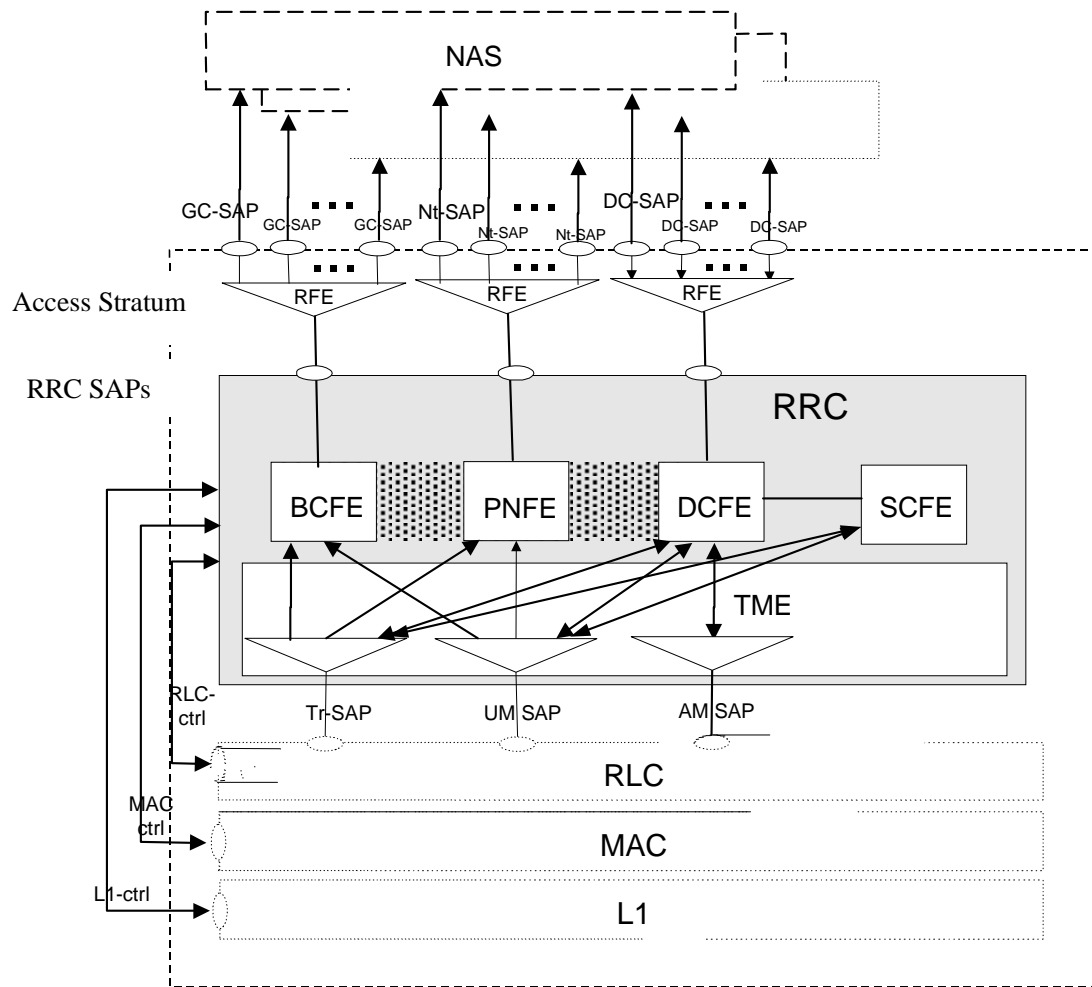

Figure 4.2-1: UE side model of RRC

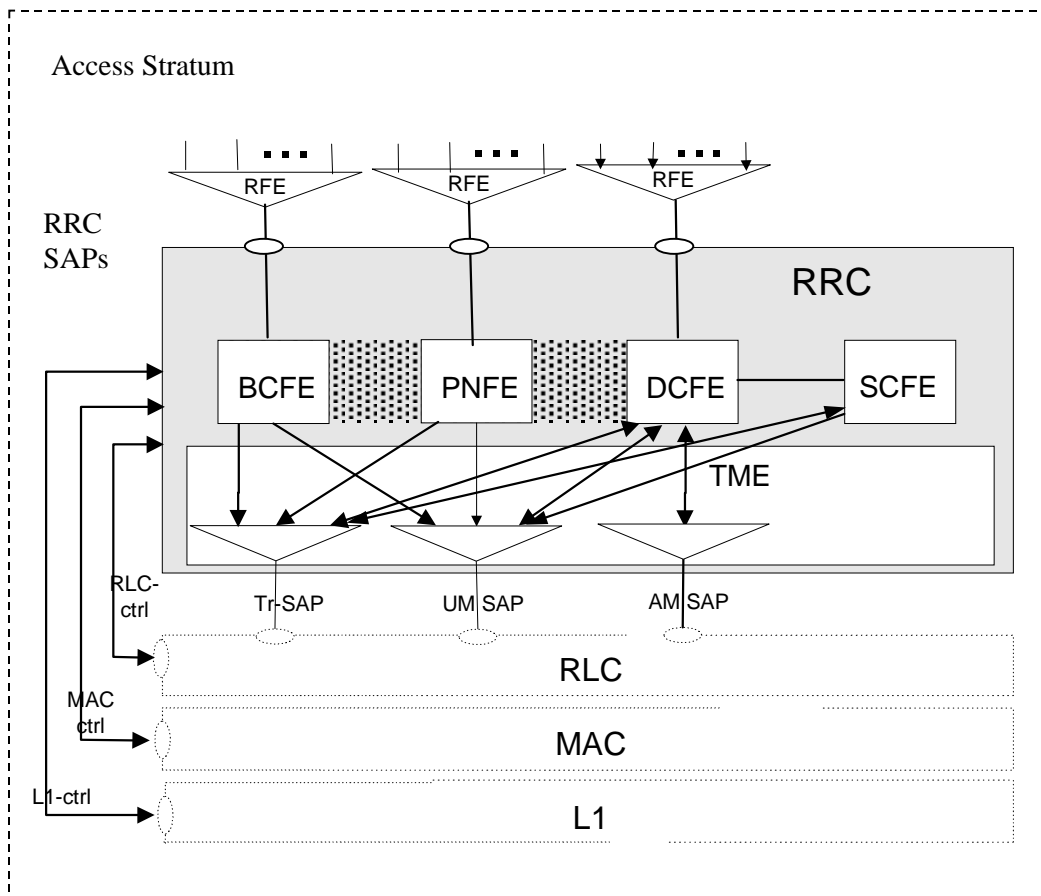

Figure 4.2-2: UTRAN side RRC model (DS-MAP system)

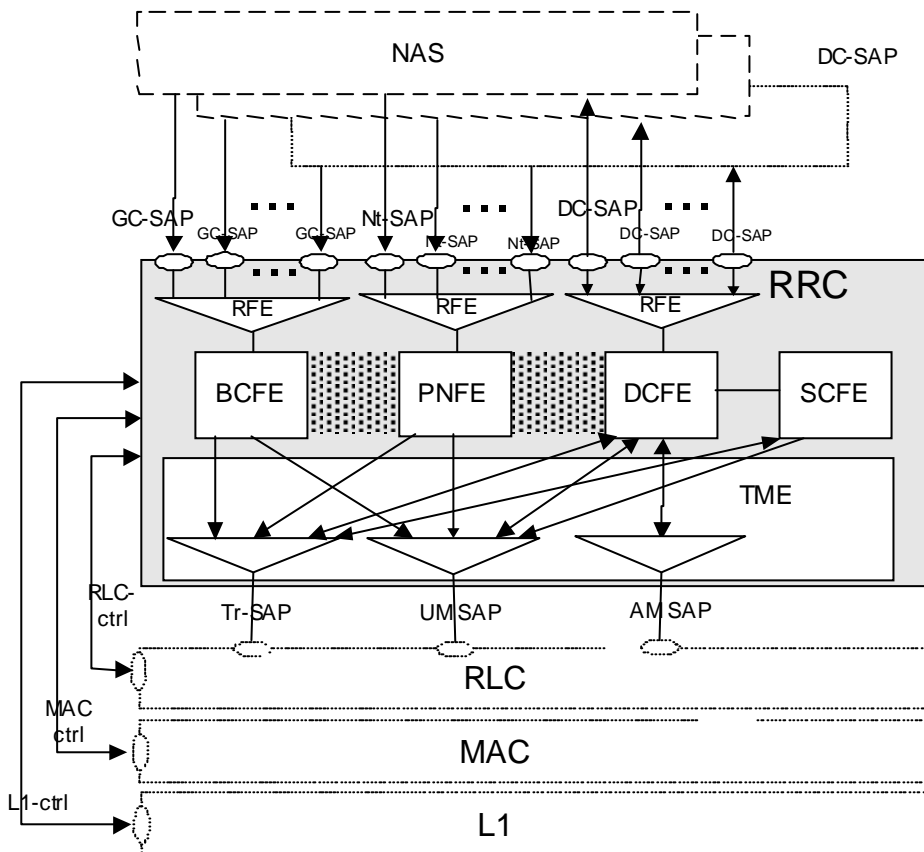

Figure 4.2-3: UTRAN side RRC model (DS-41 System)

4.3 Protocol specification principles

This protocol specification is based on the applicable general guidelines given in [14].

In this specification, a notation of variables is used. The variables are defined in subclause 13.4. Variables are typically used to represent a status or a result of an action, such as reception of an information element in a message, which is used to specify a behaviour somewhere else in the specification, such as when setting the value of an information element in a transmitted message. The variables only serve the purpose of specifying the protocol, and do not therefore impose any particular implementation.

When specifying the UE behaviour at reception of messages, the behaviour that is tied to reception or non-reception of individual information elements, and in some cases combinations of information elements, is specified in one location (subclause 8.6).

5 RRC Functions and Services provided to upper layers

5.1 RRC Functions

The RRC performs the functions listed below. A more detailed description of these functions is provided in [2]:

- Broadcast of information related to the non-access stratum (Core Network);
- Broadcast of information related to the access stratum;
- Establishment, maintenance and release of an RRC connection between the UE and UTRAN;
- Establishment, reconfiguration and release p-t-p of Radio Bearers;
- Establishment, reconfiguration and release of p-t-m Radio Bearers;
- Assignment, reconfiguration and release of radio resources for the RRC connection;
- RRC connection mobility functions;
- Control of requested QoS;
- UE measurement reporting and control of the reporting;
- Outer loop power control;
- Control of ciphering;
- Slow DCA (TDD mode);
- Paging;
- Initial cell selection and cell re-selection;
- Arbitration of radio resources on uplink DCH;
- RRC message integrity protection;
- Timing advance (TDD mode);
- CBS control;
- MBMS control.

5.2 RRC Services provided to upper layers

The RRC offers the following services to upper layers, a description and primitives of these services are provided in [2] and [17].

- General Control;
- Notification;
- Dedicated control.

The RRC layer provides the UE-UTRAN portion of signalling connections to the upper layers to support the exchange of upper layer's information flow. The signalling connection is used between the user equipment and the core network to transfer upper layer information. For each core network domain, at most one signalling connection may exist at the same time. The RRC layer maps the signalling connections for one UE on a single RRC connection. For the upper layer data transfer on signalling connections, the RRC layer supports the discrimination between two different classes, named "High priority" (corresponding to "SAPI 0" for a GSM-MAP based core network) and "Low priority" (corresponding to "SAPI 3" for a GSM-MAP based core network).

5.3 Primitives between RRC and upper layers

The primitives between RRC and the upper layers are described in [17].

6 Services expected from lower layers

6.1 Services expected from Layer 2

The services provided by layer 2 are described in [2], [15] and [16].

6.2 Services expected from Layer 1

The services provided by layer 1 are described in [2].

6.3 Signalling Radio Bearers

The Radio Bearers (RB) available for transmission of RRC messages are defined as "signalling radio bearers" and are specified in the following. The UE and UTRAN shall select the signalling radio bearers for RRC messages using RLC-TM, RLC-UM or RLC-AM on the DCCH and CCCH, according to the following:

- Signalling radio bearer RB0 shall be used for all messages sent on the CCCH (UL: RLC-TM, DL: RLC-UM).
- Signalling radio bearer RB1 shall be used for all messages sent on the DCCH, when using RLC unacknowledged mode (RLC-UM).
- Signalling radio bearer RB2 shall be used for all messages sent on the DCCH, when using RLC acknowledged mode (RLC-AM), except for the RRC messages carrying higher layer (NAS) signalling.
- Signalling radio bearer RB3 and optionally Signalling radio bearer RB4 shall be used for the RRC messages carrying higher layer (NAS) signalling and sent on the DCCH in RLC acknowledged mode (RLC-AM), as specified in subclauses 8.1.8., 8.1.9 and 8.1.10.
- Signalling radio bearer RB4 shall be used for UE INFORMATION RESPONSE message.
- Additionally, RBs whose identities shall be set between 5 and 32 may be used as signalling radio bearer for the RRC messages on the DCCH sent in RLC transparent mode (RLC-TM).
- RRC messages on the SHCCH are mapped either on RACH or on the USCH in the uplink using TM and either on FACH or on the DSCH using RLC-UM. These messages are only specified for TDD mode.

- RRC messages on the MCCH are mapped on FACH using RLC-UM. The transport channel configuration for MCCH is indicated on BCCH. For this signalling radio bearer no identity is applied.
- RRC messages on the MSCH are mapped on FACH using RLC-UM. The transport channel configuration for MSCH is indicated on MCCH. For this signalling radio bearer no identity is applied.

The Radio Bearer configuration for signalling radio bearer RB0, SHCCH, BCCH on FACH, PCCH on PCH, BCCH mapped to BCH, RB0 mapped on HS-DSCH (FDD only) and RACH, BCCH mapped on HS-DSCH (FDD and 1.28 Mcps TDD only), PCCH mapped to HS-DSCH (FDD and 1.28 Mcps TDD only) and RB0 mapped on HS-DSCH and common E-DCH (FDD and 1.28 Mcps TDD only) are specified in subclauses 13.6, 13.6a, 13.6b, 13.6c, 13.6e, 13.6f, 13.6g and 13.6h.

Ciphering is never applied to signalling radio bearer RB0 or signalling radio bearers using RLC TM.

7 Protocol states

7.1 Overview of RRC States and State Transitions including GSM and E-UTRA

Figure 7.1-1 shows the RRC states in UTRA RRC Connected Mode, including transitions between UTRA RRC connected mode and GSM connected mode for CS domain services, and between UTRA RRC connected mode and GSM/GPRS packet modes or E-UTRA RRC connected mode for PS domain services. It also shows the transitions between Idle Mode and UTRA RRC Connected Mode and furthermore the transitions within UTRA RRC connected mode.

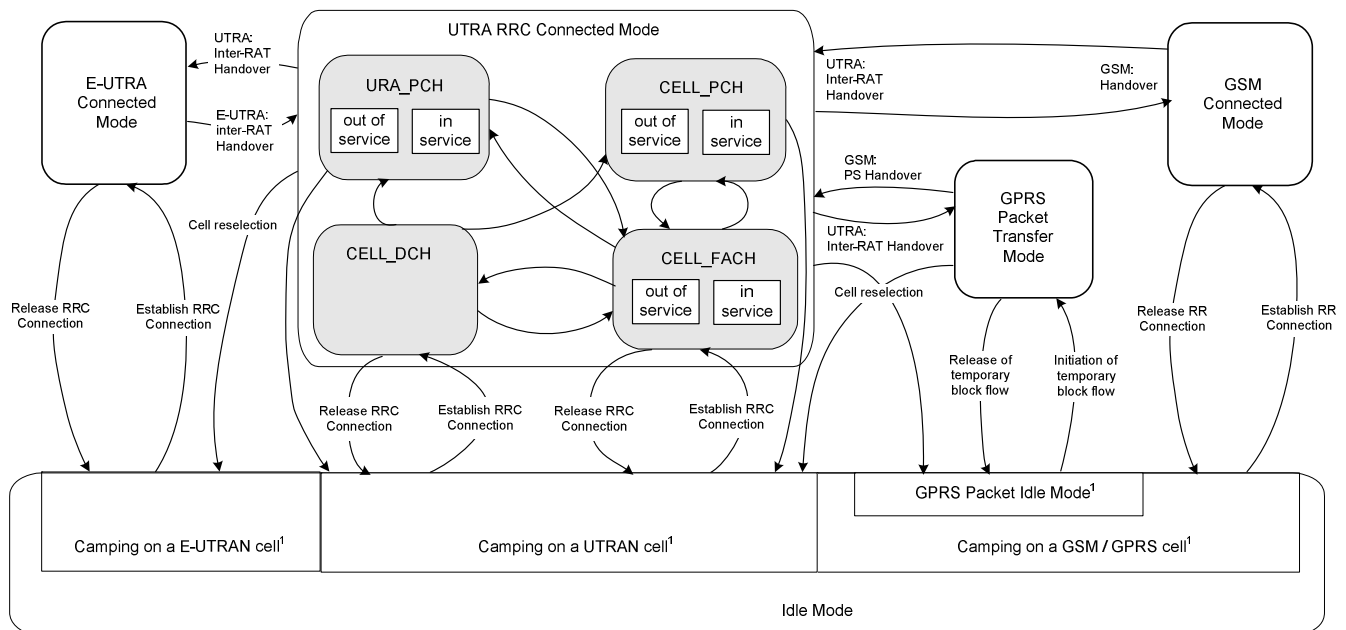

NOTE: 1: The indicated division within Idle Mode is only included for clarification and shall not be interpreted as states.

NOTE: Transitions between GSM/GPRS and E-UTRA are not shown.

Figure 7.1-1: RRC States and State Transitions including GSM and E-UTRA

The RRC connection is defined as a point-to-point bi-directional connection between RRC peer entities in the UE and the UTRAN characterised by the allocation of a U-RNTI. A UE has either zero or one RRC connection.

If NAS informs AS about a new selected PLMN, registered PLMN or equivalent PLMN list while being in connected mode, the UE shall perform the actions according to subclause 8.5.24.

NOTE: The state transitions are specified in clause 8.

7.2 Processes in UE modes/states

NOTE: This subclause specifies what processes shall be active in the UE in the different RRC modes/states. The related procedures and the conditions on which they are triggered are specified either in clause 8 or elsewhere in the relevant process definition.

7.2.1 UE Idle mode

UE processes that are active in UE Idle mode are specified in [4].

The UE shall perform a periodic search for higher priority PLMNs as specified in [25], unless the UE is receiving MBMS services via p-t-m radio bearers.

The UE shall store available measurement results as specified in [4], when logged measurement is configured.

The UE shall perform ANR measurements and logging as specified in [4], when logged ANR measurement is configured.

A UE that is capable of receiving MBMS services on cells operating in MBSFN mode as specified in subclause 8.1.1.6.3 is operating in idle mode and acts on RRC messages and system information received from this cell operating in MBSFN mode independently from messages received from cells not operating in MBSFN mode. This implies that procedures executed based on messages and system information received from a cell operating in MBSFN mode shall not interact with messages and system information received from a cell not operating in MBSFN mode unless explicitly specified otherwise.

NOTE 1: This implies that the UE is operating an independent stack for the reception of MBMS services on cells operating in MBSFN mode as specified in subclause 8.1.1.6.3.

NOTE 2: For 1.28 Mcps TDD, if the cell is operating in MBSFN mode, system information and MCCH messages are transmitted on the MBSFN Special Timeslot [30].

7.2.2 UTRA RRC Connected mode

In this specification unless otherwise mentioned "connected mode" shall refer to "UTRA RRC connected mode".

7.2.2.1 URA_PCH or CELL_PCH state

In the URA_PCH or CELL_PCH state the UE shall perform the following actions:

NOTE: For 3.84 Mcps TDD and 7.68 Mcps TDD, neither DCCH nor DTCH are available in these states. For FDD and 1.28 Mcps TDD, DCCH and DTCH reception on HS-DSCH may be configured in CELL_PCH state, if the UE supports HS-DSCH reception in CELL_PCH and URA_PCH state. Otherwise, neither DCCH nor DTCH are available in CELL_PCH state. In URA_PCH, neither DCCH nor DTCH are available.

1> if the UE is "in service area":

- 2> maintain up-to-date system information as broadcast by the serving cell as specified in the subclause 8.1.1;
- 2> perform cell reselection process as specified in [4];
- 2> perform a periodic search for higher priority PLMNs as specified in [25], unless the UE is receiving MBMS services via p-t-m radio bearers;

NOTE: If the DRX cycle length is 80ms, then a search for higher priority PLMNs may not identify all the available PLMNs due to the paging occasion on the current serving cell coinciding with the MIB of the cell of interest.

- 2> for 3.84 Mcps TDD and 7.68 Mcps TDD; or
- 2> for FDD and 1.28 Mcps TDD, if the UE does not support HS-DSCH reception in CELL_PCH and URA_PCH state; or

- 2> if the IE "HS-DSCH paging system information" is not included in System Information Block type 5 or System Information Block type 5bis; or
 - 2> for 1.28 Mcps TDD, if variable H_RNTI or variable C_RNTI is not set, and the IE "PICH info" is included in IE "Secondary CCPCCH system information" in System Information Block type 5 or System Information Block type 6:
 - 3> monitor the paging occasions and PICH monitoring occasions determined according to subclauses 8.6.3.1a, 8.6.3.2 and 8.5.42 and receive paging information on the PCH mapped on the S-CCPCH selected by the UE according to the procedure in subclause 8.5.19;
 - 2> else:
 - 3> monitor the paging occasions and PICH monitoring occasions determined according to subclauses 8.6.3.1a, 8.6.3.2 and 8.5.39 and receive PCCH on the HS-DSCH mapped on the HS-PDSCH, or DCCH and DTCH on the HS-DSCH mapped on the HS-PDSCH and the associated HS-SCCH selected by the UE according to the procedure in subclause 8.5.40 for FDD and 8.5.40a for 1.28 Mcps TDD.
 - 2> act on RRC messages received on PCCH, BCCH, and DCCH (FDD only);
 - 2> perform measurements process according to measurement control information as specified in subclause 8.4 and in subclause 14.4;
 - 2> maintain up-to-date BMC data if it supports Cell Broadcast Service (CBS) as specified in [37];
 - 2> act on RRC messages received on MCCH if it supports MBMS and has activated an MBMS service as specified in subclause 8.7;
 - 2> run timer T305 for periodical URA update if the UE is in URA_PCH or for periodical cell update if the UE is in CELL_PCH.
 - 2> store available measurements if logged measurement is configured as specified in [4].
 - 2> perform ANR measurements and logging as specified in [4], when logged ANR measurement is configured.
- 1> if the UE is "out of service area":
- 2> perform cell selection process as specified in [4];
 - 2> run timer T316;
 - 2> run timer T305 or T307;
 - 2> if the cell selection process fails to find a suitable cell after a complete scan of all RATs and all frequency bands supported by the UE, the UE shall after a minimum of TimerOutOfService time (default value 30 s) of being "out of service area":
 - 3> indicate all available PLMNs to NAS to enable the selection of a new PLMN;
 - 3> if an acceptable cell is found then the UE shall camp on that cell to obtain limited service as defined in [4] and, perform actions according to subclause 8.5.24;
 - 3> else if no acceptable cell is found, the UE shall continue looking for an acceptable cell as defined in [4].

7.2.2.2 CELL_FACH state

In the CELL_FACH state the UE shall perform the following actions:

NOTE: DCCH and, if configured, DTCH are available in this state.

- 1> if the UE is "in service area":
- 2> maintain up-to-date system information as broadcast by the serving cell as specified in subclause 8.1.1;
 - 2> perform cell reselection process as specified in [4];

- 2> perform measurements process according to measurement control information as specified in subclause 8.4 and in subclause 14.4;
- 2> run timer T305 (periodical cell update);
- 2> select and configure the RB multiplexing options applicable for the transport channels to be used in this RRC state;
- 2> store available measurements if logged measurement is configured as specified in [4] when second DRX cycle is used;
- 2> for 3.84 Mcps and 7.68 Mcps TDD; or
- 2> for FDD and 1.28 Mcps TDD, if the UE does not support HS-DSCH reception in CELL_FACH state; or
- 2> if the IE "HS-DSCH common system information" is not included in System Information Block type 5 or System Information Block type 5bis; or
- 2> for 1.28 Mcps TDD, if the IE "common E-DCH system info" is not included in System Information Block type 5:
 - 3> listen to all FACH transport channels mapped on the S-CCPCH selected by the UE according to the procedure in subclause 8.5.19.
- 2> else:
 - 3> if variable H_RNTI is set:
 - 4> receive physical channels HS-SCCH(s) using the value of the variable H_RNTI as UE identity and parameters given by the IE(s) "HS-DSCH common system information" according to the procedure in subclause 8.5.36.
 - 3> else:
 - 4> if the variable HS_DSCH_RECEPTION_OF_CCCH_ENABLED is set to TRUE:
 - 5> receive physical channel(s) of type HS-SCCH with selected common H-RNTI using parameters given by the IE(s) "HS-DSCH common system information" according to the procedure in subclause 8.5.37.
- 2> act on RRC messages received on BCCH, CCCH and DCCH;
- 2> act on RRC messages received on MCCH if it supports MBMS and has activated an MBMS service as specified in subclause 8.7;
- 2> act on RRC messages received on, if available, SHCCH (TDD only).
- 1> if the UE is "out of service area":
 - 2> perform cell selection process as specified in [4];
 - 2> run timers T305 (periodical cell update), and T317 (cell update when re-entering "in service") or T307 (transition to Idle mode), if started;
 - 2> run timers T314 and/or T315, if started;
 - 2> if the cell selection process fails to find a suitable cell after a complete scan of all RATs and all frequency bands supported by the UE, the UE shall after a minimum of TimerOutOfService time (default value 30 seconds) of being "out of service area":
 - 3> indicate all available PLMNs to NAS to enable the selection of a new PLMN;
 - 3> if an acceptable cell is found then the UE shall camp on that cell to obtain limited service as defined in [4] and perform actions according to subclause 8.5.24;
 - 3> else if no acceptable cell is found, the UE shall continue looking for an acceptable cell as defined in [4].

7.2.2.3 CELL_DCH state

In the CELL_DCH state the UE shall perform the following actions:

NOTE: DCCH and, if configured, DTCH are available in this state.

- 1> read the system information as specified in subclause 8.1.1 (for UEs in TDD mode);
- 1> perform measurements process according to measurement control information as specified in subclause 8.4 and in clause 14;
- 1> select and configure the RB multiplexing options applicable for the transport channels to be used in this RRC state;
- 1> act on RRC messages received on DCCH;
- 1> act on RRC messages received on BCCH (applicable only to UEs with certain capabilities and in FDD mode);
- 1> act on RRC messages received on MCCH if it supports MBMS and has activated an MBMS service as specified in subclause 8.7 (applicable only to UEs supporting MBMS with certain capabilities);
- 1> act on RRC messages received on BCCH (TDD only) and, if available, SHCCH (TDD only).

NOTE: If any of the above procedures results in different HS-DSCH and E-DCH serving cells, the UE behaviour is unspecified except when Serving E-DCH cell decoupling is configured.

8 RRC procedures

The UE shall be able to process several simultaneous RRC procedures. After the reception of a message which invoked a procedure, the UE shall be prepared to receive and act on another message which may invoke a second procedure. Whether this second invocation of a procedure (transaction) is accepted or rejected by the UE is specified in the subclauses of this clause, and in particular in subclause 8.6.3.11 (RRC transaction identifier).

On receiving a message the UE shall:

- 1> check that the message is addressed to the UE (e.g. by checking the IE "Initial UE identity" or the IE "U-RNTI" for messages on CCCH);
- 1> discard the messages addressed to other UEs.

and then the UE shall:

- 1> apply integrity check as appropriate;
- 1> proceed with error handling as specified in clause 9;
- 1> act upon the IE "RRC transaction identifier";
- 1> continue with the procedure as specified in the relevant subclause.

NOTE: Due to an error in the Release '99 ASN.1, a Release '99 UE is unable to determine which UE is addressed by a downlink CCCH message corresponding to a protocol version later than Release '99. As a result, the Release '99 UE will not be able to return a protocol error according to subclause 9.3a. Therefore, the UTRAN should only send a Release '99 message version towards UEs that have indicated conformance to Release '99 in the IE "Access stratum release indicator".

The RRC entity in the UE shall consider PDUs to have been transmitted when they are submitted to the lower layers. If the RRC entity in the UE submits a message for transmission using AM RLC, it shall consider the message successfully transmitted when UTRAN reception of all relevant PDUs is acknowledged by RLC. In the UE, timers are started when the PDUs are sent on the radio interface in the case of the transmission using the CCCH.

8.1 RRC Connection Management Procedures

8.1.1 Broadcast of system information

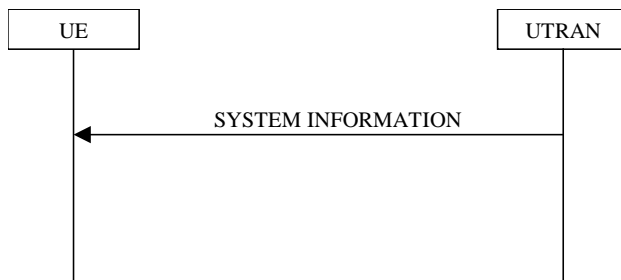

Figure 8.1.1-1: Broadcast of system information

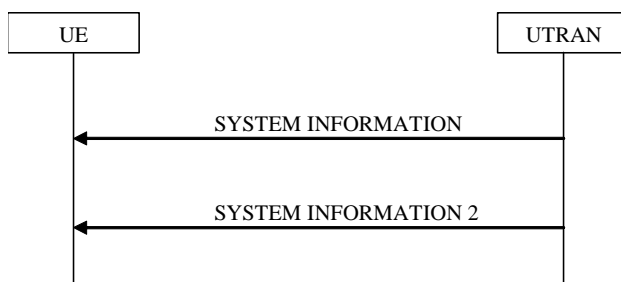

Figure 8.1.1-1a: Broadcast of system information with system information broadcast channel (BCH on PCCPCH) and second system information broadcast channel (BCH on SCCPCH)

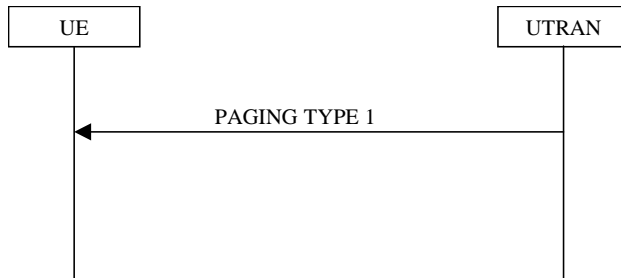

Figure 8.1.1-2: Notification of system information modification for UEs in idle mode, CELL_PCH state and URA_PCH state

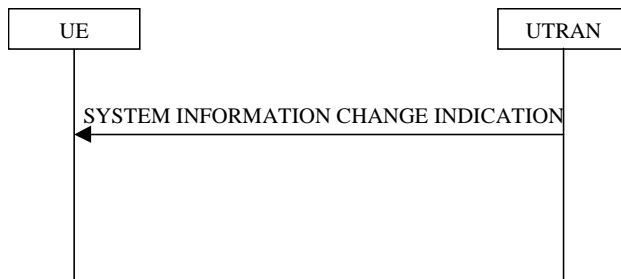

Figure 8.1.1-3: Notification of system information modification for UEs in CELL_FACH and CELL_DCH (TDD only) state

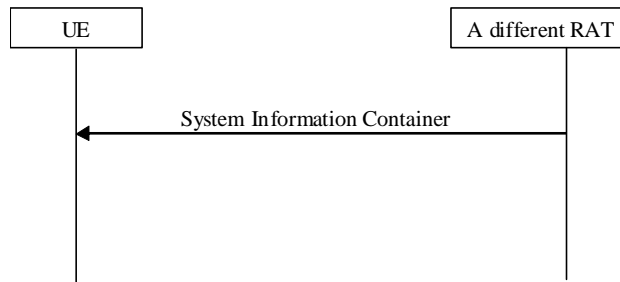

Figure 8.1.1-4: Reception of System Information Container

8.1.1.1 General

The purpose of this procedure is to broadcast system information from the UTRAN to UEs in a cell.

8.1.1.1.1 System information structure

The system information elements are broadcast in *system information blocks*. A system information block groups together system information elements of the same nature. Different system information blocks may have different characteristics, e.g. regarding their repetition rate and the requirements on UEs to re-read the system information blocks.

The system information is organised as a tree. A *master information block* gives references and scheduling information to a number of system information blocks in a cell. The system information blocks contain the actual system information. The master information block may optionally also contain reference and scheduling information to one, two or three *scheduling blocks*, which give references and scheduling information for additional system information blocks. Scheduling information for a system information block may only be included in either the master information block or one of the scheduling blocks.

For all system information blocks except System Information Block types 15.2, 15.3 and 16, the content is the same in each occurrence for system information blocks using value tag. System Information Block types 15.2, 15.3 and 16 may occur more than once with different content. In this case scheduling information is provided for each such occurrence of the system information block. System information blocks that do not use value tag may have different content for each occurrence.

8.1.1.1.2 System information blocks

Table 8.1.1 specifies all system information blocks and their characteristics.

The *area scope column* in table 8.1.1 specifies the area where a system information block's value tag is valid. If the area scope is *cell*, the UE shall consider the system information block to be valid only in the cell in which it was read. If system information blocks have been previously stored for this cell, the UE shall check whether the value tag for the system information block in the entered cell is different compared to the stored value tag. If the area scope is *PLMN* or *Equivalent PLMN*, the UE shall check the value tag for the system information block when a new cell is selected. If the value tag for the system information block in the new cell is different compared to the value tag for the system information block stored in the UE, the UE shall re-read the system information block. If the area scope is *PLMN*, the UE shall consider the system information block to be valid only within the PLMN in which it was read. If the area scope is *Equivalent PLMN*, the UE shall consider the system information block to be valid within the PLMN in which it was received and all PLMNs which are indicated by higher layers to be equivalent.

For System information block types 15.2, 15.2bis, 15.2ter, 15.3, 15.3bis and 16, which may have multiple occurrences, each occurrence has its own independent value tag. The UE shall re-read a particular occurrence if the value tag of this occurrence has changed compared to that stored in the UE.

The *UE mode/state column when block is valid* in Table 8.1.1 specifies in which UE mode or UE state the IEs in a system information block shall be regarded as valid by the UE. In other words, the indicated system information block becomes invalid upon change to a mode/state that is not included in this column. System Information Block Type 16 remains also valid upon transition to or from GSM/GPRS. In some cases, the states are inserted in brackets to indicate that the validity is dependent on the broadcast of the associated System Information Blocks by the network as explained in the relevant procedure subclause.

The *UE mode/state column when block is read* in Table 8.1.1 specifies in which UE mode or UE state the IEs in a system information block may be read by the UE. The UE shall have the necessary information prior to execution of any procedure requiring information to be obtained from the appropriate system information block. The requirements on the UE in terms of when to read the system information may therefore be derived from the procedure specifications that specify which IEs are required in the different UE modes/states in conjunction with the different performance requirements that are specified.

The UE shall:

- 1> if variable DEFERRED_MEASUREMENT_STATUS is set to FALSE:
 - 2> if System Information Block type 11 is referenced in the master information block or in the scheduling blocks:
 - 3> if System Information Block type 12 is not referenced in the master information block or in the scheduling blocks, or broadcast of System Information Block type 12 is not indicated in System Information Block type 11:
 - 4> have read and acted upon System Information Block type 11, System Information Block type 11bis and System Information Block type 11ter, if scheduled on BCH, in a cell when the UE transmits an RRC message on RACH.
 - 3> else:
 - 4> have read and acted upon System Information Block type 11, System Information Block type 11bis and System Information Block type 11ter, if scheduled on BCH, in a cell before the UE transmits the RRC CONNECTION REQUEST message;
 - 4> have read and acted upon both System Information Block type 11, System Information Block type 11bis and System Information Block type 11ter, if scheduled on BCH, and System Information Block type 12 in a cell when:
 - 5> the UE transmits an RRC message on RACH in RRC connected mode; or
 - 5> the UE receives a message commanding to enter CELL_DCH state.
 - 1> else:
 - 2> the UE may transmit an RRC message on RACH before having read and acted upon System Information Block type 11, System Information Block type 11bis, System Information Block type 11ter, System Information Block type 12, System Information Block type 18 and System Information Block type 19, if scheduled on BCH.

NOTE 1: There are a number of system information blocks that include the same IEs while the UE mode/state in which the information is valid differs. This approach is intended to allow the use of different IE values in different UE mode/states.

NOTE 2: System Information Block Type 16 is also obtained by a UE while in GSM/GPRS. The details of this are not within the scope of this specification.

NOTE 3: When DEFERRED_MEASUREMENT_STATUS variable is set TRUE, the E-UTRA capable UE should read SIB19 before initiating the RRC connection setup procedure except for the case when it is re-directed from E-UTRA.

NOTE 4: A UE supporting RAN-assisted WLAN interworking may transmit an RRC message before having read and acted upon System Information Block type 23.

The *Scheduling information* column in table 8.1.1 specifies the position and repetition period for the System Information Block.

The *modification of system information* column in table 8.1.1 specifies the update mechanisms applicable for a certain system information block. For system information blocks with a value tag, the UE shall update the information according to subclause 8.1.1.7.1 or 8.1.1.7.2. For system information blocks with an expiration timer, the UE shall, when the timer expires, perform an update of the information according to subclause 8.1.1.7.4.

Table 8.1.1: Specification of system information block characteristics

System information block	Area scope	UE mode/state when block is valid	UE mode/state when block is read	Scheduling information	Modification of system information	Additional comment
Master information block	Cell	Idle mode, CELL_FACH, CELL_PCH, URA_PCH, CELL_DCH (TDD only)	Idle mode, CELL_FACH, CELL_PCH, URA_PCH, CELL_DCH (TDD only)	SIB_POS = 0 SIB_REP = 8 (FDD) SIB_REP = 8, 16, 32 (TDD) SIB_OFF=2	Value tag	See Note 5
Scheduling block 1	Cell	Idle mode, CELL_FACH, CELL_PCH, URA_PCH, CELL_DCH (TDD only)	Idle mode, CELL_FACH, CELL_PCH, URA_PCH, CELL_DCH (TDD only)	Specified by the IE "Scheduling information" in MIB	Value tag	See Note 3
Scheduling block 2	Cell	Idle mode, CELL_FACH, CELL_PCH, URA_PCH, CELL_DCH (TDD only)	Idle mode, CELL_FACH, CELL_PCH, URA_PCH, CELL_DCH (TDD only)	Specified by the IE "Scheduling information" in MIB	Value tag	See Note 3
Scheduling block 3	Cell	Idle mode, CELL_FACH, CELL_PCH, URA_PCH	Idle mode, CELL_FACH, CELL_PCH, URA_PCH	Specified by the IE "SB3 information" in MIB SIB_POS = 4 SIB_OFF = 2	Value tag	See Note 3
System information block type 1	Cell	Idle mode, CELL_FACH, CELL_PCH, URA_PCH, CELL_DCH	Idle, CELL_FACH, CELL_PCH, URA_PCH	Specified by the IE "Scheduling information"	Value tag	Note: The area scope of SIB1 is Cell but for compliance to earlier versions of the specification the coding of the scheduling information for SIB1 contains the 'PLMN value tag' information element. See Note 3
System information block type 2	Cell	URA_PCH	URA_PCH	Specified by the IE "Scheduling information"	Value tag	See Note 3
System information block type 3	Cell	Idle mode, (CELL_FACH, CELL_PCH, URA_PCH)	Idle mode, (CELL_FACH, CELL_PCH, URA_PCH)	Specified by the IE "Scheduling information"	Value tag	See Note 5
System information block type 4	Cell	CELL_FACH, CELL_PCH, URA_PCH	CELL_FACH, CELL_PCH, URA_PCH	Specified by the IE "Scheduling information"	Value tag	If System information block type 4 is not broadcast in a cell, the connected mode UE shall apply information in System information block type 3 in connected mode. See Note 3
System information block type 5 and 5bis	Cell	Idle mode, (CELL_FACH, CELL_PCH, URA_PCH, CELL_DCH (TDD only))	Idle mode, (CELL_FACH, CELL_PCH, URA_PCH, CELL_DCH (TDD only))	Specified by the IE "Scheduling information"	Value tag	System information block type 5bis is sent instead of system information block type 5 in cells that use Band IV or Band IX or Band X.

System information block	Area scope	UE mode/state when block is valid	UE mode/state when block is read	Scheduling information	Modification of system information	Additional comment
System information block type 6	Cell	CELL_FACH, CELL_PCH, URA_PCH, CELL_DCH (TDD only)	CELL_FACH, CELL_PCH, URA_PCH, CELL_DCH (TDD only)	Specified by the IE "Scheduling information"	Value tag	<p>If system information block type 6 is not broadcast in a cell, the connected mode UE shall read System information block type 5 or System information block type 5bis.</p> <p>If some of the optional IEs are not included in System information block type 6, the UE shall read the corresponding IEs in System information block type 5 or System information block type 5bis.</p> <p>In TDD mode system information block 6 shall only be read in CELL_DCH if required for open loop power control as specified in subclause 8.5.7 and/or if shared transport channels are assigned to the UE. In these cases system information block type 6 is not broadcast the UE shall read system information block type 5. See Note 3</p>
System information block type 7	Cell	Idle mode, CELL_FACH, CELL_PCH, URA_PCH, CELL_DCH (TDD only)	Idle mode, CELL_FACH, CELL_PCH, URA_PCH, CELL_DCH (TDD only)	Specified by the IE "Scheduling information"	Expiration timer = MAX(32 , SIB_REP * ExpirationTimeFactor)	In TDD mode system information block type 7 shall only be read in CELL_DCH if shared transport channels are assigned to the UE. See Note 3
System information block type 11	Cell	Idle mode (CELL_FACH, CELL_PCH, URA_PCH, CELL_DCH)	Idle mode (CELL_FACH, CELL_PCH, URA_PCH)	Specified by the IE "Scheduling information"	Value tag	
System information block type 11bis	Cell	Idle mode (CELL_FACH, CELL_PCH, URA_PCH, CELL_DCH)	Idle mode (CELL_FACH, CELL_PCH, URA_PCH)	Specified by the IE "Scheduling information"	Value tag	See Note 3
System information block type 11ter	Cell	Idle mode (CELL_FACH, CELL_PCH, URA_PCH, CELL_DCH)	Idle mode (CELL_FACH, CELL_PCH, URA_PCH)	Specified by the IE "Scheduling information"	Value tag	See Note 3

System information block	Area scope	UE mode/state when block is valid	UE mode/state when block is read	Scheduling information	Modification of system information	Additional comment
System information block type 12	Cell	CELL_FACH, CELL_PCH, URA_PCH, CELL_DCH	Idle mode, CELL_FACH, CELL_PCH, URA_PCH	Specified by the IE "Scheduling information"	Value tag	If system information block type 12 is not broadcast in a cell, the connected mode UE shall read System information block type 11. If some of the optional IEs are not included in System information block type 12, the UE shall read the corresponding IEs in System information block type 11. See Note 3
System information block type 13	Cell	Idle Mode, CELL_FACH, CELL_PCH, URA_PCH	Idle Mode, CELL_FACH, CELL_PCH, URA_PCH	Specified by the IE "Scheduling information"	Value tag	See Note 3
System information block type 13.1	Cell	Idle Mode, CELL_FACH, CELL_PCH, URA_PCH	Idle Mode, CELL_FACH, CELL_PCH, URA_PCH	Specified by the IE "Scheduling information"	Value tag	See Note 3
System information block type 13.2	Cell	Idle Mode, CELL_FACH, CELL_PCH, URA_PCH	Idle Mode, CELL_FACH, CELL_PCH, URA_PCH	Specified by the IE "Scheduling information"	Value tag	See Note 3
System information block type 13.3	Cell	Idle Mode, CELL_FACH, CELL_PCH, URA_PCH	Idle Mode, CELL_FACH, CELL_PCH, URA_PCH	Specified by the IE "Scheduling information"	Value tag	See Note 3
System information block type 13.4	Cell	Idle Mode, CELL_FACH, CELL_PCH, URA_PCH	Idle Mode, CELL_FACH, CELL_PCH, URA_PCH	Specified by the IE "Scheduling information"	Value tag	See Note 3
System information block type 14	Cell	Idle Mode, CELL_FACH, CELL_PCH, URA_PCH, CELL_DCH	Idle Mode, CELL_FACH, CELL_PCH, URA_PCH, CELL_DCH	Specified by the IE "Scheduling information"	Expiration timer = MAX(32 , SIB_REP * ExpirationTimeFactor)	This system information block is used in 3.84 Mcps TDD and 7.68 Mcps TDD mode only. System information block type 14 shall only be read in CELL_DCH if required for open loop power control as specified in subclause 8.5.7. See Note 3
System information block type 15	Cell	Idle Mode, CELL_FACH, CELL_PCH, URA_PCH	Idle Mode, CELL_FACH, CELL_PCH, URA_PCH	Specified by the IE "Scheduling information"	Value tag	See Note 3
System information block type 15bis		Idle Mode, CELL_FACH, CELL_PCH, URA_PCH	Idle Mode, CELL_FACH, CELL_PCH, URA_PCH	Specified by the IE "Scheduling information"	Value tag	See Note 3
System information block type 15.1	Cell	Idle Mode, CELL_FACH, CELL_PCH, URA_PCH	Idle Mode, CELL_FACH, CELL_PCH, URA_PCH	Specified by the IE "Scheduling information"	Value tag	See Note 3
System information block type 15.1bis		Idle Mode, CELL_FACH, CELL_PCH, URA_PCH	Idle Mode, CELL_FACH, CELL_PCH, URA_PCH	Specified by the IE "Scheduling information"	Value tag	See Note 3

System information block	Area scope	UE mode/state when block is valid	UE mode/state when block is read	Scheduling information	Modification of system information	Additional comment
System information block type 15.1ter	Cell	Idle Mode, CELL_FACH, CELL_PCH, URA_PCH	Idle Mode, CELL_FACH, CELL_PCH, URA_PCH	Specified by the IE "Scheduling information"	Value tag	See Note 3
System information block type 15.2	Cell	Idle Mode, CELL_FACH, CELL_PCH, URA_PCH	Idle Mode, CELL_FACH, CELL_PCH, URA_PCH	Specified by the IE "Scheduling information"	Value tag	For this system information block there may be multiple occurrences See Note 3
System information block type 15.2bis	Cell	Idle Mode, CELL_FACH, CELL_PCH, URA_PCH	Idle Mode, CELL_FACH, CELL_PCH, URA_PCH	Specified by the IE "Scheduling information"	Value tag	For this system information block there may be multiple occurrences See Note 3
System information block type 15.2ter	Cell	Idle Mode, CELL_FACH, CELL_PCH, URA_PCH	Idle Mode, CELL_FACH, CELL_PCH, URA_PCH	Specified by the IE "Scheduling information"	Value tag	For this system information block there may be multiple occurrences See Note 3
System information block type 15.3	PLMN	Idle Mode, CELL_FACH, CELL_PCH, URA_PCH	Idle Mode, CELL_FACH, CELL_PCH, URA_PCH	Specified by the IE "Scheduling information"	Value tag	For this system information block there may be multiple occurrences See Note 3
System information block type 15.3bis	PLMN	Idle Mode, CELL_FACH, CELL_PCH, URA_PCH	Idle Mode, CELL_FACH, CELL_PCH, URA_PCH	Specified by the IE "Scheduling information"	Value tag	For this system information block there may be multiple occurrences See Note 3
System information block type 15.4	Cell	Idle Mode, CELL_FACH, CELL_PCH, URA_PCH	Idle Mode, CELL_FACH, CELL_PCH, URA_PCH	Specified by the IE "Scheduling information"	Value tag	See Note 3
System information block type 15.5	Cell	Idle Mode, CELL_FACH, CELL_PCH, URA_PCH	Idle Mode, CELL_FACH, CELL_PCH, URA_PCH	Specified by the IE "Scheduling information"	Value tag	See Note 3
System information block type 15.6	Cell	Idle Mode, CELL_FACH, CELL_PCH, URA_PCH	Idle Mode, CELL_FACH, CELL_PCH, URA_PCH	Specified by the IE "Scheduling information"	Value tag	See Note 3
System information block type 15.7	Cell	Idle Mode, CELL_FACH, CELL_PCH, URA_PCH	Idle Mode, CELL_FACH, CELL_PCH, URA_PCH	Specified by the IE "Scheduling information"	Value tag	See Note 3
System information block type 15.8	Cell	Idle Mode, CELL_FACH, CELL_PCH, URA_PCH	Idle Mode, CELL_FACH, CELL_PCH, URA_PCH	Specified by the IE "Scheduling information"	Value tag	See Note 3
System information block type 16	Equivalent PLMN	Idle Mode, CELL_FACH, CELL_PCH, URA_PCH, CELL_DCH	Idle Mode, CELL_FACH, CELL_PCH, URA_PCH	Specified by the IE "Scheduling information"	Value tag	For this system information block there may be multiple occurrences. This system information block is also valid while in GSM/GPRS. See Note 3

System information block	Area scope	UE mode/state when block is valid	UE mode/state when block is read	Scheduling information	Modification of system information	Additional comment
System information block type 17	Cell	CELL_FACH, CELL_PCH, URA_PCH, CELL_DCH	CELL_FACH, CELL_PCH, URA_PCH, CELL_DCH	Specified by the IE "Scheduling information"	Expiration timer = SIB_REP	This system information block is used in TDD mode only. System information block type 17 shall only be read if shared transport channels are assigned to the UE. See Note 3
System Information Block type 18	Cell	Idle mode, CELL_FACH, CELL_PCH, URA_PCH, CELL_DCH	Idle mode, CELL_FACH, CELL_PCH, URA_PCH	Specified by the IE "Scheduling information"	Value tag	See Note 3
System Information Block type 19	Cell	Idle mode, CELL_FACH, CELL_PCH, URA_PCH	Idle mode, CELL_FACH, CELL_PCH, URA_PCH	Specified by the IE "Scheduling information"	Value tag	See Note 3
System Information Block type 20	Cell	Idle mode, CELL_PCH, URA_PCH	Idle mode, CELL_PCH, URA_PCH	Specified by the IE "Scheduling information"	Value tag	See Note 3
System Information Block type 21	Cell	Idle mode, CELL_FACH, CELL_PCH, URA_PCH	Idle mode, CELL_FACH, CELL_PCH, URA_PCH	Specified by the IE "Scheduling information"	Value tag	If System information block type 21 is broadcast in a cell, the EAB capable UE shall first apply the extended access barring information in System information block type 21. If as a result access to the cell is not barred, then apply the access class barring information in System information block type 3. See Note 3
System information block type 22	Cell	Idle mode, CELL_FACH, CELL_PCH, URA_PCH	Idle mode, CELL_FACH, CELL_PCH, URA_PCH	Specified by the IE "Scheduling information"	Value tag	If some of the optional IEs are not included in System information block type 22, the UE shall read the corresponding IEs in System information block type 5 or System information block type 5bis. See Note 3
System information block type 23	Cell	Idle mode, CELL_FACH, CELL_PCH, URA_PCH	Idle mode, CELL_FACH, CELL_PCH, URA_PCH	Specified by the IE "Scheduling information"	Value tag	See Note 3
System information block type 24	Cell	CELL_FACH, CELL_PCH, URA_PCH	CELL_FACH, CELL_PCH, URA_PCH	Specified by the IE "Scheduling information"	Expiration timer = $\text{MAX}(32, \text{SIB_REP} * 2^n)$ where n = Expiration Time Factor 2)	See Note 3

NOTE 3: The UE behaviour is unspecified if this system information block is received on a cell operating in MBSFN mode as indicated in subclause 8.1.1.6.3. A network should not send these system information blocks on a cell operating in MBSFN mode.

NOTE 4: For 1.28 Mcps TDD, if a cell is operating in MBSFN mode, system information blocks are transmitted on the MBSFN Special Timeslot [30].

NOTE 5: For FDD UEs supporting the Neighbour Cell SI acquisition capability, the UE can read the System Information Block type 3 and the Master Information Block of a neighbouring cell when in CELL_DCH state.

8.1.1.1.3 Segmentation and concatenation of system information blocks

A generic SYSTEM INFORMATION message and SYSTEM INFORMATION 2 message is used to convey the system information blocks on the BCCH. The SYSTEM INFORMATION message is sent on BCH mapped on PCCPCH, and SYSTEM INFORMATION 2 message is sent on BCH mapped on SCCPCH (second system information broadcast channel). A given BCCH may be mapped onto a BCH transport channel according to subclause 8.1.1.1.2. The size of the SYSTEM INFORMATION message, and also the size of SYSTEM INFORMATION 2 message, shall fit the size of a BCH transport block.

The RRC layer in UTRAN performs segmentation and concatenation of encoded system information blocks. If the encoded system information block is larger than the size of a SYSTEM INFORMATION message or SYSTEM INFORMATION 2 message, it will be segmented and transmitted in several messages. If the encoded system information block is smaller than a SYSTEM INFORMATION message or SYSTEM INFORMATION 2 message, UTRAN may concatenate several system information blocks, or the first segment or the last segment into the same message as specified in the remainder of this clause.

Four different segment types are defined:

- First segment;
- Subsequent segment;
- Last segment;
- Complete.

Each of the types - *First*, *Subsequent* and *Last segment* - is used to transfer segments of a master information block, scheduling block or a system information block. The segment type, *Complete*, is used to transfer a complete master information block, complete scheduling block or a complete system information block.

Each segment consists of a header and a data field. The data field carries the encoded system information elements. The header contains the following parameters:

- The number of segments in the system information block (SEG_COUNT). This parameter is only included in the header if the segment type is "First segment".
- SIB type. The SIB type uniquely identifies the master information block, scheduling block or a system information block.
- Segment index. This parameter is only included in the header if the segment type is "Subsequent segment" or "Last segment".

UTRAN may combine one or several segments of variable length in the same SYSTEM INFORMATION message or SYSTEM INFORMATION 2 message. The following combinations are allowed:

1. No segment;
2. First segment;
3. Subsequent segment;
4. Last segment;
5. Last segment + First segment;

6. Last segment + one or several Complete;
7. Last segment + one or several Complete + First segment;
8. One or several Complete;
9. One or several Complete + First segment;
10. One Complete of size 215 to 226 (BCH on PCCPCH) or size 225 to 236 (BCH on SCCPCH);
11. Last segment of size 215 to 222 (BCH on PCCPCH) or size 225 to 232 (BCH on SCCPCH).

The "No segment" combination is used when there is no master information block, scheduling block or system information block scheduled for a specific BCH transport block.

UEs are not required to support the reception of multiple occurrences of the same system information block type within one SYSTEM INFORMATION message or SYSTEM INFORMATION 2 message.

NOTE: Since the SIB type is the same for each occurrence of the system information block, the UE does not know the order in which the occurrences, scheduled for this SYSTEM INFORMATION message or SYSTEM INFORMATION 2 message, appear. Therefore, the UE is unable to determine which scheduling information, e.g., value tag relates to which occurrence of the system information block.

8.1.1.1.4 Re-assembly of segments

The RRC layer in the UE shall perform re-assembly of segments. All segments belonging to the same master information block, scheduling block or system information block shall be assembled in ascending order with respect to the segment index. When all segments of the master information block, scheduling block or a system information block have been received, the UE shall perform decoding of the complete master information block, scheduling block or system information block. For System Information Block types 15.2, 15.3 and 16, which may have multiple occurrences, each occurrence shall be re-assembled independently.

The UE shall discard system information blocks of which segments were missing, of which segments were received out of sequence and/or for which duplicate segments were received. The only valid sequence is an ascending one with the sequence starting with the First Segment of the associated System Information Block. Alternatively to the re-assembly in strict ascending order without gaps and duplicates, the UE may also receive segments out of sequence and duplicates, provided that any stored segments are discarded when the value tag for that system information block type has changed. The UE is not required to re-assemble segments received from different system information broadcast channels (i.e. BCH on PCCPCH and BCH on SCCPCH).

If the UE receives a Subsequent segment or Last segment where the index in IE "Segment index" is equal to or larger than the number of segments stated in IE "SEG_COUNT" in the scheduling information for that scheduling block or system information block:

- 1> the UE may:
 - 2> read all the segments to create a system information block as defined by the scheduling information read by the UE;
 - 2> store the content of the system information block with a value tag set to the value NULL; and
 - 2> consider the content of the scheduling block or system information block as valid:
 - 3> until it receives the same type of scheduling block or system information block in a position according to its scheduling information; or
 - 3> at most for 6 hours after reception.
- 1> and the UE shall:
 - 2> re-read scheduling information for that scheduling block or system information block.

If the UE receives a Subsequent segment or Last segment where the index in IE "Segment index" is equal to or larger than the number of segments stated in IE "SEG_COUNT" in the First segment, the UE shall

- 1> discard all segments for that master information block, scheduling block or system information block; and

- 1> re-read the scheduling information for that system information block;
- 1> then re-read all segments for that system information block.

8.1.1.1.5 Scheduling of system information

Scheduling of system information blocks is performed by the RRC layer in UTRAN. If segmentation is used, it should be possible to schedule each segment separately.

To allow the mixing of system information blocks with short repetition period and system information blocks with segmentation over many frames, UTRAN may multiplex segments from different system information blocks. Multiplexing and de-multiplexing is performed by the RRC layer.

The scheduling of each system information block broadcast on a BCH transport channel is defined by the following parameters:

- the number of segments (SEG_COUNT);
- the repetition period (SIB_REP). The same value applies to all segments;
- the position (phase) of the first segment within one cycle of the Cell System Frame Number (SIB_POS(0)). Since system information blocks are repeated with period SIB_REP, the value of SIB_POS(*i*), *i* = 0, 1, 2, ... SEG_COUNT-1 must be less than SIB_REP for all segments;
- the offset of the subsequent segments in ascending index order (SIB_OFF(*i*), *i* = 1, 2, ... SEG_COUNT-1). The position of the subsequent segments is calculated using the following: SIB_POS(*i*) = SIB_POS(*i*-1) + SIB_OFF(*i*).

The scheduling is based on the Cell System Frame Number (SFN). The SFN of a frame at which a particular segment, *i*, with *i* = 0, 1, 2, ... SEG_COUNT-1 of a system information block occurs, fulfils the following relation:

$$\text{SFN mod SIB_REP} = \text{SIB_POS}(i)$$

In FDD and TDD the scheduling of the master information block is fixed as defined in table 8.1.1. For TDD, UTRAN may apply one of the values allowed for the master information block's repetition period. The value that UTRAN is using in TDD is not signalled; UEs have to determine it by trial and error.

For scheduling block 3 (SB3) on the second system information broadcast channel:

- SIB_POS(0) is 4;
- SIB_OFF(*i*) is 2 (*i* = 1, 2, ... SEG_COUNT-1), i.e. segments are transmitted consecutively.

The number of segments (SEG_COUNT) and repetition period (SIB_REP) of SB3 are signalled in IE "SB3 information" in Master Information Block.

In case the UE stores scheduling information in the variable SYSTEM_INFORMATION_CONTAINER, the information above is not used.

8.1.1.2 Initiation

The system information is continuously broadcast on a regular basis in accordance with the scheduling defined for each system information block.

8.1.1.3 Reception of SYSTEM INFORMATION messages by the UE

The UE shall read SYSTEM INFORMATION messages broadcast on a BCH transport channel in idle mode and in the connected mode in states CELL_FACH, CELL_PCH, URA_PCH and CELL_DCH (TDD only).

If the IE "SB3 information" is present in the Master Information Block and the UE supports second system information broadcast channel, the UE shall read SYSTEM INFORMATION 2 messages broadcast on a BCH transport channel in idle mode and in connected mode in states CELL_FACH, CELL_PCH and URA_PCH.

In idle mode and connected mode different combinations of system information blocks are valid. The UE shall acquire the system information blocks that are needed according to table 8.1.1. However, when the variable

READY_FOR_COMMON_EDCH is set to TRUE and IE "UL interference for common E-DCH" is included in SIB 5/5bis, the UE shall acquire the system information block 7 upon entering a new cell and shall consider the content of the system information block 7 as always valid and ignore any system information expiry timer.

The UE may store system information blocks with *cell*, *PLMN* or *Equivalent PLMN* area scope (including their value tag if applicable) for different cells and different PLMNs, to be used if the UE returns to these cells.

The UE shall consider all stored system information blocks as invalid after it has been switched off. Some information obtained from system information may be stored by the UE or in the USIM for use in a stored information cell selection.

When selecting a new cell the UE shall consider all current system information blocks with area scope cell to be invalid. If the UE has stored valid system information blocks for the newly selected cell, the UE may set those as current system information blocks.

After selecting a new cell and this cell broadcasts an IE "PLMN Identity" in the MIB which is different from the IE "PLMN Identity" broadcast in the MIB in the previously selected cell, the UE shall consider all current system information blocks with area scope *PLMN* to be invalid. If the UE has previously stored valid system information blocks for the selected cell of the new PLMN, the UE may set those as current system information blocks.

When NAS informs AS about a new selected PLMN, the UE shall consider all stored system information blocks with area scope *Equivalent PLMN* to be invalid.

8.1.1.4 Void

8.1.1.5 Actions upon reception of the Master Information Block and Scheduling Block(s)

When selecting a new cell, the UE shall read the master information block. The UE may use the pre-defined scheduling information to locate the master information block in the cell.

Upon reception of the master information block, the UE shall:

1> if the IE "Multiple PLMN List" is not present in the Master Information Block:

2> consider the IE "PLMN identity" in the Master Information Block as the PLMN identity of the cell.

1> else:

2> consider the PLMN identities in the IE "Multiple PLMN List" as the PLMN identities of the cell;

2> when reading the "Multiple PLMN List", read all the PLMN identities in the list as follows:

3> if the IE "MIB PLMN Identity" is set to TRUE:

4> read the "PLMN identity" IE in the MIB and consider it as a part of the "Multiple PLMN List".

3> if the IE "MIB PLMN Identity" is set to FALSE:

4> not consider the "PLMN identity" IE in the MIB as a part of the "Multiple PLMN List";

4> not consider the IE "PLMN identity" in the MIB as a PLMN identity of the cell;

4> not forward the PLMN in the IE "PLMN identity" of the MIB to upper layers.

3> if the MCC is not present when reading a IE "PLMN identity with Optional MCC" in the IE "Multiple PLMN List":

4> set the MCC of this PLMN identity equal to the MCC of the closest preceding "PLMN identity with Optional MCC" in the "Multiple PLMN List" that includes an MCC;

- 4> or, if no such "PLMN identity with Optional MCC" exists, the UE shall set the MCC of this PLMN identity to the MCC of the "PLMN identity" IE in the Master Information Block irrespective of the value of the IE "MIB PLMN Identity".
- 1> if the UE is operating in "ANSI-41 mode" and the IE "PLMN Type" has the value "ANSI-41" or "GSM-MAP and ANSI-41":
 - 2> store the ANSI-41 Information elements contained in the master information block and perform initial process for ANSI-41.
- 1> compare the value tag in the master information block with the value tag stored for this cell and this PLMN in the variable VALUE_TAG;
 - 1> if the value tags differ, or if no IEs for the master information block are stored:
 - 2> store the value tag into the variable VALUE_TAG for the master information block;
 - 2> read and store scheduling information included in the master information block.
 - 1> if the value tags are the same the UE may use stored system information blocks and scheduling blocks using value tag that were stored for this cell and this PLMN as valid system information;
 - 1> if the IE "SB3 information" is present in the Master Information Block and the UE supports second system information broadcast channel:
 - 2> configure the second system information broadcast channel with the signalled channelization code value;
 - 2> acquire Scheduling Block 3 (SB3) on the second system information broadcast channel.

For all system information blocks or scheduling blocks (SB1, SB2 or SB3) that are supported by the UE referenced in the master information block or the scheduling blocks, the UE shall perform the following actions:

- 1> for all system information blocks with area scope "PLMN" or "Equivalent PLMN" that use value tags:
 - 2> compare the value tag read in scheduling information for that system information block with the value stored within the variable VALUE_TAG for that system information block;
 - 2> if the value tags differ, or if no IEs for the corresponding system information block are stored:
 - 3> store the value tag read in scheduling information for that system information block into the variable VALUE_TAG;
 - 3> read and store the IEs of that system information block.
 - 2> if the value tags are the same the UE may use stored system information blocks using value tag that were stored in this PLMN as valid system information.
- 1> for all system information blocks or scheduling blocks with area scope cell that use value tags:
 - 2> compare the value tag read in scheduling information for that system information block or scheduling block with the value stored within the variable VALUE_TAG for that system information block or scheduling block;
 - 2> if the value tags differ, or if no IEs for the corresponding system information block or scheduling block are stored:
 - 3> store the value tag read in scheduling information for that system information block or scheduling block into the variable VALUE_TAG;
 - 3> read and store the IEs of that system information block or scheduling block.
 - 2> if the value tags are the same the UE may use stored system information blocks using value tags that were stored for this cell and this PLMN as valid system information;
 - 2> for any of System Information Block type 11, System Information Block type 11bis, System Information Block type 11ter or System Information Block type 12, for FDD:

- 3> if the value tag read in scheduling information for the system information block differs with the value stored within the variable VALUE_TAG for that system information block; and
- 3> if the UE is reading the system information block as a result of receiving the IE "BCCH modification info":
 - 4> clear the stored IE "Common E-RGCH info FDD", if any;
 - 4> determine the value for the READY_FOR_COMMON_ERGCH variable and take the corresponding actions as described in subclause 8.5.75.
- 1> for system information blocks which may have multiple occurrences:
 - 2> compare the value tag and the configuration or multiple occurrence identity for the occurrence of the system information blocks read in scheduling information with the value tag and configuration or multiple occurrence identity stored within the variable VALUE_TAG:
 - 3> if the value tags differ, or if no IEs from the occurrence with that configuration or multiple occurrence identity of the system information block are stored:
 - 4> store the value tag read in scheduling information for that system information block and the occurrence with that configuration or multiple occurrence identity into the variable VALUE_TAG;
 - 4> read and store the IEs of that system information block.
 - 3> if the value tags and the configuration or multiple occurrence identity are identical to those stored, the UE may use stored occurrences of system information blocks that were stored for this cell and this PLMN as valid system information.

Upon reception of the master information block or scheduling blocks, the UE shall:

- 1> if the variable BCCH_MODIFICATION_ACCESS_PROHIBITION is set to TRUE:
 - 2> if the value tag of the Master Information Block in the system information is different from the value tag stored in the variable VALUE_TAG; and
 - 2> the scheduling information of system information block type 3 is present in the master information block and the value tags for system information block type 3 in the master information block are the same:
 - 3> set the variable BCCH_MODIFICATION_ACCESS_PROHIBITION to FALSE and allow the access on the cell according to 8.1.8.2.
- 2> else if the scheduling information of system information block type 3 is present in any of the scheduling blocks:
 - 3> if the value tags for system information block type 3 in any of the scheduling blocks received after the MIB value tag change are the same:
 - 4> set the variable BCCH_MODIFICATION_ACCESS_PROHIBITION to FALSE and allow the access on the cell according to 8.1.8.2.

For system information blocks, not supported by the UE, but referenced either in the master information block or in the scheduling blocks, the UE may:

- 1> skip reading this system information block;
- 1> skip monitoring changes to this system information block.

If the UE:

- 1> receives a scheduling block at a position different from its position according to the scheduling information for the scheduling block; or
- 1> receives a scheduling block for which scheduling information has not been received:

the UE may:

- 1> store the content of the scheduling block with a value tag set to the value NULL; and
- 1> consider the content of the scheduling block as valid until it receives the same type of scheduling block in a position according to its scheduling information or at most for 6 hours after reception.

If the UE does not find a scheduling block in a position where it should be according to its scheduling information, but a transport block with correct CRC was found at that position, the UE shall:

- 1> read the scheduling information for this scheduling block.

If the UE does not find the master information block in a position fulfilling:

$$\text{SFN mod } 32 = 0$$

but a transport block with correct CRC was found at that position, the UE shall:

- 1> consider the master information block as not found; and
- 1> consider the cell to be barred according to [4]; and
- 1> consider the barred cell as using the value "allowed" in the IE "Intra-frequency cell re-selection indicator", and the maximum value in the IE " T_{barred} ".

NOTE: This permits a different repetition for the MIB in later versions for FDD. In TDD it allows for a variable SIB_REP in this and future releases.

If the cell is not operating in MBSFN mode (according to Section 8.1.1.6.3) then:

- 1> If system information block type 1 is not scheduled on BCH, and system information block type 13 is not scheduled on BCH, the UE shall:
 - 2> consider the cell to be barred according to [4]; and
 - 2> consider the barred cell as using the value "allowed" in the IE "Intra-frequency cell re-selection indicator", and the maximum value in the IE " T_{barred} ".
- 1> If the UE only supports GSM-MAP but finds a cell that broadcasts System Information Block type 13 but not System Information Block type 1, the UE shall:
 - 2> consider the cell barred.
- 1> If system information block type 1 is not scheduled on BCH; and
- 1> if the UE is operating in "GSM-MAP mode"; and
- 1> if the IE "PLMN type" in the Master Information Block has the value "GSM-MAP" or "GSM-MAP and ANSI-41", the UE shall:
 - 2> indicate to upper layers that no CN system information is available.
- 1> If in idle mode and System Information Block type 3 is not scheduled on BCH, the UE shall:
 - 2> consider the cell to be barred according to [4]; and
 - 2> consider the barred cell as using the value "allowed" in the IE "Intra-frequency cell re-selection indicator", and the maximum value in the IE " T_{barred} ".
- 1> If in connected mode and System Information Block type 3 is not scheduled on BCH, and System Information Block type 4 is not scheduled on BCH, the UE shall:
 - 2> consider the cell to be barred according to [4]; and
 - 2> consider the barred cell as using the value "allowed" in the IE "Intra-frequency cell re-selection indicator", and the maximum value in the IE " T_{barred} ".

- 1> If in idle mode and neither System Information Block type 5 nor type 5bis is scheduled on BCH, or System Information Block type 5 or type 5bis is scheduled but IE "AICH info" (FDD) or IE "PICH info" is not present, the UE shall:
 - 2> consider the cell to be barred according to [4]; and
 - 2> consider the barred cell as using the value "allowed" in the IE "Intra-frequency cell re-selection indicator", and the maximum value in the IE "T_{barred}".
- 1> If in connected mode and neither System Information Block type 5 nor type 5bis is scheduled on BCH, and System Information Block type 6 is not scheduled on BCH, or any of System Information Block type 5, type 5bis or type 6 is scheduled but IE "AICH info" (FDD) or IE "PICH info" is not present, the UE shall:
 - 2> consider the cell to be barred according to [4]; and
 - 2> consider the barred cell as using the value "allowed" in the IE "Intra-frequency cell re-selection indicator", and the maximum value in the IE "T_{barred}".
- 1> If System Information Block type 7 is not scheduled on BCH, the UE shall:
 - 2> consider the cell to be barred according to [4]; and
 - 2> consider the barred cell as using the value "allowed" in the IE "Intra-frequency cell re-selection indicator", and the maximum value in the IE "T_{barred}".
- 1> In 3.84 Mcps TDD and 7.68 Mcps TDD, if System Information Block type 14 is not scheduled on BCH, the UE shall:
 - 2> consider the cell to be barred according to [4]; and
 - 2> consider the barred cell as using the value "allowed" in the IE "Intra-frequency cell re-selection indicator", and the maximum value in the IE "T_{barred}".

If the cell is operating in MBSFN mode (according to section 8.1.1.6.3) then:

- 1> If neither System Information block type 5 nor System Information Block type 5bis is scheduled on the BCH the UE shall:
 - 2> not consider this MBSFN cluster as candidate during the MBSFN cluster selection and MBSFN cluster re-selection procedures [4]. The UE may choose to not recheck the status of this MBSFN cluster during the time corresponding to the maximum value for T_{barred}.
- 1> If System Information Block type 11 is not scheduled on the BCH the UE shall:
 - 2> not consider this MBSFN cluster as candidate during the MBSFN cluster selection and MBSFN cluster re-selection procedures [4]. The UE may choose to not recheck the status of this MBSFN cluster during the time corresponding to the maximum value for T_{barred}.

If System Information Block type 5 and System Information Block type 5bis are both scheduled on BCH:

- 1> the UE behaviour is unspecified.

8.1.1.6 Actions upon reception of system information blocks

The UE may use the scheduling information included within the master information block and the scheduling blocks to locate each system information block to be acquired. For System Information Block type 15.1bis, 15.2bis, 15.2ter, 15.3bis, 15.6, 15.7 and 15.8 the scheduling information shall be used to associate a system information block with a GNSS.

The UE should only expect one occurrence of the scheduling information for a system information block in the master information block and any of the scheduling blocks except for System Information Block type 16, System Information Block type 15.2 and System Information Block type 15.3, which may have multiple occurrences. System Information Blocks 15.1bis, 15.6, 15.7 and 15.8 have one occurrence for each GNSS supported while System Information Blocks 15.2bis, 15.2ter and 15.3bis may have multiple occurrences for each GNSS. However, to enable future introduction of

new system information blocks, the UE shall also be able to receive system information blocks other than the ones indicated within the scheduling information. The UE may ignore contents of such system information block.

If the UE:

- 1> receives a system information block in a position according to the scheduling information for the system information block; and
- 1> this system information block uses a value tag; or
- 1> this system information block uses a value tag and configuration or multiple occurrence identity:

the UE shall:

- 1> store the content of the system information block together with the value of its value tag or the values of configuration and multiple occurrence identity and the associated value tag in the scheduling information for the system information block; and
- 1> consider the content of the system information block valid until, if used, the value tag in the scheduling information for the system information block is changed or at most for 6 hours after reception.

If the UE:

- 1> receives a system information block in a position according to the scheduling information for the system information block; and
- 1> this system information block does not use a value tag according to the system information block type:

the UE shall:

- 1> store the content of the system information block;
- 1> if HS_DSCH_DRX_CELL_FACH_2CYCLE_STATUS is set to TRUE and if the system information block corresponds to System Information Block type 7; or
- 1> if HS_DSCH_DRX_CELL_FACH_STATUS is set to TRUE and if the system information block corresponds to System Information Block type 7:
 - 2> start an expiration timer using a value set to 800.
- 1> else:
 - 2> start an expiration timer using a value as defined in Table 8.1.1 for that system information block type.
- 1> consider the content of the system information block valid until, the expiration timer expires.

If the UE:

- 1> receives a system information block at a position different from its position according to the scheduling information for the system information block; or
- 1> receives a system information block for which scheduling information has not been received; and
- 1> this system information block uses a value tag:

the UE may:

- 1> store the content of the system information block with a value tag set to the value NULL; and
- 1> consider the content of the system information block as valid until it receives the same type of system information block in a position according to its scheduling information or at most for 6 hours after reception.

If the UE:

- 1> receives a system information block with multiple occurrences at a position different from its position according to the scheduling information for the system information block; or

1> receives a system information block with multiple occurrences for which scheduling information has not been received; and

1> this system information block uses a value tag and configuration or multiple occurrence identity:

the UE shall:

1> ignore this information.

If the UE does not find a system information block in a position where it should be according to its scheduling information, but a transport block with correct CRC was found at that position, the UE shall read the scheduling information for this system information block.

The UE shall act upon all received information elements as specified in subclause 8.6 unless specified otherwise in the following subclauses.

The UE behaviour is unspecified when the same system information block type with different content is transmitted on both BCH on PCCPCH (system information broadcast channel) and BCH on SCCPCH (second system information broadcast channel).

8.1.1.6.1 System Information Block type 1

The UE should store all relevant IEs included in this system information block if the UE is operating in "GSM-MAP mode" and the IE "PLMN type" in the Master Information Block has the value "GSM-MAP" or "GSM-MAP and ANSI-41". The UE shall also:

- 1> check that the cell, according to information included in IE "CN common GSM-MAP NAS system information", is suitable [4];
- 1> if in connected mode:
 - 2> not forward the content of the IE "CN common GSM-MAP NAS system information" to upper layers.
- 1> if in idle mode:
 - 2> forward the content of the IE "CN common GSM-MAP NAS system information" to upper layers.
- 1> for the IE "CN domain system information list":
 - 2> for each IE "CN domain system information" that is present:
 - 3> check that the cell, according to information included in IE "CN domain specific NAS system information", is suitable [4];
 - 3> if in connected mode:
 - 4> not forward the content of the IE "CN domain specific NAS system information" to upper layers.
 - 3> if in idle mode:
 - 4> forward the content of the IE "CN domain specific NAS system information" and the IE "CN domain identity" to upper layers;
 - 4> use the IE "CN domain specific DRX cycle length coefficient" to calculate frame number for the Paging Occasions as specified in [4];
 - 4> store the value of the IE "CN domain specific DRX cycle length coefficient" for use in connected mode.
 - 2> if an IE "CN domain system information" is not present for a particular CN domain:
 - 3> if in idle mode:
 - 4> indicate to upper layers that no CN system information is available for that CN domain.
- 1> if the UE has not yet entered UTRA RRC connected mode:
 - 2> store the values of the IE "UE Timers and constants in connected mode" in the variable TIMERS_AND_CONSTANTS;
 - 2> if the IE "T323" is not present:
 - 3> clear any value of the timer T323 stored in the IE "UE Timers and constants in connected mode" in the variable TIMERS_AND_CONSTANTS.
- 1> use the values stored in the variable TIMERS_AND_CONSTANTS for the relevant timers and constants.

8.1.1.6.2 System Information Block type 2

If in connected mode the UE should store all relevant IEs included in this system information block. The UE shall:

- 1> if in state URA_PCH, start to perform URA updates using the information in the IE "URA identity".

If in idle mode, the UE shall not use the values of the IEs in this system information block.

8.1.1.6.3 System Information Block type 3

The UE should store all relevant IEs included in this system information block. The UE shall:

- 1> if in connected mode, and System Information Block 4 is indicated as used in the cell:
 - 2> read and act on information sent in that block.
- 1> if IE "Deferred measurement control reading support" is present:
 - 2> set variable DEFERRED_MEASUREMENT_STATUS to TRUE.
- 1> else:
 - 2> set variable DEFERRED_MEASUREMENT_STATUS to FALSE.

With respect to Domain Specific Access Control and Paging Permission with Access Control, the UE shall:

- 1> if the IE "Multiple PLMN List" is not included in the Master Information Block:
 - 2> apply the domain specific access restrictions as indicated by the IE "Domain Specific Access Restriction Parameters For PLMN Of MIB", and the paging permission with access control as indicated by the IE "Paging Permission with Access Control Parameters for PLMN Of MIB".
- 1> else:
 - 2> if the PLMN specified by the IE "PLMN Identity" of the Master Information Block is chosen by the UE:
 - 3> apply the domain specific access restrictions as indicated by the IE "Domain Specific Access Restriction Parameters For PLMN Of MIB", and the paging permission with access control as indicated by the IE "Paging Permission with Access Control Parameters for PLMN Of MIB".
 - 2> else, if N-th (N=1..5) PLMN in the IE "Multiple PLMNs" contained in the IE "Multiple PLMN List" is chosen by the UE:
 - 3> if the IE "Domain Specific Access Restriction List" of the IE "Domain Specific Access Restriction For Shared Network" is indicated:
 - 4> if the IE "Domain Specific Access Restriction Parameters For OperatorN" is indicated:
 - 5> apply the domain specific access restrictions as indicated by the IE "Domain Specific Access Restriction Parameters For OperatorN".
 - 3> else:
 - 4> if the IE "Domain Specific Access Restriction Parameters For All" of the IE "Domain Specific Access Restriction For Shared Network" is indicated:
 - 5> apply the domain specific access restrictions as indicated by the IE "Domain Specific Access Restriction Parameters For All".
 - 3> if the IE "Paging Permission with Access Control List" of the IE "Paging Permission with Access Control For Shared Network" is indicated:
 - 4> if the IE "Paging Permission with Access Control Parameters For OperatorN" is indicated:
 - 5> apply the paging permission with access control as indicated by the IE "Paging Permission with Access Control Parameters For OperatorN".
 - 3> else:
 - 4> if the IE "Paging Permission with Access Control Parameters For All" of the IE "Paging Permission with Access Control For Shared Network" is indicated:

- 5> apply the paging permission with access control as indicated by the IE "Paging Permission with Access Control Parameters For All".

The UE shall apply the following handling with respect to any Access Class Barring information:

1> if in idle mode:

- 2> if the IE "Paging Permission with Access Control Parameters For PLMN Of MIB", the IE "Paging Permission with Access Control Parameters For OperatorN" or the IE "Paging Permission with Access Control Parameters For All" to be applied according to the requirements above is included in System Information Block Type 3, the UE shall:

3> if Paging Response Restriction Indication is set to "None":

- 4> when sending a response to any PAGING TYPE 1 message, Paging message specified in [67] or CS SERVICE NOTIFICATION message specified in [79], act as if no Access Class is barred in the IE "Access Class Barred List" as specified in [4].

3> if Paging Response Restriction Indication is set to "PS":

- 4> when sending a response to any PAGING TYPE 1 message, Paging message specified in [67] from CS domain or CS SERVICE NOTIFICATION message specified in [79], act as if no Access Class is barred in the IE "Access Class Barred List" as specified in [4];
- 4> when sending a response to any PAGING TYPE 1 message, Paging message specified in [67] from PS domain, act on the IE "Domain Specific Access Class Barred List" if indicated in the IE "PS Domain Specific Access Restriction" (or IE "Access Class Barred list" if IE "Domain Specific Access Class Barred List" is not present) as specified in [4].

3> if Paging Response Restriction Indication is set to "CS":

- 4> when sending a response to any PAGING TYPE 1 message, Paging message specified in [67] from PS domain, act as if no Access Class is barred in the IE "Access Class Barred List" as specified in [4];
- 4> when sending a response to any PAGING TYPE 1 message, Paging message specified in [67] from CS domain or CS SERVICE NOTIFICATION message specified in [79], act on the IE "Domain Specific Access Class Barred List" if indicated in the IE "CS Domain Specific Access Restriction" (or IE "Access Class Barred list" if IE "Domain Specific Access Class Barred List" is not present) as specified in [4].

3> else (if Paging Response Restriction Indication is set to "All"):

- 4> when sending a response to any PAGING TYPE 1 message, Paging message specified in [67] from CS domain or CS SERVICE NOTIFICATION message specified in [79], act on the IE "Domain Specific Access Class Barred List" if indicated in the IE "CS Domain Specific Access Restriction" as specified in [4];
 - 4> when sending a response to any PAGING TYPE 1 message, Paging message specified in [67] from PS domain, act on the IE "Domain Specific Access Class Barred List" if indicated in the IE "PS Domain Specific Access Restriction" as specified in [4];
 - 4> when sending a response to any PAGING TYPE 1 message, Paging message specified in [67] or CS SERVICE NOTIFICATION message specified in [79] from PS or CS domain, act on the IE "Access Class Barred list" if the IE "Domain Specific Access Class Barred List" is not present.
- 3> when initiating a Location/Registration procedure to CS domain, act on the IE "Location/Registration Access Class Barred List" if the IE "Location/Registration Restriction Indicator" is set to "All" or "CS", as specified in [4];
 - 3> when initiating an access to CS domain for any other reason, act on the IE "Domain Specific Access Class Barred List" if indicated in the IE "CS Domain Specific Access Restriction" (or IE "Access Class Barred list" if IE "Domain Specific Access Class Barred List" is not present) as specified in [4];
 - 3> when initiating a Location/Registration procedure to PS domain, act on the IE "Location/Registration Access Class Barred List" if the IE "Location/Registration Restriction Indicator" is set to "All" or "PS", as specified in [4];

- 3> when initiating an access to PS domain for any other reason, act on the IE "Domain Specific Access Class Barred List" if indicated in the IE "PS Domain Specific Access Restriction" (or IE "Access Class Barred list" if IE "Domain Specific Access Class Barred List" is not present) as specified in [4];
- 3> upon transition to UTRA RRC connected, the UE shall:
 - 4> store that Paging Permission with Access Control Parameters to the variable "PPAC_PARAM" and maintain the variable until it is cleared, the PLMN chosen by the UE is changed or the RRC connection is released;
 - 4> if the IE "Domain Specific Access Restriction Parameters For PLMN Of MIB", the IE "Domain Specific Access Restriction Parameters For OperatorN" or the IE "Domain Specific Access Restriction Parameters For All" to be applied according to the requirements above is included in System Information Block Type 3:
 - 5> store that Domain Specific Access Restriction Parameters to the variable "DSAC_PARAM" and maintain the variable until it is cleared, the PLMN chosen by the UE is changed or the RRC connection is released.
 - 4> act on the stored IE "Paging Response Restriction Indicator" when sending a response to any PAGING TYPE 1 or PAGING TYPE 2 message, Paging message specified in [67] or CS SERVICE NOTIFICATION message specified in [79];
 - 4> act on the stored IE "Location/Registration Access Class Barred List" if the IE "Location/Registration Restriction Indicator" is set to "All" or "CS", when initiating a Location/Registration procedure to the CS domain, as specified in [4];
 - 4> act on the stored IE "Location/Registration Access Class Barred List" if the IE "Location/Registration Restriction Indicator" is set to "All" or "PS", when initiating a Location/Registration procedure to the PS domain, as specified in [4];
 - 4> act on the stored IE "Domain Specific Access Class Barred List" if indicated in the IE "CS Domain Specific Access Restriction" when initiating an INITIAL DIRECT TRANSFER message to the CS domain for any other reason, as specified in [4];
 - 4> act on the stored IE "Domain Specific Access Class Barred List" if indicated in the IE "PS Domain Specific Access Restriction" when initiating an INITIAL DIRECT TRANSFER message to the PS domain, for any other reason ,as specified in [4].
- 2> if neither the IE "Paging Permission with Access Control Parameters For PLMN Of MIB", the IE "Paging Permission with Access Control Parameters For OperatorN" nor the IE "Paging Permission with Access Control Parameters For All" to be applied according to the requirements above is included in System Information Block Type 3:
- 3> if the IE "Domain Specific Access Restriction Parameters For PLMN Of MIB", the IE "Domain Specific Access Restriction Parameters For OperatorN" or the IE "Domain Specific Access Restriction Parameters For All" to be applied according to the requirements above is included in System Information Block Type 3 the UE shall:
 - 4> act on the IE "Domain Specific Access Class Barred List" if indicated in the IE "CS Domain Specific Access Restriction" when initiating RRC Connection establishment to send an INITIAL DIRECT TRANSFER message to the CS domain, as specified in [4]. If "no restriction" was indicated in restriction status, the UE shall act as if no Access Class is barred in the IE "Domain Specific Access Class Barred List", and ignore the IE "Access Class Barred List" in the IE "Cell Access Restriction";
 - 4> act on the IE "Domain Specific Access Class Barred List" if indicated in the IE "PS Domain Specific Access Restriction" when initiating RRC Connection establishment to send an INITIAL DIRECT TRANSFER message to the PS domain, as specified in [4]. If "no restriction" was indicated in restriction status, the UE shall act as if no Access Class is barred in the IE "Domain Specific Access Class Barred List", and ignore the IE "Access Class Barred List" in the IE "Cell Access Restriction";
- 4> upon transition to UTRA RRC connected, the UE shall:

- 5> store that Domain Specific Access Restriction Parameters to the variable "DSAC_PARAM" and maintain the variable until it is cleared, the PLMN chosen by the UE is changed or the RRC connection is released;
 - 5> act on the stored IE "Domain Specific Access Class Barred List" if indicated in the IE "CS Domain Specific Access Restriction" when initiating an INITIAL DIRECT TRANSFER message to the CS domain, as specified in [4];
 - 5> act on the stored IE "Domain Specific Access Class Barred List" if indicated in the IE "PS Domain Specific Access Restriction" when initiating an INITIAL DIRECT TRANSFER message to the PS domain, as specified in [4].
- 3> else:
- 4> act on the IE "Access Class Barred list" when initiating RRC Connection establishment as specified in [4].
- 1> if in connected mode:
- 2> for the variable "DSAC_PARAM":
 - 3> if the IE "Domain Specific Access Restriction Parameters For PLMN Of MIB", the IE "Domain Specific Access Restriction Parameters For OperatorN" or the IE "Domain Specific Access Restriction Parameters For All" to be applied according to the requirements above is included in the System Information Block Type 3:
 - 4> if the variable "DSAC_PARAM" is not set, the UE shall:
 - 5> store that Domain Specific Access Restriction Parameters to the variable "DSAC_PARAM" and maintain the variable until it is cleared, the PLMN chosen by the UE is changed or the RRC connection is released.
 - 4> else (the access class barring information is stored) UE shall:
 - 5> update the variable "DSAC_PARAM" with that Domain Specific Access Restriction Parameters.
 - 3> else:
 - 4> if the variable "DSAC_PARAM" is set, the UE shall:
 - 5> clear the variable "DSAC_PARAM".
 - 2> for the variable "PPAC_PARAM":
 - 3> if the IE "Paging Permission with Access Control Parameters For PLMN Of MIB", the IE "Paging Permission with Access Control Parameters For OperatorN" or the IE "Paging Permission with Access Control Parameters For All" to be applied according to the requirements above is included in the System Information Block Type 3:
 - 4> if the variable "PPAC_PARAM" is not set, the UE shall:
 - 5> store that Paging Permission with Access Control Parameters to the variable "PPAC_PARAM" and maintain the variable until it is cleared, the PLMN chosen by the UE is changed or the RRC connection is released.
 - 4> else (the access class barring information is stored) UE shall:
 - 5> update the variable "PPAC_PARAM" with that Paging Permission with Access Control Parameters.
 - 3> else:
 - 4> if the variable "PPAC_PARAM" is set, the UE shall:
 - 5> clear the variable "PPAC_PARAM".
 - 2> the UE shall:

3> if the variable "DSAC_PARAM" is set:

4> if the variable "PPAC_PARAM" is set:

5> act on the stored IE "Paging Response Restriction Indicator" when sending a response to any PAGING TYPE 1 or PAGING TYPE 2 message, Paging message specified in [67] or CS SERVICE NOTIFICATION message specified in [79];

5> act on the stored IE "Location/Registration Access Class Barred List" if the IE "Location/Registration Restriction Indicator" is set to "All" or "CS", when initiating a Location/Registration procedure to the CS domain, as specified in [4];

5> act on the stored IE "Location/Registration Access Class Barred List" if the IE "Location/Registration Restriction Indicator" is set to "All" or "PS", when initiating a Location/Registration procedure to the PS domain, as specified in [4];

5> act on the stored IE "Domain Specific Access Class Barred List" if indicated in the IE "CS Domain Specific Access Restriction" when initiating an INITIAL DIRECT TRANSFER message to the CS domain for any other reason, as specified in [4];

5> act on the stored IE "Domain Specific Access Class Barred List" if indicated in the IE "PS Domain Specific Access Restriction" when initiating an INITIAL DIRECT TRANSFER message to the PS domain, for any other reason, as specified in [4].

4> if the variable "PPAC_PARAM" is not set:

5> act on the stored IE "Domain Specific Access Class Barred List" if indicated in the IE "CS Domain Specific Access Restriction" when initiating an INITIAL DIRECT TRANSFER message to the CS domain, as specified in [4];

5> act on the stored IE "Domain Specific Access Class Barred List" if indicated in the IE "PS Domain Specific Access Restriction" when initiating an INITIAL DIRECT TRANSFER message to the PS domain, as specified in [4].

3> else:

4> act as if no Access Class is barred.

With respect to "CSG Identity" IE, the UE shall:

1> if the IE "CSG Identity" is present:

2> forward the content of IE "CSG Identity" to the upper layers.

If the IE "MBSFN only service" is set to TRUE the UE shall:

1> consider this cell to operate in MBSFN mode;

1> for TDD consider that all slots operate in MBSFN mode;

1> for FDD, 3.84 Mcps TDD IMB and 3.84/7.68 Mcps TDD if the UE capabilities allow the reception of MBSFN in addition to the normal UE operation the UE may receive MBMS services from this cell in accordance with requirements for selection of a cell providing only MBSFN as specified in [4]. For 1.28 Mcps TDD, if the UE capabilities allow the reception of MBSFN in addition to the normal UE operation the UE may get synchronized to the MBSFN cluster as specified in [4].

With respect to "IMS Emergency Support Indicator" IE, the UE shall:

1> if the IE "IMS Emergency Support Indicator" is present:

2> forward the content of IE "IMS Emergency Support Indicator" to the upper layers.

For 1.28Mcps TDD, if the IE "Mapping Info" is present and the mapping info for 3.84 Mcps TDD is included, UE shall:

1> acquire and store the TDD frequencies and PCCPCH RSCP threshold information in the variable CELL_RESELECTION_INFO_LCRTDD for cell reselection from GERAN to 1.28Mcps TDD.

else

- 1> clear the variable CELL_RESELECTION_INFO_LCRTDD.

If the variable BCCH_MODIFICATION_ACCESS_PROHIBITION is set to TRUE, the UE shall:

- 1> set the variable BCCH_MODIFICATION_ACCESS_PROHIBITION to FALSE and allow the access on the cell according to 8.1.8.2.

8.1.1.6.4 System Information Block type 4

If in connected mode, the UE should store all relevant IEs included in this system information block. The UE shall:

- 1> if in connected mode:
 - 2> read and act on information sent in this block;
 - 2> read the System Information Block Type 3 for any Access Class Barring information and act on that information as described in subclause 8.1.1.6.3.

If in idle mode, the UE shall not use the values of the IEs included in this system information block.

8.1.1.6.5 System Information Block type 5 and 5bis

The UE should store all relevant IEs included in this system information block. The UE shall:

- 1> if the IE "Frequency band indicator" is included and set to a frequency band supported in the UE radio access capability, the IE "Frequency band indicator 2" is not included, and the IE "Frequency band indicator 3" is not included; or
- 1> if the IE "Frequency band indicator" is included and set to "extension indicator", and the IE "Frequency band indicator 2" is included and set to a frequency band supported in the UE radio access capability, and the IE "Frequency band indicator 3" is not included; or
- 1> if the IE "Frequency band indicator" is included and set to "extension indicator", and the IE "Frequency band indicator 2" is included and set to "extension indicator", and the IE "Frequency band indicator 3" is included and set to a frequency band supported in the UE radio access capability; or
- 1> if the IE "Frequency band indicator" is not included in System Information Block type 5, the DL frequency is in between 2110MHz-2170MHz, and Band I is part of the frequency bands supported by the UE in the UE radio access capability, or
- 1> if the IE "Frequency band indicator" is not included in System Information Block type 5, the DL frequency is in between 1930MHz – 1990MHz, and Band II is part of the frequency bands supported by the UE in the UE radio access capability, or
- 1> if the IE "Frequency band indicator" is not included in System Information Block type 5, the DL frequency is in between 1805MHz-1880MHz, and Band III is part of the frequency bands supported by the UE in the UE radio access capability, or
- 1> if the UE supports multi-band signaling and the IE "Multiple Frequency Band indicator list" is included and contains a frequency band supported in the UE radio access capability:
 - 2> consider the cell to be not barred according to [4].
- 1> else if the IE "Frequency band indicator" is included and set to a frequency band not supported in the UE radio access capability, and the IE "Frequency band indicator 2" is not included, and the IE "Frequency band indicator 3" is not included; or
- 1> if the IE "Frequency band indicator" is included and set to "extension indicator", if the IE "Frequency band indicator 2" is included and set to a frequency band not supported in the UE radio access capability, and the IE "Frequency band indicator 3" is not included; or

- 1> if the IE "Frequency band indicator" is included and set to "extension indicator", and the IE "Frequency band indicator 2" is included and set to "extension indicator", and if the IE "Frequency band indicator 3" is included and set to "extension indicator" or to a frequency band not supported in the UE radio access capability; or
- 1> if the IE "Frequency band indicator" is not included in System Information Block type 5, the DL frequency is in between 2110MHz-2170MHz, and Band I is not part of the frequency bands supported by the UE in the UE radio access capability, or
- 1> if the IE "Frequency band indicator" is not included in System Information Block type 5, the DL frequency is in between 1930MHz-1990MHz, and Band II is not part of the frequency bands supported by the UE in the UE radio access capability, or
- 1> if the IE "Frequency band indicator" is not included in System Information Block type 5, the DL frequency is in between 1805MHz-1880MHz, and Band III is not part of the frequency bands supported by the UE in the UE radio access capability; or
- 1> if the UE supports multi-band signalling and the IE "Multiple Frequency Band indicator list" is included and does not contain a frequency band supported in the UE radio access capability:
 - 2> consider the cell to be barred according to [4]; and
 - 2> consider the barred cell as using the value "not allowed" in the IE "Intra-frequency cell re-selection indicator", and the maximum value in the IE "T_{barred}".
- 1> else:
 - 2> the UE behaviour is not specified.
- 1> if the IE "Frequency Bands Indicator Support" is included:
 - 2> if the first frequency band is one of the frequency bands supported in the UE radio access capability:
 - 3> set the "Support of the first Frequency Band" in variable FREQUENCY_BAND_INDICATOR_SUPPORT to TRUE.
 - 2> else:
 - 3> set the "Support of the first Frequency Band" in variable FREQUENCY_BAND_INDICATOR_SUPPORT to FALSE.
 - 2> if the second frequency band is present and the second frequency band is one of the frequency bands supported in the UE radio access capability:
 - 3> set the "Support of the second Frequency Band" in variable FREQUENCY_BAND_INDICATOR_SUPPORT to TRUE.
 - 2> else:
 - 3> set the "Support of the second Frequency Band" in variable FREQUENCY_BAND_INDICATOR_SUPPORT to FALSE.
- 1> else:
 - 2> for FDD, clear the variable FREQUENCY_BAND_INDICATOR_SUPPORT.
 - 2> for 1.28Mcps TDD,
 - 3> if the frequency band e is one of the frequency bands supported in the UE radio access capability:
 - 4> set the "Support of the first Frequency Band" in variable FREQUENCY_BAND_INDICATOR_SUPPORT to TRUE.
 - 3> else:
 - 4> set the "Support of the first Frequency Band" in variable FREQUENCY_BAND_INDICATOR_SUPPORT to FALSE.

- 3> if the frequency band *f* is one of the frequency bands supported in the UE radio access capability:
 - 4> set the "Support of the second Frequency Band" in variable `FREQUENCY_BAND_INDICATOR_SUPPORT` to TRUE.
- 3> else:
 - 4> set the "Support of the second Frequency Band" in variable `FREQUENCY_BAND_INDICATOR_SUPPORT` to FALSE.

- 1> if in connected mode, and System Information Block type 6 is indicated as used in the cell:
 - 2> read and act on information sent in System Information Block type 6.
- 1> if System Information Block type 22 is indicated as used in the cell:
 - 2> read and act on information sent in System Information Block type 22.
- 1> determine the value for the `HSPA_RNTI_STORED_CELL_PCH` variable and take the corresponding actions as described in subclause 8.5.56;
- 1> determine the value for the `READY_FOR_COMMON_EDCH` variable and take the corresponding actions as described in subclause 8.5.47;
- 1> determine the value for the `COMMON_E_DCH_TRANSMISSION` variable and take the corresponding actions as described in subclause 8.5.46;
- 1> for FDD, determine the value for the `READY_FOR_COMMON_ERGCH` variable and take the corresponding actions as described in subclause 8.5.75;
- 1> if the UE is in `CELL_FACH` state or Idle mode; and
- 1> if the UE does support E-DCH transmission in `CELL_FACH` state and Idle mode; and
- 1> if the IE "HS-DSCH common system information" is included in system information block type 5 or 5bis; and
- 1> if the IE "Common E-DCH system info" is included system information block type 5 or 5bis:
 - 2> for 1.28 Mcps TDD, if the IE "Frequency info" is included in system information block type 5:
 - 3> store and use the frequency indicated by the IE "Frequency info" as the secondary frequency for Enhanced Uplink transmission in `CELL_FACH` state and Idle mode;
 - 3> if the IE "E-RUCCH Access Service class" and/or "E-RUCCH persistence scaling factor list" and/or "SYNC_UL info" and/or IE "PRACH Information" are included in the IE "E-RUCCH Info" in system information block type 5:
 - 4> store and use the information contained in IE "E-RUCCH info".
 - 3> else:
 - 4> use the same configuration in the IE "PRACH system information list" on the secondary frequency indicated by the IE "Frequency info".
 - 3> if the IE "UpPCH Position Info" is included:
 - 4> store and use the UpPCH position indicated by the IE "UpPCH Position Info".
- 2> for 1.28 Mcps TDD, if the IE "Frequency info" is not included in system information block type 5:
 - 3> use the primary frequency for Enhanced Uplink transmission in `CELL_FACH` state and Idle mode;
 - 3> use the same configuration in the IE "PRACH system information list" on the primary frequency for the IE "E-RUCCH Access Service class" and/or "E-RUCCH persistence scaling factor list" and/or "SYNC_UL info" and/or IE "PRACH Information".

- 2> use the Enhanced Uplink in CELL_FACH state and Idle mode as specified in section 8.5.45 for FDD or 8.5.45a for 1.28 Mcps TDD and [15] for DTCH, DCCH and CCCH transmission;
- 2> for 1.28 Mcps TDD, if the IE "Treset Usage Indicator" is included:
 - 3> store IE "Treset Usage Indicator".
- 2> else:
 - 3> clear the stored IE.
- 1> else:
 - 2> if the UE is in CELL_PCH state; and
 - 2> if the UE does support E-DCH transmission in CELL_FACH state and Idle mode; and
 - 2> if the IE "HS-DSCH paging system information" is included in system information block type 5 or 5bis; and
 - 2> if the IE "Common E-DCH system info" is included system information block type 5 or 5bis; and
 - 2> if the variables C_RNTI, E_RNTI and H_RNTI are set:
 - 3> use the Enhanced Uplink in CELL_FACH state and Idle mode as specified in section 8.5.45 for FDD or 8.5.45a for 1.28 Mcps TDD and [15] for DTCH and DCCH transmission.
 - 2> else:
 - 3> replace the TFS of the RACH with the one stored in the UE if any;
 - 3> let the physical channel(s) of type PRACH given by the IE(s) "PRACH info" be the default in uplink for the PRACH if UE is in CELL_FACH state;
 - 3> start to receive the physical channel of type AICH using the parameters given by the IE "AICH info" (FDD only) when given allocated PRACH is used;
 - 3> if the IE "Additional Dynamic Transport Format Information for CCCH" is included for the selected PRACH:
 - 4> use this transport format for transmission of the CCCH.
 - 3> else:
 - 4> use the first instance of the list of transport formats as in the IE "RACH TFS" for the used RACH received in the IE "PRACH system information list" when using the CCCH.
- 1> for 3.84 Mcps and 7.68 Mcps TDD; or
- 1> for FDD and 1.28 Mcps TDD, if the UE does not support HS-DSCH reception in CELL_FACH state; or
- 1> if the IE "HS-DSCH common system information" is not included; or
- 1> for 1.28 Mcps TDD, if the IE "Common E-DCH system info" is not included:
 - 2> replace the TFS of the FACH/PCH with the one stored in the UE if any;
 - 2> select a Secondary CCPCH as specified in [4] and in subclause 8.5.19, and start to receive the physical channel of type PICH associated with the PCH carried by the selected Secondary CCPCH using the parameters given by the IE "PICH info" if UE is in Idle mode or in CELL_PCH or URA_PCH state;
 - 2> start to monitor its paging occasions on the selected PICH if UE is in Idle mode or in CELL_PCH or URA_PCH state;
 - 2> start to receive the selected physical channel of type Secondary CCPCH using the parameters given by the IE(s) "Secondary CCPCH info" if UE is in CELL_FACH state;
 - 2> in 3.84 Mcps TDD and 7.68 Mcps TDD:

- 3> use the IE "TDD open loop power control" as defined in subclause 8.5.7 when allocated PRACH is used.
- 2> in TDD:
 - 3> if the IE "PDSCH system information" and/or the IE "PUSCH system information" is included:
 - 4> store each of the configurations given there with the associated identity given in the IE "PDSCH Identity" and/or "PUSCH Identity" respectively. For every configuration, for which the IE "SFN Time info" is included, the information shall be stored for the duration given there.
 - 2> take the actions related to the HS_DSCH_RECEPTION_GENERAL variable as described in subclause 8.5.37a.
- 1> else:
 - 2> if the UE is in Idle mode:
 - 3> if the variable HS_DSCH_RECEPTION_OF_CCCH_ENABLED is set to TRUE:
 - 4> for FDD, start to receive HS-DSCH according to the procedure in subclause 8.5.37;
 - 4> for 1.28 Mcps TDD, if the IE "Frequency info" is included in system information block type 5:
 - 5> start to receive HS-DSCH according to the procedure in subclause 8.5.37 at the frequency indicated by the IE "Frequency info".
 - 4> for 1.28 Mcps TDD, if the IE "Frequency info" is not included in system information block type 5:
 - 5> start to receive HS-DSCH according to the procedure in subclause 8.5.37 at the primary frequency.
 - 3> else:
 - 4> replace the TFS of the FACH/PCH with the one stored in the UE if any;
 - 4> select a Secondary CCPCH as specified in [4] and in subclause 8.5.19, and start to receive the physical channel of type PICH associated with the PCH carried by the selected Secondary CCPCH using the parameters given by the IE "PICH info";
 - 4> start to monitor its paging occasions on the selected PICH.
 - 3> take the actions related to the HS_DSCH_RECEPTION_GENERAL variable as described in subclause 8.5.37a.
 - 2> if the UE is in CELL_FACH:
 - 3> if variable H_RNTI is set:
 - 4> start to receive HS-DSCH according to the procedure in subclause 8.5.36.
 - 3> else:
 - 4> if the variable HS_DSCH_RECEPTION_OF_CCCH_ENABLED is set to TRUE:
 - 5> for FDD, start to receive HS-DSCH according to the procedure in subclause 8.5.37;
 - 5> for 1.28 Mcps TDD, if the IE "Frequency info" is included in system information block type 5:
 - 6> start to receive HS-DSCH according to the procedure in subclause 8.5.37 at the frequency indicated by the IE "Frequency info".
 - 5> for 1.28 Mcps TDD, if the IE "Frequency info" is not included in system information block type 5:
 - 6> start to receive HS-DSCH according to the procedure in subclause 8.5.37 at the primary frequency.
 - 3> if the IE "HS-DSCH DRX in CELL_FACH Information" is included:

- 4> determine the value of the HS_DSCH_DRX_CELL_FACH_STATUS variable according to the procedure in subclause 8.5.48.
- 2> if the UE is in CELL_PCH or URA_PCH state:
 - 3> for FDD and for 1.28 Mcps TDD, if the UE supports HS-DSCH reception in CELL_PCH and URA_PCH state; and
 - 3> if IE "HS-DSCH paging system information" is included:
 - 4> if this IE is not currently stored; and
 - 4> if the value of the IE "SRNC identity" in the variable U_RNTI is not equal to the 12 MSBs of the received IE "Cell identity" in System Information Block type 3; and
 - 4> if the UE is in URA_PCH state:
 - 5> initiate the URA update procedure as specified in subclause 8.3.1, using the cause "periodic URA update".
 - 4> for FDD; or
 - 4> for 1.28 Mcps TDD, if both variable H_RNTI and variable C_RNTI are set:
 - 5> start to monitor the paging occasions and PICH monitoring occasions determined according to subclauses 8.6.3.1a, 8.6.3.2 and 8.5.39 and receive PCCH on the HS-DSCH mapped on the HS-PDSCH, or DCCH and DTCH and BCCH on the HS-DSCH mapped on the HS-PDSCH and the associated HS-PDSCH selected by the UE according to the procedure in subclause 8.5.40 for FDD and 8.5.40a for 1.28 Mcps TDD.
 - 3> else:
 - 4> replace the TFS of the FACH/PCH with the one stored in the UE if any;
 - 4> select a Secondary CCPCH as specified in [4] and in subclause 8.5.19, and start to receive the physical channel of type PICH associated with the PCH carried by the selected Secondary CCPCH using the parameters given by the IE "PICH info";
 - 4> start to monitor its paging occasions on the selected PICH;
 - 4> take the actions related to the HS_DSCH_RECEPTION_GENERAL variable as described in subclause 8.5.37a.

If a UE is a 12 kbps class UE according to [35] and the UE has a lower capability than required to support all transport channel configurations mapped on a specific Secondary CCPCH, the UE shall at a certain time instant still be able to decode those transport channels mapped on this Secondary CCPCH that do match the capability supported by the UE. The UE shall use the TFCI bits for that Secondary CCPCH, to distinguish a transport channel configuration that is supported by the UE from a transport channel configuration that is not supported by the UE.

In particular if the UE is a 12 kbps class UE according to [35] and it does not support the processing requirement at a given point in time for a Secondary CCPCH, it shall still be able to decode the same Secondary CCPCH when the processing requirement is consistent with the UE capability. Or if the UE does not support the number of TFs or the coding of a certain transport channel on a Secondary CCPCH, it shall still be able to decode other transport channels mapped on the same Secondary CCPCH that is consistent with what is supported by the UE.

The UE shall:

- 1> if the IE "Secondary CCPCH system information MBMS" is included:
 - 2> apply the Secondary CCPCH and FACH indicated by the IE "FACH carrying MCCH" for receiving MCCH.
- 1> otherwise, if the IE "Secondary CCPCH system information" includes the IE "MCCH configuration information":
 - 2> apply the Secondary CCPCH and FACH indicated by the IE "MCCH configuration information" for receiving MCCH.

- 1> for TDD, if the IE "TDD MBSFN Information" is included:
 - 2> apply the scrambling codes (as referenced by the "Cell parameters ID") to each timeslot indicated by "TDD MBSFN Information".

8.1.1.6.6 System Information Block type 6

If in connected mode, the UE should store all relevant IEs included in this system information block. The UE shall:

- 1> if the IE "Frequency band indicator" is included and set to a frequency band supported in the UE radio access capability, the IE "Frequency band indicator 2" is not included, and the IE "Frequency band indicator 3" is not included; or
- 1> if the IE "Frequency band indicator" is included and set to "extension indicator", and the IE "Frequency band indicator 2" is included and set to a frequency band supported in the UE radio access capability, and the IE "Frequency band indicator 3" is not included; or
- 1> if the IE "Frequency band indicator" is included and set to "extension indicator", and the IE "Frequency band indicator 2" is included and set to "extension indicator", and the IE "Frequency band indicator 3" is included and set to a frequency band supported in the UE radio access capability; or
- 1> if the IE "Frequency band indicator" is not included, the DL frequency is in between 2110MHz-2170MHz, and Band I is part of the frequency bands supported by the UE in the UE radio access capability, or
- 1> if the IE "Frequency band indicator" is not included, the DL frequency is in between 1930MHz – 1990MHz, and Band II is part of the frequency bands supported by the UE in the UE radio access capability, or
- 1> if the IE "Frequency band indicator" is not included, the DL frequency is in between 1805MHz-1880MHz, and Band III is part of the frequency bands supported by the UE in the UE radio access capability; or
- 1> if the UE supports multi-band signalling and the IE "Multiple Frequency Band indicator list" is included and contains a frequency band supported in the UE radio access capability:
 - 2> consider the cell to be not barred according to [4].
- 1> else if the IE "Frequency band indicator" is included and set to a frequency band not supported in the UE radio access capability, and the IE "Frequency band indicator 2" is not included, and the IE "Frequency band indicator 3" is not included; or
- 1> if the IE "Frequency band indicator" is included and set to "extension indicator", if the IE "Frequency band indicator 2" is included and set to a frequency band not supported in the UE radio access capability, and the IE "Frequency band indicator 3" is not included; or
- 1> if the IE "Frequency band indicator" is included and set to "extension indicator", and the IE "Frequency band indicator 2" is included and set to "extension indicator", and if the IE "Frequency band indicator 3" is included and set to "extension indicator" or to a frequency band not supported in the UE radio access capability; or
- 1> if the IE "Frequency band indicator" is not included, the DL frequency is in between 2110MHz-2170MHz, and Band I is not part of the frequency bands supported by the UE in the UE radio access capability, or
- 1> if the IE "Frequency band indicator" is not included, the DL frequency is in between 1930MHz-1990MHz, and Band II is not part of the frequency bands supported by the UE in the UE radio access capability, or
- 1> if the IE "Frequency band indicator" is not included, the DL frequency is in between 1805MHz-1880MHz, and Band III is not part of the frequency bands supported by the UE in the UE radio access capability; or
- 1> if the UE supports multi-band signaling and the IE "Multiple Frequency Band indicator list" is included and does not contain a frequency band supported in the UE radio access capability:
 - 2> consider the cell to be barred according to [4]; and
 - 2> consider the barred cell as using the value "not allowed" in the IE "Intra-frequency cell re-selection indicator", and the maximum value in the IE " T_{barred} ".
- 1> else:

- 2> the UE behaviour is not specified.
- 1> if the UE is in CELL_FACH state; and
 - 1> if the UE does support E-DCH transmission in CELL_FACH state and Idle mode; and
 - 1> if the IE "HS-DSCH common system information" is included in system information block type 5 or 5bis; and
 - 1> if the IE "Common E-DCH system info" is included system information block type 5 or 5bis:
 - 2> use the Enhanced Uplink in CELL_FACH state and Idle mode as specified in section 8.5.45 for FDD or 8.5.45a for 1.28 Mcps TDD and [15] for DTCH, DCCH and CCCH transmission.
- 1> else:
 - 2> if the UE is in CELL_PCH state; and
 - 2> if the UE does support E-DCH transmission in CELL_FACH state and Idle mode; and
 - 2> if the IE "HS-DSCH paging system information" is included in system information block type 5 or 5bis; and
 - 2> if the IE "Common E-DCH system info" is included system information block type 5 or 5bis; and
 - 2> if the variables C_RNTI, E_RNTI and H_RNTI are set:
 - 3> use the Enhanced Uplink in CELL_FACH state and Idle mode as specified in section 8.5.45 for FDD or 8.5.45a for 1.28 Mcps TDD and [15] for DTCH and DCCH transmission.
 - 2> else:
 - 3> replace the TFS of the RACH with the one stored in the UE if any;
 - 3> let the physical channel(s) of type PRACH given by the IE(s) "PRACH info" be the default in uplink if UE is in CELL_FACH state. If the IE "PRACH info" is not included, the UE shall read the corresponding IE(s) in System Information Block type 5 or System Information Block type 5bis and use that information to configure the PRACH;
 - 3> start to receive the physical channel of type AICH using the parameters given by the IE "AICH info" when associated PRACH is used. If the IE "AICH info" is not included, the UE shall read the corresponding IE in System Information Block type 5 or System Information Block type 5bis and use that information (FDD only);
 - 3> if the IE "Additional Dynamic Transport Format Information for CCCH" is included for the selected PRACH:
 - 4> use this transport format for transmission of the CCCH (FDD only).
 - 3> else:
 - 4> use the first instance of the list of transport formats as in the IE "RACH TFS" for the used RACH received in the IE "PRACH system information list" when using the CCCH (FDD only).
- 1> for 3.84 Mcps and 7.68 Mcps TDD; or
- 1> for FDD and 1.28 Mcps TDD, if the UE does not support HS-DSCH reception in CELL_FACH state; or
- 1> if the IE "HS-DSCH common system information" is not included in System Information Block type 5 or System Information Block type 5bis; or
- 1> for 1.28 Mcps TDD, if the IE "Common E-DCH system info" is not included:
 - 2> replace the TFS of the FACH/PCH with the one stored in the UE if any;
 - 2> select a Secondary CCPCH as specified in [4] and in subclause 8.5.19, and start to receive the physical channel of type PICH associated with the PCH carried by the selected Secondary CCPCH using the parameters given by the IE "PICH info" if the UE is in CELL_PCH or URA_PCH state. If the IE "PICH

info" is not included, the UE shall read the corresponding IE in System Information Block type 5 or System Information Block type 5bis and use that information;

- 2> start to monitor its paging occasions on the selected PICH if the UE is in CELL_PCH or URA_PCH state;
- 2> start to receive the selected physical channel of type Secondary CCPCH using the parameters given by the IE(s) "Secondary CCPCH info" if the UE is in CELL_FACH state. If the IE "Secondary CCPCH info" is not included, the UE shall read the corresponding IE(s) in System Information Block type 5 or System Information Block type 5bis and use that information;
- 2> in 3.84 Mcps TDD and 7.68 Mcps TDD: use the IE "TDD open loop power control" as defined in subclause 8.5.7;
- 2> in TDD: if the IE "PDSCH system information" and/or the IE "PUSCH system information" is included, store each of the configurations given there with the associated identity given in the IE "PDSCH Identity" and/or "PUSCH Identity" respectively. For every configuration, for which the IE "SFN Time info" is included, the information shall be stored for the duration given there;
- 2> take the corresponding actions as described in subclause 8.5.37a.

1> else:

- 2> if the UE is in CELL_FACH:
 - 3> read and use the IE "HS-DSCH common system information" in System Information Block type 5 or System Information Block type 5bis;
 - 3> if variable H_RNTI is set:
 - 4> start to receive HS-DSCH according to the procedure in subclause 8.5.36.
 - 3> else:
 - 4> if the variable HS_DSCH_RECEPTION_OF_CCCH_ENABLED is set to TRUE:
 - 5> start to receive HS-DSCH according to the procedure in subclause 8.5.37.
- 2> if the UE is in CELL_PCH or URA_PCH state:
 - 3> for FDD and for 1.28 Mcps TDD, if the UE supports HS-DSCH reception in CELL_PCH and URA_PCH state; and
 - 3> if IE "HS-DSCH paging system information" is included in System Information Block type 5 or System Information Block type 5bis:
 - 4> read and use the IE "HS-DSCH paging system information" in System Information Block type 5 or System Information Block type 5bis;
 - 4> for FDD; or
 - 4> for 1.28 Mcps TDD, if both variable H_RNTI and variable C_RNTI are set:
 - 5> start to monitor the paging occasions and PICH monitoring occasions determined according to subclauses 8.6.3.1a, 8.6.3.2 and 8.5.39 and receive PCCH or DCCH and DTCH according to the procedure in subclause 8.5.40 for FDD and 8.5.40a for 1.28 Mcps TDD.
 - 3> else:
 - 4> replace the TFS of the FACH/PCH with the one stored in the UE if any;
 - 4> select a Secondary CCPCH as specified in [4] and in subclause 8.5.19, and start to receive the physical channel of type PICH associated with the PCH carried by the selected Secondary CCPCH using the parameters given by the IE "PICH info". If the IE "PICH info" is not included, the UE shall read the corresponding IE in System Information Block type 5 or System Information Block type 5bis and use that information;
 - 4> start to monitor its paging occasions on the selected PICH;

- 4> take the actions related to the HS_DSCH_RECEPTION_GENERAL variable as described in subclause 8.5.37a.

If in idle mode, the UE shall not use the values of the IEs in this system information block.

If a UE is a 12 kbps class UE according to [35] and the UE has a lower capability than required to support all transport channel configurations mapped on a specific Secondary CCPCH, the UE shall at a certain time instant still be able to decode those transport channels mapped on this Secondary CCPCH that do match the capability supported by the UE. The UE shall use the TFCI bits for that Secondary CCPCH, to distinguish a transport channel configuration that is supported by the UE from a transport channel configuration that is not supported by the UE.

In particular if the UE is a 12 kbps class UE according to [35] and it does not support the processing requirement at a given point in time for a Secondary CCPCH, it shall still be able to decode the same Secondary CCPCH when the processing requirement is consistent with the UE capability. Or if the UE does not support the number of TFs or the coding of a certain transport channel on a Secondary CCPCH, it shall still be able to decode other transport channels mapped on the same Secondary CCPCH that is consistent with what is supported by the UE.

8.1.1.6.7 System Information Block type 7

The UE should store all relevant IEs included in this system information block.

8.1.1.6.8 Void

8.1.1.6.9 Void

8.1.1.6.10 Void

8.1.1.6.11 System Information Block type 11

If the cell is not operating in MBSFN mode according to subclause 8.1.1.6.3 the UE should store all relevant IEs included in this system information block. If the cell is not operating in MBSFN mode according to subclause 8.1.1.6.3 the UE shall:

1> if in idle mode:

2> clear the variable MEASUREMENT_IDENTITY.

1> if IE "FACH measurement occasion info" is included:

2> act as specified in subclause 8.6.7.

1> else:

2> may perform inter-frequency/inter-RAT measurements or inter-frequency/inter-RAT cell re-selection evaluation, if the UE capabilities permit such measurements while simultaneously receiving the S-CCPCH of the serving cell.

1> clear the variable CELL_INFO_LIST;

1> act upon the received IE "Intra-frequency cell info list"/"Inter-frequency cell info list"/"Inter-RAT cell info list" as described in subclause 8.6.7.3;

1> if the IE "Inter-frequency RACH reporting information" is included in the system information block:

2> read the IE and use that information for the inter-frequency measurements as specified in subclause 8.5.23.

1> if in idle mode; or

- 1> if in connected mode and if System Information Block type 12 is not broadcast in the cell:
 - 2> if no intra-frequency measurement stored in the variable MEASUREMENT_IDENTITY was set up or modified through a MEASUREMENT CONTROL message:
 - 3> if included, store the IE "Intra-frequency reporting quantity" and the IE "Intra-frequency measurement reporting criteria" or "Periodical reporting criteria" in order to activate reporting when state CELL_DCH is entered in the variable MEASUREMENT_IDENTITY. The IE "Cells for measurement" is absent for this measurement. The IE "Measurement Validity" is absent for this measurement after a state transition to CELL_DCH.
 - 1> if in connected mode and if System Information Block type 12 is not broadcast in the cell:
 - 2> read the IE "Traffic volume measurement system information";
 - 2> if no traffic volume measurement with the measurement identity indicated in the IE "Traffic volume measurement system information" was set up or modified through a MEASUREMENT CONTROL message:
 - 3> update the variable MEASUREMENT_IDENTITY with the measurement information received in that IE.
 - 1> if the IE "Cell selection and reselection info" is not included for a new neighbouring cell in the IE "intra-frequency cell info list", the IE "inter-frequency cell info list" or the IE "inter-RAT cell info list" in System Information Block type 11:
 - 2> use the default values specified for the IE "Cell selection and reselection info" for that cell except for the IE "HCS neighbouring cell information".
 - 1> if the IE "Use of HCS" is set to "used", indicating that HCS is used, do the following:
 - 2> if IE "HCS neighbouring cell information" is not included for the first new cell in the IE "Intra-frequency cell info list", the IE "Inter-frequency cell info list" or the IE "Inter-RAT cell info list" in System Information Block type 11:
 - 3> use the default values specified for the IE "HCS neighbouring cell information" for that cell.
 - 2> if IE "HCS neighbouring cell information" is not included for any other new cell in the IE "Intra-frequency cell info list", the IE "Inter-frequency cell info list" or the IE "Inter-RAT cell info list" in System Information Block type 11:
 - 3> for that cell use the same parameter values as used for the preceding cell in the same cell info list in System Information Block type 11.
 - 1> if the value of the IE "Cell selection and reselection quality measure" is different from the value of the IE "Cell selection and reselection quality measure" obtained from System Information Block type 3 or System Information Block type 4:
 - 2> use the value of the IE from this System Information Block and ignore the value obtained from System Information Block type 3 or System Information Block type 4.
 - 1> if in connected mode, and System Information Block type 12 is indicated as used in the cell:
 - 2> read and act on information sent in System Information Block type 12 as indicated in subclause 8.1.1.6.12.
 - 1> if IE "MBSFN frequency list" is included:
 - 2> act as specified in subclause 8.6.9.9ac.
 - 1> for FDD, determine the value for the READY_FOR_COMMON_ERGCH variable and take the corresponding actions as described in subclause 8.5.75;
- For 1.28 Mcps TDD if the cell is operating in MBSFN only mode according to subclause 8.1.1.6.3 the UE shall:
- 1> store the frequencies and their corresponding "cell parameter ID" indicated in the IE "MBSFN LCR TDD frequency list" included in the IE "MBSFN frequency list".
- If the cell is operating in MBSFN mode according to subclause 8.1.1.6.3 the UE may:

- 1> for FDD and 3.84/7.68 Mcps TDD consider the cells indicated in the IE "Intra-frequency cell info list" in the IE "Intra-frequency measurement system information" as candidates for the selection of the MBSFN cluster;
- 1> for 1.28 Mcps TDD consider there exist MBSFN clusters deployed with the frequencies and their corresponding "cell parameter ID" stored.

For 1.28 Mcps TDD if the cell is not operating in MBSFN only mode but associated with one or more MBSFN clusters the UE shall:

- 1> store the frequencies and their corresponding "cell parameter ID" indicated in the IE "MBSFN LCR TDD frequency list" included in the IE "MBSFN frequency list";
- 1> consider there exist MBSFN clusters deployed with the frequencies and their corresponding "cell parameter ID" stored;
- 1> search an MBSFN cluster in MBSFN only mode with its frequency and corresponding "cell parameter ID" for monitoring the MBMS services delivered in dedicated MBSFN frequency layer.

NOTE: The IE "Intra-frequency cell info list" may not include information about all neighbouring MBSFN clusters

8.1.1.6.11a System Information Block type 11bis

The UE should store all relevant IEs included in this system information block. The UE shall:

- 1> after reception of SIB 11 act upon the received IEs "Intra-frequency cell info list", "Inter-frequency cell info list" and "Inter-RAT cell info list" as described in subclause 8.6.7.3;
- 1> if the IE "Cell selection and reselection info" is not included for a new neighbouring cell in the IEs "New Intra-frequency cells", "New Inter-frequency cells" or "New Inter-RAT cells" in System Information Block type 11bis:
 - 2> use the default values specified for the IE "Cell selection and reselection info" for that cell except for the IE "HCS neighbouring cell information".
- 1> if the IE "Use of HCS" is set to "used", indicating that HCS is used, do the following:
 - 2> if IE "HCS neighbouring cell information" is not included for the first new cell in the IEs "New Intra-frequency cells", "New Inter-frequency cells" or "New Inter-RAT cells" in System Information Block type 11bis:
 - 3> use the default values specified for the IE "HCS neighbouring cell information" for that cell.
 - 2> if IE "HCS neighbouring cell information" is not included for any other new cell in the IEs "New Intra-frequency cells", "New Inter-frequency cells" or "New Inter-RAT cells" in System Information Block type 11bis:
 - 3> for that cell use the same parameter values as used for the preceding cell in the same cell info list in System Information Block type 11bis.
- 1> for FDD, determine the value for the READY_FOR_COMMON_ERGCH variable and take the corresponding actions as described in subclause 8.5.75.

8.1.1.6.11b System Information Block type 11ter

The UE should store all relevant IEs included in this system information block. The UE shall:

- 1> after reception of SIB11 and SIB 11bis, if scheduled on BCH, act upon the received IE "Inter-frequency cell info list" as described in subclause 8.6.7.3;
- 1> if the IE "Cell selection and reselection info" is not included for a new neighbouring cell in the IE "New Inter-frequency cells" in System Information Block type 11ter:
 - 2> use the default values specified for the IE "Cell selection and reselection info" for that cell except for the IE "HCS neighbouring cell information".

- 1> if the IE "Use of HCS" is set to "used", indicating that HCS is used, do the following:
 - 2> if IE "HCS neighbouring cell information" is not included for the first new cell in the IE "New Inter-frequency cells" in System Information Block type 11ter:
 - 3> use the default values specified for the IE "HCS neighbouring cell information" for that cell.
 - 2> if IE "HCS neighbouring cell information" is not included for any other new cell in the IE "New Inter-frequency cells" in System Information Block type 11ter:
 - 3> for that cell use the same parameter values as used for the preceding cell in the same cell info list in System Information Block type 11ter.

8.1.1.6.12 System Information Block type 12

If in connected mode, the UE should store all relevant IEs included in this system information block. The UE shall:

- 1> after reception of System Information Block type 11; and
- 1> after reception of System Information Block type 11bis, if broadcast in the cell; and
- 1> after reception of System Information Block type 11ter, if broadcast in the cell:
 - 2> update the variable MEASUREMENT_IDENTITY with the measurement information in the received IEs unless specified otherwise.
- 1> if IE "FACH measurement occasion info" is included:
 - 2> act as specified in subclause 8.6.7.
- 1> else:
 - 2> may perform inter-frequency/inter-RAT measurements or inter-frequency/inter-RAT cell re-selection evaluation, if the UE capabilities permit such measurements while simultaneously receiving the S-CCPCH of the serving cell.
- 1> act upon the received IE "Intra-frequency cell info list"/"Inter-frequency cell info list"/"Inter-RAT cell info list" as described in subclause 8.6.7.3;
- 1> if any of the IEs "Intra-frequency measurement quantity", "Intra-frequency reporting quantity for RACH reporting", "Maximum number of reported cells on RACH" or "Reporting information for state CELL_DCH" are not included in the system information block:
 - 2> read the corresponding IE(s) in system information block type 11 and use that information for the intra-frequency measurement.
- 1> if the IE "Inter-frequency RACH reporting information" is included in this system information block or in System Information Block type 11:
 - 2> if the IE is not included in the system information block, read the corresponding IE(s) in System Information Block type 11;
 - 2> use the received information for the inter-frequency measurements as specified in subclause 8.5.23.
- 1> if included in this system information block or in System Information Block type 11:
 - 2> if no intra-frequency measurement in the variable MEASUREMENT_IDENTITY was set up or modified through a MEASUREMENT CONTROL message:
 - 3> store the IE "Intra-frequency reporting quantity" and the IE "Intra-frequency measurement reporting criteria" or "Periodical reporting criteria" in order to activate reporting when state CELL_DCH is entered in the variable MEASUREMENT_IDENTITY. The IE "Cells for measurement" is absent for this measurement. The IE "Measurement Validity" is absent for this measurement after a state transition to CELL_DCH.
- 1> if the IE "Traffic volume measurement system information" is not included in this system information block:

- 2> read the corresponding IE in System Information Block type 11.
- 1> if the IE "Traffic volume measurement system information" was received either in this system information block or in System Information Block type 11:
 - 2> if no traffic volume measurement with the measurement identity indicated in the IE "Traffic volume measurement system information" was set up or modified through a MEASUREMENT CONTROL message:
 - 3> update the variable MEASUREMENT_IDENTITY with the measurement information received in that IE.
- 1> if in CELL_FACH state:
 - 2> start or continue the traffic volume measurements stored in the variable MEASUREMENT_IDENTITY that are valid in CELL_FACH state.
- 1> if the IE "Cell selection and reselection info" is not included for a new neighbouring cell in the IE "Intra-frequency cell info list", the IE "Inter-frequency cell info list" or the IE "Inter-RAT cell info list" in System Information Block type 12:
 - 2> use the default values specified for the IE "Cell selection and reselection info" for that cell except for the IE "HCS neighbouring cell information".
- 1> if the IE "Use of HCS" is set to "used", indicating that HCS is used, do the following:
 - 2> if IE "HCS neighbouring cell information" is not included for the first new cell in the IE "Intra-frequency cell info list", the IE "Inter-frequency cell info list" or the IE "Inter-RAT cell info list" in System Information Block type 12:
 - 3> use the default values specified for the IE "HCS neighbouring cell information" for that cell.
 - 2> if IE "HCS neighbouring cell information" is not included for any other new cell in the IE "Intra-frequency cell info list", the IE "Inter-frequency cell info list" or the IE "Inter-RAT cell info list" in System Information Block type 12:
 - 3> for that cell use the same parameter values as used for the preceding cell in the same cell info list in System Information Block type 12.
- 1> if the value of the IE "Cell selection and reselection quality measure" is different from the value of the IE "Cell selection and reselection quality measure" obtained from System Information Block type 3 or System Information Block type 4:
 - 2> use the value of the IE from this System Information Block and ignore the value obtained from System Information Block type 3 or System Information Block type 4.
- 1> for FDD, determine the value for the READY_FOR_COMMON_ERGCH variable and take the corresponding actions as described in subclause 8.5.75.

If in idle mode, the UE shall not use the values of the IEs in this system information block.

8.1.1.6.13 System Information Block type 13

If in idle or connected mode, the UE should store all relevant IEs included in this system information block except for the IEs "CN domain specific DRX cycle length coefficient", "UE timers and constants in idle mode" and "Capability update requirement" which shall be stored only in the idle mode case. The UE shall read System Information Block type 13 and the associated System Information Block types 13.1, 13.2, 13.3 and 13.4 only when the UE is operating in "ANSI-41 mode" and the IE "PLMN type" in the Master Information Block has the value "ANSI-41" or "GSM-MAP and ANSI-41". The UE shall also:

- 1> forward the content of the IE "CN domain specific NAS system information" to the non-access stratum entity indicated by the IE "CN domain identity";
- 1> use the IE "CN domain specific DRX cycle length coefficient" to calculate frame number for the Paging Occasions and Page indicator as specified in [4].

Refer to TIA/EIA/IS-2000.5-A for actions on information contained in System Information Block types 13.1, 13.2, 13.3 and 13.4.

8.1.1.6.14 System Information Block type 14

This system information block type is used only in 3.84 Mcps TDD and 7.68 Mcps TDD.

The UE should store all relevant IEs included in this system information block. The UE shall:

- 1> use the IE "UL Timeslot Interference" to calculate PRACH, DPCH and PUSCH transmit power for TDD uplink open loop power control as defined in subclause 8.5.7.

8.1.1.6.15 System Information Block type 15

If the UE is in idle or connected mode, and supports GPS location services it should store all relevant IEs included in this system information block. The UE shall:

- 1> if the IE "GPS Data ciphering info" is included:
 - 2> act as specified in the subclause 8.6.7.19.4.
- 1> act upon the received IE "Reference position" as specified in subclause 8.6.7.19.3.8;
- 1> act upon the received IE "GPS reference time" as specified in subclause 8.6.7.19.3.7;
- 1> if IE "Satellite information" is included:
 - 2> act upon this list of bad satellites as specified in subclause 8.6.7.19.3.6.

NOTE: For efficiency purposes, the UTRAN should broadcast System Information Block type 15 if it is broadcasting System Information Block type 15.2.

8.1.1.6.15.0 System Information Block type 15bis

If the UE is in idle or connected mode, and supports GANSS location services it should store all relevant IEs included in this system information block. The UE shall:

- 1> act upon the received IE "Reference position" as specified in subclause 8.6.7.19.7.8;
- 1> act upon the received IE "GANSS reference time" as specified in subclause 8.6.7.19.7.7;
- 1> if IE "GANSS ionospheric model" is included:
 - 2> act upon the received IE "GANSS ionospheric model" as specified in subclause 8.6.7.19.7.5.
- 1> if IE "GANSS additional ionospheric model" is included:
 - 2> act upon the received IE "GANSS additional ionospheric model" as specified in subclause 8.6.7.19.7.12.
- 1> if IE "GANSS Earth orientation parameters" is included:
 - 2> act upon the received IE "GANSS Earth orientation parameters" as specified in subclause 8.6.7.19.7.13.

8.1.1.6.15.1 System Information Block type 15.1

The UE should store all the relevant IEs included in this system information block in variable UE_POSITIONING_GPS_DATA. The UE shall:

- 1> act on "DGPS information" in the IE "DGPS Corrections" in a similar manner as specified in [13] except that the scale factors for PRC and RRC are different;
- 1> act upon the received IE "UE Positioning GPS DGPS corrections" as specified in subclause 8.6.7.19.3.3.

In this version of the specification, the UE shall:

- 1> ignore the following IEs: "Delta PRC2", "Delta RRC2", "Delta PRC3" and "Delta RRC3".

8.1.1.6.15.1a System Information Block type 15.1bis

This SIB has one occurrence for each GANSS supported. To identify the different GANSSs, the scheduling information for System Information Block type 15.1bis is associated with IE "GANSS ID". The UE should store all the relevant IEs included in this system information block in variable UE_POSITIONING_GANSS_DATA. The UE shall:

- 1> act on "DGANSS information" in the IE "DGANSS Corrections" in a similar manner as specified in [13] except that the scale factors for PRC and RRC are different;
- 1> act upon the received IE "UE Positioning DGANSS corrections" as specified in subclause 8.6.7.19.7.3.

8.1.1.6.15.1b System Information Block type 15.1ter

This SIB is for BDS only. If the UE supports BDS, then the UE shall:

- 1> if IE "UE positioning DBDS corrections" is included:
 - 2> act upon the received IE "UE positioning DBDS corrections" as specified in subclause 8.6.7.19.7.17.
- 1> if IE "UE positioning BDS Ionospheric Grid Model" is included:
 - 2> act upon the received IE "UE positioning BDS Ionospheric Grid Model" as specified in subclause 8.6.7.19.7.18.

8.1.1.6.15.2 System Information Block type 15.2

For System Information Block type 15.2 multiple occurrences may be used; one occurrence for one satellite. To identify the different occurrences, the scheduling information for System Information Block type 15.2 includes IE "SIB occurrence identity and value tag". The UE should store all the relevant IEs included in this system information block in variable UE_POSITIONING_GPS_DATA. The UE shall:

- 1> compare for each occurrence the value tag of the stored occurrence, if any, with the occurrence value tag included in the IE "SIB occurrence identity and value tag" for the occurrence of the System Information Block with the same occurrence identity;
- 1> in case the UE has no SIB occurrence stored with the same identity or in case the occurrence value tag is different:
 - 2> store the occurrence information together with its identity and value tag for later use.
- 1> in case an occurrence with the same identity but different value tag was stored:
 - 2> overwrite this one with the new occurrence read via system information for later use.
- 1> interpret IE "Transmission TOW" as a very coarse estimate of the current time, i.e., the approximate GPS time-of-week when the message is broadcast;
- 1> interpret IE "SatID" as the satellite ID of the data from which this message was obtained;
- 1> act upon the received IEs "Sat ID" and "GPS Ephemeris and Clock Corrections Parameter" as specified in subclause 8.6.7.19.3.4.

The IE "Transmission TOW" may be different each time a particular SIB occurrence is transmitted. The UTRAN should not increment the value tag of the SIB occurrence if the IE "Transmission TOW" is the only IE that is changed.

The UE may not need to receive all occurrences before it can use the information from any one occurrence.

8.1.1.6.15.2a System Information Block type 15.2bis

For System Information Block type 15.2bis multiple occurrences may be used; one occurrence for one satellite. To identify for which GANSS the occurrence is related to, the scheduling information for System Information Block type 15.2bis is associated with IE "GANSS ID". To identify the different occurrences within each GANSS, the scheduling information for System Information Block type 15.2bis includes IE "SIB occurrence identity and value tag". The UE should store all the relevant IEs included in this system information block in variable UE_POSITIONING_GANSS_DATA. The UE shall:

- 1> compare for each occurrence the value tag of the stored occurrence, if any, with the occurrence value tag included in the IE "SIB occurrence identity and value tag" for the occurrence of the System Information Block with the same occurrence identity;
- 1> in case the UE has no SIB occurrence stored with the same identity or in case the occurrence value tag is different:
 - 2> store the occurrence information together with its identity and value tag for later use.
- 1> in case an occurrence with the same identity but different value tag was stored:
 - 2> overwrite this one with the new occurrence read via system information for later use.
- 1> act upon the received IEs "GANSS Navigation Model" as specified in subclause 8.6.7.19.7.4.

The UE may not need to receive all occurrences before it can use the information from any one occurrence.

8.1.1.6.15.2b System Information Block type 15.2ter

For System Information Block type 15.2ter multiple occurrences may be used; one occurrence for one satellite. To identify for which GANSS the occurrence is related to, the scheduling information for System Information Block type 15.2ter is associated with IE "GANSS ID". To identify the different occurrences within each GANSS, the scheduling information for System Information Block type 15.2ter includes IE "SIB occurrence identity and value tag". The UE should store all the relevant IEs included in this system information block in variable UE_POSITIONING_GANSS_DATA. The UE shall:

- 1> compare for each occurrence the value tag of the stored occurrence, if any, with the occurrence value tag included in the IE "SIB occurrence identity and value tag" for the occurrence of the System Information Block with the same occurrence identity;
- 1> in case the UE has no SIB occurrence stored with the same identity or in case the occurrence value tag is different:
 - 2> store the occurrence information together with its identity and value tag for later use.
- 1> in case an occurrence with the same identity but different value tag was stored:
 - 2> overwrite this one with the new occurrence read via system information for later use.
- 1> act upon the received IE "GANSS additional navigation models" as specified in subclause 8.6.7.19.7.14.

The UE may not need to receive all occurrences before it can use the information from any one occurrence.

8.1.1.6.15.3 System Information Block type 15.3

For System Information Block type 15.3 multiple occurrences may be used; one occurrence for each set of satellite data. To identify the different occurrences, the scheduling information for System Information Block type 15.3 includes IE "SIB occurrence identity and value tag". The UE should store all the relevant IEs included in this system information block in variable UE_POSITIONING_GPS_DATA. The UE shall:

- 1> compare for each occurrence the value tag of the stored occurrence, if any, with the occurrence value tag included in the IE "SIB occurrence identity and value tag" for the occurrence of the System Information Block with the same occurrence identity;
- 1> in case the UE has no SIB occurrence stored with the same identity or in case the occurrence value tag is different:
 - 2> store the occurrence information together with its identity and value tag for later use.
- 1> in case an occurrence with the same identity but different value tag was stored:
 - 2> overwrite this one with the new occurrence read via system information for later use.
- 1> interpret IE "Transmission TOW" as a very coarse estimate of the current time, i.e., the approximate GPS time-of-week when the message is broadcast;

- 1> if the IE "GPS Almanac and Satellite Health" is included:
 - 2> interpret IE "SatMask" as the satellites that contain the pages being broadcast in this message;
 - 2> interpret IE "LSB TOW" as the least significant 8 bits of the TOW [12];
 - 2> act upon the received IE "GPS Almanac and Satellite Health" as specified in subclause 8.6.7.19.3.2.
- 1> if the IE "GPS ionospheric model" is included:
 - 2> act upon the received IE "GPS ionospheric model" as specified in subclause 8.6.7.19.3.5.
- 1> if the IE "GPS UTC model" is included:
 - 2> act upon the received IE "GPS UTC model" as specified in subclause 8.6.7.19.3.9.

The IE "Transmission TOW" may be different each time a particular SIB occurrence is transmitted. The UTRAN should not increment the value tag of the SIB occurrence if the IE "Transmission TOW" is the only IE that is changed. One SIB occurrence value tag is assigned to the table of subclause 10.2.48.8.18.3.

The UE may not need to receive all occurrences before it can use the information for any one occurrence.

8.1.1.6.15.3a System Information Block type 15.3bis

For System Information Block type 15.3bis multiple occurrences may be used; one occurrence for each set of satellite data. To identify for which GANSS the occurrence is related to, the scheduling information for System Information Block type 15.3bis is associated with IE "GANSS ID". To identify the different occurrences within each GANSS, the scheduling information for System Information Block type 15.3bis includes IE "SIB occurrence identity and value tag". The UE should store all the relevant IEs included in this system information block in variable UE_POSITIONING_GANSS_DATA. The UE shall:

- 1> compare for each occurrence the value tag of the stored occurrence, if any, with the occurrence value tag included in the IE "SIB occurrence identity and value tag" for the occurrence of the System Information Block with the same occurrence identity;
- 1> in case the UE has no SIB occurrence stored with the same identity or in case the occurrence value tag is different:
 - 2> store the occurrence information together with its identity and value tag for later use.
- 1> in case an occurrence with the same identity but different value tag was stored:
 - 2> overwrite this one with the new occurrence read via system information for later use.
- 1> if the IE "GANSS Almanac" is included:
 - 2> act upon the received IE "GANSS Almanac" as specified in subclause 8.6.7.19.7.2.
- 1> if the IE "GANSS time model" is included:
 - 2> act upon the received IE "GANSS time model" as specified in subclause 8.6.7.19.7.9.
- 1> if the IE "GANSS UTC model" is included:
 - 2> act upon the received IE "GANSS UTC model" as specified in subclause 8.6.7.19.7.10.
- 1> if the IE "GANSS additional UTC models" is included:
 - 2> act upon the received IE "GANSS additional UTC models" as specified in subclause 8.6.7.19.7.15.
- 1> if the IE "GANSS auxiliary information" is included:
 - 2> act upon the received IE "GANSS auxiliary information" as specified in subclause 8.6.7.19.7.16.

The UE may not need to receive all occurrences before it can use the information for any one occurrence.

8.1.1.6.15.4 System Information Block type 15.4

If the UE is in idle mode or connected mode, the UE shall:

- 1> if the IE "OTDOA Data ciphering info" is included:
 - 2> act as specified in subclause 8.6.7.19.4.

If the UE is in connected mode, the UE shall:

- 1> act as specified in subclause 8.6.7.19.2.

8.1.1.6.15.5 System Information Block type 15.5

If the UE is in idle or connected mode, the UE shall:

- 1> if the UE supports UE-based OTDOA positioning:
 - 2> act as specified in subclause 8.6.7.19.2a.

8.1.1.6.15.6 System Information Block type 15.6

This SIB has one occurrence for each GANSS supported. To identify the different GANSSs, the scheduling information for System Information Block type 15.6 is associated with IE "GANSS ID". The UE should store all the relevant IEs included in this system information block in variable UE_POSITIONING_GANSS_DATA. The UE shall:

- 1> use IE "GANSS TOD" as a reference time for the data in IE "GANSS reference measurement information";
- 1> act upon the received IE "GANSS reference measurement information" as specified in subclause 8.6.7.19.7.1.

8.1.1.6.15.7 System Information Block type 15.7

This SIB has one occurrence for each GANSS supported. To identify the different GANSSs, the scheduling information for System Information Block type 15.7 is associated with IE "GANSS ID". The UE should store all the relevant IEs included in this system information block in variable UE_POSITIONING_GANSS_DATA. The UE shall:

- 1> act upon the received IE "GANSS data bit assistance" as specified in subclause 8.6.7.19.7.11.

8.1.1.6.15.8 System Information Block type 15.8

This SIB has one occurrence for each GANSS supported. To identify the different GANSSs, the scheduling information for System Information Block type 15.8 is associated with IE "GANSS ID". The UE should store all the relevant IEs included in this system information block in variable UE_POSITIONING_GANSS_DATA. The UE shall:

- 1> if the IE "GANSS Data ciphering info" is included:
 - 2> act as specified in the subclause 8.6.7.19.4.
- 1> if the IE "GANSS real-time integrity" is included:
 - 2> act upon the received IE " GANSS real-time integrity" as specified in subclause 8.6.7.19.7.6.

8.1.1.6.16 System Information Block type 16

If the IE "Uplink DPCH info Pre" is included in the PhyCH Information Elements for a predefined configuration the UE shall:

- 1> for FDD:
 - 2> if the IE "Number of TPC bits" is not included:
 - 3> use 2 TPC bits in the Uplink DPCH.
 - 2> else:

3> if F-DPCH is not configured then the UE behaviour is unspecified.

For System Information Block type 16 multiple occurrences may be used; one occurrence for each predefined configuration. To identify the different predefined configurations, the scheduling information for System Information Block type 16 includes IE "Predefined configuration identity and value tag".

The UE should store all relevant IEs included in this system information block. The UE shall:

- 1> compare for each predefined configuration the value tag of the stored predefined configuration with the preconfiguration value tag included in the IE "Predefined configuration identity and value tag" for the occurrence of the System Information Block with the same predefined configuration identity;
- 1> in case the UE has no predefined configuration stored with the same identity:
 - 2> store the predefined configuration information together with its identity and value tag for later use e.g. during handover to UTRAN.
- 1> in case a predefined configuration with the same identity but different value tag was stored:
 - 2> overwrite this one with the new configuration read via system information for later use e.g. during handover to UTRAN.

The above handling applies regardless of whether the previously stored predefined configuration information has been obtained via UTRA or via another RAT.

The UE is not required to complete reading of all occurrences of System Information Block type 16 before initiating RRC connection establishment.

The UE is not required to store more than maxPredefConfig preconfigurations even in the case of multiple equivalent PLMNs.

8.1.1.6.17 System Information Block type 17

This system information block type is used only for TDD.

If in connected mode, the UE should store all relevant IEs included in this system information block. The UE shall:

- 1> if the IE "PDSCH system information" and/or the IE "PUSCH system information" is included, store each of the configurations given there with the associated identity given in the IE "PDSCH Identity" and/or "PUSCH Identity" respectively. This information shall become invalid after the time specified by the repetition period (SIB_REP) for this system information block.

If in idle mode, the UE shall not use the values of the IEs in this system information block.

8.1.1.6.18 System Information Block type 18

If the System Information Block type 18 is present, a UE shall obtain knowledge of the PLMN identity of the neighbour cells to be considered for cell reselection, and shall behave as specified in this subclause and in subclause 8.5.14a.

The UE should store all the relevant IEs included in this system information block.

A UE in idle mode shall act according to the following rules:

- 1> if System Information Block type 11ter is scheduled on BCH and the IE "Idle mode PLMN identities for SIB 11ter" is present:
 - 2> any PLMN list of a given type (IEs "PLMNs of inter-frequency cells list" or "Multiple PLMNs of inter-frequency cells list") included in the IE "Idle mode PLMN identities for SIB 11ter" is paired with the list of cells of the same type derived from System Information Block type 11ter if scheduled on BCH.
- 1> if System Information Block type 11bis is scheduled on BCH; and the IE "Idle mode PLMN identities for SIB 11bis" is present:
 - 2> any PLMN list of a given type (IEs "PLMNs of intra-frequency cells list" or "Multiple PLMNs of intra-frequency cells list", "PLMNs of inter-frequency cells list" or "Multiple PLMNs of inter-frequency cells list",

"PLMNs of inter-RAT cell lists") included in the IE "Idle mode PLMN identities for SIB 11bis" is paired with the list of cells of the same type derived from System Information Block type 11 and System Information Block type 11bis if scheduled on BCH.

1> else:

2> any PLMN list of a given type (IEs "PLMNs of intra-frequency cells list" or "Multiple PLMNs of intra-frequency cells list", "PLMNs of inter-frequency cells list" or "Multiple PLMNs of inter-frequency cells list", "PLMNs of inter-RAT cell lists") included in the IE "Idle mode PLMN identities" is paired with the list of cells of the same type derived from System Information Block type 11 and System Information Block type 11bis if scheduled on BCH.

1> the PLMN identity located at a given rank in the PLMN list is that of the cell with the same ranking in the paired list of cells, the cells being considered in the increasing order of their associated identities ("Intra-frequency cell id", "Inter-frequency cell id", "Inter-RAT cell id");

1> if no identity is indicated for the first PLMN in a list, the UE shall assume that the neighbouring cell broadcasts the same PLMN configuration (i.e. IE "PLMN Identity" and IE "Multiple PLMN List") as the current cell;

1> if no identity is indicated for another entry in the list, the UE shall assume that the neighbouring cell broadcasts the same PLMN configuration (i.e. IE "PLMN Identity" and IE "Multiple PLMN List") as the previous cell in the list;

1> if the number of identities in a PLMN list exceeds the number of neighbour cells in the paired list (if any), the extra PLMN identities are considered as unnecessary and ignored;

1> if the number of identities in a PLMN list (if any) is lower than the number of neighbour cells in the paired list, the missing PLMN identities are replaced by the PLMN configuration for the last cell in the list.

A UE in connected mode shall act in the same manner as a UE in idle mode with the following modifications:

1> if System Information Block type 11ter is scheduled on BCH:

2> the PLMN lists to be considered are the ones included, when present, in the IE "Connected mode PLMN identities for SIB 11ter";

2> otherwise, the UE shall use, in place of any missing list, when present, the corresponding one in the IE "Idle mode PLMN identities for SIB 11ter".

1> if System Information Block type 11bis is scheduled on BCH:

2> the PLMN lists to be considered are the ones included, when present, in the IE "Connected mode PLMN identities for SIB 11bis";

2> otherwise, the UE shall use, in place of any missing list, when present, the corresponding one in the IE "Idle mode PLMN identities for SIB 11bis";

2> otherwise, the UE shall use, in place of any missing list, when present, the corresponding one in the IE "Connected mode PLMN identities";

2> otherwise, the UE shall use, in place of any missing list, the corresponding one in the IE "Idle mode PLMN identities".

1> else:

2> the PLMN lists to be considered are the ones included, when present, in the IE "Connected mode PLMN identities";

2> otherwise, the UE shall use, in place of any missing list, the corresponding one in the IE "Idle mode PLMN identities".

1> the paired lists of cells are the ones derived from System Information Block type 11, System Information Block type 11bis and System Information Block type 11ter, if scheduled on BCH, and System Information Block type 12 if present.

If both the IEs "PLMNs of intra-frequency cells list" and "Multiple PLMNs of intra-frequency cells list" are included or if both the IEs "PLMNs of inter-frequency cells list" and "Multiple PLMNs of inter-frequency cells list" are included:

- 1> the UE behaviour is not specified.

8.1.1.6.19 System Information Block type 19

If the cell is not operating in MBSFN mode according to subclause 8.1.1.6.3 the UE should store all relevant IEs included in this system information block. If the cell is not operating in MBSFN mode according to subclause 8.1.1.6.3 the UE shall:

- 1> if the value of the IE "Priority status" in the variable PRIORITY_INFO_LIST equals "dedicated_priority":
 - 2> clear every stored value of "Thresh_{x, high}", "Thresh_{x, low}", "Thresh_{x, high2}", "Thresh_{x, low2}", "EUTRA-RSRQ-offsetWB" and "EUTRA-RSRQOnAllSymbolsOffset" in every occurrence of the IE "Priority Info List" in the variable PRIORITY_INFO_LIST.
- 1> otherwise:
 - 2> clear the variable PRIORITY_INFO_LIST.
- 1> clear the variable EUTRA_FREQUENCY_INFO_LIST;
- 1> act upon the received IE "UTRA priority info list" as described in subclause 8.6.7.3a;
- 1> if the IE "GSM priority info list" is present:
 - 2> act upon the received IE as described in subclause 8.6.7.3b.
- 1> if the IE "E-UTRA frequency and priority info list" is present:
 - 2> act upon the received IE as described in subclause 8.6.7.3c.
- 1> if the IE "E-UTRA frequency RACH reporting information" is present; and
- 1> if the UE supports E-UTRA RACH reporting:
 - 2> store the IE "E-UTRA frequency RACH reporting information" into the variable EUTRA_FREQUENCY_INFO_LIST_FACH and act upon the received IE as described in subclause 8.5.23.

8.1.1.6.20 System Information Block type 20

If the cell is not operating in MBSFN mode according to subclause 8.1.1.6.3, the UE shall:

- 1> if the IE "HNB Name" is present:
 - 2> forward the content of IE "HNB Name" to the upper layers.

8.1.1.6.21 System Information Block type 21

The EAB capable UE should store all relevant IEs included in this system information block. If the IE "EAB Parameters" is included, the EAB capable UE shall:

- 1> if the IE "EAB Parameters For All" is included in the IE "EAB Parameters":
 - 2> select the IE "EAB Parameters For All".
- 1> else:
 - 2> select the entry in the IE "EAB Parameters Per PLMN List" in the IE "EAB Parameters" corresponds to the PLMN chosen by the UE.
- 1> if in idle mode:
 - 2> if the IE "CS Domain Specific EAB parameters" or the IE "Common EAB parameters" is included in the selected Domain Specific EAB Parameters:

- 3> act on the IE "EAB Access Class Barred List" when initiating RRC Connection establishment to send an INITIAL DIRECT TRANSFER message to the CS domain, if upper layers indicate that the connection request is subject to EAB and the UE belongs to the category of UEs as indicated in the IE "EAB Category".
- 2> if the IE "PS Domain Specific EAB parameters" or the IE "Common EAB parameters" is included in the selected Domain Specific EAB Parameters:
 - 3> act on the IE "EAB Access Class Barred List" when initiating RRC Connection establishment to send an INITIAL DIRECT TRANSFER message to the PS domain, if upper layers indicate that the connection request is subject to EAB and the UE belongs to the category of UEs as indicated in the IE "EAB Category".
- 1> if in connected mode:
 - 2> store the selected Domain Specific EAB Parameters to the variable "EAB_PARAM" upon transition to RRC connected and maintain the variable until it is cleared, the PLMN chosen by the UE is changed or the RRC connection is released;
 - 2> if the IE "CS Domain Specific EAB parameters" or the IE "Common EAB parameters" is included in the stored Domain Specific EAB Parameters in variable "EAB_PARAM":
 - 3> act on the IE "EAB Access Class Barred List" when initiating an INITIAL DIRECT TRANSFER message to the CS domain, if upper layers indicate that the connection request is subject to EAB and the UE belongs to the category of UEs as indicated in the IE "EAB Category" and signalling connection to the PS domain is already established.
 - 2> if the IE "PS Domain Specific EAB parameters" or the IE "Common EAB parameters" is included in the stored Domain Specific EAB Parameters in variable "EAB_PARAM":
 - 3> act on the IE "EAB Access Class Barred List" when initiating an INITIAL DIRECT TRANSFER message to the PS domain, if upper layers indicate that the connection request is subject to EAB and the UE belongs to the category of UEs as indicated in the IE "EAB Category" and signalling connection to the CS domain is already established.

8.1.1.6.22 System Information Block type 22

The UE should store all relevant IEs included in this system information block.

8.1.1.6.23 System Information Block type 23

The UE that supports RAN-assisted WLAN interworking should store all relevant IEs included in this system information block. The UE that supports RAN-assisted WLAN interworking shall:

- 1> if the IE "WLAN Offload Information Per PLMN List" is included:
 - 2> select the instance in the IE "WLAN Offload Information Per PLMN List" corresponding to the PLMN chosen by the UE.
- 1> else:
 - 2> select the instance in the IE "WLAN Offload Information common for all PLMN".
- 1> store the received information elements of the selected instance in the variable SYSTEM_INFO_WLAN_OFFLOAD_INFO, clearing and replacing any previously stored information;
- 1> if the UE is in Idle mode, CELL_PCH, URA_PCH, or CELL_FACH state; and
- 1> if the variable WLAN_OFFLOAD_INFO is empty:
 - 2> use the information stored in the variable SYSTEM_INFO_WLAN_OFFLOAD_INFO as specified in [4], and forward it to the upper layers.

8.1.1.6.24 System Information Block type 24

The UE should read and store all relevant IEs included in this system information block in the variable `CONNECTED_MODE_ACCESS_CONTROL`.

The UE shall:

1> if in `CELL_FACH` state:

2> if the n-th Bit in the IE "DTCH transmission blocked" in the variable `CONNECTED_MODE_ACCESS_CONTROL` is changed from 0 to 1, where n is the value stored in the IE "Access Group identity" in the variable `CONNECTED_MODE_ACCESS_CONTROL`:

3> configure RLC entities mapped onto the logical channel DTCH to not submit any data PDUs to lower layers.

2> else:

3> if the n-th Bit in the IE "DTCH transmission blocked" in the variable `CONNECTED_MODE_ACCESS_CONTROL` is changed from 1 to 0, where n is the value stored in the IE "Access Group identity" in the variable `CONNECTED_MODE_ACCESS_CONTROL`:

4> configure RLC entities mapped onto the logical channel DTCH to allow submitting data PDUs to lower layers.

1> if in `CELL_PCH` or `URA_PCH` state:

2> if the n-th Bit in the IE "DTCH transmission blocked" in the variable `CONNECTED_MODE_ACCESS_CONTROL` is changed from 0 to 1, where n is the value stored in the IE "Access Group identity" in the variable `CONNECTED_MODE_ACCESS_CONTROL`:

3> not trigger a measurement report procedure or not initiate the cell update procedure with cell update cause "uplink data transmission".

NOTE: Measurement report and cell update procedures that are triggered by uplink RLC control PDU are permitted.

8.1.1.7 Modification of system information

For System Information Block type 15.2, 15.3 and 16 that may have multiple occurrences, the UE shall handle each occurrence independently as specified in the previous; that is each occurrence is handled as a separate system information block.

NOTE: It should be noted that for the proper operation of the BCCH Modification Information sent on a PCH or on an HS-DSCH (FDD and 1.28 Mcps TDD only), the System Information should not be changed more frequently than can be accommodated by mobile stations operating at the maximum DRX cycle length supported by the UTRAN.

8.1.1.7.1 Modification of system information blocks using a value tag

Upon modifications of system information blocks using value tags on system information broadcast channel, UTRAN should notify the new value tag for the master information block in the IE "BCCH modification info". Upon modifications of system information blocks using value tags on second system information broadcast channel, UTRAN should notify the new value tag for the Scheduling Block 3 in the IE "BCCH modification info". The notification is transmitted in the following way:

1> to reach UEs in idle mode, and in `CELL_PCH` state and `URA_PCH` state with S-CCPCH assigned, the IE "BCCH modification info" is contained in a PAGING TYPE 1 message transmitted on the PCCH in all paging occasions in the cell;

1> to reach UEs in `CELL_PCH` state and `URA_PCH` state with HS-DSCH assigned and no dedicated H-RNTI assigned, the IE "BCCH modification info" is contained in a PAGING TYPE 1 message transmitted on the PCCH in all paging occasions in the cell;

- 1> to reach UEs in CELL_FACH state or TDD UEs in CELL_DCH with S-CCPCH assigned, the IE "BCCH modification info" is contained in a SYSTEM INFORMATION CHANGE INDICATION message transmitted on the BCCH mapped on at least one FACH on every Secondary CCPCH in the cell;
- 1> for FDD and 1.28 Mcps TDD, to reach UEs in CELL_FACH state with HS-DSCH assigned and in CELL_PCH with HS-DSCH and dedicated H-RNTI assigned, the IE "BCCH modification info" is contained in a SYSTEM INFORMATION CHANGE INDICATION message transmitted on the BCCH mapped on the HS-PDSCH indicated with the first indexed HS-SCCH code by the BCCH specific H-RNTI.

If both the IE "ETWS information" and the IE "BCCH modification info" are present in a PAGING TYPE 1, an ETWS capable UE in idle mode shall:

- 1> if the value of IE "MIB value tag" in the IE "BCCH modification info" is different from the value tag stored in the variable VALUE_TAG:
 - 2> set the variable BCCH_MODIFICATION_ACCESS_PROHIBITION to TRUE;
 - 2> prohibit any RRC connection establishment attempt according to 8.1.8.2.

Upon reception of a PAGING TYPE 1 message or a SYSTEM INFORMATION CHANGE INDICATION message containing the IE "BCCH modification info" containing the IE "MIB value tag" but not containing the IE "BCCH modification time", the UE shall perform actions as specified in subclause 8.1.1.7.3.

If the IE "BCCH modification time" is included the UE shall perform actions as specified in subclause 8.1.1.7.2.

8.1.1.7.2 Synchronised modification of system information blocks

For modification of some system information elements, e.g. reconfiguration of the channels, it is important for the UE to know exactly when a change occurs. In such cases, the UTRAN should notify the SFN when the change will occur as well as the new value tag for the master information block or scheduling block 3 in the IE "BCCH modification info" transmitted in the following way:

- 1> To reach UEs in idle mode, CELL_PCH state and URA_PCH state, the IE "BCCH modification info" is contained in a PAGING TYPE 1 message transmitted on the PCCH in all paging occasions in the cell;
- 1> To reach UEs in CELL_FACH state or TDD UEs in CELL_DCH with SCCPCH assigned, the IE "BCCH modification info" is contained in a SYSTEM INFORMATION CHANGE INDICATION message transmitted on the BCCH mapped on at least one FACH on every Secondary CCPCH in the cell;
- 1> for FDD and 1.28 Mcps TDD, to reach UEs in CELL_FACH state with HS-DSCH assigned and in CELL_PCH with HS-DSCH and dedicated H-RNTI assigned, the IE "BCCH modification info" is contained in a SYSTEM INFORMATION CHANGE INDICATION message transmitted on the BCCH mapped on the HS-PDSCH indicated with the first indexed HS-SCCH code by the BCCH specific H-RNTI. For 1.28 Mcps TDD, the BCCH is transmitted on frequencies where CELL_FACH state UEs stay and UE detects the BCCH specific H-RNTI on its working frequency.

Upon reception of a PAGING TYPE 1 message or a SYSTEM INFORMATION CHANGE INDICATION message containing the IE "BCCH modification info" containing the IE "MIB value tag" and containing the IE "BCCH modification time", the UE shall:

- 1> perform the actions as specified in subclause 8.1.1.7.3 at the time, indicated in the IE "BCCH Modification Info".

8.1.1.7.3 Actions upon system information change

The UE shall:

- 1> compare the value of IE "MIB value tag" in the IE "BCCH modification info" with the value tag stored for the master information block in variable VALUE_TAG.
- 1> if the value tags differ:
 - 2> read the master information block on BCH;

- 2> if the value tag of the master information block in the system information is the same as the value in IE "MIB value tag" in "BCCH modification info" but different from the value tag stored in the variable VALUE_TAG:
 - 3> perform actions as specified in subclause 8.1.1.5.
- 2> if the value tag of the master information block in the system information is the same as the value tag stored in the variable VALUE_TAG:
 - 3> for the next occurrence of the master information block:
 - 4> perform actions as specified in subclause 8.1.1.7.3 again.
- 2> if the value tag of the master information block in the system information is different from the value tag stored in the variable VALUE_TAG, and is different from the value in IE "MIB value tag" in "BCCH modification info":
 - 3> perform actions as specified in subclause 8.1.1.5;
 - 3> if $(VT_{CI} - VT_{MIB}) \bmod 8 < 4$, where VT_{CI} is the value tag in the IE "MIB value tag" in "BCCH modification info" and VT_{MIB} is the value tag of the master information block in the system information:
 - 4> for the next occurrence of the master information block:
 - 5> perform actions as specified in subclause 8.1.1.7.3 again.
- 1> compare the value of IE "SB3 value tag" if present in the IE "BCCH modification info" with the value tag stored for the scheduling block 3 in variable VALUE_TAG;
 - 1> if the value tags differ:
 - 2> acquire Scheduling Block 3 (SB3) on the second system information broadcast channel.

8.1.1.7.4 Actions upon expiry of a system information expiry timer

When the expiry timer of a system information block not using a value tag expires

the UE shall:

- 1> consider the content of the system information block invalid;
- 1> re-acquire the system information block again before the content can be used.

In FDD for system information blocks other than System Information Block type 7, or in states other than CELL_FACH, or in state CELL_FACH and in the second DRX cycle after expiry of T329 as specified in subclause 8.5.49b; or

In TDD for system information blocks other than System Information Block type 14, or in states other than CELL_FACH or CELL_DCH:

the UE may:

- 1> postpone reading the system information block until the content is needed.

In FDD for System Information Block type 24:

- 1> if the UE in CELL_FACH state, CELL_PCH state or URA_PCH state:
 - 2> if the UE does not have a value stored in the IE "Access Group identity" in variable CONNECTED_MODE_ACCESS_CONTROL; or
 - 2> the UE does not have data to transmit:
 - 3> the UE shall not re-acquire the system information block.
- 2> else

3> if the UE has a value stored in the IE "Access Group identity" in variable CONNECTED_MODE_ACCESS_CONTROL; and

3> if the UE is in CELL_FACH state, CELL_PCH state or URA_PCH state:

4> the UE may postpone reading the system information block until it has data to transmit.

In FDD for System Information Block type 7, while in state CELL_FACH and not in the second DRX cycle after expiry of T329 as specified in subclause 8.5.49b, and in TDD for System Information Block type 14, while in state CELL_FACH or CELL_DCH the UE shall always keep an up to date version of the relevant IEs, unless this is not possible because system information can not be received due to bad radio conditions or the UE uses System Information Block type 7 in the variable SYSTEM_INFORMATION_CONTAINER.

8.1.1.8 Reception of System Information Container by the UE

If the UE was redirected from a different RAT:

1> if the UE receives the System Information Container message corresponding to a cell, on which UE is camped after a cell selection procedure triggered by the redirection procedure:

2> the UE may store the System Information Container message into variable SYSTEM_INFORMATION_CONTAINER and use the stored master information block, scheduling blocks and system information blocks in the variable SYSTEM_INFORMATION_CONTAINER until the variable is cleared, and act as if this system information was scheduled on BCCH of this cell.

NOTE: The UE may assume that the System Information Container contains a set of system information, such that no reception of system information is needed on the cell where the UE is camped after a cell selection procedure triggered by the redirection procedure.

8.1.2 Paging

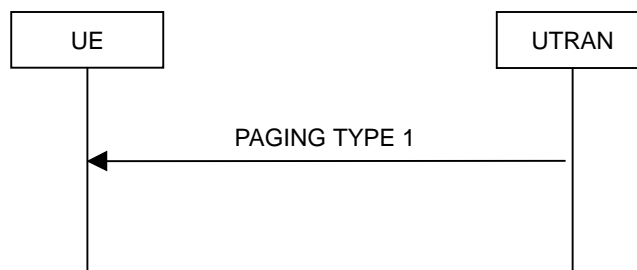

Figure 8.1.2-1: Paging

8.1.2.1 General

This procedure is used to transmit paging information to selected UEs in idle mode, CELL_PCH or URA_PCH state using the paging control channel (PCCH). Upper layers in the network may request paging, to e.g. establish a signalling connection. UTRAN may initiate paging for UEs in CELL_PCH or URA_PCH state to trigger a cell update procedure and for UEs in CELL_PCH when the variable HSPA_RNTI_STORED_CELL_PCH is set to TRUE to trigger a measurement report procedure. In addition, UTRAN may initiate paging for UEs in idle mode, CELL_PCH and URA_PCH state to trigger reading of updated system information. UTRAN may also initiate paging for UEs in CELL_PCH and URA_PCH state to release the RRC connection.

8.1.2.2 Initiation

UTRAN initiates the paging procedure by transmitting a PAGING TYPE 1 message on an appropriate paging occasion on the PCCH.

UTRAN may repeat transmission of a PAGING TYPE 1 message to a UE in several paging occasions to increase the probability of proper reception of a page.

UTRAN may page several UEs in the same paging occasion by including one IE "Paging record" for each UE in the PAGING TYPE 1 message.

For CN originated paging, UTRAN should set the IE "Paging cause" to the cause for paging received from upper layers. If no cause for paging is received from upper layers, UTRAN should set the value "Terminating – cause unknown".

UTRAN may also indicate that system information has been updated, by including the value tag of the master information block in the IE "BCCH modification info" in the PAGING TYPE 1 message. In this case, UTRAN may omit the IEs "Paging record".

UTRAN may also indicate to send Primary Notification for ETWS, by including in the IE "ETWS information" in the PAGING TYPE 1 message. In this case, UTRAN may omit the IEs "Paging record".

8.1.2.3 Reception of a PAGING TYPE 1 message by the UE

A UE in idle mode, CELL_PCH state or URA_PCH state shall receive the paging information for all its monitored paging occasions. For a UE in idle mode, the paging occasions are specified in [4] and depend on the IE "CN domain specific DRX cycle length coefficient", as specified in subclause 8.6.3.1a. For a UE in CELL_PCH state or URA_PCH state, the paging occasions depend also on the IE "UTRAN DRX cycle length coefficient" and the IE "RRC State Indicator", as specified in subclauses 8.6.3.2 and 8.6.3.3 respectively.

When the UE receives a PAGING TYPE 1 message, it shall perform the actions as specified below.

If the UE is in idle mode, for each occurrence of the IE "Paging record" included in the message the UE shall:

- 1> if the IE "Used paging identity" is a CN identity:
 - 2> compare the IE "UE identity" with all of its allocated CN UE identities:
 - 2> if one match is found:
 - 3> indicate reception of paging; and
 - 3> forward the IE "CN domain identity", the IE "UE identity" and the IE "Paging cause" to the upper layers.
- 1> otherwise:
 - 2> ignore that paging record.

If the UE is in connected mode, for each occurrence of the IE "Paging record" included in the message the UE shall:

- 1> if the IE "Used paging identity" is a UTRAN single UE identity and if this U-RNTI is the same as the U-RNTI allocated to the UE stored in the UE variable U_RNTI:
 - 2> if the optional IE "CN originated page to connected mode UE" is included:
 - 3> indicate reception of paging; and
 - 3> forward the IE "CN domain identity", the IE "Paging cause" and the IE "Paging record type identifier" to the upper layers.
- 2> if the IE "Release indicator" in the IE "RRC connection release information" has the value "Release":
 - 3> release all its radio resources;
 - 3> indicate the release of the established signalling connections (as stored in the variable ESTABLISHED_SIGNALLING_CONNECTIONS) and established radio access bearers (as stored in the variable ESTABLISHED_RABS) to the upper layers;
 - 3> clear the variable ESTABLISHED_SIGNALLING_CONNECTIONS;
 - 3> clear the variable ESTABLISHED_RABS;
 - 3> pass the value of the IE "Release cause" received in the IE "Release information" to upper layers;
 - 3> enter idle mode;

- 3> perform the actions specified in subclause 8.5.2 when entering idle mode;
- 3> and the procedure ends.
- 2> otherwise:
 - 3> if variable HSPA_RNTI_STORED_CELL_PCH is set to TRUE:
 - 4> move to CELL_FACH state as specified in subclause 8.5.56.
 - 3> else:
 - 4> perform a cell update procedure with cause "paging response" as specified in subclause 8.3.1.2.
- 2> ignore any other remaining IE "Paging record" that may be present in the message.
- 1> if the IE "Used paging identity" is a UTRAN group identity and there is a group identity match according to subclause 8.6.3.13:
 - 2> if the IE "Release indicator" in the IE "RRC connection release information" has the value "Release":
 - 3> release all its radio resources;
 - 3> indicate the release of the established signalling connections (as stored in the variable ESTABLISHED_SIGNALLING_CONNECTIONS) and established radio access bearers (as stored in the variable ESTABLISHED_RABS) to the upper layers;
 - 3> clear the variable ESTABLISHED_SIGNALLING_CONNECTIONS;
 - 3> clear the variable ESTABLISHED_RABS;
 - 3> pass the value of the IE "Release cause" received in the IE "Release information" to upper layers;
 - 3> enter idle mode;
 - 3> perform the actions specified in subclause 8.5.2 when entering idle mode;
 - 3> and the procedure ends.
 - 2> otherwise:
 - 3> if variable HSPA_RNTI_STORED_CELL_PCH is set to TRUE:
 - 4> move to CELL_FACH state as specified in subclause 8.5.56.
 - 3> else:
 - 4> perform a cell update procedure with cause "paging response" as specified in subclause 8.3.1.2.
 - 2> ignore any other remaining IE "Paging record" that may be present in the message.
- 1> otherwise:
 - 2> ignore that paging record.

If the IE "BCCH modification info" is included, any UE in idle mode, CELL_PCH or URA_PCH state shall perform the actions as specified in subclause 8.1.1 in addition to any actions caused by the IE "Paging record" occurrences in the message as specified above.

If the IE "ETWS information" is included and RRC is configured to receive ETWS, an ETWS capable UE in idle mode, CELL_PCH or URA_PCH state shall perform the actions as specified in subclause 8.6.8a.1 in addition to any actions caused by the IE "Paging record" or the IE "BCCH modification info" occurrences in the message as specified above.

8.1.3 RRC connection establishment

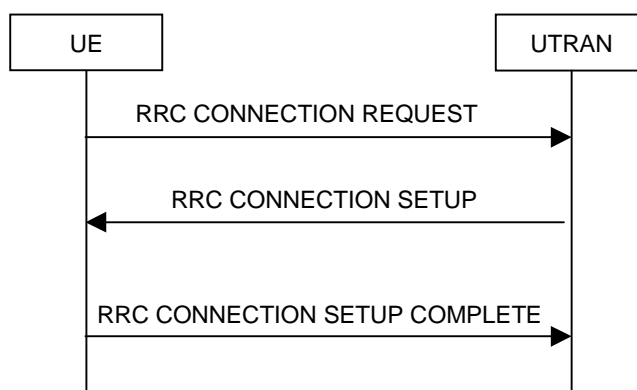

Figure 8.1.3-1: RRC Connection Establishment, network accepts RRC connection

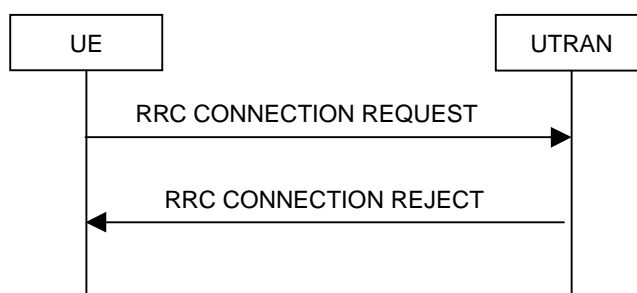

Figure 8.1.3-2: RRC Connection Establishment, network rejects RRC connection

8.1.3.1 General

The purpose of this procedure is to establish an RRC connection.

8.1.3.2 Initiation

The UE shall initiate the procedure when upper layers in the UE requests the establishment of a signalling connection and the UE is in idle mode (no RRC connection exists), as specified in subclause 8.1.8.

Upon initiation of the procedure, the UE shall:

- 1> set the variable `PROTOCOL_ERROR_INDICATOR` to `FALSE`;
- 1> if the USIM is present:
 - 2> set the value of "THRESHOLD" in the variable "START_THRESHOLD" to the 20 MSBs of the value stored in the USIM [50] for the maximum value of START for each CN Domain.
- 1> if the SIM is present:
 - 2> set the value of "THRESHOLD" in the variable "START_THRESHOLD" to the default value in [40] for each CN Domain.
- 1> set the IE "Initial UE identity" in the variable `INITIAL_UE_IDENTITY` according to subclause 8.5.1;
- 1> set the contents of the RRC CONNECTION REQUEST message according to subclause 8.1.3.3;
- 1> set CFN in relation to SFN of current cell according to subclause 8.5.15;
- 1> perform the mapping of the Access Class to an Access Service Class as specified in subclause 8.5.13, and apply the given Access Service Class when accessing the RACH or the common E-DCH (for the Enhanced Uplink in CELL_FACH state and Idle mode);

- 1> submit the RRC CONNECTION REQUEST message for transmission on the uplink CCCH;
- 1> set counter V300 to 1; and
- 1> if the variable ESTABLISHMENT_CAUSE is set to "MBMS reception":
 - 2> when the MAC layer indicates success or failure to transmit the message:
 - 3> if the MAC layer indicates failure:
 - 4> enter idle mode;
 - 4> consider the procedure to be unsuccessful;
 - 4> perform other actions when entering idle mode from connected mode as specified in subclause 8.5.2;
 - 4> the procedure ends.
 - 3> else:
 - 4> start timer T318;
 - 4> apply value 0 for counter N300 regardless of the value included in IE "UE Timers and Constants in idle mode".
- 1> otherwise:
 - 2> start timer T300 when the MAC layer indicates success or failure to transmit the message.
- 1> for 3.84 Mcps and 7.68 Mcps TDD; or
- 1> for FDD and 1.28 Mcps TDD, if the UE does not support HS-DSCH reception in CELL_FACH state; or
- 1> if the IE "HS-DSCH common system information" is not included in System Information Block type 5 or System Information Block type 5bis; or
- 1> for 1.28 Mcps TDD, if the IE "Common E-DCH system info" is not included in System Information Block type 5:
 - 2> select a Secondary CCPCH according to [4];
 - 2> start receiving all FACH transport channels mapped on the selected Secondary CCPCH.
- 1> otherwise:
 - 2> set variable HS_DSCH_RECEPTION_OF_CCCH_ENABLED to TRUE; and
 - 2> start receiving the HS-DSCH according to the procedure in subclause 8.5.37.

8.1.3.3 RRC CONNECTION REQUEST message contents to set

The UE shall, in the transmitted RRC CONNECTION REQUEST message:

- 1> set the IE "Establishment cause" to the value of the variable ESTABLISHMENT_CAUSE;
- 1> set the IE "Initial UE identity" to the value of the variable INITIAL_UE_IDENTITY;
- 1> set the IE "Protocol error indicator" to the value of the variable PROTOCOL_ERROR_INDICATOR; and
- 1> include the IE "Predefined configuration status information" and set this IE to TRUE if the UE has all pre-configurations stored with the same value tag as broadcast in the cell in which the RRC connection establishment is initiated;
- 1> if the UE is attempting to establish the signalling connection to PS-domain:
 - 2> include the IE "Domain Indicator" and set it to "PS domain".
- 1> else if the UE is attempting to establish the signalling connection to CS domain:

- 2> include the IE "Domain Indicator" and set it to "CS domain";
 - 2> set the value of the IE "CS Call type" to "speech", "video" or "other" according to the call being initiated.
 - 1> if the UE only supports HS-DSCH but not E-DCH:
 - 2> include the IE "UE capability indication" and set it to the "HS-DSCH" value.
 - 1> if the UE supports HS-DSCH and E-DCH:
 - 2> include the IE "UE capability indication" and set it to the "HS-DSCH+E-DCH" value.
 - 1> if, according to [4], the High-mobility state is applicable and it has been detected by the UE:
 - 2> include the IE "UE Mobility State Indicator" and set it to the "High-MobilityDetected" value.
 - 1> if the UE performs connection establishment for MBMS ptp radio bearer request as specified in subclause 8.6.9.6; and
 - 1> if one or more of the MBMS services for which the UE initiates the ptp radio bearer request concerns an MBMS Selected Service:
 - 2> for each MBMS Selected Service that is indicated on MCCH and for which the UE initiates the ptp radio bearer request:
 - 3> order the MBMS Selected Services such that those selected with a higher priority are listed in the IE "MBMS Selected Services Short" before those selected with a lower priority;
 - 3> include the IE "MBMS Selected Service ID" within the IE "MBMS Selected Services Short" and set it to a value in accordance with subclause 8.6.9.8.
 - 1> otherwise if the UE performs connection establishment for MBMS counting as specified in subclause 8.7.4; and
 - 1> if one or more of the MBMS services for which the UE initiates the counting response concerns an MBMS Selected Service:
 - 2> for each MBMS Selected Service that is indicated on MCCH and for which the UE initiates the counting response:
 - 3> order the MBMS Selected Services such that those selected with a higher priority are listed in the IE "MBMS Selected Services Short" before those selected with a lower priority;
 - 3> include the IE "MBMS Selected Service ID" within the IE "MBMS Selected Services Short" and set it to a value in accordance with subclause 8.6.9.8.
 - 1> if the UE included one or more "MBMS Selected Service ID" IEs:
 - 2> include the IE "MBMS Modification Period identity" and set it to a value in accordance with subclause 8.5.29.
 - 1> if the UE supports MAC-ehs:
 - 2> include the IE "MAC-ehs support" and set it to TRUE.
 - 1> if the UE supports HS-DSCH reception in CELL_FACH state:
 - 2> include the IE "HS-PDSCH in CELL_FACH" and set it to TRUE.
 - 1> if the UE supports Enhanced Uplink in CELL_FACH state and Idle mode:
 - 2> include the IE "Support of common E-DCH" and set it to TRUE.
- NOTE: In 1.28 Mcps TDD, UE supporting HS-DSCH reception in CELL_FACH state always supports Enhanced Uplink in CELL_FACH state and Idle mode, and vice versa.
- 1> if the UE supports MAC-i/is:
 - 2> include the IE "Support of MAC-i/is" and set it to TRUE.

- 1> if the UE supports E-UTRA:
 - 2> if the UE is attempting to establish the signalling connection as a result of being redirected by E-UTRA; and
 - 2> if this is the first attempt to establish the signalling connection:
 - 3> do not include the IE "Pre-Redirection info".
 - 2> else:
 - 3> if the variable EUTRA_FREQUENCY_INFO_LIST contains no E-UTRA frequencies:
 - 4> include the IE "Pre-Redirection info";
 - 4> if the UE supports E-UTRA FDD:
 - 5> set the IE "Support of E-UTRA FDD" to TRUE.
 - 4> if the UE supports E-UTRA TDD:
 - 5> set the IE "Support of E-UTRA TDD" to TRUE.
 - 3> if the UE supports any of the bands that the E-UTRA frequencies included in the variable EUTRA_FREQUENCY_INFO_LIST belong to:
 - 4> include the IE "Pre-Redirection info";
 - 4> if the UE supports any of the bands that the E-UTRA FDD frequencies included in the variable EUTRA_FREQUENCY_INFO_LIST belong to:
 - 5> set the IE "Support of E-UTRA FDD" to TRUE.
 - 4> if the UE supports any of the bands that the E-UTRA TDD frequencies included in the variable EUTRA_FREQUENCY_INFO_LIST belong to:
 - 5> set the IE "Support of E-UTRA TDD" to TRUE.
- 1> if the variable SYSTEM_INFORMATION_CONTAINER is not empty:
 - 2> include the IE "System Information Container Stored Indication" and set it to TRUE.
- 1> For FDD, if the UE supports dual cell operation on adjacent frequencies:
 - 2> include the IE "Multi cell support" and set it to TRUE;
 - 2> if the UE supports dual cell with MIMO operation on adjacent frequencies:
 - 3> include the IE "Dual cell MIMO support" and set it to TRUE.
 - 2> if the UE supports multi-cell operation on more than two cells:
 - 3> if the UE is of HS-DSCH category 30 or 32 or 34 or 35 or 36 or 38 according to [35]:
 - 4> include the IE "More than two cell or MIMO mode with four transmit antennas support" and set it to "higher rate".
 - 3> otherwise:
 - 4> include the IE "More than two cell or MIMO mode with four transmit antennas support" and set it to "lower rate".
 - 2> else if the UE supports multi-cell operation on two cells:
 - 3> if the UE is of HS-DSCH category 37 according to [35]:
 - 4> include the IE "More than two cell or MIMO mode with four transmit antennas support" and set it to "lower rate".

- 1> For 1.28 Mcps TDD, if the UE supports MU-MIMO:
 - 2> if the UE supports uplink and downlink MU-MIMO:
 - 3> include the IE "More than two cell support" and set it to "higher rate".
 - 2> if the UE supports uplink MU-MIMO only:
 - 3> include the IE "More than two cell support" and set it to "lower rate".
- 1> if the UE supports CS voice over HSPA:
 - 2> include the IE "Support for CS Voice over HSPA" and set it to TRUE.
- 1> if the IE "Support of the first Frequency Band" in variable FREQUENCY_BAND_INDICATOR_SUPPORT is set to TRUE:
 - 2> include the IE "Support of the first Frequency Band" and set it to TRUE.
- 1> if the IE "Support of the second Frequency Band" in variable FREQUENCY_BAND_INDICATOR_SUPPORT is set to TRUE:
 - 2> include the IE "Support of the second Frequency Band" and set it to TRUE.
- 1> if the UE is attempting to establish the signalling connection to CS domain due to CSFB call initiated in E-UTRA:
 - 2> include the IE "CSFB Indication" and set it to TRUE.

The UE shall not include the IE "UE Specific Behaviour Information 1 idle".

8.1.3.4 Reception of an RRC CONNECTION REQUEST message by the UTRAN

Upon receiving an RRC CONNECTION REQUEST message, UTRAN should either:

- 1> accept the request and use a predefined or default radio configuration, in which case it should:
 - 2> include the following information in the RRC CONNECTION SETUP message:
 - 3> the IE "Predefined configuration identity", to indicate which pre-defined configuration of RB and, transport channel parameters shall be used; or
 - 3> the IE "Default configuration mode" and IE "Default configuration identity", to indicate which default configuration of RB and transport channel parameters shall be used;
 - 3> PhyCH information elements.
 - 2> submit the RRC CONNECTION SETUP message to the lower layers for transmission on the downlink CCCH.

NOTE 1: UTRAN should only apply a predefined radio configuration in case it orders the UE to enter CELL_DCH. This is because the predefined configuration information included in System Information Block 16 mandatorily includes information only required in CELL_DCH state.

- 1> accept the request without using a predefined or default radio configuration, in which case it should:
 - 2> include in the RRC CONNECTION SETUP message the complete set of RB, TrCH and PhyCH information elements to be used;
 - 2> submit the RRC CONNECTION SETUP message to the lower layers for transmission on the downlink CCCH.

NOTE 2: In R'99, the RRC CONNECTION SETUP message always includes the IEs "Added or Reconfigured TrCH information list", both for uplink and downlink transport channels, even if UTRAN orders the UE to move to CELL_FACH and hence need not configure any transport channels. In these cases, UTRAN may include a configuration that adds little to the encoded message size e.g. a DCH with a single zero size transport format. At a later stage, UTRAN may either remove or reconfigure this configuration.

- 1> submit an RRC CONNECTION REJECT message on the downlink CCCH. In the RRC CONNECTION REJECT message, the UTRAN may direct the UE to another UTRA carrier or to another system. The UTRAN may direct the UE to E-UTRAN FDD only if the IE "Pre-Redirection info" is present in the RRC CONNECTION REQUEST message and the IE "Support of E-UTRA FDD" is set to TRUE; the UTRAN may direct the UE to E-UTRAN TDD only if the IE "Pre-Redirection info" is present in the RRC CONNECTION REQUEST message and the IE "Support of E-UTRA TDD" is set to TRUE. After the RRC CONNECTION REJECT message has been sent, all context information for the UE may be deleted in UTRAN.

NOTE 3: UTRAN should not send RRC CONNECTION REJECT message to direct UE to E-UTRAN if there is no means for UTRAN to determine that UE subscription allows UE access to E-UTRAN.

8.1.3.5 Cell re-selection, T300 or T318 timeout

- 1> if the UE has not yet received an RRC CONNECTION SETUP message with the value of the IE "Initial UE identity" equal to the value of the variable INITIAL_UE_IDENTITY; and
- 1> if cell re-selection or expiry of timer T300 or timer T318 occurs:

the UE shall:

- 1> if the UE performs cell reselection:
- 2> clear the variable SYSTEM_INFORMATION_CONTAINER.
- 1> check the value of V300; and
- 2> if V300 is equal to or smaller than N300:
- 3> if cell re-selection occurred:
- 4> set CFN in relation to SFN of current cell according to subclause 8.5.15;
- 4> for FDD and 1.28 Mcps TDD, if the UE supports HS-DSCH reception in CELL_FACH state and if IE: "HS-DSCH common system information" is included in System Information Block type 5 or System Information Block type 5bis:
- 5> if variable HS_DSCH_RECEPTION_OF_CCCH_ENABLED is set to TRUE:
- 6> reset the MAC-ehs entity [15].
- 5> else:
- 6> set the variable HS_DSCH_RECEPTION_OF_CCCH_ENABLED to TRUE;
- 6> start receiving the HS-DSCH according to the procedure in subclause 8.5.37.
- 3> set the IEs in the RRC CONNECTION REQUEST message according to subclause 8.1.3.3;
- 3> perform the mapping of the Access Class to an Access Service Class as specified in subclause 8.5.13; and
- 3> apply the given Access Service Class when accessing the RACH or the common E-DCH (for the Enhanced Uplink in CELL_FACH state and Idle mode);
- 3> submit a new RRC CONNECTION REQUEST message to lower layers for transmission on the uplink CCCH;
- 3> increment counter V300;
- 3> restart timer T300 when the MAC layer indicates success or failure to transmit the message.
- 2> if V300 is greater than N300:
- 3> if the UE supports logging of failed RRC Connection Establishment, perform the actions specified in subclause 8.1.3.11;

- 3> if the UE supports RRC Connection Establishment failure temporary Qoffset and RRC Connection Establishment failure has occurred a consecutive "ConnEst Fail Count" times on the same cell for which "Tx Fail Params" is included in System Information Block Type 3:
 - 4> for a period as indicated by "Offset Validity":
 - 5> use "ConnEst Fail Qoffset_{temp}" for the parameter Qoffset_{temp} for the concerned cell when performing cell selection and reselection according to TS 25.304 [4] and TS 36.304 [66].

NOTE : When performing cell selection, if no suitable or acceptable cell can be found, it is up to UE implementation whether to stop using "ConnEst Fail Qoffset_{temp}" for the parameter Qoffset_{temp} during "Offset Validity" for the concerned cell.

- 3> enter idle mode;
- 3> consider the procedure to be unsuccessful;
- 3> Other actions the UE shall perform when entering idle mode from connected mode are specified in subclause 8.5.2;
- 3> the procedure ends.

8.1.3.5a Abortion of RRC connection establishment

If the UE has not yet entered UTRA RRC Connected mode and the RRC connection establishment is to be aborted as specified in subclause 8.1.8, the UE shall:

- 1> consider the procedure to be unsuccessful;
- 1> perform the actions when entering idle mode as specified in subclause 8.5.2.

The procedure ends.

8.1.3.6 Reception of an RRC CONNECTION SETUP message by the UE

The UE shall compare the value of the IE "Initial UE identity" in the received RRC CONNECTION SETUP message with the value of the variable INITIAL_UE_IDENTITY.

If the values are different, the UE shall:

- 1> ignore the rest of the message.

If the values are identical, the UE shall:

- 1> if IE "Specification mode" is set to "Preconfiguration" and IE "Preconfiguration mode" is set to "Predefined configuration":
 - 2> initiate the radio bearer and transport channel configuration in accordance with the predefined parameters identified by the IE "Predefined configuration identity" with the following exception:
 - 3> ignore the IE "RB to setup list" and the IE "Re-establishment timer".

NOTE: IE above IEs are mandatory to include in IE "Predefined RB configuration" that is included in System Information Block 16 but should be ignored since it is not possible to establish a RAB during RRC connection establishment.

- 2> initiate the physical channels in accordance with the received physical channel information elements.
- 1> if IE "Specification mode" is set to "Preconfiguration" and IE "Preconfiguration mode" is set to "Default configuration":
 - 2> initiate the radio bearer and transport channel configuration in accordance with the default parameters identified by the IE "Default configuration mode" and IE "Default configuration identity" with the following exception:
 - 3> ignore the radio bearers other than signalling radio bearers.

2> initiate the physical channels in accordance with the received physical channel information elements.

NOTE: IE "Default configuration mode" specifies whether the FDD or TDD version of the default configuration shall be used.

1> if IE "Specification mode" is set to "Complete specification":

2> initiate the radio bearer, transport channel and physical channel configuration in accordance with the received radio bearer, transport channel and physical channel information elements.

1> if IE "Default configuration for CELL_FACH" is set:

2> act in accordance with the default parameters according to section 13.8.

1> clear the variable ESTABLISHMENT_CAUSE;

1> for FDD and 1.28 Mcps TDD, if the HS_DSCH_RECEPTION_OF_CCCH_ENABLED is set to TRUE:

2> set the variable HS_DSCH_RECEPTION_OF_CCCH_ENABLED to FALSE.

1> stop timer T300 or T318, whichever one is running, and act upon all received information elements as specified in subclause 8.6, unless specified otherwise in the following:

2> if the UE, according to subclause 8.6.3.3, will be in the CELL_FACH state at the conclusion of this procedure:

3> if the IE "Frequency info" is included:

4> select a suitable UTRA cell according to [4] on that frequency;

4> for 1.28Mcps TDD, decide the working frequency according to subclause 8.6.6.1.

3> else:

4> for 1.28Mcps TDD, continue to use the currently used frequency as working frequency.

3> enter UTRA RRC connected mode;

3> determine the value for the READY_FOR_COMMON_EDCH variable and take the corresponding actions as described in subclause 8.5.47;

3> determine the value for the COMMON_E_DCH_TRANSMISSION variable and take the corresponding actions as described in subclause 8.5.46;

3> for FDD, determine the value for the READY_FOR_COMMON_ERGCH variable and take the corresponding actions as described in subclause 8.5.75;

3> if variable READY_FOR_COMMON_EDCH is set to FALSE:

4> select PRACH according to subclause 8.5.17.

3> else:

4> configure the Enhanced Uplink in CELL_FACH state and Idle mode as specified in subclause 8.5.45 for FDD and 8.5.45a for 1.28 Mcps TDD.

3> for 3.84 Mcps and 7.68 Mcps TDD; or

3> for FDD and 1.28 Mcps TDD, if the UE does not support HS-DSCH reception in CELL_FACH state; or

3> if the IE "HS-DSCH common system information" is not included in System Information Block type 5 or System Information Block type 5bis; or

3> for 1.28 Mcps TDD, if the IE "Common E-DCH system info" is not included in System Information Block type 5:

4> select Secondary CCPCH according to subclause 8.5.19.

- 3> else:
 - 4> set variable HS_DSCH_RECEPTION_OF_CCCH_ENABLED to FALSE;
 - 4> For FDD if variable READY_FOR_COMMON_EDCH is set to FALSE:
 - 5> if the RBs have the multiplexing option with transport channel type "HS-DSCH" for the DL and transport channel type "RACH" in the UL; and
 - 5> if "new H-RNTI" and "new C-RNTI" are included:
 - 6> store the "new H-RNTI" according to subclause 8.6.3.1b;
 - 6> store the "new C-RNTI" according to subclause 8.6.3.9;
 - 6> and start to receive HS-DSCH according to the procedure in subclause 8.5.36.
 - 5> else:
 - 6> clear variable C_RNTI and delete any stored C-RNTI value;
 - 6> clear variable H_RNTI and delete any stored H-RNTI value;
 - 6> clear any stored IE "HARQ Info";
 - 6> set the variable INVALID_CONFIGURATION to TRUE.
 - 4> else:
 - 5> if the RBs have the multiplexing option with transport channel type "HS-DSCH" for the DL and transport channel type "E-DCH" in the UL; and
 - 5> if the IEs "new Primary E-RNTI", "new H-RNTI" and "new C-RNTI" are included:
 - 6> store the "new Primary E-RNTI" according to subclause 8.6.3.14;
 - 6> store the "new H-RNTI" according to subclause 8.6.3.1b;
 - 6> store the "new C-RNTI" according to subclause 8.6.3.9;
 - 6> configure Enhanced Uplink in CELL_FACH state and Idle mode according to subclause 8.5.45 for FDD and 8.5.45a for 1.28 Mcps TDD;
 - 6> and start to receive HS-DSCH according to the procedure in subclause 8.5.36.
 - 5> else:
 - 6> clear variable C_RNTI and delete any stored C-RNTI value;
 - 6> clear variable H_RNTI and delete any stored H-RNTI value;
 - 6> clear variable E_RNTI and delete any stored E-RNTI value;
 - 6> clear any stored IE "HARQ Info";
 - 6> set the variable INVALID_CONFIGURATION to TRUE.
- 3> ignore the IE "UTRAN DRX cycle length coefficient" and stop using DRX.
- 1> if the UE, according to subclause 8.6.3.3, will be in the CELL_DCH state at the conclusion of this procedure:
 - 2> perform the physical layer synchronisation procedure A as specified in [29] (FDD only);
 - 2> enter UTRA RRC connected mode;
 - 2> ignore the IE "UTRAN DRX cycle length coefficient" and stop using DRX.
- 1> submit an RRC CONNECTION SETUP COMPLETE message to the lower layers on the uplink DCCH after successful state transition per subclause 8.6.3.3, with the contents set as specified below:

- 2> set the IE "RRC transaction identifier" to:
 - 3> the value of "RRC transaction identifier" in the entry for the RRC CONNECTION SETUP message in the table "Accepted transactions" in the variable TRANSACTIONS; and
 - 3> clear that entry.
- 2> if the USIM or SIM is present:
 - 3> set the "START" for each CN domain in the IE "START list" in the RRC CONNECTION SETUP COMPLETE message with the corresponding START value that is stored in the volatile memory of the ME if the USIM [50], or the SIM is present.
- 2> if neither the USIM nor SIM is present:
 - 3> set the "START" for each CN domain in the IE "START list" in the RRC CONNECTION SETUP COMPLETE message to zero;
 - 3> set the value of "THRESHOLD" in the variable "START_THRESHOLD" to the default value [40].
- 2> retrieve its UTRA UE radio access capability information elements from variable UE_CAPABILITY_REQUESTED; and then
- 2> include this in IE "UE radio access capability" and IE "UE radio access capability extension", provided this IE is included in variable UE_CAPABILITY_REQUESTED;
- 2> retrieve its inter-RAT-specific UE radio access capability information elements from variable UE_CAPABILITY_REQUESTED; and then
- 2> include this in IE "UE system specific capability";
- 2> if the UE supports contiguous multi-cell operation on four cells in the same band, include the IE "Additional Secondary Cells" in the IE "UE radio access capability extension" and set it to 'a2' for the supported bands; otherwise, if the UE supports contiguous multi-cell operation on three cells in the same band, include the IE "Additional Secondary Cells" in the IE "UE radio access capability extension" and set it to 'a1' for the supported bands;
- 2> if the UE supports contiguous multi-cell operation on eight cells in the same band, include the IE "Additional Secondary Cells 2" in the IE "UE radio access capability extension" and set it to 'a6' for the supported bands;
- 2> if the UE supports contiguous multi-cell operation on seven cells in the same band, include the IE "Additional Secondary Cells 2" in the IE "UE radio access capability extension" and set it to 'a5' for the supported bands;
- 2> if the UE supports contiguous multi-cell operation on six cells in the same band, include the IE "Additional Secondary Cells 2" in the IE "UE radio access capability extension" and set it to 'a4' for the supported bands;
- 2> if the UE supports contiguous multi-cell operation on five cells in the same band, include the IE "Additional Secondary Cells 2" in the IE "UE radio access capability extension" and set it to 'a3' for the supported bands;
- 2> if the UE supports non-contiguous multi-cell operation on two cells in the same band:
 - 3> set the IE "Aggregated cells" in IE "Non-contiguous multi-cell" in the IE "UE radio access capability extension" to 'nc-2c' for the supported band;
 - 3> set the IE "Gap size" in IE "Non-contiguous multi-cell" in the IE "UE radio access capability extension" for the supported band to 'fiveMHz' or 'tenMHz' or 'anyGapSize', or
- 2> if the UE supports non-contiguous multi-cell operation on three cells in the same band:
 - 3> set the IE "Aggregated cells" in IE "Non-contiguous multi-cell" in the IE "UE radio access capability extension" to 'nc-3c' for the supported band;
 - 3> set the IE "Gap size" in IE "Non-contiguous multi-cell" in the IE "UE radio access capability extension" for the supported band to 'fiveMHz' or 'tenMHz' or 'anyGapSize', or
- 2> if the UE supports non-contiguous multi-cell operation on four cells in the same band:

- 3> set the IE "Aggregated cells" in IE "Non-contiguous multi-cell" in the IE "UE radio access capability extension" to 'nc-4c' for the supported band;
 - 3> set the IE "Gap size" in IE "Non-contiguous multi-cell" in the IE "UE radio access capability extension" for the supported band to 'fiveMHz' or 'tenMHz' or 'anyGapSize';
 - 3> if the UE supports an equal number of contiguous cells on each side of the gap, include the IE "Non-contiguous multi-cell Combination (2,2)";
 - 3> if the UE supports a different number of contiguous cells on each side of the gap, include the IE "Non-contiguous multi-cell Combination (3,1) (1,3)".
- 2> if the UE supports Multiflow operation on two cells on one frequency:
 - 3> set the IE "Number of cells" in IE "Multiflow per band capability" to two cells;
 - 3> set the IE "Number of frequencies" in IE "Multiflow per band capability" to one frequency.
 - 2> if the UE supports Multiflow operation on three cells on two frequencies in the same band:
 - 3> set the IE "Number of cells" in IE "Multiflow per band capability" to three cells;
 - 3> set the IE "Number of frequencies" in IE "Multiflow per band capability" to two frequencies.
 - 2> if the UE supports Multiflow operation on four cells on two frequencies in the same band:
 - 3> set the IE "Number of cells" in IE "Multiflow per band capability" to four cells;
 - 3> set the IE "Number of frequencies" in IE "Multiflow per band capability" to two frequencies.
 - 2> if the UE support Multiflow operation on three or four non-contiguous cells in the same band:
 - 3> set the IE "Gap size" in IE "Multiflow per band capability".
 - 2> if the UE supports Multiflow operation with MIMO:
 - 3> set IE "MIMO support" in IE "Multiflow per band capability" to single or dual stream MIMO transmission in all the frequency bands where the Multiflow operation is supported;
 - 3> if the UE needs more processing to generate HARQ feedback for Multiflow with MIMO operation:
 - 4> set IE "Longer HARQ processing time" in IE "Multiflow capability".
 - 2> if the UE supports Multiflow operation on three or four cells on two frequencies in different bands:
 - 3> set the IE "Supported Multiflow Combination" in IE "Radio Access Capability Band Combination List";
 - 3> if the UE supports three cells on two frequencies in different bands:
 - 4> set the IE "Number of cells in band A" to two cells;
 - 4> set the IE "Number of cells in band B" to one cell.
 - 3> if the UE supports four cells on two frequencies in different bands:
 - 4> set the IE "Number of cells in band A" to two cells;
 - 4> set the IE "Number of cells in band B" to two cells.
 - 4> set the IE "Number of frequencies in band A" to one frequency;
 - 4> set the IE "Number of frequencies in band B" to one frequency.
 - 3> if the UE supports MIMO with Multiflow in different bands:
 - 4> set IE "Support for Multiflow with MIMO operation in different bands" in IE "Multiflow capability".
 - 2> if the variable DEFERRED_MEASUREMENT_STATUS is TRUE:

- 3> if System Information Block type 11 is scheduled on the BCCH and the UE has not read nor stored the IEs present in this System Information Block; or
- 3> if System Information Block type 11bis is scheduled on the BCCH and the UE has not read nor stored the IEs present in this System Information Block; or
- 3> if System Information Block type 11ter is scheduled on the BCCH and the UE has not read nor stored the IEs present in this System Information Block; or
- 3> if System Information Block type 12 is scheduled on the BCCH and the UE has not read nor stored the IEs present in this System Information Block:
 - 4> include IE "Deferred measurement control reading".
- 2> if an IE "Logged Measurement Info-FDD" or "Logged Measurement Info-TDD" in variable LOGGED_MEAS_REPORT_VARIABLE is present and registered PLMN is present in the IE "PLMN Identity List" stored in variable LOGGED_MEAS_REPORT_VARIABLE:
 - 3> include IE "Logged Meas Available".
- 2> if an IE "Logged ANR Report Info" in variable LOG_ANR_REPORT_VARIABLE is present and the registered PLMN is the same as one of the PLMNs in the IE "PLMN Identity" or IE "Equivalent PLMN Identity List" stored in variable LOG_ANR_REPORT_VARIABLE:
 - 3> include IE "ANR Logging Results Available".
- 2> if an IE "Logged Connection Establishment Failure Info-FDD" or "Logged Connection Establishment Failure Info-TDD" in variable LOGGED_CONNECTION_ESTABLISHMENT_FAILURE is present and the current Registered PLMN is the same as the PLMN in IE "PLMN Identity" stored in variable LOGGED_CONNECTION_ESTABLISHMENT_FAILURE:
 - 3> include IE "Connection Establishment Failure Info Available".

NOTE: If the "RRC State indicator" is set to the value "CELL_FACH", the UE continues to read and store the IEs in System Information Block type 11, System Information Block type 11bis, System Information Block type 11ter, System Information Block type 12, System Information Block type 18 and System Information Block type 19, if transmitted, after submitting the RRC Connection Setup Complete message to lower layers (see 8.5.31).

When the RRC CONNECTION SETUP COMPLETE message has been submitted to lower layers for transmission the UE shall:

- 1> if the UE has entered CELL_DCH state:
 - 2> clear the variable SYSTEM_INFORMATION_CONTAINER;
 - 2> if the IE "Deferred measurement control reading" was included in the RRC CONNECTION SETUP COMPLETE message:
 - 3> clear variable MEASUREMENT_IDENTITY;
 - 3> clear the variable CELL_INFO_LIST.
 - 2> if the UE supports RAN-assisted WLAN interworking:
 - 3> stop the timer T330, if it is running;
 - 3> stop using the information stored in the variable SYSTEM_INFO_WLAN_OFFLOAD_INFO, and forward this indication to the upper layers;
 - 3> if the variable WLAN_OFFLOAD_INFO is not empty:
 - 4> use the information stored in the variable WLAN_OFFLOAD_INFO as specified in [4], and forward it to the upper layers.
- 1> if the UE has entered CELL_FACH state:

- 2> if the variable SYSTEM_INFORMATION_CONTAINER is not empty:
 - 3> the UE behaviour is unspecified.
- 2> start timer T305 using its initial value if periodical update has been configured by T305 in the IE "UE Timers and constants in connected mode" set to any other value than "infinity" in the variable TIMERS_AND_CONSTANTS;
- 2> if the UE supports RAN-assisted WLAN interworking:
 - 3> stop the timer T330, if it is running;
 - 3> if the variable WLAN_OFFLOAD_INFO is not empty:
 - 4> use the information stored in the variable WLAN_OFFLOAD_INFO as specified in [4], and forward it to the upper layers.
 - 3> else:
 - 4> use the information stored in the variable SYSTEM_INFO_WLAN_OFFLOAD_INFO as specified in [4] and forward it to the upper layers.
- 1> store the contents of the variable UE_CAPABILITY_REQUESTED in the variable UE_CAPABILITY_TRANSFERRED;
- 1> initialise variables upon entering UTRA RRC connected mode as specified in subclause 13.4;
- 1> consider the procedure to be successful.

And the procedure ends.

8.1.3.7 Physical channel failure or cell re-selection

- 1> If the UE failed to establish, per subclause 8.5.4, the physical channel(s) indicated in the RRC CONNECTION SETUP message; or
- 1> if the UE performs cell re-selection; or
- 1> if the UE will be in the CELL_FACH state at the conclusion of this procedure; and
- 1> if the received RRC CONNECTION SETUP message included the IE "Frequency info" and the UE could not find a suitable UTRA cell on that frequency but it could find a suitable UTRA cell on another frequency; or
- 1> if the received RRC CONNECTION SETUP message included the IE "Primary CPICH info" (for FDD) or "Primary CCPCH info" (for TDD), and the UE selected another cell than indicated by this IE; or
- 1> if the contents of the variable C_RNTI is empty;
- 1> after having received an RRC CONNECTION SETUP message with the value of the IE "Initial UE identity" equal to the value of the variable INITIAL_UE_IDENTITY; and
- 1> before the RRC CONNECTION SETUP COMPLETE message is delivered to lower layers for transmission:

the UE shall:

- 1> clear the entry for the RRC CONNECTION SETUP message in the table "Accepted transactions" in the variable TRANSACTIONS;
- 1> clear the variable SYSTEM_INFORMATION_CONTAINER;
- 1> check the value of V300, and:
 - 2> if V300 is equal to or smaller than N300:
 - 3> set CFN in relation to SFN of current cell according to subclause 8.5.15;
 - 3> set the IEs in the RRC CONNECTION REQUEST message according to subclause 8.1.3.3;

- 3> perform the mapping of the Access Class to an Access Service Class as specified in subclause 8.5.13, and apply the given Access Service Class when accessing the RACH or the common E-DCH (for the Enhanced Uplink in CELL_FACH and Idle mode);
 - 3> submit a new RRC CONNECTION REQUEST message to the lower layers for transmission on the uplink CCCH;
 - 3> increment counter V300; and
 - 3> restart timer T300 when the MAC layer indicates success or failure in transmitting the message.
- 2> if V300 is greater than N300:
- 3> if the UE supports logging of failed RRC Connection Establishment, perform the actions specified in subclause 8.1.3.11;
 - 3> enter idle mode;
 - 3> perform the actions specified in subclause 8.5.2 when entering idle mode from connected mode;
 - 3> consider the RRC establishment procedure to be unsuccessful;
 - 3> the procedure ends.

8.1.3.8 Invalid RRC CONNECTION SETUP message, unsupported configuration or invalid configuration

If the UTRAN instructs the UE to use a configuration, which it does not support e.g., the message includes a pre-defined configuration that the UE has not stored and/or if the received message causes the variable UNSUPPORTED_CONFIGURATION or the variable INVALID_CONFIGURATION to be set to TRUE the UE shall perform procedure specific error handling as specified in this subclause.

If the UE receives an RRC CONNECTION SETUP message which contains an IE "Initial UE identity" with a value which is identical to the value of the variable INITIAL_UE_IDENTITY, but the RRC CONNECTION SETUP message contains a protocol error causing the variable PROTOCOL_ERROR_REJECT to be set to TRUE according to clause 9, the UE shall perform procedure specific error handling as follows. The UE shall:

- 1> stop timer T300 or T318, whichever one is running; and
- 1> clear the entry for the RRC CONNECTION SETUP message in the table "Rejected transactions" in the variable TRANSACTIONS and proceed as below.

If the UE receives an RRC CONNECTION SETUP message which contains an IE "Initial UE identity" with a value which is identical to the value of the variable INITIAL_UE_IDENTITY:

- 1> if the RRC CONNECTION SETUP message contained a configuration the UE does not support; and/or
- 1> if the variable UNSUPPORTED_CONFIGURATION becomes set to TRUE due to the received RRC CONNECTION SETUP message; and/or
- 1> if the variable INVALID_CONFIGURATION becomes set to TRUE due to the received RRC CONNECTION SETUP message:

the UE shall:

- 1> stop timer T300 or T318, whichever one is running; and
- 1> clear the entry for the RRC CONNECTION SETUP message in the table "Accepted transactions" in the variable TRANSACTIONS and proceed as below.

If V300 is equal to or smaller than N300, the UE shall:

- 1> set the variable PROTOCOL_ERROR_INDICATOR to TRUE;
- 1> set the IEs in the RRC CONNECTION REQUEST message according to subclause 8.1.3.3;

- 1> perform the mapping of the Access Class to an Access Service Class as specified in subclause 8.5.13; and
- 1> apply the given Access Service Class when accessing the RACH or the common E-DCH (for the Enhanced Uplink in CELL_FACH and Idle mode);
- 1> submit a new RRC CONNECTION REQUEST message to the lower layers for transmission on the uplink CCCH;
- 1> increment counter V300; and
- 1> restart timer T300 when the MAC layer indicates success or failure in transmitting the message.

If V300 is greater than N300, the UE shall:

- 1> if the UE supports logging of failed RRC Connection Establishment, perform the actions specified in subclause 8.1.3.11;
- 1> enter idle mode;
- 1> perform the actions specified in subclause 8.5.2 when entering idle mode from connected mode;
- 1> consider the RRC establishment procedure to be unsuccessful;
- 1> the procedure ends.

8.1.3.9 Reception of an RRC CONNECTION REJECT message by the UE

When the UE receives an RRC CONNECTION REJECT message on the downlink CCCH, it shall compare the value of the IE "Initial UE identity" in the received RRC CONNECTION REJECT message with the value of the variable INITIAL_UE_IDENTITY:

If the values are different, the UE shall ignore the rest of the message;

If the values are identical, the UE shall:

- 1> stop timer T300 or T318, whichever one is running; and
- 1> clear the entry for the RRC CONNECTION REJECT message in the table "Accepted transactions" in the variable TRANSACTIONS;
- 1> if the UE has disabled cell reselection to a UTRA carrier due to an earlier RRC CONNECTION REJECT message, the UE shall resume cell reselection to that UTRA carrier;
- 1> if the Rejection Cause is 'unspecified' and the IE "Counting Completion" is present, the UE shall terminate an ongoing MBMS counting procedure according to subclause 8.7.4.4;
- 1> if the IE "wait time" \neq '0'; and
- 1> if the IE "frequency info" is present and:
 - 2> if V300 is equal to or smaller than N300:
 - 3> select a suitable UTRA cell according to [4] on that frequency;
 - 3> after having selected and camped on a suitable cell on the designated UTRA carrier:
 - 4> set CFN in relation to SFN of current cell according to subclause 8.5.15;
 - 4> set the contents of the RRC CONNECTION REQUEST message according to subclause 8.1.3.3;
 - 4> perform the mapping of the Access Class to an Access Service Class as specified in subclause 8.5.13, and apply the given Access Service Class when accessing the RACH or the common E-DCH (for the Enhanced Uplink in CELL_FACH and Idle mode);
 - 4> transmit an RRC CONNECTION REQUEST message on the uplink CCCH;
 - 4> reset counter V300;

- 4> start timer T300 when the MAC layer indicates success or failure in transmitting the message;
- 4> disable cell reselection to original UTRA carrier until the time stated in the IE "wait time" has elapsed or until the RRC connection establishment procedure ends, whichever occurs first;
- 3> if no suitable cell on the designated UTRA carrier is found:
 - 4> wait for at least the time stated in the IE "wait time";
 - 4> set CFN in relation to SFN of current cell according to subclause 8.5.15;
 - 4> set the IEs in the RRC CONNECTION REQUEST message according to subclause 8.1.3.3;
 - 4> perform the mapping of the Access Class to an Access Service Class as specified in subclause 8.5.13, and apply the given Access Service Class when accessing the RACH or the common E-DCH (for the Enhanced Uplink in CELL_FACH and Idle mode);
 - 4> then submit a new RRC CONNECTION REQUEST message to the lower layers for transmission on the uplink CCCH of the original serving cell;
 - 4> increment counter V300;
 - 4> restart timer T300 when the MAC layer indicates success or failure to transmit the message;
- 2> if V300 is greater than N300:
 - 3> if the UE supports logging of failed RRC Connection Establishment, perform the actions specified in subclause 8.1.3.11;
 - 3> enter idle mode;
 - 3> perform the actions specified in subclause 8.5.2 when entering idle mode from connected mode;
 - 3> consider the RRC establishment procedure to be unsuccessful;
 - 3> the procedure ends.
- 1> if the IE "inter-RAT info" is present:
 - 2> if the IE "wait time" = '0':
 - 3> the UE behaviour is not specified.
 - 2> if V300 is equal to or smaller than N300:
 - 3> if the IE "GSM target cell info" is present:
 - 4> attempt to camp on a suitable cell of the list of cells indicated for that RAT;
 - 4> if the UE selects and camps on one of the cells indicated for that RAT:
 - 5> disable cell reselection to the original RAT until the time stated in the IE "wait time" has elapsed.
 - 4> if the UE cannot find any suitable cell from the indicated ones within 10s, the UE is allowed to camp on any suitable cell on that RAT.
 - 5> after having selected and camped on a suitable cell on the designated RAT:
 - 6> the UE may disable cell reselection to the original RAT until the time stated in the IE "wait time" has elapsed.
 - 3> if the IE "E-UTRA target info" is present:
 - 4> attempt to camp on a suitable cell on one of the frequencies indicated for that RAT, excluding any cell indicated in the list of not allowed cells for that RAT (i.e. the "blacklisted cells per freq list" for E-UTRA), if present;
 - 4> if the UE selects and camps on one such cell:

- 5> disable cell reselection to the original RAT until the time stated in the IE "wait time" has elapsed.
- 4> if the UE cannot find any suitable cell on the indicated frequencies within 10s, the UE is allowed to camp on any suitable cell on that RAT:
 - 5> after having selected and camped on a suitable cell on the designated RAT:
 - 6> disable cell reselection to the original RAT until the time stated in the IE "wait time" has elapsed.
- 3> if neither the IE "GSM target cell info" nor the IE "E-UTRA target info" is present:
 - 4> select a suitable cell in the designated RAT;
 - 4> after having selected and camped on a suitable cell on the designated RAT:
 - 5> disable cell reselection to the original RAT until the time stated in the IE "wait time" has elapsed or until the UE successfully establishes a connection on the designated RAT, whichever occurs first.
- 3> if no suitable cell in the designated RAT is found:
 - 4> wait at least the time stated in the IE "wait time";
 - 4> set CFN in relation to SFN of current cell according to subclause 8.5.15;
 - 4> set the IEs in the RRC CONNECTION REQUEST message according to subclause 8.1.3.2.
 - 4> perform the mapping of the Access Class to an Access Service Class as specified in subclause 8.5.13, and apply the given Access Service Class when accessing the RACH or the common E-DCH (for the Enhanced Uplink in CELL_FACH and Idle mode);
 - 4> then submit a new RRC CONNECTION REQUEST message to the lower layers for transmission on the uplink CCCH;
 - 4> increment counter V300;
 - 4> restart timer T300 when the MAC layer indicates success or failure to transmit the message;
- 2> if V300 is greater than N300:
 - 3> if the UE supports logging of failed RRC Connection Establishment, perform the actions specified in subclause 8.1.3.11;
 - 3> enter idle mode;
 - 3> perform the actions specified in subclause 8.5.2 when entering idle mode from connected mode;
 - 3> consider the RRC establishment procedure to be unsuccessful;
 - 3> the procedure ends.
- 1> if the IE "wait time" <> '0'; and
- 1> if neither the IEs "frequency info" nor "inter-RAT info" are present:
 - 2> if V300 is equal to or smaller than N300:
 - 3> wait at least the time stated in the IE "wait time";
 - 3> set the IEs in the RRC CONNECTION REQUEST message according to subclause 8.1.3.2;
 - 3> perform the mapping of the Access Class to an Access Service Class as specified in subclause 8.5.13, and apply the given Access Service Class when accessing the RACH or the common E-DCH (for the Enhanced Uplink in CELL_FACH and Idle mode);
 - 3> submit a new RRC CONNECTION REQUEST message to the lower layers for transmission on the uplink CCCH;

- 3> increment counter V300;
- 3> restart timer T300 when the MAC layer indicates success or failure to transmit the message;
- 2> if V300 is greater than N300:
 - 3> if the UE supports logging of failed RRC Connection Establishment, perform the actions specified in subclause 8.1.3.11;
 - 3> enter idle mode;
 - 3> perform the actions specified in subclause 8.5.2 when entering idle mode from connected mode;
 - 3> consider the RRC establishment procedure to be unsuccessful;
 - 3> the procedure ends.
- 1> if the IE "wait time" = '0':
 - 2> if the IE "Extended Wait Time" is present and the UE supports "delay tolerant access":
 - 3> forward the IE "Extended Wait Time" to the upper layers;
 - 2> enter idle mode;
 - 2> perform the actions specified in subclause 8.5.2 when entering idle mode from connected mode;
 - 2> consider the RRC establishment procedure to be unsuccessful;
 - 2> the procedure ends.

8.1.3.10 Invalid RRC CONNECTION REJECT message

If the UE receives an RRC CONNECTION REJECT message which contains an IE "Initial UE identity" with a value which is identical to the value of the IE "Initial UE identity" in the most recent RRC CONNECTION REQUEST message sent by the UE; but the RRC CONNECTION REJECT message contains a protocol error causing the variable `PROTOCOL_ERROR_REJECT` to be set to TRUE according to clause 9, the UE shall perform procedure specific error handling as follows:

The UE shall:

- 1> stop timer T300 or T318, whichever one is running; and
- 1> clear the entry for the RRC CONNECTION REJECT message in the table "Rejected transactions" in the variable `TRANSACTIONS`;
- 1> if V300 is equal to or smaller than N300:
 - 2> set the variable `PROTOCOL_ERROR_INDICATOR` to TRUE;
 - 2> set the IEs in the RRC CONNECTION REQUEST message according to subclause 8.1.3.3;
 - 2> perform the mapping of the Access Class to an Access Service Class as specified in subclause 8.5.13, and apply the given Access Service Class when accessing the RACH or the common E-DCH (for the Enhanced Uplink in `CELL_FACH` and Idle mode);
 - 2> submit a new RRC CONNECTION REQUEST message to the lower layers for transmission on the uplink `CCCH`;
 - 2> increment counter V300;
 - 2> restart timer T300 when the MAC layer indicates success or failure to transmit the message.
- 1> if V300 is greater than N300:
 - 2> if the UE supports logging of failed RRC Connection Establishment, perform the actions specified in subclause 8.1.3.11;

- 2> enter idle mode;
- 2> perform the actions specified in subclause 8.5.2 when entering idle mode from connected mode;
- 2> consider the procedure to be successful;
- 2> the procedure ends.

8.1.3.11 Logging of failed RRC Connection Establishment

If the RRC connection establishment fails and the UE supports logging of failed RRC Connection Establishment, the UE shall perform logging of information for later retrieval. The UE shall store connection establishment failure information in the variable LOGGED_CONNECTION_ESTABLISHMENT_FAILURE by setting its fields as follows:

- 1> clear the information included in the variable LOGGED_CONNECTION_ESTABLISHMENT_FAILURE, if any;
- 1> set the IE "PLMN Identity" to the same value as the selected PLMN [4];
- 1> set the IE "Number Of RRC Msg Transmitted" to indicate the number of times the RRC CONNECTION REQUEST message was transmitted by the UE during the failed RRC Connection Establishment procedure.
- 1> for TDD:
 - 2> set the IE "FPACH Received" to TRUE if FPACH was received during the failed RRC Connection Establishment procedure.
 - 2> if common E-DCH was used, include the IE "E-RUCCH Failure" and set it to TRUE if failure indication of the E-RUCCH transmission was received during the failed RRC Connection Establishment procedure.
- 1> if detailed location information is available:
 - 2> if the UE has been able to calculate a 3-dimensional position:
 - 3> set the IE "Ellipsoid point with altitude" or the IE "Ellipsoid point with altitude and uncertainty ellipsoid" to include the location coordinates;
 - 2> else:
 - 3> set the IE "Ellipsoid point" or the IE "Ellipsoid point with uncertainty circle" or the IE "Ellipsoid point with uncertainty ellipse" to include the location coordinates;
 - 2> if horizontal velocity information is available:
 - 3> set the IE "Horizontal velocity" to include the horizontal velocity;
 - 2> a value of the IE "Confidence", different from "0" should be calculated, as the probability that the UE is located within the uncertainty region of the one of the IEs "Ellipsoid point with uncertainty ellipse" or "Ellipsoid point with altitude and uncertainty ellipsoid".
- 1> set the IE "PLMN Identity" of the Logged Measurements Failed Cell to indicate the IE "PLMN Identity" obtained from system information of the cell where the connection establishment failure was detected;
- 1> set the IE "Cell ID" to indicate cell identity obtained from system information of the cell where the connection establishment failure was detected;
- 1> set the IE "CPICH Ec/N0" and "CPICH RSCP" to include measured quantities of the cell where the connection establishment failure was detected for UTRA FDD;
- 1> set the "P-CCPCH RSCP" to include measured quantities for the cell where the connection establishment failure was detected for UTRA 1.28 Mcps TDD;
- 1> set the IE "Logged Measurements Intra Frequency Neighbouring Cells list", "Logged Measurements Inter Frequency list", "Logged Measurements E-UTRA frequency list", "Logged Measurements E-UTRA frequency extension list", in order of decreasing ranking quantity as used for cell re-selection in each frequency for at most

the following number of neighbouring cells; 6 intra-frequency and 3 inter-frequency neighbours per frequency as well as 3 inter-RAT neighbours, per frequency per RAT;

1> set the IE "Logged Measurements GSM Neighbouring Cells list" in order of decreasing RXLEV.

NOTE: The UE includes the latest available results of the measurement performed for cell reselection, which are performed in accordance with the regular performance requirements as specified in [19].

8.1.4 RRC connection release

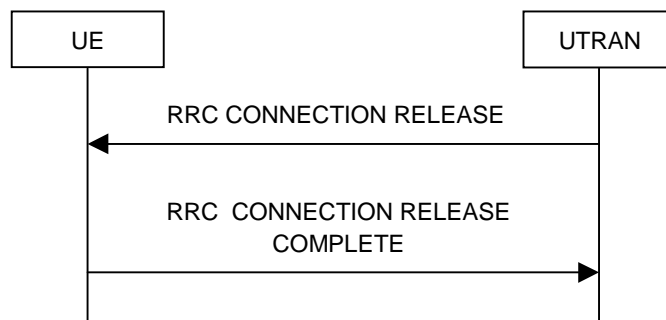

Figure 8.1.4-1: RRC Connection Release procedure on the DCCH



Figure 8.1.4-2: RRC Connection Release procedure on the CCCH

8.1.4.1 General

The purpose of this procedure is to release the RRC connection including all radio bearers and all signalling radio bearers between the UE and the UTRAN. By doing so, all established signalling connections will be released.

8.1.4.2 Initiation

When the UE is in state CELL_DCH or CELL_FACH or CELL_PCH (FDD only), the UTRAN may at anytime initiate an RRC connection release by transmitting an RRC CONNECTION RELEASE message using UM RLC.

When UTRAN transmits an RRC CONNECTION RELEASE message the downlink DCCH should be used, if available. If the downlink DCCH is not available in UTRAN and the UE is in CELL_FACH state, the downlink CCCH may be used.

UTRAN may transmit several RRC CONNECTION RELEASE messages to increase the probability of proper reception of the message by the UE. In such a case, the RRC SN for these repeated messages should be the same. The number of repeated messages and the interval between the messages is a network option.

NOTE: RRC Connection Release message on CCCH in this version of specification cannot include the IE "E-UTRA Target Frequency Info extension List".

8.1.4.3 Reception of an RRC CONNECTION RELEASE message by the UE

The UE shall receive and act on an RRC CONNECTION RELEASE message in states CELL_DCH and CELL_FACH and CELL_PCH (FDD only). Furthermore this procedure can interrupt any ongoing procedures with the UE in the above listed states.

When the UE receives the first RRC CONNECTION RELEASE message; and

1> if the message is received on the CCCH, and IE "U-RNTI" is present and has the same value as the variable U_RNTI; or

1> if the message is received on DCCH:

the UE shall perform the RRC connection release procedure as specified below.

When the UE receives the first RRC CONNECTION RELEASE message; and

1> if the message is received on the CCCH, the IE "UTRAN group identity" is present and there is a group identity match according to subclause 8.6.3.13:

the UE shall perform the RRC connection release procedure as specified below.

The UE shall:

1> in state CELL_DCH:

2> initialise the counter V308 to zero;

2> set the IE "RRC transaction identifier" in the RRC CONNECTION RELEASE COMPLETE message to the value of "RRC transaction identifier" in the entry for the RRC CONNECTION RELEASE message in the table "Accepted transactions" in the variable TRANSACTIONS;

2> submit an RRC CONNECTION RELEASE COMPLETE message to the lower layers for transmission using UM RLC on the DCCH to the UTRAN;

2> if the IE "Rplmn information" is present:

3> the UE may:

4> store the IE on the ME together with the PLMN id for which it applies;

3> the UE may then:

4> utilise this information, typically indicating where a number of BCCH frequency ranges of a RAT may be expected to be found, during subsequent Rplmn selections of the indicated PLMN.

2> if the IE "UE Mobility State Indicator" is present:

3> consider the High-mobility state to have being detected when entering idle mode.

2> start timer T308 when the RRC CONNECTION RELEASE COMPLETE message is sent on the radio interface;

2> if the IE "Extended Wait Time" is present and the UE supports "delay tolerant access":

3> forward the IE "Extended Wait Time" to the upper layers with the indication of the CN Domain used in RRC CONNECTION REQUEST message.

1> in state CELL_FACH:

2> if the RRC CONNECTION RELEASE message was received on the DCCH:

3> set the IE "RRC transaction identifier" in the RRC CONNECTION RELEASE COMPLETE message to the value of "RRC transaction identifier" in the entry for the RRC CONNECTION RELEASE message in the table "Accepted transactions" in the variable TRANSACTIONS;

3> submit an RRC CONNECTION RELEASE COMPLETE message to the lower layers for transmission using AM RLC on the DCCH to the UTRAN.

3> when the successful transmission of the RRC CONNECTION RELEASE COMPLETE message has been confirmed by the lower layers:

4> release all its radio resources; and

- 4> indicate the release of the established signalling connections (as stored in the variable ESTABLISHED_SIGNALLING_CONNECTIONS) and established radio access bearers (as stored in the variable ESTABLISHED_RABS) to upper layers; and
 - 4> clear any entry for the RRC CONNECTION RELEASE message in the tables "Accepted transactions" and "Rejected transactions" in the variable TRANSACTIONS;
 - 4> clear the variable ESTABLISHED_SIGNALLING_CONNECTIONS;
 - 4> clear the variable ESTABLISHED_RABS;
 - 4> pass the value of the IE "Release cause" received in the RRC CONNECTION RELEASE message to upper layers;
 - 4> if the IE "Extended Wait Time" is present and the UE supports "delay tolerant access":
 - 5> forward the IE "Extended Wait Time" to the upper layers with the indication of the CN Domain used in RRC CONNECTION REQUEST message;
 - 4> enter idle mode;
 - 4> perform the actions specified in subclause 8.5.2 when entering idle mode.
- 3> and the procedure ends.
- 2> if the RRC CONNECTION RELEASE message was received on the CCCH:
- 3> release all its radio resources;
 - 3> indicate the release of the established signalling connections (as stored in the variable ESTABLISHED_SIGNALLING_CONNECTIONS) and established radio access bearers (as stored in the variable ESTABLISHED_RABS) to the upper layers;
 - 3> clear any entry for the RRC CONNECTION RELEASE message in the tables "Accepted transactions" and "Rejected transactions" in the variable TRANSACTIONS;
 - 3> clear the variable ESTABLISHED_SIGNALLING_CONNECTIONS;
 - 3> clear the variable ESTABLISHED_RABS;
 - 3> pass the value of the IE "Release cause" received in the RRC CONNECTION RELEASE message to upper layers;
 - 3> if the IE "Extended Wait Time" is present and the UE supports "delay tolerant access":
 - 4> forward the IE "Extended Wait Time" to the upper layers with the indication of the CN Domain used in RRC CONNECTION REQUEST message;
 - 3> enter idle mode;
 - 3> perform the actions specified in subclause 8.5.2 when entering idle mode;
- 3> and the procedure ends.

8.1.4.4 Invalid RRC CONNECTION RELEASE message

If the RRC CONNECTION RELEASE message contains a protocol error causing the variable PROTOCOL_ERROR_REJECT to be set to TRUE according to clause 9, and if the "protocol error cause" in PROTOCOL_ERROR_INFORMATION is set to any cause value except "ASN.1 violation or encoding error", the UE shall perform procedure specific error handling as follows:

The UE shall:

- 1> ignore any IE(s) causing the error but treat the rest of the RRC CONNECTION RELEASE message as normal according to subclause 8.1.4.3, with an addition of the following actions:
- 2> if the RRC CONNECTION RELEASE message was received on the DCCH:

- 3> set the IE "RRC transaction identifier" in the RRC CONNECTION RELEASE COMPLETE message to the value of "RRC transaction identifier" in the entry for the RRC CONNECTION RELEASE message in the table "Rejected transactions" in the variable TRANSACTIONS;
- 3> include the IE "Error indication" in the RRC CONNECTION RELEASE COMPLETE message with:
 - 4> the IE "Failure cause" set to the cause value "Protocol error"; and
 - 4> the IE "Protocol error information" set to the value of the variable PROTOCOL_ERROR_INFORMATION.

8.1.4.5 Cell re-selection or radio link failure

If the UE performs cell re-selection or the radio link failure criteria in subclause 8.5.6 are met at any time during the RRC connection release procedure and the UE has not yet entered idle mode, the UE shall:

- 1> if cell re-selection occurred (CELL_FACH state or CELL_PCH (FDD only)):
 - 2> perform a cell update procedure according to subclause 8.3.1 using the cause "Cell reselection".
- 1> if radio link failure occurred (CELL_DCH state):
 - 2> release all its radio resources;
 - 2> indicate the release of the established signalling connections (as stored in the variable ESTABLISHED_SIGNALLING_CONNECTIONS) and established radio access bearers (as stored in the variable ESTABLISHED_RABS) to upper layers;
 - 2> clear the variable ESTABLISHED_SIGNALLING_CONNECTIONS;
 - 2> clear the variable ESTABLISHED_RABS;
 - 2> enter idle mode;
 - 2> perform the actions specified in subclause 8.5.2 when entering idle mode;
 - 2> and the procedure ends.

8.1.4.6 Expiry of timer T308, unacknowledged mode transmission

When in state CELL_DCH and the timer T308 expires, the UE shall:

- 1> increment V308 by one;
- 1> if V308 is equal to or smaller than N308:
 - 2> prior to retransmitting the RRC CONNECTION RELEASE COMPLETE message:
 - 3> if the IE "Status" in the variable INTEGRITY_PROTECTION_INFO has the value "Started":
 - 4> include the same IEs as in the last unsuccessful attempt of this message, except for the IE "Integrity check info", which is set as specified in subclause 8.5.10.
 - 3> else:
 - 4> include the same IEs as in the last unsuccessful attempt of this message.
 - 2> set the IE "RRC transaction identifier" in the RRC CONNECTION RELEASE COMPLETE message retransmitted below to the value of "RRC transaction identifier" in the entry for the RRC CONNECTION RELEASE message in the table "Accepted transactions" in the variable TRANSACTIONS;
 - 2> send the RRC CONNECTION RELEASE COMPLETE message on signalling radio bearer RB1;
 - 2> start timer T308 when the RRC CONNECTION RELEASE COMPLETE message is sent on the radio interface.

- 1> if V308 is greater than N308:
 - 2> release all its radio resources;
 - 2> indicate the release of the established signalling connections (as stored in the variable ESTABLISHED_SIGNALLING_CONNECTIONS) and established radio access bearers (as stored in the variable ESTABLISHED_RABS) to upper layers;
 - 2> clear any entry for the RRC CONNECTION RELEASE message in the tables "Accepted transactions" and "Rejected transactions" in the variable TRANSACTIONS;
 - 2> clear the variable ESTABLISHED_SIGNALLING_CONNECTIONS;
 - 2> clear the variable ESTABLISHED_RABS;
 - 2> enter idle mode;
 - 2> perform the actions specified in subclause 8.5.2 when entering idle mode;
 - 2> and the procedure ends.

8.1.4.7 Void

8.1.4.8 Reception of an RRC CONNECTION RELEASE COMPLETE message by UTRAN

When UTRAN receives an RRC CONNECTION RELEASE COMPLETE message from the UE, it should:

- 1> release all UE dedicated resources and the procedure ends on the UTRAN side.

8.1.4.9 Unsuccessful transmission of the RRC CONNECTION RELEASE COMPLETE message, acknowledged mode transmission

When acknowledged mode was used and RLC does not succeed in transmitting the RRC CONNECTION RELEASE COMPLETE message, the UE shall:

- 1> release all its radio resources;
- 1> indicate the release of the established signalling connections (as stored in the variable ESTABLISHED_SIGNALLING_CONNECTIONS) and established radio access bearers (as stored in the variable ESTABLISHED_RABS) to upper layers;
- 1> clear the variable ESTABLISHED_SIGNALLING_CONNECTIONS;
- 1> clear the variable ESTABLISHED_RABS;
- 1> enter idle mode;
- 1> perform the actions specified in subclause 8.5.2 when entering idle mode;
- 1> and the procedure ends.

8.1.4.10 Detection of loss of dedicated physical channel by UTRAN in CELL_DCH state

If the release is performed from the state CELL_DCH, and UTRAN detects loss of the dedicated physical channel according to subclause 8.5.6, UTRAN may release all UE dedicated resources, even if no RRC CONNECTION RELEASE COMPLETE message has been received.

8.1.4.11 Failure to receive RRC CONNECTION RELEASE COMPLETE message by UTRAN

If UTRAN does not receive any RRC CONNECTION RELEASE COMPLETE message, it should release all UE dedicated resources.

8.1.4a RRC connection release requested by upper layers

8.1.4a.1 General

The purpose of this procedure is to release the RRC connection and bar the current cell or cells. The procedure is requested by upper layers when they determine that the network has failed an authentication check [5].

8.1.4a.2 Initiation

If the upper layers request the release of the RRC connection, the UE shall:

- 1> release all its radio resources;
- 1> enter idle mode;
- 1> perform other actions when entering idle mode from connected mode as specified in subclause 8.5.2;
- 1> if the UE was in CELL_DCH state prior to entering idle mode:
 - 2> consider all cells that were in the active set prior to entering idle mode to be barred according to [4]; and
 - 2> consider the barred cells as using the value "allowed" in the IE "Intra-frequency cell re-selection indicator", and the maximum value in the IE " T_{barred} ".
- 1> if the UE was in CELL_FACH or CELL_PCH or URA_PCH state prior to entering idle mode:
 - 2> consider the cell on which the UE was camped prior to entering idle mode to be barred according to [4]; and
 - 2> consider the barred cell as using the value "allowed" in the IE "Intra-frequency cell re-selection indicator", and the maximum value in the IE " T_{barred} ".

8.1.5 Void

8.1.6 Transmission of UE capability information

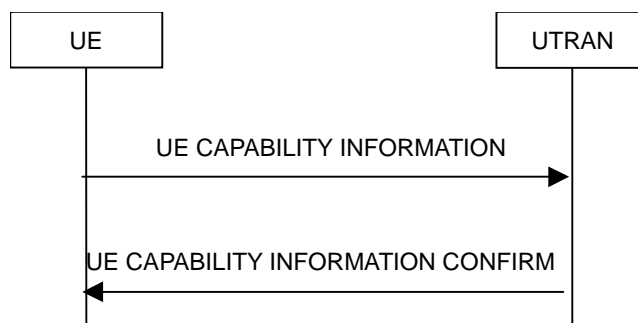

Figure 8.1.6-1: Transmission of UE capability information, normal flow

8.1.6.1 General

The UE capability update procedure is used by the UE to convey UE specific capability information to the UTRAN.

8.1.6.2 Initiation

The UE shall initiate the UE capability update procedure in the following situations:

- 1> the UE receives a UE CAPABILITY ENQUIRY message from the UTRAN;
- 1> while in CELL_DCH or CELL_FACH state, the UE capabilities change compared to those stored in the variable UE_CAPABILITY_TRANSFERRED, and the variable RNC_CAPABILITY_CHANGE_SUPPORT is set to TRUE.

If the UE CAPABILITY INFORMATION message is sent in response to a UE CAPABILITY ENQUIRY message, the UE shall:

- 1> include the IE "RRC transaction identifier"; and
- 1> set it to the value of "RRC transaction identifier" in the entry for the UE CAPABILITY ENQUIRY message in the table "Accepted transactions" in the variable TRANSACTIONS;
- 1> for the UE capabilities defined prior to REL-6:
 - 2> retrieve its UTRA UE radio access capability information elements from variable UE_CAPABILITY_REQUESTED; and
 - 2> include this in IE "UE radio access capability" and in IE "UE radio access capability extension", provided this IE is included in variable UE_CAPABILITY_REQUESTED;
 - 2> retrieve its inter-RAT-specific UE radio access capability information elements from variable UE_CAPABILITY_REQUESTED; and
 - 2> include this in IE "UE system specific capability".
- 1> for the UE capabilities defined in REL-6 or later:
 - 2> include the information elements associated with the capabilities included in the variable UE_CAPABILITY_REQUESTED and the variable UE_CAPABILITY_TRANSFERRED.

If the UE CAPABILITY INFORMATION message is sent because one or more of the UE capabilities change compared to those stored in the variable UE_CAPABILITY_TRANSFERRED while in connected state, the UE shall:

- 1> for the UE capabilities defined prior to REL-6, include the information elements associated with the capabilities that have changed in the UE CAPABILITY INFORMATION message; and
- 1> for the UE capabilities defined in REL-6 or later, include the information elements associated with the capabilities included in the variable UE_CAPABILITY_TRANSFERRED.

If the UE is in CELL_PCH or URA_PCH state, the UE shall:

- 1> if variable READY_FOR_COMMON_EDCH is set to TRUE:
 - 2> move to CELL_FACH state and continue as below.
- 1> else:
 - 2> if variable HSPA_RNTI_STORED_CELL_PCH is set to TRUE:
 - 3> move to CELL_FACH state and continue as below.
 - 2> else:
 - 3> if variable H_RNTI and variable C_RNTI are set:
 - 4> continue as below.
 - 3> else:
 - 4> first perform a cell update procedure using the cause "uplink data transmission", see subclause 8.3.1.

The UE RRC shall submit the UE CAPABILITY INFORMATION message to the lower layers for transmission on the uplink DCCH using AM RLC. When the message has been delivered to lower layers for transmission the UE RRC shall start timer T304 and set counter V304 to 1.

A UE in connected mode should only indicate changes of capability in the IEs "DL capability with simultaneous HS-DSCH configuration", "Transport channel capability", "Physical channel capability", "Device type", and the IE "UE power class extension" within "RF capability extension".

The UE should not request a changed capability that would render an existing CS configuration invalid.

A UE with HS-PDSCH configured should not request a changed capability that removes support for HSDPA or HSUPA entirely; it may request reduction of its capabilities to the lowest category, but not to "DCH only".

If the UE is MAC-ehs capable or supports dual cell operation on adjacent or non-contiguous frequencies or in different bands, the UE shall signal a value in the "HS-DSCH physical layer category extension" IE.

If the UE supports dual cell operation on adjacent frequencies, then the UE shall support this feature on all the frequency bands supported by the UE.

If the UE signals an "HS-DSCH physical layer category extension" of 13, 15, 17 or 19, it shall signal an "HS-DSCH physical layer category" of 9.

If the UE signals an "HS-DSCH physical layer category extension" of 14, 16, 18 or 20, it shall signal an "HS-DSCH physical layer category" of 10.

If the UE supports dual cell operation on adjacent or non-contiguous frequencies or in different bands, the UE shall signal a value in the "HS-DSCH physical layer category extension 2" IE.

If the UE supports dual cell with MIMO operation on adjacent or non-contiguous frequencies or in different bands, the UE shall signal a value in the "HS-DSCH physical layer category extension 3" IE.

If the UE supports dual cell with MIMO operation in different bands, or multi-cell operation on three cells with MIMO in different bands, or multi-cell operation on four cells with MIMO in different bands, the UE shall include the IE "Support for dual cell with MIMO operation in different bands" and set it to TRUE.

If the UE supports non-contiguous multi-cell operation on two, three or four cells with single gap in one band with MIMO, the UE shall include the IE "Non-contiguous multi-cell with MIMO" and set it to TRUE.

If the UE supports multi-cell operation on three cells, the UE shall signal a value in the "HS-DSCH physical layer category extension 4" IE.

If the UE supports multi-cell operation on four cells, the UE shall signal a value in the "HS-DSCH physical layer category extension 5" IE.

If the UE supports multi-cell operation on six cells, the UE shall signal a value in the "HS-DSCH physical layer category extension 6" IE.

If the UE supports multi-cell operation on eight cells, the UE shall signal a value in the "HS-DSCH physical layer category extension 7" IE.

If the UE supports Multiflow operation on two cells, the UE shall signal a value in the "HS-DSCH physical layer category extension 2" IE.

If the UE supports Multiflow operation on three cells, the UE shall signal a value in the "HS-DSCH physical layer category extension 4" IE.

If the UE supports Multiflow operation on four cells, the UE shall signal a value in the "HS-DSCH physical layer category extension 5" IE.

If the UE supports MIMO mode with four transmit antennas operation, the UE shall signal a value in the "HS-DSCH physical layer category extension 8" IE.

If the UE signals an "HS-DSCH physical layer category extension 2" of 21, it shall signal an "HS-DSCH physical layer category extension" of 9, 10, 13, 14, 15, 16, 17 or 18.

If the UE signals an "HS-DSCH physical layer category extension 2" of 22, it shall signal an "HS-DSCH physical layer category extension" of 10, 14, 16 or 18.

If the UE signals an "HS-DSCH physical layer category extension 2" of 23, it shall signal an "HS-DSCH physical layer category extension" of 13, 14, 17, 18, 19 or 20.

If the UE signals an "HS-DSCH physical layer category extension 2" of 24, it shall signal an "HS-DSCH physical layer category extension" of 14, 18 or 20.

If the UE signals an "HS-DSCH physical layer category extension 4" of 29 or an "HS-DSCH physical layer category extension 5" of 31, it shall signal an "HS-DSCH physical layer category extension 2" of 24.

If the UE signals an "HS-DSCH physical layer category extension 4" of 30, it shall signal an "HS-DSCH physical layer category extension 3" of 28.

If the UE signals an "HS-DSCH physical layer category extension 5" of 32, it shall signal an "HS-DSCH physical layer category extension 4" of 30.

If the UE signals an "HS-DSCH physical layer category extension 6" of 33, it shall either signal an "HS-DSCH physical layer category extension 5" of 32 or an "HS-DSCH physical layer category extension 5" of 31.

If the UE signals an "HS-DSCH physical layer category extension 6" of 34, it shall signal an "HS-DSCH physical layer category extension 5" of 32.

If the UE signals an "HS-DSCH physical layer category extension 7" of 35, it shall either signal an "HS-DSCH physical layer category extension 5" of 32 or an "HS-DSCH physical layer category extension 5" of 31.

If the UE signals an "HS-DSCH physical layer category extension 7" of 36, it shall signal an "HS-DSCH physical layer category extension 6" of 34.

If the UE signals an "HS-DSCH physical layer category extension 8" of 37, it shall signal an "HS-DSCH physical layer category extension 3" of 28.

If the UE signals an "HS-DSCH physical layer category extension 8" of 38, it shall signal an "HS-DSCH physical layer category extension 5" of 32.

The UE shall use the "Total number of soft channel bits" (defined in Table 5.1a of [35]) for the category it has signalled, as follows:

- 1> If MAC-hs is configured, the UE uses the category it has signalled in the IE "HS-DSCH physical layer category";
- 1> If MAC-ehs is configured without dual cell operation, the UE uses the category it has signalled in the IE "HS-DSCH physical layer category extension";
- 1> If dual cell operation is configured, the UE uses the category it has signalled in the IE "HS-DSCH physical layer category extension 2".
- 1> If dual cell with MIMO operation is configured, the UE uses the category it has signalled in the IE "HS-DSCH physical layer category extension 3".
- 1> If multi-cell operation on three cells is configured, the UE uses the category it has signalled in the IE "HS-DSCH physical layer category extension 4".
- 1> If multi-cell operation on four cells is configured, the UE uses the category it has signalled in the IE "HS-DSCH physical layer category extension 5".
- 1> If multi-cell operation on five or six cells is configured, the UE uses the category it has signalled in the IE "HS-DSCH physical layer category extension 6".
- 1> If multi-cell operation on seven or eight cells is configured, the UE uses the category it has signalled in the IE "HS-DSCH physical layer category extension 7".
- 1> If MIMO mode with four transmit antennas operation is configured, the UE uses the category it has signalled in the IE "HS-DSCH physical layer category extension 8".

If the UE supports 16QAM in the uplink, the UE shall signal a value in the "E-DCH physical layer category extension" IE.

If the UE supports Dual Cell E-DCH operation on adjacent frequencies or in different bands, the UE shall signal a value in the "E-DCH physical layer category extension 2" IE.

If the UE signals a value in the "E-DCH physical layer category extension 2" IE, it shall signal an "E-DCH physical layer category" of 6.

If the UE supports 64QAM in the uplink, the UE shall signal a value of 10 in the "E-DCH physical layer category extension 3" IE.

If the UE supports UL MIMO, the UE shall signal a value of 11 in the "E-DCH physical layer category extension 3" IE.

If the UE supports 64QAM in the uplink and UL MIMO, the UE shall signal a value of 12 in the "E-DCH physical layer category extension 3" IE

If the UE signals a value in the "E-DCH physical layer category extension 3", it shall signal an "E-DCH physical layer category" of 7.

8.1.6.3 Reception of a UE CAPABILITY INFORMATION message by the UTRAN

Upon reception of a UE CAPABILITY INFORMATION message, the UTRAN should transmit a UE CAPABILITY INFORMATION CONFIRM message on the downlink DCCH using UM or AM RLC. After the UE CAPABILITY INFORMATION CONFIRM message has been submitted to the lower layers for transmission, the procedure is complete.

If the received UE CAPABILITY INFORMATION message indicates capabilities that would be insufficient for the UE to continue in an ongoing service, the UTRAN may reconfigure the bearers for the ongoing service. In such a case, if the UTRAN does not perform such a reconfiguration, it should set the IE "Acceptance of requested change of capability" to "Refused" in the UE CAPABILITY INFORMATION CONFIRM message.

8.1.6.4 Reception of the UE CAPABILITY INFORMATION CONFIRM message by the UE

Upon reception of a UE CAPABILITY INFORMATION CONFIRM message, the UE shall:

- 1> stop timer T304;
- 1> if there is an entry for the UE CAPABILITY ENQUIRY message is present in the table "Accepted transactions" in the variable TRANSACTIONS:
 - 2> clear that entry.
- 1> if the IE "Acceptance of requested change of capability" is included and set to "Accepted":
 - 2> update its variable UE_CAPABILITY_TRANSFERRED with the UE capabilities it has last transmitted to the UTRAN during the current RRC connection.
- 1> if the IE "Acceptance of requested change of capability" is included and set to "Accepted with reconfiguration to follow":
 - 2> when a reconfiguration message with the flag "Reconfiguration in response to requested change of UE capability" set to TRUE, update its variable UE_CAPABILITY_TRANSFERRED with the UE capabilities it has last transmitted to the UTRAN during the current RRC connection;
 - 2> if a reconfiguration message with the flag "Reconfiguration in response to requested change of UE capability" set to TRUE it is not received by the UE within a time determined by the implementation, the UE shall consider the change of capabilities to be refused by the UTRAN.
- 1> if the IE "Acceptance of requested change of capability" is included and set to "Refused":
 - 2> consider the request for a change of capabilities to be refused;
 - 2> wait at least 300 seconds before transmitting another such request.

- 1> clear the variable UE_CAPABILITY_REQUESTED;
- 1> and the procedure ends.

8.1.6.5 Invalid UE CAPABILITY INFORMATION CONFIRM message

If the UE receives a UE CAPABILITY INFORMATION CONFIRM message, which contains a protocol error causing the variable PROTOCOL_ERROR_REJECT to be set to TRUE according to clause 9, the UE shall perform procedure specific error handling as follows:

- 1> stop timer T304;
- 1> transmit an RRC STATUS message on the uplink DCCH using AM RLC;
- 1> include the IE "Identification of received message"; and
- 1> set the IE "Received message type" to UE CAPABILITY INFORMATION CONFIRM; and
- 1> set the IE "RRC transaction identifier" to the value of "RRC transaction identifier" in the entry for the UE CAPABILITY INFORMATION CONFIRM message in the table "Rejected transactions" in the variable TRANSACTIONS; and
- 1> clear that entry;
- 1> include the IE "Protocol error information" with contents set to the value of the variable PROTOCOL_ERROR_INFORMATION;
- 1> when the RRC STATUS message has been submitted to lower layers for transmission:
 - 2> restart timer T304 and continue with any ongoing procedures or processes as if the invalid UE CAPABILITY INFORMATION CONFIRM message has not been received.

8.1.6.6 T304 timeout

Upon expiry of timer T304, the UE shall check the value of V304 and:

- 1> if V304 is smaller than or equal to N304:
 - 2> prior to retransmitting the UE CAPABILITY INFORMATION message:
 - 3> if the IE "Status" in the variable INTEGRITY_PROTECTION_INFO has the value "Started":
 - 4> include the same IEs as in the last unsuccessful attempt of this message, except for the IE "Integrity check info", which is set as specified in subclause 8.5.10.
 - 3> else:
 - 4> include the same IEs as in the last unsuccessful attempt of this message.
 - 2> send the UE CAPABILITY INFORMATION message on signalling radio bearer RB2;
 - 2> restart timer T304;
 - 2> increment counter V304.
- 1> if V304 is greater than N304:
 - 2> initiate the Cell update procedure as specified in subclause 8.3.1, using the cause "Radio link failure".

8.1.7 UE capability enquiry

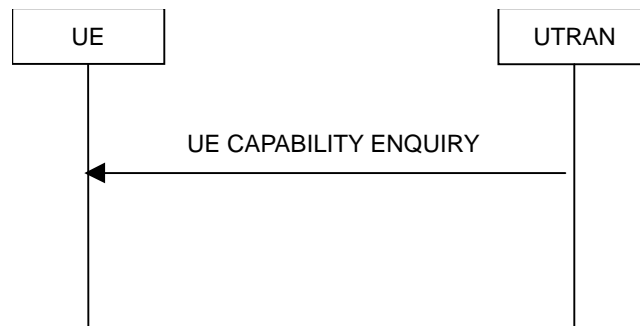

Figure 8.1.7-1: UE capability enquiry procedure, normal flow

8.1.7.1 General

The UE capability enquiry can be used to request the UE to transmit its capability information related to any radio access network that is supported by the UE.

8.1.7.2 Initiation

The UE capability enquiry procedure is initiated by the UTRAN by transmitting a UE CAPABILITY ENQUIRY message on the DCCH using UM or AM RLC.

8.1.7.3 Reception of a UE CAPABILITY ENQUIRY message by the UE

Upon reception of a UE CAPABILITY ENQUIRY message, the UE shall act on the received information elements as specified in subclause 8.6 and initiate the transmission of UE capability information procedure, which is specified in subclause 8.1.6.

8.1.7.4 Invalid UE CAPABILITY ENQUIRY message

If the UE receives a UE CAPABILITY ENQUIRY message, which contains a protocol error causing the variable `PROTOCOL_ERROR_REJECT` to be set to `TRUE` according to clause 9, the UE shall perform procedure specific error handling as follows:

- 1> transmit an RRC STATUS message on the uplink DCCH using AM RLC;
- 1> include the IE "Identification of received message"; and
- 1> set the IE "Received message type" to UE CAPABILITY ENQUIRY; and
- 1> set the IE "RRC transaction identifier" to the value of "RRC transaction identifier" in the entry for the UE CAPABILITY ENQUIRY message in the table "Rejected transactions" in the variable TRANSACTIONS; and
- 1> clear that entry;
- 1> include the IE "Protocol error information" with contents set to the value of the variable `PROTOCOL_ERROR_INFORMATION`;
- 1> when the RRC STATUS message has been submitted to lower layers for transmission:
 - 2> continue with the ongoing processes and procedures as if the invalid UE CAPABILITY ENQUIRY message has not been received.

8.1.8 Initial Direct transfer

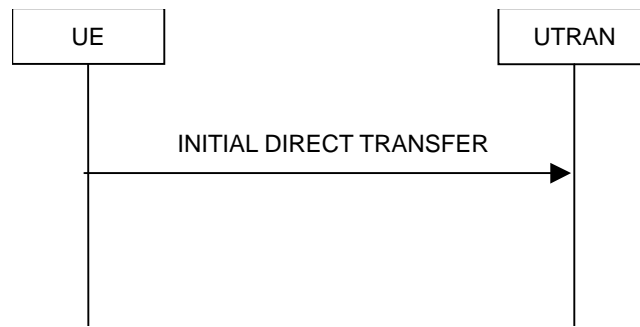

Figure 8.1.8-1: Initial Direct transfer in the uplink, normal flow

8.1.8.1 General

The initial direct transfer procedure is used in the uplink to establish a signalling connection. It is also used to carry an initial upper layer (NAS) message over the radio interface.

8.1.8.2 Initiation of Initial direct transfer procedure in the UE

In the UE, the initial direct transfer procedure shall be initiated, when the upper layers request establishment of a signalling connection. This request also includes a request for the transfer of a NAS message.

Upon initiation of the initial direct transfer procedure the UE shall:

- 1> set the variable ESTABLISHMENT_CAUSE to the cause for establishment indicated by upper layers.

Upon initiation of the initial direct transfer procedure when the UE is in idle mode, the UE shall:

- 1> if the variable BCCH_MODIFICATION_ACCESS_PROHIBITION is set to FALSE; or
- 1> if the establishment of a signalling connection is requested for CS domain; or
- 1> if the variable ESTABLISHMENT_CAUSE is set to "Emergency Call":
 - 2> perform an RRC connection establishment procedure, according to subclause 8.1.3;

NOTE: If an RRC connection establishment is ongoing, this procedure continues unchanged, i.e. it is not interrupted.

1> else:

- 2> consider the RRC connection establishment procedure to be unsuccessful.

1> if the RRC connection establishment procedure was not successful:

- 2> if the establishment cause for the failed RRC connection establishment was set to "MBMS reception" and a different cause value is stored in the variable "ESTABLISHMENT_CAUSE":
 - 3> UE-AS (RRC) initiates a new RRC connection establishment procedure, using the establishment cause as contained in the variable ESTABLISHMENT_CAUSE.

2> otherwise:

- 3> indicate failure to establish the signalling connection to upper layers and end the procedure.

1> when the RRC connection establishment procedure is completed successfully:

- 2> continue with the initial direct transfer procedure as below.

Upon initiation of the initial direct transfer procedure when the UE is in CELL_PCH or URA_PCH state, the UE shall:

- 1> if variable `READY_FOR_COMMON_EDCH` is set to `TRUE`:
 - 2> move to `CELL_FACH` state and continue with the initial direct transfer procedure as below.
- 1> else:
 - 2> if variable `HSPA_RNTI_STORED_CELL_PCH` is set to `TRUE`:
 - 3> move to `CELL_FACH` state and continue with the initial direct transfer procedure as below.
 - 2> else:
 - 3> if variable `H_RNTI` and variable `C_RNTI` are set:
 - 4> continue with the initial direct transfer procedure as below.
 - 3> else:
 - 4> perform a cell update procedure, according to subclause 8.3.1, using the cause "uplink data transmission";
 - 4> when the cell update procedure completed successfully:
 - 5> continue with the initial direct transfer procedure as below.

The UE shall, in the INITIAL DIRECT TRANSFER message:

- 1> set the IE "NAS message" as received from upper layers; and
- 1> set the IE "CN domain identity" as indicated by the upper layers; and
- 1> set the IE "Intra Domain NAS Node Selector" as follows:
 - 2> derive the IE "Intra Domain NAS Node Selector" from TMSI/PMTSI, IMSI, or IMEI; and
 - 2> provide the coding of the IE "Intra Domain NAS Node Selector" according to the following priorities:
 1. base the routing parameter for IDNNS on TMSI (CS domain) or on PTMSI (PS domain) according to the TMSI/PTMSI provided by upper layers, where the PTMSI may be mapped from a valid GUTI;
 2. base the routing parameter for IDNNS on IMSI when no TMSI/PTMSI is provided by upper layers;
 3. base the routing parameter for IDNNS on IMEI only if no (U)SIM is inserted in the UE.
- 1> if the UE, on the existing RRC connection, has received a dedicated RRC message containing the IE "Primary PLMN Identity" in the IE "CN Information Info":
 - 2> set the IE "PLMN identity" in the INITIAL DIRECT TRANSFER message to the latest PLMN information received via dedicated RRC signalling. If NAS has indicated the PLMN towards which a signalling connection is requested, and this PLMN is not in agreement with the latest PLMN information received via dedicated RRC signalling, then the initial direct transfer procedure shall be aborted, and NAS shall be informed.
- 1> if the UE, on the existing RRC connection, has not received a dedicated RRC message containing the IE "CN Information Info" , and if the IE "Multiple PLMN List" was broadcast in the cell where the current RRC connection was established:
 - 2> set the IE "PLMN identity" in the INITIAL DIRECT TRANSFER message to the PLMN chosen by higher layers [5, 25] amongst the PLMNs in the IE "Multiple PLMN List" broadcast in the cell where the RRC connection was established.
- 1> if the IE "Activated service list" within variable `MBMS_ACTIVATED_SERVICES` includes one or more MBMS services with the IE "Service type" set to "Multicast" and;
- 1> if the IE "CN domain identity" as indicated by the upper layers is set to "CS domain" and;

- 1> if the variable ESTABLISHED_SIGNALLING_CONNECTIONS does not include the CN domain identity 'PS domain':
 - 2> include the IE "MBMS joined information";
 - 2> include the IE "P-TMSI" within the IE "MBMS joined information" if a valid PTMSI is available.
- 1> if the UE is in CELL_FACH state and the IE "CN domain identity" as indicated by the upper layers is set to "CS domain":
 - 2> if the value of the variable ESTABLISHMENT_CAUSE is set to "Originating Conversational Call" or "Emergency Call":
 - 3> set the value of the IE "CS Call type" to "speech", "video" or "other" according to the call being initiated.
- 1> if the variable ESTABLISHMENT_CAUSE is initialised:
 - 2> set the IE "Establishment cause" to the value of the variable ESTABLISHMENT_CAUSE;
 - 2> clear the variable ESTABLISHMENT_CAUSE.
- 1> calculate the START according to subclause 8.5.9 for the CN domain as set in the IE "CN Domain Identity"; and
- 1> include the calculated START value for that CN domain in the IE "START".

The UE shall:

- 1> transmit the INITIAL DIRECT TRANSFER message on the uplink DCCH using AM RLC on signalling radio bearer RB3;
- 1> when the INITIAL DIRECT TRANSFER message has been submitted to lower layers for transmission:
 - 2> confirm the establishment of a signalling connection to upper layers; and
 - 2> add the signalling connection with the identity indicated by the IE "CN domain identity" in the variable ESTABLISHED_SIGNALLING_CONNECTIONS.
- 1> when the successful delivery of the INITIAL DIRECT TRANSFER message has been confirmed by RLC:
 - 2> the procedure ends.

When not stated otherwise elsewhere, the UE may also initiate the initial direct transfer procedure when another procedure is ongoing, and in that case the state of the latter procedure shall not be affected.

A new signalling connection request may be received from upper layers during transition to idle mode. In those cases, from the time of the indication of release to upper layers until the UE has entered idle mode, any such upper layer request to establish a new signalling connection shall be queued. This request shall be processed after the UE has entered idle mode.

8.1.8.2a RLC re-establishment or inter-RAT change

If a re-establishment of the transmitting side of the RLC entity on signalling radio bearer RB3 occurs before the successful delivery of the INITIAL DIRECT TRANSFER message has been confirmed by RLC, the UE shall:

- 1> retransmit the INITIAL DIRECT TRANSFER message on the uplink DCCH using AM RLC on signalling radio bearer RB3.

If an Inter-RAT handover from UTRAN to other RAT than E-UTRAN procedure occurs before the successful delivery of the INITIAL DIRECT TRANSFER message has been confirmed by RLC, for messages with the IE "CN domain identity" set to "CS domain", the UE shall:

- 1> retransmit the NAS message as specified in subclause 8.3.7.4.

8.1.8.2ab Inter-RAT handover from UTRAN to GERAN *Iu mode*

If an Inter-RAT handover from UTRAN to GERAN *Iu mode* occurs before the successful delivery of the INITIAL DIRECT TRANSFER message has been confirmed by RLC, for messages for all CN domains, the UE shall:

- 1> retransmit the NAS message as specified in subclause 8.3.7.4.

8.1.8.2b Abortion of signalling connection establishment

If the UE receives a request from upper layers to release (abort) the signalling connection for the CN domain for which the initial direct transfer procedure is ongoing, the UE shall:

- 1> if the UE has not yet entered UTRA RRC connected mode:
 - 2> abort the RRC connection establishment procedure as specified in subclause 8.1.3;

the procedure ends.

8.1.8.2c Inter-RAT handover from UTRAN to E-UTRAN

If an Inter-RAT handover from UTRAN to E-UTRAN occurs before the successful delivery of the INITIAL DIRECT TRANSFER message has been confirmed by RLC, the UE shall:

- 1> discard the NAS message.

8.1.8.3 Reception of INITIAL DIRECT TRANSFER message by the UTRAN

On reception of the INITIAL DIRECT TRANSFER message the NAS message should be routed using the IE "CN Domain Identity". UTRAN may also use the IE "Intra Domain NAS Node Selector" and the IE "PLMN identity" for routing among the CN nodes for the addressed CN domain.

If no signalling connection exists towards the chosen node, then a signalling connection is established.

When the UTRAN receives an INITIAL DIRECT TRANSFER message, it shall not affect the state of any other ongoing RRC procedures, when not stated otherwise elsewhere.

The UTRAN should:

- 1> set the START value for the CN domain indicated in the IE "CN domain identity" to the value of the IE "START".

8.1.9 Downlink Direct transfer



Figure 8.1.9-1: Downlink Direct transfer, normal flow

8.1.9.1 General

The downlink direct transfer procedure is used in the downlink direction to carry upper layer (NAS) messages over the radio interface.

8.1.9.2 Initiation of downlink direct transfer procedure in the UTRAN

In the UTRAN, the direct transfer procedure is initiated when the upper layers request the transfer of a NAS message after the initial signalling connection is established. The UTRAN may also initiate the downlink direct transfer procedure when another RRC procedure is ongoing, and in that case the state of the latter procedure shall not be affected. The UTRAN shall transmit the DOWNLINK DIRECT TRANSFER message on the downlink DCCH using AM RLC on signalling radio bearer RB3 or signalling radio bearer RB4. The UTRAN should:

- 1> if upper layers indicate "low priority" for this message:
 - 2> select signalling radio bearer RB4, if available. Specifically, for a GSM-MAP based CN, signalling radio bearer RB4 should, if available, be selected when "SAPI 3" is requested;
 - 2> select signalling radio bearer RB3 when signalling radio bearer RB4 is not available.
- 1> if upper layers indicate "high priority" for this message:
 - 2> select signalling radio bearer RB3. Specifically, for a GSM-MAP based CN, signalling radio bearer RB3 should be selected when "SAPI 0" is requested.

The UTRAN sets the IE "CN Domain Identity" to indicate, which CN domain the NAS message is originated from.

8.1.9.3 Reception of a DOWNLINK DIRECT TRANSFER message by the UE

Upon reception of the DOWNLINK DIRECT TRANSFER message, the UE RRC shall, using the IE "CN Domain Identity", route the contents of the IE "NAS message" and the value of the IE "CN Domain Identity" to upper layers.

The UE shall clear the entry for the DOWNLINK DIRECT TRANSFER message in the table "Accepted transactions" in the variable TRANSACTIONS.

When the UE receives a DOWNLINK DIRECT TRANSFER message, it shall not affect the state of any other ongoing RRC procedures when not stated otherwise elsewhere.

8.1.9.3a No signalling connection exists

If the UE receives a DOWNLINK DIRECT TRANSFER message, and the signalling connection identified with the IE "CN domain identity" does not exist according to the variable ESTABLISHED_SIGNALLING_CONNECTIONS, the UE shall:

- 1> ignore the content of the DOWNLINK DIRECT TRANSFER message;
- 1> transmit an RRC STATUS message on the uplink DCCH using AM RLC;
- 1> include the IE "Identification of received message"; and
- 1> set the IE "Received message type" to DOWNLINK DIRECT TRANSFER; and
- 1> set the IE "RRC transaction identifier" to the value of "RRC transaction identifier" in the entry for the DOWNLINK DIRECT TRANSFER message in the table "Accepted transactions" in the variable TRANSACTIONS; and
- 1> clear that entry;
- 1> include the IE "Protocol error information" with the IE "Protocol error cause" set to "Message not compatible with receiver state".

When the RRC STATUS message has been submitted to lower layers for transmission, the UE shall:

- 1> continue with any ongoing processes and procedures as if the DOWNLINK DIRECT TRANSFER message has not been received.

8.1.9.4 Invalid DOWNLINK DIRECT TRANSFER message

If the UE receives a DOWNLINK DIRECT TRANSFER message, which contains a protocol error causing the variable `PROTOCOL_ERROR_REJECT` to be set to `TRUE` according to clause 9, the UE shall perform procedure specific error handling as follows:

- 1> transmit an RRC STATUS message on the uplink DCCH using AM RLC;
- 1> include the IE "Identification of received message"; and
- 1> set the IE "Received message type" to DOWNLINK DIRECT TRANSFER; and
- 1> set the IE "RRC transaction identifier" to the value of "RRC transaction identifier" in the entry for the DOWNLINK DIRECT TRANSFER message in the table "Rejected transactions" in the variable TRANSACTIONS; and
- 1> clear that entry;
- 1> include the IE "Protocol error information" with contents set to the value of the variable `PROTOCOL_ERROR_INFORMATION`.

When the RRC STATUS message has been submitted to lower layers for transmission, the UE shall:

- 1> continue with any ongoing processes and procedures as if the invalid DOWNLINK DIRECT TRANSFER message has not been received.

8.1.10 Uplink Direct transfer

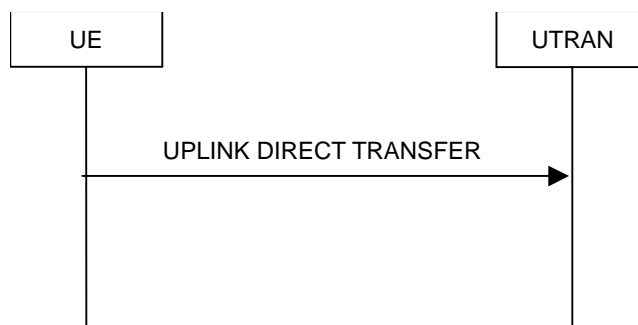

Figure 8.1.10-1: Uplink Direct transfer, normal flow

8.1.10.1 General

The uplink direct transfer procedure is used in the uplink direction to carry all subsequent upper layer (NAS) messages over the radio interface belonging to a signalling connection.

8.1.10.2 Initiation of uplink direct transfer procedure in the UE

In the UE, the uplink direct transfer procedure shall be initiated when the upper layers request a transfer of a NAS message on an existing signalling connection. When not stated otherwise elsewhere, the UE may initiate the uplink direct transfer procedure when another procedure is ongoing, and in that case the state of the latter procedure shall not be affected.

Upon initiation of the uplink direct transfer procedure in `CELL_PCH` or `URA_PCH` state, the UE shall:

- 1> if variable `READY_FOR_COMMON_EDCH` is set to `TRUE`:
 - 2> move to `CELL_FACH` state and continue with the uplink direct transfer procedure as below.
- 1> else:
 - 2> if variable `HSPA_RNTI_STORED_CELL_PCH` is set to `TRUE`:

3> move to CELL_FACH state and continue with the uplink direct transfer procedure as below.

2> else:

3> if variable H_RNTI and variable C_RNTI are set:

4> continue with the uplink direct transfer procedure as below.

3> else:

4> perform a cell update procedure, according to subclause 8.3.1, using the cause "uplink data transmission";

4> when the cell update procedure has been completed successfully:

5> continue with the uplink direct transfer procedure as below.

The UE shall transmit the UPLINK DIRECT TRANSFER message on the uplink DCCH using AM RLC on signalling radio bearer RB3 or signalling radio bearer RB4. The UE shall:

1> if upper layers indicate "low priority" for this message:

2> select signalling radio bearer RB4, if available. Specifically, for a GSM-MAP based CN, signalling radio bearer RB4 shall, if available, be selected when "SAPI 3" is requested;

2> select signalling radio bearer RB3 when signalling radio bearer RB4 is not available;

1> if upper layers indicate "high priority" for this message:

2> select signalling radio bearer RB3. Specifically, for a GSM-MAP based CN, signalling radio bearer RB3 shall be selected when "SAPI 0" is requested.

The UE shall set the IE "NAS message" as received from upper layers and set the IE "CN domain identity" as indicated by the upper layers.

When the successful delivery of the UPLINK DIRECT TRANSFER message has been confirmed by RLC the procedure ends.

8.1.10.2a RLC re-establishment or inter-RAT change

If signalling radio bearer RB n (where n equals to 3 or 4) was used when transmitting the UPLINK DIRECT TRANSFER message and a re-establishment of the transmitting side of the RLC entity on the same signalling radio bearer RB n occurs before the successful delivery of the UPLINK DIRECT TRANSFER message has been confirmed by RLC, the UE shall:

1> retransmit the UPLINK DIRECT TRANSFER message on the uplink DCCH using AM RLC on signalling radio bearer RB n.

If an Inter-RAT handover from UTRAN to other RAT than E-UTRAN procedure occurs before the successful delivery of the UPLINK DIRECT TRANSFER message has been confirmed by RLC, for messages with the IE "CN domain identity" set to "CS domain", the UE shall:

1> retransmit the NAS message as specified in subclause 8.3.7.4.

8.1.10.2b Inter-RAT handover from UTRAN to GERAN *lu mode*

If an Inter-RAT handover from UTRAN to GERAN *lu mode* occurs before the successful delivery of the UPLINK DIRECT TRANSFER message has been confirmed by RLC, for messages for all CN domains, the UE shall:

1> retransmit the NAS message as specified in subclause 8.3.7.4.

8.1.10.2c Inter-RAT handover from UTRAN to E-UTRAN

If an Inter-RAT handover from UTRAN to E-UTRAN occurs before the successful delivery of the UPLINK DIRECT TRANSFER message has been confirmed by RLC, the UE shall:

1> discard the NAS message.

8.1.10.3 Reception of UPLINK DIRECT TRANSFER message by the UTRAN

On reception of the UPLINK DIRECT TRANSFER message the NAS message should be routed using the value indicated in the IE "CN domain identity".

When the UTRAN receives an UPLINK DIRECT TRANSFER message, it shall not affect the state of any other ongoing RRC procedures, when not stated otherwise elsewhere.

8.1.11 UE dedicated paging

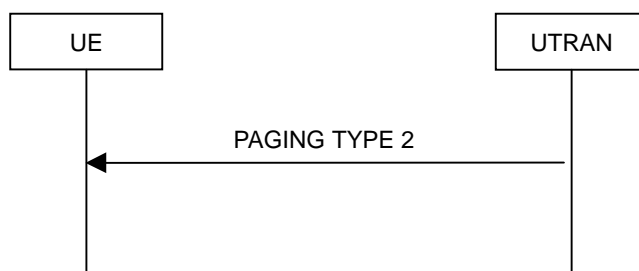

Figure 8.1.11-1: UE dedicated paging

8.1.11.1 General

This procedure is used to transmit dedicated paging information to one UE in connected mode in CELL_DCH, CELL_FACH or CELL_PCH (FDD and 1.28 Mcps TDD only) state. Upper layers in the network may request initiation of paging.

8.1.11.2 Initiation

For a UE in CELL_DCH, CELL_FACH or CELL_PCH (FDD and 1.28 Mcps TDD only) state, UTRAN initiates the procedure by transmitting a PAGING TYPE 2 message on the DCCH using AM RLC. When not stated otherwise elsewhere, the UTRAN may initiate the UE dedicated paging procedure also when another RRC procedure is ongoing, and in that case the state of the latter procedure shall not be affected.

UTRAN should set the IE "Paging cause" to the cause for paging received from upper layers. If no cause for paging is received from upper layers, UTRAN should set the value "Terminating – cause unknown".

8.1.11.3 Reception of a PAGING TYPE 2 message by the UE

When the UE receives a PAGING TYPE 2 message, it shall not affect the state of any other ongoing RRC procedures, when not stated otherwise elsewhere.

The UE shall:

- 1> indicate reception of paging; and
- 1> forward the IE "Paging cause" and the IE "Paging record type identifier" to upper layers.

The UE shall:

- 1> clear the entry for the PAGING TYPE 2 message in the table "Accepted transactions" in the variable TRANSACTIONS.

8.1.11.4 Invalid PAGING TYPE 2 message

If the UE receives a PAGING TYPE 2 message, which contains a protocol error causing the variable PROTOCOL_ERROR_REJECT to be set to TRUE according to clause 9, the UE shall perform procedure specific error handling as follows:

- 1> transmit an RRC STATUS message on the uplink DCCH using AM RLC;
- 1> include the IE "Identification of received message"; and
- 1> set the IE "Received message type" to PAGING TYPE 2; and
- 1> set the IE "RRC transaction identifier" to the value of "RRC transaction identifier" in the entry for the PAGING TYPE 2 message in the table "Rejected transactions" in the variable TRANSACTIONS; and
- 1> clear that entry;
- 1> include the IE "Protocol error information" with contents set to the value of the variable PROTOCOL_ERROR_INFORMATION;
- 1> when the RRC STATUS message has been submitted to lower layers for transmission:
 - 2> continue with any ongoing processes and procedures as if the invalid PAGING TYPE 2 message has not been received.

8.1.12 Security mode control

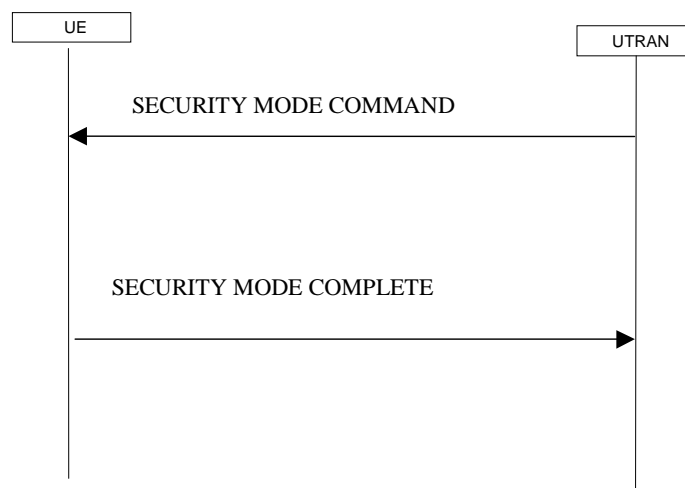

Figure 8.1.12-1: Security mode control procedure

8.1.12.1 General

The purpose of this procedure is to trigger the start of ciphering or to command the restart of the ciphering with a new ciphering configuration, for the radio bearers of one CN domain and for all signalling radio bearers.

It is also used to start integrity protection or to modify the integrity protection configuration for all signalling radio bearers.

8.1.12.2 Initiation

8.1.12.2.1 Ciphering configuration change

To start/restart ciphering, UTRAN sends a SECURITY MODE COMMAND message on the downlink DCCH in AM RLC using the most recent ciphering configuration. If no such ciphering configuration exists then the SECURITY MODE COMMAND is not ciphered. UTRAN should not transmit a SECURITY MODE COMMAND to signal a change in ciphering algorithm.

When configuring ciphering, UTRAN should ensure that the UE needs to store at most two different ciphering configurations (keyset and algorithm) per CN domain, in total over all radio bearers at any given time. For signalling radio bearers the total number of ciphering configurations that need to be stored is at most three. Prior to sending the

SECURITY MODE COMMAND, for the CN domain indicated in the IE "CN domain identity" in the SECURITY MODE COMMAND, UTRAN should:

- 1> suspend all radio bearers using RLC-AM or RLC-UM and all signalling radio bearers using RLC-AM or RLC-UM, except the signalling radio bearer used to send the SECURITY MODE COMMAND message on the downlink DCCH in RLC-AM, and except signalling radio bearer RB0, according to the following:
 - 2> not transmit RLC PDUs with sequence number greater than or equal to the number in IE "Radio bearer downlink ciphering activation time info" on all suspended radio bearers and all suspended signalling radio bearers.
- 1> set, for the signalling radio bearer used to send the SECURITY MODE COMMAND, the "RLC sequence number" in IE "Radio bearer downlink ciphering activation time info" in the IE "Ciphering mode info", at which time the new ciphering configuration shall be applied;

NOTE: The UTRAN should avoid the situation that the UE is aware of more than one pending downlink ciphering activation times for SRB2. In such a case the UE behaviour is unspecified.

- 1> if a transparent mode radio bearer for this CN domain exists:
 - 2> include the IE "Ciphering activation time for DPCH" in IE "Ciphering mode info", at which time the new ciphering configuration shall be applied and specify a CFN value for this IE that is a multiple of 8 frames ($CFN \bmod 8 = 0$).

NOTE: UTRAN should chose the value for the IE "Ciphering activation time for DPCH" such that the new ciphering configuration will occur after all the pending ciphering activation times have been reached for the transparent mode radio bearers of this CN domain.

- 1> consider a ciphering activation time in downlink to be pending until the RLC sequence number of the next RLC PDU to be transmitted for the first time is equal to or larger than the selected activation time;
- 1> set, for each suspended radio bearer and signalling radio bearer that has no pending ciphering activation time set by a previous security mode control procedure, an "RLC sequence number" in IE "Radio bearer downlink ciphering activation time info" in the IE "Ciphering mode info", at which time the new ciphering configuration shall be applied;
- 1> set, for each suspended radio bearer and signalling radio bearer that has a pending ciphering activation time set by a previous security mode control procedure, the "RLC sequence number" in IE "Radio bearer downlink ciphering activation time info" in the IE "Ciphering mode info" to the value used in the previous security mode control procedure, at which time the latest ciphering configuration shall be applied;
- 1> if Integrity protection has already been started for the UE:
 - 2> if for the CN domain indicated in the IE "CN domain identity" in the SECURITY MODE COMMAND, a new security key set (new ciphering and integrity protection keys) has been received from upper layers since the transmission of the last SECURITY MODE COMMAND message for that CN domain:
 - 3> include the IE "Integrity protection mode info" in the SECURITY MODE COMMAND.
 - 2> if the IE "CN domain identity" in the SECURITY MODE COMMAND is different from the IE "CN domain identity" that was sent in the previous SECURITY MODE COMMAND message to the UE:
 - 3> include the IE "Integrity protection mode info" in the SECURITY MODE COMMAND.
- 1> transmit the SECURITY MODE COMMAND message on RB2.

8.1.12.2.2 Integrity protection configuration change

To start or modify integrity protection, UTRAN sends a SECURITY MODE COMMAND message on the downlink DCCH in AM RLC using the new integrity protection configuration. UTRAN should not "modify" integrity protection for a CN domain to which a SECURITY MODE COMMAND configuring integrity protection has been previously sent for an ongoing signalling connection unless the application of new integrity keys needs to be signalled to the UE. UTRAN should not transmit a SECURITY MODE COMMAND to signal a change in integrity protection algorithm.

In case of Inter-RAT handover to UTRAN, after the reception of the HANDOVER TO UTRAN COMPLETE message and a key set is received, UTRAN should transmit a SECURITY MODE COMMAND message containing IE "Integrity protection mode info" in order to initiate integrity protection with the integrity key of the key set used in the other RAT (see subclause 8.3.6.3).

When configuring Integrity protection, UTRAN should:

- 1> ensure that the UE needs to store at most three different Integrity protection configurations (keysets) at any given time. This includes the total number of Integrity protection configurations for all signalling radio bearers;
- 1> if Ciphering has already been started for the UE for the CN domain to be set in the IE "CN domain identity" in the SECURITY MODE COMMAND:
 - 2> if for the CN domain indicated in the IE "CN domain identity" in the SECURITY MODE COMMAND, a new security key set (new ciphering and integrity protection keys) has been received from upper layers since the transmission of the last SECURITY MODE COMMAND message for that CN domain:
 - 3> include the IE "Ciphering mode info" in the SECURITY MODE COMMAND.
- 1> if Ciphering has already been configured for the UE for a CN domain different from the CN domain to be set in the IE "CN domain identity" in the SECURITY MODE COMMAND:
 - 2> include the IE "Ciphering mode info" in the SECURITY MODE COMMAND.

Prior to sending the SECURITY MODE COMMAND, for the CN domain indicated in the IE "CN domain identity" in the SECURITY MODE COMMAND, UTRAN should:

- 1> if this is the first SECURITY MODE COMMAND sent for this RRC connection:
 - 2> if new keys have been received:
 - 3> initialise the hyper frame numbers as follows:
 - 4> set all bits of the hyper frame numbers of the COUNT-I values for all signalling radio bearers to zero.
 - 2> else (if new keys have not been received):
 - 3> use the value "START" in the most recently received IE "START list" or IE "START" that belongs to the CN domain indicated in the IE "CN domain identity" to initialise all hyper frame numbers of COUNT-I for all the signalling radio bearers by:
 - 4> setting the 20 most significant bits of the hyper frame numbers for all signalling radio bearers to the value "START" in the most recently received IE "START list" or IE "START" for that CN domain;
 - 4> setting the remaining bits of the hyper frame numbers equal to zero.
- 1> else (this is not the first SECURITY MODE COMMAND sent for this RRC connection):
 - 2> if new keys have been received:
 - 3> initialise the hyper frame number for COUNT-I for RB2 as follows:
 - 4> set all bits of the HFN of the COUNT-I value for RB2 to zero.
 - 2> if new keys have not been received:
 - 3> initialise the hyper frame number for COUNT-I for RB2 as follows:
 - 4> set the 20 most significant bits of the HFN of the downlink and uplink COUNT-I to the value of the most recently received IE "START" or IE "START list" for the CN domain to be set in the IE "CN Domain Identity";
 - 4> set the remaining bits of the HFN of the downlink and uplink COUNT-I to zero.
- 1> if the IE "Integrity protection mode command" has the value "Start":

- 2> prohibit the transmission of signalling messages with any RRC SN on all signalling radio bearers, except RB2;
 - 2> set the FRESH value in the IE "Integrity protection initialisation number", included in the IE "Integrity protection mode info".
- 1> if the IE "Integrity protection mode command" has the value "Modify":
- 2> for each signalling radio bearer RBn, except RB2:
 - 3> prohibit the transmission of signalling messages with RRC SN greater or equal to the RRC sequence number in entry for signalling radio bearer n in the "RRC message sequence number list" in the IE "Downlink integrity protection activation info", included in the IE "Integrity protection mode info".
 - 2> consider an integrity protection activation time in downlink to be pending until the selected activation time is equal to the next RRC sequence number to be used, which means that the last RRC message using the old integrity protection configuration has been submitted to lower layers;
 - 2> set, for each signalling radio bearer RBn, that has no pending integrity protection activation time set by a previous security mode control procedure, an RRC sequence number in entry for signalling radio bearer n in the "RRC message sequence number list" in the IE "Downlink integrity protection activation info", included in the IE "Integrity protection mode info", at which time the new integrity protection configuration shall be applied;
 - 2> set, for each signalling radio bearer RBn, that has a pending integrity protection activation time set by a previous security mode control procedure, the RRC sequence number in entry for signalling radio bearer n in the "RRC message sequence number list" in the IE "Downlink integrity protection activation info", included in the IE "Integrity protection mode info", to the value used in the previous security mode control procedure, at which time the latest integrity protection configuration shall be applied.
- 1> transmit the SECURITY MODE COMMAND message on RB2 using the new integrity protection configuration.

NOTE1: In the case of re-initialisation of Integrity Protection at HFN wrap around, the network should take into account the UE actions as described in subclauses 8.5.10.1 and 8.5.10.2.

NOTE2: After the SECURITY MODE COMMAND message is transmitted, the network should ensure that it can revert back to old integrity protection until it receives the SECURITY MODE COMPLETE message, to take into account the UE actions when security mode control procedure is unsuccessful. The network should also be aware that the UE may revert to old configuration when waiting for the acknowledgement from L2 for the SECURITY MODE COMPLETE message, and act accordingly.

NOTE3: In the case of the first SECURITY MODE COMMAND message following an SRNS relocation, the network should set the IE "Downlink integrity protection activation info" for SRB3 and SRB4 to at least "the current downlink RRC sequence number +2". As a consequence, at least the first message sent on SRB3 and SRB4 by the Target RNC will use the old integrity protection configuration.

8.1.12.3 Reception of SECURITY MODE COMMAND message by the UE

Upon reception of the SECURITY MODE COMMAND message, the UE shall:

- 1> if neither IE "Ciphering mode info" nor IE "Integrity protection mode info" is included in the SECURITY MODE COMMAND:
 - 2> set the variable INVALID_CONFIGURATION to TRUE.
- 1> if the IE "Security capability" is the same as indicated by variable UE_CAPABILITY_TRANSFERRED, and the IE "GSM security capability" (if included in the SECURITY MODE COMMAND) is the same as indicated by the variable UE_CAPABILITY_TRANSFERRED:
 - 2> set the variable LATEST_CONFIGURED_CN_DOMAIN equal to the IE "CN domain identity";
 - 2> set the IE "Status" in the variable SECURITY_MODIFICATION for the CN domain indicated in the IE "CN domain identity" in the received SECURITY MODE COMMAND to the value "Affected";

- 2> set the IE "Status" in the variable SECURITY_MODIFICATION for all CN domains other than the CN domain indicated in the IE "CN domain identity" to "Not affected";
- 2> set the IE "RRC transaction identifier" in the SECURITY MODE COMPLETE message to the value of "RRC transaction identifier" in the entry for the SECURITY MODE COMMAND message in the table "Accepted transactions" in the variable TRANSACTIONS; and
- 2> clear that entry;
- 2> if the SECURITY MODE COMMAND message contained the IE "Ciphering mode info":
 - 3> perform the actions as specified in subclause 8.6.3.4.
- 2> if the SECURITY MODE COMMAND message contained the IE "Integrity protection mode info":
 - 3> perform the actions as specified in subclause 8.6.3.5.
- 1> prior to sending the SECURITY MODE COMPLETE message:
 - 2> use the old ciphering configuration for this message;
 - 2> if the SECURITY MODE COMMAND message contained the IE "Ciphering mode info":
 - 3> include and set the IE "Radio bearer uplink ciphering activation time info" to the value of the variable RB_UPLINK_CIPHERING_ACTIVATION_TIME_INFO;
 - 3> for each radio bearer and signalling radio bearer that belongs to the CN domain as indicated in the variable LATEST_CONFIGURED_CN_DOMAIN:
 - 4> start or continue incrementing the COUNT-C values for all RLC-AM and RLC-UM signalling radio bearers at the ciphering activation time as specified in the procedure;
 - 4> start or continue incrementing the COUNT-C values common for all transparent mode radio bearers for this CN domain at the ciphering activation time as specified in the procedure;
 - 4> continue incrementing the COUNT-C values for all RLC-AM and RLC-UM radio bearers.
 - 3> if no new security key set (new ciphering and integrity protection keys) has been received from the upper layers [40] for the CN domain as indicated in the variable LATEST_CONFIGURED_CN_DOMAIN:
 - 4> for ciphering on signalling radio bearers using RLC-AM and RLC-UM in the downlink, at the RLC sequence number indicated in IE "Radio bearer downlink ciphering activation time info" in the IE "Ciphering mode info" included in the SECURITY MODE COMMAND, for each signalling radio bearer:
 - 5> set the 20 most significant bits of the HFN component of the downlink COUNT-C to the value "START" in the most recently transmitted IE "START list" or IE "START", at the reception of the SECURITY MODE COMMAND, that belongs to the CN domain as indicated in the variable LATEST_CONFIGURED_CN_DOMAIN;
 - 5> set the remaining bits of the hyper frame numbers to zero.
 - 3> if new keys have been received:
 - 4> perform the actions in subclause 8.1.12.3.1.
 - 2> if the SECURITY MODE COMMAND message contained the IE "Integrity protection mode info":
 - 3> include and set the IE "Uplink integrity protection activation info" to the value of the variable INTEGRITY_PROTECTION_ACTIVATION_INFO for each signalling radio bearer;
 - 3> if no new security key set (new ciphering and integrity protection keys) has been received from the upper layers [40] for the CN domain as indicated in the variable LATEST_CONFIGURED_CN_DOMAIN, for RB2:
 - 4> in the downlink, for the received SECURITY MODE COMMAND message:

- 5> set the 20 most significant bits of the IE "Downlink RRC HFN" in the variable INTEGRITY_PROTECTION_INFO of the downlink COUNT-I to the value "START" in the most recently transmitted IE "START list" or IE "START", at the reception of the SECURITY MODE COMMAND, that belongs to the CN domain as indicated in the variable LATEST_CONFIGURED_CN_DOMAIN;
- 5> set the remaining bits of the IE "Downlink RRC HFN" to zero.
- 4> in the uplink, for the transmitted response message, SECURITY MODE COMPLETE:
 - 5> set the 20 most significant bits of the IE "Uplink RRC HFN" in the variable INTEGRITY_PROTECTION_INFO of the uplink COUNT-I to the value "START" in the most recently transmitted IE "START list" or IE "START", at the reception of the SECURITY MODE COMMAND, that belongs to the CN domain as indicated in the variable LATEST_CONFIGURED_CN_DOMAIN;
 - 5> set the remaining bits of the IE "Uplink RRC HFN" to zero.
- 3> if no new security key set (new ciphering and integrity protection keys) has been received from the upper layers [40] for the CN domain indicated in the variable LATEST_CONFIGURED_CN_DOMAIN, for each signalling radio bearer other than RB2:
 - 4> if the IE "Integrity protection mode command" has the value "start":
 - 5> in the downlink, for this signalling radio bearer:
 - 6> set the 20 most significant bits of IE "Downlink RRC HFN" in the variable INTEGRITY_PROTECTION_INFO of the downlink COUNT-I to the value START transmitted in the most recently transmitted IE "START list" or IE "START", at the reception of the SECURITY MODE COMMAND, that belongs to the CN domain as indicated in the variable LATEST_CONFIGURED_CN_DOMAIN;
 - 6> set the remaining bits of the IE "Downlink RRC HFN" in the variable INTEGRITY_PROTECTION_INFO of the downlink COUNT-I to zero;
 - 4> else:
 - 5> in the downlink, for the first message for which the RRC sequence number in a received RRC message for this signalling radio bearer is equal to or greater than the activation time as indicated in IE "Downlink integrity protection activation info" as included in the IE "Integrity protection mode info", for this signalling radio bearer:
 - 6> set the 20 most significant bits of the IE "Downlink RRC HFN" in the variable INTEGRITY_PROTECTION_INFO of the downlink COUNT-I to the value "START" in the most recently transmitted IE "START list" or IE "START", at the reception of the SECURITY MODE COMMAND, that belongs to the CN domain as indicated in the variable LATEST_CONFIGURED_CN_DOMAIN;
 - 6> set the remaining bits of the IE "Downlink RRC HFN" to zero.
 - 3> if new keys have been received:
 - 4> perform the actions in subclause 8.1.12.3.1.
 - 2> start applying the new integrity protection configuration in the uplink for signalling radio bearer RB2 from and including the transmitted SECURITY MODE COMPLETE message;
 - 2> transmit the SECURITY MODE COMPLETE message on RB2.

NOTE 1: After submission of the SECURITY MODE COMPLETE message to the lower layers, the UE should accept messages received in the DL which require the new security configuration to be applied on them. If the received message is successfully integrity checked, the UE should not discard the message due to lack of completion of the security procedure, caused by the successful delivery of the SECURITY MODE COMPLETE not having yet been confirmed by lower layers, unless the security configuration to be applied has been aborted and the message received requires integrity protection [5].

NOTE 2: After submission of the SECURITY MODE COMPLETE message to the lower layers, if the UE successfully integrity checks an RRC message received on SRB3 using the new integrity protection configuration, the UE may behave as if the successful delivery of the SECURITY MODE COMPLETE message has been confirmed by RLC.

- 1> when the successful delivery of the SECURITY MODE COMPLETE message has been confirmed by RLC:
 - 2> if the SECURITY MODE COMMAND message contained the IE "Ciphering mode info":
 - 3> if no new security key set (new ciphering and integrity protection keys) has been received from the upper layers [40] for the CN domain as indicated in the variable LATEST_CONFIGURED_CN_DOMAIN:
 - 4> for ciphering on signalling radio bearers using RLC-AM and RLC-UM in the uplink, at the RLC sequence number indicated in IE "Radio bearer uplink ciphering activation time info" included in the SECURITY MODE COMPLETE, for each signalling radio bearer:
 - 5> set the 20 most significant bits of the HFN component of the uplink COUNT-C to the value "START" in the most recently transmitted IE "START list" or IE "START", at the reception of the SECURITY MODE COMMAND, that belongs to the CN domain as indicated in the variable LATEST_CONFIGURED_CN_DOMAIN;
 - 5> set the remaining bits of the hyper frame numbers to zero.
 - 3> if new keys have been received:
 - 4> perform the actions in subclause 8.1.12.3.1.
 - 3> resume data transmission on any suspended radio bearer and signalling radio bearer mapped on RLC-AM or RLC-UM;
 - 3> set the IE "Reconfiguration" in the variable CIPHERING_STATUS to FALSE; and
 - 3> clear the variable RB_UPLINK_CIPHERING_ACTIVATION_TIME_INFO.
 - 2> if the SECURITY MODE COMMAND message contained the IE "Integrity protection mode info":
 - 3> if no new security key set (new ciphering and integrity protection keys) has been received from the upper layers [40] for the CN domain indicated in the variable LATEST_CONFIGURED_CN_DOMAIN, for each signalling radio bearer other than RB2:
 - 4> if the IE "Integrity protection mode command" has the value "start":
 - 5> in the uplink, for this signalling radio bearer:
 - 6> set the 20 most significant bits of IE "Uplink RRC HFN" in the variable INTEGRITY_PROTECTION_INFO of the uplink COUNT-I to the value START transmitted in the most recently transmitted IE "START list" or IE "START", at the reception of the SECURITY MODE COMMAND, that belongs to the CN domain as indicated in the variable LATEST_CONFIGURED_CN_DOMAIN;
 - 6> set the remaining bits of the IE "Uplink RRC HFN" in the variable INTEGRITY_PROTECTION_INFO of the uplink COUNT-I to zero.
 - 4> else:
 - 5> in the uplink, for the first transmitted RRC message for this signalling radio bearer with RRC sequence number equal to the activation time as indicated in IE "Uplink integrity protection activation info" included in the transmitted SECURITY MODE COMPLETE, for this signalling radio bearer:
 - 6> set the 20 most significant bits of the IE "Uplink RRC HFN" in the variable INTEGRITY_PROTECTION_INFO of the uplink COUNT-I to the value "START" in the most recently transmitted IE "START list" or IE "START", at the reception of the SECURITY MODE COMMAND, that belongs to the CN domain as indicated in the variable LATEST_CONFIGURED_CN_DOMAIN;

- 6> set the remaining bits of the IE "Uplink RRC HFN" to zero.
- 3> if new keys have been received:
 - 4> perform the actions in subclause 8.1.12.3.1.
 - 3> allow the transmission of RRC messages on all signalling radio bearers with any RRC SN;
 - 3> set "Uplink RRC Message sequence number" for signalling radio bearer RB0 in the variable INTEGRITY_PROTECTION_INFO to a value such that next RRC message to be sent on uplink RB0 will use the new integrity protection configuration and the "RRC Message sequence number" in the IE "Integrity check info" in the next RRC message will equal to the activation time for RB0 as indicated in IE "Uplink integrity protection activation info" included in the transmitted SECURITY MODE COMPLETE;
 - 3> set the IE "Reconfiguration" in the variable INTEGRITY_PROTECTION_INFO to FALSE; and
 - 3> clear the variable INTEGRITY_PROTECTION_ACTIVATION_INFO.
- 2> clear the variable SECURITY_MODIFICATION;
- 2> notify upper layers upon change of the security configuration;
- 2> and the procedure ends.
- 1> if the IE "Security capability" is not the same as indicated by the variable UE_CAPABILITY_TRANSFERRED, or the IE "GSM security capability" (if included in the SECURITY MODE COMMAND) is not the same as indicated by the variable UE_CAPABILITY_TRANSFERRED, or if the IE "GSM security capability" is not included in the SECURITY MODE COMMAND and is included in the variable UE_CAPABILITY_TRANSFERRED:
 - 2> release all its radio resources;
 - 2> indicate the release of the established signalling connections (as stored in the variable ESTABLISHED_SIGNALLING_CONNECTIONS) and established radio access bearers (as stored in the variable ESTABLISHED_RABS) to upper layers;
 - 2> clear the variable ESTABLISHED_SIGNALLING_CONNECTIONS;
 - 2> clear the variable ESTABLISHED_RABS;
 - 2> clear the variable SECURITY_MODIFICATION;
 - 2> enter idle mode;
 - 2> perform actions when entering idle mode as specified in subclause 8.5.2;
 - 2> and the procedure ends.

8.1.12.3.1 New ciphering and integrity protection keys

NOTE: The actions in this subclause are to be performed only if the new keys were received for an ongoing RRC connection while in UTRA.

If a new security key set (new ciphering and integrity protection keys) has been received from the upper layers [40] for the CN domain as indicated in the variable LATEST_CONFIGURED_CN_DOMAIN, the UE shall:

- 1> set the START value for the CN domain indicated in the variable LATEST_CONFIGURED_CN_DOMAIN to zero;
- 1> if the SECURITY MODE COMMAND message contained the IE "Integrity protection mode info":
 - 2> for integrity protection in the downlink on each signalling radio bearer except RB2:
 - 3> if IE "Integrity protection mode command" has the value "start":
 - 4> for the first received message on this signalling radio bearer:

- 5> start using the new integrity key;
- 5> for this signalling radio bearer:
 - 6> set the IE "Downlink RRC HFN" in the variable INTEGRITY_PROTECTION_INFO of the downlink COUNT-I to zero.
- 3> else:
 - 4> for the first message for which the RRC sequence number in a received RRC message for this signalling radio bearer is equal to or greater than the activation time as indicated in IE "Downlink integrity protection activation info" as included in the IE "Integrity protection mode info":
 - 5> start using the new integrity key;
 - 5> for this signalling radio bearer:
 - 6> set the IE "Downlink RRC HFN" in the variable INTEGRITY_PROTECTION_INFO of the downlink COUNT-I to zero.
- 2> for integrity protection in the uplink on each signalling radio bearer except RB2:
 - 3> for the first message for which the RRC sequence number in a to be transmitted RRC message for this signalling radio bearer is equal to the activation time as indicated in IE "Uplink integrity protection activation info" included in the transmitted SECURITY MODE COMPLETE message:
 - 4> start using the new integrity key;
 - 4> for this signalling radio bearer:
 - 5> set the IE "Uplink RRC HFN" in the variable INTEGRITY_PROTECTION_INFO of the uplink COUNT-I to zero.
- 2> for integrity protection in the downlink on signalling radio bearer RB2:
 - 3> at the received SECURITY MODECOMMAND:
 - 4> start using the new integrity key;
 - 4> set the IE "Downlink RRC HFN" in the variable INTEGRITY_PROTECTION_INFO of the downlink COUNT-I to zero.
- 2> for integrity protection in the uplink on signalling radio bearer RB2 :
 - 3> at the transmitted SECURITY MODE COMPLETE:
 - 4> start using the new integrity key;
 - 4> set the IE "Uplink RRC HFN" in the variable INTEGRITY_PROTECTION_INFO of the uplink COUNT-I to zero.
- 1> if the SECURITY MODE COMMAND message contained the IE "Ciphering mode info":
 - 2> for each signalling radio bearer and for each radio bearer for the CN domain indicated in the variable LATEST_CONFIGURED_CN_DOMAIN:
 - 3> if the IE "Status" in the variable CIPHERING_STATUS has the value "Started" for this CN domain, then for ciphering on radio bearers using RLC-TM:
 - 4> at the CFN as indicated in the IE "Ciphering activation time for DPCH" in the IE "Ciphering mode info":
 - 5> start using the new key in uplink and downlink;
 - 5> set the HFN component of the COUNT-C to zero.

- 3> if the IE "Status" in the variable CIPHERING_STATUS has the value "Started" for this CN domain, then for ciphering on radio bearers and signalling radio bearers using RLC-AM and RLC-UM:
 - 4> in the downlink, at the RLC sequence number indicated in IE "Radio bearer downlink ciphering activation time info" in the IE "Ciphering mode info":
 - 5> start using the new key;
 - 5> set the HFN component of the downlink COUNT-C to zero.
 - 4> in the uplink, at the RLC sequence number indicated in IE "Radio bearer uplink ciphering activation time info":
 - 5> start using the new key;
 - 5> set the HFN component of the uplink COUNT-C to zero.
- 1> consider the value of the latest transmitted START value to be zero.

8.1.12.4 Void

8.1.12.4a Incompatible simultaneous security reconfiguration

If the variable INCOMPATIBLE_SECURITY_RECONFIGURATION becomes set to TRUE of the received SECURITY MODE COMMAND message, the UE shall:

- 1> transmit a SECURITY MODE FAILURE message on the uplink DCCH using AM RLC, using the ciphering and integrity protection configurations prior to the reception of this SECURITY MODE COMMAND;
- 1> set the IE "RRC transaction identifier" in the SECURITY MODE FAILURE message to the value of "RRC transaction identifier" in the entry for the SECURITY MODE COMMAND message in the table "Accepted transactions" in the variable TRANSACTIONS; and
- 1> clear that entry;
- 1> set the IE "failure cause" to the cause value "incompatible simultaneous reconfiguration";
- 1> when the response message has been submitted to lower layers for transmission:
 - 2> set the variable INCOMPATIBLE_SECURITY_RECONFIGURATION to FALSE;
 - 2> continue with any ongoing processes and procedures as if the invalid SECURITY MODE COMMAND message has not been received;
 - 2> only accept a message on SRB 2, with a COUNT-I that:
 - 3> is higher than the COUNT-I used prior to receiving the SECURITY MODE COMMAND message incremented by one; and
 - 3> does not take into account the HFN from the received SECURITY MODE COMMAND message.
 - 2> and the procedure ends.

8.1.12.4b Cell update procedure during security reconfiguration

If:

- a cell update procedure according to subclause 8.3.1 is initiated; and
- the received SECURITY MODE COMMAND message causes either,
 - the IE "Reconfiguration" in the variable CIPHERING_STATUS to be set to TRUE; and/or
 - the IE "Reconfiguration" in the variable INTEGRITY_PROTECTION_INFO to be set to TRUE:

the UE shall:

- 1> abort the ongoing integrity and/or ciphering reconfiguration;
- 1> resume data transmission on any suspended radio bearer and signalling radio bearer mapped on RLC-AM or RLC-UM;
- 1> allow the transmission of RRC messages on all signalling radio bearers with any RRC SN;
- 1> when the CELL UPDATE message has been submitted to lower layers for transmission:
 - 2> if the SECURITY MODE COMMAND message contained the IE "Ciphering mode info":
 - 3> set the IE "Reconfiguration" in the variable CIPHERING_STATUS to FALSE; and
 - 3> clear the variable RB_UPLINK_CIPHERING_ACTIVATION_TIME_INFO;
 - 2> if the SECURITY MODE COMMAND message contained the IE "Integrity protection mode info":
 - 3> set the IE "Reconfiguration" in the variable INTEGRITY_PROTECTION_INFO to FALSE; and
 - 3> clear the variable INTEGRITY_PROTECTION_ACTIVATION_INFO.
 - 2> continue with any ongoing processes and procedures as if the SECURITY MODE COMMAND message has not been received;
 - 2> only accept a message on SRB 2, with a COUNT-I that:
 - 3> is higher than the COUNT-I used prior to receiving the SECURITY MODE COMMAND message incremented by one; and
 - 3> does not take into account the HFN from the received SECURITY MODE COMMAND message.
 - 2> if the UE has already submitted the SECURITY MODE COMPLETE message, use a COUNT-I value for transmission of the next message on SRB2 as stated below:
 - 3> take the COUNT-I used prior to the transmission of the SECURITY MODE COMPLETE message;
 - 3> increment that COUNT-I with 2;
 - 3> apply that COUNT-I on the next message to transmit.
 - 2> clear the variable SECURITY_MODIFICATION;
 - 2> the procedure ends.

8.1.12.4c Invalid configuration

If the variable INVALID_CONFIGURATION is set to TRUE due to the received SECURITY MODE COMMAND message, the UE shall:

- 1> transmit a SECURITY MODE FAILURE message on the DCCH using AM RLC after setting the IEs as specified below:
 - 2> set the IE "RRC transaction identifier" in the SECURITY MODE FAILURE message to the value of "RRC transaction identifier" in the entry for the SECURITY MODE COMMAND message in the table "Accepted transactions" in the variable TRANSACTIONS; and
 - 2> clear that entry;
 - 2> set the IE "failure cause" to the cause value "invalid configuration".
- 1> when the response message has been submitted to lower layers for transmission:
 - 2> set the variable INVALID_CONFIGURATION to FALSE;
 - 2> set the IE "Reconfiguration" in the variable CIPHERING_STATUS to FALSE;

- 2> continue with any ongoing processes and procedures as if the invalid SECURITY MODE COMMAND message has not been received;
- 2> only accept a message on SRB 2, with a COUNT-I that:
 - 3> is higher than the COUNT-I used prior to receiving the SECURITY MODE COMMAND message incremented by one; and
 - 3> does not take into account the HFN from the received SECURITY MODE COMMAND message.
- 2> and the procedure ends.

8.1.12.5 Reception of SECURITY MODE COMPLETE message by the UTRAN

UTRAN should apply integrity protection on the received SECURITY MODE COMPLETE message and all subsequent messages with the new integrity protection configuration, if changed. When UTRAN has received a SECURITY MODE COMPLETE message and the integrity protection has successfully been applied, UTRAN should:

- 1> if the IE "Ciphering mode info" was included in the SECURITY MODE COMMAND message:
 - 2> if new keys were received for the CN domain set in the IE "CN Domain Identity" in the SECURITY MODE COMMAND:
 - 3> set, at the downlink and uplink activation time, all the bits of the hyper frame numbers of the downlink and uplink COUNT-C values respectively for all radio bearers for this CN domain and all signalling radio bearers to zero.
 - 2> else (if new keys were not received):
 - 3> use, at the downlink and uplink activation time, the value "START" in the most recently received IE "START list" or IE "START" that belongs to the CN domain as indicated in the IE "CN domain identity" to initialise all hyper frame numbers of the downlink and uplink COUNT-C values respectively for all the signalling radio bearers as follows:
 - 4> set the 20 most significant bits of the hyper frame numbers of the COUNT-C for all signalling radio bearers to the value "START" in the most recently received IE "START list" or IE "START" for that CN domain;
 - 4> set the remaining bits of the hyper frame numbers equal to zero.
- 1> if the IE "Integrity protection mode info" was included in the SECURITY MODE COMMAND message:
 - 2> if this was not the first SECURITY MODE COMMAND message for this RRC connection:
 - 3> if new keys have been received for the CN domain set in the IE "CN Domain Identity" included in the transmitted SECURITY MODE COMMAND message:
 - 4> initialise, at the downlink and uplink activation time, all hyper frame numbers of the downlink and uplink COUNT-I values respectively for all the signalling radio bearers other than RB2 as follows:
 - 5> set all bits of the hyper frame numbers of the uplink and downlink COUNT-I to zero.
 - 3> if no new keys have been received for the CN domain set in the IE "CN Domain Identity" included in the transmitted SECURITY MODE COMMAND message:
 - 4> use, at the downlink and uplink activation time, the value "START" in the most recently received IE "START list" or IE "START" that belongs to the CN domain as indicated in the IE "CN domain identity" to initialise all hyper frame numbers of the downlink and uplink COUNT-I values respectively for all the signalling radio bearers other than RB2 as follows:
 - 5> set the 20 most significant bits of the hyper frame numbers of the downlink and uplink COUNT-I respectively for all signalling radio bearers to the value "START" in the most recently received IE "START list" or IE "START" for that CN domain;
 - 5> set the remaining bits of the hyper frame numbers equal to zero.

- 1> send an indication to upper layers that the new security configuration has been activated;
- 1> resume, in the downlink, all suspended radio bearers and all signalling radio bearers;
- 1> allow the transmission of RRC messages on all signalling radio bearers with any RRC SN;
- 1> if the IE "Integrity protection mode command" included in the SECURITY MODE COMMAND had the value "Start":
 - 2> start applying integrity protection in the downlink for all signalling radio bearers.
- 1> if the IE "Integrity protection mode command" included in the SECURITY MODE COMMAND had the value "Modify":
 - 2> start applying the new integrity protection configuration in the downlink at the RRC sequence number, for each signalling radio bearers RB_n, except for signalling radio bearer RB2, indicated by the entry for signalling radio bearer n in the "RRC message sequence number list" in the IE "Downlink integrity protection activation info";
 - 2> continue applying the new integrity configuration for signalling radio bearer RB2;
 - 2> apply the new integrity protection configuration on the received signalling messages with RRC SN greater than or equal to the number associated with the signalling radio bearer in IE "Uplink integrity protection activation info".
- 1> apply the old ciphering configuration for the transmission of RLC PDUs with RLC sequence number less than the number indicated in the IE "Radio bearer downlink ciphering activation time info" included in the IE "Ciphering mode info";
- 1> apply the new ciphering configuration for the transmission of RLC PDUs with RLC sequence number greater than or equal to the number indicated in IE "Radio bearer downlink ciphering activation time info" included in the IE "Ciphering mode info";
- 1> apply the old integrity protection configuration on the received signalling messages with RRC SN smaller than the number associated with the signalling radio bearer in IE "Uplink integrity protection activation info";
- 1> for radio bearers using RLC-AM or RLC-UM:
 - 2> use the old ciphering configuration for received RLC PDUs with RLC sequence number less than the RLC sequence number indicated in the IE "Radio bearer uplink ciphering activation time info" sent by the UE;
 - 2> use the new ciphering configuration for received RLC PDUs with RLC sequence number greater than or equal to the RLC sequence number indicated in the IE "Radio bearer uplink ciphering activation time info" sent by the UE;
 - 2> if an RLC reset or re-establishment of the transmitting side of an RLC entity occurs after the SECURITY MODE COMPLETE message has been received by UTRAN before the downlink activation time for the new ciphering configuration has been reached, ignore the activation time and apply the new ciphering configuration in downlink immediately after the RLC reset or RLC re-establishment;
 - 2> if an RLC reset or re-establishment of the receiving side of an RLC entity occurs after the SECURITY MODE COMPLETE message has been received by UTRAN before the uplink activation time for the new ciphering configuration has been reached, ignore the activation time and apply the new ciphering configuration in uplink immediately after the RLC reset or RLC re-establishment.
- 1> for radio bearers using RLC-TM:
 - 2> use the old ciphering configuration for the received RLC PDUs before the CFN as indicated in the IE "Ciphering activation time for DPCH" in the IE "Ciphering mode info" as included in the SECURITY MODE COMMAND;
 - 2> use the new ciphering configuration for the received RLC PDUs at the CFN as indicated in the IE "Ciphering activation time for DPCH" in the IE "Ciphering mode info" as included in the SECURITY MODE COMMAND.
- 1> and the procedure ends.

8.1.12.6 Invalid SECURITY MODE COMMAND message

If the SECURITY MODE COMMAND message contains a protocol error causing the variable `PROTOCOL_ERROR_REJECT` to be set to `TRUE` according to clause 9, the UE shall perform procedure specific error handling as follows:

- 1> transmit a SECURITY MODE FAILURE message on the uplink DCCH using AM RLC;
- 1> set the IE "RRC transaction identifier" in the SECURITY MODE FAILURE message to the value of "RRC transaction identifier" in the entry for the SECURITY MODE COMMAND message in the table "Rejected transactions" in the variable `TRANSACTIONS`; and
- 1> clear that entry;
- 1> set the IE "failure cause" to the cause value "protocol error";
- 1> include the IE "Protocol error information" with contents set to the value of the variable `PROTOCOL_ERROR_INFORMATION`;
- 1> when the response message has been submitted to lower layers for transmission:
 - 2> continue with any ongoing processes and procedures as if the invalid SECURITY MODE COMMAND message has not been received;
 - 2> only accept a message on SRB 2, with a COUNT-I that:
 - 3> is higher than the COUNT-I used prior to receiving the SECURITY MODE COMMAND message incremented by one; and
 - 3> does not take into account the HFN from the received SECURITY MODE COMMAND message.
 - 2> and the procedure ends.

8.1.13 Signalling connection release procedure



Figure 8.1.13-1: Signalling connection release procedure, normal case

8.1.13.1 General

The signalling connection release procedure is used to notify to the UE that one of its ongoing signalling connections has been released. The procedure does not initiate the release of the RRC connection.

8.1.13.2 Initiation of SIGNALLING CONNECTION RELEASE by the UTRAN

To initiate the procedure, the UTRAN transmits a SIGNALLING CONNECTION RELEASE message on DCCH using AM RLC.

8.1.13.3 Reception of SIGNALLING CONNECTION RELEASE by the UE

Upon reception of a SIGNALLING CONNECTION RELEASE message, the UE shall:

- 1> indicate the release of the signalling connection and pass the value of the IE "CN domain identity" to upper layers;
- 1> if the IE "Extended Wait Time" is present and the UE supports "delay tolerant access":
 - 2> forward the IE "Extended Wait Time" to the upper layers.
- 1> remove the signalling connection with the identity indicated by the IE "CN domain identity" from the variable ESTABLISHED_SIGNALLING_CONNECTIONS;
- 1> clear the entry for the SIGNALLING CONNECTION RELEASE message in the table "Accepted transactions" in the variable TRANSACTIONS;
- 1> the procedure ends.

8.1.13.4 Invalid SIGNALLING CONNECTION RELEASE message

If the UE receives a SIGNALLING CONNECTION RELEASE message, which contains a protocol error causing the variable PROTOCOL_ERROR_REJECT to be set to TRUE according to clause 9, the UE shall perform procedure specific error handling as follows:

- 1> include the IE "Identification of received message"; and
 - 2> set the IE "Received message type" to SIGNALLING CONNECTION RELEASE;
 - 2> set the IE "RRC transaction identifier" to the value of "RRC transaction identifier" in the entry for the SIGNALLING CONNECTION RELEASE message in the table "Rejected transactions" in the variable TRANSACTIONS; and
 - 2> clear that entry.
- 1> include the IE "Protocol error information" with contents set to the value of the variable PROTOCOL_ERROR_INFORMATION;
- 1> transmit an RRC STATUS message on the uplink DCCH using AM RLC
- 1> when the RRC STATUS message has been submitted to lower layers for transmission:
 - 2> continue with any ongoing processes and procedures as if the invalid SIGNALLING CONNECTION RELEASE message has not been received.

8.1.13.5 Invalid configuration

If radio access bearers for the CN domain indicated by the IE "CN domain identity" exist in the variable ESTABLISHED_RABS, the UE shall:

- 1> transmit an RRC STATUS message on the uplink DCCH using AM RLC;
- 1> include the IE "Identification of received message"; and
- 1> set the IE "Received message type" to SIGNALLING CONNECTION RELEASE; and
- 1> set the IE "RRC transaction identifier" to the value of "RRC transaction identifier" in the entry for the SIGNALLING CONNECTION RELEASE message in the table "Accepted transactions" in the variable TRANSACTIONS and clear that entry;
- 1> include the IE "Protocol error information" with contents set to the value "Message not compatible with receiver state";
- 1> when the RRC STATUS message has been submitted to lower layers for transmission:

- 2> continue with any ongoing processes and procedures as if the invalid SIGNALLING CONNECTION RELEASE message has not been received.

8.1.14 Signalling connection release indication procedure

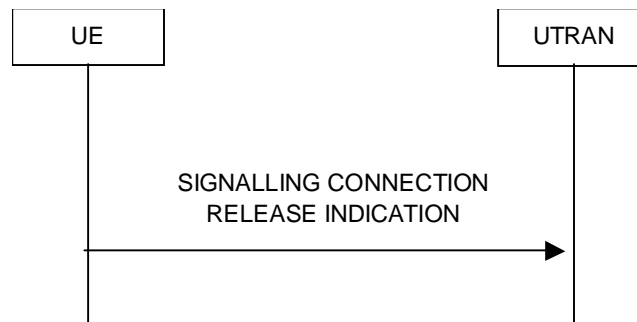

Figure 8.1.14-1: Signalling connection release indication procedure, normal case

8.1.14.1 General

The signalling connection release indication procedure is used by the UE to indicate to the UTRAN that one of its signalling connections has been released or it is used by the UE to request UTRAN to initiate a state transition to a battery efficient RRC state. The procedure may in turn initiate the RRC connection release procedure.

8.1.14.2 Initiation

The UE shall, on receiving a request to release (abort) the signalling connection from upper layers for a specific CN domain:

- 1> if a signalling connection in the variable ESTABLISHED_SIGNALLING_CONNECTIONS for the specific CN domain identified with the IE "CN domain identity" exists:
 - 2> initiate the signalling connection release indication procedure.
- 1> otherwise:
 - 2> abort any ongoing establishment of signalling connection for that specific CN domain as specified in 8.1.3.5a.

Upon initiation of the signalling connection release indication procedure in CELL_PCH or URA_PCH state, the UE shall:

- 1> if variable READY_FOR_COMMON_EDCH is set to TRUE:
 - 2> move to CELL_FACH state and continue with the signalling connection release indication procedure as below.
- 1> else:
 - 2> if variable HSPA_RNTI_STORED_CELL_PCH is set to TRUE:
 - 3> move to CELL_FACH state and continue with the signalling connection release indication procedure as below.
 - 2> else:
 - 3> if variable H_RNTI and variable C_RNTI are set:
 - 4> continue with the signalling connection release indication procedure as below.
 - 3> else:

- 4> perform a cell update procedure, according to subclause 8.3.1, using the cause "uplink data transmission";
- 4> when the cell update procedure completed successfully:
 - 5> continue with the signalling connection release indication procedure as below.

The UE shall:

- 1> set the IE "CN Domain Identity" to the value indicated by the upper layers. The value of the IE indicates the CN domain whose associated signalling connection the upper layers are indicating to be released;
- 1> if the UE includes the IE "Signalling Connection Release Indication Cause" and does not set it to "UE Requested PS Data session end";
 - 2> set the IE "Signalling Connection Release Indication Cause" to "any other cause";
- 1> transmit a SIGNALLING CONNECTION RELEASE INDICATION message on DCCH using AM RLC.
- 1> if the SIGNALLING CONNECTION RELEASE INDICATION message did not include the IE "Signalling Connection Release Indication Cause" set to "UE Requested PS Data session end".
 - 2> remove the signalling connection with the identity indicated by upper layers from the variable ESTABLISHED_SIGNALLING_CONNECTIONS.

When the successful delivery of the SIGNALLING CONNECTION RELEASE INDICATION message has been confirmed by RLC the procedure ends.

In addition, if the timer T323 value is stored in the IE "UE Timers and constants in connected mode" in the variable TIMERS_AND_CONSTANTS, and if there is no CS domain connection indicated in the variable ESTABLISHED_SIGNALLING_CONNECTIONS, the UE may:

- 1> if the upper layers indicate that there is no more PS data for a prolonged period:
 - 2> if timer T323 is not running:
 - 3> if the UE is in CELL_DCH state; or
 - 3> if the UE is in CELL_FACH state and the variable HS_DSCH_DRX_CELL_FACH_2CYCLE_STATUS is set to FALSE; or
 - 3> if the UE is in CELL_FACH state and the variable HS_DSCH_DRX_CELL_FACH_2CYCLE_STATUS is set to TRUE and HS-DSCH second DRX cycle_{FACH} is shorter than the shorter CN domain specific DRX cycle length for the PS domain and CS domain; or
 - 3> if the UE is in CELL_FACH state and the variable HS_DSCH_DRX_CELL_FACH_2CYCLE_STATUS is set to TRUE and HS-DSCH second DRX cycle_{FACH} is equal to or longer than the shorter CN domain specific DRX cycle length for the PS domain and CS domain, and $V316 < 1$; or
 - 3> if the UE is in CELL_PCH state or URA_PCH state and the DRX cycle length in use is shorter than the shorter CN domain specific DRX cycle length for the PS domain and CS domain; or
 - 3> if the UE is in CELL_PCH state or URA_PCH state and the DRX cycle length in use is equal to or longer than the shorter CN domain specific DRX cycle length for the PS domain and CS domain, and $V316 < 1$:
 - 4> if the UE is in CELL_PCH state or URA_PCH state and the DRX cycle length in use is equal to or longer than the shorter CN domain specific DRX cycle length for the PS domain and CS domain:
 - 5> increment V316 by 1.
 - 4> if the UE is in CELL_FACH state and the variable HS_DSCH_DRX_CELL_FACH_2CYCLE_STATUS is set to TRUE and HS-DSCH second DRX cycle_{FACH} is equal to or longer than the shorter CN domain specific DRX cycle length for the PS domain and CS domain:
 - 5> increment V316 by 1.

- 4> set the IE "CN Domain Identity" to PS domain;
 - 4> set the IE "Signalling Connection Release Indication Cause" to "UE Requested PS Data session end";
 - 4> transmit a SIGNALLING CONNECTION RELEASE INDICATION message on DCCH using AM RLC;
 - 4> start the timer T323;
- 3> the procedure ends.

The UE shall be inhibited from sending the SIGNALLING CONNECTION RELEASE INDICATION message with the IE "Signalling Connection Release Indication Cause" set to "UE Requested PS Data session end" whilst timer T323 is running.

The UE shall not locally release the PS signalling connection after it has sent the SIGNALLING CONNECTION RELEASE INDICATION message with the IE "Signalling Connection Release Indication Cause" set to "UE Requested PS Data session end".

At transmission or reception of PS data or signalling on SRB3 or upwards, or entering RRC Connected mode, or successful SRNS relocation, the UE shall set V316 to zero.

8.1.14.2a RLC re-establishment or inter-RAT change

If a re-establishment of the transmitting side of the RLC entity on signalling radio bearer RB2 occurs before the successful delivery of the SIGNALLING CONNECTION RELEASE INDICATION message, without the IE "Signalling Connection Release Indication Cause" or with the IE "Signalling Connection Release Indication Cause" set to a value other than "UE Requested PS Data session end", has been confirmed by RLC, the UE shall:

- 1> retransmit the SIGNALLING CONNECTION RELEASE INDICATION message on the uplink DCCH using AM RLC on signalling radio bearer RB2.

If an Inter-RAT handover from UTRAN procedure occurs before the successful delivery of the SIGNALLING CONNECTION RELEASE INDICATION message without the IE "Signalling Connection Release Indication Cause" or with the IE "Signalling Connection Release Indication Cause" set to a value other than "UE Requested PS Data session end", has been confirmed by RLC, the UE shall:

- 1> abort the signalling connection while in the new RAT.

8.1.14.3 Reception of SIGNALLING CONNECTION RELEASE INDICATION by the UTRAN

Upon reception of a SIGNALLING CONNECTION RELEASE INDICATION message, if the IE "Signalling Connection Release Indication Cause" is not included or the IE "Signalling Connection Release Indication Cause" is set to "any other cause", the UTRAN requests the release of the signalling connection from upper layers. Upper layers may then initiate the release of the signalling connection.

If the IE "Signalling Connection Release Indication Cause" is set to "UE Requested PS Data session end" in the SIGNALLING CONNECTION RELEASE INDICATION message the UTRAN may initiate a state transition to efficient battery consumption RRC state such as IDLE, CELL_PCH, URA_PCH or CELL_FACH state.

8.1.14.4 Expiry of timer T323

When timer T323 expires:

- 1> the UE may determine whether any subsequent indications from upper layers that there is no more PS data for a prolonged period in which case it triggers the transmission of a single SIGNALLING CONNECTION RELEASE INDICATION message according with clause 8.1.14.2;
- 1> the procedure ends.

NOTE: If the UE is in CELL_PCH state or URA_PCH state and the DRX cycle length in use is shorter than the shorter of the CN domain specific DRX cycle lengths for the PS domain and CS domain or the UE is in CELL_FACH state and the variable HS_DSCH_DRX_CELL_FACH_2CYCLE_STATUS is set to TRUE and HS-DSCH second DRX cycle_{FACH} is shorter than the shorter of the CN domain specific DRX cycle length for the PS domain and CS domain the UE should limit the number of subsequent SIGNALLING CONNECTION RELEASE INDICATION messages with IE "Signalling Connection Release Indication Cause" set to "UE Requested PS Data session end" in order to not adversely impact the battery lifetime or network signalling load.

8.1.15 Counter check procedure

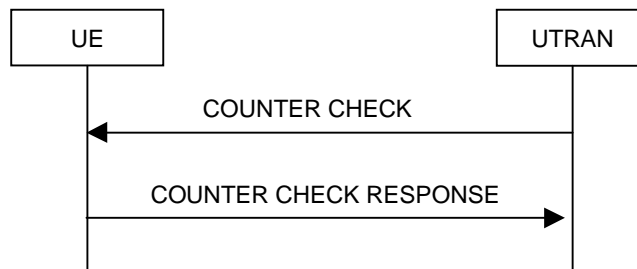

Figure 8.1.15-1: Counter check procedure

8.1.15.1 General

The counter check procedure is used by the UTRAN to perform a local authentication. The purpose of the procedure is to check that the amount of data sent in both directions (uplink and downlink) over the duration of the RRC connection is identical at the UTRAN and at the UE (to detect a possible intruder – a 'man-in-the-middle' – from operating).

This procedure is only applicable to radio bearers, and only to radio bearers using RLC-AM or RLC-UM. It should be noted that this requires that the COUNT-C values for each UL and DL radio bearers using RLC-AM or RLC-UM continue to be incremented even if ciphering is not used. This procedure is not applicable to signalling radio bearers.

8.1.15.2 Initiation

The UTRAN monitors the COUNT-C value associated with each radio bearer using UM or AM RLC. The procedure is triggered whenever any of these values reaches a critical checking value. The granularity of these checking values and the values themselves are defined to the UTRAN by the visited network. The UTRAN initiates the procedure by sending a COUNTER CHECK message on the downlink DCCH.

8.1.15.3 Reception of a COUNTER CHECK message by the UE

When the UE receives a COUNTER CHECK message it shall compare the COUNT-C MSB values received in the IE "RB COUNT-C MSB information" in the COUNTER CHECK message to the COUNT-C MSB values of the corresponding radio bearers.

The UE shall:

- 1> set the IE "RRC transaction identifier" in the COUNTER CHECK RESPONSE message to the value of "RRC transaction identifier" in the entry for the COUNTER CHECK message in the table "Accepted transactions" in the variable TRANSACTIONS; and
- 1> clear that entry.

If:

- there is one or more radio bearer(s) using UM or AM RLC mode stored in the variable ESTABLISHED_RABS, which is (are) not included in the IE "RB COUNT-C MSB information"; or
- there is one or more radio bearer(s) included in the IE "RB COUNT-C MSB information", which is (are) not stored in the variable ESTABLISHED_RABS; or

- for any radio bearer (excluding signalling radio bearers) using UM or AM RLC mode stored in the variable ESTABLISHED_RABS and included in the IE "RB COUNT-C MSB information" with COUNT-C MSB values different from the MSB part of the COUNT-C values in the UE:

the UE shall:

- 1> include these radio bearers in the IE "RB COUNT-C information" in the COUNTER CHECK RESPONSE message. For any RB which is included in the IE "RB COUNT-C MSB information" in the COUNTER CHECK message but not stored in the variable ESTABLISHED_RABS in the UE, the MSB part of COUNT-C values in the COUNTER CHECK RESPONSE message shall be set identical to COUNT-C-MSB values in the COUNTER CHECK message. The LSB part shall be filled with zeroes.

The UE shall:

- 1> if no COUNT-C exists for a radio bearer for a given direction (uplink or downlink) because:
 - 2> it is a uni-directional radio bearer configured only for the other direction (downlink or uplink respectively); or
 - 2> it has been configured to RLC-TM mode in one direction (uplink or downlink) and RLC-UM in the other (downlink or uplink respectively):
 - 3> set the COUNT-C in the IE "RB COUNT-C information" in the COUNTER CHECK RESPONSE message, to any value.
- 1> submit a COUNTER CHECK RESPONSE message to lower layers for transmission on the uplink DCCH using AM RLC.

When the COUNTER CHECK RESPONSE message has been submitted to lower layers for transmission the procedure ends.

8.1.15.4 Reception of the COUNTER CHECK RESPONSE message by UTRAN

If the UTRAN receives a COUNTER CHECK RESPONSE message that does not contain any COUNT-C values, the procedure ends.

If the UTRAN receives a COUNTER CHECK RESPONSE message that contains one or several COUNT-C values the UTRAN may release the RRC connection.

8.1.15.5 Cell re-selection

If the UE performs cell re-selection anytime during this procedure it shall, without interrupting the procedure:

- 1> initiate the cell update procedure according to subclause 8.3.1.

8.1.15.6 Invalid COUNTER CHECK message

If the UE receives a COUNTER CHECK message, which contains a protocol error causing the variable PROTOCOL_ERROR_REJECT to be set to TRUE according to clause 9, the UE shall perform procedure specific error handling as follows. The UE shall:

- 1> transmit an RRC STATUS message on the uplink DCCH using AM RLC;
- 1> include the IE "Identification of received message"; and
- 1> set the IE "Received message type" to COUNTER CHECK; and
- 1> set the IE "RRC transaction identifier" to the value of "RRC transaction identifier" in the entry for the UE COUNTER CHECK message in the table "Rejected transactions" in the variable TRANSACTIONS; and
- 1> clear that entry;
- 1> include the IE "Protocol error information" with contents set to the value of the variable PROTOCOL_ERROR_INFORMATION;

- 1> when the RRC STATUS message has been submitted to lower layers for transmission:
- 2> continue with any ongoing processes and procedures as if the invalid COUNTER CHECK message has not been received.

8.1.16 Inter RAT handover information transfer



Figure 8.1.16-1: Inter RAT handover information transfer, normal flow

8.1.16.1 General

The inter RAT handover information transfer procedure is used by the UE to convey RRC information needed for inter RAT handover to UTRAN.

8.1.16.2 Initiation

If:

- a radio access technology other than UTRA, e.g. GSM or E-UTRA, using radio access technology-specific procedures, orders the UE to provide the INTER RAT HANDOVER INFO message; or
- a radio access technology other than UTRA, e.g. GSM or E-UTRA, using radio access technology-specific procedures, configures the UE to send the INTER RAT HANDOVER INFO message upon system specific conditions not involving an explicit order e.g. early classmark sending upon entering connected mode; or
- while in connected mode using another radio access technology, the inter RAT handover info changes compared to what has previously been sent via the other radio access technology:

the UE shall:

- 1> initiate the inter RAT handover information transfer procedure.

To determine if the inter RAT handover info has changed compared to what has previously been sent, the UE shall:

- 1> store the information last sent in the variable INTER_RAT_HANDOVER_INFO_TRANSFERRED;
- 1> if this variable has not yet been set:
 - 2> not initiate the inter RAT handover information transfer procedure due to change of inter RAT handover info.

NOTE: Currently neither the UE security information nor the predefined configuration status information change while in connected mode using GSM radio access technology.

8.1.16.3 INTER RAT HANDOVER INFO message contents to set

The UE shall:

- 1> if the UE supports both UMTS TDD and FDD:
 - 2> determine whether capabilities are being requested for FDD or TDD mode; and
 - 2> use the capabilities associated with that mode for the remainder of this procedure.

- 1> include the IE "UE security information", and the IE "UE security information2" if inter-RAT PS handover is supported by the UE; and
- 1> not include the IE "UE Specific Behaviour Information 1 interRAT";
- 1> in case support for the compressed version of the inter RAT handover info is indicated via the other radio access technology:
 - 2> if the other radio access technology is not E-UTRA:
 - 3> include of the following IEs the IE that after encoding has the smallest size: IE "Predefined configuration status information compressed" or the IE "Predefined configuration status information".
 - 2> else:
 - 3> exclude the IE "Predefined configuration status information" and "Predefined configuration status information compressed".
 - 2> include the IE "UE radio access capability compressed".
- 1> else:
 - 2> if the other radio access technology is not E-UTRA:
 - 3> include the IE "Predefined configuration status information".
 - 2> else:
 - 3> exclude the IE "Predefined configuration status information".
 - 2> include the IE "UE capability container", containing the IE "UE radio access capability" and the IE "UE radio access capability extension", in accordance with the following:
 - 3> if the UE supports multiple UTRA FDD Frequency Bands; or
 - 3> if the UE supports a single UTRA FDD Frequency Band different from Band I [21]; or
 - 3> if the UE supports E-UTRA:
 - 4> include the IE "UE radio access capability", excluding IEs "RF capability FDD" and "Measurement capability" for FDD and including the IE "Measurement capability TDD" for TDD;
 - 4> include the IE "UE radio access capability extension", including the IEs "RF capability FDD extension", the "Measurement capability extension", the "Additional Secondary Cells", the "Additional Secondary Cells 2", the "Non-contiguous multi-cell", the "Support of uplink closed loop transmit diversity" and the "Support of uplink open loop transmit diversity" associated with each supported UTRA FDD frequency band indicated in the IE "Frequency band", but may omit all or part of these IEs for supported inter-RAT bands.
 - 3> else:
 - 4> include the IE "UE radio access capability", including the IEs "RF capability FDD" and "Measurement capability" associated with the Band I [21] for FDD and excluding the IE "Measurement capability TDD" for TDD;
 - 4> include the IE "UE radio access capability extension", including the IEs "RF capability FDD extension", the "Measurement capability extension", the "Additional Secondary Cells", the "Additional Secondary Cells 2", the "Non-contiguous multi-cell", the "Support of uplink closed loop transmit diversity" and the "Support of uplink open loop transmit diversity" associated with each supported UTRA FDD frequency band indicated in the IE "Frequency band".
- 1> For FDD, include the IE "UE radio access capability comp 2";
- 1> For 1.28 Mcps TDD, include the IE "UE radio access capability comp for 1.28 Mcps TDD";
- 1> initiate the transfer of the INTER RAT HANDOVER INFO message via the other radio access technology, using radio access technology-specific procedures;

- 1> store the following in the variable INTER_RAT_HANDOVER_INFO_TRANSFERRED if they were included in the INTER RAT HANDOVER INFO message:
 - 2> the IE "Predefined configuration status information";
 - 2> the IE "Predefined configuration status information compressed";
 - 2> the IE "UE security information";
 - 2> the IE "UE security information2";
 - 2> the IE "UE radio access capability";
 - 2> the IE "UE radio access capability extension"; and
 - 2> the IE "UE radio access capability compressed";
 - 2> if the IE "UE radio access capability compressed" were included in the INTER RAT HANDOVER INFO message:
 - 3> set the IE "Security Capability" to the mandatory R99 algorithms.
- 1> and the procedure ends.

8.1.17 ETWS primary notification with security procedure

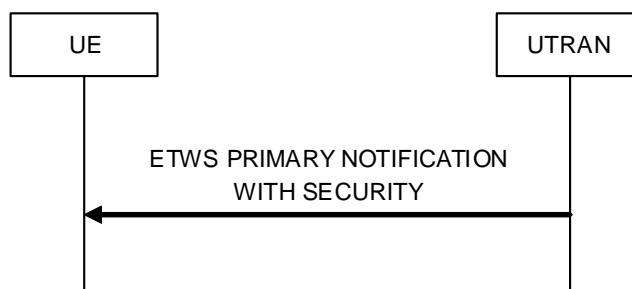

Figure 8.1.17-1: ETWS primary notification with security

8.1.17.1 General

The ETWS primary notification with security procedure is used to transfer an ETWS primary notification to the UE. The ETWS PRIMARY NOTIFICATION WITH SECURITY message is received via the dedicated control channel (DCCH).

The UE may receive the ETWS PRIMARY NOTIFICATION WITH SECURITY message via DCCH, when the UE is in a state where it is configured to receive DCCH. The UTRAN may use this option to send an ETWS primary notification to the UE when RRC is configured from upper layers to receive the ETWS primary notification either. The UE behaviour is specified in subclause 8.1.17.4.

8.1.17.2 Initiation

The UTRAN may initiate the ETWS primary notification with security procedure towards UEs in connected mode CELL_DCH state by sending the ETWS PRIMARY NOTIFICATION WITH SECURITY message on DCCH using UM or AM RLC.

8.1.17.3 Void

8.1.17.4 Reception of the ETWS PRIMARY NOTIFICATION WITH SECURITY message

If the UE receives the ETWS PRIMARY NOTIFICATION WITH SECURITY message on DCCH, the ETWS capable UE shall:

- 1> forward the ETWS primary notification to upper layers as specified in subclause 8.1.17.5.

If the UE receives the ETWS PRIMARY NOTIFICATION WITH SECURITY message, an ETWS incapable UE shall ignore this message.

8.1.17.5 Forward of the ETWS primary notification to the upper layers

If the UE has received the ETWS PRIMARY NOTIFICATION WITH SECURITY message on DCCH, the ETWS capable UE shall:

- 1> forward the content of the IE "ETWS information" received in the ETWS PRIMARY NOTIFICATION WITH SECURITY message to upper layers.

8.1.17.6 Void

8.2 Radio Bearer control procedures

8.2.1 Radio bearer establishment

See subclause 8.2.2 Reconfiguration procedures.

8.2.2 Reconfiguration procedures

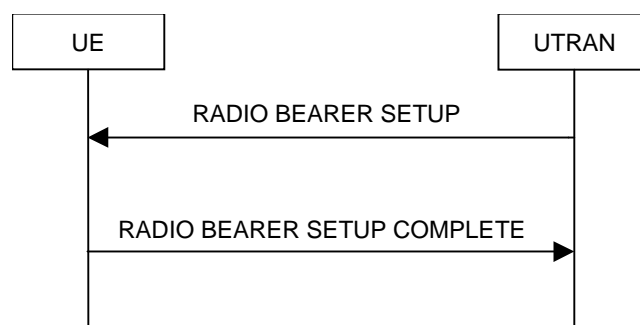

Figure 8.2.2-1: Radio Bearer Establishment, normal case

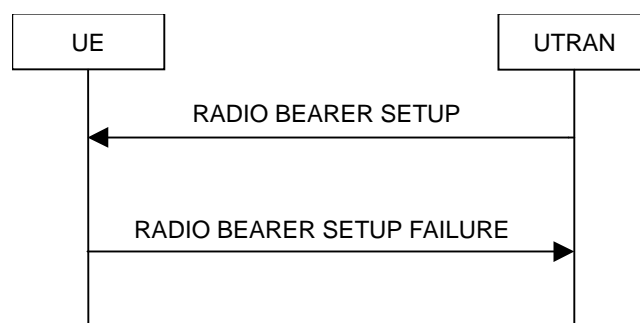

Figure 8.2.2-2: Radio Bearer Establishment, failure case

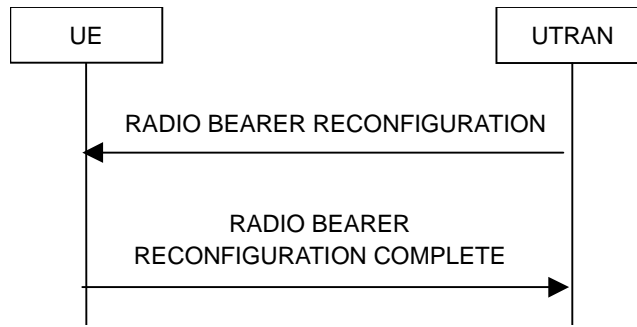

Figure 8.2.2-3: Radio bearer reconfiguration, normal flow

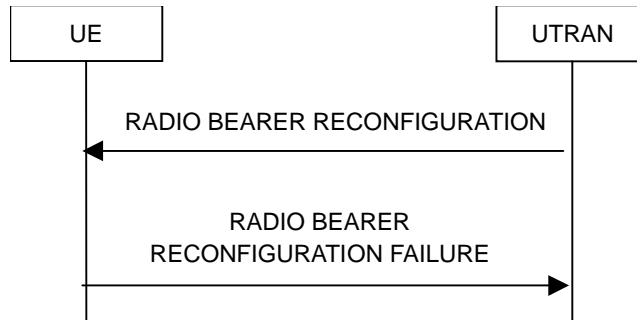

Figure 8.2.2-4: Radio bearer reconfiguration, failure case

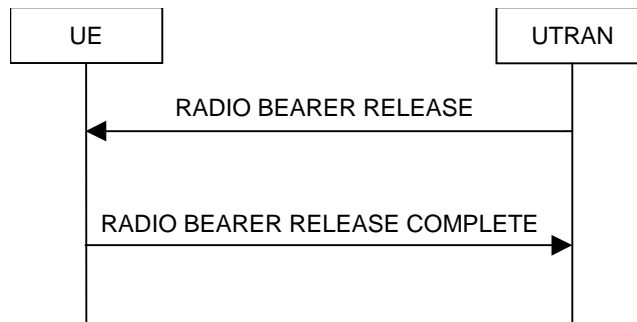

Figure 8.2.2-5: Radio Bearer Release, normal case

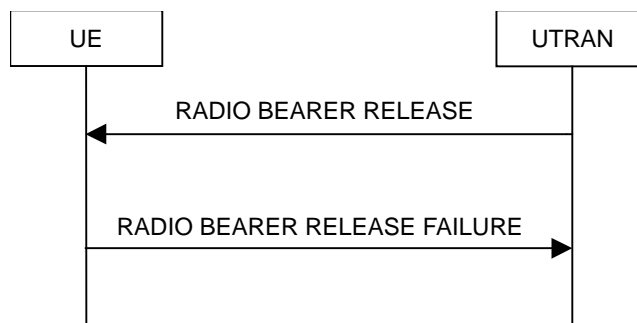

Figure 8.2.2-6: Radio Bearer Release, failure case

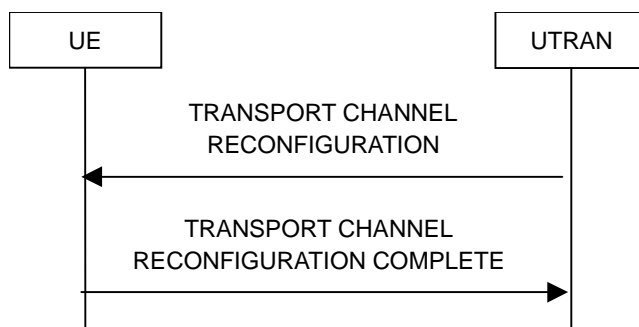

Figure 8.2.2-7: Transport channel reconfiguration, normal flow

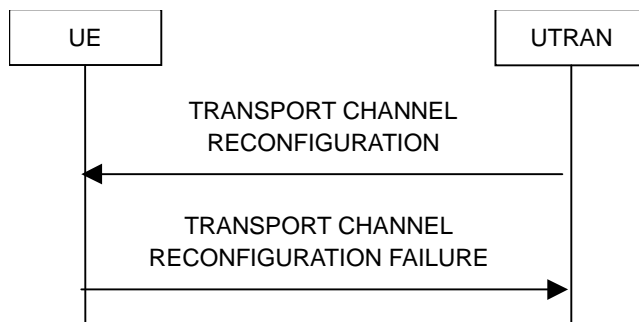

Figure 8.2.2-8: Transport channel reconfiguration, failure case

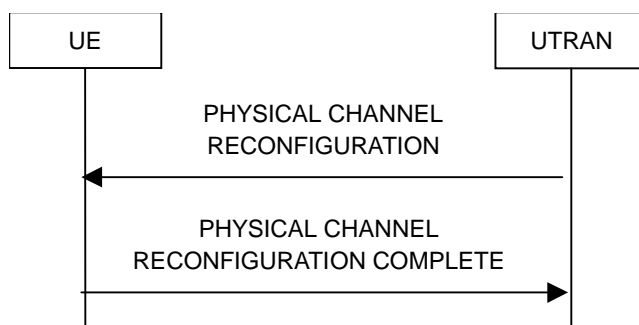

Figure 8.2.2-9: Physical channel reconfiguration, normal flow

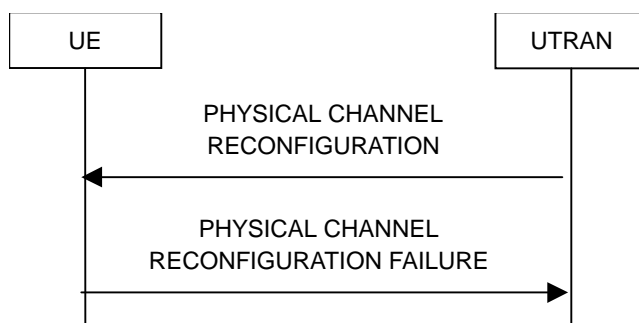

Figure 8.2.2-10: Physical channel reconfiguration, failure case

8.2.2.1 General

Reconfiguration procedures include the following procedures:

- the radio bearer establishment procedure;
- radio bearer reconfiguration procedure;

- the radio bearer release procedure;
- the transport channel reconfiguration procedure; and
- the physical channel reconfiguration procedure.

The radio bearer establishment procedure is used to establish new radio bearer(s).

The radio bearer reconfiguration procedure is used to reconfigure parameters for a radio bearer.

The radio bearer release procedure is used to release radio bearer(s).

The transport channel reconfiguration procedure is used to reconfigure transport channel parameters.

The physical channel reconfiguration procedure is used to establish, reconfigure and release physical channels.

While performing any of the above procedures, these procedures may perform a hard handover (subclause 8.3.5) and/or an HS-DSCH cell change and/or a serving E-DCH cell change. The reconfiguration procedures are also used to change the feedback configuration for HS-DSCH.

8.2.2.2 Initiation

To initiate any one of the reconfiguration procedures, UTRAN should:

- 1> configure new radio links in any new physical channel configuration;
- 1> start transmission and reception on the new radio links;
- 1> for a radio bearer establishment procedure:
 - 2> transmit a RADIO BEARER SETUP message on the downlink DCCH using AM or UM RLC;
 - 2> if signalling radio bearer RB4 is setup with this procedure and signalling radio bearers RB1-RB3 were already established prior to the procedure:
 - 3> if the variable "LATEST_CONFIGURED_CN_DOMAIN" has been initialised:
 - 4> connect any radio bearers setup by the same message as signalling radio bearer RB4 to the CN domain indicated in the variable "LATEST_CONFIGURED_CN_DOMAIN".
- 1> for a radio bearer reconfiguration procedure:
 - 2> transmit a RADIO BEARER RECONFIGURATION message on the downlink DCCH using AM or UM RLC.
- 1> for a radio bearer release procedure:
 - 2> transmit a RADIO BEARER RELEASE message on the downlink DCCH using AM or UM RLC.
- 1> for a transport channel reconfiguration procedure:
 - 2> transmit a TRANSPORT CHANNEL RECONFIGURATION message on the downlink DCCH using AM or UM RLC.
- 1> for a physical channel reconfiguration procedure:
 - 2> transmit a PHYSICAL CHANNEL RECONFIGURATION message on the downlink DCCH using AM or UM RLC.
- 1> if the reconfiguration procedure is simultaneous with SRNS relocation procedure:
 - 2> if the transmitted message is a RADIO BEARER RECONFIGURATION:
 - 3> include the IE "New U-RNTI".
 - 2> else:

- 3> include the IE "Downlink counter synchronisation info".
- 2> if ciphering and/or integrity protection are activated:
 - 3> include new ciphering and/or integrity protection configuration information to be used after reconfiguration.
- 2> use the downlink DCCH using AM RLC.
- 1> if transport channels are added, reconfigured or deleted in uplink and/or downlink:
 - 2> set TFCS according to the new transport channel(s).
- 1> if transport channels are added or deleted in uplink and/or downlink, and RB Mapping Info applicable to the new configuration has not been previously provided to the UE, the UTRAN should:
 - 2> send the RB Mapping Info for the new configuration.
- 1> if the UE supports the UM RLC re-establishment via reconfiguration; and
- 1> if one or more UM RLC radio bearers are re-established:
 - 2> transmit a reconfiguration message on the downlink DCCH using AM or UM RLC;
 - 2> include the IE "UM RLC re-establishment RB List" and include the Radio Bearer ID encountered the error in the list.

In the Radio Bearer Reconfiguration procedure UTRAN may indicate that uplink transmission shall be stopped or continued on certain radio bearers. Uplink transmission on a signalling radio bearer used by the RRC signalling (signalling radio bearer RB1 or signalling radio bearer RB2) should not be stopped.

NOTE 1: The Release '99 RADIO BEARER RECONFIGURATION message always includes the IE "RB information to reconfigure", even if UTRAN does not require the reconfiguration of any RB. In these cases, UTRAN may include only the IE "RB identity" within the IE "RB information to reconfigure".

NOTE 2: The Release '99 RADIO BEARER RECONFIGURATION message always includes the IE "Downlink information per radio link list", even if UTRAN does not require the reconfiguration of any RL. In these cases, UTRAN may re-send the currently assigned values for the mandatory IEs included within the IE "Downlink information per radio link list".

NOTE 3: The Release '99 RADIO BEARER RECONFIGURATION message always includes the IE "Primary CPICH Info" (FDD) or IE "Primary CCPCH Info" (TDD) within IE "Downlink information per radio link list". This implies that in case UTRAN applies the RADIO BEARER RECONFIGURATION message to move the UE to CELL_FACH state, it has to indicate a cell. However, UTRAN may indicate any cell; the UE anyhow performs cell selection and notifies UTRAN if it selects another cell than indicated by UTRAN.

If the IE "Activation Time" is included, UTRAN should set it to a value taking the UE performance requirements into account.

UTRAN should take the UE capabilities into account when setting the new configuration.

If the message is used to initiate a transition from CELL_DCH to CELL_FACH state, the UTRAN may assign a C-RNTI to be used in that cell by the UE. In FDD and 1.28 Mcps TDD, if a C-RNTI is assigned, then UTRAN may additionally assign an H-RNTI and an E-RNTI to be used in that cell by the UE.

For FDD and 1.28 Mcps TDD, if the message is used to initiate a transition to CELL_PCH state, the UTRAN may assign a C-RNTI, an H-RNTI and an E-RNTI to be used in that cell by the UE.

8.2.2.2a Initiation of handover from GERAN *Iu mode*

To initiate the handover from GERAN *Iu mode*, UTRAN should:

- 1> provide a RADIO BEARER RECONFIGURATION message to be encapsulated in INTERSYSTEM HANDOVER TO UTRAN COMMAND message, sent on the downlink SRB2 in GERAN *Iu mode*.

1> in case UTRAN decides to use a predefined or default radio configuration that is stored in the UE, it should include the following information in the RADIO BEARER RECONFIGURATION message:

- PhyCH information elements; and
- either:
 - the IE "Predefined configuration identity", to indicate which pre-defined configuration of RB, transport channel and physical channel parameters shall be used; or
 - the IE "Default configuration mode" and IE "Default configuration identity", to indicate which default configuration of RB, transport channel and physical channel parameters shall be used.

8.2.2.3 Reception of RADIO BEARER SETUP or RADIO BEARER RECONFIGURATION or RADIO BEARER RELEASE or TRANSPORT CHANNEL RECONFIGURATION or PHYSICAL CHANNEL RECONFIGURATION message, TTI switch HS-SCCH order or Target cell HS-SCCH order by the UE

The UE shall:

1> be able to receive any of the following messages:

- 2> RADIO BEARER SETUP message; or
- 2> RADIO BEARER RECONFIGURATION message; or
- 2> RADIO BEARER RELEASE message; or
- 2> TRANSPORT CHANNEL RECONFIGURATION message; or
- 2> PHYSICAL CHANNEL RECONFIGURATION message;

1> be able to perform a hard handover and apply physical layer synchronisation procedure A as specified in [29], even if no prior UE measurements have been performed on the target cell and/or frequency.

For FDD: in case a measurement report was triggered by intra frequency event 1d and if the table "Target cell preconfigurations" in the variable TARGET_CELL_PRECONFIGURATION includes the cell that triggered the event, or in case a measurement report was triggered by intra frequency event 1c requesting the serving HS-DSCH cell change and if the table "Target cell preconfigurations" in the variable TARGET_CELL_PRECONFIGURATION includes the target cell, as per the definition of Target cell HS-SCCH order

the UE shall be able to receive:

- 1> Target cell HS-SCCH order.

For FDD: in case a filtered UPH report [15] was triggered the UE shall be able to receive:

- 1> TTI switch HS-SCCH order.

In case the reconfiguration procedure is used to remove all existing RL(s) in the active set while new RL(s) are established the UE shall:

1> For FDD:

- 2> if the UE has a pending "TGPS reconfiguration CFN" at the activation time received in the reconfiguration message and the reconfiguration requests a timing re-initialised hard handover (see subclause 8.3.5.1), the UE may:
 - 3> abort the pending CM activation;
 - 3> set the CM_PATTERN_ACTIVATION_ABORTED to TRUE.
- 2> otherwise:
 - 3> set the CM_PATTERN_ACTIVATION_ABORTED to FALSE.

If the UE receives:

- a RADIO BEARER SETUP message; or
- a RADIO BEARER RECONFIGURATION message; or
- a RADIO BEARER RELEASE message; or
- a TRANSPORT CHANNEL RECONFIGURATION message; or
- a PHYSICAL CHANNEL RECONFIGURATION message; or
- a TTI switch HS-SCCH order; or
- a Target cell HS-SCCH order

it shall:

- 1> stop and reset timer T324 if running;
- 1> stop monitoring target cell HS-SCCH;
- 1> set the variable ORDERED_RECONFIGURATION to TRUE;
- 1> if the UE will enter the CELL_DCH state from any state other than CELL_DCH state at the conclusion of this procedure:
 - 2> if COMMON_E_DCH_TRANSMISSION is set to FALSE before entering CELL_DCH state or IE "E-DCH info" is not included in the reconfiguration message:
 - 3> perform the physical layer synchronisation procedure A as specified in [29] (FDD only).
- 1> if the UE has received a Target cell HS-SCCH order:
 - 2> if the IE "Serving Cell Change MAC reset" in the target cell preconfiguration is set to TRUE:
 - 3> reset the MAC-hs/ehs entity [15].
 - 2> else:
 - 3> determine the value for the "TPC combination index" for current cell and the cell in which the Target cell HS-SCCH order is received;
 - 3> if the values of the IE "TPC combination index" for current cell and the cell in which the Target cell HS-SCCH order is received are different:
 - 4> reset the MAC-hs/ehs entity [15].
- 1> act upon all received information elements, or Target cell preconfiguration information in the case of received Target cell HS-SCCH order, as specified in subclause 8.6, unless specified in the following and perform the actions below.
- 1> in the case of received TTI switch HS-SCCH order, perform the actions as described in 8.5.86.

The UE may:

- 1> maintain a list of the set of cells to which the UE has Radio Links if the IE "Cell ID" is present.

The UE may first release the physical channel configuration used at reception of the reconfiguration message. The UE shall then:

- 1> enter a state according to subclause 8.6.3.3.

In case the UE receives a RADIO BEARER RECONFIGURATION message including the IE "RB information to reconfigure" that only includes the IE "RB identity", the UE shall:

- 1> handle the message as if IE "RB information to reconfigure" was absent.

NOTE: The ASN.1 "r3" version of the RADIO BEARER RECONFIGURATION message always includes the IE "RB information to reconfigure". UTRAN has to include it even if it does not require the reconfiguration of any RB.

In case the UE receives a RADIO BEARER RECONFIGURATION message with the IE "Specification mode" set to "Preconfiguration" while the message is not sent through GERAN *Iu mode*, the UE behaviour is unspecified.

In case the UE receives a RADIO BEARER SETUP message with the IE "Specification mode" not set to "Complete Specification", the UE behaviour is unspecified.

The UE shall:

- 1> if IE "Default configuration for CELL_FACH" is set:
 - 2> if the message is RADIO BEARER RECONFIGURATION:
 - 3> if IE "new U-RNTI" is included:
 - 4> act in accordance with the default parameters according to section 13.8.
 - 3> else:
 - 4> the UE behaviour is unspecified.

For FDD: in CELL_DCH state, in case the UE receives a Target cell HS-SCCH order the UE shall:

- 1> ignore RADIO BEARER SETUP, RADIO BEARER RECONFIGURATION, TRANSPORT CHANNEL RECONFIGURATION or PHYSICAL CHANNEL RECONFIGURATION messages as described in subclause 8.6.3.11.

If after state transition the UE enters CELL_DCH state, the UE shall, after the state transition:

- 1> in FDD; or
- 1> in TDD when "Primary CCPCH Info" is included indicating a new target cell and "New C-RNTI" is not specified:
 - 2> remove any C-RNTI from MAC;
 - 2> clear the variable C_RNTI.
- 1> determine the value for the READY_FOR_COMMON_EDCH variable and take the corresponding actions as described in subclause 8.5.47;
- 1> determine the value for the COMMON_E_DCH_TRANSMISSION variable and take the corresponding actions as described in subclause 8.5.46;
- 1> for FDD, determine the value for the READY_FOR_COMMON_ERGCH variable and take the corresponding actions as described in subclause 8.5.75;
- 1> if the IE "E-DCH info" was not included in the message:
 - 2> for FDD:
 - 3> stop any E-AGCH, E-RGCH and E-HICH reception procedures;
 - 3> stop any E-DPCCH and E-DPDCH transmission procedures;
 - 3> act as if the IE "MAC-es/e reset indicator" was received and set to TRUE;
 - 3> release all E-DCH HARQ resources;
 - 3> no longer consider any radio link to be the serving E-DCH radio link.
 - 2> for 1.28 Mcps TDD:
 - 3> stop any E-AGCH and E-HICH reception procedures;

- 3> stop any E-RUCCH and E-PUCH transmission procedure;
- 3> act as if the IE "MAC-es/e reset indicator" was received and set to TRUE;
- 3> release all E-DCH HARQ resources;
- 3> no longer consider any radio link to be the serving E-DCH radio link.

If after state transition the UE leaves CELL_DCH state, the UE shall, before state transition:

- 1> clear any stored IE "E-DCH info";
- 1> for FDD, clear any stored IE "Secondary serving E-DCH cell info" and IE "Secondary E-DCH info common";
- 1> for 1.28Mcps TDD, clear any stored IE "Multi-carrier E-DCH Info for LCR TDD";
- 1> determine the value for the E_DCH_TRANSMISSION variable and take the corresponding actions as described in subclause 8.5.28.

If after state transition the UE leaves CELL_DCH state, the UE shall, after the state transition:

- 1> if any IEs related to HS-DSCH are stored in the UE:
 - 2> clear any stored IE "Downlink HS-PDSCH information";
 - 2> clear any stored IE "Downlink Secondary Cell Info FDD";
 - 2> clear all the entries from the variable TARGET_CELL_PRECONFIGURATION;
 - 2> for 1.28Mcps TDD, clear the IE "HS-PDSCH Midamble Configuration" and the IE "HS-SCCH Set Configuration" in the IE "DL Multi Carrier Information";
 - 2> determine the value for the HS_DSCH_RECEPTION variable and take the corresponding actions as described in subclause 8.5.25.
- 1> if any IEs related to E-DCH are stored in the UE:
 - 2> clear any stored IE "E-DCH info";
 - 2> for FDD, clear any stored IE "Secondary serving E-DCH cell info" and IE "Secondary E-DCH info common";
 - 2> for 1.28Mcps TDD, clear any stored IE "Multi-carrier E-DCH Info for LCR TDD";
 - 2> determine the value for the E_DCH_TRANSMISSION variable and take the corresponding actions as described in subclause 8.5.28.
- 1> if any of the IEs "DTX-DRX timing information" or "DTX-DRX information" are stored in the UE:
 - 2> determine the value for the DTX_DRX_STATUS variable and take the corresponding actions as described in subclause 8.5.34.
- 1> if the IE "HS-SCCH less information" is stored in the UE:
 - 2> determine the value for the HS_SCCH_LESS_STATUS variable and take the corresponding actions as described in subclause 8.5.35.
- 1> if any IEs related to MIMO are stored in the UE:
 - 2> determine the value for the MIMO_STATUS variable and take the corresponding actions as described in subclause 8.5.33.
- 1> if the IE "MIMO mode with four transmit antennas" is stored in the UE:
 - 2> determine the value for the MIMO_MODE_WITH_FOUR_TRANSMIT_ANTENNAS_STATUS variable and take the corresponding actions as described in subclause 8.5.79.
- 1> if the IE "UE Mobility State Indicator" was present in the reconfiguration message:

2> consider the High-mobility state to have being detected.

1> for 1.28 Mcps TDD, if the IEs "Control Channel DRX Information" is stored in the UE:

2> determine the value for the CONTROL_CHANNEL_DRX_STATUS variable and take the corresponding actions as described in subclause 8.5.53.

1> for 1.28 Mcps TDD, if the IE "SPS information" is stored in the UE:

2> determine the value for the E_DCH_SPS_STATUS variable and take the corresponding actions as described in subclause 8.5.54;

2> determine the value for the HS_DSCH_SPS_STATUS variable and take the corresponding actions as described in subclause 8.5.55.

1> for 1.28 Mcps TDD, if the IE "MU-MIMO info" is stored in the UE:

2> determine the value for the MU_MIMO_STATUS variable and take the corresponding actions as described in subclause 8.5.61.

1> for FDD, if the IE "Uplink CLTD info FDD" is stored in the UE:

2> determine the value for the UPLINK_CLTD_TRANSMISSION variable and take the corresponding actions as described in subclause 8.5.69.

1> for FDD, if the IE "Uplink OLTD info FDD" is stored in the UE:

2> determine the value for the UPLINK_OLTD_TRANSMISSION variable and take the corresponding actions as described in subclause 8.5.70.

1> for FDD, clear the IE "Radio Links without DPCH/F-DPCH info", if stored;

1> for FDD, if the IE "DPCCH2 info FDD" is stored in the UE:

2> determine the value for the DPCCH2_TRANSMISSION variable and take the corresponding actions as described in subclause 8.5.83.

For 1.28 Mcps TDD, if the UE supports the non-rectangular resource allocation, the UE shall:

1> determine the value for the NON_RECTANGULAR_RESOURCE_ALLOCATION_STATUS variable and take the corresponding actions as described in subclause 8.5.82.

If the UE was in CELL_DCH state upon reception of the reconfiguration message and remains in CELL_DCH state, the UE shall:

1> if the IE "Uplink DPCH Info" is absent, not change its current UL Physical channel configuration;

1> for FDD:

2> determine the value for the SECONDARY_CELL_HS_DSCH_RECEPTION variable and take the corresponding actions as described in subclause 8.5.51.

2> determine the value for the SECONDARY_CELL_E_DCH_TRANSMISSION and take the corresponding actions as described in subclause 8.5.58.

2> if the variable SECONDARY_CELL_E_DCH_TRANSMISSION is set to TRUE:

3> if the IE "Secondary E-DCH info common" is included and the IE "Frequency info" is different from the stored "Frequency info" in the IE "Secondary E-DCH info common"; or

3> if the IE "Frequency info" is included in an IE other than the IE "Uplink secondary cell info FDD":

4> consider the secondary uplink frequency as not activated and take the corresponding actions as described in subclause 8.5.58.

3> else:

- 4> if the IE "Downlink information per radio link list on secondary UL frequency" is not included in the received message:
 - 5> keep the current activation status of the secondary uplink frequency and take the corresponding actions as described in subclause 8.5.58.
- 2> determine the value for the UPLINK_CLTD_TRANSMISSION variable and take the corresponding actions as described in subclause 8.5.69.
- 2> determine the value for the UPLINK_OLTD_TRANSMISSION variable and take the corresponding actions as described in subclause 8.5.70.
- 2> determine the value for the DPCCH2_TRANSMISSION variable and take the corresponding actions as described in subclause 8.5.83.
- 1> in TDD:
 - 2> if "Primary CCPCH Info" is included indicating a new target cell and "New C-RNTI" is not specified:
 - 3> remove any C-RNTI from MAC;
 - 3> clear the variable C_RNTI.
 - 2> if "Primary CCPCH Info" is included indicating a new target cell and "New H-RNTI" is not specified:
 - 3> remove any H-RNTI from MAC;
 - 3> clear the variable H_RNTI;
 - 3> determine the value for the HS_DSCH_RECEPTION variable and take the corresponding actions as described in subclause 8.5.25.
 - 2> if the reconfiguration message caused a change from FDD mode to 3.84/7.68 Mcps TDD mode and provides for E-DCH/HS-DSCH operation without an uplink DPCH:
 - 3> the UE shall obtain timing advance for the 3.84/7.68 Mcps TDD cell according to [15].
- 1> if "DPCH frame offset" is included for one or more RLS in the active set, and the reconfiguration procedure does not request a timing reinitialized hard handover (see subclause 8.3.5.1):
 - 2> use its value to determine the beginning of the DPCH or F-DPCH frame in accordance with the following:
 - 3> if the received IE "DPCH frame offset" is across the value range border compared to the DPCH or F-DPCH frame offset currently used by the UE:
 - 4> consider it to be a request to adjust the timing with 256 chips across the frame border (e.g. if the UE receives value 0 while the value currently used is 38144 consider this as a request to adjust the timing with +256 chips).
 - 3> if after taking into account value range borders, the received IE "DPCH frame offset" corresponds to a request to adjust the timing with a step exceeding 256 chips:
 - 4> set the variable INVALID_CONFIGURATION to TRUE.
 - 3> and the procedure ends.
- 2> adjust the radio link timing accordingly.

If after state transition the UE enters CELL_FACH state, the UE shall, after the state transition:

- 1> if the UE was in CELL_DCH state upon reception of the reconfiguration message:
 - 2> clear the variable E_RNTI.
- 1> if the IE "new Primary E-RNTI" is included in the received reconfiguration message:
 - 2> store the "new Primary E-RNTI" according to subclause 8.6.3.14.

- 1> determine the value for the READY_FOR_COMMON_EDCH variable and take the corresponding actions as described in subclause 8.5.47;
- 1> determine the value for the COMMON_E_DCH_TRANSMISSION variable and take the corresponding actions as described in subclause 8.5.46;
- 1> for FDD, determine the value for the READY_FOR_COMMON_ERGCH variable and take the corresponding actions as described in subclause 8.5.75;
- 1> for 1.28 Mcps TDD, determine the value for the MU_MIMO_STATUS variable and take the corresponding actions as described in subclause 8.5.61;
- 1> if the IE "Frequency info" is included in the received reconfiguration message:
 - 2> select a suitable UTRA cell according to [4] on that frequency;
 - 2> if the UE finds a suitable UTRA cell on that frequency:
 - 3> if the received reconfiguration message included the IE "Primary CPICH info" (for FDD) or "Primary CCPCH info" (for TDD), and the UE selects another cell than indicated by this IE or the received reconfiguration message did not include the IE "Primary CPICH info" (for FDD) or "Primary CCPCH info" (for TDD):
 - 4> initiate a cell update procedure according to subclause 8.3.1 using the cause "Cell reselection";
 - 4> when the cell update procedure completed successfully:
 - 5> if the UE is in CELL_PCH or URA_PCH state:
 - 6> if variable READY_FOR_COMMON_EDCH is set to TRUE:
 - 7> move to CELL_FACH state and proceed as below.
 - 6> else:
 - 7> if variable H_RNTI and variable C_RNTI are set:
 - 8> proceed as below.
 - 7> else:
 - 8> initiate a cell update procedure according to subclause 8.3.1 using the cause "Uplink data transmission" and proceed as below.
 - 3> else:
 - 4> for 1.28Mcps TDD, decide the working frequency according to subclause 8.6.6.1.
 - 2> else, if the UE can not find a suitable UTRA cell on that frequency but it finds a suitable UTRA cell on another frequency:
 - 3> initiate a cell update procedure according to subclause 8.3.1 using the cause "Cell reselection";
 - 3> when the cell update procedure completed successfully:
 - 4> if the UE is in CELL_PCH or URA_PCH state:
 - 5> if variable READY_FOR_COMMON_EDCH is set to TRUE:
 - 6> move to CELL_FACH state and proceed as below.
 - 5> else:
 - 6> if variable H_RNTI and variable C_RNTI are set:
 - 7> proceed as below.
 - 6> else:

- 7> initiate a cell update procedure according to subclause 8.3.1 using the cause "Uplink data transmission" and proceed as below.
- 1> if the IE "Frequency info" is not included in the received reconfiguration message:
 - 2> select a suitable UTRA cell according to [4];
 - 2> if the UE finds a suitable UTRA cell on the current frequency:
 - 3> if the received reconfiguration message included the IE "Primary CPICH info" (for FDD) or "Primary CCPCH info" (for TDD), and the UE selects another cell than indicated by this IE or the received reconfiguration message did not include the IE "Primary CPICH info" (for FDD) or "Primary CCPCH info" (for TDD):
 - 4> initiate a cell update procedure according to subclause 8.3.1 using the cause "Cell reselection";
 - 4> when the cell update procedure completed successfully:
 - 5> if the UE is in CELL_PCH or URA_PCH state:
 - 6> if variable READY_FOR_COMMON_EDCH is set to TRUE:
 - 7> move to CELL_FACH state and proceed as below.
 - 6> else:
 - 7> if variable H_RNTI and variable C_RNTI are set:
 - 8> proceed as below.
 - 7> else:
 - 8> initiate a cell update procedure according to subclause 8.3.1 using the cause "Uplink data transmission" and proceed as below.
 - 3> else:
 - 4> for 1.28Mcps TDD, decide the working frequency according to subclause 8.6.6.1.
 - 2> else, if the UE can not find a suitable UTRA cell on the current frequency but it finds a suitable UTRA cell on another frequency:
 - 3> initiate a cell update procedure according to subclause 8.3.1 using the cause "Cell reselection";
 - 3> when the cell update procedure completed successfully:
 - 4> if the UE is in CELL_PCH or URA_PCH state:
 - 5> if variable READY_FOR_COMMON_EDCH is set to TRUE:
 - 6> move to CELL_FACH state and proceed as below.
 - 5> else:
 - 6> if variable H_RNTI and variable C_RNTI are set:
 - 7> proceed as below.
 - 6> else:
 - 7> initiate a cell update procedure according to subclause 8.3.1 using the cause "Uplink data transmission" and proceed as below.
 - 1> start timer T305 using its initial value if timer T305 is not running and if periodical update has been configured by T305 in the IE "UE Timers and constants in connected mode" set to any other value than "infinity" in the variable TIMERS_AND_CONSTANTS;
 - 1> if variable READY_FOR_COMMON_EDCH is set to FALSE:

- 2> select PRACH according to subclause 8.5.17;
- 1> else:
 - 2> configure the Enhanced Uplink in CELL_FACH state and Idle mode as specified in subclause 8.5.45 for FDD and 8.5.45a for 1.28 Mcps TDD.
 - 1> for 3.84 Mcps and 1.28 Mcps TDD; or
 - 1> for FDD, if the UE does not support HS-DSCH reception in CELL_FACH state; or
 - 1> if the IE "HS-DSCH common system information" is not included in System Information Block type 5 or System Information Block type 5bis; or
 - 1> for 1.28 Mcps TDD, if the IE "Common E-DCH system info" is not included in System Information Block type 5:
 - 2> select Secondary CCPCH according to subclause 8.5.19;
 - 2> use the transport format set given in system information;
 - 2> take the actions related to the HS_DSCH_RECEPTION_GENERAL variable as described in subclause 8.5.37a.
 - 1> else:
 - 2> for FDD if variable READY_FOR_COMMON_EDCH is set to FALSE:
 - 3> if the RBs have the multiplexing option with transport channel type "HS-DSCH" for the DL and transport channel type "RACH" in the UL; and
 - 3> if variable H_RNTI and variable C_RNTI are set:
 - 4> start to receive HS-DSCH according to the procedure in subclause 8.5.36.
 - 3> else:
 - 4> clear variable C_RNTI and delete any stored C-RNTI value;
 - 4> clear variable H_RNTI and delete any stored H-RNTI value;
 - 4> clear any stored IE "HARQ Info".
 - 2> else:
 - 3> if the RBs have the multiplexing option with transport channel type "HS-DSCH" for the DL and transport channel type "E-DCH" in the UL; and
 - 3> if variable E_RNTI, variable H_RNTI and variable C_RNTI are set:
 - 4> start to receive HS-DSCH according to the procedure in subclause 8.5.36.
 - 3> else:
 - 4> clear variable C_RNTI and delete any stored C-RNTI value;
 - 4> clear variable H_RNTI and delete any stored H-RNTI value;
 - 4> clear variable E_RNTI and delete any stored E-RNTI value;
 - 4> clear any stored IE "HARQ Info".
 - 1> if the IE "UTRAN DRX cycle length coefficient" is included in the same message:
 - 2> ignore that IE and stop using DRX.
 - 1> if the UE supports RAN-assisted WLAN interworking:

- 2> stop the timer T330 if it is running;
- 2> if the variable WLAN_OFFLOAD_INFO is not empty:
 - 3> use the information stored in the variable WLAN_OFFLOAD_INFO as specified in [4], and forward it to the upper layers.
- 2> else:
 - 3> use the information stored in the variable SYSTEM_INFO_WLAN_OFFLOAD_INFO as specified in [4] and forward it to the upper layers.
- 1> if the contents of the variable C_RNTI is empty:
 - 2> perform a cell update procedure according to subclause 8.3.1 using the cause "Cell reselection";
 - 2> when the cell update procedure completed successfully:
 - 3> if the UE is in CELL_PCH or URA_PCH state:
 - 4> initiate a cell update procedure according to subclause 8.3.1 using the cause "Uplink data transmission";
 - 4> proceed as below.

If the UE was in CELL_FACH state upon reception of the reconfiguration message and remains in CELL_FACH state, the UE shall:

- 1> determine the value for the READY_FOR_COMMON_EDCH variable and take the corresponding actions as described in subclause 8.5.47;
- 1> determine the value for the COMMON_E_DCH_TRANSMISSION variable and take the corresponding actions as described in subclause 8.5.46;
- 1> for FDD, determine the value for the READY_FOR_COMMON_ERGCH variable and take the corresponding actions as described in subclause 8.5.75;
- 1> for 1.28 Mcps TDD, determine the value for the MU_MIMO_STATUS variable and take the corresponding actions as described in subclause 8.5.61;
- 1> if the IE "Frequency info" is included in the received reconfiguration message:
 - 2> select a suitable UTRA cell according to [4] on that frequency;
 - 2> if the UE finds a suitable UTRA cell on that frequency:
 - 3> if the received reconfiguration message included the IE "Primary CPICH info" (for FDD) or "Primary CCPCH info" (for TDD), and the UE selected another cell than indicated by this IE or the received reconfiguration message did not include the IE "Primary CPICH info" (for FDD) or "Primary CCPCH info" (for TDD):
 - 4> initiate a cell update procedure according to subclause 8.3.1 using the cause "cell reselection";
 - 4> when the cell update procedure completed successfully:
 - 5> if the UE is in CELL_PCH or URA_PCH state:
 - 6> if variable READY_FOR_COMMON_EDCH is set to TRUE:
 - 7> move to CELL_FACH state and proceed as below.
 - 6> else:
 - 7> if variable H_RNTI and variable C_RNTI are set:
 - 8> proceed as below.
 - 7> else:

- 8> initiate a cell update procedure according to subclause 8.3.1 using the cause "Uplink data transmission" and proceed as below.
- 2> else, if the UE can not find a suitable UTRA cell on that frequency but it finds a suitable UTRA cell on another frequency:
 - 3> initiate a cell update procedure according to subclause 8.3.1 using the cause "Cell reselection";
 - 3> when the cell update procedure completed successfully:
 - 4> if the UE is in CELL_PCH or URA_PCH state:
 - 5> if variable READY_FOR_COMMON_EDCH is set to TRUE:
 - 6> move to CELL_FACH state and proceed as below.
 - 5> else:
 - 6> if variable H_RNTI and variable C_RNTI are set:
 - 7> proceed as below.
 - 6> else:
 - 7> initiate a cell update procedure according to subclause 8.3.1 using the cause "Uplink data transmission" and proceed as below.
 - 1> if the IE "Frequency info" is not included in the received reconfiguration message:
 - 2> if the IE "Primary CPICH info" (for FDD) or "Primary CCPCH info" (for TDD) is included the UE shall either:
 - 3> ignore the content of the IE "Primary CPICH info" (for FDD) or "Primary CCPCH info" (for TDD) and proceed as below;
 - 2> or:
 - 3> if the received reconfiguration message included the IE "Primary CPICH info" (for FDD) or "Primary CPCH info" (for TDD), and it is different from the current cell:
 - 4> initiate a cell update procedure according to subclause 8.3.1 using the cause "Cell reselection";
 - 4> when the cell update procedure completed successfully:
 - 5> if the UE is in CELL_PCH or URA_PCH state:
 - 6> if variable READY_FOR_COMMON_EDCH is set to TRUE:
 - 7> move to CELL_FACH state and proceed as below.
 - 6> else:
 - 7> if variable H_RNTI and variable C_RNTI are set:
 - 8> proceed as below.
 - 7> else:
 - 8> initiate a cell update procedure according to subclause 8.3.1 using the cause "Uplink data transmission" and proceed as below.

If after state transition the UE leaves CELL_FACH state, the UE shall:

- 1> stop timer T305.

If after state transition the UE enters CELL_PCH or URA_PCH state, the UE shall:

- 1> if the UE enters CELL_PCH state:

- 2> if the UE supports E-DCH transmission in CELL_FACH state and Idle mode and the IE "Common E-DCH system info" is included in system information block type 5 or 5bis:
 - 3> if variable H_RNTI or variable C_RNTI or variable E_RNTI is not set:
 - 4> clear variable C_RNTI and delete any stored C-RNTI value;
 - 4> clear variable H_RNTI and delete any stored H-RNTI value;
 - 4> clear variable E_RNTI and delete any stored E-RNTI value;
 - 4> clear any stored IE "HARQ Info";
 - 4> reset the MAC-ehs entity [15];
 - 4> reset the MAC-i/is entity [15].
- 1> determine the value for the HSPA_RNTI_STORED_CELL_PCH variable and take the corresponding actions as described in subclause 8.5.56;
- 1> determine the value for the READY_FOR_COMMON_EDCH variable and take the corresponding actions as described in subclause 8.5.47;
- 1> determine the value for the COMMON_E_DCH_TRANSMISSION variable and take the corresponding actions as described in subclause 8.5.46;
- 1> for FDD, determine the value for the READY_FOR_COMMON_ERGCH variable and take the corresponding actions as described in subclause 8.5.75;
- 1> if the IE "UTRAN DRX cycle length coefficient" is not included in the same message:
 - 2> set the variable INVALID_CONFIGURATION to TRUE.
- 1> if the UE supports RAN-assisted WLAN interworking:
 - 2> if timer T330 is not configured:
 - 3> clear the variable WLAN_OFFLOAD_INFO;
 - 3> use the information stored in the variable SYSTEM_INFO_WLAN_OFFLOAD_INFO as specified in [4], and forward it to the upper layers.
 - 2> else:
 - 3> if timer T330 is not running:
 - 4> start the timer T330;
 - 4> use the information stored in the variable WLAN_OFFLOAD_INFO as specified in [4], and forward it to the upper layers.

The UE shall transmit a response message as specified in subclause 8.2.2.4, setting the information elements as specified below. The UE shall:

- 1> if the received reconfiguration message included the IE "Downlink counter synchronisation info"; or
- 1> if the received reconfiguration message is a RADIO BEARER RECONFIGURATION and the IE "New U-RNTI" is included; or
- 1> if the received reconfiguration message included the IE "SR-VCC Info":
 - 2> if the variable PDCP_SN_INFO is empty:
 - 3> configure the corresponding RLC entity for all AM and UM radio bearers and AM and UM signalling radio bearers except RB2 to "stop".
 - 2> else:

- 3> configure the RLC entity for signalling radio bearers RB1, RB3 and RB4 to "stop";
- 3> configure the RLC entity for UM and AM radio bearers for which the IE "PDCP SN Info" is not included to "stop".
- 2> re-establish the RLC entity for RB2;
- 2> clear all entries in the table "Processed transactions" in the variable TRANSACTIONS;
- 2> for the downlink and the uplink, apply the ciphering configuration as follows:
 - 3> if the received re-configuration message included the IE "Ciphering Mode Info":
 - 4> use the ciphering configuration in the received message when transmitting the response message.
 - 3> if the ciphering configuration for RB2 from a previously received SECURITY MODE COMMAND has not yet been applied because the activation times not having been reached:
 - 4> if the previous SECURITY MODE COMMAND was received due to new keys being received:
 - 5> consider the new ciphering configuration to include the received new keys;
 - 5> initialise the HFN component of the uplink COUNT-C and downlink COUNT-C of SRB2 as indicated in subclause 8.1.12.3.1.
 - 4> else if the ciphering configuration for RB2 from a previously received SECURITY MODE COMMAND has not yet been applied because of the corresponding activation times not having been reached and the previous SECURITY MODE COMMAND caused a change in LATEST_CONFIGURED_CN_DOMAIN:
 - 5> consider the new ciphering configuration to include the keys associated with the LATEST_CONFIGURED_CN_DOMAIN;
 - 5> initialise the HFN component of the uplink COUNT-C and downlink COUNT-C of SRB2 to the most recently transmitted IE "START list" or IE "START" for the LATEST_CONFIGURED_CN_DOMAIN at the reception of the previous SECURITY MODE COMMAND.
 - 4> apply the new ciphering configuration immediately following RLC re-establishment.
- 3> else:
 - 4> continue using the current ciphering configuration.
- 2> set the new uplink and downlink HFN component of COUNT-C of RB2 to MAX(uplink HFN component of COUNT-C of RB2, downlink HFN component of COUNT-C of RB2);
- 2> increment by one the downlink and uplink values of the HFN of COUNT-C for RB2;
- 2> calculate the START value according to subclause 8.5.9;
- 2> include the calculated START values for each CN domain in the IE "START list" in the IE "Uplink counter synchronisation info";
- 2> For any measurement of type CSG Proximity detection or any measurement associated with CELL_INFO_CSG_LIST (i.e.CSG Proximity detection, CSG intra-frequency measurement, CSG inter-frequency measurement and/or SI acquisition):
 - 3> stop all measurements of type CSG Proximity detection and all measurements associated with CELL_INFO_CSG_LIST (i.e.CSG Proximity detection, CSG intra-frequency measurement, CSG inter-frequency measurement and/or SI acquisition);
 - 3> delete measurement control information for all measurements of type CSG Proximity detection and all measurements associated with CELL_INFO_CSG_LIST (i.e.CSG Proximity detection, CSG intra-frequency measurement, CSG inter-frequency measurement and/or SI acquisition);
- 3> clear the variable CELL_INFO_CSG_LIST.

- 2> if timer T323 value is stored in the IE "UE Timers and constants in connected mode" in the variable TIMERS_AND_CONSTANTS:
 - 3> stop and reset timer T323;
 - 3> clear any value of the timer T323 stored in the IE "UE Timers and constants in connected mode" in the variable TIMERS_AND_CONSTANTS.
- 2> if after state transition the UE enters CELL_DCH state:
 - 3> clear the variable DSAC_PARAM, the variable PPAC_PARAM, the variable EAB_PARAM, the variable DSAC_PARAM_2, the variable PPAC_PARAM_2, the variable CONNECTED_MODE_ACCESS_CONTROL and the stored IE "Access Class Barred List" if stored.
- 1> else if the received reconfiguration message included the IE "UM RLC re-establishment RB List":
 - 2> for each radio bearer included in the IE "UM RLC re-establishment RB List"
 - 3> if the radio bearer uses UM RLC:
 - 4> calculate the START value according to subclause 8.5.9;
 - 4> include the calculated START values for the CN domain associated with the radio bearer in the IE "START list" in the IE "Uplink counter synchronisation info";
 - 3> re-establish the UM RLC entities for the radio bearer and set the first 20 bits of all the HFN component of the respective COUNT-C values to the latest transmitted START value for the CN domain associated with the radio bearer;
 - 3> set the remaining bits of the HFN component of COUNT-C values of all the re-established UM RLC entities to zero.
- 1> if the received reconfiguration message did not include the IE "Downlink counter synchronisation info":
 - 2> if the variable START_VALUE_TO_TRANSMIT is set:
 - 3> include and set the IE "START" to the value of that variable.
 - 2> if the variable START_VALUE_TO_TRANSMIT is not set and the IE "New U-RNTI" is included:
 - 3> calculate the START value according to subclause 8.5.9;
 - 3> include the calculated START values for each CN domain in the IE "START list" in the IE "Uplink counter synchronisation info".
 - 2> if the received reconfiguration message caused a change in the RLC PDU size, a change from flexible to fixed RLC PDU size or a change from fixed to flexible DL RLC PDU size with RLC length indicator set to 15 bits or a change of the RLC LI size for any RB using RLC-AM:
 - 3> calculate the START value according to subclause 8.5.9;
 - 3> include the calculated START values for the CN domain associated with the corresponding RB identity in the IE "START list" in the IE "Uplink counter synchronisation info".
- 1> if the received reconfiguration message contained the IE "Ciphering mode info" or contained the IE "Integrity protection mode info":
 - 2> set the IE "Status" in the variable SECURITY_MODIFICATION for all the CN domains in the variable SECURITY_MODIFICATION to "Affected".
- 1> if the received reconfiguration message contained the IE "Ciphering mode info":
 - 2> if the reconfiguration message is not used to perform an SRNS relocation, an SR-VCC or a handover from GERAN *Iu mode* with change of ciphering algorithm:
 - 3> the UE behaviour is not specified.

- 2> if the message is used to perform a timing re-initialised hard handover:
 - 3> if IE "Ciphering activation time for DPCH" is included:
 - 4> the UE behaviour is not specified.
 - 2> else:
 - 3> if the reconfiguration message is used to setup radio bearer(s) using RLC-TM; or
 - 3> if radio bearer(s) using RLC-TM already exist:
 - 4> if IE "Ciphering activation time for DPCH" is not included:
 - 5> the UE behaviour is not specified.
 - 1> if the received reconfiguration message contained the IE "Integrity Protection mode info":
 - 2> if the reconfiguration message is not used to perform an SRNS relocation, an SR-VCC or a handover from GERAN *Iu mode*:
 - 3> the UE behaviour is not specified.
 - 1> if the received reconfiguration message did not contain the IE "Ciphering activation time for DPCH" in IE "Ciphering mode info":
 - 2> if prior to this procedure there exist no transparent mode RLC radio bearers:
 - 3> if, at the conclusion of this procedure, the UE will be in CELL_DCH state; and
 - 3> if, at the conclusion of this procedure, at least one transparent mode RLC radio bearer exists:
 - 4> include the IE "COUNT-C activation time" and specify a CFN value for this IE that is a multiple of 8 frames ($CFN \bmod 8 = 0$) and lies at least 200 frames ahead of the CFN in which the response message is first transmitted.
- NOTE: UTRAN should not include the IE "Ciphering mode info" in any reconfiguration message unless it is also used to perform an SRNS relocation with change of ciphering algorithm or it is also used to perform an SR-VCC.
- 1> set the IE "RRC transaction identifier" to the value of "RRC transaction identifier" in the entry for the received message in the table "Accepted transactions" in the variable TRANSACTIONS; and
 - 1> clear that entry;
 - 1> if the variable PDCP_SN_INFO is not empty:
 - 2> include the IE "RB with PDCP information list" and set it to the value of the variable PDCP_SN_INFO.
 - 1> in TDD, if the procedure is used to perform a handover to a cell where timing advance is enabled, and the UE can calculate the timing advance value in the new cell (i.e. in a synchronous TDD network):
 - 2> set the IE "Uplink Timing Advance" according or the IE "Extended UL Timing Advance" to subclause 8.6.6.26.
 - 1> if the IE "Integrity protection mode info" was present in the received reconfiguration message:
 - 2> start applying the new integrity protection configuration in the uplink for signalling radio bearer RB2 from and including the transmitted response message.
 - 1> if IE "RRC state indicator" is set to "CELL_DCH":
 - 2> if the variable DEFERRED_MEASUREMENT_STATUS is set to TRUE:
 - 3> if System Information Block type 11 is scheduled on the BCCH and the UE has not read nor stored the IEs present in this System Information Block, or

- 3> if System Information Block type 11bis is scheduled on the BCCH and the UE has not read nor stored the IEs present in this System Information Block, or
- 3> if System Information Block type 11ter is scheduled on the BCCH and the UE has not read nor stored the IEs present in this System Information Block, or
- 3> if System Information Block type 12 is scheduled on the BCCH and the UE has not read nor stored the IEs present in this System Information Block:
 - 4> include IE "Deferred measurement control reading".

If after state transition the UE enters CELL_DCH state, the UE shall, after the state transition:

- 1> if the IE "Deferred measurement control reading" was included in the response message:
 - 2> clear the variable CELL_INFO_LIST.
- 1> if the UE supports RAN-assisted WLAN interworking:
 - 2> stop the timer T330 if it is running;
 - 2> stop using the information stored in the variable SYSTEM_INFO_WLAN_OFFLOAD_INFO, and forward this indication to the upper layers;
 - 2> if the variable WLAN_OFFLOAD_INFO is not empty:
 - 3> use the information stored in the variable WLAN_OFFLOAD_INFO as specified in [4], and forward it to the upper layers.

If after state transition the UE enters URA_PCH state, the UE shall, after the state transition and transmission of the response message:

- 1> if the IE "Frequency info" is included in the received reconfiguration message:
 - 2> select a suitable UTRA cell according to [4] on that frequency.
 - 2> if the UE can not find a suitable UTRA cell on that frequency but it finds a suitable UTRA cell on another frequency:
 - 3> proceed as below.
- 1> if the IE "Frequency info" is not included in the received reconfiguration message:
 - 2> select a suitable UTRA cell according to [4].
- 1> prohibit periodical status transmission in RLC;
- 1> start timer T305 using its initial value if timer T305 is not running and if periodical update has been configured by T305 in the IE "UE Timers and constants in connected mode" set to any other value than "infinity" in the variable TIMERS_AND_CONSTANTS;
- 1> for 3.84 Mcps and 7.68 Mcps TDD; or
- 1> for FDD and 1.28 Mcps TDD, if the UE does not support HS-DSCH reception in CELL_PCH or URA_PCH state; or
- 1> if the IE "HS-DSCH paging system information" is not included in System Information Block type 5 or System Information Block type 5bis:
 - 2> remove any C-RNTI from MAC;
 - 2> clear the variable C_RNTI;
 - 2> select Secondary CCPCH according to subclause 8.5.19;
 - 2> take the actions related to the HS_DSCH_RECEPTION_GENERAL variable as described in subclause 8.5.37a.

- 1> else:
 - 2> clear variable C_RNTI and delete any stored C-RNTI value;
 - 2> clear variable H_RNTI and delete any stored H-RNTI value;
 - 2> clear any stored IE "HARQ Info";
 - 2> reset the MAC-ehs entity [15];
 - 2> for FDD; or
 - 2> for 1.28 Mcps TDD, if the IE "PICH info" isn't included in IE "Secondary CCPCH system information" in System Information Block type 5 or System Information Block type 6:
 - 3> monitor its paging occasions on the selected PICH determined according to subclauses 8.6.3.1a, 8.6.3.2 and 8.5.39 and receive paging on the HS-DSCH mapped on the HS-PDSCH selected by the UE according to the procedures in subclause 8.5.40 for FDD and 8.5.40a for 1.28 Mcps TDD.
- 1> determine the value for the HSPA_RNTI_STORED_CELL_PCH variable and take the corresponding actions as described in subclause 8.5.56;
- 1> determine the value for the READY_FOR_COMMON_EDCH variable and take the corresponding actions as described in subclause 8.5.47;
- 1> determine the value for the COMMON_E_DCH_TRANSMISSION variable and take the corresponding actions as described in subclause 8.5.46;
- 1> for FDD, determine the value for the READY_FOR_COMMON_ERGCH variable and take the corresponding actions as described in subclause 8.5.75;
- 1> if the IE "UTRAN DRX cycle length coefficient" is included in the same message:
 - 2> use the values in the IE "UTRAN DRX Cycle length coefficient" for calculating Paging occasion and PICH Monitoring Occasion as specified in subclause 8.6.3.2.
- 1> if the criteria for URA update caused by "URA reselection" according to subclause 8.3.1 are fulfilled after cell selection:
 - 2> initiate a URA update procedure according to subclause 8.3.1 using the cause "URA reselection";
 - 2> when the URA update procedure is successfully completed:
 - 3> the procedure ends.

If after state transition the UE enters CELL_PCH state from CELL_DCH state, the UE shall, after the state transition and transmission of the response message:

- 1> if the IE "Frequency info" is included in the received reconfiguration message:
 - 2> select a suitable UTRA cell according to [4] on that frequency.
 - 2> if the UE finds a suitable UTRA cell on that frequency:
 - 3> if the received reconfiguration message included the IE "Primary CPICH info" (for FDD) or "Primary CCPCH info" (for TDD), and the UE selects another cell than indicated by this IE or the received reconfiguration message did not include the IE "Primary CPICH info" (for FDD) or "Primary CCPCH info" (for TDD):
 - 4> initiate a cell update procedure according to subclause 8.3.1 using the cause "Cell reselection";
 - 4> proceed as below.
 - 2> else, if the UE can not find a suitable UTRA cell on that frequency but it finds a suitable UTRA cell on another frequency:
 - 3> initiate a cell update procedure according to subclause 8.3.1 using the cause "Cell reselection";

- 3> proceed as below.
- 1> if the IE "Frequency info" is not included in the received reconfiguration message:
 - 2> select a suitable UTRA cell according to [4].
 - 2> if the UE finds a suitable UTRA cell on the current frequency:
 - 3> if the received reconfiguration message included the IE "Primary CPICH info" (for FDD) or "Primary CCPCH info" (for TDD), and the UE selects another cell than indicated by this IE or the received reconfiguration message did not include the IE "Primary CPICH info" (for FDD) or "Primary CCPCH info" (for TDD):
 - 4> initiate a cell update procedure according to subclause 8.3.1 using the cause "Cell reselection";
 - 4> proceed as below.
 - 2> else, if the UE can not find a suitable UTRA cell on the current frequency but it finds a suitable UTRA cell on another frequency:
 - 3> initiate a cell update procedure according to subclause 8.3.1 using the cause "Cell reselection";
 - 3> proceed as below.
 - 1> prohibit periodical status transmission in RLC;
 - 1> start timer T305 using its initial value if timer T305 is not running and if periodical update has been configured by T305 in the IE "UE Timers and constants in connected mode" set to any other value than "infinity" in the variable TIMERS_AND_CONSTANTS;
 - 1> for 3.84 Mcps and 7.68 Mcps TDD; or
 - 1> for FDD and 1.28 Mcps TDD, if the UE does not support HS-DSCH reception in CELL_PCH or URA_PCH state; or
 - 1> if the IE "HS-DSCH paging system information" is not included in System Information Block type 5 or System Information Block type 5bis and the variable HSPA_RNTI_STORED_CELL_PCH is set to FALSE:
 - 2> remove any C-RNTI from MAC;
 - 2> clear the variable C_RNTI;
 - 2> select Secondary CCPCH according to subclause 8.5.19;
 - 2> take the actions related to the HS_DSCH_RECEPTION_GENERAL variable as described in subclause 8.5.37a.
 - 1> else:
 - 2> if IE "New C-RNTI" is not included:
 - 3> clear variable H_RNTI and delete any stored H-RNTI value;
 - 3> clear any stored IE "HARQ Info";
 - 3> reset the MAC-ehs entity [15].
 - 2> if the variable HSPA_RNTI_STORED_CELL_PCH is set to TRUE:
 - 3> select Secondary CCPCH according to subclause 8.5.19;
 - 3> take the actions related to the HS_DSCH_RECEPTION_GENERAL variable as described in subclause 8.5.37a.
 - 2> else:
 - 3> for FDD; or

- 3> for 1.28 Mcps TDD, if both variable H_RNTI and variable C_RNTI are set:
 - 4> monitor its paging occasions on the selected PICH determined according to subclauses 8.6.3.1a, 8.6.3.2 and 8.5.39 and receive PCCH or DCCH and DTCH on the HS-DSCH according to the procedures in subclause 8.5.40 for FDD and 8.5.40a for 1.28 Mcps TDD.
- 1> determine the value for the READY_FOR_COMMON_EDCH variable and take the corresponding actions as described in subclause 8.5.47;
- 1> determine the value for the COMMON_E_DCH_TRANSMISSION variable and take the corresponding actions as described in subclause 8.5.46;
- 1> for FDD, determine the value for the READY_FOR_COMMON_ERGCH variable and take the corresponding actions as described in subclause 8.5.75;
- 1> if the IE "UTRAN DRX cycle length coefficient" is included in the same message:
 - 2> use the values in the IE "UTRAN DRX Cycle length coefficient" for calculating Paging occasion and PICH Monitoring Occasion as specified in subclause 8.6.3.2.
- 1> the procedure ends.

If after state transition the UE enters CELL_DCH state from CELL_FACH or from CELL_PCH state:

- 1> if the IE "Default DPCH Offset Value" is not included:
 - 2> the UE behaviour is not specified.

If after state transition the UE enters CELL_PCH state from CELL_FACH state, the UE shall, after the state transition and transmission of the response message:

- 1> if the IE "Frequency info" is included in the received reconfiguration message:
 - 2> select a suitable UTRA cell according to [4] on that frequency.
 - 2> if the UE finds a suitable UTRA cell on that frequency:
 - 3> if the received reconfiguration message included the IE "Primary CPICH info" (for FDD) or "Primary CCPCH info" (for TDD), and the UE selected another cell than indicated by this IE or the received reconfiguration message did not include the IE "Primary CPICH info" (for FDD) or "Primary CCPCH info" (for TDD):
 - 4> initiate a cell update procedure according to subclause 8.3.1 using the cause "cell reselection";
 - 4> proceed as below.
 - 2> else, if the UE can not find a suitable UTRA cell on that frequency but it finds a suitable UTRA cell on another frequency:
 - 3> initiate a cell update procedure according to subclause 8.3.1 using the cause "Cell reselection";
 - 3> proceed as below.
 - 1> if the IE "Frequency info" is not included in the received reconfiguration message:
 - 2> if the IE "Primary CPICH info" (for FDD) or "Primary CCPCH info" (for TDD) is included the UE shall either:
 - 3> ignore the content of the IE "Primary CPICH info" (for FDD) or "Primary CCPCH info" (for TDD) and proceed as below;
 - 2> or:
 - 3> if the received reconfiguration message included the IE "Primary CPICH info" (for FDD) or "Primary CPCH info" (for TDD), and it is different from the current cell:
 - 4> initiate a cell update procedure according to subclause 8.3.1 using the cause "Cell reselection";

4> proceed as below.

- 1> prohibit periodical status transmission in RLC;
- 1> start timer T305 using its initial value if timer T305 is not running and if periodical update has been configured by T305 in the IE "UE Timers and constants in connected mode" set to any other value than "infinity" in the variable TIMERS_AND_CONSTANTS;
- 1> for 3.84 Mcps and 7.68 Mcps TDD; or
- 1> for FDD and 1.28 Mcps TDD, if the UE does not support HS-DSCH reception; or
- 1> if the IE "HS-DSCH paging system information" is not included in System Information Block type 5 or System Information Block type 5bis and the variable HSPA_RNTI_STORED_CELL_PCH is set to FALSE:
 - 2> remove any C-RNTI from MAC;
 - 2> clear the variable C_RNTI.
 - 2> select Secondary CCPCH according to subclause 8.5.19;
 - 2> take the actions related to the HS_DSCH_RECEPTION_GENERAL variable as described in subclause 8.5.37a.
- 1> else:
 - 2> if IE "New C-RNTI" is not included:
 - 3> clear variable C_RNTI and delete any stored C-RNTI value;
 - 3> clear variable H_RNTI and delete any stored H-RNTI value;
 - 3> clear any stored IE "HARQ Info";
 - 3> reset the MAC-ehs entity [15].
 - 2> if the variable HSPA_RNTI_STORED_CELL_PCH is set to TRUE:
 - 3> select Secondary CCPCH according to subclause 8.5.19;
 - 3> take the actions related to the HS_DSCH_RECEPTION_GENERAL variable as described in subclause 8.5.37a.
 - 2> else:
 - 3> for FDD; or
 - 3> for 1.28 Mcps TDD, if both variable H_RNTI and variable C_RNTI are set:
 - 4> monitor its paging occasions on the selected PICH determined according to subclauses 8.6.3.1a, 8.6.3.2 and 8.5.39 and receive PCCH or DCCH and DTCH on the HS-DSCH according to the procedures in subclause 8.5.40 for FDD and 8.5.40a for 1.28 Mcps TDD.
- 1> determine the value for the READY_FOR_COMMON_EDCH variable and take the corresponding actions as described in subclause 8.5.47;
- 1> determine the value for the COMMON_E_DCH_TRANSMISSION variable and take the corresponding actions as described in subclause 8.5.46;
- 1> for FDD, determine the value for the READY_FOR_COMMON_ERGCH variable and take the corresponding actions as described in subclause 8.5.75;
- 1> if the IE "UTRAN DRX cycle length coefficient" is included in the same message:
 - 2> use the values in the IE "UTRAN DRX Cycle length coefficient" for calculating Paging occasion and PICH Monitoring Occasion as specified in subclause 8.6.3.2.
- 1> the procedure ends.

8.2.2.3a Reception of RADIO BEARER RECONFIGURATION message by the UE performing handover from GERAN *Iu mode*

If the UE is performing handover from GERAN *Iu mode*, the UE shall, in addition to the actions in 8.2.2.3:

- 1> if the IE "Specification mode" is set to "Preconfiguration" and the IE "Preconfiguration mode" is set to "Predefined configuration":
 - 2> initiate the radio bearer and transport channel configuration in accordance with the predefined parameters identified by the IE "Predefined configuration identity";
 - 2> initiate the physical channels in accordance with the predefined parameters identified by the IE "Predefined radio configuration identity" and the received physical channel information elements;
 - 2> store information about the established radio access bearers and radio bearers according to the IE "Predefined configuration identity"; and
- 1> if the IE "Specification mode" is set to "Preconfiguration" and the IE "Preconfiguration mode" is set to "Default configuration":
 - 2> initiate the radio bearer and transport channel configuration in accordance with the default parameters identified by the IE "Default configuration mode" and the IE "Default configuration identity";
 - 2> initiate the physical channels in accordance with the default parameters identified by the IE "Default configuration mode" and IE "Default configuration identity" and the received physical channel information elements;

NOTE: The IE "Default configuration mode" specifies whether the FDD or TDD version of the default configuration shall be used.

- 1> if IE "Specification mode" is set to "Complete specification":
 - 2> initiate the radio bearer, transport channel and physical channel configuration in accordance with the received radio bearer, transport channel and physical channel information elements.
- 1> if IE "Default configuration for CELL_FACH" is set:
 - 2> act in accordance with the default parameters according to section 13.8.
- 1> perform an open loop estimation to determine the UL transmission power according to subclause 8.5.3;
- 1> set the following variables equal to the corresponding variables in GERAN *Iu mode*:

CIPHERING_STATUS

ESTABLISHED_RABS

ESTABLISHED_SIGNALLING_CONNECTIONS

INTEGRITY_PROTECTION_INFO

INTER_RAT_HANDOVER_INFO_TRANSFERRED

LATEST_CONFIGURED_CN_DOMAIN

START_THRESHOLD

UE_CAPABILITY_TRANSFERRED.

- 1> set the new uplink and downlink HFN of RB2 to $MSB_{20}(\text{MAX}(\text{uplink HFN of RB2}, \text{downlink HFN of RB2}))$;

NOTE: $MSB_{20}()$ operation provides the HFN mapping from GERAN *Iu mode* to UTRAN. In GERAN *Iu mode* the length of HFN component of the COUNT-C of RB2 is longer than 20 bits.

- 1> initialise the variable TIMERS_AND_CONSTANTS to the default values and start to use those timer and constants values.

8.2.2.4 Transmission of a response message by the UE, normal case

In case the procedure was triggered by reception of a RADIO BEARER SETUP message, the UE shall:

- 1> transmit a RADIO BEARER SETUP COMPLETE as response message on the uplink DCCH using AM RLC.

In case the procedure was triggered by reception of a RADIO BEARER RECONFIGURATION message, the UE shall:

- 1> transmit a RADIO BEARER RECONFIGURATION COMPLETE as response message on the uplink DCCH using AM RLC.

In case the procedure was triggered by reception of a RADIO BEARER RELEASE message, the UE shall:

- 1> transmit a RADIO BEARER RELEASE COMPLETE as response message on the uplink DCCH using AM RLC.

In case the procedure was triggered by reception of a TRANSPORT CHANNEL RECONFIGURATION message, the UE shall:

- 1> transmit a TRANSPORT CHANNEL RECONFIGURATION COMPLETE as response message on the uplink DCCH using AM RLC.

In case the procedure was triggered by reception of a PHYSICAL CHANNEL RECONFIGURATION message, the UE shall:

- 1> transmit a PHYSICAL CHANNEL RECONFIGURATION COMPLETE as response message on the uplink DCCH using AM RLC.

In case the procedure was triggered by reception of a Target cell HS-SCCH order, the UE shall:

- 1> determine the corresponding RADIO BEARER SETUP COMPLETE or RADIO BEARER RECONFIGURATION COMPLETE or TRANSPORT CHANNEL RECONFIGURATION COMPLETE or PHYSICAL CHANNEL RECONFIGURATION COMPLETE response message that shall be used given by the IE "Serving Cell Change Message Type" in the stored HS-DSCH cell configuration;
- 1> set the IE "RRC transaction identifier" in the corresponding response message to the value of "RRC Transaction Identifier" in the entry for the corresponding response message in the table "Accepted transactions" in the variable TRANSACTIONS; and
- 1> transmit the corresponding RADIO BEARER SETUP COMPLETE or RADIO BEARER RECONFIGURATION COMPLETE or TRANSPORT CHANNEL RECONFIGURATION COMPLETE or PHYSICAL CHANNEL RECONFIGURATION COMPLETE response message on the uplink DCCH using AM RLC;
- 1> store the IE "Serving Cell Change Message Type" and the IE "Serving Cell Change Transaction Id" in the table "Processed transactions" in the variable TRANSACTIONS.

If the new state is CELL_DCH or CELL_FACH, the response message shall be transmitted using the new configuration after the state transition, and the UE shall:

- 1> if the IE "Downlink counter synchronisation info" was included in the reconfiguration message; or
- 1> if the received reconfiguration message is a RADIO BEARER RECONFIGURATION and the IE "New U-RNTI" is included; or
- 1> if the received reconfiguration message included the IE "SR-VCC Info":
 - 2> when RLC has confirmed the successful transmission of the response message:
 - 3> if the variable PDCP_SN_INFO is empty:
 - 4> configure the RLC entity for all AM and UM radio bearers and AM and UM signalling radio bearers except RB2 to "continue".
 - 3> else:
 - 4> configure the RLC entity for signalling radio bearers RB1, RB3 and RB4 to "continue";

- 4> configure the RLC entity for UM and AM radio bearers for which the IE "PDCP SN Info" is not included to "continue".
- 3> re-establish all AM and UM RLC entities with RB identities larger than 4 and set the first 20 bits of all the HFN component of the respective COUNT-C values to the START value included in the response message for the corresponding CN domain;
- 3> re-establish the RLC entities with RB identities 1, 3 and 4 and set the first 20 bits of all the HFN component of the respective COUNT-C values to the START value included in the response message for the CN domain stored in the variable LATEST_CONFIGURED_CN_DOMAIN;
- 3> set the remaining bits of the HFN component of COUNT-C values of all UM RLC entities to zero;
- 3> if the IE "PDCP context relocation info" is not present:
 - 4> re-initialise the PDCP header compression entities of each radio bearer in the variable ESTABLISHED_RABS as specified in [36].
- 3> if the IE "PDCP context relocation info" is present:
 - 4> perform the actions as specified in subclause 8.6.4.13.
- 1> if the variable PDCP_SN_INFO is empty:
 - 2> if the received reconfiguration message contained the IE "Ciphering mode info":
 - 3> when RLC has confirmed the successful transmission of the response message:
 - 4> notify upper layers upon change of the security configuration;
 - 4> perform the actions below.
 - 2> if the received reconfiguration message did not contain the IE "Ciphering mode info":
 - 3> when RLC has been requested to transmit the response message:
 - 4> perform the actions below.
- 1> if the variable PDCP_SN_INFO is non-empty:
 - 2> when RLC has confirmed the successful transmission of the response message:
 - 3> for each radio bearer in the variable PDCP_SN_INFO:
 - 4> if the IE "RB started" in the variable ESTABLISHED_RABS is set to "started":
 - 5> configure the RLC entity for that radio bearer to "continue".
 - 3> perform the actions below.

If the new state is CELL_PCH or URA_PCH, the response message shall be transmitted using the old configuration before the state transition, but the new C-RNTI shall be used if the IE "New C-RNTI" was included in the received reconfiguration message, and the UE shall:

- 1> when RLC has confirmed the successful transmission of the response message:
 - 2> for each radio bearer in the variable PDCP_SN_INFO:
 - 3> if the IE "RB started" in the variable ESTABLISHED_RABS is set to "started":
 - 4> configure the RLC entity for that radio bearer to "continue".
 - 2> enter the new state (CELL_PCH or URA_PCH, respectively);
 - 2> perform the actions below.

The UE shall:

- 1> set the variable ORDERED_RECONFIGURATION to FALSE;
- 1> if the received reconfiguration message contained the IE "Ciphering mode info":
 - 2> resume data transmission on any suspended radio bearer and signalling radio bearer mapped on RLC-AM or RLC-UM;
 - 2> set the IE "Reconfiguration" in the variable CIPHERING_STATUS to FALSE; and
 - 2> clear the variable RB_UPLINK_CIPHERING_ACTIVATION_TIME_INFO.
- 1> if the received reconfiguration message contained the IE "Integrity protection mode info":
 - 2> allow the transmission of RRC messages on all signalling radio bearers with any RRC SN;
 - 2> set "Uplink RRC Message sequence number" for signalling radio bearer RB0 in the variable INTEGRITY_PROTECTION_INFO to a value such that next RRC message to be sent on uplink RB0 will use the new integrity protection configuration;
 - 2> set the IE "Reconfiguration" in the variable INTEGRITY_PROTECTION_INFO to FALSE; and
 - 2> clear the variable INTEGRITY_PROTECTION_ACTIVATION_INFO.
- 1> clear the variable PDCP_SN_INFO;
- 1> clear the variable START_VALUE_TO_TRANSMIT;
- 1> clear the variable SECURITY_MODIFICATION.

8.2.2.5 Reception of a response message by the UTRAN, normal case

When UTRAN has received

- the RADIO BEARER SETUP COMPLETE message; or
- the RADIO BEARER RECONFIGURATION COMPLETE message; or
- the RADIO BEARER RELEASE COMPLETE message; or
- the TRANSPORT CHANNEL RECONFIGURATION COMPLETE message; or
- the PHYSICAL CHANNEL RECONFIGURATION COMPLETE message.

UTRAN may:

- 1> delete the old configuration.

If the procedure caused the UE to leave the CELL_FACH state, UTRAN may:

- 1> delete the C-RNTI of the UE.

If the IE "UL Timing Advance" or the IE "Extended UL Timing Advance" is included in TDD, UTRAN should:

- 1> evaluate the timing advance value that the UE has to use in the new cell after handover.

If the IE "START" or the IE "START list" is included, UTRAN should:

- 1> set the START value for each CN domain with the corresponding values as received in this response message;
- 1> consequently, then use the START values to initialise the hyper frame numbers, in the same way as specified for the UE in subclause 8.2.2.3, for any new radio bearers that are established.

If UTRAN has ordered a ciphering reconfiguration by including the IE "Ciphering mode info", UTRAN should:

- 1> for radio bearers using RLC-AM or RLC-UM:
 - 2> on the receiving side of an RLC entity apply the new ciphering configuration in uplink immediately;

- 2> on the transmitting side of an RLC entity apply the new ciphering configuration in downlink immediately.
- 1> for radio bearers using RLC-TM:
 - 2> begin incrementing the COUNT-C at the CFN only as indicated in:
 - 3> the IE "Ciphering activation time for DPCH" in the IE "Ciphering mode info", if included in the message that triggered the radio bearer control procedure; or
 - 3> the IE "COUNT-C activation time", if included in the response message for this procedure.
 - 1> and the procedure ends on the UTRAN side.

8.2.2.5a Rejection by the UE

If the UTRAN establishes one or more p-t-p radio bearer(s) for the transmission of a session of an MBMS service, identified by the IE "MBMS Session identity", for which upper layers indicate that it has already been received correctly, the UE shall:

- 1> transmit a failure response as specified in subclause 8.2.2.9, setting the information elements as specified below:
 - 2> include the IE "RRC transaction identifier";
 - 2> set it to the value of "RRC transaction identifier" in the entry for the received message in the table "Accepted transactions" in the variable TRANSACTIONS;
 - 2> clear that entry; and
 - 2> set the IE "failure cause" to "MBMS session already received correctly".
- 1> set the variable UNSUPPORTED_CONFIGURATION to FALSE;
- 1> continue with any ongoing processes and procedures as if the reconfiguration message was not received.
- 1> the procedure ends.

If the UTRAN establishes one or more p-t-p radio bearer(s) for the transmission of a session of an MBMS service, which will inhibit reception of one or more MBMS services which according to upper layers are of higher priority, the UE may:

- 1> transmit a failure response as specified in subclause 8.2.2.9, setting the information elements as specified below:
 - 2> include the IE "RRC transaction identifier";
 - 2> set it to the value of "RRC transaction identifier" in the entry for the received message in the table "Accepted transactions" in the variable TRANSACTIONS;
 - 2> clear that entry; and
 - 2> set the IE "failure cause" to "Lower priority MBMS service".
- 1> set the variable UNSUPPORTED_CONFIGURATION to FALSE;
- 1> continue with any ongoing processes and procedures as if the reconfiguration message was not received.
- 1> the procedure ends.

8.2.2.6 Unsupported configuration in the UE

If the UTRAN instructs the UE to use a configuration, which it does not support and/or if the received message causes the variable UNSUPPORTED_CONFIGURATION to be set to TRUE, the UE shall:

- 1> transmit a failure response as specified in subclause 8.2.2.9, setting the information elements as specified below:
 - 2> include the IE "RRC transaction identifier"; and

- 2> set it to the value of "RRC transaction identifier" in the entry for the received message in the table "Accepted transactions" in the variable TRANSACTIONS; and
- 2> clear that entry;
- 2> set the IE "failure cause" to "configuration unsupported".
- 1> set the variable UNSUPPORTED_CONFIGURATION to FALSE;
- 1> continue with any ongoing processes and procedures as if the reconfiguration message was not received.

The procedure ends.

8.2.2.7 Physical channel failure

If the received message caused the UE to be in CELL_DCH state and the UE according to subclause 8.5.4 failed to establish the dedicated physical channel(s) indicated in the received message or for 3.84 Mcps TDD or 7.68 Mcps TDD failed to establish the physical channel(s) indicated in the received message to which DCCH(s) are mapped the UE shall:

- 1> For TDD or for FDD if the CM_PATTERN_ACTIVATION_ABORTED flag is not set to TRUE:
 - 2> revert to the configuration prior to the reception of the message (old configuration), including any HS-DSCH, E-DCH, DTX and DRX configuration if existing. If there exists any DTX or DRX configuration, the UE shall instruct the physical layer to consider only the HS-SCCH orders which were acknowledged prior to the activation time of the received message;
 - 2> For FDD: if the UE was in Cell DCH state prior to the reconfiguration:
 - 3> if the variable DTX_DRX_STATUS is set to TRUE, re-configure the physical layer to perform discontinuous uplink DPCCCH transmission and enable or disable discontinuous downlink reception operations according to the variable DTX_DRX_PARAMS at the CFN corresponding to the frame boundary that is offset by the stored value of the IE "Enabling Delay" from the frame boundary where uplink transmission resumes with the old configuration;
 - 3> if the variable SECONDARY_CELL_E_DCH_TRANSMISSION is set to TRUE:
 - 4> consider the secondary uplink frequency as not activated.
 - 3> perform the physical layer synchronisation procedure A as specified in [29];
 - 3> apply power control preamble according to [26] during the number of frames indicated in the IE "PC preamble" in the variable LATEST_CONFIGURED_SRB_DELAY_AND_PC_PREAMBLE; and
 - 3> then not send any data on signalling radio bearers RB0 to RB4 during the number of frames indicated in the IE "SRB delay" in the variable LATEST_CONFIGURED_SRB_DELAY_AND_PC_PREAMBLE or while the physical channel is not considered established;.
- 1> if the old configuration includes dedicated physical channels (CELL_DCH state) and the UE is unable to revert to the old configuration or for FDD if the CM_PATTERN_ACTIVATION_ABORTED flag is set to TRUE:
 - 2> initiate a cell update procedure according to subclause 8.3.1, using the cause "radio link failure";
 - 2> after the cell update procedure has completed successfully:
 - 3> proceed as below.
- 1> if the old configuration does not include dedicated physical channels (CELL_FACH state):
 - 2> select a suitable UTRA cell according to [4];
 - 2> if the UE selects another cell than the cell the UE camped on upon reception of the reconfiguration message:
 - 3> initiate a cell update procedure according to subclause 8.3.1, using the cause "Cell reselection";
 - 3> after the cell update procedure has completed successfully:

4> proceed as below.

- 1> transmit a failure response message as specified in subclause 8.2.2.9, setting the information elements as specified below:
 - 2> include the IE "RRC transaction identifier"; and
 - 2> set it to the value of "RRC transaction identifier" in the entry for the received message in the table "Accepted transactions" in the variable TRANSACTIONS; and
 - 2> clear that entry;
 - 2> set the IE "failure cause" to "physical channel failure".
- 1> set the variable ORDERED_RECONFIGURATION to FALSE;
- 1> continue with any ongoing processes and procedures as if the reconfiguration message was not received.

The procedure ends.

8.2.2.8 Cell re-selection

If the UE performs cell re-selection during the reconfiguration procedure, the UE shall:

- 1> initiate a cell update procedure, as specified in subclause 8.3.1;
- 1> continue with the reconfiguration procedure.

NOTE: After the completion of the cell update procedure and completion of the reconfiguration procedure within the UE, the UE will move to the RRC state as indicated in the reconfiguration message.

8.2.2.9 Transmission of a response message by the UE, failure case

The UE shall:

- 1> in case of reception of a RADIO BEARER SETUP message:
 - 2> if the radio bearer establishment procedure affects several radio bearers:
 - 3> (may) include the identities of the radio bearers for which the procedure would have been successful into the RADIO BEARER SETUP FAILURE message.
 - 2> transmit a RADIO BEARER SETUP FAILURE as response message on the DCCH using AM RLC.
- 1> in case of reception of a RADIO BEARER RECONFIGURATION message:
 - 2> if the radio bearer reconfiguration procedure affects several radio bearers:
 - 3> (may) include the identities of the radio bearers for which the procedure would have been successful into the RADIO BEARER RECONFIGURATION FAILURE message.
 - 2> transmit a RADIO BEARER RECONFIGURATION FAILURE as response message on the DCCH using AM RLC.
- 1> in case of reception of a RADIO BEARER RECONFIGURATION message encapsulated in INTERSYSTEM HANDOVER TO UTRAN COMMAND message in GERAN *Iu mode*:
 - 2> perform the actions.
- 1> in case of reception of a RADIO BEARER RELEASE message:
 - 2> if the radio bearer release procedure affects several radio bearers:
 - 3> (may) include the identities of the radio bearers for which the procedure would have been successful into the RADIO BEARER RELEASE FAILURE message.

- 2> transmit a RADIO BEARER RELEASE FAILURE as response message on the DCCH using AM RLC.
- 1> in case of reception of a TRANSPORT CHANNEL RECONFIGURATION message:
 - 2> transmit a TRANSPORT CHANNEL RECONFIGURATION FAILURE as response message on the DCCH using AM RLC.
- 1> in case of reception of a PHYSICAL CHANNEL RECONFIGURATION message:
 - 2> transmit a PHYSICAL CHANNEL RECONFIGURATION FAILURE as response message on the DCCH using AM RLC.
- 1> when the response message has been submitted to lower layers for transmission:
 - 2> continue with any ongoing processes and procedures as if no reconfiguration attempt had occurred.

8.2.2.10 Reception of a response message by the UTRAN, failure case

When the UTRAN has received:

- the RADIO BEARER SETUP FAILURE message; or
- the RADIO BEARER RECONFIGURATION FAILURE message; or
- the RADIO BEARER RELEASE FAILURE message; or
- the TRANSPORT CHANNEL RECONFIGURATION FAILURE message; or
- the PHYSICAL CHANNEL RECONFIGURATION FAILURE message;

the UTRAN may restore the old and delete the new configuration. Upper layers should be notified of the failure.

The procedure ends on the UTRAN side.

8.2.2.11 Invalid configuration

If the variable INVALID_CONFIGURATION is set to TRUE the UE shall:

- 1> keep the configuration existing before the reception of the message;
- 1> transmit a failure response message as specified in subclause 8.2.2.9, setting the information elements as specified below:
 - 2> include the IE "RRC transaction identifier"; and
 - 3> set it to the value of "RRC transaction identifier" in the entry for the received message in the table "Accepted transactions" in the variable TRANSACTIONS; and
 - 3> clear that entry.
 - 2> set the IE "failure cause" to "invalid configuration".
- 1> set the variable INVALID_CONFIGURATION to FALSE;
- 1> continue with any ongoing processes and procedures as if the reconfiguration message was not received.

The procedure ends.

8.2.2.12 Incompatible simultaneous reconfiguration

If the table "Rejected transactions" in the variable TRANSACTIONS is set due to the received message and the variable PROTOCOL_ERROR_REJECT is set to FALSE, the UE shall:

- 1> not apply the configuration contained in the received reconfiguration message;

- 1> transmit a failure response message as specified in subclause 8.2.2.9, setting the information elements as specified below:
 - 2> include the IE "RRC transaction identifier"; and
 - 2> set it to the value of "RRC transaction identifier" in the entry for the received message in the table "Rejected transactions" in the variable TRANSACTIONS; and
 - 2> clear that entry;
 - 2> set the IE "failure cause" to "incompatible simultaneous reconfiguration".
- 1> continue with any ongoing processes and procedures as if the reconfiguration message was not received.

The procedure ends.

8.2.2.12a Incompatible simultaneous security reconfiguration

If the variable INCOMPATIBLE_SECURITY_RECONFIGURATION is set to TRUE due to the received reconfiguration message, the UE shall:

- 1> transmit a failure response message as specified in subclause 8.2.2.9, setting the information elements as specified below:
 - 2> include the IE "RRC transaction identifier"; and
 - 2> set it to the value of "RRC transaction identifier" in the entry for the received message in the table "Accepted transactions" in the variable TRANSACTIONS; and
 - 2> clear that entry;
 - 2> set the IE "failure cause" to the cause value "incompatible simultaneous reconfiguration".
- 1> set the variable INCOMPATIBLE_SECURITY_RECONFIGURATION to FALSE;
- 1> continue with any ongoing processes and procedures as if the reconfiguration message was not received.

The procedure ends.

8.2.2.12b Cell update procedure during security reconfiguration

If:

- a cell update procedure according to subclause 8.3.1 is initiated; and
- the received reconfiguration message causes either:
 - the IE "Reconfiguration" in the variable CIPHERING_STATUS to be set to TRUE; and/or
 - the IE "Reconfiguration" in the variable INTEGRITY_PROTECTION_INFO to be set to TRUE:

the UE shall:

- 1> release all radio resources;
- 1> indicate the release of the established signalling connections (as stored in the variable ESTABLISHED_SIGNALLING_CONNECTIONS) and established radio access bearers (as stored in the variable ESTABLISHED_RABS) to upper layers; and
- 1> clear any entry for the RRC CONNECTION RELEASE message in the tables "Accepted transactions" and "Rejected transactions" in the variable TRANSACTIONS;
- 1> clear the variable ESTABLISHED_SIGNALLING_CONNECTIONS;
- 1> clear the variable ESTABLISHED_RABS;

- 1> if the received reconfiguration message contained the IE "Ciphering mode info":
 - 2> set the IE "Reconfiguration" in the variable CIPHERING_STATUS to FALSE; and
 - 2> clear the variable RB_UPLINK_CIPHERING_ACTIVATION_TIME_INFO;
 - 2> clear the variable SECURITY_MODIFICATION.
- 1> if the received reconfiguration message contained the IE "Integrity protection mode info":
 - 2> set the IE "Reconfiguration" in the variable INTEGRITY_PROTECTION_INFO to FALSE; and
 - 2> clear the variable INTEGRITY_PROTECTION_ACTIVATION_INFO.
- 1> enter idle mode;
- 1> perform the actions specified in subclause 8.5.2 when entering idle mode;
- 1> and the procedure ends.

NOTE: UTRAN should use RB Control messages to perform an SRNS relocation only in case of state transitions from CELL_DCH to CELL_DCH.

8.2.2.13 Invalid received message

If the received reconfiguration message contains a protocol error causing the variable PROTOCOL_ERROR_REJECT to be set to TRUE according to clause 9, the UE shall perform procedure specific error handling as follows. The UE shall:

- 1> transmit a failure response message as specified in subclause 8.2.2.9, setting the information elements as specified below:
 - 2> include the IE "RRC transaction identifier"; and
 - 2> set it to the value of "RRC transaction identifier" in the entry for the received message in the table "Rejected transactions" in the variable TRANSACTIONS; and
 - 2> clear that entry;
 - 2> set the IE "failure cause" to the cause value "protocol error";
 - 2> include the IE "Protocol error information" with contents set to the value of the variable PROTOCOL_ERROR_INFORMATION.

The procedure ends.

8.2.2.14 Radio link failure

If the criteria for radio link failure are met in the old configuration during the reconfiguration procedure as specified in subclause 8.5.6, the UE shall:

- 1> if UE would have entered CELL_PCH or URA_PCH as a result of this reconfiguration procedure and UE has already submitted a response message to lower layers:
 - 2> act as if the reconfiguration message was not received;
 - 2> initiate a cell update procedure according to subclause 8.3.1, using the cause "radio link failure";
 - 2> the procedure ends.

NOTE: UTRAN should consider the reconfiguration procedure as unsuccessful in this case even if a success response message had been received.

- 1> if the UE would have remained in CELL_DCH state as a result of this reconfiguration procedure:
 - 2> initiate a cell update procedure according to subclause 8.3.1, using the cause "radio link failure";

- 2> after the cell update procedure has completed successfully:
 - 3> transmit a failure response message as specified in subclause 8.2.2.9, setting the information elements as specified below:
 - 4> include the IE "RRC transaction identifier"; and
 - 4> set it to the value of "RRC transaction identifier" in the entry for the received message in the table "Accepted transactions" in the variable TRANSACTIONS; and
 - 4> clear that entry;
 - 4> set the IE "failure cause" to "physical channel failure".
 - 3> act as if the reconfiguration message was not received;
 - 3> the procedure ends.

In case of SRNS relocation, if the criteria for radio link failure are met in the new configuration during the reconfiguration procedure (i.e. while UE is waiting for RLC acknowledgement for a response message.) as specified in subclause 8.5.6, the UE shall:

- 1> if the received reconfiguration causes either:
 - the IE "Reconfiguration" in the variable CIPHERING_STATUS to be set to TRUE; and/or
 - the IE "Reconfiguration" in the variable INTEGRITY_PROTECTION_INFO to be set to TRUE:
- 2> perform the actions specified in subclause 8.2.2.12b.
- 1> else:
 - 2> release all its radio resources;
 - 2> indicate the release of the established signalling connections (as stored in the variable ESTABLISHED_SIGNALLING_CONNECTIONS) and established radio access bearers (as stored in the variable ESTABLISHED_RABS) to upper layers;
 - 2> clear any entry for the RRC CONNECTION RELEASE message in the tables "Accepted transactions" and "Rejected transactions" in the variable TRANSACTIONS;
 - 2> clear the variable ESTABLISHED_SIGNALLING_CONNECTIONS;
 - 2> clear the variable ESTABLISHED_RABS;
 - 2> enter idle mode;
 - 2> perform the actions specified in subclause 8.5.2 when entering idle mode; and
 - 2> the procedure ends.

8.2.3 Radio bearer release

See subclause 8.2.2 (Reconfiguration procedures).

8.2.4 Transport channel reconfiguration

See subclause 8.2.2 (Reconfiguration procedures).

8.2.5 Transport format combination control

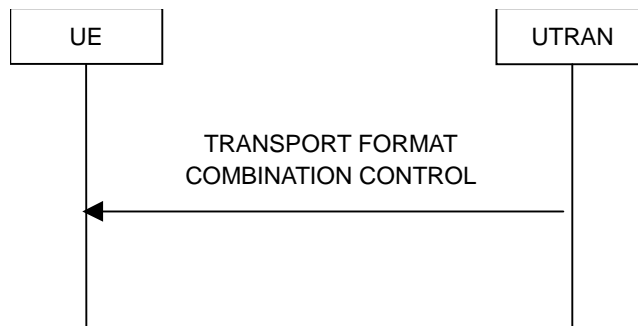

Figure 8.2.5-1: Transport format combination control, normal flow

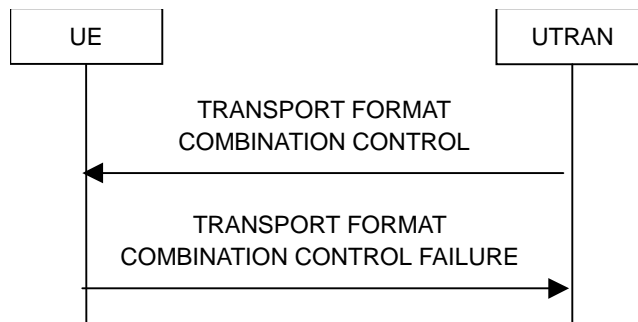

Figure 8.2.5-2: Transport format combination control, failure case

8.2.5.1 General

The transport format combination control procedure is used to control the allowed uplink transport format combinations within the transport format combination set.

8.2.5.2 Initiation

To initiate the transport format combination control procedure, the UTRAN transmits the TRANSPORT FORMAT COMBINATION CONTROL message on the downlink DCCH using AM, UM or TM RLC. When not stated otherwise elsewhere, the UTRAN may initiate the transport format combination control procedure also when another procedure is ongoing, and in that case the state of the latter procedure shall not be affected.

To change the sub-set of allowed transport format combinations, the UTRAN should:

- 1> set the allowed TFCs in the IE "Transport Format Combination subset" ("TFC subset"). The UTRAN may specify the duration for which a new TFC sub-set applies by using the IE "TFC Control duration" and independently may specify the time at which a new TFC sub-set shall be applied using the IE "Activation time for TFC subset".

To remove completely the previous restrictions of allowed transport format combinations, the UTRAN should:

- 1> set the IE "full transport format combination set" in the IE "TFC subset".

8.2.5.3 Reception of a TRANSPORT FORMAT COMBINATION CONTROL message by the UE

If the TRANSPORT FORMAT COMBINATION CONTROL message was received on AM RLC or UM RLC, the UE shall:

- 1> act upon all received information elements as specified in 8.6, unless specified otherwise in the following;
- 1> perform the actions for the transport format combination subset specified in the IE "DPCH/PUSCH TFCS in uplink" according to subclause 8.6.5.3;

- 1> if the IE "UL AMR rate" is included in the message:
 - 2> forward the content of the IE "UL AMR rate" to upper layers.
- 1> if the message is received in CELL_FACH state, and the IE "TFC Control duration" or the IE "Activation time for TFC subset" is present in the message:
 - 2> set the variable INVALID_CONFIGURATION to TRUE.
- 1> if the variable INVALID_CONFIGURATION is set to FALSE:
 - 2> if the IE "TFC Control duration" is included in the message:
 - 3> store the value of the IE "TFC Control duration" in the IE "Duration" in the variable TFC_SUBSET;
 - 3> set the IE "Current TFC subset" (for the CCTrCH indicated by the IE "TFCS Id" in case of TDD) in the variable TFC_SUBSET to the value of the IE "Transport format combination subset";
 - 3> at the CFN indicated by IE "Activation time for TFC subset" apply the transport format combination subset in the IE "Current TFC subset" stored in the variable TFC_SUBSET for the number of (10 ms) frames specified in the IE "Duration";
 - 3> at the end of the time period defined by the IE "Duration" in the variable TFC_SUBSET:
 - 4> if the IE "Current TFC subset" (for the CCTrCH indicated by the IE "TFCS Id" in case of TDD) in the variable TFC_SUBSET has not subsequently been changed by another message:
 - 5> set the value of the IE "Current TFC subset" to the value of the IE "Default TFC subset" in the variable TFC_SUBSET;
 - 5> clear the IE "Duration" in the variable TFC_SUBSET;
 - 5> apply the transport format combination subset in the IE "Current TFC subset" stored in the variable TFC_SUBSET;
 - 2> if the IE "TFC Control duration" is not included in the message:
 - 3> clear the value of the IE "Duration" in the variable TFC_SUBSET;
 - 3> set both the IE "Current TFC subset" and the IE "Default TFC subset" (for the CCTrCH indicated by the IE "TFCS Id" in case of TDD) in the variable TFC_SUBSET to the value of the IE "Transport format combination subset";
 - 3> at the CFN indicated by the IE "Activation time for TFC subset" apply the transport format combination subset in the IE "Current TFC subset" stored in the variable TFC_SUBSET.
 - 2> when the UE enters a state other than CELL_DCH state after the reception of the message:
 - 3> if the CFN indicated by IE "Activation time for TFC subset" has been reached and the time period defined by the IE "Duration" in the variable TFC_SUBSET has not been reached:
 - 4> if the IE "Current TFC subset" (for the CCTrCH indicated by the IE "TFCS Id" in case of TDD) in the variable TFC_SUBSET has not subsequently been changed by another message:
 - 5> set the value of the IE "Current TFC subset" to the value of the IE "Default TFC subset" in the variable TFC_SUBSET;
 - 5> clear the IE "Duration" in the variable TFC_SUBSET;
 - 5> apply the transport format combination subset in the IE "Current TFC subset" stored in the variable TFC_SUBSET.
 - 3> if the CFN indicated by IE "Activation time for TFC subset" has not been reached:
 - 4> if the IE "TFC Control duration" is not included in the message:

- 5> apply the transport format combination subset in the IE "Current TFC subset" stored in the variable TFC_SUBSET.
- 4> if the IE "TFC Control duration" is included in the message, and if the IE "Current TFC subset" (for the CCTrCH indicated by the IE "TFCS Id" in case of TDD) in the variable TFC_SUBSET has not subsequently been changed by another message:
 - 5> set the value of the IE "Current TFC subset" to the value of the IE "Default TFC subset" in the variable TFC_SUBSET;
 - 5> clear the IE "Duration" in the variable TFC_SUBSET;
 - 5> apply the transport format combination subset in the IE "Current TFC subset" stored in the variable TFC_SUBSET.

If the TRANSPORT FORMAT COMBINATION CONTROL message was received on TM RLC, the UE shall:

- 1> if the IE "TFC subset identity" identifies one of the TFC subsets stored in the IE "TFC subset list" in the variable TFC_SUBSET:
 - 2> perform the actions as specified in subclause 8.6.5.3;
 - 2> if the variable INVALID_CONFIGURATION is set to FALSE:
 - 3> in the variable TFC_SUBSET, set the IE "Current TFC subset" and the IE "default TFC subset" to the value of the IE "TFC subset" in "TFC subset list" which is identified by the IE "TFC subset identity";
 - 3> clear the IE "Duration" in the variable TFC_SUBSET;
 - 3> apply the transport format combination subset in the IE "Current TFC subset" stored in the variable TFC_SUBSET.
- 1> if the IE "TFC subset identity" is greater than the maximum number of TFC subsets stored in the IE "TFC subset list" in the variable TFC_SUBSET:
 - 2> set the variable INVALID_CONFIGURATION to TRUE.

NOTE: The UTRAN should only send the TRANSPORT FORMAT COMBINATION CONTROL message on TM RLC in order to control the rate of TM RBs (for example, carrying multi-rate AMR or WB-AMR) otherwise the UE behaviour is not specified.

The UE shall:

- 1> clear the entry for the TRANSPORT FORMAT COMBINATION CONTROL message in the table "Accepted transactions" in the variable TRANSACTIONS;
- 1> and the procedure ends.

8.2.5.4 Invalid configuration

If the variable INVALID_CONFIGURATION is set to TRUE due to the received TRANSPORT FORMAT COMBINATION CONTROL message the UE shall:

- 1> if the TRANSPORT FORMAT COMBINATION CONTROL message was received on AM RLC:
 - 2> keep the TFC subset existing before the TRANSPORT FORMAT COMBINATION CONTROL message was received;
 - 2> transmit a TRANSPORT FORMAT COMBINATION CONTROL FAILURE message on the DCCH using AM RLC;
 - 2> set the IE "RRC transaction identifier" in the TRANSPORT FORMAT COMBINATION CONTROL FAILURE message to the value of "RRC transaction identifier" in the entry for the TRANSPORT FORMAT COMBINATION CONTROL message in the table "Accepted transactions" in the variable TRANSACTIONS; and

- 2> clear that entry;
 - 2> set the IE "failure cause" to "invalid configuration";
 - 2> when the TRANSPORT FORMAT COMBINATION CONTROL FAILURE message has been submitted to lower layers for transmission the procedure ends.
- 1> if the TRANSPORT FORMAT COMBINATION CONTROL message was received on UM RLC or TM RLC:
- 2> ignore the TRANSPORT FORMAT COMBINATION CONTROL message;
 - 2> clear the entry for the TRANSPORT FORMAT COMBINATION CONTROL message in the table "Accepted transactions" in the variable TRANSACTIONS.

8.2.5.5 Invalid TRANSPORT FORMAT COMBINATION CONTROL message

If the TRANSPORT FORMAT COMBINATION CONTROL message was received on AM RLC or UM RLC and contains a protocol error causing the variable `PROTOCOL_ERROR_REJECT` to be set to `TRUE` according to clause 9, the UE shall perform procedure specific error handling as follows. The UE shall:

- 1> transmit a TRANSPORT FORMAT COMBINATION CONTROL FAILURE message on the uplink DCCH using AM RLC setting the information elements as specified below:
 - 2> set the IE "RRC transaction identifier" in the TRANSPORT FORMAT COMBINATION CONTROL FAILURE message to the value of "RRC transaction identifier" in the entry for the TRANSPORT FORMAT COMBINATION CONTROL message in the table "Rejected transactions" in the variable TRANSACTIONS; and
 - 2> clear that entry;
 - 2> set the IE "failure cause" to the cause value "protocol error";
 - 2> include the IE "Protocol error information" with contents set to the value of the variable `PROTOCOL_ERROR_INFORMATION`.
- 1> when the TRANSPORT FORMAT COMBINATION CONTROL FAILURE message has been submitted to lower layers for transmission:
 - 2> continue with any ongoing processes and procedures as if the invalid TRANSPORT FORMAT COMBINATION CONTROL message has not been received;
 - 2> and the procedure ends.

If the TRANSPORT FORMAT COMBINATION CONTROL message was received on TM RLC and contains a protocol error causing the variable `PROTOCOL_ERROR_REJECT` to be set to `TRUE` according to clause 9, the UE shall perform procedure specific error handling as follows. The UE shall:

- 1> ignore the invalid TRANSPORT FORMAT COMBINATION CONTROL message as if it has not been received;
- 1> the procedure ends.

8.2.6 Physical channel reconfiguration

See subclause 8.2.2 Reconfiguration procedures.

8.2.7 Physical Shared Channel Allocation [TDD only]



Figure 8.2.7-1: Physical Shared Channel Allocation

8.2.7.1 General

The purpose of this procedure is to allocate radio resources to USCH and/or DSCH transport channels in TDD mode, for use by a UE. This procedure can also be used to indicate to the UE, that a PUSCH allocation is pending, in order to prevent further capacity requests from the UE.

UEs are not required to receive FACH and DSCH simultaneously, i.e. if resources are allocated to DSCH the FACH reception may be suspended.

8.2.7.2 Initiation

To initiate the Physical Shared Channel Allocation procedure, the UTRAN sends the "PHYSICAL SHARED CHANNEL ALLOCATION" message on the downlink SHCCH or on the downlink DCCH using UM RLC. The DSCH-RNTI shall be included for UE identification, if the message is sent on the SHCCH.

8.2.7.3 Reception of a PHYSICAL SHARED CHANNEL ALLOCATION message by the UE

Upon reception of a "PHYSICAL SHARED CHANNEL ALLOCATION" message, if the message is received on the downlink SHCCH the UE shall:

- 1> check the DSCH-RNTI to see if the UE is addressed by the message;
- 1> if the UE is addressed by the message, or if the message is received on the downlink DCCH:
 - 2> perform the following actions.
- 1> otherwise:
 - 2> ignore the message.
- 1> act upon all received information elements as specified in subclause 8.6, unless specified otherwise in the following:
 - 1> if the IE "ISCP Timeslot list" is included:
 - 2> store the timeslot numbers given there for future Timeslot ISCP measurements and reports in the variable PHYSICAL_SHARED_CHANNEL_CONFIGURATION.
 - 1> if the IE "PDSCH capacity allocation info" is included:
 - 2> configure the physical resources used for the downlink CCTrCH given by the IE "TFCS ID" according to the following:
 - 3> if the CHOICE "Configuration" has the value "Old configuration":
 - 4> if the UE has stored a PDSCH configuration in the variable PHYSICAL_SHARED_CHANNEL_CONFIGURATION with the identity given by the IE "PDSCH Identity":
 - 5> configure the physical resources according to that configuration.

- 4> otherwise:
 - 5> ignore the IE "PDSCH capacity allocation info".
- 3> if the CHOICE "Configuration" has the value "New configuration":
 - 4> configure the physical resources according to the information given in IE "PDSCH Info". If IE "Common timeslot info" or IE "PDSCH timeslots and codes" IE are not present in IE "PDSCH Info":
 - 5> reuse the configuration stored in the variable PHYSICAL_SHARED_CHANNEL_CONFIGURATION for this CCTrCH.
 - 4> if the IE "PDSCH Identity" is included:
 - 5> store the new configuration in the variable PHYSICAL_SHARED_CHANNEL_CONFIGURATION using that identity.
- 2> start using the new configuration at the CFN specified by the IE "Allocation activation time", and use that for the duration given by the IE "Allocation duration";
- 2> if the IE "Confirm request" has the value "Confirm PDSCH" and IE "PDSCH Identity" is included in IE "PDSCH capacity allocation info":
 - 3> initiate the PUSCH CAPACITY REQUEST procedure as described in subclause 8.2.8.
- 1> if the IE "PUSCH capacity allocation info" is included:
 - 2> stop the timer T310, if running;
 - 2> if the CHOICE "PUSCH allocation" has the value "PUSCH allocation pending":
 - 3> start the timer T311.
 - 2> if the CHOICE "PUSCH allocation" has the value "PUSCH allocation assignment":
 - 3> stop the timer T311, if running;
 - 3> configure the physical resources used for the uplink CCTrCH given by the IE "TFCS ID" according to the following:
 - 4> if the CHOICE "Configuration" has the value "Old configuration":
 - 5> if the UE has stored a PUSCH configuration with the identity given by the IE "PUSCH Identity" in the variable PHYSICAL_SHARED_CHANNEL_CONFIGURATION:
 - 6> configure the physical resources according to that configuration.
 - 5> otherwise:
 - 6> ignore the IE "PUSCH capacity allocation info".
 - 4> if the CHOICE "Configuration" has the value "New configuration", the UE shall:
 - 5> configure the physical resources according to the information given in IE "PUSCH Info". If IE "Common timeslot info" or IE "PUSCH timeslots and codes" is not present in IE "PUSCH Info":
 - 6> reuse the configuration stored in the variable PHYSICAL_SHARED_CHANNEL_CONFIGURATION for this CCTrCH.
 - 5> if the IE "PUSCH Identity" is included:
 - 6> store the new configuration in the variable PHYSICAL_SHARED_CHANNEL_CONFIGURATION using that identity.
 - 3> if the IE "PUSCH power control info" is present in this message and includes the parameter "UL target SIR" for 3.84 Mcps TDD or 7.68 Mcps TDD, or the parameters "PRX_{PUSCHdes}" and "Beacon PL Est. " and

"TPC Step Size" for 1.28 Mcps TDD, or the parameters are stored in the variable PHYSICAL SHARED CHANNEL CONFIGURATION for this CCTrCH:

- 4> start using the new configuration at the CFN specified by the IE "Allocation activation time", and use that for the duration given by the IE "Allocation duration".
- 3> otherwise:
 - 4> ignore the IE "PUSCH capacity allocation info".
- 3> if the IE "PUSCH power control info" is present in this message and includes the parameter "UL target SIR" for 3.84 Mcps TDD or 7.68 Mcps TDD, or the parameters "PRX_{PUSCHdes}" and/or "Beacon PL Est. " and/or "TPC Step Size" for 1.28 Mcps TDD:
 - 4> replace the parameters "UL target SIR" or "PRX_{PUSCHdes}" or "TPC Step Size" stored in the variable PHYSICAL SHARED CHANNEL CONFIGURATION for this CCTrCH with the signalled values.
- 3> if the IE "Traffic volume report request " is included:
 - 4> initiate the PUSCH CAPACITY REQUEST procedure as described in subclause 8.2.8 at the time indicated by the IE "Traffic volume report request".
- 3> if the IE "Confirm request" has the value "Confirm PUSCH" and IE "PUSCH Identity" is included in IE "PUSCH capacity allocation info":
 - 4> initiate the PUSCH CAPACITY REQUEST procedure as described in subclause 8.2.8.
- 3> determine the TFCS subset and hence the TFCI values which are possible given the PUSCH allocation for that CCTrCH;
- 3> configure the MAC-c/sh in the UE with this TFCS restriction if necessary;
- 3> transmit USCH Transport Block Sets as required, within the TFCS limits given by the PUSCH allocation.

NOTE: If the UE has just entered a new cell and System Information Block Type 6 has not yet been scheduled, PUSCH/PDSCH information should be specified in the allocation message.

The UE shall:

- 1> clear the entry for the PHYSICAL SHARED CHANNEL ALLOCATION message in the table "Accepted transactions" in the variable TRANSACTIONS;
- 1> and the procedure ends.

8.2.7.4 Invalid PHYSICAL SHARED CHANNEL ALLOCATION message

If the UE receives a PHYSICAL SHARED CHANNEL ALLOCATION message, which contains a protocol error causing the variable PROTOCOL_ERROR_REJECT to be set to TRUE according to clause 9, the UE shall perform procedure specific error handling as follows. The UE shall:

- 1> ignore the invalid PHYSICAL SHARED CHANNEL ALLOCATION message;
- 1> submit the PUSCH CAPACITY REQUEST message for transmission on the uplink SHCCH, setting the information elements in the message as specified in subclause 8.2.8.3;
- 1> reset counter V310;
- 1> start timer T310;
- 1> proceed as described in subclause 8.2.8.

8.2.8 PUSCH capacity request [TDD only]

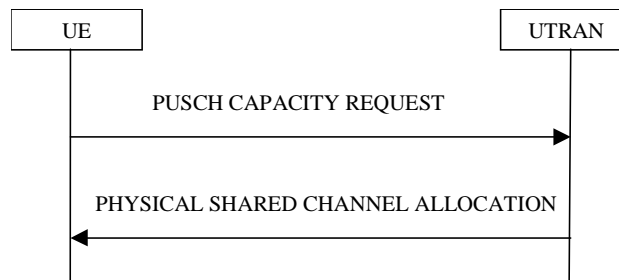

Figure 8.2.8-1: PUSCH Capacity request procedure

8.2.8.1 General

With this procedure, the UE transmits its request for PUSCH resources to the UTRAN. In the normal case, the UTRAN responds with a PHYSICAL SHARED CHANNEL ALLOCATION message, which either allocates the requested PUSCH resources, and/or allocates a PDSCH resource, or may just serve as an acknowledgement, indicating that PUSCH allocation is pending.

This procedure can also be used to acknowledge the reception of a PHYSICAL SHARED CHANNEL ALLOCATION message, or to indicate a protocol error in that message.

With the PUSCH CAPACITY REQUEST message, the UE can request capacity for one or more USCH.

8.2.8.2 Initiation

This procedure is initiated:

- 1> in the CELL_FACH or CELL_DCH state;
- 1> and when at least one RB using USCH has been established;
- 1> and when the UE sees the requirement to request physical resources (PUSCH) for an USCH channel or there is the need to reply to a PHYSICAL SHARED CHANNEL ALLOCATION message as described in clause 8.2.7 (i.e. to confirm the reception of a message, if requested to do so, or to indicate a protocol error).

The procedure can be initiated if:

- Timer T311 is not running.
- The timer T310 (capacity request repetition timer) is not running.

The UE shall:

- 1> set the IEs in the PUSCH CAPACITY REQUEST message according to subclause 8.2.8.3;
- 1> if the procedure is triggered to reply to a previous PHYSICAL SHARED CHANNEL ALLOCATION message by the IE "Confirm request" set to "Confirm PUSCH" and the IE "PUSCH capacity allocation info" is not present:
 - 2> transmit the PUSCH CAPACITY REQUEST message on RACH.
- 1> else:
 - 2> transmit the PUSCH CAPACITY REQUEST message on the uplink SHCCH.
- 1> set counter V310 to 1;
- 1> start timer T310.

8.2.8.3 PUSCH CAPACITY REQUEST message contents to set

With one PUSCH CAPACITY REQUEST message, capacity for one or more USCH can be requested. It shall include these information elements:

- 1> DSCH-RNTI to be used as UE identity if the message is sent on RACH;
- 1> Traffic volume measured results for each radio bearer satisfying the reporting criteria as specified in the MEASUREMENT CONTROL procedure (if no radio bearer satisfies the reporting criteria, traffic volume measured results shall not be included). These results shall include:
 - 2> Radio Bearer ID of the Radio Bearer being reported;
 - 2> RLC buffer payload for these radio bearers, as specified by the MEASUREMENT CONTROL procedure.

The UE shall:

- 1> if the initiation of the procedure is triggered by the IE "Traffic volume report request" in a previously received PHYSICAL SHARED CHANNEL ALLOCATION message:
 - 2> report the traffic volume measurement result for the radio bearer mapped on USCH transport channel specified in the received message. These results shall include:
 - 3> Radio Bearer ID of the Radio Bearer being reported;
 - 3> RLC buffer payload for this radio bearer.
- 1> if the initiation of the procedure is triggered by the IE "Confirm request" set to "Confirm PDSCH" in a previously received PHYSICAL SHARED CHANNEL ALLOCATION message and the IE "PUSCH capacity allocation info" is present in this message:
 - 2> set the CHOICE "Allocation confirmation" to "PDSCH Confirmation" with the value given in the IE "PDSCH Identity" stored in the variable PHYSICAL_SHARED_CHANNEL_CONFIGURATION.
- 1> if the initiation of the procedure is triggered by the IE "Confirm request" set to "Confirm PUSCH" in a previously received PHYSICAL SHARED CHANNEL ALLOCATION message:
 - 2> set the CHOICE "Allocation confirmation" to "PUSCH Confirmation" with the value given in the IE "PUSCH Identity" stored in the variable PHYSICAL_SHARED_CHANNEL_CONFIGURATION.
- 1> if the variable PROTOCOL_ERROR_REJECT is set to TRUE:
 - 2> include the IE "RRC transaction identifier" in the response message transmitted below; and
 - 2> set it to the value of "RRC transaction identifier" in the entry for the PHYSICAL SHARED CHANNEL ALLOCATION message in the table "Rejected transactions" in the variable TRANSACTIONS; and
 - 2> clear that entry;
 - 2> set the IE "protocol error indicator" to TRUE;
 - 2> include the IE "Protocol error information" with contents set to the value of the variable PROTOCOL_ERROR_INFORMATION.
- 1> if the value of the variable PROTOCOL_ERROR_REJECT is FALSE:
 - 2> set the IE "Protocol error indicator" to FALSE.

As an option, the message may include IE "Timeslot ISCP" and IE "Primary CCPCH RSCP".

The timeslots for which "Timeslot ISCP" may be reported shall have been configured with a previous PHYSICAL SHARED CHANNEL ALLOCATION message and stored in the variable PHYSICAL_SHARED_CHANNEL_CONFIGURATION.

"Primary CCPCH RSCP" is reported when requested with a previous PHYSICAL SHARED CHANNEL ALLOCATION message.

8.2.8.4 Reception of a PUSCH CAPACITY REQUEST message by the UTRAN

Upon receiving a PUSCH CAPACITY REQUEST message with traffic volume measurement included for at least one radio bearer, the UTRAN should initiate the PHYSICAL SHARED CHANNEL ALLOCATION procedure, either for allocating PUSCH or PDSCH resources as required, or just as an acknowledgement, indicating a pending PUSCH allocation, as described in subclause 8.2.7.

8.2.8.5 T310 expiry

Upon expiry of timer T310, the UE shall:

- 1> if V310 is smaller than N310:
 - 2> transmit a new PUSCH CAPACITY REQUEST message on the Uplink SHCCH;
 - 2> restart timer T310;
 - 2> increment counter V310;
 - 2> set the IEs in the PUSCH CAPACITY REQUEST message as specified in subclause 8.2.8.3.
- 1> if V310 is greater than or equal to N310:
 - 2> the procedure ends.

8.2.9 Void

8.2.10 Uplink Physical Channel Control [TDD only]

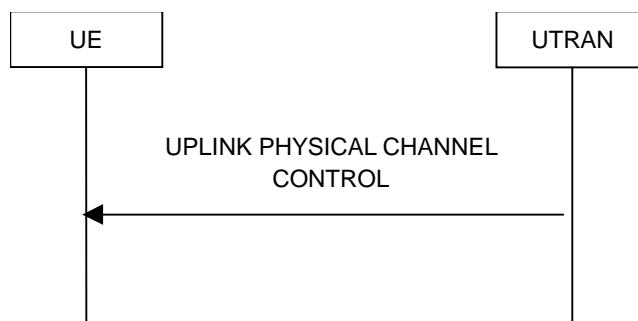

Figure 8.2.10-1: Uplink Physical Channel Control

8.2.10.1 General

The uplink physical channel control procedure is used in TDD to control the uplink outer loop power control and timing advance running in the UE.

8.2.10.2 Initiation

The UTRAN initiates the procedure by transmitting the UPLINK PHYSICAL CHANNEL CONTROL message on the downlink DCCH using AM or UM RLC in order to update parameters for uplink open loop power control in the UE for one CCTrCH or to inform the UE about a new timing advance value to be applied. Especially, uplink interference information measured by the UTRAN can be included for the uplink timeslots used for the CCTrCH.

8.2.10.3 Reception of UPLINK PHYSICAL CHANNEL CONTROL message by the UE

Upon reception of the UPLINK PHYSICAL CHANNEL CONTROL message, the UE shall:

- 1> act upon all received information elements as specified in subclause 8.6.

In 1.28 Mcps TDD, if the IE "Uplink DPCH Power Control Info" and IE "PRX_{HS-SICH}" and IE "TPC step size" are transmitted, this information shall be taken into account by the UE for uplink open loop power control and for uplink closed loop power control as described in subclause 8.6.6.11, and the "PRX_{HS-SICH}" shall be taken into account by the UE for open loop power control as described in subclause 8.5.7 and the "TPC step size" for closed loop power control on HS-SICH.

In 3.84 Mcps TDD or 7.68 Mcps TDD, if the IEs "Uplink DPCH Power Control Info", "PRACH Constant Value", "PUSCH Constant Value", "HS-SICH Power Control Info", "Alpha" or IE group "list of UL Timeslot Interference" are transmitted, this information shall be taken into account by the UE for uplink open loop power control as specified in subclause 8.5.7. If the UE is capable of using IPDLs for UE positioning, the IE "IPDL-Alpha" shall be used instead of the IE "Alpha". If the IE "IPDL-Alpha" parameter is not present, the UE shall use IE "Alpha".

If the IE Special Burst Scheduling is transmitted the UE shall:

- 1> use the new value for the "Special Burst Generation Period".

The UE shall:

- 1> clear the entry for the UPLINK PHYSICAL CHANNEL CONTROL message in the table "Accepted transactions" in the variable TRANSACTIONS;
- 1> and the procedure ends.

8.2.10.4 Invalid UPLINK PHYSICAL CHANNEL CONTROL message

If the UE receives a UPLINK PHYSICAL CHANNEL CONTROL message, which contains a protocol error causing the variable PROTOCOL_ERROR_REJECT to be set to TRUE according to clause 9, the UE shall perform procedure specific error handling as follows. The UE shall:

- 1> transmit an RRC STATUS message on the uplink DCCH using AM RLC, setting the information elements as specified below:
 - 2> include the IE "Identification of received message"; and
 - 2> set the IE "Received message type" to UPLINK PHYSICAL CHANNEL CONTROL; and
 - 2> set the IE "RRC transaction identifier" to the value of "RRC transaction identifier" in the entry for the UPLINK PHYSICAL CHANNEL CONTROL message in the table "Rejected transactions" in the variable TRANSACTIONS; and
 - 2> clear that entry;
 - 2> include the IE "Protocol error information" with contents set to the value of the variable PROTOCOL_ERROR_INFORMATION.
- 1> when the RRC STATUS message has been submitted to lower layers for transmission:
 - 2> continue with any ongoing processes and procedures as if the invalid UPLINK PHYSICAL CHANNEL CONTROL message has not been received.

8.2.11 Physical channel reconfiguration failure

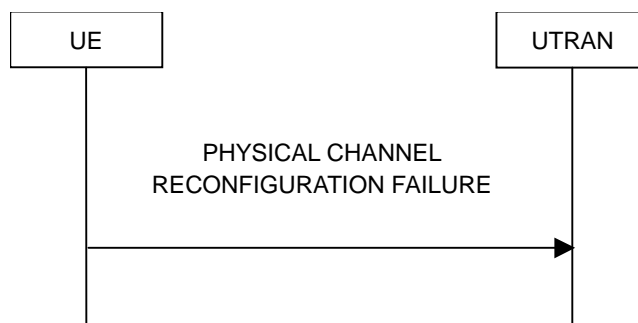

Figure 8.2.11-1: Physical channel reconfiguration failure in case of runtime configuration error

8.2.11.1 General

The physical channel reconfiguration failure procedure is used to indicate to the network a runtime configuration error in the UE.

8.2.11.2 Runtime error due to overlapping compressed mode configurations

When the UE has received from the UTRAN the configurations of several compressed mode transmission gap pattern sequences, and if several of these patterns are to be simultaneously active, the UE shall check to see if these simultaneously active transmission gap pattern sequences create transmission gaps in the same frame. An illegal overlap is created if two or more transmission gap pattern sequences create transmission gaps in the same frame, irrespective of the gaps are created in uplink or downlink.

If the parallel transmission gap pattern sequences create an illegal overlap, the UE shall:

- 1> delete the overlapping transmission gap pattern sequence configuration stored in the variable TGPS_IDENTITY, which is associated with the highest value of IE "TGPSI";
- 1> transmit a PHYSICAL CHANNEL RECONFIGURATION FAILURE message on the DCCH using AM RLC, setting the information elements as specified below:
 - 2> not include the IE "RRC transaction identifier";
 - 2> set the cause value in IE "failure cause" to value "compressed mode runtime error".
- 1> terminate the inter-frequency and/or inter-RAT measurements corresponding to the deleted transmission gap pattern sequence;
- 1> when the PHYSICAL CHANNEL RECONFIGURATION FAILURE message has been submitted to lower layers for transmission:
 - 2> the procedure ends.

8.2.11.3 Void

8.3 RRC connection mobility procedures

8.3.1 Cell and URA update procedures

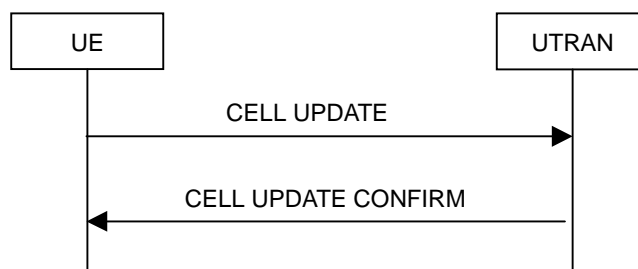

Figure 8.3.1-1: Cell update procedure, basic flow

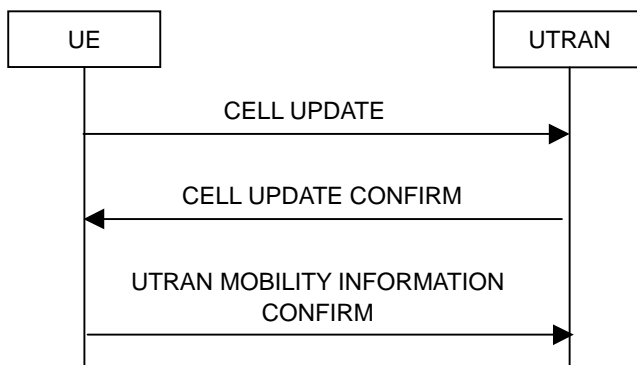

Figure 8.3.1-2: Cell update procedure with update of UTRAN mobility information

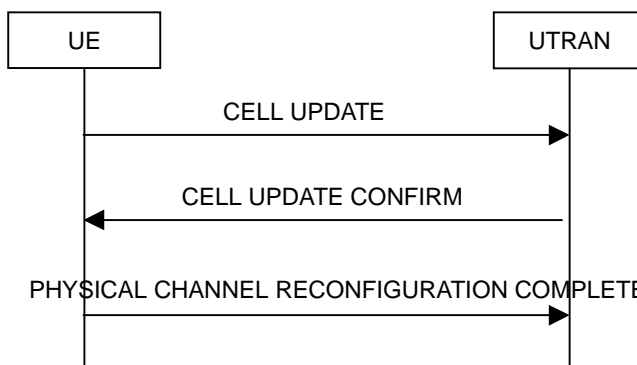

Figure 8.3.1-3: Cell update procedure with physical channel reconfiguration

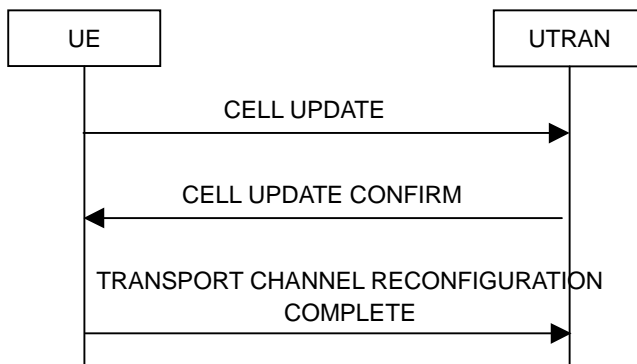

Figure 8.3.1-4: Cell update procedure with transport channel reconfiguration

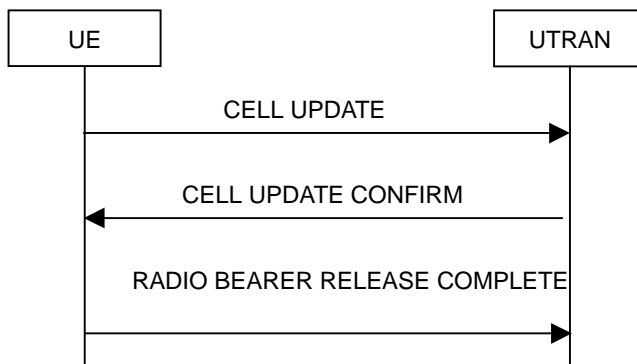

Figure 8.3.1-5: Cell update procedure with radio bearer release

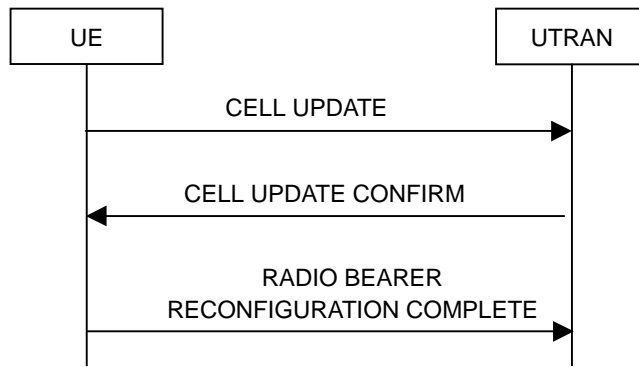

Figure 8.3.1-6: Cell update procedure with radio bearer reconfiguration

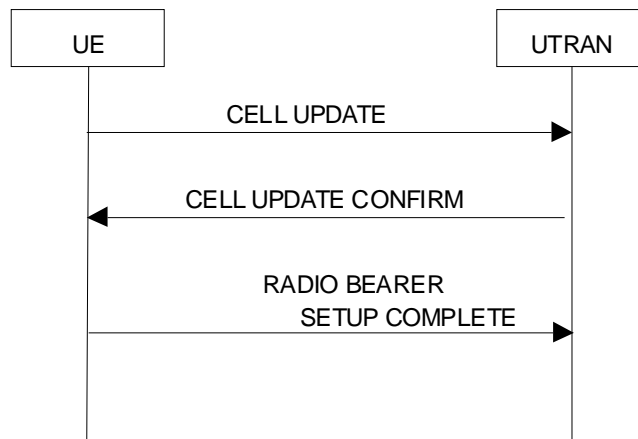

Figure 8.3.1-6a: Cell update procedure with radio bearer setup

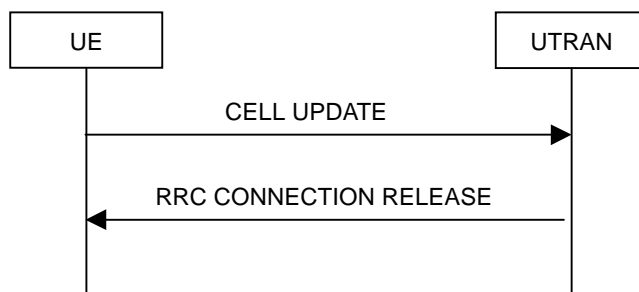

Figure 8.3.1-7: Cell update procedure, failure case

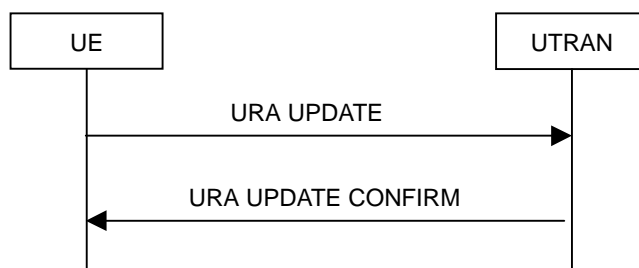

Figure 8.3.1-8: URA update procedure, basic flow

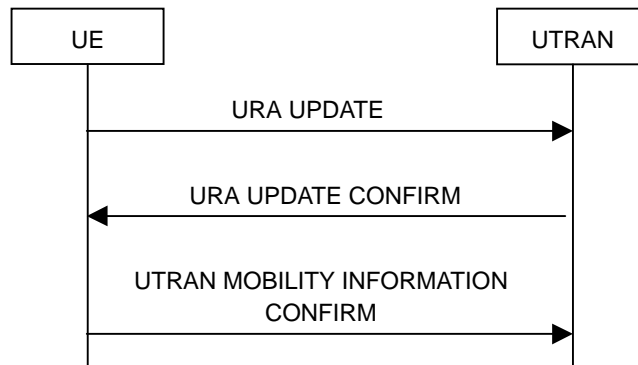

Figure 8.3.1-9: URA update procedure with update of UTRAN mobility information

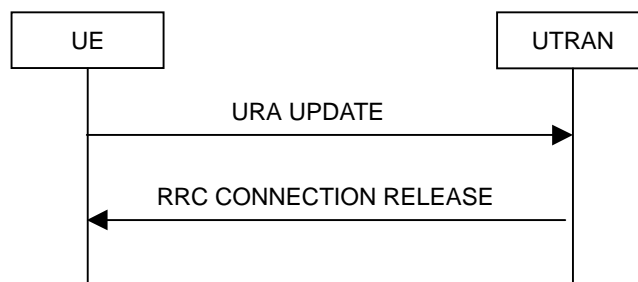

Figure 8.3.1-10: URA update procedure, failure case

8.3.1.1 General

The URA update and cell update procedures serve several main purposes:

- to notify UTRAN after re-entering service area in the URA_PCH or CELL_PCH state;
- to notify UTRAN of an RLC unrecoverable error [16] on an AM RLC entity;
- to be used as a supervision mechanism in the CELL_FACH, CELL_PCH, or URA_PCH state by means of periodical update.

In addition, the URA update procedure also serves the following purpose:

- to retrieve a new URA identity after cell re-selection to a cell not belonging to the current URA assigned to the UE in URA_PCH state.

In addition, the cell update procedure also serves the following purposes:

- to update UTRAN with the current cell the UE is camping on after cell reselection;
- to act on a radio link failure in the CELL_DCH state;
- to act on the transmission failure of the UE CAPABILITY INFORMATION message;
- for FDD and 1.28 Mcps TDD, if the variable H_RNTI is not set, and for 3.84 Mcps TDD and 7.68 Mcps TDD: when triggered in the URA_PCH or CELL_PCH state, to notify UTRAN of a transition to the CELL_FACH state due to the reception of UTRAN originated paging or due to a request to transmit uplink data;
- to count the number of UEs in URA_PCH, CELL_PCH and CELL_FACH that are interested to receive an MBMS transmission;
- when triggered in the URA_PCH, CELL_PCH and CELL_FACH state, to notify UTRAN of the UEs interest to receive an MBMS service;
- to request the MBMS P-T-P RB setup by the UE in CELL_PCH, URA_PCH and CELL_FACH state.

The URA update and cell update procedures may:

1> include an update of mobility related information in the UE;

1> cause a state transition from the CELL_FACH state to the CELL_DCH, CELL_PCH or URA_PCH states or idle mode.

The cell update procedure may also include:

- a re-establish of AM RLC entities;
- a re-establish of UM RLC entities;
- a radio bearer release, radio bearer reconfiguration, transport channel reconfiguration or physical channel reconfiguration.

8.3.1.2 Initiation

A UE shall initiate the cell update procedure in the following cases:

1> Uplink data transmission:

2> for FDD and 1.28 Mcps TDD, if the variable H_RNTI is not set, and for 3.84 Mcps TDD and 7.68 Mcps TDD:

3> if the UE is in URA_PCH or CELL_PCH state; and

3> if timer T320 is not running:

4> if the UE has uplink RLC data PDU or uplink RLC control PDU on RB1 or upwards to transmit:

5> perform cell update using the cause "uplink data transmission".

3> else:

4> if the variable ESTABLISHMENT_CAUSE is set:

5> perform cell update using the cause "uplink data transmission".

1> Paging response:

2> if the criteria for performing cell update with the cause specified above in the current subclause are not met; and

2> if the UE in URA_PCH or CELL_PCH state, receives a PAGING TYPE 1 message fulfilling the conditions for initiating a cell update procedure specified in subclause 8.1.2.3:

3> perform cell update using the cause "paging response".

1> Radio link failure:

2> if none of the criteria for performing cell update with the causes specified above in the current subclause is met:

3> if the UE is in CELL_DCH state and the criteria for radio link failure are met as specified in subclause 8.5.6; or

3> if the transmission of the UE CAPABILITY INFORMATION message fails as specified in subclause 8.1.6.6; or

3> if the UE detects PDCP Unrecoverable Error [36] in a PDCP entity

4> perform cell update using the cause "radio link failure".

1> MBMS ptp RB request:

2> if none of the criteria for performing cell update with the causes specified above in the current subclause is met; and

- 2> if the UE is in URA_PCH, CELL_PCH or CELL_FACH state; and
- 2> if timer T320 is not running; and
- 2> if the UE should perform cell update for MBMS ptp radio bearer request as specified in subclause 8.6.9.6:
 - 3> perform cell update using the cause "MBMS ptp RB request".
- 1> Re-entering service area:
 - 2> if none of the criteria for performing cell update with the causes specified above in the current subclause is met; and
 - 2> if the UE is in CELL_FACH or CELL_PCH state; and
 - 2> if the UE has been out of service area and re-enters service area before T307 or T317 expires:
 - 3> perform cell update using the cause "re-entering service area".
- 1> RLC unrecoverable error:
 - 2> if none of the criteria for performing cell update with the causes specified above in the current subclause is met; and
 - 2> if the UE detects RLC unrecoverable error [16] in an AM RLC entity:
 - 3> perform cell update using the cause "RLC unrecoverable error".
- 1> Cell reselection:
 - 2> if none of the criteria for performing cell update with the causes specified above in the current subclause is met:
 - 3> if the UE is in CELL_FACH or CELL_PCH state and the UE performs cell re-selection; or
 - 3> if the UE is in CELL_FACH state and the variable C_RNTI is empty:
 - 4> perform cell update using the cause "cell reselection".
- 1> Periodical cell update:
 - 2> if none of the criteria for performing cell update with the causes specified above in the current subclause is met; and
 - 2> if the UE is in CELL_FACH or CELL_PCH state; and
 - 2> if the timer T305 expires; and
 - 2> if the criteria for "in service area" as specified in subclause 8.5.5.2 are fulfilled; and
 - 2> if periodic updating has been configured by T305 in the IE "UE Timers and constants in connected mode" set to any other value than "infinity":
 - 3> for FDD:
 - 4> if the variable COMMON_E_DCH_TRANSMISSION is set to FALSE:
 - 5> perform cell update using the cause "periodical cell update".
 - 4> else:
 - 5> restart the timer T305;
 - 5> and end the procedure.
 - 3> for 1.28 Mcps TDD and 3.84/7.68 Mcps TDD:
 - 4> perform cell update using the cause "periodical cell update".

1> MBMS reception:

- 2> if none of the criteria for performing cell update with the causes specified above in the current subclause is met; and
- 2> if the UE is in URA_PCH, CELL_PCH or CELL_FACH state; and
- 2> if the UE should perform cell update for MBMS counting as specified in subclause 8.7.4:
 - 3> perform cell update using the cause "MBMS reception".

A UE in URA_PCH state shall initiate the URA update procedure in the following cases:

1> URA reselection:

- 2> if the UE detects that the current URA assigned to the UE, stored in the variable URA_IDENTITY, is not present in the list of URA identities in system information block type 2; or
- 2> if the list of URA identities in system information block type 2 is empty; or
- 2> if the system information block type 2 can not be found:
 - 3> perform URA update using the cause "change of URA".

1> Periodic URA update:

- 2> if the criteria for performing URA update with the causes as specified above in the current subclause are not met:
 - 3> if the timer T305 expires and if periodic updating has been configured by T305 in the IE "UE Timers and constants in connected mode" set to any other value than "infinity"; or
 - 3> if the conditions for initiating an URA update procedure specified in subclause 8.1.1.6.5 are fulfilled:
 - 4> perform URA update using the cause "periodic URA update".

When initiating the URA update or cell update procedure, the UE shall:

1> if timer T320 is running:

- 2> stop timer T320;
- 2> if the UE has uplink RLC data PDU or uplink RLC control PDU on RB1 or upwards to transmit:
 - 3> perform cell update using the cause "uplink data transmission".

2> else:

- 3> if the cell update procedure is not triggered due to Paging response or Radio link failure; and
- 3> if the UE should perform cell update for MBMS ptp radio bearer request as specified in subclause 8.6.9.6:
 - 4> perform cell update using the cause "MBMS ptp RB request".

1> stop timer T319 if it is running;

1> stop timer T305;

1> for FDD and 1.28 Mcps TDD:

- 2> if the UE is in CELL_FACH state; and
- 2> if the IE "HS-DSCH common system information" is included in System Information Block type 5 or System Information Block type 5bis; and
- 2> for 1.28 Mcps TDD, if IE "Common E-DCH system info" in System Information Block type 5; and
- 2> if the UE does support HS-DSCH reception in CELL_FACH state:

- 3> if variable H_RNTI is not set or variable C_RNTI is not set; or
- 3> for FDD, an unrecoverable error [16] in an AM RLC entity detected:
 - 4> clear variable H_RNTI;
 - 4> clear variable C_RNTI;
 - 4> clear variable E_RNTI;
 - 4> clear any stored IEs "HARQ info";
 - 4> set variable HS_DSCH_RECEPTION_OF_CCCH_ENABLED to TRUE;
 - 4> and start receiving the HS-DSCH transport channels mapped physical channel(s) of type HS-SCCH and HS-PDSCH, by using parameters given by the IE(s) "HS-DSCH common system information" according to the procedure in subclause 8.5.37.
- 3> else:
 - 4> receive the HS-DSCH transport channels mapped physical channel(s) of type HS-SCCH and HS-PDSCH, by using parameters given by the IE(s) "HS-DSCH common system information" according to the procedure in subclause 8.5.36;
 - 4> determine the value for the HSPA_RNTI_STORED_CELL_PCH variable and take the corresponding actions as described in subclause 8.5.56;
 - 4> determine the value for the READY_FOR_COMMON_EDCH variable and take the corresponding actions as described in subclause 8.5.47;
 - 4> determine the value for the COMMON_E_DCH_TRANSMISSION variable and take the corresponding actions as described in subclause 8.5.46;
 - 4> for FDD, determine the value for the READY_FOR_COMMON_ERGCH variable and take the corresponding actions as described in subclause 8.5.75;
 - 4> if variable READY_FOR_COMMON_EDCH is set to TRUE:
 - 5> configure the Enhanced Uplink in CELL_FACH state and Idle mode as specified in subclause 8.5.45 for FDD and 8.5.45a for 1.28 Mcps TDD.
- 1> if the UE is in CELL_DCH state:
 - 2> in the variable RB_TIMER_INDICATOR, set the IE "T314 expired" and the IE "T315 expired" to FALSE;
 - 2> if the stored values of the timer T314 and timer T315 are both equal to zero; or
 - 2> if the stored value of the timer T314 is equal to zero and there are no radio bearers associated with any radio access bearers for which in the variable ESTABLISHED_RABS the value of the IE "Re-establishment timer" is set to "useT315" and signalling connection exists only to the CS domain:
 - 3> release all its radio resources;
 - 3> indicate release (abort) of the established signalling connections (as stored in the variable ESTABLISHED_SIGNALLING_CONNECTIONS) and established radio access bearers (as stored in the variable ESTABLISHED_RABS) to upper layers;
 - 3> clear the variable ESTABLISHED_SIGNALLING_CONNECTIONS;
 - 3> clear the variable ESTABLISHED_RABS;
 - 3> enter idle mode;
 - 3> perform other actions when entering idle mode from connected mode as specified in subclause 8.5.2;
 - 3> and the procedure ends.

- 2> if the stored value of the timer T314 is equal to zero:
 - 3> release all radio bearers, associated with any radio access bearers for which in the variable ESTABLISHED_RABS the value of the IE "Re-establishment timer" is set to "useT314";
 - 3> in the variable RB_TIMER_INDICATOR set the IE "T314 expired" to TRUE;
 - 3> if all radio access bearers associated with a CN domain are released:
 - 4> release the signalling connection for that CN domain;
 - 4> remove the signalling connection for that CN domain from the variable ESTABLISHED_SIGNALLING_CONNECTIONS;
 - 4> indicate release (abort) of the signalling connection to upper layers;
- 2> if the stored value of the timer T315 is equal to zero:
 - 3> release all radio bearers associated with any radio access bearers for which in the variable ESTABLISHED_RABS the value of the IE "Re-establishment timer" is set to "useT315";
 - 3> in the variable RB_TIMER_INDICATOR set the IE "T315 expired" to TRUE.
 - 3> if all radio access bearers associated with a CN domain are released:
 - 4> release the signalling connection for that CN domain;
 - 4> remove the signalling connection for that CN domain from the variable ESTABLISHED_SIGNALLING_CONNECTIONS;
 - 4> indicate release (abort) of the signalling connection to upper layers;
- 2> if the stored value of the timer T314 is greater than zero:
 - 3> if there are radio bearers associated with any radio access bearers for which in the variable ESTABLISHED_RABS the value of the IE "Re-establishment timer" is set to "useT314":
 - 4> start timer T314.
 - 3> if there are no radio bearers associated with any radio access bearers for which in the variable ESTABLISHED_RABS the value of the IE "Re-establishment timer" is set to "useT314" or "useT315" and the signalling connection exists to the CS domain:
 - 4> start timer T314.
- 2> if the stored value of the timer T315 is greater than zero:
 - 3> if there are radio bearers associated with any radio access bearers for which in the variable ESTABLISHED_RABS the value of the IE "Re-establishment timer" is set to "useT315"; or
 - 3> if the signalling connection exists to the PS domain:
 - 4> start timer T315.
- 2> for the released radio bearer(s):
 - 3> delete the information about the radio bearer from the variable ESTABLISHED_RABS;
 - 3> when all radio bearers belonging to the same radio access bearer have been released:
 - 4> indicate local end release of the radio access bearer to upper layers using the CN domain identity together with the RAB identity stored in the variable ESTABLISHED_RABS;
 - 4> delete all information about the radio access bearer from the variable ESTABLISHED_RABS.
- 2> if the variable E_DCH_TRANSMISSION is set to TRUE:
 - 3> set the variable E_DCH_TRANSMISSION to FALSE;

- 3> stop any E-AGCH and E-HICH reception procedures;
- 3> for FDD, stop any E-RGCH reception procedures.
- 3> for FDD, stop any E-DPCCH and E-DPDCH transmission procedures.
- 3> for 1.28 Mcps TDD, stop any E-PUCH transmission procedure.
- 3> clear the variable E_RNTI;
- 3> act as if the IE "MAC-es/e reset indicator" was received and set to TRUE;
- 3> release all E-DCH HARQ resources;
- 3> no longer consider any radio link to be the serving E-DCH radio link.
- 2> move to CELL_FACH state;
- 2> select a suitable UTRA cell on the current frequency according to [4];
- 2> clear variable E_RNTI and:
 - 3> determine the value for the HSPA_RNTI_STORED_CELL_PCH variable and take the corresponding actions as described in subclause 8.5.56;
 - 3> determine the value for the READY_FOR_COMMON_EDCH variable and take the corresponding actions as described in subclause 8.5.47;
 - 3> determine the value for the COMMON_E_DCH_TRANSMISSION variable and take the corresponding actions as described in subclause 8.5.46.
 - 3> for FDD, determine the value for the READY_FOR_COMMON_ERGCH variable and take the corresponding actions as described in subclause 8.5.75;
- 2> for 3.84 Mcps TDD and 7.68Mcps TDD; or
- 2> for FDD and 1.28 Mcps TDD, if the UE does not support HS-DSCH reception in CELL_FACH state; or
- 2> if the IE "HS-DSCH common system information" is not included in System Information Block type 5 or System Information Block type 5bis; or
- 2> for 1.28 Mcps TDD, if the IE "Common E-DCH system info" is not included in System Information Block type 5:
 - 3> select PRACH according to subclause 8.5.17;
 - 3> select Secondary CCPCH according to subclause 8.5.19;
 - 3> use the transport format set given in system information as specified in subclause 8.6.5.1;
 - 3> take the actions related to the HS_DSCH_RECEPTION_GENERAL variable as described in subclause 8.5.37a.
- 2> else:
 - 3> if variable READY_FOR_COMMON_EDCH is set to TRUE:
 - 4> configure the Enhanced Uplink in CELL_FACH state and Idle mode as specified in subclause 8.5.45.
 - 3> else:
 - 4> select PRACH according to subclause 8.5.17 and:
 - 5> use for the PRACH the transport format set given in system information as specified in subclause 8.6.5.1.
- 3> clear variable H_RNTI;

- 3> clear any stored IEs "HARQ info";
- 3> reset the MAC-ehs entity [15];
- 3> set variable HS_DSCH_RECEPTION_OF_CCCH_ENABLED to TRUE;
- 3> and start receiving the HS-DSCH according to the procedure in subclause 8.5.37.
- 2> for FDD, if the IE "Uplink CLTD info FDD" is stored in the UE:
 - 3> determine the value for the UPLINK_CLTD_TRANSMISSION variable and take the corresponding actions as described in subclause 8.5.69.
- 2> for FDD, if the IE "Uplink OLTD info FDD" is stored in the UE:
 - 3> determine the value for the UPLINK_OLTD_TRANSMISSION variable and take the corresponding actions as described in subclause 8.5.70.
- 2> set the variable ORDERED_RECONFIGURATION to FALSE.
- 1> set the variables PROTOCOL_ERROR_INDICATOR, FAILURE_INDICATOR, UNSUPPORTED_CONFIGURATION and INVALID_CONFIGURATION to FALSE;
- 1> set the variable CELL_UPDATE_STARTED to TRUE;
- 1> if any IEs related to HS-DSCH are stored in the UE:
 - 2> clear any stored IE "Downlink HS-PDSCH information";
 - 2> clear any stored IE "Downlink Secondary Cell Info FDD";
 - 2> clear all the entries from the variable TARGET_CELL_PRECONFIGURATION;
 - 2> for 1.28Mcps TDD, clear the IE "HS-PDSCH Midamble Configuration" and the IE "HS-SCCH Set Configuration" in the IE "DL Multi Carrier Information";
 - 2> determine the value for the HS_DSCH_RECEPTION variable and take the corresponding actions as described in subclause 8.5.25;
 - 2> determine the value for the SECONDARY_CELL_HS_DSCH_RECEPTION variable and take the corresponding actions as described in subclause 8.5.51.
- 1> if any IEs related to E-DCH are stored in the UE:
 - 2> clear any stored IE "E-DCH info";
 - 2> for FDD, clear any stored IE "Secondary serving E-DCH cell info" and IE "Secondary E-DCH info common";
 - 2> for 1.28Mcps TDD, clear any stored IE "Multi-carrier E-DCH Info for LCR TDD";
 - 2> determine the value for the E_DCH_TRANSMISSION variable and take the corresponding actions as described in subclause 8.5.28.
- 1> if any of the IEs "DTX-DRX timing information" or "DTX-DRX information" are stored in the UE:
 - 2> determine the value for the DTX_DRX_STATUS variable and take the corresponding actions as described in subclause 8.5.34.
- 1> if the IE "HS-SCCH less information" is stored in the UE:
 - 2> determine the value for the HS_SCCH_LESS_STATUS variable and take the corresponding actions as described in subclause 8.5.35.
- 1> if any IEs related to MIMO are stored in the UE:
 - 2> determine the value for the MIMO_STATUS variable and take the corresponding actions as described in subclause 8.5.33.

- 1> if the IE "MIMO mode with four transmit antennas" is stored in the UE:
 - 2> determine the value for the MIMO_MODE_WITH_FOUR_TRANSMIT_ANTENNAS_STATUS variable and take the corresponding actions as described in subclause 8.5.79.
- 1> for 1.28 Mcps TDD, if the IEs "Control Channel DRX Information" is stored in the UE:
 - 2> determine the value for the CONTROL_CHANNEL_DRX_STATUS variable and take the corresponding actions as described in subclause 8.5.53.
- 1> for 1.28 Mcps TDD, if the IE "SPS information" is stored in the UE:
 - 2> determine the value for the E_DCH_SPS_STATUS variable and take the corresponding actions as described in subclause 8.5.54;
 - 2> determine the value for the HS_DSCH_SPS_STATUS variable and take the corresponding actions as described in subclause 8.5.55.
- 1> for 1.28 Mcps TDD, if the IE "MU-MIMO info" is stored in the UE:
 - 2> determine the value for the MU_MIMO_STATUS variable and take the corresponding actions as described in subclause 8.5.61.
- 1> if the UE is not already in CELL_FACH state:
 - 2> move to CELL_FACH state;
 - 2> determine the value for the HSPA_RNTI_STORED_CELL_PCH variable and take the corresponding actions as described in subclause 8.5.56;
 - 2> determine the value for the READY_FOR_COMMON_EDCH variable and take the corresponding actions as described in subclause 8.5.47;
 - 2> determine the value for the COMMON_E_DCH_TRANSMISSION variable and take the corresponding actions as described in subclause 8.5.46;
 - 2> for FDD, determine the value for the READY_FOR_COMMON_ERGCH variable and take the corresponding actions as described in subclause 8.5.75;
 - 2> for 1.28 Mcps TDD, determine the value for the MU_MIMO_STATUS variable and take the corresponding actions as described in subclause 8.5.61;
 - 2> for 3.84 Mcps TDD and 7.68 Mcps TDD; or
 - 2> for FDD and 1.28 Mcps TDD, if the UE does not support HS-DSCH reception in CELL_FACH state; or
 - 2> if the IE "HS-DSCH common system information" is not included in System Information Block type 5 or System Information Block type 5bis; or
 - 2> for 1.28 Mcps TDD, if the IE "Common E-DCH system info" is not included in System Information Block type 5:
 - 3> select PRACH according to subclause 8.5.17;
 - 3> select Secondary CCPCH according to subclause 8.5.19;
 - 3> use the transport format set given in system information as specified in subclause 8.6.5.1;
 - 3> take the actions related to the HS_DSCH_RECEPTION_GENERAL variable as described in subclause 8.5.37a.
 - 2> else:
 - 3> if variable READY_FOR_COMMON_EDCH is set to TRUE:
 - 4> configure the Enhanced Uplink in CELL_FACH state and Idle mode as specified in subclause 8.5.45.

- 3> else:
 - 4> select PRACH according to subclause 8.5.17 and:
 - 5> use for the PRACH the transport format set given in system information as specified in subclause 8.6.5.1.
 - 3> if variable H_RNTI is not set or variable C_RNTI is not set:
 - 4> clear variable C_RNTI;
 - 4> clear variable H_RNTI;
 - 4> clear any stored IEs "HARQ info";
 - 4> set variable HS_DSCH_RECEPTION_OF_CCCH_ENABLED to TRUE;
 - 4> and start receiving the HS-DSCH according to the procedure in subclause 8.5.37.
 - 3> else:
 - 4> receive the HS-DSCH according to the procedure in subclause 8.5.36.
- 1> if the UE performs cell re-selection; or
- 1> if the UE re-enters service area and the UE supports HS-DSCH reception in CELL_FACH state and System Information Block type 5 or System Information Block type 5bis includes IE "HS-DSCH common system information", and for 1.28 Mcps TDD, System Information Block type 5 includes IE "Common E-DCH system info":
- 2> clear the variable C_RNTI; and
 - 2> stop using that C_RNTI just cleared from the variable C_RNTI in MAC;
 - 2> for FDD and 1.28 Mcps TDD, if the variable H_RNTI is set:
 - 3> clear the variable H_RNTI; and
 - 3> stop using that H_RNTI just cleared from the variable H_RNTI in MAC;
 - 3> clear any stored IEs "HARQ info";
 - 2> for FDD and 1.28 Mcps TDD, if the variable E_RNTI is set:
 - 3> clear the variable E_RNTI.
 - 2> determine the value for the HSPA_RNTI_STORED_CELL_PCH variable and take the corresponding actions as described in subclause 8.5.56;
 - 2> determine the value for the READY_FOR_COMMON_EDCH variable and take the corresponding actions as described in subclause 8.5.47;
 - 2> determine the value for the COMMON_E_DCH_TRANSMISSION variable and take the corresponding actions as described in subclause 8.5.46;
 - 2> for FDD, determine the value for the READY_FOR_COMMON_ERGCH variable and take the corresponding actions as described in subclause 8.5.75;
 - 2> for FDD and 1.28 Mcps TDD, if the UE does support HS-DSCH reception in CELL_FACH state and IE "HS-DSCH common system information" is included in System Information Block type 5 or System Information Block type 5bis:
 - 3> reset the MAC-ehs entity [15].
 - 3> set variable HS_DSCH_RECEPTION_OF_CCCH_ENABLED to TRUE;
 - 3> and start receiving the HS-DSCH according to the procedure in subclause 8.5.37.

- 2> else:
 - 3> take the actions related to the HS_DSCH_RECEPTION_GENERAL variable as described in subclause 8.5.37a.
- 1> set CFN in relation to SFN of current cell according to subclause 8.5.15;
- 1> in case of a cell update procedure:
 - 2> set the contents of the CELL UPDATE message according to subclause 8.3.1.3;
 - 2> submit the CELL UPDATE message for transmission on the uplink CCCH.
- 1> in case of a URA update procedure:
 - 2> set the contents of the URA UPDATE message according to subclause 8.3.1.3;
 - 2> submit the URA UPDATE message for transmission on the uplink CCCH.
- 1> set counter V302 to 1;
- 1> start timer T302 when the MAC layer indicates success or failure in transmitting the message.

8.3.1.3 CELL UPDATE / URA UPDATE message contents to set

In case of cell update procedure the UE shall transmit a CELL UPDATE message.

In case of URA update procedure the UE shall transmit a URA UPDATE message.

The UE shall set the IEs in the CELL UPDATE message as follows:

- 1> for FDD, if the UE supports the IE "Cell Update message with optimised encoding" and this IE is included in system information block type 5 or 5bis:
 - 2> use "CELL UPDATE FDD" defined in subclause 10.2.7a to signal IEs;
- 1> else:
 - 2> use "CELL UPDATE" defined in subclause 10.2.7 to signal IEs;
- 1> set the IE "Cell update cause" corresponding to the cause specified in subclause 8.3.1.2 that is valid when the CELL UPDATE message is submitted to lower layers for transmission;

NOTE: During the time period starting from when a cell update procedure is initiated by the UE until when the procedure ends, additional CELL UPDATE messages may be transmitted by the UE with different causes.

- 1> if the IE "Cell update cause" is set to "uplink data transmission" and if an event triggered traffic volume measurement has been configured:
 - 2> if the TCTV is larger than the threshold in the IE "Reporting threshold" for a traffic volume measurement stored in the MEASUREMENT_IDENTITY variable and that traffic volume measurement has "measurement identity" equal to 4, "Traffic volume event identity" equal to "4a", "Measurement validity" equal to "all states" or "all states except CELL_DCH":
 - 3> set the IE "Traffic volume indicator" to TRUE.
- 1> set the IE "U-RNTI" to the value of the variable U_RNTI;
- 1> if the value of the variable PROTOCOL_ERROR_INDICATOR is TRUE:
 - 2> include the IE "RRC transaction identifier"; and
 - 3> set it to the value of "RRC transaction identifier" in the entry for the CELL UPDATE CONFIRM message in the table "Rejected transactions" in the variable TRANSACTIONS.
 - 2> include and set the IE "failure cause" to the cause value "protocol error";

- 2> set the IE "Protocol error information" set to the value of the variable PROTOCOL_ERROR_INFORMATION.
- 1> if the value of the variable FAILURE_INDICATOR is TRUE:
 - 2> include the IE "RRC transaction identifier"; and
 - 3> set it to the value of "RRC transaction identifier" in the entry for the CELL UPDATE CONFIRM message in the table "Accepted transactions" in the variable TRANSACTIONS.
 - 2> include and set the IE "failure cause" to the value of the variable FAILURE_CAUSE.
- 1> if the variable "LATEST_CONFIGURED_CN_DOMAIN" has been initialised:
 - 2> for each CN domain for which an entry exists in the variable ESTABLISHED_RABS or which is indicated in the variable LATEST_CONFIGURED_CN_DOMAIN:
 - 3> include the START value calculated according to subclause 8.5.9.
- 1> else:
 - 2> include the START value for either the CS domain or the PS domain, calculated according to subclause 8.5.9.
- 1> if an unrecoverable error [16] in any of the AM RLC entities for the signalling radio bearers RB2, RB3 or RB4 is detected:
 - 2> set the IE "AM_RLC error indication (RB2, RB3 or RB4)" to TRUE;
 - 2> set the variable AM_RLC_ERROR_PENDING_RB234 to TRUE.
- 1> otherwise:
 - 2> if the value of the variable AM_RLC_ERROR_PENDING_RB234 is TRUE:
 - 3> set the IE "AM_RLC error indication (RB2, RB3 or RB4)" to TRUE.
 - 2> otherwise:
 - 3> set the IE "AM_RLC error indication (RB2, RB3 or RB4)" to FALSE.
- 1> if an unrecoverable error [16] in any of the AM RLC entities for the RB5 or upward is detected:
 - 2> set the IE "AM_RLC error indication (RB>4)" to TRUE;
 - 2> set the variable AM_RLC_ERROR_PENDING_RB5_AND_UP to TRUE.
- 1> otherwise:
 - 2> if the value of the variable AM_RLC_ERROR_PENDING_RB5_AND_UP is TRUE:
 - 3> set the IE "AM_RLC error indication (RB>4)" to TRUE.
 - 2> otherwise:
 - 3> set the IE "AM_RLC error indication (RB>4)" to FALSE.
- 1> set the IE "RB Timer indicator" to the value of the variable RB_TIMER_INDICATOR;
- 1> if the variable ESTABLISHMENT_CAUSE is initialised:
 - 2> include the IE "Establishment cause" and set it to the value of the variable ESTABLISHMENT_CAUSE;
 - 2> if the value of the variable ESTABLISHMENT_CAUSE is set to "Originating Conversational Call" or "Emergency Call" and a CS call is being initiated:
 - 3> set the value of the IE "CS Call type" to "speech", "video" or "other" according to the call being initiated.

- 1> if the variable ORDERED_RECONFIGURATION is set to TRUE:
 - 2> include the IE "Reconfiguration Status Indicator" and set it to TRUE.
 - 1> if the IE "Cell update cause" is set to "radio link failure" or "RLC Unrecoverable error" and the UE has submitted a reconfiguration response message to RLC and the UE has not received the RLC acknowledgement for the response message:
 - 2> include the IE "Reconfiguration Status Indicator" and set it to TRUE.
 - 1> if the UE supports HS-DSCH reception in CELL_FACH state:
 - 2> include the IE "HS-PDSCH in CELL_FACH" and set it to TRUE.
 - 1> if the UE supports Enhanced Uplink in CELL_FACH state and Idle mode:
 - 2> include the IE "Support of common E-DCH" and set it to TRUE.
 - 1> if the UE supports reporting of the IE "Security Revert Status Indicator":
 - 2> if the UE has reverted back old security configuration by aborting ongoing security mode command as cell update procedure was initiated:
 - 3> include the IE "Security Revert Status Indicator" and set it to "Reverted Back".
 - 2> otherwise:
 - 3> include the IE "Security Revert Status Indicator" and set it to "Normal Operation".
 - 1> if the UE supports Two DRX schemes in URA_PCH and CELL_PCH
 - 2> include the IE "Support for Two DRX schemes in URA_PCH and CELL_PCH" and set it to TRUE.
- NOTE: In 1.28 Mcps TDD, UE supporting HS-DSCH reception in CELL_FACH state always supports Enhanced Uplink in CELL_FACH state and Idle mode, and vice versa.
- 1> if the UE supports MAC-i/is:
 - 2> include the IE "Support of MAC-i/is" and set it to TRUE.
 - 1> if the UE supports HS-DSCH DRX operation in CELL_FACH state:
 - 2> include the IE "Support of HS-DSCH DRX operation" and set it to TRUE.
 - 1> if the UE supports SPS operation:
 - 2> include the IE "Support of SPS operation" and set it to TRUE.
 - 1> if the UE supports control channel DRX operation:
 - 2> include the IE "Support of control channel DRX operation" and set it to TRUE.
 - 1> if the UE performs cell update for MBMS ptp radio bearer request as specified in subclause 8.6.9.6; and
 - 1> if one or more of the MBMS services for which the UE initiates the ptp radio bearer request concerns an MBMS Selected Service:
 - 2> for each MBMS Selected Service that is indicated on MCCH and for which the UE initiates ptp radio bearer request:
 - 3> order the MBMS Selected Services such that those selected with a higher priority are listed in the IE "MBMS Selected Services Short" before those selected with a lower priority;
 - 3> include the IE "MBMS Selected Service ID" within the IE "MBMS Selected Services Short" and set it to a value in accordance with subclause 8.6.9.8.
 - 1> otherwise, if the UE performs cell update for MBMS counting as specified in subclause 8.7.4; and

- 1> if one or more of the MBMS services for which the UE initiates the counting response concerns an MBMS Selected Service:
 - 2> for each MBMS Selected Service that is indicated on MCCH and for which the UE initiates the counting response:
 - 3> order the MBMS Selected Services such that those selected with a higher priority are listed in the IE "MBMS Selected Services Short" before those selected with a lower priority;
 - 3> include the IE "MBMS Selected Service ID" within the IE "MBMS Selected Services Short" and set it to a value in accordance with subclause 8.6.9.8.
- 1> if the UE included one or more "MBMS Selected Service ID" IEs:
 - 2> include the IE "MBMS Modification Period identity" and set it to a value in accordance with subclause 8.5.29.
- 1> if, according to [4], the High-mobility state is applicable and it has been detected by the UE:
 - 2> include the IE "UE Mobility State Indicator" and set it to the "High-MobilityDetected" value.
- 1> if an IE "Logged Measurement Info-FDD" or "Logged Measurement Info-TDD" in variable LOGGED_MEAS_REPORT_VARIABLE is present and registered PLMN is present in the IE "PLMN Identity List" stored in variable LOGGED_MEAS_REPORT_VARIABLE:
 - 2> include IE "Logged Meas Available".
- 1> if an IE "Logged ANR Report Info" in variable LOG_ANR_REPORT_VARIABLE is present and the registered PLMN is the same as one of the PLMNs in the IE "PLMN Identity" or IE "Equivalent PLMN Identity List" stored in variable LOG_ANR_REPORT_VARIABLE:
 - 2> include IE "ANR Logging Results Available".

The UE shall:

- 1> if the UE capability has changed compared to the value stored in the variable UE_CAPABILITY_TRANSFERRED and the variable RNC_CAPABILITY_CHANGE_SUPPORT is set to TRUE:
 - 2> include the IE "Capability change indicator".

NOTE: Transmitting the IE "Capability change indicator" does not trigger any actual changed behaviour on the part of the UE. It serves only to inform the network that the UE is requesting an opportunity to send a UE CAPABILITY INFORMATION message.

If the UE needs to include the IE "Failure Cause" and the Cell Update message size exceeds the used transport format size, then the UE may omit the IE "Support for Two DRX schemes in URA_PCH and CELL_PCH" (i.e. omit the cellUpdate-r3-add-ext), the UE may omit IE "MBMS Selected Services" (i.e. omit the mbmsSelectedServices) and the UE may omit the Rel-10 non-critical extensions (i.e. omit the cellUpdate-va40ext).

If the UE does not need to include the IE "Failure Cause" and the Cell Update message size exceeds the used transport format size, then the UE may omit the IE "Support for Two DRX schemes in URA_PCH and CELL_PCH" (i.e. omit the cellUpdate-r3-add-ext), and the UE may omit IE "MBMS Selected Services" (i.e. omit the mbmsSelectedServices) to be able to include the Rel-10 non-critical extensions (i.e. include the cellUpdate-va40ext), or to be able to include IE "Measured results on RACH". The UE should first omit the IEs before applying the prioritization rules in section 8.5.23 to include the IE "Measured results on RACH".

The UE shall set the IEs in the URA UPDATE message as follows:

- 1> set the IE "U-RNTI" to the value of the variable U_RNTI;
- 1> set the IE "URA update cause" corresponding to which cause as specified in subclause 8.3.1.2 that is valid when the URA UPDATE message is submitted to lower layers for transmission;

NOTE: During the time period starting from when a URA update procedure is initiated by the UE until when the procedure ends, additional URA UPDATE messages may be transmitted by the UE with different causes, depending on which causes are valid for the respective URA UPDATE message.

1> if the value of the variable `PROTOCOL_ERROR_INDICATOR` is TRUE:

2 > include the IE "RRC transaction identifier"; and

3> set it to the value of "RRC transaction identifier" in the entry for the URA UPDATE CONFIRM message in the table "Rejected transactions" in the variable `TRANSACTIONS`.

2> set the IE "Protocol error indicator" to TRUE;

2> include the IE "Protocol error information" set to the value of the variable `PROTOCOL_ERROR_INFORMATION`.

1> if the value of the variable `PROTOCOL_ERROR_INDICATOR` is FALSE:

2> if the value of the variable `INVALID_CONFIGURATION` is TRUE:

3> include the IE "RRC transaction identifier"; and

3> set it to the value of "RRC transaction identifier" in the entry for the URA UPDATE CONFIRM message in the table "Accepted transactions" in the variable `TRANSACTIONS`;

3> set the IE "Protocol error indicator" to TRUE;

3> include the IE "Protocol error information" set to "Information element value not comprehended".

2> if the value of the variable `INVALID_CONFIGURATION` is FALSE:

3> set the IE "Protocol error indicator" to FALSE.

1> if the UE supports HS-DSCH reception in `CELL_FACH` state:

2> include the IE "HS-PDSCH in `CELL_FACH`" and set it to TRUE.

1> if the UE supports HS-DSCH reception `CELL_PCH` and `URA_PCH` state:

2> include the IE "HS-PDSCH in `CELL_PCH` and `URA_PCH`" and set it to TRUE.

1> if the UE supports Enhanced Uplink in `CELL_FACH` state and Idle mode:

2> include the IE "Support of common E-DCH" and set it to TRUE.

1> if an IE "Logged Measurement Info-FDD" or "Logged Measurement Info-TDD" in variable `LOGGED_MEAS_REPORT_VARIABLE` is present and registered PLMN is present in the IE "PLMN Identity List" stored in variable `LOGGED_MEAS_REPORT_VARIABLE`:

2> include IE "Logged Meas Available".

1> if IE "Logged ANR report" in variable `LOG_ANR_REPORT_VARIABLE` is present and registered PLMN is the same as one of the PLMNs in the IE "PLMN Identity" or IE "Equivalent PLMN Identity List" stored in variable `LOG_ANR_REPORT_VARIABLE`:

2> include IE "ANR Logging Results Available".

8.3.1.4 T305 expiry and the UE detects "out of service area"

When the T305 expires and the UE detects that it is "out of service area" as specified in subclause 8.5.5.1, the UE shall

1> start timer T307;

1> act according to subclause 7.2.2.

8.3.1.4.1 Re-entering "in service area"

If the UE detects "in service area" according to subclause 8.5.5.2 and timer T307 or T317 is running, the UE shall:

- 1> check the value of V302; and
- 1> if V302 is equal to or smaller than N302:
 - 2> in case of a cell update procedure:
 - 3> set the contents of the CELL UPDATE message according to subclause 8.3.1.3;
 - 3> submit the CELL UPDATE message for transmission on the uplink CCCH.
 - 2> in case of a URA update procedure:
 - 3> set the contents of the URA UPDATE message according to subclause 8.3.1.3;
 - 3> submit the URA UPDATE message for transmission on the uplink CCCH.
 - 2> increment counter V302;
 - 2> restart timer T302 when the MAC layer indicates success or failure to transmit the message.
- 1> if V302 is greater than N302:
 - 2> clear the variable RB_UPLINK_CIPHERING_ACTIVATION_TIME_INFO;
 - 2> clear the variable INTEGRITY_PROTECTION_ACTIVATION_INFO;
 - 2> in case of a cell update procedure:
 - 3> clear the entry for the CELL UPDATE CONFIRM message in the table "Rejected transactions" in the variable TRANSACTIONS.
 - 2> in case of a URA update procedure:
 - 3> clear the entry for the URA UPDATE CONFIRM message in the table "Rejected transactions" in the variable TRANSACTIONS.
 - 2> release all its radio resources;
 - 2> indicate release (abort) of the established signalling connections (as stored in the variable ESTABLISHED_SIGNALLING_CONNECTIONS) and established radio access bearers (as stored in the variable ESTABLISHED_RABS) to upper layers;
 - 2> clear the variable ESTABLISHED_SIGNALLING_CONNECTIONS;
 - 2> clear the variable ESTABLISHED_RABS;
 - 2> enter idle mode;
 - 2> perform other actions when entering idle mode from connected mode as specified in subclause 8.5.2;
 - 2> and the procedure ends.

8.3.1.4.2 Expiry of timer T307

When the T307 expires, the UE shall:

- 1> move to idle mode;
- 1> release all dedicated resources;
- 1> indicate release (abort) of the established signalling connections (as stored in the variable ESTABLISHED_SIGNALLING_CONNECTIONS) and established radio access bearers (as stored in the variable ESTABLISHED_RABS) to upper layers;

- 1> clear the variable ESTABLISHED_SIGNALLING_CONNECTIONS;
- 1> clear the variable ESTABLISHED_RABS;
- 1> perform other actions when entering idle mode from connected mode as specified in subclause 8.5.2;
- 1> and the procedure ends.

8.3.1.5 Reception of an CELL UPDATE/URA UPDATE message by the UTRAN

When the UTRAN receives a CELL UPDATE/URA UPDATE message, the UTRAN should:

- 1> in case the procedure was triggered by reception of a CELL UPDATE:
 - 2> if SRNS relocation was performed:
 - 3> transmit a CELL UPDATE CONFIRM message on the downlink DCCH.
 - 2> otherwise:
 - 3> update the START value for each CN domain as maintained in UTRAN (refer to subclause 8.5.9) with "START" in the IE "START list" for the CN domain as indicated by "CN domain identity" in the IE "START list";
 - 3> transmit a CELL UPDATE CONFIRM message on the downlink DCCH or optionally on the CCCH but only if ciphering is not required; and
 - 3> optionally set the IE "RLC re-establish indicator (RB2, RB3 and RB4)" and/or the IE "RLC re-establish indicator (RB5 and upwards)" to TRUE to request a RLC re-establishment in the UE, in which case the corresponding RLC entities should also be re-established in UTRAN; or
- 1> in case the procedure was triggered by reception of a URA UPDATE:
 - 2> if SRNS relocation was performed:
 - 3> transmit a URA UPDATE CONFIRM message on the downlink DCCH.
 - 2> otherwise:
 - 3> transmit a URA UPDATE CONFIRM message on the downlink CCCH or DCCH.
 - 2> include the IE "URA identity" in the URA UPDATE CONFIRM message in a cell where multiple URA identifiers are broadcast; or
- 1> initiate an RRC connection release procedure (see subclause 8.1.4) by transmitting an RRC CONNECTION RELEASE message on the downlink CCCH. In particular UTRAN should:
 - 2> if the CELL UPDATE message was sent because of an unrecoverable error in RB2, RB3 or RB4:
 - 3> initiate an RRC connection release procedure (subclause 8.1.4) by transmitting an RRC CONNECTION RELEASE message on the downlink CCCH.
- 1> if the radio bearer is connected to a CS domain radio access bearer and the radio bearer uses UM RLC:
 - 2> the UM RLC entity should be re-established in UTRAN.

UTRAN may transmit several CELL UPDATE CONFIRM/URA UPDATE CONFIRM messages to increase the probability of proper reception of the message by the UE. In such a case, the RRC SN for these repeated messages should be the same.

8.3.1.6 Reception of the CELL UPDATE CONFIRM/URA UPDATE CONFIRM message by the UE

When the UE receives a CELL UPDATE CONFIRM/URA UPDATE CONFIRM message; and

- if the message is received on the CCCH, and IE "U-RNTI" is present and has the same value as the variable U_RNTI; or
- if the message is received on DCCH:

the UE may:

- 1> maintain a list of the set of cells to which the UE has Radio Links if the IE "Cell ID" is present.

the UE shall:

- 1> stop timer T302;
- 1> set variable HS_DSCH_RECEPTION_OF_CCCH_ENABLED to FALSE;
- 1> in case of a cell update procedure and the CELL UPDATE CONFIRM message:
 - 2> includes "RB information elements"; and/or
 - 2> includes "Transport channel information elements"; and/or
 - 2> includes "Physical channel information elements"; and
 - 2> if the variable ORDERED_RECONFIGURATION is set to FALSE:
 - 3> set the variable ORDERED_RECONFIGURATION to TRUE.
- 1> act upon all received information elements as specified in subclause 8.6, unless specified otherwise in the following:
 - 2> if the IE "Frequency info" is included in the message:
 - 3> if the IE "RRC State Indicator" is set to the value "CELL_FACH":
 - 4> select a suitable UTRA cell according to [4] on that frequency;
 - 4> if the UE finds a suitable UTRA cell on that frequency:
 - 5> if the received CELL UPDATE CONFIRM message included the IE "Primary CPICH info" (for FDD) or "Primary CCPCH info" (for TDD), and the UE selects another cell than indicated by this IE or the received CELL UPDATE CONFIRM message did not include the IE "Primary CPICH info" (for FDD) or "Primary CCPCH info" (for TDD):
 - 6> act as specified in subclause 8.3.1.12.
 - 5> else:
 - 6> for 1.28Mcps TDD, decide the working frequency according to subclause 8.6.6.1.
 - 4> else, if the UE can not find a suitable UTRA cell on the indicated frequency but it finds a suitable UTRA cell on another frequency:
 - 5> act as specified in subclause 8.3.1.12.
 - 3> if the IE "RRC State Indicator" is set to the value "CELL_PCH" or "URA_PCH":
 - 4> select a suitable UTRA cell according to [4] on that frequency;
 - 4> if the UE finds a suitable UTRA cell on that frequency:
 - 5> if the received CELL UPDATE CONFIRM message included the IE "Primary CPICH info" (for FDD) or "Primary CCPCH info" (for TDD), and the UE in CELL_PCH state selects another cell than indicated by this IE or the received CELL UPDATE CONFIRM message did not include the IE "Primary CPICH info" (for FDD) or "Primary CCPCH info" (for TDD); or
 - 5> if the received CELL UPDATE CONFIRM message included the IE "URA identity", and the UE in URA_PCH state selects cell being part of another URA than indicated by this IE or the received CELL UPDATE CONFIRM message did not include the IE "URA identity":

- 6> act as specified in subclause 8.3.1.12.
- 4> else, if the UE can not find a suitable UTRA cell on the indicated frequency but it finds a suitable UTRA cell on another frequency:
 - 5> act as specified in subclause 8.3.1.12.
- 3> if the IE "RRC State Indicator" is set to the value "CELL_DCH":
 - 4> act on the IE "Frequency info" as specified in subclause 8.6.6.1.
- 2> if the IE "RRC State Indicator" is set to the value "CELL_PCH" or "URA_PCH":
 - 3> if the IE "Wait time" <> 0 is included in the message and the UE supports timer T320:
 - 4> start timer T320 with value set to the time stated in the IE "wait time".
 - 2> use the transport channel(s) applicable for the physical channel types that is used; and
 - 2> if the IE "TFS" is neither included nor previously stored in the UE for that transport channel(s):
 - 3> use the TFS given in system information.
 - 2> if none of the TFS stored is compatible with the physical channel:
 - 3> delete the stored TFS;
 - 3> use the TFS given in system information.
 - 2> if the IE "RLC re-establish indicator (RB2, RB3 and RB4)" in the CELL UPDATE CONFIRM message is set to TRUE:
 - 3> re-establish the RLC entities for signalling radio bearer RB2, signalling radio bearer RB3 and signalling radio bearer RB4 (if established);
 - 3> clear all entries in the table "Processed transactions" in the variable TRANSACTIONS;
 - 3> if the value of the IE "Status" in the variable CIPHERING_STATUS of the CN domain stored in the variable LATEST_CONFIGURED_CN_DOMAIN is set to "Started":
 - 4> set the HFN component of the respective COUNT-C values for AM RLC entities with RB identity 2, RB identity 3 and RB identity 4 (if established) equal to the START value included in the latest transmitted CELL UPDATE message for the CN domain stored in the variable LATEST_CONFIGURED_CN_DOMAIN.
- NOTE: UTRAN should not send a CELL UPDATE CONFIRM message with a target state CELL_PCH or URA_PCH, and including C-RNTI, and setting the IE "RLC re-establish indicator (RB2, RB3 and RB4)" to TRUE, otherwise the UE behaviour is not specified.
- 2> if the IE "RLC re-establish indicator (RB5 and upwards)" in the CELL UPDATE CONFIRM message is set to TRUE:
 - 3> for radio bearers with RB identity 5 and upwards:
 - 4> re-establish the AM RLC entities;
 - 4> if the value of the IE "Status" in the variable CIPHERING_STATUS of the CN domain as indicated in the IE "CN domain identity" in the IE "RAB info" in the variable ESTABLISHED_RABS is set to "Started":
 - 5> set the HFN component of the respective COUNT-C values for AM RLC entities equal to the START value included in this CELL UPDATE message for the CN domain as indicated in the IE "CN domain identity" in the IE "RAB info" in the variable ESTABLISHED_RABS.
- NOTE: UE actions, in case IE "Downlink counter synchronisation info" is included and either IE "RLC re-establish indicator (RB2, RB3 and RB4)" or IE "RLC re-establish indicator (RB5 and upwards)" are set to TRUE, are not defined.

- 1> if the CELL UPDATE CONFIRM / URA UPDATE CONFIRM message contained the IE "Ciphering mode info" or contained the IE "Integrity protection mode info":
 - 2> set the IE "Status" in the variable SECURITY_MODIFICATION for all the CN domains in the variable SECURITY_MODIFICATION to "Affected".
- 1> if the variable ESTABLISHMENT_CAUSE is set:
 - 2> clear the variable ESTABLISHMENT_CAUSE.
- 1> enter a state according to subclause 8.6.3.3 applied on the CELL UPDATE CONFIRM / URA UPDATE CONFIRM message.

If the UE after state transition enters CELL_DCH, CELL_FACH, CELL_PCH or URA_PCH state, the UE shall, after state transition:

- 1> determine the value for the HSPA_RNTI_STORED_CELL_PCH variable and take the corresponding actions as described in subclause 8.5.56;
- 1> determine the value for the READY_FOR_COMMON_EDCH variable and take the corresponding actions as described in subclause 8.5.47;
- 1> determine the value for the COMMON_E_DCH_TRANSMISSION variable and take the corresponding actions as described in subclause 8.5.46.
- 1> for FDD, determine the value for the READY_FOR_COMMON_ERGCH variable and take the corresponding actions as described in subclause 8.5.75;
- 1> for 1.28 Mcps TDD, determine the value for the MU_MIMO_STATUS variable and take the corresponding actions as described in subclause 8.5.61;
- 1> for 1.28 Mcps TDD, if the UE supports the non-rectangular resource allocation, the UE shall:
 - 2> determine the value for the NON_RECTANGULAR_ALLOCATION STATUS variable and take the corresponding actions as described in subclause 8.5.82;

If the UE after state transition enters CELL_DCH state, it shall:

- 1> perform the physical layer synchronisation procedure A as specified in [29] (FDD only);
- 1> not prohibit periodical status transmission in RLC;
- 1> if the IE "Default DPCH Offset Value" is not included:
 - 2> the UE behaviour is not specified.

If the UE after state transition remains in CELL_FACH state, it shall

- 1> start the timer T305 using its initial value if timer T305 is not running and periodical cell update has been configured by T305 in the IE "UE Timers and constants in connected mode" set to any other value than "infinity";
- 1> if variable READY_FOR_COMMON_EDCH is set to TRUE:
 - 2> configure the Enhanced Uplink in CELL_FACH state and Idle mode as specified in subclause 8.5.45 for FDD and 8.5.45a for 1.28 Mcps TDD.
- 1> else:
 - 2> select PRACH according to subclause 8.5.17;
- 1> for 3.84 Mcps TDD and 7.68 Mcps TDD; or
- 1> for FDD and 1.28 Mcps TDD, if the UE does not support HS-DSCH reception in CELL_FACH state; or
- 1> if the IE "HS-DSCH common system information" is not included in System Information Block type 5 or System Information Block type 5bis; or

- 1> for 1.28 Mcps TDD, if the IE "Common E-DCH system info" is not included in System Information Block type 5:
 - 2> select Secondary CCPCH according to subclause 8.5.19;
 - 2> take the actions related to the HS_DSCH_RECEPTION_GENERAL variable as described in subclause 8.5.37a.
- 1> else:
 - 2> For FDD, if the RBs have the multiplexing option with transport channel type "HS-DSCH" for the DL and transport channel type "RACH" in the UL; and
 - 2> if the UE does not supports E-DCH transmission in CELL_FACH state and Idle mode or the IE "Common E-DCH system info" is not included system information block type 5 or 5bis; and
 - 2> if variable H_RNTI and variable C_RNTI are set:
 - 3> start to receive HS-DSCH according to the procedure in subclause 8.5.36.
 - 2> else:
 - 3> if the RBs have the multiplexing option with transport channel type "HS-DSCH" for the DL and transport channel type "E-DCH" in the UL; and
 - 3> if variable READY_FOR_COMMON_EDCH is set to TRUE; and
 - 3> if variable H_RNTI and variable C_RNTI and variable E_RNTI are set:
 - 4> start to receive HS-DSCH according to the procedure in subclause 8.5.36.
 - 3> else:
 - 4> clear variable C_RNTI and delete any stored C-RNTI value;
 - 4> clear variable H_RNTI and delete any stored H-RNTI value;
 - 4> clear variable E_RNTI and delete any stored E-RNTI value;
 - 4> clear any stored IEs "HARQ info";
 - 4> set the variable INVALID_CONFIGURATION to TRUE.
- 1> not prohibit periodical status transmission in RLC;
- 1> if the IE "UTRAN DRX cycle length coefficient" is included in the same message:
 - 2> ignore that IE and stop using DRX.

If the UE after state transition enters URA_PCH or CELL_PCH state, it shall:

- 1> if the UE enters CELL_PCH state:
 - 2> if the UE supports E-DCH transmission in CELL_FACH state and Idle mode and the IE "Common E-DCH system info" is included in system information block type 5 or 5bis:
 - 3> if variable H_RNTI or variable C_RNTI or variable E_RNTI is not set:
 - 4> clear variable C_RNTI and delete any stored C-RNTI value;
 - 4> clear variable H_RNTI and delete any stored H-RNTI value;
 - 4> clear variable E_RNTI and delete any stored E-RNTI value;
 - 4> clear any stored IE "HARQ Info";
 - 4> reset the MAC-ehs entity [15];

- 4> reset the MAC-i/is entity [15].
- 1> prohibit periodical status transmission in RLC;
- 1> for 3.84 Mcps TDD and 7.68 Mcps TDD; or
- 1> for FDD and 1.28 Mcps TDD, if the UE does not support HS-DSCH reception in CELL_PCH and URA_PCH state; or
- 1> if the IE "HS-DSCH paging system information" is not included in System Information Block type 5 or System Information Block type 5bis and the variable HSPA_RNTI_STORED_CELL_PCH is set to FALSE:
 - 2> clear the variable C_RNTI;
 - 2> stop using that C_RNTI just cleared from the variable C_RNTI in MAC.
- 1> start the timer T305 using its initial value if timer T305 is not running and periodical update has been configured by T305 in the IE "UE Timers and constants in connected mode" set to any other value than "infinity";
- 1> for 3.84 Mcps TDD and 7.68 Mcps TDD; or
- 1> for FDD and 1.28 Mcps TDD, if the UE does not support HS-DSCH reception in CELL_PCH and URA_PCH state; or
- 1> if the IE "HS-DSCH paging system information" is not included in System Information Block type 5 or System Information Block type 5bis and the variable HSPA_RNTI_STORED_CELL_PCH is set to FALSE:
 - 2> select Secondary CCPCH according to subclause 8.5.19;
 - 2> take the actions related to the HS_DSCH_RECEPTION_GENERAL variable as described in subclause 8.5.37a.
- 1> else:
 - 2> if the UE is in CELL_PCH:
 - 3> if IE "New C-RNTI" is not included:
 - 4> clear the variable C_RNTI;
 - 4> clear the variable H_RNTI;
 - 4> clear any stored IEs "HARQ info";
 - 4> determine the value for the READY_FOR_COMMON_EDCH variable and take the corresponding actions as described in subclause 8.5.47.
 - 4> for FDD, determine the value for the READY_FOR_COMMON_ERGCH variable and take the corresponding actions as described in subclause 8.5.75;
 - 2> if the variable HSPA_RNTI_STORED_CELL_PCH is set to TRUE:
 - 3> select Secondary CCPCH according to subclause 8.5.19;
 - 3> take the actions related to the HS_DSCH_RECEPTION_GENERAL variable as described in subclause 8.5.37a.
 - 2> else:
 - 3> for FDD; or
 - 3> for 1.28 Mcps TDD, if both variable H_RNTI and variable C_RNTI are set:
 - 4> monitor its paging occasions on the selected PICH determined according to subclauses 8.6.3.1a, 8.6.3.2 and 8.5.39 and receive PCCH on the HS-DSCH mapped on the HS-PDSCH, or DCCH and DTCH mapped on the HS-PDSCH and the associated HS-SCCH selected by the UE according to the procedures in subclause 8.5.40 for FDD and 8.5.40a for 1.28 Mcps TDD.

- 1> if the IE "UTRAN DRX cycle length coefficient" is included in the same message:
 - 2> use the values in the IE "UTRAN DRX Cycle length coefficient" for calculating Paging Occasion and PICH Monitoring Occasion as specified in subclause 8.6.3.2.

NOTE: In the case of a cell update procedure during an ongoing reconfiguration procedure moving the UE into CELL_PCH/URA_PCH then the value of the IE "UTRAN DRX Cycle length coefficient" sent in the CELL UPDATE CONFIRM message should be the same as the value sent in the reconfiguration message.

- 1> if the IE "UTRAN DRX cycle length coefficient" is not included in the same message:
 - 2> set the variable INVALID_CONFIGURATION to TRUE.

If the UE after the state transition remains in CELL_FACH state; and

- 1> the contents of the variable C_RNTI are empty:

it shall check the value of V302; and:

- 1> if V302 is equal to or smaller than N302:
 - 2> if, caused by the received CELL UPDATE CONFIRM or URA UPDATE CONFIRM message:
 - 3> the IE "Reconfiguration" in the variable CIPHERING_STATUS is set to TRUE; and/or
 - 3> the IE "Reconfiguration" in the variable INTEGRITY_PROTECTION_INFO is set to TRUE:
 - 4> abort the ongoing integrity and/or ciphering reconfiguration;
 - 4> if the received CELL UPDATE CONFIRM or URA UPDATE CONFIRM message contained the IE "Ciphering mode info":
 - 5> set the IE "Reconfiguration" in the variable CIPHERING_STATUS to FALSE; and
 - 5> clear the variable RB_UPLINK_CIPHERING_ACTIVATION_TIME_INFO.
 - 4> if the received CELL UPDATE CONFIRM or URA UPDATE CONFIRM message contained the IE "Integrity protection mode info":
 - 5> set the IE "Reconfiguration" in the variable INTEGRITY_PROTECTION_INFO to FALSE; and
 - 5> clear the variable INTEGRITY_PROTECTION_ACTIVATION_INFO.
 - 2> in case of a URA update procedure:
 - 3> stop the URA update procedure;
 - 3> clear any entry for the URA UPDATE CONFIRM message in the table "Accepted transactions" in the variable TRANSACTIONS; and
 - 3> continue with a cell update procedure.
 - 2> set the contents of the CELL UPDATE message according to subclause 8.3.1.3, except for the IE "Cell update cause" which shall be set to "cell reselection";
 - 2> submit the CELL UPDATE message for transmission on the uplink CCCH;
 - 2> increment counter V302;
 - 2> restart timer T302 when the MAC layer indicates success or failure to transmit the message.
 - 1> if V302 is greater than N302:
 - 2> clear the variable RB_UPLINK_CIPHERING_ACTIVATION_TIME_INFO;
 - 2> clear the variable INTEGRITY_PROTECTION_ACTIVATION_INFO;

- 2> in case of a cell update procedure:
 - 3> clear the entry for the CELL UPDATE CONFIRM message in the table "Rejected transactions" in the variable TRANSACTIONS.
- 2> in case of a URA update procedure:
 - 3> clear the entry for the URA UPDATE CONFIRM message in the table "Rejected transactions" in the variable TRANSACTIONS.
- 2> release all its radio resources;
- 2> indicate release (abort) of the established signalling connections (as stored in the variable ESTABLISHED_SIGNALLING_CONNECTIONS) and established radio access bearers (as stored in the variable ESTABLISHED_RABS) to upper layers;
- 2> clear the variable ESTABLISHED_SIGNALLING_CONNECTIONS;
- 2> clear the variable ESTABLISHED_RABS;
- 2> enter idle mode;
- 2> other actions the UE shall perform when entering idle mode from connected mode are specified in subclause 8.5.2;
- 2> and the procedure ends.

If the UE after the state transition remains in CELL_FACH state; and

- a C-RNTI is stored in the variable C_RNTI;

or

- the UE after the state transition moves to another state than the CELL_FACH state:

the UE shall:

- 1> in case cell reselection interrupted an ongoing cell update procedure and a CELL UPDATE CONFIRM/URA UPDATE CONFIRM was received with the IE "Downlink counter synchronisation info" present and the response to which was not submitted to the lower layers due to the cell re-selection:
 - 2> include the IE "START list" in the response message transmitted according to subclause 8.3.1.7;
 - 2> if the CELL UPDATE CONFIRM/URA UPDATE CONFIRM, the response to which was not delivered to the lower layers, due to the cell re-selection, included the IE "RB with PDCP information list":
 - 3> include the IE "RB with PDCP information list" in the response message transmitted according to subclause 8.3.1.7.
- 1> in case of a cell update procedure:
 - 2> set the IE "RRC transaction identifier" in any response message transmitted below to the value of "RRC transaction identifier" in the entry for the CELL UPDATE CONFIRM message in the table "Accepted transactions" in the variable TRANSACTIONS; and
 - 2> clear that entry.
- 1> in case of a URA update procedure:
 - 2> set the IE "RRC transaction identifier" in any response message transmitted below to the value of "RRC transaction identifier" in the entry for the URA UPDATE CONFIRM message in the table "Accepted transactions" in the variable TRANSACTIONS; and
 - 2> clear that entry;
- 1> if the variable PDCP_SN_INFO is non-empty:

- 2> include the IE "RB with PDCP information list" in any response message transmitted below and set it to the value of the variable PDCP_SN_INFO.
- 1> if the received CELL UPDATE CONFIRM or URA UPDATE CONFIRM message included the IE "Downlink counter synchronisation info":
 - 2> if the variable PDCP_SN_INFO is empty:
 - 3> configure the corresponding RLC entity for all AM and UM radio bearers and AM and UM signalling radio bearers except RB2 to "stop".
 - 2> else:
 - 3> configure the RLC entity for signalling radio bearers RB1, RB3 and RB4 to "stop";
 - 3> configure the RLC entity for UM and AM radio bearers for which the IE "PDCP SN Info" is not included to "stop".
 - 2> re-establish the RLC entity for RB2;
 - 2> clear all entries in the table "Processed transactions" in the variable TRANSACTIONS;
 - 2> for the downlink and the uplink, apply the ciphering configuration as follows:
 - 3> if the received re-configuration message included the IE "Ciphering Mode Info":
 - 4> use the ciphering configuration in the received message when transmitting the response message.
 - 3> if the ciphering configuration for RB2 from a previously received SECURITY MODE COMMAND has not yet been applied because the activation times not having been reached:
 - 4> if the previous SECURITY MODE COMMAND was received due to new keys being received:
 - 5> consider the new ciphering configuration to include the received new keys;
 - 5> initialise the HFN component of the uplink COUNT-C and downlink COUNT-C of SRB2 as indicated in subclause 8.1.12.3.1.
 - 4> else if the ciphering configuration for RB2 from a previously received SECURITY MODE COMMAND has not yet been applied because of the corresponding activation times not having been reached and the previous SECURITY MODE COMMAND caused a change in LATEST_CONFIGURED_CN_DOMAIN:
 - 5> consider the new ciphering configuration to include the keys associated with the LATEST_CONFIGURED_CN_DOMAIN;
 - 5> initialise the HFN component of the uplink COUNT-C and downlink COUNT-C of SRB2 to the most recently transmitted IE "START list" or IE "START" for the LATEST_CONFIGURED_CN_DOMAIN at the reception of the previous SECURITY MODE COMMAND.
 - 4> apply the new ciphering configuration immediately following RLC re-establishment.
 - 3> else:
 - 4> continue using the current ciphering configuration.
 - 2> set the new uplink and downlink HFN component of the COUNT-C of RB2 to MAX(uplink HFN component of the COUNT-C of RB2, downlink HFN component of the COUNT-C of RB2);
 - 2> increment by one the downlink and uplink values of the HFN component of the COUNT-C for RB2;
 - 2> calculate the START value according to subclause 8.5.9;
 - 2> include the calculated START values for each CN domain in the IE "START list" in the IE "Uplink counter synchronisation info" in any response message transmitted below;

- 2> for any measurement of type CSG Proximity detection or any measurement associated with CELL_INFO_CSG_LIST (i.e. CSG Proximity detection, CSG intra-frequency measurement, CSG inter-frequency measurement and/or SI acquisition):
 - 3> stop all measurements of type CSG Proximity detection and all measurements associated with CELL_INFO_CSG_LIST (i.e. CSG Proximity detection, CSG intra-frequency measurement, CSG inter-frequency measurement and/or SI acquisition);
 - 3> delete measurement control information for all measurements of type CSG Proximity detection and all measurements associated with CELL_INFO_CSG_LIST (i.e. CSG Proximity detection, CSG intra-frequency measurement, CSG inter-frequency measurement and/or SI acquisition);
 - 3> clear the variable CELL_INFO_CSG_LIST.
- 2> if timer T323 value is stored in the IE "UE Timers and constants in connected mode" in the variable TIMERS_AND_CONSTANTS:
 - 3> stop and reset timer T323;
 - 3> clear any value of the timer T323 stored in the IE "UE Timers and constants in connected mode" in the variable TIMERS_AND_CONSTANTS.
- 1> else if the radio bearer is connected to a CS domain radio access bearer and the radio bearer uses UM RLC:
 - 2> re-establish the UM RLC entity;
 - 2> if the value of the IE "Status" in the variable CIPHERING_STATUS of the CN domain as indicated in the IE "CN domain identity" in the IE "RAB info" in the variable ESTABLISHED_RABS is set to "Started":
 - 3> set the HFN component of the respective COUNT-C values for the UM RLC entity equal to the START value included in this CELL UPDATE message for the CN domain as indicated in the IE "CN domain identity" in the IE "RAB info" in the variable ESTABLISHED_RABS;
 - 3> set the remaining bits of the HFN component of the COUNT-C values of the UM RLC entity to zero.
- 1> if the received CELL UPDATE CONFIRM or URA UPDATE CONFIRM message did not include the IE "Downlink counter synchronisation info":
 - 2> if the variable START_VALUE_TO_TRANSMIT is set:
 - 3> include the value of the variable START_VALUE_TO_TRANSMIT in the IE "START" in the response message transmitted below.
- 1> if the variable DEFERRED_MEASUREMENT_STATUS is set to TRUE:
 - 2> if System Information Block type 11 is scheduled on the BCCH and the UE has not read nor stored the IEs present in this System Information Block; or
 - 2> if System Information Block type 11bis is scheduled on the BCCH and the UE has not read nor stored the IEs present in this System Information Block; or
 - 2> if System Information Block type 11ter is scheduled on the BCCH and the UE has not read nor stored the IEs present in this System Information Block, or
 - 2> if System Information Block type 12 is scheduled on the BCCH and the UE has not read nor stored the IEs present in this System Information Block:
 - 3> include the IE "Deferred measurement control reading" in any response message transmitted.
- 1> transmit a response message as specified in subclause 8.3.1.7;
- 1> if the IE "Integrity protection mode info" was present in the CELL UPDATE CONFIRM or URA UPDATE CONFIRM message:
 - 2> start applying the new integrity protection configuration in the uplink for signalling radio bearer RB2 from and including the transmitted response message.

- 1> if the variable ORDERED_RECONFIGURATION is set to TRUE caused by the received CELL UPDATE CONFIRM message in case of a cell update procedure:
 - 2> set the variable ORDERED_RECONFIGURATION to FALSE.
- 1> clear the variable PDCP_SN_INFO;
- 1> when the response message transmitted per subclause 8.3.1.7 to the UTRAN has been confirmed by RLC:
 - 2> if the CELL UPDATE CONFIRM / URA UPDATE CONFIRM message contained the IE "Ciphering mode info":
 - 3> resume data transmission on any suspended radio bearer and signalling radio bearer mapped on RLC-AM or RLC-UM;
 - 3> set the IE "Reconfiguration" in the variable CIPHERING_STATUS to FALSE; and
 - 3> clear the variable RB_UPLINK_CIPHERING_ACTIVATION_TIME_INFO.
 - 2> if the CELL UPDATE CONFIRM / URA UPDATE CONFIRM message contained the IE "Integrity protection mode info":
 - 3> set "Uplink RRC Message sequence number" for signalling radio bearer RB0 in the variable INTEGRITY_PROTECTION_INFO to a value such that next RRC message to be sent on uplink RB0 will use the new integrity protection configuration;
 - 3> allow the transmission of RRC messages on all signalling radio bearers with any RRC SN;
 - 3> set the IE "Reconfiguration" in the variable INTEGRITY_PROTECTION_INFO to FALSE.
 - 2> clear the variable INTEGRITY_PROTECTION_ACTIVATION_INFO.
- 1> in case of a cell update procedure:
 - 2> clear the entry for the CELL UPDATE CONFIRM message in the table "Rejected transactions" in the variable TRANSACTIONS.
- 1> in case of a URA update procedure:
 - 2> clear the entry for the URA UPDATE CONFIRM message in the table "Rejected transactions" in the variable TRANSACTIONS.
- 1> set the variable CELL_UPDATE_STARTED to FALSE;
- 1> if the variable AM_RLC_ERROR_PENDING_RB234 is set to TRUE:
 - 2> set the variable AM_RLC_ERROR_PENDING_RB234 to FALSE.
- 1> if the variable AM_RLC_ERROR_PENDING_RB5_AND_UP is set to TRUE:
 - 2> set the variable AM_RLC_ERROR_PENDING_RB5_AND_UP to FALSE.
- 1> clear the variable SECURITY_MODIFICATION.
- 1> stop timers T314 and/or T315 if they are running.

The procedure ends.

8.3.1.7 Transmission of a response message to UTRAN

If CELL UPDATE CONFIRM message:

- includes the IE "RAB information to setup":

the UE shall:

- 1> transmit a RADIO BEARER SETUP COMPLETE as response message using AM RLC.

If the CELL UPDATE CONFIRM message:

- does not include the IE "RAB information for setup"; and
- includes the IE "RB information to release list";

the UE shall:

- 1> transmit a RADIO BEARER RELEASE COMPLETE as response message using AM RLC.

If the CELL UPDATE CONFIRM message:

- does not include the IE "RAB information for setup", nor the IE "RB information to release list"; and
- includes the IE "RB information to reconfigure list"; or
- includes the IE "RB information to be affected list";

the UE shall:

- 1> transmit a RADIO BEARER RECONFIGURATION COMPLETE as response message using AM RLC.

If the CELL UPDATE CONFIRM message:

- does not include the IE "RAB information for setup", the IE "RB information to release list", the IE "RB information to reconfigure list", nor the IE "RB information to be affected list"; and
- includes "Transport channel information elements";

the UE shall:

- 1> transmit a TRANSPORT CHANNEL RECONFIGURATION COMPLETE as response message using AM RLC.

If the CELL UPDATE CONFIRM message:

- does not include the IE "RAB information for setup", the IE "RB information to release list", the IE "RB information to reconfigure list", nor the IE "RB information to be affected list"; and
- does not include "Transport channel information elements"; and
- includes "Physical channel information elements";

the UE shall:

- 1> transmit a PHYSICAL CHANNEL RECONFIGURATION COMPLETE as response message using AM RLC.

If the CELL UPDATE CONFIRM message:

- does not include the IE "RAB information for setup", the IE "RB information to release list", the IE "RB information to reconfigure list", nor the IE "RB information to be affected list"; and
- does not include "Transport channel information elements"; and
- does not include "Physical channel information elements"; and
- includes "CN information elements"; or
- includes the IE "Ciphering mode info"; or

- includes the IE "Integrity protection mode info"; or
- includes the IE "New C-RNTI"; or
- includes the IE "New U-RNTI"; or
- includes the IE "Downlink counter synchronisation info" and the IE "New U-RNTI";

NOTE: In the case of a cell update procedure during an ongoing reconfiguration procedure moving the UE into CELL_PCH/URA_PCH the CELL UPDATE CONFIRM message should include the IE "New C-RNTI".

the UE shall:

- 1> transmit a UTRAN MOBILITY INFORMATION CONFIRM as response message using AM RLC.

If the CELL UPDATE CONFIRM message:

- does not include "RAB information to setup"; and
- does not include "RB information elements"; and
- does not include "Transport channel information elements"; and
- does not include "Physical channel information elements"; and
- does not include "CN information elements"; and
- does not include the IE "Ciphering mode info"; and
- does not include the IE "Integrity protection mode info"; and
- does not include the IE "New C-RNTI"; and
- does not include the IE "New U-RNTI";

the UE shall:

- 1> transmit no response message.

If the URA UPDATE CONFIRM message:

- includes "CN information elements"; or
- includes the IE "Ciphering mode info"; or
- includes the IE "Integrity protection mode info"; or
- includes any one or both of the IEs "New C-RNTI" and "New U-RNTI"; or
- includes the IE "Downlink counter synchronisation info" and the IE "New U-RNTI";

the UE shall:

- 1> transmit a UTRAN MOBILITY INFORMATION CONFIRM as response message using AM RLC.

If the URA UPDATE CONFIRM message:

- does not include "CN information elements"; and
- does not include the IE "Ciphering mode info"; and
- does not include the IE "Integrity protection mode info"; and

- does not include the IE "New U-RNTI"; and
- does not include the IE "New C-RNTI":

the UE shall:

- 1> transmit no response message.

If the new state is CELL_DCH state, the UE shall, after the state transition:

- 1> if the IE "Deferred measurement control reading" was included in the response message:
 - 2> clear the variable CELL_INFO_LIST.

If the new state is CELL_DCH or CELL_FACH, the response message shall be transmitted using the new configuration after the state transition., and the UE shall:

- 1> if the IE "Downlink counter synchronisation info" was included in the received CELL UPDATE CONFIRM or URA UPDATE CONFIRM message:
 - 2> when RLC has confirmed the successful transmission of the response message:
 - 3> if the variable PDCP_SN_INFO is empty:
 - 4> configure the RLC entity for all AM and UM radio bearers and AM and UM signalling radio bearers except RB2 to "continue".
 - 3> else:
 - 4> configure the RLC entity for signalling radio bearers RB1, RB3 and RB4 to "continue";
 - 4> configure the RLC entity for UM and AM radio bearers for which the IE " PDCP SN Info" is not included to "continue".
 - 3> re-establish all AM and UM RLC entities with RB identities larger than 4 and set the first 20 bits of all the HFN component of the respective COUNT-C values to the START value included in the response message for the corresponding CN domain;
 - 3> re-establish the RLC entities with RB identities 1, 3 and 4 and set the first 20 bits of all the HFN component of the respective COUNT-C values to the START value included in the response message for the CN domain stored in the variable LATEST_CONFIGURED_CN_DOMAIN;
 - 3> set the remaining bits of the HFN component of the COUNT-C values of all UM RLC entities to zero;
 - 3> if the IE "PDCP context relocation info" is not present:
 - > re-initialise the PDCP header compression entities of each radio bearer in the variable ESTABLISHED_RABS as specified in [36].
 - 3> if the IE "PDCP context relocation info" is present:
 - 4> perform the actions as specified in subclause 8.6.4.13.
- 1> if the variable PDCP_SN_INFO is empty:
 - 2> if the CELL UPDATE CONFIRM or URA UPDATE CONFIRM message contained the IE "Ciphering mode info":
 - 3> when RLC has confirmed the successful transmission of the response message:
 - 4> continue with the remainder of the procedure.
 - 2> if the CELL UPDATE CONFIRM or URA UPDATE CONFIRM message did not contain the IE "Ciphering mode info":
 - 3> when RLC has been requested to transmit the response message,

- 4> continue with the remainder of the procedure.
- 1> if the variable PDCP_SN_INFO is non-empty:
 - 2> when RLC has confirmed the successful transmission of the response message:
 - 3> for each radio bearer in the variable PDCP_SN_INFO:
 - 4> if the IE "RB started" in the variable ESTABLISHED_RABS is set to "started":
 - 5> configure the RLC entity for that radio bearer to "continue".
 - 3> continue with the remainder of the procedure.

If the new state is CELL_PCH or URA_PCH, the response message shall be transmitted in CELL_FACH state, and the UE shall:

- 1> when RLC has confirmed the successful transmission of the response message:
 - 2> if the IE "Downlink counter synchronisation info" was included in the received CELL UPDATE CONFIRM or URA UPDATE CONFIRM message:
 - 3> re-establish all AM and UM RLC entities with RB identities larger than 4 and set the first 20 bits of all the HFN component of the respective COUNT-C values to the START value included in the response message for the corresponding CN domain;
 - 3> re-establish the RLC entities with RB identities 1, 3 and 4 and set the first 20 bits of all the HFN component of the respective COUNT-C values to the START value included in the response message for the CN domain stored in the variable LATEST_CONFIGURED_CN_DOMAIN;
 - 3> set the remaining bits of the HFN component of the COUNT-C values of all UM RLC entities to zero;
 - 3> re-initialise the PDCP header compression entities of each radio bearer in the variable ESTABLISHED_RABS as specified in [36].
 - 2> for each radio bearer in the variable PDCP_SN_INFO:
 - 3> if the IE "RB started" in the variable ESTABLISHED_RABS is set to "started":
 - 4> configure the RLC entity for that radio bearer to "continue".
 - 2> enter the new state (CELL_PCH or URA_PCH, respectively).
- 1> continue with the remainder of the procedure.

8.3.1.7a Physical channel failure

If the received CELL UPDATE CONFIRM message would cause the UE to transit to CELL_DCH state:

- 1> if the UE failed to establish the physical channel(s) indicated in the received CELL UPDATE CONFIRM message according to the criteria defined in subclause 8.5.4 are not fulfilled;
- 1> for FDD and 3.84/7.68 Mcps TDD, if the received CELL UPDATE CONFIRM message does not contain dedicated physical channels; or
- 1> for 1.28 Mcps TDD, if the received CELL UPDATE CONFIRM message does not contain dedicated physical channels nor physical shared channels as defined in clause 8.5.4; or
- 1> for 3.84 Mcps TDD or 7.68 Mcps TDD, if the received CELL UPDATE CONFIRM does not contain physical channels to which DCCH(s) are mapped:

the UE shall:

- 1> if, caused by the received CELL UPDATE CONFIRM message

- 2> the IE "Reconfiguration" in the variable CIPHERING_STATUS is set to TRUE; and/or
- 2> the IE "Reconfiguration" in the variable INTEGRITY_PROTECTION_INFO is set to TRUE:
 - 3> abort the ongoing integrity and/or ciphering reconfiguration;
 - 3> if the received CELL UPDATE CONFIRM message contained the IE "Ciphering mode info":
 - 4> set the IE "Reconfiguration" in the variable CIPHERING_STATUS to FALSE; and
 - 4> clear the variable RB_UPLINK_CIPHERING_ACTIVATION_TIME_INFO.
 - 3> if the received CELL UPDATE CONFIRM message contained the IE "Integrity protection mode info":
 - 4> set the IE "Reconfiguration" in the variable INTEGRITY_PROTECTION_INFO to FALSE; and
 - 4> clear the variable INTEGRITY_PROTECTION_ACTIVATION_INFO.
- 1> if the variable ORDERED_RECONFIGURATION is set to TRUE caused by the received CELL UPDATE CONFIRM message:
 - 2> set the IE "failure cause" to "physical channel failure";
 - 2> set the variable ORDERED_RECONFIGURATION to FALSE.
- 1> if V302 is equal to or smaller than N302:
 - 2> select a suitable UTRA cell according to [4];
 - 2> set the contents of the CELL UPDATE message according to subclause 8.3.1.3, except for the IE "Cell update cause" which shall be set to "Radio link failure";
 - 2> submit the CELL UPDATE message for transmission on the uplink CCCH;
 - 2> increment counter V302;
 - 2> restart timer T302 when the MAC layer indicates success or failure to transmit the message.
- 1> if V302 is greater than N302:
 - 2> clear the variable RB_UPLINK_CIPHERING_ACTIVATION_TIME_INFO;
 - 2> clear the variable INTEGRITY_PROTECTION_ACTIVATION_INFO;
 - 2> in case of a cell update procedure:
 - 3> clear the entry for the CELL UPDATE CONFIRM message in the table "Rejected transactions" in the variable TRANSACTIONS.
 - 2> release all its radio resources;
 - 2> indicate release (abort) of the established signalling connections (as stored in the variable ESTABLISHED_SIGNALLING_CONNECTIONS) and established radio access bearers (as stored in the variable ESTABLISHED_RABS) to upper layers;
 - 2> clear the variable ESTABLISHED_SIGNALLING_CONNECTIONS;
 - 2> clear the variable ESTABLISHED_RABS;
 - 2> set the variable CELL_UPDATE_STARTED to FALSE;
 - 2> enter idle mode.

8.3.1.8 Unsupported configuration by the UE

If the UE does not support the configuration in the CELL UPDATE CONFIRM message and/or the variable UNSUPPORTED_CONFIGURATION is set to TRUE, the UE shall:

- 1> if V302 is equal to or smaller than N302, the UE shall:
 - 2> if, caused by the received CELL UPDATE CONFIRM message
 - 3> the IE "Reconfiguration" in the variable CIPHERING_STATUS is set to TRUE; and/or
 - 3> the IE "Reconfiguration" in the variable INTEGRITY_PROTECTION_INFO is set to TRUE:
 - 4> abort the ongoing integrity and/or ciphering reconfiguration;
 - 4> if the received CELL UPDATE CONFIRM message contained the IE "Ciphering mode info":
 - 5> set the IE "Reconfiguration" in the variable CIPHERING_STATUS to FALSE; and
 - 5> clear the variable RB_UPLINK_CIPHERING_ACTIVATION_TIME_INFO.
 - 4> if the received CELL UPDATE CONFIRM message contained the IE "Integrity protection mode info":
 - 5> set the IE "Reconfiguration" in the variable INTEGRITY_PROTECTION_INFO to FALSE; and
 - 5> clear the variable INTEGRITY_PROTECTION_ACTIVATION_INFO.
 - 2> if the variable ORDERED_RECONFIGURATION is set to TRUE due to the received CELL UPDATE CONFIRM message in case of a cell update procedure:
 - 3> set the variable ORDERED_RECONFIGURATION to FALSE.
 - 2> set the variable FAILURE_INDICATOR to TRUE;
 - 2> set the variable FAILURE_CAUSE to "Unsupported configuration";
 - 2> set the content of the CELL UPDATE message according to subclause 8.3.1.3;
 - 2> submit the CELL UPDATE message for transmission on the uplink CCCH;
 - 2> increment counter V302;
 - 2> restart timer T302 when the MAC layer indicates success or failure to transmit the message.
 - 1> if V302 is greater than N302, the UE shall:
 - 2> clear the variable RB_UPLINK_CIPHERING_ACTIVATION_TIME_INFO;
 - 2> clear the variable INTEGRITY_PROTECTION_ACTIVATION_INFO;
 - 2> clear the variable PDCP_SN_INFO;
 - 2> clear the entry for the CELL UPDATE CONFIRM message in the table "Rejected transactions" in the variable TRANSACTIONS;
 - 2> release all its radio resources;
 - 2> indicate release (abort) of the established signalling connections (as stored in the variable ESTABLISHED_SIGNALLING_CONNECTIONS) and established radio access bearers (as stored in the variable ESTABLISHED_RABS) to upper layers;
 - 2> clear the variable ESTABLISHED_SIGNALLING_CONNECTIONS;
 - 2> clear the variable ESTABLISHED_RABS;
 - 2> set the variable CELL_UPDATE_STARTED to FALSE;
 - 2> enter idle mode;
 - 2> Other actions the UE shall perform when entering idle mode from connected mode are specified in subclause 8.5.2;

2> and the procedure ends.

8.3.1.9 Invalid configuration

If the variable INVALID_CONFIGURATION is set to TRUE, the UE shall:

1> if V302 is equal to or smaller than N302:

2> if, caused by the received CELL UPDATE CONFIRM or URA UPDATE CONFIRM message

3> the IE "Reconfiguration" in the variable CIPHERING_STATUS is set to TRUE; and/or

3> the IE "Reconfiguration" in the variable INTEGRITY_PROTECTION_INFO is set to TRUE:

4> abort the ongoing integrity and/or ciphering reconfiguration;

4> if the received CELL UPDATE CONFIRM or URA UPDATE CONFIRM message contained the IE "Ciphering mode info":

5> set the IE "Reconfiguration" in the variable CIPHERING_STATUS to FALSE; and

5> clear the variable RB_UPLINK_CIPHERING_ACTIVATION_TIME_INFO.

4> if the received CELL UPDATE CONFIRM or URA UPDATE CONFIRM message contained the IE "Integrity protection mode info";

5> set the IE "Reconfiguration" in the variable INTEGRITY_PROTECTION_INFO to FALSE; and

5> clear the variable INTEGRITY_PROTECTION_ACTIVATION_INFO.

2> if the variable ORDERED_RECONFIGURATION is set to TRUE caused by the received CELL UPDATE CONFIRM message in case of a cell update procedure:

3> set the variable ORDERED_RECONFIGURATION to FALSE.

2> in case of a cell update procedure:

3> set the variable FAILURE_INDICATOR to TRUE;

3> set the variable FAILURE_CAUSE to "Invalid configuration";

3> set the contents of the CELL UPDATE message according to subclause 8.3.1.3;

3> submit the CELL UPDATE message for transmission on the uplink CCCH.

2> in case of a URA update procedure:

3> set the contents of the URA UPDATE message according to subclause 8.3.1.3;

3> submit the URA UPDATE message for transmission on the uplink CCCH.

2> increment counter V302;

2> restart timer T302 when the MAC layer indicates success or failure to transmit the message.

1> if V302 is greater than N302:

2> clear the variable RB_UPLINK_CIPHERING_ACTIVATION_TIME_INFO;

2> clear the variable INTEGRITY_PROTECTION_ACTIVATION_INFO;

2> clear the variable PDCP_SN_INFO;

2> clear the entry for the CELL UPDATE CONFIRM message in the table "Rejected transactions" in the variable TRANSACTIONS;

2> release all its radio resources;

- 2> indicate release (abort) of the established signalling connections (as stored in the variable ESTABLISHED_SIGNALLING_CONNECTIONS) and established radio access bearers (as stored in the variable ESTABLISHED_RABS) to upper layers;
- 2> clear the variable ESTABLISHED_SIGNALLING_CONNECTIONS;
- 2> clear the variable ESTABLISHED_RABS;
- 2> set the variable CELL_UPDATE_STARTED to FALSE;
- 2> enter idle mode;
- 2> Other actions the UE shall perform when entering idle mode from connected mode are specified in subclause 8.5.2;
- 2> the procedure ends.

8.3.1.9a Incompatible simultaneous reconfiguration

In case of a cell update procedure and if the received CELL UPDATE CONFIRM message

- includes the IE "RB information to release list", and/or the IE "RB information to reconfigure list", and/or the IE "RB information to be affected list", and/or
- includes "Transport channel information elements"; and/or
- includes "Physical channel information elements"; and
- the variable ORDERED_RECONFIGURATION is set to TRUE because of an ongoing Reconfiguration procedure;

or

If the variable INCOMPATIBLE_SECURITY_RECONFIGURATION is set to TRUE due to the received CELL UPDATE CONFIRM or URA UPDATE CONFIRM message:

the UE shall:

- 1> if V302 is equal to or smaller than N302:
 - 2> if, caused by the received CELL UPDATE CONFIRM or URA UPDATE CONFIRM message
 - 3> the IE "Reconfiguration" in the variable CIPHERING_STATUS is set to TRUE; and/or
 - 3> the IE "Reconfiguration" in the variable INTEGRITY_PROTECTION_INFO is set to TRUE:
 - 4> abort the ongoing integrity and/or ciphering reconfiguration;
 - 4> if the received CELL UPDATE CONFIRM or URA UPDATE CONFIRM message contained the IE "Ciphering mode info":
 - 5> set the IE "Reconfiguration" in the variable CIPHERING_STATUS to FALSE; and
 - 5> clear the variable RB_UPLINK_CIPHERING_ACTIVATION_TIME_INFO.
 - 4> if the received CELL UPDATE CONFIRM or URA UPDATE CONFIRM message contained the IE "Integrity protection mode info":
 - 5> set the IE "Reconfiguration" in the variable INTEGRITY_PROTECTION_INFO to FALSE; and
 - 5> clear the variable INTEGRITY_PROTECTION_ACTIVATION_INFO.
 - 2> if the variable ORDERED_RECONFIGURATION is set to TRUE due to the received CELL UPDATE CONFIRM message in case of a cell update procedure:
 - 3> set the variable ORDERED_RECONFIGURATION to FALSE.

- 2> set the variable FAILURE_INDICATOR to TRUE;
 - 2> set the variable FAILURE_CAUSE to "Incompatible simultaneous reconfiguration";
 - 2> set the content of the CELL UPDATE message according to subclause 8.3.1.3;
 - 2> submit the CELL UPDATE message for transmission on the uplink CCCH;
 - 2> increment counter V302;
 - 2> restart timer T302 when the MAC layer indicates success or failure to transmit the message.
- 1> if V302 is greater than N302:
- 2> clear the variable RB_UPLINK_CIPHERING_ACTIVATION_TIME_INFO;
 - 2> clear the variable INTEGRITY_PROTECTION_ACTIVATION_INFO;
 - 2> clear the variable PDCP_SN_INFO;
 - 2> set the variable INCOMPATIBLE_SECURITY_RECONFIGURATION to FALSE;
 - 2> clear the entry for the CELL UPDATE CONFIRM message in the table "Rejected transactions" in the variable TRANSACTIONS;
 - 2> release all its radio resources;
 - 2> indicate release (abort) of the established signalling connections (as stored in the variable ESTABLISHED_SIGNALLING_CONNECTIONS) and established radio access bearers (as stored in the variable ESTABLISHED_RABS) to upper layers;
 - 2> clear the variable ESTABLISHED_SIGNALLING_CONNECTIONS;
 - 2> clear the variable ESTABLISHED_RABS;
 - 2> set the variable CELL_UPDATE_STARTED to FALSE;
 - 2> enter idle mode;
 - 2> Other actions the UE shall perform when entering idle mode from connected mode are specified in subclause 8.5.2;
 - 2> the procedure ends.

8.3.1.9b Security reconfiguration during Cell update procedure

If:

- the variable CELL_UPDATE_STARTED is set to TRUE; and
- the UE receives a SECURITY MODE COMMAND message:

the UE shall

- 1> ignore the received SECURITY MODE COMMAND and continue with any ongoing processes and procedures as if the SECURITY MODE COMMAND message has not been received.

8.3.1.10 Confirmation error of URA ID list

If the URA UPDATE CONFIRM message causes a confirmation error of URA identity list as specified in subclause 8.6.2.1 the UE shall:

- 1> check the value of V302; and
- 1> if V302 is smaller or equal than N302:
 - 2> if, caused by the received URA UPDATE CONFIRM message

- 3> the IE "Reconfiguration" in the variable CIPHERING_STATUS is set to TRUE; and/or
- 3> the IE "Reconfiguration" in the variable INTEGRITY_PROTECTION_INFO is set to TRUE:
 - 4> abort the ongoing integrity and/or ciphering reconfiguration;
 - 4> if the received URA UPDATE CONFIRM message contained the IE "Ciphering mode info":
 - 5> set the IE "Reconfiguration" in the variable CIPHERING_STATUS to FALSE; and
 - 5> clear the variable RB_UPLINK_CIPHERING_ACTIVATION_TIME_INFO.
 - 4> if the received URA UPDATE CONFIRM message contained the IE "Integrity protection mode info"
 - 5> set the IE "Reconfiguration" in the variable INTEGRITY_PROTECTION_INFO to FALSE; and
 - 5> clear the variable INTEGRITY_PROTECTION_ACTIVATION_INFO.
- 2> set the IEs in the URA UPDATE message according to subclause 8.3.1.3;
- 2> submit the URA UPDATE message for transmission on the uplink CCCH;
- 2> increment counter V302;
- 2> restart timer T302 when the MAC layer indicates success or failure to transmit the message.
- 1> if V302 is greater than N302:
 - 2> release all its radio resources;
 - 2> clear the variable RB_UPLINK_CIPHERING_ACTIVATION_TIME_INFO;
 - 2> clear the variable INTEGRITY_PROTECTION_ACTIVATION_INFO;
 - 2> clear the variable PDCP_SN_INFO;
 - 2> indicate release (abort) of the established signalling connections (as stored in the variable ESTABLISHED_SIGNALLING_CONNECTIONS) and established radio access bearers (as stored in the variable ESTABLISHED_RABS) to upper layers;
 - 2> clear the variable ESTABLISHED_SIGNALLING_CONNECTIONS;
 - 2> clear the variable ESTABLISHED_RABS;
 - 2> set the variable CELL_UPDATE_STARTED to FALSE;
 - 2> enter idle mode;
 - 2> perform the actions specified in subclause 8.5.2 when entering idle mode from connected mode;
 - 2> the procedure ends.

8.3.1.11 Invalid CELL UPDATE CONFIRM/URA UPDATE CONFIRM message

If the UE receives an CELL UPDATE CONFIRM/URA UPDATE CONFIRM message, which contains a protocol error causing the variable PROTOCOL_ERROR_REJECT to be set to TRUE according to clause 9, the UE shall perform procedure specific error handling as follows:

- 1> If V302 is equal to or smaller than N302, the UE shall:
 - 2> set the variable PROTOCOL_ERROR_INDICATOR to TRUE;
 - 2> in case of a cell update procedure:
 - 3> set the contents of the CELL UPDATE message according to subclause 8.3.1.3;
 - 3> submit the CELL UPDATE message for transmission on the uplink CCCH.

- 2> in case of a URA update procedure:
 - 3> set the contents of the URA UPDATE message according to subclause 8.3.1.3;
 - 3> submit the URA UPDATE message for transmission on the uplink CCCH.
- 2> increment counter V302;
- 2> restart timer T302 when the MAC layer indicates success or failure to transmit the message.
- 1> if V302 is greater than N302, the UE shall:
 - 2> clear the variable RB_UPLINK_CIPHERING_ACTIVATION_TIME_INFO;
 - 2> in case of a cell update procedure:
 - 3> clear the entry for the CELL UPDATE CONFIRM message in the table "Rejected transactions" in the variable TRANSACTIONS.
 - 2> in case of a URA update procedure:
 - 3> clear the entry for the URA UPDATE CONFIRM message in the table "Rejected transactions" in the variable TRANSACTIONS.
 - 2> indicate release (abort) of the established signalling connections (as stored in the variable ESTABLISHED_SIGNALLING_CONNECTIONS) and established radio access bearers (as stored in the variable ESTABLISHED_RABS) to upper layers;
 - 2> clear the variable ESTABLISHED_SIGNALLING_CONNECTIONS;
 - 2> clear the variable ESTABLISHED_RABS;
 - 2> set the variable CELL_UPDATE_STARTED to FALSE;
 - 2> release all its radio resources;
 - 2> enter idle mode;
 - 2> Other actions the UE shall perform when entering idle mode from connected mode are specified in subclause 8.5.2;
 - 2> the procedure ends.

8.3.1.12 T302 expiry or cell reselection

If any or several of the following conditions are true:

- expiry of timer T302;
- reselection to another UTRA cell (including the previously serving cell) before completion of the cell update or URA update procedure;

the UE shall:

- 1> stop T302 if it is running;
- 1> if the UE was in CELL_DCH state prior to the initiation of the procedure; and
 - 2> if timers T314 and T315 have elapsed while T302 was running:
 - 3> enter idle mode.
 - 3> indicate release (abort) of the established signalling connections (as stored in the variable ESTABLISHED_SIGNALLING_CONNECTIONS) and established radio access bearers (as stored in the variable ESTABLISHED_RABS) to upper layers. Other actions the UE shall perform when entering idle mode from connected mode are specified in subclause 8.5.2.

- 3> and the procedure ends.
- 2> if timer T314 has elapsed while T302 was running and,
 - 3> if "T314 expired" in the variable RB_TIMER_INDICATOR is set to FALSE and
 - 3> if T315 is still running:
 - 4> release locally all radio bearers which are associated with any radio access bearers for which in the variable ESTABLISHED_RABS the value of the IE "Re-establishment timer" is set to "useT314";
 - 4> indicate release of those radio access bearers to upper layers;
 - 4> delete all information about those radio access bearers from the variable ESTABLISHED_RABS;
 - 4> set "T314 expired" in the variable RB_TIMER_INDICATOR to TRUE;
 - 4> if all radio access bearers associated with a CN domain are released:
 - 5> release the signalling connection for that CN domain;
 - 5> remove the signalling connection for that CN domain from the variable ESTABLISHED_SIGNALLING_CONNECTIONS;
 - 5> indicate release (abort) of the signalling connection to upper layers.
- 2> if timer T315 has elapsed while T302 was running and,
 - 3> if "T315 expired" in the variable RB_TIMER_INDICATOR is set to FALSE and,
 - 3> if T314 is still running:
 - 4> release locally all radio bearers which are associated with any radio access bearers for which in the variable ESTABLISHED_RABS the value of the IE "Re-establishment timer" is set to "useT315";
 - 4> indicate release of those radio access bearers to upper layers;
 - 4> delete all information about those radio access bearers from the variable ESTABLISHED_RABS;
 - 4> set "T315 expired" in the variable RB_TIMER_INDICATOR to TRUE;
 - 4> if all radio access bearers associated with a CN domain are released:
 - 5> release the signalling connection for that CN domain;
 - 5> remove the signalling connection for that CN domain from the variable ESTABLISHED_SIGNALLING_CONNECTIONS;
 - 5> indicate release (abort) of the signalling connection to upper layers.
- 2> if timers T314 and T315 are not running:
 - 3> enter idle mode;
 - 3> indicate release (abort) of the established signalling connections (as stored in the variable ESTABLISHED_SIGNALLING_CONNECTIONS) and established radio access bearers (as stored in the variable ESTABLISHED_RABS) to upper layers. Other actions the UE shall perform when entering idle mode from connected mode are specified in subclause 8.5.2;
 - 3> and the procedure ends.
- 1> check whether it is still in "in service area" (see subclause 8.5.5.2);
- 1> if the variable ORDERED_RECONFIGURATION is set to TRUE caused by the received CELL UPDATE CONFIRM message in case of a cell update procedure:
 - 2> set the variable ORDERED_RECONFIGURATION to FALSE.

1> in case of a cell update procedure:

2> clear any entry for the CELL UPDATE CONFIRM message in the table "Accepted transactions" in the variable TRANSACTIONS.

1> in case of a URA update procedure:

2> clear any entry for the URA UPDATE CONFIRM message in the table "Accepted transactions" in the variable TRANSACTIONS.

If the UE detects "in service area" if it has not entered idle mode, and:

1> if V302 is equal to or smaller than N302, the UE shall:

2> if the UE performed cell re-selection:

3> delete its C-RNTI;

3> for FDD and 1.28 Mcps TDD, if the variable H_RNTI is set:

4> clear the variable H_RNTI;

4> stop using that H_RNTI just cleared from the variable H_RNTI in MAC;

4> clear any stored IEs "HARQ info".

3> for FDD and 1.28 Mcps TDD, if the variable E_RNTI is set:

4> clear the variable E_RNTI.

3> for FDD and 1.28 Mcps TDD, if the UE does support HS-DSCH reception in CELL_FACH state and the IE "HS-DSCH common system information" is included in System Information Block type 5 or System Information Block type 5bis:

4> reset the MAC-ehs entity [15];

4> set variable HS_DSCH_RECEPTION_OF_CCCH_ENABLED to TRUE;

4> and start receiving the HS-DSCH according to the procedure in subclause 8.5.37.

3> else:

4> take the actions related to the HS_DSCH_RECEPTION_GENERAL variable as described in subclause 8.5.37a.

3> if the UE supports RAN-assisted WLAN interworking:

4> stop the timer T330, if it is running;

4> clear the variable WLAN_OFFLOAD_INFO;

4> use the information stored in the variable SYSTEM_INFO_WLAN_OFFLOAD_INFO as specified in [4], and forward it to upper layers.

3> determine the value for the READY_FOR_COMMON_EDCH variable and take the corresponding actions as described in subclause 8.5.47;

3> determine the value for the COMMON_E_DCH_TRANSMISSION variable and take the corresponding actions as described in subclause 8.5.46.

3> for FDD, determine the value for the READY_FOR_COMMON_ERGCH variable and take the corresponding actions as described in subclause 8.5.75;

2> in case of a cell update procedure:

3> set the contents of the CELL UPDATE message according to subclauses 8.3.1.3 and 8.5.10;

- 3> if a CELL UPDATE CONFIRM message was received and caused the IE "Reconfiguration" in the variable CIPHERING_STATUS to be set to TRUE and/or the IE "Reconfiguration" in the variable INTEGRITY_PROTECTION_INFO to be set to TRUE:
 - 4> if the IE "Downlink counter synchronisation info" was included in the received CELL UPDATE CONFIRM message:
 - 5> apply the new security (integrity protection) configuration received in the CELL UPDATE CONFIRM on the CELL UPDATE message.
- 3> submit the CELL UPDATE message for transmission on the uplink CCCH.
- 2> in case of a URA update procedure:
 - 3> if the UE supports RAN-assisted WLAN interworking and URA update is initiated due to a URA reselection:
 - 4> stop the timer T330, if it is running;
 - 4> clear the variable WLAN_OFFLOAD_INFO;
 - 4> use the information stored in the variable SYSTEM_INFO_WLAN_OFFLOAD_INFO as specified in [4], and forward it to upper layers.
 - 3> set the contents of the URA UPDATE message according to subclauses 8.3.1.3 and 8.5.10;
 - 3> if a URA UPDATE CONFIRM message was received and caused the IE "Reconfiguration" in the variable CIPHERING_STATUS to be set to TRUE and/or the IE "Reconfiguration" in the variable INTEGRITY_PROTECTION_INFO is set to TRUE:
 - 4> if the IE "Downlink counter synchronisation info" was included in the received URA UPDATE CONFIRM message:
 - 5> apply the new security (integrity protection) configuration received in the URA UPDATE CONFIRM on the URA UPDATE message.
 - 3> submit the URA UPDATE message for transmission on the uplink CCCH.
- 2> increment counter V302;
- 2> restart timer T302 when the MAC layer indicates success or failure to transmit the message.
- 1> if V302 is greater than N302, the UE shall:
 - 2> clear the variable RB_UPLINK_CIPHERING_ACTIVATION_TIME_INFO;
 - 2> clear the variable INTEGRITY_PROTECTION_ACTIVATION_INFO;
 - 2> clear the variable PDCP_SN_INFO;
 - 2> in case of a cell update procedure:
 - 3> clear the entry for the CELL UPDATE CONFIRM message in the table "Rejected transactions" in the variable TRANSACTIONS.
 - 2> in case of a URA update procedure:
 - 3> clear the entry for the URA UPDATE CONFIRM message in the table "Rejected transactions" in the variable TRANSACTIONS.
 - 2> release all its radio resources;
 - 2> indicate release (abort) of the established signalling connections (as stored in the variable ESTABLISHED_SIGNALLING_CONNECTIONS) and established radio access bearers (as stored in the variable ESTABLISHED_RABS) to upper layers;
 - 2> clear the variable ESTABLISHED_SIGNALLING_CONNECTIONS;

- 2> clear the variable ESTABLISHED_RABS;
- 2> set the variable CELL_UPDATE_STARTED to FALSE;
- 2> enter idle mode;
- 2> other actions the UE shall perform when entering idle mode from connected mode are specified in subclause 8.5.2;
- 2> and the procedure ends.

If the UE detects "out of service area", it shall:

- 1> act according to subclause 7.2.2.

8.3.1.13 T314 expiry

Upon expiry of timer T314 the UE shall:

- 1> if timer T302 is running:
 - 2> continue awaiting response message from UTRAN.
- 1> if timer T302 is not running and timer T315 is running:
 - 2> set IE "T314 expired" in variable RB_TIMER_INDICATOR to TRUE;
 - 2> release locally all radio bearers which are associated with any radio access bearers for which in the variable ESTABLISHED_RABS the value of the IE "Re-establishment timer" is set to "useT314";
 - 2> indicate release of those radio access bearers to upper layers;
 - 2> delete all information about those radio access bearers from the variable ESTABLISHED_RABS;
 - 2> if all radio access bearers associated with a CN domain are released:
 - 3> release the signalling connection for that CN domain;
 - 3> remove the signalling connection for that CN domain from the variable ESTABLISHED_SIGNALLING_CONNECTIONS;
 - 3> indicate release (abort) of the signalling connection to upper layers.
- 1> if timers T302 and T315 are not running:
 - 2> clear the variable RB_UPLINK_CIPHERING_ACTIVATION_TIME_INFO;
 - 2> clear the variable INTEGRITY_PROTECTION_ACTIVATION_INFO;
 - 2> clear the variable PDCP_SN_INFO;
 - 2> clear the entry for the CELL UPDATE CONFIRM message in the table "Rejected transactions" in the variable TRANSACTIONS;
 - 2> release all its radio resources;
 - 2> indicate release (abort) of the established signalling connections (as stored in the variable ESTABLISHED_SIGNALLING_CONNECTIONS) and established radio access bearers (as stored in the variable ESTABLISHED_RABS) to upper layers;
 - 2> clear the variable ESTABLISHED_SIGNALLING_CONNECTIONS;
 - 2> clear the variable ESTABLISHED_RABS;
 - 2> set the variable CELL_UPDATE_STARTED to FALSE;
 - 2> enter idle mode;

- 2> other actions the UE shall perform when entering idle mode from connected mode are specified in subclause 8.5.2;
- 2> and the procedure ends.

8.3.1.14 T315 expiry

Upon expiry of timer T315 the UE shall:

- 1> if timer T302 is running:
 - 2> continue awaiting response message from UTRAN.
- 1> if timer T302 is not running and timer T314 is running:
 - 2> set IE "T315 expired" in variable RB_TIMER_INDICATOR to TRUE;
 - 2> release locally all radio bearers which are associated with any radio access bearers for which in the variable ESTABLISHED_RABS the value of the IE "Re-establishment timer" is set to "use T315";
 - 2> indicate release of those radio access bearers to upper layers;
 - 2> delete all information about those radio access bearers from the variable ESTABLISHED_RABS;
 - 2> if all radio access bearers associated with a CN domain are released:
 - 3> release the signalling connection for that CN domain;
 - 3> remove the signalling connection for that CN domain from the variable ESTABLISHED_SIGNALLING_CONNECTIONS;
 - 3> indicate release (abort) of the signalling connection to upper layers.
- 1> if timers T302 and T314 are not running:
 - 2> clear the variable RB_UPLINK_CIPHERING_ACTIVATION_TIME_INFO;
 - 2> clear the variable INTEGRITY_PROTECTION_ACTIVATION_INFO;
 - 2> clear the variable PDCP_SN_INFO;
 - 2> clear the entry for the CELL_UPDATE_CONFIRM message in the table "Rejected transactions" in the variable TRANSACTIONS;
 - 2> release all its radio resources;
 - 2> indicate release (abort) of the established signalling connections (as stored in the variable ESTABLISHED_SIGNALLING_CONNECTIONS) and established radio access bearers (as stored in the variable ESTABLISHED_RABS) to upper layers;
 - 2> clear the variable ESTABLISHED_SIGNALLING_CONNECTIONS;
 - 2> clear the variable ESTABLISHED_RABS;
 - 2> set the variable CELL_UPDATE_STARTED to FALSE;
 - 2> enter idle mode;
 - 2> other actions the UE shall perform when entering idle mode from connected mode are specified in subclause 8.5.2;
 - 2> and the procedure ends.

8.3.1.15 Reception of the UTRAN MOBILITY INFORMATION CONFIRM message by the UTRAN

See subclause 8.3.3.4.

8.3.1.16 T320 Expiry

Upon expiry of timer T320, the UE shall:

- 1> if the UE has uplink RLC data PDU or uplink RLC control PDU on RB1 or upwards to transmit:
 - 2> perform a cell update procedure according to subclause 8.3.1 using the cause corresponding to "uplink data transmission".
- 1> else:
 - 2> if the UE should perform cell update for MBMS ptp radio bearer request as specified in subclause 8.6.9.6:
 - 3> perform a cell update procedure according to subclause 8.3.1 using the cause corresponding to "MBMS ptp RB request".

8.3.2 URA update

See subclause 8.3.1.

8.3.3 UTRAN mobility information

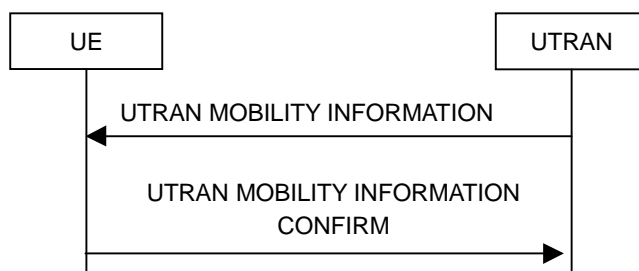

Figure 8.3.3-1: UTRAN mobility information procedure, normal flow

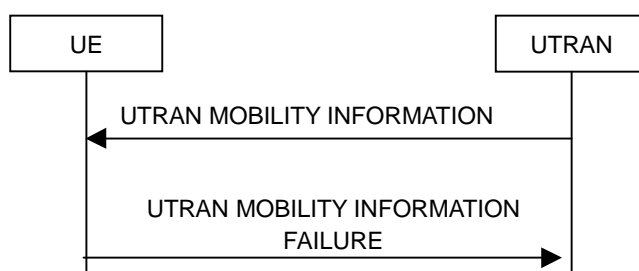

Figure 8.3.3-2: UTRAN mobility information procedure, failure case

8.3.3.1 General

The purpose of this procedure is to allocate any one or a combination of the following to a UE in connected mode:

- a new C-RNTI;
- a new U-RNTI;
- a new H-RNTI (FDD, CELL_FACH state and 1.28 Mcps TDD only);
- a new E-RNTI (FDD, CELL_FACH state and 1.28 Mcps TDD only);

- other mobility related information;
- DSAC and/or PPAC related information.

8.3.3.2 Initiation

To initiate the procedure UTRAN transmits a UTRAN MOBILITY INFORMATION message to the UE on the downlink DCCH using AM or UM RLC. In case of SRNS relocation, the message is sent using UM RLC only.

8.3.3.3 Reception of UTRAN MOBILITY INFORMATION message by the UE

When the UE receives a UTRAN MOBILITY INFORMATION message, it shall:

- 1> act on received information elements as specified in subclause 8.6;
- 1> if the IE "Dedicated Priority Information" is present:
 - 2> act upon the received IE as described in subclause 8.6.7.23.
- 1> if the IE "Measurement Release Enhancement" is present:
 - 2> if the IE "Measurement Release Enhancement" is set to "Release some measurements", for each measurement indicated by IE "Measurement Identity" in the "Released measurements" list, the UE shall:
 - 3> terminate the corresponding measurement;
 - 3> clear corresponding measurement control information stored in variable MEASUREMENT_IDENTITY.
 - 2> else:
 - 3> terminate all measurements;
 - 3> clear all stored measurement control information in variable MEASUREMENT_IDENTITY.
- 1> if the IE "UE Timers and constants in connected mode" is present:
 - 2> store the values of the IE "UE Timers and constants in connected mode" in the variable TIMERS_AND_CONSTANTS, replacing any previously stored value for each timer and constant; and
 - 2> if the IE "T323" is not present:
 - 3> clear any value of the timer T323 stored in the IE "UE Timers and constants in connected mode" in the variable TIMERS_AND_CONSTANTS; and
 - 2> for each updated timer value:
 - 3> start using the new value next time the timer is started;

NOTE: If a new value of timer T305 is included in the IE "UE Timers and constants in connected mode", and the old value of timer T305 is "infinity", the new value may not be used immediately.

 - 2> for each updated constant value:
 - 3> start using the new value directly;
- 1> if the IE "CN domain specific DRX cycle length coefficient" is present:
 - 2> store the value of the IE "CN domain specific DRX cycle length coefficient" for that CN domain, replacing any previously stored value; and
 - 2> use the value to determine the connected mode paging occasions according to [4].
- 1> set the IE "RRC transaction identifier" in the UTRAN MOBILITY INFORMATION CONFIRM message to the value of "RRC transaction identifier" in the entry for the UTRAN MOBILITY INFORMATION message in the table "Accepted transactions" in the variable TRANSACTIONS; and

- 1> clear that entry;
- 1> if the UTRAN MOBILITY INFORMATION message contained the IE "Ciphering mode info" or contained the IE "Integrity protection mode info":
 - 2> set the IE "Status" in the variable SECURITY_MODIFICATION for all the CN domains in the variable SECURITY_MODIFICATION to "Affected".
- 1> if the variable PDCP_SN_INFO is non-empty:
 - 2> include the IE "RB with PDCP information list" in the UTRAN MOBILITY INFORMATION CONFIRM message and set it to the value of the variable PDCP_SN_INFO.
- 1> if the received UTRAN MOBILITY INFORMATION message included the IE "Downlink counter synchronisation info":
 - 2> if the variable PDCP_SN_INFO is empty:
 - 3> configure the corresponding RLC entity for all AM and UM radio bearers and AM and UM signalling radio bearers except RB2 to "stop".
 - 2> else:
 - 3> configure the RLC entity for signalling radio bearers RB1, RB3 and RB4 to "stop";
 - 3> configure the RLC entity for UM and AM radio bearers for which the IE "PDCP SN Info" is not included to "stop".
 - 2> re-establish the RLC entity for RB2;
 - 2> clear all entries in the table "Processed transactions" in the variable TRANSACTIONS;
 - 2> for the downlink and the uplink, apply the ciphering configuration as follows:
 - 3> if the received re-configuration message included the IE "Ciphering Mode Info":
 - 4> use the ciphering configuration in the received message when transmitting the response message.
 - 3> if the ciphering configuration for RB2 from a previously received SECURITY MODE COMMAND has not yet been applied because the activation times not having been reached:
 - 4> if the previous SECURITY MODE COMMAND was received due to new keys being received:
 - 5> consider the new ciphering configuration to include the received new keys;
 - 5> initialise the HFN component of the uplink COUNT-C and downlink COUNT-C of SRB2 as indicated in subclause 8.1.12.3.1.
 - 4> else if the ciphering configuration for RB2 from a previously received SECURITY MODE COMMAND has not yet been applied because of the corresponding activation times not having been reached and the previous SECURITY MODE COMMAND caused a change in LATEST_CONFIGURED_CN_DOMAIN:
 - 5> consider the new ciphering configuration to include the keys associated with the LATEST_CONFIGURED_CN_DOMAIN;
 - 5> initialise the HFN component of the uplink COUNT-C and downlink COUNT-C of SRB2 to the most recently transmitted IE "START list" or IE "START" for the LATEST_CONFIGURED_CN_DOMAIN at the reception of the previous SECURITY MODE COMMAND.
 - 4> apply the new ciphering configuration immediately following RLC re-establishment.
 - 3> else:
 - 4> continue using the current ciphering configuration.

- 2> set the new uplink and downlink HFN component of COUNT-C of RB2 to MAX(uplink HFN component of COUNT-C of RB2, downlink HFN component of COUNT-C of RB2);
- 2> increment by one the downlink and uplink values of the HFN component of COUNT-C for RB2;
- 2> calculate the START value according to subclause 8.5.9;
- 2> include the calculated START values for each CN domain in the IE "START list" in the IE "Uplink counter synchronisation info" in the UTRAN MOBILITY INFORMATION CONFIRM message.
- 2> if an IE "Logged Measurement Info-FDD" or "Logged Measurement Info-TDD" in variable LOGGED_MEAS_REPORT_VARIABLE is present and registered PLMN is present in the IE "PLMN Identity List" stored in variable LOGGED_MEAS_REPORT_VARIABLE:
 - 3> include IE "Logged Meas Available".
- 2> for any measurement of type CSG Proximity detection or any measurement associated with CELL_INFO_CSG_LIST (i.e. CSG Proximity detection, CSG intra-frequency measurement, CSG inter-frequency measurement and/or SI acquisition):
 - 3> stop all measurements of type CSG Proximity detection and all measurements associated with CELL_INFO_CSG_LIST (i.e. CSG Proximity detection, CSG intra-frequency measurement, CSG inter-frequency measurement and/or SI acquisition);
 - 3> delete measurement control information for all measurements of type CSG Proximity detection and all measurements associated with CELL_INFO_CSG_LIST (i.e. CSG Proximity detection, CSG intra-frequency measurement, CSG inter-frequency measurement and/or SI acquisition);
 - 3> clear the variable CELL_INFO_CSG_LIST.
- 2> if the UE is in CELL_DCH state:
 - 3> clear the variable DSAC_PARAM, the variable PPAC_PARAM, the variable EAB_PARAM, the variable DSAC_PARAM_2, the variable PPAC_PARAM_2, the variable CONNECTED_MODE_ACCESS_CONTROL and the stored IE "Access Class Barred List" if stored.
- 1> if the UE is in CELL_DCH state:
 - 2> if the received UTRAN MOBILITY INFORMATION message included the IE "Domain Specific Access Restriction Parameters Update":
 - 3> for the variable "DSAC_PARAM_2":
 - 4> if the variable "DSAC_PARAM_2" is not set, the UE shall:
 - 5> store that Domain Specific Access Restriction Parameters to the variable "DSAC_PARAM_2" and maintain the variable until it is cleared or the PLMN is changed.
 - 4> else (DSAC_PARAM_2 is stored), the UE shall:
 - 5> update the variable "DSAC_PARAM_2" with that Domain Specific Access Restriction Parameters.
 - 2> if the received UTRAN MOBILITY INFORMATION message included the IE "Paging Permission with Access Control Parameters Update":
 - 3> for the variable "PPAC_PARAM_2":
 - 4> if the variable "PPAC_PARAM_2" is not set, the UE shall:
 - 5> store that Paging Permission with Access Control Parameters to the variable "PPAC_PARAM_2" and maintain the variable until it is cleared or the PLMN is changed.
 - 4> else (PPAC_PARAM_2 is stored) UE shall:
 - 5> update the variable "PPAC_PARAM_2" with that Paging Permission with Access Control Parameters.

- 2> the UE shall:
 - 3> if the variable "DSAC_PARAM_2" is set:
 - 4> if the variable "PPAC_PARAM_2" is set:
 - 5> act on the stored IE "Paging Response Restriction Indication" when sending a response to any PAGING TYPE 2 message, Paging message specified in [67] or CS SERVICE NOTIFICATION message specified in [79];
 - 5> act on the stored IE "Location/Registration Access Class Barred List" if the IE "Location/Registration Restriction Indicator" is set to "All" or "CS", when initiating a Location/Registration procedure to the CS domain, as specified in [4];
 - 5> act on the stored IE "Location/Registration Access Class Barred List" if the IE "Location/Registration Restriction Indicator" is set to "All" or "PS", when initiating a Location/Registration procedure to the PS domain, as specified in [4];
 - 5> act on the stored IE "Domain Specific Access Class Barred List" if indicated in the IE "CS Domain Specific Access Restriction" when initiating an INITIAL DIRECT TRANSFER message to the CS domain for any other reason, as specified in [4];
 - 5> act on the stored IE "Domain Specific Access Class Barred List" if indicated in the IE "PS Domain Specific Access Restriction" when initiating an INITIAL DIRECT TRANSFER message to the PS domain, for any other reason, as specified in [4].
 - 4> if the variable "PPAC_PARAM_2" is not set:
 - 5> act on the stored IE "Domain Specific Access Class Barred List" if indicated in the IE "CS Domain Specific Access Restriction" when initiating an INITIAL DIRECT TRANSFER message to the CS domain, as specified in [4];
 - 5> act on the stored IE "Domain Specific Access Class Barred List" if indicated in the IE "PS Domain Specific Access Restriction" when initiating an INITIAL DIRECT TRANSFER message to the PS domain, as specified in [4].
 - 3> else:
 - 4> act as if no DSAC/PPAC restriction applies.
- 1> transmit a UTRAN MOBILITY INFORMATION CONFIRM message on the uplink DCCH using AM RLC;
- 1> if the IE "Integrity protection mode info" was present in the UTRAN MOBILITY INFORMATION message:
 - 2> start applying the new integrity protection configuration in the uplink for signalling radio bearer RB2 from and including the transmitted UTRAN MOBILITY INFORMATION CONFIRM message.
- 1> if the IE "Downlink counter synchronisation info" was included in the received UTRAN MOBILITY INFORMATION message:
 - 2> when RLC has confirmed the successful transmission of the response message:
 - 3> if the variable PDCP_SN_INFO is empty:
 - 4> configure the RLC entity for all AM and UM radio bearers and AM and UM signalling radio bearers except RB2 to "continue".
 - 3> else:
 - 4> configure the RLC entity for signalling radio bearers RB1, RB3 and RB4 to "continue";
 - 4> configure the RLC entity for UM and AM radio bearers for which the IE "PDCP SN Info" is not included to "continue".
 - 3> re-establish all AM and UM RLC entities with RB identities larger than 4 and set the first 20 bits of all the HFN component of the respective COUNT-C values to the START value included in the response message for the corresponding CN domain;

- 3> re-establish the RLC entities with RB identities 1, 3 and 4 and set the first 20 bits of all the HFN component of the respective COUNT-C values to the START value included in the response message for the CN domain stored in the variable LATEST_CONFIGURED_CN_DOMAIN;
- 3> set the remaining bits of the HFN component of the COUNT-C values of all UM RLC entities to zero;
- 3> if the IE "PDCP context relocation info" is not present:
 - 4> re-initialise the PDCP header compression entities of each radio bearer in the variable ESTABLISHED_RABS as specified in [36].
- 3> if the IE "PDCP context relocation info" is present:
 - 4> perform the actions as specified in subclause 8.6.4.13.
- 1> if the variable PDCP_SN_INFO is empty; and
 - 2> if the UTRAN MOBILITY INFORMATION message contained the IE "Ciphering mode info":
 - 3> when RLC has confirmed the successful transmission of the UTRAN MOBILITY INFORMATION CONFIRM message:
 - 4> perform the actions below:
 - 2> if the UTRAN MOBILITY INFORMATION message did not contain the IE "Ciphering mode info":
 - 3> when RLC has been requested to transmit the UTRAN MOBILITY INFORMATION CONFIRM message:
 - 4> perform the actions below.
 - 1> if the variable PDCP_SN_INFO is non-empty:
 - 2> when RLC has confirmed the successful transmission of the UTRAN MOBILITY INFORMATION CONFIRM message:
 - 3> for each radio bearer in the variable PDCP_SN_INFO:
 - 4> if the IE "RB started" in the variable ESTABLISHED_RABS is set to "started":
 - 5> configure the RLC entity for that radio bearer to "continue".
 - 3> clear the variable PDCP_SN_INFO; and
 - 3> perform the actions below.

The UE shall:

- 1> if the UTRAN MOBILITY INFORMATION message contained the IE "Ciphering mode info":
 - 2> resume data transmission on any suspended radio bearer and signalling radio bearer mapped on RLC-AM or RLC-UM;
 - 2> set the IE "Reconfiguration" in the variable CIPHERING_STATUS to FALSE; and
 - 2> clear the variable RB_UPLINK_CIPHERING_ACTIVATION_TIME_INFO.
- 1> if the UTRAN MOBILITY INFORMATION message contained the IE "Integrity protection mode info":
 - 2> allow the transmission of RRC messages on all signalling radio bearers with any RRC SN;
 - 2> set the IE "Reconfiguration" in the variable INTEGRITY_PROTECTION_INFO to FALSE; and
 - 2> clear the variable INTEGRITY_PROTECTION_ACTIVATION_INFO.
- 1> clear the variable SECURITY_MODIFICATION.

The procedure ends.

8.3.3.4 Reception of an UTRAN MOBILITY INFORMATION CONFIRM message by the UTRAN

When the network receives UTRAN MOBILITY INFORMATION CONFIRM message, UTRAN may delete any old U-RNTI. The procedure ends.

8.3.3.5 Cell re-selection

If the UE performs cell re-selection, the UE shall:

- 1> initiate a cell update procedure according to subclause 8.3.1;
- 1> if the UTRAN MOBILITY INFORMATION message contains the IE "New C-RNTI"; and
- 1> if the UE has not yet submitted the UTRAN MOBILITY INFORMATION CONFIRM message to lower layers for transmission; and
- 1> if the IE "Downlink counter synchronisation info" was not included in the received UTRAN MOBILITY INFORMATION message:
 - 2> transmit a UTRAN MOBILITY INFORMATION FAILURE message on the uplink DCCH using AM RLC;
 - 2> set the IE "RRC transaction identifier" in the UTRAN MOBILITY INFORMATION FAILURE message to the value of "RRC transaction identifier" in the entry for the UTRAN MOBILITY INFORMATION message in the table "Accepted transactions" in the variable TRANSACTIONS; and
 - 2> clear that entry.
 - 2> set the IE "failure cause" to the cause value "cell update occurred";
 - 2> when the UTRAN MOBILITY INFORMATION FAILURE message has been submitted to lower layers for transmission:
 - 3> continue with any ongoing processes and procedures as if the invalid UTRAN MOBILITY INFORMATION message has not been received and the procedure ends.
- 1> otherwise:
 - 2> if a UTRAN MOBILITY INFORMATION message was received and caused the IE "Reconfiguration" in the variable CIPHERING_STATUS to be set to TRUE and/or the IE "Reconfiguration" in the variable INTEGRITY_PROTECTION_INFO to be set to TRUE; and
 - 2> if the IE "Downlink counter synchronisation info" was included in the received UTRAN MOBILITY INFORMATION message:
 - 3> apply the new security (integrity protection) configuration received in the UTRAN MOBILITY INFORMATION message on the CELL UPDATE message to be transmitted.
 - 2> continue the procedure normally.

8.3.3.5a Incompatible simultaneous security reconfiguration

If the variable INCOMPATIBLE_SECURITY_RECONFIGURATION becomes set to TRUE of the received UTRAN MOBILITY INFORMATION message, the UE shall:

- 1> transmit a UTRAN MOBILITY INFORMATION FAILURE message on the uplink DCCH using AM RLC;
- 1> set the IE "RRC transaction identifier" in the UTRAN MOBILITY INFORMATION FAILURE message to the value of "RRC transaction identifier" in the entry for the UTRAN MOBILITY INFORMATION message in the table "Accepted transactions" in the variable TRANSACTIONS; and
- 1> clear that entry;
- 1> set the IE "failure cause" to the cause value "incompatible simultaneous reconfiguration";

- 1> when the UTRAN MOBILITY INFORMATION FAILURE message has been delivered to lower layers for transmission:
 - 2> set the variable INCOMPATIBLE_SECURITY_RECONFIGURATION to FALSE;
 - 2> continue with any ongoing processes and procedures as if the UTRAN MOBILITY INFORMATION message has not been received;
 - 2> and the procedure ends.

8.3.3.6 Invalid UTRAN MOBILITY INFORMATION message

If the UTRAN MOBILITY INFORMATION message contains a protocol error causing the variable PROTOCOL_ERROR_REJECT to be set to TRUE according to clause 9, the UE shall perform procedure specific error handling as follows. The UE shall:

- 1> transmit a UTRAN MOBILITY INFORMATION FAILURE message on the uplink DCCH using AM RLC;
- 1> set the IE "RRC transaction identifier" in the UTRAN MOBILITY INFORMATION FAILURE message to the value of "RRC transaction identifier" in the entry for the UTRAN MOBILITY INFORMATION message in the table "Rejected transactions" in the variable TRANSACTIONS, and;
- 1> clear that entry.
- 1> set the IE "failure cause" to the cause value "protocol error";
- 1> include the IE "Protocol error information" with contents set to the value of the variable PROTOCOL_ERROR_INFORMATION;
- 1> when the UTRAN MOBILITY INFORMATION FAILURE message has been submitted to lower layers for transmission:
 - 2> continue with any ongoing processes and procedures as if the invalid UTRAN MOBILITY INFORMATION message has not been received;
 - 2> and the procedure ends.

8.3.3.7 T322 expiry

Upon expiry of timer T322 the UE shall:

- 1> clear the stored IE "Dedicated Priority Information";
- 1> clear the variable PRIORITY_INFO_LIST;
- 1> set the value of IE "Priority status" in the variable PRIORITY_INFO_LIST to "sys_info_priority";
- 1> if the UE is not in CELL_DCH state:
 - 2> take the actions as described in subclause 8.1.1.6.19 using stored System information Block type 19.

8.3.4 Active set update

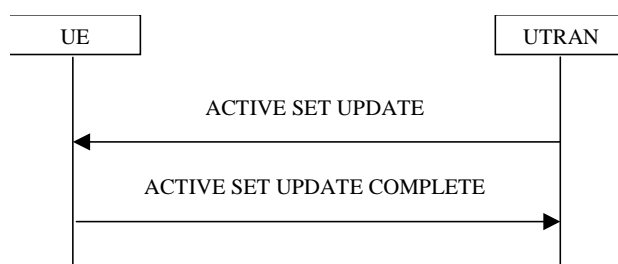

Figure 8.3.4-1: Active Set Update procedure, successful case

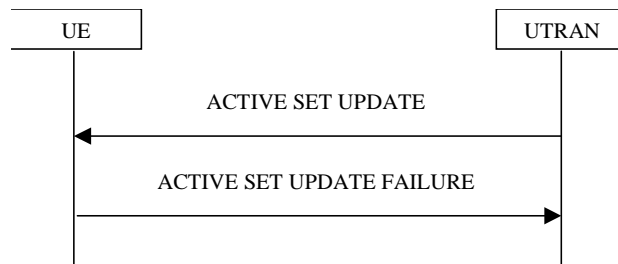

Figure 8.3.4-2: Active Set Update procedure, failure case

8.3.4.1 General

The purpose of the active set update procedure is to update the active set of the connection between the UE and UTRAN. This procedure shall be used in CELL_DCH state. The UE should keep on using the old RLs while configuring the new RLs. Also the UE should keep the transmitter turned on during the procedure. This procedure is only used in FDD mode.

8.3.4.2 Initiation

The procedure is initiated when UTRAN orders a UE in CELL_DCH state, to make the following modifications of the active set of the connection:

- a) Radio link addition to the active set;
- b) Radio link removal from the active set;
- c) Combined radio link addition and removal on the active set;
- d) Addition of a radio link to the E-DCH active set;
- e) Removal of a radio link from the E-DCH active set.
- f) Radio link addition to the secondary E-DCH active set;
- g) Radio link removal from the secondary E-DCH active set;
- h) Combined radio link addition and removal on the secondary E-DCH active set;

The procedure also allows the addition or removal of a radio link on the downlink frequencies associated with the secondary serving HS-DSCH cells. If the UE is not operating in Dual Cell E-DCH operation, radio links on the downlink frequencies associated with the secondary serving HS-DSCH cells are not part of the active set. Otherwise, radio links on the frequency associated with the first secondary serving HS-DSCH cell, are part of the secondary E-DCH active set.

Additionally, the procedure also allows the update of Target cell preconfiguration information for existing radio link(s).

In case a), c), f) and h), UTRAN should:

- 1> prepare new additional radio link(s) in the UTRAN prior to the command to the UE.

In case a), b), c), d) and e), UTRAN should:

- 1> send an ACTIVE SET UPDATE message on downlink DCCH using AM or UM RLC;
- 1> create active sets that contain at least one common radio link across a DPCH or F-DPCH frame boundary as the result of one or multiple (parallel) active set update procedures.

In case f), g) and h), UTRAN should:

- 1> send an ACTIVE SET UPDATE message on downlink DCCH using AM or UM RLC;
- 1> create secondary E-DCH active sets that contain at least one common radio link across a F-DPCH frame boundary as the result of one or multiple (parallel) active set update procedures.

UTRAN should include the following information:

- 1> IE "Radio Link Addition Information": Downlink DPCH information and other optional parameters relevant for the radio links to be added along with the IE "Primary CPICH info" used for the reference ID to indicate which radio link to add. This IE is needed in cases a) and c) listed above;
- 1> IEs "Downlink Secondary Cell Info FDD": Downlink optional parameters relevant to the reception of secondary serving HS-DSCH cells;
- 1> IE "Uplink Secondary Cell Info FDD": Uplink optional parameters relevant to transmission on secondary uplink frequency;
- 1> IE "Radio Link Removal Information": IE "Primary CPICH info" used for the reference ID to indicate which radio link to remove. This IE is needed in cases b) and c) listed above;
- 1> IE "Radio link addition information on secondary UL frequency": Downlink F-DPCH information and other optional parameters relevant for the radio links to be added along with the IE "Primary CPICH info" used for the reference ID to indicate which radio link to add on the secondary uplink frequency. This IE is needed in cases f) and h) listed above;
- 1> IE "Radio link removal information on secondary UL frequency": IE "Primary CPICH info" used for the reference ID to indicate which radio link to remove on the secondary uplink frequency. This IE is needed in cases g) and h) listed above;
- 1> IE "E-DCH reconfiguration information": IE "Primary CPICH info" used for the reference ID along with the IE "E-HICH information" to indicate which radio link to add to the E-DCH active set. This IE is needed in case d) above, when the RL added to the E-DCH active set is already in the DCH active set;
- 1> IE "E-DCH reconfiguration information": IE "Primary CPICH info" used for the reference ID along with the IE "E-HICH release indicator" to indicate which radio link to remove from the E-DCH active set. This IE is needed in case e) above, when the RL removed from the E-DCH active set remains in the DCH active set.

NOTE: The UE behaviour is unspecified if SRBs are mapped on E-DCH and the value for the E_DCH_TRANSMISSION variable is changed to FALSE via the Active Set Update procedure; or if SRBs are mapped on HS-DSCH and the value for the HS_DSCH_RECEPTION variable is changed to FALSE via the Active Set Update procedure.

8.3.4.3 Reception of an ACTIVE SET UPDATE message by the UE

Upon reception of an ACTIVE SET UPDATE message the UE shall act upon all received information elements as specified in 8.6, unless specified otherwise in the following.

The UE may:

- 1> maintain a list of the set of cells to which the UE has Radio Links if the IE "Cell ID" is present.

The UE shall:

- 1> first add the RLs indicated in the IE "Radio Link Addition Information" which are not yet contained in the UEs active set;
- 1> remove the RLs indicated in the IE "Radio Link Removal Information". If the UE active set is full or becomes full, an RL, which is included in the IE "Radio Link Removal Information" for removal, shall be removed before adding RL, which is included in the IE "Radio Link Addition Information" for addition;
- 1> if the IE "Radio Links without DPCH/F-DPCH info" is present:
 - 2> store this IE and indicate to lower layers to start operation with Radio Links without DPCH/F-DPCH.
- 1> else:
 - 2> perform the physical layer synchronisation procedure B as specified in [29] for the radio links which are not yet contained in the UEs active set.
- 1> if the IE "E-HICH information" is included:

- 2> store this E-HICH configuration for the concerning radio link.
 - 1> if the IE "E-HICH information" is included:
 - 2> store this E-RGCH configuration for the concerning radio link, if included.
 - 1> determine the value for the E_DCH_TRANSMISSION variable and take the corresponding actions as described in subclause 8.5.28;
 - 1> stop and reset timer T324 if running;
 - 1> stop monitoring target cell HS-SCCH;
 - 1> if the IE "MAC-es/e reset indicator" is included in the IE "UL 16QAM configuration":
 - 2> reset the MAC-es/e / MAC-is/i entity [15].
 - 1> if the IE "MAC-is/i reset indicator" is included in the IE "UL 64QAM configuration":
 - 2> reset the MAC-is/i entity [15].
 - 1> if both "UL 16QAM configuration" and "UL 64QAM configuration" IEs are included:
 - 2> the UE behaviour is unspecified.
- NOTE 1: If the IE "MAC-es/e reset indicator" is not included in the IE "UL 16QAM configuration" and 16QAM operations starts or stops, the UE behaviour is unspecified.
- NOTE 1a: If the IE "MAC-is/i reset indicator" is not included in the IE "UL 64QAM configuration" and 64QAM operations starts or stops, the UE behaviour is unspecified.
- 1> if the IE "UL 16QAM settings" is not included in the IE "16QAM configuration":
 - 2> indicate to lower layers to stop any operation in 16QAM mode.
 - 1> if the IE "UL 64QAM settings" is not included in the IE "UL 64QAM configuration":
 - 2> indicate to lower layers to stop any operation in 64QAM mode.
- NOTE 2: If the IE "UL 16QAM configuration" is not included and 16QAM mode operation is currently ongoing, the UE behaviour is unspecified.
- NOTE 2a: If the IE "UL 64QAM configuration" is not included and 64QAM mode operation is currently ongoing, the UE behaviour is unspecified.
- 1> if the IEs "E-TFCI Boost Info" and/or "E-DPDCH power interpolation" are present, act on the received information elements;
 - 1> if the IEs "E-DPCCH/DPCCH power offset" and/or "Reference E-TFCI PO" are included in the IE "E-DCH reconfiguration information same serving cell", act on the received information elements;
- NOTE 3: If E-TFCI boost is signalled to the UE and a reference E-TFCI \leq E-TFCI Boost is signalled to the UE with a Reference E-TFCI PO of value 30 or 31, the UE behaviour is unspecified.
- 1> if the IE "Uplink MIMO Info FDD" is present, then act on the received information element as specified in 8.6.6.62.
 - 1> if the radio link currently considered to be the serving HS-DSCH radio link is indicated in the IE "Radio Link Removal Information":
 - 2> no longer consider any radio link as the serving HS-DSCH radio link;
 - 2> determine the value for the HS_DSCH_RECEPTION variable and take the corresponding actions as described in subclause 8.5.25.
 - 1> for each radio link in the IE "Radio Link Addition Information":

2> take the actions related to TARGET_CELL_PRECONFIGURATION variable as described in subclause 8.5.52.

1> if the radio link in the IE "Radio Link Addition Information" is already contained in the UE active set and the IE "Radio Link Addition Information" attempts to reconfigure parameters other than "Target cell preconfiguration information" IE for the radio link:

2> the UE behaviour is unspecified.

NOTE: To configure or reconfigure the "Target cell preconfiguration information" IE for the radio link already contained in the UE active set, UTRAN should provide the same value of the mandatory IEs in the IE "Radio Link Addition Information" as the one previously configured. Otherwise the UE behaviour is unspecified.

1> if the table "Target cell preconfigurations" in the variable TARGET_CELL_PRECONFIGURATION included the RL indicated in IE "Radio Link Removal Information":

2> clear the entry from the variable TARGET_CELL_PRECONFIGURATION.

1> if the "E-DCH RL Info other cells" in the table "Target cell preconfiguration information" in the variable TARGET_CELL_PRECONFIGURATION included the RL indicated in the IE "Radio Link Removal Information":

2> clear all "E-DCH RL Info other cells" entries in the variable TARGET_CELL_PRECONFIGURATION for the removed RL(s).

1> if the radio link currently considered to be the serving E-DCH radio link is indicated in the IE "Radio Link Removal Information":

2> no longer consider any radio link as the serving E-DCH radio link.

1> if the IE "Uplink Secondary Cell Info FDD" is included; or

1> if the IE "E-DCH reconfiguration information on secondary uplink frequency" is included; or

1> if the IE "Radio link addition information on secondary UL frequency" is included; or

1> if the IE "Radio link removal information on secondary UL frequency" is included:

2> act as specified in 8.3.4.3a.

1> determine the value for the E_DCH_TRANSMISSION variable and take the corresponding actions as described in subclause 8.5.28;

1> if the IE "DPCCH2 info FDD" is present, determine the value for the DPCCH2_TRANSMISSION variable and take the corresponding actions as described in subclause 8.5.83;

1> set the IE "RRC transaction identifier" in the ACTIVE SET UPDATE COMPLETE message to the value of "RRC transaction identifier" in the entry for the ACTIVE SET UPDATE message in the table "Accepted transactions" in the variable TRANSACTIONS; and

1> clear that entry;

1> transmit an ACTIVE SET UPDATE COMPLETE message on the uplink DCCH using AM RLC without waiting for the completion of the Physical Layer synchronisation B, as specified in [29];

1> the procedure ends on the UE side.

8.3.4.3a Handling of ACTIVE SET UPDATE message on secondary uplink frequency (FDD only)

The UE shall:

1> if the IE "Uplink Secondary Cell Info FDD" is included:

- 2> act as specified in subclause 8.6.6.49.
- 2> determine the value for the SECONDARY_CELL_E_DCH_TRANSMISSION variable and take the corresponding actions as described in subclause 8.5.58.
- 1> if the IE "Radio link addition information on secondary UL frequency" or the IE "Radio link removal information on secondary UL frequency" is included:
 - 2> first add the RLS indicated in the IE "Radio link addition information on secondary UL frequency";
 - 2> remove the RLS indicated in the IE "Radio link removal information on secondary UL frequency". If the UE secondary E-DCH active set is full or becomes full, an RL, which is included in the IE "Radio link removal information on secondary UL frequency" for removal, shall be removed before adding RL, which is included in the IE "Radio link addition information on secondary UL frequency" for addition;
 - 2> store this E-HICH configuration for the concerning radio link to be added, if included;
 - 2> store this E-RGCH configuration for the concerning radio link to be added, if included;
 - 2> if the secondary uplink frequency is an activated uplink frequency after the active set update procedure:
 - 3> if the IE "Radio Links without DPCH/F-DPCH indicator" is present:
 - 4> store the IE "F-DPCH frame offset" and ignore all other IEs received in "Downlink F-DPCH info for each RL on secondary UL frequency";
 - 4> indicate to lower layers to start operation with Radio Links without DPCH/F-DPCH.
 - 3> else:
 - 4> perform the physical layer synchronisation procedure B as specified in [29] for the concerning radio link to be added if included.
- 1> if the IE "E-DCH reconfiguration information on secondary UL frequency" is included:
 - 2> if the IE "E-DCH RL Info for other cells" is present:
 - 3> if the IE "E-HICH Information" is present:
 - 4> store the E-HICH and E-RGCH information (if present), contained therein, for the indicated radio link.
 - 3> if the IE "E-RGCH release indicator" is present:
 - 4> delete the stored E-RGCH configuration for the indicated radio link.
 - 2> if the IE "E-DCH RL Info for new secondary serving E-DCH cell" is present:
 - 3> consider the radio link identified by the IE "Primary CPICH info" in the first IE "Downlink secondary cell info FDD" as the secondary serving E-DCH radio link, and no longer consider any other radio link as secondary serving E-DCH radio link except when Serving E-DCH cell decoupling is configured.
 - 3> store the E-HICH and E-RGCH information (if present), contained therein, for the new secondary serving E-DCH radio link;
 - 3> if the IE "E-RGCH release indicator" is present:
 - 4> delete the stored E-RGCH configuration for the new secondary serving E-DCH radio link.
 - 3> store the newly received E-AGCH configuration for the new secondary serving E-DCH radio link;
 - 3> if the old secondary serving E-DCH cell remains in the secondary E-DCH active set after the active set update, or if the new secondary serving E-DCH cell was already in the secondary E-DCH active set prior to the active set update:
 - 4> keep the current activation status of the secondary uplink frequency and take the corresponding actions as described in subclause 8.5.58.

3> otherwise:

4> consider the secondary uplink frequency as not activated and take the corresponding actions as described in subclause 8.5.58.

NOTE: UTRAN should configure the same value of IE "F-DPCH frame offset" for the serving E-DCH radio link and the secondary serving E-DCH radio link, otherwise the UE behaviour is unspecified.

8.3.4.4 Unsupported configuration in the UE

If UTRAN instructs the UE to use a configuration that it does not support, the UE shall:

- 1> keep the active set as it was before the ACTIVE SET UPDATE message was received;
- 1> transmit an ACTIVE SET UPDATE FAILURE message on the DCCH using AM RLC;
- 1> set the IE "RRC transaction identifier" in the ACTIVE SET UPDATE FAILURE message to the value of "RRC transaction identifier" in the entry for the ACTIVE SET UPDATE message in the table "Accepted transactions" in the variable TRANSACTIONS; and
- 1> clear that entry;
- 1> set the IE "failure cause" to "configuration unsupported";
- 1> when the ACTIVE SET UPDATE FAILURE message has been submitted to lower layers for transmission:
 - 2> the procedure ends on the UE side.

8.3.4.5 Invalid configuration

If any of the following conditions are valid:

- a radio link indicated by the IE "Downlink DPCH info for each RL" in the IE "Radio link addition information" has a different spreading factor than the spreading factor for the radio links in the active set that will be established at the time indicated by the IE "Activation time"; and/or
- a radio link in the IE "Radio link addition information" is also present in the IE "Radio Link Removal Information"; and/or
- a radio link in the IE "Radio link addition information on secondary UL frequency" is also present in the IE "Radio link removal information on secondary UL frequency"; and/or
- the IE "Radio Link Removal Information" contains all the radio links which are part of or will be part of the active set at the time indicated by the IE "Activation time"; and/or
- the IE "Radio link removal information on secondary UL frequency" contains all the radio links which are part of or will be part of the secondary E-DCH active set at the time indicated by the IE "Activation time"; and/or
- the IE "TX Diversity Mode" is not set to "none" and it indicates a diversity mode that is different from the one currently used (<STTD> or <closed loop mode1>) in all or part of the active set; and/or
- the IE "TX Diversity Mode" is set to "closed loop mode1" and there are two configured uplink frequencies; and/or
- a radio link indicated by the IE "Radio Link Removal Information" does not exist in the active set; and/or
- a radio link indicated by the IE "Radio link removal information on secondary UL frequency" does not exist in the secondary E-DCH active set; and/or
- after the removal of all radio links indicated by the IE "Radio Link Removal Information" and the addition of all radio links indicated by the IE "Radio Link Addition Information" the active set would contain more than the maximum allowed number of radio links; and/or

- after the removal of all radio links indicated by the IE "Radio link removal information on secondary UL frequency" and the addition of all radio links indicated by the IE "Radio link addition information on secondary UL frequency" the secondary E-DCH active set would contain more than the maximum allowed number of radio links; and/or
- after the addition of all radio links indicated by the IE "Radio Link Addition Information" the active set would contain radio links indicated by the IE "Downlink DPCH info for each RL" and radio links indicated by the IE "Downlink F-DPCH info for each RL"; and/or
- after the addition of all radio links, the active set would contain a radio link configured with the IE "Downlink DPCH info for each RL" and the RL would be included in the table "Target cell preconfigurations" in the variable TARGET_CELL_PRECONFIGURATION; and/or
- the IE "Downlink information per radio link list on secondary UL frequency" is present in the IE "Uplink Secondary Cell Info FDD" in the received message; and/or
- the IE "Radio link addition information on secondary UL frequency" or the IE "Radio link removal information on secondary UL frequency" is included while the secondary E-DCH active set prior to the reception of the message do not contain any radio link; and/or
- the variable INVALID_CONFIGURATION is set to TRUE:

the UE shall:

- 1> keep the active set as it was before the ACTIVE SET UPDATE message was received;
- 1> transmit an ACTIVE SET UPDATE FAILURE message on the DCCH using AM RLC;
- 1> set the IE "RRC transaction identifier" in the ACTIVE SET UPDATE FAILURE message to the value of "RRC transaction identifier" in the entry for the ACTIVE SET UPDATE message in the table "Accepted transactions" in the variable TRANSACTIONS; and
- 1> clear that entry;
- 1> set the IE "failure cause" to "Invalid configuration";
- 1> When the ACTIVE SET UPDATE FAILURE message has been submitted to lower layers for transmission:
 - 2> the procedure ends on the UE side.

If the following condition is valid:

- the active set update procedure results in active sets that do not contain at least one common radio link before and after a DPCH or F-DPCH frame boundary:

the UE behaviour is not specified.

8.3.4.5a Void

8.3.4.5b Incompatible simultaneous reconfiguration

If the variable ORDERED_RECONFIGURATION is set to TRUE, the UE may:

- 1> if the activation time for the procedure that has set variable ORDERED_RECONFIGURATION and the activation time for the Active Set Update procedure are within a time window of 5 frames:
 - 2> transmit an ACTIVE SET UPDATE FAILURE message on the uplink DCCH using AM RLC;
 - 2> set the IE "RRC transaction identifier" in the ACTIVE SET UPDATE FAILURE message to the value of "RRC transaction identifier" in the entry for the ACTIVE SET UPDATE message in the table "Accepted transactions" in the variable TRANSACTIONS; and
 - 2> clear that entry;

- 2> set the IE "failure cause" to the cause value "incompatible simultaneous reconfiguration";
- 2> when the ACTIVE SET UPDATE FAILURE message has been delivered to lower layers for transmission:
 - 3> continue with any ongoing processes and procedures as if the ACTIVE SET UPDATE message has not been received.
 - 3> and the procedure ends.

8.3.4.6 Reception of the ACTIVE SET UPDATE COMPLETE message by the UTRAN

When the UTRAN has received the ACTIVE SET UPDATE COMPLETE message,

- 1> the UTRAN may remove radio link(s) that are indicated to remove to the UE in case b), c), g) and h); and
- 1> the procedure ends on the UTRAN side.

8.3.4.7 Reception of the ACTIVE SET UPDATE FAILURE message by the UTRAN

When the UTRAN has received the ACTIVE SET UPDATE FAILURE message, the UTRAN may delete radio links that were included in the IE "Radio Link Addition Information" and the IE "Radio link addition information on secondary UL frequency" for addition. The procedure ends on the UTRAN side.

8.3.4.8 Invalid ACTIVE SET UPDATE message

If the ACTIVE SET UPDATE message contains a protocol error causing the variable `PROTOCOL_ERROR_REJECT` to be set to TRUE according to clause 9, the UE shall perform procedure specific error handling as follows. The UE shall:

- 1> transmit a ACTIVE SET UPDATE FAILURE message on the uplink DCCH using AM RLC;
- 1> set the IE "RRC transaction identifier" in the ACTIVE SET UPDATE FAILURE message to the value of "RRC transaction identifier" in the entry for the ACTIVE SET UPDATE message in the table "Rejected transactions" in the variable `TRANSACTIONS`; and
- 1> clear that entry;
- 1> set the IE "failure cause" to the cause value "protocol error";
- 1> include the IE "Protocol error information" with contents set to the value of the variable `PROTOCOL_ERROR_INFORMATION`;
- 1> when the ACTIVE SET UPDATE FAILURE message has been delivered to lower layers for transmission:
 - 2> continue with any ongoing processes and procedures as if the invalid ACTIVE SET UPDATE message has not been received;
 - 2> and the procedure ends.

8.3.4.9 Reception of an ACTIVE SET UPDATE message in wrong state

If the UE is in another state than `CELL_DCH` state upon reception of the ACTIVE SET UPDATE message, the UE shall perform procedure specific error handling as follows. The UE shall:

- 1> transmit a ACTIVE SET UPDATE FAILURE message on the uplink DCCH using AM RLC;
- 1> set the IE "RRC transaction identifier" in the ACTIVE SET UPDATE FAILURE message to the value of "RRC transaction identifier" in the entry for the ACTIVE SET UPDATE message in the table "Accepted transactions" in the variable `TRANSACTIONS`; and
- 1> clear that entry;
- 1> set the IE "failure cause" to the cause value "protocol error";

- 1> include the IE "Protocol error information" with the IE "Protocol error cause" set to "Message not compatible with receiver state";
- 1> when the ACTIVE SET UPDATE FAILURE message has been delivered to lower layers for transmission:
 - 2> continue with any ongoing processes and procedures as if the ACTIVE SET UPDATE message has not been received;
 - 2> and the procedure ends.

8.3.5 Hard handover

When performing hard handover with change of frequency, the UE shall:

- 1> clear the variable "Adjacent frequency info", "Inter-band frequency info" and "Frequency info list for enhanced measurement" if any of them is stored in CELL_INFO_LIST;
- 1> stop all intra-frequency and inter-frequency measurement reporting on the cells listed in the variable CELL_INFO_LIST. Each stopped measurement is restarted when a MEASUREMENT CONTROL message is received with the corresponding measurement identity.

8.3.5.1 Timing re-initialised hard handover

8.3.5.1.1 General

The purpose of the timing re-initialised hard handover procedure is to remove all the RL(s) in the active set and establish new RL(s) along with a change in the CFN in the UE according to the SFN of the target cell.(see subclause 8.5.15).

For TDD timing re-initialised hard handover is realised via CFN calculation (see subclause 8.5.15.2).

NOTE: For FDD, during the hard-handover procedure, the UE will align the timing of the uplink transmission as specified in [26].

This procedure is initiated when UTRAN does not know the target SFN timing before hard handover.

8.3.5.1.2 Initiation (FDD only)

Timing re-initialised hard handover initiated by the UTRAN is normally performed by using the procedure "Physical channel reconfiguration" (subclause 8.2.6), but may also be performed by using either one of the following procedures:

- "radio bearer establishment" (subclause 8.2.1);
- "Radio bearer reconfiguration" (subclause 8.2.2);
- "Radio bearer release" (subclause 8.2.3); or
- "Transport channel reconfiguration" (subclause 8.2.4).

In this case of a timing re-initialised hard handover, UTRAN should include the IE "Default DPCH Offset Value" and:

- 1> in FDD mode:
 - 2> if the UE is configured for DPCH:
 - 3> set "Default DPCH Offset Value" and "DPCH frame offset" respecting the following relation

$$(\text{Default DPCH Offset Value}) \bmod 38400 = \text{DPCH frame offset}_j$$
 - where j indicates the first radio link listed in the message and the IE values used are the Actual Values of the IEs as defined in clause 11.
 - 2> if the UE is configured for F-DPCH:
 - 3> set "Default DPCH Offset Value" and "DPCH frame offset;" respecting one of the following relations:

- 4> $(\text{Default DPCH Offset Value}) \bmod 38400 = \text{DPCH frame offset}_j$; or
- 4> $(\text{Default DPCH Offset Value}+256) \bmod 38400 = \text{DPCH frame offset}_j$,
 - where j indicates the first radio link listed in the message and the IE values used are the Actual Values of the IEs as defined in clause 11.

If the IE "Default DPCH Offset Value" is included, the UE shall:

- 1> in FDD mode:
 - 2> if the UE is configured for DPCH:
 - 3> if $(\text{Default DPCH Offset Value}) \bmod 38400 = \text{DPCH frame offset}_j$,
 - where j indicates the first radio link listed in the message:
 - 4> set DOFF (see subclause 8.5.15.1) to Default DPCH Offset Value.
 - 3> else:
 - 4> set the variable INVALID_CONFIGURATION to TRUE.
- 2> if the UE is configured for F-DPCH:
 - 3> if $(\text{Default DPCH Offset Value}) \bmod 38400 = \text{DPCH frame offset}_j$,
 - where j indicates the first radio link listed in the message:
 - 4> set DOFF (see subclause 8.5.15.1) to Default DPCH Offset Value.
 - 3> else if $(\text{Default DPCH Offset Value}+256) \bmod 38400 = \text{DPCH frame offset}_j$,
 - where j indicates the first radio link listed in the message:
 - 4> set DOFF (see subclause 8.5.15.1) to Default DPCH Offset Value + 256.
 - 3> else:
 - 4> set the variable INVALID_CONFIGURATION to TRUE.

If the IE "Default DPCH Offset Value" is not included, the UE shall:

- 1> set the variable INVALID_CONFIGURATION to TRUE.

8.3.5.2 Timing-maintained hard handover

8.3.5.2.1 General

The purpose of the Timing-maintained hard handover procedure is to remove all the RL(s) in the active set and establish new RL(s) while maintaining the CFN in the UE.

For TDD timing re-initialised hard handover is realised via CFN calculation (see subclause 8.5.15.2).

NOTE: For FDD, during the hard-handover procedure, the UE will align the timing of the uplink transmission as specified in [26].

This procedure can be initiated only if UTRAN knows the target SFN timing before hard handover. The target SFN timing can be known by UTRAN in the following 2 cases:

- UE reads SFN when measuring "Cell synchronisation information" and sends it to the UTRAN in MEASUREMENT REPORT message.
- UTRAN internally knows the time difference between the cells.

8.3.5.2.2 Initiation (FDD only)

Timing-maintained hard handover initiated by the network is normally performed by using the procedure "Physical channel reconfiguration" (subclause 8.2.6), but may also be performed by using either one of the following procedures:

- "radio bearer establishment" (subclause 8.2.1);
- "Radio bearer reconfiguration" (subclause 8.2.2);
- "Radio bearer release" (subclause 8.2.3); or
- "Transport channel reconfiguration" (subclause 8.2.4).

In this case of a timing maintained hard handover procedure the UTRAN should not include the IE "Default DPCH Offset Value".

If the IE "Default DPCH Offset Value" is included, the UE shall:

- 1> ignore the IE "Default DPCH Offset Value".

8.3.6 Inter-RAT handover to UTRAN

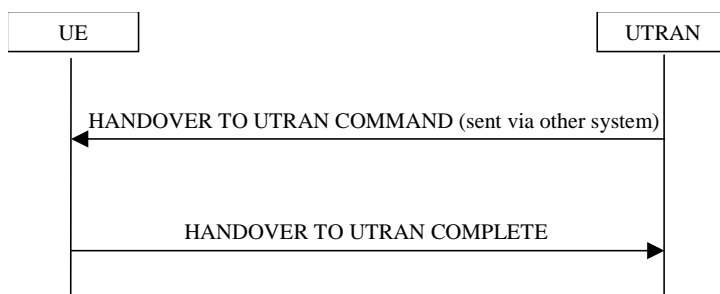

Figure 8.3.6-1: Inter-RAT handover to UTRAN, successful case

8.3.6.1 General

The purpose of the inter-RAT handover procedure is to, under the control of the network, transfer a connection between the UE and another radio access technology (e.g. GSM or E-UTRA) to UTRAN.

This procedure may be used to perform CS handover which applies when there is a signalling connection to the CS domain.

When the UE supports Inter-RAT PS handover, this procedure may be used to perform PS handover which applies when there is only a signalling connection to the PS domain.

This procedure may be used to perform simultaneous CS and PS handover (i.e. DTM Handover) which applies when there are signalling connections to both CS and PS domains.

This procedure may be used to perform PS to CS handover (i.e. SR-VCC Handover) which applies when there is a signalling connection in E-UTRA PS domain to be transferred to UTRA CS domain. SR-VCC handover may be performed with a simultaneous PS handover.

This procedure may be used to perform CS to PS handover (i.e. rSR-VCC Handover) which applies when there is a signalling connection in GSM CS domain to be transferred to UTRA PS domain. The rSR-VCC Handover may be performed with a simultaneous PS handover.

8.3.6.2 Initiation

The procedure is initiated when a radio access technology other than UTRAN, e.g. GSM or E-UTRA, using radio access technology-specific procedures, orders the UE to make a handover to UTRAN.

A HANOVER TO UTRAN COMMAND message is sent to the UE via the radio access technology from which inter-RAT handover is performed.

In case UTRAN decides to use a predefined or default radio configuration that is stored in the UE, it should include the following information in the HANOVER TO UTRAN COMMAND message.

- the IE "New U-RNTI" to be assigned;
- the IE "Predefined configuration identity", to indicate which pre-defined configuration of RB, transport channel and physical channel parameters shall be used; or
- the IE "Default configuration mode" and IE "Default configuration identity", to indicate which default configuration of RB, transport channel and physical channel parameters shall be used;
- PhyCH information elements.

NOTE 1: When using a predefined or default configuration during handover to UTRAN, UTRAN can only assign values of IEs "New U-RNTI" and "scrambling code" that are within the special subranges defined exclusively for this procedure. UTRAN may re-assign other values after completion of the handover procedure.

NOTE 2: When using a predefined or default configuration during handover to UTRAN, fewer IEs are signalled; when using this signalling option some parameters e.g. concerning compressed mode, DSCH can not be configured. In this case, the corresponding functionality can not be activated immediately.

NOTE 3: When using a predefined or default configuration, the HANOVER TO UTRAN COMMAND should not include more than one radio link. If UTRAN includes more than one radio link in the HANOVER TO UTRAN COMMAND using a predefined or default configuration, the UE behaviour is unspecified.

In case UTRAN does not use a predefined radio configuration that is stored in the UE, it should include the following information in the HANOVER TO UTRAN COMMAND message.

- the IE "New U-RNTI" to be assigned;
- the complete set of RB, TrCH and PhyCH information elements to be used.

8.3.6.3 Reception of HANOVER TO UTRAN COMMAND message by the UE

The UE shall be able to receive a HANOVER TO UTRAN COMMAND message and perform an inter-RAT handover, even if no prior UE measurements have been performed on the target UTRAN cell and/or frequency.

The UE shall act upon all received information elements as specified in subclause 8.6, unless specified otherwise in the following.

The UE may:

- 1> maintain a list of the set of cells to which the UE has Radio Links if the IE "Cell ID" is present.

The UE shall:

- 1> store a U-RNTI value (32 bits), which is derived by the IEs "SRNC identity" and "S-RNTI 2" included in IE "U-RNTI-short". In order to produce a full size U-RNTI value, a full size "S-RNTI" (20 bits) shall be derived by padding the IE "S-RNTI 2" with 10 zero bits in the most significant positions; and
- 1> if the HANOVER TO UTRAN COMMAND message is used to perform anything other than CS handover from GERAN and the message does not contain at least one instance of the IE "RAB Info";
 - 2> the UE behaviour is unspecified.
- 1> initialise the variable ESTABLISHED_SIGNALLING_CONNECTIONS with the signalling connections that remains after the handover according to the specifications of the source RAT;

NOTE 0: The IE "CN domain identity" in IE "RAB Info" in the HANDOVER TO UTRAN COMMAND message determines towards which CN domain signalling connections are established. The HANDOVER TO UTRAN COMMAND message contains at least one IE "RAB Info" except in the CS domain handover from GERAN case where it may not be present, in which case the UE behaviour is the same as if "CN domain identity" had been received and set to "CS Domain".

- 1> initialise the variable UE_CAPABILITIES_TRANSFERRED with the UE capabilities that have been transferred to the network up to the point prior to the handover, if any;
- 1> initialise the variable TIMERS_AND_CONSTANTS to the default values and start to use those timer and constants values;
- 1> if IE "Specification mode" is set to "Preconfiguration" and IE "Preconfiguration mode" is set to "Predefined configuration":
 - 2> initiate the radio bearer and transport channel configuration in accordance with the predefined parameters identified by the IE "Predefined configuration identity";
 - 2> initiate the physical channels in accordance with the predefined parameters identified by the IE "Predefined radio configuration identity" and the received physical channel information elements;
 - 2> store information about the established radio access bearers and radio bearers according to the IE "Predefined configuration identity"; and
 - 2> set the IE "RAB Info Post" in the variable ESTABLISHED_RABS and the IE "Re-establishment timer" in the IE "RAB Info" in the variable ESTABLISHED_RABS to "useT314".
- 1> if IE "Specification mode" is set to "Preconfiguration" and IE "Preconfiguration mode" is set to "Default configuration":
 - 2> initiate the radio bearer and transport channel configuration in accordance with the default parameters identified by the IE "Default configuration mode" and IE "Default configuration identity";
 - 2> initiate the physical channels in accordance with the default parameters identified by the IE "Default configuration mode" and IE "Default configuration identity" and the received physical channel information elements;

NOTE 1: IE "Default configuration mode" specifies whether the FDD or TDD version of the default configuration shall be used.

- 2> set the IE "RAB Info Post" in the variable ESTABLISHED_RABS and the IE "Re-establishment timer" in the IE "RAB Info" in the variable ESTABLISHED_RABS to "useT314".
- 1> if IE "Specification mode" is set to "Preconfiguration":
 - 2> use the following values for parameters that are neither signalled within the HANDOVER TO UTRAN COMMAND message nor included within pre-defined or default configuration:
 - 3> 0 dB for the power offset $P_{\text{Pilot-DPCH}}$ bearer in FDD;
 - 3> calculate the Default DPCH Offset Value using the following formula:
 - 3> in FDD:

$$\text{Default DPCH Offset Value} = (\text{SRNTI} \cdot 2 \bmod 600) \cdot 512$$
 - 3> in TDD:

$$\text{Default DPCH Offset Value} = (\text{SRNTI} \cdot 2 \bmod 7)$$
 - 3> handle the above Default DPCH Offset Value as if an IE with that value was included in the message, as specified in subclause 8.6.6.14.
- 1> if IE "Specification mode" is set to "Complete specification":
 - 2> initiate the radio bearer, transport channel and physical channel configuration in accordance with the received radio bearer, transport channel and physical channel information elements.

- 1> if IE "Default configuration for CELL_FACH" is set:
 - 2> act in accordance with the default parameters according to section 13.8.
- 1> perform an open loop estimation to determine the UL transmission power according to subclause 8.5.3;
- 1> set the IE "START" for each CN domain, in the IE "START list" in the HANDOVER TO UTRAN COMPLETE message equal to the START value for each CN domain as stored in the volatile memory of the ME for each CN domain if the USIM or the SIM is present;

NOTE 2: Keys received while in another RAT (GERAN) or generated when coming from another RAT (EUTRAN) are not regarded as "new" (i.e. do not trigger the actions in subclause 8.1.12.3.1) in a subsequent security mode control procedure in UTRAN, irrespective of whether the keys are already being used in the other RAT or not. If the UE has received new keys in the other RAT before handover, then the START values in the USIM (sent in the HANDOVER TO UTRAN COMPLETE message and in the INTER_RAT_HANDOVER_INFO sent while in the other RAT) will not reflect the receipt of these new keys

If the source RAT is not E-UTRAN and the procedure is not an rSR-VCC handover: If ciphering has been active for the CS domain in the source RAT, then during the first security mode control procedure following the Inter-RAT handover to UTRAN procedure, UE activates integrity protection using the integrity key of the key set used. The term "key set used" denotes the key set that was used in the last successfully completed RRC Security Mode Control (UTRAN), RR Cipher Mode Control procedure or GMM Authentication and Ciphering procedure (GERAN) after entering connected mode in UTRAN or GERAN. The term "if ciphering has been active for the CS domain" is defined by a successfully completed RRC Security Mode Control procedure with "Ciphering Mode Info" (UTRAN) or RR Cipher Mode Control procedure (GERAN) for the CS domain. More specifically the state of ciphering refers to the establishment of a security context where the key is loaded from the (U)SIM to the ME even if the security command indicates NULL ciphering ("no ciphering" in GERAN or UEA0 in UTRAN).

If the source RAT is GERAN: Upon performing rSR-VCC(CS to PS), then during the first security mode control procedure following the Inter-RAT handover to UTRAN procedure, UE activates integrity protection using the integrity key of the key set as defined in [40].

If the source RAT is E-UTRAN: Upon performing SR-VCC (PS to CS) or PS handover, then during the first security mode control procedure following the Inter-RAT handover to UTRAN procedure, UE activates integrity protection using the integrity key of the key set used (see 8.1.12.2.2.). The term "key set used" denotes the CS (SR-VCC) or PS (PS handover) key set (KSI, CK, IK) which was mapped using the current SECURITY CONTEXT in EUTRAN as defined in [78] and [79].

- 1> set the value of "THRESHOLD" in the variable "START_THRESHOLD" to the 20 MSBs of the value stored in the USIM [50] for the maximum value of START for each CN Domain, or to the default value in [40] if the SIM is present;
- 1> if ciphering is indicated in the HANDOVER TO UTRAN COMMAND by the presence of the IE "Ciphering Algorithm":
 - 2> for the handover of CS domain, indicated by the IE "CN domain identity" of the IE "RAB info" of the IE "RAB information to setup" set to "CS domain" or absence of this IE, if ciphering was not active in the radio access technology from which inter-RAT handover is performed:
 - 3> the UE behaviour is unspecified.

NOTE 2a: The handover of the CS domain from GERAN to UTRAN is particular because CS ciphering must be maintained across the inter-RAT handover procedure. For other inter-RAT handover procedures (SR-VCC, rSR-VCC and PS handover) ciphering in UTRAN is not dependent on previous ciphering status in the source radio access technology.

- 2> if the handover is from EUTRAN and there is no current SECURITY CONTEXT in EUTRAN:
 - 3> the UE behaviour is unspecified.

NOTE 2b: The current EUTRAN security context is defined in [78] and [79]. For EUTRA to UTRA key mapping, this context consists of a minimum of the current KASME, the associated key set identifier (KSI) and the associated downlink NAS COUNT values.

- 2> set the variable LATEST_CONFIGURED_CN_DOMAIN to the value indicated in the IE "CN domain identity" of the IE "RAB info" of the IE "RAB information to setup" if all instances of the IE indicate the same CN domain, or to the CS domain when this IE is either not present or different instances indicate different CN domains;
- 2> for the CN domain in variable LATEST_CONFIGURED_CN_DOMAIN set the IE "Status" in the variable CIPHERING_STATUS to "Started";
- 2> if the variable LATEST_CONFIGURED_CN_DOMAIN is set to "CS domain":
 - 3> set the 20 MSB of the HFN component of the COUNT-C variable for all signalling radio bearers to the "START" value from the IE "UE security information" in the variable INTER_RAT_HANDOVER_INFO_TRANSFERRED.
- 2> else if the variable LATEST_CONFIGURED_CN_DOMAIN is set to "PS domain":
 - 3> set the 20 MSB of the HFN component of the COUNT-C variable for all signalling radio bearers to the "START" value from the IE "UE security information2" in the variable INTER_RAT_HANDOVER_INFO_TRANSFERRED.
- 2> if the CN domain indicated in the IE "CN domain identity" of any instance of the IE "RAB info" in the IE "RAB information to setup" is "CS domain":
 - 3> set the 20 MSB of the HFN component of the COUNT-C variable for all CS domain radio bearers to the "START" value included in the IE "UE security information" in the variable INTER_RAT_HANDOVER_INFO_TRANSFERRED;
 - 3> set the IE "Status" in the variable CIPHERING_STATUS to "Started".
- 2> if the CN domain indicated in the IE "CN domain identity" of any instance of the IE "RAB info" in the IE "RAB information to setup" is "PS domain":
 - 3> set the 20 MSB of the HFN component of the COUNT-C variable for all PS domain radio bearers to the "START" value included in the IE "UE security information2" in the variable INTER_RAT_HANDOVER_INFO_TRANSFERRED;
 - 3> set the IE "Status" in the variable CIPHERING_STATUS to "Started".
- 2> set the remaining LSBs of the HFN component of COUNT-C for all radio bearers to zero;
- 2> not increment the HFN component of COUNT-C for radio bearers using RLC-TM, i.e. keep the HFN value fixed without incrementing every CFN cycle;
- 2> set the CFN component of the COUNT-C variable for radio bearers using RLC-TM to the value of the CFN as calculated in subclause 8.5.15;
- 2> for all user radio bearers belonging to the "CS domain" and for signalling radio bearers when the variable LATEST_CONFIGURED_CN_DOMAIN is set to "CS domain":
 - 3> apply the algorithm according to IE "Ciphering Algorithm" with the ciphering key of the key set used and apply ciphering immediately upon reception of the HANDOVER TO UTRAN COMMAND.
- 2> for all user radio bearers belonging to the "PS domain" and for signalling radio bearers when the variable LATEST_CONFIGURED_CN_DOMAIN is set to "PS domain":
 - 3> If the source RAT is E-UTRA; or
 - 3> if the source RAT is GERAN and the procedure is an rSR-VCC handover:
 - 4> apply the algorithm according to IE "Ciphering Algorithm" with the ciphering key of the PS key set used and apply ciphering immediately upon reception of the HANDOVER TO UTRAN COMMAND.
 - 3> Otherwise:

- 4> apply the algorithm according to IE "Ciphering Algorithm" with the ciphering key stored in the USIM/SIM and apply ciphering immediately upon reception of the HANDOVER TO UTRAN COMMAND.

NOTE 3: If ciphering is indicated in the HANDOVER TO UTRAN COMMAND, UTRAN should not include the IE "Ciphering mode info" in the SECURITY MODE COMMAND message that starts Integrity protection. Upon performing simultaneous CS and PS handover (i.e. DTM Handover or SR-VCC with a simultaneous PS handover), UTRAN should start Integrity protection for the CS domain first then the PS domain. UTRAN should not include the IE "Ciphering mode info" in the SECURITY MODE COMMAND message that starts Integrity protection for the CS domain and UTRAN should include the IE "Ciphering mode info" in the SECURITY MODE COMMAND message that starts Integrity protection for the PS domain.

NOTE 4: DTM Handover is not possible if the IE "specification mode" is set to "Preconfiguration" due to the existence of a single IE "RAB Info".

1> if ciphering is not indicated in the HANDOVER TO UTRAN COMMAND:

- 2> for the CN domain(s) included in the IE "CN domain identity" which is included in the IE "RAB info" of the IE "RAB information to setup", or the CS domain when these IEs are not present:

- 3> set the IE "Status" in the variable CIPHERING_STATUS to "Not Started".

If the UE succeeds in establishing the connection to UTRAN, it shall:

1> if "RAB Info" list contained only one CN domain identity in IE "CN domain identity":

- 2> if CN domain is set to CS domain only indicate to upper layers that no CN system information is available for any domain other than the CS domain (see NOTE 5);

- 2> if CN domain is set to PS domain only indicate to upper layers that no CN system information is available for any domain other than the PS domain (see NOTE 6).

1> if "RAB Info" list contained RABs for the PS and CS domain:

- 2> indicate to upper layers that CN system information is available for the PS and CS domain (see NOTE 7).

NOTE 5: After CS handover or SR-VCC handover without a simultaneous PS handover has been completed, the UTRAN should provide the UE with the CN system information of the PS domain as soon as possible, in order not to delay access to the PS domain.

NOTE 6: After PS handover or rSR-VCC handover has been completed, the UTRAN should provide the UE with the CN system information of the CS and PS domain as soon as possible in order not to delay access to the CS domain and trigger a NAS procedure for the PS domain.

NOTE 7: After DTM handover or SR-VCC handover with a simultaneous PS handover has been completed, the UTRAN should provide the UE with the CN system information of the PS domain as soon as possible in order to trigger a NAS procedure for the PS domain.

1> if the IE "Status" in the variable CIPHERING_STATUS of a CN domain is set to "Started" and transparent mode radio bearers have been established by this procedure for that CN domain:

- 2> include the IE "COUNT-C activation time" in the response message and specify a CFN value for this IE other than the default, "Now", that is a multiple of 8 frames ($CFN \bmod 8 = 0$) and lies at least 200 frames ahead of the CFN in which the response message is first transmitted;

- 2> at the CFN value as indicated in the response message in the IE "COUNT-C activation time" for radio bearers using RLC-TM:

- 3> set the 20 MSB of the HFN component of the COUNT-C variable common for all transparent mode radio bearers of this CN domain to the START value as indicated in the IE "START list" of the response message for the relevant CN domain; and

- 3> set the remaining LSBs of the HFN component of COUNT-C to zero;

- 3> increment the HFN component of the COUNT-C variable by one even if the "COUNT-C activation time" is equal to zero;
 - 3> set the CFN component of the COUNT-C to the value of the IE "COUNT-C activation time" of the response message. The HFN component and the CFN component completely initialise the COUNT-C variable;
 - 3> step the COUNT-C variable, as normal, at each CFN value. The HFN component is no longer fixed in value but incremented at each CFN cycle.
- 1> if the IE "Status" in the variable CIPHERING_STATUS of a CN domain is set to "Not Started" and transparent mode radio bearers have been established by this procedure for that CN domain:
 - 2> initialise the 20 MSB of the HFN component of COUNT-C common for all transparent mode radio bearers of this CN domain with the START value as indicated in the IE "START list" of the response message for the relevant CN domain;
 - 2> set the remaining LSBs of the HFN component of COUNT-C to zero;
 - 2> do not increment the COUNT-C value common for all transparent mode radio bearers for this CN domain.
 - 1> for 3.84/7.68 Mcps TDD, if the HANOVER TO UTRAN COMMAND provides for E-DCH/HS-DSCH operation without an uplink DPCH:
 - 2> the UE shall obtain timing advance for the 3.84/7.68 Mcps TDD cell according to [15] before transmitting on the uplink DCCH.
 - 1> if an IE "Logged Measurement Info-FDD" or "Logged Measurement Info-TDD" in variable LOGGED_MEAS_REPORT_VARIABLE is present and registered PLMN is present in the IE "PLMN Identity List" stored in variable LOGGED_MEAS_REPORT_VARIABLE:
 - 2> include IE "Logged Meas Available".
 - 1> if an IE "Logged Connection Establishment Failure Info-FDD" or "Logged Connection Establishment Failure Info-TDD" in variable LOGGED_CONNECTION_ESTABLISHMENT_FAILURE is present and the current Registered PLMN is the same as the PLMN in IE "PLMN Identity" stored in variable LOGGED_CONNECTION_ESTABLISHMENT_FAILURE:
 - 2> include IE "Connection Establishment Failure Info Available".
 - 1> transmit a HANOVER TO UTRAN COMPLETE message on the uplink DCCH, using, if ciphering has been started, the new ciphering configuration;
 - 1> when the HANOVER TO UTRAN COMPLETE message has been submitted to lower layers for transmission:
 - 2> if the source RAT was E-UTRA:
 - 3> store the CS "key set used" including the mapped KSI to the USIM CS security key if SR-VCC was performed;
 - 3> store the PS "key set used" including the mapped KSI to the USIM PS security key if PS handover was performed;
 - 2> if the source RAT was GERAN:
 - 3> store the PS "key set used" including the mapped KSI to the USIM PS security key if rSR-VCC was performed;
 - 2> if the UE supports voice and video SRVCC handover, and a SR-VCC handover is performed:
 - 3> if radio bearer configurations contain Conversational / speech CS RAB:
 - 4> indicate to the upper layer that voice-only SRVCC handover was completed successfully.
 - 3> if radio bearer configurations contain Conversational / unknown / UL:64 DL:64 kbps CS RAB:
 - 4> indicate to the upper layer that voice and video SRVCC handover was completed successfully.

- 2> if the UE supports rSRVCC handover, and an rSR-VCC handover is performed;
 - 3> indicate to the upper layer that rSR-VCC handover was completed successfully.
 - 2> enter UTRA RRC connected mode in state CELL_DCH;
 - 2> initialise variables upon entering UTRA RRC connected mode as specified in subclause 13.4;
 - 2> update the variable UE_CAPABILITY_TRANSFERRED with the UE capabilities stored in the variable INTER_RAT_HANDOVER_INFO_TRANSFERRED.
- 1> and the procedure ends.

8.3.6.4 Invalid Handover to UTRAN command message

If the UE receives a HANDOVER TO UTRAN COMMAND message, which contains a protocol error causing the variable PROTOCOL_ERROR_REJECT to be set to TRUE according to clause 9, the UE shall perform procedure specific error handling according to the source radio access technology. The UE shall:

- 1> if allowed by the source RAT:
 - 2> transmit an RRC FAILURE INFO message to the source radio access technology; and
 - 2> include the IE "Protocol error information" with contents set to the value of the variable PROTOCOL_ERROR_INFORMATION;
- 1> Other details may be provided in the specifications related to the source radio access technology.

NOTE: The other RAT may include the above diagnostics information in a subsequent handover request towards the same RNC.

8.3.6.4a Unsupported configuration in HANDOVER TO UTRAN COMMAND message

If the UE does not support the configuration included in the HANDOVER TO UTRAN COMMAND message, e.g., the message includes a pre-defined configuration that the UE has not stored, the UE shall:

- 1> continue the connection using the other radio access technology; and
- 1> indicate the failure to the other radio access technology.

8.3.6.5 UE fails to perform handover

If the UE does not succeed in establishing the connection to UTRAN, it shall:

- 1> terminate the procedure including release of the associated resources;
- 1> resume the connection used before the handover; and
- 1> indicate the failure to the other radio access technology.

Upon receiving an indication about the failure from the other radio access technology, UTRAN should release the associated resources and the context information concerning this UE.

8.3.6.6 Reception of message HANDOVER TO UTRAN COMPLETE by the UTRAN

Upon receiving a HANDOVER TO UTRAN COMPLETE message, UTRAN should consider the inter-RAT handover procedure as having been completed successfully and indicate this to the Core Network.

8.3.7 Inter-RAT handover from UTRAN

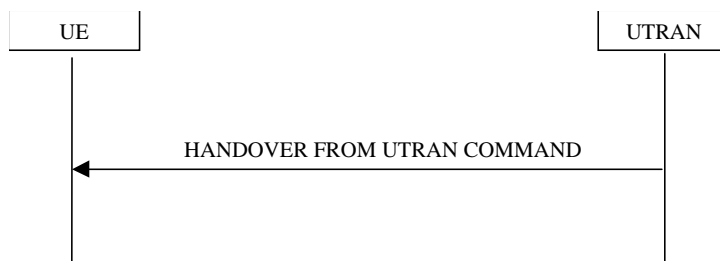

Figure 8.3.7-1: Inter-RAT handover from UTRAN, successful case

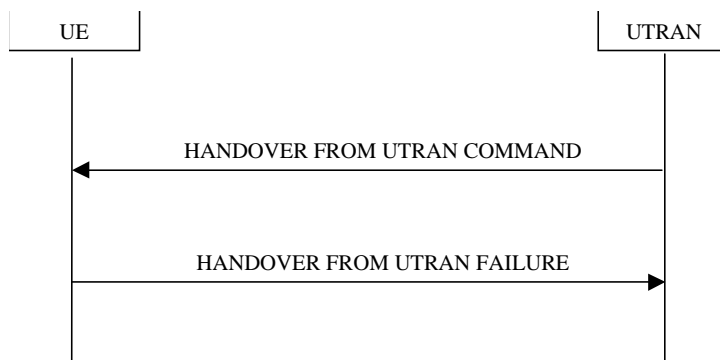

Figure 8.3.7-2: Inter-RAT handover from UTRAN, failure case

8.3.7.1 General

The purpose of the inter-RAT handover procedure is to, under the control of the network, transfer a connection between the UE and UTRAN to another radio access technology (e.g. GSM or E-UTRA). This procedure may be used in CELL_DCH state.

This procedure may be used to perform CS handover which applies when the variable ESTABLISHED_SIGNALLING_CONNECTIONS includes at least the CN domain identity "CS Domain".

When the UE supports Inter-RAT PS handover, this procedure may be used to perform PS handover which applies when the variable ESTABLISHED_SIGNALLING_CONNECTIONS includes at least the CN domain identity "PS Domain".

When the UE supports PS to CS handover, this procedure may be used to perform PS to CS handover which applies when the variable ESTABLISHED_SIGNALLING_CONNECTIONS includes at least the CN domain identity "PS Domain".

When the UE supports CS to PS handover, this procedure may be used to perform CS to PS handover which applies when the variable ESTABLISHED_SIGNALLING_CONNECTIONS includes at least the CN domain identity "CS Domain".

This procedure may be used to perform simultaneous CS and PS handover, simultaneous CS to PS and PS handover or, simultaneous PS to CS and PS handover which applies when the variable ESTABLISHED_SIGNALLING_CONNECTIONS includes CN domain identities for both "CS Domain" and "PS Domain".

8.3.7.2 Initiation

The procedure is initiated when UTRAN orders a UE in CELL_DCH state, to make a handover to a radio access technology other than UTRAN, e.g. GSM or E-UTRA.

To initiate the procedure, UTRAN sends a HANDOVER FROM UTRAN COMMAND message.

8.3.7.3 Reception of a HANDOVER FROM UTRAN COMMAND message by the UE

The UE shall be able to receive a HANDOVER FROM UTRAN COMMAND message and perform an inter-RAT handover, even if no prior UE measurements have been performed on the target cell.

The UE shall:

1> For FDD:

2> if the UE has a pending "TGPS reconfiguration CFN" at the activation time received in the HANDOVER FROM UTRAN COMMAND the UE may:

3> abort the pending CM activation;

3> set the CM_PATTERN_ACTIVATION_ABORTED to TRUE.

2> otherwise:

3> set the CM_PATTERN_ACTIVATION_ABORTED to FALSE.

1> if the IE "NONCE" in IE "SR-VCC Info" is present:

2> perform security configurations according to subclause 8.6.3.15.

1> if the IE "rSR-VCC Info" is included:

2> act as specified in subclause 8.6.3.16.

1> establish the connection to the target radio access technology, by using the contents of the IE "Inter-RAT message". This IE contains a message specified in another standard, as indicated by the IE "System type", and carries information about the candidate/ target cell identifier(s) and radio parameters relevant for the target radio access technology. The correspondence between the value of the IE "System type", the standard to apply and the message contained within IE "Inter RAT message" is shown in the following:

Value of the IE "System type"	Standard to apply	Inter-RAT Message
GSM	GSM TS 04.18, version 8.5.0 or later, or 3GPP TS 44.018	HANDOVER COMMAND
	3GPP TS 44.060, version 6.13.0 or later	PS HANDOVER COMMAND
	3GPP TS 44.060, version 7.6.0 or later	DTM HANDOVER COMMAND
cdma2000	TIA/EIA/IS-2000 or later, TIA/EIA/IS-833 or later, TIA/EIQ/IS-834 or later	
E-UTRA	3GPP TS 36.331	<i>DL-DCCH-Message</i> containing <i>RRCCConnectionReconfiguration</i>

1> if the IE "RAB info to replace" is present:

2> indicate to the upper layers that the radio access bearer identified by the IE "RAB info to replace" is released as part of a SR-VCC procedure.

1> if the IE "System type" has the value "GSM" or "GERAN Iu":

2> if the IE "Frequency band" has the value "GSM /DCS 1800 band used":

3> set the BAND_INDICATOR [45] to "ARFCN indicates 1800 band".

2> if the IE "Frequency band" has the value " GSM /PCS 1900 band used":

3> set the BAND_INDICATOR [45] to "ARFCN indicates 1900 band".

1> apply the "Inter RAT Message" according to the "standard to apply" in the table above.

- 1> if the IE "RAB information List" is included in the HANDOVER FROM UTRAN COMMAND message:
 - 2> if the IE "RAB information List" includes one IE "RAB Info" with the IE "CN domain Identity" set to "CS domain":
 - 3> connect upper layer entities corresponding to the indicated CS domain RAB to the radio resources indicated in the inter-RAT message.
 - 2> if the IE "RAB information List" includes one IE "RAB Info" with the IE "CN domain Identity" set to "PS domain":
 - 3> connect upper layer entities corresponding to the indicated PS domain RAB to the radio resources indicated in the inter-RAT message.
 - 3> if the "System type" is "GSM":
 - 4> use the contents of the IE "GERAN system information" as the system information to begin access on the target GERAN cell.

NOTE1: In this version of the specification the maximum number of CS domain RABs which may be included in the IE "RAB information List" is limited to 1.

NOTE2: In handover to GERAN *Iu mode*, the RAB information is included in the RADIO BEARER RECONFIGURATION message.

NOTE3: Requirements concerning the establishment of the radio connection towards the other radio access technology and the signalling procedure are outside the scope of this specification.

NOTE4: The UE may ignore the IE "NAS synchronisation indicator" if included in the HANDOVER FROM UTRAN COMMAND message;

NOTE5: The UE behaviour is undefined if the IE "Re-establishment timer" in the IE "RAB info" indicates a timer different from the timer currently configured for this RAB.

NOTE6: The IE "GERAN System Information" is constructed in the same way as in 2G to 2G PS Handover in [44].

8.3.7.4 Successful completion of the inter-RAT handover

Upon successfully completing the handover, UTRAN should:

- 1> release the radio connection; and
- 1> remove all context information for the concerned UE.

Upon successfully completing the handover, the UE shall:

- 1> if inter-RAT handover to GERAN *Iu mode* is performed:
 - 2> perform the actions on reception of the RADIO BEARER RECONFIGURATION message.
- 1> if inter-RAT handover to GERAN *Iu mode* is performed and if there are any NAS messages for which the successful delivery of the INITIAL DIRECT TRANSFER message or UPLINK DIRECT TRANSFER message on signalling radio bearer RB3 or signalling radio bearer RB4 has not yet been confirmed by RLC; or
- 1> if inter-RAT handover to other RAT than GERAN *Iu mode* and E-UTRAN is performed and if there are any NAS messages with the IE "CN domain identity" set to "CS domain" for which the successful delivery of the INITIAL DIRECT TRANSFER message or UPLINK DIRECT TRANSFER message on signalling radio bearer RB3 or signalling radio bearer RB4 that have not yet been confirmed by RLC:
 - 2> retransmit those NAS messages to the network on the newly established radio connection to the target radio access technology.
- 1> if inter-RAT handover or rSR-VCC to E-UTRAN is performed and if there are any NAS messages for which the successful delivery of the INITIAL DIRECT TRANSFER message or UPLINK DIRECT TRANSFER message on signalling radio bearer RB3 or signalling radio bearer RB4 has not yet been confirmed by RLC:

2> discard those NAS messages.

1> clear or set variables upon leaving UTRA RRC connected mode as specified in subclause 13.4;

NOTE: The release of the UMTS radio resources is initiated from the target RAT.

8.3.7.5 UE fails to complete requested handover

If the UE does not succeed in establishing the connection to the target radio access technology, it shall:

1> revert back to the UTRA configuration;

1> For FDD:

2> if the CM_PATTERN_ACTIVATION_ABORTED flag is not set to TRUE:

3> establish the UTRA physical channel(s) (including HS-DSCH and E-DCH related channels. If there exists any DTX or DRX configuration, the UE shall instruct the physical layer to consider only the HS-SCCH orders which were acknowledged prior to the activation time of the received message) used at the time for reception of HANDOVER FROM UTRAN COMMAND;

3> if the variable DTX_DRX_STATUS is set to TRUE, re-configure the physical layer to perform discontinuous uplink DPCH transmission and enable or disable discontinuous downlink reception operations according to the variable DTX_DRX_PARAMS at the CFN corresponding to the frame boundary that is offset by the stored value of the IE "Enabling Delay" from the frame boundary where uplink transmission resumes with the old configuration;

3> if the variable SECONDARY_CELL_E_DCH_TRANSMISSION is set to TRUE:

4> consider the secondary uplink frequency as not activated.

3> perform the physical layer synchronisation procedure A as specified in [29] (FDD only);

3> apply power control preamble according to [26] during the number of frames indicated in the IE "PC preamble" in the variable LATEST_CONFIGURED_SRB_DELAY_AND_PC_PREAMBLE; and

3> then not send any data on signalling radio bearers RB0 to RB4 during the number of frames indicated in the IE "SRB delay" in the variable LATEST_CONFIGURED_SRB_DELAY_AND_PC_PREAMBLE or while the physical channel is not considered established.

1> if the UE does not succeed to establish the UTRA physical channel(s) or for FDD if the CM_PATTERN_ACTIVATION_ABORTED flag is set to TRUE:

2> perform a cell update procedure according to subclause 8.3.1 with cause "Radio link failure";

2> when the cell update procedure has completed successfully:

3> proceed as below.

1> transmit the HANDOVER FROM UTRAN FAILURE message setting the information elements as specified below:

2> include the IE "RRC transaction identifier"; and

2> set it to the value of "RRC transaction identifier" in the entry for the HANDOVER FROM UTRAN COMMAND message in the table "Accepted transactions" in the variable TRANSACTIONS; and

2> clear that entry;

2> set the IE "Inter-RAT handover failure" to "physical channel failure".

1> When the HANDOVER FROM UTRAN FAILURE message has been submitted to lower layer for transmission:

2> the procedure ends.

8.3.7.6 Invalid HANDOVER FROM UTRAN COMMAND message

If the IE "Inter-RAT message" received within the HANDOVER FROM UTRAN COMMAND message does not include a valid inter RAT handover message in accordance with the protocol specifications for the target RAT, the UE shall perform procedure specific error handling as follows. The UE shall:

- 1> set the IE "failure cause" to the cause value "Inter-RAT protocol error";
- 1> include the IE "Inter-RAT message" in accordance with the specifications applicable to the other RAT;
- 1> transmit a HANDOVER FROM UTRAN FAILURE message on the uplink DCCH using AM RLC;
- 1> when the transmission of the HANDOVER FROM UTRAN FAILURE message has been confirmed by RLC:
 - 2> continue with any ongoing processes and procedures as if the invalid HANDOVER FROM UTRAN COMMAND message has not been received;
 - 2> and the procedure ends.

If the HANDOVER FROM UTRAN COMMAND message contains a protocol error causing the variable `PROTOCOL_ERROR_REJECT` to be set to TRUE according to clause 9, the UE shall perform procedure specific error handling as follows. The UE shall:

- 1> set the IE "RRC transaction identifier" in the HANDOVER FROM UTRAN FAILURE message to the value of "RRC transaction identifier" in the entry for the HANDOVER FROM UTRAN COMMAND message in the table "Rejected transactions" in the variable `TRANSACTIONS`; and
- 1> clear that entry;
- 1> set the IE "failure cause" to the cause value "protocol error";
- 1> include the IE "Protocol error information" with contents set to the value of the variable `PROTOCOL_ERROR_INFORMATION`;
- 1> transmit a HANDOVER FROM UTRAN FAILURE message on the uplink DCCH using AM RLC;
- 1> when the HANDOVER FROM UTRAN FAILURE message has been submitted to lower layers for transmission:
 - 2> continue with any ongoing processes and procedures as if the invalid HANDOVER FROM UTRAN COMMAND message has not been received;
 - 2> and the procedure ends.

8.3.7.7 Reception of an HANDOVER FROM UTRAN FAILURE message by UTRAN

Upon receiving an HANDOVER FROM UTRAN FAILURE message, UTRAN may initiate the release the resources in the target radio access technology.

8.3.7.8 Unsupported configuration in HANDOVER FROM UTRAN COMMAND message

If:

- the UTRAN instructs the UE to perform a non-supported handover scenario; or
- the UTRAN instructs the UE to use a non-supported configuration; or
- the UE does not support PS Handover to GERAN, and the inter-RAT handover to GERAN *A/Gb mode* is performed and the IE "RAB information List" is included in the HANDOVER FROM UTRAN COMMAND message and this IE does not include any IE "RAB Info" with the IE "CN domain Identity" set to "CS domain"; or

- the inter-RAT PS handover to GERAN is performed and the HANOVER FROM UTRAN COMMAND message includes the IE "RAB information List" and includes at least one IE "RAB Info" with the IE "CN domain Identity" set to "PS domain", and the IE "GERAN System Information" is not present; or
- the inter-RAT handover to E-UTRAN is performed and the HANOVER FROM UTRAN COMMAND message includes the IE "RAB information List" and includes at least one IE "RAB Info" with the IE "CN domain Identity" set to "CS domain":

the UE shall:

- 1> transmit a HANOVER FROM UTRAN FAILURE message, setting the information elements as specified below:
 - 2> include the IE "RRC transaction identifier"; and
 - 2> set it to the value of "RRC transaction identifier" in the entry for the HANOVER FROM UTRAN COMMAND message in the table "Accepted transactions" in the variable TRANSACTIONS; and
 - 2> clear that entry;
 - 2> set the IE "Inter-RAT handover failure" to "configuration unacceptable";
 - 2> when the HANOVER FROM UTRAN FAILURE message has been submitted to lower layers for transmission:
 - 3> resume normal operation as if the invalid HANOVER FROM UTRAN COMMAND message has not been received;
 - 3> and the procedure ends.

8.3.7.8a Reception of HANOVER FROM UTRAN COMMAND message by UE in CELL_FACH

If the UE receives HANOVER FROM UTRAN COMMAND while in CELL_FACH, the UE shall:

- 1> transmit a HANOVER FROM UTRAN FAILURE message, setting the information elements as specified below:
 - 2> include the IE "RRC transaction identifier"; and
 - 2> set it to the value of "RRC transaction identifier" in the entry for the HANOVER FROM UTRAN COMMAND message in the table "Accepted transactions" in the variable TRANSACTIONS; and
 - 2> clear that entry;
 - 2> set the IE "Inter-RAT handover failure" to "protocol error", include IE "Protocol error information"; and
 - 2> set the value of IE "Protocol error cause" to "Message not compatible with receiver state";
 - 2> when the HANOVER FROM UTRAN FAILURE message has been submitted to lower layers for transmission:
 - 3> resume normal operation as if the invalid HANOVER FROM UTRAN COMMAND message has not been received;
 - 3> and the procedure ends.

8.3.8 Inter-RAT cell reselection to UTRAN

8.3.8.1 General

The purpose of the inter-RAT cell reselection procedure to UTRAN is to transfer, under the control of the UE and to some extent the source radio access technology, a connection between the UE and another radio access technology (e.g. GSM/GPRS, but not UTRAN) to UTRAN.

8.3.8.2 Initiation

When the UE makes an inter-RAT cell reselection to UTRAN according to the criteria specified in [4], it shall initiate this procedure. The inter-RAT cell reselection made by the UE may use system information broadcast from the source radio access technology or UE dedicated information.

If the NAS procedures associated with inter-system change specified in [5] require the establishment of an RRC connection, the UE shall:

- 1> set the variable ESTABLISHMENT_CAUSE to "Inter-RAT cell reselection";

NOTE: This value of ESTABLISHMENT_CAUSE has priority over the cause requested by upper layers.

- 1> initiate an RRC connection establishment procedure as specified in subclause 8.1.3;

- 1> after initiating an RRC connection establishment:

- 2> release all resources specific to the other radio access technology.

If the NAS procedures associated with inter-system change specified in [5] do not require the establishment of an RRC connection, the UE shall:

- 1> enter idle mode in the target cell without accessing the cell; and

- 1> release all resources specific to the other radio access technology.

8.3.8.2a Initiation of inter-RAT cell reselection from GERAN *Iu mode*

When the UE performs an inter-RAT cell reselection from GERAN *Iu mode* Cell_Shared state, the UE shall:

- 1> initiate the cell update procedure as specified for the cell reselection case in CELL_FACH and CELL_PCH states, using the cause "cell reselection" and setting the G-RNTI in the IE "U-RNTI".

When the UE performs an inter-RAT cell reselection from GERAN *Iu mode* GRA_PCH state, the UE shall:

- 1> compare the GRA identity which the MS had been assigned to in GERAN against the URA identities which are broadcast in the UTRAN cell.

- 1> If the assigned GRA identity is not present in the list of URA identities that are broadcast in the UTRAN cell:

- 2> initiate the URA update procedure as specified for the URA reselection case in URA_PCH state, using the cause "change of URA" and setting the G-RNTI in the IE "U-RNTI".

The UE shall:

- 1> set the following variables equal to the corresponding variables in GERAN *Iu mode*:

CIPHERING_STATUS

ESTABLISHED_RABS

ESTABLISHED_SIGNALLING_CONNECTIONS

INTEGRITY_PROTECTION_INFO

INTER_RAT_HANDOVER_INFO_TRANSFERRED

LATEST_CONFIGURED_CN_DOMAIN

START_THRESHOLD

UE_CAPABILITY_TRANSFERRED.

- 1> set the new uplink and downlink HFN of RB2 to $MSB_{20}(\text{MAX}(\text{uplink HFN of RB2}, \text{downlink HFN of RB2}))$.

NOTE: $MSB_{20}()$ operation provides the HFN mapping from GERAN *Iu mode* to UTRAN. In GERAN *Iu mode* the length of HFN component of the COUNT-C of RB2 is longer than 20 bits.

- 1> initialise the variable TIMERS_AND_CONSTANTS to the default values and start to use those timer and constants values.

8.3.8.3 UE fails to complete an inter-RAT cell reselection

If the inter-RAT cell reselection fails before the UE has initiated the RRC connection establishment the UE may return back to the other radio access technology.

If the RRC connection establishment fails, the UE shall enter idle mode.

8.3.8.3a UE fails to complete an inter-RAT cell reselection from GERAN *Iu mode*

When the UE performs an inter-RAT cell reselection from GERAN *Iu mode* to UTRAN, and the cell reselection fails:

- 1> the UE may return back to the GERAN *Iu mode* state from which it initiated the inter-RAT cell reselection.

8.3.9 Inter-RAT cell reselection from UTRAN

8.3.9.1 General

The purpose of the inter-RAT cell reselection procedure from UTRAN is to transfer, under the control of the UE and to some extent the UTRAN, a connection between the UE and UTRAN to another radio access technology (e.g. GSM/GPRS or E-UTRA).

8.3.9.2 Initiation

This procedure is applicable in states CELL_FACH, CELL_PCH or URA_PCH.

When the UE based on received system information makes a cell reselection to a radio access technology other than UTRAN, e.g. GSM/GPRS or E-UTRA, according to the criteria specified in [4], the UE shall:

- 1> If the NAS procedures associated with inter-system change specified in [5] require the establishment of a connection:
 - 2> initiate the establishment of a connection to the target radio access technology according to its specifications.

8.3.9.2a Initiation of inter-RAT cell reselection to GERAN *Iu mode*

When the UE in CELL_PCH or CELL_FACH state performs an inter-RAT cell reselection to GERAN *Iu mode*, according to the criteria specified in [4], the UE shall:

- 1> initiate the cell update procedure, setting the U-RNTI in the IE "G-RNTI".

When the UE in URA_PCH state performs an inter-RAT cell reselection to GERAN *Iu mode*, according to the criteria specified in [4], the UE shall:

- 1> compare the URA identity which the UE had been assigned to in UTRAN against the GRA identities which are broadcast in the GERAN cell;
 - 1> If the assigned URA identity is not present in the list of GRA identities that are broadcast in the GERAN cell:
 - 2> initiate the GRA update procedure, setting the U-RNTI in the IE "G-RNTI".

8.3.9.3 Successful cell reselection

When the UE has succeeded in reselecting a cell in the target radio access technology, the UE shall:

- 1> release all UTRAN specific resources.

UTRAN should:

- 1> release all UE dedicated resources upon indication that the UE has completed a connection establishment to the other radio access technology.

8.3.9.4 UE fails to complete an inter-RAT cell reselection

If the inter-RAT cell reselection fails, the UE shall:

- 1> resume the connection to UTRAN using the resources used before initiating the inter-RAT cell reselection procedure.

8.3.10 Inter-RAT cell change order to UTRAN

8.3.10.1 General

The purpose of the inter-RAT cell change order to UTRAN procedure is to transfer, under the control of the source radio access technology, a connection between the UE and another radio access technology (e.g. GSM/GPRS) to UTRAN.

8.3.10.2 Initiation

The procedure is initiated when a radio access technology other than UTRAN, e.g. GSM/GPRS, using procedures specific for that RAT, orders the UE to change to a UTRAN cell.

NOTE: Within the message used to order the UE to change to a UTRAN cell, the source RAT should specify the identity of the target UTRAN cell as specified in the specifications for that RAT.

The UE shall:

- 1> set the variable ESTABLISHMENT_CAUSE to "Inter-RAT cell change order";

NOTE: This value of ESTABLISHMENT_CAUSE has priority over the cause requested by upper layers.

- 1> initiate an RRC connection establishment procedure as specified in subclause 8.1.3.

8.3.10.3 UE fails to complete an inter-RAT cell change order

If the inter-RAT cell reselection fails the UE shall return to the other radio access technology and proceed as specified in the appropriate specifications for that RAT.

NOTE 3: The cell change was network ordered. Therefore, failure to change to the target cell should not cause the UE to move to UE- controlled cell selection.

8.3.11 Inter-RAT cell change order from UTRAN

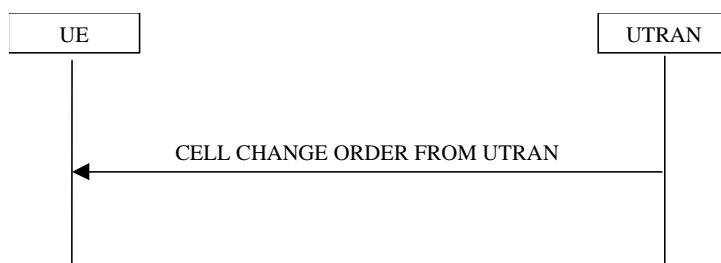

Figure 8.3.11-1: Inter-RAT cell change order from UTRAN

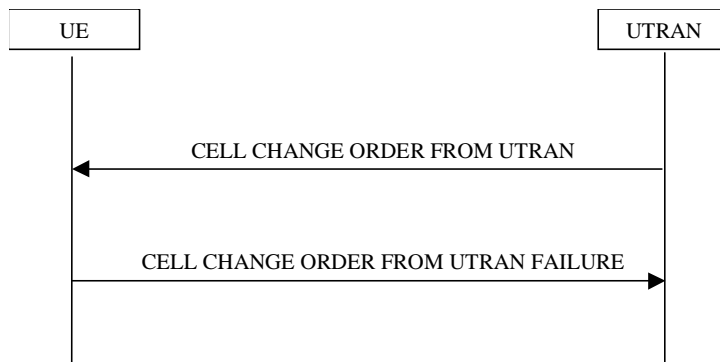

Figure 8.3.11-2: Inter-RAT cell change order from UTRAN, failure case

8.3.11.1 General

The purpose of the inter-RAT cell change order procedure is to transfer, under the control of the network, a connection between the UE and UTRAN to another radio access technology (e.g. GSM). This procedure may be used in CELL_DCH and CELL_FACH state. This procedure may be used when no RABs are established or when the established RABs are only from PS domain. This procedure may not be used when there is no PS signalling connection.

8.3.11.2 Initiation

The procedure is initiated when UTRAN orders a UE in CELL_DCH or CELL_FACH state, to make a cell change to a radio access technology other than UTRAN, e.g. GSM.

To initiate the procedure, UTRAN sends a CELL CHANGE ORDER FROM UTRAN message.

8.3.11.3 Reception of an CELL CHANGE ORDER FROM UTRAN message by the UE

The UE shall be able to receive a CELL CHANGE ORDER FROM UTRAN message and perform a cell change order to another RAT, even if no prior UE measurements have been performed on the target cell.

If the variable ESTABLISHED_SIGNALLING_CONNECTIONS does not include the CN domain identity "PS domain", or if the variable ESTABLISHED_SIGNALLING_CONNECTIONS includes the CN domain identity "CS domain":

- 1> the UE shall act as if the message was never received.

The UE shall:

- 1> For FDD:
 - 2> if the UE has a pending "TGPS reconfiguration CFN" at the activation time received in the CELL CHANGE ORDER FROM UTRAN message the UE may:
 - 3> abort the pending CM activation;
 - 3> set the CM_PATTERN_ACTIVATION_ABORTED to TRUE.
 - 2> otherwise:
 - 3> set the CM_PATTERN_ACTIVATION_ABORTED to FALSE.
- 1> start timer T309; and
- 1> establish the connection to the other radio access technology, as specified within IE "Target cell description". This IE specifies the target cell identity, in accordance with the specifications for that other RAT. In case the target cell is a GSM/ GPRS cell, IE "Target cell description" may also include IE "NC mode", which specifies the cell selection mode to be applied in the target cell; and
- 1> if IE "NC mode" is not included in the CELL CHANGE ORDER FROM UTRAN:

- 2> retrieve it from the target cell as specified in [43];
- 2> act upon IE "NC mode" as specified in [43].
- 1> if the IE "RAB Information List" is included in the CELL CHANGE ORDER FROM UTRAN message:
 - 2> ignore the contents of the IE "RAB Information List".

NOTE: Requirements concerning the establishment of the radio connection towards the other radio access technology and the signalling procedure are outside the scope of this specification. In case of GSM/GPRS proceed according to the procedure Network control cell reselection procedure as specified in [44].

- 1> if the UE supports UTRAN to GERAN Network Assisted Cell Change, the IE "Geran System Information" is present and the UE is in CELL_DCH state:
 - 2> if according to [44] the IE "GERAN System Information" includes a correct and consistent set of SI or PSI messages:
 - 3> use this information as the system information to begin access on the target GERAN cell.
 - 2> otherwise:
 - 3> ignore the IE "GERAN System Information" and continue the Cell Change Order procedure.

NOTE: The IE "GERAN System Information" is constructed in the same way as in 2G to 2G NACC, i.e. the PSI messages are encoded as such, whereas the SI messages exclude 2 octets of headers, see [44].

8.3.11.4 Successful completion of the cell change order

The UE regards the procedure as completed when it has received a successful response from the target RAT, e.g. in case of GSM when it received the response to a (PACKET) CHANNEL REQUEST in the new cell.

Upon successful completion of the cell change order, the UE shall:

- 1> stop timer T309;
- 1> clear or set variables upon leaving UTRA RRC connected mode as specified in subclause 13.4.

8.3.11.5 Expiry of timer T309 or UE fails to complete requested cell change order

If:

- timer T309 expires prior to the successful establishment of a connection to the target RAT; or
- if the establishment of the connection to the other RAT failed due to other reasons e.g. (random) access failure, rejection due to lack of resources:

the UE shall:

- 1> if it received the CELL CHANGE ORDER FROM UTRAN message in state CELL_DCH:
 - 2> For TDD or for FDD if the CM_PATTERN_ACTIVATION_ABORTED flag is not set to TRUE:
 - 3> revert back to the UTRA configuration;
 - 3> establish the UTRA physical channel(s) (including HS-DSCH and E-DCH related channels) used at the time for reception of CELL CHANGE ORDER FROM UTRAN.
 - 2> For FDD:
 - 3> perform the physical layer synchronisation procedure A as specified in [29];
 - 3> if there exists any DTX or DRX configuration prior to the reception of the CELL CHANGE ORDER FROM UTRAN COMMAND, instruct the physical layer to consider only the HS-SCCH orders which were acknowledged prior to the activation time of the received message;

- 3> if the variable DTX_DRX_STATUS is set to TRUE, re-configure the physical layer to perform discontinuous uplink DPCCCH transmission and enable or disable discontinuous downlink reception operations according to the variable DTX_DRX_PARAMS at the CFN corresponding to the frame boundary that is offset by the stored value of the IE "Enabling Delay" from the frame boundary where uplink transmission resumes with the old configuration;
- 3> if the variable SECONDARY_CELL_E_DCH_TRANSMISSION is set to TRUE:
 - 4> consider the secondary uplink frequency as not activated.
 - 3> apply power control preamble according to [26] during the number of frames indicated in the IE "PC preamble" in the variable LATEST_CONFIGURED_SRB_DELAY_AND_PC_PREAMBLE; and
 - 3> then not send any data on signalling radio bearers RB0 to RB4 during the number of frames indicated in the IE "SRB delay" in the variable LATEST_CONFIGURED_SRB_DELAY_AND_PC_PREAMBLE or while the physical channel is not considered established;
 - 3> if the CM_PATTERN_ACTIVATION_ABORTED flag is set to TRUE or if the UE does not succeed in establishing the UTRA physical channel(s):
 - 4> perform a cell update procedure according to subclause 8.3.1 with cause "Radio link failure";
 - 4> when the cell update procedure has completed successfully:
 - 5> proceed as below.
 - 3> transmit the CELL CHANGE ORDER FROM UTRAN FAILURE message setting the information elements as specified below:
 - 4> include the IE "RRC transaction identifier"; and
 - 4> set it to the value of "RRC transaction identifier" in the entry for the received message in the table "Accepted transactions" in the variable TRANSACTIONS; and
 - 4> clear that entry;
 - 4> set the IE "Inter-RAT change failure" to "physical channel failure".
 - 3> When the CELL CHANGE ORDER FROM UTRAN FAILURE message has been submitted to lower layer for transmission, the procedure ends.
- 1> if the UE receives the CELL CHANGE ORDER FROM UTRAN message in CELL_FACH state:
 - 2> revert to the cell it was camped on at the reception of the CELL CHANGE ORDER FROM UTRAN message;
 - 2> if the UE is unable to return to this cell:
 - 3> select a suitable UTRA cell according to [4];
 - 3> initiate the cell update procedure according to subclause 8.3.1 using the cause "cell re-selection";
 - 3> when the cell update procedure completed successfully:
 - 4> proceed as below.
 - 2> transmit the CELL CHANGE ORDER FROM UTRAN FAILURE message setting the information elements as specified below:
 - 3> include the IE "RRC transaction identifier"; and
 - 3> set it to the value of "RRC transaction identifier" in the entry for the CELL CHANGE ORDER FROM UTRAN message in the table "Accepted transactions" in the variable TRANSACTIONS; and
 - 3> clear that entry;
 - 3> set the IE "Inter-RAT change failure" to "physical channel failure".

- 2> When the CELL CHANGE ORDER FROM UTRAN FAILURE message has been submitted to lower layer for transmission:
- 3> the procedure ends.

8.3.11.6 Unsupported configuration in CELL CHANGE ORDER FROM UTRAN message

If the UTRAN instructs the UE to perform a non-supported cell change order scenario or to use a non-supported configuration, the UE shall:

- 1> transmit a CELL CHANGE ORDER FROM UTRAN FAILURE message, setting the information elements as specified below:
 - 2> include the IE "RRC transaction identifier"; and
 - 2> set it to the value of "RRC transaction identifier" in the entry for the received message in the table "Accepted transactions" in the variable TRANSACTIONS; and
 - 2> clear that entry;
 - 2> set the IE "Inter-RAT change failure" to "configuration unacceptable";
- 2> when the CELL CHANGE ORDER FROM UTRAN FAILURE message has been submitted to lower layers for transmission:
 - 3> resume normal operation as if the CELL CHANGE ORDER FROM UTRAN message has not been received;
 - 3> and the procedure ends.

8.3.11.7 Invalid CELL CHANGE ORDER FROM UTRAN message

If the CELL CHANGE ORDER FROM UTRAN message contains a protocol error causing the variable PROTOCOL_ERROR_REJECT to be set to TRUE according to clause 9, the UE shall perform procedure specific error handling as follows. The UE shall:

- 1> set the IE "RRC transaction identifier" in the CELL CHANGE ORDER FROM UTRAN FAILURE message to the value of "RRC transaction identifier" in the entry for the CELL CHANGE ORDER FROM UTRAN message in the table "Rejected transactions" in the variable TRANSACTIONS; and
- 1> clear that entry;
- 1> set the IE "Inter-RAT change failure" to the cause value "protocol error";
- 1> include the IE "Protocol error information" with contents set to the value of the variable PROTOCOL_ERROR_INFORMATION;
- 1> transmit a CELL CHANGE ORDER FROM UTRAN FAILURE message on the uplink DCCH using AM RLC;
- 1> when the CELL CHANGE ORDER FROM UTRAN FAILURE message has been submitted to lower layers for transmission:
 - 2> resume normal operation as if the invalid CELL CHANGE ORDER FROM UTRAN message has not been received;
 - 2> and the procedure ends.

8.4 Measurement procedures

8.4.0 Measurement related definitions

UTRAN may control a measurement in the UE either by broadcast of SYSTEM INFORMATION and/or by transmitting a MEASUREMENT CONTROL message.

The following information is used to control the UE measurements and the measurement results reporting:

1. **Measurement identity:** A reference number that should be used by the UTRAN when setting up, modifying or releasing the measurement and by the UE in the measurement report.
2. **Measurement command:** One out of three different measurement commands.
 - Setup: Setup a new measurement.
 - Modify: Modify a previously defined measurement, e.g. to change the reporting criteria.
 - Release: Stop a measurement and clear all information in the UE that are related to that measurement.
3. **Measurement type:** One of the types listed below describing what the UE shall measure.

Presence or absence of the following control information depends on the measurement type

4. **Measurement objects:** The objects on which the UE shall measure measurement quantities, and corresponding object information.
5. **Measurement quantity:** The quantity the UE shall measure on the measurement object. This also includes the filtering of the measurements.
6. **Reporting quantities:** The quantities the UE shall include in the report in addition to the quantities that are mandatory to report for the specific event.
7. **Measurement reporting criteria:** The triggering of the measurement report, e.g. periodical or event-triggered reporting.
8. **Measurement Validity:** Defines in which UE states the measurement is valid.
9. **Measurement reporting mode:** This specifies whether the UE shall transmit the measurement report using AM or UM RLC.
10. **Additional measurement identities:** A list of references to other measurements. When this measurement triggers a measurement report, the UE shall also include the reporting quantities for the measurements referenced by the additional measurement identities.

All these measurement parameters depend on the measurement type and are described in more detail in clause 14.

The different types of measurements are:

- **Intra-frequency measurements:** measurements on downlink physical channels at the same frequency as the active set and the secondary E-DCH active set. A measurement object corresponds to one cell. Detailed description is found in subclause 14.1.
- **Inter-frequency measurements:** measurements on downlink physical channels at frequencies that differ from the frequency of the active set and on downlink physical channels in the active set. A measurement object corresponds to one cell. Detailed description is found in subclause 14.2.
- **Inter-RAT measurements:** measurements on downlink physical channels belonging to another radio access technology than UTRAN, e.g. GSM or E-UTRA. A measurement object corresponds to one cell (e.g. GSM) or one frequency (e.g. E-UTRA). Detailed description is found in subclause 14.3.
- **Traffic volume measurements:** measurements on uplink traffic volume. A measurement object corresponds to one cell. Detailed description is found in subclause 14.4.

- **Quality measurements:** Measurements of downlink quality parameters, e.g. downlink transport block error rate. A measurement object corresponds to one transport channel in case of BLER. A measurement object corresponds to one timeslot in case of SIR (TDD only). Detailed description is found in subclause 14.5.
- **UE-internal measurements:** Measurements of UE transmission power and UE received signal level. Detailed description is found in subclause 14.6.
- **UE positioning measurements:** Measurements of UE position. Detailed description is found in subclause 14.7.
- **CSG Proximity detection:** Detection of the UE's proximity to one or more CSG member cells. Detailed description is found in subclause 14.7a.3.
- **E-UTRA measurement for CELL_FACH:** measurements on downlink physical channels belonging to E-UTRA when UE is in CELL_FACH state. Detailed description is found in subclause 14.15.

The UE shall support a number of measurements running in parallel as specified in [19] and [20]. The UE shall also support that each measurement is controlled and reported independently of every other measurement.

Cells that the UE is monitoring are grouped in the UE into three mutually exclusive categories:

1. Cells, which belong to the **active set**. User information is sent from all these cells. In FDD, the cells in the active set are involved in soft handover. In TDD the active set always comprises one cell only. The UE shall only consider active set cells and the secondary E-DCH active set cells included in the variable CELL_INFO_LIST for measurement; i.e. active set cells and the secondary E-DCH active set cells not included in the CELL_INFO_LIST shall not be considered in any event evaluation and measurement reporting.
2. Cells, which are not included in the active set, but are included in the CELL_INFO_LIST belong to the **monitored set**.
3. Cells detected by the UE, which are neither in the CELL_INFO_LIST nor in the active set belong to the **detected set**. Reporting of measurements of the detected set is only applicable to intra-frequency and inter-frequency measurements made by UEs in CELL_DCH state.

For CSG measurements, cells that the UE is monitoring are grouped in the UE into two mutually exclusive categories:

1. Cells, which belong to the **CSG set**, i.e., the cells included in the variable CELL_INFO_CSG_LIST. CSG set cells may also belong to the active set, monitored set, or detected set as defined above.
2. Cells, which are not included in the CSG set, belong to the **non-CSG set**. Cells in the non-CSG set may also belong to the active set, monitored set, or detected set as defined above.

If a particular measurement has been configured with CSG Set cells, then the CSG Set cells are monitored. For the purpose of measurement and measurement reporting procedures, the CSG Set shall be considered as the monitored set, and the non-CSG Set shall be considered as the detected set, for the purpose of measurement and measurement reporting procedures. i.e. that CELL_INFO_CSG_LIST is used instead of CELL_INFO_LIST to determine what cells are in the monitored set and detected set for that measurement.

If the IE "Cells for measurement" has been included in a MEASUREMENT CONTROL message, only monitored set cells explicitly indicated for a given intra-frequency (resp. inter-frequency, interRAT) measurement by the IE "Cells for measurement" shall be considered for measurement. If the IE "Cells for measurement" has not been included in a MEASUREMENT CONTROL message, all of the intra-frequency (resp. inter-frequency, inter RAT) cells stored in the variable CELL_INFO_LIST shall be considered for measurement. The IE "Cells for measurement" is not applicable to active set cells e.g. when the triggering condition refers to active set cells, the UE shall consider all active set cells in the CELL_INFO_LIST for measurement irrespective if these cells are explicitly indicated by the IE "Cells for measurement".

8.4.1 Measurement control



Figure 8.4.1-1: Measurement Control, normal case

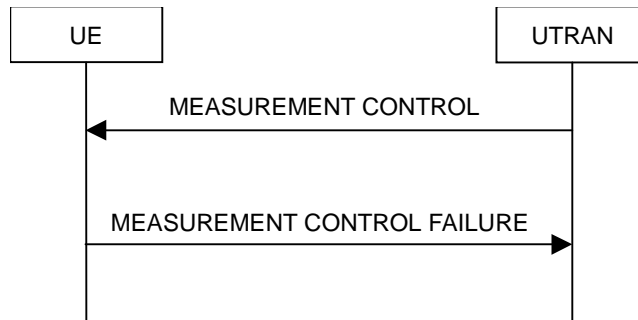

Figure 8.4.1-2: Measurement Control, failure case

8.4.1.1 General

The purpose of the measurement control procedure is to setup, modify or release a measurement in the UE.

In subclause 8.4.1 and its subclauses references to System Information Block type 11 mean the merge of System Information Block Type 11, System Information Block type 11bis and System Information Block type 11ter, if scheduled on BCH.

8.4.1.2 Initiation

The UTRAN may request a measurement by the UE to be setup, modified or released with a MEASUREMENT CONTROL message, which is transmitted on the downlink DCCCH using AM RLC.

The UTRAN should take the UE capabilities into account when a measurement is requested from the UE.

When a new measurement is created, UTRAN should set the IE "Measurement identity" to a value, which is not used for other measurements. UTRAN may use several "Measurement identity" for the same "Measurement type". In case of setting several "Measurement identity" within a same "Measurement type", the measurement object or the list of measurement objects can be set differently for each measurement with different "Measurement identity".

When a current measurement is modified or released, UTRAN should set the IE "Measurement identity" to the value, which is used for the measurement being modified or released. In case of modifying IEs within a "Measurement identity", it is not needed for UTRAN to indicate the IEs other than modified IEs, and the UE continues to use the current values of the IEs that are not modified. UTRAN should not use "modify" to change the type of measurement stored in the variable MEASUREMENT_IDENTITY for a given measurement identity.

For the frequency associated with the secondary serving HS-DSCH cell in IE "Inter-frequency measurement objects list", UTRAN should set the UARFCN to the same value as used for reception/transmission.

8.4.1.3 Reception of MEASUREMENT CONTROL by the UE

Upon reception of a MEASUREMENT CONTROL message the UE shall perform actions specified in subclause 8.6 unless otherwise specified below.

The UE shall:

- 1> read the IE "Measurement command";
- 1> if the IE "Measurement command" has the value "setup":
 - 2> store this measurement in the variable MEASUREMENT_IDENTITY according to the IE "measurement identity", first releasing any previously stored measurement with that identity if that exists;
 - 2> for FDD or 3.84/7.68 Mcps TDD, if the measurement type is quality, UE internal, intra-frequency, inter-frequency or inter-RAT:
 - 3> if the UE is in CELL_FACH state:
 - 4> the UE behaviour is not specified.
 - 2> for 1.28 Mcps TDD, if the measurement type is quality, UE internal, or inter-RAT:
 - 3> if the UE is in CELL_FACH state:
 - 4> the UE behaviour is not specified.
 - 2> for 1.28 Mcps TDD, if the measurement type is intra-frequency or inter-frequency:
 - 3> if the UE is in CELL_FACH state:
 - 4> if the UE is working on the secondary frequency:
 - 5> begin measurements according to the stored control information for this measurement identity.
 - 4> else:
 - 5> may begin measurements according to the stored control information for this measurement identity.
 - 2> if the measurement type is "inter-frequency measurement" and the IE "Inter-frequency SI Acquisition" is included or if the measurement type is "inter-RAT measurement" and the IE "E-UTRA SI Acquisition" is included:
 - 3> if the IE "report criteria" is not set to "Periodical reporting criteria":
 - 4> the UE behaviour is not specified.
 - 2> for measurement types "inter-RAT measurement" or "inter-frequency measurement" that require measurements on a frequency other than the actually used frequency:
 - 3> if, according to its measurement capabilities, the UE requires compressed mode to perform that measurement type:
 - 4> if, according to its measurement capabilities in the IE "Frequency specific compressed mode", the UE does not require the compressed mode on all the frequencies associated the serving HS-DSCH cell and the secondary serving HS-DSCH cells; and
 - 4> the frequency to measure is in the band other than the band of the frequency of the serving HS-DSCH cell; and
 - 4 the frequency to measure is in the band for which there is at least one frequency associated with the entry in the variable SECONDARY_CELL_HS_DSCH_RECEPTION set to TRUE; and
 - 4> if after reception of this message, a compressed mode pattern sequence with the IE "Frequency specific compressed mode" set to TRUE is active according to the IE "Current TGPS Status Flag" in UE variable TGPS_IDENTITY:
 - 5> if the measurement is valid in the current RRC state of the UE:
 - 6> begin measurements according to the stored control information for this measurement identity by applying the compressed mode pattern only to the band where the frequency to measure is.

- 4> if, according to its measurement capabilities in the IE "Frequency specific compressed mode for non-contiguous operation", the UE does not require the compressed mode on all the frequencies associated the serving HS-DSCH cell and the secondary serving HS-DSCH cells; and
- 4> the frequency to measure is in the same band as the frequency of the serving HS-DSCH cell; and
- 4 the frequency to measure is not associated with the serving HS-DSCH cell or with any entry in the variable SECONDARY_CELL_HS_DSCH_RECEPTION, which is in the same block of contiguous HS-DSCH cells as the serving HS-DSCH cell; and
- 4> if after reception of this message, a compressed mode pattern sequence with the IE "Frequency specific compressed mode" set to TRUE is active according to the IE "Current TGPS Status Flag" in UE variable TGPS_IDENTITY:
 - 5> if the measurement is valid in the current RRC state of the UE:
 - 6> begin measurements according to the stored control information for this measurement identity by applying the compressed mode pattern only to the block of contiguous secondary serving HS-DSCH cells, which does not contain the serving HS-DSCH cell.
 - 4> else:
 - 5> if after reception of this message a compressed mode pattern sequence with an appropriate measurement purpose is active according to the IE "Current TGPS Status Flag" in UE variable TGPS_IDENTITY
 - 6> if the measurement is valid in the current RRC state of the UE:
 - 7> begin measurements according to the stored control information for this measurement identity.
- 3> if, according to its measurement capabilities in the IE "Inter-frequency measurements on configured carriers without compressed mode", the UE does not require compressed mode to perform the measurements on the frequencies configured for HS-DSCH operation:
 - 4> if at least one of the entries in the variable SECONDARY_CELL_HS_DSCH_RECEPTION is set to TRUE and the frequency to measure is same as the frequency of the secondary serving HS-DSCH cell; and
 - 4> if the measurement is valid in the current RRC state of the UE:
 - 5> begin measurements according to the stored control information for this measurement identity.
- 3> if, according to its measurement capabilities, the UE does not require compressed mode to perform the measurements on at least one supported band of that measurement type:
 - 4> if the measurement is valid in the current RRC state of the UE:
 - 5> begin measurements according to the stored control information for this measurement identity.
- 3> if, according to its measurement capabilities in the IE "Enhanced inter-frequency measurements without compressed mode", the UE does not require compressed mode to perform the measurements on two frequencies in addition to the downlink frequency in the IE "Frequency info" not included in the IE "Uplink secondary cell info FDD":
 - 4> if, the frequency to measure is same as the frequency derived from one of the entries in "Frequency info list for enhanced measurement" included in the variable CELL_INFO_LIST; and
 - 4> the frequency to measure along with all frequencies associated with entries in the variable SECONDARY_CELL_HS_DSCH_RECEPTION that are set to TRUE and the frequency of the serving HS-DSCH cell, corresponds to a valid configuration according to the number of additional secondary serving cells and the carrier combinations supported by the UE:
 - 5> if the measurement is valid in the current RRC state of the UE; and

- 5> if the number of frequencies on which inter-frequency measurements without compressed mode are configured is less than or equal to two:
 - 6> begin measurements according to the stored control information for this measurement identity.
 - 3> if according to its measurement capabilities, the UE does not require compressed mode to perform measurement on adjacent frequency and the frequency derived from "Adjacent frequency info" included in the variable CELL_INFO_LIST is an adjacent frequency:
 - 4> if all the entries in the variable SECONDARY_CELL_HS_DSCH_RECEPTION are set to FALSE; or
 - 4> if at least one of the entries in the variable SECONDARY_CELL_HS_DSCH_RECEPTION is set to TRUE and the frequency derived from "Adjacent frequency info" included in the variable CELL_INFO_LIST is same as the frequency of the secondary serving HS-DSCH cell associated with such an entry:
 - 5> if the measurement is valid in the current RRC state of the UE; and
 - 5> inter-frequency measurements without compressed mode are not configured on any other frequency::
 - 6> begin measurements according to the stored control information for this measurement identity.
 - 3> if according to its measurement capabilities, the UE does not require compressed mode to perform measurement on a frequency in a different band from the band of the frequency of the serving HS-DSCH cell and these two bands form one of the band combinations reported in the IE "Radio Access Capability Band Combination List":
 - 4> if all the entries in the variable SECONDARY_CELL_HS_DSCH_RECEPTION are set to FALSE, and the frequency derived from "Inter-band frequency info" included in the variable CELL_INFO_LIST is in another band, and these two bands form one of the band combinations reported in the IE "Radio Access Capability Band Combination List"; or
 - 4> if at least one of the entries in the variable SECONDARY_CELL_HS_DSCH_RECEPTION is set to TRUE, and the frequency derived from "Inter-band frequency info" included in the variable CELL_INFO_LIST is in another band, and is same as the frequency of the secondary serving HS-DSCH cell associated with such an entry:
 - 5> if the measurement is valid in the current RRC state of the UE; and
 - 5> if inter-frequency measurements without compressed mode are not configured on any other frequency:
 - 6> begin measurements according to the stored control information for this measurement identity.
 - 2> for measurement type "inter-frequency measurement" that requires measurements on the downlink frequency associated with the secondary uplink frequency:
 - 3> the UE shall not require compressed mode to perform the measurement, regardless of the activation status of secondary uplink frequency;
 - 3> if the measurement is valid in the current RRC state of the UE:
 - 4> begin measurements according to the stored control information for this measurement identity on the downlink frequency associated with the secondary uplink frequency.
- NOTE: The UE is not required to perform measurements on cells for which it needs compressed mode but a suitable compressed mode pattern is not activated.
- 2> for measurement type "inter-frequency measurement" that requires measurements only on the same frequency as the actually used frequency:
 - 3> if the measurement is valid in the current RRC state of the UE:
 - 4> begin measurements according to the stored control information for this measurement identity.

- 2> for measurement type "UE positioning measurement":
 - 3> if the UE is in CELL_FACH state:
 - 4> if IE "Positioning Method" is set to "OTDOA":
 - 5> if IE "Method Type" is set to "UE assisted":
 - 6> if IE "UE positioning OTDOA assistance data for UE assisted" is not included:
 - 7> if System Information Block type 15.4 is broadcast:
 - 8> read System Information Block type 15.4.
 - 7> act as specified in subclause 8.6.7.19.2.
 - 5> if IE "Method Type" is set to "UE based":
 - 6> if IE "UE positioning OTDOA assistance data for UE based" is not included:
 - 7> if System Information Block type 15.5 is broadcast:
 - 8> read System Information Block type 15.5.
 - 7> act as specified in subclause 8.6.7.19.2a.
- 2> for measurement type "CSG Proximity detection":
 - 3> if the value of IE "UTRA CSG Proximity detection" is set to "enable":
 - 4> the UE shall perform CSG proximity detection function for UTRA CSG member cells;
 - 4> the UE shall include the detection result, if proximity is detected, in the IE "CSG Proximity Indication" of the corresponding MEASUREMENT REPORT message, as specified in subclause 14.7a.4.
 - 3> else:
 - 4> the UE shall disable the CSG proximity detection function for UTRA cells and not send measurement report containing the IE "CSG Proximity Indication" for any UTRA cells.
 - 3> if the value of IE "E-UTRA CSG Proximity detection" is set to "enable":
 - 4> the UE shall perform CSG proximity detection function for E-UTRA CSG member;
 - 4> the UE shall include the detection result, if proximity is detected, in the IE "CSG Proximity Indication" of the corresponding MEASUREMENT REPORT message, as specified in subclause 14.7a.4.
 - 3> else:
 - 4> the UE shall disable the CSG proximity detection function for E-UTRA cells and not send measurement report containing the IE "CSG Proximity Indication" for any E-UTRA cells.
- 2> for measurement type "E-UTRA measurement for CELL_FACH":
 - 3> if the UE is not in CELL_FACH state:
 - 4> the UE behaviour is unspecified.
 - 3> else:
 - 4> act as specified in subclause 8.6.7.28.
- 2> for any other measurement type:
 - 3> if the measurement is valid in the current RRC state of the UE:

- 4> begin measurements according to the stored control information for this measurement identity.
- 1> if the IE "Measurement command" has the value "modify":
- 2> for all IEs present in the MEASUREMENT CONTROL message:
 - 3> if a measurement was stored in the variable MEASUREMENT_IDENTITY associated to the identity by the IE "measurement identity":
 - 4> for FDD or 3.84/7.68 Mcps TDD, if the measurement type is quality, UE internal, intra-frequency, inter-frequency or inter-RAT:
 - 5> if the UE is in CELL_FACH state:
 - 6> the UE behaviour is not specified.
 - 4> for 1.28 Mcps TDD, if the measurement type is quality, UE internal, or inter-RAT:
 - 5> if the UE is in CELL_FACH state:
 - 6> the UE behaviour is not specified.
 - 4> for 1.28 Mcps TDD, if the measurement type is intra-frequency or inter-frequency:
 - 5> if the UE is in CELL_FACH state:
 - 6> perform the actions as specified below.
 - 4> if measurement type is set to "intra-frequency measurement", for any of the optional IEs "Intra-frequency measurement objects list", "Intra-frequency measurement objects list on secondary UL frequency", "Intra-frequency measurement quantity", "Intra-frequency reporting quantity", "Measurement Validity", "report criteria" and "parameters required for each event" (given "report criteria" is set to "intra-frequency measurement reporting criteria") that are present in the MEASUREMENT CONTROL message:
 - 4> if measurement type is set to "inter-frequency measurement", for any of the optional IEs "Inter-frequency measurement quantity", "Inter-frequency reporting quantity", "Measurement Validity", "Inter-frequency set update" and "parameters required for each event" (given "report criteria" is set to either "inter-frequency measurement reporting criteria" or "intra-frequency measurement reporting criteria") that are present in the MEASUREMENT CONTROL message:
 - 4> if measurement type is set to "inter-RAT measurement", for any of the optional IEs "Inter-RAT measurement objects list", "E-UTRA frequency list", "E-UTRA frequency extension list", "Inter-RAT measurement quantity", and "Inter-RAT reporting quantity" that are present in the MEASUREMENT CONTROL message:
 - 4> if measurement type is set to "UE positioning measurement" and the IE "UE positioning OTDOA assistance data" is present, for any of the optional IEs "UE positioning OTDOA neighbour cell info for UE-assisted", "UE positioning OTDOA reference cell info for UE-assisted", "UE positioning OTDOA reference cell info for UE-based", "UE positioning OTDOA neighbour cell info for UE-based" and "UE positioning" that are present in the MEASUREMENT CONTROL message:
 - 4> if measurement type is set to "UE positioning measurement" and the IE "UE positioning GPS assistance data" is present, for any of the optional IEs "UE positioning GPS reference time", "UE positioning GPS reference UE position", "UE positioning GPS DGPS corrections", "UE positioning GPS ionospheric model", "UE positioning GPS UTC model", "UE positioning GPS acquisition assistance", "UE positioning GPS real-time integrity" that are present in the MEASUREMENT CONTROL message:
 - 4> if measurement type is set to "UE positioning measurement" and the IE "UE positioning GANSS assistance data" is present, for any of the optional IEs "UE positioning GANSS reference time", "UE positioning GANSS reference UE position", "UE positioning DGANSS corrections", "UE positioning GANSS ionospheric model", "UE positioning GANSS additional ionospheric model", "UE positioning GANSS UTC model", "UE positioning GANSS additional UTC models", "UE positioning GANSS reference measurement information", "UE positioning GANSS data bit assistance", "UE positioning GANSS Time model", "UE positioning GANSS real-time integrity", "UE positioning

GANSS Earth orientation parameters", "UE positioning GANSS auxiliary information", "UE positioning DBDS corrections", "UE positioning BDS Ionospheric Grid Model" that are present in the MEASUREMENT CONTROL message:

- 4> if measurement type is set to "traffic volume measurement", for any of the optional IEs "Traffic volume measurement Object", "Traffic volume measurement quantity", "Traffic volume reporting quantity", and "Measurement Validity" that are present in the MEASUREMENT CONTROL message:
- 4> if measurement type is set to "quality measurement", for the optional IE "Quality reporting quantity" if it is present in the MEASUREMENT CONTROL message:
- 4> if measurement type is set to "UE internal measurement", for any of the optional IEs "UE internal measurement quantity", and "UE internal reporting quantity" that are present in the MEASUREMENT CONTROL message:
- 4> if measurement type is set to "CSG Proximity detection", for any of the IEs "UTRA CSG Proximity detection", and "E-UTRA CSG Proximity detection" that are present in the MEASUREMENT CONTROL message:
 - 5> replace all instances of the IEs listed above (and all their children) stored in variable MEASUREMENT_IDENTITY associated to the identity indicated by the IE "measurement identity" with the IEs received in the MEASUREMENT CONTROL message;
 - 5> leave all other stored information elements unchanged in the variable MEASUREMENT_IDENTITY.

3> otherwise:

- 4> set the variable CONFIGURATION_INCOMPLETE to TRUE.

2> if measurement type is set to "inter-frequency measurement":

- 3> if "report criteria" is set to "intra-frequency measurement reporting criteria" and "reporting criteria" in "inter-frequency measurement quantity" is set to "intra-frequency reporting criteria":
 - 4> for FDD, 3.84 Mcps TDD and 7.68 Mcps TDD; or
 - 4> for 1.28 Mcps TDD, if the UE only uses one frequency:
 - 5> leave the currently stored "inter-frequency measurement reporting criteria" within "report criteria" and "inter-frequency reporting criteria" within "inter-frequency measurement quantity" unchanged, and continue to act on the information stored in these variables.

NOTE: If the UTRAN wants to modify the inter-frequency cell info list for an inter-frequency measurement configured with event based reporting without repeating any IEs related to the configured events, one possibility is to set the IE "report criteria" to "intra-frequency measurement reporting criteria", not include the IE "parameters required for each event", and set the IE "reporting criteria" in the IE "inter-frequency measurement quantity" to "intra-frequency reporting criteria".

- 4> for 1.28 Mcps TDD, if the UE uses multiple frequencies:
 - 5> use the content of MEASUREMENT CONTROL to replace the IEs related to MEASUREMENT_IDENTITY which have stored;
 - 5> not delete the unchanged values.

2> for measurement types "inter-frequency measurement" that require measurements on a frequency other than the actually used frequency, or that require measurements on another RAT:

- 3> if, according to its measurement capabilities, the UE requires compressed mode to perform that measurement type:
 - 4> if, according to its measurement capabilities in the IE "Frequency specific compressed mode", the UE does not require the compressed mode on all the frequencies associated the serving HS-DSCH cell and the secondary serving HS-DSCH cells; and

- 4> the frequency to measure is in the band other than the band of the frequency of the serving HS-DSCH cell; and
- 4> the frequency to measure is in the band for which there is at least one frequency associated with the entry in the variable SECONDARY_CELL_HS_DSCH_RECEPTION set to TRUE; and
- 4> if after reception of this message, a compressed mode pattern sequence with the IE "Frequency specific compressed mode" set to TRUE is active according to the IE "Current TGPS Status Flag" in UE variable TGPS_IDENTITY:
 - 5> if the measurement is valid in the current RRC state of the UE:
 - 6> begin measurements according to the stored control information for this measurement identity by applying the compressed mode pattern only to the band where the frequency to measure is.
 - 4> if, according to its measurement capabilities in the IE "Frequency specific compressed mode for non-contiguous operation", the UE does not require the compressed mode on all the frequencies associated the serving HS-DSCH cell and the secondary serving HS-DSCH cells; and
 - 4> the frequency to measure is in the same band as the frequency of the serving HS-DSCH cell; and
 - 4 the frequency to measure is not associated with the serving HS-DSCH cell or with any entry in the variable SECONDARY_CELL_HS_DSCH_RECEPTION, which is in the same block of contiguous HS-DSCH cells as the serving HS-DSCH cell; and
 - 4> if after reception of this message, a compressed mode pattern sequence with the IE "Frequency specific compressed mode" set to TRUE is active according to the IE "Current TGPS Status Flag" in UE variable TGPS_IDENTITY:
 - 5> if the measurement is valid in the current RRC state of the UE:
 - 6> begin measurements according to the stored control information for this measurement identity by applying the compressed mode pattern only to the block of contiguous secondary serving HS-DSCH cells, which does not contain the serving HS-DSCH cell.
 - 4> else:
 - 5> if after reception of this message a compressed mode pattern sequence with an appropriate measurement purpose is active according to the IE "Current TGPS Status Flag" in UE variable TGPS_IDENTITY
 - 6> if the measurement is valid in the current RRC state of the UE:
 - 7> begin measurements according to the stored control information for this measurement identity.
- 3> if, according to its measurement capabilities in the IE "Inter-frequency measurements on configured carriers without compressed mode", the UE does not require compressed mode to perform the measurements on the frequencies configured for HS-DSCH operation:
 - 4> if at least one of the entries in the variable SECONDARY_CELL_HS_DSCH_RECEPTION is set to TRUE and the frequency to measure is same as the frequency of the secondary serving HS-DSCH cell; and
 - 4> if the measurement is valid in the current RRC state of the UE:
 - 5> begin measurements according to the stored control information for this measurement identity.
- 3> if, according to its measurement capabilities, the UE does not require compressed mode, on at least one supported band of that measurement type, to perform the measurements:
 - 4> resume the measurements according to the new stored measurement control information.
- 3> if, according to its measurement capabilities in the IE "Enhanced inter-frequency measurements without compressed mode", the UE does not require compressed mode to perform the measurements on two

frequencies in addition to the downlink frequency in the IE "Frequency info" not included in the IE "Uplink secondary cell info FDD":

- 4> if the frequency to measure is same as the frequency derived from one of the entries in "Frequency info list for enhanced measurement" included in the variable CELL_INFO_LIST; and
- 4> the frequency to measure along with all frequencies associated with entries in the variable SECONDARY_CELL_HS_DSCH_RECEPTION that are set to TRUE and the frequency of the serving HS-DSCH cell, corresponds to a valid configuration according to the number of additional secondary serving cells and the carrier combinations supported by the UE:
 - 5> if the number of frequencies on which inter-frequency measurements without compressed mode are configured is less than or equal to two:
 - 6> resume the measurements according to the new stored measurement control information.
- 3> if according to its measurement capabilities, the UE does not require compressed mode to perform measurement on adjacent frequency and the frequency derived from "Adjacent frequency info" included in the variable CELL_INFO_LIST is an adjacent frequency:
 - 4> if all the entries in the variable SECONDARY_CELL_HS_DSCH_RECEPTION are set to FALSE and inter-frequency measurements without compressed mode are not configured on any other frequency; or
 - 4> if at least one of the entries in the variable SECONDARY_CELL_HS_DSCH_RECEPTION is set to TRUE and the frequency derived from "Adjacent frequency info" included in the variable CELL_INFO_LIST is same as the frequency of the secondary serving HS-DSCH cell associated with such an entry and inter-frequency measurements without compressed mode are not configured on any other frequency:
 - 5> if inter-frequency measurements without compressed mode are not configured on any other frequency:
 - 6> resume the measurements according to the new stored measurement control information.
- 3> if according to its measurement capabilities, the UE does not require compressed mode to perform measurement on a frequency in a different band from the band of the frequency of the serving HS-DSCH cell and these two bands for one of the band combinations reported in the IE "Radio Access Capability Band Combination List":
 - 4> if all the entries in the variable SECONDARY_CELL_HS_DSCH_RECEPTION are set to FALSE, and the frequency derived from "Inter-band frequency info" included in the variable CELL_INFO_LIST is in another band, and these two bands form one of the band combinations reported in the IE "Radio Access Capability Band Combination List"; or
 - 4> if at least one of the entries in the variable SECONDARY_CELL_HS_DSCH_RECEPTION is set to TRUE, and the frequency derived from "Inter-band frequency info" included in the variable CELL_INFO_LIST is in another band, and is the same as the frequency of the secondary serving HS-DSCH cell associated with such an entry:
 - 5> if inter-frequency measurements without compressed mode are not configured on any other frequency:
 - 6> resume the measurements according to the new stored measurement control information.
- 2> for measurement type "inter-frequency measurement" that requires measurements on the downlink frequency associated with the secondary uplink frequency:
 - 3> the UE shall not require compressed mode to perform the measurement, regardless of the activation status of secondary uplink frequency;
 - 3> if the measurement is valid in the current RRC state of the UE:
 - 4> resume the measurements according to the new stored control information for this measurement identity on the downlink frequency associated with the secondary uplink frequency.

- 2> for measurement type "inter-frequency measurement" that requires measurements only on the same frequency as the actually used frequency:
 - 3> if the measurement is valid in the current RRC state of the UE:
 - 4> resume measurements according to the new stored control information for this measurement identity.
- 2> for measurement type "E-UTRA measurement for CELL_FACH":
 - 3> if the UE is not in CELL_FACH state:
 - 4> the UE behaviour is unspecified.
 - 3> else:
 - 4> act as specified in subclause 8.6.7.28.
- 2> for any other measurement type:
 - 3> resume the measurements according to the new stored measurement control information.
- 2> for measurement type "inter-RAT measurement":
 - 3> if "report criteria" is set to "inter-RAT measurement reporting criteria":
 - 4> if the value of "report criteria" stored in the variable MEASUREMENT_IDENTITY associated to the identity indicated by the IE "measurement identity" is not "inter-RAT measurement reporting criteria"; or
 - 4> if the value of "report criteria" stored in the variable MEASUREMENT_IDENTITY associated to the identity indicated by the IE "measurement identity" is "inter-RAT measurement reporting criteria" and if the IE "Parameters required for each event" is present:
 - 5> replace the IE "report criteria" (and all its children) stored in variable MEASUREMENT_IDENTITY associated to the identity indicated by the IE "measurement identity" with the IE "reporting criteria" received in the MEASUREMENT CONTROL message.
 - 3> if "report criteria" is not set to "inter-RAT measurement reporting criteria":
 - 4> replace the IE "reporting criteria" (and all its children) stored in variable MEASUREMENT_IDENTITY associated to the identity indicated by the IE "measurement identity" with the IE "reporting criteria" received in the MEASUREMENT CONTROL message.
- 2> for measurement type "UE positioning measurement":
 - 3> if "reporting criteria" is set to "UE positioning reporting criteria":
 - 4> if the value of "reporting criteria" stored in the variable MEASUREMENT_IDENTITY associated to the identity indicated by the IE "measurement identity" is not "UE positioning reporting criteria", or;
 - 4> if the value of "reporting criteria" stored in the variable MEASUREMENT_IDENTITY associated to the identity indicated by the IE "measurement identity" is "UE positioning reporting criteria" and if the IE "Parameters required for each event" is present:
 - 5> replace the IE "reporting criteria" (and all its children) stored in variable MEASUREMENT_IDENTITY associated to the identity indicated by the IE "measurement identity" with the IE "report criteria" received in the MEASUREMENT CONTROL message.
 - 3> if "reporting criteria" is not set to "UE positioning reporting criteria":
 - 4> replace the IE "report criteria" (and all its children) stored in variable MEASUREMENT_IDENTITY associated to the identity indicated by the IE "measurement identity" with the IE "report criteria" received in the MEASUREMENT CONTROL message.
- 2> for measurement type "traffic volume measurement":

- 3> replace the IE "report criteria" (and all its children) stored in variable MEASUREMENT_IDENTITY associated to the identity indicated by the IE "measurement identity" with the IE "report criteria" received in the MEASUREMENT CONTROL message.
- 2> for measurement type "quality measurement":
 - 3> replace the IE "report criteria" (and all its children) stored in variable MEASUREMENT_IDENTITY associated to the identity indicated by the IE "measurement identity" with the IE "report criteria" received in the MEASUREMENT CONTROL message;
 - 3> if "report criteria" is set to "quality measurement reporting criteria":
 - 4> if the value of "BLER reporting" in any instance of the IE "Quality reporting quantity" stored in the variable MEASUREMENT_IDENTITY associated to the identity indicated by the IE "measurement identity" with the IE "report criteria" received in the MEASUREMENT CONTROL message is set to TRUE:
 - 5> the UE behaviour is unspecified.
- 2> for measurement type "UE internal measurement":
 - 3> if "report criteria" is set to "UE internal measurement reporting criteria":
 - 4> if the value of "report criteria" stored in the variable MEASUREMENT_IDENTITY associated to the identity indicated by the IE "measurement identity" is not "UE internal measurement reporting criteria"; or
 - 4> if the value of "report criteria" stored in the variable MEASUREMENT_IDENTITY associated to the identity indicated by the IE "measurement identity" is "UE internal measurement reporting criteria" and if the IE "Parameters sent for each UE internal measurement event" is present:
 - 5> replace the IE "report criteria" (and all its children) stored in variable MEASUREMENT_IDENTITY associated to the identity indicated by the IE "measurement identity" with the IE "report criteria" received in the MEASUREMENT CONTROL message.
 - 3> if "report criteria" is not set to "UE internal measurement reporting criteria":
 - 4> replace the IE "report criteria" (and all its children) stored in variable MEASUREMENT_IDENTITY associated to the identity indicated by the IE "measurement identity" with the IE "report criteria" received in the MEASUREMENT CONTROL message.
- 1> if the IE "Measurement command" has the value "Release":
 - 2> terminate the measurement associated with the identity given in the IE "measurement identity";
 - 2> clear all stored measurement control information related associated to this measurement identity in variable MEASUREMENT_IDENTITY;
- 1> if any configured inter-frequency measurement is to be released; and
- 1> if the UE supports Inter-frequency detected set measurements and Cells excluded from detected set measurements:
 - 2> for each non-used frequency, if "Cells to be excluded in non-used frequency detected cells" for a non-used frequency is stored, the UE shall:
 - 3> if the "measurement identity" corresponding with the stored "Cells to be excluded in non-used frequency detected cells" for that non-used frequency was released:
 - 4> clear the stored "Cells to be excluded in non-used frequency detected cells" for that non-used frequency.
- 1> if any configured intra-frequency measurement is to be released; and
- 1> if the UE supports Cells excluded from detected set measurements, and "Cells to be excluded in detected set cells" for the intra-frequency is stored, the UE shall:

- 2> if the "measurement identity" corresponding with the stored "Cells to be excluded in detected set cells" for the intra-frequency was released:
 - 3> clear the stored "Cells to be excluded in detected set cells" for the intra-frequency.
 - 1> if the IE "Measurement command" has the value "ReleaseAll":
 - 2> terminate all measurements;
 - 2> clear corresponding measurement control information in variable MEASUREMENT_IDENTITY.
 - 1> if the IE "Measurement command" has the value "ReleaseSome":
 - 2> for each measurement indicated by IE "Measurement Identity" in the "Released measurements" list in IE "Release Some Measurements", the UE shall:
 - 3> terminate the corresponding measurement;
 - 3> clear corresponding measurement control information stored in variable MEASUREMENT_IDENTITY.
 - 1> if the IE "DPCH Compressed Mode Status Info" is present:
 - 2> if, as the result of this message, UE will have more than one transmission gap pattern sequence with the same measurement purpose active (according to IEs "TGMP" and "Current TGPS Status Flag" in variable TGPS_IDENTITY):
 - 3> set the variable CONFIGURATION_INCOMPLETE to TRUE.
 - 2> if there is any pending "TGPS reconfiguration CFN" or any pending "TGCFN":
 - 3> the UE behaviour is unspecified.
 - 2> if there is a pending "activation time" for a reconfiguration procedure that included the IE "DPCH Compressed mode info":
 - 3> the UE behaviour is unspecified.
 - 2> if pattern sequence corresponding to IE "TGPSI" is already active (according to "Current TGPS Status Flag") in the variable TGPS_IDENTITY):
 - 3> if the "TGPS Status Flag" in this message is set to "deactivate" for the corresponding pattern sequence:
 - 4> deactivate this pattern sequence at the beginning of the frame indicated by IE "TGPS reconfiguration CFN" received in the message;
 - 4> set the "Current TGPS Status Flag" for this pattern sequence in the variable TGPS_IDENTITY to "inactive" at the frame indicated by IE "TGPS reconfiguration CFN" received in the message.
 - 3> if the "TGPS Status Flag" in this message is set to "activate" for the corresponding pattern sequence:
 - 4> deactivate this pattern sequence at the beginning of the frame indicated by IE "TGPS reconfiguration CFN" received in the message.
- NOTE1: The temporary deactivation of pattern sequences for which the status flag is set to "activate" can be used by the network to align the timing of already active patterns with newly activated patterns.
- NOTE2: The deactivation of pattern sequences only occurs as a result of RRC messages received by the UE, i.e. the UE does not set the "Current TGPS Status Flag" to "inactive" after the final gap of a finite length pattern sequence.
- 2> after the time indicated by IE "TGPS reconfiguration CFN" has elapsed:
 - 3> activate the pattern sequence corresponding to each IE "TGPSI" for which the "TGPS status flag" in this message is set to "activate" at the time indicated by IE "TGCFN"; and
 - 3> set the corresponding "Current TGPS status flag" for this pattern sequence in the variable TGPS_IDENTITY to "active"; and

- 3> begin the inter-frequency and/or inter-RAT measurements corresponding to the pattern sequence measurement purpose of each activated pattern sequence;
- 3> if the values of IE "TGPS reconfiguration CFN" and IE "TGCFN" are equal:
 - 4> start the concerned pattern sequence immediately at that CFN.
- 2> not alter pattern sequences stored in variable TGPS_IDENTITY, if the pattern sequence is not identified in IE "TGPSI" in the received message.
- 1> if the IE "CELL_DCH measurement occasion info LCR" is present:
 - 2> perform actions for the IE "CELL_DCH measurement occasion info LCR" as specified in subclause 8.6.7.26;
- 1> if the UE in CELL_FACH state receives a MEASUREMENT CONTROL message, which indicates the same measurement identity as that stored in the variable MEASUREMENT_IDENTITY:
 - 2> update the stored information with the traffic volume measurement control information in variable MEASUREMENT_IDENTITY; and
 - 2> refrain from updating the traffic volume measurement control information associated with this measurement identity in the variable MEASUREMENT_IDENTITY with the information received in System Information Block type 12 (or System Information Block type 11, according to subclause 8.1.1.6.11) until this measurement is explicitly released with another MEASUREMENT CONTROL message.
- 1> for FDD, if the IE "Read SFN indicator" included in the IE "Cell info" of an inter-frequency cell is set to TRUE and according to the UE's measurement capabilities, the UE requires DL compressed mode in order to perform measurements on the frequency for which the SFN is to be read:
 - 2> set the variable CONFIGURATION_INCOMPLETE to TRUE.
- 1> clear the entry for the MEASUREMENT CONTROL message in the table "Accepted transactions" in the variable TRANSACTIONS.

The UE may:

- 1> if the IE "Measurement command" has the value "setup":
 - 2> for measurement type "UE positioning measurement":
 - 3> if the UE is CELL_FACH state:
 - 4> if IE "Positioning Method" is set to "GPS":
 - 5> if IE "UE positioning GPS assistance data" is not included and variable UE_POSITIONING_GPS_DATA is empty:
 - 6> if System Information Block types 15, 15.1, 15.2 and 15.3 are broadcast:
 - 7> read System Information Block types 15, 15.1, 15.2 and 15.3.
 - 6> act as specified in subclause 8.6.7.19.3.
 - 5> if IE "GANSS Positioning Methods" is present:
 - 6> for each GNSS indicated in IE "GANSS Positioning Methods" and supported by UE:
 - 7> if IE "UE positioning GANSS assistance data" is not included and variable UE_POSITIONING_GANSS_DATA does not contain data for that GNSS:
 - 8> if System Information Block types 15bis, 15.1bis, 15.2bis, 15.2ter, 15.3bis, 15.6, 15.7 and 15.8 are broadcast:
 - 9> read System Information Block types 15bis, 15.1bis, 15.2bis, 15.2ter, 15.3bis, 15.6, 15.7 and 15.8.
 - 8> act as specified in subclause 8.6.7.19.7.

6> if BDS is indicated in IE "GANSS Positioning Methods" and supported by UE:

7> if IE "UE positioning GANSS assistance data" is not included:

8> if System Information Block type 15.1ter is broadcast:

9> read System Information Block type 15.1ter.

8> act as specified in subclause 8.6.7.19.7.

1> and the procedure ends.

8.4.1.4 Unsupported measurement in the UE

If UTRAN instructs the UE to perform a measurement that is not supported by the UE, or would cause the maximum number of reporting criteria supported by the UE [19] to be exceeded, the UE shall:

- 1> retain the measurement configuration that was valid before the MEASUREMENT CONTROL message was received;
- 1> if the UE supports inclusion of measurement identity, set the IE "Measurement Identity" in the MEASUREMENT CONTROL FAILURE message to the value of "Measurement identity" in the entry for the MEASUREMENT CONTROL message in the table "Accepted transactions" in the variable TRANSACTIONS;
- 1> set the IE "RRC transaction identifier" in the MEASUREMENT CONTROL FAILURE message to the value of "RRC transaction identifier" in the entry for the MEASUREMENT CONTROL message in the table "Accepted transactions" in the variable TRANSACTIONS; and
- 1> clear that entry;
- 1> set the cause value in IE "failure cause" to "unsupported measurement";
- 1> submit the MEASUREMENT CONTROL FAILURE message to lower layers for transmission on the DCCH using AM RLC;
- 1> continue with any ongoing processes and procedures as if the invalid MEASUREMENT CONTROL message has not been received;
- 1> and the procedure ends.

8.4.1.4a Configuration Incomplete

If the variable CONFIGURATION_INCOMPLETE is set to TRUE, the UE shall:

- 1> retain the measurement configuration that was valid before the MEASUREMENT CONTROL message was received;
- 1> if the UE supports inclusion of measurement identity, set the IE "Measurement Identity" in the MEASUREMENT CONTROL FAILURE message to the value of "Measurement identity" in the entry for the MEASUREMENT CONTROL message in the table "Accepted transactions" in the variable TRANSACTIONS;
- 1> set the IE "RRC transaction identifier" in the MEASUREMENT CONTROL FAILURE message to the value of "RRC transaction identifier" in the entry for the MEASUREMENT CONTROL message in the table "Accepted transactions" in the variable TRANSACTIONS; and
- 1> clear that entry;
- 1> clear the variable CONFIGURATION_INCOMPLETE;
- 1> set the cause value in IE "failure cause" to "Configuration incomplete";
- 1> submit the MEASUREMENT CONTROL FAILURE message to lower layers for transmission on the DCCH using AM RLC;
- 1> continue with any ongoing processes and procedures as if the invalid MEASUREMENT CONTROL message has not been received;

1> and the procedure ends.

8.4.1.5 Invalid MEASUREMENT CONTROL message

If the MEASUREMENT CONTROL message contains a protocol error causing the variable `PROTOCOL_ERROR_REJECT` to be set to `TRUE` according to clause 9, the UE shall perform procedure specific error handling as follows. The UE shall:

- 1> if the UE supports inclusion of measurement identity, set the IE "Measurement Identity" in the MEASUREMENT CONTROL FAILURE message to the value of "Measurement identity" in the entry for the MEASUREMENT CONTROL message in the table "Rejected transactions" in the variable `TRANSACTIONS`;
- 1> set the IE "RRC transaction identifier" in the MEASUREMENT CONTROL FAILURE message to the value of "RRC transaction identifier" in the entry for the MEASUREMENT CONTROL message in the table "Rejected transactions" in the variable `TRANSACTIONS`; and
- 1> clear that entry;
- 1> set the IE "failure cause" to the cause value "protocol error";
- 1> include the IE "Protocol error information" with contents set to the value of the variable `PROTOCOL_ERROR_INFORMATION`;
- 1> submit the MEASUREMENT CONTROL FAILURE message to lower layers for transmission on the DCCH using AM RLC;
- 1> continue with any ongoing processes and procedures as if the invalid MEASUREMENT CONTROL message has not been received;
- 1> and the procedure ends.

8.4.1.6 Measurements after transition from CELL_DCH to CELL_FACH/CELL_PCH/URA_PCH state

The UE shall apply the following rules for different measurement types after transiting from CELL_DCH to CELL_FACH/CELL_PCH/URA_PCH state:

8.4.1.6.1 Intra-frequency measurement

Upon transition from CELL_DCH to CELL_FACH/CELL_PCH/URA_PCH state, the UE shall:

- 1> stop intra-frequency type measurement reporting;
- 1> if the transition is due to a reconfiguration message which included the IE "Primary CPICH info" (for FDD) or "Primary CCPCH info" (for TDD), and the UE selects a cell other than that indicated by this IE on the current frequency (in case the IE "Frequency info" is not received) or other than that indicated by this IE on the frequency indicated by the IE "Frequency info" (when the IE "Frequency info" is included); or
- 1> if the transition is due to a reconfiguration message which does not include the IE "Primary CPICH info" (for FDD) or "Primary CCPCH info" (for TDD); or
- 1> if the transition is not due to a reconfiguration message:
 - 2> delete the measurements of type intra-frequency associated with the variable `MEASUREMENT_IDENTITY`.
- 1> for FDD and 3.84/7.68 Mcps TDD:
 - 2> begin monitoring cells listed in the IE "intra-frequency cell info list" received in System Information Block type 12 (or System Information Block type 11, according to subclause 8.1.1.6.11).
- 1> for 1.28 Mcps TDD:
 - 2> if after state transition the UE enters CELL_FACH state and is working on the primary frequency:

- 3> begin monitoring cells listed in the IE "intra-frequency cell info list" received in System Information Block type 12 (or System Information Block type 11, according to subclause 8.1.1.6.11).
- 2> else if after state transition the UE enters CELL_FACH state and is working on the secondary frequency:
 - 3> if the cell in which the UE transitioned from CELL_DCH state is not included in the active set for the CELL_FACH state; or
 - 3> if the working frequency changes after the state transition:
 - 4> the measurement shall be started when a MEASUREMENT CONTROL message is received with the measurements of type intra-frequency.

8.4.1.6.2 Inter-frequency measurement

Upon transition from CELL_DCH to CELL_FACH/ CELL_PCH/URA_PCH state, the UE shall:

- 1> stop the inter-frequency type measurement reporting assigned in a MEASUREMENT CONTROL message;
- 1> if the transition is due to a reconfiguration message which included the IE "Primary CPICH info" (for FDD) or "Primary CCPCH info" (for TDD), and the UE selects a cell other than that indicated by this IE on the current frequency (in case the IE "Frequency info" is not received) or other than that indicated by this IE on the frequency indicated by the IE "Frequency info" (when the IE "Frequency info" is included); or
- 1> if the transition is due to a reconfiguration message which does not include the IE "Primary CPICH info" (for FDD) or "Primary CCPCH info" (for TDD); or
- 1> if the transition is not due to a reconfiguration message:
 - 2> delete the measurements of type inter-frequency associated with the variable MEASUREMENT_IDENTITY and delete the corresponding compressed mode pattern stored in the variable TGPS_IDENTITY.
- 1> for remaining compressed mode patterns, set the IE "TGPS Status Flag" to "deactivate" and the IE "Current TGPS Status Flag" to "inactive" in the variable TGPS_IDENTITY.
- 1> for FDD and 3.84/7.68 Mcps TDD:
 - 2> begin monitoring cells listed in the IE "inter-frequency cell info list" received in System Information Block type 12 (or System Information Block type 11, according to subclause 8.1.1.6.11 and System Information Block type 11bis, according to subclause 8.1.1.6.11a if scheduled on BCH);
- 1> for FDD:
 - 2> begin monitoring cells listed in the IE "inter-frequency cell info list" received in System Information Block type 11ter, according to subclause 8.1.1.6.11b if scheduled on BCH);
- 1> in CELL_FACH state:
 - 2> for FDD if variable HS_DSCH_RECEPTION_CELL_FACH_STATE is set to TRUE and the variable HS_DSCH_DRX_CELL_FACH_STATUS is set to TRUE:
 - 3> perform measurements on other frequencies according to the requirements in [19], during the frame(s) with the SFN value not fulfilling the inequality specified in subclause 8.5.49.
 - 2> for FDD, if variable HS_DSCH_RECEPTION_CELL_FACH_STATE is set to TRUE and the variable HS_DSCH_DRX_CELL_FACH_2CYCLE_STATUS is set to TRUE:
 - 3> perform measurements on other frequencies according to the requirements in [19], during the frame(s) with the SFN value not fulfilling the inequality specified in subclause 8.5.49b.
 - 2> otherwise:
 - 3> perform measurements on other frequencies, according to the IE "FACH measurement occasion info", as specified in subclause 8.5.11.
- 2> for TDD:

- 3> perform measurements on other frequencies according to the IE "FACH measurement occasion info".
- 1> for 1.28 Mcps TDD:
 - 2> if after state transition the UE enters CELL_FACH state and is working on the primary frequency:
 - 3> begin monitoring cells listed in the IE "inter-frequency cell info list" received in System Information Block type 12 (or System Information Block type 11, according to subclause 8.1.1.6.11).
 - 2> else if after state transition the UE enters CELL_FACH state and is working on the secondary frequency:
 - 3> if the cell in which the UE transitioned from CELL_DCH state is not included in the active set for the CELL_FACH state; or
 - 3> if the working frequency changes after the state transition:
 - 4> the measurement shall be started when a MEASUREMENT CONTROL message is received with the measurements of type inter-frequency.

8.4.1.6.3 Inter-RAT measurement

Upon transition from CELL_DCH to CELL_FACH/CELL_PCH/URA_PCH state, the UE shall:

- 1> stop the inter-RAT type measurement reporting assigned in a MEASUREMENT CONTROL message;
- 1> delete the measurements of type inter-RAT associated with the variable MEASUREMENT_IDENTITY and delete the corresponding compressed mode pattern stored in the variable TGPS_IDENTITY;
- 1> begin monitoring cells listed in the IE "inter-RAT cell info list" received in System Information Block type 12 (or System Information Block type 11, according to subclause 8.1.1.6.11);
- 1> in CELL_PCH or URA_PCH state:
 - 2> begin monitoring E-UTRA frequencies listed in the IE "E-UTRA frequency and priority info list" received in System Information Block type 19.
- 1> in CELL_FACH state:
 - 2> if the IE "CELL_FACH Absolute Priority Measurement Indicator" is present in System Information Block type 19:
 - 3> begin monitoring E-UTRA frequencies listed in the IE "E-UTRA frequency and priority info list" received in System Information Block type 19.
 - 2> for FDD if variable HS_DSCH_RECEPTION_CELL_FACH_STATE is set to TRUE and the variable HS_DSCH_DRX_CELL_FACH_STATUS is set to TRUE:
 - 3> perform measurements on other systems according to the requirements in [19], during the frame(s) with the SFN value not fulfilling the inequality specified in subclause 8.5.49.
 - 2> for FDD, if variable HS_DSCH_RECEPTION_CELL_FACH_STATE is set to TRUE and the variable HS_DSCH_DRX_CELL_FACH_2CYCLE_STATUS is set to TRUE:
 - 3> perform measurements on other systems according to the requirements in [19], during the frame(s) with the SFN value not fulfilling the inequality specified in subclause 8.5.49b.
 - 2> otherwise:
 - 3> perform measurements on other frequencies according to the IE "FACH measurement occasion info";
 - 3> perform measurements on other systems, according to the IE "FACH measurement occasion info", as specified in subclause 8.5.11.

8.4.1.6.4 Quality measurement

Upon transition from CELL_DCH to CELL_FACH/CELL_PCH/URA_PCH state, the UE shall:

1> stop quality type measurement reporting;

1> delete all measurement control information of measurement type "quality" stored in the variable MEASUREMENT_IDENTITY.

8.4.1.6.5 UE internal measurement

Upon transition from CELL_DCH to CELL_FACH/CELL_PCH/URA_PCH state, the UE shall:

1> stop UE internal measurement type measurement reporting;

1> delete all measurement control information of measurement type "UE internal" stored in the variable MEASUREMENT_IDENTITY.

8.4.1.6.6 Traffic volume measurement

Upon transition from CELL_DCH to CELL_FACH or CELL_PCH or URA_PCH state, the UE shall:

1> retrieve each set of measurement control information of measurement type "traffic volume" stored in the variable MEASUREMENT_IDENTITY; and

2> if the optional IE "measurement validity" for this measurement has not been included:

3> delete the measurement associated with the variable MEASUREMENT_IDENTITY.

2> if the IE "measurement validity" for the measurement has been included, and the IE "UE state" has been assigned to value "CELL_DCH":

3> stop measurement reporting;

3> store the measurement associated with the variable MEASUREMENT_IDENTITY to be used after the next transition to CELL_DCH state.

2> if the IE "measurement validity" for the measurement has been included, and the IE "UE state" has been assigned to value "all states" or "all states except CELL_DCH", and if the state transition is from CELL_DCH to CELL_PCH or URA_PCH state:

3> stop measurement reporting;

3> store the measurement associated with the variable MEASUREMENT_IDENTITY to be used after the next transition to CELL_FACH state.

2> if the IE "measurement validity" for the measurement has been included, and the IE "UE state" has been assigned to value "all states", and if the state transition is from CELL_DCH to CELL_FACH state:

3> if variable READY_FOR_COMMON_EDCH is set to FALSE after state transition:

4> continue measurement reporting.

3> else:

4> for FDD:

5> stop measurement reporting;

5> store the measurement associated with the variable MEASUREMENT_IDENTITY to be used after the next transition to CELL_DCH state, or after cell reselection.

4> for 1.28 Mcps TDD:

5> continue measurement reporting.

2> if the IE "measurement validity" has been included and the IE "UE state" has been assigned to value "all states except CELL_DCH", and if the state transition is from CELL_DCH to CELL_FACH state:

3> resume this measurement and associated reporting.

- 1> if no traffic volume type measurement has been assigned to the UE with a MEASUREMENT CONTROL message that is valid in CELL_FACH or CELL_PCH or URA_PCH states (stored in the variable MEASUREMENT_IDENTITY), which has the same identity as the one indicated in the IE "Traffic volume measurement system information":
 - 2> store the measurement control information from the IE "Traffic volume measurement system information" received in System Information Block type 12 (or System Information Block type 11, according to subclause 8.1.1.6.11) in the variable MEASUREMENT_IDENTITY;
 - 2> perform traffic volume measurement reporting according to the assigned information, when in CELL_FACH state.

8.4.1.6.7 UE positioning measurement

Upon transition from CELL_DCH to CELL_FACH and upon transition from CELL_DCH to CELL_PCH or URA_PCH for UE assisted GPS or GANSS measurements, the UE shall:

- 1> retrieve each set of measurement control information of measurement type "UE positioning" stored in the variable MEASUREMENT_IDENTITY; and
 - 2> if the optional IE "measurement validity" for this measurement has not been included:
 - 3> delete the measurement associated with the variable MEASUREMENT_IDENTITY.
 - 2> if the IE "measurement validity" for the measurement has been included, and the IE "UE state" has been assigned to value "CELL_DCH":
 - 3> stop measurement reporting;
 - 3> store the measurement associated with the variable MEASUREMENT_IDENTITY to be used after the next transition to CELL_DCH state.
 - 2> if the IE "measurement validity" for the measurement has been included, and the IE "UE state" has been assigned to value "all states":
 - 3> upon transition from CELL_DCH to CELL_PCH or URA_PCH:
 - 4> if the choice in the IE "Reporting Criteria" included the IE "UE Positioning measurement" stored in the variable MEASUREMENT_IDENTITY is set to "UE positioning reporting criteria" and the value of the IE "Measurement interval" included in this IE is less than 64 seconds:
 - 5> use a value of 64 seconds for the measurement interval associated with this measurement while the UE remains in CELL_PCH/URA_PCH.
 - 4> if the choice in the IE "Reporting Criteria" included the IE "UE Positioning measurement" stored in the variable MEASUREMENT_IDENTITY is set to "Periodical Reporting Criteria" and the value of the IE "Reporting interval" included in this IE is less than 64 seconds:
 - 5> use a value of 64 seconds for the reporting interval associated with this measurement while the UE remains in CELL_PCH/URA_PCH.
 - 3> continue measurement reporting according to its UE positioning measurement reporting capability.
 - 2> if the IE "measurement validity" has been included and the IE "UE state" has been assigned to value "all states except CELL_DCH":
 - 3> upon transition from CELL_DCH to CELL_PCH or URA_PCH:
 - 4> if the choice in the IE "Reporting Criteria" included the IE "UE Positioning measurement" stored in the variable MEASUREMENT_IDENTITY is set to "UE positioning reporting criteria" and the value of the IE "Measurement interval" included in this IE is less than 64 seconds:
 - 5> use a value of 64 seconds for the measurement interval associated with this measurement while the UE remains in CELL_PCH/URA_PCH.

- 4> if the choice in the IE "Reporting Criteria" included the IE "UE Positioning measurement" stored in the variable MEASUREMENT_IDENTITY is set to "Periodical Reporting Criteria" and the value of the IE "Reporting interval" included in this IE is less than 64 seconds:
 - 5> use a value of 64 seconds for the reporting interval associated with this measurement while the UE remains in CELL_PCH/URA_PCH.
- 3> resume this measurement and associated reporting according to its UE Positioning measurement reporting capability.
- 1> if the transition is due to a reconfiguration message which included the IE "Primary CPICH info" (for FDD) or "Primary CCPCH info" (for TDD), and the UE selects a cell other than that indicated by this IE; or
- 1> if the transition is due to a reconfiguration message which does not include the IE "Primary CPICH info" (for FDD) or "Primary CCPCH info" (for TDD); or
- 1> if the transition is due to a reconfiguration message which included the IE "Frequency info", and the UE selects a cell on another frequency than that indicated by this IE; or
- 1> if the transition is due to a reconfiguration message which does not include the IE "Frequency info", and the UE can not find a cell on the current frequency, but it selects a cell on another frequency; or
- 1> if the transition is not due to a reconfiguration message:
 - 2> delete the assistance data included in the variable UE_POSITIONING_OTDOA_DATA_UE_BASED and UE_POSITIONING_OTDOA_DATA_UE_ASSISTED.
- 1> if the IE "Positioning Methods" stored in the variable MEASUREMENT_IDENTITY is set to "OTDOA" or "OTDOA or GPS":
 - 2> if the IE "Method type" stored in the variable MEASUREMENT_IDENTITY is set to "UE-based" or "UE assisted preferred but UE-based allowed" or "UE-based preferred but UE-assisted allowed":
 - 3> begin monitoring assistance data received in System Information Block type 15.4 and System Information Block type 15.5 according to subclause 8.1.1.6.15.
 - 2> if the IE "Method type" stored in the variable MEASUREMENT_IDENTITY is set to "UE-assisted":
 - 3> begin monitoring assistance data received in System Information Block type 15.4 according to subclause 8.1.1.6.15.
- 1> if the UE is in CELL_FACH state:
 - 2> if the IE "UE positioning OTDOA neighbour cell list for UE assisted" stored in the variable UE_POSITIONING_OTDOA_DATA_UE_ASSISTED or UE_POSITIONING_OTDOA_DATA_UE_BASED contains neighbour cells on other frequencies than the current frequency:
 - 3> perform measurements on other frequencies according to the IE "FACH measurement occasion info".

The UE may:

- 1> if the IE "Positioning Methods" stored in the variable MEASUREMENT_IDENTITY is set to "GPS" or "OTDOA or GPS":
 - 2> begin monitoring assistance data received in System Information Block type 15 and/or System Information Block type 15.1 and/or System Information Block type 15.2 and/or System Information Block type 15.3 according to subclause 8.1.1.6.15.
- 2> if the IE "GANSS Positioning Methods" is present:
 - 3> begin monitoring assistance data received in System Information Block type 15bis and/or System Information Block type 15.1bis and/or System Information Block type 15.2bis and/or System Information Block type 15.2ter and/or System Information Block type 15.3bis and/or System Information Block type 15.6 and/or System Information Block type 15.7 and/or System Information Block type 15.8 according to subclause 8.1.1.6.15.

- 3> if BDS is indicated in IE "GANSS Positioning Methods" and supported by UE;
- 4> begin monitoring assistance data received in System Information Block type 15.1ter according to subclause 8.1.1.6.15.1b.

NOTE: In the case that the measurement or reporting intervals are modified to 64 seconds during a transition to CELL_PCH/URA_PCH as described above, the UE retains the previously used values of "Measurement interval" and "Reporting interval" for use after transition out of CELL_PCH/URA_PCH.

8.4.1.6.8 CSG Proximity detection measurement

Upon transition from CELL_DCH to CELL_FACH/CELL_PCH/URA_PCH state, the UE shall:

- 1> stop CSG Proximity detection type measurement reporting.

8.4.1.6a Actions in CELL_FACH/CELL_PCH/URA/PCH state upon cell re-selection

Upon cell reselection while in CELL_FACH/CELL_PCH/URA/PCH state and the cell reselection has occurred after the measurement control information was stored, the UE shall:

- 1> delete all measurements of type intra-frequency, inter-frequency, inter-RAT and E-UTRA measurement for CELL_FACH associated with the variable MEASUREMENT_IDENTITY;
- 1> delete all compressed mode patterns associated with inter-frequency and inter-RAT measurements stored in the variable TGPS_IDENTITY;
- 1> delete the traffic volume measurements that have not been set up or modified through a MEASUREMENT CONTROL message.

8.4.1.7 Measurements after transition from CELL_FACH to CELL_DCH state

The UE shall apply the following rules for different measurement types after transiting from CELL_FACH to CELL_DCH state:

8.4.1.7.1 Intra-frequency measurement

Upon transition from CELL_FACH to CELL_DCH state:

- 1> for FDD or 3.84/7.68 Mcps TDD; or
- 1> for 1.28 Mcps TDD, if the UE is working on the same frequency after the state transition:
 - 2> if intra-frequency measurements applicable to CELL_DCH state are stored in the variable MEASUREMENT_IDENTITY:
 - 3> if the cell in which the UE transited from CELL_FACH state is included in the active set for the CELL_DCH state, the UE shall:
 - 4> resume the measurement reporting on that frequency;
 - 4> not resume the measurement reporting on the downlink frequency associated with the secondary uplink frequency. The measurement shall be restarted when a MEASUREMENT CONTROL message is received with the corresponding measurement identity.
 - 3> otherwise, the UE shall:
 - 4> not resume the measurement reporting. The measurement shall be restarted when a MEASUREMENT CONTROL message is received with the corresponding measurement identity.
 - 1> for 1.28 Mcps TDD, if the UE is working on the different frequency after the state transition:
 - 2> not resume the measurement reporting.
 - 2> delete the measurements of type intra-frequency associated with the variable MEASUREMENT_IDENTITY.

8.4.1.7.2 Inter-frequency measurement

Upon transition from CELL_FACH to CELL_DCH state:

- 1> for FDD or 3.84/7.68 Mcps TDD; or
- 1> for 1.28 Mcps TDD, if the UE is working on the same frequency after the state transition:
 - 2> if inter-frequency measurements applicable to CELL_DCH state are stored in the variable MEASUREMENT_IDENTITY:
 - 3> if the cell in which the UE transitioned from CELL_FACH state is included in the active set for the CELL_DCH state, the UE shall:
 - 4> resume the measurement reporting.
 - 3> otherwise, the UE shall:
 - 4> not resume the measurement reporting. The measurement shall be restarted when a MEASUREMENT CONTROL message is received with the corresponding measurement identity.
- 1> for 1.28 Mcps TDD, if the UE is working on the different frequency after the state transition:
 - 2> not resume the measurement reporting.
 - 2> delete the measurements of type inter-frequency associated with the variable MEASUREMENT_IDENTITY.

8.4.1.7.3 Inter-RAT measurement

Upon transition from CELL_FACH to CELL_DCH state, the UE shall:

- 1> stop monitoring the list of cells assigned in the IE "inter-RAT cell info list" in System Information Block type 12 (or System Information Block type 11, according to subclause 8.1.1.6.11).
- 1> stop monitoring E-UTRA frequencies listed in the IE "E-UTRA frequency and priority info list" in System Information Block type 19.

8.4.1.7.4 Traffic volume measurement

Upon transition from CELL_FACH to CELL_DCH state, the UE shall:

- 1> retrieve each set of measurement control information of measurement type "traffic volume" stored in the variable MEASUREMENT_IDENTITY;
- 2> if the optional IE "measurement validity" for this measurement has not been included:
 - 3> delete the measurement associated with the variable MEASUREMENT_IDENTITY.
- 2> if the IE "measurement validity" for the measurement has been included, and the IE "UE state" has been assigned to value "all states except CELL_DCH":
 - 3> stop measurement reporting; and
 - 3> save the measurement associated with the variable MEASUREMENT_IDENTITY to be used after the next transition to CELL_FACH/CELL_PCH/URA_PCH state.
- 2> if the IE "measurement validity" for the measurement has been included, and the IE "UE state" has been assigned to value "all states":
 - 3> if variable READY_FOR_COMMON_EDCH is set to FALSE before state transition:
 - 4> continue measurement reporting.
 - 3> else:
 - 4> for FDD:

- 5> resume this measurement and associated reporting.
- 4> for 1.28 Mcps TDD:
 - 5> continue measurement reporting.
- 2> if the IE "measurement validity" has been included and the IE "UE state" has been assigned to value "CELL_DCH":
 - 3> resume this measurement and associated reporting.
- 1> if no traffic volume type measurement has been assigned to the UE with a MEASUREMENT CONTROL message that is valid in CELL_DCH and has the same identity as the one indicated in the IE "Traffic volume measurement system information":
 - 2> store the measurement control information from the IE "Traffic volume measurement system information" received in System Information Block type 12 (or System Information Block type 11, according to subclause 8.1.1.6.11) in the variable MEASUREMENT_IDENTITY;
 - 2> begin traffic volume measurement reporting according to the assigned information.

8.4.1.7.5 UE positioning measurement

Upon transition from CELL_FACH to CELL_DCH state, the UE shall:

- 1> retrieve each set of measurement control information of measurement type "UE positioning" stored in the variable MEASUREMENT_IDENTITY; and
 - 2> if the optional IE "Measurement validity" for this measurement has not been included:
 - 3> delete the measurement associated with the variable MEASUREMENT_IDENTITY.
 - 2> if the IE "measurement validity" for the measurement has been included, and the IE "UE state" has been assigned to value "all states except CELL_DCH":
 - 3> stop measurement reporting; and
 - 3> save the measurement associated with the variable MEASUREMENT_IDENTITY to be used after the next transition to CELL_FACH/CELL_PCH/URA_PCH state.
 - 2> if the IE "measurement validity" for the measurement has been included, and the IE "UE state" has been assigned to value "all states":
 - 3> continue measurement reporting.
 - 2> if the IE "measurement validity" has been included and the IE "UE state" has been assigned to value "CELL_DCH":
 - 3> resume this measurement and associated reporting.
- 1> stop monitoring assistance data received in System Information Block type 15 or System Information Block type 15.1 or System Information Block type 15.2 or System Information Block type 15.3 or System Information Block type 15.4 or System Information Block type 15.5 or System Information Block type 15bis or System Information Block type 15.1bis or System Information Block type 15.1ter or System Information Block type 15.2bis or System Information Block type 15.2ter or System Information Block type 15.3bis or System Information Block type 15.6 or System Information Block type 15.7 or System Information Block type 15.8.

8.4.1.7.6 CSG Proximity detection measurement

Upon transition from CELL_FACH to CELL_DCH state, the UE shall:

- 1> resume CSG Proximity detection type measurement reporting, if configured.

8.4.1.7.7 E-UTRA measurement for CELL_FACH

Upon transition from CELL_FACH to CELL_DCH state, for FDD the UE shall:

- 1> stop the E-UTRA measurement for CELL_FACH type measurement;
- 1> delete the measurement of type E-UTRA measurement for CELL_FACH associated with the variable MEASUREMENT_IDENTITY.

8.4.1.8 Measurements after transition from idle mode to CELL_DCH state

The UE shall obey the following rules for different measurement types after transiting from idle mode to CELL_DCH state:

8.4.1.8.1 Intra-frequency measurement

Upon transition from idle mode to CELL_DCH state:

- 1> if intra-frequency measurements applicable to CELL_DCH state are stored in the variable MEASUREMENT_IDENTITY:
 - 2> if the cell in which the UE transited from idle mode is included in the active set for the CELL_DCH state, the UE shall:
 - 3> begin measurement reporting.
 - 2> otherwise, the UE shall:
 - 3> not begin the measurement reporting. The measurement shall be restarted when a MEASUREMENT CONTROL message is received with the corresponding measurement identity.

8.4.1.8.2 Inter-frequency measurement

Upon transition from idle mode to CELL_DCH state, the UE shall:

- 1> stop monitoring the list of cells assigned in the IE "inter-frequency cell info list" in System Information Block type 12 (or System Information Block type 11, according to subclause 8.1.1.6.11, and System Information Block type 11bis, according to subclause 8.1.1.6.11a if scheduled on BCH, and System Information Block type 11ter, according to subclause 8.1.1.6.11b if scheduled on BCH).

8.4.1.8.3 Inter-RAT measurement

Upon transition from idle mode to CELL_DCH state, the UE shall:

- 1> stop monitoring the list of cells assigned in the IE "inter-RAT cell info list" in System Information Block type 12 (or System Information Block type 11, according to subclause 8.1.1.6.11);
- 1> stop monitoring the list of E-UTRA frequencies assigned in the IE "E-UTRA frequency and priority info list" in System Information Block type 19.

8.4.1.8.4 Traffic volume measurement

Upon transition from idle mode to CELL_DCH state, the UE shall:

- 1> begin a traffic volume type measurement, assigned in System Information Block type 11 (or System Information Block type 12, according to subclause 8.1.1.6.11).

8.4.1.8.5 UE positioning measurement

Upon transition from idle mode to CELL_DCH state, the UE shall:

- 1> stop monitoring assistance data received in System Information Block type 15 or System Information Block type 15.1 or System Information Block type 15.2 or System Information Block type 15.3 or System Information

Block type 15.4 or System Information Block type 15.5 or System Information Block type 15bis or System Information Block type 15.1bis or System Information Block type 15.1ter or System Information Block type 15.2bis or System Information Block type 15.2ter or System Information Block type 15.3bis or System Information Block type 15.6 or System Information Block type 15.7 or System Information Block type 15.8.

8.4.1.9 Measurements after transition from idle mode to CELL_FACH state

The UE shall obey the follow rules for different measurement types after transiting from idle mode to CELL_FACH state:

8.4.1.9.1 Intra-frequency measurement

Upon transition from idle mode to CELL_FACH state, the UE shall:

- 1> begin or continue monitoring cells listed in the IE "intra-frequency cell info list" received in System Information Block type 12 (or System Information Block type 11, according to subclause 8.1.1.6.11).

8.4.1.9.2 Inter-frequency measurement

Upon transition from idle mode to CELL_FACH state, the UE shall:

- 1> begin or continue monitoring cells listed in the IE "inter-frequency cell info list" received in System Information Block type 12 (or System Information Block type 11, according to subclause 8.1.1.6.11, and System Information Block type 11bis, according to subclause 8.1.1.6.11a if scheduled on BCH, and System Information Block type 11ter, according to subclause 8.1.1.6.11b if scheduled on BCH);

- 1> for FDD, if variable HS_DSCH_RECEPTION_CELL_FACH_STATE is set to TRUE and the variable HS_DSCH_DRX_CELL_FACH_STATUS is set to TRUE:

- 2> perform measurements on other frequencies according to the requirements in [19], during the frame(s) with the SFN value not fulfilling the inequality specified in subclause 8.5.49.

- 1> for FDD, if variable HS_DSCH_RECEPTION_CELL_FACH_STATE is set to TRUE and the variable HS_DSCH_DRX_CELL_FACH_2CYCLE_STATUS is set to TRUE:

- 2> perform measurements on other frequencies according to the requirements in [19], during the frame(s) with the SFN value not fulfilling the inequality specified in subclause 8.5.49b.

- 1> otherwise:

- 2> perform measurements on other frequencies, according to the IE "FACH measurement occasion info", as specified in subclause 8.5.11.

- 1> for TDD:

- 2> perform measurements on other frequencies according to the IE "FACH measurement occasion info".

8.4.1.9.3 Inter-RAT measurement

Upon transition from idle mode to CELL_FACH state, the UE shall:

- 1> begin or continue monitoring cells listed in the IE "inter-RAT cell info list" received in System Information Block type 12 (or System Information Block type 11, according to subclause 8.1.1.6.11);

- 1> if the IE "CELL_FACH Absolute Priority Measurement Indicator" is present in System Information Block type 19:

- 2> continue monitoring the list of E-UTRA frequencies assigned in the IE "E-UTRA frequency and priority info list" in System Information Block type 19.

- 1> else:

- 2> stop monitoring the list of E-UTRA frequencies assigned in the IE "E-UTRA frequency and priority info list" in System Information Block type 19;

- 1> for FDD, if variable HS_DSCH_RECEPTION_CELL_FACH_STATE is set to TRUE and the variable HS_DSCH_DRX_CELL_FACH_STATUS is set to TRUE:
 - 2> perform measurements on other systems according to the requirements in [19], during the frame(s) with the SFN value not fulfilling the inequality specified in subclause 8.5.49.
- 1> for FDD, if variable HS_DSCH_RECEPTION_CELL_FACH_STATE is set to TRUE and the variable HS_DSCH_DRX_CELL_FACH_2CYCLE_STATUS is set to TRUE:
 - 2> perform measurements on other systems according to the requirements in [19], during the frame(s) with the SFN value not fulfilling the inequality specified in subclause 8.5.49b.
- 1> otherwise:
 - 2> perform measurements on other systems, according to the IE "FACH measurement occasion info", as specified in subclause 8.5.11.
- 1> for TDD:
 - 2> perform measurements on other frequencies according to the IE "FACH measurement occasion info".

8.4.1.9.4 Traffic volume measurement

Upon transition from idle mode to CELL_FACH state, the UE shall:

- 1> store the measurement control information from the IE "Traffic volume measurement system information" received in System Information Block type 12 (or System Information Block type 11, according to subclause 8.1.1.6.11) in the variable MEASUREMENT_IDENTITY;
- 1> begin traffic volume measurement reporting according to the assigned information.

8.4.1.9.5 UE positioning measurement

Upon transition from idle mode to CELL_FACH state, the UE may:

- 1> begin or continue monitoring assistance data received in System Information Block type 15 or System Information Block type 15.1 or System Information Block type 15.2 or System Information Block type 15.3 or System Information Block type 15.4 or System Information Block type 15.5 or System Information Block type 15bis or System Information Block type 15.1bis or System Information Block type 15.1ter or System Information Block type 15.2bis or System Information Block type 15.2ter or System Information Block type 15.3bis or System Information Block type 15.6 or System Information Block type 15.7 or System Information Block type 15.8 according to subclause 8.1.1.6.15;
- 1> if the IE "UE positioning OTDOA neighbour cell list for UE assisted" stored in the variable UE_POSITIONING_OTDOA_DATA_UE_ASSISTED; or
- 1> if the IE "UE positioning OTDOA neighbour cell list for UE based" stored in the variable UE_POSITIONING_OTDOA_DATA_UE_BASED contains neighbour cells on other frequencies than the current frequency:
 - 2> perform measurements on other frequencies according to the IE "FACH measurement occasion info".

8.4.1.9a Measurements after transition from connected mode to idle mode

Upon transition from connected mode to idle mode the UE shall:

- 1> stop measurement reporting for all measurements stored in the variable MEASUREMENT_IDENTITY;
- 1> clear the variable MEASUREMENT_IDENTITY;
- 1> apply the following rules for different measurement types.

8.4.1.9a.1 Intra-frequency measurement

Upon transition from connected mode to idle mode, the UE shall:

- 1> stop monitoring intra-frequency cells listed in the IE "intra-frequency cell info list" received in System Information Block type 12 (if System Information Block type 12 is transmitted in the cell, according to subclause 8.1.1.6.11);
- 1> begin monitoring intra-frequency cells listed in the IE "intra-frequency cell info list" received in System Information Block type 11.

8.4.1.9a.2 Inter-frequency measurement

Upon transition from connected mode to idle mode, the UE shall:

- 1> stop monitoring inter-frequency cells listed in the IE "inter-frequency cell info list" received in System Information Block type 12 (if System Information Block type 12 is transmitted in the cell, according to subclause 8.1.1.6.11);
- 1> begin monitoring inter-frequency cells listed in the IE "inter-frequency cell info list" received in System Information Block type 11 and System Information Block type 11bis, according to subclause 8.1.1.6.11a if scheduled on BCH, and System Information Block type 11ter, according to subclause 8.1.1.6.11b if scheduled on BCH.

8.4.1.9a.3 Inter-RAT measurement

Upon transition from connected mode to idle mode, the UE shall:

- 1> stop monitoring inter-RAT cells listed in the IE "inter-RAT cell info list" received in System Information Block type 12 (if System Information Block type 12 is transmitted in the cell, according to 8.1.1.6.11);
- 1> begin monitoring inter-RAT cells listed in the IE "inter-RAT cell info list" received in System Information Block type 11;
- 1> begin or continue monitoring E-UTRA frequencies listed in the IE "E-UTRA frequency and priority info list" received in System Information Block type 19.

8.4.1.9a.4 UE positioning measurement

Upon transition from connected mode to idle mode, the UE may:

- 1> begin or continue monitoring assistance data received in System Information Block type 15 or System Information Block type 15.1 or System Information Block type 15.2 or System Information Block type 15.3 or System Information Block type 15.4 or System Information Block type 15.5 or System Information Block type 15bis or System Information Block type 15.1bis or System Information Block type 15.1ter or System Information Block type 15.2bis or System Information Block type 15.2ter or System Information Block type 15.3bis or System Information Block type 15.6 or System Information Block type 15.7 or System Information Block type 15.8.

8.4.1.9b Measurements after transition from CELL_FACH to CELL_PCH/URA_PCH

8.4.1.9b.1 Traffic volume measurement

Upon transition from CELL_FACH to CELL_PCH or URA_PCH, the UE shall:

- 1> stop any ongoing traffic volume measurement, and associated traffic volume measurement reporting.
- 1> store the measurement associated with the variable MEASUREMENT_IDENTITY to be used after the next transition to CELL_FACH state;
- 1> if no traffic volume type measurement has been assigned to the UE with a MEASUREMENT CONTROL message that is valid in CELL_FACH or CELL_PCH or URA_PCH states (stored in the variable

MEASUREMENT_IDENTITY), which has the same identity as the one indicated in the IE "Traffic volume measurement system information":

- 2> store the measurement control information from the IE "Traffic volume measurement system information" received in System Information Block type 12 (or System Information Block type 11, according to subclause 8.1.1.6.11) in the variable MEASUREMENT_IDENTITY.

8.4.1.9b.2 UE positioning measurement

Upon transition from CELL_FACH to CELL_PCH or URA_PCH, the UE shall:

- 1> retrieve each set of measurement control information of measurement type "UE positioning" stored in the variable MEASUREMENT_IDENTITY; and
- 2> if the optional IE "measurement validity" for this measurement has not been included:
 - 3> delete the measurement associated with the variable MEASUREMENT_IDENTITY.
- 2> if the IE "measurement validity" for the measurement has been included, and the IE "UE state" has been assigned to value "all states" or "all states except CELL_DCH":
 - 3> if the choice in the IE "Reporting Criteria" included in the IE "UE Positioning measurement" stored in the variable MEASUREMENT_IDENTITY is set to "UE positioning reporting criteria" and the value of the IE "Measurement interval" included in this IE is less than 64 seconds:
 - 4> use a value of 64 seconds for the measurement interval associated with this measurement while the UE remains in CELL_PCH/URA_PCH.
 - 3> if the choice in the IE "Reporting Criteria" included in the IE "UE Positioning measurement" stored in the variable MEASUREMENT_IDENTITY is set to "Periodical Reporting Criteria" and the value of the IE "Reporting interval" included in this IE is less than 64 seconds:
 - 4> use a value of 64 seconds for the reporting interval associated with this measurement while the UE remains in CELL_PCH/URA_PCH.

NOTE: In the case that the measurement or reporting intervals are modified to 64 seconds as described above, the UE retains the previously used values of "Measurement interval" and "Reporting interval" for use after transition out of CELL_PCH/URA_PCH.

8.4.1.9b.3 Inter-RAT measurement

Upon transition from CELL_FACH to CELL_PCH or URA_PCH, the UE shall:

- 1> begin or continue monitoring E-UTRA frequencies listed in the IE "E-UTRA frequency and priority info list" in System Information Block type 19.

8.4.1.9b.4 Intra-frequency measurement

Upon transition from CELL_FACH to CELL_PCH or URA_PCH, the UE shall:

- 1> for 1.28 Mcps TDD, if the UE is working on the secondary frequency before state transition:
 - 2> delete the measurements of type intra-frequency associated with the variable MEASUREMENT_IDENTITY.
 - 2> the measurement shall be started when the IE "intra-frequency cell info list" is received in System Information Block type 12 (or System Information Block type 11, according to subclause 8.1.1.6.11).

8.4.1.9b.5 Inter-frequency measurement

Upon transition from CELL_FACH to CELL_PCH or URA_PCH, the UE shall:

- 1> for 1.28 Mcps TDD, if the UE is working on the secondary frequency before state transition:
 - 2> delete the measurements of type inter-frequency associated with the variable MEASUREMENT_IDENTITY.

- 2> the measurement shall be started when the IE "inter-frequency cell info list" is received in System Information Block type 12 (or System Information Block type 11, according to subclause 8.1.1.6.11).

8.4.1.9b.6 E-UTRA measurement for CELL_FACH

Upon transition from CELL_FACH to CELL_PCH or URA_PCH, for FDD the UE shall:

- 1> stop the E-UTRA measurement for CELL_FACH type measurement;
- 1> delete the measurement of type E-UTRA measurement for CELL_FACH associated with the variable MEASUREMENT_IDENTITY.

8.4.1.9c Measurements after transition from CELL_PCH/URA_PCH to CELL_FACH

8.4.1.9c.1 Traffic volume measurement

Upon transition from CELL_PCH or URA_PCH to CELL_FACH and if variable READY_FOR_COMMON_EDCH is set to FALSE after state transition, the UE shall resume any traffic volume measurement stored in the variable MEASUREMENT_IDENTITY with measurement validity "all states" or "all states except CELL_DCH", and start the associated traffic volume measurement reporting.

For FDD, upon transition from CELL_PCH or URA_PCH to CELL_FACH and if variable READY_FOR_COMMON_EDCH is set to TRUE after state transition, the UE shall resume any traffic volume measurement stored in the variable MEASUREMENT_IDENTITY with measurement validity "all states except CELL_DCH" and Uplink transport channel type set to "DCH", and start the associated traffic volume measurement reporting.

NOTE: In FDD, if IE "measurement validity" is set to "all states except CELL_DCH" and IE "Uplink transport channel type" to "DCH", DCH refers as a matter of fact to E-DCH.

For 1.28 Mcps TDD, upon transition from CELL_PCH or URA_PCH to CELL_FACH and if variable READY_FOR_COMMON_EDCH is set to TRUE after state transition, the UE shall resume any traffic volume measurement stored in the variable MEASUREMENT_IDENTITY with measurement validity "all states" or "all states except CELL_DCH" and Uplink transport channel type set to "USCH" and the UL transport channel id is set to 32, and start the associated traffic volume measurement reporting.

NOTE: In 1.28Mcps TDD, if IE "measurement validity" is set to "all states" or "all states except CELL_DCH" and IE "Uplink transport channel type" to "USCH" and the IE "UL Target Transport Channel ID" to 32, it refers as a matter of fact to E-DCH.

8.4.1.9c.2 UE positioning measurement

Upon transition from CELL_PCH or URA_PCH to CELL_FACH, the UE shall continue any UE positioning measurement stored in the variable MEASUREMENT_IDENTITY with measurement validity "all states" or "all states except CELL_DCH", and continue the associated UE positioning measurement reporting.

NOTE: The UE's values of "Measurement interval" in the IE "UE positioning reporting criteria" and "Reporting interval" in the IE "Periodical Reporting Criteria" after this state transition revert to the values stored during the transition to CELL_PCH/URA_PCH (i.e., the 64-second interval specified in subclause 8.4.1.9b.2 is not retained).

8.4.1.9c.3 Inter-RAT measurement

Upon transition from CELL_PCH or URA_PCH to CELL_FACH, the UE shall:

- 1> if the IE "CELL_FACH Absolute Priority Measurement Indicator" is present in System Information Block type 19:
 - 2> continue monitoring the list of E-UTRA frequencies assigned in the IE "E-UTRA frequency and priority info list" in System Information Block type 19.
- 1> else:

- 2> stop monitoring E-UTRA frequencies listed in the IE "E-UTRA frequency and priority info list" in System Information Block type 19.
- 1> for FDD if variable HS_DSCH_RECEPTION_CELL_FACH_STATE is set to TRUE and the variable HS_DSCH_DRX_CELL_FACH_STATUS is set to TRUE:
 - 2> perform measurements on other systems according to the requirements in [19], during the frame(s) with the SFN value not fulfilling the inequality specified in subclause 8.5.49.
- 1> otherwise:
 - 2> perform measurements on other systems, according to the IE "FACH measurement occasion info", as specified in subclause 8.5.11.

8.4.1.10 Changes in measurement objects

8.4.1.10.1 Traffic volume measurement

When performing traffic volume event evaluation or reporting related to a certain transport channel, the UE shall consider all RBs which are mapped to the concerning transport channel e.g. if an additional RB is established on a transport channel used for event triggering or reporting, the new RB shall be taken into account.

NOTE: In this subclause, an "existing" uplink transport channel refers to a configured uplink transport channel applicable in the current RRC state.

The UE shall:

- 1> if variable READY_FOR_COMMON_EDCH is set to FALSE:
 - 2> if the IE "Traffic volume measurement object" is included for this measurement:
 - 3> while a transport channel that is referenced in the IE "Traffic volume measurement object" does not exist:
 - 4> not perform any reporting related to this transport channel.
 - 2> else:
 - 3> report on all existing uplink transport channels; e.g. if an additional transport channel is established while the measurement is ongoing, this new transport channel shall be taken into account in the traffic volume measurement reporting.
- 1> else:
 - 2> if the UE is in CELL_FACH state:
 - 3> for FDD, if one transport channel that is referenced in the IE "Traffic volume measurement object" as "DCH" and IE "measurement validity" is set to "all states except CELL_DCH":
 - 4> report on the existing transport channel E-DCH.
 - 3> for 1.28 Mcps TDD, if one transport channel that is referenced in the IE "Uplink transport channel type" as "USCH" and the related IE "UL Target Transport Channel ID" is set to 32 and the IE "measurement validity" is set to "all states" or "all states except CELL_DCH":
 - 4> report on the existing transport channel E-DCH.

For every traffic volume event, the UE shall:

- 1> if variable READY_FOR_COMMON_EDCH is set to FALSE:
 - 2> if the IE "Uplink transport channel type" is not included in the IE "Traffic volume measurement reporting criteria", or the "Uplink transport channel type" has the value "DCH" or "USCH" and the IE "UL transport channel id" is not included in the IE "Traffic volume measurement reporting criteria":
 - 3> if the IE "Traffic volume measurement object" is not included:

4> take all existing UL transport channels into account for event triggering; e.g. if an additional transport channel is established while the measurement is ongoing, this new transport channel shall be taken into account in the traffic volume event triggering.

3> else:

4> while a transport channel that is referenced in the IE "Traffic Volume Measurement object" does not exist:

5> not take this transport channel identity into account in the traffic volume measurement triggering.

2> else:

3> while a transport channel that is referenced in the IE "Traffic Volume Measurement Reporting Criteria" does not exist:

4> not take this transport channel identity into account in the traffic volume event triggering.

8.4.1.10.2 Quality measurement

While a transport channel that is explicitly referenced with a transport channel identity in the IE "Quality Reporting Quantity" does not exist, the UE shall:

1> not perform any reporting related to this transport channel identity.

If the IE "Quality Reporting Quantity" does not contain any explicit transport channel identities, the UE shall:

1> report the quality of all existing downlink dedicated transport channels;

1> if an additional transport channel is established while the measurement is ongoing:

2> take into account this new transport channel in the quality measurement reporting.

While a transport channel that is explicitly referenced with a transport channel id in the IE "Quality Measurement Reporting Criteria" does not exist, the UE shall:

1> not take this transport channel identity into account in the quality measurement event triggering.

8.4.1.10.3 Intra-frequency, Inter-frequency and Inter-RAT measurements

For measurements which include the IE "Cells for measurement" the UE shall:

1> while an IE "Intra-frequency cell id" or IE "Inter-frequency cell id" or IE "Inter-RAT cell id" in the IE "Cells for measurement" points to a position in the variable CELL_INFO_LIST which is marked as "vacant":

2> not take this position into account for event triggering and reporting.

8.4.1.11 Cell Reselection (FDD only and 1.28 Mcps TDD only)

8.4.1.11.1 Traffic volume measurement

When performing cell reselection in CELL_FACH state, the UE shall:

1> retrieve each set of measurement control information of measurement type "traffic volume" stored in the variable MEASUREMENT_IDENTITY:

2> if the IE "measurement validity" for the measurement has been included, and the IE "UE state" has been assigned to value "all states":

3> if variable READY_FOR_COMMON_EDCH is set to FALSE before state transition and set to TRUE after cell reselection:

4> stop measurement reporting;

- 4> store the measurement associated with the variable MEASUREMENT_IDENTITY to be used after the next transition to CELL_DCH state, or after cell reselection.
- 2> if variable READY_FbOR_COMMON_EDCH is set to TRUE before state transition and set to FALSE after cell reselection:
- 3> resume measurement reporting.

8.4.2 Measurement report



Figure 8.4.2-1: Measurement report, normal case

8.4.2.1 General

The purpose of the measurement reporting procedure is to transfer measurement results from the UE to UTRAN.

For intra frequency measurement, the UE shall do the measurement reporting procedure on each configured uplink frequency regardless its activation status.

8.4.2.2 Initiation

In CELL_DCH state, the UE shall:

- 1> transmit a MEASUREMENT REPORT message on the uplink DCCH when the reporting criteria stored in variable MEASUREMENT_IDENTITY are met for any ongoing measurements that are being performed in the UE.

In CELL_FACH state, the UE shall:

- 1> transmit a MEASUREMENT REPORT message on the uplink DCCH when the reporting criteria stored in variable MEASUREMENT_IDENTITY are met for any ongoing traffic volume measurement or UE positioning measurement or E-UTRA measurement for CELL_FACH that is being performed in the UE.

In TDD, if the Radio Bearer associated with the MEASUREMENT_IDENTITY fulfilling the reporting criteria for an ongoing traffic volume measurement is mapped on transport channel of type USCH, the UE shall:

- 1> initiate the "PUSCH CAPACITY REQUEST" procedure instead of transmitting a MEASUREMENT REPORT (TDD Only).

In CELL_PCH or URA_PCH state, the UE shall:

- 1> if the measurement reporting is not initiated according to subclause 8.5.40, subclause 8.5.47 or subclause 8.5.56:
- 2> if variable READY_FOR_COMMON_EDCH or HSPA_RNTI_STORED_CELL_PCH is set to TRUE:
 - 3> move to CELL_FACH;
 - 3> transmit a MEASUREMENT REPORT message on the uplink DCCH when the reporting criteria stored in variable MEASUREMENT_IDENTITY are fulfilled for any ongoing UE positioning measurement which is being performed in the UE.
- 2> else:
 - 3> first perform the cell update procedure according to subclause 8.3.1, using the cause "uplink data transmission", in order to transit to CELL_FACH state; and then

- 3> transmit a MEASUREMENT REPORT message on the uplink DCCH when the reporting criteria stored in variable MEASUREMENT_IDENTITY are fulfilled for any ongoing UE positioning measurement which is being performed in the UE.

For FDD and 1.28 Mcps TDD, the UE in CELL_PCH state shall:

- 1> if variable H_RNTI is set:

- 2> if the measurement reporting is initiated according to subclause 8.5.40 or subclause 8.5.47 or subclause 8.5.56:

- 3> set the IE "measurement identity" to "16";

- 3> not set the IE "measured results" or "E-UTRA measured results";

- 3> include the IE "measured results on RACH";

- 3> if an event triggered traffic volume measurement has been configured:

- 4> if the TCTV is larger than the threshold in the IE "Reporting threshold" for a traffic volume measurement stored in the MEASUREMENT_IDENTITY variable and that traffic volume measurement has "measurement identity" equal to 4, "Traffic volume event identity" equal to "4a", "Measurement validity" equal to "all states" or "all states except CELL_DCH":

- 5> set the IE "Traffic volume event identity" to "4a".

- 3> if an IE "Logged Measurement Info-FDD" or "Logged Measurement Info-TDD" in variable LOGGED_MEAS_REPORT_VARIABLE is present and registered PLMN is present in the IE "PLMN Identity List" stored in variable LOGGED_MEAS_REPORT_VARIABLE:

- 4> include IE "Logged Meas Available".

- 3> if IE "Logged ANR Report" in variable LOG_ANR_REPORT_VARIABLE is present and registered PLMN is the same as one of the PLMNs in the IE "PLMN Identity" or IE "Equivalent PLMN Identity List" stored in variable LOG_ANR_REPORT_VARIABLE:

- 4> include IE "ANR Logging Results Available".

- 3> and then transmit the MEASUREMENT REPORT message on the uplink DCCH using AM RLC; when the MEASUREMENT REPORT message has been submitted to lower layers for transmission the procedure ends.

The reporting criteria are fulfilled if either:

- a periodic MEASUREMENT REPORT message shall be sent according to the IE "Periodical Reporting Criteria"; or
- an event in stored IE "Measurement reporting criteria" was triggered. Events and triggering of reports for different measurement types are described in detail in clause 14.

For the measurement, which triggered the MEASUREMENT REPORT message, the UE shall:

- 1> set the IE "measurement identity" to the measurement identity, which is associated with that measurement in variable MEASUREMENT_IDENTITY;

- 1> set the IE "measured results" or "measured results on secondary UL frequency" or "E-UTRA measured results" to include measurements according to the IE "reporting quantity" of that measurement stored in variable MEASUREMENT_IDENTITY; and

- 2> if all the reporting quantities are set to FALSE:

- 3> not set the IE "measured results" or "measured results on secondary UL frequency".

- 1> if measurement type "E-UTRA measurement for CELL_FACH" is configured:

- 2> set the IE "E-UTRA results for CELL_FACH" to include measurements according to the IE "Measurement quantity" of that measurement stored in variable MEASUREMENT_IDENTITY.

- 1> set the IE "Measured results" in the IE "Additional measured results" or "Measured results" in the IE "Additional measured results on secondary UL frequency" according to the IE "reporting quantity" for all measurements associated with the measurement identities included in the "Additional measurements list" stored in variable MEASUREMENT_IDENTITY of the measurement that triggered the measurement report; and
 - 2> if one or more additional measured results are to be included:
 - 3> include only the available additional measured results, and sort them in ascending order according to their IE "measurement identity" in the MEASUREMENT REPORT message.
- 1> if the measurement report is triggered by an intra frequency event; and
- 1> if this intra frequency event type was configured for both primary and secondary uplink frequencies; and
- 1> if the same measurement identity is used to configure the measurements for both primary and secondary uplink frequencies:
 - 2> set both the IE "measured results" and "measured results on secondary UL frequency" as specified above.
 - 2> set both the IE "Measured results" in the IE "Additional measured results" and in the IE "Additional measured results on secondary UL frequency" as specified above.
- 1> if the MEASUREMENT REPORT message was triggered by an event (i.e. not a periodical report):
 - 2> set the IE "Event results" or "Event results on secondary UL frequency" or "E-UTRA event results" or "E-UTRA results for CELL_FACH" according to the event that triggered the report.
 - 2> if the measurement report is triggered by an intra frequency event and the same measurement identity is used to configure the measurements for both primary and secondary uplink frequencies:
 - 3> if the measurement report was triggered by an event in both primary and secondary uplink frequencies at the same time:
 - 4> set both the IE "Event results" and "Event results on secondary UL frequency" according to the event that triggered the report.
- 1> if the IE Inter-RAT measured results list or the IE Inter-RAT measurement event results is included in the measurement report:
 - 2> if the indication status of the IE "Inter-RAT cell info indication" in the variable CELL_INFO_LIST is marked "present" , include the stored value of the IE "Inter-RAT cell info indication" in the MEASUREMENT REPORT message.
- 1> if the measurement report is triggered by intra frequency event 1d and the table "Target cell preconfigurations" in the variable TARGET_CELL_PRECONFIGURATION includes the radio link that triggered the event or,
- 1> if the measurement report is triggered by intra frequency event 1c on the primary frequency which indicates the current serving HS-DSCH cell as the only active CPICH triggering this event 1c report and the table "Target cell preconfigurations" in the variable TARGET_CELL_PRECONFIGURATION includes the target cell which fulfils the definition of Target cell HS-SCCH order, and if the "Enhanced Serving Cell Change for Event 1c Support Indicator" is received:
 - 2> if an "Activation time offset" different from 0 is configured for the target cell, include the IE "Activation time" in MEASUREMENT REPORT message. The Activation time shall be calculated by adding the Activation time offset to the current CFN:
 - 3> start continuous monitoring of target cell HS-SCCH indexed as number 1 in IE "Serving HS-DSCH cell information" in the stored configuration;
 - 3> stop monitoring target cell HS-SCCH at Activation time.
 - 2> else:
 - 3> start if not running, or restart if running, timer T324;

- 3> start continuous monitoring of target cell HS-SCCH indexed as number 1 in IE "Serving HS-DSCH cell information" in the stored configuration until the expiry of timer T324.

The UE shall:

- 1> transmit the MEASUREMENT REPORT message on the uplink DCCH using either AM or UM RLC according to the stored IE "measurement reporting mode" associated with the measurement identity that triggered the report.

When the MEASUREMENT REPORT message has been submitted to lower layers for transmission:

- 1> the procedure ends.

8.4.3 Assistance Data Delivery



Figure 8.4.3-1 Assistance Data Delivery

8.4.3.1 General

The purpose of the assistance data delivery procedure is to transfer UE positioning related assistance data from the UTRAN to the UE.

8.4.3.2 Initiation

When requested by the Core Network, the UTRAN may deliver UE positioning related assistance data with a ASSISTANCE DATA DELIVERY message, which is transmitted on the downlink DCCH using AM RLC

8.4.3.3 Reception of ASSISTANCE DATA DELIVERY message by the UE

Upon reception of a ASSISTANCE DATA DELIVERY message the UE shall:

- 1> if IE "UE positioning OTDOA assistance data for UE-based" is included:
 - 2> act as specified in subclause 8.6.7.19.2a.
- 1> if IE "UE positioning GPS assistance data" is included:
 - 2> act as specified in subclause 8.6.7.19.3.
- 1> if IE "UE positioning GANSS assistance data" is included:
 - 2> act as specified in subclause 8.6.7.19.7.

8.4.3.4 Invalid ASSISTANCE DATA DELIVERY message

If the UE receives a ASSISTANCE DATA DELIVERY message, which contains a protocol error causing the variable `PROTOCOL_ERROR_REJECT` to be set to `TRUE` according to clause 9, the UE shall perform procedure specific error handling as follows. The UE shall:

- 1> transmit an RRC STATUS message on the uplink DCCH using AM RLC;
- 1> include the IE "Identification of received message"; and

- 1> set the IE "Received message type" to ASSISTANCE DATA DELIVERY; and
- 1> set the IE "RRC transaction identifier" to the value of "RRC transaction identifier" in the entry for the ASSISTANCE DATA DELIVERY message in the table "Rejected transactions" in the variable TRANSACTIONS; and
- 1> clear that entry;
- 1> include the IE "Protocol error information" with contents set to the value of the variable PROTOCOL_ERROR_INFORMATION.
- 1> when the RRC STATUS message has been submitted to lower layers for transmission:
 - 2> continue with any ongoing processes and procedures as if the invalid ASSISTANCE DATA DELIVERY message has not been received.

8.5 General procedures

8.5.1 Selection of initial UE identity

The purpose of the IE "Initial UE identity" is to provide a unique UE identification at the establishment of an RRC connection. The type of identity shall be selected by the UE according to the following.

If the UE is operating in "GSM-MAP mode", the UE shall choose "UE id type" in the IE "Initial UE identity" with the following priority:

1. TMSI (GSM-MAP): The TMSI (GSM-MAP) shall be chosen if provided by upper layers. The IE "LAI" in the IE "Initial UE identity" shall also be present when TMSI (GSM-MAP) is used, for making it unique.
2. P-TMSI (GSM-MAP): The P-TMSI (GSM-MAP) shall be chosen if provided by upper layers and no TMSI (GSM-MAP) is available. The IE "RAI" in the IE "Initial UE identity" shall in this case also be present when P-TMSI (GSM-MAP) is used, for making it unique.
3. IMSI (GSM-MAP): The IMSI (GSM-MAP) shall be chosen if provided by upper layers and no TMSI (GSM-MAP) or P-TMSI is available.
4. IMEI: The IMEI shall be chosen when none of the above three conditions are fulfilled.

When being used, the IEs "TMSI (GSM-MAP)", "P-TMSI (GSM-MAP)", "IMSI (GSM-MAP)", "LAI" and "RAI" shall be set equal to the values provided by upper layers. The "P-TMSI (GSM-MAP)" and "RAI" may be mapped from a valid GUTI..

If the UE is operating in "ANSI-41 mode", the UE shall choose "UE id type" in the IE "Initial UE identity" according to the procedure specified in the 3GPP2 document "3GPP2 C.P0004-A".

8.5.2 Actions when entering idle mode from connected mode

When entering idle mode from connected mode, the UE shall:

- 1> clear or set variables upon leaving UTRA RRC connected mode as specified in subclause 13.4;
- 1> stop timer T323 if it is running;
- 1> clear the variable SYSTEM_INFORMATION_CONTAINER;
- 1> if the RRC CONNECTION RELEASE message was received and the IE "Redirection info" was present therein:
 - 2> if the IE "Frequency info" is present, attempt to camp on a suitable cell on the indicated UTRA carrier included in the RRC CONNECTION RELEASE message;
 - 2> if the IE "GSM target cell info" is present, attempt to camp on a suitable cell of the list of cells for the indicated RAT included in the RRC CONNECTION RELEASE message. If no cells were indicated for that

RAT or no suitable cell of the indicated cells for that RAT is found within 10s, attempt to camp on any suitable cell of that RAT; or

- 2> if the IE "E-UTRA target info" is present, attempt to camp on any of the frequencies for the indicated RAT included in the RRC CONNECTION RELEASE message, excluding any cell indicated in the list of not allowed cells for that RAT (i.e. the "blacklisted cells per freq list" for E-UTRA), if present. If no suitable cell on the indicated frequencies for that RAT is found in less than N seconds (where N is the number of E-UTRA frequencies listed in IE "E-UTRA target info"), attempt to camp on any suitable cell on any frequencies of that RAT in less than 4 seconds;
 - 2> if no suitable cell is found on the indicated UTRA carrier or RAT camp on any suitable cell.
- 1> For UTRA TDD, if the RRC CONNECTION RELEASE message was received and the IE "Redirection info" was not present:
- 2> if the to be released RRC connection was established due to CSFB call initiated in E-UTRA:
 - 3> attempt to camp on a suitable cell on an E-UTRA frequency. If no suitable cell is found on any of E-UTRA frequencies in less than 2 seconds, attempt to camp on any suitable cell.
- 1> attempt to select a suitable cell to camp on.

When leaving connected mode according to [4], the UE shall:

- 1> perform cell selection.

While camping on a cell, the UE shall:

- 1> acquire system information according to the system information procedure in subclause 8.1;
- 1> perform measurements according to the measurement control procedure specified in subclause 8.4; and
- 1> if the UE is registered:
 - 2> be prepared to receive paging messages according to the paging procedure in subclause 8.2.

If the UE is operating in "GSM-MAP mode", the UE shall:

- 1> delete any NAS system information received in connected mode;
- 1> acquire the NAS system information in system information block type 1; and
- 1> proceed according to subclause 8.6.1.2.

When entering idle mode, the UE shall:

- 1> if the USIM is present, for each CN domain:
 - 2> if a new security key set was received for this CN domain but was not used either for integrity protection or ciphering during this RRC connection:
 - 3> set the START value for this domain to zero; and
 - 3> store this START value for this domain in the volatile memory of the ME.
 - 2> else:
 - 3> if the current "START" value, according to subclause 8.5.9 for a CN domain, is greater than or equal to the value "THRESHOLD" of the variable START_THRESHOLD:
 - 4> delete the ciphering and integrity keys that are stored in the USIM for that CN domain;
 - 4> set the "START" values for this CN domain to zero and store it in the volatile memory of the ME;
 - 4> inform the deletion of these keys to upper layers.
 - 3> else:

4> store the current "START" value for this CN domain in the volatile memory of the ME.

NOTE: Prior to storing the "START" value, the UE should calculate this "START" value according to subclause 8.5.9.

1> else:

2> if the SIM is present, for each CN domain:

3> if a new security key set was received for this CN domain but was not used either for integrity protection or ciphering during this RRC connection:

4> set the START value for this domain to zero; and

4> store this START value for this domain in the volatile memory of the ME

3> else:

4> if the current "START" value, according to subclause 8.5.9 for this CN domain, is greater than or equal to the value "THRESHOLD" of the variable START_THRESHOLD:

5> delete the Kc key for this CN domain;

5> delete the ciphering and integrity keys that are stored in the UE for that CN domain;

5> set the "START" values for this CN domain to zero and store it the volatile memory of the ME;

5> inform the deletion of the key to upper layers.

4> else:

5> store the current "START" value for this CN domain in the volatile memory of the ME.

NOTE: Prior to storing the "START" value, the UE should calculate this "START" value according to subclause 8.5.9.

1> if the UE supports RAN-assisted WLAN interworking:

2> if timer T330 is not configured:

3> clear the variable WLAN_OFFLOAD_INFO;

3> use the information stored in the variable SYSTEM_INFO_WLAN_OFFLOAD_INFO as specified in [4], and forward it to upper layers.

2> else:

3> if timer T330 is not running:

4> start the timer T330;

4> use the information stored in the variable WLAN_OFFLOAD_INFO as specified in [4], and forward it to upper layers.

8.5.3 Open loop power control upon establishment of DPCCH

This procedure is used in FDD mode only.

When establishing the first DPCCH in CELL_DCH the UE shall start the UL inner loop power control at a power level according to:

1> $DPCCH_Initial_power = DPCCH_Power_offset - CPICH_RSCP$

Where

DPCCH_Power_offset shall have the value of IE "DPCCH Power offset" in IE "Uplink DPCH power control info"

The value for the CPICH_RSCP shall be measured by the UE.

When establishing the DPCCH in CELL_FACH state or Idle mode the UE shall start the UL inner loop power control at a power level according to:

$$1 > \text{DPCCH_Initial_power} = P_{\text{preamble}} + \text{"Power offset } P_{p-e}\text{"}$$

Where

- P_{preamble} is the power of the last transmitted preamble and "Power offset P_{p-e} " power offset between the last transmitted preamble and the initial power of the DPCCH transmission in the Enhanced Uplink in CELL_FACH state and Idle mode.

8.5.4 Physical channel establishment criteria in CELL_DCH state

When a physical dedicated channel establishment on the downlink frequency associated with the primary uplink frequency is initiated by the UE, the UE shall start a timer T312 and wait for layer 1 to indicate N312 "in sync" indications. On receiving N312 "in sync" indications on the downlink frequency associated with the primary uplink frequency, the physical channel is considered established on the downlink frequency associated with the primary uplink frequency and the timer T312 is stopped and reset.

For 1.28Mcps TDD, when physical dedicated channel(s) are not configured, if a physical shared channel establishment is initiated by the UE, the UE shall start a timer T312 and wait for layer 1 to indicate N312 "in sync" indications. On receiving N312 "in sync" indications, the physical channel is considered established and the timer T312 is stopped and reset.

If the timer T312 expires before the physical channel is established on the downlink frequency associated with the primary uplink frequency, the UE shall consider this as a "physical channel failure".

NOTE: The criteria defined in this subclause only apply in case the UE performs synchronisation procedure A (FDD only).

NOTE: The physical shared channel defined in this subclause are HS-PDSCH, HS-SCCH or E-AGCH. (1.28 Mcps TDD only).

8.5.4A Physical channel establishment criteria for Enhanced Uplink in CELL_FACH state and Idle mode

When the physical channel establishment for Enhanced Uplink in CELL_FACH state and Idle mode is initiated by the UE, the UE shall consider the physical channel being immediately established.

If the physical layer considers the post-verification of procedure AA failed [29, section 4.3.2.3A], the UE shall consider this as a "physical channel failure".

NOTE: The criteria defined in this subclause only apply in case the UE performs synchronisation procedure AA (FDD only).

8.5.4B Physical channel establishment criteria in CELL_DCH state on the secondary uplink frequency (FDD only)

When a physical dedicated channel establishment on the downlink frequency associated with the secondary uplink frequency is initiated by the UE, the UE shall for that downlink frequency start a timer T312 and wait for layer 1 to indicate N312 "in sync" indications. On receiving N312 "in sync" indications on the downlink frequency associated with the secondary uplink frequency, the physical channel is considered established on the downlink frequency associated with the secondary uplink frequency and the timer T312 is stopped and reset.

If the timer T312 expires before the physical channel is established on the downlink frequency associated with the secondary uplink frequency, the UE shall consider this as a "physical channel failure" on the downlink frequency associated with the secondary uplink frequency, and deactivate the secondary uplink frequency as if a HS-SCCH order to deactivate had been received.

NOTE: The criteria defined in this subclause only apply in case the UE performs synchronisation procedure A (FDD only).

8.5.5 Actions in "out of service area" and "in service area"

This subclause specifies the general actions the UE shall perform when it detects "out of service" or "in service" area. The specific UE behaviour when it detects "out of service" or "in service area" and periodical update has been configured by T305 in the IE "UE Timers and constants in connected mode" set to any other value than "infinity" is specified in subclause 8.3.1.

8.5.5.1 Detection of "out of service" area

The UE shall detect "out of service" area as defined in [19].

8.5.5.1.1 Actions following detection of "out of service" area in URA_PCH or CELL_PCH state

If the UE detects the "out of service area" and the UE is in URA_PCH or CELL_PCH state it shall perform the following actions:

- 1> start timer T316;
- 1> perform processes described in subclause 7.2.2.

8.5.5.1.2 Actions following detection of "out of service" area in CELL_FACH state

If the UE detects the "out of service area" and the UE is in CELL_FACH state it shall perform the following actions. The UE shall:

- 1> start timer T317 if not already running;
- 1> perform processes described in subclause 7.2.2.

8.5.5.1.3 Actions following detection of "out of service" area on transition from CELL_DCH to URA_PCH or CELL_PCH

If the UE detects the "out of service area" on transition from CELL_DCH to URA_PCH or CELL_PCH, it shall perform the following actions:

- 1> start timer T316;
- 1> start the timer T305 using its initial value if timer T305 is not running and periodical cell update has been configured by T305 in the IE "UE Timers and constants in connected mode" set to any other value than "infinity";
- 1> perform processes described in subclause 7.2.2.

8.5.5.1.4 Actions following detection of "out of service" area on transition from CELL_DCH to CELL_FACH

If the UE detects the "out of service area" on transition from CELL_DCH to CELL_FACH, it shall perform the following actions:

- 1> if the transition is triggered by a reconfiguration procedure:
 - 2> start timer T317;
 - 2> start the timer T305 using its initial value if timer T305 is not running and periodical cell update has been configured by T305 in the IE "UE Timers and constants in connected mode" set to any other value than "infinity";

2> perform processes described in subclause 7.2.2.

1> otherwise:

2> perform processes described in subclause 7.2.2.

8.5.5.2 Detection of "in service" area

When a suitable cell is found based on the description in [4], the UE considers it as having detected "in service area".

8.5.5.2.1 Actions following Re-entry into "in service area" in URA_PCH or CELL_PCH state

If the UE re-enters "in service area" before T316 expiry the UE shall perform the following actions. The UE shall:

1> stop T316;

1> if T307 is active:

2> stop T307.

1> if the UE is in CELL_PCH state and the UE is camped on a cell different from the one where service was lost:

2> for FDD and 1.28 Mcps TDD:

3> clear the variables C_RNTI, H_RNTI and E_RNTI;

3> stop using that C-RNTI, H-RNTI and E-RNTI just cleared from variables C_RNTI, H_RNTI and E_RNTI in MAC.

2> initiate the cell update procedure using the cause "cell-reselection" as specified in subclause 8.3.1.

1> perform processes described in subclause 7.2.2.

8.5.5.2.2 Actions following re-entry into "in service area" in CELL_FACH state

If the UE detects "in service area" before T317 expiry the UE shall perform the following actions. If no cell update procedure or URA update procedure is ongoing, the UE shall:

1> stop T317;

1> if T307 is active:

2> stop T307.

1> initiate the cell update procedure using as cause "Re-entering service area" as specified in subclause 8.3.1;

1> perform processes described in subclause 7.2.2.

If a cell update procedure or URA update procedure is ongoing, the UE shall:

1> stop T317;

1> perform the actions as specified in 8.3.1.

8.5.5.3 T316 expiry

On T316 expiry the UE shall perform the following actions. The UE shall:

1> if "out of service area" is detected:

2> start timer T317;

2> move to CELL_FACH state;

2> perform processes described in subclause 7.2.2.

1> if "in service area" is detected:

2> initiate the cell update procedure using as cause "Re-entering service area" as specified in subclause 8.3.1;

2> perform processes described in subclause 7.2.2.

8.5.5.4 T317 expiry

T317 shall never expire, i.e. all its values shall be assumed to be "infinity".

If T317 is running:

1> the UE behaviour shall be as specified in subclause 7.2.2.2.

8.5.6 Radio link failure criteria and actions upon radio link failure

In CELL_DCH state, after receiving N313 consecutive "out of sync" indications from layer 1 for the established DPCH or F-DPCH physical channel on the downlink frequency associated with the primary uplink frequency in FDD, and the physical channels associated with mapped DCCHs in TDD, the UE shall:

1> start timer T313;

1> upon receiving N315 successive "in sync" indications from layer 1 on the downlink frequency associated with the primary uplink frequency and upon change of UE state:

2> stop and reset timer T313.

1> if T313 expires:

2> consider it as a "Radio link failure".

Periods in time where neither "in sync" nor "out of sync" is reported by layer 1 on the downlink frequency associated with the primary uplink frequency do not affect the evaluation of the number of consecutive (resp. successive) "in sync" or "out of sync" indications.

For 1.28 Mcps TDD, when the variable E_DCH_TRANSMISSION is set to TRUE (see subclause 8.5.28) and the UE has stored the IE "E-RUCCH info", a "Radio link failure" shall be triggered as below:

1> if the E-RUCCH transmission counter is added greater than N_RUCCH, another hysteresis Timer with the value of N_RUCCH times of T-RUCCH period shall be started:

2> upon the hysteresis Timer expires and still no Grant has been received for the whole time duration since the last E-RUCCH transmission:

3> consider it as a "Radio link failure", refer to [59].

For FDD in CELL_DCH state and in TDD when a radio link failure occurs, the UE shall:

1> clear the dedicated physical channel configuration;

1> perform actions as specified for the ongoing procedure;

1> if no procedure is ongoing or no actions are specified for the ongoing procedure:

2> perform a cell update procedure according to subclause 8.3.1 using the cause "radio link failure".

For FDD, in CELL_FACH state and Idle mode, in conjunction with the Enhanced Uplink in CELL_FACH state, after receiving an indication from layer 1 that physical layer transmission stopped caused by an DL out-of-synchronisation, the UE shall:

1> consider it as a "Radio link failure".

8.5.6a Radio link failure criteria and actions upon radio link failure on the secondary uplink frequency (FDD only)

In CELL_DCH state, after receiving N313 consecutive "out of sync" indications from layer 1 for the established F-DPCH physical channel on the downlink frequency associated with the secondary uplink frequency in FDD, the UE shall for that downlink frequency:

- 1> start timer T313;
- 1> upon receiving N315 successive "in sync" indications from layer 1 on the downlink frequency associated with the secondary uplink frequency and upon change of UE state:
 - 2> stop and reset timer T313.
- 1> if T313 expires:
 - 2> consider it as a "Radio link failure" on the downlink frequency associated with the secondary uplink frequency;
 - 2> deactivate the secondary uplink frequency, as if a HS-SCCH order to deactivate had been received.

Periods in time where neither "in sync" nor "out of sync" is reported by layer 1 on the downlink frequency associated with the secondary uplink frequency do not affect the evaluation of the number of consecutive (resp. successive) "in sync" or "out of sync" indications.

8.5.7 Open loop power control

For FDD, and prior to PRACH transmission or prior to a transmission in Enhanced Uplink in CELL_FACH state and Idle mode, the UE shall:

- 1> acquire valid versions of the necessary System Information IEs as follows:
 - 2> if the UE has stored valid versions of the IEs "Primary CPICH Tx power" and "Constant value":
 - 3> use the stored content of the IEs.
 - 2> otherwise:
 - 3> read and store the IE "Primary CPICH Tx power" and "Constant value" in System Information Block type 6 (or System Information Block type 5 or System Information Block type 5bis, if System Information Block type 6 is not being broadcast).
 - 2> if variable READY_FOR_COMMON_EDCH is set to TRUE; and
 - 2> if IE "UL interference for common E-DCH" is included in system information block type 5 or 5bis:
 - 3> use the stored value of IE "UL interference for common E-DCH".
 - 2> otherwise:
 - 3> if the UE has a valid version of the IE "UL interference" stored:
 - 4> use the stored content of the IE "UL interference".
 - 3> otherwise:
 - 4> read and store the IE "UL interference" in System Information Block type 7;
 - 4> if the UE fails to read the IE "UL interference" in System Information Block type 7 due to bad radio conditions, the UE shall use the last stored IE "UL interference".
- 1> measure the value for the CPICH_RSCP;
- 1> calculate the power for the first preamble as:

$$\text{Preamble_Initial_Power} = \text{Primary CPICH TX power} - \text{CPICH_RSCP} + \text{UL interference} + \text{Constant Value}$$

Where,

Primary CPICH TX power shall have the value of IE "Primary CPICH Tx power",

UL interference shall have the value of IE "UL interference for common E-DCH" if variable READY_FOR_COMMON_EDCH is set to TRUE and IE "UL interference for common E-DCH" is included in SIB 5/5bis; otherwise UL interference shall have the value of IE "UL interference"; and

Constant Value shall have the value of IE "Constant value".

- 1> as long as the physical layer is configured for PRACH transmission or the PRACH preamble part (as part of the Enhanced Uplink in CELL_FACH state and Idle mode):
 - 2> continuously recalculate the Preamble_Initial_Power when any of the broadcast parameters used in the above formula changes; and
 - 2> resubmit to the physical layer the new calculated Preamble_Initial_Power.

For 3.84 Mcps TDD or 7.68 Mcps TDD the UE shall:

- 1> if in the IE "Uplink DPCH Power Control info" the "CHOICE UL OL PC info" has the value "Broadcast UL OL PC info":
 - 2> prior to DPCH transmission the UE shall:
 - 3> acquire valid versions of the necessary System Information IEs as follows:
 - 4> if the UE has stored valid versions of the IEs "Primary CCPCH Tx power" and "DPCH Constant value":
 - 5> use the stored content of the IEs.
 - 4> otherwise:
 - 5> read and store the IE "Primary CCPCH Tx power" and "DPCH Constant value" in System Information Block type 6 (or System Information Block type 5, if System Information Block type 6 is not being broadcast).
 - 3> if the UE has a valid version of the IE "UL interference" for each active UL timeslot stored:
 - 4> use the stored content of the IE "UL interference" for each active UL timeslot.
 - 3> otherwise:
 - 4> read and store the IE "UL Timeslot Interference" for each active UL timeslot in System Information Block type 14;
 - 4> if the UE fails to read the IE "UL Timeslot Interference" for each active UL time slot in System Information Block type 14 due to bad radio conditions, the UE shall use the last stored IE "UL Timeslot interference" for each active UL timeslot.
 - 1> otherwise:
 - 2> acquire Reference Power, Constant Values and I_{BTs} for all active UL timeslots from the IE "Uplink DPCH Power Control info".
- 1> for PUSCH, PRACH and HS-SICH power control:
 - 2> prior to PUSCH or PRACH transmission the UE shall:
 - 3> acquire valid versions of the necessary System Information IEs as follows:
 - 4> if the UE has stored valid versions of the IEs "Primary CCPCH Tx power" and "PUSCH Constant value" for PUSCH transmissions or "PRACH Constant value" for PRACH transmissions:
 - 5> use the stored content of the IEs.

4> otherwise:

5> read and store the IE "Primary CCPCH Tx power" and "PUSCH Constant value" for PUSCH transmissions or "PRACH Constant value" for PRACH transmissions in System Information Block type 6 (or System Information Block type 5, if System Information Block type 6 is not being broadcast).

3> if the UE has a valid version of the IE "UL interference" for each active UL timeslot stored:

4> use the stored content of the IE "UL interference" for each active UL timeslot.

3> otherwise:

4> read and store the IE "UL Timeslot Interference" for each active UL timeslot in System Information Block type 14;

4> if the UE fails to read the IE "UL Timeslot Interference" for each active UL time slot in System Information Block type 14 due to bad radio conditions, the UE shall use the last stored IE "UL Timeslot interference" for each active UL timeslot.

calculate the UL transmit power according to the following formula for the PRACH continuously while the physical channel is active:

$$P_{\text{PRACH}} = L_{\text{PCCPCH}} + I_{\text{BTS}} + \text{PRACH Constant value},$$

2> 3dB shall be added to RACH Constant Value in the above equation for the case where RACH Spreading Factor = 8;

2> for 7.68 Mcps TDD, 3dB shall be added to RACH Constant Value in the above equation for the case where RACH Spreading Factor = 16.

1> calculate the UL transmit power according to the following formula for the DPCH continuously while the physical channel is active:

$$P_{\text{DPCH}} = \alpha L_{\text{PCCPCH}} + (1-\alpha)L_0 + I_{\text{BTS}} + \text{SIR}_{\text{TARGET}} + \text{DPCH Constant value}$$

1> calculate the UL transmit power according to the following formula for the PUSCH continuously while the physical channel is active:

$$P_{\text{PUSCH}} = \alpha L_{\text{PCCPCH}} + (1-\alpha)L_0 + I_{\text{BTS}} + \text{SIR}_{\text{TARGET}} + \text{PUSCH Constant value}$$

1> calculate the initial UL transmit power for HS-SICH according to the following formula:

$$P_{\text{HS-SICH}} = \alpha L_{\text{PCCPCH}} + (1-\alpha)L_0 + I_{\text{BTS}} + \text{SIR}_{\text{TARGET}} + \text{HS-SICH Constant value}$$

Where, for all the above equations for 3.84 Mcps TDD or 7.68 Mcps TDD the following apply:

- P_{PRACH} , P_{DPCH} , P_{PUSCH} and $P_{\text{HS-SICH}}$: Transmitter power level in dBm;
- Pathloss values:
 - L_{PCCPCH} : Measurement representing path loss in dB based on beacon channels (the reference transmit power is signalled as the value of the IE "Primary CCPCH Tx Power" on BCH in System Information Block type 6 (or System Information Block type 5, according to subclause 8.1.1.6.5), or individually signalled in the IE "Uplink DPCH Power Control info").
 - L_0 : Long term average of path loss in dB;
 - If the midamble is used in the evaluation of L_{PCCPCH} and L_0 , and the Tx diversity scheme used for the PCCPCH involves the transmission of different midambles from the diversity antennas, the received power of the different midambles from the different antennas shall be combined prior to evaluation of the variables.
- I_{BTS} : Interference signal power level at cell's receiver in dBm. I_{BTS} shall have the value of the IE "UL Timeslot Interference" (IE "UL Timeslot Interference" is broadcast on BCH in System Information Block

type 14 or individually signalled to each UE in the IE "Uplink DPCH Power Control info" for each active uplink timeslot).

- α : α is a weighting parameter, which represents the quality of path loss measurements. α may be a function of the time delay between the uplink time slot and the most recent down link PCCPCH time slot. α is calculated at the UE. α shall be smaller or equal to the value of the IE "Alpha". If the IE "Alpha" is not explicitly signalled to the UE α shall be set to 1. If UE is capable of estimating its position by using the OTDOA IPDL method, the UE shall use the IPDL- α parameter.
- SIR_{TARGET} : Target SNR in dB. This value is individually signalled to UEs in IE "UL target SIR" in IE "Uplink DPCH Power Control Info" or in IE "PUSCH Power Control Info" or in IE "HS-SICH Power Control Info".
- PRACH Constant value: PRACH Constant value shall have the value of the IE "PRACH Constant value".
- DPCH Constant value: DPCH Constant value shall have the value of the IE "DPCH Constant value".
- PUSCH Constant value: PUSCH Constant value shall have the value of the IE "PUSCH Constant value".
- HS-SICH Constant value: HS-SICH Constant value shall have the value of the IE "HS-SICH Constant value".
- Values received by dedicated signalling shall take precedence over broadcast values.
- If IPDLs are applied, the UE may increase UL Tx power by the value given in the IE "Max power increase". This power increase is only allowed in the slots between an idle slot and the next beacon slot.

For 1.28 Mcps TDD the UE shall:

- 1> acquire valid versions of the necessary System Information IEs as follows:
 - 2> if the UE has stored a valid version of the IE "Primary CCPCH Tx Power":
 - 3> use the stored content of the IE.
 - 2> otherwise:
 - 3> read and store the IE "Primary CCPCH Tx Power" from System Information Block type 6 (or System Information Block type 5, if System Information Block type 6 is not being broadcast).

- 1> calculate the UL transmit power according to the following formula for each UpPCH code transmission:

$$P_{UpPCH} = L_{PCCPCH} + PRX_{UpPCHdes} + (i-1) * P_{Wramp}$$

NOTE: When i equals 1, the initial signature power "Signature_Initial_Power" defined in [33] corresponds to P_{UpPCH} with i set to 1.

- 1> calculate the UL transmit power according to the following formula for each PRACH transmission:

$$P_{PRACH} = L_{PCCPCH} + PRX_{PRACHdes} + (i_{UpPCH}-1) * P_{Wramp}$$

- 1> calculate the initial UL transmit power according to the following formula for the PUSCH. Once the UE receives TPC bits relating to the PUSCH then it transitions to closed loop power control. If successive PUSCH resource allocations are contiguous then no return is made to open loop power control at the beginning of the succeeding resource allocation.

$$P_{USCH} = PRX_{PUSCHdes} + L_{PCCPCH}$$

- 1> calculate the initial UL transmit power for HS-SICH according to the following formula:

$$P_{HS-SICH} = PRX_{HS-SICH} + L_{PCCPCH}$$

- 1> calculate the initial UL transmit power according to the following formula for the DPCH. Once the UE receives TPC bits relating to the uplink DPCH then it transitions to closed loop power control.

$$P_{DPCH} = PRX_{DPCHdes} + L_{PCCPCH}$$

1> calculate the initial UL transmit power for E-PUCH according to the following formula:

$$P_{E\text{-PUCH}} = PRX_{\text{des_base}} + L_{\text{PCCPCH}} + \beta_e$$

Where:

- P_{UpPCH} , P_{PRACH} , P_{DPCH} , $P_{\text{HS-SICH}}$, P_{USCH} , & $P_{E\text{-PUCH}}$: Transmitter power level in dBm.
- L_{PCCPCH} : Measurement representing path loss in dB (reference transmit power "Primary CCPCH Tx Power" is broadcast on BCH in System Information Block type 5 and System Information Block type 6, or individually signalled to each UE in the IE "Uplink DPCH Power Control info").
- i is the number of transmission attempts on UpPCH, $i=1 \dots \text{Max SYNC_UL Transmissions}$.
- i_{UpPCH} is the final value of i .
- PRX_{PRACHdes} : Desired PRACH RX power at the cell's receiver in dBm signalled to the UE by the network in the FPACH response to the UE's successful SYNC_UL transmission.
- PRX_{UpPCHdes} : Desired UpPCH RX power at the cell's receiver in dBm. The value is broadcast in "PRX_{UpPCHdes}" in IE "SYNC_UL info" on BCH and shall be read on System Information Block type 5 and System Information Block type 6. It can also be signalled directly to the UE in IE "Uplink Timing Advance Control" contained in a protocol message triggering a hard handover or a transition from cell FACH to cell DCH state.
- PRX_{PUSCHdes} : Desired PUSCH RX power at the cell's receiver in dBm signalled to the UE in IE "PUSCH Power Control Info".
- PRX_{DPCHdes} : Desired DPCH RX power at the cell's receiver in dBm signalled to the UE in IE "Uplink DPCH Info" and IE "Uplink DPCH Power Control Info".
- P_{wramp} : The UE shall increase its transmission power by the value of the IE "Power Ramp step" by every UpPCH transmission. Its value is signalled in the IE "SYNC UL info" in System Information Block type 5 and System Information Block type 6 or is signalled to the UE in the IE "Uplink Timing Advance Control" contained in a protocol message triggering a hard handover or a transition from cell FACH state to cell DCH state.
- $PRX_{\text{HS-SICH}}$: Desired HS-SICH RX power at the cell's receiver in dBm signalled to the UE in IE "Downlink HS-PDSCH Information".
- Ack-Nack Power Offset: Difference in the desired RX power between HS-SICH transmissions conveying an acknowledgement and transmissions conveying a negative acknowledgement signalled to the UE in IE "HS-SCCH Info".
- $PRX_{\text{des_base}}$: Reference Desired E-PUCH RX power at the cell's receiver in dBm signalled to the UE in CELL_DCH in IE "E-PUCH Info" via dedicated signalling; or via System Information Block 5 for UE in enhanced CELL_FACH and Idle mode.
- β_e : Gain factor for the selected E-TFC transport block size, the allocated E-PUCH physical resources, and the Modulation type and the HARQ power offset (see [33]).

8.5.8 Maintenance of Hyper Frame Numbers

The MSBs of both the ciphering sequence numbers (COUNT-C) and integrity sequence numbers (COUNT-I), for the ciphering and integrity protection algorithms, respectively [40], are called the Hyper Frame Numbers (HFN).

For integrity protection, the UE shall:

- 1> maintain COUNT-I as specified in subclause 8.5.10.

The following hyper frame numbers types are defined:

MAC-d HFN:
24 MSB of COUNT-C for data sent over RLC TM

RLC UM HFN:
25 MSB of COUNT-C for data sent over RLC UM

RLC AM HFN:
20 MSB of COUNT-C for data sent over RLC AM

RRC HFN:
28 MSB of COUNT-I

For non-transparent mode RLC signalling radio bearers and radio bearers, the UE shall:

- 1> maintain one uplink and one downlink COUNT-C per signalling radio bearer and per radio bearer and one uplink and one downlink COUNT-I per signalling radio bearer;
- 1> increment the RLC UM HFN and RLC AM HFN in uplink and downlink by one each time the RLC sequence number wraps around in uplink and downlink respectively;
- 1> if the activation time for a new ciphering configuration set by an RRC procedure is equal to zero:
 - 2> apply the configured RLC UM HFN or RLC AM HFN at this activation time, i.e. the configured HFN is not incremented.

NOTE: On the receiver side it may happen that the RLC PDU with sequence number equal to the activation time is lost and the first received PDU after the activation time implies a wrap around of the sequence number compared to the activation time. In this case the configured HFN is incremented by one. This action is taken only when the activation time is set to a RLC PDU sequence number value other than zero.

For all transparent mode RLC signalling radio bearers and radio bearers of each CN domain, the UE shall:

- 1> maintain one COUNT-C, common for all radio bearers in uplink and downlink;
- 1> increment the MAC-d HFN by one each time the CFN wraps around;
- 1> if the activation time for a new ciphering configuration set by an RRC procedure is equal to zero:
 - 2> apply the configured MAC-d HFN at this activation time, i.e. the configured HFN is not incremented.
- 1> maintain one uplink and one downlink COUNT-I per signalling radio bearer.

NOTE: In this release of the specification there is only an uplink transparent mode COUNT-I, which is used for signalling radio bearer RB0.

COUNT-C and COUNT-I are defined in [40], with the following supplement for COUNT-C: for transparent mode RLC radio bearers with a transmission time interval of x radio frames ($x = 2, 4, 8$), the MAC PDU is carried by L1 in x consecutive radio frames due to radio frame segmentation. In this case, the CFN of the first radio frame in the TTI shall be used as the CFN component of COUNT-C for ciphering of all data in the TTI [15].

8.5.9 START value calculation

In connected mode, if a security mode command procedure has been successfully completed for a CN domain during the current RRC connection, the START value for that CN domain is calculated as:

Let $START_X$ = the START value for CN domain 'X' prior to the calculation below:

$START_X' = MSB_{20} (MAX \{ COUNT-C, COUNT-I \mid \text{radio bearers and signalling radio bearers using the most recently configured } CK_X \text{ and } IK_X \}) + 2$.

- if $START_X' = \text{the maximum value} = 1048575$ then $START_X = START_X'$;
- if the current $START_X < START_X'$ then $START_X = START_X'$, otherwise $START_X$ is unchanged.

NOTE: Here, "most recently configured" means that if there is more than one key in use for a CN domain, due to non-expiry of the ciphering and/or integrity protection activation time for any signalling radio bearers and/or radio bearers, do not include the COUNT-I/COUNT-C for these signalling radio bearers and/or radio bearers in the calculation of the $START_X'$.

COUNT-C corresponding to non-ciphered radio bearers (i.e. RBs with ciphering status set to "not started") shall not be included in the calculation of the $START_X'$. If a radio bearer is released and the radio bearer was ciphered, the values of the COUNT-C at the time the radio bearer is released shall be taken into account in the calculation of the $START_X'$.

If a security mode command procedure has not been successfully completed for a CN domain during the current RRC connection, the UE shall use the latest transmitted START value for this CN domain.

8.5.10 Integrity protection

If the "Status" in the variable INTEGRITY_PROTECTION_INFO has the value "Started" then the UE shall:

1> perform integrity protection (and integrity checking) on all RRC messages, with the following exceptions:

ETWS PRIMARY NOTIFICATION WITH SECURITY

HANDOVER TO UTRAN COMPLETE

MBMS ACCESS INFORMATION

MBMS COMMON P-T-M RB INFORMATION

MBMS CURRENT CELL P-T-M RB INFORMATION

MBMS GENERAL INFORMATION

MBMS MODIFIED SERVICES INFORMATION (MCCH only)

MBMS NEIGHBOURING CELL P-T-M RB INFORMATION

MBMS SCHEDULING INFORMATION

MBMS UNMODIFIED SERVICES INFORMATION

PAGING TYPE 1

PUSCH CAPACITY REQUEST

PHYSICAL SHARED CHANNEL ALLOCATION

RRC CONNECTION REQUEST

RRC CONNECTION SETUP

RRC CONNECTION SETUP COMPLETE

RRC CONNECTION REJECT

RRC CONNECTION RELEASE (CCCH only)

SYSTEM INFORMATION

SYSTEM INFORMATION CHANGE INDICATION

TRANSPORT FORMAT COMBINATION CONTROL (TM DCCH only)

If the "Status" in the variable INTEGRITY_PROTECTION_INFO has the value "Not started" then integrity protection (and integrity checking) shall not be performed on any RRC message.

For each signalling radio bearer, the UE shall use two RRC hyper frame numbers:

- "Uplink RRC HFN";

- "Downlink RRC HFN".

and two message sequence numbers:

- "Uplink RRC Message sequence number";
- "Downlink RRC Message sequence number".

The above information is stored in the variable INTEGRITY_PROTECTION_INFO per signalling radio bearer (RB0-RB4).

Upon the first activation of integrity protection for an RRC connection, UE and UTRAN initialise the "Uplink RRC Message sequence number" and "Downlink RRC Message sequence number" for all signalling radio bearers as specified in subclauses 8.6.3.5 and 8.5.10.1.

The RRC message sequence number (RRC SN) is incremented for every integrity protected RRC message.

If the IE "Integrity Protection Mode Info" is present in a received message, the UE shall:

- 1> perform the actions in subclause 8.6.3.5 before proceeding with the integrity check of the received message.

8.5.10.1 Integrity protection in downlink

If the UE receives an RRC message on signalling radio bearer with RB identity n, the "Status" in the variable INTEGRITY_PROTECTION_INFO has the value "Started" and the IE 'Integrity check info' is present the UE shall:

- 1> check the value of the IE "RRC message sequence number" included in the IE "Integrity check info";
 - 2> if the "Downlink RRC Message sequence number" is not present in the variable INTEGRITY_PROTECTION_INFO:
 - 3> initialise the "Downlink RRC Message sequence number" for signalling radio bearer RBn in the variable INTEGRITY_PROTECTION_INFO with the value of the IE "RRC message sequence number" included in the IE "Integrity check info" of the received message.
 - 2> if the "Downlink RRC Message sequence number" is present in the variable INTEGRITY_PROTECTION_INFO:
 - 3> if the RRC message sequence number is lower than the "Downlink RRC Message sequence number" for signalling radio bearer RBn in the variable INTEGRITY_PROTECTION_INFO:
 - 4> increment "Downlink RRC HFN" for signalling radio bearer RBn in the variable INTEGRITY_PROTECTION_INFO with one.

NOTE: The actions above imply that also for the case the "Downlink RRC HFN" is re-initialised by a security mode control procedure, this "Downlink RRC HFN" value is incremented by one before it is applied for the integrity protection of any received message if the conditions above are fulfilled.

- 3> if the RRC message sequence number is equal to the "Downlink RRC Message sequence number" for signalling radio bearer RBn in the variable INTEGRITY_PROTECTION_INFO:
 - 4> discard the message.
- 1> calculate an expected message authentication code in accordance with subclause 8.5.10.3;
- 1> compare the expected message authentication code with the value of the received IE "message authentication code" contained in the IE "Integrity check info";
 - 2> if the expected message authentication code and the received message authentication code are the same, the integrity check is successful:
 - 3> update the "Downlink RRC Message sequence number" for signalling radio bearer RBn in the variable INTEGRITY_PROTECTION_INFO with the value of the IE "RRC message sequence number" included in the IE "Integrity check info" of the received RRC message.
 - 2> if the calculated expected message authentication code and the received message authentication code differ:

3> act as if the message was not received.

If the UE receives an RRC message on signalling radio bearer with identity 0, 1, or 2, the "Status" in the variable INTEGRITY_PROTECTION_INFO has the value "Started" and the IE 'Integrity check info' is not present the UE shall:

1> discard the message.

If the UE receives an RRC message on signalling radio bearer with identity 3 or 4, the "Status" in the variable INTEGRITY_PROTECTION_INFO has the value "Started" and the IE 'Integrity check info' is not present:

1> if a security mode command procedure has not been successfully completed during the current RRC connection for the CN domain indicated by IE "CN Domain Identity" in the received message:

2> the UE shall forward the message to upper layer.

1> else:

2> the UE shall discard the message.

UTRAN may transmit several copies of the same message in the downlink to increase the probability of proper reception of the message by the UE. In such a case, the RRC SN for these repeated messages should be the same.

8.5.10.2 Integrity protection in uplink

Prior to sending an RRC message using the signalling radio bearer with radio bearer identity n, and the "Status" in the variable INTEGRITY_PROTECTION_INFO has the value "Started" the UE shall:

1> increment "Uplink RRC Message sequence number" for signalling radio bearer RBn in the variable INTEGRITY_PROTECTION_INFO with 1, even if the message is a retransmission of a previously transmitted message.

1> if the "Uplink RRC Message sequence number" for signalling radio bearer RBn in the variable INTEGRITY_PROTECTION_INFO equals zero:

2> increment "Uplink RRC HFN" for signalling radio bearer RBn in the variable INTEGRITY_PROTECTION_INFO by one.

NOTE 1: The actions above imply that also for the case the "Uplink RRC HFN" is re-initialised by a security mode control procedure, this "Uplink RRC HFN" is incremented before it is applied in the integrity protection of any transmitted message if the conditions above are fulfilled.

NOTE 2: For SRB0, this is also valid in case the Message Sequence Number has been increased by N302 +2 resulting in an MSN which equals 0 (i.e.: SRB0 UL activation time equals 0). Then the uplink RRC HFN is incremented by 1 after it is re-initialized and before it is applied in the integrity protection of any transmitted message.

1> calculate the message authentication code in accordance with subclause 8.5.10.3;

1> replace the "Message authentication code" in the IE "Integrity check info" in the message with the calculated message authentication code;

1> replace the "RRC Message sequence number" in the IE "Integrity check info" in the message with contents set to the new value of the "Uplink RRC Message sequence number" for signalling radio bearer RBn in the variable INTEGRITY_PROTECTION_INFO.

In the response message for the procedure ordering the security reconfiguration, the UE indicates the activation time, for each signalling radio bearer. When the new integrity configuration is to be applied in uplink, UTRAN should start to apply the new integrity protection configuration according to the activation time for each signalling radio bearer (except for the signalling radio bearer which is used to send the message that is reconfiguring the security configuration where the new configuration is to be applied starting from and including reception of the response message).

8.5.10.3 Calculation of message authentication code

The UE shall calculate the message authentication code in accordance with [40]. The input parameter MESSAGE [40] for the integrity algorithm shall be constructed by:

- 1> setting the "Message authentication code" in the IE "Integrity check info" in the message to the value of the IE "RB identity" for the signalling radio bearer;
- 1> setting the "RRC Message sequence number" in the IE "Integrity check info" in the message to zero;
- 1> encoding the message;
- 1> appending RRC padding (if any) as a bit string to the encoded bit string as the least significant bits.

For usage on an RRC message transmitted or received on the radio bearer with identity n, the UE shall:

- 1> construct the input parameter COUNT-I [40] by appending the following IEs from the IE "Signalling radio bearer specific integrity protection information" for radio bearer n in the variable INTEGRITY_PROTECTION_INFO:
 - 2> for uplink:
 - 3> "Uplink RRC HFN", as the MSB, and "Uplink RRC Message sequence number", as LSB.
 - 2> for downlink:
 - 3> "Downlink RRC HFN", as the MSB, and the IE "RRC message sequence number" included in the IE "Integrity check info", as LSB.

8.5.11 FACH measurement occasion calculation

For 3.84 Mcps TDD and 7.68 Mcps TDD, when in CELL_FACH state and when the variable C_RNTI is non-empty, or for FDD and 1.28 Mcps TDD, when in CELL_FACH state, when the variable C_RNTI is non-empty and when variable HS_DSCH_RECEPTION_CELL_FACH_STATE is set to FALSE, then the UE shall perform measurements as specified in subclauses 8.4.1.6 and 8.4.1.9 during the frame(s) with the SFN value fulfilling the following equation:

$$\text{SFN div } N = \text{C_RNTI mod } M_REP + n * M_REP$$

where

- N is the TTI (in number of 10ms frames) of the FACH having the largest TTI on the SCCPCH selected by the UE according to the procedure in subclause 8.5.19. FACHs that only carry MBMS logical channels (MTCH, MSCH, or MCCH) are excluded from measurement occasion calculations.
- C_RNTI is the C-RNTI value of the UE stored in the variable C_RNTI
- M_REP is the Measurement Occasion cycle length. According to the equation above, a FACH Measurement Occasion of N frames will be repeated every $N * M_REP$ frame, and $M_REP = 2^k$.

where,

- k is the FACH Measurement occasion cycle length coefficient.
The value of the FACH Measurement occasion cycle length coefficient is read in system information in "System Information Block type 11" or "System Information Block type 12" in the IE "FACH measurement occasion info".
- n = 0,1,2... as long as SFN is below its maximum value

The UE is allowed to measure on other occasions in case the UE moves "out of service" area or in case it can simultaneously perform the ordered measurements.

A UE in TDD mode shall use the frame(s) with the SFN value fulfilling the above equation for neighbour cells measurements.

For FDD when in CELL_FACH state, when the variable C_RNTI is non-empty, when variable HS_DSCH_RECEPTION_CELL_FACH_STATE is set to TRUE, when variable COMMON_E_DCH_TRANSMISSION is set to FALSE, when the variable HS_DSCH_DRX_CELL_FACH_STATUS is set to FALSE and when the variable HS_DSCH_DRX_CELL_FACH_2CYCLE_STATUS is set to FALSE then the UE in FDD mode shall perform measurements as specified in subclauses 8.4.1.6 and 8.4.1.9 during the frame(s) with the SFN value fulfilling the following equation:

$$\text{SFN} = \text{H-RNTI} \bmod \text{M_REP} + n * \text{M_REP}$$

where

- H-RNTI is the value stored in the variable H_RNTI.
- M_REP is the Measurement Occasion cycle length. According to the equation above, a FACH Measurement Occasion of 10ms-frame will be repeated every M_REP frame, and $\text{M_REP} = 2^k$.

where,

- k is the FACH Measurement occasion cycle length coefficient.
The value of the FACH Measurement occasion cycle length coefficient is read in system information in "System Information Block type 11" or "System Information Block type 12" in the IE "FACH measurement occasion info".
- n = 0,1,2... as long as SFN is below its maximum value.

The UE is allowed to measure on other occasions in case the UE moves "out of service" area or in case it can simultaneously perform the ordered measurements.

NOTE: For FDD, in order to meet the MBMS demodulation performance requirements [21], a UE receiving MBMS PTM may not be able use the entire measurement occasion.

For 1.28 Mcps TDD when in CELL_FACH state, when the variable C_RNTI is non-empty, when variable HS_DSCH_RECEPTION_CELL_FACH_STATE is set to TRUE, and when the HS-SCCH(s), E-AGCH(s) and HS-PDSCH are not configured in TS0, then UE can perform the ordered measurements on any occasions.

For 1.28 Mcps TDD when in CELL_FACH state, when the variable C_RNTI is non-empty, when variable HS_DSCH_RECEPTION_CELL_FACH_STATE is set to TRUE, and when the HS-SCCH(s), E-AGCH(s) or HS-PDSCH are configured in TS0, then the UE shall perform measurements as specified in subclauses 8.4.1.6 and 8.4.1.9 during the frame(s) with the SFN value fulfilling the following equation:

$$\text{SFN} = \text{H-RNTI} \bmod \text{M_REP} + n * \text{M_REP}$$

where

- H-RNTI is the value stored in the variable H_RNTI.
- M_REP is the Measurement Occasion cycle length. According to the equation above, a FACH Measurement Occasion of 10ms-frame will be repeated every M_REP frame, and $\text{M_REP} = 2^k$.

where,

- k is the FACH Measurement occasion cycle length coefficient.
The value of the FACH Measurement occasion cycle length coefficient is read in system information in "System Information Block type 11" or "System Information Block type 12" in the IE "FACH measurement occasion info".
- n = 0,1,2... as long as SFN is below its maximum value.

The UE is allowed to measure on other occasions in case the UE moves "out of service" area or in case it can simultaneously perform the ordered measurements.

8.5.11a CELL_DCH measurement occasion calculation (1.28 Mcps TDD only)

In CELL_DCH state, when the CELL_DCH measurement occasion pattern sequence(s) is(are) configured and activated for the specified measurement purpose as specified in the subclause 8.6.7.26, then the UE shall perform corresponding measurements as specified in subclauses 8.4.1.7 and 8.4.1.8 during the timeslot(s) indicated by IE: "Timeslot Bitmap" within the frames from the frame SFN_{start} to SFN_{start} + M_Length - 1 frame belong to the allocation with SFN_{start} fulfilling the following equation:

$$\text{SFN}_{\text{start}} \bmod (2^k) = \text{offset}$$

where

- k is CELL_DCH measurement occasion cycle length coefficient and signalled by the IE "k" in the IE "CELL_DCH measurement occasion info LCR". The actual measurement occasion period equal to 2^k radio frames.
- Offset is the measurement occasion position in the measurement period. and signalled by the IE "Offset" in the IE "CELL_DCH measurement occasion info LCR".
- M_Length is the actual measurement occasion length in frames starting from the Offset and signalled by the IE "M_Length" in the IE "CELL_DCH measurement occasion info LCR".

8.5.12 Establishment of Access Service Classes

The PRACH resources (i.e. access slots and preamble signatures for FDD), timeslot (with specific frame allocation and channelisation code for 3.84 Mcps TDD and 7.68 Mcps TDD, and SYNC_UL codes (with specific frame allocation) for 1.28 Mcps TDD) may be divided between different Access Service Classes in order to provide different priorities of RACH usage. It is possible for more than one ASC or for all ASCs to be assigned to the same access slot/signature space in FDD or frame allocation/channelisation codes in 3.84 Mcps TDD or 7.68 Mcps TDD, or frame allocation/SYNC_UL codes in 1.28 Mcps TDD.

Access Service Classes shall be numbered in the range $0 \leq i \leq \text{NumASC} \leq 7$ (i.e. the maximum number of ASCs is 8). An ASC is defined by an identifier, i , that defines a certain partition of the PRACH resources (SYNC_UL resources in 1.28 Mcps TDD) and an associated persistence value P_i . A set of ASC parameters consists of "NumASC+1" such parameters (i, P_i) , $i = 0, \dots, \text{NumASC}$.

PRACH partitions shall be established using the information element "PRACH partitioning". The persistence values P_i to be associated with each ASC shall be derived from the dynamic persistence level $N = 1, \dots, 8$ which is broadcast in System Information Block 7, and the persistence scaling factors s_i , broadcast in System Information Block Type 5 or System Information Block type 5bis and possibly also in System Information Block Type 6, as follows:

$$P(N) = 2^{-(N-1)}$$

ASC # i	0	1	2	3	4	5	6	7
P_i	1	$P(N)$	$s_2 P(N)$	$s_3 P(N)$	$s_4 P(N)$	$s_5 P(N)$	$s_6 P(N)$	$s_7 P(N)$

In addition, MBMS specific persistence values may be provided within the MBMS MODIFIED SERVICES INFORMATION message. The UE behaviour upon receiving upon receiving an MBMS dynamic persistence value is specified in subclause 8.6.9.1a.

Scaling factors s_i are provided optionally for $i = 2, \dots, \text{NumASC}$, where NumASC+1 is the number of ASCs as defined by PRACH partitioning. If no scaling factors are broadcast, default value 1 shall be used if NumASC ≥ 2 .

If $k \geq 1$ scaling factors are broadcast and NumASC $\geq k+2$ then the last scaling factor s_{k+1} shall be used as default for the ASCs where $i > k+1$.

In the case of E-RUCCH operation (3.84/7.68 Mcps TDD only) a separate set of persistence values will be used. For E-RUCCH a single scaling factor S_i is signalled. If the E-RUCCH shares resource with a PRACH then dynamic persistence levels of the PRACH are used and persistence values are determined using the table below:

ASC # <i>i</i>	0	1	2 – 7
P_i (E-RUCCH)	1	$P(N)$	$S_r P(N)$

Else if the E-RUCCH does not share resource with a PRACH then persistence values are determined using the table below:

ASC # <i>i</i>	0	1	2--7
P_i (E-RUCCH)	1	1	S_r

The establishment of Access Service Classes for E-RUCCH (1.28 Mcps TDD only) is similar as PRACH, differently Access Service Classes parameters and persistence scaling factors of E-RUCCH may be acquired from the information element "E-RUCCH info", e.g. in the case of E-DCH serving cell change. Only in the case that the UEs with E-DCH and E-RUCCH configured on the Primary Frequency of the multi-frequency cell, the E-DCH serving cell unchanged and the UEs can obtain the dynamic persistence level N from SIB7 according to the configuration of information element "E-RUCCH info", the dynamic persistence value N shall be used. Otherwise, dynamic persistence level $N=1$ shall always be used. The persistence values are determined using the table below:

ASC # <i>i</i>	0	1	2	3	4	5	6	7
P_i (E-RUCCH)	1	$P(N)$	$s_2 P(N)$	$s_3 P(N)$	$s_4 P(N)$	$s_5 P(N)$	$s_6 P(N)$	$s_7 P(N)$

The set of ASC parameters is provided to MAC with the CMAC-Config-REQ primitive (see [15]), the PRACH partitioning is provided to PHY using the CPHY-RL-Setup-REQ primitive (see [34]). For 3.84/7.68 Mcps TDD E-DCH operation the E-RUCCH persistence values will also be provided to MAC with the CMAC-Config-REQ primitive.

The ASC enumeration shall be such that it corresponds to the order of priority (ASC 0 = highest priority, ASC 7 = lowest priority). ASC 0 shall be used in case of Emergency Call or for reasons with equivalent priority.

ASCs are numbered according to the order in which the IEs "ASC Setting" appear in the IE "PRACH partitioning", where the first IE "ASC Setting" describes ASC 0, the second IE "ASC Setting" describes ASC 1, etc.

At radio bearer setup/reconfiguration each involved logical channel is assigned a MAC Logical channel Priority (MLP) in the range 1,...,8. When the MAC sublayer is configured for RACH transmission in the UE, these MLP levels shall be employed for ASC selection on MAC.

8.5.13 Mapping of Access Classes to Access Service Classes

Access Classes shall only be applied at initial access, i.e. when sending an RRC CONNECTION REQUEST message. A mapping between Access Class (AC) and Access Service Class (ASC) shall be indicated by the information element "AC-to-ASC mapping" in System Information Block type 5 or System Information Block type 5bis. The correspondence between AC and ASC shall be indicated as follows.

AC	0 - 9	10	11	12	13	14	15
ASC	1 st IE	2 nd IE	3 rd IE	4 th IE	5 th IE	6 th IE	7 th IE

In the table, "nth IE" designates an ASC number i in the range 0 - 7 to AC. If the ASC indicated by the "nth IE" is undefined, the UE behaviour is unspecified.

For the random access and the Enhanced Uplink in CELL_FACH state and Idle mode, the parameters implied by the respective ASC shall be employed. In case the UE is member of several ACs it shall select the ASC for the highest AC number. In connected mode, AC shall not be applied.

8.5.14 PLMN Type Selection

Depending on UE configuration, the UE is operating in "ANSI-41 mode" or "GSM-MAP mode".

8.5.14a Neighbour cells list narrowing for cell reselection

While a UE is camping on a suitable cell, a UE having performed the PLMN identification of the neighbour cells as specified in subclause 8.1.1.6.18 shall narrow the cell list to be used for cell reselection ([4]) to those neighbour cells for which:

The PLMN identity is part of the PLMNs that can make a cell suitable as defined in [4].

8.5.15 CFN calculation

The DOFF used in the formulas in this clause concerns the value of IE "Default DPCH Offset Value" received in the message that instructs the UE to enter CELL_DCH state or to perform timing re-initialised hard handover.

Subclause 8.5.15.5 is used in FDD to initialise the CFN for MTCH and/or MSCH if the IE "MBMS Soft Combining Timing Offset" is included for an S-CCPCH in MBMS CURRENT CELL P-T-M RB INFORMATION or MBMS NEIGHBOURING CELL P-T-M RB INFORMATION, and if only MTCH and/or MSCH are on the S-CCPCH. Otherwise, subclauses 8.5.15.1 through 8.5.15.4 are used to initialise the CFN.

8.5.15.1 Initialisation for CELL_DCH state after state transition

When the UE receives any of the messages causing the UE to perform a state transition to CELL_DCH, the UE shall set the CFN in relation to the SFN of the first radio link listed in the IE "Downlink information per radio link list" included in that message according to the following formula:

- for FDD:

$$\text{CFN} = (\text{SFN} - (\text{DOFF} \text{ div } 38400)) \text{ mod } 256$$

where the formula gives the CFN of the downlink DPCH or F-DPCH frame which starts at the same time as or which starts during the PCCPCH frame with the given SFN. DOFF is determined according to subclause 8.6.6.14.

- for TDD:

$$\text{CFN} = (\text{SFN} - \text{DOFF}) \text{ mod } 256.$$

8.5.15.2 Initialisation in CELL_DCH state at hard handover

When the UE is in CELL_DCH state and receives any of the messages causing the UE to perform a hard handover, the UE shall check the IE "Timing indication" in that message and:

1> if IE "Timing indication" has the value "initialise" (i.e. timing re-initialised hard handover):

2> read SFN on target cell identified by the first radio link listed in the IE "Downlink information per radio link list" included in that message;

2> set the CFN according to the following formula:

3> for FDD:

$$\text{CFN} = (\text{SFN} - (\text{DOFF} \text{ div } 38400)) \text{ mod } 256$$

where the formula gives the CFN of the downlink DPCH or F-DPCH frame which starts at the same time as or which starts during the PCCPCH frame with the given SFN.

3> for TDD:

$$\text{CFN} = (\text{SFN} - \text{DOFF}) \text{ mod } 256.$$

- 1> if IE "Timing indication" has the value "maintain" (i.e. timing-maintained hard handover), the UE shall keep CFN with no change due to the hard handover, and only increase CFN (mod 256) by 1 every frame.

8.5.15.3 Initialisation for CELL_FACH

Unless the conditions of subclause 8.5.15.5 are met, when the UE performs cell selection, re-selection or changes to CELL_FACH state the UE shall set CFN for all common or shared channels according to:

$$\text{CFN} = \text{SFN} \bmod 256$$

where the formula gives the CFN of the downlink common or shared channel frame which starts at the same time as or which starts during the PCCPCH frame with the given SFN.

After the initialisation, the CFN in the UE is increased (mod 256) by 1 every frame.

8.5.15.4 Initialisation after intersystem handover to UTRAN

Upon inter RAT handover to UTRAN the UE shall, regardless of the value received within IE "Timing indication" (if received):

- 1> read SFN on target cell and set the CFN according to the following formula:

- 2> for FDD:

$$\text{CFN} = (\text{SFN} - (\text{DOFF} \div 38400)) \bmod 256$$

where the formula gives the CFN of the downlink DPCH frame which starts at the same time as or which starts during the PCCPCH frame with the given SFN.

- 2> for TDD:

$$\text{CFN} = (\text{SFN} - \text{DOFF}) \bmod 256.$$

8.5.15.5 Initialisation for MTCH and/or MSCH carried on S-CCPCH that may be soft combined

For FDD, if the IE "MBMS Soft Combining Timing Offset" is included for an S-CCPCH in MBMS CURRENT CELL P-T-M RB INFORMATION or MBMS NEIGHBOURING CELL P-T-M RB INFORMATION, and if only MTCH and/or MSCH are on the S-CCPCH, the UE shall set CFN for the S-CCPCH according to:

$$\text{CFN} = (\text{SFN} - (\text{SCTO} \div 10\text{ms})) \bmod 256$$

where the formula gives the CFN of the downlink S-CCPCH frame which starts at the same time as or which starts during the PCCPCH frame with the given SFN.

the SCTO used in the formula is the IE "MBMS Soft Combining Timing Offset".

After the initialisation, the CFN in the UE is increased (mod 256) by 1 every frame.

8.5.16 Configuration of CTCH occasions

The CTCH, carrying CBS data is mapped onto only one S-CCPCH. If more than one CTCH is defined, the first CTCH that is configured in the list of S-CCPCHs is the one that is used for CBS data. If the UE is in connected mode it shall ignore any CTCH configuration contained in System Information Block type 6 and use the CTCH configuration contained in System Information Block 5.

The CTCH occasions are identified by the first radio frame of the TTI that can contain CTCH data. The CTCH occasions are fixed on the system frame number cycle 0 .. 4095 (i.e. no modulo calculation) and thus repeated cyclically.

The CTCH occasions are determined by a set of parameters.

M_{TTI} : number of radio frames within the TTI of the FACH used for CTCH

N: period of CTCH allocation on S-CCPCH, integer number of radio frames,
 $M_{TTI} \leq N \leq 256$, where N is a multiple of M_{TTI} (see [27] and [31]).

MaxSFN: maximum system frame number = 4095 (see [10]).

K: CBS frame offset, integer number of radio frames $0 \leq K \leq N-1$ where K is a multiple of M_{TTI} .

The CTCH occasions are calculated as follows:

$$SFN = (K + m N), m = 0, 1, \dots, M, \text{ with } M \text{ chosen that } K + MN \leq \text{MaxSFN}.$$

The parameters N and K are broadcast as system information.

If the IE "Period of BMC scheduling messages (P)" is included in System Information Block type 5 or System Information Block type 5bis then BMC Schedule Messages are transmitted periodically every P CTCH occasions. One BMC Schedule Message may be segmented across more than one CTCH occasion. The CTCH occasions that contain the start of the BMC Schedule Messages are calculated as follows:

$$SFN = (K + m P N), \text{ where } m \text{ is an integer and } 0 \leq SFN \leq \text{MaxSFN}$$

If the IE "Period of BMC scheduling messages (P)" is not included in system information block type 5 then BMC Schedule Messages could be transmitted in any CTCH occasion.

8.5.17 PRACH selection

For this version of the specification, when a UE selects a cell, the uplink frequency to be used for the initial PRACH transmission shall have a default duplex frequency spacing offset from the downlink frequency that the cell was selected on. The default duplex frequency separation to be used by the UE is specified in [21] for each frequency band (for FDD only).

NOTE: The PRACH selection scheme assumes that all PRACHs configured in System Information Block type 5, System Information Block type 5bis and System Information Block type 6 support all (implicitly or explicitly) configurable RLC sizes of the cell, i.e. at least the transport formats corresponding to a single transport block of each applicable RLC size of the cell must be defined for each PRACH.

The UE shall select a "PRACH system information" according to the following rule. The UE shall:

- 1> select a "PRACH system information" from the ones indicated in the IE "PRACH system information list" in System Information Block type 5 or in System Information Block type 5bis (applicable in Idle Mode and Connected Mode) or System Information Block type 6 (applicable in Connected Mode only), as follows:
 - 2> if in connected mode and System Information Block type 6 is defined and includes PRACH info:
 - 3> compile a list of candidate PRACHs that consists of the PRACH system information listed in System Information Block 6, in the order of appearance as in System Information Block 6.
 - 2> otherwise:
 - 3> compile a list of candidate PRACHs that consists of the PRACH system information listed in System Information Block 5 or in System Information Block 5bis, in the order of appearance as in System Information Block 5 or in System Information Block 5bis, respectively.
- 2> in FDD:
 - 3> perform RACH TTI selection as specified in subclause 8.5.18.1.
- 2> in 1.28 Mcps TDD:
 - 3> perform RACH TTI selection according to subclause 8.5.18.2.
- 2> remove from the list of candidate PRACHs those PRACHs that have a TTI length different from the selected value;
- 2> select a PRACH randomly from the list of candidate PRACHs as follows:

"Index of selected PRACH" = floor (rand * K)

where K is equal to the number of candidate PRACH system informations, "rand" is a random number uniformly distributed in the range $0 \leq \text{rand} < 1$ and "floor" refers to rounding down to nearest integer. The candidate PRACH system informations shall be indexed from 0 to K-1. The random number generator is left to implementation. The scheme shall be implemented such that one of the available PRACH system informations is randomly selected with uniform probability. At start-up of the random number generator in the UE the seed shall be dependent on the IMSI of the UE or time, thereby avoiding that all UEs select the same RACH;

- 2> use the TFCS of the selected PRACH when performing TFC selection (see [15]);
- 2> reselect the PRACH system information when a new cell is selected. RACH reselection may also be performed after each transmission of a Transport Block Set on RACH.
- 1> for emergency call, the UE is allowed to select any of the available PRACH system informations.

After selecting a PRACH system information, the RRC in the UE shall configure the MAC and the physical layer for the RACH access according to the parameters included in the selected "PRACH system information" IE.

8.5.18 Selection of RACH TTI

8.5.18.1 FDD

In FDD mode, a RACH may employ either 10 or 20 ms TTI. The supported TTI is indicated as a semi-static parameter of the RACH Transport Format in system information. The UE shall select an appropriate TTI length from the RACHs included in the list of candidate PRACH(s) according to the following rule.

The UE shall:

- 1> if only RACHs with one particular TTI length are included in the list of candidate PRACH(s):
 - 2> select this TTI length and proceed as specified in subclause 8.5.17.
- 1> if both PRACHs with 10ms and 20ms TTI lengths are included in the list of candidate PRACH(s):
 - 2> perform TTI selection as follows:
 - 3> when the UE calculates the initial preamble transmit power ("Preamble_Initial_Power") as specified in subclause 8.5.7:
 - 4> select a TF to be employed for calculation of a transmit power margin as follows:
 - 5> from the TFs supported by all candidate PRACHs keep those which correspond to a single transport block of all configured RLC sizes (i.e., in idle mode, the RLC size applicable for RB0, in connected mode, the RLC sizes configured with explicit "RB mapping info"). If more than a single TF remain applicable, the UE may select any of these. Preferably the UE should select the TF which is intended to be used at the next transmission or, if such information is not available, the TF corresponding to the largest configured RLC size.
 - 4> calculate a transmit power margin,

$$\text{Margin} = \{ \min(\text{Maximum allowed UL tx power, P_MAX}) - \max(\text{Preamble_Initial_Power, Preamble_Initial_Power} + \Delta P_{p-m} + 10 \cdot \log_{10}(1 + (\beta_d / \beta_c)^2)) \}$$

where "Maximum allowed UL tx power" is the maximum allowed uplink transmit power indicated in system information (in dBm), and P_MAX is the maximum RF output power of the UE (dBm). The margin shall be calculated for the gain factors β_d and β_c of the TF selected in the step above, using 10ms TTI length.

NOTE 1: the expression $\text{Preamble_Initial_Power} + \Delta P_{p-m} + 10 \cdot \log_{10}(1 + (\beta_d / \beta_c)^2)$ represents the total RACH message power if the message would be sent after the initial preamble.

NOTE 2: For all PRACHs with the same TTI the UTRAN should set each of the IEs "Primary CPICH TX power", "Constant value" to the same value, and within these PRACH configurations, the UTRAN should, for all TFs including a single TB, set each of the IEs "Gain Factor β_c ", "Gain Factor β_d " and "Power offset P_{p-m} " to the same value. If these guidelines are not followed, the UE behaviour is unspecified.

3> if the resulting "Margin" value is less than 6 dB:

4> select RACH with 20 ms TTI, and proceed as specified in subclause 8.5.17.

3> otherwise, if the last L1 message transmission on PRACH failed (see [15]):

4> the UE may select RACH with 20ms TTI length and proceed as specified in subclause 8.5.17.

3> otherwise:

4> select RACH with 10ms TTI length and proceed as specified in subclause 8.5.17.

8.5.18.2 1.28 Mcps TDD

In 1.28 Mcps TDD, a RACH may be assigned a 5, 10 or 20 ms TTI. If, in one cell, more than one RACH is defined a UE shall select the RACH that is to be used for each transmission according to the following rule:

1> if only RACHs with one particular TTI length are assigned a transport format that is suitable for the transmission of the transport block set:

2> select this RACH's TTI length.

1> if more than one RACHs are assigned a transport format that is suitable for the transmission of the transport block set:

2> select the longest of the TTI lengths of these RACHs.

8.5.19 Secondary CCPCH selection

In UTRAN Connected mode, the UE shall select the Secondary CCPCH according to the following rules:

1> in CELL_DCH state:

2> select Secondary CCPCH according to subclause 8.6.6.4.

1> in CELL_FACH state:

2> if System Information Block type 6 is defined and includes one or more SCCPCH that carry a FACH, compile a list of candidate SCCPCH that consists of these SCCPCH, in the order of appearance in System Information Block type 6.

NOTE 1: An SCCPCH carries a FACH if the size of the "FACH/PCH information" list within the IE "Secondary CCPCH system information" exceeds 1 or if the size of this list equals 1 while IE "Secondary CCPCH system information" does not contain an IE "PICH info".

2> otherwise:

3> compile a list of candidate SCCPCH that consists of the SCCPCH(s) included in System Information Block type 5 or System Information Block type 5bis that carry a FACH, in the order of appearance in System Information Block type 5 or System Information Block type 5bis.

2> select an SCCPCH from the list of candidate SCCPCHs based on U-RNTI as follows:

$$\text{"Index of selected SCCPCH"} = \text{U-RNTI mod K},$$

where K is equal to the number of candidate SCCPCHs.

1> in CELL_PCH and URA_PCH states:

- 2> if System Information Block type 6 is defined and includes one or more SCCPCH that carry a PCH, compile a list of candidate SCCPCH that consists of these SCCPCH, in the order of appearance in System Information Block type 6

NOTE 2: An SCCPCH carries a PCH if the IE "Secondary CCPCH system information" contains IE "PICH info"

- 2> otherwise compile a list of candidate SCCPCH that consists of the SCCPCH(s) included in System Information Block type 5 or System Information Block type 5bis that that carry a PCH , in the order of appearance in System Information Block type 5 or System Information Block type 5bis;
- 2> select an SCCPCH from the list of candidate SCCPCHs based on U-RNTI as follows:

$$\text{"Index of selected SCCPCH"} = \text{U-RNTI mod K},$$

where K is equal to the number of candidate SCCPCHs.

The UE shall set the CFN in relation to the SFN of the current cell according to subclause 8.5.15.

The UE shall decode all transport formats on all FACHs multiplexed on the selected S-CCPCH according to its UE capability, as defined in subclauses 8.1.1.6.5 and 8.1.1.6.6, to find blocks addressed to the UE.

8.5.19a Secondary CCPCH and FACH selection for MCCH reception

The UE shall select the Secondary CCPCH for acquiring MCCH information according to the following rules:

- 1> if System Information Block type 5 or System Information Block type 5bis is defined and includes an S-CCPCH within the IE "Secondary CCPCH system information" including a FACH for which the IE "MCCH configuration information" is included:
 - 2> select that S-CCPCH and FACH for receiving MCCH.
- 1> otherwise if System Information Block type 5 or System Information Block type 5bis is defined and includes an SCCPCH within the IE "Secondary CCPCH system information MBMS" for which the IE "FACH carrying MCCH" is included:
 - 2> select that S-CCPCH and FACH for receiving MCCH.

8.5.20 Unsupported configuration

The UE should set the variable UNSUPPORTED_CONFIGURATION to TRUE if the received message is not according to the UE capabilities.

8.5.21 Actions related to Radio Bearer mapping

When the UE receives the IEs "RB mapping info", "CCCH mapping info", "SRB1 mapping info" and/or the IE "Transport format set", when transport channels, MAC-d flows, MAC-ehs reordering queues or E-DCH MAC-d flows are added or deleted, when the UE performs a cell reselection or a state transition, or when the UE releases a RB, or when the value stored in the variable FALLBACK_R99_PRACH_ENABLED changes, the UE shall for each of the configured Radio Bearers:

- 1> upon moving to CELL_FACH state from URA_PCH, CELL_PCH or CELL_DCH state to initiate a cell update procedure and upon subsequent cell reselections until the first successfully completed cell update procedure, only perform the actions defined in the remainder of this subclause after reception of the CELL UPDATE CONFIRM message;
- 1> for FDD, select the multiplexing option according to the following:
 - 2> if the UE is in CELL_PCH state:
 - 3> if the UE does support HS-DSCH reception in CELL_PCH and URA_PCH state and IE "HS-DSCH paging system information" is included in System Information Block type 5 or System Information Block type 5bis; or
 - 3> if the variable HSPA_RNTI_STORED_CELL_PCH is set to TRUE:

- 4> if the UE does support Enhanced Uplink in CELL_FACH state and Idle mode and the IE "Common E-DCH system info" is included in System Information Block type 5 or System Information Block type 5bis and if C-RNTI, H-RNTI and primary E-RNTI are provided to the UE:
 - 5> if the RB has a multiplexing option with transport channel type "HS-DSCH" for the DL, and the corresponding MAC-ehs reordering queue is configured, and transport channel type "E-DCH" for the UL and the corresponding common E-DCH MAC-d flow is configured:
 - 6> select this multiplexing option;
 - 4> else:
 - 5> if the RB has a multiplexing option with transport channel type "HS-DSCH" for the DL, and the corresponding MAC-ehs reordering queue is configured, and transport channel type "RACH" for the UL:
 - 6> select this multiplexing option.
- 2> if the UE is in CELL_FACH state:
- 3> if the UE does not support HS-DSCH reception in CELL_FACH state; or
 - 3> if the IE "HS-DSCH common system information" is not included in System Information Block type 5 or System Information Block type 5bis:
 - 4> if the RB has a multiplexing option with transport channel type "FACH" for the DL, and transport channel type "RACH" for the UL:
 - 5> select this multiplexing option.
 - 3> else:
 - 4> if the UE does not support Enhanced Uplink in CELL_FACH state and Idle mode; or
 - 4> if the IE "Common E-DCH system info" is not included in System Information Block type 5 or System Information Block type 5bis:
 - 5> if the RB has a multiplexing option with transport channel type "HS-DSCH" for the DL, and the corresponding MAC-ehs reordering queue is configured, and transport channel type "RACH" for the UL:
 - 6> select this multiplexing option.
 - 4> else:
 - 5> if either of the following conditions is met: and
 - 6> the radio bearer is mapped to CCCH and IE "CCCH Fallback" is set to TRUE;
 - 6> the radio bearer is mapped to DCCH and IE "DCCH Fallback" is set to TRUE.
 - 5> if the variable FALLBACK_R99_PRACH_ENABLED is set to TRUE:
 - 6> if the RB has a multiplexing option with transport channel type "HS-DSCH" for the DL, and the corresponding MAC-ehs reordering queue is configured, and transport channel type "RACH" for the UL:
 - 7> select this multiplexing option.
 - 5> else:
 - 6> if the RB has a multiplexing option with transport channel type "HS-DSCH" for the DL, and the corresponding MAC-ehs reordering queue is configured, and transport channel type "E-DCH" for the UL and the corresponding common E-DCH MAC-d flow is configured:
 - 6> select this multiplexing option.

- 2> if the UE is in CELL_DCH state:
 - 3> if the RB has a multiplexing option with transport channel type "DCH + HS-DSCH" for the DL, and both the corresponding DCH transport channel and the corresponding MAC-d flow or MAC-ehs reordering queue are configured, and with transport channel type "E-DCH" for the UL, and the corresponding E-DCH MAC-d flow is configured:
 - 4> select this multiplexing option; else
 - 3> if the RB has a multiplexing option with transport channel type "DCH + HS-DSCH" for the DL, and both the corresponding DCH transport channel and the corresponding MAC-d flow or MAC-ehs reordering queue are configured, and with transport channel type "DCH" for the UL, and the corresponding DCH transport channel is configured:
 - 4> select this multiplexing option; else
 - 3> if the RB has a multiplexing option with transport channel type "DCH + DSCH" for the DL:
 - 4> the UE behaviour is unspecified; else
 - 3> if the RB has a multiplexing option with transport channel type "HS-DSCH" for the DL, and the corresponding MAC-d flow or MAC-ehs reordering queue is configured, and with transport channel type "E-DCH" for the UL, and the corresponding E-DCH MAC-d flow is configured:
 - 4> select this multiplexing option; else
 - 3> if the RB has a multiplexing option with transport channel type "HS-DSCH" for the DL, and the corresponding MAC-d flow or MAC-ehs reordering queue is configured, and with transport channel type "DCH" for the UL, and the corresponding DCH transport channel is configured:
 - 4> select this multiplexing option; else
 - 3> if the RB has a multiplexing option with transport channel type "DSCH" for the DL:
 - 4> the UE behaviour is unspecified; else
 - 3> if the RB has a multiplexing option with transport channel type "DCH" for the DL, and the corresponding DCH transport channel is configured, and with transport channel type "E-DCH" for the UL, and the corresponding E-DCH MAC-d flow is configured:
 - 4> select this multiplexing option; else
 - 3> if the RB has a multiplexing option with transport channel type "DCH" for the DL, and the corresponding DCH transport channel is configured, and with transport channel type "DCH" for the UL, and the corresponding DCH transport channel is configured:
 - 4> select this multiplexing option.
- 1> for 3.84 Mcps TDD and 7.68 Mcps TDD, select the multiplexing option according to the following:
 - 2> if the UE is in CELL_FACH state:
 - 3> if the RB has the multiplexing options with the transport channel types "FACH" and "DSCH" for the DL, and the corresponding FACH and DSCH transport channels are configured, and with the transport channel types "RACH" and "USCH" for the UL, and the corresponding RACH and USCH transport channels are configured:
 - 4> if both PUSCH and PDSCH are allocated:
 - 5> select the multiplexing option "DSCH" for DL and "USCH" for UL; else
 - 4> if only PUSCH is allocated:
 - 5> select the multiplexing option "FACH" for DL and "USCH" for UL; else
 - 4> if only PDSCH is allocated:

- 5> select the multiplexing option "DSCH" for DL and "RACH" for UL; else
- 4> if neither PUSCH nor PDSCH is allocated:
 - 5> select the multiplexing option "FACH" for DL and "RACH" for UL.
- 3> if the RB has a single multiplexing option with the transport channel type "FACH" for the DL and the transport channel type "RACH" for the UL:
 - 4> select this multiplexing option; else
- 3> if the RB has a single multiplexing option with the transport channel type "DSCH" for the DL, and the corresponding DSCH transport channel is configured, and with the transport channel type "USCH" for the UL, and the corresponding USCH transport channel is configured:
 - 4> select this multiplexing option; else
- 2> if the UE is in CELL_DCH state:
 - 3> if the RB has a multiplexing option with transport channel type "DCH + HS-DSCH" for the DL, and both the corresponding DCH transport channel and MAC-d flow are configured, and with transport channel type "E-DCH" for the UL, and the corresponding E-DCH MAC-d flow is configured:
 - 4> select this multiplexing option; else
 - 3> if the RB has a multiplexing option with transport channel type "DCH + HS-DSCH" for the DL, and both the corresponding DCH transport channel and MAC-d flow are configured, and with transport channel type "DCH" for the UL, and the corresponding DCH transport channel is configured:
 - 4> select this multiplexing option; else
 - 3> if the RB has a multiplexing option with transport channel type "DCH + DSCH" for the DL, and both the corresponding DCH and DSCH transport channels are configured, and with transport channel type "DCH" for the UL, and the corresponding DCH transport channel is configured:
 - 4> select this multiplexing option; else
 - 3> if the RB has a multiplexing option with transport channel type "HS-DSCH" for the DL, and the corresponding MAC-d flow is configured, and with transport channel type "E-DCH" for the UL, and the corresponding E-DCH MAC-d flow is configured:
 - 4> select this multiplexing option; else
 - 3> if the RB has a multiplexing option with transport channel type "HS-DSCH" for the DL, and the corresponding MAC-d flow is configured, and with transport channel type "DCH" for the UL, and the corresponding DCH transport channel is configured:
 - 4> select this multiplexing option; else
 - 3> if the RB has a multiplexing option with transport channel type "DCH" for the DL, and the corresponding DCH transport channel is configured, and with transport channel type "E-DCH" for the UL, and the corresponding E-DCH MAC-d flow is configured:
 - 4> select this multiplexing option; else
 - 3> if the RB has a multiplexing option with transport channel type "DCH" for the DL, and the corresponding DCH transport channel is configured, and with transport channel type "DCH" for the UL, and the corresponding DCH transport channel is configured:
 - 4> select this multiplexing option; else
 - 3> if the RB has a multiplexing option with transport channel type "DSCH" for the DL, and the corresponding DSCH transport channel is configured, and with transport channel "USCH" for the UL, and the corresponding USCH transport channel is configured:
 - 4> select this multiplexing option.

1> for 1.28 Mcps TDD, select the multiplexing option according to the following:

2> if the UE is in CELL_PCH state:

3> if the UE does support HS-DSCH reception in CELL_PCH and URA_PCH state and IE "HS-DSCH paging system information" is included in System Information Block type 5 and the IE "Common E-DCH system info" is included in System Information Block type 5 and if C-RNTI, H-RNTI and primary E-RNTI are provided to the UE:

4> if the RB has a multiplexing option with transport channel type "HS-DSCH" for the DL and transport channel type "E-DCH" for the UL:

5> select this multiplexing option.

2> if the UE is in CELL_FACH state:

3> if the UE does not support HS-DSCH reception in CELL_FACH state and Enhanced Uplink in CELL_FACH state and Idle mode; or

3> if the IE "HS-DSCH common system information" is not included in System Information Block type 5; or

3> if the IE "Common E-DCH system info" is not included in System Information Block type 5:

4> if the RB has a multiplexing option with transport channel type "FACH" for the DL and transport channel type "RACH" for the UL:

5> select this multiplexing option; else

4> if the RB has the multiplexing options with the transport channel types "FACH" and "DSCH" for the DL, and the corresponding FACH and DSCH transport channels are configured, and with the transport channel types "RACH" and "USCH" for the UL, and the corresponding RACH and USCH transport channels are configured:

5> if both PUSCH and PDSCH are allocated:

6> select the multiplexing option "DSCH" for DL and "USCH" for UL; else

5> if only PUSCH is allocated:

6> select the multiplexing option "FACH" for DL and "USCH" for UL; else

5> if only PDSCH is allocated:

6> select the multiplexing option "DSCH" for DL and "RACH" for UL; else

5> if neither PUSCH nor PDSCH is allocated:

6> select the multiplexing option "FACH" for DL and "RACH" for UL.

4> if the RB has a single multiplexing option with the transport channel type "DSCH" for the DL, and the corresponding DSCH transport channel is configured, and with the transport channel type "USCH" for the UL, and the corresponding USCH transport channel is configured:

5> select this multiplexing option; else

3> else:

4> if the RB has a multiplexing option with transport channel type "HS-DSCH" for the DL and transport channel type "E-DCH" for the UL:

5> select this multiplexing option.

2> if the UE is in CELL_DCH state:

3> if the RB has a multiplexing option with transport channel type "DCH + HS-DSCH" for the DL, and both the corresponding DCH transport channel and the corresponding MAC-d flow or MAC-ehs reordering

queue are configured, and with transport channel type "E-DCH" for the UL, and the corresponding E-DCH MAC-d flow is configured:

4> select this multiplexing option; else

3> if the RB has a multiplexing option with transport channel type "DCH + HS-DSCH" for the DL, and both the corresponding DCH transport channel and the corresponding MAC-d flow or MAC-ehs reordering queue are configured, and with transport channel type "DCH" for the UL, and the corresponding DCH transport channel is configured:

4> select this multiplexing option; else

3> if the RB has a multiplexing option with transport channel type "DCH + DSCH" for the DL, and both the corresponding DCH and DSCH transport channels are configured, and with transport channel type "DCH" for the UL, and the corresponding DCH transport channel is configured:

4> select this multiplexing option; else

3> if the RB has a multiplexing option with transport channel type "HS-DSCH" for the DL, and the corresponding MAC-d flow or MAC-ehs reordering queue is configured, and with transport channel type "E-DCH" for the UL, and the corresponding E-DCH MAC-d flow is configured:

4> select this multiplexing option; else

3> if the RB has a multiplexing option with transport channel type "HS-DSCH" for the DL, and the corresponding MAC-d flow or MAC-ehs reordering queue is configured, and with transport channel type "DCH" for the UL, and the corresponding DCH transport channel is configured:

4> select this multiplexing option; else

3> if the RB has a multiplexing option with transport channel type "DCH" for the DL, and the corresponding DCH transport channel is configured, and with transport channel type "E-DCH" for the UL, and the corresponding E-DCH MAC-d flow is configured:

4> select this multiplexing option; else

3> if the RB has a multiplexing option with transport channel type "DCH" for the DL, and the corresponding DCH transport channel is configured, and with transport channel type "DCH" for the UL, and the corresponding DCH transport channel is configured:

4> select this multiplexing option; else

3> if the RB has a multiplexing option with transport channel type "DSCH" for the DL, and the corresponding DSCH transport channel is configured, and with transport channel "USCH" for the UL, and the corresponding USCH transport channel is configured:

4> select this multiplexing option.

1> configure the MAC with the appropriate transport format set (with computed transport block sizes) for the transport channel used by that RB; or

1> configure the MAC with the appropriate MAC-d flow or MAC-ehs reordering queue used by that RB;

1> in case the selected multiplexing option is a multiplexing option on E-DCH:

2> if the RLC PDU size is set to "fixed size", the set of RLC sizes that apply to the logical channel used by that RB consists of all RLC PDU sizes listed in the IE "RLC PDU size list" in the RB mapping info for E-DCH.

1> else:

2> determine the sets of RLC sizes that apply to the logical channels used by that RB, based on the IEs "RLC size list" and/or the IEs "Logical Channel List" included in the applicable "Transport format set" (either the ones received in the same message or the ones stored if none were received);

1> in case the selected multiplexing option is a multiplexing option on RACH:

- 2> ignore the RLC size indexes that do not correspond to any RLC size within the Transport Format Set stored for RACH.
- 2> if there is no remaining RLC size index corresponding to an RLC size within the Transport Format Set stored for RACH:
 - 3> set the variable INVALID_CONFIGURATION to TRUE.
- 1> if RACH is the transport channel to be used on the uplink, if that RB has a multiplexing option on RACH and if it is using AM:
 - 2> apply the largest size amongst the ones derived according to the previous bullet for the RLC size (or RLC sizes in case the RB is realised using two logical channels) for the corresponding RLC entity.

NOTE: The IE "RB mapping info" is only included in the IE "Predefined RB configurations" in system information when used for Inter-RAT handover to UTRAN and there is no AM RLC size change involved in this case.

- 1> if the uplink RLC PDU size is set to "flexible size" and no uplink RLC PDU size is currently set in the RLC entity:
 - 2> if this radio bearer is a signalling radio bearer:
 - 3> the UE behaviour is unspecified.
 - 2> else, configure the corresponding RLC entity with the RLC length indicator size indicated in the IE "Length indicator size".

NOTE1: In uplink, if the UTRAN has configured "Flexible size" RLC PDUs and 7-bit "Length indicator size" field and "Largest UL RLC PDU size" > 126 octets, but the UTRAN has not configured "Use special value of HE field", then the UE behaviour is unspecified.

NOTE2: In uplink, if the UTRAN has configured "Flexible size" RLC PDUs and 7-bit "Length indicator size" field, but the UTRAN has also configured "Minimum UL RLC PDU" > 126 octets, then the UE behaviour is unspecified.

- 1> if the uplink RLC PDU size is changed from "fixed" to "flexible size" and the RLC length indicator size is 7 bits:
 - 2> if this radio bearer is a signalling radio bearer:
 - 3> the UE behaviour is unspecified.
 - 2> else, configure the corresponding RLC entity with flexible RLC PDU size and the RLC length indicator size indicated in the IE "Length indicator size".

1> if that RB is using AM and the RLC size applicable to the uplink logical channel transporting data PDUs is different from the one derived from the previously stored configuration; or

1> if that RB is using AM and the RLC size applicable to the uplink logical channel transporting data PDUs changed from "flexible size" to "fixed size"; or

1> if that RB is using AM and "flexible size" RLC PDUs and the Length Indicator size applicable to the uplink logical channel transporting data PDUs is different from the one derived from the previously stored configuration; or

1> if that RB is using AM and the RLC PDU size applicable to the uplink logical channel transporting data PDUs changed from "fixed size" to "flexible size" and the indicated RLC length indicator size is 15 bits; and

1> none of the following conditions is met:

- the RLC size change is caused by a CELL UPDATE CONFIRM and the CELL UPDATE CONFIRM message includes the IE "Downlink counter synchronisation info".
- the RLC size change is caused by a reconfiguration message, and a cell update procedure occurs during the reconfiguration procedure and the CELL UPDATE CONFIRM message includes the IE "Downlink counter synchronisation info".

- the RLC size change is caused by a reconfiguration message, and a cell update procedure occurs during this reconfiguration procedure and the CELL UPDATE CONFIRM message includes the IE "RLC re-establish indicator" being set to TRUE for the corresponding radio bearer.
- 2> if the RLC PDU size is set to "flexible size":
 - 3> if this radio bearer is a signalling radio bearer:
 - 4> the UE behaviour is unspecified.
 - 2> if the RLC size change is caused by a reconfiguration message or a CELL UPDATE CONFIRM and the IE "one sided RLC re-establishment" is included in that message and is set to TRUE; or
 - 2> the uplink RLC size change is caused by changing the multiplexing option with transport channel type "E-DCH" to transport channel type "RACH" during cell reselection or due to a system information modification, and the UE enters or remains in CELL_FACH state, or the UE enters CELL_PCH state and the H-RNTI is stored after the state transition into CELL_PCH state, the UE shall after receiving the CELL UPDATE CONFIRM:
 - 3> re-establish the transmitting side of the corresponding RLC entity.
 - 2> else:
 - 3> re-establish the corresponding RLC entity;
 - 3> if the RLC entity for SRB2 is re-established:
 - 4> clear all entries in the table "Processed transactions" in the variable TRANSACTIONS.
 - 2> if the RLC PDU size is set to "fixed size":
 - 3> configure the corresponding RLC entity with the new uplink RLC size.
 - 2> if the RLC PDU size is set to "flexible size":
 - 3> configure the corresponding RLC entity with the RLC length indicator size indicated in the IE "Length indicator size".
 - 2> for each AM RLC radio bearer in the CN domain as indicated in the IE "CN domain identity" in the IE "RAB info" in the variable ESTABLISHED_RABS whose RLC size is changed; and
 - 2> for each AM RLC signalling radio bearer in the CN domain as indicated in the IE "CN domain identity" in the variable LATEST_CONFIGURED_CN_DOMAIN whose RLC size is changed:
 - 3> if the IE "Status" in the variable CIPHERING_STATUS of this CN domain is set to "Started":
 - 4> if the information causing the RLC re-establishment was included in system information:
 - 5> set the HFN values for the corresponding RLC entity equal to the value of the IE "START" for this CN domain that will be included in the CELL UPDATE message following cell reselection.

NOTE: Since the UE cannot predict the START value at the time of the next CELL UPDATE transmission in the future, UTRAN should desist from changing the RLC size for a signalling radio bearer within a cell. Other than this case the change in RLC size for a signalling radio bearer is known to the UE when reading system information following cell reselection.

- 4> if the RLC re-establishment is caused by a CELL UPDATE CONFIRM:
 - 5> if the whole RLC entity was re-established:
 - 6> set the HFN values for the corresponding RLC entity in uplink and downlink equal to the value of the IE "START" included in the latest transmitted CELL UPDATE message for this CN domain.
 - 5> if only the transmitting side of the RLC entity was re-established:

- 6> set the HFN value for the corresponding RLC entity in the uplink equal to the value of the IE "START" included in the latest transmitted CELL UPDATE message for this CN domain.
- 4> if the RLC re-establishment is caused by a reconfiguration message:
 - 5> if the whole RLC entity was re-established:
 - 6> set the HFN values for the corresponding RLC entity in uplink and downlink equal to the value of the IE "START" that will be included in the reconfiguration complete message for this CN domain.
 - 5> if only the transmitting side of the RLC entity was re-established:
 - 6> set the HFN value for the corresponding RLC entity in the direction uplink equal to the value of the IE "START" that will be included in the reconfiguration complete message for this CN domain.

NOTE1: If the UTRAN modifies the RLC size for RB2 on any reconfiguration message or Cell Update Confirm message, the UE behaviour is unspecified in this version of the specification.

NOTE2: The UE cannot rely on the configured Transport Formats to determine the RLC sizes to be used in downlink for a particular logical channel. This size can be signalled explicitly in the RLC Info IE.

1> if that RB is using AM or UM; and

1> MAC-i/is is configured and the RLC PDU size is set to "flexible size":

2> indicate the largest RLC size applicable for uplink to the corresponding RLC entity;

2> indicate the minimum RLC size applicable for the uplink to the corresponding RLC entity.

1> MAC-e/es is configured and the RLC PDU size is set to "flexible size":

2> set the variable INVALID_CONFIGURATION to TRUE.

1> if that RB is using UM and MAC-i/is is not configured:

2> indicate the largest RLC size applicable for uplink to the corresponding RLC entity.

1> configure MAC multiplexing according to the selected multiplexing option (MAC multiplexing shall only be configured for a logical channel if the transport channel it is mapped on according to the selected multiplexing option is the same as the transport channel another logical channel is mapped on according to the multiplexing option selected for it);

1> configure the MAC with the logical channel priorities according to selected multiplexing option;

1> configure the MAC with the set of applicable RLC Sizes for each of the logical channels used for that RB;

1> if there is no multiplexing option applicable for the transport channels, MAC-d flows and MAC-ehs reordering queues to be used:

2> set the variable INVALID_CONFIGURATION to TRUE.

1> if there is more than one multiplexing option applicable for the transport channels, MAC-d flows or MAC-ehs reordering queues to be used:

2> set the variable INVALID_CONFIGURATION to TRUE.

If upon cell re-selection or upon moving to CELL_FACH state from URA_PCH, CELL_PCH or CELL_DCH state to initiate cell update procedure the UE sets variable INVALID_CONFIGURATION to TRUE as a result of the actions defined in this subclause, the UE should:

1> move to idle mode;

1> release (locally) the established signalling connections (as stored in the variable ESTABLISHED_SIGNALLING_CONNECTIONS) and the established radio access bearers (as stored in the variable ESTABLISHED_RABS) and indicate this to upper layers;

1> perform other actions when entering idle mode from connected mode as specified in subclause 8.5.2.

8.5.22 Actions when entering another RAT from connected mode

NOTE: This section does not apply when entering GERAN Iu mode from UTRAN connected mode.

When entering another RAT from connected mode (due to Inter-RAT handover from UTRAN, Inter-RAT cell change order from UTRAN or Inter-RAT cell reselection from UTRAN), after successful completion of the procedure causing the transition to the other RAT, the UE shall:

1> if the USIM is present, for each CN domain:

2> if a new security key set was received for this CN domain but was not used either for integrity protection or ciphering during this RRC connection:

3> set the START value for this domain to zero and;

3> store this START value for this domain in the volatile memory of the ME;

2> else:

3> store the current START value for every CN domain in the volatile memory of the ME.

NOTE: Prior to storing the START value, the UE should calculate this START value according to subclause 8.5.9.

1> if the SIM is present, for each CN domain:

2> if a new security key was received for this CN domain but was not used either for integrity protection or ciphering during this RRC connection:

3> set the START value for this domain to zero and;

3> store this START value for this domain in the volatile memory of the ME.

2> else:

3> store the current START value for this CN domain in the volatile memory of the ME.

NOTE: Prior to storing the START value, the UE should calculate this START value according to subclause 8.5.9.

8.5.23 Measured results on RACH

When transmitting an uplink RRC message and System Information Block type 11, System Information Block type 11bis, System Information Block type 11ter and System Information Block type 12, if transmitted, have been received, the UE shall:

1> if the uplink RRC message is an RRC CONNECTION REQUEST message:

2> if the IE "Intra-frequency reporting quantity for RACH reporting" and the IE "Maximum number of reported cells on RACH" are included in System Information Block type 11:

3> include a measurement report in the IE "Measured results on RACH", as specified in the IE "Intra-frequency reporting quantity for RACH reporting" and the IE "Maximum number of reported cells on RACH" in System Information Block type 11.

2> if the IE "Inter-frequency RACH reporting information" is included in System Information Block type 11:

3> if, at the time the message is to be sent, valid measurements are available; and

3> there is one or more cells for which the quantity, indicated by the IE "Reporting quantity" in the IE "Inter-frequency RACH reporting information", exceeds the threshold specified by the IE "Inter-frequency RACH reporting threshold":

- 4> include a measurement report in the IE "Measured results on RACH";
 - 4> include the cells for which the quantity, indicated by the IE "Reporting quantity" in the IE "Inter-frequency RACH reporting information", exceeds the threshold specified by the IE "Inter-frequency RACH reporting threshold";
 - 4> set the IE "Inter-frequency cell indication- SIB11" to the following value: Value_Tag MOD 2, with Value_Tag corresponding to the value tag of System Information Block Type 11;
 - 4> set the IE "Inter-frequency cell indication- SIB12" to any value.
- 2> for FDD, if System Information Block type 19 has been received and if the IE "E-UTRA frequency RACH reporting information" is included in System Information Block type 19; and
- 2> if the UE supports E-UTRA RACH reporting:
- 3> if, at the time the message is to be sent, valid measurements are available; and
 - 3> there is one or more cells for which the Physical layer Cell Identity is not included in the blacklist of whose frequency and the quantity, indicated by the IE "E-UTRA frequency RACH Reporting quantity" in the IE "E-UTRA frequency RACH reporting information", exceeds the threshold specified by the IE "E-UTRA frequency RACH reporting threshold" according to the criteria specified in subclause 10.3.7.45:
 - 4> include a measurement report in the IE "Measured results on RACH";
 - 4> set the value of the IE "E-UTRA frequency indicator";
 - 4> set the IE "E-UTRA frequency indication-SIB19" to the following value: Value_Tag MOD 2, with Value_Tag corresponding to the value tag of System Information Block Type 19.
- 1> for any other uplink RRC message which optionally includes the IE "Measured results on RACH":
- 2> if the IE "Intra-frequency reporting quantity for RACH reporting" and the IE "Maximum number of reported cells on RACH" are included in System Information Block type 12 (or "System Information Block Type 11", if these IEs are not included in the broadcast "System Information Block Type 12" or "System Information Block Type 12" is not being broadcast).
 - 3> include a measurement report in the IE "Measured results on RACH", as specified in the IE "Intra-frequency reporting quantity for RACH reporting" and the IE "Maximum number of reported cells on RACH" in System Information Block type 12 (or "System Information Block Type 11" if these IEs are not included in the broadcast "System Information Block Type 12" or "System Information Block Type 12" is not being broadcast).
 - 2> if the IE "Inter-frequency RACH reporting information" is included in "System Information Block type 12" (or "System Information Block Type 11" if this IE is not included in the "System Information Block Type 12" or if "System Information Block Type 12" is not being broadcast):
 - 3> if, at the time the message is to be sent, valid measurements are available; and
 - 3> there is one or more cells for which the quantity, indicated by the IE "Reporting quantity" in the IE "Inter-frequency RACH reporting information", exceeds the threshold specified by the IE "Inter-frequency RACH reporting threshold":
 - 4> include a measurement report in the IE "Measured results on RACH";
 - 4> include the cells for which the quantity, indicated by the IE "Reporting quantity" in the IE "Inter-frequency RACH reporting information", exceeds the threshold specified by the IE "Inter-frequency RACH reporting threshold";
 - 4> set the IE "Inter-frequency cell indication- SIB11" to the following value: Value_Tag MOD 2, with Value_Tag corresponding to the value tag of System Information Block Type 11;
 - 4> if "System Information Block Type 12" is being broadcast:
 - 5> set the IE "Inter-frequency cell indication- SIB12" to the following value: Value_Tag MOD 2, with Value_Tag corresponding to the value tag of System Information Block Type 12.

- 4> else:
 - 5> set the IE "Inter-frequency cell indication- SIB12" to any value.
 - 2> for FDD, if System Information Block type 19 has been received and if the IE "E-UTRA frequency RACH reporting information" is included in System Information Block type 19; and
 - 2> if the UE supports E-UTRA RACH reporting:
 - 3> if, at the time the message is to be sent, E-UTRA measurement for CELL_FACH is not configured; and
 - 3> if, at the time the message is to be sent, valid measurements are available; and
 - 3> there is one or more cells for which the Physical layer Cell Identity is not included in the blacklist of whose frequency and the quantity, indicated by the IE "E-UTRA frequency RACH Reporting quantity" in the IE "E-UTRA frequency RACH reporting information", exceeds the threshold specified by the IE "E-UTRA frequency RACH reporting threshold" according to the criteria specified in subclause 10.3.7.45:
 - 4> include a measurement report in the IE "Measured results on RACH";
 - 4> set the value of the IE "E-UTRA frequency indicator";
 - 4> set the IE "E-UTRA frequency indication-SIB19" to the following value: Value_Tag MOD 2, with Value_Tag corresponding to the value tag of System Information Block Type 19.
 - 1> include in the IE "Measured results on RACH" all requested reporting quantities for cells for which measurements are reported.
- NOTE: The UE only includes measurement results for neighbour cells for which valid measurements are available at the time the message is sent. At cell access following selection or reselection to a cell, the UE may not have had sufficient time to obtain valid measurement results for neighbour cells.
- 1> for messages transmitted on CCCH, take care that the maximum allowed message size is not exceeded when forming the IE "Measured results on RACH", i.e. limit the number of included neighbour cells or if required omit the IE "Measured results on RACH" altogether. When limiting the number of included neighbouring cells, for UE's not supporting E-UTRA RACH reporting, the number of inter-frequency cells should be limited first i.e. inter-frequency cells should be omitted before limiting the number of intra- frequency cells. For UE's supporting E-UTRA RACH reporting, when limiting the number of included neighbouring cells:
 - 2> if the IE "RACH reporting priority" is not present:
 - 3> E-UTRA measurements shall be omitted first, followed by limiting the number of inter-frequency cells, before limiting the number of intra-frequency cells. Measurement result for the current cell shall be omitted last.
 - 2> if the IE "RACH reporting priority" is present and set to "IntraEUTRAInter":
 - 3> the number of inter-frequency cells shall be limited first, followed by omitting E-UTRA measurements, before limiting the number of intra-frequency cells. Measurement result for the current cell shall be omitted last.
 - 2> if the IE "RACH reporting priority" is present and set to "InterEUTRAIntra":
 - 3> the number of intra-frequency cells shall be limited first, followed by omitting E-UTRA measurements, before limiting the number of inter-frequency cells. Measurement result for the current cell shall be omitted last.
 - 2> if the IE "RACH reporting priority" is present and set to "InterIntraEUTRA":
 - 3> E-UTRA measurements shall be omitted first, followed by limiting the number of intra-frequency cells, before limiting the number of inter-frequency cells. Measurement result for the current cell shall be omitted last.
 - 2> if the IE "RACH reporting priority" is present and set to "EUTRAIntraInter":

- 3> the number of inter-frequency cells shall be limited first, followed by limiting the number of intra-frequency cells, before omitting E-UTRA measurements. Measurement result for the current cell shall be omitted last.
- 2> if the IE "RACH reporting priority" is present and set to "EUTRAInterIntra":
 - 3> the number of intra-frequency cells shall be limited first, followed by limiting the number of inter-frequency cells, before omitting E-UTRA measurements. Measurement result for the current cell shall be omitted last.

When transmitting an uplink RRC message and the System Information Block type 11, System Information Block type 11bis, System Information Block type 11ter and System Information Block type 12, if transmitted, have not been received, the UE shall:

- 1> for any uplink RRC message which optionally includes the IE "Measured results on RACH", include a measurement report in the IE "Measured results on RACH" according to the following rules:
 - 2> if the IE "Intra-frequency reporting quantity SIB3" was not present in System Information Block type 3:
 - 3> include a measurement report for the serving cell using CPICH RSCP as a measurement quantity;
 - 3> include measurement reports for cells on the used frequency for which measured results are available, using CPICH RSCP as measurement quantity for each cell;
 - 3> omit the IE "Measurement results for monitored cells on non-used frequencies";
 - 3> omit the IE "Measurement results for E-UTRA frequencies".
 - 2> if the IE "Intra-frequency reporting quantity SIB3" was present in System Information Block type 3:
 - 3> include a measurement report for the serving cell using as a measurement quantity given in IE "Intra-frequency reporting quantity SIB3";
 - 3> include measurement reports for cells on the used frequency for which measured results are available, using as a measurement quantity given in IE "Intra-frequency reporting quantity SIB3" for each cell;
 - 3> omit the IE "Measurement results for monitored cells on non-used frequencies";
 - 3> omit the IE "Measurement results for E-UTRA frequencies".
- 2> for TDD, include measurement reports using the measurement quantities specified in the IE "Reporting quantity list".

If the IE "Measured results on RACH" is present in the message, the UTRAN should extract the contents to be used for radio resource control.

8.5.24 Change of PLMN while in RRC connected mode

If the UE camps on an acceptable cell to obtain limited service while in RRC connected mode the UE shall:

- 1> keep the RRC connection and its behaviour, while camping on an acceptable cell as if in Idle mode in that PLMN;
- 1> if the UE re-enters "in service area" in a suitable cell, or cannot maintain limited service (i.e. cannot find any acceptable cell of any PLMN), the UE shall resume its RRC Connected mode behaviour as if it had not camped on any cell whilst being in "out of service area".

The UE shall:

- 1> if the NAS indicates the selection of a new PLMN resulting from manual- or automatic mode PLMN selection [25] while the UE is in RRC connected mode; or
- 1> if the UE attempts transmission on an acceptable cell while the UE is in RRC connected mode (i.e. to initiate emergency call), the UE shall:
 - 2> move to idle mode;

- 2> release all dedicated resources;
- 2> indicate release (abort) of the established signalling connections (as stored in the variable ESTABLISHED_SIGNALLING_CONNECTIONS) and established radio access bearers (as stored in the variable ESTABLISHED_RABS) to upper layers;
- 2> clear the variable ESTABLISHED_SIGNALLING_CONNECTIONS;
- 2> clear the variable ESTABLISHED_RABS; and
- 2> perform actions specified in subclause 8.5.2 when entering idle mode from connected mode.

NOTE: NAS can inform AS about a new selected PLMN as a result of a PLMN selection (manual- or automatic mode PLMN selection (see [25])), or as a result of network signalling (after inter-RAT handover or inter-PLMN SRNS relocation). Only in the first case (manual- or automatic mode PLMN selection), this will result in an immediate RRC connection release.

8.5.25 Actions related to HS_DSCH_RECEPTION variable

The variable HS_DSCH_RECEPTION shall be set to TRUE only when all the following conditions are met:

- 1> for FDD and 1.28 Mcps TDD:
 - 2> the UE is in CELL_DCH state.
- 1> for 3.84 Mcps TDD or 7.68 Mcps TDD:
 - 2> a dedicated physical channel is allocated to the UE in the uplink.
- 1> the variable H_RNTI is set;
- 1> the UE has a stored IE "HS-SCCH info";
- 1> the UE has a stored IE "HARQ info";
- 1> for FDD:
 - 2> one of the radio links in the active set is configured as the serving HS-DSCH radio link;
 - 2> the UE has stored the following IEs:
 - IE "Measurement Feedback Info";
 - IE "Uplink DPCH Power Control Info" including stored Δ_{ACK} , Δ_{NACK} and Ack-NACK Repetition factor.
- 1> for 3.84 Mcps TDD or 7.68 Mcps TDD, the UE has stored the IE "HS-PDSCH Timeslot Configuration" and either of the following conditions are met:
 - 2> a dedicated physical channel is allocated to the UE in the downlink;
 - 2> the UE has stored $D_{hs-sync}$.
- 1> for 1.28 Mcps TDD, the UE has stored the IE "HS-PDSCH Midamble Configuration":
- 1> there is at least one RB mapped to HS-DSCH;
- 1> at least for one of the RBs mapped to HS-DSCH, there is either:
 - 2> at least one MAC-hs queue (including the IE "MAC-d PDU size Info") configured for the concerning MAC-d flow; or
 - 2> at least one MAC-ehs reordering queue configured for the associated logical channel.

NOTE 1: In CELL_DCH, to enable or disable HS-DSCH reception, the UTRAN has the possibility to add/remove the concerning HS-DSCH related RB mapping options, add/remove the concerning MAC-d flows or, for FDD, add/remove the concerning MAC-ehs reordering queue, add/remove the serving HS-DSCH radio link or, for TDD add/remove H-RNTI upon hard handover.

NOTE 2: In CELL_DCH, if HS_DSCH_RECEPTION is set to TRUE and a reconfiguration, an inter-RAT handover from UTRAN, or a cell change order procedure is initiated, the UE checks the conditions only when the reconfiguration, inter-RAT handover from UTRAN, or cell change order procedure is successfully completed. Doing so ensures that, in case of failure in the reconfiguration, inter-RAT handover from UTRAN, or cell change order procedure, the UE can return to the old configuration as if the message was not received, e.g. without performing a MAC-HS reset.

If any of the above conditions is not met and the variable HS_DSCH_RECEPTION is set to TRUE, the UE shall:

- 1> set the variable HS_DSCH_RECEPTION to FALSE;
- 1> for UE in CELL_DCH:
 - 2> set the variable HS_DSCH_RECEPTION_GENERAL to FALSE;
 - 2> stop any HS-SCCH reception procedures;
 - 2> stop any HS-DSCH reception procedures;
 - 2> clear the variable H_RNTI and remove any stored H-RNTI;
 - 2> reset the MAC-hs/ehs entity [15];
 - 2> release all HARQ resources;
 - 2> no long consider any radio link to be the HS-DSCH serving radio link.
- 1> for 3.84 Mcps TDD or 7.68 Mcps TDD, if no downlink DPCH is assigned the UE shall clear the uplink DPCH configuration and initiate the Cell Update procedure according to subclause 8.3.1, cause "radio link failure".

NOTE 3: If configured for HS-DSCH and not explicitly indicated as being cleared, the UE will have still stored the IEs "HARQ info", "Added or Reconfigured MAC-d flow", "Added or Reconfigured MAC-ehs reordering queue", "RB mapping Info", "Downlink HS-PDSCH information" and "Downlink secondary cell info FDD".

Whenever the variable HS_DSCH_RECEPTION is set to TRUE, the UE shall:

- 1> set the variable HS_DSCH_RECEPTION_GENERAL to TRUE;
- 1> perform HS-SCCH reception procedures according to the stored HS-SCCH configuration as stated in:
 - 2> subclause 8.6.6.33 for the IE "HS-SCCH Info".
 - 2> for 1.28 Mcps TDD, when performing reception on signalling radio bearer before RAB has been established,
 - 3> if MAC-ehs is not configured,
 - 4> use the table of transport block size for the HS-DSCH physical layer category 1 as specified in [15], and consider the UE capability "Total number of soft channel bits in HS-DSCH" equal to that of the HS-DSCH physical layer category 1 as specified in [35].
 - 3> else,
 - 4> use the table of transport block size for the HS-DSCH physical layer category 9 as specified in [15], and consider the UE capability "Total number of soft channel bits in HS-DSCH" equal to that of the HS-DSCH physical layer category 9 as specified in [35].

NOTE 4: For 1.28 Mcps TDD, when performing transmission on signalling radio bearer before RAB has been established, UTRAN should use the same rules with the UE as described above, when performing scheduling and signalling the control information on HS-SCCH, as it is not possible for Node B to be aware of the UE's HSDPA capability category during this period.

- 1> perform HS-DSCH reception procedures according to the stored HS-PDSCH configuration as stated in:
 - 2> subclause 8.6.3.1b for the IE "H-RNTI";
 - 2> subclause 8.6.5.6b for the IE "HARQ info";

2> subclause 8.6.6.34 for the IE "Measurement Feedback Info".

1> use the relevant CQI reporting table as stated in subclause 8.5.44.

In CELL_DCH, whenever the variable HS_DSCH_RECEPTION is set to FALSE, the UE shall:

1> not perform HS-SCCH reception procedures;

1> not perform HS-DSCH reception procedures.

For FDD and CELL_DCH state, determine the value for the SECONDARY_CELL_HS_DSCH_RECEPTION variable and take the corresponding actions as described in subclause 8.5.51.

8.5.26 Service prioritisation

If the UE detects an MBMS service reception inability as specified in subclause 8.5.30, the UE may:

1> request upper layers to prioritise the services and to initiate release of non- prioritised services that may cause interruption in the reception of the prioritised services;

1> if reception of the prioritised MBMS service is inhibited by one or more MBMS service(s) provided via a p-t-p radio bearer:

2> request UTRAN to terminate these MBMS service(s) using the MBMS MODIFICATION REQUEST message as specified in subclause 8.7.6.

NOTE: The termination of MBMS services is performed by RRC procedures, while clearing of non- MBMS services is performed by upper layers.

8.5.27 MBMS frequency selection

The UE shall perform the MBMS frequency layer selection procedure upon receiving the IE "MBMS Preferred frequency information", when specified explicitly e.g. as in subclause 8.6.9.2, or when the priority for an MBMS service as indicated by upper layers changes.

The UE shall:

1> if there exist two or more preferred frequencies for services included in variable MBMS_ACTIVATED_SERVICES:

2> request from upper layers the priorities of the different MBMS services included in variable MBMS_ACTIVATED_SERVICES for which a preferred frequency has been received.

1> if the UE is in idle mode:

2> if a preferred frequency layer applies for a service included in variable MBMS_ACTIVATED_SERVICES:

3> select the preferred frequency indicated for the MBMS service(s) prioritised most by upper layers for which a preferred frequency exists as the preferred frequency.

1> if the UE is in CELL_FACH, CELL_PCH or URA_PCH state; and

1> if there exists one or more preferred frequencies for services included in variable MBMS_ACTIVATED_SERVICES and the variable MBMS_PL_SERVICE_RESTRICTION_INFO_DEDICATED is set to FALSE:

2> if the IE "RAB information" in the variable ESTABLISHED_RABS is not empty:

3> if the current frequency is the frequency corresponding with the preferred frequency indicated for the MBMS service(s) prioritised most by upper layers for which a preferred frequency exists:

4> select the current frequency as the preferred frequency.

3> else:

- 4> if there exists one or more preferred frequencies for services included in variable MBMS_ACTIVATED_SERVICES for which the IE "MBMS PL Service Restriction Information" has not been received in the MBMS GENERAL INFORMATION message:
 - 5> select the preferred frequency indicated for the MBMS service(s) prioritised most by upper layers for which a preferred frequency exists for which the IE "MBMS PL Service Restriction Information" has not been received in the MBMS GENERAL INFORMATION message as the preferred frequency.
- 2> else:
 - 3> select the preferred frequency indicated for the MBMS service(s) prioritised most by upper layers for which a preferred frequency exists as the preferred frequency.
- 1> if the UE is in CELL_DCH:
 - 2> if there exists one or more preferred frequencies for services included in variable MBMS_ACTIVATED_SERVICES and the variable MBMS_PL_SERVICE_RESTRICTION_INFO_DEDICATED is set to FALSE:
 - 3> if the current frequency does not correspond to the preferred frequency indicated for the MBMS service(s) prioritised most by upper layers for which a preferred frequency exists:
 - 4> select as preferred frequency the preferred frequency indicated for the MBMS service(s) prioritised most by upper layers for which a preferred frequency exists for which the IE "MBMS PL Service Restriction Information" is not included in the MBMS GENERAL INFORMATION message;
 - 4> if a preferred frequency has been selected and the current frequency is different from the selected frequency:
 - 5> request UTRAN to be moved to the preferred frequency by means of the MBMS MODIFICATION REQUEST message as specified in subclause 8.7.6;
 - 5> if the variable MBMS_PREV_FREQUENCY_INFO is empty:
 - 6> upon receiving a request to move to the requested preferred frequency, store the frequency information of the frequency on which the UE was operating prior to the hard-handover to the preferred frequency in the variable MBMS_PREV_FREQUENCY_INFO.
 - 1> if a preferred frequency has been selected:
 - 2> if the UE is not in CELL_DCH state:
 - 3> apply the cell-reselection procedure as described in [4], using the received "MBMS Preferred frequency information" applicable to the selected frequency;
 - 3> if the UE re-selects to a cell on the indicated preferred frequency:
 - 4> if HCS is not used, and the IE "Qoffmbms" is not present for the MBMS preferred frequency:
 - 5> consider the cells on the MBMS preferred frequency having a Qoffmbms equal to "infinity".
 - 4> if HCS is used, and the IE "HCS_OFFmbms" is not present for the MBMS preferred frequency:
 - 5> consider the cells on the MBMS preferred frequency having the highest HCS priority level.
 - 4> if the UE is in CELL_FACH, CELL_PCH or URA_PCH:
 - 5> act according to subclause 8.3.1.2.
 - 4> if the selected frequency is different to the frequency on which the UE was previously operating; and
 - 4> if the variable MBMS_PREV_FREQUENCY_INFO is empty:
 - 5> store the frequency information of the frequency on which the UE was operating prior to cell-reselection to the preferred frequency in the variable MBMS_PREV_FREQUENCY_INFO.

4> apply the MCCH acquisition procedure, as specified in subclause 8.7.2.

1> else:

2> if the UE is not in CELL_DCH state:

3> stop applying any "MBMS Preferred frequency information".

3> if the UE is not redirected to another frequency; and

3> if the UE does not decide to receive an MBMS service; and

3> if the variable MBMS_PREV_FREQUENCY_INFO is not empty:

4> if any frequency in SIB11 or SIB12 has the same frequency stored in the variable MBMS_PREV_FREQUENCY_INFO:

5> select a suitable UTRA cell in that frequency;

5> if no suitable UTRA cell in that frequency is found:

6> select a suitable UTRA cell in another frequency.

4> if no frequency in SIB11 or SIB12 has the same frequency stored in the variable MBMS_PREV_FREQUENCY_INFO:

5> select a frequency randomly among the inter-frequencies indicated in SIB11 or SIB12:

6> select a suitable UTRA cell in the selected frequency;

6> if no suitable UTRA cell in the selected frequency is found:

7> select a suitable UTRA cell in another frequency.

4> clear the variable MBMS_PREV_FREQUENCY_INFO.

NOTE: The UE is only required to acquire the relevant SIB11 or SIB12, according to what is specified in subclauses 8.1.1.6.11 and 8.1.1.6.12.

8.5.28 Actions related to E_DCH_TRANSMISSION variable

The variable E_DCH_TRANSMISSION shall be set to TRUE only when all the following conditions are met:

1> the UE is in CELL_DCH state;

1> the variable E_RNTI includes either the Primary E-RNTI or the Secondary E-RNTI or both the Primary and the Secondary E-RNTI;

1> For FDD:

2> the UE has stored the following IEs:

- IE "E-DCH Transmission Time Interval";
- IE "HARQ info for E-DCH";
- IE "E-DCH info", including the IE "E-DPCCH info" and the IE "E-DPDCH info";
- one of the radio links in the active set is configured as the serving E-DCH radio link, and for this radio link the UTRAN has configured the IE "E-HICH configuration" and the IE "E-AGCH info".

1> For TDD:

2> for non-scheduled transmission, the UE has stored the following IEs:

- IE "HARQ info for E-DCH";

- IE "E-DCH information", including the IE "E-PUCH info";
- IE "Non-scheduled transmission grant info".

2> for scheduled transmission, the UE has stored the following IEs:

- IE "HARQ info for E-DCH";
- IE "E-DCH information", including the IE "E-RUCCH info" and the IE "E-PUCH info";
- IE "E-HICH info";
- IE "E-AGCH info".

1> there is at least one logical channel mapped to E-DCH for which:

- 2> the corresponding E-DCH MAC-d flow is configured, i.e. the IEs "E-DCH MAC-d flow power offset" and "E-DCH MAC-d flow maximum number of retransmissions", and the transmission grant type are configured.

If any of the above conditions is not met and the variable E_DCH_TRANSMISSION is set to TRUE, the UE in CELL_DCH state shall:

1> set the variable E_DCH_TRANSMISSION to FALSE;

1> stop any E-AGCH and E-HICH reception procedures;

1> For FDD:

- 2> stop any E-RGCH reception procedures.

1> For FDD:

- 2> stop any E-DPCCH and E-DPDCH transmission procedures.

1> For TDD:

- 2> stop any E-RUCCH and E-PUCH transmission procedures.

1> clear the variable E_RNTI;

1> act as if the IE "MAC-es/e reset indicator" was received and set to TRUE;

1> release all E-DCH HARQ resources;

1> no longer consider any radio link to be the serving E-DCH radio link.

Whenever the variable E_DCH_TRANSMISSION is set to TRUE, the UE shall:

1> if MAC-i/is is configured:

- 2> if MAC-hs is configured:

- 3> the UE behaviour is not specified.

1> For FDD:

- 2> perform E-AGCH reception procedures according to the stored E-AGCH configuration as stated in:

- 3> subclause 8.6.3.14 for the IE "New Primary E-RNTI" and the IE "New Secondary E-RNTI".

- 2> perform E-HICH reception procedures for all radio links in the E-DCH active set;

- 2> perform E-RGCH reception procedures for all radio links in the active set for which an E-RGCH configuration has been provided;

- 2> perform E-DPCCH transmission procedures according to the stored E-DPCCH configuration as stated in:

- 3> subclause 8.6.6.37 for the IE "E-DPCCH Info".

- 2> perform E-DPDCH transmission procedures according to the stored E-DPDCH configuration as stated in:
 - 3> subclause 8.6.5.16 for the IE "E-DCH Transmission Time Interval";
 - 3> subclause 8.6.5.17 for the IE "HARQ info for E-DCH";
 - 3> subclause 8.6.6.37 for the IE "E-DPDCH Info".
 - 2> inclusion of MAC-d PDU's in a MAC-e or MAC-i PDU for logical channels belonging to a MAC-d flow for which the IE "Non-scheduled transmission grant info" is configured shall:
 - 3> obey the scheduling and size restrictions as specified for that MAC-d flow (see subclause 8.6.5.18).
 - 2> inclusion of MAC-d PDU's in a MAC-e or MAC-i PDU for logical channels belonging to a MAC-d flow for which the IE "Scheduled transmission grant info" is configured shall:
 - 3> be performed in accordance with the received scheduling grant on E-AGCH/E-RGCH (see [15]); and
 - 3> obey the scheduling restrictions as specified for scheduled transmissions (see subclause 8.6.6.37).
 - 1> For TDD:
 - 2> if scheduled transmission is configured, perform E-AGCH reception procedures according to the stored E-AGCH configuration as stated in:
 - 3> subclause 8.6.3.14 for the IE "New Primary E-RNTI".
 - 2> Perform E-HICH reception;
 - 2> for 3.84/7.68 Mcps TDD, perform E-RUCCH transmission procedures according to the stored E-RUCCH configuration as stated in:
 - 3> subclause 8.6.6.37 for the IE "E-RUCCH Info".
 - 2> for 1.28 Mcps TDD, if scheduled transmission is configured, perform E-RUCCH transmission procedure according to the stored PRACH configuration (see [60]) and the stored E-RUCCH configuration as stated in:
 - 3> subclause 8.6.6.37 for the IE "E-RUCCH Info".
- NOTE 1: The PRACH configuration is signalled directly to the UE in "E-RUCCH Info" IE in case of E-DCH serving cell change.
- 2> Perform E-PUCH transmission procedures according to the stored E-PUCH configuration as stated in:
 - 3> subclause 8.6.6.37 for the IE "E-PUCH Info".
 - 2> inclusion of MAC-d PDU's in a MAC-e or MAC-i PDU for logical channels belonging to a MAC-d flow for which the IE "Non-scheduled transmission grant info" is configured shall:
 - 3> obey the scheduling and size restrictions as specified for that MAC-d flow (see subclause 8.6.5.18).
 - 2> inclusion of MAC-d PDU's in a MAC-e or MAC-i PDU for logical channels belonging to a MAC-d flow for which the IE "Scheduled transmission grant info" is configured shall:
 - 3> be performed in accordance with the received scheduling grant on E-AGCH (see [15]); and
 - 3> obey the scheduling restrictions as specified for scheduled transmissions (see subclause 8.6.6.37).
 - 2> obtain and format the appropriate information on E-UCCH (see [15]).
 - 2> for 1.28 Mcps TDD, when performing transmission on signalling radio bearer before RAB has been established,
 - 3> if MAC-i/is is not configured,
 - 4> use the tables of transport block size for the E-DCH physical layer category 1 as specified in [15].
 - 3> else,

4> use the tables of transport block size for the E-DCH physical layer category 3 as specified in [15].

NOTE 2: For 1.28 Mcps TDD, when performing transmission on signalling radio bearer before RAB has been established, UTRAN should use the same rules with the UE as described above, when performing configuration, scheduling and reading the control information on E-UCCH, as it is not possible for Node B to be aware of the UE's E-DCH capability category during this period.

1> For FDD and CELL_DCH state, determine the value for the SECONDARY_CELL_E_DCH_TRANSMISSION and take the corresponding actions as described in subclause 8.5.58.

1> For 1.28Mcps TDD and CELL_DCH state, determine the value for the MULTI_CARRIER_E_DCH_TRANSMISSION and take the corresponding actions as described in subclause 8.5.62.

Whenever the variable E_DCH_TRANSMISSION is set to FALSE, the UE in CELL_DCH state shall:

1> delete any stored E-AGCH, E-RGCH and E-HICH information for all radio links;

1> not perform E-AGCH, E-HICH and/or E-RGCH reception procedures;

1> not perform E-DPCCH, E-DPDCH, E-RUCCH and/or E-PUCH transmission procedures.

1> For FDD, determine the value for the SECONDARY_CELL_E_DCH_TRANSMISSION and take the corresponding actions as described in subclause 8.5.58.

1> For 1.28Mcps TDD, determine the value for the MULTI_CARRIER_E_DCH_TRANSMISSION and take the corresponding actions as described in subclause 8.5.62.

8.5.29 MBMS modification period identity calculation

The UE shall calculate the identity of a Modification period as follows:

$$MP\ identity = (SFN_{MP} \div MP_{len}) \bmod 2$$

With SFN_{MP} being the SFN corresponding with the frame in which the concerned Modification Period starts

MP_{len} being the length of the Modification Period, that is indicated by the IE "Modification period coefficient" that is included in System Information Block type 5 and 5bis.

8.5.30 Detecting MBMS service reception inability

The UE may detect that it becomes incapable of receiving all services it is interested in at any time due to implementation specific constraints as well as upon state transitions, service / session start, service / session stop, service reconfiguration e.g. transfer mode change and preferred frequency layer changes or whenever there are changes concerning the subset of services that it has selected to receive.

When evaluating its MBMS service reception abilities, the UE shall:

1> consider that MBMS services, for which a preferred frequency layer is specified, are available only on the concerned frequency;

1> consider that MBMS services, for which no preferred frequency layer is specified are available on all frequencies;

1> consider non- MBMS services to be available on all frequencies unless specified otherwise in the following;

1> if the variable MBMS_PL_SERVICE_RESTRICTION_INFO_DEDICATED is set to TRUE:

2> consider the established non-MBMS services not to be available on any MBMS preferred frequency.

1> if the IE "MBMS PL Service Restriction Information" is included in the MBMS GENERAL INFORMATION message for the MBMS preferred frequency the UE is considering to select to:

2> consider non-MBMS services not to be available on the concerned MBMS preferred frequency.

If the UE is unable to receive the MBMS and the non-MBMS services it is interested in, the UE shall:

- 1> detect an MBMS service reception inability.

8.5.31 Actions related to DEFERRED_MEASUREMENT_STATUS variable

If after state transition the UE remains in a state other than CELL_DCH state, the UE shall:

- 1> if variable DEFERRED_MEASUREMENT_STATUS is set to TRUE:
 - 2> if System Information Block type 11 is referenced in the master information block or in the scheduling blocks:
 - 3> if the UE has not read and stored System Information Block type 11:
 - 4> read and store System Information Block type 11.
 - 3> if System Information Block type 11bis is referenced in the master information block or in the scheduling blocks:
 - 4> if the UE has not read and stored System Information Block type 11bis:
 - 5> read and store System Information Block type 11bis.
 - 3> if System Information Block type 11ter is referenced in the master information block or in the scheduling blocks:
 - 4> if the UE has not read and stored System Information Block type 11ter:
 - 5> read and store System Information Block type 11ter.
 - 2> if System Information Block type 12 is referenced in the master information block or in the scheduling blocks, or broadcast of System Information Block type 12 is indicated in System Information Block type 11:
 - 3> if the UE has not read and stored System Information Block type 12:
 - 4> read and store System Information Block type 12.
 - 2> if System Information Block type 18 is referenced in the master information block or in the scheduling blocks:
 - 3> if the UE has not read and stored System Information Block type 18:
 - 4> read and store System Information Block type 18.
 - 2> if System Information Block type 19 is referenced in the master information block or in the scheduling blocks:
 - 3> if the UE has not read and stored System Information Block type 19:
 - 4> read and store System Information Block type 19.

8.5.32 Actions related to MIMO_PARAMS variable

If the UE receives an ACTIVE SET UPDATE, CELL UPDATE CONFIRM, or any reconfiguration message:

- 1> if the IE "MIMO parameters" is not included:
 - 2> clear the MIMO_PARAMS variable;
 - 2> trigger lower layers to stop operation in MIMO mode.
- 1> otherwise:
 - 2> for FDD, if the IE "MIMO N_cqi_typeA/M_cqi ratio" is included:
 - 3> store the value of the IE "MIMO N_cqi_typeA/M_cqi ratio" in the MIMO_PARAMS variable.

- 2> for FDD, if the IE "MIMO pilot configuration" is included:
 - 3> store the value of the IE "MIMO pilot configuration" in the MIMO_PARAMS variable.
- 2> for 1.28 Mcps TDD, if the IE "MIMO SF Mode for HS-PDSCH dual stream" is included:
 - 3> store the value of the IE "MIMO SF Mode for HS-PDSCH dual stream" in the MIMO_PARAMS variable.
- 2> if the IE "MIMO operation" is set to "start":
 - 3> for FDD, if the IE "Precoding weight set restriction" is included:
 - 4> store the value of the IE "Precoding weight set restriction" in the MIMO_PARAMS variable. In addition, it shall be indicated to lower layers that precoding weight set restriction is configured.
 - 3> else:
 - 4> clear the value of the IE "Precoding weight set restriction" in the MIMO_PARAMS variable. In addition, it shall be indicated to lower layers that precoding weight set restriction is not configured.
- 2> else if the IE "MIMO operation" is set to "continue":
 - 3> if the IE "Precoding weight set restriction" is included:
 - 4> if the IE "Precoding weight set restriction" is already stored in the variable MIMO_PARAMS before receiving this message:
 - 5> continue using "Precoding weight set restriction" for MIMO operation.
 - 4> else:
 - 5> UE behaviour is undefined.
 - 3> else:
 - 4> if the IE "Precoding weight set restriction" is already stored in the variable MIMO_PARAMS before receiving this message:
 - 5> continue using "Precoding weight set restriction" for MIMO operation.
 - 4> else:
 - 5> continue MIMO operation without using "Precoding weight set restriction".

NOTE: This subclause applies to FDD and 1.28 Mcps TDD only.

8.5.33 Actions related to MIMO_STATUS variable

If the UE receives an ACTIVE SET UPDATE, CELL UPDATE CONFIRM, or any reconfiguration message, the UE shall:

- 1> take actions related to the MIMO_PARAMS variable as specified in subclause 8.5.32;
- 1> determine the value of the MIMO_STATUS variable.

The MIMO_STATUS variable shall be set to TRUE only when all the following conditions are met:

- 1> The UE is in CELL_DCH state;
- 1> the variable HS_DSCH_RECEPTION is set to TRUE;
- 1> for FDD, if the UE does not support MIMO only with single stream restriction, or if UE that signalled an HS-DSCH physical layer category of 17 or 18 supports MIMO only with single stream restriction but 64QAM is not configured for downlink, the variable MIMO_PARAMS contains a value for the IE "MIMO_N_cqi_typeA/M_cqi ratio"; and

1> for FDD, the variable MIMO_PARAMS contains a value for the IE "MIMO pilot configuration".

1> for 1.28 Mcps TDD, the variable MIMO_PARAMS contains a value for the IE "MIMO SF Mode for HS-PDSCH dual stream".

If any of the above conditions is not met and the MIMO_STATUS variable is set to TRUE, the UE shall:

1> set the MIMO_STATUS variable to FALSE;

1> clear the MIMO_PARAMS variable;

1> trigger lower layers to stop operation in MIMO mode on the serving HS-DSCH cell.

If the MIMO_STATUS variable is set to FALSE:

1> if prior to receiving an ACTIVE SET UPDATE, CELL UPDATE CONFIRM, or any reconfiguration message, the MIMO_STATUS variable was set to TRUE:

2> if the IE "HARQ info" is not included in the received message:

3> the UE behaviour is unspecified.

If the MIMO_STATUS variable is set to TRUE:

1> if prior to receiving an ACTIVE SET UPDATE, CELL UPDATE CONFIRM, or any reconfiguration message, the MIMO_STATUS variable was set to FALSE:

2> if the IE "HARQ info" is not included in the received message:

3> the UE behaviour is unspecified.

NOTE: This subclause applies to FDD and 1.28 Mcps TDD only.

8.5.34 Actions related to DTX_DRX_STATUS variable (FDD only)

If the UE receives RRC CONNECTION SETUP, ACTIVE SET UPDATE, CELL UPDATE CONFIRM, any reconfiguration message, or target cell HS-SCCH order:

1> the UE shall determine the value for the DTX_DRX_STATUS variable.

The variable DTX_DRX_STATUS shall be set to TRUE only when all the following conditions are met:

1> the UE is in CELL_DCH state;

1> both variables HS_DSCH RECEPTION and E_DCH_TRANSMISSION are set to TRUE;

1> if the variable DCH_ENHANCEMENTS_STATUS is set to FALSE:

2> no DPDCH is present in uplink and F-DPCH is configured in downlink;

1> the variable DTX_DRX_PARAMS is set;

1> the IE "DTX-DRX timing information" is included in the received message or in the IE "Target cell preconfiguration information" stored in the variable TARGET_CELL_PRECONFIGURATION associated with the cell from which target cell HS-SCCH order is received.

If any of the above conditions is not met and the variable DTX_DRX_STATUS is set to TRUE, the UE shall:

1> set the variable DTX_DRX_STATUS to FALSE;

1> clear the variable DTX_DRX_PARAMS;

1> stop DTX-DRX mode related activities.

NOTE: If the uplink slot format is not changed by the received RRC message, the UE keeps using the same uplink slot format currently configured.

If the variable DTX_DRX_STATUS is set to TRUE and the serving HS-DSCH cell was changed as a result of the received message or HS-SCCH order from the target cell, the UE shall instruct the physical layer to consider that the HS-SCCH orders from the serving cell were never received.

If the variable DTX_DRX_STATUS is set to TRUE, the value of IE "DTX-DRX timing information" included in the message is not "Continue" and the serving HS-DSCH cell was not changed as a result of the received message, the UE shall instruct the physical layer to consider that the DTX, DRX related HS-SCCH orders were never received.

If the variable DTX_DRX_STATUS is set to TRUE, the value of IE "DTX-DRX timing information" included in the message is "Continue" and the serving HS-DSCH cell was not changed as a result of the received message, the UE shall instruct the physical layer to consider that the DTX, DRX related HS-SCCH orders were received.

Whenever the variable DTX_DRX_STATUS is set to TRUE after receiving this message and the value of IE "DTX-DRX timing information" included in this message is not "Continue", the UE shall:

- 1> if the variable DTX_DRX_STATUS was set to TRUE before receiving this message:
 - 2> re-configure the physical layer to perform discontinuous uplink DPCCH transmission and enable or disable discontinuous downlink reception operations according to the variable DTX_DRX_PARAMS at the CFN corresponding to the frame boundary that is offset by the value of the IE "Enabling Delay" from the frame boundary where uplink transmission starts with the new configuration;
 - 2> let the MAC layer continue any current restriction on E-DCH transmission and monitoring of absolute and relative grant channels from the frame boundary where the uplink transmission starts with the new configuration and for the duration of the IE "Enabling Delay".

1> else:

- 2> perform discontinuous uplink DPCCH transmission and enable discontinuous downlink reception operations by configuring the physical layer according to the variable DTX_DRX_PARAMS at the CFN corresponding to the frame boundary that is offset by the value of the IE "Enabling Delay" from the frame boundary where the uplink transmission starts with the new configuration.
- 2> configure the MAC layer to start restricting E-DCH transmissions and monitor absolute and relative grant channels at the CFN corresponding to the frame boundary that is offset by the value of IE "Enabling Delay" from the frame boundary where the uplink transmission starts with the new configuration taking into account the IEs "UE DTX DRX Offset", "MAC DTX Cycle", "MAC Inactivity Threshold" and "Inactivity Threshold for UE Grant Monitoring".

NOTE: If a post-verification period is configured [29], then the uplink transmission starts when the physical channel establishment is initiated by the UE. If a post-verification period is configured and the post-verification procedure fails then uplink transmission (re)starts when the downlink physical channel is established and the enabling delay timer is (re)started. If a post-verification period is not configured, the uplink transmission starts when the downlink physical channel is established.

8.5.35 Actions related to HS_SCCH_LESS_STATUS variable (FDD only)

If the UE receives RRC CONNECTION SETUP, ACTIVE SET UPDATE, CELL UPDATE CONFIRM, or any reconfiguration message;

- 1> the UE shall determine the value for the HS_SCCH_LESS_STATUS variable.

The variable HS_SCCH_LESS_STATUS shall be set to TRUE only when all the following conditions are met:

- 1> the UE is in CELL_DCH state;
- 1> the variable HS_DSCH_RECEPTION is set to TRUE;
- 1> no DPDCH is present in uplink and F-DPCH is configured in downlink;
- 1> the UE is not configured in MIMO mode;
- 1> the UE is not configured in MIMO mode with four transmit antennas;
- 1> the variable HS_SCCH_LESS_PARAMS is set;

1> the IE "HS-SCCH less information" is included in the received message.

If any of the above conditions is not met and the variable HS_SCCH_LESS_STATUS is set to TRUE the UE shall:

1> set the variable HS_SCCH_LESS_STATUS to FALSE;

1> clear the variable HS_SCCH_LESS_PARAMS;

1> stop all HS-SCCH less related activities.

If variable HS_SCCH_LESS_STATUS is set to TRUE and the serving HS-DSCH cell was changed as a result of the received message or HS-SCCH order from the target cell, the UE shall instruct the physical layer to consider that the HS-SCCH orders from the serving cell were never received.

If the variable HS_SCCH_LESS_STATUS is set to TRUE, the value of IE "HS-SCCH less information" included in the message is not "Continue HS-SCCH less operation" and the serving HS-DSCH cell was not changed as a result of the received message, the UE shall instruct the physical layer to consider that the HS-SCCH less related HS-SCCH orders were never received.

If the variable HS_SCCH_LESS_STATUS is set to TRUE, the value of IE "HS-SCCH less information" included in the message is "Continue HS-SCCH less operation" and the serving HS-DSCH cell was not changed as a result of the received message, the UE shall instruct the physical layer to consider that the HS-SCCH less related HS-SCCH orders were received.

Whenever the variable HS_SCCH_LESS_STATUS is set to TRUE, the UE shall:

1> configure the physical and MAC layers to operate according to the HS_SCCH_LESS_PARAMS;

1> configure the physical layer to use a virtual IR buffer size of at least 4536 bits for HS-SCCH less HS-DSCH transmissions.

8.5.36 Actions related to HS_DSCH_RECEPTION_CELL_FACH_STATE variable (FDD and 1.28 Mcps TDD only)

The variable HS_DSCH_RECEPTION_CELL_FACH_STATE shall be set to TRUE only when all the following conditions are met:

1> the UE is in CELL_FACH;

1> the UE supports HS-DSCH reception in CELL_FACH state;

1> the variable H_RNTI is set;

1> the variable C_RNTI is set;

1> the UE has stored the IE "Added or reconfigured MAC-ehs reordering queue";

1> System Information Block type 5 or System Information Block type 5bis includes IE "HS-DSCH common system information";

1> for 1.28 Mcps TDD, System Information Block type 5 includes IE "Common E-DCH system info".

If any of the above conditions is not met and the variable HS_DSCH_RECEPTION_CELL_FACH_STATE is set to TRUE, the UE shall:

1> set the variable HS_DSCH_RECEPTION_CELL_FACH_STATE to FALSE;

1> if the UE is in CELL_FACH and variable HS_DSCH_RECEPTION_OF_CCCH_ENABLED is set to FALSE:

2> set the variable HS_DSCH_RECEPTION_GENERAL to FALSE;

2> stop any HS-SCCH reception procedures;

2> stop any HS-DSCH reception procedures;

2> clear the variable H_RNTI and remove any stored H-RNTI;

- 2> reset the MAC-ehs entity [15];
- 2> release all HARQ resources;
- 2> clear any stored IEs "HARQ info";

Whenever the variable HS_DSCH_RECEPTION_CELL_FACH_STATE is set to TRUE, the UE shall:

- 1> set the variable HS_DSCH_RECEPTION_GENERAL to TRUE;
- 1> use the IE "HS-DSCH common system information" in System Information Block type 5 or System Information Block type 5bis;
- 1> for FDD, receive the HS-SCCH(s) according to the IE "HS-SCCH channelisation code" on the serving cell applying the scrambling code as received in the IE "DL Scrambling code" as received in IE "HS-DSCH common system information";
- 1> for 1.28 Mcps TDD, receive the HS-SCCH(s) according to the stored HS-SCCH configuration, applying the HS-PDSCH midamble code according to the stored HS-PDSCH midamble configuration;
- 1> for FDD:
 - 2> determine the "Total number of soft channel bits" (defined in Table 5.1a of [35]) according to subclause 8.1.6.2 and use it in the physical layer;
 - 2> use the octet aligned HS-DSCH transport block table [15] in the MAC-ehs entity.
- 1> perform HS-DSCH reception procedures for DCCH or DTCH:
 - 2> if the UE has a stored IE "HARQ info":
 - 3> act on subclause 8.6.5.6b for the stored IE "HARQ info".
 - 2> else:
 - 3> act on subclause 8.6.5.20 for the IE "HARQ System info" as received in IE "HS-DSCH common system information".
 - 2> and use the value of the variable H_RNTI as UE identity in the HS-SCCH reception procedure in the physical layer;
 - 2> configure the MAC-ehs reordering queues according to IE "Added or reconfigured MAC-ehs reordering queue" as defined in subclauses 8.6.5.23.
- 1> and for FDD, for BCCH reception perform HS-DSCH reception procedures by listening to the first indexed HS-SCCH code listed in the IE "HS-SCCH channelisation code" with "BCCH specific H-RNTI" as received in IE "HS-DSCH common system information".
- 1> and for 1.28 Mcps TDD, for BCCH reception perform HS-DSCH reception procedures by listening to the first indexed HS-SCCH according to the stored HS-SCCH configuration with "BCCH specific H-RNTI" as received in IE "HS-DSCH common system information".

NOTE : For 1.28 Mcps TDD, when performing HS-DSCH reception in CELL_FACH state, the UE shall use the table of transport block size for the HS-DSCH physical layer category 9 as specified in [15].

Whenever the variable HS_DSCH_RECEPTION_CELL_FACH_STATE is set to FALSE, the UE shall:

- 1> if the UE is in CELL_FACH and variable HS_DSCH_RECEPTION_OF_CCCH_ENABLED is set to FALSE:
 - 2> not perform HS-SCCH reception procedures;
 - 2> not perform HS-DSCH reception procedures.

8.5.37 Actions related to HS_DSCH_RECEPTION_OF_CCCH_ENABLED variable (FDD and 1.28 Mcps TDD only)

When UE does not support HS-DSCH reception in CELL_FACH state or when the IE "HS-DSCH common system information" is not included in System Information Block type 5 or System Information Block type 5bis, the UE shall:

- 1> set the variable HS_DSCH_RECEPTION_OF_CCCH_ENABLED to FALSE;
- 1> set the variable HS_DSCH_RECEPTION_GENERAL to FALSE.

When the variable HS_DSCH_RECEPTION_OF_CCCH_ENABLED is set to TRUE, the UE shall:

- 1> set the variable HS_DSCH_RECEPTION_GENERAL to TRUE;
- 1> use the IE "HS-DSCH common system information" in System Information Block type 5 or System Information Block type 5bis;
- 1> for FDD:
 - 2> configure the physical layer to use the "Total number of soft channel bits" (defined in Table 5.1a of [35]) for category 12 for HS-DSCH reception;
 - 2> use the octet aligned HS-DSCH transport block table [15] in the MAC-ehs entity;
- 1> configure the HARQ according to IE "HARQ System info" as defined in subclause 8.6.5.20;
- 1> configure the common MAC-ehs reordering queues according to IE "Common MAC-ehs reordering queues" as defined in subclauses 8.6.5.22; and then
- 1> receive the CCCH according to IE "CCCH mapping info" as defined in subclause 8.6.5.21;
- 1> if the UE is RRC Connected mode:
 - 2> select a common H-RNTI as specified in 8.5.38;
 - 2> if the variable HS_DSCH_RECEPTION_OF_CCCH_ENABLED is set to TRUE:
 - 3> receive the SRB1 according to IE "SRB1 mapping info" as defined in subclause 8.6.5.19.
- 1> else:
 - 2> select a common H-RNTI as specified in [4].
- 1> and for FDD, start to receive the HS-SCCH(s) with selected H-RNTI according to the IE "HS-SCCH channelisation code" on the selected cell applying the scrambling code as received in the IE "DL Scrambling code";
- 1> and for 1.28 Mcps TDD, start to receive the HS-SCCH(s) with selected H-RNTI according to the IE "HS-SCCH system info" on primary frequency in the selected cell applying the midamble code as received in the IE "HS-PDSCH Midamble Configuration";
- 1> configure the MAC flow for BCCH reception as specified in [15];
- 1> and for FDD, start to receive the first indexed HS-SCCH code listed in the IE "HS-SCCH channelisation code" with "BCCH specific H-RNTI" as received in IE "HS-DSCH common system information".
- 1> and for 1.28 Mcps TDD, for BCCH reception perform HS-DSCH reception procedures by listening to the first indexed HS-SCCH according to the IE "HS-SCCH system info" with "BCCH specific H-RNTI" as received in IE "HS-DSCH common system information".

NOTE : For 1.28 Mcps TDD, when performing HS-DSCH reception in CELL_FACH state, the UE shall use the table of transport block size for the HS-DSCH physical layer category 9 as specified in [15].

8.5.37a Actions related to HS_DSCH_RECEPTION_GENERAL

The UE shall:

- 1> For CELL_FACH state, if the UE supports HS-DSCH reception in CELL_FACH state and the IE "HS-DSCH common system information" is not included in the System Information Block Type 5/5bis; or,
- 1> For CELL_PCH and URA PCH state, if the UE supports HS-DSCH reception in CELL_PCH and URA_PCH state and the IE "HS-DSCH paging system information" is not included in System Information Block type 5 or System Information Block type 5bis:
 - 2> if the variable HS_DSCH_RECEPTION_GENERAL is set to TRUE:
 - 3> set the variable HS_DSCH_RECEPTION_GENERAL to FALSE;
 - 3> stop any HS-SCCH reception procedures;
 - 3> stop any HS-DSCH reception procedures;
 - 3> if the variable HSPA_RNTI_STORED_CELL_PCH is set to FALSE:
 - 4> clear the variable H_RNTI and remove any stored H-RNTI.
 - 3> reset the MAC-ehs entity [15];
 - 3> release all HARQ resources;

8.5.38 Common H-RNTI selection (FDD and 1.28 Mcps TDD only)

When the IE "Common H-RNTI Information" is included in System Information Block type 5 or System Information Block type 5bis, the UE shall select the Common H-RNTI according to the following rules:

- 1> compile a list of candidate Common H-RNTI IE(s) "Common H-RNTI" in the order of appearance in System Information Block type 5 or System Information Block type 5bis;
- 1> select a Common H-RNTI from the list of candidate Common H-RNTIs based on U-RNTI as follows:

$$\text{"Index of selected Common H-RNTI"} = \text{U-RNTI mod K},$$

where K is equal to the number of candidate Common H-RNTIs.

The UE shall set the CFN in relation to the SFN of the current cell according to subclause 8.5.15.

8.5.39 PICH selection for HSDPA based paging (FDD and 1.28 Mcps TDD only)

For FDD, when the IE "HS-DSCH paging system information" is included in System Information Block type 5 or System Information Block type 5bis and the UE is in UTRAN in CELL_PCH or URA_PCH state, the UE shall select the PICH according to the following rules:

- 1> compile a list of candidate PICH for HSDPA from IE(s) "HSDPA associated PICH info" in the order of appearance in System Information Block type 5 or System Information Block type 5bis;
- 1> select a PICH from the list of candidate PICHs based on U-RNTI as follows:

$$\text{"Index of selected HSDPA associated PICH"} = \text{U_RNTI value mod K},$$

where K is equal to the number of candidate PICHs for HSDPA.

For 1.28 Mcps TDD, when the IE "PICH for HS-DSCH list" is included in the IE "HS-DSCH paging system information" in System Information Block type 5 and the UE is in CELL_PCH or URA_PCH state, and the variable HS_DSCH_RECEPTION_GENERAL is set to TRUE, the UE shall select the PICH according to the following rules:

- 1> compile a list of candidate PICH for HSDPA from IE(s) "HSDPA associated PICH info" in the order of appearance in System Information Block type 5;
- 1> select a PICH from the list of candidate PICHs based on U-RNTI as follows:

$$\text{"Index of selected HSDPA associated PICH"} = \text{U_RNTI value mod K},$$

where K is equal to the number of candidate PICHs for HSDPA.

8.5.40 HS_DSCH Reception in CELL_PCH and URA_PCH (FDD only)

When the IE "HS-DSCH paging system information" is included in System Information Block type 5 or System Information Block type 5bis and the UE supports HS-DSCH reception in CELL_PCH and URA_PCH state and the UE is in CELL_PCH or URA_PCH state, the UE shall:

- 1> set the variable HS_DSCH_RECEPTION_GENERAL to TRUE;
- 1> use the octet aligned HS-DSCH transport block table [15] in the MAC-ehs entity;
- 1> if variable H_RNTI and variable C_RNTI are set and UE is in CELL_PCH state:
 - 2> determine the "Total number of soft channel bits" (defined in Table 5.1a of [35]) according to subclause 8.1.6.2 and use it in the physical layer;
 - 2> for DCCH or DTCH reception:
 - 3> use the value of the variable H_RNTI as UE identity in the HS-SCCH reception procedure in the physical layer.
 - 2> for BCCH reception:
 - 3> perform HS-DSCH reception procedures by listening to the first indexed HS-SCCH code listed in the IE "HS-SCCH channelisation code" with "BCCH specific H-RNTI" as received in IE "HS-DSCH common system information" from System Information Block type 5 or System Information Block type 5bis.
 - 2> if the UE detects the value of the variable H_RNTI in the HS-SCCH reception procedure; and
 - 2> if the value of the variable READY_FOR_COMMON_EDCH has not been changed due to a system information modification:
 - 3> initiate the measurement report procedure as specified in subclause 8.4.2;
 - 3> move to CELL_FACH;
 - 3> start to receive HS-DSCH according to the procedure in subclause 8.5.36;
 - 3> stop timer T319 if it is running;
 - 3> restart the timer T305 if it is set to any value other than "infinity".
 - 2> if the UE has uplink RLC data PDU or uplink RLC control PDU on RB1 or upwards to transmit; and
 - 2> if the value of the variable READY_FOR_COMMON_EDCH has not been changed due to a system information modification:
 - 3> initiate the measurement report procedure as specified in subclause 8.4.2;
 - 3> move to CELL_FACH state;
 - 3> start to receive HS-DSCH according to the procedure in subclause 8.5.36;
 - 3> stop timer T319 if it is running;
 - 3> restart the timer T305 if it is set to any value other than "infinity".
- 1> else:
 - 2> if variable H_RNTI or variable C_RNTI are set, or if the UE is in URA_PCH state:
 - 3> clear the variable H_RNTI;
 - 3> clear the variable C_RNTI;
 - 3> clear any stored IE "HARQ Info";

- 3> reset the MAC-ehs entity [15].
- 2> perform the HS-DSCH reception procedure according to IE "HS-DSCH paging system information" as received in System Information Block type 5 or System Information Block type 5bis, receive the HS-PDSCH applying:
 - 3> a scrambling code as received in the IE "DL Scrambling code";
 - 3> a channelisation code selected according to 8.5.41 in "Number of PCCH transmissions" consecutive TTIs;
 - 3> the Transport block sizes indexed in the IE "Transport Block Size List" for demultiplexing of upper layer PDUs from transport blocks delivered from the physical layer on HS-DSCH, as described in [29]; and
 - 3> configure the physical layer to use the "Total number of soft channel bits" (defined in Table 5.1a of [35]) for category 12 for HS-DSCH reception.

8.5.40a HS_DSCH Reception in CELL_PCH and URA_PCH (1.28 Mcps TDD only)

When the IE "HS-DSCH paging system information" is included in System Information Block type 5 and the UE is in CELL_PCH or URA_PCH state, the UE shall:

- 1> if variable H_RNTI and variable C_RNTI are set:
 - 2> if the UE is in CELL_PCH state:
 - 3> set the variable HS_DSCH_RECEPTION_GENERAL to TRUE;
 - 3> use the value of the variable H_RNTI as UE identity in the HS-SCCH reception procedure in the physical layer for DCCH or DTCH reception; and
 - 3> for BCCH reception perform HS-DSCH reception procedures by listening to the first indexed HS-SCCH code listed in the IE "HS-SCCH channelisation code" for FDD or first instance in the IE "HS-SCCH Set Configuration" for 1.28 Mcps TDD with "BCCH specific H-RNTI" as received in IE "HS-DSCH common system information" from System Information Block type 5 or System Information Block type 5bis;
 - 3> if the UE detects the value of the variable H_RNTI in the HS-SCCH reception procedure:
 - 4> initiate the enhanced uplink synchronization procedure;
 - 4> move to CELL_FACH;
 - 4> stop timer T319 if it is running.
 - 3> if the UE has uplink RLC data PDU or uplink RLC control PDU on RB1 or upwards to transmit:
 - 4> move to CELL_FACH state;
 - 4> stop timer T319 if it is running.
 - 2> if the UE is in URA_PCH state:
 - 3> clear the variable H_RNTI;
 - 3> clear the variable C_RNTI;
 - 3> clear any stored IE "HARQ Info";
 - 3> reset the MAC-ehs entity [15];
 - 3> if the IE "PICH info" isn't included in IE "Secondary CCPCH system information" in System Information Block type 5 or System Information Block type 6:
 - 4> set the variable HS_DSCH_RECEPTION_GENERAL to TRUE;

- 4> perform the HS-DSCH reception procedure according to IE "HS-DSCH paging system information" as received in System Information Block type 5:
 - 5> receive the HS-PDSCH applying the configuration according to 8.5.41 in "Paging Sub-Channel Size" * 2 consecutive TTIs and use the Transport block sizes indexed in the IE "Transport Block Size List" for demultiplexing of upper layer PDUs from transport blocks delivered from the physical layer on HS-DSCH, as described in [33].
- 1> else:
 - 2> if variable H_RNTI or variable C_RNTI are set:
 - 3> clear the variable H_RNTI;
 - 3> clear the variable C_RNTI;
 - 3> clear any stored IE "HARQ Info";
 - 3> reset the MAC-ehs entity [15].
 - 2> if the IE "PICH info" isn't included in IE "Secondary CCPCCH system information" in System Information Block type 5 or System Information Block type 6:
 - 3> set the variable HS_DSCH_RECEPTION_GENERAL to TRUE;
 - 3> perform the HS-DSCH reception procedure according to IE "HS-DSCH paging system information" as received in System Information Block type 5, receive the HS-PDSCH applying:
 - 4> HS-PDSCH configuration selected according to 8.5.41 in "Paging Sub-Channel Size" * 2 consecutive TTIs;
 - 4> the Transport block sizes indexed in the IE "Transport Block Size List" for demultiplexing of upper layer PDUs from transport blocks delivered from the physical layer on HS-DSCH, as described in [33].

NOTE : When performing HS-DSCH reception in CELL_PCH and URA_PCH state, the UE shall use the table of transport block size for the HS-DSCH physical layer category 9 as specified in [15].

8.5.41 HS-PDSCH channelisation codes selection for paging reception (FDD and 1.28 Mcps TDD only)

For FDD, when the IE "HS-DSCH paging system information" is included in System Information Block type 5 or System Information Block type 5bis and the UE is in UTRAN in CELL_PCH or URA_PCH state with variable H_RNTI not set, the UE shall select the channelisation code for HS-PDSCH reception according to the following rules:

- 1> compile a list of candidate HS-PDSCH channelisation codes from the IE(s) "HS-PDSCH Channelisation Code" in the order of appearance in System Information Block type 5 or System Information Block type 5bis;
- 1> select a HS-PDSCH channelisation codes from the list of candidate HS-PDSCH channelisation codes based on U-RNTI as follows:

$$\text{"Index of selected HS-PDSCH channelisation codes"} = U_RNTI \text{ value mod } K,$$

where K is equal to the number of candidate HS-PDSCH channelisation codes.

For 1.28 Mcps TDD, when the IE "Paging associated HS-PDSCH info" is included in the IE "HS-DSCH paging system information" in System Information Block type 5 and the UE is in CELL_PCH or URA_PCH state, and the variable HS_DSCH_RECEPTION_GENERAL is set to TRUE, the UE shall select the HS-PDSCH according to the following rules:

- 1> compile a list of candidate HS-PDSCH configuration from IE(s) "Paging associated HS-PDSCH info" in the order of appearance in System Information Block type 5;
- 1> select an HS-PDSCH configuration from the list of candidate HS-PDSCHs based on U-RNTI as follows:

"Index of selected HS-PDSCH" = U_RNTI value mod K,

where K is equal to the number of candidate HS-PDSCH configuration.

8.5.42 Autonomous UTRAN DRX Cycle length coefficient change

If timer T319 expires:

- 1> set k to the value of the stored IE "DRX cycle length coefficient";
- 1> store the result of $\text{MAX}(2^k, \text{PBP})$, where PBP is the Paging Block Periodicity, as the DRX cycle length; and
- 1> determine its connected mode paging occasions and PICH monitoring occasions in the same way as for idle mode, according to [4].

NOTE: The DRX cycle length to use in connected mode is defined in [4].

8.5.43 Reception of MBMS from a cell operating in MBSFN mode

A cell provides MBMS service in MBSFN mode if it is indicated so in system information, see subclause 8.1.1.6.3. A UE that supports MBSFN operation may receive MBMS services via a cell operating in MBSFN mode. For FDD, 3.84 Mcps TDD IMB and 3.84/7.68 Mcps TDD in order to receive an MBMS service via a MBSFN cluster the UE shall select the MBSFN cluster as specified in [4] in addition to selecting a cell for normal camping as specified in [4]. For 1.28 Mcps TDD in order to receive an MBMS service via an MBSFN cluster the UE shall at the first step camp on a unicast cell and get the frequency and "cell parameter ID" from the system information, and then get synchronized to the MBSFN cluster operating with that frequency and "cell parameter ID". For 3.84/7.68 Mcps TDD a cell shall be considered to be operating in MBSFN mode when individual scrambling codes are assigned to all timeslots (via the IE "TDD MBSFN Information").

For 3.84 Mcps TDD IMB, MBMS reception is provided on a 3.84 Mcps TDD frequency [22]. The S-CCPCH frame type 2 format shall be used for the S-CCPCHs carrying MTCH. Unless specified otherwise, the RRC protocol is operated according to the FDD requirements applicable for MBSFN.

8.5.44 HS-DSCH CQI reporting tables

If the variable HS_DSCH_RECEPTION is set to "TRUE", the UE shall:

- 1> if the UE has been configured with at least one MAC-ehs reordering queue:
 - 2> use the relevant CQI tables, as defined in [29], for the HS-DSCH category extension stored in the variable UE_CAPABILITY_TRANSFERRED. For 1.28 Mcps TDD, use the table of transport block size, as defined in [15], for the HS-DSCH category indicated by the IE "HS-DSCH physical layer category extension" stored in the variable UE_CAPABILITY_TRANSFERRED.
- 1> otherwise:
 - 2> use the relevant CQI tables, as defined in [29], for the HS-DSCH category indicated by the IE "HS-DSCH physical layer category" stored in the variable UE_CAPABILITY_TRANSFERRED. For 1.28 Mcps TDD, use the table of transport block size, as defined in [15], for the HS-DSCH category indicated by the IE "HS-DSCH physical layer category" stored in the variable UE_CAPABILITY_TRANSFERRED.

8.5.45 Enhanced Uplink in CELL_FACH state and Idle mode (FDD only)

For this version of the specification, when a UE selects a cell, the uplink frequency to be used for the PRACH preamble (physical signal) and DPCCCH/E-DPCCH/E-DPDCH transmission shall have a default duplex frequency spacing offset from the downlink frequency that the cell was selected on. The default duplex frequency separation to be used by the UE is specified in [21] for each frequency band.

If variable READY_FOR_COMMON_EDCH is set to TRUE the UE shall:

- 1> if the UE supports concurrent deployment and System Information Block type 22 includes the IE's "Concurrent deployment of 2ms and 10ms TTI" and "PRACH preamble control parameters extension list Type 2 (for Enhanced Uplink)"; or
- 1> if the UE supports concurrent deployment and TTI alignment and Per HARQ process and System Information Block type 22 includes the IE's "Concurrent deployment of 2ms and 10ms TTI", "PRACH preamble control parameters extension list Type 3 (for Enhanced Uplink)", and either of the IE's "Offset" or "Scheduled Transmission configuration":
 - 2> configure the lower layers for concurrent deployment of 2ms and 10ms TTI in a cell;
 - 2> perform common E-DCH TTI selection as described in subclause 8.5.72;
 - 2> configure and use the MAC and the physical layer for the PRACH preamble transmission for both 2ms and 10ms common E-DCH TTI as described in subclause 8.5.73.
- 1> else if the IE "PRACH preamble control parameters extension list Type 1 (for Enhanced Uplink)" is included in System Information Block 22:
 - 2> if the UE supports NodeB triggered HS-DPCCH transmission and System Information Block type 22 includes IE "NodeB triggered HS-DPCCH transmission"; or
 - 2> if the UE supports HS-DSCH DRX operation with second DRX cycle and System Information Block type 22 includes IE "HS-DSCH DRX in CELL_FACH with second DRX cycle Information "; or
 - 2> if the UE supports Fallback to R99 PRACH and System Information Block type 22 includes IE "Fallback R99 PRACH info":
 - 3> configure and use the MAC and the physical layer for the PRACH preamble transmission as described in subclause 8.5.74.
 - 2> else:
 - 3> configure and use the MAC and the physical layer for the PRACH preamble transmission according to the parameters included in the selected "PRACH preamble control parameters (for Enhanced Uplink)" IE according to [15].
- 1> else:
 - 2> configure and use the MAC and the physical layer for the PRACH preamble transmission according to the parameters included in the selected "PRACH preamble control parameters (for Enhanced Uplink)" IE according [15].
- 1> compile a list of candidate common E-DCH resource configuration in the order of appearance as contained in IE "Common E-DCH Resource Configuration information list" and, if present, in IE "Common E-DCH Resource Configuration Information List Extension".

If variable `READY_FOR_COMMON_EDCH` is set to `TRUE`, then after receiving the "E-DCH resource index" by MAC with the `CMAC-STATUS` primitive, the UE shall:

- 1> determine the value for the `FALLBACK_R99_PRACH_ENABLED` variable and take the corresponding actions as described in subclause 8.5.76.
- 1> if variable `FALLBACK_R99_PRACH_ENABLED` is set to `FALSE`:
 - 2> the UE selects the Common E-DCH Resource Configuration from the list of candidate common E-DCH resource configuration as follows:

"Index of the selected Common E-DCH resource configuration" = "E-DCH resource index".

 - 2> After selection of a common E-DCH resource configuration, the UE shall configure MAC and the physical layer for E-DCH and HSDPA transmission according to the following:
 - 3> configure Uplink DPCH in accordance with the uplink DPCCH slot format 1 [26], the IE "Uplink DPCH code info" and IE "Uplink DPCH power control info";

- 3> if IE "ACK/NACK support on HS-DPCCH" is set to TRUE:
 - 4> if any of the IE "ACK", "NACK", or "Ack-Nack repetition factor" is not included in the IE "Uplink DPCCH power control info":
 - 5> the UE behaviour is not specified.
 - 4> else:
 - 5> configure the HS-DPCCH in accordance with HS-DPCCH slot format [26], the HS-DPCCH code [28] and IE "Uplink DPCCH power control info".
- 3> for NodeB triggered HS-DPCCH transmission:
 - 4> if any of the IE "ACK", "NACK", or "Ack-Nack repetition factor" is not included in the IE "Uplink DPCCH power control info", or if the IE "Measurement Feedback Info" is not included:
 - 5> the UE behaviour is not specified.
 - 4> else:
 - 5> configure the HS-DPCCH in accordance with HS-DPCCH slot format [26], the HS-DPCCH code [28], the IE "Uplink DPCCH power control info" and the IE "Measurement Feedback Info".
- 3> configure the common E-DCH MAC-d flows as described in subclause 8.6.5.24;
- 3> configure the UL E-DPCCH in accordance with the IE "E-DPCCH info" configuration;
- 3> if the UE supports concurrent deployment and System Information Block type 22 includes the IE's "Concurrent deployment of 2ms and 10ms TTI" and "PRACH preamble control parameters extension list Type 2 (for Enhanced Uplink)"; or
- 3> if the UE supports concurrent deployment and TTI alignment and Per HARQ process and System Information Block type 22 includes the IE's "Concurrent deployment of 2ms and 10ms TTI", "PRACH preamble control parameters extension list Type 3 (for Enhanced Uplink)", and either of the IE's "Coffset" or "Scheduled Transmission configuration":
 - 4> if the last selected common E-DCH TTI value in subclause 8.5.72 is 10ms TTI:
 - 5> apply a TTI of 10ms on the E-DPDCH.
 - 4> else:
 - 5> if the "Index of the selected Common E-DCH resource configuration" is less than "Concurrent TTI partition index":
 - 6> apply a TTI of 10ms on the E-DPDCH.
 - 5> else:
 - 6> apply a TTI of 2ms on the E-DPDCH.
 - 6> if the UE supports TTI alignment and Per HARQ process and System Information Block type 22 includes the IE "PRACH preamble control parameters extension list Type 3 (for Enhanced Uplink)", and either of the IE's "Coffset" or "Scheduled Transmission configuration":
 - 7> if System Information Block type 22 includes the IE "Coffset":
 - 8> configure the lower layers with the IE "Coffset";
 - 7> if System Information Block type 22 includes the IE "Scheduled Transmission configuration":
 - 8> enable "Per HARQ process" scope in the MAC.
 - 8> configure the MAC with a list of HARQ processes on which grants are allowed using information contained in the IE "2ms HARQ process allocation".

- 3> else:
 - 4> apply the TTI as signalled in the IE "E-DCH Transmission Time Interval" on the E-DPDCH;
- 3> use a redundancy version for each HARQ transmission as configured by the IE "HARQ RV Configuration";
- 3> use the same scrambling code for F-DPCH, E-RGCH, E-HICH and E-AGCH reception as configured for the Primary CPICH;
- 3> use a channelization code for F-DPCH reception as configured by IE "F-DPCH Code number";
- 3> configure F-DPCH with the F-DPCH slot format as specified in [26];
- 3> apply the DPC_Mode=0 for F-DPCH according to [29];
- 3> configure the MAC with the stored IE "E-DPDCH info" configuration;
- 3> configure the E-HICH in accordance with the IE "E-HICH info" configuration;
- 3> configure the E-AGCH in accordance with the IE "E-AGCH info" configuration;
- 3> configure the E-RGCH in accordance with the IE "E-RGCH info" configuration if an E-RGCH configuration has been provided with the system information;
- 3> configure the radio link as the serving E-DCH radio link;
- 3> determine the value for the COMMON_E_DCH_TRANSMISSION variable and take the corresponding actions as described in subclause 8.5.46.
- 3> if variable READY_FOR_COMMON_ERGCH is set to TRUE:
 - 4> configure the E-RGCH for radio links other than the serving E-DCH radio link in accordance with the configuration in the stored IE "Common E-RGCH info FDD".

NOTE: If according to the above procedure, the TTI applied on E-DPDCH is different from the TTI signalled in the IE "E-DCH Transmission Time Interval", then the IE's "Uplink DPCH power control info" and "Measurement Feedback Info" in fact refer the IE's "Uplink DPCH power control info for Concurrent TTI" and "Measurement Feedback Info for Concurrent TTI" respectively if present in the IE "Common E-DCH system info parameters for Concurrent TTI" of System Information Block type 22.

8.5.45a Enhanced Uplink in CELL_FACH state and Idle mode (1.28 Mcps TDD only)

If variable READY_FOR_COMMON_EDCH is set to TRUE, the RRC in the UE shall configure MAC and the physical layer for E-DCH and HS-DSCH transmission, and the UE shall:

- 1> configure the common E-DCH MAC-d flows as described in subclause 8.6.5.24;
- 1> use a redundancy version for each HARQ transmission as configured by the IE "HARQ info for E-DCH";
- 1> configure the PHY with the stored IE "E-PUCH info" configuration and the information contained in IE "E-RUCCH info";
- 1> configure the E-HICH in accordance with the stored IE "E-HICH info" configuration;
- 1> configure the E-AGCH in accordance with the stored IE "E-AGCH info" configuration;
- 1> configure the radio link as the serving E-DCH radio link;
- 1> determine the value for the COMMON_E_DCH_TRANSMISSION variable and take the corresponding actions as described in subclause 8.5.46.

NOTE: For 1.28 Mcps TDD, when performing E-DCH transmission in CELL_FACH state and Idle mode, the UE shall use the tables of transport block size for the E-DCH physical layer category 3 as specified in [15].

8.5.46 Actions related to COMMON_E_DCH_TRANSMISSION variable (FDD and 1.28 Mcps TDD only)

The variable COMMON_E_DCH_TRANSMISSION shall be set to TRUE only when all the following conditions are met:

- 1> the UE is in CELL_FACH state or Idle mode;
- 1> one radio link is configured as the serving E-DCH radio link, and for this radio link the UTRAN has configured the IE "E-HICH info" and the IE "E-AGCH info", and for 1.28Mcps TDD the IE "E-RUCCH Info" and "E-PUCH Info";
- 1> all logical channels are mapped to E-DCH, and for each of which there is:
 - 2> one E-DCH MAC-d flow is configured, i.e. the IEs "E-DCH MAC-d flow power offset", "E-DCH MAC-d flow maximum number of retransmissions", and for 1.28 Mcps TDD, the IEs "E-DCH MAC-d flow retransmission timer".

If any of the above conditions is not met and the variable COMMON_E_DCH_TRANSMISSION is set to TRUE, the UE shall:

- 1> set the variable COMMON_E_DCH_TRANSMISSION to FALSE;
- 1> if not in CELL_DCH state:
 - 2> stop any E-AGCH, E-RGCH (FDD only) and E-HICH reception procedures;
 - 2> for FDD, stop any E-DPCCH and E-DPDCH transmission procedures;
 - 2> for 1.28 Mcps TDD, stop any E-RUCCH and E-PUCH transmission procedure;
 - 2> act as if the IE "MAC-es/e reset indicator" was received and set to TRUE;
 - 2> release all E-DCH HARQ resources;
 - 2> no longer consider any radio link to be the serving E-DCH radio link.

For FDD, whenever the variable COMMON_E_DCH_TRANSMISSION is set to TRUE, the UE shall:

- 1> perform uplink DPCCH transmission;
- 1> if a CCCH message is submitted for transmission on the uplink:
 - 2> no E-AGCH and E-RGCH reception procedure is performed in the physical layer.
- 1> if a DCCH and/or DTCH message is submitted for transmission on the uplink; or
- 1> for NodeB triggered HS-DPCCH transmission:
 - 2> use the value stored in the variable E_RNTI as UE identity in the E-AGCH reception procedure in the physical layer;
 - 2> perform E-RGCH reception procedure for the serving radio link if an E-RGCH configuration has been provided with the common E-DCH resource.
 - 2> if variable READY_FOR_COMMON_ERGCH is set to TRUE:
 - 3> determine up to three common E-DCH RL(s) using the procedure specified in subclause 14.1.7 and perform E-RGCH reception on those radio links according to the performance requirements as specified in [19].
- 1> perform E-HICH reception procedures for the serving E-DCH radio link;
- 1> perform E-DPCCH transmission procedures for the serving E-DCH radio link;
- 1> perform E-DPDCH transmission procedures for the serving E-DCH radio link;

- 1> perform the inclusion of MAC-d PDUs or MAC-c PDUs in a MAC-i PDU for logical channels belonging to the MAC-d or MAC-c flows in accordance with the serving grant (see [15]);
- 1> if the transmission is a result of receiving an HS-SCCH order for NodeB triggered HS-DPCCH transmission:
 - 2> at the allowed start time of the E-DCH transmission, provide ACK/NACK feedback in accordance with [29] in the physical layer on the serving HS-DSCH radio link, using the information in the IE "Uplink DPCH power control info";
 - 2> at the allowed start time of the E-DCH transmission, use the information for the channel quality indication (CQI) procedure in the physical layer on the serving HS-DSCH radio link, to provide feedback using the information in the IE "Measurement Feedback Info".
- 1> else:
 - 2> if transmitting DCCH or DTCH data:
 - 3> if IE "ACK/NACK support on HS-DPCCH" is set to TRUE:
 - 4> after collision resolution provide ACK/NACK feedback in accordance with [29] in the physical layer on the serving HS-DSCH radio link, using the information in the IE "Uplink DPCH power control info";
 - 4> after collision resolution use the information for the channel quality indication (CQI) procedure in the physical layer on the serving HS-DSCH radio link if the IE "Measurement Feedback Info" has been provided with the common E-DCH resource.
- 1> if the UE received the "Enhanced Uplink in CELL_FACH and Idle mode process termination" by MAC with the CMAC-STATUS primitive; or
- 1> if the UE according to subclause 8.5.4A failed to establish the physical channels; or
- 1> if the criteria for radio link failure are met as specified in subclause 8.5.6:
 - 2> set the variable COMMON_E_DCH_TRANSMISSION to FALSE;
 - 2> stop any E-AGCH, E-RGCH and E-HICH reception procedures;
 - 2> stop any E-DPCCH and E-DPDCH transmission procedures;
 - 2> act as if the IE "MAC-es/e reset indicator" was received and set to TRUE;
 - 2> release all E-DCH HARQ resources;
 - 2> no longer consider any radio link to be the serving E-DCH radio link;
 - 2> if variable READY_FOR_COMMON_ERGCH is set to TRUE:
 - 3> not consider any radio link to be a Common E-RGCH radio link.

For 1.28 Mcps TDD, whenever the variable COMMON_E_DCH_TRANSMISSION is set to TRUE, the UE shall:

- 1> if CCCH message is submitted for transmission on the uplink and if the variable E_RNTI is not set:
 - 2> select a common E-RNTI according to subclause 8.5.50;
 - 2> perform E-RUCCH transmission procedure, using the selected common E-RNTI as UE identity;
 - 2> use the selected common E-RNTI as UE identity in the E-AGCH reception procedure in the physical layer in the common E-RNTI scheduling window according to subclause 8.5.50.
- 1> else:
 - 2> perform E-RUCCH transmission procedure according to the stored PRACH configuration (see [60]), using the value stored in the variable E_RNTI as UE identity;

2> use the value stored in the variable E_RNTI as UE identity in the E-AGCH reception procedure in the physical layer.

1> perform E-HICH reception procedures for the serving E-DCH radio link;

1> perform E-PUCH transmission procedures according to the stored E-PUCH configuration;

1> perform the inclusion of MAC-d PDUs and MAC-c PDUs in a MAC-i PDU for logical channels belonging to the MAC-d flows in accordance with the received scheduling grant on E-AGCH (see [15]).

NOTE: For 1.28 Mcps TDD, when performing E-DCH transmission in CELL_FACH state and Idle mode, the UE shall use the tables of transport block size for the E-DCH physical layer category 3 as specified in [15].

Whenever the variable COMMON_E_DCH_TRANSMISSION is set to FALSE, the UE shall:

1> if not in CELL_DCH state:

2> for FDD, not perform uplink DPCCCH transmission;

2> not perform E-AGCH, E-RGCH (FDD only) and E-HICH reception procedures;

2> for FDD, not perform E-DPCCH and/or E-DPDCH transmission procedures;

2> for 1.28 Mcps TDD, not perform E-RUCCH and E-PUCH transmission procedures.

1> for FDD, if variable READY_FOR_COMMON_ERGCH is set to TRUE:

2> not consider any radio link to be a Common E-RGCH radio link.

NOTE: For FDD, if according to subclause 8.5.45, the TTI applied on E-DPDCH is different from the TTI signalled in the IE "E-DCH Transmission Time Interval", then the IE's "Uplink DPCH power control info" and "Measurement Feedback Info" in fact refer the IE's "Uplink DPCH power control info for Concurrent TTI" and "Measurement Feedback Info for Concurrent TTI" respectively if present in the IE "Common E-DCH system info parameters for Concurrent TTI" of System Information Block type 22.

8.5.47 Actions related to READY_FOR_COMMON_EDCH variable (FDD and 1.28 Mcps TDD only)

The variable READY_FOR_COMMON_EDCH shall be set to TRUE only when all the following conditions are met:

1> if the UE is in CELL_FACH state or in Idle mode:

2> the UE supports E-DCH transmission in CELL_FACH state and Idle mode;

2> the IE "HS-DSCH common system information" is included in system information block type 5 or 5bis;

2> the IE "Common E-DCH system info" is included system information block type 5 or 5bis.

1> if the UE is in CELL_PCH state:

2> the UE supports E-DCH transmission in CELL_FACH state and Idle mode;

2> the UE supports HS-DSCH reception in CELL_PCH and URA_PCH state;

2> the IE "HS-DSCH paging system information" is included in system information block type 5 or 5bis;

2> the IE "Common E-DCH system info" is included system information block type 5 or 5bis;

2> variable H_RNTI is set;

2> variable E_RNTI is set;

2> variable C_RNTI is set.

If any of the above conditions is not met and the variable READY_FOR_COMMON_EDCH is set to TRUE, the UE shall:

- 1> set the variable `READY_FOR_COMMON_EDCH` to `FALSE`;
- 1> if in `CELL_FACH`, `CELL_PCH`, `URA_PCH` state or in Idle mode:
 - 2> if the variable `HSPA_RNTI_STORED_CELL_PCH` is set to `FALSE`:
 - 3> clear variable `E_RNTI`.
 - 2> reset the MAC-is/i entity [15];
 - 2> if in connected mode and System Information Block type 6 is indicated in System Information Block type 5 or 5bis as used in the cell:
 - 3> replace the TFS of the RACH with the one stored in the UE if any;
 - 3> let the physical channel(s) of type PRACH given by the IE(s) "PRACH info" be the default in uplink if UE is in `CELL_FACH` state. If the IE "PRACH info" is not included in System Information Block type 6, the UE shall read the corresponding IE(s) in System Information Block type 5 or System Information Block type 5bis and use that information to configure the PRACH;
 - 3> start to receive the physical channel of type AICH using the parameters given by the IE "AICH info" when associated PRACH is used. If the IE "AICH info" is not included in System Information Block type 6, the UE shall read the corresponding IE in System Information Block type 5 or System Information Block type 5bis and use that information (FDD only);
 - 3> if the IE "Additional Dynamic Transport Format Information for CCCH" is included for the selected RACH:
 - 4> use this transport format for transmission of the CCCH (FDD only).
 - 3> else:
 - 4> use the first instance of the list of transport formats as in the IE "RACH TFS" for the used RACH received in the IE "PRACH system information list" when using the CCCH (FDD only).
 - 2> else:
 - 3> replace the TFS of the RACH with the one stored in the UE if any;
 - 3> let the physical channel(s) of type PRACH given by the IE(s) "PRACH info" in System Information Block type 5 or 5bis be the default in uplink for the PRACH if UE is in `CELL_FACH` state;
 - 3> start to receive the physical channel of type AICH using the parameters given by the IE "AICH info" in System Information Block type 5 or 5bis when given allocated PRACH is used;
 - 3> if the IE "Additional Dynamic Transport Format Information for CCCH" is included in System Information Block type 5 or 5bis for the selected PRACH:
 - 4> use this transport format for transmission of the CCCH.
 - 3> else:
 - 4> use the first instance of the list of transport formats as in the IE "RACH TFS" in System Information Block type 5 or 5bis for the used RACH received in the IE "PRACH system information list" in System Information Block type 5 or 5bis when using the CCCH.
 - 1> for FDD, if the UE supports NodeB triggered HS-DPCCH transmission:
 - 2> configure the lower layers to not perform NodeB triggered HS-DPCCH transmission.
 - 1> for FDD, determine the value of the variable `READY_FOR_FALLBACK_R99_PRACH` and take the corresponding actions as described in subclause 8.5.77.

If variable `READY_FOR_COMMON_EDCH` is set to `TRUE`:

- 1> if the UE is in `CELL_PCH` state; and

- 1> if the UE has uplink RLC data PDU or uplink RLC control PDU on RB1 or upwards to transmit:
 - 2> initiate the measurement report procedure as specified in subclause 8.4.2;
 - 2> move the UE to CELL_FACH state;
 - 2> restart the timer T305 using its initial value if periodical cell update has been configured by T305 in the IE "UE Timers and constants in connected mode" set to any other value than "infinity".
- 1> for 1.28 Mcps TDD, if the UE is in CELL_PCH state and if the UE initiates uplink synchronization:
 - 2> move the UE to CELL_FACH state.
- 1> for FDD:
 - 2> if the UE supports NodeB triggered HS-DPCCH transmission;
 - 3> if System Information Block type 22 includes IE "NodeB triggered HS-DPCCH transmission":
 - 4> if variable H_RNTI, E_RNTI and C_RNTI is set:
 - 5> configure the lower layers to perform NodeB triggered HS-DPCCH transmission.
 - 4> else:
 - 5> configure the lower layers to not perform NodeB triggered HS-DPCCH transmission.
 - 3> else:
 - 4> configure the lower layers to not perform NodeB triggered HS-DPCCH transmission.
 - 2> determine the value of the variable READY_FOR_FALLBACK_R99_PRACH and take the corresponding actions as described in subclause 8.5.77.
 - 2> if the UE supports cell reselection indication reporting in CELL_FACH state:
 - 3> if System Information Block type 22 includes IE "Cell reselection indication reporting":
 - 4> configure the MAC layer to enable cell reselection indication reporting.
 - 3> else:
 - 4> configure the MAC layer to disable cell reselection indication reporting.

If the UE is in CELL_FACH state or CELL_PCH state and the value of the variable READY_FOR_COMMON_EDCH has changed due to a system information modification, the UE shall:

- 1> when the UE has uplink RLC data PDU or uplink RLC control PDU on RB1 or upwards to transmit:
 - 2> clear the variable C_RNTI, variable H_RNTI and variable E_RNTI;
 - 2> if the UE is in CELL_FACH state:
 - 3> initiate the cell update procedure with cell update cause "cell reselection" as specified in subclause 8.3.1.2.
 - 2> if the UE is in CELL_PCH state:
 - 3> initiate the cell update procedure with cell update cause "uplink data transmission" as specified in subclause 8.3.1.2.

8.5.48 Actions related to HS_DSCH_DRX_CELL_FACH_STATUS variable (FDD and 1.28 Mcps TDD only) and HS_DSCH_DRX_CELL_FACH_2CYCLE_STATUS variable (FDD only)

The HS_DSCH_DRX_CELL_FACH_2CYCLE_STATUS variable shall be set to TRUE only when the following conditions are met:

- 1> the UE supports HS-DSCH DRX operation with second DRX cycle in CELL_FACH state;
- 1> the UE is in CELL_FACH state;
- 1> the UE has a dedicated H-RNTI configured;
- 1> the IE's "HS-DSCH DRX in CELL_FACH Information" and "Common E-DCH system info" have been received from System Information Block Type 5 or System Information Block Type 5bis and the IE "HS-DSCH DRX in CELL_FACH with second DRX cycle Information" has been received from System Information Block Type 22.

If any of the above conditions is not met and the HS_DSCH_DRX_CELL_FACH_2CYCLE_STATUS variable is set to TRUE, the UE shall:

- 1> stop any ongoing CELL_FACH HS-DSCH DRX operation with second DRX cycle;
- 1> set the HS_DSCH_DRX_CELL_FACH_2CYCLE_STATUS to FALSE;
- 1> stop the timer T328, if it is ongoing;
- 1> stop the timer T329, if it is ongoing.

If the HS_DSCH_DRX_CELL_FACH_2CYCLE_STATUS variable is set to FALSE, the HS_DSCH_DRX_CELL_FACH_STATUS variable shall be set to TRUE only when the following conditions are met:

- 1> the UE supports HS-DSCH DRX operation in CELL_FACH state;
- 1> the UE is in CELL_FACH state;
- 1> the UE has a dedicated H-RNTI configured;
- 1> the IE "HS-DSCH DRX in CELL_FACH Information" for FDD or IE "HS-DSCH DRX in CELL_FACH Information 1.28 Mcps TDD" for 1.28 Mcps TDD has been received from System Information Block Type 5 or System Information Block Type 5bis;
- 1> for 1.28 Mcps TDD, UE with dedicated H-RNTI configured, after transiting from CELL_PCH to CELL_FACH state, has detected its dedicated H-RNTI on HS-SCCH indicating HS-DSCH reception;
- 1> for FDD, either of the following conditions is met:
 - 2> the value of the IE "DRX Interruption by HS-DSCH data" received from System Information Block Type 5 or System Information Block Type 5bis has been set to TRUE; or
 - 2> the UE supports common E-DCH transmission and the IE "Common E-DCH system info" is included in System Information Block type 5 or System Information Block Type 5bis.

If any of the above conditions is not met and the HS_DSCH_DRX_CELL_FACH_STATUS variable is set to TRUE, the UE shall:

- 1> stop any ongoing CELL_FACH HS-DSCH DRX operation;
- 1> set the HS_DSCH_DRX_CELL_FACH_STATUS to FALSE;
- 1> stop the timer T321, if it is ongoing.

8.5.49 CELL_FACH HS-DSCH DRX operation (FDD only)

The CELL_FACH HS-DSCH DRX operation determines the occasions in which the UE is allowed to discontinuously receive HS-DSCH in CELL_FACH state.

If the variable HS_DSCH_DRX_CELL_FACH_STATUS is set to TRUE, the UE shall:

- 1> if E-DCH resource index information is received from lower layers; and
- 1> if "E-DCH resource index" received from MAC with the CMAC-STATUS primitive is not equal to -1:
 - 2> stop the timer T321, if it is ongoing;
 - 2> continuously receive HS-DSCH.
- 1> if E-DCH enhanced random access process termination information is received from lower layers:
 - 2> start the timer T321.
- 1> if the value of the IE "DRX Interruption by HS-DSCH data" received from System Information Block Type 5 or System Information Block Type 5bis is TRUE:
 - 2> if the UE does not have an E-DCH resource assigned and data on HS-DSCH or HS-SCCH order for NodeB triggered HS-DPCCH transmission is received:
 - 3> start or, if the timer is running, restart the timer T321 at the end of the HS-SCCH subframe addressed to this UE.
 - 3> continuously receive HS-DSCH.

Upon timer T321 expiry:

- 1> the UE shall receive HS-DSCH during the frame(s) with the SFN value fulfilling the following inequality:

$$(\text{SFN} - \text{H-RNTI} + 65536) \bmod \text{DRX_cycle} < \text{Rx_burst}$$

where:

- H-RNTI is the value stored in the variable H_RNTI;
- DRX_cycle is the length of the DRX cycle in radio frames, signalled by the IE "HS-DSCH DRX cycle_{FACH}";
- Rx burst is the period in frames within the DRX cycle, in which the UE receives HS-DSCH, signalled by the IE "HS-DSCH Rx burst_{FACH}".

For FDD when in CELL_FACH state, when the variable HS_DSCH_RECEPTION_CELL_FACH_STATE is set to TRUE and the variable HS_DSCH_DRX_CELL_FACH_STATUS is set to TRUE, then the UE in FDD mode shall perform measurements as specified in subclauses 8.4.1.6 and 8.4.1.9, according to the requirements in [4] and [19].

8.5.49a CELL_FACH HS-DSCH DRX operation (1.28Mcps TDD only)

The CELL_FACH HS-DSCH DRX operation determines the occasions in which the UE is allowed to discontinuously receive HS-DSCH in CELL_FACH state.

The HS-DSCH DRX pattern is the set of frames in which the UE shall receive on downlink during the frame(s) with the SFN value fulfilling the following inequality:

$$(\text{SFN} - \text{H-RNTI} + 65536) \bmod \text{DRX_cycle} < \text{Rx_burst}$$

where:

- H-RNTI is the value stored in the variable H_RNTI;
- DRX_cycle is the length of the DRX cycle in radio frames, signalled by the IE "DRX cycle_{FACH}";

- Rx burst is the period in frames within the DRX cycle, in which the UE receives on downlink, signalled by the IE "Rx burst_{FACH}".

8.5.49b CELL_FACH HS-DSCH DRX operation with second DRX cycle (FDD only)

The CELL_FACH HS-DSCH DRX operation with second DRX cycle determines the occasions in which the UE is allowed to discontinuously receive HS-DSCH in CELL_FACH state.

If the variable HS_DSCH_DRX_CELL_FACH_2CYCLE_STATUS is set to TRUE, the UE shall:

- 1> if E-DCH resource index information is received from lower layers and the "E-DCH resource index" received from MAC with the CMAC-STATUS primitive is not equal to -1; or
- 1> if "Fallback transmission initiation" is received from MAC with the CMAC-STATUS primitive:
 - 2> stop the timer T328, if it is ongoing;
 - 2> stop the timer T329, if it is ongoing;
 - 2> continuously receive HS-DSCH.
- 1> if "Fallback transmission termination" is received from MAC with the CMAC-STATUS primitive; or
- 1> if E-DCH enhanced random access process termination information is received from lower layers:
 - 2> if the CHOICE "DRX level" in the IE "HS-DSCH DRX in CELL_FACH with second DRX cycle Information" has the value "2-level DRX":
 - 3> start the timer T328.
 - 2> if the CHOICE "DRX level" in the IE "HS-DSCH DRX in CELL_FACH with second DRX cycle Information" has the value "1-level DRX":
 - 3> start the timer T329.
- 1> if the UE does not have an E-DCH resource assigned and data on HS-DSCH or HS-SCCH order for NodeB triggered HS-DPCCH transmission is received:
 - 2> if the CHOICE "DRX level" in the IE "HS-DSCH DRX in CELL_FACH with second DRX cycle Information" has the value "2-level DRX":
 - 3> stop the timer T329, if it is ongoing;
 - 3> start or, if the timer is running, restart the timer T328 at the end of the HS-SCCH subframe addressed to this UE.
 - 2> if the CHOICE "DRX level" in the IE "HS-DSCH DRX in CELL_FACH with second DRX cycle Information" has the value "1-level DRX":
 - 3> start or, if the timer is running, restart the timer T329 at the end of the HS-SCCH subframe addressed to this UE.
 - 2> continuously receive HS-DSCH.

Upon timer T328 expiry:

- 1> start the timer T329:
- 1> if the value used for IE "HS-DSCH first Rx burst_{FACH}" is a multiple number of frames:
 - 2> the UE shall receive HS-DSCH during the frame(s) with the SFN value fulfilling the following inequality:

$$(\text{SFN} - \text{H-RNTI} + 65536) \bmod \text{DRX_cycle} < \text{Rx_burst}$$

where:

- H-RNTI is the value stored in the variable H_RNTI;
- DRX_cycle is the length of the DRX cycle in radio frames, indicated by the IE "HS-DSCH first DRX cycle_{FACH}";
- Rx burst is the period in frames within the DRX cycle, in which the UE receives HS-DSCH, indicated by the IE "HS-DSCH first Rx burst_{FACH}".

1> else:

- 2> the UE shall receive HS-DSCH during the subframe(s) with the Subframe_Number and SFN value fulfilling the following inequality:

$$((\text{SFN} * 5 + \text{Subframe_Number}) - \text{H-RNTI} + 65536) \bmod \text{DRX_cycle} < \text{Rx_burst}$$

where:

- H-RNTI is the value stored in the variable H_RNTI;
- DRX_cycle is the length of the DRX cycle in unit of subframes, indicated by the IE "HS-DSCH first DRX cycle_{FACH}";
- Rx burst is the period in unit of subframes within the DRX cycle, in which the UE receives HS-DSCH, indicated by the IE "HS-DSCH first Rx burst_{FACH}".

Upon timer T329 expiry:

- 1> the UE shall receive HS-DSCH during the frame(s) with the SFN value fulfilling the following inequality:

$$(\text{SFN} - \text{H-RNTI} + 65536) \bmod \text{DRX_cycle} < \text{Rx_burst}$$

where:

- H-RNTI is the value stored in the variable H_RNTI;
- DRX_cycle is the length of the DRX cycle in radio frames, indicated by the IE "HS-DSCH second DRX cycle_{FACH}";
- Rx burst is the period in frames within the DRX cycle, in which the UE receives HS-DSCH, indicated by the IE "HS-DSCH second Rx burst_{FACH}".

For FDD when in CELL_FACH state, when the variable HS_DSCH_RECEPTION_CELL_FACH_STATE is set to TRUE and the variable HS_DSCH_DRX_CELL_FACH_2CYCLE_STATUS is set to TRUE, then the UE in FDD mode shall perform measurements as specified in subclauses 8.4.1.6 and 8.4.1.9, according to the requirements in [19].

8.5.50 Common E-RNTI selection (1.28 Mcps TDD only)

When the IE "Common E-RNTI Information" is included in System Information Block type 5, and if the UE is in CELL_FACH state or Idle mode, and if the variable E_RNTI is not set, UE shall use a common E-RNTI for CCCH transmission (i.e. the common E-RNTI identifies the initial access, including RRC connection request and cell update after cell re-selection):

- 1> configure the MAC layer with the information in the IE(s) "Common E-RNTI information";
- 1> when a CCCH message is to be sent, and if the variable E_RNTI is not set, the MAC layer operates as follows:
 - 2> select an E-RUCCH;
 - 2> select the instance of the IE(s) "Common E-RNTI information" which is related to the selected E-RUCCH;
 - 2> select a common E-RNTI which is related to the selected E-RUCCH according to the following procedure:
 - 3> compile a list of candidate common E-RNTI group from the selected instance of the IE(s) "Common E-RNTI information" in the order of appearance in System Information Block type 5, and select a common E-RNTI group from the list of candidate Common E-RNTI groups based on the E-RUCCH transmission occasion;

"Index of selected Common E-RNTI group" = $SFNE\text{-}RUCCH \bmod K$, for TTI of E-RUCCH = 10ms;

or "Index of selected Common E-RNTI group" = $SFN'E\text{-}RUCCH \bmod K$, for TTI of E-RUCCH = 5ms;

Where K is the number of E-RNTI groups related to the E-RUCCH; $SFN_{E\text{-}RUCCH}$ or $SFN'E_{E\text{-}RUCCH}$ is the frame or sub-frame on which the E-RUCCH shall be sent [33].

- 3> select a common E-RNTI randomly amongst the candidate the candidate E-RNTIs in the selected group.
- 2> use the value of the selected common E-RNTI as UE identity in current E-RUCCH transmission, and in the E-AGCH reception within the common E-RNTI scheduling window which is of K frames or K sub-frames length.

8.5.51 Actions related to SECONDARY_CELL_HS_DSCH_RECEPTION variable (FDD only)

An entry in the variable SECONDARY_CELL_HS_DSCH_RECEPTION shall be set to TRUE only when all the following conditions are met:

- 1> the UE is in CELL_DCH state;
- 1> the corresponding IE "Downlink Secondary Cell Info FDD" is included;
- 1> the variable HS_DSCH_RECEPTION is set to TRUE;
- 1> either of the following conditions are met:
 - 2> the IE "Memory Partitioning" is set to 'Implicit' in the IE "HARQ Info"; or
 - 2> the IE "Memory Partitioning" is set to 'Explicit' in the IE "HARQ Info" and MIMO or MIMO mode with four transmit antennas is configured on all or none of the serving HS-DSCH cell and the secondary serving HS-DSCH cells.

If any of the above conditions is not met for a secondary serving HS-DSCH cell, and the corresponding entry in the variable SECONDARY_CELL_HS_DSCH_RECEPTION is set to TRUE, the UE shall:

- 1> set the corresponding entry in the variable SECONDARY_CELL_HS_DSCH_RECEPTION to FALSE;
- 1> clear the corresponding entry in the variable DOWNLINK_SECONDARY_CELL_INFO;
- 1> flush the HARQ buffers of the HARQ entity associated to that secondary serving HS-DSCH cell;
- 1> release the HARQ resources associated to that secondary serving HS-DSCH cell.
- 1> determine the configuration of "TSN field extension" for MAC-ehs entity as specified in subclause 8.5.60

If there are more than one entry in the variable SECONDARY_CELL_HS_DSCH_RECEPTION set to TRUE and the corresponding entries in the variable DOWNLINK_SECONDARY_CELL_INFO indicate that the network has configured non-contiguous multi-cell operation together with dual band operation:

- 1> the UE behaviour is not specified.

If there is at least one entry in the variable SECONDARY_CELL_HS_DSCH_RECEPTION set to TRUE, the UE shall:

- 1> apply the i-th entry in the variables DOWNLINK_SECONDARY_CELL_INFO, SECONDARY_CELL_HS_DSCH_RECEPTION, SECONDARY_CELL_MIMO_STATUS and SECONDARY_CELL_MIMO_MODE_WITH_FOUR_TRANSMIT_ANTENNAS_STATUS to the i-th secondary serving HS-DSCH cell.
- 1> After the new configuration is applied, the UE shall renumber the configured secondary serving HS-DSCH cells, starting from 1, contiguously, by skipping empty entries in the above variables. The secondary serving HS-DSCH cells are numbered in the order their configuration IEs appears in the message. The RRC Layer shall pass the new numbering of the secondary serving HS-DSCH cells to the lower layers.

NOTE: Regardless of the renumbering, the IEs in the variable DOWNLINK_SECONDARY_CELL_INFO remain stored as specified in subclause 8.6.6.45.

- 1> partition the soft memory buffer in the MAC-e-hs, used for the secondary serving HS-DSCH cells reception, using the information in the IE "HARQ Info" of the serving HS-DSCH cell and performing the procedure described in subclause 8.6.5.6b;
- 1> determine the value for the SECONDARY_CELL_E_DCH_TRANSMISSION and take the corresponding actions as described in subclause 8.5.58.
- 1> determine the configuration of "TSN field extension" for MAC-e-hs entity as specified in subclause 8.5.60.

For each entry in the variable SECONDARY_CELL_HS_DSCH_RECEPTION which is set to TRUE, the UE shall:

- 1> receive the HS-SCCH(s) according to the corresponding IE "Downlink Secondary Cell Info FDD" on the serving HS-DSCH radio link applying the scrambling code as received in the corresponding IE "DL Scrambling code";
- 1> perform HS-DSCH reception procedures for the corresponding secondary serving HS-DSCH cell according to the stored HS-PDSCH configuration as stated in:
 - 2> subclause 8.6.3.1b for the IE "H-RNTI";
 - 2> subclause 8.6.5.6b for the IE "HARQ info";
 - 2> subclause 8.6.6.34 for the IE "Measurement Feedback Info";
 - 2> subclause 8.6.6.45 for the IE "Downlink Secondary Cell Info FDD";
- 1> use the relevant CQI reporting table as stated in subclause 8.5.44.

Whenever any entry in the variable SECONDARY_CELL_HS_DSCH_RECEPTION is set to FALSE, the UE shall:

- 1> not perform HS-SCCH reception procedures on the corresponding secondary serving HS-DSCH cell;
- 1> determine the value for the SECONDARY_CELL_E_DCH_TRANSMISSION and take the corresponding actions as described in subclause 8.5.58.

If any entry in the variable SECONDARY_CELL_HS_DSCH_RECEPTION is set to TRUE and the serving HS-DSCH cell was changed as a result of the received message or HS-SCCH order from the target cell, the UE shall instruct the physical layer to consider that the HS-SCCH orders from the serving cell were never received.

If prior to the reconfiguration and after the reconfiguration the *i*-th entry in the variable SECONDARY_CELL_HS_DSCH_RECEPTION is set to TRUE, and the value of IE "Configuration info" contained in the corresponding IE "Downlink Secondary Cell Info FDD" is set to either "Continue" or "New configuration", and the serving HS-DSCH cell was not changed as a result of the received message, the UE shall instruct the physical layer to remember the corresponding secondary serving HS-DSCH cell activation/deactivation HS-SCCH orders that were received prior to the reconfiguration.

NOTE: If any entry in the variable SECONDARY_CELL_HS_DSCH_RECEPTION is set to TRUE and the IE "Tx Diversity Mode" is set to "closed loop mode1", the UE behaviour is unspecified.

If prior to the reconfiguration the *i*-th entry in the variable SECONDARY_CELL_HS_DSCH_RECEPTION was set to FALSE, and after the reconfiguration the *i*-th entry in the variable SECONDARY_CELL_HS_DSCH_RECEPTION is set to TRUE, the UE shall instruct the physical layer to activate the corresponding serving HS-DSCH cell.

If there is an ongoing inter-frequency measurement with the compressed mode for the frequency, which is not in the same frequency band as the serving HS-DSCH cell:

- 1> if there is a compressed mode pattern sequence with the IE "Frequency specific compressed mode" set to TRUE in the IE "Current TGPS Status Flag" in UE variable TGPS_IDENTITY; and
- 1> if there is no entry in the DOWNLINK_SECONDARY_CELL_INFO variable, associated frequency of which is in the same frequency band as the frequency to measure:
 - 2> the UE behaviour is unspecified.

8.5.52 Actions related to TARGET_CELL_PRECONFIGURATION variable (FDD only)

When all the following conditions are met:

- 1> the UE is in CELL_DCH state;
- 1> the UE has indicated support of Target Cell Pre-Configuration; or
- 1> the UE has indicated support of Enhanced Serving Cell Change for Event 1c;
- 1> the IE "Target cell preconfiguration information" is included in the Radio link addition information in the Active Set Update message;

the UE shall:

- 1> in case the "Target cell preconfiguration information" IE is present for more than one radio link in the received active set update message, if the IE "Secondary E-DCH info common" is included in the IE "Target cell preconfiguration information" for this radio link, and the IE "Secondary E-DCH info common" has already been stored in the variable TARGET_CELL_PRECONFIGURATION for other radio links, the UE behaviour is unspecified;
- 1> if the variable TARGET_CELL_PRECONFIGURATION already contains the information for this radio link:
 - 2> clear the old entry from the variable TARGET_CELL_PRECONFIGURATION.
- 1> store the "Target cell preconfiguration information" in the variable TARGET_CELL_PRECONFIGURATION so that the configurations are to be applied later once the Target cell HS-SCCH order has been read from the target cell;
- 1> store the configuration given in the IEs "Serving Cell Change MAC reset", "Serving Cell Change Message Type", "Serving Cell Change Transaction Id" and "Enhanced Serving Cell Change for Event 1c Support Indicator" in the variable TARGET_CELL_PRECONFIGURATION to be applied later once the Target cell HS-SCCH order has been read from the target cell.

NOTE: If the IE "Primary CPICH info" is received in IE "Serving HS-DSCH cell information" as part of the IE "Target cell preconfiguration information" and is not the same value as the IE "Primary CPICH info" of the corresponding IE "Radio Link Addition Information" then the UE behaviour is unspecified.

If any of the above conditions is not met and the Radio Link is included in the table "Target cell preconfigurations" in the variable TARGET_CELL_PRECONFIGURATION, the UE shall:

- 1> clear the entry from the variable TARGET_CELL_PRECONFIGURATION.

8.5.53 Actions related to CONTROL_CHANNEL_DRX_STATUS variable (1.28 Mcps TDD only)

If the UE receives RRC CONNECTION SETUP, CELL UPDATE CONFIRM, or any reconfiguration message:

- 1> the UE shall determine the value for the CONTROL_CHANNEL_DRX_STATUS variable.

The variable CONTROL_CHANNEL_DRX_STATUS shall be set to TRUE only when all the following conditions are met:

- 1> the UE is in CELL_DCH state;
- 1> the variable HS_DSCH RECEPTION is set to TRUE;
- 1> the IE "Control Channel DRX information" is included in the received message.

If any of the above conditions is not met and the variable CONTROL_CHANNEL_DRX_STATUS is set to TRUE, the UE shall:

- 1> set the variable CONTROL_CHANNEL_DRX_STATUS to FALSE;

1> clear the variable CONTROL_CHANNEL_DRX_PARAMS;

1> disable the Control Channel DRX related activities.

If variable CONTROL_CHANNEL_DRX_STATUS is set to TRUE and the serving HS-DSCH cell was changed as a result of the received message, the UE shall instruct the physical layer to consider HS-SCCH orders were never received.

Whenever the variable CONTROL_CHANNEL_DRX_STATUS is set to TRUE after receiving this message and the value of IE "Control Channel DRX information" included in this message is "Continue Control Channel DRX operation", the UE shall:

1> continue the Control Channel DRX related activities with the IE in the variable CONTROL_CHANNEL_DRX_PARAMS.

8.5.54 Actions related to E_DCH_SPS_STATUS variable (1.28 Mcps TDD only)

If the UE receives RRC CONNECTION SETUP, CELL UPDATE CONFIRM, or any reconfiguration message:

1> the UE shall determine the value for the E_DCH_SPS_STATUS variable.

The variable E_DCH_SPS_STATUS shall be set to TRUE only when all the following conditions are met:

1> the UE is in CELL_DCH state;

1> the variable E_DCH_TRANSMISSION is set to TRUE;

1> the IE "E-DCH SPS information" is included in the received message and the UE has stored the following IEs in variable E_DCH_SPS_PARAMS:

2> IE "Transmission Pattern List".

If any of the above conditions is not met and the variable E_DCH_SPS_STATUS is set to TRUE, the UE shall:

1> set the variable E_DCH_SPS_STATUS to FALSE;

1> clear the variable E_DCH_SPS_PARAMS;

1> stop all E-DCH SPS related activities.

Whenever the variable E_DCH_SPS_STATUS is set to TRUE, the UE shall:

1> configure the physical and MAC layers to operate according to the E_DCH_SPS_PARAMS.

If variable E_DCH_SPS_STATUS is set to TRUE and the serving E-DCH cell was changed as a result of the received message and the value of IE "E-DCH SPS Information" included in this message is "Continue E-DCH SPS operation", then UE behaviour is unspecified.

8.5.55 Actions related to HS_DSCH_SPS_STATUS variable (1.28 Mcps TDD only)

If the UE receives RRC CONNECTION SETUP, CELL UPDATE CONFIRM, or any reconfiguration message:

1> the UE shall determine the value for the HS_DSCH_SPS_STATUS variable.

The variable HS_DSCH_SPS_STATUS shall be set to TRUE only when all the following conditions are met:

1> the UE is in CELL_DCH state;

1> the variable HS_DSCH_RECEPTION is set to TRUE;

1> the IE "HS-DSCH SPS information" is included in the received message and the UE has stored the following IEs in variable HS_DSCH_SPS_PARAMS:

- 2> IE "Transmission Pattern List";
- 2> IE "Reception Pattern List";
- 2> IE "HARQ Info for Semi-Persistent Scheduling".

If any of the above conditions is not met and the variable HS_DSCH_SPS_STATUS is set to TRUE, the UE shall:

- 1> set the variable HS_DSCH_SPS_STATUS to FALSE;
- 1> clear the variable HS_DSCH_SPS_PARAMS;
- 1> stop all HS-DSCH SPS related activities.

Whenever the variable HS_DSCH_SPS_STATUS is set to TRUE, the UE shall:

- 1> configure the physical and MAC layers to operate according to the HS_DSCH_SPS_PARAMS.

If variable HS_DSCH_SPS_STATUS is set to TRUE and the serving HS-DSCH cell was changed as a result of the received message and the value of IE "HS-DSCH SPS information" included in this message is "Continue HS-DSCH SPS operation", then UE behaviour is unspecified.

8.5.56 Actions related to HSPA_RNTI_STORED_CELL_PCH variable (FDD and 1.28 Mcps TDD only)

The variable HSPA_RNTI_STORED_CELL_PCH shall be set to TRUE only when all the following conditions are met:

- 1> the UE is in CELL_PCH state or the UE after state transition enters CELL_PCH state if the variable HSPA_RNTI_STORED_CELL_PCH is determined according to subclause 8.2.2.3 or 8.3.1.6; and
- 1> the UE supports E-DCH transmission in CELL_FACH state and Idle mode; and
- 1> the UE supports HS-DSCH reception in CELL_FACH state; and
- 1> the IE "HS-DSCH common system information" is included in system information block type 5 or 5bis; and
- 1> the IE "Common E-DCH system info" is included in system information block type 5 or 5bis; and
- 1> the IE "HS-DSCH paging system information" is not included in system information block type 5 or 5bis or the UE does not support HS-DSCH reception in CELL_PCH and URA_PCH state; and
- 1> the RBs have the multiplexing option with transport channel type "HS-DSCH" for the DL and transport channel type "E-DCH" in the UL; and
- 1> variable H_RNTI is set; and
- 1> variable E_RNTI is set; and
- 1> IE "New C-RNTI" is included in the received message if the variable HSPA_RNTI_STORED_CELL_PCH is determined according to subclause 8.2.2.3 or 8.3.1.6, or variable C_RNTI is set if the variable HSPA_RNTI_STORED_CELL_PCH is determined according to subclause 8.1.1.6.5.

If any of the above conditions is not met and the variable HSPA_RNTI_STORED_CELL_PCH is set to TRUE, the UE shall:

- 1> set the variable HSPA_RNTI_STORED_CELL_PCH to FALSE.

If the variable HSPA_RNTI_STORED_CELL_PCH is set to TRUE:

- 1> if the UE has uplink RLC data PDU or uplink RLC control PDU on RB1 or upwards to transmit: or
- 1> if the UE is requested to move into CELL_FACH state by paging type 1 as described in subclause 8.1.2.3, UE shall:
 - 2> move the UE to CELL_FACH state;

- 2> set the variable HSPA_RNTI_STORED_CELL_PCH to FALSE;
- 2> stop timer T319 if it is running;
- 2> restart the timer T305 if it is set to any value other than "infinity";
- 2> determine the value for the READY_FOR_COMMON_EDCH variable and take the corresponding actions as described in subclause 8.5.47;
- 2> determine the value for the COMMON_E_DCH_TRANSMISSION variable and take the corresponding actions as described in subclause 8.5.46;
- 2> for FDD, determine the value for the READY_FOR_COMMON_ERGCH variable and take the corresponding actions as described in subclause 8.5.75;
- 2> for FDD and 1.28 Mcps TDD:
 - 3> initiate the measurement report procedure as specified in subclause 8.4.2;
 - 3> not prohibit periodical status transmission in RLC;
 - 3> configure the Enhanced Uplink in CELL_FACH state and Idle mode as specified in subclause 8.5.45 for FDD and 8.5.45a for 1.28 Mcps TDD;
 - 3> start to receive HS-DSCH according to the procedure in subclause 8.5.36.

8.5.57 Actions related to SECONDARY_CELL_MIMO_STATUS variable

If the UE receives an ACTIVE SET UPDATE, CELL UPDATE CONFIRM, or any reconfiguration message which includes the IE "Downlink secondary cell info FDD" for any of the secondary serving HS-DSCH cells, the UE shall:

- 1> if the IE "Secondary cell MIMO parameters" is not included in the IE "Downlink secondary cell info FDD":
 - 2> clear the corresponding entry in the SECONDARY_CELL_MIMO_PARAMS variable;
- 1> if the CHOICE "Configuration Info" in the IE "Secondary cell MIMO parameters" has the value "Continue":
 - 2> continue using the stored parameters in the corresponding entry in the SECONDARY_CELL_MIMO_PARAMS variable;
- 1> otherwise:
 - 2> if the IE "MIMO N_cqi_typeA/M_cqi ratio" is included:
 - 3> store the value of the IE "MIMO N_cqi_typeA/M_cqi ratio" in the corresponding entry in the SECONDARY_CELL_MIMO_PARAMS variable.
 - 2> if the IE "MIMO pilot configuration" is included:
 - 3> store the value of the IE "MIMO pilot configuration" in the corresponding entry in the SECONDARY_CELL_MIMO_PARAMS variable.
 - 2> if the IE "Precoding weight set restriction" is included in the IE "Secondary cell MIMO parameters":
 - 3> store the value of the IE "Precoding weight set restriction" in the corresponding entry in the SECONDARY_CELL_MIMO_PARAMS variable;
 - 2> else if the IE "Precoding weight set restriction" is not included in the IE "Secondary cell MIMO parameters":
 - 3> if the IE "MIMO operation" is included in the IE "MIMO parameters" and it is set to "start":
 - 4> if the IE "Precoding weight set restriction" is included in the IE "MIMO parameters":
 - 5> store the value of the IE "Precoding weight set restriction" in the corresponding entry in the SECONDARY_CELL_MIMO_PARAMS variable;

- 4> else if the IE "Precoding weight set restriction" is not included in the IE "MIMO parameters":
 - 5> clear the value of the IE "Precoding weight set restriction" in the corresponding entry in the SECONDARY_CELL_MIMO_PARAMS variable;
- 3> else if the IE "MIMO operation" is included in the IE "MIMO parameters" and it is set to "continue" and if the IE "Precoding weight set restriction" is present in the variable MIMO_PARAMS:
 - 4> copy the value of the IE "Precoding weight set restriction" in the variable MIMO_PARAMS and store it in the IE "Precoding weight set restriction" in the corresponding entry in the SECONDARY_CELL_MIMO_PARAMS variable;
- 3> else:
 - 4> clear the value of the IE "Precoding weight set restriction" in the corresponding entry in the SECONDARY_CELL_MIMO_PARAMS variable.
- 2> RRC shall indicate to lower layers whether precoding weight set restriction is configured based on the value of the IE "Precoding weight set restriction" in the variable SECONDARY_CELL_MIMO_PARAMS.
- 1> determine the value of the SECONDARY_CELL_MIMO_STATUS variable for the corresponding secondary serving HS-DSCH cell.

The SECONDARY_CELL_MIMO_STATUS variable shall be set to TRUE for a secondary serving HS-DSCH cell only when all the following conditions are met:

- 1> The UE is in CELL_DCH state;
- 1> the corresponding entry in the variable SECONDARY_CELL_HS_DSCH_RECEPTION is set to TRUE for that secondary serving HS-DSCH cell;
- 1> if the UE does not support MIMO only with single stream restriction, the corresponding entry in the variable SECONDARY_CELL_MIMO_PARAMS contains a value for the IE "MIMO N_cqi_typeA/M_cqi ratio"; and
- 1> the corresponding entry in the variable SECONDARY_CELL_MIMO_PARAMS contains a value for the IE "MIMO pilot configuration".

If any of the above conditions is not met and the SECONDARY_CELL_MIMO_STATUS variable is set to TRUE for that secondary serving HS-DSCH cell, the UE shall:

- 1> set the entry in the SECONDARY_CELL_MIMO_STATUS variable corresponding to that secondary serving HS-DSCH cell to FALSE;
- 1> clear the entry in the the SECONDARY_CELL_MIMO_PARAMS variable corresponding to that secondary serving HS-DSCH cell;
- 1> trigger lower layers to stop MIMO operation on that secondary serving HS-DSCH cell.

Whenever the entry in the variable SECONDARY_CELL_MIMO_STATUS is set to TRUE for a secondary serving HS-DSCH cell, the UE shall:

- 1> if the UE supports MIMO only with single stream restriction (FDD only):
 - 2> indicate to lower layers to start operation in MIMO mode restricted to single stream transmission on that secondary serving HS-DSCH cell, using the parameter values stored in the corresponding entry in the variable SECONDARY_CELL_MIMO_PARAMS.
- 1> else:
 - 2> indicate to lower layers to start operation in MIMO mode on that secondary serving HS-DSCH cell, using the parameter values stored in the corresponding entry in the variable SECONDARY_CELL_MIMO_PARAMS.
- 1> for FDD, when MIMO only with single stream restriction is configured:
 - 2> if MAC-ehs is not configured:
 - 3> the UE behaviour is undefined.

NOTE: This subclause applies to FDD only.

8.5.58 Actions related to SECONDARY_CELL_E_DCH_TRANSMISSION variable (FDD only)

The variable SECONDARY_CELL_E_DCH_TRANSMISSION shall be set to TRUE only when all the following conditions are met:

- 1> the UE is in CELL_DCH state;
- 1> the UE has stored IE "Secondary serving E-DCH cell info" and IE "Secondary E-DCH info common";
- 1> one of the radio links in the secondary E-DCH active set is configured as the secondary serving E-DCH radio link, and for this radio link the UTRAN has configured the IE "E-HICH configuration" and the IE "E-AGCH info".
- 1> either the Primary E-RNTI or the Secondary E-RNTI or both the Primary and the Secondary E-RNTI are included in the stored IE "Secondary serving E-DCH cell info";
- 1> the IE "Number of DPDCH" in the IE "Uplink DPCH info" is set to 0;
- 1> the variable E_DCH_TRANSMISSION is set to TRUE;
- 1> the i-th entry in the variable SECONDARY_CELL_HS_DSCH_RECEPTION is set to TRUE, where the i-th entry is the position of the first non-empty entry in the variable DOWNLINK_SECONDARY_CELL_INFO;

If any of the above conditions are not met and the variable SECONDARY_CELL_E_DCH_TRANSMISSION is set to TRUE, the UE shall:

- 1> set the variable SECONDARY_CELL_E_DCH_TRANSMISSION to FALSE;
- 1> stop any F-DPCH, E-AGCH, E-HICH and E-RGCH reception procedures on the downlink frequency associated with the secondary uplink frequency;
- 1> stop any DPCCH, E-DPCCH and E-DPDCH transmission procedures on the secondary uplink frequency;
- 1> release all E-DCH HARQ resources for the secondary uplink frequency;
- 1> do not configure "TSN field extension" for the MAC-i/is entity;
- 1> reset the MAC-i/is entity [15];
- 1> clear any stored IE "Secondary serving E-DCH cell info" and IE "Secondary E-DCH info common";
- 1> remove all the radio links associated to the secondary E-DCH active set.
- 1> for FDD, if the IE "Uplink CLTD info FDD" is stored in the UE:
 - 2> determine the value for the UPLINK_CLTD_TRANSMISSION variable and take the corresponding actions as described in subclause 8.5.69.
- 1> for FDD, if the IE "Uplink OLTD info FDD" is stored in the UE:
 - 2> determine the value for the UPLINK_OLTD_TRANSMISSION variable and take the corresponding actions as described in subclause 8.5.70.

If all of the above conditions are met and the variable SECONDARY_CELL_E_DCH_TRANSMISSION is set to FALSE, the UE shall:

- 1> set the variable SECONDARY_CELL_E_DCH_TRANSMISSION to TRUE;
- 1> configure "TSN field extension" for the MAC-i/is entity;
- 1> reset the MAC-i/is entity [15].

- 1> for FDD, if the IE "Uplink CLTD info FDD" is stored in the UE:
 - 2> determine the value for the UPLINK_CLTD_TRANSMISSION variable and take the corresponding actions as described in subclause 8.5.69.
- 1> for FDD, if the IE "Uplink OLTD info FDD" is stored in the UE:
 - 2> determine the value for the UPLINK_OLTD_TRANSMISSION variable and take the corresponding actions as described in subclause 8.5.70.

Whenever the variable SECONDARY_CELL_E_DCH_TRANSMISSION is set to TRUE, and the secondary uplink frequency is an activated uplink frequency, the UE shall:

- 1> perform E-AGCH reception procedures on the secondary serving E-DCH cell according to the stored E-AGCH configuration as stated in:
 - 2> subclause 8.6.3.14 for the IE "Primary E-RNTI" and the IE "Secondary E-RNTI" for secondary serving E-DCH cell.
- 1> perform E-HICH reception procedures for all radio links in the secondary E-DCH active set;
- 1> perform E-RGCH reception procedures for all radio links in the secondary E-DCH active set for which an E-RGCH configuration has been provided;
- 1> perform uplink DPCH transmission on the secondary uplink frequency according to the stored uplink DPCH info configuration as stated in:
 - 2> subclause 8.6.6.6 for the IE "Uplink DPCH info";
 - 2> subclause 8.6.6.49 for the IE "Uplink Secondary Cell Info FDD".
- 1> perform E-DPCH transmission procedures on the secondary uplink frequency according to the stored E-DPCH configuration as stated in:
 - 2> subclause 8.6.6.37 for the IE "E-DPCH Info";
 - 2> subclause 8.6.6.49 for the IE "Uplink Secondary Cell Info FDD".
- 1> perform E-DPDCH transmission procedures on the secondary uplink frequency according to the stored E-DPDCH configuration as stated in:
 - 2> subclause 8.6.5.16 for the IE "E-DCH Transmission Time Interval";
 - 2> subclause 8.6.5.17 for the IE "HARQ info for E-DCH";
 - 2> subclause 8.6.6.37 for the IE "E-DPDCH Info";
 - 2> subclause 8.6.6.49 for the IE "Uplink Secondary Cell Info FDD".
- 1> inclusion of MAC-d PDU's in a MAC-i PDU for logical channels on the secondary uplink frequency shall:
 - 2> be performed in accordance with the received scheduling grant on E-AGCH/E-RGCH (see [15]) on the downlink frequency associated with the secondary uplink frequency; and
 - 2> obey the scheduling restrictions as specified for scheduled transmissions (see subclause 8.6.6.37).

Whenever the variable SECONDARY_CELL_E_DCH_TRANSMISSION is set to FALSE, or the secondary uplink frequency is not an activated uplink frequency, the UE shall:

- 1> not perform F-DPCH, E-AGCH, E-HICH and E-RGCH reception procedures on the downlink frequency associated with the secondary uplink frequency;
- 1> not perform DPCH, E-DPCH and E-DPDCH transmission procedures on the secondary uplink frequency.

8.5.59 Actions related to reception of a HS-SCCH order for secondary uplink frequency activation/deactivation (FDD only)

The UE shall:

- 1> if the variable `SECONDARY_CELL_E_DCH_TRANSMISSION` is set to `TRUE` and the HS-SCCH order is to activate the secondary uplink frequency:
 - 2> consider the secondary uplink frequency as activated;
 - 2> initiate the physical dedicated channel establishment procedure on the downlink frequency associated with the secondary uplink frequency according to the stored configuration;
 - 2> configure the serving grant on the secondary uplink frequency in accordance with the IE "Serving Grant Value" configuration.
- 1> if the HS-SCCH order is to deactivate the secondary uplink frequency:
 - 2> consider the secondary uplink frequency as not activated.
- 1> determine the value for the `SECONDARY_CELL_E_DCH_TRANSMISSION` and take the corresponding actions as described in subclause 8.5.58.

8.5.60 Configuration of "TSN field extension" for MAC-ehs entity

The MAC-ehs shall be configured with "TSN field extension" only when all the following conditions are met:

- 1> The UE is in `CELL_DCH` state;
- 1> either one of the following conditions are met:
 - 2> two or more entries in the variable `SECONDARY_CELL_HS_DSCH_RECEPTION` are set to `TRUE`; or
 - 2> the variable `MIMO_MODE_WITH_FOUR_TRANSMIT_ANTENNAS_STATUS` is set to `TRUE`, and "MIMO mode with four transmit antennas only with dual stream restriction" is not configured; or
 - 2> both of the following conditions are met:
 - 3> an entry in the variable `SECONDARY_CELL_HS_DSCH_RECEPTION` is set to `TRUE`;
 - 3> and the variable `MIMO_STATUS` or an entry in the variable `SECONDARY_CELL_MIMO_STATUS` is set to `TRUE` or the variable `MIMO_MODE_WITH_FOUR_TRANSMIT_ANTENNAS_STATUS` or an entry in the variable `SECONDARY_CELL_MIMO_MODE_WITH_FOUR_TRANSMIT_ANTENNAS_STATUS` is set to `TRUE`.

If all of the above conditions are met and "TSN field extension" is not configured for the MAC-ehs entity, the UE shall:

- 1> configure the MAC-ehs entity with "TSN field extension";
- 1> reset the MAC-ehs entity [15].

If any of the above conditions is not met and "TSN field extension" is configured for the MAC-ehs entity, the UE shall:

- 1> configure the MAC-ehs entity without "TSN field extension";
- 1> reset the MAC-ehs entity [15].

8.5.61 Actions related to `MU_MIMO_STATUS` variable (1.28 Mcps TDD only)

If the UE receives a `CELL_UPDATE_CONFIRM`, or any reconfiguration message, the UE shall:

- 1> determine the value of the `MU_MIMO_STATUS` variable.

The MU_MIMO_STATUS variable shall be set to TRUE only when all the following conditions are met:

- 1> the variable MU_MIMO_INFO is set;
- 1> either of the following conditions is met:
 - 2> the UE is in CELL_DCH state:
 - 3> the variable HS_DSCH_RECEPTION or E_DCH_TRANSMISSION is set to TRUE;
 - 2> the UE is in CELL_FACH state:
 - 3> the variable HS_DSCH_RECEPTION_CELL_FACH_STATE and COMMON_E_DCH_TRANSMISSION is set to TRUE;

If any of the above conditions is not met and the MU_MIMO_STATUS variable is set to TRUE, the UE shall:

- 1> set the MU_MIMO_STATUS variable to FALSE;
- 1> if the variable HS_DSCH_RECEPTION_CELL_FACH_STATE and COMMON_E_DCH_TRANSMISSION is set to TRUE or HS_DSCH_RECEPTION or E_DCH_TRANSMISSION is set to TRUE and the UE will be in CELL_PCH state:
 - 2> leave the variable MU_MIMO_INFO unchanged;
- 1> otherwise:
 - 2> clear the MU_MIMO_INFO variable.
- 1> trigger lower layers to stop operation in MU-MIMO mode.

If only HS_DSCH_RECEPTION is set to TRUE and IE "MU-MIMO operation" has the value other than "Downlink" or if only E_DCH_TRANSMISSION is set to TRUE and IE "MU-MIMO operation" has the value other than "Uplink", the UE behaviour is unspecified.

8.5.62 Actions related to MULTI_CARRIER_E_DCH_TRANSMISSION variable (1.28Mcps TDD only)

The variable MULTI_CARRIER_E_DCH_TRANSMISSION shall be set to TRUE only when all the following conditions are met:

- 1> the UE is in CELL_DCH state;
- 1> the UE has stored IE "Multi-carrier E-DCH Info for LCR TDD";
- 1> the variable E_DCH_TRANSMISSION is set to TRUE;
- 1> the UE has not stored IE "Non-scheduled transmission grant info"

If any of the above conditions are not met and the variable MULTI_CARRIER_E_DCH_TRANSMISSION is set to TRUE, the UE shall:

- 1> set the variable MULTI_CARRIER_E_DCH_TRANSMISSION to FALSE;
- 1> stop any E-AGCH, E-HICH reception procedures on all additional E-DCH carriers;
- 1> stop any E-PUCH transmission procedures on all additional E-DCH carriers;
- 1> release all E-DCH HARQ resources for all additional E-DCH carriers;
- 1> clear any stored IE "Multi-carrier E-DCH Info for LCR TDD";

If all of the above conditions are met and the variable MULTI_CARRIER_E_DCH_TRANSMISSION is set to FALSE, the UE shall:

- 1> set the variable MULTI_CARRIER_E_DCH_TRANSMISSION to TRUE;

1> reset the MAC-i/is entity [15].

Whenever the variable MULTI_CARRIER_E_DCH_TRANSMISSION is set to TRUE, the UE shall:

- 1> perform E-AGCH reception procedures on the additional E-DCH carrier according to the stored IE "Multi-carrier E-DCH Info for LCR TDD";
- 1> perform E-HICH reception procedures on the additional E-DCH carrier according to the stored IE "Multi-carrier E-DCH Info for LCR TDD";
- 1> perform uplink E-PUCH transmission on the additional E-DCH carrier according to the stored IE "Multi-carrier E-DCH Info for LCR TDD";
- 1> inclusion of MAC-d PDU's in a MAC-i PDU for logical channels on the additional E-DCH carrier shall:
 - 2> be performed in accordance with the received scheduling grant on E-AGCH (see [15]) on the additional E-DCH carrier;

Whenever the variable MULTI_CARRIER_E_DCH_TRANSMISSION is set to FALSE, the UE shall:

- 1> not perform E-AGCH, E-HICH reception procedures on any additional E-DCH carrier;
- 1> not perform E-PUCH transmission procedures on any additional E-DCH carrier.

8.5.63 Logged Measurements Configuration

8.5.63.1 General

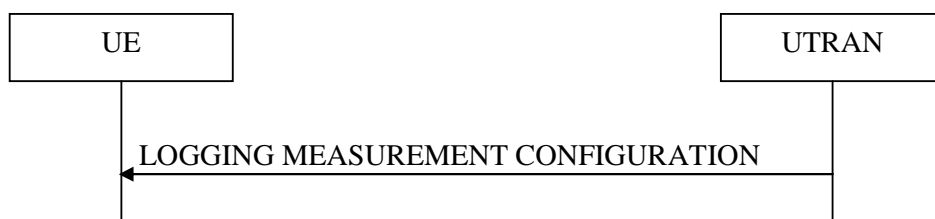

Figure 8.5.63.1-1: Logged measurements configuration

The purpose of this procedure is to configure the UE to perform logging of measurement results while in IDLE mode, CELL_PCH, URA_PCH and CELL_FACH state when second DRX cycle is used.

NOTE: UTRAN may retrieve stored logged measurement information by means of the UE Information procedure.

8.5.63.2 Initiation

UTRAN initiates the logged measurements configuration procedure to the UE by sending the LOGGING MEASUREMENT CONFIGURATION message.

8.5.63.3 Reception of LOGGING MEASUREMENT CONFIGURATION by the UE

Upon receiving the LOGGING MEASUREMENT CONFIGURATION message the UE shall:

- 1> if IE "Logged Measurements Configuration Info" is present:
 - 2> if stored, discard the existing logged measurement configuration as well as the logged measurement information as specified in 8.5.66;

- 2> store the received IEs "Logging Duration", "Logging Interval", "Area Configuration" if included in IE "Logged Measurements Configuration Info" in variable LOGGED_MEAS_CONFIG and IEs "Absolute Time Info", "Trace reference", "Trace recording session" and "TCE Id" in variable LOGGED_MEAS_REPORT_VARIABLE;
- 2> if the IE "PLMN Identity List" is present, store it in variable LOGGED_MEAS_REPORT_VARIABLE;
- 2> add the current Registered PLMN to the contents of the IE "PLMN Identity List" in variable LOGGED_MEAS_REPORT_VARIABLE;
- 2> start timer T326 with the timer value set to the IE "Logging Duration".

NOTE: The UE should not stop timer T326 unless explicitly stated when it moves to another RAT.

1> if IE "Logged ANR configuration Info" is present:

- 2> if variable LOG_ANR_CONFIG was already stored, discard the existing logged measurement configuration for ANR purpose as well as the associated logged measurement information as specified in 8.5.68;
- 2> store the received IEs in the IE "Logged ANR configuration Info" in variable LOG_ANR_CONFIG;
- 2> store the current Registered PLMN in the IE "PLMN Identity" in variable LOG_ANR_REPORT_VARIABLE;
- 2> store the list of Equivalent PLMNs in the IE "Equivalent PLMN Identity List" in variable LOG_ANR_REPORT_VARIABLE;
- 2> start timer T327 with the timer value set to the IE "Logging Duration" included in IE "Logged ANR configuration Info".

8.5.63.4 T326 Expiry

When timer T326 expires, the UE shall:

- 1> release variable LOGGED_MEAS_CONFIG.

The UE is allowed to release stored logged measurements, i.e. to release LOGGED_MEAS_REPORT_VARIABLE 48 hours after T326 expiry.

8.5.63.5 T327 Expiry

When timer T327 expires, the UE shall:

- 1> stop performing ANR measurement and logging, release the variable LOG_ANR_CONFIG.

NOTE: The UE should not stop timer T327 upon transition to Idle mode, when it moves to another RAT or a PLMN not included in the IE "PLMN Identity" or IE "Equivalent PLMN Identity List" stored in variable LOG_ANR_REPORT_VARIABLE. The UE is allowed to keep the stored logged ANR measurements, i.e. to store LOG_ANR_REPORT_VARIABLE 48 hours after T327 starts.

8.5.64 UE INFORMATION

8.5.64.1 General

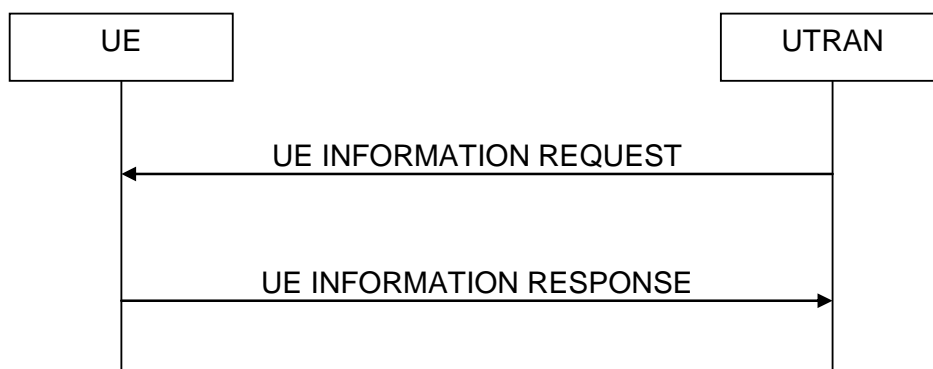

Figure 8.5.64.1-1: UE INFORMATION Procedure

The purpose of this procedure is to request the UE to report information.

8.5.64.2 Initiation

The procedure is initiated when the UTRAN sends a UE INFORMATION REQUEST to the UE.

8.5.64.3 Reception of the UE INFORMATION REQUEST message by the UE

UE Shall:

- 1> if IE "Logged Measurements Report Request" is present:
 - 2> if Registered PLMN is present in the IE "PLMN Identity List" stored in variable LOGGED_MEAS_REPORT_VARIABLE:
 - 3> if an IE "Logged Measurement Info-FDD" or "Logged Measurement Info-TDD" in variable LOGGED_MEAS_REPORT_VARIABLE is present:
 - 4> set IE "Logged Meas Report" in the UE INFORMATION RESPONSE as follows:
 - 5> include the IE "Absolute Time Info" and set it to the value of the IE "Absolute Time Info" in the variable LOGGED_MEAS_REPORT_VARIABLE;
 - 5> include the IE "Trace reference" and set it to the value of IE "Trace reference" in the variable LOGGED_MEAS_REPORT_VARIABLE;
 - 5> include the IE "Trace recording session" and set it to the value of IE "Trace recording session" in the variable LOGGED_MEAS_REPORT_VARIABLE;
 - 5> include the IE "TCE Id" and set it to the value of IE "TCE Id" in the variable LOGGED_MEAS_REPORT_VARIABLE;
 - 5> include the IEs "Logged Measurement Info-FDD" or "Logged Measurement Info-TDD" and set it to include, in the same order as logged, one or more entries from LOGGED_MEAS_REPORT_VARIABLE;
 - 5> clear the logged measurement results included in the list of IEs "Logged Measurement Info-FDD" or "Logged Measurement Info-TDD" from LOGGED_MEAS_REPORT_VARIABLE;
 - 5> if the variable LOGGED_MEAS_REPORT_VARIABLE is not empty:
 - 6> include IE "Logged Meas Available";

- 1> if IE "Logged ANR Report Request" is present:
 - 2> if Registered PLMN is the same as one of the PLMNs in the IE "PLMN Identity" or IE "Equivalent PLMN Identity List" stored in variable LOG_ANR_REPORT_VARIABLE:
 - 3> if IE "Logged ANR Report Info" in variable LOG_ANR_REPORT_VARIABLE is present:
 - 4> set IEs "Logged ANR Report Info" in the UE INFORMATION RESPONSE as follows:
 - 5> include the IEs "Logged ANR Report Info List" and set it to include entries from LOG_ANR_REPORT_VARIABLE;
 - 5> clear the logged measurement results included in the list of IEs "Logged ANR Report Info List" from the LOG_ANR_REPORT_VARIABLE;
 - 5> clear the variable LOG_ANR_CONFIG and stop timer T327.
 - 1> if IE "Connection Establishment Failure Request" is present:
 - 2> if Registered PLMN is the same as the PLMN in the IE "PLMN Identity" stored in variable LOGGED_CONNECTION_ESTABLISHMENT_FAILURE:
 - 3> set IE "Connection Establishment Failure Report" in the UE INFORMATION RESPONSE as follows:
 - 4> include the IE "Logged Connection Establishment Failure Info-FDD" or "Logged Connection Establishment Failure Info-TDD" and set it to include the entry from the variable LOGGED_CONNECTION_ESTABLISHMENT_FAILURE;
 - 4> set the IE "Time Since Failure" to indicate the elapsed time starting from the Logging of the Connection establishment failure information that is stored in the variable LOGGED_CONNECTION_ESTABLISHMENT_FAILURE.
 - 3> clear the variable LOGGED_CONNECTION_ESTABLISHMENT_FAILURE;
 - 1> transmit a UE INFORMATION RESPONSE message on the uplink DCCH using AM RLC.

8.5.64.4 Reception of the UE INFORMATION RESPONSE message by the UTRAN

Upon receiving an UE INFORMATION RESPONSE message, UTRAN may:

- 1> if the message includes the IE "Logged Meas Available" send a further UE INFORMATION REQUEST

8.5.65 Measurements logging

When in idle mode, CELL_PCH, URA_PCH states or CELL_FACH state when second DRX cycle is used and Logged Measurements has been configured, the UE shall:

- 1> Store the available measurements according to the logged measurements configuration in LOGGED_MEAS_CONFIG variable as specified in subclause 8.5.65.2.

8.5.65.1 General

This procedure specifies the logging of available measurements by a UE in idle mode, CELL_PCH, URA_PCH states or CELL_FACH state when second DRX cycle is used that has logged measurements configuration

8.5.65.2 Initiation

While T326 is running, the UE shall:

- 1> perform this logging in accordance with the following:
 - 2> perform the logging while camping normally on an UTRA cell and the RPLMN of the UE is present in the "PLMN Identity List" stored in LOGGED_MEAS_REPORT_VARIABLE and, if the IE "Area Configuration" is present in variable LOGGED_MEAS_CONFIG, that is part of the concerned area;

- 2> perform the logging at regular intervals, as defined by the IE "Logging Interval" in variable LOGGED_MEAS_CONFIG;
- 2> when adding a logged measurement entry in variable LOGGED_MEAS_REPORT_VARIABLE, include the fields in accordance with the following:
 - 3> set the IE "Relative Time Stamp" to indicate time relative to the moment at which the logged measurement configuration was received;
 - 3> if GNSS location information became available during the last logging interval:
 - 4> if the UE has been able to calculate a 3-dimensional position:
 - 5> set IE "Ellipsoid point with altitude" or the IE "Ellipsoid point with altitude and uncertainty ellipsoid" to include the location coordinates;
 - 4> else:
 - 5> set IE "Ellipsoid point" or the IE "Ellipsoid point with uncertainty circle" or the IE "Ellipsoid point with uncertainty ellipse" to include the location coordinates;
 - 4> a value of the IE "Confidence", different from "0" should be calculated, as the probability that the UE is located within the uncertainty region of the one of the IEs "Ellipsoid point with uncertainty ellipse" or "Ellipsoid point with altitude and uncertainty ellipsoid".
 - 3> set the IE "PLMN Identity" of the Logged Measurements Serving Cell to indicate the PLMN Identity of the cell the UE is camping on obtained from system information;
 - 3> set the IE "Cell ID" to indicate cell identity of the cell the UE is camping on obtained from system information;
 - 3> set the IE "CPICH Ec/N0" and "CPICH RSCP" to include measured quantities of the cell that the UE is camping on for UTRA FDD;
 - 3> set the IE "P-CCPCH RSCP" to include measured quantities for the cell that the UE is camping on for UTRA 1.28 Mcps TDD;
 - 3> set the IE "Logged Measurements Intra Frequency Neighbouring Cells list", "Logged Measurements Inter Frequency list", "Logged Measurements E-UTRA frequency list", "Logged Measurements E-UTRA frequency extension list", in order of decreasing ranking quantity as used for cell re-selection in each frequency for at most the following number of neighbouring cells; 6 intra-frequency and 3 inter-frequency neighbours per frequency as well as 3 inter-RAT neighbours, per frequency per RAT;
 - 3> set the IE "Logged Measurements GSM Neighbouring Cells list" in order of decreasing RXLEV.

NOTE: The UE includes, only once, the latest available results of the measurement performed for cell reselection, which are performed in accordance with the regular performance requirements as specified in [19].

- 2> when the memory reserved for the logging of measurements becomes full, stop timer T326 and performs the same actions as performed upon expiry of T326, as specified in 8.5.63.4.

8.5.66 Release of Logged Measurements Configuration

8.5.66.1 General

The purpose of this procedure is to release the configuration controlling the logging of measurement results while in IDLE mode, CELL_PCH, URA_PCH states and CELL_FACH state when second DRX cycle is used as well as the logged measurement information.

8.5.66.2 Initiation

The UE initiates the procedure upon receiving a logged measurement configuration in UTRAN or in another RAT. The UE also shall initiate the procedure upon switch off or detach.

The UE shall:

- 1> if stored, discard the existing logged measurement configuration as well as the logged measurement information, i.e. release the UE variables LOGGED_MEAS_CONFIG and LOGGED_MEAS_REPORT_VARIABLE and stop timer T326.

8.5.67 Measurements logging for ANR

When in idle mode, CELL_PCH, URA_PCH state or CELL_FACH state when second DRX cycle is used and Logged Measurements for ANR has been configured, the UE shall:

- 1> Store the available measurements according to the logged measurements configuration in variable LOG_ANR_CONFIG as specified in subclause 8.5.67.2.

8.5.67.1 General

This procedure specifies the logging of available measurements by a UE in idle mode, CELL_PCH, URA_PCH state or CELL_FACH state when second DRX cycle is used that has logged measurements configuration.

8.5.67.2 Initiation

While T327 is running, the UE shall:

- 1> perform the ANR measurements and evaluation on UTRAN, E-UTRAN or GERAN cells in accordance with the following:
 - 2> if IE "Intra-UTRA ANR" is included in variable LOG_ANR_CONFIG:
 - 3> if the UE camps normally on an UTRA cell (serving) that is part of the PLMN which is the same as one of the PLMNs in the IE "PLMN Identity" or IE "Equivalent PLMN Identity List" stored in variable LOG_ANR_REPORT_VARIABLE; and
 - 3> if the serving cell and UTRA cell, not included in the neighbour cell list, together have not earlier been stored by UE in an entry of "Logged ANR Report Info" in the LOG_ANR_REPORT_VARIABLE; and
 - 3> if the quality of the UTRA cell, not included in the neighbour cell list, exceeds the quality of the serving cell with more than the value of "Logging Relative Threshold", if this IE is present in the Logging Measurement Configuration message; and
 - 3> if the quality of UTRA cell, not included in the neighbour cell list, is above the value of "Absolute Threshold"; and
 - 3> if both the camping UTRAN cell and UTRA cell, not included in the neighbour cell list, are not CSG cells:
 - 4> log the ANR information into the variable LOG_ANR_REPORT_VARIABLE as follows:
 - 5> set the IEs "Serving PLMN Identity" to indicate the IE "PLMN Identity" included in MIB and "Serving Cell" to indicate cell identity of the cell the UE is camping on;
 - 5> try to acquire the corresponding system information of the UTRA cell and set to the variable LOG_ANR_REPORT_VARIABLE as follows:
 - 6> set the IE "Cell Identity" to indicate cell identity of this UTRA cell;
 - 6> set the IE "PLMN Identity" to indicate the IE "PLMN Identity" included in MIB of this UTRA cell;
 - 6> set the IE "UARFCN" and "Cell parameter ID" for a TDD cell or "Primary Scrambling Code" for a FDD cell.
 - 2> if IE "Inter-RAT ANR for E-UTRA Indicator" is included in variable LOG_ANR_CONFIG:

- 3> if the UE reselected from a E-UTRA cell to an UTRA cell (serving cell) that is part of the PLMN which is the same as one of the PLMNs in the IE "PLMN Identity" or IE "Equivalent PLMN Identity List" stored in variable LOG_ANR_REPORT_VARIABLE; and
- 3> if the previously camped E-UTRAN cell is not included in the blacklist for the EUTRAN frequency in SIB19 of the serving cell; and
- 3> if both the previously camped E-UTRAN cell and serving cell are not CSG cells; and
- 3> if the serving cell and E-UTRAN cell together have not earlier been stored by UE in an entry of "Logged ANR Report Info" in the LOG_ANR_REPORT_VARIABLE:
 - 4> log the ANR information into the variable LOG_ANR_REPORT_VARIABLE as follows:
 - 5> set the IEs "Serving PLMN Identity" to indicate the IE "PLMN Identity" included in MIB and "Serving Cell" to indicate cell identity of the serving cell;
 - 5> set the IE "Cell Identity" to indicate cell identity of this previously camped E-UTRAN cell;
 - 5> set the IE "PLMN Identity" to indicate the Primary PLMN which this previously camped E-UTRAN cell belongs to;
 - 5> set the IE "Tracking Area Code" to indicate the TAC which this previously camped E-UTRAN cell belongs to;
 - 5> set the IE "EARFCN" and the IE "EARFCN extension" when applicable and "Physical Cell Identity" of this previously camped E-UTRAN cell.
- 2> if IE "Inter-RAT ANR for GSM Indicator" is included in variable LOG_ANR_CONFIG:
 - 3> if the UE reselected from a GSM cell to an UTRA cell (serving cell) that is part of the PLMN which is the same as one of the PLMNs in the IE "PLMN Identity" or IE "Equivalent PLMN Identity List" stored in variable LOG_ANR_REPORT_VARIABLE; and
 - 3> if the previously camped GSM cell is not included in the neighbour cell list in SIB11/11bis/12 of the serving cell; and
 - 3> if the serving cell is not a CSG cell; and
 - 3> if the serving cell and GSM cell, not included in the neighbour cell list, together have not earlier been stored by UE in an entry of "Logged ANR Report Info" in the LOG_ANR_REPORT_VARIABLE:
 - 4> log the ANR information into the variable LOG_ANR_REPORT_VARIABLE, as follows:
 - 5> set the IEs "Serving PLMN Identity" to indicate the IE "PLMN Identity" included in MIB and "Serving Cell" to indicate cell identity of the serving cell;
 - 5> set the IE "PLMN Identity", "Cell Identity" and "LAC" to indicate global cell identity of this previously camped GSM set cell;
 - 5> set the IE "BSIC", "BCCH ARFCN" and "Band Indicator" of this previously camped GSM set cell.
- 2> when maximum number of entries for the ANR logging is reached, stop timer T327 and perform the same actions as upon expiry of T327, as specified in 8.5.63.5.

8.5.68 Release of ANR Logging Measurements Configuration

8.5.68.1 General

The purpose of this procedure is to release the Logged ANR Configuration controlling the logging of measurement results while in IDLE mode, CELL_PCH, URA_PCH states and CELL_FACH state when second DRX cycle is used as well as the logged measurement information.

8.5.68.2 Initiation

The UE initiates the procedure to release the existing logging measurements configuration upon receiving a new Logged ANR Configuration in UTRAN. The UE also shall initiate the procedure after sending UE INFORMATION RESPONSE message as well as upon switch off or detach.

The UE shall:

- 1> if stored, discard the existing logged measurement configuration as well as the logged measurement information, i.e. release the UE variables LOG_ANR_CONFIG and LOG_ANR_REPORT_VARIABLE and stop timer T327.

8.5.69 Actions related to UPLINK_CLTD_TRANSMISSION variable (FDD only)

The variable UPLINK_CLTD_TRANSMISSION shall be set to TRUE only when all the following conditions are met:

- 1> the UE is in CELL_DCH state;
- 1> the UE has stored IE "Uplink CLTD info FDD";
- 1> the UE has stored IE "F-TPICH info" for the radio link transmitted from the serving HS-DSCH cell if HS-DSCH is configured or from the cell identified by the IE "Primary CPICH info" in the IE "Uplink CLTD info FDD" if only DCH is configured;
- 1> the UE is configured with MAC-i/is if E-DCH is configured;
- 1> the variable SECONDARY_CELL_E_DCH_TRANSMISSION is set to FALSE if the UE supports Dual Cell E-DCH operation.

If any of the above conditions is not met and the variable UPLINK_CLTD_TRANSMISSION is set to TRUE, the UE shall:

- 1> set the variable UPLINK_CLTD_TRANSMISSION to FALSE;
- 1> stop the F-TPICH reception procedure;
- 1> trigger lower layers to stop the uplink CLTD transmission;
- 1> clear the stored IE "Uplink CLTD info FDD".

If all of the above conditions are met and the variable UPLINK_CLTD_TRANSMISSION is set to FALSE, the UE shall:

- 1> set the variable UPLINK_CLTD_TRANSMISSION to TRUE;
- 1> instruct the physical layer to switch to the uplink CLTD activation state as indicated by the IE "Initial CLTD activation state" (see [27]).

Whenever the variable UPLINK_CLTD_TRANSMISSION is set to TRUE, the UE shall:

- 1> perform the F-TPICH reception procedure;
- 1> trigger lower layers to perform the uplink CLTD transmission.

Whenever the variable UPLINK_CLTD_TRANSMISSION is set to FALSE, the UE shall:

- 1> not perform the F-TPICH reception procedure;
- 1> not perform the uplink CLTD transmission.

If the variable UPLINK_CLTD_TRANSMISSION is set to TRUE and the serving HS-DSCH cell was changed as a result of the received message or HS-SCCH order from the target cell, and the IE "Initial CLTD activation state" is included, the UE shall instruct the physical layer to switch to the uplink CLTD activation state as indicated by the IE "Initial CLTD activation state" (see [27]).

If the variable UPLINK_CLTD_TRANSMISSION is set to TRUE, and the serving HS-DSCH cell was changed as a result of the received message or HS-SCCH order from the target cell, and the IE "Uplink CLTD info FDD" is included, and the IE "Initial CLTD activation state" is not included, the UE shall instruct the physical layer to remember the received uplink CLTD activation state switching HS-SCCH orders.

If the variable UPLINK_CLTD_TRANSMISSION is set to TRUE, and the value of IE "Configuration info" contained in the IE "Uplink CLTD info FDD" is set to either "Continue" or "New configuration", and the serving HS-DSCH cell was not changed as a result of the received message, the UE shall instruct the physical layer to remember the received uplink CLTD activation state switching HS-SCCH orders.

8.5.70 Actions related to UPLINK_OLTD_TRANSMISSION variable (FDD only)

The variable UPLINK_OLTD_TRANSMISSION shall be set to TRUE only when all the following conditions are met:

- 1> the UE is in CELL_DCH state;
- 1> the UE has stored IE "Uplink OLTD info FDD";
- 1> the variable SECONDARY_CELL_E_DCH_TRANSMISSION is set to FALSE if the UE supports Dual Cell E-DCH operation.

If any of the above conditions is not met and the variable UPLINK_OLTD_TRANSMISSION is set to TRUE, the UE shall:

- 1> set the variable UPLINK_OLTD_TRANSMISSION to FALSE;
- 1> trigger lower layers to stop the uplink OLTD transmission;
- 1> clear the stored IE "Uplink OLTD info FDD".

Whenever the variable UPLINK_OLTD_TRANSMISSION is set to TRUE, the UE shall:

- 1> trigger lower layers to perform the uplink OLTD transmission.

Whenever the variable UPLINK_OLTD_TRANSMISSION is set to FALSE, the UE shall:

- 1> not perform the uplink OLTD transmission.

8.5.71 Actions related to MULTIFLOW_STATUS variable (FDD only)

The variable MULTIFLOW_STATUS shall be set to TRUE only when all the following conditions are met:

- 1> the UE is in CELL_DCH state;
- 1> the variable HS_DSCH_RECEPTION is TRUE;
- 1> at least one of the entries in the variable SECONDARY_CELL_HS_DSCH_RECEPTION is TRUE;
- 1> the IE "Multiflow configuration" is present in all the entries in DOWNLINK_SECONDARY_CELL_INFO.

If any of the above conditions is not met and the variable MULTIFLOW_STATUS is set to TRUE, the UE shall:

- 1> set the variable MULTIFLOW_STATUS to FALSE.

Whenever the variable MULTIFLOW_STATUS is set to TRUE, the UE shall:

- 1> perform Multiflow data reception as specified in [51];
- 1> indicate to lower layers value of "Multiflow configuration" IE of each entry in DOWNLINK_SECONDARY_CELL_INFO;
- 1> for every entry in DOWNLINK_SECONDARY_CELL_INFO:
 - 2> if the stored UARFCN downlink (Nd) in the entry is the same as the value of the serving HS-DSCH cell:

- 3> if the IE "Multiflow time reference cell" is not present:
 - 4> indicate to lower layers that the serving HS-DSCH cell is time reference for HS-DPCCH;
- 3> else:
 - 4> indicate to lower layers that the cell is a time reference for HS-DPCCH;
- 2> else:
 - 3> if the IE "Multiflow time reference cell" is present:
 - 4> indicate to lower layers that the cell and the time reference cell are in the same cell group as specified in [27];
 - 3> else:
 - 4> indicate to lower layers that the cell and the non-time reference cell are in the same cell group as specified in [27];
- 1> If there is at least one entry in DOWNLINK_SECONDARY_CELL_INFO with the IE "Multiflow cell", value of which is set to "inter-NodeB":
 - 2> configure two MAC-ehs entities;
 - 2> associate with the first MAC-ehs entity the serving HS-DSCH cell and all the HS-DSCH cells, entries of which in DOWNLINK_SECONDARY_CELL_INFO have the IE "Multiflow cell" set to "intra-NodeB";
 - 2> associate with the second MAC-ehs entity all the HS-DSCH cells, entries of which in DOWNLINK_SECONDARY_CELL_INFO have the IE "Multiflow cell" set to "inter-NodeB";

Whenever the variable MULTIFLOW_STATUS is set to FALSE, the UE shall:

- 1> stop Multiflow operation;
- 1> if Timer_Reordering was configured for the receiving RLC entity:
 - 2> configure the receiving RLC entity not to use the corresponding function;
- 1> if two MAC-ehs entities were configured for the inter-Node B Multiflow operation:
 - 2> configure one MAC-ehs entity;
- 1> indicate to lower layers that the serving HS-DSCH cell must be used as a time reference for HS-DPCCH.

8.5.72 Selection of common E-DCH TTI (FDD only)

A common E-DCH resource may employ either 2 or 10 ms TTI. The UE shall make the selection on an appropriate TTI length according to the procedure below and indicate the selection to the lower layers.

The UE shall:

- 1> if the CHOICE "TTI selection" in the IE "Concurrent Deployment of 2ms and 10ms TTI" has the value "Fixed":
 - 2> if "Fixed common E-DCH TTI selection" is set to "10ms":
 - 3> indicate a selection of common E-DCH TTI of 10 ms to the physical layer for all preamble transmissions.
 - 2> if "Fixed common E-DCH TTI selection" is set to "2ms":
 - 3> indicate a selection of common E-DCH TTI of 2 ms to the physical layer for all preamble transmissions.
- 1> if the CHOICE "TTI selection" in the IE "Concurrent Deployment of 2ms and 10ms TTI" has the value "Threshold based":
 - 2> perform TTI selection as follows:

3> for the first preamble transmission:

4> when the UE calculates the initial preamble transmit power ("Preamble_Initial_Power") as specified in subclause 8.5.7:

5> calculate a transmit power headroom,

$$\text{Headroom} = \{ \min(\text{Maximum allowed UL tx power, P_MAX}) - (\text{Preamble_Initial_Power} + \Delta\text{Pp-e}) \}$$

where "Maximum allowed UL tx power" is the maximum allowed uplink transmit power indicated in system information (in dBm), P_MAX is the maximum RF output power of the UE (dBm) and ΔPp-e is the Power offset between the last transmitted preamble and the initial DPCCCH transmission as defined in [26].

NOTE 1: the expression Preamble_Initial_Power + ΔPp-e represents the DPCCCH power if the common E-DCH transmission would be sent after the initial preamble.

3> for preamble transmissions other than the first:

4> when the UE calculates the preamble transmit power ("Commanded Preamble Power") as specified [29] subclause 6.1A:

5> calculate a transmit power headroom,

$$\text{Headroom} = \{ \min(\text{Maximum allowed UL tx power, P_MAX}) - (\text{Commanded Preamble Power} + \Delta\text{Pp-e}) \}$$

where "Maximum allowed UL tx power" is the maximum allowed uplink transmit power indicated in system information (in dBm), P_MAX is the maximum RF output power of the UE (dBm) and ΔPp-e is the Power offset between the last transmitted preamble and the initial DPCCCH transmission as defined in [26].

3> if the resulting "Headroom" value is less than "Common E-DCH TTI selection threshold":

4> indicate a selection of common E-DCH TTI of 10 ms to the physical layer for the preamble transmission.

3> else:

4> indicate a selection of common E-DCH TTI of 2 ms to the physical layer for the preamble transmission.

2> for emergency call, the UE is allowed to select a common E-DCH TTI of 10ms.

8.5.73 PRACH preamble control parameters selection with Concurrent Deployment of 2ms and 10ms TTI (for Enhanced Uplink, FDD only)

If the UE supports concurrent deployment and System Information Block type 22 includes the IE "Concurrent deployment of 2ms and 10ms TTI", the UE shall select PRACH preamble control parameters (for Enhanced Uplink) according to the following rule. The UE shall:

1> for common E-DCH TTI value equal to 10ms:

2> if the IE "PRACH preamble control parameters extension list Type 1 (for Enhanced Uplink)" is included in System Information Block 22:

3> compile a list of candidate PRACH preamble control parameters from the IE "PRACH preamble control parameters extension list Type 1 (for Enhanced Uplink)" included in System Information Block 22, and if the TTI signalled in the IE "E-DCH Transmission Time Interval" is equal to 10ms, the IE "PRACH preamble control parameters (for Enhanced Uplink)" included in "Common E-DCH system info" in System Information Block 5/5bis, in the order of appearance as in System Information Block 22 followed by System Information Block 5/5bis, respectively;

3> select PRACH preamble control parameters randomly from the candidate list as follows:

"Index of selected PRACH preamble control parameters (for Enhanced Uplink)" = rand

where "rand" is a random number taking integer values i , $0 \leq i < K$ with probability given by the $(i+1)^{\text{th}}$ occurrence of the weight value in the list of candidate PRACH preamble control parameters and K is equal to the number of candidate PRACH preamble control parameters.

If any of the $K-1$ occurrences of the IE "Weight" is not present, "rand" is a random number taking integer values i , $0 \leq i < K$ with equal probability. The candidate PRACH preamble control parameters shall be indexed from 0 to $K-1$. The random number generator is left to implementation. At start-up of the random number generator in the UE the seed shall be dependent on the IMSI of the UE or time, thereby avoiding that all UEs select the same parameters;

NOTE: The K^{th} occurrence of the weight value is not explicitly given but calculated by UE, see 10.3.6.134.

3> configure and use the MAC and the physical layer for the PRACH preamble transmission according to the parameters included in the selected IE "PRACH preamble control parameters (for Enhanced Uplink)".

3> for emergency call, the UE is allowed to select any of the PRACH preamble control parameters from the candidate list.

2> else:

3> configure and use the MAC and the physical layer for the PRACH preamble transmission according to the parameters included in the selected "PRACH preamble control parameters (for Enhanced Uplink)" IE according to [15] if the TTI signalled in the IE "E-DCH Transmission Time Interval" is equal to 10ms.

1> for common E-DCH TTI value equal to 2ms:

2> if the UE supports TTI alignment and Per HARQ process and System Information Block type 22 includes the IE "PRACH preamble control parameters extension list Type 3 (for Enhanced Uplink)", and either of the IE's "Offset" or "Scheduled Transmission configuration":

3> compile a list of candidate PRACH preamble control parameters from the IE "PRACH preamble control parameters extension list Type 3 (for Enhanced Uplink)" included in System Information Block 22, in the order of appearance as in System Information Block 22.

2> else if System Information Block type 22 includes the IE "PRACH preamble control parameters extension list Type 2 (for Enhanced Uplink)":

3> compile a list of candidate PRACH preamble control parameters from the IE "PRACH preamble control parameters extension list Type 2 (for Enhanced Uplink)" included in System Information Block 22, in the order of appearance as in System Information Block 22.

2> else:

3> the UE behaviour is not specified.

2> select PRACH preamble control parameters randomly from the candidate list as follows:

"Index of selected PRACH preamble control parameters (for Enhanced Uplink)" = rand

where "rand" is a random number taking integer values i , $0 \leq i < L$ with probability given by the $(i+1)^{\text{th}}$ occurrence of the IE "Weight" in the list of candidate PRACH preamble control parameters and L is equal to the number of candidate PRACH preamble control parameters. If any of the first $L-1$ occurrences of the IE "Weight" is not present, "rand" is a random number taking integer values i , $0 \leq i < L$ with equal probability. The candidate PRACH preamble control parameters shall be indexed from 0 to $L-1$. The random number generator is left to implementation. At start-up of the random number generator in the UE the seed shall be dependent on the IMSI of the UE or time, thereby avoiding that all UEs select the same parameters;

NOTE: The L^{th} occurrence of the weight value is not explicitly given but calculated by UE, see 10.3.6.135.

- 2> configure and use the MAC and the physical layer for the PRACH preamble transmission according to the parameters included in the selected IE "PRACH preamble control parameters (for Enhanced Uplink)".
- 2> for emergency call, the UE is allowed to select any of the PRACH preamble control parameters from the candidate list.
- 1> reselect the PRACH preamble control parameters when a new cell is selected. PRACH preamble control parameter reselection may also be performed at the start of each Enhanced Uplink in CELL_FACH state and IDLE mode transmission.

8.5.74 PRACH preamble control parameters selection without Concurrent Deployment of 2ms and 10ms TTI (for Enhanced Uplink, FDD only)

The UE shall select PRACH preamble control parameters (for Enhanced Uplink) according to the following rule. The UE shall:

- 1> if the TTI signalled in the IE "E-DCH Transmission Time Interval" is equal to 10ms:
 - 2> if the IE "PRACH preamble control parameters extension list Type 1 (for Enhanced Uplink)" is included in System Information Block 22:
 - 3> compile a list of candidate PRACH preamble control parameters from the IE "PRACH preamble control parameters extension list Type 1 (for Enhanced Uplink)" included in System Information Block 22 and the IE "PRACH preamble control parameters (for Enhanced Uplink)" included in "Common E-DCH system info" in System Information Block 5/5bis, in the order of appearance as in System Information Block 22 followed by System Information Block 5/5bis, respectively;
 - 3> select PRACH preamble control parameters randomly from the candidate list as follows:

"Index of selected PRACH preamble control parameters (for Enhanced Uplink)" = rand

where "rand" is a random number taking integer values i , $0 \leq i < K$ with probability given by the $(i+1)^{\text{th}}$ occurrence of the weight value in the list of candidate PRACH preamble control parameters and K is equal to the number of candidate PRACH preamble control parameters. If any of the $K-1$ occurrences of the IE "Weight" is not present, "rand" is a random number taking integer values i , $0 \leq i < K$ with equal probability. The candidate PRACH preamble control parameters shall be indexed from 0 to $K-1$. The random number generator is left to implementation. At start-up of the random number generator in the UE the seed shall be dependent on the IMSI of the UE or time, thereby avoiding that all UEs select the same parameters;

NOTE: The K^{th} occurrence of the weight value is not explicitly given but calculated by UE, see 10.3.6.134.
 - 3> configure and use the MAC and the physical layer for the PRACH preamble transmission according to the parameters included in the selected IE "PRACH preamble control parameters (for Enhanced Uplink)".
 - 3> for emergency call, the UE is allowed to select any of the PRACH preamble control parameters from the candidate list.
 - 2> else:
 - 3> configure and use the MAC and the physical layer for the PRACH preamble transmission according to the parameters included in the selected "PRACH preamble control parameters (for Enhanced Uplink)" IE according to [15].
- 1> else:
 - 2> configure and use the MAC and the physical layer for the PRACH preamble transmission according to the parameters included in the selected "PRACH preamble control parameters (for Enhanced Uplink)" IE according to [15].
 - 1> reselect the PRACH preamble control parameters when a new cell is selected. PRACH preamble control parameter reselection may also be performed at the start of each Enhanced Uplink in CELL_FACH state and IDLE mode transmission.

8.5.75 Actions related to READY_FOR_COMMON_ERGCH variable (FDD only)

The variable READY_FOR_COMMON_ERGCH shall be set to TRUE only when all the following conditions are met:

- 1> if the UE is in CELL_FACH state:
 - 2> the UE supports Common E-RGCH Based Interference Control;
 - 2> the UE has stored IE "Common E-RGCH info FDD";
 - 2> if System Information Block type 11 is scheduled on the BCCH:
 - 3> the UE has read and stored the IEs present in this System Information Block.
 - 2> if System Information Block type 11bis is scheduled on the BCCH:
 - 3> the UE has read and stored the IEs present in this System Information Block.
 - 2> if System Information Block type 12 is scheduled on the BCCH:
 - 3> the UE has read and stored the IEs present in this System Information Block.
- 1> if the UE is in CELL_PCH state:
 - 2> the UE supports HS-DSCH reception in CELL_PCH and URA_PCH state;
 - 2> the IE "HS-DSCH paging system information" is included in system information block type 5 or 5bis;
 - 2> variable H_RNTI is set;
 - 2> variable E_RNTI is set;
 - 2> variable C_RNTI is set;
 - 2> the UE supports Common E-RGCH Based Interference Control;
 - 2> the UE has stored IE "Common E-RGCH info FDD";
 - 2> if System Information Block type 11 is scheduled on the BCCH:
 - 3> the UE has read and stored the IEs present in this System Information Block.
 - 2> if System Information Block type 11bis is scheduled on the BCCH:
 - 3> the UE has read and stored the IEs present in this System Information Block.
 - 2> if System Information Block type 12 is scheduled on the BCCH:
 - 3> the UE has read and stored the IEs present in this System Information Block.

If any of the above conditions is not met and the variable READY_FOR_COMMON_ERGCH is set to TRUE, the UE shall:

- 1> set the variable READY_FOR_COMMON_ERGCH to FALSE;
- 1> clear the stored IE "Common E-RGCH info FDD".

Whenever the variable READY_FOR_COMMON_ERGCH is set to FALSE, the UE shall:

- 1> not consider any radio link to be a Common E-RGCH RL.

Whenever the variable READY_FOR_COMMON_ERGCH is set to TRUE, the UE shall:

- 1> configure the MAC to use reference_ETPR2.

8.5.76 Actions related to FALLBACK_R99_PRACH_ENABLED variable (FDD only)

The variable FALLBACK_R99_PRACH_ENABLED shall be set to TRUE only when all the following conditions are met:

- 1> the variable READY_FOR_FALLBACK_R99_PRACH is set to TRUE;
- 1> "E-DCH resource index" received is equal to -1;
- 1> either of the following conditions is met:
 - 2> the IE "CCCH Fallback" is set to TRUE and there is CCCH message(s) for transmission on the uplink;
 - 2> the IE "DCCH Fallback" is set to TRUE and there is DCCH message(s) for transmission on the uplink.

If any of the above conditions is not met and the variable FALLBACK_R99_PRACH_ENABLED is set to TRUE, the UE shall:

- 1> set the variable FALLBACK_R99_PRACH_ENABLED to FALSE;

If the UE receives "Fallback transmission termination" from MAC with the CMAC-STATUS primitive, the UE shall:

- 1> set the variable FALLBACK_R99_PRACH_ENABLED to FALSE.

If variable FALLBACK_R99_PRACH_ENABLED is set to TRUE:

- 1> replace the TFS of the RACH with the one stored in the UE if any;
- 1> let the physical channel(s) of type PRACH given by the IE(s) "PRACH info" be the default in uplink for the PRACH if UE is in CELL_FACH state;
- 1> start to receive the physical channel of type AICH using the parameters given by the IE "AICH info" (FDD only) when given allocated PRACH is used;
- 1> if the IE "Additional Dynamic Transport Format Information for CCCH" is included for the selected PRACH:
 - 2> use this transport format for transmission of the CCCH.
- 1> else:
 - 2> use the first instance of the list of transport formats as in the IE "RACH TFS" for the used RACH received in the IE "PRACH system information list" when using the CCCH.
- 1> select PRACH according to subclause 8.5.17;

If the variable FALLBACK_R99_PRACH_ENABLED is set from TRUE to FALSE and the variable READY_FOR_COMMON_EDCH is set to TRUE:

- 1> use the Enhanced Uplink in CELL_FACH state and Idle mode as specified in section 8.5.45.

8.5.77 Actions related to READY_FOR_FALLBACK_R99_PRACH variable (FDD only)

The variable READY_FOR_FALLBACK_R99_PRACH shall be set to TRUE only when all the following conditions are met:

- 1> the UE is in CELL_FACH state or in Idle mode;
- 1> the variable READY_FOR_COMMON_EDCH is set to TRUE;
- 1> the IE "Fallback R99 PRACH info" is included in system information block type 22;
- 1> UE supports fallback to R99 PRACH;
- 1> the IE "E-AI Indication" is set to TRUE;

1> for each configured radio bearer:

- 2> if the radio bearer is mapped to CCCH and IE "CCCH Fallback" is set to TRUE; or
- 2> if the radio bearer is mapped to DCCH and IE "DCCH Fallback" is set to TRUE:

 - 3> the RB has a multiplexing option with transport channel type "HS-DSCH" for the DL, and the corresponding MAC-ehs reordering queue is configured, and transport channel type "RACH" for the UL.

- 3> if the radio bearer is mapped to DCCH and IE "DCCH Fallback" is set to TRUE, then for any logical channel(s) corresponding to that radio bearer:
 - 4> the RLC sizes that apply for the logical channel with transport channel type "RACH" for the UL are the same as the RLC sizes that apply for that logical channel with transport channel type "E-DCH" for the UL, as per subclause 8.5.21.

If any of the above conditions is not met and the variable `READY_FOR_FALLBACK_R99_PRACH` is set to TRUE, the UE shall:

- 1> set the variable `READY_FOR_FALLBACK_R99_PRACH` to FALSE;

If variable `READY_FOR_FALLBACK_R99_PRACH` is set to TRUE:

- 1> configure the MAC for CCCH and DCCH fallback according to the IE's "CCCH Fallback" and "DCCH Fallback" respectively.

8.5.78 Actions related to `MIMO_MODE_WITH_FOUR_TRANSMIT_ANTENNAS_PARAMS` variable (FDD only)

If the UE receives an ACTIVE SET UPDATE, CELL UPDATE CONFIRM, or any reconfiguration message:

- 1> if the IE "MIMO mode with four transmit antennas parameters" is not included:
 - 2> clear the `MIMO_MODE_WITH_FOUR_TRANSMIT_ANTENNAS_PARAMS` variable;
 - 2> trigger lower layers to stop operation in MIMO mode with four transmit antennas.
- 1> otherwise:
 - 2> if the IE "MIMO mode with four transmit antennas `N_cqi_typeA/M_cqi` ratio" is included:
 - 3> store the value of the IE "MIMO mode with four transmit antennas `N_cqi_typeA/M_cqi` ratio" in the `MIMO_MODE_WITH_FOUR_TRANSMIT_ANTENNAS_PARAMS` variable.
 - 2> if the IE "MIMO mode with four transmit antennas pilot configuration" is included:
 - 3> store the value of the IE "MIMO mode with four transmit antennas pilot configuration" in the `MIMO_MODE_WITH_FOUR_TRANSMIT_ANTENNAS_PARAMS` variable.

8.5.79 Actions related to `MIMO_MODE_WITH_FOUR_TRANSMIT_ANTENNAS_STATUS` variable (FDD only)

If the UE receives an ACTIVE SET UPDATE, CELL UPDATE CONFIRM, or any reconfiguration message, the UE shall:

- 1> take actions related to the `MIMO_MODE_WITH_FOUR_TRANSMIT_ANTENNAS_PARAMS` variable as specified in subclause 8.5.78;
- 1> determine the value of the `MIMO_MODE_WITH_FOUR_TRANSMIT_ANTENNAS_STATUS` variable.

The MIMO_MODE_WITH_FOUR_TRANSMIT_ANTENNAS_STATUS variable shall be set to TRUE only when all the following conditions are met:

- 1> The UE is in CELL_DCH state;
- 1> the variable HS_DSCH_RECEPTION is set to TRUE;
- 1> the variable MIMO_MODE_WITH_FOUR_TRANSMIT_ANTENNAS_PARAMS contains a value for the IE "MIMO mode with four transmit antennas N_cqi_typeA/M_cqi ratio"; and
- 1> the variable MIMO_MODE_WITH_FOUR_TRANSMIT_ANTENNAS_PARAMS contains a value for the IE "MIMO mode with four transmit antennas pilot configuration".

If any of the above conditions is not met and the MIMO_MODE_WITH_FOUR_TRANSMIT_ANTENNAS_STATUS variable is set to TRUE, the UE shall:

- 1> set the MIMO_MODE_WITH_FOUR_TRANSMIT_ANTENNAS_STATUS variable to FALSE;
- 1> clear the MIMO_MODE_WITH_FOUR_TRANSMIT_ANTENNAS_PARAMS variable;
- 1> trigger lower layers to stop operation in MIMO mode with four transmit antennas on the serving HS-DSCH cell.

If the MIMO_MODE_WITH_FOUR_TRANSMIT_ANTENNAS_STATUS variable is set to FALSE and the variable HS_DSCH_RECEPTION is set to TRUE:

- 1> if prior to receiving an ACTIVE SET UPDATE, CELL UPDATE CONFIRM, or any reconfiguration message, the MIMO_MODE_WITH_FOUR_TRANSMIT_ANTENNAS_STATUS variable was set to TRUE:
 - 2> if the IE "HARQ info" is not included in the received message:
 - 3> the UE behaviour is unspecified.

If the MIMO_MODE_WITH_FOUR_TRANSMIT_ANTENNAS_STATUS variable is set to TRUE:

- 1> if prior to receiving an ACTIVE SET UPDATE, CELL UPDATE CONFIRM, or any reconfiguration message, the MIMO_MODE_WITH_FOUR_TRANSMIT_ANTENNAS_STATUS variable was set to FALSE:
 - 2> if the IE "HARQ info" is not included in the received message:
 - 3> the UE behaviour is unspecified.
- 1> when MIMO mode with four transmit antennas is configured:
 - 2> if MAC-ehs is not configured:
 - 3> the UE behaviour is undefined.

8.5.80 Actions related to SECONDARY_CELL_MIMO_MODE_WITH_FOUR_TRANSMIT_ANTENNAS_STATUS variable (FDD only)

If the UE receives an ACTIVE SET UPDATE, CELL UPDATE CONFIRM, or any reconfiguration message which includes the IE "Downlink secondary cell info FDD" for any of the secondary serving HS-DSCH cells, the UE shall:

- 1> if the IE "Secondary cell MIMO mode with four transmit antennas parameters" is not included in the IE "Downlink secondary cell info FDD":
 - 2> clear the corresponding entry in the SECONDARY_CELL_MIMO_MODE_WITH_FOUR_TRANSMIT_ANTENNAS_PARAMS variable;
- 1> if the CHOICE "Configuration Info" in the IE "Secondary cell MIMO mode with four transmit antennas parameters" has the value "Continue":
 - 2> continue using the stored parameters in the corresponding entry in the SECONDARY_CELL_MIMO_MODE_WITH_FOUR_TRANSMIT_ANTENNAS_PARAMS variable;

- 1> otherwise:
 - 2> if the IE "MIMO mode with four transmit antennas N_cqi_typeA/M_cqi ratio" is included:
 - 3> store the value of the IE "MIMO mode with four transmit antennas N_cqi_typeA/M_cqi ratio" in the corresponding entry in the SECONDARY_CELL_MIMO_MODE_WITH_FOUR_TRANSMIT_ANTENNAS_PARAMS variable.
 - 2> if the IE "MIMO mode with four transmit antennas pilot configuration" is included:
 - 3> store the value of the IE "MIMO mode with four transmit antennas pilot configuration" in the corresponding entry in the SECONDARY_CELL_MIMO_MODE_WITH_FOUR_TRANSMIT_ANTENNAS_PARAMS variable.
- 1> determine the value of the SECONDARY_CELL_MIMO_MODE_WITH_FOUR_TRANSMIT_ANTENNAS_STATUS variable for the corresponding secondary serving HS-DSCH cell.

The SECONDARY_CELL_MIMO_MODE_WITH_FOUR_TRANSMIT_ANTENNAS_STATUS variable shall be set to TRUE for a secondary serving HS-DSCH cell only when all the following conditions are met:

- 1> The UE is in CELL_DCH state;
- 1> the corresponding entry in the variable SECONDARY_CELL_HS_DSCH_RECEPTION is set to TRUE for that secondary serving HS-DSCH cell;
- 1> the corresponding entry in the variable SECONDARY_CELL_MIMO_MODE_WITH_FOUR_TRANSMIT_ANTENNAS_PARAMS contains a value for the IE "MIMO mode with four transmit antennas N_cqi_typeA/M_cqi ratio"; and
- 1> the corresponding entry in the variable SECONDARY_CELL_MIMO_MODE_WITH_FOUR_TRANSMIT_ANTENNAS_PARAMS contains a value for the IE "MIMO mode with four transmit antennas pilot configuration".

If any of the above conditions is not met and the SECONDARY_CELL_MIMO_MODE_WITH_FOUR_TRANSMIT_ANTENNAS_STATUS variable is set to TRUE for that secondary serving HS-DSCH cell, the UE shall:

- 1> set the entry in the SECONDARY_CELL_MIMO_MODE_WITH_FOUR_TRANSMIT_ANTENNAS_STATUS variable corresponding to that secondary serving HS-DSCH cell to FALSE;
- 1> clear the entry in the the SECONDARY_CELL_MIMO_MODE_WITH_FOUR_TRANSMIT_ANTENNAS_PARAMS variable corresponding to that secondary serving HS-DSCH cell;
- 1> trigger lower layers to stop MIMO mode with four transmit antennas operation on that secondary serving HS-DSCH cell.
- 1> when MIMO mode with four transmit antennas is configured:
 - 2> if MAC-ehs is not configured:
 - 3> the UE behaviour is undefined.

Whenever the entry in the variable SECONDARY_CELL_MIMO_MODE_WITH_FOUR_TRANSMIT_ANTENNAS_STATUS is set to TRUE for a secondary serving HS-DSCH cell, the UE shall:

- 1> if the UE supports MIMO mode with four transmit antennas only with dual stream restriction:
 - 2> indicate to lower layers to start operation in MIMO mode with four transmit antennas restricted to dual stream transmission on that secondary serving HS-DSCH cell, using the parameter values stored in the corresponding entry in the variable SECONDARY_CELL_MIMO_MODE_WITH_FOUR_TRANSMIT_ANTENNAS_PARAMS.

1> else:

2> indicate to lower layers to start operation in MIMO mode with four transmit antennas on that secondary serving HS-DSCH cell, using the parameter values stored in the corresponding entry in the variable SECONDARY_CELL_MIMO_MODE_WITH_FOUR_TRANSMIT_ANTENNAS_PARAMS.

1> when MIMO mode with four transmit antennas only with dual stream restriction is configured:

2> if MAC-ehs is not configured:

3> the UE behaviour is undefined.

8.5.81 Actions related to UPLINK_MIMO_TRANSMISSION variable (FDD only)

The variable UPLINK_MIMO_TRANSMISSION shall be set to TRUE only when all the following conditions are met:

1> the UE is in CELL_DCH state;

1> the variable UPLINK_CLTD_TRANSMISSION is set to TRUE;

1> the variable HS_DSCH_RECEPTION is set to TRUE;

1> the variable E-DCH transmission is set to TRUE;

1> the UE has stored IE "Uplink MIMO info FDD";

1> the UE has stored IE "E-ROCH info FDD";

1> the UE has stored "E-TFC Boost Info";

1> the UE is configured with MAC-i/is.

If any of the above conditions is not met and the variable UPLINK_MIMO_TRANSMISSION is set to TRUE, the UE shall:

1> set the variable UPLINK_MIMO_TRANSMISSION to FALSE;

1> indicate to lower layers to stop the uplink MIMO transmission;

1> do not configure "TSN field extension" for the MAC-i/is entity;

1> reset the MAC-i/is entity;

1> clear the stored IE "Uplink MIMO info FDD";

1> if configured, clear the stored E-HICH configuration for the secondary stream.

If all of the above conditions are met and the variable UPLINK_MIMO_TRANSMISSION is set to FALSE, the UE shall:

1> set the variable UPLINK_MIMO_TRANSMISSION to TRUE;

1> reset MAC-i/is entity;

1> configure "TSN field extension" for MAC-i/is entity;

1> indicate to lower layers to start the uplink MIMO transmission in rank1.

Whenever the variable UPLINK_MIMO_TRANSMISSION is set to FALSE, the UE shall:

1> stop the uplink MIMO transmission.

If the variable UPLINK_MIMO_TRANSMISSION is set to TRUE and the serving HS-DSCH cell was changed as a result of the received message or HS-SCCH order from the target cell, the UE shall instruct the physical layer to switch to the uplink MIMO transmission in rank1.

8.5.82 Actions related to NON_RECTANGULAR_RESOURCE_ALLOCATION_STATUS variable (1.28 Mcps TDD only)

The NON_RECTANGULAR_RESOURCE_ALLOCATION_STATUS variable shall be set to TRUE only when all the following conditions are met:

- 1> the IE "Non-rectangular resource allocation indicator" is present;
- 1> the UE is in CELL_DCH state;
- 1> the variable HS_DSCH_RECEPTION or E_DCH_TRANSMISSION is set to TRUE;

If any of the above conditions is not met and the NON_RECTANGULAR_RESOURCE_ALLOCATION_STATUS variable is set to TRUE, the UE shall:

- 1> set the NON_RECTANGULAR_RESOURCE_ALLOCATION_STATUS variable to FALSE;
- 1> trigger lower layers to stop operation in non-rectangular resource allocation mode.

Whenever the variable NON_RECTANGULAR_RESOURCE_ALLOCATION_STATUS is set to TRUE, the UE shall:

- 1> trigger lower layers to start operation in non-rectangular resource allocation mode.

8.5.83 Actions related to DPCCH2_TRANSMISSION variable (FDD only)

The DPCCH2_TRANSMISSION variable shall be set to TRUE only when all the following conditions are met:

- 1> the UE is in CELL_DCH state;
- 1> the UE has stored IE "DPCCH2 info FDD";
- 1> the variable HS_DSCH_RECEPTION is set to TRUE.

If any of the above conditions is not met and the DPCCH2_TRANSMISSION variable is set to TRUE, the UE shall:

- 1> set the DPCCH2_TRANSMISSION variable to FALSE;
- 1> trigger lower layers to stop DPCCH2 transmission;
- 1> clear the stored IE "DPCCH2 info FDD".

If all of the above conditions are met and the variable DPCCH2_TRANSMISSION is set to FALSE, the UE shall:

- 1> set the variable DPCCH2_TRANSMISSION to TRUE;
- 1> trigger lower layers to perform DPCCH2 transmission.

Whenever the variable DPCCH2_TRANSMISSION is set to TRUE, the UE shall:

- 1> trigger lower layers to perform DPCCH2 transmission.

Whenever the variable DPCCH2_TRANSMISSION is set to FALSE, the UE shall:

- 1> not perform DPCCH2 transmission.

8.5.84 Actions related to DCH_ENHANCEMENTS_STATUS variable (FDD only)

If the UE receives an ACTIVE SET UPDATE, CELL UPDATE CONFIRM, or any reconfiguration message, the UE shall:

- 1> take actions related to the IE "DCH Enhancements info FDD" as specified in subclause 8.6.6.64;

1> determine the value of the DCH_ENHANCEMENTS_STATUS variable.

The DCH_ENHANCEMENTS_STATUS variable shall be set to TRUE only when all the following conditions are met:

- 1> the UE is in CELL_DCH state;
- 1> the UE supports DCH Enhancements;
- 1> the UE has stored IE "DCH Enhancements info FDD".

If any of the above conditions is not met and the DCH_ENHANCEMENTS_STATUS variable is set to TRUE, the UE shall:

- 1> set the DCH_ENHANCEMENTS_STATUS variable to FALSE;
- 1> trigger the lower layers to stop operation with DCH Enhancements.

Whenever the variable DCH_ENHANCEMENTS_STATUS is set to TRUE, the UE shall:

- 1> if the UE indicates basic support for DCH Enhancements and choice "DL FET Mode" is set to Full; or
- 1> if the IE "Power offset $P_{TPC-DPDCH}$ " is not included for any one or more of the radio links in the active set; or
- 1> if the IE "Power offset PO_{SRB} " is not included for any one or more of the radio links in the active set; or
- 1> if the IE "Number of bits for Pilot bits" is not set to 0; or
- 1> if the variables HS_DSCH RECEPTION or E_DCH_TRANSMISSION are set to TRUE, the variable DTX_DRX_STATUS is set to FALSE, and DL FET Basic mode is indicated in the IE "DL FET Mode"; or
- 1> if the variables HS_DSCH RECEPTION or E_DCH_TRANSMISSION are set to TRUE, the variable DTX_DRX_STATUS is set to FALSE, and DL FET Full mode is indicated in the IE "DL FET Mode" with choice "UL Transmission Mode" not set to 20ms ; or
- 1> if "UL Transmission Mode" is configured as "10ms only" and the IE "Power offset Information 10ms Mode" is not included for each CTFC in the received message; or
- 1> if "UL Transmission Mode" is configured as "10ms only" and the "Power offset Information 10ms Mode" configuration is not available for each CTFC in the current TFCS; or
- 1> if "UL Transmission Mode" is configured as "10ms or 20ms" and the IE "Power offset Information 10ms Mode" is not available for at least one CTFC in the received message; or
- 1> if "UL Transmission Mode" is configured as "10ms or 20ms" and the IE "Power offset Information 10ms Mode" configuration is not available for at least one CTFC in the current TFCS:
 - 2> set the variable INVALID_CONFIGURATION to TRUE.
- 1> else:
 - 2> trigger the lower layers to operate with DCH Enhancements in DL FET Basic mode or DL FET Full mode as indicated in the IE "DL FET Mode".

Whenever the variable DCH_ENHANCEMENTS_STATUS is set to FALSE, the UE shall:

- 1> if the IE "Number of bits for Pilot bits" is set to 0:
 - 2> if the UE is in CELL_DCH state:
 - 3> set the variable INVALID_CONFIGURATION to TRUE.

8.5.85 Actions related to IMPLICIT_GRANT variable (FDD only)

The variable IMPLICIT_GRANT shall be set to TRUE only when the following conditions are met:

- 1> the UE is in CELL_DCH state;

1> the variable SECONDARY_CELL_E_DCH_TRANSMISSION is set to TRUE;

1> the IE "Implicit Grant handling" is included in the IE "Uplink Secondary Cell Info FDD" and is set to TRUE: or

1> the IE "Uplink Secondary Cell Info FDD" is included in received message with the CHOICE "Configuration info" set to "Continue" and the variable IMPLICIT_GRANT is set to TRUE.

If the above conditions are not met and the variable IMPLICIT_GRANT is set to TRUE, the UE shall:

1> set the variable IMPLICIT_GRANT to FALSE;

1> configure the MAC layer to stop using Implicit Grant handling on the secondary UL frequency.

If all of the above conditions are met and the variable IMPLICIT_GRANT is set to FALSE, the UE shall:

1> set the variable IMPLICIT_GRANT to TRUE;

1> configure the MAC layer to use Implicit Grant handling on the secondary UL frequency.

8.5.86 Actions related to reception of a HS-SCCH order for TTI switching (FDD only)

If the UE receives a TTI switch HS-SCCH Order, the UE shall:

1> calculate the activation time T, by adding the value of the IE "Activation delay" in the variable OTHER_TTI_EDCH_CONFIGURATION to the CFN as specified in [29];

1> at the activation time T:

2> if the current configured TTI length is 2ms TTI:

3> release the physical channel configuration for 2ms TTI which was present before T;

3> apply the physical channel configuration for 10ms TTI as specified for the information elements in the IE "10ms TTI Configuration Information" in the variable OTHER_TTI_EDCH_CONFIGURATION, respecting the requirement in [29].

2> else:

3> release the physical channel configuration for 10ms TTI, which was present before T;

3> apply the physical channel configuration for 2ms TTI as specified for the information elements in the IE "2ms TTI Configuration Information" in the variable OTHER_TTI_EDCH_CONFIGURATION, respecting the requirement in [29].

2> set the variable ORDERED_RECONFIGURATION to FALSE.

8.6 Generic actions on receipt and absence of an information element

8.6.1 CN information elements

8.6.1.1 Void

8.6.1.2 CN information info

If the IE "CN information info" is present in a message, the UE shall:

1> if the IE "Primary PLMN Identity" is present:

- 2> forward the content of the IE "Primary PLMN identity" to upper layers.
- 1> else:
 - 2> if the IE "PLMN Identity" is present:
 - 3> forward the content of the IE "PLMN identity" to upper layers.
 - 1> if present, forward the content of the IE "CN common GSM-MAP NAS system information" to upper layers;
 - 1> if the IE "CN domain related information" is present:
 - 2> forward each occurrence of the IE "CN domain specific GSM-MAP NAS system info" together with the IE "CN domain identity" to upper layers.
 - 2> if an IE "CN domain specific GSM-MAP NAS system info" is not present for a particular CN domain:
 - 3> indicate to upper layers that no CN system information is available for that CN domain.

NOTE: If UTRAN at SRNS relocation includes and sets the IE "Primary PLMN identity" to the PLMN identity signalled in RANAP RELOCATION REQUEST [57], the UTRAN should also set the IE "PLMN identity" to the PLMN identity in the IE "PLMN Identity" of the Master Information Block transmitted in the cell(s) used by the UE after completed SRNS relocation.

8.6.1.3 Signalling connection release indication

If the IE "Signalling Connection release indication" is present in a message, the UE shall:

- 1> if all radio access bearers for the CN domain identified with the value of the IE "Signalling Connection release indication" would have been released in the variable ESTABLISHED_RABS after processing of the received message:
 - 2> indicate release of the signalling connection identified with the value of the IE "Signalling Connection release indication" to the upper layers;
 - 2> remove the signalling connection identified with the value of the IE "Signalling Connection release indication" from the variable ESTABLISHED_SIGNALLING_CONNECTIONS.
- 1> if radio access bearers for the CN domain identified with the value of the IE "Signalling Connection release indication" would remain in the variable ESTABLISHED_RABS after processing of the received message:
 - 2> set the variable INVALID_CONFIGURATION to TRUE.

8.6.2 UTRAN mobility information elements

8.6.2.1 URA identity

The UE shall:

- 1> if the IE "URA identity" is included in a received message:
 - 2> if the IE "RRC State Indicator" is included and set to "URA_PCH":
 - 3> store this URA identity in the variable URA_IDENTITY;
 - 3> after sending a possible message to UTRAN and entering URA_PCH state as specified elsewhere, read system information block type 2 in the selected cell;
 - 3> if the stored URA identity in the variable URA_IDENTITY is not included in the list of URA identities in System Information Block type 2 in the selected cell, the list of URA identities in system information block type 2 is empty or if the system information block type 2 can not be found, a confirmation error of URA identity list has occurred:
 - 4> if no URA update procedure is ongoing:

- 5> initiate a URA update procedure after entering URA_PCH state; see subclause 8.3.1.2.
- 4> if a URA update procedure is ongoing:
 - 5> take actions as specified in subclause 8.3.1.10.
- 1> if the IE "URA identity" is not included in a received message:
 - 2> if the IE "RRC State Indicator" is included and set to " URA_PCH":
 - 3> after sending a possible message to UTRAN and entering URA_PCH state as specified elsewhere, read System Information Block type 2 in the selected cell;
 - 3> if System Information Block type 2 in the selected cell contains a single URA identity:
 - 4> store this URA identity in the variable URA_IDENTITY.
 - 3> if System Information Block type 2 of the selected cell contains more than one URA identity, the list of URA identities in system information block type 2 is empty or if the system information block type 2 can not be found, a confirmation error of URA identity list has occurred:
 - 4> if no URA update procedure is ongoing:
 - 5> initiate a URA update procedure after entering URA_PCH state, see subclause 8.3.1.2.
 - 4> if a URA update procedure is ongoing:
 - 5> take actions as specified in subclause 8.3.1.10.

8.6.2.2 Mapping info

For FDD, 3.84 Mcps TDD and 7.68 Mcps TDD, if the IE "Mapping info" is received, the UE shall in this version of the specification:

- 1> ignore the contents of this IE.

For 1.28 Mcps TDD, if the IE "Mapping info" is received, the UE shall:

- 1> if the IE "Map parameter 1" is included, interpret the IE "Map parameter 1" as IE "UpPCH Position Info":
 - 2> store and use the UpPCH position indicated by the IE "UpPCH Position Info". The calculation of the uplink access position is described in [33].
- 1> if the IE "Map parameter 1" is not included:
 - 2> use the UpPTS as the default UpPCH position.
- 1> ignore other contents of the IE "Mapping info".

8.6.2.3 RNC support for change of UE capability

The UE shall:

- 1> if the IE "RNC support for change of UE capability" is included in a received message:
 - 2> set the variable RNC_CAPABILITY_CHANGE_SUPPORT to the value of the IE "RNC support for change of UE capability".

8.6.2.4 CSG PSC Split Information

The UE shall:

- 1> if the IE "CSG PSC Split Information" is included in a received message:
 - 2> consider the CSG PSC split information received on this cell to be valid for:

- 3> the UARFCN of the carrier on which it was received;
- 3> any cell not referenced in SIB18, or when SIB18 is not broadcast, while the cell the UE is camped on has a PLMN which is the same as the PLMN of the cell where the CSG PSC split information was received;
- 3> any cell referenced in SIB18 that has the same PLMN as the PLMN of the cell in which the CSG PSC split information was received;
- 3> while UE is not in Any Cell Selection state [4];
- 3> 24 hours from the time it was received.

NOTE 1: If the IE "CSG PSC Split Information" is received in both SIB3 and SIB11bis in the same cell then UE behaviour is unspecified.

NOTE 2: The PLMN of a cell in the above paragraph is the PLMN in IE 'PLMN identity' of that cell.

NOTE 3: The 6 hour validity restriction (section 8.1.1.6) does not apply to this field.

8.6.2.5 E-UTRA detection

If the IE "E-UTRA detection" is included in a received message and set to TRUE and the UE is in CELL_PCH, URA_PCH state or idle mode, the UE may detect the presence of a E-UTRA cell on a frequency with a priority lower than the current UTRA cell and report the information to the NAS.

8.6.3 UE information elements

8.6.3.1 Activation time

If the UE receives a message in which presence is needed for the IE "Activation time", and the value is other than the default value "Now", the UE shall:

- 1> let the "reference CCTrCH" be defined as the CCTrCh that includes any transport channel or is associated with any physical channel which is being added, re-configured or removed, or, in the case of HS-DSCH, the CCTrCh including the associated DCH;
- 1> if the frame boundary immediately before the frame with the CFN (Connection Frame Number) value indicated by the IE "Activation Time" is at the TTI boundary common to all the transport channels that are multiplexed onto the reference CCTrCh:
 - 2> select that frame boundary as the activation time T.
- 1> else:
 - 2> select the next TTI boundary, which is common to all the transport channels that are multiplexed onto the reference CCTrCh, after the frame with the CFN (Connection Frame Number) value indicated by the IE "Activation Time", as the activation time T.
- 1> if the IE "Delay restriction flag" is received and activation time T is more than 128 frames from the CFN at which the message was received:
 - 2> choose an activation time T as soon as possible after reception of the message, respecting the performance requirements in subclause 13.5, which is common to all the transport channels that are multiplexed onto the reference CCTrCh.

NOTE: If the UE receives a message containing the IE "Delay restriction flag" and that message causes a transport channel or physical channel reconfiguration of the reference CCTrCH then the UE behaviour is not specified.

1> at the activation time T:

- 2> for a physical channel reconfiguration other than an HS-DSCH related reconfiguration, caused by the received message:

- 3> release the physical channel configuration, which was present before T;
- 3> initiate the establishment of the physical channel configuration as specified for the physical channel information elements in the received message as specified elsewhere.
- 2> for an HS-DSCH related reconfiguration in FDD or 1.28 Mcps TDD caused by the received message:
 - 3> select the HS-SCCH subframe boundary immediately before the first HS-SCCH subframe, which entirely falls within the 10 ms frame following T;
 - 3> start using, at that HS-SCCH subframe boundary, the new HS-DSCH configuration in the received message, replacing any old HS-DSCH configuration.
- 2> for an HS-DSCH related reconfiguration in 3.84 Mcps TDD or 7.68 Mcps TDD caused by the received message:
 - 3> start using, at activation time T, the new HS-DSCH configuration in the received message, replacing any old HS-DSCH configuration.
- 2> for actions, other than a physical channel reconfiguration, caused by the received message:
 - 3> perform the actions for the information elements in the received message as specified elsewhere.

NOTE: In FDD an "HS-DSCH related reconfiguration" includes, in particular, reconfigurations that need to be time-aligned with the 2ms subframe of the HS-SCCH, HS-PDSCH and/or HS-DPCCH. For example, start and stop of HS-SCCH reception and serving HS-DSCH cell change.

If the UE receives a message in which presence is needed for the IE "Activation time", and the value is the default value "Now", the UE shall:

- 1> choose an activation time T as soon as possible after the reception of the message, respecting the performance requirements in subclause 13.5;
- 1> at the activation time T:
 - 2> perform the actions for the information elements in the received message as specified elsewhere.

NOTE: In FDD, if the UE was in idle mode or CELL_FACH or CELL_PCH state upon reception of the message, regardless of the state the UE enters after reception of the message, and the value of the IE "Activation time" in the received message is different from "Now", the UE behaviour is unspecified. In TDD, if the UE was in idle mode or CELL_FACH state upon reception of the message, the value of the IE "Activation time" in the received message is relative to the CFN associated with the cell from which the message was received.

8.6.3.1a CN domain specific DRX cycle length coefficient

The UE updates CN domain specific DRX cycle length coefficient as specified in [4]. The UE shall use it to calculate the CN domain specific DRX cycle length, according to the following:

- 1> set k to the value of the IE "CN domain specific DRX cycle length coefficient".
- 1> store the result of $\text{MAX}(2^k, \text{PBP})$, where PBP is the Paging Block Periodicity, as the CN domain specific DRX cycle length for the CN domain indicated by the IE "CN domain identity". For FDD PBP=1.

The UE shall determine its idle mode paging occasions and PICH monitoring occasions for that CN domain, according to [4], based on the stored CN domain specific DRX cycle length, when using DRX in idle mode.

8.6.3.1b H-RNTI

If an IE "New H-RNTI" is included and the UE will be in CELL_DCH state after completion of this procedure, the UE shall:

- 1> if the IE "New H-RNTI" is received in a UTRAN MOBILITY INFORMATION message
- 2> the UE behaviour is unspecified.

1> store the value in the variable H_RNTI;

1> determine the value for the HS_DSCH_RECEPTION variable and take the corresponding actions as described in subclause 8.5.25;

1> determine the value for the SECONDARY_CELL_HS_DSCH_RECEPTION variable and take the corresponding actions as described in subclause 8.5.51.

If the message that triggers the HS_DSCH_RECEPTION variable to change value from FALSE to TRUE does not contain the IE "New H-RNTI"; and

if, before receiving that message, the UE is not in CELL_FACH or CELL_PCH state or the variable H_RNTI is not set:

1> the UE behaviour is not defined.

When the variable HS_DSCH_RECEPTION is set to TRUE the UE shall:

1> use the value of the variable H_RNTI as UE identity in the HS-SCCH reception procedure in the physical layer.

In FDD and 1.28 Mcps TDD, if the IE "New H-RNTI" is included and the UE will be in CELL_FACH state after completion of this procedure, the UE shall:

1> store the value in the variable H_RNTI;

1> determine the value for the HS_DSCH_RECEPTION_CELL_FACH_STATE variable and take the corresponding actions as described in subclause 8.5.36.

1> for 1.28 Mcps TDD, If the IE "Treset Usage Indicator" has been stored:

2> stop using all configured Treset timer [15].

When the variable HS_DSCH_RECEPTION_CELL_FACH_STATE is set to TRUE the UE shall:

1> use the value of the variable H_RNTI as UE identity in the HS-SCCH reception procedure in the physical layer.

When an entry in the variable SECONDARY_CELL_HS_DSCH_RECEPTION is set to TRUE the UE shall:

1> use the value of the variable H_RNTI associated with the corresponding secondary serving HS-DSCH cell as UE identity in the HS-SCCH reception procedure in the physical layer on that cell.

In FDD and 1.28 Mcps TDD, if the IE "New H-RNTI" is included and the UE will be in CELL_PCH state after completion of this procedure, the UE shall:

1> store the value in the variable H_RNTI.

1> for 1.28 Mcps TDD, If the IE "Treset Usage Indicator" has been stored:

2> stop using all configured Treset timer [15].

8.6.3.2 UTRAN DRX Cycle length coefficient

If the IE "UTRAN DRX cycle length coefficient" is present, the UE shall use it to calculate the UTRAN DRX cycle length, according to the following:

1> start timer T319 using the IE "Time for DRX cycle 2" value;

1> store IE "DRX cycle length coefficient";

1> set k to the value of the IE "DRX cycle length coefficient 2";

1> store the result of $\text{MAX}(2^k \cdot \text{PBP})$, where PBP is the Paging Block Periodicity, as the DRX cycle length.

The UE shall determine its connected mode paging occasions and PICH monitoring occasions in the same way as for idle mode, according to [4].

The DRX cycle length to use in connected mode is defined in [4].

8.6.3.3 Generic state transition rules depending on received information elements

The IE "RRC State Indicator" indicates the state the UE shall enter. The UE shall enter the state indicated by the IE "RRC State Indicator" even if the received message includes other IEs relevant only for states other than indicated by the IE "RRC State Indicator". E.g. if the RRC state indicator is set to CELL_FACH while other IEs provide information about a configuration including dedicated channels, the UE shall enter CELL_FACH state. If however the UE has no information about the configuration corresponding to the state indicated by the IE "RRC State Indicator", it shall consider the requested configuration as invalid.

The UE shall, if the IE "RRC State Indicator" in the received message has the value:

1> "CELL_FACH":

2> enter CELL_FACH state as dictated by the procedure governing the message received.

1> "CELL_DCH":

2> if neither DPCH is assigned in the message nor is the UE in CELL_DCH:

3> set the variable INVALID_CONFIGURATION to TRUE.

2> else:

3> enter CELL_DCH state as dictated by the procedure governing the message received.

1> "CELL_PCH":

2> if the received message is RRC CONNECTION SETUP and IE "RRC State Indicator" is set to CELL_PCH:

3> set the variable INVALID_CONFIGURATION to TRUE.

2> else:

3> enter CELL_PCH state as dictated by the procedure governing the message received.

1> "URA_PCH":

2> if the received message is RRC CONNECTION SETUP and IE "RRC State Indicator" is set to URA_PCH:

3> set the variable INVALID_CONFIGURATION to TRUE.

2> else:

3> enter URA_PCH state as dictated by the procedure governing the message received.

8.6.3.4 Ciphering mode info

The IE "Ciphering mode info" defines the new ciphering configuration. At any given time, the UE needs to store at most two different ciphering configurations (keyset and algorithm) per CN domain at any given time in total for all radio bearers and three configurations in total for all signalling radio bearers.

If the IE "Ciphering mode info" is present and if the IE "Reconfiguration" in the variable CIPHERING_STATUS is set to TRUE, the UE shall:

1> ignore this second attempt to change the ciphering configuration; and

1> set the variable INCOMPATIBLE_SECURITY_RECONFIGURATION to TRUE.

If the IE "Ciphering mode info" is present and if the IE "Reconfiguration" in the variable CIPHERING_STATUS is set to FALSE, the UE shall:

1> if none of the IE "Status" in the variable CIPHERING STATUS has the value "Started", and this IE "Ciphering mode info" was included in a message that is not the message SECURITY MODE COMMAND or this IE "Ciphering mode info" was included in a message that doesn't include the IE "SR-VCC Info"; or

1> if the IE "Ciphering Mode Info" was received in the message SECURITY MODE COMMAND and there does not exist exactly one ciphering activation time in the IE "Radio bearer downlink ciphering activation time info"

for each established RLC-AM and RLC-UM radio bearers included in the IE "RB information" in the IE "ESTABLISHED_RABS" for the CN domain as indicated in the variable LATEST_CONFIGURED_CN_DOMAIN; or

- 1> if the IE "Ciphering Mode Info" was received in the message SECURITY MODE COMMAND and the IE "Ciphering activation time for DPCH" is not included in the message, and there exist radio bearers using RLC-TM according to the IE "RB information" in the IE "ESTABLISHED_RABS" for the CN domain as indicated in the variable LATEST_CONFIGURED_CN_DOMAIN; or
- 1> if the IE "Ciphering Mode Info" was received in the message SECURITY MODE COMMAND and there does not exist exactly one ciphering activation time in the IE "Radio bearer downlink ciphering activation time info" for each established signalling radio bearer included in the IE "Signalling radio bearer information" in the IE "ESTABLISHED_RABS":
 - 2> ignore this attempt to change the ciphering configuration;
 - 2> set the variable INVALID_CONFIGURATION to TRUE;
 - 2> perform the actions as specified in subclause 8.1.12.4c.
- 1> set the IE "Reconfiguration" in the variable CIPHERING_STATUS to TRUE;
- 1> set the IE "Status" in the variable CIPHERING_STATUS of the CN domains for which the IE "Status" of the variable SECURITY_MODIFICATION is set to "Affected" to "Started";
- 1> apply the new ciphering configuration in the lower layers for all RBs that belong to a CN domain for which the IE "Status" of the variable SECURITY_MODIFICATION is set to "Affected" and all signalling radio bearers:
 - 2> using the ciphering algorithm (UEA [40]) indicated by the IE "Ciphering algorithm" as part of the new ciphering configuration;
 - 2> for each radio bearer that belongs to a CN domain for which the IE "Status" of the variable SECURITY_MODIFICATION is set to "Affected" and all signalling radio bearers:
 - 3> using the value of the IE "RB identity" in the variable ESTABLISHED_RABS minus one as the value of BEARER [40] in the ciphering algorithm.
- 1> for the downlink and the uplink, apply the new ciphering configuration as follows:
 - 2> if the ciphering configuration for a AM or UM radio bearer or signalling radio bearer from a previously received SECURITY MODE COMMAND has not yet been applied because of the corresponding activation times not having been reached and the current received message includes the IE "DL Counter Synch Info" or the current received message is a RADIO BEARER RECONFIGURATION message and includes the IE "New U-RNTI":
 - 3> if the previous SECURITY MODE COMMAND was received due to new keys being received:
 - 4> consider the new ciphering configuration to include the received new keys.
 - 3> else if the previous SECURITY MODE COMMAND caused a change in LATEST_CONFIGURED_CN_DOMAIN:
 - 4> consider the new ciphering configuration to include the keys associated with the LATEST_CONFIGURED_CN_DOMAIN.
 - 3> apply the new ciphering configuration in uplink and downlink immediately following RLC re-establishment.
- 2> if the IE "Ciphering activation time for DPCH" is present in the IE "Ciphering mode info" and the UE was in CELL_DCH state prior to this procedure:
 - 3> for radio bearers using RLC-TM:
 - 4> apply the old ciphering configuration for CFN less than the number indicated in the IE "Ciphering activation time for DPCH";

4> apply the new ciphering configuration for CFN greater than or equal to the number indicated in IE "Ciphering activation time for DPCH".

2> if the IE "Radio bearer downlink ciphering activation time info" is present:

3> apply the following procedure for each radio bearer and signalling radio bearers using RLC-AM or RLC-UM indicated by the IE "RB identity":

4> suspend uplink transmission on the radio bearer or the signalling radio bearer (except for the SRB where the response message is transmitted) according to the following:

5> do not transmit RLC PDUs with sequence number greater than or equal to the uplink activation time, where the uplink activation time is selected according to the rules below.

4> select an "RLC sequence number" at which (activation) time the new ciphering configuration shall be applied in uplink for that radio bearer according to the following:

5> consider a ciphering activation time in uplink to be pending until the RLC sequence number of the next RLC PDU to be transmitted for the first time is equal to or larger than the selected activation time;

5> for each radio bearer and signalling radio bearer that has no pending ciphering activation time in uplink as set by a previous procedure changing the security configuration:

6> set a suitable value that would ensure a minimised delay in the change to the latest ciphering configuration.

5> for each radio bearer and signalling radio bearer that has a pending ciphering activation time in uplink as set by a previous procedure changing the security configuration:

6> for radio bearers and signalling radio bearers except SRB2:

7> set the same value as the pending ciphering activation time.

6> for signalling radio bearer SRB2:

7> set a suitable value that would ensure a minimised delay in the change to the latest ciphering configuration.

4> store the selected "RLC sequence number" for that radio bearer in the entry for the radio bearer in the variable RB_UPLINK_CIPHERING_ACTIVATION_TIME_INFO;

4> switch to the new ciphering configuration according to the following:

5> use the old ciphering configuration for the transmitted and received RLC PDUs with RLC sequence numbers smaller than the corresponding RLC sequence numbers indicated in the IE "Radio bearer uplink ciphering activation time info" sent to UTRAN and in the received IE "Radio bearer downlink ciphering activation time info" received from UTRAN, respectively;

5> use the new ciphering configuration for the transmitted and received RLC PDUs with RLC sequence numbers greater than or equal to the corresponding RLC sequence numbers indicated in the IE "Radio bearer uplink ciphering activation time info" sent to UTRAN and in the received IE "Radio bearer downlink ciphering activation time info" received from UTRAN, respectively;

5> for a radio bearer using RLC-AM, when the RLC sequence number indicated in the IE "Radio bearer downlink ciphering activation time info" falls below the RLC receiving window and the RLC sequence number indicated in the IE "Radio bearer uplink ciphering activation time info" falls below the RLC transmission window, the UE may release the old ciphering configuration for that radio bearer;

5> if an RLC reset or re-establishment of the transmitting side of an RLC entity occurs before the activation time for the new ciphering configuration has been reached in uplink, ignore the activation time and apply the new ciphering configuration in uplink immediately after the RLC reset or RLC re-establishment;

- 5> if an RLC reset or re-establishment of the receiving side of an RLC entity occurs before the activation time for the new ciphering configuration has been reached in downlink, ignore the activation time and apply the new ciphering configuration in downlink immediately after the RLC reset or RLC re-establishment.
- 2> if the current received message includes the IE "Downlink counter synchronisation info" or the current received message is a RADIO BEARER RECONFIGURATION message and includes the IE "New U-RNTI"; or
- 2> if the current received message includes the IE "SR-VCC Info":
 - 3> apply the new ciphering configuration in uplink and downlink immediately following RLC re-establishment.

If the IE "Radio bearer downlink ciphering activation time info" was received in another message than SECURITY MODE COMMAND:

- 1> the UE behaviour is unspecified.

If the IE "Ciphering mode info" is not present, the UE shall:

- 1> for the downlink and the uplink, apply the ciphering configuration as follows:
 - 2> if the ciphering configuration for a AM or UM radio bearer or signalling radio bearer from a previously received SECURITY MODE COMMAND has not yet been applied because of the corresponding activation times not having been reached and the current received message includes the IE "Downlink counter synchronisation info" or the current received message is a RADIO BEARER RECONFIGURATION message and includes the IE "New U-RNTI" or the current received message triggering SR-VCC:
 - 3> if the previous SECURITY MODE COMMAND was received due to new keys being received:
 - 4> consider the ciphering configuration to include the received new keys.
 - 3> else if the previous SECURITY MODE COMMAND caused a change in LATEST_CONFIGURED_CN_DOMAIN:
 - 4> consider the ciphering configuration to include the keys associated with the LATEST_CONFIGURED_CN_DOMAIN.
 - 3> apply the ciphering configuration in uplink and downlink immediately following RLC re-establishment.
 - 2> else:
 - 3> not change the ciphering configuration.

8.6.3.5 Integrity protection mode info

The IE "Integrity protection mode info" defines the new integrity protection configuration. At any given time, the UE needs to store at most three different integrity protection configurations (keysets) in total for all signalling radio bearers for all CN domains.

If the IE "Integrity protection mode info" is present and if the IE "Reconfiguration" in the variable INTEGRITY_PROTECTION_INFO is set to TRUE, the UE shall:

- 1> ignore this second attempt to change the integrity protection configuration; and
- 1> set the variable INCOMPATIBLE_SECURITY_RECONFIGURATION to TRUE.

If the IE "Integrity protection mode command" has the value "Start", the IE "Status" in the variable INTEGRITY_PROTECTION_INFO has the value "Not started" and the IE "Integrity protection mode info" was not included in the message SECURITY MODE COMMAND and the IE "Integrity protection mode info" was not included in the message triggering SR-VCC and including the IE "NONCE"; or

If the IE "Integrity protection mode command" has the value "Start", the IE "Status" in the variable INTEGRITY_PROTECTION_INFO has the value "Not started", the IE "Integrity protection mode info" was included

in the message SECURITY MODE COMMAND and the IE "Integrity protection algorithm" is not included or the IE "Integrity protection mode info" was included in the message triggering SR-VCC; or

If the IE "Integrity protection mode command" has the value "Modify" and the IE "Status" in the variable INTEGRITY_PROTECTION_INFO has the value "Not Started"; or

If the IE "Integrity protection mode command" has the value "Start", the IE "Status" in the variable INTEGRITY_PROTECTION_INFO has the value "Started" and the IE "Integrity protection mode command info" was included in the message SECURITY MODE COMMAND; or

If the IE "Integrity protection mode command" has the value "Modify" and there does not exist exactly one integrity protection activation time in the IE "Downlink integrity protection activation info" for each established signalling radio bearer included in the IE "Signalling radio bearer information" in the IE "ESTABLISHED_RABS"; or

If the IE "Integrity protection mode command" has the value "Modify", the IE "Status" in the variable INTEGRITY_PROTECTION_INFO has the value "Started" and the IE "Integrity protection mode info" was not included in the message SECURITY MODE COMMAND and the IE "Integrity protection mode info" was not included in the message triggering SR-VCC:

the UE shall:

- 1> ignore this attempt to change the integrity protection configuration; and
- 1> set the variable INVALID_CONFIGURATION to TRUE.

If the IE "Integrity protection mode info" is not present, the UE shall:

- 1> not change the integrity protection configuration.

If the IE "Integrity protection mode info" is present and if the IE "Reconfiguration" in the variable INTEGRITY_PROTECTION_INFO is set to FALSE, the UE shall:

- 1> set the IE "Reconfiguration" in the variable INTEGRITY_PROTECTION_INFO to TRUE;
- 1> perform the actions in accordance with subclauses 8.6.3.5.1, 8.6.3.5.2 and 8.6.3.5.3.

8.6.3.5.1 Initialisation of Integrity Protection

The UE shall:

- 1> if the IE "Integrity protection mode command" has the value "start" and the IE "Status" in the variable INTEGRITY_PROTECTION_INFO has the value "Not started", and this IE was included in the message SECURITY MODE COMMAND or this IE was included in the message triggering SR-VCC and including the IE "NONCE":
 - 2> initialise the information for all signalling radio bearers in the variable INTEGRITY_PROTECTION_INFO according to the following:
 - 3> set the IE "Uplink RRC Message sequence number" in the variable INTEGRITY_PROTECTION_INFO to zero;
 - 3> do not set the IE "Downlink RRC Message sequence number" in the variable INTEGRITY_PROTECTION_INFO;
 - 3> set the variable INTEGRITY_PROTECTION_ACTIVATION_INFO to zero for each signalling radio bearer in the IE "ESTABLISHED_RABS".

NOTE: The IEs "Integrity protection activation info" and "RRC Message sequence number" included in the IE "Integrity Check Info" in the transmitted message do not have identical values, but integrity protection is applied from the first transmitted message.

- 2> set the IE "Status" in the variable INTEGRITY_PROTECTION_INFO to the value "Started";
- 2> perform integrity protection on the received message, applying the new integrity protection configuration, as described in subclause 8.5.10.1 by:

- 3> using the algorithm (UIA [40]) indicated by the IE "Integrity protection algorithm" contained in the IE "Integrity protection mode info";
- 3> using the IE "Integrity protection initialisation number", contained in the IE "Integrity protection mode info" as the value of FRESH [40].
- 2> start applying the new integrity protection configuration in the downlink for each signalling radio bearer in the IE "ESTABLISHED_RABS" except RB2 at the next received RRC message;
- 2> start applying the new integrity protection configuration in the downlink for signalling radio bearer RB2 from and including the received SECURITY MODE COMMAND message or the message triggering SR-VCC;
- 2> start applying the new integrity protection configuration in the uplink for signalling radio bearer RB2 from and including the transmitted SECURITY MODE COMPLETE message or the transmitted response message for the message triggering SR-VCC;
- 2> start applying the new integrity protection configuration in the uplink for signalling radio bearers other than RB2 at the uplink activation time included in the IE "Uplink integrity protection activation info".

NOTE: After Inter-RAT handover to UTRAN, and ciphering was activated in the other RAT, then during the first security mode control procedure following the handover, UE activates integrity protection using the integrity key of the same key set as used in the other RAT (see.subclause 8.3.6.3).

8.6.3.5.2 Integrity Protection Re-configuration for SRNS Relocation, intra-RAT SR-VCC and handover from GERAN Iu mode

The UE shall:

- 1> if IE "Integrity protection mode command" has the value "start" and the IE "Status" in the variable INTEGRITY_PROTECTION_INFO has the value "Started" and this IE was not included SECURITY MODE COMMAND:

NOTE: This case is used in SRNS relocation, in SR-VCC and in handover from GERAN *Iu mode*.

- 2> perform integrity protection on the received message, applying the new integrity protection configuration, as described in subclause 8.5.10.1 by:
 - 3> using the algorithm (UIA [40]) indicated by the IE "Integrity protection algorithm" contained in the IE "Integrity protection mode info";

NOTE: If the algorithm indicated by the IE "Integrity protection algorithm" is different from the one currently used by the UE, then this leads to a change of the integrity protection algorithm.

- 3> using the IE "Integrity protection initialisation number", contained in the IE "Integrity protection mode info" as the value of FRESH [40].
- 2> let RB_m be the signalling radio bearer where the reconfiguration message was received and let RB_n be the signalling radio bearer where the response message is transmitted;
- 2> prohibit transmission of RRC messages on all signalling radio bearers in the IE "ESTABLISHED_RABS" except on RB0 and the radio bearer where the response message is transmitted;
- 2> for the downlink, for each signalling radio bearer, if for the signalling radio bearer, a security configuration triggered by a previous SECURITY MODE COMMAND or a previous message triggering SR-VCC has not yet been applied, due to the activation time for the signalling radio bearer not having been reached:
 - 3> set "Down link RRC Message sequence number" for this signalling radio bearer in the variable INTEGRITY_PROTECTION_INFO to (activation time -1), where the activation time is the corresponding activation time for this signalling radio bearer;
- 3> if the previous SECURITY MODE COMMAND was received due to new keys being received:
 - 4> consider the new integrity protection configuration to include the received new keys.

- 3> else if the previous SECURITY MODE COMMAND or the previous message triggering SR-VCC caused a change in LATEST_CONFIGURED_CN_DOMAIN:
 - 4> consider the new Integrity Protection configuration to include the keys associated with the LATEST_CONFIGURED_CN_DOMAIN associated with the previously received SECURITY MODE COMMAND.
- 2> start applying the new integrity protection configuration in the downlink for each signalling radio bearer in the IE "ESTABLISHED_RABS" except RBm at the next received RRC message for the corresponding signalling radio bearer;
- 2> start applying the new integrity protection configuration in the downlink for signalling radio bearer RBm from and including the received configuration message;
- 2> start applying the new integrity protection configuration in the uplink for signalling radio bearer RBn from and including the transmitted response message;
- 2> start applying the new integrity protection configuration in the uplink for signalling radio bearers other than RBn from the first message onwards.

8.6.3.5.3 Integrity Protection modification in case of new keys or initialisation of signalling connection

The UE shall:

- 1> if the IE "Integrity protection mode command" has the value "modify" and the IE "Status" in the variable INTEGRITY_PROTECTION_INFO has the value "Started" and this IE was included in SECURITY MODE COMMAND or this IE was included in a message triggering SR-VCC:
 - 2> store the (oldest currently used) integrity protection configuration until activation times have elapsed for the new integrity protection configuration to be applied on all signalling radio bearers;
 - 2> start applying the new integrity protection configuration in the downlink for each signalling radio bearer n, at the first received message with RRC Sequence number greater than or equal to the RRC sequence number indicated by the entry for signalling radio bearer n in the "RRC message sequence number list" in the IE "Downlink integrity protection activation info", included in the IE "Integrity protection mode info";
 - 2> perform integrity protection on the received message, applying the new integrity protection configuration, as described in subclause 8.5.10.1;
 - 3> if present, use the algorithm indicated by the IE "Integrity protection algorithm" (UIA [40]);
 - 2> set the content of the variable INTEGRITY_PROTECTION_ACTIVATION_INFO according to the following:
 - 3> for each established signalling radio bearer, stored in the variable ESTABLISHED_RABS:
 - 4> select a value of the RRC sequence number at which (activation) time the new integrity protection configuration shall be applied in uplink for that signalling radio bearer according to the following:
 - 5> for each signalling radio bearer except RB0:
 - 6> set the activation time for the new integrity protection configuration to the next RRC SN.
 - 4> for signalling radio bearer RB0:
 - 5> set the value of the included RRC sequence number to greater than or equal to the current value of the RRC sequence number for signalling radio bearer RB0 in the variable INTEGRITY_PROTECTION_INFO, plus the value of the constant N302 plus two.
 - 4> prohibit the transmission of RRC messages on all signalling radio bearers, except for RB2, with RRC SN greater than or equal to the value in the "RRC message sequence number list" for the signalling radio bearer in the IE "Uplink integrity protection activation info" of the variable INTEGRITY_PROTECTION_ACTIVATION_INFO.

- 2> start applying the new integrity protection configuration in the uplink at the RRC sequence number, for each RBn, except for signalling radio bearer RB2, indicated by the entry for signalling radio bearer n in the "RRC message sequence number list" in the IE "Uplink integrity protection activation info", included in the variable INTEGRITY_PROTECTION_ACTIVATION_INFO;
- 2> start applying the new integrity protection configuration in the uplink at the RRC sequence number for signalling radio bearer RB2, as specified for the procedure initiating the integrity protection reconfiguration;
- 2> start applying the new integrity protection configuration in the downlink at the RRC sequence number, for each RBn, except for signalling radio bearer RB2, indicated by the entry for signalling radio bearer n in the "RRC message sequence number list" in the IE "Downlink integrity protection activation info";

NOTE: For signalling radio bearers that have a pending activation time as set for integrity protection by a previous procedure changing the integrity protection configuration, UTRAN should set this value in IE "Downlink integrity protection activation info".

- 2> start applying the new integrity protection configuration in the downlink at the RRC sequence number for signalling radio bearer RB2, as specified for the procedure initiating the integrity protection reconfiguration.

8.6.3.6 Void

8.6.3.7 Void

8.6.3.8 Integrity check info

If the IE "Integrity check info" is present the UE shall:

- 1> act as described in subclause 8.5.10.1.

8.6.3.9 New C-RNTI

If the IE "New C-RNTI" is included, the UE shall:

- 1> store the value in the variable C_RNTI, replacing any old stored value;
- 1> use that C-RNTI when using common transport channels of type RACH and FACH in the current cell;
- 1> for FDD and 1.28 Mcps TDD:
 - 2> if the UE is in CELL_FACH and CELL_PCH:
 - 3> use that C-RNTI when using the transport channel of type HS-DSCH.

8.6.3.9a New DSCH-RNTI

In TDD if the IE "New DSCH-RNTI" is included, the UE shall:

- 1> if the UE will be in CELL_DCH or CELL_FACH at the end of the procedure where the received message included this IE:
 - 2> if the UE supports DSCH or USCH as indicated in the IE "Physical Channel Capability" included in the IE "UE Radio Access Capability":
 - 3> store the value in the variable DSCH_RNTI, replacing any old stored value;
 - 3> use that DSCH-RNTI when using SHCCH signalling in the current cell.

8.6.3.10 New U-RNTI

If the IE "New U-RNTI" is included in a received message, the UE shall:

- 1> store the value in the variable U_RNTI, replacing any old stored value.

8.6.3.11 RRC transaction identifier

The IE "RRC transaction identifier" may be used, together with the message type, for identification of an invocation of a downlink procedure (transaction). The UE behaviour for accepting or rejecting transactions based on the message type and the IE "RRC transaction identifier" is specified below.

If the IE "RRC transaction identifier" is included in a received message or if a Target cell HS-SCCH order is received, the UE shall perform the actions below. When a Target cell HS-SCCH order is received, the UE shall consider this as a received message with IE "RRC transaction identifier" and "Message Type" equivalent to the fields "Serving Cell Change Transaction Id" and "Serving Cell Change Message Type" stored in the variable TARGET_CELL_PRECONFIGURATION. The UE shall:

If the received message is any of the messages:

- RADIO BEARER SETUP; or
- RADIO BEARER RECONFIGURATION; or
- RADIO BEARER RELEASE; or
- TRANSPORT CHANNEL RECONFIGURATION; or
- PHYSICAL CHANNEL RECONFIGURATION; or
- a Target cell HS-SCCH order:

the UE shall:

- 1> if the variable ORDERED_RECONFIGURATION is set to FALSE; and
- 1> if the variable CELL_UPDATE_STARTED is set to FALSE; and
- 1> if the received message does not contain a protocol error according to clause 9 and the variable PROTOCOL_ERROR_REJECT is set to FALSE; and
- 1> if the table "Accepted transactions" in the variable TRANSACTIONS does not contain an entry with an IE "Message Type" set to ACTIVE SET UPDATE; and
- 1> if the UE has received:
 - 2> a Target cell HS-SCCH order; or
 - 2> an RRC message and the table "Processed transactions" in the variable TRANSACTIONS does not contain an entry with the same "Message Type" and "Transaction identifier" as the received message, the UE shall:
 - 3> accept the transaction; and
 - 3> store the IE "Message type" and the IE "RRC transaction identifier" of the received message in the table "Accepted transactions" in the variable TRANSACTIONS. In case of the reception of a Target cell HS-SCCH order, the UE shall use the values received in the IEs "Serving Cell Change Message Type" and "Serving Cell Change Transaction Id" which were received in the Active Set Update; and
 - 3> if the received message is not a Target cell HS-SCCH order:
 - 4> clear all entries in the table "Processed transactions" in the variable TRANSACTIONS.
- 1> else:
 - 2> if the variable ORDERED_RECONFIGURATION is set to TRUE; or
 - 2> if the variable CELL_UPDATE_STARTED is set to TRUE; or

- 2> if the table "Accepted transactions" in the variable TRANSACTIONS contains an entry with an IE "Message Type" set to ACTIVE SET UPDATE; or
- 2> if the received message contains a protocol error according to clause 9 causing the variable PROTOCOL_ERROR_REJECT to be set to TRUE; or
- 2> if the UE received an RRC message and the table "Processed transactions" in the variable TRANSACTIONS contains an entry with the same "Message Type" and "Transaction identifier" as the received message:
 - 3> if the UE received an RRC message and the table "Processed transactions" in the variable TRANSACTIONS contains an entry with the same "Message Type" and "Transaction identifier" as the received message:
 - 4> ignore the transaction; and
 - 4> continue with any ongoing processes and procedures as if the message was not received; and
 - 4> clear one entry which is identified by IE "Message Type" and "RRC transaction identifier" of the received message in "Processed transactions" in the variable TRANSACTIONS; and
 - 4> end the procedure.
 - 3> else if the IE "RRC transaction identifier" of the received message is identical to the "RRC transaction identifier" stored for the same "Message Type" as the received message in the table "Accepted transactions" in the variable TRANSACTIONS:
 - 4> ignore the transaction; and
 - 4> continue with any ongoing processes and procedures as if the message was not received; and
 - 4> end the procedure.
- 3> else:
 - 4> reject the transaction; and
 - 4> if the IE "Message Type" of the received message is not present in the table "Rejected transactions" in the variable TRANSACTIONS:
 - 5> store the IE "Message type" and the IE "RRC transaction identifier" of the received message in the table "Rejected transactions" in the variable TRANSACTIONS.

Else:

If the received message is any of the messages:

- RRC CONNECTION SETUP; or
- CELL UPDATE CONFIRM; or
- URA UPDATE CONFIRM; or
- UE CAPABILITY ENQUIRY:

the UE shall:

- 1> if the IE "Message Type" of the received message is not present in the table "Accepted transactions" in the variable TRANSACTIONS:
- 2> if the received message does not contain a protocol error according to clause 9 and the variable PROTOCOL_ERROR_REJECT is set to FALSE:
 - 3> accept the transaction; and
 - 3> store the IE "Message type" and the IE "RRC transaction identifier" of the received message in the table "Accepted transactions" in the variable TRANSACTIONS.

2> else:

- 3> if the received message contains a protocol error according to clause 9 causing the variable `PROTOCOL_ERROR_REJECT` to be set to `TRUE`:
 - 4> reject the transaction; and
 - 4> if the IE "Message Type" of the received message is not present in the table "Rejected transactions" in the variable `TRANSACTIONS`:
 - 5> store the IE "Message type" and the IE "RRC transaction identifier" of the received message in the table "Rejected transactions" in the variable `TRANSACTIONS`.

1> else:

- 2> if the IE "Message Type" of the received message is present in the table "Accepted transactions" in the variable `TRANSACTIONS`:
 - 3> if the IE "RRC transaction identifier" of the received message is identical to the "RRC transaction identifier" stored for the "Message Type" in the table "Accepted transactions" in the variable `TRANSACTIONS`:
 - 4> ignore the transaction; and
 - 4> continue with any ongoing processes and procedures as the message was not received; and
 - 4> end the procedure.

3> else:

- 4> if the IE "RRC transaction identifier" of the received message is different from the "RRC transaction identifier" stored for the "Message Type" in the table "Accepted transactions" in the variable `TRANSACTIONS`:
 - 5> if the received message does not contain a protocol error according to clause 9 and the variable `PROTOCOL_ERROR_REJECT` is set to `FALSE`:
 - 6> ignore the once accepted transaction and instead accept the new transaction; and
 - 6> store the IE "Message type" and the IE "RRC transaction identifier" of the received message in the table "Accepted transactions" in the variable `TRANSACTIONS`, replacing the previous entry.

NOTE 1: The UE is expected to process the first RRC CONNECTION SETUP/CELL UPDATE CONFIRM/URA UPDATE CONFIRM message that it receives after transmitting an RRC CONNECTION REQUEST/CELL_UPDATE/URA_UPDATE message. If the UE receives further RRC CONNECTION SETUP/CELL UPDATE CONFIRM/URA UPDATE CONFIRM messages without having transmitted another RRC CONNECTION REQUEST/CELL_UPDATE/URA_UPDATE message, the UE is not required to process these messages.

NOTE 2: If the previously accepted transaction was a CELL UPDATE CONFIRM/URA UPDATE CONFIRM that included the IE "Dowlink counter synchronisation info", rather than ignore the first accepted transaction the UE may continue with the first transaction in the case where a cell re-selection interrupted the ongoing procedure causing a cell update procedure to be triggered. In this case the response message acts as an explicit acknowledgement of both the CELL UPDATE CONFIRM/URA UPDATE CONFIRM message signalling an SRNS relocation and the subsequent CELL UPDATE CONFIRM/URA UPDATE CONFIRM.

5> else:

- 6> if the received message contains a protocol error according to clause 9 causing the variable `PROTOCOL_ERROR_REJECT` to be set to `TRUE`:
 - 7> reject the transaction; and

7> if the IE "Message Type" of the received message is not present in the table "Rejected transactions" in the variable TRANSACTIONS:

8> store the IE "Message type" and the IE "RRC transaction identifier" of the received message in the table "Rejected transactions" in the variable TRANSACTIONS.

Else:

If the received message is any of the messages:

- HANDOVER FROM UTRAN COMMAND; or
- CELL CHANGE ORDER FROM UTRAN:

the UE shall:

1> if the variable ORDERED_RECONFIGURATION is set to TRUE;

2> reject the transaction; and

2> if the IE "Message Type" of the received message is not present in the table "Rejected transactions" in the variable TRANSACTIONS:

3> store the IE "Message type" and the IE "RRC transaction identifier" of the received message in the table "Rejected transactions" in the variable TRANSACTIONS.

Else:

If the received message is:

- MEASUREMENT CONTROL:

the UE shall:

1> if the IE "Message Type" of the received message is not present in the table "Accepted transactions" in the variable TRANSACTIONS:

2> if the received message does not contain a protocol error according to clause 9 and the variable PROTOCOL_ERROR_REJECT is set to FALSE:

3> accept the transaction; and

3> store the IE "Message type", the IE "RRC transaction identifier", and the IE "Measurement identity" of the received message in the table "Accepted transactions" in the variable TRANSACTIONS.

2> else:

3> if the received message contains a protocol error according to clause 9 causing the variable PROTOCOL_ERROR_REJECT to be set to TRUE:

4> reject the transaction; and

4> store the IE "Message type", the IE "RRC transaction identifier", and the IE "Measurement identity" of the received message in the table "Rejected transactions" in the variable TRANSACTIONS.

1> else:

2> if the IE "Message Type" of the received message is present in the table "Accepted transactions" in the variable TRANSACTIONS:

3> if the IE "RRC transaction identifier" of the received message is identical to the "RRC transaction identifier" stored in any entry for the "Message Type" in the table "Accepted transactions" in the variable TRANSACTIONS:

4> ignore the transaction; and

4> continue with any ongoing processes and procedures as the message was not received; and

4> end the procedure.

3> else:

4> if the IE "RRC transaction identifier" of the received message is different from the "RRC transaction identifier" stored in all entries for the "Message Type" in the table "Accepted transactions" in the variable TRANSACTIONS:

5> if the received message does not contain a protocol error according to clause 9 and the variable PROTOCOL_ERROR_REJECT is set to FALSE:

6> accept the additional transaction; and

6> store the IE "Message type", the IE "RRC transaction identifier", and the IE "Measurement identity" of the received message in the table "Accepted transactions" in the variable TRANSACTIONS, in addition to the already existing entries.

5> else:

6> if the received message contains a protocol error according to clause 9 causing the variable PROTOCOL_ERROR_REJECT to be set to TRUE:

7> reject the transaction; and

7> store the IE "Message type", IE "RRC transaction identifier", and the IE "Measurement identity" of the received message in the table "Rejected transactions" in the variable TRANSACTIONS.

If the received message is any other message, the UE shall:

1> if the IE "Message Type" of the received message is not present in the table "Accepted transactions" in the variable TRANSACTIONS:

2> if the received message does not contain a protocol error according to clause 9 and the variable PROTOCOL_ERROR_REJECT is set to FALSE:

3> accept the transaction; and

3> store the IE "Message type" and the IE "RRC transaction identifier" of the received message in the table "Accepted transactions" in the variable TRANSACTIONS.

2> else:

3> if the received message contains a protocol error according to clause 9 causing the variable PROTOCOL_ERROR_REJECT to be set to TRUE:

4> reject the transaction; and

4> store the IE "Message type" and the IE "RRC transaction identifier" of the received message in the table "Rejected transactions" in the variable TRANSACTIONS.

1> else:

2> if the IE "Message Type" of the received message is present in the table "Accepted transactions" in the variable TRANSACTIONS:

3> if the IE "RRC transaction identifier" of the received message is identical to the "RRC transaction identifier" stored in any entry for the "Message Type" in the table "Accepted transactions" in the variable TRANSACTIONS:

4> ignore the transaction; and

4> continue with any ongoing processes and procedures as the message was not received; and

4> end the procedure.

3> else:

- 4> if the IE "RRC transaction identifier" of the received message is different from the "RRC transaction identifier" stored in all entries for the "Message Type" in the table "Accepted transactions" in the variable TRANSACTIONS:
 - 5> if the received message does not contain a protocol error according to clause 9 and the variable PROTOCOL_ERROR_REJECT is set to FALSE:
 - 6> accept the additional transaction; and
 - 6> store the IE "Message type" and the IE "RRC transaction identifier" of the received message in the table "Accepted transactions" in the variable TRANSACTIONS, in addition to the already existing entries.
 - 5> else:
 - 6> if the received message contains a protocol error according to clause 9 causing the variable PROTOCOL_ERROR_REJECT to be set to TRUE:
 - 7> reject the transaction; and
 - 7> store the IE "Message type" and the IE "RRC transaction identifier" of the received message in the table "Rejected transactions" in the variable TRANSACTIONS.

8.6.3.12 Capability Update Requirement

If the IE "Capability Update Requirement" is included the UE shall:

- 1> if the IE "UE radio access FDD capability update requirement" has the value TRUE:
 - 2> if the UE supports FDD mode:
 - 3> store its UTRA FDD capabilities and its UTRA capabilities common to FDD and TDD in the IE "UE radio access capability" and the IE "UE radio access capability extension" in variable UE_CAPABILITY_REQUESTED as specified below:
 - 4> if the UE supports any radio access capability included in IE "UE radio access capability extension" that is not included in IE "UE radio access capability":

NOTE: This is valid e.g. for UE that supports multiple UTRA FDD Bands, UE that supports a single UTRA FDD Band different from Band I [21] or UE that supports E-UTRA.

- 5> store the IE "UE radio access capability", excluding IEs "RF capability FDD" and "Measurement capability";
- 5> store the IE "UE radio access capability extension", including the IEs "RF capability FDD extension", the "Measurement capability extension", the "Additional Secondary Cells" and the "Non-contiguous multi-cell" associated with each supported UTRA FDD frequency band indicated in the IE "Frequency band".
- 4> else:
 - 5> store the IE "UE radio access capability", including the IEs "RF capability FDD" and "Measurement capability" associated with the Band I [21].
- 1> if the IE "UE radio access 3.84 Mcps TDD capability update requirement" has the value TRUE:
 - 2> if the UE supports 3.84 Mcps TDD mode:
 - 3> store its UTRAN-specific 3.84 Mcps TDD capabilities and its UTRAN-specific capabilities common to FDD and TDD in the variable UE_CAPABILITY_REQUESTED.
- 1> if the IE "UE radio access 7.68 Mcps TDD capability update requirement" has the value TRUE:
 - 2> if the UE supports 7.68 Mcps TDD mode:

- 3> store its UTRAN-specific 7.68 Mcps TDD capabilities and its UTRAN-specific capabilities common to FDD and TDD in the variable UE_CAPABILITY_REQUESTED.
- 1> if the IE "UE radio access 1.28 Mcps TDD capability update requirement" has the value TRUE:
 - 2> if the UE supports 1.28 Mcps TDD mode:
 - 3> store its UTRAN-specific 1.28 Mcps TDD capabilities and its UTRAN-specific capabilities common to FDD and TDD in the variable UE_CAPABILITY_REQUESTED;
 - 3> if the UE supports E-UTRA:
 - 4> store the IE "UE radio access capability", including "Measurement capability TDD" associated with each supported E-UTRA band.
 - 1> if the IE "System specific capability update requirement list" is present:
 - 2> for each of the RAT requested in the IE "UE system specific capability":
 - 3> if the UE supports the listed RAT:
 - 4> include its inter-RAT radio access capabilities for the listed RAT in the IE "UE system specific capability" from the variable UE_CAPABILITY_REQUESTED;
 - 4> if the listed RAT is GSM and PS Handover to GPRS is supported:
 - 5> include the IE "MS Radio Access Capability" in the variable UE_CAPABILITY_REQUESTED.
 - 4> if the listed RAT is E-UTRA:
 - 5> if the IE "Requested E-UTRA Frequency Band list" is present and supported by the UE:
 - 6> include in IE "UE system specific capability" in the variable UE_CAPABILITY_REQUESTED all supported E-UTRA bands according to sub-clause 5.6.3.3 in [67];
 - 6> include in IE "UE system specific capability" in the variable UE_CAPABILITY_REQUESTED all supported non-CA bands according to sub-clause 5.6.3.3 in [67];
 - 6> include in IE "UE system specific capability" in the variable UE_CAPABILITY_REQUESTED CA band combinations according to sub-clause 5.6.3.3 in [67] as if the UE supports only those E-UTRA frequency bands signaled in IE "Requested E-UTRA Frequency Band list";
 - 6> include in IE "UE system specific capability" in the variable UE_CAPABILITY_REQUESTED other E-UTRA capabilities.

If the IE "Capability update requirement" is not present, the UE shall:

- 1> assume the default values as specified in subclause 10.3.3.2 and act in accordance with the above.

8.6.3.13 Group release information

The UE shall apply the following procedure to compare the IE "U-RNTI group" with the U-RNTI allocated to the UE stored in the variable U_RNTI.

If the IE "group discriminator" is equal to "All":

- 1> consider this as a group identity match.

If the IE "group discriminator" is equal to "U-RNTI mask":

- 1> let N be the value of the IE "U-RNTI bit mask index";
- 1> if N is equal to b20, b21, ... or b31:

- 2> compare pairs of bits, starting from bit b31 downto, and including, bit N of the "SRNC identity" of the IE "U-RNTI" with the corresponding bits stored in the variable U_RNTI;
- 2> if all pairs of bits are equal:
 - 3> consider this as a group identity match.
- 1> if N is equal to b1, b2, ... or b19:
 - 2> compare pairs of bits, starting from bit b31 downto, and including, bit b20 of the "SRNC identity" in the IE "U-RNTI" with the corresponding bits of the "SRNC identity" stored in the variable U_RNTI;
 - 2> if all pairs of bits are equal:
 - 3> then compare pairs of bits, starting from bit b19 downto, and including, bit N of the "S-RNTI" in the IE "U-RNTI" with the corresponding bits of the "S-RNTI" stored in the variable U_RNTI;
 - 3> if all pairs of bits are equal:
 - 4> consider this as a group identity match.

NOTE 1: The most significant bits of the U-RNTI, which indicate the "SRNC identity" must be unique among all RNC's, which support all the UEs in the group to be released, in order to obtain correct behaviour of group release.

8.6.3.14 New E-RNTI

If the IE "New Primary E-RNTI" and/or the IE "New Secondary E-RNTI" (FDD only) are/is included and the UE will be in CELL_DCH state after completion of this procedure, the UE shall:

- 1> if the IE "New Primary E-RNTI" is received in a UTRAN MOBILITY INFORMATION message:
 - 2> the UE behaviour is unspecified;
- 1> store the new value(s) in the variable E_RNTI;
- 1> determine the value for the E_DCH_TRANSMISSION variable and take the corresponding actions as described in subclause 8.5.28.

If, after state transition the UE enters CELL_PCH or URA_PCH state and the UE was in CELL_DCH state upon reception of the reconfiguration message the UE shall:

- 1> if the UE supports E-DCH transmission in CELL_FACH state and Idle mode and the IE "Common E-DCH system info" is included in system information block type 5 or 5bis:
 - 2> clear the variable E_RNTI.

For FDD and 1.28 Mcps TDD, if the IE "New Primary E-RNTI" is included and the UE will be in CELL_FACH or CELL_PCH state after completion of this procedure, the UE shall:

- 1> store the new value in the variable E_RNTI;
- 1> determine the value for the READY_FOR_COMMON_EDCH variable and perform the corresponding actions as described in subclause 8.5.47.
- 1> for FDD, determine the value for the READY_FOR_COMMON_ERGCH variable and perform the corresponding actions as described in subclause 8.5.75.

If, after the completion of this procedure, the variable E_DCH_TRANSMISSION is set to FALSE, the UE in CELL_DCH state shall:

- 1> clear the variable E_RNTI.

If, after the completion of this procedure, the variable READY_FOR_COMMON_EDCH is set to FALSE and the variable HSPA_RNTI_STORED_CELL_PCH is also set to FALSE, the UE shall:

- 1> if not in CELL_DCH state:

2> clear the variable E_RNTI.

When the variable E_DCH_TRANSMISSION is set to TRUE the UE shall:

1> for FDD:

2> use the value of the Primary E-RNTI and/or Secondary E-RNTI stored in the variable E_RNTI as UE identities in the E-AGCH reception procedure in the physical layer.

1> for TDD:

2> use the value of New Primary E-RNTI stored in the variable E_RNTI as the UE identity in the E-AGCH reception procedure and the E-RUCCH transmission procedure in the physical layer.

When the variable SECONDARY_CELL_E_DCH_TRANSMISSION is set to TRUE and the secondary uplink frequency is an activated uplink frequency, the UE shall:

1> use the primary E-RNTI and/or secondary E-RNTI stored in the IE "Secondary serving E-DCH cell info" as UE identities in the E-AGCH reception procedure in the physical layer on the downlink frequency associated with the secondary uplink frequency.

8.6.3.15 SR-VCC Info

The presence of the IE "NONCE" in the IE "SR-VCC Info" triggers the relevant actions for mapping keys from the PS domain to the CS domain. The IE "NONCE" is not included if ciphering is not active for PS domain prior to the reception of the the IE "SR-VCC Info".

If the IE "SR-VCC Info" is included and the IE "NONCE" is present in the IE "SR-VCC Info", the UE shall:

1> set the "Status" in the variable CIPHERING_STATUS of the CS domain to "Started";

1> calculate the CK and IK for the CS domain as specified in [40];

1> if the IE "SR-VCC Info" is included in a message other than HANDOVER FROM UTRAN COMMAND:

2> set the variable LATEST_CONFIGURED_CN_DOMAIN to "CS domain";

2> use the ciphering algorithm in use for the PS domain as part of the new ciphering configuration for the CS domain unless otherwise specified by the message triggering SR-VCC.

If the IE "SR-VCC Info" is included, the UE shall:

1> add the signalling connection with the identity "CS domain" in the variable ESTABLISHED_SIGNALLING_CONNECTIONS.

8.6.3.16 rSR-VCC Info

If the IE "rSR-VCC Info" is received and contains the IE "IMS information", the UE shall:

1> indicate the "IMS information" IE to the upper layers as part of rSR-VCC procedure.

If the IE "rSR-VCC Info" is received and contains the IE "NONCE", the UE shall:

1> forward the IE "NONCE" to upper layers as specified in [79];

8.6.3.17 Access Group identity

If the IE "Access Group identity" is included, the UE shall:

1> store the value in the variable CONNECTED_MODE_ACCESS_CONTROL, replacing any stored value of the IE "Access Group identity";

1> if in CELL_FACH:

2> if System Information Block type 24 is scheduled on the broadcast channel:

- 3> if the n-th Bit in the IE "DTCH transmission blocked" in the variable CONNECTED_MODE_ACCESS_CONTROL is set to 1, where n is the value stored in the IE "Access Group identity" in the variable CONNECTED_MODE_ACCESS_CONTROL:
 - 4> configure RLC entities mapped onto the logical channel DTCH to not submit any data PDUs to lower layers.
- 3> else:
 - 4> configure RLC entities mapped onto the logical channel DTCH to allow submitting data PDUs to lower layers.
- 1> if in CELL_PCH or URA_PCH:
 - 2> if System Information Block type 24 is scheduled on the broadcast channel:
 - 3> if the n-th Bit in the IE "DTCH transmission blocked" in the variable CONNECTED_MODE_ACCESS_CONTROL is set to 1, where n is the value stored in the IE "Access Group identity" in the variable CONNECTED_MODE_ACCESS_CONTROL:
 - 4> not trigger a measurement report procedure or not initiate the cell update procedure with cell update cause "uplink data transmission".

NOTE: Measurement report and cell update procedures that are triggered by uplink RLC control PDU are permitted.

8.6.4 Radio bearer information elements

8.6.4.1 Signalling RB information to setup list

If the IE "Signalling RB information to setup list" is included the UE shall:

- 1> use the same START value to initialise the COUNT-C and COUNT-I variables for all the signalling radio bearers in the list;
- 1> if the IE "Signalling RB information to setup list" was included in the RADIO BEARER SETUP message:
 - 2> if the variable LATEST_CONFIGURED_CN_DOMAIN has been initialised:
 - 3> calculate the START value only once during this procedure according to subclause 8.5.9 for the CN domain indicated in the variable LATEST_CONFIGURED_CN_DOMAIN;
 - 3> store the calculated START value in the variable START_VALUE_TO_TRANSMIT.
- 1> for each occurrence of the IE "Signalling RB information to setup":
 - 2> use the value of the IE "RB identity" as the identity of the signalling radio bearer to setup;
 - 2> if the signalling radio bearer identified with the IE "RB identity" does not exist in the variable ESTABLISHED_RABS:
 - 3> create a new entry for the signalling radio bearer in the variable ESTABLISHED_RABS.
 - 2> if the IE "Signalling RB information to setup list" was received in a message other than HANDOVER TO UTRAN COMMAND; and
 - 2> if the variable LATEST_CONFIGURED_CN_DOMAIN has been initialised and the value "STATUS" of the variable CIPHERING_STATUS of the CN domain stored in this variable is "Started":
 - 3> if the IE "Uplink RLC mode" or the IE "Downlink RLC mode" either in the IE "RLC info" or referenced by the RB identity in the IE "Same as RB" is set to "AM RLC" or "UM RLC":
 - 4> initialise the 20 MSB of the hyper frame number component of COUNT-C for this signalling radio bearer with the START value in the variable START_VALUE_TO_TRANSMIT;

- 4> set the remaining LSB of the hyper frame number component of COUNT-C for this signalling radio bearer to zero;
- 4> start to perform ciphering on this signalling radio bearer, using the value of the IE "RB identity" minus one as the value of BEARER in the ciphering algorithm.
- 2> if the IE "Signalling RB information to setup list" was received in a message other than HANDOVER TO UTRAN COMMAND; and
- 2> if the variable LATEST_CONFIGURED_CN_DOMAIN has been initialised and the value "Status" of the variable "INTEGRITY_PROTECTION_INFO" of the CN domain stored in this variable is "Started":
 - 3> initialise the 20 MSB of the hyper frame number component of COUNT-I for this signalling radio bearer with the START value in the variable START_VALUE_TO_TRANSMIT;
 - 3> set the remaining LSB of the hyper frame number component of COUNT-I for this signalling radio bearer to zero;
 - 3> for this signalling radio bearer, set the IE "Uplink RRC Message sequence number" in the variable INTEGRITY_PROTECTION_INFO to zero;
 - 3> start performing integrity protection according to subclauses 8.5.10.1 and 8.5.10.2.
- 2> perform the actions for the IE "RLC info" as specified in subclause 8.6.4.9, applied for that signalling radio bearer;
- 2> perform the actions for the IE "RB mapping info" as specified in subclause 8.6.4.8, applied for that signalling radio bearer.
- 1> apply a default value of the IE "RB identity" equal to 1 for the first IE "Signalling RB information to setup"; and
- 1> increase the default value by 1 for each occurrence.

NOTE: The UTRAN should only use the default value of the IE "RB identity" within the RRC Connection Setup and Handover to UTRAN Command messages. If the default value of the IE "RB identity" is used in any other message then the UE behaviour is not specified.

8.6.4.2 RAB information for setup

If the IE "RAB information for setup" is included, the procedure is used to establish or establish/release (only if CS domain RAB mapping is reconfigured between DCH and EDCH/HSPA or IE "RAB info to replace" exists) radio bearers belonging to a radio access bearer, and the UE shall:

- 1> if several IEs "RAB information for setup" are included in a message other than HANDOVER TO UTRAN COMMAND and the included IEs "CN domain identity" in the IE "RAB info" does not all have the same value:
 - 2> set the variable INVALID_CONFIGURATION to TRUE.
- 1> if the radio access bearer identified with the IE "RAB info" does not exist in the variable ESTABLISHED_RABS:
 - 2> create a new entry for the radio access bearer in the variable ESTABLISHED_RABS;
 - 2> store the content of the IE "RAB info" in the entry for the radio access bearer in the variable ESTABLISHED_RABS;
 - 2> indicate the establishment of each radio access bearer to the upper layer entity using the IE "CN domain identity", forwarding the content of the IE "RAB identity" and the IEs NAS Synchronization Indicator as well as the following IEs if included in the IE "RAB info": "MBMS Session identity" and/ or "MBMS Service Identity";
 - 2> if prior to this procedure there exists no transparent mode radio bearer for the CN domain included in the IE "CN domain identity" and at least one transparent mode radio bearer is included in the IE "RB information to setup"; or
 - 2> if at least one RLC-AM or RLC-UM radio bearer is included in the IE "RB information to setup":

- 3> calculate the START value only once during this procedure (the same START value shall be used on all new radio bearers created for this radio access bearer) according to subclause 8.5.9 for the CN domain as indicated in the IE "CN domain identity" in the IE "RAB info" part of the IE "RAB information to setup";

NOTE: For the case of SR-VCC the START value from the mapped CS key will be incremented and compared with the START value read from the (U)SIM at connection setup. The largest value will be used for the new CS START value. For the case of rSR-VCC the START value from the mapped PS key will be incremented and compared with the START value read from the (U)SIM at connection setup. The largest value will be used for the new PS START value. This operation is provided with the existing procedure in subclause 8.5.9.

- 3> store the calculated START value in the variable START_VALUE_TO_TRANSMIT.

1> if the radio access bearer identified with the IE "RAB identity" in the IE "RAB info" already exists in the variable ESTABLISHED_RABS:

- 2> if prior to this procedure there exists no transparent mode radio bearer for the CN domain included in the IE "CN domain identity" and at least one transparent mode radio bearer is included in the IE "RB information to setup"; or

2> if at least one RLC-AM or RLC-UM radio bearer is included in the IE "RB information to setup":

- 3> calculate the START value only once during this procedure (the same START value shall be used on all new radio bearers created for this radio access bearer) according to subclause 8.5.9 for the CN domain as indicated in the IE "CN domain identity" in the IE "RAB info" part of the IE "RAB information to setup";

- 3> store the calculated START value in the variable START_VALUE_TO_TRANSMIT.

2> for each radio bearer in the variable ESTABLISHED_RABS for that radio access bearer:

- 3> release the PDCP and RLC entities for that radio bearer;

- 3> release the RAB subflow associated with the radio bearer;

- 3> delete the information about the radio bearer from the variable ESTABLISHED_RABS.

NOTE: When CS domain RAB mapping is reconfigured between DCH and E-DCH/HS-DSCH, UTRAN should change the radio bearer identity.

1> if the radio access bearer identified with the IE "RAB info to replace" already exists in the variable ESTABLISHED_RABS:

2> for each radio bearer in the variable ESTABLISHED_RABS for that radio access bearer:

- 3> release the PDCP and RLC entities for that radio bearer;

- 3> release the RAB subflow associated with the radio bearer;

- 3> delete the information about the radio bearer from the variable ESTABLISHED_RABS.

NOTE: When an SR-VCC procedure is initiated, if the received reconfiguration message attempts to configure RBs with the same RB Identity as an existing or about to be released radio bearer identity, the UE behaviour is not specified.

2> indicate to the upper layers that the radio access bearer identified by the IE "RAB info to replace" is released as part of a SR-VCC procedure.

1> for each radio bearer in the IE "RB information to setup":

2> if the radio bearer identified with the IE "RB identity" does not exist in the variable ESTABLISHED_RABS:

- 3> perform the actions specified in subclause 8.6.4.3;

- 3> store information about the new radio bearer in the entry for the radio access bearer identified by "RAB info" in the variable ESTABLISHED_RABS;

- 3> create a new RAB subflow for the radio access bearer;

- 3> number the RAB subflow in ascending order, assigning the smallest number to the RAB subflow corresponding to the first radio bearer in the list;
- 3> if the IE "CN domain identity" in the IE "RAB info" is set to "PS domain" and the number of RAB subflows for the radio access bearer is greater than 1:
 - 4> set the variable INVALID_CONFIGURATION to TRUE.
- 2> if the radio bearer identified with the IE "RB identity" already exists in the variable ESTABLISHED_RABS:
 - 3> set the variable INVALID_CONFIGURATION to TRUE.
- 1> if the IE "CS-HSPA information" is included:
 - 2> forward the content of the IE "UL AMR rate" to upper layers;
 - 2> use the information in the IE "Max CS delay" to determine the maximum buffering of the voice frames (see [36]).

8.6.4.2a RAB information to reconfigure

If the IE "RAB information to reconfigure" is included then the UE shall:

- 1> if the entry for the radio access bearer identified by the IE "CN domain identity" together with the IE "RAB Identity" in the variable ESTABLISHED_RABS already exists:
 - 2> perform the action for the IE "NAS Synchronization Indicator", according to subclause 8.6.4.12.
- 1> else:
 - 2> set the variable INVALID_CONFIGURATION to TRUE.
- 1> if the IE "CS-HSPA information" is included:
 - 2> forward the content of the IE "UL AMR rate" to upper layers;
 - 2> use the information in the IE "Max CS delay" to determine the maximum buffering of the voice frames (see [36]).

8.6.4.3 RB information to setup

If the IE "RB information to setup" is included, the UE shall apply the following actions on the radio bearer identified with the value of the IE "RB identity". The UE shall:

- 1> use the same START value to initialise the hyper frame number components of COUNT-C variables for all the new radio bearers to setup;
- 1> perform the actions for the IE "PDCP info", if present, according to subclause 8.6.4.10, applied for the radio bearer;
- 1> perform the actions for the IE "RLC info", according to subclause 8.6.4.9, applied for the radio bearer;
- 1> perform the actions for the IE "RB mapping info", according to subclause 8.6.4.8, applied for the radio bearer;
- 1> if the IE "Downlink RLC mode" either in the IE "RLC info" or referenced by the RB identity in the IE "Same as RB" is set to "TM RLC":
 - 2> configure delivery of erroneous SDUs in lower layers according to indication from upper layer [5].
- 1> if the IE "Downlink RLC mode" either in the IE "RLC info" or referenced by the RB identity in the IE "Same as RB" is set to "UM RLC" and if the radio bearer is connected to a CS domain radio access bearer:
 - 2> configure delivery of RLC sequence number in lower layers;
 - 2> if the IE "RB information to setup" was received in a message other than HANDOVER TO UTRAN COMMAND:

- 3> if the IE "SR-VCC Info" is present and contains the IE "NONCE":
 - 4> initialise the 20 MSB of the hyper frame number component of COUNT-C for this radio bearer (including uplink and downlink) with zero for CS domain;
 - 3> else:
 - 4> initialise the 20 MSB of the hyper frame number component of COUNT-C for this radio bearer (including uplink and downlink) with the latest transmitted START for CS domain;
 - 3> set the remaining LSB of the hyper frame number component of COUNT-C for this radio bearer (including uplink and downlink) to zero;
 - 3> start incrementing the COUNT-C values.
- 1> else if the IE "RB information to setup" was received in a message other than HANDOVER TO UTRAN COMMAND; and
 - 1> if the IE "Uplink RLC mode" or the IE "Downlink RLC mode" either in the IE "RLC info" or referenced by the RB identity in the IE "Same as RB" is set to "AM RLC" or "UM RLC":
 - 2> initialise the 20 MSB of the hyper frame number component of COUNT-C for this radio bearer with the START value in the variable START_VALUE_TO_TRANSMIT;
 - 2> set the remaining LSB of the hyper frame number component of COUNT-C for this radio bearer to zero;
 - 2> start incrementing the COUNT-C values.
 - 1> if the IE "RB information to setup" was received in a message other than HANDOVER TO UTRAN COMMAND; and
 - 1> if the IE "Uplink RLC mode" and the IE "Downlink RLC mode" either in the IE "RLC info" or referenced by the RB identity in the IE "Same as RB" is set to "TM RLC":
 - 2> if prior to this procedure there exists no transparent mode radio bearer for the CN domain included in the IE "CN domain identity" in the IE "RAB info" in the variable ESTABLISHED_RABS and at least one transparent mode radio bearer is included in the IE "RB information to setup":
 - 3> if the IE "Status" in the variable CIPHERING_STATUS of the CN domain as indicated in the IE "CN domain identity" in the IE "RAB info" in the variable ESTABLISHED_RABS is set to "Not Started":
 - 4> at the activation time as specified in the IE "Ciphering activation time for DPCH" if included in the IE "Ciphering mode info" in the command message or, if this IE is not included, as specified in the IE "COUNT-C activation time" included in the response message:
 - 5> initialise the 20 most significant bits of the hyper frame number component of COUNT-C common for all transparent mode radio bearers of this CN domain with the START value in the variable START_VALUE_TO_TRANSMIT;
 - 5> set the remaining LSB of the hyper frame number component of COUNT-C to zero;
 - 5> do not increment the COUNT-C value common for all transparent mode radio bearers for this CN domain.
 - 3> if the IE "Status" in the variable CIPHERING_STATUS of the CN domain as indicated in the IE "CN domain identity" in the IE "RAB info" in the variable ESTABLISHED_RABS is set to "Started":
 - 4> at the activation time as specified in the IE "Activation Time" in the RADIO BEARER SETUP message:
 - 5> if the IE "CN domain identity" in the "IE RAB info" is set to CS; and
 - 5> if the IE "SR-VCC Info" is present and contains the IE "NONCE":
 - 6> initialise the 20 most significant bits of the HFN component of COUNT-C common for all transparent mode RLC radio bearers to zero.

- 5> otherwise:
 - 6> initialise the 20 most significant bits of the HFN component of COUNT-C common for all transparent mode RLC radio bearer to the value of the latest transmitted START for this CN domain.
 - 5> while not incrementing the value of the HFN component of COUNT-C at each CFN cycle; and
 - 5> set the remaining LSB of the HFN component of COUNT-C to zero;
 - 5> start to perform ciphering on the radio bearer in lower layers while not incrementing the HFN.
- 4> at the activation time as specified in the IE "Ciphering activation time for DPCH" if included in the IE "Ciphering mode info" in the command message or, if this IE is not included, as specified in the IE "COUNT-C activation time" included in the response message:
 - 5> initialise the 20 most significant bits of the HFN component of COUNT-C common for all transparent mode radio bearers of this CN domain with the START value in the variable START_VALUE_TO_TRANSMIT;
 - 5> set the remaining LSB of the HFN component of COUNT-C to zero;
 - 5> if the received message is used to perform a Timing re-initialised hard handover:
 - 6> increment the HFN component of the COUNT-C variable by one even if the "COUNT-C activation time" is set to zero.
 - 5> start incrementing the COUNT-C value common for all transparent mode radio bearers of this CN domain as normal, at each CFN value, i.e. the HFN component is no longer fixed in value but incremented at each CFN cycle.
- 2> if prior to this procedure there exists at least one transparent mode radio bearer for the CN domain included in the IE "CN domain identity" in the IE "RAB info" in the variable ESTABLISHED_RABS:
 - 3> if the IE "Status" in the variable CIPHERING_STATUS of the CN domain as indicated in the IE "CN domain identity" in the IE "RAB info" in the variable ESTABLISHED_RABS is set to "Not Started":
 - 4> do not increment the COUNT-C value common for all transparent mode radio bearers for this CN domain.
 - 3> if the IE "Status" in the variable CIPHERING_STATUS of the CN domain as indicated in the IE "CN domain identity" in the IE "RAB info" in the variable ESTABLISHED_RABS is set to "Started":
 - 4> use the COUNT-C value common for all transparent mode radio bearers of this CN domain.
- 1> if the IE "Status" in the variable CIPHERING_STATUS of the CN domain as indicated in the IE "CN domain identity" in the IE "RAB info" in the variable ESTABLISHED_RABS is set to "Started":
 - 2> start to perform ciphering on the radio bearer in lower layers, using the value of the IE "RB identity" minus one as the value of BEARER in the ciphering algorithm.

NOTE: UTRAN should not use the IE "RB information to setup" to setup radio bearers with RB identity in the range 1-4.

8.6.4.4 RB information to be affected

If the IE "RB information to be affected" is included, the UE shall apply the following actions on the radio bearer identified with the value of the IE "RB identity". The UE shall:

- 1> perform the actions for the IE "RB mapping info", according to subclause 8.6.4.8, applied for the radio bearer.

8.6.4.4a Void

8.6.4.5 RB information to reconfigure

If the IE "RB information to reconfigure" is included, the UE shall apply the following actions on the radio bearer identified with the value of the IE "RB identity". The UE shall:

- 1> perform the actions for the IE "PDCP info", if present, according to subclause 8.6.4.10, applied for the radio bearer;
- 1> if the IE "RLC info" is present:
 - 2> perform the actions for the IE "RLC info", according to subclause 8.6.4.9, applied for the radio bearer.
- 1> else:
 - 2> continue using the current RLC configuration for the radio bearer.
- 1> perform the actions for the IE "RB mapping info", according to subclause 8.6.4.8, applied for the radio bearer;
- 1> if the IE "Downlink RLC mode" in the IE "RLC info" is set to "TM RLC":
 - 2> configure delivery of erroneous SDUs in lower layers according to indication from upper layer [5].
- 1> if the IE "PDCP SN info" is included:
 - 2> perform the actions as specified in subclause 8.6.4.11 applied for the radio bearer.
- 1> if the IE "RB stop/continue" is included; and
 - 2> if the "RB identity" has a value greater than 2; and
 - 3> if the value of the IE "RB stop/continue" is "stop":
 - 4> configure the RLC entity for the radio bearer to stop;
 - 4> set the IE "RB started" in the variable ESTABLISHED_RABS to "stopped" for that radio bearer.
 - 3> if the value of the IE "RB stop/continue" is "continue":
 - 4> configure the RLC entity for the radio bearer to continue;
 - 4> set the IE "RB started" in the variable ESTABLISHED_RABS to "started" for that radio bearer.
 - 2> if the IE "RB identity" is set to a value less than or equal to 2:
 - 3> set the variable INVALID_CONFIGURATION to TRUE.

8.6.4.6 RB information to release

If the IE "RB information to release" is included, the UE shall apply the following actions on the radio bearer identified with the value of the IE "RB identity". The UE shall:

- 1> if the IE "RB identity" is set to a value less than 4:
 - 2> set the variable INVALID_CONFIGURATION to TRUE.
- 1> if the IE "RB identity" refers to a signalling radio bearer:
 - 2> release the RLC entity for the signalling radio bearer;
 - 2> delete the information about the signalling radio bearer from the variable ESTABLISHED_RABS.
- 1> if the IE "RB identity" refers to a radio bearer:
 - 2> release the PDCP and RLC entities for that radio bearer;
 - 2> indicate release of the RAB subflow associated with the radio bearer to upper layers;
 - 2> delete the information about the radio bearer from the variable ESTABLISHED_RABS;

- 2> when all radio bearers belonging to the same radio access bearer have been released:
 - 3> indicate release of the radio access bearer to upper layers providing the "CN domain identity" together with the "RAB identity" and the "MBMS Service Identity" if stored in the variable ESTABLISHED_RABS;
 - 3> delete all information about the radio access bearer from the variable ESTABLISHED_RABS.

The UE shall:

- 1> determine the value for the HS_DSCH_RECEPTION variable and take the corresponding actions as described in subclause 8.5.25;
- 1> determine the value for the E_DCH_TRANSMISSION variable and take the corresponding actions as described in subclause 8.5.28.

8.6.4.7 RB with PDCP information

If the IE "RB with PDCP information" is included, the UE shall apply the following actions on the radio bearer identified with the value of the IE "RB identity". The UE shall:

- 1> for the IE "PDCP SN info":
 - 2> perform the actions as specified in subclause 8.6.4.11.

8.6.4.8 RB mapping info

If the IE "RB mapping info" is included, the UE shall:

- 1> for each multiplexing option of the RB:
 - 2> if a multiplexing option that maps a logical channel corresponding to a TM-RLC entity onto RACH, FACH, USCH, DSCH (only for TDD), HS-DSCH or E-DCH is included:
 - 3> set the variable INVALID_CONFIGURATION to TRUE.
 - 2> if the multiplexing option realises the radio bearer on the uplink (resp. on the downlink) using two logical channels with different values of the IE "Uplink transport channel type" (resp. of the IE "Downlink transport channel type"):
 - 3> set the variable INVALID_CONFIGURATION to TRUE.
 - 2> if that RB is using TM and the IE "Segmentation indication" is set to TRUE and, based on the multiplexing configuration resulting from this message, the logical channel corresponding to it is mapped onto the same transport channel as another logical channel:
 - 3> set the variable INVALID_CONFIGURATION to TRUE.
 - 2> if the transport channel considered in that multiplexing option is different from RACH and if that RB is using AM and the set of RLC sizes applicable to the uplink logical channel transferring data PDUs has more than one element not equal to zero:
 - 3> set the variable INVALID_CONFIGURATION to TRUE.
 - 2> if that RB is using UM or TM and the multiplexing option realises it using two logical channels:
 - 3> set the variable INVALID_CONFIGURATION to TRUE.
- 2> for each logical channel in that multiplexing option:
 - 3> if the value of the IE "RLC size list" is set to "Explicit list":
 - 4> if a "Transport format set" for the transport channel this logical channel is mapped on in this multiplexing option is included in the same message, and the value (index) of any IE "RLC size index" in the IE "Explicit list" does not correspond to an "RLC size" in the IE transport format set of that transport channel given in the message; or

- 4> if the transport channel this logical channel is mapped on in this multiplexing option is different from RACH, and if a "Transport format set" for that transport channel is not included in the same message, and the value (index) of any IE "RLC size index" in the IE "Explicit list" does not correspond to an "RLC size" in the stored transport format set of that transport channel; or
- 4> if a "Transport format set" for the transport channel this logical channel is mapped on in this multiplexing option is included in the same message, and the value of any IE "Logical channel list" in the transport format set is not set to "Configured"; or
- 4> if a "Transport format set" for the transport channel this logical channel is mapped on in this multiplexing option is not included in the same message, and the value of any IE "Logical channel list" in the stored transport format set of that transport channel is not set to "Configured":
 - 5> set the variable INVALID_CONFIGURATION to TRUE.
- 3> if the value of the IE "RLC size list" is set to "All":
 - 4> if the transport channel this logical channel is mapped on is RACH; or
 - 4> if a "Transport format set" for the transport channel this logical channel is mapped on in this multiplexing option is included in the same message, and the value of any IE "Logical channel list" in the transport format set is not set to "Configured"; or
 - 4> if a "Transport format set" for the transport channel this logical channel is mapped on in this multiplexing option is not included in the same message, and the value of any IE "Logical channel list" in the stored transport format set of that transport channel is not set to "Configured":
 - 5> set the variable INVALID_CONFIGURATION to TRUE.
- 3> if the value of the IE "RLC size list" is set to "Configured":
 - 4> if the transport channel this logical channel is mapped on is RACH; or
 - 4> if a "Transport format set" for the transport channel this logical channel is mapped on in this multiplexing option is included in the same message, and for none of the RLC sizes defined for that transport channel in the "Transport format set", the "Logical Channel List" is set to "All" or given as an "Explicit List" which contains this logical channel; or
 - 4> if a "Transport format set" for the transport channel this logical channel is mapped on in this multiplexing option is not included in the same message, and for none of the RLC sizes defined in the transport format set stored for that transport channel, the "Logical Channel List" is set to "All" or given as an "Explicit List" which contains this logical channel:
 - 5> set the variable INVALID_CONFIGURATION to TRUE.
- 1> if, for the HS-DSCH transport channel, when MAC-hs is configured and as a result of the message this IE is included in, several radio bearers can be mapped onto the same MAC-d flow, and the IE "Logical Channel Identity" was not included in the RB mapping info of any of those radio bearers for a multiplexing option on that MAC-d flow or the same "Logical Channel Identity" was used more than once in the RB mapping info of those radio bearers for the multiplexing options on that MAC-d flow:
 - 2> the UE behaviour is not specified.
- 1> if, for the HS-DSCH transport channel, when MAC-ehs is configured and as a result of the message this IE is included in, several radio bearers can be mapped onto the reordering queue(s), and the IE "Logical Channel Identity" was not included in the RB mapping info of any of those radio bearers for a multiplexing option on at least one reordering queue or the same "Logical Channel Identity" was used more than once in the RB mapping info of those radio bearers for the multiplexing options on any reordering queue:
 - 2> the UE behaviour is not specified.
- 1> if, as a result of the message this IE is included in, several radio bearers can be mapped onto the E-DCH MAC-d flows(s), and the IE "Logical Channel Identity" was not included in the RB mapping info of any of those radio bearers for a multiplexing option on at least one E-DCH MAC-d flow or the same "Logical Channel Identity" was used more than once in the RB mapping info of those radio bearers for the multiplexing options on any MAC-d flow:

- 2> the UE behaviour is not specified.
- 1> if, for transport channels other than HS-DSCH and E-DCH, as a result of the message this IE is included in, several radio bearers can be mapped onto the same transport channel, and the IE "Logical Channel Identity" was not included in the RB mapping info of any of those radio bearers for a multiplexing option on that transport channel or the same "Logical Channel Identity" was used more than once in the RB mapping info of those radio bearers for the multiplexing options on that transport channel:
 - 2> set the variable INVALID_CONFIGURATION to TRUE.
- 1> if, as a result of the message this IE is included in, there are several radio bearers configured with a multiplexing option mapped on "HS-DSCH", i.e., a downlink transport channel of type "HS-DSCH" or "DCH + HS-DSCH", and there is at least one radio bearer with a multiplexing option configured with the DL MAC header type set to "MAC-hs" and at least one radio bearer with a multiplexing option configured with the DL MAC header type set to "MAC-ehs":
 - 2> set the variable INVALID_CONFIGURATION to TRUE.
- 1> if the "RB mapping info" is considered as valid according to the rules above:
 - 2> delete all previously stored multiplexing options for that radio bearer;
 - 2> store each new multiplexing option for that radio bearer;
 - 2> perform the actions as specified in subclause 8.5.21;
 - 2> determine the value for the HS_DSCH_RECEPTION variable and take the corresponding actions as described in subclause 8.5.25;
 - 2> determine the value for the E_DCH_TRANSMISSION variable and take the corresponding actions as described in subclause 8.5.28.
- 1> if the IE "Uplink transport channel type" is set to the value "RACH":
 - 2> in FDD:
 - 3> refer the IE "RLC size index" to the RACH Transport Format Set of the first PRACH received in the IE "PRACH system information list" received in System Information Block 5, System Information Block 5bis or System Information Block 6.
 - 2> in TDD:
 - 3> use the first Transport Format of the PRACH of the IE "PRACH system information list" at the position equal to the value in the IE "RLC size index".
- 1> if the IE "Downlink transport channel type" is set to the value "HS-DSCH" or "DCH + HS-DSCH"; and
- 1> the DL MAC header type is set to "MAC-ehs":
 - 2> if the IE "Logical channel identity" is present:
 - 3> configure the receiving MAC-ehs entity with the value of the IE "Logical channel identity" to be used in the "LCH-ID" field of the MAC-ehs header [15] associated with the MAC-ehs reordering queue identified by the value of the IE "DL HS-DSCH MAC-ehs Queue Id".
 - 2> else:
 - 3> set the variable INVALID_CONFIGURATION to TRUE.

In case IE "RLC info" includes IE "Downlink RLC mode" ("DL RLC logical channel info" is mandatory present) but IE "Number of downlink RLC logical channels" is absent in the corresponding IE "RB mapping info", the parameter values are exactly the same as for the corresponding UL logical channels. In case two multiplexing options are specified for the UL, the first options shall be used as default for the DL. As regards the IE "Channel type", the following rule should be applied to derive the DL channel type from the UL channel included in the IE:

Channel used in UL	DL channel type implied by "same as"
DCH	DCH
RACH	FACH
USCH	DSCH

If ciphering is applied, UTRAN should not map Transparent Mode RBs of different CN domains on the same transport channel and it should not map transparent mode SRBs and RBs onto the same transport channel. In such cases the UE behaviour is not specified.

For FDD the list of multiplexing options configured in the UE for each RB and SRB should comply with the following rules otherwise the UE behaviour is not specified:

- at most one multiplexing option can contain the combination "FACH" for the DL and "RACH" for the UL;
- for FDD, at most one multiplexing option can contain the combination "HS-DSCH" mapped on MAC-ehs for the DL and "RACH" for the UL;
- at most one multiplexing option can contain the combination "DCH" or "DCH + HS-DSCH" for the DL together with "DCH" for the UL;
- at most one multiplexing option can contain the combination "HS-DSCH" or "DCH + HS-DSCH" for the DL together with "DCH" for the UL;
- at most one multiplexing option can contain the combination "DCH" or "DCH + HS-DSCH" for the DL together with "E-DCH" for the UL; and
- at most one multiplexing option can contain the combination "HS-DSCH" or "DCH + HS-DSCH" for the DL together with "E-DCH" for the UL.

8.6.4.9 RLC Info

Upon reception of the IE "RLC Info", the UE shall:

- 1> if both the IE "Uplink RLC mode" and the IE "Downlink RLC mode" are present in the IE "RLC info":
 - 2> configure the transmitting and receiving RLC entities in the UE for that radio bearer accordingly.
- 1> else, if the IE "Uplink RLC mode" is present and the IE "Downlink RLC mode" is not present in the IE "RLC info":
 - 2> configure the transmitting RLC entity in the UE for that radio bearer accordingly and keep the configuration existing before the reception of the message for the receiving RLC entity.
- 1> else, if the IE "Uplink RLC mode" is not present and the IE "Downlink RLC mode" is present in the IE "RLC info":
 - 2> configure the receiving RLC entity in the UE for that radio bearer accordingly and keep the configuration existing before the reception of the message for the transmitting RLC entity.
- 1> if the IE "Polling info" is present in the IE "RLC info":
 - 2> for each present IE in the IE "Polling info":
 - 3> configure RLC to use the corresponding function according to the value of the IE.
 - 2> for each absent IE in the IE "Polling info":
 - 3> configure RLC to not use the corresponding function.
- 1> if the IE "Polling info" is absent:
 - 2> configure RLC to not use the polling functionality.
- 1> if the IE "Downlink RLC STATUS info" is present in the IE "RLC info" (this IE is present for AM RLC):

- 2> for each present IE in the IE "Downlink RLC STATUS info":
 - 3> configure RLC to use the corresponding function according to value of the IE.
 - 2> for each absent IE in the IE "Downlink RLC STATUS info":
 - 3> configure RLC to not use the corresponding function.
 - 1> if the IE "Transmission RLC discard" is present:
 - 2> configure the discard procedure in RLC according to the IE "Transmission RLC discard"
 - 1> if the IE "Transmission RLC discard" is absent (only possible for TM RLC and UM RLC):
 - 2> do not configure SDU discard in RLC.
 - 1> if the IE "Uplink RLC mode" is present and is set to "AM RLC":
 - 2> if the IE "Use special value of HE field" is present:
 - 3> configure the uplink RLC entity to use the special value of the HE field to indicate the end of an SDU.
 - 2> if the IE "Use special value of HE field" is not present:
 - 3> configure the uplink RLC entity to not use the special value of the HE field to indicate the end of an SDU.
 - 1> if the IE "Uplink RLC mode" is present and is set to "UM RLC":
 - 2> if the IE "Alternative E-bit interpretation" is present:
 - 3> configure the uplink RLC entity to use the alternative E-bit interpretation and corresponding LI's.
 - 2> if the IE "Alternative E-bit interpretation" is not present:
 - 3> configure the uplink RLC entity to use the normal E-bit interpretation and corresponding LI's.
 - 1> if the IE "Downlink RLC mode" is present and is set to "AM RLC":
 - 2> if IE "DL RLC PDU size" is not present:
 - 3> determining the downlink RLC PDU size will be handled at RLC level as described in [16], without any configuration from RRC.
- NOTE: The case where this mandatory IE is not present is meant to handle the interaction with a network using an earlier release of the specification.
- 2> else, if the IE "DL RLC PDU size" is present, the DL RLC PDU size is set to "fixed size" and no downlink RLC PDU size is currently set in the RLC entity:
 - 3> configure the corresponding RLC entity with the downlink RLC PDU size.
 - 2> else, if the DL RLC PDU size is set to "flexible size" and no downlink RLC PDU size is currently set in the RLC entity:
 - 3> if this radio bearer is a signalling radio bearer:
 - 4> the UE behaviour is unspecified.
 - 3> else, configure the corresponding RLC entity with the RLC length indicator size indicated in the IE "Length indicator size".
 - 2> else, if the DL RLC PDU size is changed to "flexible size" from "fixed size" and the the indicated RLC length indicator size is 7 bits:
 - 3> if this radio bearer is a signalling radio bearer:
 - 4> the UE behaviour is unspecified.

- 3> else, configure the corresponding RLC entity with flexible RLC PDU size and the RLC length indicator size indicated in the IE "Length indicator size".
- 2> else, if the IE "DL RLC PDU size" is present, the DL RLC PDU size is set to "fixed size" and DL RLC PDU size value is different from the one currently set in the RLC entity; or
- 2> the DL RLC PDU size is set to "flexible size" and the indicated RLC length indicator size is different from the one currently set in the RLC entity; or
- 2> the DL RLC PDU size is changed to "fixed size" from "flexible size"; or
- 2> the DL RLC PDU size is changed to "flexible size" from "fixed size" and the indicated RLC length indicator size is 15 bits:

NOTE: The downlink RLC PDU size set in the RLC entity should be explicitly configured in this release of the specification.

- 3> if the DL RLC PDU size is set to "flexible size":
 - 4> if this radio bearer is a signalling radio bearer:
 - 5> the UE behaviour is unspecified.
- 3> if the IE "one sided RLC re-establishment" is set to TRUE:
 - 4> re-establish the receiving side of the corresponding RLC entity.
- 3> else:
 - 4> re-establish the corresponding RLC entity.
- 3> if the RLC entity for SRB2 is re-established:
 - 4> clear all entries in the table "Processed transactions" in the variable TRANSACTIONS.
- 3> if the DL RLC PDU size is set to "fixed size":
 - 4> configure the corresponding RLC entity with the new downlink RLC PDU size.
- 3> if the DL RLC PDU size is set to "flexible size":
 - 4> configure the corresponding RLC entity with the RLC length indicator size indicated in the IE "Length indicator size".
- 3> if the UE supports the lossless DL RLC PDU size change and PDCP was configured for that radio bearer with the IE "Support for lossless SRNS relocation or for lossless DL RLC PDU size change" set to TRUE:
 - 4> include the current DL PDCP receive sequence number and the radio bearer identity for that radio bearer in the variable PDCP_SN_INFO.
- 3> if the IE "Status" in the variable CIPHERING_STATUS of the CN domain as indicated in the IE "CN domain identity" in the IE "RAB info" for this radio bearer is set to "Started":
 - 4> if the RLC re-establishment is caused by a CELL UPDATE CONFIRM:
 - 5> if only the receiving side of the RLC entity was re-established:
 - 6> set the HFN values for the corresponding RLC entity in downlink equal to the value of the IE "START" included in the latest transmitted CELL UPDATE message for this CN domain.
 - 5> if the whole RLC entity was re-established:
 - 6> set the HFN values for the corresponding RLC entity in uplink and downlink equal to the value of the IE "START" included in the latest transmitted CELL UPDATE message for this CN domain.

- 4> if the RLC re-establishment is caused by a reconfiguration message:
 - 5> if only the receiving side of the RLC entity was re-established:
 - 6> set the HFN values for the corresponding RLC entity in downlink equal to the value of the IE "START" that will be included in the reconfiguration complete message for this CN domain.
 - 5> if the whole RLC entity was re-established:
 - 6> set the HFN values for the corresponding RLC entity in uplink and downlink equal to the value of the IE "START" that will be included in the reconfiguration complete message for this CN domain.
 - 2> if the UE supports MAC-ehs:
 - 3> configure the downlink RLC entity to use the special value of the HE field to indicate the end of an SDU.
 - 2> else:
 - 3> configure the downlink RLC entity to not use the special value of the HE field to indicate the end of an SDU.
 - 1> if the IE "Downlink RLC mode" is present and is set to "UM RLC":
 - 2> if the IE "DL UM RLC LI size" is not present:
 - 3> configure the corresponding RLC entity with an LI size of 7 bits;
- NOTE: The case where this mandatory IE is not present is meant to handle the interaction with a network using an earlier release of the specification.
- 2> else:
 - 3> configure the corresponding RLC entity with the LI size indicated in the IE "DL UM RLC LI size".
 - 2> if the IE "DL Reception Window Size" is present:
 - 3> if the variable UE_CAPABILITY_TRANSFERRED indicates "Support of HS-PDSCH" as "Supported":
 - 4> configure the corresponding RLC entity to support out-of-sequence reception with the receive window size indicated in the IE.
 - 3> if the variable UE_CAPABILITY_TRANSFERRED indicates "Support of HS-PDSCH" as "Unsupported":
 - 4> the UE behaviour is not specified.
 - 2> else:
 - 3> configure the corresponding RLC entity without out-of-sequence reception.
- NOTE: If the "Uplink RLC mode" or the "Downlink RLC mode" of an existing radio bearer is modified by a reconfiguration message, the UE behaviour is unspecified.
- 2> if the IE "Alternative E-bit interpretation" is present:
 - 3> configure the downlink RLC entity to use the alternative E-bit interpretation and corresponding LI's.
 - 2> if the IE "Alternative E-bit interpretation" is not present:
 - 3> configure the downlink RLC entity to use the normal E-bit interpretation and corresponding LI's.

8.6.4.10 PDCP Info

For ROHC, as specified in [83] and [84]:

- 1> the chosen MAX_CID shall be less than the value "Maximum number of ROHC context sessions" as indicated in the IE "PDCP Capability".

If IE "PDCP info" is included, the UE shall:

- 1> if the radio bearer is connected to a CS domain radio access bearer:
 - 2> if the IE "PDCP info" is included in any other message than the RADIO BEARER SETUP, CELL UPDATE CONFIRM or the HANDOVER TO UTRAN COMMAND message; or
 - 2> if the IE "PDCP PDU header" is set to the value "absent"; or
 - 2> if the IE "Support for lossless SRNS relocation or for lossless DL RLC PDU size change" is set to TRUE; or
 - 2> if the IE "Header compression information" is present; or
 - 2> if the UE does not support CS voice service over HSDPA and EDCH:
 - 3> set the variable INVALID_CONFIGURATION to TRUE.
 - 2> else
 - 3> include PDCP headers in both uplink and downlink PDCP PDUs.
 - 3> configure "PDCP Unrecoverable Error Detection" in lower layer.
- 1> else if the radio bearer is connected to a PS domain radio access bearer:
 - 2> if the IE "PDCP PDU header" is set to the value "absent":
 - 3> if the IE "Support for lossless SRNS relocation or for lossless DL RLC PDU size change" is TRUE:
 - 4> set the variable INVALID_CONFIGURATION to TRUE.
 - 2> if the IE "PDCP PDU header" is set to the value "present":
 - 3> include PDCP headers in both uplink and downlink PDCP PDUs;
 - 3> if the IE "Support for lossless SRNS relocation or for lossless DL RLC PDU size change" is FALSE:
 - 4> if the IE "Header compression information" is absent:
 - 5> set the variable INVALID_CONFIGURATION to TRUE.
 - 2> if the IE "Header compression information" is absent:
 - 3> not use Header compression after the successful completion of this procedure;
 - 3> remove any stored configuration for the IE "Header compression information".
 - 2> if the IE "Header compression information" is present:
 - 3> if the IE "Algorithm Type" is set to "RFC 2507":
 - 4> if the UE capability "Maximum header compression context space", as specified in [35], is exceeded with this configuration:
 - 5> set the variable INVALID_CONFIGURATION to TRUE.
 - 4> if the IE "PDCP PDU header" is set to the value "absent":
 - 5> the behaviour of the UE is unspecified.
 - 3> if the IE "Algorithm Type" is set to "RFC 3095":
 - 4> if the uplink RLC mode for this radio bearer is RLC-TM:
 - 5> the behaviour of the UE is unspecified.

- 1> configure the PDCP entity for that radio bearer accordingly;
- 1> configure the RLC entity for that radio bearer according to the value of the IE "Support for lossless SRNS relocation or for lossless DL RLC PDU size change";
- 1> set the PROFILES parameter, used by inband ROHC profile negotiation, for this PDCP entity for both UL and DL equal to the list of ROHC profiles received in the IE "PDCP info". A UE complying to this version of the protocol shall support ROHC profiles 0x0000 (ROHC uncompressed), 0x0001 (ROHC RTP), 0x0002 (ROHC UDP) and 0x0003 (ROHC ESP) (see [52]).
- 1> if the IE "PDCP ROHC target mode" is received:
 - 2> set the variable " PDCP_ROHC_TARGET_MODE " to the received value.
- 1> if the IE "PDCP ROHC target mode" is not received in either of the CELL UPDATE CONFIRM, the RADIO BEARER RECONFIGURATION or the RADIO BEARER SETUP message:
 - 2> delete the variable "PDCD_ROHC_TARGET_MODE" and act according to actions specified in [36].

8.6.4.11 PDCP SN Info

If the IE "PDCP SN Info" is included, the UE shall:

- 1> transfer the sequence number to the PDCP entity for the radio bearer;
- 1> configure the RLC entity for the radio bearer to stop;
- 1> include the current PDCP receive sequence number and the radio bearer identity for the radio bearer in the variable PDCP_SN_INFO.

8.6.4.12 NAS Synchronisation Indicator

If the IE "NAS Synchronisation Indicator" is present in a message, the UE shall:

- 1> forward the content to upper layers along with the IE "CN domain identity" of the associated RAB stored in the variable ESTABLISHED_RABS at the CFN indicated in the IE "Activation time" in order to synchronise actions in NAS and AS.

8.6.4.13 PDCP context relocation info

If the IE "PDCP context relocation info" is included, the UE shall, for each radio bearer included in this IE:

- 1> If the IE "Downlink RFC 3095 context relocation indication" is set to TRUE:
 - 2> perform the actions as specified in [36] for all ROHC contexts associated with that radio bearer in the downlink.
- 1> If the IE "Uplink RFC 3095 context relocation indication" is set to TRUE:
 - 2> perform the actions as specified in [36] for all ROHC contexts associated with that radio bearer in the uplink.

8.6.4.14 RLC Info MBMS

Upon reception of the IE "RLC Info MBMS", the UE shall:

- 1> configure the receiving RLC entity in the UE for that radio bearer accordingly;
- 1> configure the corresponding RLC entity with the LI size indicated in the IE "DL UM RLC LI size".
- 1> if the IE "DL Duplication Avoidance and Reordering info" is present:
 - 2> configure the corresponding RLC entity to use the UM duplication avoidance and reordering functionality.
- 1> if the IE "DL Out of sequence delivery info" is present:

2> configure the corresponding RLC entity to use the UM out of sequence delivery functionality.

8.6.4.15 RAB information for MBMS ptp bearer

If the IE "RAB information for MBMS ptp bearer" is included then the UE shall:

- 1> if an entry for the radio access bearer identified by the IE "RB Identity" already exists in the variable ESTABLISHED_RABS and a value of the IE "MBMS Service Identity" is stored in this entry of the variable ESTABLISHED_RABS:
 - 2> notify upper layers that the radio access bearer characterised by the parameters currently stored in this entry of the variable ESTABLISHED_RABS is released;
 - 2> reuse this entry of the variable ESTABLISHED_RABS and update it with the received value of IE "MBMS Service Identity" and, if included, with the received value of IE "MBMS Session Identity";
 - 2> notify upper layers that the radio access bearer characterised by the updated parameters in this entry is established.
- 1> else:
 - 2> set the variable INVALID_CONFIGURATION to TRUE.

8.6.5 Transport channel information elements

8.6.5.1 Transport Format Set

If the IE "Transport format set" is included, the UE shall:

- 1> if the transport format set is a RACH TFS received in System Information Block type 5 or System Information Block type 5bis or System Information Block type 6, and CHOICE "Logical Channel List" has a value different from "Configured":
 - 2> ignore that System Information Block.

NOTE: The TFS added by the IE "Additional Dynamic Transport Format Information for CCCH" has no CHOICE "Logical Channel List" and can thus never be considered as different from "Configured".

- 1> if the transport format set for a downlink transport channel is received in a System Information Block, and CHOICE "Logical Channel List" has a value different from 'ALL':
 - 2> ignore that System Information Block.
- 1> if the transport format set for a downlink transport channel is received in a message on a DCCH, and CHOICE "Logical Channel List" has a value different from 'ALL':
 - 2> keep the transport format set if this exists for that transport channel;
 - 2> set the variable INVALID_CONFIGURATION to TRUE.
- 1> if the value of any IE "RB identity" (and "Logical Channel" for RBs using two UL logical channels) in the IE "Logical channel list" does not correspond to a logical channel indicated to be mapped onto this transport channel in any RB multiplexing option (either included in the same message or previously stored and not changed by this message); or
- 1> if the "Logical Channel List" for any of the RLC sizes defined for that transport channel is set to "Configured" while it is set to "All" or given as an "Explicit List" for any other RLC size; or
- 1> if the "Logical Channel List" for any of the RLC sizes defined for that transport channel is set to "All" and for any logical channel mapped to this transport channel, the value of the "RLC size list" (either provided in the IE "RB mapping info" if included in the same message, or stored) is not set to "Configured"; or

- 1> if the "Logical Channel List" for any of the RLC sizes defined for that transport channel is given as an "Explicit List" that contains a logical channel for which the value of the "RLC size list" (either provided in the IE "RB mapping info" if included in the same message, or stored) is not set to "Configured"; or
- 1> if the "Logical Channel List" for all the RLC sizes defined for that transport channel are given as "Explicit List" and if one of the logical channels mapped onto this transport channel is not included in any of those lists; or
- 1> if the "Logical Channel List" for the RLC sizes defined for that transport channel is set to "Configured" and for any logical channel mapped onto that transport channel, the value of the "RLC size list" (either provided in the IE "RB mapping info" if included in the same message, or stored) is also set to "Configured"; or
- 1> if the IE "Transport Format Set" was not received within the IE "PRACH system information list" and if the "Logical Channel List" for the RLC sizes defined for that transport channel is set to "Configured" and for any logical channel mapped onto that transport channel, the "RLC size list" (either provided in the IE "RB mapping info" if included in the same message, or stored) is given as an "Explicit List" that includes an "RLC size index" that does not correspond to any RLC size in this "Transport Format Set"; or
- 1> if the IE "Transport Format Set" was not received within the IE "PRACH system information list", and if that RB is using AM and the set of RLC sizes applicable to the logical channel transferring data PDUs has more than one element not equal to zero:
 - 2> keep the transport format set if this exists for that transport channel;
 - 2> set the variable INVALID_CONFIGURATION to TRUE.
- 1> if the total number of configured transport formats for the transport channel exceeds maxTF:
 - 2> keep the transport format set if this exists for that transport channel;
 - 2> set the variable INVALID_CONFIGURATION to TRUE.
- 1> if the IE "Transport format set" is considered as valid according to the rules above:
 - 2> remove a previously stored transport format set if this exists for that transport channel;
 - 2> store the transport format set for that transport channel;
 - 2> consider the first instance of the parameter *Number of TBs and TTI List* within the *Dynamic transport format information* to correspond to transport format 0 for this transport channel, the second to transport format 1 and so on;
 - 2> if the IE "Transport format Set" has the choice "Transport channel type" set to "Dedicated transport channel":
 - 3> calculate the transport block size for all transport formats in the TFS using the following

TB size = RLC size + MAC header size	if "RLC size" <> 0,
TB size = 0	if "RLC size" = 0,

where:

 - MAC header size is calculated according to [15] if MAC multiplexing is used. Otherwise it is 0 bits;
 - 'RLC size' reflects the RLC PDU size.
- 2> if the IE "Transport format Set" has the choice "Transport channel type" set to "Common transport channel":
 - 3> calculate the transport block size for all transport formats in the TFS using the following:

$$\text{TB size} = \text{RLC size.}$$
- 2> if the IE "Number of Transport blocks" <> 0 and IE "RLC size" = 0, no RLC PDU data exists but only parity bits exist for that transport format;
- 2> if the IE "Number of Transport blocks" = 0, neither RLC PDU neither data nor parity bits exist for that transport format;
- 2> perform the actions as specified in subclause 8.5.21.

For configuration restrictions on Blind Transport Format Detection, see [27].

8.6.5.2 Transport format combination set

If the IE "Transport format combination set" is included for the uplink, the UE shall for that direction:

- 1> store the new transport format combination set, or (if this exists) modify a previously stored transport format combination set according to IEs included in IE "Transport format combination set";
- 1> start to respect those transport format combinations;
- 1> if IE "Transport format combination subset" is received in this message:
 - 2> perform the actions as specified in subclause 8.6.5.3.
- 1> if IE "Transport format combination subset" is not received in this message:
 - 2> clear the IE "Duration" in the variable TFC_SUBSET;
 - 2> set both the IE "Current TFC subset" and the IE "Default TFC subset" in the variable TFC_SUBSET to the value indicating "full transport format combination set".

If the IE "Transport format combination set" is included for the downlink, the UE shall for that direction:

- 1> store the new transport format combination set, or (if this exists) modify a previously stored transport format combination set according to IEs included in IE "Transport format combination set";
- 1> start to respect those transport format combinations.

If the IE "Transport format combination set" is not included for the uplink and if there is no addition, removal or reconfiguration of transport channels, the UE shall for that direction:

- 1> use a previously stored transport format combination set if this exists.

If the IE "Transport format combination set" is not included for the downlink and if there is no addition, removal or reconfiguration of transport channels, the UE shall for that direction:

- 1> use a previously stored transport format combination set if this exists.

If the IE "Transport format combination set" is not included for either the uplink or the downlink and for that direction after the reconfiguration there is one or more stored DCH configuration; and

- 1> if no transport format combination set is stored in the UE; or
- 1> if transport channels are added or removed in the message; or
- 1> if any transport channel is reconfigured in the message such that the size of the transport format set is changed:

the UE shall:

- 1> set the variable INVALID_CONFIGURATION to TRUE.

If the IE "Transport format combination set" is not included for either the uplink or the downlink and for that direction after the reconfiguration there is no stored DCH configuration, the UE shall:

- 1> remove any stored transport format combination set for dedicated channels for that direction.

In the uplink TFCS the minimum set of TFCs is the set of TFCs that is needed for the TFC selection algorithm defined in [15] to give a predictable result. Any configured TFCS or TFC subset shall satisfy the requirements as specified by the minimum set. In the definition of the minimum set of TFCs below, only logical channels for which the TFCS or the TFC subset include at least one TFC with non-empty TF for the corresponding transport channel should be considered.

The minimum set of TFCs consists of the following:

- 1> for each UM logical channel:

2> a TFC with one transport block for this transport channel and empty TFs (see [34]) for all the others. If more than one TFC fulfils these criteria, only the TFC with the lowest number of bits should be included in the minimum set of TFCs.

1> for each AM logical channel:

2> a TFC with a non-empty TF for the corresponding transport channel and empty TFs for all other transport channels, where the non-empty TF includes one transport block with "Configured RLC Size" equal to the RLC PDU size.

1> for each set of "synchronous" TM logical channels (see the definition below) and for each set of SDU sizes associated with it:

2> a TFC with TFs corresponding to any combination of SDU sizes that can be received in a TTI from higher layers on the corresponding transport channels and empty TFs for all other transport channels.

NOTE: In case an adaptive rate codec is used and the TFCS has been restricted by the IE "TFC subset", the minimum set consists of the set of TFCs with TFs corresponding to any combination of SDU sizes that can be received in a TTI respecting the restricted TFCS.

1> for each TM logical channel that is not part of a set of "synchronous" TM logical channels (see the definition below):

2> a TFC with non-empty TFs for the corresponding transport channel, and empty TFs for all other transport channels, where

3> for non-segmented mode TM-RLC logical channels the non-empty TFs include, for the smallest SDU size that can be received in a single TTI from higher layer:

4> a TF with non-zero number of transport blocks with "Configured RLC Size" equal to the corresponding SDU size. If more than one TFC fulfils these criteria, only the TFC with the lowest number of bits in the TFC is included in the minimum set of TFCs.

3> for segmented mode TM-RLC, the non-empty TFs include any TF such that the number of transport blocks multiplied by the "Configured RLC Size" is equal to the smallest SDU size that can be received in a single TTI from higher layer.

1> an "empty" TFC (see [34]).

Furthermore, the UTRAN should ensure that the uplink TFCS and any configured TFC Subset satisfies the following rules:

1> for each TTI length with which at least one transport channel is configured:

2> for each combination of TFs for the transport channels configured with this TTI length included in the TFCS:

3> a TFC with these TFs for the transport channels configured with this TTI length and empty TFs on all transport channels configured with shorter TTI lengths is also included in the TFCS.

For TDD, the TFCS of a CCTrCH should include those of the above combinations, which include a TF with one transport block for a transport channel used in that CCTrCH, and the "empty" TFC should be included in the TFCS of every CCTrCH.

Synchronous TM logical channels are logical channels on which higher layer traffic is generated in a perfectly correlated fashion (e.g. AMR RAB).

NOTE: The "Configured RLC Size" is defined as the transport block size minus the MAC header size.

8.6.5.3 Transport format combination subset

When configuring a TFC Subset, the UTRAN should follow the guidelines defined in subclause 8.6.5.2.

If a DCH is configured on the uplink and the IE "Transport format combination subset" ("TFC subset") is included, the UE shall:

1> if the IE "Minimum allowed Transport format combination index" is included; and

- 2> if the value of the IE "Minimum allowed Transport format combination index" is greater than the highest TFCI value in the current transport format combination set:
 - 3> consider the TFC subset to be incompatible with the current transport format combination set.
- 1> if the IE "Allowed transport format combination list" is included; and
 - 2> if the value of any of the IEs "Allowed transport format combination" included in the IE "Allowed transport format combination list" does not match a TFCI value in the current transport format combination set:
 - 3> consider the TFC subset to be incompatible with the current transport format combination set.
- 1> if the IE "Non-allowed transport format combination list" is included; and
 - 2> if the value of any of the IEs "Non-allowed transport format combination" included in the IE "Non-allowed transport format combination list" does not match a TFCI value in the current transport format combination set:
 - 3> consider the TFC subset to be incompatible with the current transport format combination set.
- 1> if the IE "Restricted TrCH information" is included:
 - 2> if the value of any of the IEs "Uplink transport channel type" and "Restricted UL TrCH identity" included in the IE "Restricted TrCH information" do not correspond to any of the transport channels for which the current transport format combination set is valid:
 - 3> consider the TFC subset to be incompatible with the current transport format combination set.
 - 2> if the IE "Allowed TFIs" is included; and
 - 3> if the value of each of the IEs "Allowed TFI" included in the IE "Allowed TFIs" corresponds to a transport format for that transport channel within the current transport format combination set:
 - 4> allow all transport format combinations that include these transport formats for the transport channel;
 - 4> restrict all other transport format combinations.
 - 3> else:
 - 4> consider the TFC subset to be incompatible with the current transport format combination set.
 - 2> if the IE "Allowed TFIs" is not included:
 - 3> restrict all transport format combinations where the transport channel has a transport format of non-zero rate.
- 1> if the UE considers the TFC subset to be incompatible with the current Transport format combination set according to the above:
 - 2> keep any previous restriction of the transport format combination set;
 - 2> set the variable INVALID_CONFIGURATION to TRUE.
- 1> if the UE does not consider the TFC subset to be incompatible with the current Transport format combination set according to the above:
 - 2> if the IE "Transport format combination subset" is received in a message other than a TRANSPORT FORMAT COMBINATION CONTROL message:
 - 3> set both the IE "Current TFC subset" and the IE "Default TFC subset" in the variable TFC_SUBSET to the IE "Transport format combination subset" (in case of TDD for the uplink CCTrCH specified by the IE "TFCS Id");
 - 3> clear the IE "Duration" in the variable TFC_SUBSET;
 - 3> apply the transport format combination subset in the IE "Current TFC subset" stored in the variable TFC_SUBSET.

- 1> if the IE "transport format combination subset" indicates the "full transport format combination set":
 - 2> set both the IE "Current TFC subset" and the IE "Default TFC subset" in the variable TFC_SUBSET to the value indicating "full transport format combination set";
 - 2> clear the IE "Duration" in the variable TFC_SUBSET;
 - 2> if the IE "Transport format combination subset" is received in a TRANSPORT FORMAT COMBINATION CONTROL message, then at the CFN indicated by the IE "Activation time for TFC subset" any restriction on transport format combination set is released and the UE may use the full transport format combination set;
 - 2> else:
 - 3> any restriction on transport format combination set is released and the UE may use the full transport format combination set.

8.6.5.4 DCH quality target

When not operating with DCH Enhancements, if the IE "DCH quality target" is included, the UE shall:

- 1> set, at physical channel establishment, the initial downlink target SIR value based on the received IE "DCH quality target" for the transport channel with respect to all transport formats;
- 1> adjust the target SIR for the downlink power control to meet the quality target received in the IE "DCH quality target" for the transport channel. The UE shall not compensate for the fact that the required SIR to achieve a target BLER for a particular transport format may be different from the required SIR to achieve the target BLER for another transport format..

NOTE 1: Adjusting the target SIR is possible to do continuously by the UE if a CRC exists in all transport formats in the downlink TFS for a DCH. If a CRC does not exist in all transport formats, the UE can only adjust the target SIR when receiving transport formats containing a CRC and the UE has knowledge about the transport format according to [27].

NOTE 2: If the UTRAN configures a UE to use blind transport format detection and configures a transport channel such that single transport format detection [27] must be used to detect the TF, then it is not possible for the UE to maintain a quality target for that transport channel.

When operating with DCH Enhancements in DL FET Basic mode, the UE shall:

- 1> set, at physical channel establishment, the initial downlink target SIR value based on the received IE "DCH quality target" for the transport channel with respect to all transport formats;
- 1> when the selected uplink TFC is in 10ms Mode, adjust the target SIR for the downlink power control to meet the quality target received in the IE "DCH quality target" for the transport channel at the end of slot number 14 in a TTI;
- 1> when the selected uplink TFC is in 20ms Mode, adjust the target SIR for the downlink power control to meet the quality target received in the IE "DCH quality target" for the transport channel at the end of slot number 29 in a TTI;
- 1> reduce the target SIR for the downlink power control by 3dB reduction when switching transmission from 10ms Mode to 20ms Mode;
- 1> increase the target SIR for the downlink power control by 3dB reduction when switching transmission from 20ms Mode to 10ms Mode.

8.6.5.5 Added or Reconfigured UL TrCH information

If the IE "Added or Reconfigured UL TrCH information" is included then the UE shall:

- 1> for the transport channel identified by the IE "UL Transport Channel Identity" and IE "Uplink transport channel type":
 - 2> perform the actions for the IE "Transport Format Set" as specified in subclause 8.6.5.1.

NOTE: The UE stores the UL transport channel configuration until it is explicitly deleted by a message containing the IE "Deleted UL TrCH information" or the UE leaves RRC Connected mode.

1> if the choice "UL parameters" is set to 'E-DCH':

2> for FDD:

3> apply the values of the IE "E-DCH Transmission Time Interval" and the IE "HARQ info for E-DCH" to all E-DCH MAC-d flows.

2> for TDD:

3> apply the value of the IE "HARQ info for E-DCH" to all E-DCH MAC-d flows.

2> for the IE "HARQ Info for E-DCH":

3> perform the actions specified in subclause 8.6.5.17.

2> if the IE "Added or Reconfigured E-DCH MAC-d Flow list" is included:

3> for each MAC-d flow identified by the IE "Mac-d flow identity":

4> perform the actions as specified in subclause 8.6.5.18.

2> determine the value for the E_DCH_TRANSMISSION variable and take the corresponding actions as described in subclause 8.5.28.

NOTE: In case of multiple E-DCH MAC-d flows, IE "Added or Reconfigured UL TrCH information" is only included once. If the IE "Added or Reconfigured UL TrCH information" is included more than once with the IE "Uplink transport channel type" set to 'E-DCH', the UE behaviour is unspecified.

NOTE: In case the IE "Added or Reconfigured UL TrCH information" is included in a message that contains the IE "Deleted UL TrCH information" with a transport channel with the same identity as indicated by IE "UL Transport Channel Identity" and same type as indicated in the IE "Uplink transport channel type" then the UE behaviour is unspecified.

8.6.5.5a Added or reconfigured MAC-d flow

If the IE "Added or reconfigured MAC-d flow" is included, the UE shall:

1> if a MAC-hs queue (identified by the IE "MAC-hs queue Id") is included in both the IE "MAC-hs queue to add or reconfigure list" and the IE "MAC-hs queue to delete list":

2> set the variable INVALID_CONFIGURATION to TRUE.

1> for each MAC-hs queue included in the IE "MAC-hs queue to add or reconfigure" list:

2> if the UE has previously stored a mapping between this MAC-hs queue and a MAC-d flow:

3> delete the old mapping.

2> map the MAC-d flow indicated in the current message to this MAC-hs queue;

2> set the release timer for each of the MAC-hs queues in the MAC-hs entity to the value in the corresponding IE "T1";

2> set the MAC-hs receiver window size for each of the MAC-hs queues in the MAC-hs entity to the value in the corresponding IE "MAC-hs window size"; and

2> configure MAC-hs with the mapping between MAC-d PDU sizes index and allowed MAC-d PDU sizes as follows:

3> if a MAC-d PDU size has been stored for a MAC-d PDU size index for the corresponding MAC-hs queue and no mapping is provided in the current message for this MAC-d PDU index:

4> continue to use this mapping.

- 3> if a MAC-d PDU size has been stored for a MAC-d PDU size index for the corresponding MAC-hs queue and a mapping is provided in the current message for this MAC-d PDU index:
 - 4> configure the MAC-hs entity with the mapping indicated in the current message.
- 1> for each MAC-hs queue included in the IE "MAC-hs queue to delete" list:
 - 2> delete any information about the MAC-hs queue identified by the IE "MAC-hs queue Id".
- 1> if the IE "Added or reconfigured MAC-d flow" is considered valid according to the rules above:
 - 2> perform the actions as specified in subclause 8.5.21.

8.6.5.6 Added or Reconfigured DL TrCH information

If the IE "Added or Reconfigured DL TrCH information" is included the UE shall:

- 1> for the transport channel identified by the IE "DL Transport Channel Identity":
 - 2> if the choice "DL parameters" is set to 'explicit':
 - 3> perform the actions for the IE "Transport Format Set" as specified in subclause 8.6.5.1.
 - 2> if the choice "DL parameters" is set to 'same as uplink':
 - 3> if the IE "UL Transport Channel Identity" indicates an existing or a new UL Transport Channel:
 - 4> store as transport format for this transport channel the transport format associated with the transport channel identified by the IE "UL Transport Channel Identity".
 - 3> else:
 - 4> set the variable INVALID_CONFIGURATION to TRUE.
 - 2> if the IE "DCH quality target" is included:
 - 3> perform the actions specified in subclause 8.6.5.4.
- 1> if the choice "DL parameters" is set to "HSDSCH":
 - 2> if the IE "HARQ Info" is included:
 - 3> perform the actions specified in subclause 8.6.5.6b.
 - 2> if the IE "Added or Reconfigured MAC-d Flow" is included:
 - 3> perform the actions as specified in subclause 8.6.5.5a.
 - 2> if the IE "Added or Reconfigured MAC-ehs reordering queue" is included:
 - 3> if inter-Node B Multiflow operation is configured:
 - 4> perform the actions as specified in subclause 8.6.5.23 for both MAC-ehs entities.
 - 3> else:
 - 4> perform the actions as specified in subclause 8.6.5.23.
 - 2> determine the value for the HS_DSCH_RECEPTION variable and take the corresponding actions as described in subclause 8.5.25.

NOTE: The UE stores the DL transport channel configuration until it is explicitly deleted by a message containing the IE "Deleted DL TrCH information" or the UE leaves RRC connected mode.

NOTE: In case the IE "Added or Reconfigured DL TrCH information" is included in a message that contains the IE "Deleted DL TrCH information" with a transport channel with the same identity as indicated by IE "DL Transport Channel Identity" and same type as indicated in the IE "Downlink transport channel type" then the UE behaviour is unspecified.

8.6.5.6a Void

8.6.5.6b HARQ Info

If the IE "HARQ Info" is included, the UE shall:

- 1> store the received configuration;
- 1> determine the value for the HS_DSCH_RECEPTION variable and take the corresponding actions as described in subclause 8.5.25;
- 1> determine the value for the HS_DSCH_RECEPTION_CELL_FACH_STATE variable and take the corresponding actions as described in subclause 8.5.36.

When the corresponding entry in the variable SECONDARY_CELL_HS_DSCH_RECEPTION is set to TRUE, the number of processes for the secondary serving HS-DSCH cell is derived from Table 8.6.5.6b:

Table 8.6.5.6b: "Number of Processes for a secondary serving HS-DSCH cell"

	The IE "Number of Processes" is set to a value between 1 and 5, inclusive	The IE "Number of Processes" is set to a value between 6 and 8, inclusive	The IE "Number of Processes" is set to 12,14 or 16	The IE "Number of Processes" is set to 24, 28 or 32
If MIMO or MIMO mode with four transmit antennas with dual stream restriction is configured for this secondary serving HS-DSCH cell	If Memory Partitioning is set to implicit, the UE behaviour is not specified. Else, the number of processes for the secondary serving HS-DSCH cell is equal to twice the value of the IE "Number of Processes"	The number of processes for this secondary serving HS-DSCH cell is equal to twice the value of the IE "Number of Processes"	The number of processes for this secondary serving HS-DSCH cell is equal to the value of the IE "Number of Processes"	The number of processes for this secondary serving HS-DSCH cell is equal to half the value of the IE "Number of Processes"
If MIMO or MIMO mode with four transmit antennas is not configured for this secondary serving HS-DSCH cell	If Memory Partitioning is set to implicit, the UE behaviour is not specified. Else, the number of processes for the secondary serving HS-DSCH cell is equal to the value of the IE "Number of Processes"	The number of processes for this secondary serving HS-DSCH cell is equal to the value of the IE "Number of Processes"	The number of processes for this secondary serving HS-DSCH cell is equal to half the value of the IE "Number of Processes"	The number of processes for this secondary serving HS-DSCH cell is equal to quarter the value of the IE "Number of Processes"
If MIMO mode with four transmit antennas is configured for this secondary serving HS-DSCH cell	If Memory Partitioning is set to implicit, the UE behaviour is not specified. Else, the number of processes for the secondary serving HS-DSCH cell is equal to four times the value of the IE "Number of Processes"	The number of processes for this secondary serving HS-DSCH cell is equal to four times the value of the IE "Number of Processes"	The number of processes for this secondary serving HS-DSCH cell is equal to twice the value of the IE "Number of Processes"	The number of processes for this secondary serving HS-DSCH cell is equal to the value of the IE "Number of Processes"

When the variable HS_DSCH_RECEPTION or HS_DSCH_RECEPTION_CELL_FACH_STATE is set to TRUE, or the corresponding entry in the variable SECONDARY_CELL_HS_DSCH_RECEPTION is set to TRUE the UE shall:

- 1> for 1.28 Mcps TDD, when variable HS_DSCH_RECEPTION_CELL_FACH_STATE is TRUE,
- 2> consider the UE capability "Total number of soft channel bits in HS-DSCH" equal to that of the HS-DSCH physical layer category 9 as specified in [35];
- 1> if inter-Node B Multiflow operation is configured:

- 2> configure both MAC-ehs entities with the number of HARQ processes indicated in IE "Number of Processes" and in Table 8.6.5.6b.
- 1> else:
- 2> configure the MAC-hs/ehs entity with the number of HARQ processes indicated in IE "Number of Processes" and in Table 8.6.5.6b.
- 1> assign to each of these HARQ processes IDs going from 0 to "Number of Processes" – 1 per HS-DSCH;
- 1> if the IE "Memory Partitioning" is set to 'Implicit':
- 2> partition the soft memory buffer equally among the HS-DSCH transport channels, assuming that the number of HS-DSCH transport channels is equal to the "Total Number of serving/secondary serving HS-DSCH cells" (defined in Table 5.1a of [35]) for the category used by the UE in accordance to subclause 8.1.6.2. In the event that the division of the soft memory buffer results in a non-Integer value the partition memory size is rounded down to the nearest Integer value.
 - 2> if MIMO is configured on some but not all HS-DSCH transport channels:
 - 3> for each of the HS-DSCH transport channels configured with MIMO, partition the soft memory buffer equally among the processes configured above. In the event that the division of the soft memory buffer results in a non-Integer value the partition memory size is rounded down to the nearest Integer value.
 - 3> for each of the HS-DSCH transport channels configured without MIMO, use the HARQ process memory buffer size calculated for the MIMO configured HS-DSCH transport channels above.
 - 2> if MIMO mode with four transmit antennas is configured on some but not all HS-DSCH transport channels:
 - 3> for each of the HS-DSCH transport channels configured with MIMO mode with four transmit antennas, partition the soft memory buffer in the MAC-ehs entity equally among the processes configured above. In the event that the division of the soft memory buffer results in a non-Integer value the partition memory size is rounded down to the nearest Integer value.
 - 3> for each of the HS-DSCH transport channels configured without MIMO mode with four transmit antennas, use the HARQ process memory buffer size calculated for the MIMO configured HS-DSCH transport channels above.
 - 2> else if multi-cell operation on more than two cells without MIMO is configured, and UE is capable of multi-cell MIMO operation on more than two cells:
 - 3> partition the soft memory buffer equally among the processes configured above, as if MIMO is configured. In the event that the division of the soft memory buffer results in a non-Integer value the partition memory size is rounded down to the nearest Integer value.
- 2> else:
- 3> partition the soft memory buffer per HS-DSCH transport channels equally among the processes configured above. In the event that the division of the soft memory buffer results in a non-Integer value the partition memory size is rounded down to the nearest Integer value.
- 1> if the IE "Memory Partitioning" is set to 'Explicit':
- 2> if the UE capability "Total number of soft channel bits in HS-DSCH", as specified in [35], is exceeded with this configuration; or
 - 2> if MIMO is not configured and if the IE "Process Memory size" is set to a value greater than the number of soft channel bits for an implicit memory partitioning with 6 processes per HS-DSCH transport channel, and the IE "Downlink secondary cell info FDD" is included; or
 - 2> if MIMO is configured and the IE "Process Memory size" is set to a value greater than number of soft channel bits for an implicit memory partitioning with 12 processes per HS-DSCH transport channel, and the IE "Downlink secondary cell info FDD" is included; or

- 2> if MIMO mode with four transmit antennas is configured and the IE "Process Memory size" is set to a value greater than number of soft channel bits for an implicit memory partitioning with 24 processes per HS-DSCH transport channel, and the IE "Downlink secondary cell info FDD" is included:
 - 3> set the variable INVALID_CONFIGURATION to TRUE.
- 2> else:
 - 3> partition the soft memory buffer equally among the HS-DSCH transport channels. In the event that the division of the soft memory buffer results in a non-Integer value the partition memory size is rounded down to the nearest Integer value.
 - 3> partition the soft memory buffer per HS-DSCH transport channel according to the IE "Process memory size" assuming that the order in the list follows the order in the HARQ process IDs.
 - 3> if MIMO mode with four transmit antennas is configured partition the soft memory buffer per HS-DSCH transport channel in the MAC-ehs entity according to the IE "Process memory size" assuming that the order in the list follows the order in the HARQ process IDs.
 - 3> If the IE "Process memory size" included in the IE "Memory size" different from the IE "Process memory size" included in the IE "Additional memory sizes for 4th MIMO stream":
 - 4> set the variable INVALID_CONFIGURATION to TRUE.
 - 3> If the IE "Process memory size" included in the IE "Additional memory sizes for MIMO" different from the IE "Process memory size" included in the IE "Additional memory sizes for 3rd MIMO stream":
 - 4> set the variable INVALID_CONFIGURATION to TRUE.

8.6.5.6c Void

8.6.5.7 Deleted UL TrCH information

If the IE "Deleted UL TrCH information" is included the UE shall:

- 1> if an Uplink transport channel is requested to be deleted:
 - 2> delete any information about the transport channel identified by the IE "UL TrCH identity" and the IE "Uplink transport channel type".
- 1> if an E-DCH MAC-d flow is requested to be deleted:
 - 2> delete any information about the E-DCH MAC-d flow identified by the IE "E-DCH MAC-d flow identity";
 - 2> determine the value for the E_DCH_TRANSMISSION variable and take the corresponding actions as described in subclause 8.5.28.

8.6.5.8 Deleted DL TrCH information

If the IE "Deleted DL TrCH information" is included the UE shall:

- 1> if a Downlink transport channel is requested to be deleted:
 - 2> delete any information about the transport channel identified by the IE "DL TrCH identity".
- 1> if a DL MAC-d flow is requested to be deleted:
 - 2> delete any information about the DL HS-DSCH MAC-d flow identified by the IE "MAC-d Flow Identity", i.e. delete any information about MAC-hs queue(s) mapped onto this MAC-d flow.
 - 2> determine the value for the HS_DSCH_RECEPTION variable and take the corresponding actions as described in subclause 8.5.25.

- 1> if a DL MAC-ehs reordering queue is requested to be deleted:
 - 2> if inter-Node B Multiflow operation is configured:
 - 3> delete any information about the DL HS-DSCH DL MAC-ehs reordering queue identified by the IE "DL HS-DSCH MAC-ehs queue Id" from both MAC-ehs entities.
 - 2> else:
 - 3> delete any information about the DL HS-DSCH DL MAC-ehs reordering queue identified by the IE "DL HS-DSCH MAC-ehs queue Id".
- 2> determine the value for the HS_DSCH_RECEPTION variable and take the corresponding actions as described in subclause 8.5.25.

8.6.5.9 UL Transport channel information common for all transport channels

If the IE "UL Transport channel information common for all transport channels" is included the UE shall:

- 1> perform actions for the IE "TFC subset" as specified in subclause 8.6.5.3;
- 1> if the IE "PRACH TFCS" is included:
 - 2> set the variable INVALID_CONFIGURATION to TRUE.
- 1> if the IE has the choice "mode" set to FDD:
 - 2> perform actions for the IE "UL DCH TFCS" as specified in subclause 8.6.5.2.
- 1> if the IE has the choice "mode" set to TDD:
 - 2> if the IE "Individual UL CTrCH information" is included:
 - 3> for each TFCS identified by IE "UL TFCS id":
 - 4> perform actions for the IE "UL TFCS" as specified in subclause 8.6.5.2.
- 1> if the IE "TFC subset list" is included:
 - 2> remove a previously stored TFC subset list if this exists in the IE "TFC subset list" in the variable TFC_SUBSET;
 - 2> store the IE "TFC subset list" in the IE "TFC subset list" in the variable TFC_SUBSET;
 - 2> consider the first instance of the IE "TFC subset" in the IE "TFC subset list" as Transport Format Combination Subset 0 (TFC subset identity = 0), the second instance as Transport Format Combination Subset 1 (TFC subset identity = 1) and so on;
 - 2> if the IE "TFC subset list" contains greater than 8 elements then the UE behaviour is not specified.

NOTE: The UTRAN should not modify the TFC subset list when a temporary restriction of the TFC set is being applied, due to the reception of the IE "TFC Control Duration" in a TRANSPORT FORMAT COMBINATION CONTROL message is still being applied.

8.6.5.10 DL Transport channel information common for all transport channels

If the IE "DL Transport channel information common for all transport channels" is included the UE shall:

- 1> if the IE "SCCPCH TFCS" is included:
 - 2> set the variable INVALID_CONFIGURATION to TRUE.
- 1> if the IE choice "mode" is set to FDD:
 - 2> if the choice "DL parameters" is set to 'explicit':

3> if the IE "DL DCH TFCS" is included:

4> if the IE "SCCPCH TFCS" is included and the state the UE enters after handling the received information is other than CELL_DCH:

5> ignore the received IE "DL DCH TFCS".

NOTE: the IE "DL Transport channel information common for all transport channels" always includes a DL DCH TFCS configuration, either by including the IE "DL DCH TFCS " or by specifying that the TFCS is the same as in UL. If UTRAN does not require the reconfiguration of the concerned parameters, UTRAN may replace one TFC with the value that is already assigned for this IE.

4> else:

5> perform actions as specified in subclause 8.6.5.2.

1> if the IE choice "mode" is set to TDD:

2> if the IE "Individual DL CCTRCH information" is included:

3> for each DL TFCS identified by the IE "DL TFCS identity":

4> if the IE choice "DL parameters" is set to 'independent':

5> perform actions for the IE "DL TFCS" as specified in subclause 8.6.5.2.

4> if the IE choice "DL parameters" is set to 'same as UL':

5> if the IE "UL DCH TFCS identity" indicates an existing or a new UL TFCS:

6> store for that DL TFCS the TFCS identified by the IE "UL DCH TFCS identity".

5> else:

6> set the variable INVALID_CONFIGURATION to TRUE.

8.6.5.11 Void

8.6.5.12 TFCS Reconfiguration/Addition Information

If the IE "TFCS Reconfiguration/Addition Information" is included the UE shall:

1> store the TFCs to be reconfigured/added indicated in the IE "CTFC information" as specified below;

1> if the IE "Power offset information" is included:

2> perform actions as specified in [29].

In order to identify the TFCs included in this IE the UE shall calculate the CTFC as specified in subclause 14.10.

1> if the IE "Additional Dynamic Transport Format Information for CCCH" was included in the IE "RACH TFS":

2> ignore for the CTFC calculation any TF added by the IE "Additional Dynamic Transport Format Information for CCCH".

If the IE "TFCS Reconfiguration/Addition Information" is used in case of TFCS "Complete reconfiguration" the UE shall:

1> remove a previously stored transport format combination set if this exists;

1> consider the first instance of the IE "CTFC information" as Transport Format Combination 0 in FDD (TFCI=0) and 1 in TDD (TFCI=1), the second instance as Transport Format Combination 1 in FDD (TFCI=1) and 2 in TDD (TFCI=2) and so on. In TDD the TFCI value = 0 is reserved for physical layer use.

If the IE "TFCS Reconfiguration/Addition Information" is used in case of TFCS "Addition" the UE shall insert the new additional(s) TFC into the first available position(s) in ascending TFCI order in the TFCS.

8.6.5.12a Additional RACH TFCS for CCCH

If the IE "Additional RACH TFCS for CCCH " is included the UE shall:

1> if the IE "Power offset information" is included:

2> perform actions as specified in [29].

1> add to the TFCS as calculated in 8.6.5.12 for the corresponding PRACH the TFC which consists of the TF added by the IE "Additional Dynamic Transport Format Information for CCCH" into the next position in ascending order after the highest TFCI value already used.

NOTE: On PRACH only one transport channel can be multiplexed.

8.6.5.13 TFCS Removal Information

If the IE "TFCS Removal Information" is included the UE shall:

1> remove the TFC indicated by the IE "TFCI" from the current TFCS, and regard this position (TFCI) in the TFCS as vacant.

8.6.5.14 Void

8.6.5.15 TFCS Explicit Configuration

If the IE " TFCS Explicit Configuration" is included the UE shall:

1> if the IE choice "TFCS representation" is set to 'complete reconfiguration':

2> perform the actions for the IE "TFCS Reconfiguration/Addition Information" as specified in subclause 8.6.5.12.

1> if the IE choice "TFCS representation" is set to 'addition':

2> perform the actions for the IE "TFCS Reconfiguration/Addition Information" as specified in subclause 8.6.5.12.

1> if the IE choice "TFCS representation" is set to 'removal':

2> perform the actions for the IE "TFCS Removal Information" as specified in subclause 8.6.5.13.

1> if the IE choice "TFCS representation" is set to 'replace':

2> perform first the actions for the IE "TFCS Removal Information" as specified in subclause 8.6.5.13; and then

2> perform the actions for the IE "TFCS Reconfiguration/Addition Information" as specified in subclause 8.6.5.12.

8.6.5.16 E-DCH Transmission Time Interval (FDD only)

If the IE "E-DCH Transmission Time Interval" is included, the UE shall:

1> store the received TTI;

1> determine the value for the E_DCH_TRANSMISSION variable and take the corresponding actions as described in subclause 8.5.28.

When the variable E_DCH_TRANSMISSION is set to TRUE the UE shall:

1> apply the TTI as signalled in the IE "E-DCH Transmission Time Interval" on the E-DPDCH.

If the received "E-DCH Transmission Time Interval" is 2 ms and the previously stored TTI was 10 ms:

1> not send any data on E-DPDCH in first 8 TTIs after activation time of new TTI.

8.6.5.17 HARQ Info for E-DCH

If the IE "HARQ Info for E-DCH" is included, the UE shall:

1> store the received configuration;

1> determine the value for the E_DCH_TRANSMISSION variable and take the corresponding actions as described in subclause 8.5.28.

When the variable E_DCH_TRANSMISSION is set to TRUE the UE shall:

1> use a redundancy version for each HARQ transmission as configured by the IE "HARQ RV Configuration".

8.6.5.18 Added or reconfigured E-DCH MAC-d flow

If the IE "Added or reconfigured E-DCH MAC-d flow" is included, the UE shall:

1> if the IE "E-DCH MAC-d flow power offset" is included:

2> configure the power offset indicated in the IE "E-DCH MAC-d flow power offset" for the E-DCH MAC-d flow identified by the IE "E-DCH MAC-d flow identity".

1> if the IE "E-DCH MAC-d flow maximum number of retransmissions" is included:

2> configure the maximum number of retransmissions indicated in the IE "E-DCH MAC-d flow maximum number of retransmissions" for the E-DCH MAC-d flow identified by the IE "E-DCH MAC-d flow identity".

1> for 1.28 Mcps TDD, if the IE "E-DCH MAC-d flow retransmission timer" is included:

2> configure the retransmission timer for the E-DCH MAC-d flow identified by the IE "E-DCH MAC-d flow identity".

1> if the IE "E-DCH MAC-d flow multiplexing list" is included:

2> only multiplex MAC-d PDU's from the E-DCH MAC-d flow indicated in the IE "E-DCH MAC-d flow identity" with MAC-d PDU's from E-DCH MAC-d flows with which multiplexing in the same MAC-e or MAC-i PDU is allowed in accordance to the IE "E-DCH MAC-d flow multiplexing list".

1> else:

2> if previously the IE "E-DCH MAC-d flow multiplexing list" was already received for this E-DCH MAC-d flow:

3> continue to only multiplex E-DCH PDU's from the E-DCH MAC-d flow indicated in the IE "E-DCH MAC-d flow identity" with MAC-d PDU's from E-DCH MAC-d flows with which multiplexing in the same MAC-e or MAC-i PDU is allowed according to the previously received IE "E-DCH MAC-d flow multiplexing list".

2> else (never received the IE "E-DCH MAC-d flow multiplexing list" for this E-DCH MAC-d flow):

3> allow multiplexing of MAC-d PDU's from the E-DCH MAC-d flow indicated in the IE "E-DCH MAC-d flow identity" with MAC-d PDU's from any other E-DCH MAC-d flow in the same MAC-e or MAC-i PDU.

1> for FDD:

2> if the IE "Non-scheduled transmission grant info" is included:

3> if the TTI configured on the E-DCH equals 2ms, and the IE "2ms non-scheduled transmission grant HARQ process allocation" is configured for this MAC-d flow:

- 4> MAC-d PDU's for logical channels belonging to this MAC-d flow shall only be included in a MAC-e or MAC-i PDU transmitted by HARQ processes allowed by the IE "2ms non-scheduled transmission grant HARQ process allocation", with a total contribution from this MAC-d flow (i.e. including MAC-e/es or MAC-i/is headers) not exceeding the size as signalled by the IE "Max MAC-e PDU contents size".
- 3> else:
 - 4> MAC-d PDU's for logical channels belonging to this MAC-d flow shall be included in a MAC-e or MAC-i PDU transmitted by any HARQ process, with a total contribution from this MAC-d flow (i.e. including MAC-e/es or MAC-i/is headers) not exceeding the size as signalled by the IE "Max MAC-e PDU contents size".
- 2> if the IE "Scheduled transmission grant info" is included:
 - 3> transmission of MAC-d PDU's for logical channels belonging to this MAC-d flow shall be in accordance with the received scheduled grant on E-AGCH/E-RGCH (see [15]).
- 1> for TDD:
 - 2> if the IE "Non-scheduled transmission grant info" is included:
 - 3> MAC-d PDU's for logical channels belonging to this MAC-d flow shall only be included in a MAC-e or MAC-i PDU transmitted by HARQ processes designated as non scheduled (Ids 4 – 7) in the TTIs indicated (for 3.84 Mcps TDD and 7.68 Mcps TDD, as determined from the IEs "Activation Time", "Resource Duration" and "Resource Periodicity"; for 1.28 Mcps TDD, as determined from the IEs "Activation Time", "Subframe number", "Resource Duration" and "Resource Periodicity", and the calculation of assigned Non-scheduled transmission grant is specified in subclause 8.6.6.16a).
 - 2> if the IE "Scheduled transmission grant info" is included:
 - 3> transmission of MAC-d PDUs for logical channels belonging to this MAC-d flow shall be in accordance with the received scheduled grant on E-AGCH (see [15]).
- 1> perform the actions as specified in subclause 8.5.21;
- 1> determine the value for the E_DCH_TRANSMISSION variable and take the corresponding actions as described in subclause 8.5.28.

8.6.5.19 SRB1 mapping info (FDD and 1.28 Mcps TDD only)

When variable HS_DSCH_RECEPTION_OF_CCCH_ENABLED is set to TRUE and the UE is in CELL_FACH state, the UE shall:

- 1> if no MAC-ehs queue with identified by the "MAC-ehs queue identity" value as received in IE "SRB1 mapping info" of System Information Block type 5 or System Information Block type 5bis is configured:
 - 2> the UE behaviour is unspecified.
- 1> else:
 - 2> map the logical channel identified by the IE "Logical channel identity" to the MAC-ehs queue identified by the IE "MAC-ehs queue identity" as received in IE "SRB1 mapping info" of System Information Block type 5 or System Information Block type 5bis.

8.6.5.20 HARQ System Info (FDD and 1.28 Mcps TDD only)

When the UE is not in RRC Connected state and the variable HS_DSCH_RECEPTION_OF_CCCH_ENABLED is set to TRUE, or when the UE is in CELL_FACH state or will be in CELL_FACH state at the completion of this procedure, the UE shall:

- 1> if IE "HS-DSCH common system information" is included in System Information Block type 5 or System Information Block type 5bis:

- 2> for 1.28 Mcps TDD, consider the UE capability "Total number of soft channel bits in HS-DSCH" equal to that of the HS-DSCH physical layer category 9 as specified in [35];
- 2> configure the MAC-ehs entity with the number of HARQ processes indicated in IE "Number of Processes";
- 2> assign to each of these HARQ processes IDs going from 0 to "Number of Processes" – 1;
- 2> if the IE "Memory Partitioning" is set to 'Implicit':
 - 3> partition the soft memory buffer in the MAC-ehs entity equally among the processes configured above. In the event that the division of the soft memory buffer results in a non-Integer value the partition memory size is rounded down to the nearest Integer value.
- 2> if the IE "Memory Partitioning" is set to 'Explicit':
 - 3> if the UE capability "Total number of soft channel bits in HS-DSCH", as specified in [35], is exceeded with this configuration:
 - 4> the UE behaviour is unspecified.
 - 3> else:
 - 4> partition the soft memory buffer in the MAC-ehs entity according to the IE "Process memory size" assuming that the order in the list follows the order in the HARQ process IDs.

8.6.5.21 CCCH mapping info (FDD and 1.28 Mcps TDD only)

When the variable HS_DSCH_RECEPTION_OF_CCCH_ENABLED is set to TRUE, the UE shall:

- 1> if no MAC-ehs queue with identified by the "MAC-ehs queue identity" value as received in IE "CCCH mapping info" of System Information Block type 5 or System Information Block type 5bis is configured:
 - 2> set the variable INVALID_CONFIGURATION to TRUE.
- 1> else:
 - 2> map the logical channel identified by the IE "Logical channel identity" to the MAC-ehs queue identified by the IE "MAC-ehs queue identity" as received in IE "CCCH mapping info" of System Information Block type 5 or System Information Block type 5bis.
- 1> if there is more than one multiplexing option applicable for logical channels to be used:
 - 2> the UE behaviour is not specified.

8.6.5.22 Common MAC-ehs reordering queue (FDD and 1.28 Mcps TDD only)

When the variable HS_DSCH_RECEPTION_OF_CCCH_ENABLED is set to TRUE, the UE shall:

- 1> set the release timer for the MAC-ehs queue in the MAC-ehs entity to the value in the corresponding IE "T1";
- 1> set the reset timer for the MAC-ehs queue in the MAC-ehs entity to the value in te corresponding IE "Treset";
- 1> set the MAC-ehs receiver window size for the MAC-ehs queues in the MAC-ehs entity to the value in the corresponding IE "MAC-ehs window size".

8.6.5.23 Added or reconfigured MAC-ehs reordering queue

If the IE "Added or reconfigured MAC-ehs reordering queue" is included, the UE shall:

- 1> if the IE "Deleted DL TrCH information" is included in the received message; and
- 1> if a MAC-ehs queue (identified by the IE "MAC-ehs queue Id") is included in both the IE "MAC-ehs queue to add or reconfigure list" and the IE "DL HS-DSCH MAC-ehs reordering queue" within the IE "Deleted DL TrCH information":

2> the UE behaviour is unspecified.

1> for each MAC-ehs queue included in the IE "MAC-ehs queue to add or reconfigure" list:

2> set the release timer for each of the MAC-ehs queues in the MAC-ehs entity to the value in the corresponding IE "T1";

2> set the reset timer for the MAC-ehs queue in the MAC-ehs entity to the value in the corresponding IE "Treset";

NOTE: A UE that does not support reception of HS-DSCH in CELL_FACH state may ignore the IE "Treset".

2> set the MAC-ehs receiver window size for each of the MAC-ehs queues in the MAC-ehs entity to the value in the corresponding IE "MAC-ehs window size".

1> if the IE "Added or reconfigured MAC-ehs reordering queue" is considered valid according to the rules above:

2> perform the actions as specified in subclause 8.5.21.

8.6.5.24 Common E-DCH MAC-d flows (FDD and 1.28 Mcps TDD only)

The UE shall:

1> configure the power offset indicated in the IE "E-DCH MAC-d flow power offset" for the E-DCH MAC-d or MAC-c (for FDD) flow identified by the IE "E-DCH MAC-d flow identity";

1> configure the maximum number of retransmissions indicated in the IE "E-DCH MAC-d flow maximum number of retransmissions" for the E-DCH MAC-d flow identified by the IE "E-DCH MAC-d flow identity";

1> for 1.28 Mcps TDD, configure the maximum retransmission timer indicated in the IE "E-DCH MAC-d flow retransmission timer" for the E-DCH MAC-d or MAC-c (for FDD) flow identified by the IE "E-DCH MAC-d flow identity";

1> if the IE "E-DCH MAC-d flow multiplexing list" is included:

2> only multiplex MAC-d PDUs from the E-DCH MAC-d flow indicated in the IE "E-DCH MAC-d flow identity" with MAC-d PDUs from E-DCH MAC-d flows with which multiplexing in the same MAC-i PDU is allowed in accordance to the IE "E-DCH MAC-d flow multiplexing list".

1> else (IE "E-DCH MAC-d flow multiplexing list" not included in the system information):

2> allow multiplexing of MAC-d PDUs from the E-DCH MAC-d flow indicated in the IE "E-DCH MAC-d flow identity" with MAC-d PDUs from any other E-DCH MAC-d flow in the same MAC-i PDU.

2> for FDD, prohibit multiplexing of MAC-c PDUs from the E-DCH MAC-c flow indicated in the IE "E-DCH MAC-d flow identity" with MAC-d PDUs from any other E-DCH MAC-d flow in the same MAC-i PDU.

1> transmission of MAC-d PDUs or MAC-c PDUs for logical channels belonging to this MAC-d or MAC-c flow shall be in accordance with the serving grant (FDD only) (see [15]);

1> perform the actions as specified in subclause 8.5.21.

NOTE For FDD, if as per subclause 8.5.45, the TTI applied on E-DPDCH is different from the TTI signalled in the IE "E-DCH Transmission Time Interval", then the IE's "E-DCH MAC-d flow identity", "E-DCH MAC-d flow power offset" and "E-DCH MAC-d flow maximum number of retransmissions" in fact refer to the corresponding IE's, if present, in "Common E-DCH MAC-d flow info for Concurrent TTI" in the IE "Common E-DCH system info parameters for Concurrent TTI" of System Information Block type 22.

8.6.5.25 Early DCH quality target

When operating with DCH Enhancements in DL FET Full mode, the UE shall:

1> set, at physical channel establishment, the initial downlink target SIR based on either the IE "Early DCH quality target" or the IE "DCH quality target" if included, whichever requires a higher value, for transport channel(s) undergoing concatenation at the physical layer as indicated in the IE "TrCh Concatenation Info";

- 1> adjust the downlink target SIR for the downlink power control to meet either the early quality target received in the IE "Early DCH quality target" at the end of the slot number received in the IE "Early DCH quality target slot" or the quality target received in the IE "DCH quality target" at the end of slot number 29, whichever requires a higher value, for those transport channel(s).

8.6.6 Physical channel information elements

This subclause specifies the actions upon reception and/or non-reception of the physical channel information elements. The combination of the values of those information elements included in a given message shall follow the compatibility rules that are specified in the physical layer specifications. In case those rules are not followed, the UE shall set the variable INVALID_CONFIGURATION to TRUE.

8.6.6.1 Frequency info

If, after completion of the procedure, the UE will be in CELL_DCH state, the UE shall:

- 1> for 3.84 Mcps TDD and 7.68 Mcps TDD, if the IE "Frequency info" is included; or
- 1> for 1.28 Mcps TDD, if the IE "Frequency info" is included and the "Second Frequency info" is not included; or
- 1> for FDD, if the IE "Frequency info" is included in an IE other than the IE "Uplink secondary cell info FDD":
 - 2> if the frequency is different from the currently used frequency:
 - 3> store and use the frequency indicated by the IE "Frequency Info";
 - 3> if the received message is used to perform a Timing-maintained hard handover (see subclause 8.3.5.2), and IE "Timing maintained Synchronization indicator" is included:
 - 4> not perform any physical layer synchronisation procedure (FDD only);
 - 3> else:
 - 4> perform the physical layer synchronisation procedure A as specified in [29] (FDD only).
 - 2> if the frequency is the same as the currently used frequency:
 - 3> continue to use the currently used frequency;
 - 3> perform the physical layer synchronisation procedure A as specified in [29] (FDD only).
- 1> for 1.28 Mcps TDD, if both the IE "Frequency info" and the IE "Second Frequency info" are included:
 - 2> the frequency in IE "Frequency info" is used as the primary frequency, and the frequency in IE "Second Frequency info" is used as the secondary frequency;
 - 2> store the primary frequency;
 - 2> if the secondary frequency is different with the currently used frequency:
 - 3> store and use the secondary frequency.
 - 2> if the secondary frequency is the same as the currently used frequency:
 - 3> continue to use the currently used frequency.
- 1> if the IE "Frequency info" is not included and the UE has a currently used frequency:
 - 2> continue to use the currently used frequency;

NOTE If the received message is used to perform a Timing-reinitialised hard handover, and the IE "Frequency Info" is not included, the UE may perform the physical layer synchronisation procedure A as specified in [29] (FDD only).

For 1.28 Mcps TDD, if, after completion of the procedure, the UE will be in CELL_FACH state, the UE shall:

- 1> if the IE "Frequency info" is included and the "Second Frequency info" is not included:
 - 2> store and use the frequency indicated by the IE "Frequency Info" as working frequency.
- 1> if both the IE "Frequency info" and the IE "Second Frequency info" are included:
 - 2> the frequency in IE "Frequency info" is used as the primary frequency, and the frequency in IE "Second Frequency info" is used as the secondary frequency;
 - 2> store the primary frequency;
 - 2> if the secondary frequency is different with the currently used frequency:
 - 3> store and use the secondary frequency as working frequency.
 - 2> if the secondary frequency is the same as the currently used frequency:
 - 3> continue to use the currently used frequency as working frequency.

8.6.6.2 Void

8.6.6.2a PNBSCH allocation

The UE shall consider the frame numbers fulfilling the following equation as "PRACH blocked frames" as specified in [33].

$$SFN = \lfloor k * \text{Repetition period} \rfloor$$

for an integer k with $k \in \{0, 1, 2, 3, 4, \dots, \text{value of IE "Number of repetitions per SFN period"} - 1\}$, where:

Repetition period is: $4096 / \text{value of IE "Number of repetitions per SFN period"}$.

The UE shall configure the physical layer for the physical random access procedure accordingly.

8.6.6.3 Void

8.6.6.3a Downlink information per radio link list

If the IE "Downlink information per radio link list" is included in a received message, the UE shall:

- 1> if the active set resulting after the reception of the IE "Downlink information per radio link list" would contain radio links indicated by the IE "Downlink DPCH info for each RL" and radio links indicated by the IE "Downlink F-DPCH info for each RL":
 - 2> set the variable INVALID_CONFIGURATION to TRUE.
- 1> if the active set resulting after the reception of the IE "Downlink information per radio link list" would contain radio links indicated by the IE "Downlink DPCH info for each RL" and the radio link is included in the table "Target cell preconfigurations" in the variable TARGET_CELL_PRECONFIGURATION:
 - 2> clear all the entries from the variable TARGET_CELL_PRECONFIGURATION.
- 1> if the message was received in CELL_DCH state and the UE remains in CELL_DCH state according to subclause 8.6.3.3 applied on the received message:
 - 2> for FDD, check whether the radio links included in the IE "Downlink information per radio link list" are part of the current active set considering that a radio link is uniquely identified by the downlink UARFCN and the primary scrambling code;

- 2> for TDD, check whether the radio links included in the IE "Downlink information per radio link list" are part of the current active set considering that a radio link is uniquely identified by the UARFCN and the primary CCPCH;
- 2> if all radio links included in the IE "Downlink information per radio link list" are part of the current active set:
 - 3> for radio links part of the current active set, and present in the IE "Downlink information per radio link list":
 - 4> update the downlink physical channel configuration according to the IE "Downlink information for each radio link" as specified in subclause 8.6.6.4.
 - 3> for radio links part of the current active set, and absent in the IE "Downlink information per radio link list":
 - 4> not change its current downlink physical channel configuration;
 - 4> For FDD, in case the IE "Serving HS-DSCH radio link indicator" is set to 'TRUE' for another radio link, no longer consider any of these absent radio links as serving HS-DSCH radio link;
 - 4> For FDD, in case the IE "Serving E-DCH radio link indicator" is set to 'TRUE' for another radio link, no longer consider any of these absent radio links as serving E-DCH radio link.
- 2> if all radio links included in the IE "Downlink information per radio link list" are not part of the current active set:
 - 3> perform a hard handover by replacing all the radio links in the current active set with the radio links in the IE "Downlink information per radio link list", each with a downlink physical channel configuration according to the IE "Downlink information for each radio link" as specified in subclause 8.6.6.4;
 - 3> perform the checks on the value of the IE "Default DPCH Offset Value" as specified in subclause 8.3.5.1.2 or 8.3.5.2.2;
 - 3> act on the IE "Timing indication" and the IE "Default DPCH Offset Value", if included, as specified in subclause 8.5.15.2;

NOTE: UTRAN should not mix radio links which are part of the current active set and radio links which are not part of the current active set in the same IE "Downlink information per radio link list". In such cases the UE behaviour is unspecified.

1> otherwise:

- 2> if the message was received in CELL_FACH state and the UE would transit to CELL_DCH state according to subclause 8.6.3.3 applied on the received message:
 - 3> establish a downlink physical channel configuration for each of the included radio links according to the IE "Downlink information for each radio link" as specified in subclause 8.6.6.4.

8.6.6.3b Downlink information per radio link list on secondary UL frequency (FDD only)

If the IE "Downlink information per radio link list on secondary UL frequency" is included in a received message, the UE shall:

- 1> if the message was received in CELL_DCH state and the UE remains in CELL_DCH state according to subclause 8.6.3.3 applied on the received message; and
- 1> the secondary E-DCH active set prior to the reception of the message contains one or more radio links:
 - 2> check whether the radio links included in the IE "Downlink information per radio link list on secondary UL frequency" are part of the current secondary E-DCH active set considering that a radio link is uniquely identified by the primary scrambling code;

- 2> if all radio links included in the IE "Downlink information per radio link list on secondary UL frequency" are part of the current secondary E-DCH active set:
 - 3> for radio links part of the current secondary E-DCH active set, and present in the IE "Downlink information per radio link list on secondary UL frequency":
 - 4> update the downlink physical channel configuration according to the downlink information for each radio link on secondary uplink frequency, as specified in subclause 8.6.6.4a.
 - 3> for radio links part of the current secondary E-DCH active set, and absent in the IE "Downlink information per radio link list on secondary UL frequency":
 - 4> not change its current downlink physical channel configuration;
 - 3> keep the current activation status of the secondary uplink frequency and take the corresponding actions as described in subclause 8.5.58.
- 2> if all radio links included in the IE "Downlink information per radio link list on secondary UL frequency" are not part of the current secondary E-DCH active set:
 - 3> replace all the radio links in the current secondary E-DCH active set with the radio links in the IE "Downlink information per radio link list on secondary UL frequency", each with a downlink physical channel configuration according to the downlink information for each radio link on secondary uplink frequency, as specified in subclause 8.6.6.4a;
 - 3> consider the secondary uplink frequency as not activated and take the corresponding actions as described in subclause 8.5.58.

NOTE: UTRAN should not mix radio links which are part of the current secondary E-DCH active set and radio links which are not part of the current secondary E-DCH active set in the same IE "Downlink information per radio link list on secondary UL frequency". In such cases the UE behaviour is unspecified.

1> otherwise:

- 2> if the message was received in CELL_FACH state and the UE would transit to CELL_DCH state according to subclause 8.6.3.3 applied on the received message; or
- 2> if the message was received in CELL_DCH state and the secondary E-DCH active set prior to the reception of the message do not contain any radio link:
 - 3> configure the downlink physical channel on the downlink frequency associated with the secondary uplink frequency for each of the included radio links as specified in subclause 8.6.6.4a;
 - 3> consider the secondary uplink frequency as not activated and take the corresponding actions as described in subclause 8.5.58.

8.6.6.4 Downlink information for each radio link

If the IE "Downlink information for each radio link" is included in a received message, the UE shall:

- 1> if the UE would enter CELL_DCH state according to subclause 8.6.3.3 applied on the received message:
 - 2> if the UE is in TDD mode and shared transport channels are assigned to the UE:
 - 3> start to receive the indicated Secondary CCPCH.
 - 2> if the UE is in TDD mode and no shared transport channels are assigned to the UE:
 - 3> set the variable UNSUPPORTED_CONFIGURATION to TRUE.
- 2> For FDD:
 - 3> if the IE "Serving HS-DSCH radio link indicator" is set to 'TRUE':

- 4> consider this radio link as the serving HS-DSCH radio link and no longer consider any other radio link as serving HS-DSCH radio link.
- 2> For FDD:
 - 3> if the IE "Serving E-DCH radio link indicator" is set to 'TRUE':
 - 4> consider this radio link as the serving E-DCH radio link and no longer consider any other radio link as serving E-DCH radio link.
 - 3> if the IE "E-AGCH Info" is included for the serving E-DCH radio link:
 - 4> store the newly received E-AGCH configuration.
 - NOTE: The UTRAN should always include the IE "E-AGCH info" if the serving E-DCH radio link indicated in the message is another radio link than the serving E-DCH radio link prior to the procedure.
 - 3> if the IE "E-ROCH Info" is included for the serving E-DCH radio link:
 - 4> store the newly received E-ROCH configuration.
 - 3> if the IE "E-HICH information" is included:
 - 4> store this E-HICH configuration for the concerning radio link.
 - 3> if the IE "E-HICH information" is included or previously stored:
 - 4> store this E-RGCH configuration for the concerning radio link, if included.
 - 3> if the IE "E-HICH release indicator" is present:
 - 4> delete the stored E-HICH information;
 - 4> if variable UPLINK_MIMO_TRANSMISSION is set to TRUE:
 - 5> delete the stored E-HICH information for the secondary stream;
 - 3> if the "Secondary TB E-HICH release indicator" is present:
 - 4> delete the stored E-HICH information for the secondary stream;
 - 3> determine the value for the E_DCH_TRANSMISSION variable and take the corresponding actions as described in subclause 8.5.28.
 - 3> if the IE "F-TPICH info" is included:
 - 4> store this F-TPICH configuration for the concerning radio link.
 - 3> determine the value for the variable UPLINK_CLTD_TRANSMISSION and take the corresponding actions as described in subclause 8.5.69.
 - 3> if the IE "Radio Links without DPCH/F-DPCH info" is present:
 - 4> store this IE and indicate to lower layers to start operation with Radio Links without DPCH/F-DPCH.
- 2> for TDD:
 - 3> if the IE "E-AGCH Info" is included:
 - 4> store the newly received E-AGCH configuration.
 - 3> if the IE "E-HICH information" is included:
 - 4> store the E-HICH configuration.
 - 3> determine the value for the E_DCH_TRANSMISSION variable and take the corresponding actions as described in subclause 8.5.28.

- 2> act on the other IEs contained in the IE "Downlink information for each radio link" as specified in subclause 8.6 applied on this radio link.
- 1> in addition, if the message was received in CELL_DCH state and the UE remains in CELL_DCH state according to subclause 8.6.3.3 applied on the received message:
 - 2> For FDD:
 - 3> if the IE "Serving HS-DSCH radio link indicator" is set to "TRUE":
 - 4> consider this radio link as the serving HS-DSCH radio link;
 - 4> if the serving HS-DSCH radio link was another radio link than this radio link prior to reception of the message and the IE "H-RNTI" is not included:
 - 5> clear the variable H_RNTI.
 - 3> if the IE "Serving HS-DSCH radio link indicator" is set to 'FALSE' and this radio link was considered the serving HS-DSCH radio link prior to reception of this message:
 - 4> no longer consider this radio link as the serving HS-DSCH radio link.
 - 3> determine the value for the HS_DSCH_RECEPTION variable and take the corresponding actions as described in subclause 8.5.25;
 - 3> if the IE "Serving E-DCH radio link indicator" is set to "TRUE":
 - 4> consider this radio link as the serving E-DCH radio link;
 - 4> if the serving E-DCH radio link was another radio link than this radio link prior to reception of the message:
 - 5> if the IE "New Primary E-RNTI" is not included:
 - 6> clear the Primary E-RNTI stored in the variable E_RNTI.
 - 5> if the IE "New Secondary E-RNTI" is not included:
 - 6> clear the Secondary E-RNTI stored in the variable E_RNTI.
 - 3> if the IE "Serving E-DCH radio link indicator" is set to 'FALSE' and this radio link was considered the serving E-DCH radio link prior to reception of this message:
 - 4> no longer consider this radio link as the serving E-DCH radio link.
 - 3> if the IE "E-HICH release indicator" is present:
 - 4> delete the stored E-HICH, E-AGCH and E-RGCH (if any) configurations.
 - 3> if the IE "E-RGCH release indicator" is present:
 - 4> delete the stored E-RGCH configuration for this RL.
 - 3> determine the value for the E_DCH_TRANSMISSION variable and take the corresponding actions as described in subclause 8.5.28.
 - 3> if the IE "F-TPICH release indicator" is present:
 - 4> delete the stored F-TPICH configuration for this RL.
 - 3> determine the value for the variable UPLINK_CLTD_TRANSMISSION and take the corresponding actions as described in subclause 8.5.69.
 - 2> For TDD:
 - 3> if the IE "H-RNTI" is not included and the primary CCPCH has changed:
 - 4> clear the variable H_RNTI.

3> determine the value for the HS-DSCH_RECEPTION variable and take the corresponding actions as described in subclause 8.5.25.

2> for TDD:

3> if the IE "New Primary E-RNTI" is not included:

4> clear the variable E_RNTI.

3> determine the value for the E_DCH_TRANSMISSION variable and take the corresponding actions as described in subclause 8.5.28.

2> for each optional IE part of the IE "Downlink information for each radio link" that is not present:

3> do not change its current downlink physical channel configuration corresponding to the IE, which is absent, if not stated otherwise elsewhere.

NOTE: The Release '99 RADIO BEARER RECONFIGURATION message always includes at least one IE "Downlink information for each radio link" containing the mandatory IEs, even if UTRAN does not require the reconfiguration of any radio link.

1> if the UE would enter either the CELL_FACH, CELL_PCH or URA_PCH state according to subclause 8.6.3.3 applied on the received message:

2> if IEs other than the IE "Primary CPICH info" (for FDD) or the IE "Primary CCPCH info" (for TDD) are included in the IE "Downlink information for each radio link":

3> ignore these IEs.

2> act on the other IEs contained in the IE "Downlink information for each radio link" as specified in subclause 8.6 applied on this radio link.

2> for 1.28Mcps TDD:

3> if the IE "E-AGCH Info" is included:

4> store the newly received E-AGCH configuration.

3> if the IE "E-HICH information" is included:

4> store the E-HICH configuration.

3> determine the value for the COMMON_E_DCH_TRANSMISSION variable and take the corresponding actions as described in subclause 8.5.46.

8.6.6.4a Downlink information for each radio link on secondary UL frequency (FDD only)

For each of the IE "Downlink information for each radio link on secondary UL frequency" included in a received message, the UE shall:

1> if the UE would enter CELL_DCH state according to subclause 8.6.3.3 applied on the received message:

2> if the IE "Secondary serving E-DCH radio link indicator" is present:

3> consider the radio link, identified by the IE "Primary CPICH info" as the secondary serving E-DCH radio link, and no longer consider any other radio link as secondary serving E-DCH radio link.

2> else:

3> consider the radio link, identified by the IE "Primary CPICH info" in the first IE "Downlink secondary cell info FDD" as the secondary serving E-DCH radio link, and no longer consider any other radio link as secondary serving E-DCH radio link.

2> if the IE "E-AGCH Info" is included for the secondary serving E-DCH radio link:

3> store the newly received E-AGCH configuration.

NOTE: The UTRAN should always include the IE "E-AGCH info" if the secondary serving E-DCH radio link indicated in the message is another radio link than the secondary serving E-DCH radio link prior to the procedure.

2> if the IE "E-HICH information" is included:

3> store the E-HICH configuration for the concerning radio link.

2> if the IE "E-RGCH information" is included:

3> store the E-RGCH configuration for the concerning radio link.

2> if the IE "Radio Links without DPCH/F-DPCH indicator" is present:

3> store the IE "F-DPCH frame offset" and ignore all other IEs received in "Downlink F-DPCH info for each RL on secondary UL frequency";

3> indicate to lower layers to start operation with Radio Links without DPCH/F-DPCH.

2> act on the other IEs contained in the IE "Downlink information for each radio link on secondary UL frequency" as specified in subclause 8.6 applied on this radio link, according to the rules for primary uplink frequency.

1> in addition, if the message was received in CELL_DCH state and the UE remains in CELL_DCH state according to subclause 8.6.3.3 applied on the received message and the secondary E-DCH active set prior to reception of this message contains one or more radio links:

2> if the IE "E-RGCH release indicator" is present:

3> delete the stored E-RGCH configuration for this RL.

2> for each optional IE part of the IE "Downlink information for each radio link on secondary UL frequency", except the IE "Radio Links without DPCH/F-DPCH indicator", that is not present:

3> do not change its current downlink physical channel configuration corresponding to the IE, which is absent, if not stated otherwise elsewhere.

NOTE: UTRAN should configure the same value of IE "F-DPCH frame offset" for the serving E-DCH radio link and the secondary serving E-DCH radio link, otherwise the UE behaviour is unspecified.

8.6.6.5 Void

8.6.6.6 Uplink DPCH info

If the IE "Uplink DPCH info" is included, the UE shall:

For FDD:

1> release any active uplink physical channels and activate the given physical channels;

1> if the IE "Number of FBI bits" is not included:

2> use 0 FBI bits in the Uplink DPCH.

1> if the IE "Number of TPC bits" is not included:

2> use 2 TPC bits in the Uplink DPCH.

1> else:

2> if F-DPCH is not configured then the UE behaviour is unspecified.

1> use an SF equal to or greater than the minimum SF indicated in the IE "Spreading Factor" during uncompressed frames or compressed frames by HL scheduling;

1> use an SF equal to or greater than the minimum SF divided by 2 during compressed frames by SF reduction.

For TDD:

1> release the uplink physical channels associated with any CCTrCH that is removed or reconfigured and activate the physical channels assigned to any CCTrCH that is added or reconfigured;

1> for 3.84 Mcps TDD or 7.68 Mcps TDD use the IE "UL target SIR" specified for each added or reconfigured CCTrCH as described in subclause 8.5.7. For 1.28 Mcps TDD use the value of IE "UL target SIR" specified for each added or reconfigured CCTrCH for parameter $PRX_{DPCHdes}$ as described in subclause 8.5.7;

1> for 1.28 Mcps TDD:

2> if "PLCCH Info" is included then store PLCCH Info parameters with respect to this uplink DPCH (overwriting parameter values previously stored);

2> if "PLCCH Info" is not included then delete the PLCCH Info stored with respect to this uplink DPCH.

1> use the parameters of the IE "Time info" for each added or reconfigured CCTrCH;

1> if present, use the IE "Uplink Timing Advance Control" as specified in subclause 8.6.6.26.

8.6.6.7 Void

8.6.6.8 Maximum allowed UL TX power

If the IE "Maximum allowed UL TX power" is included in the Handover to UTRAN Command, in any other dedicated message or in System Information Block type 3 or in System Information Block 4, the UE shall:

1> store and use the value until it is updated.

If the IE "Maximum allowed UL TX power" was not included in any dedicated message, the UE shall:

1> use the value previously stored, when received in an earlier dedicated message, Handover to UTRAN Command message or received in System Information Block type 3 or in System Information Block 4.

For all cases, the UE shall:

1> keep the UE uplink transmit power at or below the indicated power value;

1> if the current UE uplink transmit power is above the indicated power value:

2> decrease the power to a level at or below the power value.

The maximum UE TX power is defined as the lower of the maximum output power of the UE power class and the maximum allowed UL TX power indicated in this IE. The maximum UE TX power shall not be exceeded.

8.6.6.9 Void

8.6.6.10 Void

8.6.6.11 Uplink DPCH power control info

The UE shall:

1> in FDD:

2> if the IE "Uplink DPCH power control info" is included:

3> if a synchronisation procedure A in CELL_DCH is performed according to [29]; or

3> if a synchronisation procedure AA for Enhanced Uplink in CELL_FACH state or Idle mode is performed according to [29]:

4> calculate and set an initial uplink transmission power;

4> start inner loop power control as specified in subclause 8.5.3;

4> for the UL inner loop power control:

5> use the parameters specified in the IE.

3> else:

4> ignore the IEs "DPCCH Power offset", "PC Preamble" and "SRB delay";

4> act on the IE "Power control algorithm" and the IE "TPC step size", if included.

3> act on the IEs " Δ_{ACK} ", " Δ_{NACK} " and "Ack-Nack repetition factor", if included;

3> if the IE "Ack-Nack repetition factor for Multiflow assisting cells" is included:

4> if Multiflow operation on two frequencies and three cells with MIMO or Multiflow operation on two frequencies and four cells (with or without MIMO) is configured:

5> act on the IE "Ack-Nack repetition factor for Multiflow assisting cells" for configured multiflow assisting cell(s).

4> else:

5> if the value in the IE "Ack-Nack repetition factor for Multiflow assisting cells" is not set to 1:

6> the UE behavior is unspecified.

5> else:

6> act on the IE "Ack-Nack repetition factor for Multiflow assisting cells" for configured multiflow assisting cell(s).

3> else:

4> act on the IE "Ack-Nack repetition factor" for configured Multiflow assisting cell(s).

3> use the procedure for transmitting HS-DPCCH preamble and postamble according to [29], if the IE "HARQ_preamble_mode" is set to 1.

1> in 3.84 Mcps TDD or 7.68 Mcps TDD:

2> if the IE "Uplink DPCH power control info" is included:

3> use the parameters specified in the IE for open loop power control as defined in subclause 8.5.7.

2> else:

3> use the current uplink transmission power.

1> in 1.28 Mcps TDD:

2> if the CHOICE UL OL PC info is set to 'Broadcast UL OL PC info':

- 3> set the variable INVALID_CONFIGURATION to TRUE.
- 2> if the IE "Uplink DPCH power control info" is included in the UPLINK PHYSICAL CHANNEL CONTROL message:
 - 3> use "Beacon PL Est. " and the TPC step size for the closed loop power control of the CCTrCH identified in the message, replacing the existing value used for the CCTrCH.
 - 3> if the IE " UL target SIR " is included:
 - 4> use this value for parameter $PRX_{DPCHdes}$ for open loop power control of the CCTrCH identified in the message in the case of a transition from closed loop to open loop power control as specified in [33].
- 2> if the IE "Uplink DPCH power control info" is included in the IE "Uplink DPCH info":
 - 3> use the "Beacon PL Est. " and TPC step size for the closed loop power control of all CCTrCH added or reconfigured by the IE replacing any existing values used for the CCTrCHs;
 - 3> if the IE " UL target SIR " is included ignore the parameter.
- 1> both in FDD and TDD;
 - 2> if the IE "Uplink DPCH power control info" is not included in a message used to enter CELL_DCH:
 - 3> set the variable INVALID_CONFIGURATION to TRUE.
- 1> determine the value for the HS_DSCH_RECEPTION variable and take the corresponding actions as described in subclause 8.5.25.

8.6.6.12 Secondary CPICH info

If the IE Secondary CPICH info is included, the UE may:

- 1> use the channelisation code according to IE "channelisation code", with scrambling code according to IE "DL scrambling code" in the IE "Secondary CPICH info", for channel estimation of that radio link;
- 1> use the pilot bits on DPCCH for channel estimation.

If the IE Secondary CPICH info is not included, the UE shall:

- 1> not use any previously stored configuration corresponding to the usage of the Secondary CPICH info.

8.6.6.13 Primary CPICH usage for channel estimation

If the IE "Primary CPICH usage for channel estimation" is included and has the value "Primary CPICH may be used" the UE:

- 1> may use the Primary CPICH for channel estimation;
- 1> may use the pilot bits on DPCCH for channel estimation.

NOTE: If the IE "Primary CPICH usage for channel estimation" has the value "Primary CPICH shall not be used" and the IE "Secondary CPICH info" is not included for that radio link then the UE behaviour is not specified.

If the IE "Primary CPICH usage for channel estimation" is included and has the value "Primary CPICH shall not be used" the UE:

- 1> shall not use the Primary CPICH for channel estimation;
- 1> may use the Secondary CPICH for channel estimation;
- 1> may use the pilot bits on DPCCH for channel estimation.

8.6.6.14 DPCH frame offset (FDD Only)

If "DPCH frame offset" is included in a message that instructs the UE to enter CELL_DCH state:

1> UTRAN should:

2> if only one Radio Link is included in the message:

3> if the UE is configured for DPCH:

4> set "Default DPCH Offset Value" and "DPCH frame offset" respecting the following relation:

$$(\text{Default DPCH Offset Value}) \bmod 38400 = \text{DPCH frame offset}$$

- where the IE values used are the Actual Values of the IEs as defined in clause 11.

3> if the UE is configured for F-DPCH:

4> set "Default DPCH Offset Value" and "DPCH frame offset" respecting one of the following relations:

5> $(\text{Default DPCH Offset Value}) \bmod 38400 = \text{DPCH frame offset}$; or

5> $(\text{Default DPCH Offset Value} + 256) \bmod 38400 = \text{DPCH frame offset}$,

- where the IE values used are the Actual Values of the IEs as defined in clause 11.

2> if more than one Radio Link are included in the message:

3> if the UE is configured for DPCH:

4> set "Default DPCH Offset Value" and "DPCH frame offset" respecting the following relation:

$$(\text{Default DPCH Offset Value}) \bmod 38400 = \text{DPCH frame offset}_j$$

- where j indicates the first radio link listed in the message and the IE values used are the Actual Values of the IEs as defined in clause 11.

3> if the UE is configured for F-DPCH:

4> set "Default DPCH Offset Value" and "DPCH frame offset _{j} " respecting one of the following relations:

5> $(\text{Default DPCH Offset Value}) \bmod 38400 = \text{DPCH frame offset}_j$; or

5> $(\text{Default DPCH Offset Value} + 256) \bmod 38400 = \text{DPCH frame offset}_j$,

- where j indicates the first radio link listed in the message and the IE values used are the Actual Values of the IEs as defined in clause 11.

1> The UE shall:

2> if only one Radio Link is included in the message:

3> if the UE is configured for DPCH:

4> if $(\text{Default DPCH Offset Value}) \bmod 38400 = \text{DPCH frame offset}$:

5> set DOFF (see subclause 8.5.15.1) to Default DPCH Offset Value.

4> else:

5> set the variable INVALID_CONFIGURATION to TRUE.

3> if the UE is configured for F-DPCH:

4> if $(\text{Default DPCH Offset Value}) \bmod 38400 = \text{DPCH frame offset}$:

5> set DOFF (see subclause 8.5.15.1) to Default DPCH Offset Value.

4> else if $(\text{Default DPCH Offset Value} + 256) \bmod 38400 = \text{DPCH frame offset}$:

- 5> set DOFF (see subclause 8.5.15.1) to Default DPCH Offset Value + 256.
- 4> else:
 - 5> set the variable INVALID_CONFIGURATION to TRUE.
- 2> if more than one Radio Links are included in the message:
 - 3> if the UE is configured for DPCH:
 - 4> if (Default DPCH Offset Value) mod 38400 = DPCH frame offset_j,
 - where *j* indicates the first radio link listed in the message:
 - 5> set DOFF (see subclause 8.5.15.1) to Default DPCH Offset Value.
 - 4> else:
 - 5> set the variable INVALID_CONFIGURATION to TRUE.
 - 3> if the UE is configured for F-DPCH:
 - 4> if (Default DPCH Offset Value) mod 38400 = DPCH frame offset_j,
 - where *j* indicates the first radio link listed in the message:
 - 5> set DOFF (see subclause 8.5.15.1) to Default DPCH Offset Value.
 - 4> else if (Default DPCH Offset Value+256) mod 38400 = DPCH frame offset_j,
 - where *j* indicates the first radio link listed in the message:
 - 5> set DOFF (see subclause 8.5.15.1) to Default DPCH Offset Value + 256.
 - 4> else:
 - 5> set the variable INVALID_CONFIGURATION to TRUE.

If the IE "DPCH frame offset" is included the UE shall:

- 1> use its value to determine the beginning of the DPCH or F-DPCH frame.

8.6.6.15 DPCH Compressed mode info

If the IE "DPCH compressed mode info" is included, and if the IE group "transmission gap pattern sequence configuration parameters" is included, the UE shall for each transmission gap pattern sequence perform the following consistency checks:

- 1> if the UE, according to its measurement capabilities, and for all supported bands of the UTRA mode or RAT associated with the measurement purpose indicated by IE "TGMP", requires UL compressed mode, and CHOICE 'UL/DL mode' indicates 'DL only':
 - 2> set the variable INVALID_CONFIGURATION to TRUE.
- 1> if the UE, according to its measurement capabilities, and for all supported bands of the UTRA mode or RAT associated with the measurement purpose indicated by IE "TGMP", requires DL compressed mode, and CHOICE 'UL/DL mode' indicates 'UL only':
 - 2> set the variable INVALID_CONFIGURATION to TRUE.
- 1> if the UE, according to its measurement capabilities, does not require UL compressed mode for any of supported band of the UTRA mode or RAT associated with the measurement purpose indicated by the IE "TGMP", and CHOICE 'UL/DL mode' indicates 'UL only' or 'UL and DL':
 - 2> set the variable INVALID_CONFIGURATION to TRUE.

- 1> if the UE, according to its measurement capabilities, does not require DL compressed mode for any supported band of the UTRA mode or RAT associated with the measurement purpose indicated by the IE "TGMP", and CHOICE 'UL/DL mode' indicates 'DL only' or 'UL and DL':
 - 2> set the variable INVALID_CONFIGURATION to TRUE.
- 1> if UE already has an active transmission gap pattern sequence that, according to IE "TGMP", has the same measurement purpose, and both patterns will be active (according to the IE "Current TGPS Status Flag" in variable TGPS_IDENTITY) after the new configuration has been taken into use:
 - 2> set the variable INVALID_CONFIGURATION to TRUE.
- 1> if there is any pending "TGPS reconfiguration CFN" or any pending "TGCFN":
 - 2> the UE behaviour is unspecified.

If variable INVALID_CONFIGURATION has value FALSE after UE has performed the checks above, the UE shall:

- 1> if pattern sequence corresponding to IE "TGPSI" is already active (according to "Current TGPS Status Flag") in the variable TGPS_IDENTITY):
 - 2> if the "TGPS Status Flag" in this message is set to "deactivate" for the corresponding pattern sequence:
 - 3> deactivate this pattern sequence at the beginning of the frame, indicated by IE "Activation time" (see subclause 8.6.3.1) received in this message, when the new configuration received in this message is taken into use.
 - 3> set the "Current TGPS Status Flag" for this pattern sequence in the variable TGPS_IDENTITY to "inactive" at the frame, indicated by IE "Activation time" (see subclause 8.6.3.1) received in this message, when the new configuration received in this message is taken into use.
 - 2> if the "TGPS Status Flag" in this message is set to "activate" for the corresponding pattern sequence:
 - 3> deactivate this pattern sequence at the beginning of the frame, indicated by IE "Activation time" (see subclause 8.6.3.1) received in this message, when the new configuration received in this message is taken into use.

NOTE1: The temporary deactivation of pattern sequences for which the status flag is set to "activate" can be used by the network to align the timing of already active patterns with newly activated patterns.

NOTE2: The deactivation of pattern sequences only occurs as a result of RRC messages received by the UE, i.e. the UE does not set the "Current TGPS Status Flag" to "inactive" after the final gap of a finite length pattern sequence.

- 1> update each pattern sequence to the variable TGPS_IDENTITY according to the IE "TGPSI";
- 1> update into the variable TGPS_IDENTITY the configuration information defined by IE group "transmission gap pattern sequence configuration parameters";
- 1> if an F-DPCH is configured:
 - 2> not use the IEs "Downlink compressed mode method", "Downlink frame type", "DeltaSIR1", "DeltaSIRafter1", and if included, the IEs "DeltaSIR2", "DeltaSIRafter2".
- 1> after the instant in which the message is to be executed, as specified in subclause 8.6.3.1:
 - 2> activate the stored pattern sequence corresponding to each IE "TGPSI" for which the "TGPS status flag" in the variable TGPS_IDENTITY is set to "activate" at the time indicated by IE "TGCFN"; and
 - 2> set the "Current TGPS Status Flag" for this pattern sequence in the variable TGPS_IDENTITY to "active".

NOTE1: If the pattern is activated with a message that includes the IE "Activation time", and if the CFN value indicated by the IE "Activation Time" and the CFN value indicated by the TGCFN are included in the same TTI (but not at the TTI boundary) common to all the transport channels that are multiplexed onto the reference CCTrCh (as defined in subclause 8.6.3.1), and if the CFN value indicated by the TGCFN is equal or higher than the CFN value indicated by the IE "Activation Time" (as defined in subclause 8.6.3.1) value, the UE behaviour is not specified.

NOTE2: If the pattern is activated with a message used to perform timing re-initialised hard handover, the UE can start evaluating the activation of the pattern (i.e. compare the value of the CFN in the new configuration with the value of the TGCFN) at any time between the message activation time and the completion of the synchronisation procedure A.

- 2> if the IE "DPCH compressed mode info" is included in a message used to perform a Hard Handover with change of frequency (see subclause 8.3.5); or
- 2> if the IE "DPCH compressed mode info" is included in a message used to transfer the UE from CELL_FACH to CELL_DCH, and the cell in which the UE transited from CELL_FACH state is not included in the active set for the CELL_DCH state (see subclause 8.4.1.7.2):
 - 3> not begin the inter-frequency measurement reporting corresponding to the pattern sequence measurement purpose of each activated pattern sequence.
- 2> else:
 - 3> begin the inter-frequency measurement reporting corresponding to the pattern sequence measurement purpose of each activated pattern sequence.
- 2> begin the inter-RAT measurement reporting corresponding to the pattern sequence measurement purpose of each activated pattern sequence;
- 2> if the new configuration is taken into use at the same CFN as indicated by IE "TGCFN":
 - 3> start the concerned pattern sequence immediately at that CFN.
- 1> monitor if the parallel transmission gap pattern sequences create an illegal overlap, and in case of overlap, take actions as specified in subclause 8.2.11.2.

If the IE "DPCH compressed mode info" is included, and if the IE group "transmission gap pattern sequence configuration parameters" is not included, the UE shall:

- 1> if, as the result of this message, UE will have more than one transmission gap pattern sequence with the same measurement purpose active (according to IEs "TGMP" and "Current TGPS Status Flag" in variable TGPS_IDENTITY):
 - 2> set the variable CONFIGURATION_INCOMPLETE to TRUE.
- 1> if there is any pending "TGPS reconfiguration CFN" or any pending "TGCFN":
 - 2> the UE behaviour is unspecified.
- 1> if pattern sequence corresponding to IE "TGPSI" is already active (according to "Current TGPS Status Flag" in the variable TGPS_IDENTITY):
 - 2> if the "TGPS Status Flag" in this message is set to "deactivate" for the corresponding pattern sequence:
 - 3> deactivate this pattern sequence at the beginning of the frame, indicated by IE "Activation time"(see subclause 8.6.3.1) received in this message, when the new configuration received in this message is taken into use;
 - 3> set the "Current TGPS Status Flag" for this pattern sequence in the variable TGPS_IDENTITY to "inactive" at the frame, indicated by IE "Activation time"(see subclause 8.6.3.1) received in this message, when the new configuration received in this message is taken into use.
 - 2> if the "TGPS Status Flag" in this message is set to "activate" for the corresponding pattern sequence:

- 3> deactivate this pattern sequence at the beginning of the frame, indicated by IE "Activation time"(see subclause 8.6.3.1) received in this message, when the new configuration received in this message is taken into use.

NOTE1: The temporary deactivation of pattern sequences for which the status flag is set to "activate" can be used by the network to align the timing of already active patterns with newly activated patterns.

NOTE2: The deactivation of pattern sequences only occurs as a result of RRC messages received by the UE, i.e. the UE does not set the "Current TGPS Status Flag" to "inactive" after the final gap of a finite length pattern sequence.

1> after the instant in which the message is to be executed, as specified in subclause 8.6.3.1:

- 2> activate the stored pattern sequence corresponding to each IE "TGPSI" for which the "TGPS status flag" is set to "activate" at the time indicated by IE "TGCFN"; and

NOTE1: If the pattern is activated with a message that includes the IE "Activation time", and if the CFN value indicated by the IE "Activation Time" and the CFN value indicated by the TGCFN are included in the same TTI (but not at the TTI boundary) common to all the transport channels that are multiplexed onto the reference CCTrCh (as defined in subclause 8.6.3.1), and if the CFN value indicated by the TGCFN is equal or higher than the CFN value indicated by the IE "Activation Time" (as defined in subclause 8.6.3.1) value, the UE behaviour is not specified.

NOTE2: If the pattern is activated with a message used to perform timing re-initialised hard handover, the UE can start evaluating the activation of the pattern (i.e. compare the value of the CFN in the new configuration with the value of the TGCFN) at any time between the message activation time and the completion of the synchronisation procedure A.

- 2> set the "Current TGPS Status Flag" for this pattern sequence in the variable TGPS_IDENTITY to "active";
- 2> if the IE "DPCH compressed mode info" is included in a message used to perform a Hard Handover with change of frequency (see subclause 8.3.5); or
- 2> if the IE "DPCH compressed mode info" is included in a message used to transfer the UE from CELL_FACH to CELL_DCH, and the cell in which the UE transited from CELL_FACH state is not included in the active set for the CELL_DCH state (see subclause 8.4.1.7.2):
 - 3> not begin the inter-frequency measurement reporting corresponding to the pattern sequence measurement purpose of each activated pattern sequence.
- 2> else:
 - 3> begin the inter-frequency measurement reporting corresponding to the pattern sequence measurement purpose of each activated pattern sequence.
- 2> begin the inter-RAT measurement reporting corresponding to the pattern sequence measurement purpose of each activated pattern sequence;
- 2> if the new configuration is taken into use at the same CFN as indicated by IE "TGCFN":
 - 3> start the concerned pattern sequence immediately at that CFN.

For transmission gap pattern sequences stored in variable TGPS_IDENTITY, but not identified in IE "TGPSI" (either due to the absence of the IE "DPCH compressed mode info" in the received message or due to not receiving the corresponding TGPSI value in the IE "DPCH compressed mode info"), the UE shall:

- 1> if the received message implies a timing re-initialised hard handover (see subclause 8.3.5.1):
 - 2> deactivate such transmission gap pattern sequences at the beginning of the frame, indicated by IE "Activation time" (see subclause 8.6.3.1) received in this message; and
 - 2> set IE "Current TGPS Status Flag" in corresponding UE variable TGPS_IDENTITY to 'inactive'.
- 1> if the received message not implies a timing re-initialised hard handover (see subclause 8.3.5.1):

2> continue such transmission gap pattern sequence according to IE "Current TGPS Status Flag" in the corresponding UE variable TGPS_IDENTITY.

Uplink and downlink compressed mode methods are described in [27]. For UL "higher layer scheduling" compressed mode method and transport format combination selection, see [15].

8.6.6.16 Repetition period, Repetition length, Offset (TDD only)

In case the physical allocations of different channels overlap the following priority rules shall apply for common channels and shall be taken into account by the UE:

- 1> PICH takes precedence over Primary CCPCH;
- 1> PICH takes precedence over Secondary CCPCH;
- 1> MICH takes precedence over Primary CCPCH;
- 1> MICH takes precedence over Secondary CCPCH;
- 1> Secondary CCPCH takes precedence over Primary CCPCH.

The frame allocation can be derived by following rules:

If no IE "Offset" is explicitly given, the parameter "Offset" to be used is calculated by the following equation:

$$\text{Activation time mod Repetition period} = \text{Offset.}$$

Frames from CFN CFN_{off} to $CFN_{\text{off}} + \text{Repetition length} - 1$ belong to the allocation with CFN_{off} fulfilling the following equation:

$$CFN_{\text{off}} \text{ mod Repetition period} = \text{Offset.}$$

Repetition length is always a multiple of the largest TTI within the CCTrCH fulfilling the following equation:

$$(\text{largest TTI within CCTrCH}) * X = \text{Repetition Length}$$

Example of usage:

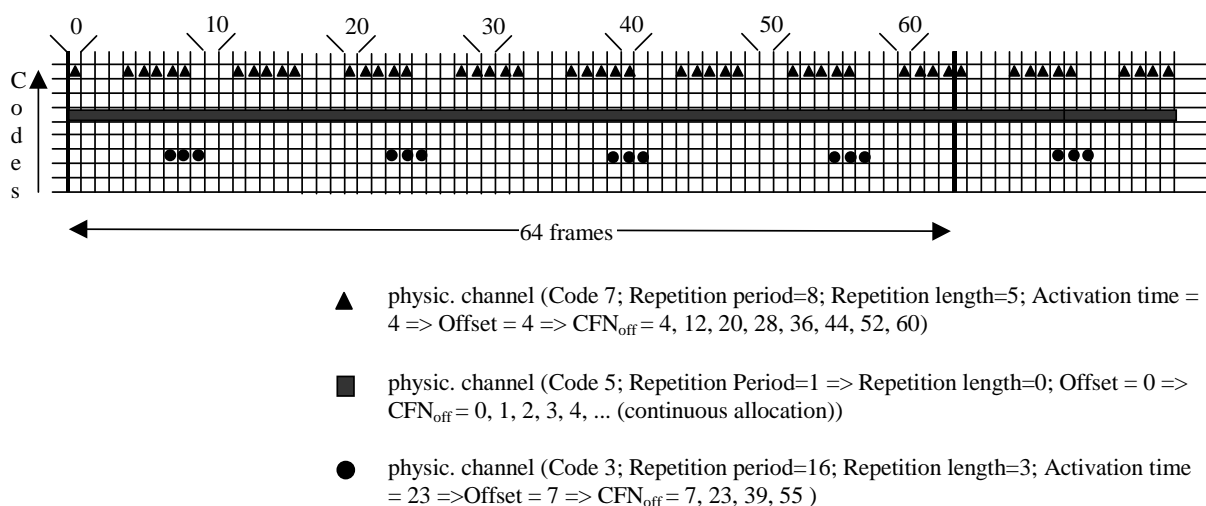

Figure 8.6.6.16-1: Examples for frame allocations in TDD

8.6.6.16a Repetition period, Repetition length, Offset_{sub} (1.28 Mcps TDD only)

The subframes, i.e. TTI in 5ms, of non-scheduled E-PUCH allocated can be determined from "Activation Time", "Subframe number", "Resource Duration" and "Resource Periodicity", or of initial SPS E-PUCH and HS-PDSCH or

Standalone midamble allocated can be determined from "Activation time", "Subframe number", "Repetition period" and "Repetition length" as below:

The parameter "Offset_{sub}" is defined to denote the offset of assigned E-PUCH or HS-PDSCH physical resource within each Repetition period and numerated in subframe number.

"Offset_{sub}" to be used is calculated by the following equation:

$$(\text{Activation time} * 2 + \text{Subframe number}) \bmod \text{Repetition period} = \text{Offset}_{\text{sub}}$$

Here, a new term subCFN is defined to represent the Subframe within a specified CFN, and subCFN within a specified CFN is counted as below:

$$\text{CFN} * 2 + \text{Subframe number} = \text{subCFN}$$

SubFrames from subCFN_{off} to subCFN_{off} + Repetition length - 1 belong to the allocation with subCFN_{off} fulfilling the following equation:

$$\text{subCFN}_{\text{off}} \bmod \text{Repetition period} = \text{Offset}_{\text{sub}}$$

Example of usage:

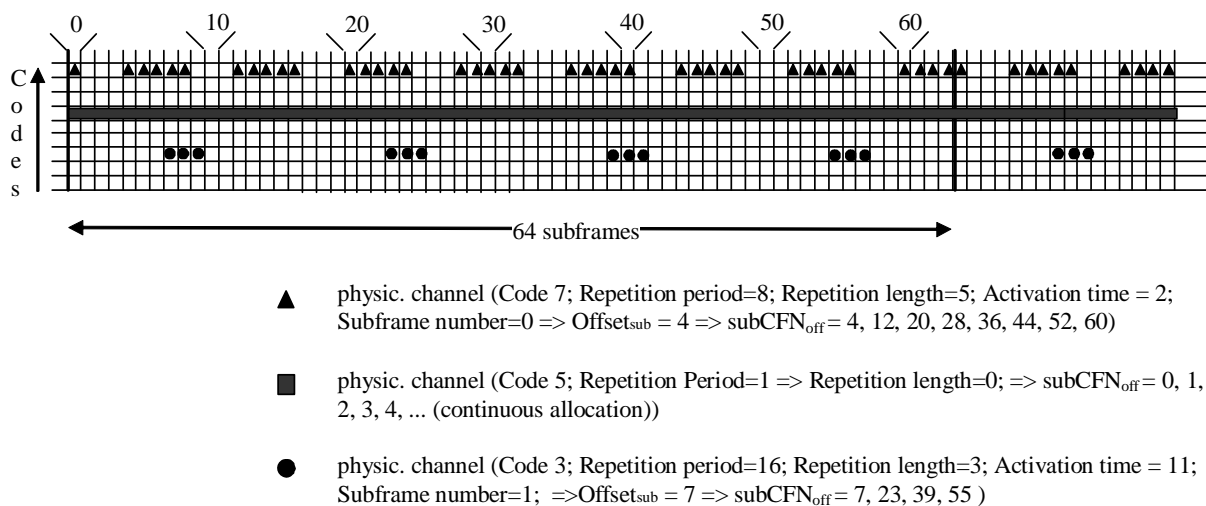

Figure 8.6.6.16a-1: Examples for subframe allocations in TDD

8.6.6.17 Primary CCPCH info

If the IE "Primary CCPCH info" is included, the UE shall:

- 1> use the information elements in this IE.

8.6.6.18 Primary CPICH info

If the IE "Primary CPICH info" in FDD is included, the UE shall:

- 1> use the value of this IE as the primary scrambling code for the downlink radio link.

8.6.6.19 Void

8.6.6.20 Void

8.6.6.21 Void

8.6.6.22 Secondary Scrambling Code, Code Number

The following description applies to FDD.

Code Number can be assigned by following rules:

- 1> When more than one DL DPDCH is assigned per RL, the segmented physical channel shall be mapped on to DL DPDCHs according to [27]. When p number of DL DPDCHs are assigned to each RL, the first pair of Secondary Scrambling Code and Code Number corresponds to "*PhCH number 1*", the second to "*PhCH number 2*", and so on until the p th to "*PhCH number p*".

8.6.6.23 PDSCH Power Control info

The UE shall:

- 1> if the IE "PDSCH Power Control info" is included:
 - 2> configure PDSCH power control with the received values.
- 1> if the IE "PDSCH Power Control info" is not included:
 - 2> continue to use the stored values.

8.6.6.24 Tx Diversity Mode

If the IE "Tx Diversity Mode" is included the UE shall:

- 1> if the value of the IE "Tx Diversity Mode" is STTD:
 - 2> configure the Layer 1 to use the Tx diversity mode indicated in the IE "Tx Diversity Mode" for the radio links for which the IE "Closed loop timing adjustment mode" is included, ignoring the actual value of IE "Closed loop timing adjustment mode".
- 1> if the value of the IE "Tx Diversity Mode" is closed loop mode 1:
 - 2> configure the Layer 1 to use the Tx diversity mode indicated in the IE "Tx Diversity Mode" for the radio links for which the IE "Closed loop timing adjustment mode" is included, using the actual value of the IE "Closed loop timing adjustment mode".
- 1> if the value of the IE "Tx Diversity Mode" is "none":
 - 2> configure the Layer 1 not to use Tx diversity for all radio links in the active set.

If the IE "Tx Diversity Mode" is not included, the UE shall:

- 1> continue to use the already configured Tx diversity mode;
- 1> in case no Tx diversity mode has been configured:
 - 2> do not apply Tx diversity.

For F-DPCH the UE shall:

- 1> if the IE "STTD indication" is included in the IE "Downlink F-DPCH info for each RL":
 - 2> use STTD for F-DPCH on the radio links for which the IE "STTD indication" is set to TRUE.

For HS-SCCH, the UE shall:

- 1> if the DPCH associated with a HS-SCCH is using either open or closed loop transmit diversity on the radio link transmitted from the HS-DSCH serving cell:

2> use STTD for this HS-SCCH;

1> if the F-DPCH associated with an HS-SCCH is using open loop transmit diversity on the radio link transmitted from the HS-DSCH serving cell:

2> use STTD for this HS-SCCH.

1> otherwise:

2> not use Tx diversity for this HS-SCCH.

For E-AGCH, E-RGCH, and E-HICH from the same cell, the UE shall:

1> for each radio link:

2> if the DPCH associated with E-AGCH, E-RGCH, and E-HICH from the same cell is using either open or closed loop transmit diversity:

3> use STTD for these E-AGCH, E-RGCH, and E-HICH.

2> if the F-DPCH associated with E-AGCH, E-RGCH, and E-HICH from the same cell is using open loop transmit diversity:

3> use STTD for these E-AGCH, E-RGCH, and E-HICH.

2> otherwise:

3> not use Tx diversity for these E-AGCH, E-RGCH, and E-HICH.

For F-TPICH, the UE shall:

1> for each radio link:

2> if the DPCH associated with the F-TPICH is using either open or closed loop transmit diversity:

3> use STTD for the F-TPICH.

2> if the F-DPCH associated with the F-TPICH is using open loop transmit diversity:

3> use STTD for the F-TPICH.

2> otherwise:

3> not use Tx diversity for the F-TPICH.

NOTE: The IE "Tx Diversity Mode" shall be ignored with respect to the radio links that are in the secondary E-DCH active set.

8.6.6.25 Void

8.6.6.26 UL Timing Advance Control (TDD only)

If the IE "UL Timing Advance Control" is present, the UE shall:

1> if the IE "Uplink Timing Advance Control" has the value "disabled":

2> reset timing advance to 0;

2> disable calculated timing advance following handover;

2> in case of handover:

3> start uplink transmissions in the target cell without applying timing advance.

1> if the IE "Uplink Timing Advance Control" has the value "enabled":

- 2> in 3.84 Mcps TDD or 7.68 Mcps TDD:
 - 3> in case of no cell change:
 - 4> evaluate and apply the timing advance value for uplink transmission as indicated in the IE "Uplink Timing Advance" or the IE "Extended Uplink Timing Advance" at the CFN indicated in the IE "Activation Time".
 - 3> in case of cell change:
 - 4> use the IE "Uplink Timing Advance" or the IE "Extended UL Timing Advance" as TA_{old} and apply TA_{new} for uplink transmission in the target cell at the CFN indicated in the IE "Activation Time" as specified in [33];
 - 4> include the value of the applied timing advance in the IE "Timing Advance" or the IE "Extended UL Timing Advance" in the COMPLETE message.
- 2> in 1.28 Mcps TDD:
 - 3> if the IE "Synchronisation parameters" is included:
 - 4> initiate a sequence of UpPCH SYNC_UL code transmissions using a code selected from the set specified and continue until a timing correction is received in the specified FPACH (received for WT sub-frames following the sub-frame in which the transmission was made) or until Max SYNC_UL transmissions have been completed. The power used for each SYNC_UL transmission is as specified in subclause 8.5.7. Each transmission is made in the first sub-frame possible following the end of each FPACH reception interval using the timing specified in [33]. A new code is selected for each transmission. The detection that the FPACH relates to the transmitted SYNC_UL code is described in [33];
 - 4> if a timing correction is received within Max SYNC_UL transmissions the procedure is completed. The assigned uplink resources may then be used, commencing at the first possible TTI boundary or the SFN in which the assignment commences, whichever is the later. The timing of the uplink transmission is described in [33];
 - 4> if no timing correction has been received within Max SYNC_UL transmissions, the synchronisation procedure has failed. If the assigned resources are DCH, the UE should not transmit using these resources and should respond as if a physical channel failure has occurred as specified in subclauses 8.1.3.7 or 8.2.2.7 or 8.3.1.7, or 8.3.6.5. If the assigned resources are USCH then the UE should ignore the USCH allocation.
 - 3> if the IE "Synchronisation parameters" is not included:
 - 4> in case of no cell change:
 - 5> continue to use the current uplink timing.
 - 4> in case of cell change:
 - 5> evaluate and apply the timing correction TA_{new} for uplink transmissions using the procedure as specified in [33].

8.6.6.26a Uplink synchronisation parameters (TDD only)

The UE shall apply uplink synchronisation using the values of the IEs "Uplink synchronisation step size" and "Uplink synchronisation frequency" as specified in [33].

8.6.6.27 Downlink information common for all radio links

If the IE "Downlink information common for all radio links " is included the UE shall:

- 1> if the IE "Downlink DPCH info common for all RL" is included:
 - 2> perform actions as specified in subclause 8.6.6.28.

- 1> if the IE "Downlink F-DPCH info common for all RL" is included:
 - 2> perform actions as specified in subclause 8.6.6.28a.
- 1> if the IE choice "mode" is set to 'FDD':
 - 2> perform actions for the IE "DPCH compressed mode info" as specified in subclause 8.6.6.15;
 - 2> perform actions for the IE "Tx Diversity mode" as specified in subclause 8.6.6.24.
- 1> if the IE "MAC-hs reset indicator" is included:
 - 2> if the serving HS-DSCH radio link is the same radio link as prior to the reception of the message; and
 - 2> if, as a result of the reconfiguration message where this IE is received, the MAC header type (i.e., either MAC-hs or MAC-ehs) is unchanged; and
 - 2> if, as a result of the reconfiguration message where this IE is received, the UE does not perform a state transition between CELL_FACH state and CELL_DCH state:
 - 3> the UE behaviour is unspecified.
 - 2> if inter-Node B Multiflow operation is not configured:
 - 3> reset the MAC-hs/ehs entity [15].
 - 2> else:
 - 3> reset the MAC-hs/ehs entity related to the serving cell [15].
- 1> if the IE "MAC-hs reset indicator for Multiflow assisting cells" is included:
 - 2> if inter-Node B Multiflow operation is configured:
 - 3> reset the MAC-hs/ehs entity related to the configured assisting cells [15].
 - 2> else:
 - 3> the UE behaviour is unspecified.

NOTE: If the MAC header type is changed, either from MAC-hs to MAC-ehs or from MAC-ehs to MAC-hs, UTRAN should include the IE "MAC-hs reset indicator" in order to ensure a reset of the MAC-hs/ehs entity in the UE prior to MAC-hs/ehs reconfiguration, otherwise the UE behaviour is unspecified.

8.6.6.28 Downlink DPCH info common for all radio links

If the IE "Downlink DPCH info common for all RL" is included the UE shall:

- 1> if:
 - 2> the IE "Downlink DPCH info common for all RL" is included in a reconfiguration message; and
 - 2> the UE was in CELL_DCH state upon reception of the message and remains in CELL_DCH state; and
 - 2> the message is not used to perform a hard handover (as specified in subclause 8.6.6.3a) and the IE "Timing indication" is set to "initialise":
 - 3> the UE behaviour is not specified.
- 1> if the IE "Downlink DPCH power control information" is included:
 - 2> in the case of FDD:
 - 3> perform actions for the IE "DPC Mode" according to [29].
 - 2> in the case of TDD:
 - 3> perform actions for the IE "TPC Step Size" according to [33].

- 1> if the IE choice "mode" is set to 'FDD':
 - 2> if the IE "Downlink rate matching restriction information" is included:
 - 3> set the variable INVALID_CONFIGURATION to TRUE.
 - 2> perform actions for the IE "spreading factor";
 - 2> perform actions for the IE "Fixed or Flexible position";
 - 2> perform actions for the IE "TFCI existence";
 - 2> if the IE choice "SF" is set to 256:
 - 3> store the value of the IE "Number of bits for pilot bits".
 - 2> if the IE choice "SF" is set to 128:
 - 3> store the value of the IE "Number of bits for pilot bits".

If the IE "Downlink DPCH info common for all RL" is included in a message used to perform a Timing re-initialised hard handover or the IE "Downlink DPCH info common for all RL" is included in a message other than RB SETUP used to transfer the UE from a state different from CELL_DCH to CELL_DCH, and ciphering is active for any radio bearer using RLC-TM, the UE shall, after having activated the dedicated physical channels indicated by that IE:

- 1> if any ciphering configuration for a radio bearer using RLC-TM has not been applied, due to that the activation time from a previous procedure has not elapsed:
 - 2> apply the ciphering configuration immediately and consider the activation time from the previous procedure to be elapsed.
- 1> if the IE "MAC-d HFN initial value" is included in the IE "Downlink DPCH info common for all RL":
 - 2> set the HFN component of COUNT-C for TM-RLC to the value of the IE "MAC-d HFN initial value", while not incrementing the value of the HFN component of COUNT-C at each CFN cycle.

NOTE: The UTRAN should choose a value for the IE "MAC-d HFN initial value" using the COUNT-C value of the RBs using RLC-TM indicated by the Source RNC to the Target RNC in the IE "SRNS Relocation Info" and include some margin in such a way that no values of COUNT-C are repeated after the handover.

- 1> else:
 - 2> set the 20 MSB of the HFN component of COUNT-C for TM-RLC to the value of the latest transmitted IE "START" or "START List" for this CN domain, while not incrementing the value of the HFN component of COUNT-C at each CFN cycle; and
 - 2> set the remaining LSBs of the HFN component of COUNT-C to zero.
- 1> start to perform ciphering on the radio bearer in lower layers while not incrementing the HFN;
- 1> include the IE "COUNT-C activation time" in the response message and specify a CFN value for this IE other than the default, "Now", that is a multiple of 8 frames ($CFN \bmod 8 = 0$) and lies at least 200 frames ahead of the CFN in which the response message is first transmitted;
- 1> calculate the START value according to subclause 8.5.9;
- 1> include the calculated START values for each CN domain in the IE "START list" in the IE "Uplink counter synchronisation info" in the response message;
- 1> at the CFN value as indicated in the response message in the IE "COUNT-C activation time":
 - 2> set the 20 MSB of the HFN component of the COUNT-C variable common for all transparent mode radio bearers of this CN domain to the START value as indicated in the IE "START list" of the response message for the relevant CN domain; and
 - 2> set the remaining LSBs of the HFN component of COUNT-C to zero;

- 2> increment the HFN component of the COUNT-C variable by one even if the "COUNT-C activation time" is equal to zero;
- 2> set the CFN component of the COUNT-C to the value of the IE "COUNT-C activation time" of the response message. The HFN component and the CFN component completely initialise the COUNT-C variable;
- 2> step the COUNT-C variable, as normal, at each CFN value, i.e. the HFN component is no longer fixed in value but incremented at each CFN cycle.

8.6.6.28a Downlink F-DPCH info common for all radio links

If the IE "Downlink F-DPCH info common for all RL" is included the UE shall:

- 1> if the IE "Downlink F-DPCH info common for all RL" is included in a message used to perform a hard handover:
 - 2> perform actions for the IE "Timing indication" as specified in subclause 8.5.15.2, and subclause 8.3.5.1 or 8.3.5.2.
- 1> if the IE "Downlink DPCH power control information" is included:
 - 2> perform actions for the IE "DPC Mode" according to [29].

8.6.6.29 ASC setting

If the IE "ASC setting" is included, the UE shall:

- 1> establish the available signatures for this ASC as specified in the following:
 - 2> separately renumber the list of available signatures specified in the IE "Available signature" included in the IE "PRACH info" and the IE "PRACH preamble control parameters (for Enhanced Uplink)" contained in the IE "Common E-DCH system info" from signature index 0 to signature index N-1, where N is the number of available signatures, starting with the lowest available signature number and continuing in sequence, in the order of increasing signature numbers;
 - 2> for each occurrence in the IE "PRACH preamble control parameters extension list Type 1 (for Enhanced Uplink)", IE "PRACH preamble control parameters extension list Type 2 (for Enhanced Uplink)", and IE "PRACH preamble control parameters extension list Type 3 (for Enhanced Uplink)"
 - 3> separately renumber the list of available signatures specified in the IE "Available signature" included in the IE "PRACH preamble control parameters (for Enhanced Uplink)" from signature index 0 to signature index N-1, where N is the number of available signatures, starting with the lowest available signature number and continuing in sequence, in the order of increasing signature numbers;
 - 2> consider as available signatures for this ASC the signatures included in this renumbered list from the index specified by the IE "Available signature Start Index" to the index specified by the IE "Available signature End Index".
- 1> establish the available access slot sub-channels for this ASC as specified in the following:
 - 2> if the IE "AICH transmission timing" included in the IE "AICH Info" is set to '0':
 - 3> ignore the leftmost (most significant) bit (bit b3) of the bit string specified by the IE "Assigned Sub-Channel Number";
 - 3> repeat 4 times the 3 rightmost (least significant) bits (bits b2-b0) of the bit string specified by the IE "Assigned Sub-Channel Number" to form a resulting bit string 'b2 b1 b0 b2 b1 b0 b2 b1 b0 b2 b1 b0' of length 12 bits, where the leftmost bit is the most significant.
 - 2> if the IE "AICH transmission timing" included in the IE "AICH Info" is set to '1':
 - 3> repeat 3 times the bit string (bits b3-b0) specified by the IE "Assigned Sub-Channel Number" to form a bit string 'b3 b2 b1 b0 b3 b2 b1 b0 b3 b2 b1 b0' of length 12 bits, where the leftmost bit is the most significant.

- 2> perform in both cases, for the resulting bit string (that includes the repetitions) bit-wise logical AND operation separately with the IE "Available Sub Channel number" included in IE "PRACH info (for RACH)" and "PRACH preamble control parameters (for Enhanced Uplink)";
- 2> consider as available sub-channels for this ASC the available sub-channels indicated in the resulting bit string, after logical AND operation i.e. each bit set to 1 or 0 indicates availability or non-availability, respectively, of sub-channel number x , with x from 0 to 11, for the respective ASC.

NOTE 1: In FDD, the list of available signatures is renumbered from signature index 0 to signature index N-1, where N is the number of available signatures, starting with the lowest available signature number and continuing in sequence, in the order of increasing signature numbers.

- List of available signatures: 16 or fewer signatures are available.
- Example: only signatures 0, 5, 10 and 15 are available, then :
 - Signature 0 is: available signature index 0
 - Signature 5 is: available signature index 1
 - Signature 10 is: available signature index 2
 - Signature 15 is: available signature index 3

NOTE 2: In 3.84 Mcps TDD, the list of available channelisation codes (defined in PRACH info) is renumbered from channelisation code index 0 to channelisation code index N-1, where N is the number of available channelisation codes, starting with the lowest available channelisation code number and continuing in sequence, in the order of increasing channelisation code numbers

List of available channelisation codes : 8 or less channelisation codes are available.

The i -th bit of the bitmap defined in the IE "Available Channelisation Code indices" defines whether the channelisation code with the available channelisation code index i is to be used for this ASC (bit set means used, bit unset means not used). Only the low N bits shall be used in the bitmap, where N is the number of available channelisation codes defined in PRACH info.

Ex : spreading factor 16, channelisation codes 16/1, 16/2, 16/5, 16/8 are available :

- Channelisation code 16/1 is: available channelisation code index 0
- Channelisation code 16/2 is: available channelisation code index 1
- Channelisation code 16/5 is: available channelisation code index 2
- Channelisation code 16/8 is: available channelisation code index 3

Available Channelisation Code indices has the value '00001100' means: Channelisation Codes 16/5 and 16/8 are available for this ASC.

NOTE 2a: In 7.68 Mcps TDD, the list of available channelisation codes (defined in PRACH info) is renumbered from channelisation code index 0 to channelisation code index N-1, where N is the number of available channelisation codes, starting with the lowest available channelisation code number and continuing in sequence, in the order of increasing channelisation code numbers

List of available channelisation codes : 16 or less channelisation codes are available.

The i -th bit of the bitmap defined in the IE "Available Channelisation Code indices" defines whether the channelisation code with the available channelisation code index i is to be used for this ASC (bit set means used, bit unset means not used). Only the low N bits shall be used in the bitmap, where N is the number of available channelisation codes defined in PRACH info.

Ex : spreading factor 32, channelisation codes 32/1, 32/2, 32/5, 32/8 are available :

- Channelisation code 32/1 is: available channelisation code index 0
- Channelisation code 32/2 is: available channelisation code index 1
- Channelisation code 32/5 is: available channelisation code index 2
- Channelisation code 32/8 is: available channelisation code index 3

Available Channelisation Code indices has the value '000000000001100' means: Channelisation Codes 32/5 and 32/8 are available for this ASC.

NOTE 3: In TDD, the subchannel description is found in [33].

NOTE 4: In 1.28 Mcps TDD, the list of available SYNC_UL codes (defined in PRACH info) is numbered from SYNC_UL code index 0 to SYNC_UL code index N-1, where N is the number of available SYNC_UL codes, starting with the lowest available SYNC_UL code number and continuing in sequence, in the order of increasing SYNC_UL code numbers

The i-th bit of the bitmap defined in the IE "Available SYNC_UL codes indices" defines whether the SYNC_UL code with the available SYNC_UL code index i is to be used for this ASC (bit set means used, bit unset means not used). Only the low N bits shall be used in the bitmap, where N is the number of available SYNC_UL codes defined in PRACH info.

- List of available SYNC_UL codes: 8 or fewer SYNC_UL codes are available.

Example: only signatures 0, 5, 6 and 7 are available, then:

- SYNC_UL codes 0 is: available SYNC_UL codes index 0
- SYNC_UL codes 5 is: available SYNC_UL codes index 1
- SYNC_UL codes 6 is: available SYNC_UL codes index 2
- SYNC_UL codes 7 is: available SYNC_UL codes index 3

Available SYNC_UL codes indices has the value '00001100' means: SYNC_UL codes 6 and 7 are available for this ASC.

8.6.6.30 SRB delay, PC preamble (FDD only)

When the IE "SRB delay" and IE "PC preamble" is received in a message that results in a configuration of uplink DPCH or E-DPCH, and synchronisation procedure A is being used as specified in [29], the UE shall:

- 1> store the received IE "SRB delay" and IE "PC preamble" in the variable LATEST_CONFIGURED_SRB_DELAY_AND_PC_PREAMBLE;
- 1> apply power control preamble according to [26] during the number of frames indicated in the IE "PC preamble"; and
- 1> then not send any data on signalling radio bearers RB0 to RB4 during the number of frames indicated in the IE "SRB delay" or while the physical channel is not considered established.

8.6.6.31 Void

8.6.6.32 Void

8.6.6.33 HS-SCCH Info

If the IE "HS-SCCH Info" is included and the UE will be in CELL_DCH state after completion of this procedure, the UE shall:

- 1> store the received configuration.
- 1> determine the value for the HS_DSCH_RECEPTION variable and take the corresponding actions as described in subclause 8.5.25.

When the variable HS_DSCH_RECEPTION is set to TRUE the UE shall:

- 1> in the case of FDD:
 - 2> receive the HS-SCCH(s) according to the IE "HS-SCCH channelisation code" on the serving HS-DSCH radio link applying the scrambling code as received in the IE "DL Scrambling code".

- 1> in the case of TDD:
 - 2> receive the HS-SCCH(s) according to the IEs "Timeslot Number", "Channelisation Code" and Midamble configuration IEs.
 - 2> transmit the HS-SICH according to the IEs "Timeslot Number", "Channelisation Code" and Midamble configuration IEs.
 - 2> for HS-SCCH power control the UE shall use the "BLER target" signalled in the first occurrence of the "HS-SCCH Set Configuration", and the UE shall also use the IE "Power Control GAP" for 1.28 Mcps TDD.
 - 2> in 3.84 Mcps TDD and 7.68 Mcps TDD:
 - 3> use the parameters specified in the IE "HS-SICH power control info" for open loop power control as defined in subclause 8.5.7.
 - 2> in 1.28 Mcps TDD:
 - 3> use the IE "PRX_{HS-SICH}" to calculate and set an initial uplink transmission power;
 - 3> use the IE "TPC step size" upon reception of TPC commands for closed loop power control;
 - 3> perform closed loop power control on HS-SICH within the interval indicated in the IE "Power Control GAP";
 - 3> use the IE "Pathloss compensation switch" to determine if the pathloss compensation from the beacon channel estimation should be taken into account for closed loop power control on HS-SICH;
 - 3> use default value of "Uplink synchronisation frequency" and same value of "Uplink synchronisation step size" in "Uplink DPCH info" for HS-SICH upon reception of SS commands for closed loop uplink synchronisation on HS-SICH.

For 1.28 Mcps TDD, if the IE "HS-SCCH Info" is included and the UE will be in CELL_FACH state after completion of this procedure, the UE shall:

- 1> store the received configuration;
- 1> determine the value for the HS_DSCH_RECEPTION_CELL_FACH_STATE variable and take the corresponding actions as described in subclause 8.5.36.

For 1.28 Mcps TDD, when the variable HS_DSCH_RECEPTION_CELL_FACH_STATE is set to TRUE the UE shall:

- 1> receive the HS-SCCH(s) according to the IEs "Timeslot Number", "Channelisation Code" and Midamble configuration IEs;
- 1> transmit the HS-SICH according to the IEs "Timeslot Number", "Channelisation Code" and Midamble configuration IEs;
- 1> for HS-SCCH power control the UE shall use the "BLER target" signalled in the first occurrence of the "HS-SCCH Set Configuration", and the UE shall also use the IE "Power Control GAP" for 1.28 Mcps TDD;
- 1> use the IE "PRX_{HS-SICH}" to calculate and set an initial uplink transmission power;
- 1> use the value of "TPC step size" in the IE "E-AGCH info" for HS-SCCH closed loop power control;
- 1> use the IE "TPC step size" upon reception of TPC commands for closed loop power control;
- 1> perform closed loop power control on HS-SICH within the interval indicated in the IE "Power Control GAP";
- 1> use the IE "Pathloss compensation switch" to determine if the pathloss compensation from the beacon channel estimation should be taken into account for closed loop power control on HS-SICH;
- 1> use default value of "Uplink synchronisation frequency" and same value of "Uplink synchronisation step size" in "Uplink DPCH info" for HS-SICH upon reception of SS commands for closed loop uplink synchronisation on HS-SICH.

8.6.6.34 Measurement Feedback Info

If the IE "Measurement Feedback Info" is included and the UE will be in CELL_DCH state after completion of this procedure, the UE shall:

- 1> store the received configuration;
- 1> determine the value for the HS_DSCH_RECEPTION variable and take the corresponding actions as described in subclause 8.5.25.
- 1> if the IE "CQI repetition factor for Multiflow assisting cells" is included:
 - 2> if Multiflow operation on single frequency and two cells without MIMO is configured:
 - 3> if the value in the IE "CQI repetition factor for Multiflow assisting cells" is the same as the value in the IE "CQI repetition factor":
 - 4> act on the IE "CQI repetition factor for Multiflow assisting cells" for configured multiflow assisting cell(s).
 - 3> else:
 - 4> the UE behavior is unspecified.
 - 2> else:
 - 3> act on the IE "CQI repetition factor for Multiflow assisting cells" for configured multiflow assisting cell(s).
- 1> else:
 - 2> act on the IE "CQI repetition factor" for configured multiflow assisting cell(s).

When the variable HS_DSCH_RECEPTION is set to TRUE the UE shall:

- 1> use the information for the channel quality indication (CQI) procedure in the physical layer on the serving HS-DSCH radio link.

8.6.6.35 DPC Mode

If the IE "DPC Mode" is included, the UE shall:

- 1> apply the indicated DPC mode according to [29].

If the IE "DPC Mode" is not included, the UE shall:

- 1> continue with the currently used DPC mode.

8.6.6.36 Downlink HS-PDSCH Information

If the IE "Downlink HS-PDSCH Information" is included and the UE would be in CELL_DCH state after completion of this procedure, the UE shall:

- 1> for 1.28 Mcps TDD, if the HS-PDSCH has been configured by the IE "DL Multi-carrier information":
 - 2> clear other stored carriers configuration in the IE "DL Multi-carrier information".
- 1> if the IE "HS-SCCH Info" is included:
 - 2> act as specified in subclause 8.6.6.33.
- 1> if the IE "Measurement Feedback Info" is included:
 - 2> act as specified in subclause 8.6.6.34.
- 1> if the IE "HS-DSCH Timeslot Configuration" or "HS-PDSCH Midamble Configuration" is included:

- 2> store the received configuration;
- 2> determine the value for the HS_DSCH_RECEPTION variable and take actions as described in subclause 8.5.25.

For 1.28 Mcps TDD, if the IE "Downlink HS-PDSCH Information" is included and the UE would be in CELL_FACH state after completion of this procedure, the UE shall:

- 1> if the IE "HS-SCCH Info" is included:
 - 2> act as specified in subclause 8.6.6.33.
- 1> if the IE "HS-PDSCH Midamble Configuration" is included:
 - 2> store the received configuration.
- 1> determine the value for the HS_DSCH_RECEPTION_CELL_FACH_STATE variable and take the corresponding actions as described in subclause 8.5.36.

8.6.6.36a DL Multi-carrier information (1.28 Mcps TDD only)

The IE "DL Multi-carrier information" is used in multiple carriers system.

NOTE: When only one frequency is configured to the UE, either the IE "DL Multi-carrier information" or the IE "Downlink HS-PDSCH Information" may be used but should use only one of them and the DPCH frequency shall be aligned with the IE "DL Multi-carrier information".

If the IE "DL Multi-carrier information" is included, the UE shall:

- 1> if the IE "TSN-Length" is included:
 - 2> store the new TSN length indicated by the IE "TSN-Length".
- 1> if the IE "TSN-Length" is not included:
 - 2> if the UE has stored TSN length:
 - 3> use the stored content of the IE.
 - 2> else:
 - 3> set the TSN length to 6bits.
- 1> if the IE "Multi-Carrier number" is included:
 - 2> store the new multiple carriers number indicated by the IE "Multi-Carrier number";
 - 2> start reception procedure on the HS-SCCHs (refer to [33]).
- 1> if the IE "DL-HSPDSCH-MultiCarrier-Information" is included:
 - 2> if the IE "HS-SCCH Set Configuration" is included:
 - 3> perform processes described in subclause 8.6.6.33.
 - 2> if the IE "HARQ-Info" is included:
 - 3> perform processes described in subclause 8.6.5.6b.
 - 2> if the IE "HS-PDSCH Midamble Configuration" is included:
 - 3> store the HS-PDSCH midamble configuration indicated by the IE "HS-PDSCH Midamble Configuration";
 - 3> perform processes described in subclause 8.5.25.

- 1> if the carrier which has been stored by the UE is not included in the the IE "DL-HSPDSCH-MultiCarrier-Information", the UE should delete all the configurations related to this carrier.

8.6.6.37 E-DCH Info

If the IE "E-DCH Info" is included and the UE will be in CELL_DCH state after completion of this procedure, the UE shall:

- 1> for FDD:

- 2> if the IE "E-DPCCH Info" is included:

- 3> store the newly received E-DPCCH configuration.

- 2> if the IE "E-DPDCH Info" is included:

- 3> store the newly received E-DPDCH configuration.

- 2> if the IE "Uplink MIMO info FDD" is included:

- 3> store the newly received UL MIMO configuration and perform actions as specified in sub-clause 8.5.81.

- 2> if the IE "UL 16QAM settings" is not included:

- 3> indicate to lower layers to stop any operation in 16QAM mode.

- 2> if the IE "UL 64QAM settings" is not included:

- 3> indicate to lower layers to stop any operation in 64QAM mode.

- 2> if both the IE "UL 16QAM settings" and IE "UL 64QAM settings" are included:

- 3> the UE behaviour is unspecified.

- 1> for TDD:

- 2> if the IE "E-RUCCH Info" is included:

- 3> store the newly received E-RUCCH configuration.

- 2> if the IE "E-PUCH Info" is included:

- 3> store the newly received E-PUCH configuration.

NOTE 1: The UTRAN should ensure the ordering of the E-TFCI table in strictly increasing order of transmission power prior to quantization, by correct setting of the reference E-TFCI power offsets otherwise the UE behaviour is unspecified.

NOTE 2: If a reference E-TFCI signalled to the UE is outside the UE physical channel capability, the UE behaviour is unspecified.

NOTE 2a: If E-TFCI boost is signalled to the UE and a reference E-TFCI \leq E-TFCI Boost is signalled to the UE with a Reference E-TFCI PO of value 30 or 31, the UE behaviour is unspecified.

NOTE 2b: If the UE is configured with E-TFCI table 0 and 2ms TTI, and a reference E-TFCI =120 has been configured, the UE behavior is unspecified.

NOTE 2c: If the UE is configured with E-TFCI table 1 and 2ms TTI, and a reference E-TFCI =115 has been configured, the UE behavior is unspecified.

NOTE 2d: If the UE is configured with E-TFCI table 2 and 2ms TTI, and a reference E-TFCI =121 has been configured, the UE behavior is unspecified.

NOTE 2e: If the UE is configured with E-TFCI table 3 and 2ms TTI, and a reference E-TFCI =101 or a reference E-TFCI = 102 has been configured, the UE behavior is unspecified.

- 1> if the IE "MAC-es/e reset indicator" is included:

2> reset the MAC-es/e or MAC-i/is entity [15].

NOTE 3: If the IE "MAC-es/e reset indicator" is not set to TRUE in case the IE "E-DCH Transmission Time Interval" is reconfigured, the UE behaviour is unspecified.

NOTE 4: If the IE "MAC-es/e reset indicator" is not set to TRUE in case the UL MAC header type is reconfigured from MAC-es/e to MAC-is/i or from MAC-is/i to MAC-e/es, the UE behaviour is unspecified.

NOTE 5: If the IE "MAC-es/e reset indicator" is not included in the IE "E-DCH Info" and 16QAM or 64QAM operation starts or stops, the UE behaviour is unspecified.

1> determine the value for the E_DCH_TRANSMISSION variable and take the corresponding actions as described in subclause 8.5.28.

When the variable E_DCH_TRANSMISSION is set to TRUE the UE shall:

1> for FDD:

2> configure the UL E-DPCCH in accordance with the stored IE "E-DPCCH" configuration;

2> configure the MAC with the stored IE "E-DPDCH" configuration and/or the information contained in IE "Scheduled Transmission configuration".

1> for TDD:

2> configure the E-RUCCH with the stored E-RUCCH configuration;

2> configure the MAC with the stored E-PUCH configuration.

For 1.28 Mcps TDD, If the IE "E-DCH Info" is included and the UE will be in CELL_FACH state after completion of this procedure, the UE shall:

1> if the IE "E-RUCCH Info" is included:

2> store the newly received E-RUCCH configuration.

1> if the IE "E-PUCH Info" is included:

2> store the newly received E-PUCH configuration.

1> if the IE "MAC-es/e reset indicator" is included:

2> reset the MAC-es/e or MAC-i/is entity [15].

1> determine the value for the COMMON_E_DCH_TRANSMISSION variable and take the corresponding actions as described in subclause 8.5.46.

For 1.28 Mcps TDD, when the variable COMMON_E_DCH_TRANSMISSION is set to TRUE the UE shall:

1> configure the E-RUCCH with the stored E-RUCCH configuration;

1> configure the MAC with the stored E-PUCH configuration.

8.6.6.38 DTX-DRX timing information (FDD only)

If the IE "DTX-DRX timing information" is included and the UE will be in CELL_DCH state after completion of this procedure, the UE shall:

1> if the CHOICE "timing" is set to "New timing":

2> use the newly received DTX-DRX timing configuration.

1> if the CHOICE "timing" is set to "Continue", and the message is used to perform a hard handover (as specified in subclause 8.6.6.3a); or

1> if the received message does not include the IE "DTX-DRX information" and this message will perform E-DCH TTI reconfiguration:

2> the UE behaviour is unspecified.

1> determine the value for the DTX_DRX_STATUS variable and take the corresponding actions as described in subclause 8.5.34.

8.6.6.39 DTX-DRX information (FDD only)

If the IE "DTX-DRX information" is included and the UE will be in CELL_DCH state after completion of this procedure, the UE shall:

- 1> store the contents of the IE in the variable DTX_DRX_PARAMS, replacing or clearing any previously stored "DTX Information" or "DRX Information";
- 1> determine the value for the DTX_DRX_STATUS variable and take the corresponding actions as described in subclause 8.5.34;
- 1> if the value of the IE "UE DTX cycle 2" is not an integer multiple of the value of the IE "UE DTX cycle 1"; or
- 1> if the value of the IE "UE DTX cycle 2" is not an integer multiple or a divisor of the value of the IE "CQI Feedback cycle, k" divided by 2; or
- 1> if the value of the IE "UE DPCCH burst 1" is greater than the value of the IE "UE DTX cycle 1"; or
- 1> if the value of the IE "UE DPCCH burst 2" is greater than the value of the IE "UE DTX cycle 2"; or
- 1> if the IE "UE DTX long preamble length" is set to 4 or 15 slots and the value of the IE "Inactivity Threshold for UE DTX cycle 2" is less than 4 TTIs (for 10ms E-DCH TTI) or 8 TTIs (for 2ms E-DCH TTI); or
- 1> if the IE "UE DRX cycle" is not an integer multiple or a divisor of the value of the IE "UE DTX cycle 1"; or
- 1> if the IE "UE DRX cycle 2" is not an integer multiple or a divisor of the value of the IE "UE DTX cycle 2"; or
- 1> if the value of the IE "UE DTX cycle 1" is not an integer multiple or a divisor of the value of the IE "MAC DTX cycle"; or
- 1> if the IE "UE DTX cycle 2 secondary" is present and the value of the IE "UE DTX cycle 2 secondary" is not an integer multiple of the value of the IE "UE DTX cycle 1 secondary"; or
- 1> if the IE "UE DPCCH burst 1 secondary" is present and the value of the IE "UE DPCCH burst 1 secondary" is greater than the value of the IE "UE DTX cycle 1 secondary"; or
- 1> if the IE "UE DPCCH burst 2 secondary" is present and the value of the IE "UE DPCCH burst 2 secondary" is greater than the value of the IE "UE DTX cycle 2 secondary"; or
- 1> if the IE "UE DTX long preamble length secondary" is present and set to 4 or 15 slots and the value of the IE "Inactivity Threshold for UE DTX cycle 2 secondary" is less than 8 TTIs (for 2ms E-DCH TTI); or
- 1> if the IE "UE DRX cycle" is present and is not an integer multiple or a divisor of the value of the IE "UE DTX cycle 1 secondary"; or
- 1> if the IE "UE DRX cycle 2" is present and is not an integer multiple or a divisor of the value of the IE "UE DRX cycle 2 secondary"; or
- 1> if the IE "UE DTX cycle 1 secondary" is present and is not an integer multiple or a divisor of the value of the IE "MAC DTX cycle"; or
- 1> if the IE "DTX-DRX timing information" is included in this message and if the CHOICE "timing" is set to "continue"; or
- 1> if the IE "Uplink DPCCH slot format information" is received in an ACTIVE SET UPDATE message and indicates different uplink DPCCH slot format from the one currently configured, and neither the indicated uplink DPCCH slot format nor the currently configured uplink DPCCH slot format are uplink DPCCH slot format 4; or
- 1> if the IE "DTX Information" is not included in this message:
 - 2> the UE behaviour is unspecified.

NOTE: If the IE "Uplink DPCH info" is included in this message, the UTRAN should ensure that the configuration of the uplink DPCH does not contradict the uplink DPCH configuration indicated in the IE "Uplink DPCH slot format information".

8.6.6.40 HS-SCCH less information (FDD only)

If the IE "HS-SCCH less information" is included and the UE will be in CELL_DCH state after completion of this procedure, the UE shall:

- 1> if the CHOICE "HS-SCCH less operation" is set to "New HS-SCCH less operation":
 - 2> store the contents of the IE in the variable HS_SCCH_LESS_PARAMS.
- 1> determine the value for the HS_SCCH_LESS_STATUS variable and take the corresponding actions as described in subclause 8.5.35.

8.6.6.41 MIMO parameters

If the IE "MIMO parameters" is included, the UE shall:

- 1> act as specified in clauses 8.5.32 and 8.5.33;
- 1> If the IE "MIMO operation" is set to "start":
 - 2> If the MIMO_STATUS variable is set to FALSE:
 - 3> the UE behaviour is undefined.
 - 2> otherwise:
 - 3> if the UE supports MIMO only with single stream restriction (FDD only); and
 - 3> if the UE signalled HS-DSCH physical layer category 17 or 18 [35] and 64QAM is configured for downlink, or if the UE signalled other HS-DSCH physical layer category than 17 and 18:
 - 4> indicate to lower layers to start operation in MIMO mode restricted to single stream transmission, using the parameter values stored in the variable MIMO_PARAMS.
 - 3> else:
 - 4> indicate to lower layers to start operation in MIMO mode, using the parameter values stored in the variable MIMO_PARAMS.
- 1> If the IE "MIMO operation" is set to "continue":
 - 2> If the MIMO_STATUS variable is set to FALSE:
 - 3> the UE behaviour is undefined.
- 1> for FDD, if the IE "Primary CPICH usage for Channel Estimation" is set to "Primary CPICH shall not be used":
 - 2> the UE behavior is undefined.
- 1> for FDD, if the IE "Secondary CPICH Info" is included and if the IE "Channelisation code" in MIMO pilot configuration is different from the IE "Channelisation Code" in Secondary CPICH info:
 - 2> the UE behavior is undefined.
- 1> for FDD, if the IE "Secondary CPICH Info" is included and if the IE "Power Offset for S-CPICH for MIMO" is provided, then pass the offset value received in the IE "Power Offset for S-CPICH for MIMO" to the lower layers.
- 1> determine the configuration of "TSN field extension" for MAC-ehs entity as specified in subclause 8.5.60.
- 1> for FDD, when MIMO only with single stream restriction is configured:

2> if MAC-ehs is not configured:

3> the UE behaviour is undefined.

NOTE: This subclause applies to FDD and 1.28 Mcps TDD only.

8.6.6.42 UL 16QAM settings

If the IE "UL 16QAM settings" is included, the UE shall:

1> indicate to lower layers to operate in 16QAM mode, using the parameters contained in the IE.

8.6.6.42b UL 64QAM settings

If the IE "UL 64QAM settings" is included, the UE shall:

1> indicate to lower layers to operate in 64QAM mode, using the parameters contained in the IE;

1> if MAC-i/is not configured:

2> the UE behaviour is unspecified.

8.6.6.43 Multi-frequency Info (1.28 Mcps TDD only)

Upon reception of the IE "Multi-frequency info", the UE shall:

1> If the IE "Second Frequency info" is included:

2> act as specified in section 8.6.6.1.

1> If the IE "FPACH Frequency info" is included:

2> store the FPACH frequency indicated in the IE "FPACH Frequency info".

1> else:

2> use the primary frequency as FPACH frequency.

1> If the IE "UpPCH Position Info" is included:

2> store and use the UpPCH position indicated by the IE "UpPCH Positon Info ". The calculation of the uplink access position is described in [33].

1> else:

2> use the UpPTS as the default UpPCH position.

8.6.6.44 Void

8.6.6.45 Downlink Secondary Cell Info FDD

In the following, any information in the "Downlink Secondary Cell Info FDD" is stored in the first entry of the variable DOWNLINK_SECONDARY_CELL_INFO. Any first (respectively second) IE "Downlink Secondary Cell Info FDD" in the "Additional downlink secondary cell info list FDD" IE, is stored in the second (respectively third) entry of the variable DOWNLINK_SECONDARY_CELL_INFO. Any first (respectively second, third and fourth) IE "Downlink secondary Cell Info FDD" in the "Additional downlink secondary cell info list FDD 2" IE, is stored in the fourth (respectively fifth, sixth and seventh) entry of the variable DOWNLINK_SECONDARY_CELL_INFO.

If the i-th IE "Downlink Secondary Cell Info FDD" is not included and the UE has a stored i-th entry in the DOWNLINK_SECONDARY_CELL_INFO variable, the UE shall:

1> clear the stored i-th entry in the DOWNLINK_SECONDARY_CELL_INFO variable.

For each included IE "Downlink Secondary Cell Info FDD", if the UE will be in CELL_DCH state after completion of this procedure, the UE shall:

- 1> if the CHOICE "Configuration info" is set to "New configuration":
 - 2> store the i-th IE "Downlink Secondary Cell Info FDD", replacing any stored i-th entry in the DOWNLINK_SECONDARY_CELL_INFO variable.
- 1> if the CHOICE "Configuration info" is set to "Continue" and the UE has a stored i-th entry in the DOWNLINK_SECONDARY_CELL_INFO:
 - 2> keep the stored i-th entry in the DOWNLINK_SECONDARY_CELL_INFO.

The UE shall:

- 1> determine the value for the SECONDARY_CELL_HS_DSCH_RECEPTION variable and take the corresponding actions as described in subclause 8.5.51.
- 1> if the UE supports Multiflow operation:
 - 2> determine the value for the MULTIFLOW_STATUS variable and take the corresponding actions as described in subclause 8.5.71.

For each entry in the variable SECONDARY_CELL_HS_DSCH_RECEPTION which is set to TRUE, the UE shall:

- 1> if the IE "Different Tx diversity mode configuration from serving HS-DSCH cell" is present in the i-th entry in the DOWNLINK_SECONDARY_CELL_INFO variable, and Tx diversity is configured in the serving HS-DSCH cell,
 - 2> not configure Tx diversity for the i-th secondary serving HS-DSCH cell.
- 1> if the IE "Different Tx diversity mode configuration from serving HS-DSCH cell" is present in the i-th entry in the DOWNLINK_SECONDARY_CELL_INFO variable and Tx diversity is not configured in the serving HS-DSCH cell,
 - 2> configure Tx diversity in the i-th secondary serving HS-DSCH cell.
- 1> if the IE "Different Tx diversity mode configuration from serving HS-DSCH cell" is not present in the i-th entry in the DOWNLINK_SECONDARY_CELL_INFO variable,
 - 2> the Tx diversity mode configured in the i-th secondary serving HS-DSCH cell shall be the same as the Tx diversity mode configured in the serving HS-DSCH cell.

For each of the variables "Adjacent frequency info" and "Inter-band frequency info" that are stored in CELL_INFO_LIST, and for which the "UARFCN downlink (Nd)" is different from the "UARFCN downlink (Nd)" of any stored entry in the DOWNLINK_SECONDARY_CELL_INFO variable:

- 1> stop all inter-frequency measurement reporting on the cells that belong to the frequency derived from the stored variable. Each stopped measurement is restarted when a MEASUREMENT CONTROL message is received with the corresponding measurement identity.
- 1> clear the stored variable.

If the variable "Frequency info list for enhanced measurement" is stored in CELL_INFO_LIST, then for each of the variable "Frequency info for enhanced measurement" included in the variable "Frequency info list for enhanced measurement":

- 1> if the "UARFCN downlink (Nd)" in the variable "Frequency info for enhanced measurement" is different from the "UARFCN downlink (Nd)" of any stored entry in the DOWNLINK_SECONDARY_CELL_INFO variable:
 - 2> stop all inter-frequency measurement reporting on the cells that belong to the frequency derived from the variable "Frequency info for enhanced measurement". Each stopped measurement is restarted when a MEASUREMENT CONTROL message is received with the corresponding measurement identity.
 - 2> clear the variable "Frequency info for enhanced measurement".

8.6.6.46 Control Channel DRX information (1.28 Mcps TDD only)

If the IE "Control Channel DRX information" is included and the UE will be in CELL_DCH state after completion of this procedure, the UE shall:

- 1> if the CHOICE "*Control Channel DRX operation*" is set to "New Control Channel DRX operation":
 - 2> store the contents of the IE in the variable CONTROL_CHANNEL_DRX_PARAMS, replacing or clearing any previously stored "Control Channel DRX operation";
 - 2> use the newly received Control Channel DRX configuration.
- 2> if the IE "E-AGCH DRX Information" is not included:
 - 3> not perform E-AGCH discontinuous reception.
- 1> if the CHOICE "*Control Channel DRX operation*" is set to "Continue", and the message is used to perform a hard handover (as specified in subclause 8.6.6.3a):
 - 2> the UE behaviour is unspecified.
- 1> determine the value for the CONTROL_CHANNEL_DRX_STATUS variable and take the corresponding actions as described in subclause 8.5.53.
- 1> if the IE "E-AGCH DRX Information" is included, and the variable E_DCH_TRANSMISSION is set to FALSE:
 - 2> the UE behaviour is unspecified.

8.6.6.47 SPS information (1.28 Mcps TDD only)

If the IE "SPS information" is included and the UE will be in CELL_DCH state after completion of this procedure, the UE shall:

- 1> if the IE "E-DCH SPS Information" is included and the UE will be in CELL_DCH state after completion of this procedure, the UE shall:
 - 2> if the CHOICE "E-DCH SPS operation" is set to "New E-DCH SPS operation":
 - 3> after the UE has received IE "E-HICH Information":
 - 4> if the CHOICE "Configuration Mode" is set to "Implicit":
 - 5> if the IE "EI" is included:
 - 6> consider the E-HICH has the same configuration as that in the IE "E-HICH Info" for 1.28Mcps TDD which has the same value of EI indicated by the IE "EI" in this message.
 - 5> else:
 - 6> use the same configuration as the E-HICH for non-schedule transmission.
 - 4> else:
 - 5> store the E-HICH configuration according to the IEs "Timeslot Number", "Channelisation Code" and midamble configuration IEs.
 - 4> store and use the Signature Sequence indicated by the IE "Signature Sequence Group Index".
 - 3> if the IE "Transmission Pattern List" is included:
 - 4> store the contents of the IE in the variable E_DCH_SPS_PARAMS.
 - 3> if the IE "Initial SPS info for E-DCH" is included:
 - 4> perform E-DCH SPS operation on the semi-persistent E-PUCH resource configured by the IE at the CFN determined by the IE "Activation Time" and the IE "Subframe number".

- 2> determine the value for the E_DCH_SPS_STATUS variable and take the corresponding actions as described in subclause 8.5.54.
 - 2> if the IE "Initial SPS info for E-DCH" is included, the calculation of assigned initial E-DCH SPS transmission grant is specified in subclause 8.6.6.16a
- 1> else if the IE "E-DCH SPS Information" is not included, the UE shall:
- 2> set the variable E_DCH_SPS_STATUS to FALSE;
 - 2> clear the variable E_DCH_SPS_PARAMS;
 - 2> stop all E-DCH SPS related activities.
- 1> if the IE "HS-DSCH SPS Information" is included and the UE will be in CELL_DCH state after completion of this procedure, the UE shall:
- 2> if the CHOICE "HS-DSCH SPS operation" is set to "New HS-DSCH SPS operation":
 - 3> if the IE "Transport Block Size List" or the IE "Reception Pattern List" is included:
 - 4> store the contents of the IE in the variable HS_DSCH_SPS_PARAMS.
 - 3> if the IE "HARQ Info for Semi-Persistent Scheduling" is included:
 - 4> calculate the size of each virtual IR buffer according to following equation:
 Size of virtual IR soft buffer = Total buffer for HS-SCCH SPS operation / N_{IR}
 where
 - Total buffer for HS-SCCH SPS operation is signalled in the IE "Process Memory size", and the IE is the total size of the virtual IR buffers which could be used in HS-SCCH SPS operation;
 - N_{IR} is the value of the IE "Number of Processes", and the IE is the number of HARQ processes which could be used in HS-SCCH SPS operation.
 - 3> after the UE has received IE "HS-SICH List":
 - 4> if the CHOICE "Configuration Mode" is set to "Implicit":
 - 5> transmit the HS-SICH according to the configuration in the IE "HS-SCCH Configuration" for 1.28Mcps TDD, of which the position listed in the IE "HS-SCCH Set Configuration" in ascending order is indicated by the IE "HS-SCCH Index" in this message.
 - 4> else:
 - 5> transmit the HS-SICH according to the IEs "Timeslot Number", "Channelisation Code" and Midamble configuration IEs.
 - 3> if the IE "Initial SPS info for HS-DSCH" is included:
 - 4> perform HS-SCCH SPS operation on the semi-persistent HS-PDSCH resource configured by the IE at the CFN determined by the IE "Activation Time" and the IE "Subframe number".
 - 2> determine the value for the HS_DSCH_SPS_STATUS variable and take the corresponding actions as described in subclause 8.5.55.
 - 2> if the IE "Initial SPS info for HS-DSCH" is included, the calculation of assigned initial HS-DSCH SPS transmission grant is specified in subclause 8.6.6.16a
- 1> else if the IE "HS-DSCH SPS Information" is not included, the UE shall:
- 2> set the variable HS_DSCH_SPS_STATUS to FALSE;
 - 2> clear the variable HS_DSCH_SPS_PARAMS;
 - 2> stop all HS-DSCH SPS related activities.

8.6.6.48 Secondary cell MIMO parameters

If the IE "Secondary cell MIMO parameters" is included, the UE shall:

- 1> Determine the value for the corresponding SECONDARY_CELL_MIMO_STATUS variable and take the corresponding actions as described in subclause 8.5.57;
- 1> determine the configuration of "TSN field extension" for MAC-ehs entity as specified in subclause 8.5.60.

NOTE: This subclause applies to FDD only.

8.6.6.49 Uplink Secondary Cell Info FDD (FDD only)

If the IE "Uplink Secondary Cell Info FDD" is included and the UE will be in CELL_DCH state after completion of this procedure, the UE shall:

- 1> if the CHOICE "Configuration info" is set to "New configuration":
 - 2> if the IE "Secondary serving E-DCH cell info" is included in the IE "Uplink Secondary Cell Info FDD":
 - 3> if the IE "Frequency info" included in the IE "Secondary E-DCH info common" is different from the stored frequency info:
 - 4> stop intra-frequency and inter-frequency measurement reporting on the downlink frequency associated with the current secondary uplink frequency. Each stopped measurement is restarted when a MEASUREMENT CONTROL message is received with the corresponding measurement identity.
 - 3> store the IE "Secondary serving E-DCH cell info", replacing any stored IE "Secondary serving E-DCH cell info".
 - 2> if the IE "Secondary E-DCH info common" is included in the IE "Uplink Secondary Cell Info FDD":
 - 3> store the IE "Secondary E-DCH info common", replacing any stored IE "Secondary E-DCH info common".
 - 2> if the IE "Downlink information per radio link list on secondary UL frequency" is included in the IE "Uplink Secondary Cell Info FDD":
 - 3> act as specified in subclause 8.6.6.3b.
 - 2> determine the value for the IMPLICIT_GRANT variable and take the corresponding actions as described in subclause 8.5.85;
- 1> if the CHOICE "Configuration info" is set to "Continue" and the UE has any stored IE "Secondary E-DCH info common":
 - 2> keep the stored IE "Secondary serving E-DCH cell info" and IE "Secondary E-DCH info common".
- 1> if SECONDARY_CELL_E_DCH_TRANSMISSION variable is set to TRUE:
 - 2> if the IE "UARFCN downlink (Nd)" is present in the first IE "Downlink Secondary Cell Info FDD" and is different from the stored "Frequency info" in the IE "Secondary E-DCH info common":
 - 3> UE behaviour is unspecified.
 - 2> if the variable SECONDARY_CELL_E_DCH_TRANSMISSION was previously set to FALSE; or
 - 2> if the IE "Frequency info" included in the IE "Secondary E-DCH info common" is different from the previously stored frequency info:
 - 3> continue inter-frequency measurement reporting on the downlink frequency associated with the new secondary uplink frequency. The UE shall not require compressed mode to perform the measurement, regardless of the activation status of secondary uplink frequency.

If the IE "Uplink Secondary Cell Info FDD" is not included and the UE has any stored IE "Secondary E-DCH info common", the UE shall:

- 1> clear the stored IE "Secondary serving E-DCH cell info" and IE "Secondary E-DCH info common";
- 1> stop intra-frequency and inter-frequency measurements reporting on the downlink frequency associated with the current secondary uplink frequency. Each stopped measurement is restarted when a MEASUREMENT CONTROL message is received with the corresponding measurement identity.

8.6.6.50 Additional downlink secondary cell info list FDD

If the IE "Additional downlink secondary cell info list FDD" is included, the UE shall process its parameters as specified in 8.6.6.45.

If the IE "Additional downlink secondary cell info list FDD" is not included, the UE shall clear the second and third entries in the variables DOWNLINK_SECONDARY_CELL_INFO, SECONDARY_CELL_HS_DSCH_RECEPTION, SECONDARY_CELL_MIMO_STATUS and SECONDARY_CELL_MIMO_MODE_WITH_FOUR_TRANSMIT_ANTENNAS_STATUS.

8.6.6.51 MU-MIMO info (1.28 Mcps TDD only)

If the IE "MU-MIMO info" is included, the UE shall:

- 1> act as specified in clauses 8.5.61;
- 1> if the CHOICE "Configuration MU-MIMO info" has the value "Continue":
 - 2> continue using the stored parameters in the MU_MIMO_INFO variable;
- 1> otherwise:
 - 2> store and perform MU-MIMO in the direction indicated by IE "MU-MIMO operation";
 - 2> store and use the midamble indicated by IE "Midamble configuration", IE "Midamble shift" and IE "Timeslot information", the calculation of assigned Standalone midamble transmission grant is specified in subclause 8.6.6.16a.

8.6.6.52 Multi-carrier E-DCH Info for LCR TDD (1.28 Mcps TDD only)

The IE "Multi-carrier E-DCH Info for LCR TDD" is used in multiple carriers system.

If the IE "Multi-carrier E-DCH Info for LCR TDD" is included, the UE shall:

- 1> if a serving cell change will be caused by the received message:
 - 2> clear the stored IE "Multi-carrier E-DCH Info for LCR TDD";
- 1> if the CHOICE "Configuration info" is set to "New configuration":
 - 2> if the IE "TSN-Length" is included:
 - 3> store and set the TSN length to 14bits.
 - 2> else:
 - 3> store and set the TSN length to 6bits.
 - 2> for each carrier in the IE "UL-Multicarrier-EDCH- Information List":
 - 3> store the value of "UARFCN" in the IE "UARFCN" for the additional E-DCH carrier;
 - 3> store the E-PUCH configuration in the IE "E-PUCH info" for the additional E-DCH carrier;
 - 3> store the E-AGCH configuration in the IE "E-AGCH Info" for the additional E-DCH carrier;
 - 3> store the E-HICH configuration in the IE "E-HICH Info" for the additional E-DCH carrier;
 - 2> for each carrier in the IE "UL-Multicarrier-EDCH-DeleteList":

3> delete the stored additional E-DCH carrier information indicated by the IE "UARFCN" ;

1> if the CHOICE "Configuration info" is set to "Continue" and the UE has any stored IE "Multi-carrier E-DCH Info for LCR TDD":

2> keep the stored IE "Multi-carrier E-DCH Info for LCR TDD".

If the IE "Multi-carrier E-DCH Info for LCR TDD" is not included and the UE has any stored IE "Multi-carrier E-DCH Info for LCR TDD", the UE shall:

1> clear the stored IE "Multi-carrier E-DCH Info for LCR TDD";

8.6.6.53 Serving HS-DSCH cell information

If "Serving HS-DSCH cell information" IE is present, the UE shall:

1> act on received information elements as specified in subclause 8.6:

1> if the IEs "ACK", "NACK", and "HARQ_preamble_mode" are present, act on the received information elements;

2> if the new H-RNTI and "Primary CPICH info" are included:

3> consider the cell indicated in Primary CPICH as serving HS-DSCH cell and no longer consider any other radio link as serving HS-DSCH cell. If any IE "Downlink Secondary Cell Info FDD" is included for a cell associated with a serving HS-DSCH cell, consider that cell a secondary serving HS-DSCH cell on the appropriate frequency.

1> if the IE "MAC-hs reset indicator" is included:

2> if inter-Node B Multiflow operation is not configured:

3> reset the MAC-hs/ehs entity [15].

2> else:

3> reset the MAC-hs/ehs entity related to the serving cell [15].

1> if the IE "MAC-hs reset indicator for Multiflow assisting cells" is included:

2> if inter-Node B Multiflow operation is configured:

3> reset the MAC-hs/ehs entity related to the configured assisting cells [15].

2> else:

3> the UE behaviour is unspecified.

1> determine the value for the HS_DSCH_RECEPTION variable and take the corresponding actions as described in subclause 8.5.25.

8.6.6.54 E-DCH reconfiguration information

If the IE "E-DCH reconfiguration information" is included, the UE shall:

1> if the IE "E-DCH RL Info other cells" is present:

2> if the IE "E-HICH Information" is present:

3> store the E-HICH and E-RGCH information (if present), contained therein, for the indicated radio link.

2> if the IE "E-HICH release indicator" is present:

3> delete the stored E-HICH, E-AGCH and E-RGCH (if any) configurations;

3> if variable UPLINK_MIMO_TRANSMISSION is set to TRUE:

- 4> delete the stored E-HICH configuration for the secondary stream.
- 2> if the IE "Secondary TB E-HICH release indicator" is present:
 - 3> delete the stored E-HICH configuration for the secondary stream.
- 2> if the IE "E-RGCH release indicator" is set present:
 - 3> delete the stored E-RGCH configuration for this RL.
- 1> if the IE "E-DCH RL Info new serving cell" is present:
 - 2> consider the cell indicated in "Primary CPICH info" as serving E-DCH radio link and no longer consider any other radio link as serving E-DCH radio link;
 - 2> store the E-HICH and E-RGCH information (if present), contained therein, for the new serving E-DCH radio link;
 - 2> if the IE "E-RGCH release indicator" is present:
 - 3> delete the stored E-RGCH configuration for this RL.
 - 2> store the newly received E-AGCH configuration;
 - 2> if the IE "E-ROCH Info" is present:
 - 3> store the newly received E-ROCH configuration;
 - 2> if the IE "Serving Grant" is included, and if the IE "Serving Grant Value" is not included:
 - 3> the UE behaviour is not specified.
- 1> if the IEs "E-DPCCH/DPCCH power offset" and/or "Reference E-TFCI PO" and/or "Power offset for scheduling info" are present, act on the received information elements.
- 1> if the serving E-DCH radio link was another radio link than this radio link prior to reception of the message:
 - 2> if the IE "New Primary E-RNTI" is not included:
 - 3> clear the Primary E-RNTI stored in the variable E_RNTI.
 - 2> if the IE "New Secondary E-RNTI" is not included:
 - 3> clear the Secondary E-RNTI stored in the variable E_RNTI.
- 1> determine the value for the E_DCH_TRANSMISSION variable and take the corresponding actions as described in subclause 8.5.28.

8.6.6.55 Additional downlink secondary cell info list FDD 2

If the IE "Additional downlink secondary cell info list FDD 2" is included, the UE shall process its parameters as specified in 8.6.6.45.

If the IE "Additional downlink secondary cell info list FDD 2" is not included, the UE shall clear the fourth, the fifth, the sixth and the seventh entries in the variables DOWNLINK_SECONDARY_CELL_INFO, SECONDARY_CELL_HS_DSCH_RECEPTION, and SECONDARY_CELL_MIMO_STATUS.

8.6.6.56 Uplink CLTD info FDD

If the IE "Uplink CLTD info FDD" is included and the UE will be in CELL_DCH state after completion of this procedure, the UE shall:

- 1> if the CHOICE "Configuration info" is set to "New configuration":
 - 2> store the IE "Uplink CLTD info FDD", replacing any stored IE "Uplink CLTD info FDD";

2> if the IE "Primary CPICH Info" is present:

3> if variable MULTIFLOW_STATUS is TRUE, but the value of IE "Primary CPICH Info" does not correspond to the assisting serving HS-DSCH cell:

4> the UE behaviour is unspecified.

1> if the CHOICE "Configuration info" is set to "Continue" and the UE has any stored IE "Uplink CLTD info FDD":

2> keep the stored IE "Uplink CLTD info FDD".

If the IE "Uplink CLTD info FDD" is not included and the UE has any stored IE "Uplink CLTD info FDD", the UE shall:

1> clear the stored IE "Uplink CLTD info FDD".

Determine the value for the variable UPLINK_CLTD_TRANSMISSION and take the corresponding actions as described in subclause 8.5.69.

8.6.6.57 Uplink OLTD info FDD

If the IE "Uplink OLTD info FDD" is included and the UE will be in CELL_DCH state after completion of this procedure, the UE shall:

1> store the IE "Uplink OLTD info FDD".

If the IE "Uplink OLTD info FDD" is not included and the UE has any stored IE "Uplink OLTD info FDD", the UE shall:

1> clear the stored IE "Uplink OLTD info FDD".

Determine the value for the variable UPLINK_OLTD_TRANSMISSION and take the corresponding actions as described in subclause 8.5.70.

8.6.6.58 F-TPICH reconfiguration info

If the IE "F-TPICH reconfiguration info" is included, the UE shall:

1> if the IE "F-TPICH info other cells" is present:

2> for each radio link:

3> if the IE "F-TPICH info" is present:

4> store the F-TPICH configuration, contained therein, for the indicated radio link.

3> if the IE "F-TPICH release indicator" is present:

4> delete the stored F-TPICH configuration, for the indicated radio link.

1> if the IE "F-TPICH info new cell that determines the precoding weights" is present:

2> store the F-TPICH configuration, contained therein, for the radio link transmitted from the serving HS-DSCH cell if HS-DSCH is configured or from the cell identified by the IE "Primary CPICH info" in the IE "Uplink CLTD info FDD" if only DCH is configured.

1> determine the value for the variable UPLINK_CLTD_TRANSMISSION and take the corresponding actions as described in subclause 8.5.69.

8.6.6.59 Common E-RGCH info FDD

If the IE "Common E-RGCH info FDD" is included and the UE will be in CELL_FACH or CELL_PCH state after completion of this procedure, the UE shall:

- 1> if the CHOICE "Configuration info" is set to "New configuration":
 - 2> store the IE "Common E-RGCH info FDD", replacing any stored IE "Common E-RGCH info FDD".
- 1> if the CHOICE "Configuration info" is set to "Continue" and the UE has any stored IE "Common E-RGCH info FDD":
 - 2> keep the stored IE "Common E-RGCH info FDD".

If the IE "Common E-RGCH info FDD" is not included and the UE has any stored IE "Common E-RGCH info FDD", the UE shall:

- 1> clear the stored IE "Common E-RGCH info FDD".

Determine the value for the variable `READY_FOR_COMMON_ERGCH` and take the corresponding actions as described in subclause 8.5.75.

8.6.6.60 MIMO_MODE_WITH_FOUR_TRANSMIT_ANTENNAS parameters (FDD only)

If the IE "MIMO mode with four transmit antennas parameters" is included, the UE shall:

- 1> act as specified in clauses 8.5.78 and 8.5.79;
- 1> If the IE "MIMO mode with four transmit antennas parameters " is set to "New configuration":
 - 2> If the `MIMO_MODE_WITH_FOUR_TRANSMIT_ANTENNAS_STATUS` variable is set to FALSE:
 - 3> the UE behaviour is undefined.
 - 2> otherwise:
 - 3> if the UE supports MIMO mode with four transmit antennas only with dual stream restriction:
 - 4> indicate to lower layers to start operation in MIMO mode with four transmit antennas restricted to dual stream transmission, using the parameter values stored in the variable `MIMO_MODE_WITH_FOUR_TRANSMIT_ANTENNAS_PARAMS`.
 - 3> else:
 - 4> indicate to lower layers to start operation in MIMO mode with four transmit antennas, using the parameter values stored in the variable `MIMO_MODE_WITH_FOUR_TRANSMIT_ANTENNAS_PARAMS`.
- 1> If the IE "MIMO mode with four transmit antennas parameters" is set to "continue":
 - 2> If the `MIMO_MODE_WITH_FOUR_TRANSMIT_ANTENNAS_STATUS` variable is set to FALSE:
 - 3> the UE behaviour is undefined.
- 1> when MIMO mode with four transmit antennas is configured:
 - 2> if MAC-ehs is not configured:
 - 3> the UE behaviour is undefined.
- 1> if the IE "Primary CPICH usage for Channel Estimation" is set to "Primary CPICH shall not be used":
 - 2> the UE behavior is undefined.
- 1> if the IE "Secondary CPICH Info" is included and if the IE "Channelisation code" in MIMO mode with four transmit antennas pilot configuration is different from the IE "Channelisation Code" in Secondary CPICH info:
 - 2> the UE behavior is undefined.
- 1> if the IE "Secondary CPICH Info" is included and if the IEs "Power Offset for S-CPICH for MIMO mode with four transmit antennas on Antenna2", "Common Power Offset for S-CPICH for MIMO mode with four transmit

antennas on Antenna3 and 4" and "Common Power Offset for D-CPICH for MIMO mode with four transmit antennas on Antenna3 and 4" are provided, then pass the offset value received in the IEs "Power Offset for S-CPICH for MIMO mode with four transmit antennas on Antenna2", "Common Power Offset for S-CPICH for MIMO mode with four transmit antennas on Antenna3 and 4", and "Common Power Offset for D-CPICH for MIMO mode with four transmit antennas on Antenna3 and 4" to the lower layers.

1> determine the configuration of "TSN field extension" for MAC-ehs entity as specified in subclause 8.5.60.

1> when MIMO mode with four transmit antennas only with dual stream restriction is configured:

2> if MAC-ehs is not configured:

3> the UE behaviour is undefined.

8.6.6.61 Secondary cell MIMO_MODE_WITH_FOUR_TRANSMIT_ANTENNAS parameters (FDD only)

If the IE "Secondary cell MIMO mode with four transmit antennas parameters" is included, the UE shall:

1> Determine the value for the corresponding SECONDARY_CELL_MIMO_MODE_WITH_FOUR_TRANSMIT_ANTENNAS_STATUS variable and take the corresponding actions as described in subclause 8.5.80;

1> determine the configuration of "TSN field extension" for MAC-ehs entity as specified in subclause 8.5.60.

8.6.6.62 Uplink MIMO info FDD

If the IE "Uplink MIMO info FDD" is included and the UE will be in CELL_DCH state after completion of this procedure, the UE shall:

1> if the CHOICE "Configuration info" is set to "New configuration":

2> store the IE "Uplink MIMO info FDD", replacing any stored IE "Uplink MIMO info FDD".

1> if the CHOICE "Configuration info" is set to "Continue" and the UE has any stored IE "Uplink MIMO info FDD":

2> keep the stored IE "Uplink MIMO info FDD".

If the IE "Uplink MIMO info FDD" is not included and the UE has any stored IE "Uplink MIMO info FDD", the UE shall:

1> clear the stored IE "Uplink MIMO info FDD".

Determine the value for the variable UPLINK_MIMO_TRANSMISSION and take the corresponding actions as described in subclause 8.5.81.

8.6.6.63 DPCCH2 info FDD

If the IE "DPCCH2 info FDD" is included and the UE will be in CELL_DCH state after completion of this procedure, the UE shall:

1> if the CHOICE "Configuration info" is set to "New configuration":

2> store the IE "DPCCH2 info FDD", replacing any stored IE "DPCCH2 info FDD";

2> if the IE "TPC command error rate target" is present:

3> store the TPC command error rate target for F-DPCH.

2> if the IE "Extended E-DPCCH/DPCCH power offset" is present:

3> store the Extended E-DPCCH/DPCCH power offset.

2> if the IE "Designated non-serving HS-DSCH cell info" is present:

- 3> store the Designated non-serving HS-DSCH cell information;
- 3> if the Serving E-DCH cell decoupling is configured and the Designated non-serving HS-DSCH cell is not the serving E-DCH cell:
 - 4> the UE behaviour is unspecified.

1> if the CHOICE "Configuration info" is set to "Continue" and the UE has any stored IE "DPCCH2 info FDD":

- 2> keep the stored IE "DPCCH2 info FDD".

If the IE "DPCCH2 info FDD" is not included and the UE has any stored IE "DPCCH2 info FDD", the UE shall:

- 1> clear the stored IE "DPCCH2 info FDD".

Determine the value for the variable DPCCH2_TRANSMISSION and take the corresponding actions as described in subclause 8.5.83.

8.6.6.64 DCH Enhancements info FDD

If the IE "DCH Enhancements info FDD" is included, the UE shall:

- 1> if the CHOICE "Configuration info" is set to "New configuration":
 - 2> store the IE "DCH Enhancements info FDD", replacing any stored IE "DCH Enhancements info FDD".
- 1> if the CHOICE "Configuration info" is set to "Continue" and the UE has any stored IE "DCH Enhancements info FDD":
 - 2> keep the stored IE "DCH Enhancements info FDD".

If the IE "DCH Enhancements info FDD" is not included and the UE has any stored IE "DCH Enhancements info FDD", the UE shall:

- 1> clear the stored IE "DCH Enhancements info FDD".

8.6.6.65 Other TTI E-DCH Configuration Information

If the IE "Other TTI E-DCH Configuration Information" is included and the UE will be in CELL_DCH state after completion of this procedure, the UE shall:

- 1> if the information received would result in a configuration which is considered to be invalid:
 - 2> set the variable INVALID_CONFIGURATION to TRUE.
- 1> else
 - 2> if the current configured TTI length is 2ms TTI:
 - 3> store the relevant information for the current TTI configuration in the IE "2ms TTI Configuration Information" in the variable OTHER_TTI_EDCH_CONFIGURATION;
 - 3> store the received preconfiguration information in the IE "10ms TTI Configuration Information" in the variable OTHER_TTI_EDCH_CONFIGURATION.
 - 2> else:
 - 3> store the relevant information for the current TTI configuration in the IE "10ms TTI Configuration Information" in the variable OTHER_TTI_EDCH_CONFIGURATION;
 - 3> store the received preconfiguration information in the IE "2ms TTI Configuration Information" in the variable OTHER_TTI_EDCH_CONFIGURATION.
- 2> if the IE "Activation delay" is included:
 - 3> store the received value in the variable OTHER_TTI_EDCH_CONFIGURATION.

2> else:

3> set the value of the IE "Activation delay" in the variable OTHER_TTI_EDCH_CONFIGURATION to 0.

8.6.7 Measurement information elements

On reception of measurement information elements the UE shall:

- 1> store the received information in the variable MEASUREMENT_IDENTITY and CELL_INFO_LIST as specified;
- 1> perform further actions as specified in subclause 8.6.7 and subclause 8.4, based on the content of the variable MEASUREMENT_IDENTITY.

If a configuration is considered to be invalid the UE may:

- 1> set the variable CONFIGURATION_INCOMPLETE to TRUE.

8.6.7.1 Measurement validity

If the IE "measurement validity" for a given measurement has not been included in measurement control information, the UE shall delete the measurement associated with the variable MEASUREMENT_IDENTITY after the UE makes a transition to a new state.

If the IE "measurement validity" for this measurement has been included in measurement control information, the UE shall save the measurement associated with the variable MEASUREMENT_IDENTITY. The IE "UE state" defines the scope of resuming the measurement.

If the "UE state" is defined as "all states", the UE shall continue the measurement after making a transition to a new state. This scope is assigned for traffic volume measurement type and UE positioning measurement type. For traffic volume measurement type this scope can only be applied by the UE if the IE "traffic volume measurement object" has been included in measurement control information. If the IE "traffic volume measurement object" has not been included in measurement control information, the UE shall not save the measurement control information in variable MEASUREMENT_IDENTITY, but shall send a MEASUREMENT CONTROL FAILURE message to the UTRAN with failure cause "Configuration incomplete". For 1.28 Mcps TDD, this scope is also assigned for intra-frequency measurement type and inter-frequency measurement type.

If the "UE state" is defined as "all states except CELL_DCH", the UE shall store the measurement to be resumed after a subsequent transition from CELL_DCH state to any of the other states in connected mode. This scope is assigned for traffic volume measurement type or UE positioning measurement type. For 1.28 Mcps TDD, this scope is also assigned for intra-frequency measurement type and inter-frequency measurement type.

If the "UE state" is defined as "CELL_DCH", the UE shall store the measurement to be resumed after a subsequent transition to CELL_DCH state.

For FDD, 3.84/7.68 Mcps TDD, if the IE "measurement type" received in a MEASUREMENT CONTROL message is set to "inter-frequency measurement" or "intra-frequency measurement" and the IE "measurement validity" is present and is set to a value other than "CELL_DCH", the UE behaviour is unspecified.

8.6.7.2 Filter coefficient

If the IE "Filter coefficient" is received the UE shall, depending on the measurement quantity (see Table 8.6.7.2), apply filtering of the measurements for that measurement quantity according to the formula below. This filtering shall be performed by the UE before UE event evaluation. The UE shall depending on the reporting quantity (see Table 8.6.7.2), also filter the measurements reported in the IE "Measured results" and "Measured results on secondary UL frequency", or "E-UTRA measured results". The filtering shall not be performed for the measurements reported in the IE "Measured results on RACH" and for cell-reselection in connected or idle mode.

The filtering shall be performed according to the following formula.

$$F_n = (1 - a) \cdot F_{n-1} + a \cdot M_n$$

The variables in the formula are defined as follows:

F_n is the updated filtered measurement result

F_{n-1} is the old filtered measurement result

M_n is the latest received measurement result from physical layer measurements, the unit used for M_n is the same unit as the reported unit in the MEASUREMENT REPORT message or the unit used in the event evaluation.

$a = 1/2^{(k/2)}$, where k is the parameter received in the IE "Filter coefficient".

NOTE: if k is set to 0 that will mean no layer 3 filtering.

In order to initialise the averaging filter, F_0 is set to M_1 when the first measurement result from the physical layer measurement is received.

The physical layer measurement results are sampled once every measurement period. The measurement period and the accuracy for a certain measurement is defined in [19] and [20].

Table 8.6.7.2 lists for all measurement quantities and reporting quantities if L3-filtering is applicable or not and used L3-filtering type for each measurement quantity.

Table 8.6.7.2: L3 filtering applicable for each measurement quantity and reporting quantity

Measurement- / Reporting quantity	L3-filtering applicable	Linear or logarithmic filtering	Comment
Pathloss	Yes	Log	
Cell synchronisation information	No	-	
Cell Identity	No	-	
Frequency quality estimate	No	-	Although the frequency quality estimate itself is not filtered, the inputs to the frequency quality estimate calculation (CPICH Ec/N0 or CPICH RSCP or P-CCPCH RSCP) are filtered
UTRA carrier RSSI	Yes	Log	
GSM carrier RSSI	Yes	Log	
UE transmitted power	Yes	Log	
FDD			
> UE Rx-Tx time difference	No	-	
> CPICH Ec/N0	Yes	Log	
> CPICH RSCP	Yes	Log	
TDD			
> Primary CCPCH RSCP	Yes	Log	
> Proposed TGSN	No	-	
> Timeslot ISCP	Yes	Log	
> TADV (1.28 Mcps TDD)	No	-	
> Applied TA (3.84 Mcps TDD)	No	-	
> Applied TA (7.68 Mcps TDD)	No	-	

E-UTRA RSRP	Yes	Log	
E-UTRA RSRQ	Yes	Log	

The UE shall support 2 different layer 3 filters per measurement type defined in subclause 8.4.0 (i.e. the UE shall be capable to apply at least 2 different L3 filters to intra-frequency measurement results – see NOTE, at least 2 different L3 filters to inter-frequency measurement results, etc.). If a MEASUREMENT CONTROL message is received that would require the UE to configure more than 2 different layer 3 filters, the UE may:

1> set the variable CONFIGURATION_INCOMPLETE to TRUE.

NOTE: Any L3 filter applied to a measurement configured with measurement quantity and/or reporting quantity that evaluates or reports measurement results for the current used frequency, is counted as one intra-frequency L3 filter, and is therefore included in the count of used intra-frequency filters.

8.6.7.3 Intra-frequency/Inter-frequency/Inter-RAT cell info list

If the IE "Intra-frequency cell info list" is received in System Information Block Type 11, the UE shall update the variable CELL_INFO_LIST accordingly and in the following order. The UE shall:

- 1> if the IE "Intra-frequency cell removal" is received:
 - 2> ignore the IE.
- 1> if the IE "New Intra-frequency cells" is received, for each cell, and in the same order as the cells appear in the IE:
 - 2> update the variable CELL_INFO_LIST as follows:
 - 3> if the IE "Intra-frequency cell id" is received:
 - 4> store received cell information at this position in the Intra-frequency cell info list in the variable CELL_INFO_LIST, possibly overwriting any existing information in this position; and
 - 4> mark the position "occupied".
 - 3> if the IE "Intra-frequency cell id" is not received:
 - 4> store the received cell information at the first vacant position in ascending order in the Intra-frequency cell info list in the variable CELL_INFO_LIST; and
 - 4> mark the position as "occupied".

If the IE "Intra-frequency cell info list" is received in System Information Block Type 11bis, the UE shall update the variable CELL_INFO_LIST accordingly and in the following order. The UE shall:

- 1> for each cell, and in the same order as the cells appear in the IE:
 - 2> update the variable CELL_INFO_LIST as follows:
 - 3> if the IE "Intra-frequency cell id" is received:
 - 4> store received cell information at this position in the Intra-frequency cell info list in the variable CELL_INFO_LIST, possibly overwriting any existing information in this position; and
 - 4> mark the position "occupied".
 - 3> if the IE "Intra-frequency cell id" is not received:
 - 4> store the received cell information at the first vacant position in ascending order in the Intra-frequency cell info list in the variable CELL_INFO_LIST; and
 - 4> mark the position as "occupied".

If the IE "Intra-frequency cell info list" is received in System Information Block Type 12, the UE shall update the variable CELL_INFO_LIST accordingly and in the following order. The UE shall:

- 1> if the IE "Intra-frequency cell removal" is received:
 - 2> if it has the value "Remove some intra-frequency cells", at the position indicated by the IE "Intra-frequency cell id":
 - 3> clear the cell information stored in the variable CELL_INFO_LIST; and
 - 3> mark the position "vacant".
 - 2> if it has the value "Remove all intra-frequency cells":
 - 3> for each position referring to an intra-frequency cell in the variable CELL_INFO_LIST:
 - 4> clear the cell information stored in the variable CELL_INFO_LIST; and
 - 4> mark the position "vacant".
 - 2> if it has the value "Remove no intra-frequency cells":
 - 3> leave the variable CELL_INFO_LIST unchanged.
- 1> if the IE "New Intra-frequency cells" is received, for each cell, and in the same order as the cells appear in the IE:
 - 2> update the variable CELL_INFO_LIST as follows:
 - 3> if the IE "Intra-frequency cell id" is received:
 - 4> store received cell information at this position in the Intra-frequency cell info list in the variable CELL_INFO_LIST, possibly overwriting any existing information in this position; and
 - 4> mark the position "occupied".
 - 3> if the IE "Intra-frequency cell id" is not received:
 - 4> store the received cell information at the first vacant position in ascending order in the Intra-frequency cell info list in the variable CELL_INFO_LIST; and
 - 4> mark the position as "occupied".

If the IE "Intra-frequency cell info list" is received in a MEASUREMENT CONTROL message, the UE shall update the variable CELL_INFO_LIST accordingly and in the following order. The UE shall:

- 1> if the CHOICE "Intra-frequency cell removal" is received:
 - 2> if it has the value "Remove some intra-frequency cells", at the position indicated by the IE "Intra-frequency cell id":
 - 3> clear the cell information stored in the variable CELL_INFO_LIST; and
 - 3> mark the position "vacant".
 - 2> if it has the value "Remove all intra-frequency cells":
 - 3> for each position referring to an intra-frequency cell in the variable CELL_INFO_LIST:
 - 4> clear the cell information stored in the variable CELL_INFO_LIST; and
 - 4> mark the position "vacant".
 - 2> if it has the value "Remove no intra-frequency cells":
 - 3> leave the variable CELL_INFO_LIST unchanged.

- 1> if the IE "New Intra-frequency cells" is received, for each cell, and in the same order as the cells appear in the IE:
 - 2> update the variable CELL_INFO_LIST as follows:
 - 3> if the IE "Intra-frequency cell id" is received:
 - 4> store received cell information at this position in the Intra-frequency cell info list in the variable CELL_INFO_LIST, possibly overwriting any existing information in this position; and
 - 4> mark the position "occupied".
 - 3> if the IE "Intra-frequency cell id" is not received:
 - 4> store the received cell information at the first vacant position in ascending order in the Intra-frequency cell info list in the variable CELL_INFO_LIST; and
 - 4> mark the position as "occupied".
- 1> if the IE "Cells for measurement" is received, in the measurement configured by this message only:
 - 2> consider Intra-frequency cells whose cell information is stored at the position indicated by the IE "Intra-frequency cell id" in the variable CELL_INFO_LIST.
- 1> if the IE "Cells for measurement" is not received, in the measurement configured by this message:
 - 2> consider all Intra-frequency cells whose cell information is stored in CELL_INFO_LIST.
- 1> if the IE "CSG Intra-frequency cell info" is received:
 - 2> store the received information in the CSG Intra-frequency cell info in the variable CELL_INFO_CSG_LIST;
 - 2> consider the cells in CSG Intra-frequency cell info in variable CELL_INFO_CSG_LIST as monitored set and consider the cells not included in the CSG Intra-frequency cell info as detected set for the associated measurement.

If the IE "Intra-frequency cell info list on secondary UL frequency" is received in a MEASUREMENT CONTROL message, the UE shall update the variable CELL_INFO_LIST accordingly and in the following order. The UE shall:

- 1> if the variable SECONDARY_CELL_E_DCH_TRANSMISSION is set to FALSE:
 - 2> the UE behaviour is unspecified.
- 1> if the CHOICE "Intra-frequency cell removal" is received:
 - 2> if it has the value "Remove some intra-frequency cells", at the position indicated by the IE "Intra-frequency cell id":
 - 3> clear the cell information stored in the Intra-frequency cell info on secondary UL frequency list in the variable CELL_INFO_LIST; and
 - 3> mark the position "vacant".
 - 2> if it has the value "Remove all intra-frequency cells":
 - 3> for each position referring to an intra-frequency cell on secondary UL frequency in the variable CELL_INFO_LIST:
 - 4> clear the cell information stored in the Intra-frequency cell info on secondary UL frequency list in the variable CELL_INFO_LIST;
 - 4> mark the position "vacant".
 - 2> if it has the value "Remove no intra-frequency cells":
 - 3> leave the variable CELL_INFO_LIST unchanged.

- 1> if the IE "New Intra-frequency cells" is received, for each cell, and in the same order as the cells appear in the IE:
 - 2> update the variable CELL_INFO_LIST as follows:
 - 3> if the IE "Intra-frequency cell id" is received:
 - 4> store received cell information at this position in the Intra-frequency cell info on secondary UL frequency list in the variable CELL_INFO_LIST, possibly overwriting any existing information in this position; and
 - 4> mark the position "occupied".
 - 3> if the IE "Intra-frequency cell id" is not received:
 - 4> store the received cell information at the first vacant position in ascending order in the Intra-frequency cell info on secondary UL frequency list in the variable CELL_INFO_LIST; and
 - 4> mark the position as "occupied".
- 1> if the IE "Cells for measurement" is received, in the measurement configured by this message only:
 - 2> consider Intra-frequency cells whose cell information is stored at the position indicated by the IE "Intra-frequency cell id" in the Intra-frequency cell info on secondary UL frequency list in the variable CELL_INFO_LIST.
- 1> if the IE "Cells for measurement" is not received, in the measurement configured by this message:
 - 2> consider all Intra-frequency cells whose cell information is stored in the Intra-frequency cell info on secondary UL frequency list in the variable CELL_INFO_LIST.

If the IE "Inter-frequency cell info list" is received in System Information Block Type 11 update the variable CELL_INFO_LIST accordingly and in the following order. The UE shall:

- 1> if the IE "Inter-frequency cell removal" is received:
 - 2> ignore the IE.
- 1> if the IE "New Inter-frequency cells" is received, for each cell, and in the same order as the cells appear in the IE:
 - 2> update the variable CELL_INFO_LIST as follows:
 - 3> if the IE "Inter-frequency cell id" is received:
 - 4> store received cell information at this position in the Inter-frequency cell info list in the variable CELL_INFO_LIST, possibly overwriting any existing information in this position; and
 - 4> mark the position "occupied".
 - 3> if the IE "Inter-frequency cell id" is not received:
 - 4> store the received cell information at the first vacant position in ascending order in the Inter-frequency cell info list in the variable CELL_INFO_LIST; and
 - 4> mark the position as "occupied".

If the IE "Inter-frequency cell info list" is received in System Information Block Type 11bis, the UE shall update the variable CELL_INFO_LIST accordingly and in the following order. The UE shall:

- 1> for each cell, and in the same order as the cells appear in the IE:
 - 2> update the variable CELL_INFO_LIST as follows:
 - 3> if the IE "Inter-frequency cell id" is received:

- 4> store received cell information at this position in the Inter-frequency cell info list in the variable CELL_INFO_LIST, possibly overwriting any existing information in this position; and
 - 4> mark the position "occupied".
- 3> if the IE "Inter-frequency cell id" is not received:
 - 4> store the received cell information at the first vacant position in ascending order in the Inter-frequency cell info list in the variable CELL_INFO_LIST; and
 - 4> mark the position as "occupied".

If the IE "Inter-frequency cell info list extension" is received in System Information Block Type 11ter, and the UE supports SIB11ter, the UE shall update the variable CELL_INFO_LIST accordingly and in the following order. If the UE supports SIB11ter, the UE shall:

- 1> for each cell, and in the same order as the cells appear in the IE:
 - 2> update the variable CELL_INFO_LIST as follows:
 - 3> if the IE "Inter-frequency cell id" is received:
 - 4> store received cell information at this position in the Inter-frequency cell info list extension in the variable CELL_INFO_LIST, possibly overwriting any existing information in this position; and
 - 4> mark the position "occupied".
 - 3> if the IE "Inter-frequency cell id" is not received:
 - 4> store the received cell information at the first vacant position in ascending order in the Inter-frequency cell info list extension in the variable CELL_INFO_LIST; and
 - 4> mark the position as "occupied".

If the IE "Inter-frequency cell info list" is received in System Information Block Type 12, the UE shall update the variable CELL_INFO_LIST accordingly and in the following order. The UE shall:

- 1> if the CHOICE "Inter-frequency cell removal" is received:
 - 2> if it has the value "Remove some inter-frequency cells", at the position indicated by the IE "Inter-frequency cell id":
 - 3> clear the cell information stored in the variable CELL_INFO_LIST; and
 - 3> mark the position "vacant".
 - 2> if it has the value "Remove all inter-frequency cells":
 - 3> for each position referring to an inter-frequency cell in the variable CELL_INFO_LIST:
 - 4> clear the cell information stored in the variable CELL_INFO_LIST; and
 - 4> mark the position "vacant".
 - 2> if it has the value "Remove no inter-frequency cells":
 - 3> leave the variable CELL_INFO_LIST unchanged.
- 1> if the IE "New Inter-frequency cells" is received, for each cell, and in the same order as the cells appear in the IE:
 - 2> update the variable CELL_INFO_LIST as follows:
 - 3> if the IE "Inter-frequency cell id" is received:
 - 4> store received cell information at this position in the Inter-frequency cell info list in the variable CELL_INFO_LIST, possibly overwriting any existing information in this position; and

- 4> mark the position "occupied".
- 3> if the IE "Inter-frequency cell id" is not received:
 - 4> store the received cell information at the first vacant position in ascending order in the Inter-frequency cell info list in the variable CELL_INFO_LIST; and
 - 4> mark the position as "occupied".

If the IE "Inter-frequency cell info list" is received in a MEASUREMENT CONTROL message, the UE shall update the variable CELL_INFO_LIST accordingly and in the following order:

- 1> if the CHOICE "Inter-frequency cell removal" is received:
 - 2> if it has the value "Remove some inter-frequency cells", at the position indicated by the IE "Inter-frequency cell id":
 - 3> clear the cell information stored in the variable CELL_INFO_LIST; and
 - 3> mark the position "vacant".
 - 2> if it has the value "Remove all inter-frequency cells":
 - 3> for each position referring to an inter-frequency cell in the variable CELL_INFO_LIST:
 - 4> clear the cell information stored in the variable CELL_INFO_LIST; and
 - 4> mark the position "vacant".
 - 2> if it has the value "Remove no inter-frequency cells":
 - 3> leave the variable CELL_INFO_LIST unchanged.
- 1> if the IE "New Inter-frequency cells" is received, for each cell, and in the same order as the cells appear in the IE:
 - 2> update the variable CELL_INFO_LIST as follows:
 - 3> if the IE "Inter-frequency cell id" is received:
 - 4> store received cell information at this position in the Inter-frequency cell info list in the variable CELL_INFO_LIST, possibly overwriting any existing information in this position; and
 - 4> mark the position "occupied".
 - 3> if the IE "Inter-frequency cell id" is not received:
 - 4> store the received cell information at the first vacant position in ascending order in the Inter-frequency cell info list in the variable CELL_INFO_LIST; and
 - 4> mark the position as "occupied".
- 1> if the IE "Cells for measurement" is received, in the measurement configured by this message only:
 - 2> consider Inter-frequency cells whose cell information is stored at the position indicated by the IE "Inter-frequency cell id" in the variable CELL_INFO_LIST.
- 1> if the IE "Cells for measurement" is not received, in the measurement configured by this message:
 - 2> consider all Inter-frequency cells whose cell information is stored in CELL_INFO_LIST.
- 1> if the IE "CSG Inter frequency cell info" is received:
 - 2> store the received information in the CSG Inter-frequency cell info in the variable CELL_INFO_CSG_LIST;
 - 2> consider the cells in CSG Inter-frequency cell info in variable CELL_INFO_CSG_LIST as monitored set for the associated measurement.

If the UE supports multi-band signaling and the IE "Multiple Frequency Info List FDD" is received in System Information Block Type 11 or System Information Block Type 11bis or System Information Block Type 11ter or System Information Block Type 12, the UE shall update the variable CELL_INFO_LIST accordingly. The UE shall:

- 1> for each entry in the IE "New Inter-frequency cells":
 - 2> if the IE "Frequency info" is included:
 - 3> if the UE does not support the Frequency Band associated with the UARFCN downlink (Nd) in the IE "Frequency info", but does understand the UARFCN downlink (Nd):
 - 4> if the IE "Multiple Frequency Bands Indicator List FDD" is present in the n-th entry in the IE "Multiple Frequency Info List FDD", where n corresponds to this occurrence of IE "Frequency info" in "New Inter-frequency cells":
 - 5> for the first entry in the IE "Multiple Frequency Bands Indicator List FDD" corresponding to a UE supported band:
 - 6> extract the band and compute the corresponding UARFCN downlink (Nd) and UARFCN uplink (Nu) values;
 - 6> overwrite the corresponding Frequency Info in the CELL_INFO_LIST variable with the new computed UARFCN downlink (Nd) and UARFCN uplink (Nu) values.
 - 2> else:
 - 3> if the UE does not support the Frequency Band associated with the UARFCN downlink (Nd) in the previous occurrence of the IE "Frequency info" in "New Inter-frequency cells", but does understand the UARFCN downlink (Nd):
 - 4> overwrite the corresponding Frequency Info in the CELL_INFO_LIST variable with the UARFCN downlink (Nd) and UARFCN uplink (Nu) values which were computed for the previous instance of the IE "Frequency info" in the IE "New Inter-frequency cells".

If the IE "Inter-RAT cell info list" is received in System Information Block Type 11, the UE shall update the variable CELL_INFO_LIST accordingly and in the following order. The UE shall:

- 1> ignore the IE "Inter-RAT cell removal";
- 1> if the IE "New Inter-RAT cells" is received, for each cell, and in the same order as the cells appear in the IE:
 - 2> if the IE "Radio Access Technology" is set to "None":
 - 3> ignore the cell.
 - 2> otherwise:
 - 3> update the variable CELL_INFO_LIST as follows:
 - 4> if the IE "Inter-RAT cell id" is received:
 - 5> store received cell information at this position in the Inter-RAT cell info list in the variable CELL_INFO_LIST, possibly overwriting any existing information in this position; and
 - 5> mark the position "occupied".
 - 4> if the IE "Inter-RAT cell id" is not received:
 - 5> store the received cell information at the first vacant position in ascending order in the Inter-RAT cell info list in the variable CELL_INFO_LIST; and
 - 5> mark the position as "occupied".
- 1> if the IE "Cells for measurement" is received:
 - 2> ignore the IE.

- 1> set the "Inter-RAT cell info indication" to the value "0" and mark the indication status "present" in the variable CELL_INFO_LIST.

If the IE "Inter-RAT cell info list" is received in System Information Block Type 11bis, the UE shall update the variable CELL_INFO_LIST accordingly and in the following order. The UE shall:

- 1> for each cell, and in the same order as the cells appear in the IE:
 - 2> update the variable CELL_INFO_LIST as follows:
 - 3> if the IE "Inter-RAT cell id" is received:
 - 4> store received cell information at this position in the Inter-RAT cell info list in the variable CELL_INFO_LIST, possibly overwriting any existing information in this position; and
 - 4> mark the position "occupied".
 - 3> if the IE "Inter-RAT cell id" is not received:
 - 4> store the received cell information at the first vacant position in ascending order in the Inter-RAT cell info list in the variable CELL_INFO_LIST; and
 - 4> mark the position as "occupied".

If the IE "Inter-RAT cell info list" is received in System Information Block Type 12, the UE shall update the variable CELL_INFO_LIST accordingly and in the following order. The UE shall:

- 1> if the IE "Inter-RAT cell removal" is received:
 - 2> if it has the value "Remove some inter-RAT cells", at the position indicated by the IE "Inter-RAT cell id":
 - 3> clear the cell information stored in the variable CELL_INFO_LIST; and
 - 3> mark the position "vacant".
 - 2> if it has the value "Remove all inter-RAT cells":
 - 3> for each position referring to an inter-RAT cell in the variable CELL_INFO_LIST:
 - 4> clear the cell information stored in the variable CELL_INFO_LIST; and
 - 4> mark the position "vacant".
 - 2> if it has the value "Remove no inter-RAT cells":
 - 3> leave the variable CELL_INFO_LIST unchanged.

1> if the IE "New Inter-RAT cells" is received, for each cell, and in the same order as the cells appear in the IE:

- 2> if the IE "Radio Access Technology" is set to "None":
 - 3> ignore the cell.
- 2> otherwise:
 - 3> update the variable CELL_INFO_LIST as follows:
 - 4> if the IE "Inter-RAT cell id" is received:
 - 5> store received cell information at this position in the Inter-RAT cell info list in the variable CELL_INFO_LIST, possibly overwriting any existing information in this position; and
 - 5> mark the position "occupied".
 - 4> if the IE "Inter-RAT cell id" is not received:
 - 5> store the received cell information at the first vacant position in ascending order in the Inter-RAT cell info list in the variable CELL_INFO_LIST; and

5> mark the position as "occupied".

1> if the IE "Cells for measurement" is received:

2> ignore the IE.

1> set the "Inter-RAT cell info indication" to the value "0" and mark the indication status "present" in the variable CELL_INFO_LIST.

If the IE "Inter-RAT cell info list" is received in a MEASUREMENT CONTROL message, the UE shall update the variable CELL_INFO_LIST accordingly and in the following order. The UE shall:

1> if the IE "Inter-RAT cell removal" is received:

2> if it has the value "Remove some inter-RAT cells", at the position indicated by the IE "Inter-RAT cell id":

3> clear the cell information stored in the variable CELL_INFO_LIST; and

3> mark the position "vacant".

2> if it has the value "Remove all inter-RAT cells":

3> for each position referring to an inter RAT cell in the variable CELL_INFO_LIST:

4> clear the cell information stored in the variable CELL_INFO_LIST; and

4> mark the position "vacant".

2> if it has the value "Remove no inter-RAT cells":

3> leave the variable CELL_INFO_LIST unchanged.

1> if the IE "New Inter-RAT cells" is received, for each cell, and in the same order as the cells appear in the IE:

2> if the IE "Radio Access Technology" is set to "None":

3> ignore the cell.

2> otherwise:

3> update the variable CELL_INFO_LIST as follows:

4> if the IE "Inter-RAT cell id" is received:

5> store received cell information at this position in the Inter-RAT cell info list in the variable CELL_INFO_LIST, possibly overwriting any existing information in this position; and

5> mark the position "occupied".

4> if the IE "Inter-RAT cell id" is not received:

5> store the received cell information at the first vacant position in ascending order in the Inter-RAT cell info list in the variable CELL_INFO_LIST; and

5> mark the position as "occupied".

1> if the IE "Cells for measurement" is received, in the measurement configured by this message only:

2> consider Inter-RAT cells whose cell information is stored at the position indicated by the IE "Inter-RAT cell id" in the variable CELL_INFO_LIST.

1> if the IE "Cells for measurement" is not received, in the measurement configured by this message:

2> consider all Inter-RAT cells whose cell information is stored in CELL_INFO_LIST.

1> if the IE "Cell selection and re-selection info for SIB11/12" is present:

2> ignore the IE.

- 1> if the IE "Inter-RAT cell info indication" is present:
 - 2> store the received value of the IE "Inter-RAT cell info indication" and mark the indication status "present" in the variable CELL_INFO_LIST.
- 1> if the IE "Inter-RAT cell info indication" is not present:
 - 2> clear the "Inter-RAT cell info indication" and mark the indication status "not present" in the variable CELL_INFO_LIST.

For 1.28 Mcps TDD, if the IE "Intra-frequency cell info list" or "Inter-frequency cell info list" is received in a MEASUREMENT CONTROL message, the UE shall:

- 1> if the IE "SNPL Monitor Set Indicator" is received:
 - 2> consider E-DCH carriers whose neighbour cells are the same for SNPL calculation into a SNPL carrier group;
 - 2> configure the MAC-i/is entity with the SNPL carrier groups information.

NOTE: If UTRAN signalling would result in more than "maxCellMeas" cells for the Intra-frequency cell information list on primary uplink frequency, Inter-frequency cell information list (in SIB11 and SIB11bis) or Inter-RAT cell information list the UE behaviour is unspecified.

NOTE: If UTRAN signalling would result in more than "maxCellMeas-ext" cells for the Inter-frequency cell information list (in SIB11, SIB11bis and SIB11ter) the UE behaviour is unspecified.

NOTE: If UTRAN signalling would result in more than "maxCellMeasOnSecULFreq" cells for the Intra-frequency cell information list on secondary uplink frequency the UE behaviour is unspecified.

8.6.7.3a UTRA priority info list

If the IE "UTRA priority info list" is received in System Information Block Type 19, the UE shall:

- 1> if the value of the IE "Priority status" in the variable PRIORITY_INFO_LIST equals "dedicated_priority":
 - 2> store the value of the IEs "S_{prioritysearch1}", "S_{prioritysearch2}", "Thresh_{serv,low}" and "Thresh_{serv,low2}" in the IE "UTRA Serving Cell" in the variable PRIORITY_INFO_LIST;
 - 2> if any of the values in any of the occurrences of the IE "Frequency List" in any occurrence of the IE "Priority Info List" within the variable PRIORITY_INFO_LIST is the frequency of the serving cell:
 - 3> store the value of the IE "priority" in the IE "UTRA Serving Cell" in the variable PRIORITY_INFO_LIST.
 - 2> otherwise:
 - 3> clear the value of the IE "priority" in the IE "UTRA Serving Cell" in the variable PRIORITY_INFO_LIST.
 - 2> for each occurrence of the IE "UTRAN FDD Frequencies":
 - 3> if the value of the IE "UARFCN" exists in the list of UTRA FDD priorities in the PRIORITY_INFO_LIST; or
 - 3> if the UE supports multi-band signalling and a UARFCN exists in the list of UTRA FDD priorities in the PRIORITY_INFO_LIST which has overlap with the frequency band associated with the IE "UARFCN":
 - 4> then in the corresponding occurrence of IE "Frequency List" within the variable PRIORITY_INFO_LIST:
 - 5> store the value of the IEs "Thresh_{x,high}", "Thresh_{x,low}", "QqualminFDD" and "QrxlevminFDD".
 - 2> for each occurrence of the IE "UTRAN TDD Frequencies":

3> if the value of the IE "UARFCN" exists in the list of UTRA TDD priorities in the PRIORITY_INFO_LIST then, in the occurrence of IE "Frequency List" within the variable PRIORITY_INFO_LIST with that value of the IE "UARFCN":

4> store the value of the IEs "Thresh_{x,high}", "Thresh_{x,low}" and "QrxlevminTDD".

1> otherwise:

2> update the PRIORITY_INFO_LIST IE "Priority status" to cause "sys_info_priority".

2> store information in the IE "UTRA Serving Cell" in the IE "UTRA Serving Cell" within the variable PRIORITY_INFO_LIST;

2> for each occurrence of the IE "UTRAN FDD Frequencies":

3> if an entry already exists in the IE "Priority Info List" in the variable PRIORITY_INFO_LIST with the same priority value as indicated in the IE "priority" and has the CHOICE "Radio Access Technology" set to "UTRA FDD":

4> create a new entry in the IE "Frequency List" in that occurrence of IE "Priority Info List":

5> if the UE supports multi-band signalling and the UE does not support the frequency band associated with the IE "UARFCN", but does understand the value of "UARFCN"; and

5> if the UARFCN downlink (Nd) of a frequency band, which has overlap with the band associated with the IE "UARFCN", is stored in the variable CELL_INFO_LIST:

6> store the UARFCN downlink (Nd) value from the variable CELL_INFO_LIST in this occurrence of the IE "Frequency List" within the variable PRIORITY_INFO_LIST, and in that new entry:

7> store the IEs "Thresh_{x,high}", "Thresh_{x,low}", "QqualminFDD" and "QrxlevminFDD".

5> else:

6> store the value of "UARFCN" in the IE "UARFCN" in this occurrence of the IE "Frequency List" within the variable PRIORITY_INFO_LIST, and in that new entry:

7> store the IEs "Thresh_{x,high}", "Thresh_{x,low}", "QqualminFDD" and "QrxlevminFDD".

3> otherwise:

4> create a new entry in the IE "Priority Info List" and store the value of "priority" in the IE "priority" in this occurrence of the IE "Priority Info List" within the variable PRIORITY_INFO_LIST, and in that new entry:

5> set the CHOICE "Radio Access Technology" to "UTRA FDD";

5> if the UE supports multi-band signalling and the UE does not support the frequency band associated with the IE "UARFCN", but does understand the value of "UARFCN"; and

5> if the UARFCN downlink (Nd) of a frequency band, which has overlap with the band associated with the IE "UARFCN", is stored in the variable CELL_INFO_LIST:

6> store the UARFCN downlink (Nd) value from the variable CELL_INFO_LIST in the first occurrence of the IE "Frequency List", and in that occurrence of the IE "Frequency List";

7> store the IEs "Thresh_{x,high}", "Thresh_{x,low}", "QqualminFDD" and "QrxlevminFDD".

5> else:

6> store the value of "UARFCN" in the IE "UARFCN" in the first occurrence of the IE "Frequency List", and in that occurrence of the IE "Frequency List";

7> store the IEs "Thresh_{x,high}", "Thresh_{x,low}", "QqualminFDD" and "QrxlevminFDD".

2> for each occurrence of the IE "UTRAN TDD Frequencies":

- 3> if an entry already exists in the IE "Priority Info List" in the variable PRIORITY_INFO_LIST with the same priority value as indicated in the IE "priority" and has the CHOICE "Radio Access Technology" set to "UTRA TDD":
 - 4> create a new entry in the IE "Frequency List" in that occurrence of IE "Priority Info List", and store the value of "UARFCN" in the IE "UARFCN" in this occurrence of the IE "Frequency List" within the variable PRIORITY_INFO_LIST, and in that new entry:
 - 5> store the IEs "Thresh_{x,high}", "Thresh_{x,low}" and "QrxlevminTDD".
- 3> otherwise:
 - 4> create a new entry in the IE "Priority Info List" and store the value of "priority" in the IE "priority" in this occurrence of the IE "Priority Info List" within the variable PRIORITY_INFO_LIST, and in that new entry:
 - 5> set the CHOICE "Radio Access Technology" to "UTRA TDD" and store the value of "UARFCN" in the IE "UARFCN" in the first occurrence of the IE "Frequency List";
 - 5> store the IEs "Thresh_{x,high}", "Thresh_{x,low}" and "QrxlevminTDD" in that occurrence of the IE "Frequency List".

8.6.7.3b GSM priority info list

If the IE "GSM priority info list" is received in System Information Block Type 19, the UE shall:

- 1> if the value of the IE "Priority status" in the variable PRIORITY_INFO_LIST equals "dedicated_priority":
 - 2> for each occurrence of the IE "GSM Priority Info":
 - 3> store the IEs "QrxlevminGSM", "Thresh_{x,high}" and "Thresh_{x,low}" in every entry of PRIORITY_INFO_LIST with CHOICE "Radio Access Technology" set to "GSM", which contains an IE "BCCH ARFCN" matching a BCCH ARFCN indicated in the IE "GSM cell group".
- 1> otherwise:
 - 2> for each occurrence of the IE "GSM Priority Info":
 - 3> create a new entry in the IE "Priority Info List" in the variable PRIORITY_INFO_LIST, and in this new entry:
 - 4> store the value of IE "priority" from the IE "GSM Priority Info", and set the CHOICE "Radio Access Technology" to "GSM";
 - 4> for each of the BCCH ARFCNs indicated by the IE "GSM cell group":
 - 5> create a new entry in the IE "Frequency List" and store the IEs "Band Indicator", "QrxlevminGSM", "Thresh_{x,high}" and "Thresh_{x,low}" and store the indicated BCCH ARFCN in the IE "BCCH ARFCN".

8.6.7.3c E-UTRA frequency and priority info list

If the IE "E-UTRA frequency and priority info list" is received in System Information Block Type 19, the UE shall:

- 1> for each occurrence of the IE "E-UTRA frequency and priority":
 - 2> create a new entry in the IE "Frequency Info List" in the variable EUTRA_FREQUENCY_INFO_LIST, and in that new entry:
 - 3> store the IEs "EARFCN" and "Measurement bandwidth";
 - 3> if the IE "Blacklisted cells per freq list" is present in the IE "E-UTRA frequency and priority":
 - 4> store the blacklisted cells information.

- 2> if the UE supports multi-band signalling and the UE does not support the E-UTRA Frequency Band associated with the EARFCN in the IE "EARFCN", but does understand the EARFCN downlink (Nd):
 - 3> if the IE "Multiple E-UTRA frequency info list" is present for this occurrence of "E-UTRA frequency and priority":
 - 4> for the first entry in the IE "Multiple E-UTRA frequency band indicator list" which the UE supports, the UE shall:
 - 5> extract the supported band and compute the corresponding EARFCN downlink (Nd) value;
 - 5> overwrite the previously stored EARFCN value with the computed EARFCN downlink (Nd) value.
 - 3> if the UE did not find a band which it supports in the IE "Multiple E-UTRA frequency band indicator list" and the IE "Multiple E-UTRA frequency info extension list" is present for this occurrence of "E-UTRA frequency and priority":
 - 4> for the first entry in the IE "Multiple E-UTRA frequency band extension indicator list" which the UE supports, the UE shall:
 - 5> extract the supported band and compute the corresponding EARFCN downlink(Nd) value;
 - 5> overwrite the previously stored EARFCN value with the computed EARFCN downlink (Nd) value.
- 1> for each occurrence of the IE "E-UTRA frequency and priority extension":
 - 2> create a new entry in the IE "Frequency Info List" in the variable EUTRA_FREQUENCY_INFO_LIST, and in that new entry:
 - 3> store the IE "EARFCN extension" in "EARFCN";
 - 3> store the IE "Measurement bandwidth";
 - 3> if the IE "Blacklisted cells per freq list" is present in the IE "E-UTRA frequency and priority extension":
 - 4> store the blacklisted cells information.
 - 2> if the UE supports multi-band signalling and the UE does not support the E-UTRA Frequency Band associated with the EARFCN in the IE "EARFCN extension", but does understand the EARFCN downlink (Nd):
 - 3> if the i-th entry in the IE "Multiple E-UTRA frequency info list" is present for this occurrence of "E-UTRA frequency and priority extension":

where $i = (\text{index of this occurrence of "E-UTRA frequency and priority extension"} + \text{the value in IE "Number of applicable EARFCN"})$

 - 4> for the first entry in the IE "Multiple E-UTRA frequency band indicator list" which the UE supports, the UE shall:
 - 5> extract the supported band and compute the corresponding EARFCN downlink (Nd) value;
 - 5> overwrite the previously stored EARFCN value with the computed EARFCN downlink (Nd) value.
 - 3> if the UE did not find a band which it supports in the IE "Multiple E-UTRA frequency band indicator list" and the i-th entry in the IE "Multiple E-UTRA frequency info extension list" is present for this occurrence of "E-UTRA frequency and priority extension":

where $i = (\text{index of this occurrence of "E-UTRA frequency and priority extension"} + \text{the value in IE "Number of applicable EARFCN"})$

 - 4> for the first entry in the IE "Multiple E-UTRA frequency band indicator extension list" which the UE supports, the UE shall:

- 5> extract the supported band and compute the corresponding EARFCN downlink (Nd) value;
 - 5> overwrite the previously stored EARFCN value with the computed EARFCN downlink (Nd) value.
- 1> if the value of the IE "Priority status" in the variable PRIORITY_INFO_LIST equals "dedicated_priority":
- 2> for each occurrence of the IE "E-UTRA frequency and priority":
 - 3> if the value of IE "EARFCN" exists in the list of E-UTRA priorities in the variable PRIORITY_INFO_LIST, then in that occurrence of the IE "Priority Info List":
 - 4> store the IEs "Thresh_{x, high}", "Thresh_{x, low}", "QrxlevminEUTRA" and "QqualminEUTRA" from the IE "E-UTRA frequency and priority" occurrence;
 - 4> store the IEs "Thresh_{x, high2}" and "Thresh_{x, low2}" from the IE "E-UTRA frequency and priority" occurrence if the IEs are present;
 - 4> if the UE supports RSRQ measurement on all OFDM symbols and the IE's "QqualminRSRQ - OnAllSymbols" and "QqualminEUTRA-WB" from the IE "E-UTRA frequency and priority" occurrence are both present:
 - 5> calculate the value of the received IE "QqualminEUTRA" minus the value of the received IE "QqualminRSRQ-OnAllSymbols" and store it in "EUTRA-RSRQ-OnAllSymbolsOffset";
 - 5> calculate the value of the received IE "QqualminEUTRA" minus the value of the received IE "QqualminEUTRA-WB" and store it in "EUTRA-RSRQ-offsetWB";
 - 5> calculate the value of the received IE "QqualminRSRQ-OnAllSymbols" minus the value of the "EUTRA-RSRQ-offsetWB" and store it in "QqualminEUTRA".
 - 4> else if the UE supports RSRQ measurement on all OFDM symbols and the IE "QqualminRSRQ - OnAllSymbols" from the IE "E-UTRA frequency and priority" occurrence is present:
 - 5> calculate the value of the received IE "QqualminEUTRA" minus the value of the received IE "QqualminRSRQ-OnAllSymbols" and store it in "EUTRA-RSRQ-OnAllSymbolsOffset";
 - 5> store the value of the received IE "QqualminRSRQ-OnAllSymbols" in "QqualminEUTRA".
 - 4> else if the IE "QqualminEUTRA-WB" from the IE "E-UTRA frequency and priority" occurrence is present:
 - 5> calculate the value of the received IE "QqualminEUTRA" minus the value of the received IE "QqualminEUTRA-WB" and store it in "EUTRA-RSRQ-offsetWB";
 - 5> store the value of the received IE "QqualminEUTRA-WB" in "QqualminEUTRA".
 - 3> if the UE supports multi-band signalling and the UE does not support the E-UTRA Frequency Band associated with the EARFCN in the IE "EARFCN", but does understand the EARFCN downlink (Nd):
 - 4> if the IE "Multiple E-UTRA frequency info list" is present for this occurrence of "E-UTRA frequency and priority":
 - 5> for the first entry in the IE "Multiple E-UTRA frequency band indicator list" which the UE supports, the UE shall:
 - 6> extract the supported band and compute the corresponding EARFCN downlink (Nd) value.
 - 4> if the UE did not find a band which it supports in the IE "Multiple E-UTRA frequency band indicator list" and the IE "Multiple E-UTRA frequency info extension list" is present for this occurrence of "E-UTRA frequency and priority":
 - 5> for the first entry in the IE "Multiple E-UTRA frequency band extension indicator list" which the UE supports, the UE shall:
 - 6> extract the supported band and compute the corresponding EARFCN downlink(Nd) value.

- 4> if the computed EARFCN value exists in the list of E-UTRA priorities in the variable PRIORITY_INFO_LIST, then in that occurrence of the IE "Priority Info List":
 - 5> store the IEs "Thresh_{x,high}", "Thresh_{x,low}", "QrxlevminEUTRA" and "QqualminEUTRA" from the IE "E-UTRA frequency and priority" occurrence;
 - 5> store the IEs "Thresh_{x,high2}" and "Thresh_{x,low2}" from the IE "E-UTRA frequency and priority" occurrence if the IEs are present;
 - 5> if the UE supports RSRQ measurement on all OFDM symbol and the IE's "QqualminRSRQ-OnAllSymbols" and "QqualminEUTRA-WB" from the IE "E-UTRA frequency and priority" occurrence are both present:
 - 6> calculate the value of the received IE "QqualminEUTRA" minus the value of the received IE "QqualminRSRQ-OnAllSymbols" and store it in "EUTRA-RSRQ-OnAllSymbolsOffset";
 - 6> calculate the value of the received IE "QqualminEUTRA" minus the value of the received IE "QqualminEUTRA-WB" and store it in "EUTRA-RSRQ-offsetWB";
 - 6> calculate the value of the received IE "QqualminRSRQ-OnAllSymbols" minus the value of the "EUTRA-RSRQ-offsetWB" and store it in "QqualminEUTRA".
 - 5> else if the UE supports RSRQ measurement on all OFDM symbols and the IE "QqualminRSRQ-OnAllSymbols" from the IE "E-UTRA frequency and priority" occurrence is present:
 - 6> calculate the value of the received IE "QqualminEUTRA" minus the value of the received IE "QqualminRSRQ-OnAllSymbols" and store it in "EUTRA-RSRQ-OnAllSymbolsOffset";
 - 6> store the value of the received IE "QqualminRSRQ-OnAllSymbols" in "QqualminEUTRA".
 - 5> else if the IE "QqualminEUTRA-WB" from the IE "E-UTRA frequency and priority" occurrence is present:
 - 6> calculate the value of the received IE "QqualminEUTRA" minus the value of the received IE "QqualminEUTRA-WB" and store it in "EUTRA-RSRQ-offsetWB";
 - 6> store the value of the received IE "QqualminEUTRA-WB" in "QqualminEUTRA".
- 2> for each occurrence of the IE "E-UTRA frequency and priority extension":
 - 3> if the value of IE "EARFCN extension" exists in the list of E-UTRA priorities in the variable PRIORITY_INFO_LIST, then in that occurrence of the IE "Priority Info List":
 - 4> store the IEs "Thresh_{x,high}", "Thresh_{x,low}", "QrxlevminEUTRA" and "QqualminEUTRA" from the IE "E-UTRA frequency and priority extension" occurrence;
 - 4> store the IEs "Thresh_{x,high2}" and "Thresh_{x,low2}" from the IE "E-UTRA frequency and priority extension" occurrence if the IEs are present;
 - 4> if the UE supports RSRQ measurement on all OFDM symbols and the IE's "QqualminRSRQ-OnAllSymbols" and "QqualminEUTRA-WB" from the IE "E-UTRA frequency and priority extension" occurrence are both present:
 - 5> calculate the value of the received IE "QqualminEUTRA" minus the value of the received IE "QqualminRSRQ-OnAllSymbols" and store it in "EUTRA-RSRQ-OnAllSymbolsOffset";
 - 5> calculate the value of the received IE "QqualminEUTRA" minus the value of the received IE "QqualminEUTRA-WB" and store it in "EUTRA-RSRQ-offsetWB";
 - 5> calculate the value of the received IE "QqualminRSRQ-OnAllSymbols" minus the value of the "EUTRA-RSRQ-offsetWB" and store it in "QqualminEUTRA".
 - 4> else if the UE supports RSRQ measurement on all OFDM symbols and the IE "QqualminRSRQ-OnAllSymbols" from the IE "E-UTRA frequency and priority extension" occurrence is present:

- 5> calculate the value of the received IE "QqualminEUTRA" minus the value of the received IE "QqualminRSRQ-OnAllSymbols" and store it in "EUTRA-RSRQ-OnAllSymbolsOffset";
- 5> store the value of the received IE "QqualminRSRQ-OnAllSymbols" in "QqualminEUTRA".
- 4> else if the IE "QqualminEUTRA-WB" from the IE "E-UTRA frequency and priority extension" occurrence is present:
 - 5> calculate the value of the received IE "QqualminEUTRA" minus the value of the received IE "QqualminEUTRA-WB" and store it in "EUTRA-RSRQ-offsetWB";
 - 5> store the value of the received IE "QqualminEUTRA-WB" in "QqualminEUTRA".
- 3> if the UE supports multi-band signalling and the UE does not support the E-UTRA Frequency Band associated with the EARFCN in the IE "EARFCN extension", but does understand the EARFCN downlink (Nd):
 - 4> if i-th entry in the IE "Multiple E-UTRA frequency info list" is present for this occurrence of "E-UTRA frequency and priority extension":

where $i = (\text{index of this occurrence of "E-UTRA frequency and priority extension"} + \text{the value in IE "Number of applicable EARFCN"})$

 - 5> for the first entry in the IE "Multiple E-UTRA frequency band indicator list" which the UE supports, the UE shall:
 - 6> extract the supported band and compute the corresponding EARFCN downlink (Nd) value.
 - 4> if the UE did not find a band which it supports in the IE "Multiple E-UTRA frequency band indicator list" and the i-th entry in the IE "Multiple E-UTRA frequency info extension list" is present for this occurrence of "E-UTRA frequency and priority extension":

where $i = (\text{index of this occurrence of "E-UTRA frequency and priority extension"} + \text{the value in IE "Number of applicable EARFCN"})$

 - 5> for the first entry in the IE "Multiple E-UTRA frequency band indicator extension list" which the UE supports, the UE shall:
 - 6> extract the supported band and compute the corresponding EARFCN downlink (Nd) value.
- 4> if the computed EARFCN value exists in the list of E-UTRA priorities in the variable PRIORITY_INFO_LIST, then in that occurrence of the IE "Priority Info extension List":
 - 5> store the IEs "Thresh_{x, high}", "Thresh_{x, low}", "QrxlevminEUTRA" and "QqualminEUTRA" from the IE "E-UTRA frequency and priority extension" occurrence;
 - 5> store the IEs "Thresh_{x, high2}" and "Thresh_{x, low2}" from the IE "E-UTRA frequency and priority extension" occurrence if the IEs are present;
 - 5> if the UE supports RSRQ measurement on all OFDM symbols and the IE's "QqualminRSRQ-OnAllSymbols" and "QqualminEUTRA-WB" from the IE "E-UTRA frequency and priority extension" occurrence are both present:
 - 6> calculate the value of the received IE "QqualminEUTRA" minus the value of the received IE "QqualminRSRQ-OnAllSymbols" and store it in "EUTRA-RSRQ-OnAllSymbolsOffset";
 - 6> calculate the value of the received IE "QqualminEUTRA" minus the value of the received IE "QqualminEUTRA-WB" and store it in "EUTRA-RSRQ-offsetWB";
 - 6> calculate the value of the received IE "QqualminRSRQ-OnAllSymbols" minus the value of the "EUTRA-RSRQ-offsetWB" and store it in "QqualminEUTRA".
 - 5> else if the UE supports RSRQ measurement on all OFDM symbols and the IE "QqualminRSRQ-OnAllSymbols" from the IE "E-UTRA frequency and priority extension" occurrence is present:

- 6> calculate the value of the received IE "QqualminEUTRA" minus the value of the received IE "QqualminRSRQ-OnAllSymbols" and store it in "EUTRA-RSRQ-OnAllSymbolsOffset";
- 6> store the value of the received IE "QqualminRSRQ-OnAllSymbols" in "QqualminEUTRA".
- 5> else if the IE "QqualminEUTRA-WB" from the IE "E-UTRA frequency and priority extension" occurrence is present:
 - 6> calculate the value of the received IE "QqualminEUTRA" minus the value of the received IE "QqualminEUTRA-WB" and store it in "EUTRA-RSRQ-offsetWB";
 - 6> store the value of the received IE "QqualminEUTRA-WB" in "QqualminEUTRA".
- 1> otherwise:
 - 2> for each occurrence of the IE "E-UTRA frequency and priority":
 - 3> if an entry already exists in the IE "Priority Info List" in the variable PRIORITY_INFO_LIST with the same priority value as indicated in the IE "priority" and has the CHOICE "Radio Access Technology" set to "E-UTRA":
 - 4> create a new entry in the IE "Frequency List" in that occurrence of IE "Priority Info List", and store the value of "EARFCN" in the IE "EARFCN" in this occurrence of the IE "Frequency List" within the variable PRIORITY_INFO_LIST, and:
 - 5> store the IEs "Thresh_{x,high}", "Thresh_{x,low}", "QrxlevminEUTRA" and "QqualminEUTRA" in that occurrence of the IE "Frequency List";
 - 5> store the IEs "Thresh_{x,high2}" and "Thresh_{x,low2}" in that occurrence of the IE "Frequency List" if the IEs are present;
 - 5> if the UE supports RSRQ measurement on all OFDM symbols and the IE's "QqualminRSRQ-OnAllSymbols" and "QqualminEUTRA-WB" from the IE "E-UTRA frequency and priority" occurrence are both present:
 - 6> calculate the value of the received IE "QqualminEUTRA" minus the value of the received IE "QqualminRSRQ-OnAllSymbols" and store it in "EUTRA-RSRQ-OnAllSymbolsOffset";
 - 6> calculate the value of the received IE "QqualminEUTRA" minus the value of the received IE "QqualminEUTRA-WB" and store it in "EUTRA-RSRQ-offsetWB";
 - 6> calculate the value of the received IE "QqualminRSRQ-OnAllSymbols" minus the value of the "EUTRA-RSRQ-offsetWB" and store it in "QqualminEUTRA".
 - 5> else if the UE supports RSRQ measurement on all OFDM symbols and the IE "QqualminRSRQ-OnAllSymbols" from the IE "E-UTRA frequency and priority" occurrence is present:
 - 6> calculate the value of the received IE "QqualminEUTRA" minus the value of the received IE "QqualminRSRQ-OnAllSymbols" and store it in "EUTRA-RSRQ-OnAllSymbolsOffset";
 - 6> store the value of the received IE "QqualminRSRQ-OnAllSymbols" in "QqualminEUTRA".
 - 5> else if the IE "QqualminEUTRA-WB" from the IE "E-UTRA frequency and priority" occurrence is present:
 - 6> calculate the value of the received IE "QqualminEUTRA" minus the value of the received IE "QqualminEUTRA-WB" and store it in "EUTRA-RSRQ-offsetWB";
 - 6> store the value of the received IE "QqualminEUTRA-WB" in "QqualminEUTRA".
 - 4> if the UE supports multi-band signalling and if the UE does not support the E-UTRA Frequency Band associated with the EARFCN in the IE "EARFCN", but does understand the EARFCN downlink (Nd):
 - 5> if the IE "Multiple E-UTRA frequency info list" is present for this occurrence of "E-UTRA frequency and priority":

- 6> for the first entry in the IE "Multiple E-UTRA frequency band indicator list" which the UE supports, the UE shall:
 - 7> extract the supported band and compute the corresponding EARFCN downlink (Nd) value;
 - 7> overwrite the previously stored EARFCN value in this occurrence of the IE "Frequency List" within the variable PRIORITY_INFO_LIST with the computed EARFCN downlink (Nd) value.
- 5> if the UE did not find a band which it supports in the IE "Multiple E-UTRA frequency band indicator list" and the IE "Multiple E-UTRA frequency info extension list" is present for this occurrence of "E-UTRA frequency and priority":
 - 6> for the first entry in the IE "Multiple E-UTRA frequency band extension indicator list" which the UE supports, the UE shall:
 - 7> extract the supported band and compute the corresponding EARFCN downlink(Nd) value;
 - 7> overwrite the previously stored EARFCN value in this occurrence of the IE "Frequency List" within the variable PRIORITY_INFO_LIST with the computed EARFCN downlink (Nd) value.
- 3> otherwise:
 - 4> create a new entry in the IE "Priority Info List" and store the value of "priority" in the IE "priority" in this occurrence of the IE "Priority Info List" within the variable PRIORITY_INFO_LIST, and in that new entry:
 - 5> set the CHOICE "Radio Access Technology" to "E-UTRA" and store the value of "EARFCN" in the IE "EARFCN" in the first occurrence of the IE "Frequency List";
 - 5> store the IEs "Thresh_{x,high}", "Thresh_{x,low}", "QrxlevminEUTRA" and "QqualminEUTRA" in that occurrence of the IE "Frequency List";
 - 5> store the IEs "Thresh_{x,high2}" and "Thresh_{x,low2}" in that occurrence of the IE "Frequency List" if the IEs are present;
 - 5> if the UE supports RSRQ measurement on all OFDM symbols and the IE's "QqualminRSRQ-OnAllSymbols" and "QqualminEUTRA-WB" from the IE "E-UTRA frequency and priority" occurrence are both present:
 - 6> calculate the value of the received IE "QqualminEUTRA" minus the value of the received IE "QqualminRSRQ-OnAllSymbols" and store it in "EUTRA-RSRQ-OnAllSymbolsOffset";
 - 6> calculate the value of the received IE "QqualminEUTRA" minus the value of the received IE "QqualminEUTRA-WB" and store it in "EUTRA-RSRQ-offsetWB";
 - 6> calculate the value of the received IE "QqualminRSRQ-OnAllSymbols" minus the value of the "EUTRA-RSRQ-offsetWB" and store it in "QqualminEUTRA".
 - 5> else if the UE supports RSRQ measurement on all OFDM symbols and the IE "QqualminRSRQ-OnAllSymbols" from the IE "E-UTRA frequency and priority" occurrence is present:
 - 6> calculate the value of the received IE "QqualminEUTRA" minus the value of the received IE "QqualminRSRQ-OnAllSymbols" and store it in "EUTRA-RSRQ-OnAllSymbolsOffset";
 - 6> store the value of the received IE "QqualminRSRQ-OnAllSymbols" in "QqualminEUTRA".
 - 5> else if the IE "QqualminEUTRA-WB" from the IE "E-UTRA frequency and priority" occurrence is present:
 - 6> calculate the value of the received IE "QqualminEUTRA" minus the value of the received IE "QqualminEUTRA-WB" and store it in "EUTRA-RSRQ-offsetWB";
 - 6> store the value of the received IE "QqualminEUTRA-WB" in "QqualminEUTRA".

- 5> if the UE supports multi-band signalling and if the UE does not support the E-UTRA Frequency Band associated with the EARFCN in the IE "EARFCN", but does understand the EARFCN downlink (Nd):
 - 6> if the IE "Multiple E-UTRA frequency info list" is present for this occurrence of "E-UTRA frequency and priority":
 - 7> for the first entry in the IE "Multiple E-UTRA frequency band indicator list" which the UE supports, the UE shall:
 - 8> extract the supported band and compute the corresponding EARFCN downlink (Nd) value;
 - 8> overwrite the previously stored EARFCN value in this occurrence of the IE "Frequency List" within the variable PRIORITY_INFO_LIST with the computed EARFCN downlink (Nd) value.
 - 6> if the UE did not find a band which it supports in the IE "Multiple E-UTRA frequency band indicator list" and the IE "Multiple E-UTRA frequency info extension list" is present for this occurrence of "E-UTRA frequency and priority":
 - 7> for the first entry in the IE "Multiple E-UTRA frequency band extension indicator list" which the UE supports, the UE shall:
 - 8> extract the supported band and compute the corresponding EARFCN downlink(Nd) value;
 - 8> overwrite the previously stored EARFCN value in this occurrence of the IE "Frequency List" within the variable PRIORITY_INFO_LIST with the computed EARFCN downlink (Nd) value.
- 3> store the IE "E-UTRA detection".
- 2> for each occurrence of the IE "E-UTRA frequency and priority extension":
 - 3> if an entry already exists in the IE "Priority Info List" in the variable PRIORITY_INFO_LIST with the same priority value as indicated in the IE "priority" and has the CHOICE "Radio Access Technology" set to "E-UTRA":
 - 4> create a new entry in the IE "Frequency List" in that occurrence of IE "Priority Info List", and store the value of "EARFCN extension" in the IE "EARFCN" in this occurrence of the IE "Frequency List" within the variable PRIORITY_INFO_LIST, and:
 - 5> store the IEs "Thresh_{x, high}", "Thresh_{x, low}", "QrxlevminEUTRA" and "QqualminEUTRA" in that occurrence of the IE "Frequency List";
 - 5> store the IEs "Thresh_{x, high2}" and "Thresh_{x, low2}" in that occurrence of the IE "Frequency List" if the IEs are present;
 - 5> if the UE supports RSRQ on all OFDM symbols measurement and the IE's "QqualminRSRQ-OnAllSymbols" and "QqualminEUTRA-WB" from the IE "E-UTRA frequency and priority extension" occurrence are both present:
 - 6> calculate the value of the received IE "QqualminEUTRA" minus the value of the received IE "QqualminRSRQ-OnAllSymbols" and store it in "EUTRA-RSRQ-OnAllSymbolsOffset";
 - 6> calculate the value of the received IE "QqualminEUTRA" minus the value of the received IE "QqualminEUTRA-WB" and store it in "EUTRA-RSRQ-offsetWB";
 - 6> calculate the value of the received IE "QqualminRSRQ-OnAllSymbols" minus the value of the "EUTRA-RSRQ-offsetWB" and store it in "QqualminEUTRA".
 - 5> else if the UE supports RSRQ measurement on all OFDM symbols and the IE "QqualminRSRQ-OnAllSymbols" from the IE "E-UTRA frequency and priority extension" occurrence is present:

- 6> calculate the value of the received IE "QqualminEUTRA" minus the value of the received IE "QqualminRSRQ-OnAllSymbols" and store it in "EUTRA-RSRQ-OnAllSymbolsffset";
- 6> store the value of the received IE "QqualminRSRQ-OnAllSymbols" in "QqualminEUTRA".
- 5> else if the IE "QqualminEUTRA-WB" from the IE "E-UTRA frequency and priority extension" occurrence is present:
 - 6> calculate the value of the received IE "QqualminEUTRA" minus the value of the received IE "QqualminEUTRA-WB" and store it in "EUTRA-RSRQ-offsetWB";
 - 6> store the value of the received IE "QqualminEUTRA-WB" in "QqualminEUTRA".
- 4> if the UE supports multi-band signalling and the UE does not support the E-UTRA Frequency Band associated with the EARFCN in the IE "EARFCN extension", but does understand the EARFCN downlink (Nd):
 - 5> if the i-th entry in the IE "Multiple E-UTRA frequency info list" is present for this occurrence of "E-UTRA frequency and priority extension":
 - where $i = (\text{index of this occurrence of "E-UTRA frequency and priority extension"} + \text{the value in IE "Number of applicable EARFCN"})$
 - 6> for the first entry in the IE "Multiple E-UTRA frequency band indicator list" which the UE supports, the UE shall:
 - 7> extract the supported band and compute the corresponding EARFCN downlink (Nd) value;
 - 7> overwrite the previously stored EARFCN value in this occurrence of the IE "Frequency List" within the variable PRIORITY_INFO_LIST with the computed EARFCN downlink (Nd) value.
 - 5> if the UE did not find a band which it supports in the IE "Multiple E-UTRA frequency band indicator list" and the i-th entry in the IE "Multiple E-UTRA frequency info extension list" is present for this occurrence of "E-UTRA frequency and priority extension":
 - where $i = (\text{index of this occurrence of "E-UTRA frequency and priority extension"} + \text{the value in IE "Number of applicable EARFCN"})$
 - 6> for the first entry in the IE "Multiple E-UTRA frequency band indicator extension list" which the UE supports, the UE shall:
 - 7> extract the supported band and compute the corresponding EARFCN downlink (Nd) value;
 - 7> overwrite the previously stored EARFCN value in this occurrence of the IE "Frequency List" within the variable PRIORITY_INFO_LIST with the computed EARFCN downlink (Nd) value.
- 3> otherwise:
 - 4> create a new entry in the IE "Priority Info List" and store the value of "priority" in the IE "priority" in this occurrence of the IE "Priority Info List" within the variable PRIORITY_INFO_LIST, and in that new entry:
 - 5> set the CHOICE "Radio Access Technology" to "E-UTRA" and store the value of "EARFCN extension" in the IE "EARFCN extension" in the first occurrence of the IE "Frequency List";
 - 5> store the IEs "Thresh_{x,high}", "Thresh_{x,low}", "QrxlevminEUTRA" and "QqualminEUTRA" in that occurrence of the IE "Frequency List";
 - 5> store the IEs "Thresh_{x,high2}" and "Thresh_{x,low2}" in that occurrence of the IE "Frequency List" if the IEs are present;
 - 5> if the UE supports RSRQ measurement on all OFDM symbols and the IE's "QqualminRSRQ-OnAllSymbols" and "QqualminEUTRA-WB" from the IE "E-UTRA frequency and priority extension" occurrence are both present:

- 6> calculate the value of the received IE "QqualminEUTRA" minus the value of the received IE "QqualminRSRQ-OnAllSymbols" and store it in "EUTRA-RSRQ-OnAllSymbolsOffset";
- 6> calculate the value of the received IE "QqualminEUTRA" minus the value of the received IE "QqualminEUTRA-WB" and store it in "EUTRA-RSRQ-offsetWB";
- 6> calculate the value of the received IE "QqualminRSRQ-OnAllSymbols" minus the value of the "EUTRA-RSRQ-offsetWB" and store it in "QqualminEUTRA".
- 5> else if the UE supports RSRQ measurement on all OFDM symbols and the IE "QqualminRSRQ-OnAllSymbols" from the IE "E-UTRA frequency and priority extension" occurrence is present:
 - 6> calculate the value of the received IE "QqualminEUTRA" minus the value of the received IE "QqualminRSRQ-OnAllSymbols" and store it in "EUTRA-RSRQ-OnAllSymbolsOffset";
 - 6> store the value of the received IE "QqualminRSRQ-OnAllSymbols" in "QqualminEUTRA".
- 5> else if the IE "QqualminEUTRA-WB" from the IE "E-UTRA frequency and priority extension" occurrence is present:
 - 6> calculate the value of the received IE "QqualminEUTRA" minus the value of the received IE "QqualminEUTRA-WB" and store it in "EUTRA-RSRQ-offsetWB";
 - 6> store the value of the received IE "QqualminEUTRA-WB" in "QqualminEUTRA".
- 5> if the UE supports multi-band signalling and the UE does not support the E-UTRA Frequency Band associated with the EARFCN in the IE "EARFCN extension", but does understand the EARFCN downlink (Nd):
 - 6> if the i-th entry in the IE "Multiple E-UTRA frequency info list" is present for this occurrence of "E-UTRA frequency and priority extension":
 - where $i = (\text{index of this occurrence of "E-UTRA frequency and priority extension"} + \text{the value in IE "Number of applicable EARFCN"})$
 - 7> for the first entry in the IE "Multiple E-UTRA frequency band indicator list" which the UE supports, the UE shall:
 - 8> extract the supported band and compute the corresponding EARFCN downlink (Nd) value;
 - 8> overwrite the previously stored EARFCN value in this occurrence of the IE "Frequency List" within the variable PRIORITY_INFO_LIST with the computed EARFCN downlink (Nd) value.
 - 5> if the UE did not find a band which it supports in the IE "Multiple E-UTRA frequency band indicator list" and the i-th entry in the IE "Multiple E-UTRA frequency info extension list" is present for this occurrence of "E-UTRA frequency and priority extension":
 - where $i = (\text{index of this occurrence of "E-UTRA frequency and priority extension"} + \text{the value in IE "Number of applicable EARFCN"})$
 - 6> for the first entry in the IE "Multiple E-UTRA frequency band indicator extension list" which the UE supports, the UE shall:
 - 7> extract the supported band and compute the corresponding EARFCN downlink (Nd) value;
 - 7> overwrite the previously stored EARFCN value in this occurrence of the IE "Frequency List" within the variable PRIORITY_INFO_LIST with the computed EARFCN downlink (Nd) value.- 3> store the IE "E-UTRA detection".

8.6.7.3d E-UTRA frequency list

If the "E-UTRA frequency list" IE is received in a MEASUREMENT CONTROL message, the UE shall update the variable EUTRA_FREQUENCY_INFO_LIST accordingly and in the following order. The UE shall:

- 1> if the IE "E-UTRA frequency removal" is received:
 - 2> if it has the value "Remove some frequencies", for all the frequencies indicated by the IE "Removed frequencies":
 - 3> clear the information stored in the variable EUTRA_FREQUENCY_INFO_LIST for the indicated frequencies in "E-UTRA frequency list" IE and "E-UTRA frequency extension list" IE.
 - 2> if it has the value "Remove all frequencies":
 - 3> clear the information stored in the variable EUTRA_FREQUENCY_INFO_LIST for all frequencies.
 - 2> if it has the value "Remove no frequencies":
 - 3> leave the variable EUTRA_FREQUENCY_INFO_LIST unchanged.
- 1> if the IE "New frequencies" is received, for each frequency:
 - 2> update the variable EUTRA_FREQUENCY_INFO_LIST as follows:
 - 3> if the frequency is not present in the variable EUTRA_FREQUENCY_INFO_LIST:
 - 4> store the information for the received frequency, including measurement bandwidth, blacklist and wideband RSRQ measurements, in the variable EUTRA_FREQUENCY_INFO_LIST.
 - 3> otherwise, if the frequency is already included in the variable EUTRA_FREQUENCY_INFO_LIST:
 - 4> store the information for the received frequency, including measurement bandwidth, blacklist and wideband RSRQ measurements, in the variable EUTRA_FREQUENCY_INFO_LIST, overwriting the existing information for the frequency.

8.6.7.4 Intra-frequency measurement quantity

If the IE "Intra-frequency measurement quantity" is received in a MEASUREMENT CONTROL message, the UE shall:

- 1> if the IE "Measurement quantity" is set to "pathloss"; and
 - 2> for any intra-frequency cell indicated by the IE "Cells for measurement", if the IE "Primary CPICH Tx power" in FDD or the IE "Primary CCPCH TX Power" in TDD in the intra frequency cell info list in the variable CELL_INFO_LIST is not present, or;
 - 2> for any intra-frequency cell indicated by the IE "Cells for measurement", if the IE "Primary CPICH Tx power" in FDD in the intra-frequency cell info on secondary UL frequency list in the variable CELL_INFO_LIST is not present:
 - 3> set the variable CONFIGURATION_INCOMPLETE to TRUE.
 - 2> else:
 - 3> configure the measurement quantity accordingly.
- 1> else:
 - 2> configure the measurement quantity accordingly.

8.6.7.5 Inter-RAT measurement quantity

If the IE "Inter-RAT measurement quantity" is received in a MEASUREMENT CONTROL message and CHOICE system is GSM, the UE shall:

- 1> if IE "BSIC verification required" is set to "required", for cells that match any of the BCCH ARFCN and BSIC combinations in the list of inter-RAT cells that the UE has received in IE "Inter-RAT cell info list", and that has a "verified" BSIC:
 - 2> report measurement quantities according to IE "inter-RAT reporting quantity" taking into account the restrictions defined in subclause 8.6.7.6;
 - 2> trigger inter-RAT events according to IE "inter-RAT measurement reporting criteria"; and
 - 2> perform event evaluation for event-triggered reporting after BSIC has been verified for a GSM cell as defined in [19]; and
 - 2> trigger periodical reports according to the given "Reporting interval"; and
 - 2> when a periodical measurement report is triggered, include only BSIC verified GSM cells in the IE "Inter-RAT measured results list"; and
 - 3> indicate verified BSIC for a GSM cell in the IE "Inter-RAT measured results list" as defined in subclause 8.6.7.6.
 - 2> when an event triggered measurement report is triggered, include only BSIC verified GSM cells in the IE "Inter-RAT measured results list"; and
 - 3> indicate verified BSIC for a GSM cell in the IE "Inter-RAT measured results list" as defined in subclause 8.6.7.6.
- 1> if IE "BSIC verification required" is set to "not required", for cells that match any of the BCCH ARFCN in the list of inter-RAT cells that the UE has received in IE "Inter-RAT cell info list", regardless if the BSIC is "verified" or "non-verified":
 - 2> report measurement quantities according to IE "inter-RAT reporting quantity";
 - 2> trigger inter-RAT events according to IE "inter-RAT measurement reporting criteria";
 - 2> when an event triggered or periodical measurement report is triggered, include GSM cells in the IE "Inter-RAT measured results list" regardless of whether the BSIC of the GSM cell has been verified or not; and
 - 3> for any GSM cell that has not been verified, indicate non-verified BSIC for a GSM cell in the "Inter-RAT measured results list" IE as defined in subclause 8.6.7.6.
 - 3> for any GSM cell that has been verified, indicate verified BSIC for a GSM cell in the "Inter-RAT measured results list" IE as defined in subclause 8.6.7.6.
- 1> if the IE "Measurement quantity" is set to "pathloss":
 - 2> set the variable CONFIGURATION_INCOMPLETE to TRUE.

NOTE: The requirements for a cell to be considered "verified" or "non-verified" can be found in [19].

If the IE "Inter-RAT measurement quantity" is received in a MEASUREMENT CONTROL message and CHOICE system is E-UTRA, the UE shall:

- 1> for cells whose carrier frequency matches any of the EARFCNs or extended EARFCNs in the list of E-UTRA frequencies that the UE has stored in the variable "EUTRA_FREQUENCY_INFO_LIST", and for which the Physical Cell Identity is not included in the blacklist for that frequency:
 - 2> report measurement quantities according to IE "inter-RAT reporting quantity" taking into account the restrictions defined in subclause 8.6.7.6;
 - 2> trigger inter-RAT events according to IE "inter-RAT measurement reporting criteria"; and
 - 2> perform event evaluation for event-triggered reporting; and
 - 2> trigger periodical reports according to the given "Reporting interval"; and

- 2> when a periodical measurement report is triggered, for each frequency include in the IE "E-UTRA measured results list" only E-UTRA cells for which the Physical layer Cell Identity has been identified and is not included in the blacklist for that frequency; and
 - 3> include the Physical layer Cell Identity for a E-UTRA cell in the IE "E-UTRA measured results list" as defined in subclause 8.6.7.6.
- 2> when an event triggered measurement report is triggered, include in the IE "E-UTRA measured results list" only E-UTRA cells for which the Physical layer Cell Identity has been identified and is not included in the blacklist for that frequency; and
 - 3> include the Physical layer Cell Identity for a E-UTRA cell in the IE "E-UTRA measured results list" as defined in subclause 8.6.7.6.

8.6.7.6 Inter-RAT reporting quantity

If the IE "Inter-RAT reporting quantity" is received by the UE, the UE shall:

- 1> store the content of the IE to the variable MEASUREMENT_IDENTITY.

If the IE "Inter-RAT measurement quantity" is received and CHOICE system is GSM, the UE shall check each quantity in the GSM choice. The UE shall include measured results in MEASUREMENT REPORT as specified in the IE "Inter-RAT reporting quantity" with the following restrictions:

- 1> if the UE has not confirmed the BSIC of the measured cell:
 - 2> if no compressed mode pattern sequence specified with measurement purpose "Initial BSIC identification" is active and according to its capabilities the UE requires compressed mode to measure this, the UE is not required to include the "inter-RAT cell id" in the IE "Inter-RAT measured results list", when a MEASUREMENT REPORT is triggered.
- 1> if the UE has confirmed the BSIC of the measured cell, then:
 - 2> if no compressed mode pattern sequence specified with measurement purpose "Initial BSIC identification" nor "BSIC re-confirmation" is active and according to its capabilities the UE requires compressed mode to measure this, the UE is not required to include the "inter-RAT cell id" in the IE "Inter-RAT measured results list", when a MEASUREMENT REPORT is triggered. If no compressed mode pattern sequence with measurement purpose "GSM carrier RSSI measurements" is active and according to its capabilities the UE requires compressed mode to measure this, the UE may include "inter-RAT cell id" in MEASUREMENT REPORT without "GSM carrier RSSI" even if it is defined in the IE "Inter-RAT reporting quantity".
- 1> if the IE "UTRAN estimated quality" is set to TRUE:
 - 2> ignore that IE.
- 1> if IE "GSM Carrier RSSI" is set to TRUE:
 - 2> include optional IE "GSM Carrier RSSI" with a value set to the measured RXLEV to that GSM cell in IE "Inter-RAT measured results list". If no compressed mode pattern sequence specified with measurement purpose "GSM carrier RSSI measurements" is active and according to its capabilities the UE requires compressed mode to measure this, the UE is not required to include the "GSM carrier RSSI" in the IE "Inter-RAT measured results list", when a MEASUREMENT REPORT is triggered.
- 1> if the BSIC of reported GSM cell is "verified":
 - 2> set the CHOICE BSIC to "Verified BSIC" and IE "inter-RAT cell id" to the value that GSM cell had in the IE "Inter-RAT cell info list".
- 1> if the BSIC of reported GSM cell is "non-verified":
 - 2> set the CHOICE BSIC to "Non verified BSIC" and the IE "BCCH ARFCN" to the value of that GSM cells ARFCN.

The requirements for a cell to be considered "verified" or "non-verified" can be found in [19].

If the IE "Inter-RAT reporting quantity" is received and CHOICE system is E-UTRA, the UE shall check each quantity in the E-UTRA choice. The UE shall include measured results in MEASUREMENT REPORT as specified in the IE "Inter-RAT reporting quantity".

8.6.7.7 Cell Reporting Quantities

If the IE "Cell Reporting Quantities" is received by the UE, the UE shall store the content of the IE "Cell Reporting Quantities" to the variable MEASUREMENT_IDENTITY.

The UE shall include measured results in MEASUREMENT REPORT as specified in the IE "Cell Reporting Quantities", except for the following cases:

If the IE "Cell Identity reporting indicator" is set to TRUE, the UE shall in this version of the specification:

- 1> treat the IE as if the IE "Cell Identity reporting indicator" is set to FALSE, except when configured for CSG related measurements, as described in sections 14.7a.1 and 14.7a.2.

If the IE "Cell synchronisation information reporting indicator" is set to TRUE, the UE shall:

- 1> include the IE "Cell synchronisation information" in MEASUREMENT REPORT as specified in the IE "Cell Reporting Quantities":
 - 2> if the measurement is performed on another frequency; or
 - 2> if the IE "Read SFN indicator" included in the IE "Cell info" of the measured cell is set to FALSE:
 - 3> the UE may omit the information group "COUNT-C-SFN frame difference" in the IE "Cell synchronisation information".
 - 2> if the measurement is performed on the same frequency and no RLC Transparent Mode COUNT-C exists in the UE:
 - 3> set the IE "COUNT-C-SFN high" to 0.
 - 2> otherwise:
 - 3> include the information group "COUNT-C-SFN frame difference" with IE "COUNT-C-SFN high" set to:
$$\text{COUNT-C-SFN high} = (((\text{SFN} - (\text{COUNT-C mod } 4096)) \text{ mod } 4096) \text{ div } 256) * 256;$$
 - 3> if RLC Transparent Mode COUNT-Cs exist in both CN domains:
 - 4> use the COUNT-C of CS domain in this measurement.

If the IE "Proposed TGSN Reporting required" is set to TRUE, the UE shall:

- 1> if compressed mode was used to monitor a TDD cell and the variable TGSN_REPORTED is set to FALSE:
 - 2> report the IE "Proposed TGSN" indicating the TGSN that suits best to the measured cell;
 - 2> set the variable TGSN_REPORTED to TRUE.
- 1> otherwise
 - 2> omit the IE "Proposed TGSN".

8.6.7.8 Periodical Reporting Criteria

If the IE "Periodical Reporting Criteria" is received by the UE, the UE shall:

- 1> store the contents of the IE "Amount of Reporting" and IE "Reporting interval" in the variable MEASUREMENT_IDENTITY.

For the first MEASUREMENT REPORT message, the UE shall:

- 1> send the MEASUREMENT REPORT as soon as all requested reporting quantities are available according to the requirements and the measurement capabilities set in [19] and [20] and in the case of SI acquisition as soon as SI is available, for at least one measurement object stored in the variable MEASUREMENT_IDENTITY, but never later than one reporting interval after measurement initiation.

Following the first MEASUREMENT REPORT message, the UE shall:

- 1> send a MEASUREMENT REPORT message one reporting interval after the previous MEASUREMENT REPORT message;

The first and subsequent periodic MEASUREMENT REPORT messages shall only include measured results for reporting quantities that are available according to the requirements and the measurement capabilities set in [19] and [20] and available SI reading results for cells included in the IEs "Intra-frequency SI Acquisition", "Inter-frequency SI Acquisition" or "E-UTRA SI Acquisition", i.e. if no measured results are available and the measurement type is not UE positioning, the IE "Measured Results" shall not be included in the MEASUREMENT REPORT message. If no measured results are available and the measurement type is UE positioning, the UE shall include the IE "Measured Results" in the MEASUREMENT REPORT message in order to include the IE "UE positioning error" as specified in 8.6.7.19a and 8.6.7.19b.

After the UE has sent a total number of MEASUREMENT REPORT messages, which equal the value indicated in the IE "Amount of reporting", the UE shall:

- 1> terminate measurement reporting; and
- 1> delete all measurement information linked with the "Measurement identity" of the ongoing measurement from the variable MEASUREMENT_IDENTITY.

If according to subclause 8.6.7.19.1a or 8.6.7.19.1b, a UE configured with a UE positioning measurement is unable to report the requested measurement results due to missing GPS or GANSS assistance data and sends a MEASUREMENT REPORT containing the IE "UE positioning error" and the IE "Error reason" is set to "Assistance Data Missing", then this is not counted in the total number of MEASUREMENT REPORT messages sent.

If the IE "Periodical reporting criteria on secondary UL frequency" is received by the UE, the UE shall:

- 1> store the contents of the IE in the variable MEASUREMENT_IDENTITY; and
- 1> apply the configurations given by the IE for the downlink frequency indicated by the IE "Frequency info" in the IE "Periodical reporting criteria on secondary UL frequency" and associated with the secondary uplink frequency as described above.

8.6.7.9 Reporting Cell Status

If the IE "Reporting Cell Status" is received, the UE shall set the IE "Measured Results" in MEASUREMENT REPORT as follows. The UE shall:

- 1> for intra-frequency measurement and inter-frequency measurement:
 - 2> include the IE "Cell Measured Results" for cells (excluding cells of another RAT) that satisfy the condition (such as "Report cells within active set") specified in the IE "Reporting Cell Status", in descending order by the measurement quantity.
 - 2> the maximum number of the IE "Cell Measured Results" to be included in the IE "Measured Results" per reported frequency is the number specified in the IE "Reporting Cell Status".
- 1> for periodic inter-frequency measurement:
 - 2> include in the IE "Inter-frequency measured results list" the measured results for all non-used frequencies.
- 1> for inter-RAT measurement:
 - 2> include the measurement results for cells of other RAT (e.g., GSM or E-UTRA) that satisfy the condition specified in the IE "Reporting Cell Status", in descending order by the measurement quantity.
 - 2> the maximum number of the IE "Measured GSM Cells" to be included in the IE "Measured Results" is the number specified in the IE "Reporting Cell Status"; or:

- 2> the maximum number of the IE "Measured E-UTRA Cells" to be included in the IE "E-UTRA measured results" is the number specified in the IE "Reporting Cell Status".

If the IE "Reporting Cell Status" in the IE "Intra-frequency measurement reporting criteria on secondary UL frequency" is received, the UE shall set the IE "Measured Results on Secondary UL frequency" in MEASUREMENT REPORT as follows. The UE shall:

1> for intra-frequency measurement:

- 2> include the IE "Cell Measured Results" in the IE "Measured results on secondary UL frequency" for cells (excluding cells of another RAT) that satisfy the condition (such as "Report cells within active set") specified in the IE "Reporting Cell Status" in the IE "Intra-frequency measurement reporting criteria on secondary UL frequency", in descending order by the measurement quantity.
- 2> the maximum number of the IE "Cell Measured Results" in the IE "Measured results on secondary UL frequency" to be included in the IE "Measured Results on Secondary UL frequency" per reported frequency is the number specified in the IE "Reporting Cell Status" in the IE "Intra-frequency measurement reporting criteria on secondary UL frequency".

If the IE "Reporting Cell Status" in the IE "Periodical reporting criteria on secondary UL frequency" is received, the UE shall set the IE "Measured Results on Secondary UL frequency" in MEASUREMENT REPORT as follows. The UE shall:

- 1> include the IE "Cell Measured Results" in the IE "Measured results on secondary UL frequency" for cells (excluding cells of another RAT) that satisfy the condition (such as "Report cells within active set") specified in the IE "Reporting Cell Status" in the IE "Periodical reporting criteria on secondary UL frequency", in descending order by the measurement quantity.
- 1> the maximum number of the IE "Cell Measured Results" in the IE "Measured results on secondary UL frequency" to be included in the IE "Measured Results on Secondary UL frequency" per reported frequency is the number specified in the IE "Reporting Cell Status" in the IE "Periodical reporting criteria on secondary UL frequency".

If the IE "Reporting Cell Status" is not received for intra-frequency, inter-frequency measurement, or inter-RAT measurement, the UE shall:

- 1> for intra-frequency measurement, inter-frequency measurement and inter-RAT measurement:
 - 2> exclude the IE "Measured Results" in MEASUREMENT REPORT.

NOTE: The IE "Reporting Cell Status" within "Event Criteria List" defines whether "Cell Measured Results" is present for event-based reporting.

If the IE "Reporting Cell Status" in the IE "Intra-frequency measurement reporting criteria on secondary UL frequency" is not received for intra-frequency, the UE shall:

- 1> for intra-frequency measurement:
 - 2> exclude the IE "Measured Results on Secondary UL frequency" in MEASUREMENT REPORT.

If the IE "Reporting Cell Status" in the IE "Periodical reporting criteria on secondary UL frequency" is not received, the UE shall:

- 1> exclude the IE "Measured Results on Secondary UL frequency" in MEASUREMENT REPORT.

The IE "Reporting Cell Status" is not included in System Information Block 11/12 for periodic intra-frequency measurements. In this case the UE shall assume the default values "Report cells within active set and/or monitored set on used frequency" and "6".

8.6.7.10 Traffic Volume Measurement

If the IE "Traffic Volume Measurement" is received by the UE, the UE shall:

- 1> store the content of the IE to the variable MEASUREMENT_IDENTITY.

If IE "Traffic volume measurement" is received by the UE in a MEASUREMENT CONTROL message, where IE "Measurement command" has the value "setup", and if the IE "traffic volume reporting quantity" is included, the UE shall:

- 1> if the parameter "Average of RLC Buffer Payload for each RB" or the parameter "Variance of RLC Buffer payload for each RB" is set to TRUE:
 - 2> if the IE "Traffic volume measurement quantity" is not included:
 - 3> set the variable CONFIGURATION_INCOMPLETE to TRUE.
 - 2> if the IE "Traffic volume measurement quantity" is included:
 - 3> if the parameter "time interval to take an average or a variance" is not included:
 - 4> set the variable CONFIGURATION_INCOMPLETE to TRUE.

If IE "Traffic volume measurement" is received by the UE in a MEASUREMENT CONTROL message, where IE "Measurement command" has the value "setup", but IE "Traffic volume reporting quantity" or is not received, the UE shall:

- 1> set the variable CONFIGURATION_INCOMPLETE to TRUE.

8.6.7.11 Traffic Volume Measurement Reporting Criteria

If the IE "Traffic Volume Measurement Reporting Criteria" is received by the UE, the UE shall:

- 1> if the IE "Parameters sent for each transport channel" is absent:
 - 2> set the variable PROTOCOL_ERROR_REJECT to TRUE;
 - 2> set the IE "Protocol error cause" in the variable PROTOCOL_ERROR_INFORMATION to "Information element missing".
- 1> for each IE "Parameters sent for each transport channel":
 - 2> if the IE "Parameters required for each Event" is absent:
 - 3> set the variable CONFIGURATION_INCOMPLETE to TRUE.

8.6.7.12 FACH measurement occasion info

IE "FACH measurement occasion info" is used to control UE measurement activities in inter-frequency and inter-RAT cells in CELL_FACH state.

For FDD and 1.28 Mcps TDD when variable HS_DSCH_RECEPTION_CELL_FACH_STATE is set to FALSE, or for 3.84Mcps TDD and 7.68Mcps TDD: if IE "FACH measurement occasion info" is received, UE shall, when in CELL_FACH state:

- 1> if IE "FACH Measurement occasion cycle length coefficient" is included:
 - 2> if, according to its measurement capabilities, UE is not able to perform some of the indicated measurements in this IE simultaneously as receiving the SCCPCH of serving cell:
 - 3> perform those measurements during FACH measurement occasions, see subclause 8.5.11.
 - 2> if, according to its measurement capabilities, UE is able to perform some of the indicated measurements in this IE simultaneously as receiving the SCCPCH of serving cell:
 - 3> UE may perform measurements also on other occasions.
 - 2> if, according to its measurement capabilities, UE is able to perform the measurements and indicated in this IE simultaneously as receiving the SCCPCH of serving cell:
 - 3> perform the measurements simultaneously as receiving the SCCPCH of serving cell.

- 1> if IE "FACH Measurement occasion cycle length coefficient" is not included:
 - 2> perform those indicated measurements indicated in this IE that UE, according to its measurement capabilities, is able to perform simultaneously as receiving the SCCPCH of serving cell.
- 1> if IE "Inter-frequency FDD measurement indicator" is set to TRUE:
 - 2> perform measurements and evaluate cell re-selection criteria according to [4] on inter-frequency FDD cells listed in "System Information Block type 11", "System Information Block type 11bis", "System Information Block type 11ter", if scheduled on BCH, and "System Information Block type 12", if scheduled on BCH.
- 1> if IE "Inter-frequency FDD measurement indicator" is set to FALSE:
 - 2> neither perform measurements nor evaluate cell re-selection criteria on inter-frequency FDD cells.
- 1> if IE "Inter-frequency TDD measurement indicator" is set to TRUE:
 - 2> perform measurements and evaluate cell re-selection criteria according to [4] on inter-frequency TDD cells listed in "System Information Block type 11", "System Information Block type 11bis", "System Information Block type 11ter", if scheduled on BCH, and "System Information Block type 12", if scheduled on BCH.
- 1> if IE "Inter-frequency TDD measurement indicator" is set to FALSE:
 - 2> neither perform measurements nor evaluate cell re-selection criteria on inter-frequency TDD cells.
- 1> if IE "Inter-RAT measurement indicators" is included:
 - 2> perform measurements and evaluate cell re-selection criteria according to [4] on those cells of listed Inter-RAT types/layers that are present in "System Information Block type 11", "System Information Block type 11bis", if scheduled on BCH, "System Information Block type 12", if scheduled on BCH, and "System Information Block type 19", if scheduled on BCH.

For FDD and 1.28 Mcps TDD when variable HS_DSCH_RECEPTION_CELL_FACH_STATE is set to TRUE: if IE "FACH measurement occasion info" is received, UE shall:

- 1> if IE "FACH Measurement occasion cycle length coefficient" is included:
 - 2> if, according to its measurement capabilities, the UE is not able to perform some of the indicated measurements in this IE simultaneously as receiving the HS-DSCH and its associated physical channels of serving cell:
 - 3> perform those measurements during FACH measurement occasions, see subclause 8.5.11.
 - 2> if, according to its measurement capabilities, the UE is able to perform some of the indicated measurements in this IE simultaneously as receiving the HS-DSCH and its associated physical channels of serving cell:
 - 3> the UE may perform measurements also on other occasions.
 - 2> if, according to its measurement capabilities, the UE is able to perform the measurements and indicated in this IE simultaneously as receiving the HS-DSCH and its associated physical channels of serving cell:
 - 3> perform the measurements simultaneously as receiving the HS-DSCH and its associated physical channels of serving cell.
- 1> if IE "FACH Measurement occasion cycle length coefficient" is not included:
 - 2> perform those indicated measurements indicated in this IE that UE, according to its measurement capabilities, is able to perform simultaneously as receiving the HS-DSCH and its associated physical channels of serving cell.
- 1> if IE "Inter-frequency FDD measurement indicator" is set to TRUE:
 - 2> perform measurements and evaluate cell re-selection criteria according to [4] on inter-frequency FDD cells listed in "System Information Block type 11", "System Information Block type 11bis", "System Information Block type 11ter", if scheduled on BCH, and "System Information Block type 12", if scheduled on BCH.
- 1> if IE "Inter-frequency FDD measurement indicator" is set to FALSE:

2> neither perform measurements nor evaluate cell re-selection criteria on inter-frequency FDD cells.

1> if IE "Inter-RAT measurement indicators" is included:

2> perform measurements and evaluate cell re-selection criteria according to [4] on those cells of listed Inter-RAT types/layers that are present in "System Information Block type 11", "System Information Block type 11bis", if scheduled on BCH, "System Information Block type 12", if scheduled on BCH, and "System Information Block type 19", if scheduled on BCH.

8.6.7.13 Measurement Reporting Mode

If IE "Measurement Reporting Mode" is received by the UE, the UE shall:

1> store the contents of the IE "Measurement Report Transfer Mode" in the variable MEASUREMENT_IDENTITY;

1> use the indicated RLC mode when sending MEASUREMENT REPORT message(s) related to this measurement;

1> ignore IE "Periodical Reporting / Event Trigger Reporting Mode".

If IE "Measurement Reporting Mode" is not received by the UE in MEASUREMENT CONTROL message, where IE "Measurement command" has the value "setup", the UE shall:

1> clear all stored measurement control information related associated to this measurement identity in variable MEASUREMENT_IDENTITY;

1> set the variable CONFIGURATION_INCOMPLETE to TRUE.

8.6.7.14 Inter-frequency measurement

If the Inter-frequency cell info list, included in the variable CELL_INFO_LIST, includes a number (M) of frequencies that is larger than the number (N) considered in a UE performance requirement defined in [19] and [20]:

1> the UE shall:

2> meet this performance requirement on the first relevant (N) frequencies, according to the order defined by the position of the frequencies in the Inter-frequency cell info list, included in the variable CELL_INFO_LIST.

1> the UE may:

2> ignore the remaining (M-N) frequencies.

NOTE: If the variable SECONDARY_CELL_E_DCH_TRANSMISSION is TRUE, the relevant (N) frequencies do not include the downlink frequency associated with the secondary uplink frequency.

If IE "Inter-frequency measurement" is received by the UE in a MEASUREMENT CONTROL message, where IE "Measurement command" has the value "setup", but IE "Inter-frequency measurement quantity", IE "Inter-frequency reporting quantity" or IE "parameters required for each event" (given "CHOICE Report criteria" is set to "inter-frequency measurement reporting criteria") is not received, the UE shall:

1> clear all stored measurement control information related associated to this measurement identity in variable MEASUREMENT_IDENTITY;

1> set the variable CONFIGURATION_INCOMPLETE to TRUE.

If IE "Inter-frequency measurement" is received by the UE in a MEASUREMENT CONTROL message, where IE "Measurement command" has the value "modify":

1> if CHOICE "Report criteria" in IE "Inter-frequency measurement" is set to "intra-frequency measurement reporting criteria" and IE "parameters required for each event" is present:

2> for FDD, 3.84 Mcps TDD and 7.68 Mcps TDD; or

2> for 1.28 Mcps TDD, if the UE uses only one frequency:

3> the UE behaviour is unspecified.

If IE "Inter-frequency measurement" is received by the UE in a MEASUREMENT CONTROL message, where IE "Measurement command" has the value "setup" and CHOICE "Report criteria" in IE "Inter-frequency measurement" is set to "intra-frequency measurement reporting criteria":

- 1> for FDD, 3.84 Mcps TDD and 7.68 Mcps TDD; or
- 1> for 1.28 Mcps TDD, if the UE uses only one frequency:
 - 2> the UE behaviour is unspecified.

In the case of an inter-frequency measurement for FDD, the UE shall:

- 1> if IE "Inter-frequency measurement" is received by the UE in a MEASUREMENT CONTROL message, where IE "Measurement command" has the value "setup", if an inter-frequency event is configured that is different from event 2d or 2f, and if at least one frequency other than the downlink frequency associated with the secondary uplink frequency is configured, and if the IE "Inter-frequency SET UPDATE" is not received in that same message:
 - 2> set the variable CONFIGURATION_INCOMPLETE to TRUE.

NOTE: The UTRAN should include the IE "Inter-frequency SET UPDATE" in the MEASUREMENT CONTROL message with the IE "Measurement command" set to "modify" when event 2a, 2b, 2c 2e or 2g is first configured, and when the UE is requested to measure a frequency other than the downlink frequency associated with the secondary uplink frequency that has not been previously measured. Otherwise the UE behaviour is unspecified.

If IE "Inter-frequency measurement" is received by the UE in a MEASUREMENT CONTROL message:

- 1> if CHOICE "Report criteria" is set to "inter-frequency measurement reporting criteria" and CHOICE "reporting criteria" in "inter-frequency measurement quantity" is not set to "inter-frequency reporting criteria"; or
- 1> if CHOICE "Report criteria" is set to "intra-frequency measurement reporting criteria" and CHOICE "reporting criteria" in "inter-frequency measurement quantity" is not set to "intra-frequency reporting criteria":
 - 2> for FDD, 3.84 Mcps TDD and 7.68 Mcps TDD; or
 - 2> for 1.28 Mcps TDD, if the UE uses only one frequency:
 - 3> the UE behaviour is not specified.
- 1> for FDD, if CHOICE "Report criteria" is set to "inter-frequency measurement reporting criteria" and "Cells to be excluded in non-used frequency detected cells" is received, and if the UE supports Inter-frequency detected set measurements and Cells excluded from detected set measurements,
 - 2> for each non-used frequency, the UE shall:
 - 3> if there is no stored "Cells to be excluded in non-used frequency detected cells" for the indicated non-used frequency:
 - 4> store the "Cells to be excluded in non-used frequency detected cells" for that non-used frequency and the associated "measurement identity" of the received message.
 - 3> else, if the "Cells to be excluded in non-used frequency detected cells" for the indicated non-used frequency has been stored:
 - 4> overwrite the stored value with the newly received "Cells to be excluded in non-used frequency detected cells" for that non-used frequency and corresponding "measurement identity".

If the variable CONFIGURATION_INCOMPLETE is set to TRUE, the UE shall:

- 1> act as described in subclause 8.4.1.4a.

8.6.7.15 Inter-RAT measurement

If the Inter-RAT cell info list, included in the variable CELL_INFO_LIST, includes a number (M) of frequencies that is larger than the number (N) considered in a UE performance requirement defined in [19] and [20]:

1> the UE shall:

2> meet this performance requirement on the first relevant (N) frequencies, according to the order defined by the position of the frequencies in the Inter-RAT cell info list, included in the variable CELL_INFO_LIST.

1> the UE may:

2> ignore the remaining (M-N) frequencies.

If IE "Inter-RAT measurement" is received by the UE in a MEASUREMENT CONTROL message, where IE "Measurement command" has the value "setup", but IE "Inter-RAT measurement quantity", IE "Inter-RAT reporting quantity" or "parameters required for each event" (given "CHOICE Report criteria" is set to "inter-RAT measurement reporting criteria") is not received, the UE shall:

1> clear all stored measurement control information related associated to this measurement identity in variable MEASUREMENT_IDENTITY;

1> set the variable CONFIGURATION_INCOMPLETE to TRUE.

8.6.7.16 Intra-frequency measurement

If IE "Intra-frequency measurement" is received by the UE in a MEASUREMENT CONTROL message, where IE "Measurement command" has the value "setup", but IE "Intra-frequency measurement quantity", IE "Intra-frequency reporting quantity", "CHOICE Report criteria" or "parameters required for each event" (given "CHOICE report criteria" is set to "intra-frequency measurement reporting criteria") is not received, the UE shall:

1> clear all stored measurement control information related associated to this measurement identity in variable MEASUREMENT_IDENTITY;

1> set the variable CONFIGURATION_INCOMPLETE to TRUE.

In case of 1a or 1e event-triggered reporting:

1> if the IE "Intra-frequency measurement quantity" is set to "pathloss", the UE shall:

2> if detected set cells are indicated as possibly triggering the event within the IEs "Triggering condition 2":

3> set the variable CONFIGURATION_INCOMPLETE to TRUE.

In case of 1a or 1e event-triggered reporting on the secondary uplink frequency:

1> if the IE "Intra-frequency measurement quantity" is set to "pathloss", the UE shall:

2> if detected set cells are indicated as possibly triggering the event within the IEs "Triggering condition 2" in the IE "Intra-frequency measurement reporting criteria on secondary UL frequency":

3> set the variable CONFIGURATION_INCOMPLETE to TRUE.

If the IE "Intra-frequency measurement" is received by the UE in a MEASUREMENT CONTROL message:

1> for FDD, if CHOICE "Report criteria" is set to "Intra-frequency measurement reporting criteria" and "Cells to be excluded in detected set cells" is received, and if the UE supports Cells excluded from detected set measurements, the UE shall:

2> if there is no stored "Cells to be excluded in detected set cells" for the intra-frequency:

3> store the "Cells to be excluded in detected set cells" for the intra-frequency and the associated "measurement identity" of the received message.

2> else, if the "Cells to be excluded in detected set cells" has been stored for the intra-frequency:

3> overwrite the stored value with the newly received "Cells to be excluded in detected set cells" for the intra-frequency and corresponding "measurement identity".

8.6.7.17 Quality measurement

If IE "Quality measurement" is received by the UE in a MEASUREMENT CONTROL message, where IE "Measurement command" has the value "setup", but IE "Quality reporting quantity" is not received, the UE shall:

- 1> clear all stored measurement control information related associated to this measurement identity in variable MEASUREMENT_IDENTITY;
- 1> set the variable CONFIGURATION_INCOMPLETE to TRUE.

If Transport Channel BLER reporting is requested in IE "Quality Reporting Quantity", but no transport channels are explicitly referenced with transport channel identities, the UE shall

- 1> report BLER for all downlink transport channels, for which Transport Channel BLER is defined and can be requested [7, 8].

If a transport channel, for which Transport Channel BLER is not defined and can not be requested [7, 8], is referenced with a transport channel identity in IE "Quality Reporting Quantity" and/or IE "Quality Measurement Reporting Criteria":

- 1> the UE behaviour is not specified.

8.6.7.18 UE internal measurement

If IE "UE internal measurement" is received by the UE in a MEASUREMENT CONTROL message, where IE "Measurement command" has the value "setup", but IE "UE internal measurement quantity", IE "UE internal reporting quantity" or "parameters sent for each UE internal measurement event" (given "CHOICE report criteria" is set to "UE internal measurement reporting criteria") is not received, the UE shall:

- 1> clear all stored measurement control information related associated to this measurement identity in variable MEASUREMENT_IDENTITY;
- 1> set the variable CONFIGURATION_INCOMPLETE to TRUE.

8.6.7.18a Void

8.6.7.19 UE positioning

8.6.7.19.0 UE positioning reporting criteria

If IE "UE positioning reporting criteria" is included, the UE shall:

- 1> perform the necessary measurements and evaluate the event in the interval indicated in IE "Measurement Interval";
- 1> if IE "Event ID" is set to "7a" and if IE "Report first fix" is set to TRUE:
 - 2> if the IE "Method Type" included in the variable MEASUREMENT_IDENTITY is set to "UE based":
 - 3> act as specified in subclause 8.6.7.19.1b.

8.6.7.19.1 UE positioning reporting quantity

The UE shall:

- 1> ignore IE "Multiple Sets";
- 1> ignore IE "Response Time";
- 1> if IE "Horizontal Accuracy" and/or IE "Vertical Accuracy" is included:
 - 2> should try to achieve the requested level(s) of positioning accuracy with 67% confidence.

- 1> if IE "Positioning Methods" is set to "Cell ID":
 - 2> act as specified in subclause 8.6.7.19.1a.
- 1> if the IE "Method Type" is set to "UE based":
 - 2> if the IE "Positioning Methods" is set to "GPS"; and
 - 2> if the IE "Additional Assistance Data Request" is set to FALSE; and
 - 2> if the IE "UE positioning GPS assistance data" is not received in the MEASUREMENT CONTROL message; and
 - 2> if, according to its UE positioning capabilities, the UE supports a standalone positioning method:
 - 3> use the standalone positioning method.
 - 2> act as specified in subclause 8.6.7.19.1b.
- 1> if the IE "Method Type" is set to "UE assisted":
 - 2> act as specified in subclause 8.6.7.19.1a.
- 1> if the IE "Method Type" is set to "UE-assisted preferred but UE-based allowed" or "UE-based preferred but UE-assisted allowed":
 - 2> act either according to subclause 8.6.7.19.1a or 8.6.7.19.1b depending on the method type chosen by the UE.

If UE according to its capabilities supports Rx-Tx time difference type 2 measurement and if IE "Positioning Methods" is set to "Cell ID" and the IE "Method Type" is set to "UE-based", the UE shall:

- 1> set the variable CONFIGURATION_INCOMPLETE to TRUE.

If UE according to its capabilities supports Rx-Tx time difference type 2 measurement and if IE "Positioning Methods" is set to "Cell ID" and the IE "Measurement validity" stored in the variable MEASUREMENT_IDENTITY is other than "CELL_DCH", the UE shall:

- 1> set the variable CONFIGURATION_INCOMPLETE to TRUE.

The UE shall perform the following consistency check:

- 1> if UE, according to its capabilities, does not support UE-based OTDOA and if IE "Positioning Methods" is set to "OTDOA" and if IE "Method Type" is set to "UE-based":
 - 2> set the variable CONFIGURATION_INCOMPLETE to TRUE.
- 1> if UE, according to its capabilities, does not support UE-assisted OTDOA and if IE "Positioning Methods" is set to "OTDOA" and if IE "Method Type" is set to "UE-assisted":
 - 2> set the variable CONFIGURATION_INCOMPLETE to TRUE.
- 1> if UE, according to its capabilities, does not support UE-based GPS and does not support a standalone positioning method and if IE "Positioning Methods" is set to "GPS" and if the IE "GANSS Positioning Methods" is not present and if IE "Method Type" is set to "UE-based":
 - 2> set the variable CONFIGURATION_INCOMPLETE to TRUE.
- 1> if UE, according to its capabilities, does not support UE-assisted GPS and if the IE "GANSS Positioning Methods" is not present and if IE "Positioning Methods" is set to "GPS" and if IE "Method Type" is set to "UE-assisted":
 - 2> set the variable CONFIGURATION_INCOMPLETE to TRUE.
- 1> if UE, according to its capabilities, does not support UE-based positioning and if IE "Positioning Methods" is set to "OTDOAorGPS" and if IE "Method Type" is set to "UE-based":
 - 2> set the variable CONFIGURATION_INCOMPLETE to TRUE.

- 1> if UE, according to its capabilities, does not support UE-based GANSS and if IE "Positioning Methods" is set to "GPS" and if IE "GANSS Positioning Methods" is present and if IE "Method Type" is set to "UE-based":
 - 2> set the variable CONFIGURATION_INCOMPLETE to TRUE.
- 1> if UE, according to its capabilities, does not support UE-assisted GANSS and if IE "Positioning Methods" is set to "GPS" and if IE "GANSS Positioning Methods" is present and if IE "Method Type" is set to "UE-assisted":
 - 2> set the variable CONFIGURATION_INCOMPLETE to TRUE.
- 1> if IE "Positioning Methods" is set to "GPS" and if IE "GANSS Positioning Methods" is present and if UE, according to its capabilities, does not support any GNSS indicated in IE "GANSS Positioning Methods":
 - 2> set the variable CONFIGURATION_INCOMPLETE to TRUE.
- 1> if UE, according to its capabilities, does not support Rx-Tx time difference type 2 measurement and if IE "Positioning Methods" is set to "Cell ID":
 - 2> set the variable CONFIGURATION_INCOMPLETE to TRUE.
- 1> if UE, according to its capabilities, does not support UE GPS timing of cell frames measurement and if IE "GPS timing of Cell wanted" is set to TRUE:
 - 2> set the variable CONFIGURATION_INCOMPLETE to TRUE.

8.6.7.19.1a UE positioning reporting for UE assisted methods

The UE shall:

- 1> when a measurement report is triggered:
 - 2> if the UE was able to perform measurements on at least one neighbour cell included in the variable UE_POSITIONING_OTDOA_DATA_UE_ASSISTED in case of OTDOA or one satellite included in the variable UE_POSITIONING_GPS_DATA in case of GPS positioning or one satellite included in the variable UE_POSITIONING_GANSS_DATA in case of GANSS positioning or one cell from the active set in case of CELL ID:
 - 3> if the IE "Vertical Accuracy" is included:
 - 4> interpret the presence of this IE to indicate that the UTRAN desires to compute a 3-dimensional position estimate.
 - 3> if the IE "Positioning Methods" is set to "GPS" and if the IE "GANSS Positioning Methods" is not present or if the IE "GANSS Positioning Methods" is present indicating GPS allowed:
 - 4> include the IE "UE positioning GPS measured results" in the measurement report and set the contents of the IE as follows:
 - 5> if the UE supports the capability to provide the GPS timing of the cell frames measurement:
 - 6> if the IE "GPS timing of Cell wanted" is set to TRUE:
 - 7> perform the UE GPS timing of cell frames measurement on the serving cell or on one cell of the active set.
 - 7> include the IE "Primary CPICH Info" for FDD or the IE "cell parameters id" for TDD; and
 - 7> include the IE "Reference SFN", the IE "UE GPS timing of cell frames" and the IE "UE Positioning GPS Reference Time Uncertainty".
 - 6> if the IE "GPS timing of Cell wanted" is set to FALSE:
 - 7> include the IE "GPS TOW msec" and set it to the GPS TOW when the measurements included in the MEASUREMENT REPORT were valid;

- 7> include the IE "UE Positioning GPS Reference Time Uncertainty" and set it to the uncertainty of the GPS TOW when the measurements included in the MEASUREMENT REPORT were valid.
- 5> if the UE does not support the capability to provide the GPS timing of the cell:
 - 6> include the IE "GPS TOW msec" and set it to the GPS TOW when the measurements included in the MEASUREMENT REPORT were valid;
 - 6> include the IE "UE Positioning GPS Reference Time Uncertainty" and set it to the uncertainty of the GPS TOW when the measurements included in the MEASUREMENT REPORT were valid.
- 3> if the IE "Positioning Methods" is set to "GPS" and the IE "GANSS Positioning Methods" is present indicating other GNSS than GPS allowed and if any of these other GNSSs is measured:
 - 4> include the IE "UE positioning GANSS measured results" in the measurement report and set the contents of the IE as follows:
 - 5> if the UE supports the capability to provide the GANSS timing of the cell frames measurement:
 - 6> if the IE "GANSS timing of Cell wanted" is included with one bit set to value one for a supported GANSS and if IE "UE GPS timing of cell frames" is not present:
 - 7> perform the UE GANSS timing of cell frames measurement on the serving cell or on one cell of the active set;
 - 7> include the IE "Primary CPICH Info" for FDD or the IE "cell parameters id" for TDD; and
 - 7> include the IE "Reference SFN" and the IE "UE GANSS timing of cell frames".
 - 6> if the IE "GANSS timing of Cell wanted" is not included, or included with each bit set to value zero and if IE "UE positioning GPS measured results" is not present:
 - 7> include the IE "GANSS TOD msec" and set it to the GANSS TOD when the measurements included in the MEASUREMENT REPORT were valid.
 - 5> if the UE does not support the capability to provide the GANSS timing of the cell and if IE "UE positioning GPS measured results" is not present:
 - 6> include the IE "GANSS TOD msec" and set it to the GANSS TOD when the measurements included in the MEASUREMENT REPORT were valid.
 - 5> if the UE supports the capability to provide the GANSS carrier-phase measurements:
 - 6> if the IE "GANSS Carrier-Phase Measurement Requested" is included with one bit set to value one for a supported GANSS:
 - 7> include the IE "Carrier Quality Indication" and include the IE "ADR".
 - 5> if the UE supports the capability to perform GANSS measurements on multiple GANSS frequencies:
 - 6> if the IE "GANSS Multi-frequency Measurement Requested" is included with one bit set to value one for a supported GANSS, and if any of these GANSS signals are measured:
 - 7> include the IE "GANSS Signal Measurement Information" for each measured GANSS signal.
- 3> if the IE "Positioning Methods" is set to "OTDOA":
 - 4> include the IE "UE positioning OTDOA measured results " in the measurement report and set the contents of the IE as follows:
 - 5> set IE "SFN" to the SFN when the last measurement was performed;
 - 5> if the UE supports the capability to perform the Rx-Tx time difference type 2 measurement:

- 6> if the UE is in CELL_DCH state:
 - 7> if the measured value is equal to "1279.9375":
 - 8> set the IE "Rx-Tx time difference type 2" in IE "UE positioning OTDOA measured results" for the reference cell to "1279.8750".
 - 7> otherwise:
 - 8> set the IE "Rx-Tx time difference type 2" in IE "UE positioning OTDOA measured results" for the reference cell to the measured value.
 - 7> include the IE group "Rx-Tx time difference type 2 info" for the reference cell and for each neighbour cell listed in variable UE_POSITIONING_OTDOA_DATA_UE_ASSISTED that belongs to the active set.
- 5> if the UE does not support the capability to perform the Rx-Tx time difference type 2 measurement:
 - 6> set the IE "Rx-Tx time difference type 2" in IE "UE positioning OTDOA measured results" for the reference cell to value "1279.9375" to indicate that the measurement is not supported.
- 4> include IE group "Neighbour" for all neighbour cells listed in variable UE_POSITIONING_OTDOA_DATA_UE_ASSISTED on which the SFN-SFN observed time difference type 2 measurement could be performed.
- 3> if IE "Positioning Methods" in the MEASUREMENT CONTROL message has been assigned to value "OTDOA or GPS":
 - 4> the UE may choose to either act as if IE "Positioning Methods" is set to "GPS" or "OTDOA" depending on the method chosen by the UE.
- 3> if the IE "Positioning Methods" is set to "CELL ID":
 - 4> if the UE supports the capability to perform the Rx-Tx time difference type 2 measurement; and
 - 4> if the UE is in CELL_DCH state:
 - 5> perform the Rx-Tx time difference type 2 measurement on the cells in the active set; and
 - 5> report the measurement results back to the network in the MEASUREMENT REPORT by using IE "UE positioning OTDOA measured results" including measurements on the cells in the active set; and
 - 5> report Rx-Tx time difference type 2 measurement of the reference cell (as designated by the UE); and
 - 5> for all reported neighbour cells:
 - 6> report Rx-Tx time difference type 2 measurement; and
 - 6> set the IE "SFN-SFN observed time difference type 2" and all IEs within the corresponding IE "UE positioning OTDOA quality" in IE "UE positioning OTDOA measured results" to value "0".
- 2> if the UE is not able to report the requested measurement results:
 - 3> include IE "UE positioning error" in the MEASUREMENT REPORT and set the contents of this IE as specified in subclause 8.6.7.19.5.
- 1> if the UE is unable to report the requested measurement results due to missing GPS assistance data:
 - 2> the UE may at anytime send a measurement report containing the IE "UE positioning error" and set the contents of this IE as specified in subclause 8.6.7.19.5.

- 2> after sending the measurement report, the UE shall not send another measurement report to request the same GPS assistance data for at least 20s. This requirement does not apply after release of the current RRC connection.
- 1> if the UE is unable to report the requested measurement results due to missing GANSS assistance data:
 - 2> the UE may at anytime send a measurement report containing the IE "UE positioning error" and set the contents of this IE as specified in subclause 8.6.7.19.5;
 - 2> after sending the measurement report, the UE shall not send another measurement report to request the same GANSS assistance data for at least 20s. This requirement does not apply after release of the current RRC connection.

8.6.7.19.1b UE positioning reporting for UE based methods

The UE shall:

- 1> when a measurement report is triggered:
 - 2> if the UE has been able to calculate a position after performing measurements on the cells included in the variable `UE_POSITIONING_OTDOA_DATA_UE_BASED` in case of OTDOA or the UE has been able to calculate a position in case of GPS or GANSS positioning or the UE has been able to calculate a position using a standalone positioning method:
 - 3> include IE "UE positioning Position Estimate Info" in the MEASUREMENT REPORT and set the contents of the IE as follows:
 - 4> if the UE supports the capability to perform the UE GPS timing of cell frames measurement:
 - 5> if the IE "GPS timing of Cell wanted" is set to TRUE:
 - 6> perform the UE GPS timing of cell frames measurement on the serving cell or on one cell of the active set.
 - 6> include the IE "Primary CPICH Info" for FDD or the IE "cell parameters id" for TDD;
 - 6> include the SFN when the position was determined;
 - 6> include the IE "UE GPS timing of cell frames";
 - 6> include the IE "UE Positioning GPS Reference Time Uncertainty".
 - 5> if the IE "GPS timing of Cell wanted" is set to FALSE:
 - 6> include the IE "GPS TOW msec" and set it to the GPS TOW when the position estimate was valid.
 - 4> if the position was calculated with GPS; and
 - 4> the UE does not support the capability to provide the GPS timing of the cell:
 - 5> include the IE "GPS TOW msec" and set it to the GPS TOW when the position estimate was valid.
 - 4> if the UE supports the capability to provide the GANSS timing of the cell frames measurement:
 - 5> if the IE "GANSS timing of Cell wanted" is included with one bit set to value one for a supported GANSS:
 - 6> perform the UE GANSS timing of cell frames measurement on the serving cell or on one cell of the active set;
 - 6> include the IE "GANSS Time ID" to identify the GNSS system time;
 - 6> include the IE "Primary CPICH Info" for FDD or the IE "cell parameters id" for TDD; and
 - 6> include the IE "Reference SFN" and the IE "UE GANSS timing of cell frames".

- 5> if the IE "GANSS timing of Cell wanted" is not included, or included with each bit set to value zero:
 - 6> include the IE "GANSS TOD msec" and set it to the GANSS TOD when the position estimate was valid.
- 4> if the UE does not support the capability to provide the GANSS timing of the cell:
 - 5> include the IE "GANSS TOD msec" and set it to the GANSS TOD when the position estimate was valid;
 - 5> include the IE "GANSS Time ID" to identify the GNSS system time.
- 4> if IE "Vertical Accuracy" has been included in IE "UE positioning reporting quantity":
 - 5> if the IE "Vertical Accuracy" has been assigned to value "0":
 - 6> if the IE "Horizontal Accuracy" has been assigned a value "0":
 - 7> may include IE "Ellipsoid point with altitude".
 - 6> if the IE "Horizontal Accuracy" has been assigned a value unequal to "0"; and
 - 6> if the UE has been able to calculate a 3-dimensional position
 - 7> include IE "Ellipsoid point with altitude" or IE "Ellipsoid point with altitude and uncertainty ellipsoid" as the position estimate.
 - 6> if the UE has not been able to calculate a 3-dimensional position:
 - 7> may act as if IE "Vertical Accuracy" was not included in IE "UE positioning reporting quantity".
 - 5> if the IE "Vertical Accuracy" has been assigned to a value unequal to "0":
 - 6> if the UE has been able to calculate a 3-dimensional position:
 - 7> include IE "Ellipsoid point with altitude and uncertainty ellipsoid" as the position estimate.
 - 6> if the UE has not been able to calculate a 3-dimensional position:
 - 7> act as if IE "Vertical Accuracy" has not been included in IE "UE positioning reporting quantity".
- 4> if IE "Vertical Accuracy" has not been included in IE "UE positioning reporting quantity":
 - 5> if IE "Horizontal Accuracy" in IE "UE positioning reporting quantity" has been assigned to value "0":
 - 6> may include IE "Ellipsoid point".
 - 5> if IE "Horizontal Accuracy" in IE "UE positioning reporting quantity" has been assigned to a value unequal to 0:
 - 6> include either IE "Ellipsoid point with uncertainty circle" or IE "Ellipsoid point with uncertainty ellipse" or IE "Ellipsoid point with altitude and uncertainty ellipsoid" as the position estimate.
- 4> if any of the IEs "Ellipsoid point with uncertainty ellipse" or "Ellipsoid point with altitude and uncertainty ellipsoid" is reported:
 - 5> should calculate a value of the IE "Confidence", different from "0", as the probability that the UE is located within the uncertainty region of the one of the IEs "Ellipsoid point with uncertainty ellipse" or "Ellipsoid point with altitude and uncertainty ellipsoid" that is reported.

NOTE: The value "0" of the IE "Confidence" is interpreted as "no information" by the UTRAN [57].

- 4> if IE "Velocity Requested" has been included in IE "UE positioning reporting quantity":
 - 5> include IE "Velocity estimate" if supported and available.
- 2> if the UE was not able to calculate a position:
 - 3> include IE "UE positioning error" in the MEASUREMENT REPORT and set the contents of this IE as specified in subclause 8.6.7.19.5.
- 1> if the UE is unable to calculate a position due to missing GPS assistance data:
 - 2> the UE may at any time send a measurement report containing the IE "UE positioning error" and set the contents of this IE as specified in subclause 8.6.7.19.5;
 - 2> after sending the measurement report, the UE shall not send another measurement report to request the same GPS assistance data for at least 20s. This requirement does not apply after release of the current RRC connection.
- 1> if the UE is unable to report the requested measurement results due to missing GANSS assistance data:
 - 2> the UE may at anytime send a measurement report containing the IE "UE positioning error" and set the contents of this IE as specified in subclause 8.6.7.19.5;
 - 2> after sending the measurement report, the UE shall not send another measurement report to request the same GANSS assistance data for at least 20s. This requirement does not apply after release of the current RRC connection.

8.6.7.19.2 UE positioning OTDOA assistance data for UE-assisted

If IE "UE positioning OTDOA reference cell info for UE-assisted" is received in System Information Block type 15.4 or in the MEASUREMENT CONTROL message, the UE shall update the variable UE_POSITIONING_OTDOA_DATA_UE_ASSISTED accordingly. The UE shall:

- 1> store received cell information in the UE positioning reference cell info in the variable UE_POSITIONING_OTDOA_DATA_UE_ASSISTED, overwriting any existing information.

If IE "UE positioning OTDOA neighbour cell list for UE-assisted" is received in System Information Block type 15.4 or in the MEASUREMENT CONTROL message, the UE shall update the variable UE_POSITIONING_OTDOA_DATA_UE_ASSISTED accordingly. The UE shall:

- 1> store received cell information in the neighbour cell info list in the variable UE_POSITIONING_OTDOA_DATA_UE_ASSISTED, overwriting any existing information.

If, according to its capabilities, UE does not support IPDLs and if IE "IPDL parameters" is received for the reference or any of the neighbour cells, the UE shall:

- 1> ignore this IE.

In 1.28 Mcps TDD, if the IE "IPDL parameters" is received and the UE supports IPDLs, the UE shall:

- 1> ignore the IE IP_Slot;
- 1> if the IE "IP_PCCPCH" is set to FALSE:
 - 2> configure the physical layer with IP_Sub to be first subframe according to [33].
- 1> if the IE "IP_PCCPCH" is set to TRUE:
 - 2> configure the physical layer with IP_Sub to be second subframe according to [33].
- 1> if the IE "IP_PCCPCH" is absent:
 - 2> configure the physical layer with IP_Sub to use both subframes according to [33].

If IE "SFN offset validity" is set to FALSE, the UE shall:

- 1> ignore the IE "SFN offset".

If IE "UE positioning measurement" is received in the MEASUREMENT CONTROL message, the UE shall also perform the following consistency checks:

- 1> if IE "Positioning Methods" is set to "OTDOA":
 - 2> if IE "UE positioning OTDOA reference cell info for UE-assisted" is not included and if UE positioning OTDOA reference cell info for UE-assisted in variable UE_POSITIONING_OTDOA_DATA_UE_ASSISTED is empty:
 - 3> set the variable CONFIGURATION_INCOMPLETE to TRUE.
- 1> if IE "Positioning Methods" is set to "OTDOA":
 - 2> if IE "UE positioning OTDOA neighbour cell list for UE-assisted" is not included and if less than two neighbour cells are stored in UE positioning OTDOA neighbour cell info list for UE-assisted in variable UE_POSITIONING_OTDOA_DATA_UE_ASSISTED:
 - 3> set the variable CONFIGURATION_INCOMPLETE to TRUE.

8.6.7.19.2a UE positioning OTDOA assistance data for UE-based

The UE shall:

- 1> if IE "UE positioning OTDOA reference cell info for UE-based" is received in System Information Block type 15.5 or in the MEASUREMENT CONTROL message or in the ASSISTANCE DATA DELIVERY:
 - 2> update the variable UE_POSITIONING_OTDOA_DATA_UE_BASED accordingly;
 - 2> store received cell information in the UE positioning reference cell info for UE-based in the variable UE_POSITIONING_OTDOA_DATA_UE_BASED, overwriting any existing information.
- 1> if IE "UE positioning OTDOA neighbour cell list for UE-based" is received in System Information Block type 15.5 or in the MEASUREMENT CONTROL message or in the ASSISTANCE DATA DELIVERY:
 - 2> update the variable UE_POSITIONING_OTDOA_DATA_UE_BASED accordingly;
 - 2> store received cell information in the neighbour cell info list for UE-based in the variable UE_POSITIONING_OTDOA_DATA_UE_BASED, overwriting any existing information.
- 1> if, according to its capabilities, UE does not support IPDLs and if IE "IPDL parameters" is received for the reference or any of the neighbour cells:
 - 2> ignore this IE.
- 1> in 1.28 Mcps TDD:
 - 2> if the IE "IPDL parameters" is received and the UE supports IPDLs:
 - 3> ignore the IE IP_Slot;
 - 3> if the IE "IP_PCCPCH" is set to FALSE:
 - 4> configure the physical layer with IP_Sub to be first subframe according to [33].
 - 3> if the IE "IP_PCCPCH" is set to TRUE:
 - 4> configure the physical layer with IP_Sub to be second subframe according to [33].
 - 3> if the IE "IP_PCCPCH" is absent:
 - 4> configure the physical layer with IP_Sub to use both subframes according to [33].
- 1> if IE "SFN offset validity" is set to FALSE:
 - 2> ignore the IE "SFN offset".
- 1> if IE "UE positioning measurement" is received in the MEASUREMENT CONTROL message:

2> also perform the following consistency checks:

3> if IE "Positioning Methods" is set to "OTDOA":

4> if IE "UE positioning OTDOA reference cell info for UE-based" is not included and if UE positioning OTDOA reference cell info for UE-based in variable UE_POSITIONING_OTDOA_DATA_UE_BASED is empty:

5> set the variable CONFIGURATION_INCOMPLETE to TRUE.

3> if IE "Positioning Methods" is set to "OTDOA":

4> if IE "UE positioning OTDOA neighbour cell list for UE-based" is not included and if less than two neighbour cells are stored in UE positioning OTDOA neighbour cell info list for UE-based in variable UE_POSITIONING_OTDOA_DATA_UE_BASED:

5> set the variable CONFIGURATION_INCOMPLETE to TRUE.

4> if IE "Method Type" is set to "UE based":

5> if IE "UE positioning OTDOA reference cell info for UE-based" is included and if IE "Cell Position" for the reference cell is not included:

6> set the variable CONFIGURATION_INCOMPLETE to TRUE.

5> if the IE "UE positioning OTDOA neighbour cell list for UE-based" is included and if cell position of less than two neighbour cells of the cells included in this IE and stored in variable UE_POSITIONING_OTDOA_DATA_UE_BASED are different; or

5> if the IE "UE positioning OTDOA neighbour cell list for UE-based" is included and if cell position of only two neighbour cells of the cells included in this IE and stored in variable UE_POSITIONING_OTDOA_DATA_UE_BASED are different and if those cell positions are not different to the one of the reference cell stored in variable UE_POSITIONING_OTDOA_DATA_UE_BASED:

6> set the variable CONFIGURATION_INCOMPLETE to TRUE.

5> if the IE "Round Trip Time" is neither included for the neighbour cells nor for the reference cell info; and

6> if the IE "UE positioning OTDOA neighbour cell list for UE-based" is included and if cell position of only two neighbour cells of the cells included in this IE and stored in variable UE_POSITIONING_OTDOA_DATA_UE_BASED are different; or

6> if the IE "UE positioning OTDOA neighbour cell list for UE-based" is included and if cell position of only three neighbour cells of the cells included in this IE and stored in variable UE_POSITIONING_OTDOA_DATA_UE_BASED are different and if those cell positions are not different to the one of the reference cell stored in variable UE_POSITIONING_OTDOA_DATA_UE_BASED:

7> set the variable CONFIGURATION_INCOMPLETE to TRUE.

8.6.7.19.3 UE positioning GPS assistance data

The UE may receive GPS assistance data in System Information Block types 15, 15.1, 15.2, or 15.3, or in the ASSISTANCE DATA DELIVERY message, or in the MEASUREMENT CONTROL message.

8.6.7.19.3.1 UE positioning GPS acquisition assistance

If the IE "UE positioning GPS acquisition assistance" is included, the UE shall:

1> update the variable UE_POSITIONING_GPS_DATA as follows:

2> delete all information currently stored in the IE "UE positioning GPS acquisition assistance" in the variable UE_POSITIONING_GPS_DATA;

- 2> store the received acquisition assistance information in the IE "UE positioning GPS acquisition assistance" in the variable UE_POSITIONING_GPS_DATA;
- 2> store the IE "GPS TOW msec" in the IE "UE positioning GPS acquisition assistance" in variable UE_POSITIONING_GPS_DATA and use it as an estimate of the GPS Time-of-Week at the time of reception of the complete message containing the IE "GPS TOW msec";

NOTE: The UE does not need to apply any compensation on the GPS Time-of-Week.

- 1> if the IEs "SFN" and "UTRAN GPS timing of cell frames" are included:
 - 2> if the UE is able to utilise these IEs:
 - 3> store these IEs in the IE "UE positioning GPS acquisition assistance" in variable UE_POSITIONING_GPS_DATA;
 - 3> if the IE "Primary CPICH Info" for FDD or IE "cell parameters id" for TDD is not included:
 - 4> if the UE is not in CELL_DCH state:
 - 5> use IEs "SFN" and "UTRAN GPS timing of cell frames" to estimate the relationship between GPS time and radio interface timing of the NODE B transmission in the serving cell.
 - 5> if the IE "UE Positioning GPS ReferenceTime Uncertainty" is included:
 - 6> store this IE in the IE "UE Positioning GPS acquisition assistance" in variable UE_POSITIONING_GPS_DATA and use it to determine the relationship between GPS time and air-interface timing of the NODE B transmission.
 - 4> if the UE is in CELL_DCH state:
 - 5> ignore IEs "SFN" and "UTRAN GPS timing of cell frames".
 - 3> if the IE "Primary CPICH Info" for FDD or IE "cell parameters id" for TDD is also included:
 - 4> store this IE in the IE "UE positioning acquisition assistance" in variable UE_POSITIONING_GPS_DATA;
 - 4> use IEs "SFN" and "UTRAN GPS timing of cell frames" to estimate the relationship between GPS time and air-interface timing of the NODE B transmission in the cell indicated by "Primary CPICH info" or "cell parameters id".
 - 4> if the IE "UE Positioning GPS ReferenceTime Uncertainty" is included:
 - 5> store this IE in the IE "UE Positioning GPS acquisition assistance" in variable UE_POSITIONING_GPS_DATA and use it to determine the relationship between GPS time and air-interface timing of the NODE B transmission.
 - 1> if the IE "Confidence" is included:
 - 2> store this IE in the IE "UE Positioning GPS acquisition assistance" in variable UE_POSITIONING_GPS_DATA and use it to determine the confidence level of the reference location area or volume used to calculate the acquisition assistance parameters (search windows).
 - 1> if the IE "Azimuth and Elevation LSB" is included:
 - 2> use the IEs "Azimuth" and "Azimuth LSB" to determine the visible satellites azimuth angles;
 - 2> use the IEs "Elevation" and "Elevation LSB" to determine the visible satellites elevation angles.

8.6.7.19.3.2 UE positioning GPS Almanac

If the IE "UE positioning GPS Almanac" is included, the UE shall:

- 1> if the IE "SV Global Health" is included:

1> store this IE in the IE in the IE "SV Global Health" in the IE "UE positioning GPS Almanac" in variable UE_POSITIONING_GPS_DATA.

1> for each satellite:

2> store received GPS almanac information at the position indicated by the IE "Sat ID" in the IE "UE positioning GPS Almanac" in the variable UE_POSITIONING_GPS_DATA, possibly overwriting any existing information in this position.

2> interpret IE "Data ID" as the Data ID field contained in the indicated subframe, word 3, most significant 2 bits, as defined by [12];

2> act on the rest of the IEs in a similar manner as specified in [12].

1> if the IE "Complete Almanac Provided" is included:

2> store this IE in the IE "Complete Almanac Provided" in the IE "UE positioning GPS Almanac" in variable UE_POSITIONING_GPS_DATA;

2> use the IE "Complete Almanac Provided" to determine whether almanac is provided for all satellites in the GPS constellation (TRUE) or not (FALSE).

8.6.7.19.3.3 UE positioning D-GPS Corrections

If the IE "UE positioning GPS DGPS corrections" is included, the UE shall:

1> update the variable UE_POSITIONING_GPS_DATA as follows:

2> delete all information currently stored in the IE "UE positioning GPS DGPS corrections" in the variable UE_POSITIONING_GPS_DATA;

2> store the received DGPS corrections in the IE "UE positioning GPS DGPS corrections" in the variable UE_POSITIONING_GPS_DATA.

1> use IE "GPS TOW sec" to determine when the differential corrections were calculated;

1> use IE "Status/Health" to determine the status of the differential corrections.

8.6.7.19.3.3a UE positioning GPS Navigation Model

If the IE "UE positioning GPS Navigation Model" is included, for each satellite, the UE shall:

1> use IE "Satellite Status" to determine if an update of IE "UE positioning GPS Ephemeris and Clock Correction parameters" has been provided for the satellite indicated by the IE "SatID";

1> if an update has been provided for this satellite:

2> act as specified in subclause 8.6.7.19.3.4.

8.6.7.19.3.4 UE positioning GPS Ephemeris and Clock Correction Parameters

If the IE "UE positioning GPS Ephemeris and Clock Correction parameters" is included, for each satellite, the UE shall:

1> update the variable UE_POSITIONING_GPS_DATA as follows:

2> store this IE at the position indicated by the IE "Sat ID" in the IE "UE positioning GPS Navigation Model" in the variable UE_POSITIONING_GPS_DATA, possibly overwriting any existing information in this position.

1> act on these GPS ephemeris and clock correction parameters in a manner similar to that specified in [12].

8.6.7.19.3.5 UE positioning GPS ionospheric model

If IE "UE positioning GPS ionospheric model" is included, the UE shall:

- 1> store this IE in the IE "UE positioning GPS ionospheric model" in variable UE_POSITIONING_GPS_DATA;
- 1> act on these GPS ionospheric model parameters in a manner similar to that specified in [12].

8.6.7.19.3.6 UE positioning GPS real-time integrity

If this list of bad satellites is included, the UE shall:

- 1> update the variable UE_POSITIONING_GPS_DATA as follows:
 - 2> add the Sat IDs that are not yet included in the list of satellites in the IE "UE positioning GPS real time integrity" in the variable UE_POSITIONING_GPS_DATA;
 - 2> remove all Sat IDs in the list of satellites in the IE "UE positioning GPS real time integrity" in the variable UE_POSITIONING_GPS_DATA that are not included in IE UE positioning GPS real time integrity.
- 1> consider the data associated with the satellites identified in the variable UE_POSITIONING_GPS_DATA as invalid.

8.6.7.19.3.7 UE positioning GPS reference time

If the IE "UE positioning GPS reference time" is included, the UE shall:

- 1> store the IE "GPS Week" in "UE positioning GPS reference time" in variable UE_POSITIONING_GPS_DATA and use it as the current GPS week;
- 1> if the the IE "GPS Week Cycle Number" is included:
 - 2> store the IE "GPS Week Cycle Number" in "UE positioning GPS reference time" in variable UE_POSITIONING_GPS_DATA and use it to determine the number of 1024 GPS week cycles occurred since the GPS zero time-point.
- 1> store the IE "GPS TOW msec" in the IE "UE positioning GPS reference time" in variable UE_POSITIONING_GPS_DATA and use it as an estimate of the GPS Time-of-Week at the time of reception of the complete message containing the IE "GPS TOW msec";

NOTE: The UE does not need to apply any compensation on the GPS Time-of-Week.

- 1> if the IE "SFN" and IE "UTRAN GPS timing of cell frames" are included:
 - 2> if the UE is able to utilise the IEs:
 - 3> store these IEs in the IE "UE positioning GPS reference time" in variable UE_POSITIONING_GPS_DATA;
 - 3> if the IE "Primary CPICH Info" for FDD or IE "cell parameters id" for TDD is not included:
 - 4> if the UE is not in CELL_DCH state:
 - 5> use IEs "SFN" and "UTRAN GPS timing of cell frames" to estimate the relationship between GPS time and air-interface timing of the NODE B transmission in the serving cell.
 - 5> if the IE "UE Positioning GPS ReferenceTime Uncertainty" is included:
 - 6> store this IE in the IE "UE positioning GPS reference time" in variable UE_POSITIONING_GPS_DATA and use it to determine the relationship between GPS time and air-interface timing of the NODE B transmission.
 - 4> if the UE is in CELL_DCH state:
 - 5> ignore IEs "SFN" and "UTRAN GPS timing of cell frames".
 - 3> if the IE "Primary CPICH Info" for FDD or IE "cell parameters id" for TDD is also included:
 - 4> store this IE in the IE "UE positioning GPS reference time" in variable UE_POSITIONING_GPS_DATA;

4> use IEs "SFN" and "UTRAN GPS timing of cell frames" to estimate the relationship between GPS time and air-interface timing of the NODE B transmission in the cell indicated by "Primary CPICH info" or "cell parameters id".

4> if the IE "UE Positioning GPS ReferenceTime Uncertainty" is included:

5> store this IE in the IE "UE positioning GPS reference time" in variable UE_POSITIONING_GPS_DATA and use it to determine the relationship between GPS time and air-interface timing of the NODE B transmission.

1> if the IE "UE Positioning GPS ReferenceTime Uncertainty" is not included; and

1> if the IE "SFN-TOW Uncertainty" is included:

2> store this IE in the IE "UE positioning GPS reference time" in variable UE_POSITIONING_GPS_DATA and use it to determine if the relationship between GPS time and air-interface timing of the NODE B transmission is known to within at least 10ms.

1> if the IE "T_{UTRAN-GPS} drift rate" is included:

2> store this IE in the IE "UE positioning GPS reference time" in variable UE_POSITIONING_GPS_DATA; and

2> may use it as an estimate of the drift rate of the NODE B clock relative to GPS time.

1> if the IE "GPS TOW Assist" is included:

2> for each satellite:

3> delete all information currently stored in the IE "GPS TOW Assist" in the IE "UE positioning GPS reference time" in the variable UE_POSITIONING_GPS_DATA;

3> store the received GPS TOW Assist information in the IE "UE positioning GPS reference time" in the variable UE_POSITIONING_GPS_DATA.

8.6.7.19.3.8 UE positioning GPS reference UE position

If the IE "UE positioning GPS reference UE position" is included, the UE shall:

1> store this IE in the IE "UE positioning GPS reference UE position" in variable UE_POSITIONING_GPS_DATA; and

1> use it as a priori knowledge of the approximate location of the UE.

8.6.7.19.3.9 UE positioning UTC model

If the IE "UE positioning GPS UTC model" is included, the UE shall:

1> store this IE in the IE "UE positioning GPS UTC model" in variable UE_POSITIONING_GPS_DATA.

8.6.7.19.4 UE positioning Ciphering info

The UE shall:

1> if deciphering information is received from higher layers for deciphering of GPS assistance data broadcast on system information:

2> store the current key in IE "Current deciphering key" in variable UE_POSITIONING_GPS_DATA;

2> store the next key in IE "Next deciphering key" in variable UE_POSITIONING_GPS_DATA;

2> store the ciphering key flag in UE_POSITIONING_GPS_DATA.

1> if deciphering information is received from higher layers for deciphering of GANSS assistance data broadcast on system information:

- 2> store the current key in IE "Current deciphering key" in variable UE_POSITIONING_GANSS_DATA;
 - 2> store the next key in IE "Next deciphering key" in variable UE_POSITIONING_GANSS_DATA;
 - 2> store the ciphering key flag in UE_POSITIONING_GANSS_DATA.
- 1> if deciphering information is received from higher layers for deciphering of OTDOA assistance data broadcast on system information:
- 2> store the current key in IE "Current deciphering key" in variable UE_POSITIONING_OTDOA_DATA_UE_BASED;
 - 2> store the next key in IE "Next deciphering key" in variable UE_POSITIONING_OTDOA_DATA_UE_BASED;
 - 2> store the ciphering key flag in UE_POSITIONING_OTDOA_DATA_UE_BASED.
- 1> if the IE "GPS Data ciphering info" is included in System Information Block type 15:
- 2> select one of the two deciphering keys received and stored it in UE_POSITIONING_GPS_DATA according to the following:
 - 3> if the value of the received IE "Ciphering Key Flag" is the same as the value of the IE "Ciphering Key Flag" stored in the variable UE_POSITIONING_GPS_DATA:
 - 4> select the current deciphering key.
 - 3> if the value of the received IE "Ciphering Key Flag" is different from the value of the IE "Ciphering Key Flag" stored in the variable UE_POSITIONING_GPS_DATA:
 - 4> select the next deciphering key.
 - 2> store the received IE in the variable UE_POSITIONING_GPS_DATA;
 - 2> use the selected deciphering key to decipher the broadcast UE positioning GPS information contained within the System Information Block types 15.1, 15.2 and 15.3.
- 1> if the IE "GANSS Data ciphering info" is included in System Information Block type 15.8:
- 2> select one of the two deciphering keys received and stored it in UE_POSITIONING_GANSS_DATA according to the following:
 - 3> if the value of the received IE "Ciphering Key Flag" is the same as the value of the IE "Ciphering Key Flag" stored in the variable UE_POSITIONING_GANSS_DATA:
 - 4> select the current deciphering key.
 - 3> if the value of the received IE "Ciphering Key Flag" is different from the value of the IE "Ciphering Key Flag" stored in the variable UE_POSITIONING_GANSS_DATA:
 - 4> select the next deciphering key.
 - 2> store the received IE in the variable UE_POSITIONING_GANSS_DATA;
 - 2> use the selected deciphering key to decipher the broadcast UE positioning GANSS information contained within the System Information Block types 15.1bis, 15.1ter, 15.2bis, 15.2ter, 15.3bis, 15.6 and 15.7.
- 1> if the IE "OTDOA positioning ciphering info" is included in System Information Block type 15.4:
- 2> select one of the two deciphering keys and stored it in UE_POSITIONING_OTDOA_DATA_UE_BASED according to the following:
 - 3> if the value of the received IE "Ciphering Key Flag" is the same as the value of the IE "Ciphering Key Flag" stored in the variable UE_POSITIONING_OTDOA_DATA_UE_BASED:
 - 4> select the current deciphering key.

- 3> if the value of the received IE "Ciphering Key Flag" is different from the value of the IE "Ciphering Key Flag" stored in the variable UE_POSITIONING_OTDOA_DATA_UE_BASED:
 - 4> select the next deciphering key.
- 2> store the received IE in the variable UE_POSITIONING_OTDOA_DATA_UE_BASED;
- 2> use the selected deciphering key to decipher the IE "OTDOA assistance data" included in the System Information Block types 15.4.

8.6.7.19.5 UE positioning Error

The UE shall set the contents of the IE "UE positioning Error" as follows:

- 1> if the IE "Positioning Methods" in IE "UE positioning reporting quantity" has been assigned to value "OTDOA" and no neighbour cells could be received,
 - 2> set IE "Error reason" to "Not Enough OTDOA Cells";
- 1> if the IE "Positioning Methods" in IE "UE positioning reporting quantity" has been assigned to value "GPS":
 - 2> if there were not enough GPS satellites to be received:
 - 3> set IE "Error reason" to "Not Enough GPS Satellites".
 - 2> if some GPS assistance data was missing:
 - 3> set IE "Error reason" to "Assistance Data Missing"; and
 - 3> if the IE "Additional Assistance Data Request" included in the IE "UE positioning reporting quantity" stored in the variable MEASUREMENT_IDENTITY is set to TRUE:
 - 4> include the IE "GPS Additional Assistance Data Request".
 - 3> if the IE "Additional Assistance Data Request" included in the IE "UE positioning reporting quantity" stored in the variable MEASUREMENT_IDENTITY is set to FALSE:
 - 4> not include the IE "GPS Additional Assistance Data Request", and use the assistance data available for doing a positioning estimate.
 - 2> if the UE was not able to read the SFN of the reference cell included in the IE "UE positioning GPS reference time" or in the IE "UE positioning acquisition assistance":
 - 3> set IE "Error reason" to "Reference Cell Not Serving Cell".
 - 2> if the UE was not able to measure the requested GPS timing of cell frames measurement:
 - 3> set IE "Error reason" to "Not Accomplished GPS Timing Of Cell Frames".
 - 1> if the IE "Positioning Methods" in IE "UE positioning reporting quantity" has been assigned to value "GPS" and the IE "GANSS Positioning Methods" is present:
 - 2> if there were not enough GANSS satellites to be received:
 - 3> set IE "Error reason" to "Not Enough GANSS Satellites".
 - 2> if some GANSS assistance data was missing:
 - 3> set IE "Error reason" to "Assistance Data Missing"; and
 - 3> if the IE "Additional Assistance Data Request" included in the IE "UE positioning reporting quantity" stored in the variable MEASUREMENT_IDENTITY is set to TRUE:
 - 4> include the IE "GANSS Additional Assistance Data Request".
 - 3> if the IE "Additional Assistance Data Request" included in the IE "UE positioning reporting quantity" stored in the variable MEASUREMENT_IDENTITY is set to FALSE:

- 4> not include the IE "GANSS Additional Assistance Data Request", and use the assistance data available for doing a positioning estimate.
- 2> if the UE was not able to read the SFN of the reference cell included in the IE "UE positioning GANSS reference time":
 - 3> set IE "Error reason" to "Reference Cell Not Serving Cell".
- 2> if the UE was not able to measure the requested GANSS timing of cell frames measurement:
 - 3> set IE "Error reason" to "Not Accomplished GANSS Timing Of Cell Frames".
- 1> if none of the conditions above are fulfilled:
 - 2> set IE "Error reason" to "Undefined Error".

The UE shall not set the IE "Error reason" to "Request Denied By User" or "Not Processed and Timeout".

8.6.7.19.6 Void

8.6.7.19.7 UE positioning GANSS assistance data

The UE may receive GANSS assistance data in System Information Block types 15bis, 15.1bis, 15.1ter, 15.2bis, 15.2ter, 15.3bis, 15.6, 15.7 or 15.8 or in the ASSISTANCE DATA DELIVERY message, or in the MEASUREMENT CONTROL message. IE "UE positioning GANSS assistance data" is divided into a common part which is applicable to any GNSS and a generic part which contains assistance data separately for each supported GNSS.

8.6.7.19.7.1 UE positioning GANSS reference measurement information

If the IE "UE positioning GANSS reference measurement information" is included, the UE shall:

- 1> update the variable UE_POSITIONING_GANSS_DATA as follows:
 - 2> for each GANSS the IE "UE positioning GANSS reference measurement information" is included:
 - 3> delete all information currently stored in the IE "UE positioning GANSS reference measurement information" in the variable UE_POSITIONING_GANSS_DATA;
 - 3> store the received information in the IE "UE positioning GANSS reference measurement information" in the variable UE_POSITIONING_GANSS_DATA.
- 1> for each GANSS:
 - 2> if the IE "Confidence" is included:
 - 3> store this IE in the IE "UE Positioning GANSS reference measurement information" in variable UE_POSITIONING_GANSS_DATA and use it to determine the confidence level of the reference location area or volume used to calculate the acquisition assistance parameters (search windows).
 - 2> if the IE "Azimuth and Elevation LSB" is included:
 - 3> use the IEs "Azimuth" and "Azimuth LSB" to determine the visible satellites azimuth angles;
 - 3> use the IEs "Elevation" and "Elevation LSB" to determine the visible satellites elevation angles.
- 1> perform the following consistency check:
 - 2> if the IE "UE positioning GANSS reference time" is included and the IE "UE positioning GPS acquisition assistance" is not included, the UE shall interpret the IE "Satellite information" to be valid at the time provided in IE "UE positioning GANSS reference time";
 - 2> if the IE "UE positioning GPS acquisition assistance" is included, the UE shall interpret the IE "Satellite information" to be valid at the time provided in the IE "UE positioning GPS acquisition assistance";
 - 2> if neither the IE "UE positioning GANSS reference time" nor the IE "UE positioning GPS acquisition assistance" is included:

3> set the variable CONFIGURATION_INCOMPLETE to TRUE.

8.6.7.19.7.2 UE positioning GANSS Almanac

If the IE "UE positioning GANSS Almanac" is included, the UE shall:

1> for each GANSS:

2> for each satellite:

3> store received GANSS almanac information at the position indicated by the IE "SV ID" in the IE "UE positioning GANSS Almanac" in the variable UE_POSITIONING_GANSS_DATA, possibly overwriting any existing information in this position;

3> act on the information in a similar manner as specified in [61], [68], [69], [70], [71], [72], [73], [86] for a particular GANSS.

2> if the IE "Complete Almanac Provided" is included:

3> store this IE in the IE "Complete Almanac Provided" in the IE "UE positioning GANSS Almanac" in variable UE_POSITIONING_GANSS_DATA;

3> use the IE "Complete Almanac Provided" to determine whether almanac is provided for all satellites in the GANSS constellation (TRUE) or not (FALSE).

8.6.7.19.7.3 UE positioning D-GANSS Corrections

If the IE "UE positioning DGANSS corrections" is included, the UE shall:

1> for each GANSS:

2> update the variable UE_POSITIONING_GANSS_DATA as follows:

3> delete all information currently stored in the IE "UE positioning DGANSS corrections" in the variable UE_POSITIONING_GANSS_DATA;

3> store the received DGANSS corrections in the IE "UE positioning DGANSS corrections" in the variable UE_POSITIONING_GANSS_DATA.

2> use IE "DGANSS Reference Time" to determine when the differential corrections were calculated;

2> use IE "Status/Health" to determine the status of the differential corrections.

8.6.7.19.7.4 UE positioning GANSS Navigation Model

If the IE "UE positioning GANSS Navigation Model" is included, the UE shall:

1> for each GANSS:

2> for each satellite, the UE shall:

3> for IE "UE positioning GANSS clock model":

4> act as specified in subclause 8.6.7.19.7.4a.

3> for IE "UE positioning GANSS orbit model":

4> act as specified in subclause 8.6.7.19.7.4b.

8.6.7.19.7.4a UE positioning GANSS Clock Model

If the IE "UE positioning GANSS clock model" is included, the UE shall:

1> for each GANSS:

2> update the variable UE_POSITIONING_GANSS_DATA as follows:

3> store this IE at the position indicated by the IE "Sat ID" in the IE "UE positioning GANSS Navigation Model" in the variable UE_POSITIONING_GANSS_DATA, possibly overwriting any existing information in this position.

2> act on these GANSS clock models in a manner similar to that specified in a relevant ICD.

8.6.7.19.7.4b UE positioning GANSS Orbit Model

If the IE "UE positioning GANSS orbit model" is included, for each satellite of each supported GNSS, the UE shall:

1> update the variable UE_POSITIONING_GANSS_DATA as follows:

2> store this IE at the position indicated by the IE "Sat ID" in the IE "UE positioning GANSS Navigation Model" in the variable UE_POSITIONING_GANSS_DATA, possibly overwriting any existing information in this position..

1> act on these GANSS orbit models in a manner similar to that specified in a relevant ICD.

8.6.7.19.7.5 UE positioning GANSS ionospheric model

If the IE "UE positioning GANSS ionospheric model" is included, the UE shall:

1> store this IE in the IE "UE positioning GANSS ionospheric model" in variable UE_POSITIONING_GANSS_DATA;

1> act on these GANSS ionospheric model parameters in a manner similar to that specified in [61].

8.6.7.19.7.6 UE positioning GANSS real-time integrity

If this list of bad satellites is included, the UE shall for each GANSS:

1> update the variable UE_POSITIONING_GANSS_DATA as follows:

2> for each satellite included in the list:

3> add the Sat IDs that are not yet included in the list of satellites in the IE "UE positioning GANSS real time integrity" in the variable UE_POSITIONING_GANSS_DATA;

3> if the IE "Bad GNSS Signal ID" is included in the satellite information:

4> store this IE at the position indicated by the IE "Bad GNSS SatID" in the variable UE_POSITIONING_GANSS_DATA, possibly overwriting any existing information in this position.

3> remove all Sat IDs in the list of satellites in the IE "UE positioning GANSS real time integrity" in the variable UE_POSITIONING_GANSS_DATA that are not included in IE "UE positioning GANSS real time integrity".

1> consider the data associated with the satellites or signals identified in the variable UE_POSITIONING_GANSS_DATA as invalid.

8.6.7.19.7.7 UE positioning GANSS reference time

If the IE "UE positioning GANSS reference time" is included, the UE shall:

1> if the IE "GANSS Day" is included:

2> store this IE in "UE positioning GANSS reference time" in variable UE_POSITIONING_GANSS_DATA and use it as the current GANSS day.

1> if the IE "GANSS Day Cycle Number" is included:

2> store the IE "GANSS Day Cycle Number" in "UE positioning GANSS reference time" in variable UE_POSITIONING_GANSS_DATA and use it to determine the number of 8192 GANSS day cycles occurred since the GANSS zero time-point;

- 1> store the IE "GANSS TOD" in the IE "UE positioning GANSS reference time" in variable UE_POSITIONING_GANSS_DATA and use it as an estimate of the GANSS Time-of-Day at the time of reception of the complete message containing the IE "GANSS TOD";

NOTE: The UE does not need to apply any compensation on the GANSS Time-of-Day.

- 1> if the IE "GANSS TOD Uncertainty" is included:

- 2> store this IE in the IE "UE positioning GANSS reference time" in variable UE_POSITIONING_GANSS_DATA and use it to determine the uncertainty of the relationship between GANSS time and air-interface timing of the NODE B transmission.

- 1> if the IE "GANSS Time ID" is not included:

- 2> use Galileo system time as a reference for GANSS-Time-of-Day.

- 1> if the IE "GANSS Time ID" is included:

- 2> use the system time indicated by this IE as a reference for GANSS-Time-of-Day.

- 1> if the IE "SFN" and IE "UTRAN GANSS timing of cell frames" are included:

- 2> if the UE is able to utilise the IEs:

- 3> store these IEs in the IE "UE positioning GANSS reference time" in variable UE_POSITIONING_GANSS_DATA;

- 3> if the IE "Primary CPICH Info" for FDD or IE "cell parameters id" for TDD is not included:

- 4> if the UE is not in CELL_DCH state:

- 5> use IEs "SFN" and "UTRAN GANSS timing of cell frames" to estimate the relationship between GANSS time and air-interface timing of the NODE B transmission in the serving cell.

- 4> if the UE is in CELL_DCH state:

- 5> ignore IEs "SFN" and "UTRAN GANSS timing of cell frames".

- 3> if the IE "Primary CPICH Info" for FDD or IE "cell parameters id" for TDD is also included:

- 4> store this IE in the IE "UE positioning GANSS reference time" in variable UE_POSITIONING_GANSS_DATA;

- 4> use IEs "SFN" and "UTRAN GANSS timing of cell frames" to estimate the relationship between GANSS time and air-interface timing of the NODE B transmission in the cell indicated by "Primary CPICH info" or "cell parameters id".

- 1> if the IE "T_{UTRAN-GANSS} drift rate" is included:

- 2> store this IE in the IE "UE positioning GANSS reference time" in variable UE_POSITIONING_GANSS_DATA; and

- 2> may use it as an estimate of the drift rate of the NODE B clock relative to GANSS time.

8.6.7.19.7.8 UE positioning GANSS reference UE position

If the IE "UE positioning GANSS reference UE position" is included, the UE shall:

- 1> store this IE in the IE "UE positioning GANSS reference UE position" in variable UE_POSITIONING_GANSS_DATA; and

- 1> use it as a priori knowledge of the approximate location of the UE.

8.6.7.19.7.9 UE positioning GANSS time model

If the IE "UE positioning GANSS time model" is included, the UE shall for each GANSS:

- 1> store the information in "UE positioning GANSS time model" in variable UE_POSITIONING_GANSS_DATA;
- 1> use the stored parameters to relate GANSS time for the GANSS indicated by "GANSS ID" to time reference indicated by IE "GNSS_TO_ID".

8.6.7.19.7.10 UE positioning GANSS UTC model

If the IE "UE positioning GANSS UTC model" is included, the UE shall for each GANSS:

- 1> store this IE in the IE "UE positioning GANSS UTC model" in variable UE_POSITIONING_GANSS_DATA.

8.6.7.19.7.11 UE positioning GANSS data bit assistance

If the IE "UE positioning GANSS data bit assistance" is included, the UE shall for each GANSS:

- 1> store this IE in the IE "UE positioning GANSS data bit assistance" in variable UE_POSITIONING_GANSS_DATA;
- 1> use the data in IE "Data Bits" for data wipe-off of satellite signal indicated by IEs "Satellite ID" and "GANSS Signal ID".

8.6.7.19.7.12 UE positioning GANSS additional ionospheric model

If the IE "UE positioning GANSS additional ionospheric model" is included, the UE shall:

- 1> store this IE in the IE "UE positioning GANSS additional ionospheric model" in variable UE_POSITIONING_GANSS_DATA;
- 1> act on these GANSS additional ionospheric model parameters in a manner similar to that specified in [72], [86].

8.6.7.19.7.13 UE positioning GANSS Earth orientation parameters

If the IE "UE positioning GANSS Earth orientation parameters" is included, the UE shall:

- 1> store this IE in the IE "UE positioning GANSS Earth orientation parameters" in variable UE_POSITIONING_GANSS_DATA;
- 1> act on these GANSS Earth orientation parameters in a manner similar to that specified in [68].

8.6.7.19.7.14 UE positioning GANSS additional navigation models

If the IE "UE positioning GANSS additional navigation models" is included, the UE shall:

- 1> for each GANSS:
 - 2> for each satellite, the UE shall:
 - 3> for IE "UE positioning GANSS additional clock models":
 - 4> act as specified in subclause 8.6.7.19.7.14a.
 - 3> for IE "UE positioning GANSS additional orbit models":
 - 4> act as specified in subclause 8.6.7.19.7.14b.

8.6.7.19.7.14a UE positioning GANSS additional clock models

If the IE "UE positioning GANSS additional clock models" is included, the UE shall:

- 1> for each GANSS:
 - 2> update the variable UE_POSITIONING_GANSS_DATA as follows:

- 3> store this IE at the position indicated by the IE "Sat ID" in the IE "UE positioning GANSS additional navigation models" in the variable UE_POSITIONING_GANSS_DATA, possibly overwriting any existing information in this position.
- 2> act on these GANSS additional clock models in a manner similar to that specified in the ICD for the particular model.

8.6.7.19.7.14b UE positioning GANSS additional orbit models

If the IE "UE positioning GANSS additional orbit models" is included, for each satellite of each supported GANSS, the UE shall:

- 1> update the variable UE_POSITIONING_GANSS_DATA as follows:
 - 2> store this IE at the position indicated by the IE "Sat ID" in the IE "UE positioning GANSS additional navigation models" in the variable UE_POSITIONING_GANSS_DATA, possibly overwriting any existing information in this position.
- 1> act on these GANSS additional orbit models in a manner similar to that specified in the ICD for the particular model.

8.6.7.19.7.15 UE positioning GANSS additional UTC models

If the IE "UE positioning GANSS additional UTC models" is included, the UE shall for each GANSS:

- 1> store this IE in the IE "UE positioning GANSS additional UTC models" in variable UE_POSITIONING_GANSS_DATA;
- 1> act on these GANSS additional UTC models in a manner similar to that specified in the ICD for the particular model.

8.6.7.19.7.16 UE positioning GANSS auxiliary information

If the IE "UE positioning GANSS auxiliary information" is included, the UE shall for each GANSS:

- 1> store this IE in the IE "UE positioning GANSS auxiliary information" in variable UE_POSITIONING_GANSS_DATA;
- 1> if the IE "GANSS-ID-1" is included:
 - 2> use the IE "Signals Available" as an indication of ranging signals supported on the satellite identified by the IE "Sat ID" for the GANSS "Modernized GPS".
- 1> if the IE "GANSS-ID-3" is included:
 - 2> use the IE "Signals Available" as an indication of ranging signals supported on the satellite identified by the IE "Sat ID" for the GANSS "GLONASS";
 - 2> use the IE "Channel Number" as an indication of the carrier frequency number of the satellite identified by the IE "Sat ID" for the GANSS "GLONASS".

8.6.7.19.7.17 UE positioning DBDS corrections

If the IE "UE positioning DBDS corrections" is included, the UE shall:

- 1> if the UE supports DBDS:
 - 2> update the variable UE_POSITIONING_GANSS_DATA as follows:
 - 3> delete all information currently stored in the IE "UE positioning DBDS corrections" in the variable UE_POSITIONING_GANSS_DATA;
 - 3> store the received DBDS corrections in the IE "UE positioning DBDS corrections" in the variable UE_POSITIONING_GANSS_DATA.

2> act on these DBDS corrections parameters as specified in [86].

8.6.7.19.7.18 UE positioning BDS Ionospheric Grid Model

If the IE "UE positioning BDS Ionospheric Grid Model" is included, the UE shall:

1> if the UE supports BDS:

2> store this IE in the IE "UE positioning BDS Ionospheric Grid Model" in variable UE_POSITIONING_GANSS_DATA;

2> act on these BDS ionospheric grid model parameters as specified in [86].

8.6.7.20 Void

8.6.7.21 Intra-frequency reporting quantity for RACH reporting

If the IE "Intra-frequency reporting quantity for RACH reporting" is included, the UE shall:

1> if the IE "SFN-SFN observed time difference reporting indicator" has the value "type 2":

2> act as if the value of the IE "SFN-SFN observed time difference reporting indicator" is "no reporting".

1> if the IE "Reporting quantity" (FDD) or all IEs "Reporting quantity" (TDD) have the value "no report":

2> the UE behaviour is unspecified.

8.6.7.22 Additional Measurement List

If the IE "Additional Measurement List" is received in a MEASUREMENT CONTROL message, the UE shall:

1> if the received measurement configuration in this MEASUREMENT CONTROL message, or any measurement referenced in the "Additional Measurement List" do not all have the same validity (for this consistency check the UE shall assume "CELL_DCH" as the measurement validity for measurements of type "inter-RAT", "UE internal", and "quality"):

2> set the variable CONFIGURATION_INCOMPLETE to TRUE.

1> if any of the measurements referenced in the "Additional Measurement List" is an intra-frequency, inter-frequency or inter-RAT measurement, and this measurement is configured with event based reporting:

2> the UE behaviour is not specified.

1> if any of the "intra-frequency", "inter-frequency", "traffic volume" or "UE positioning" measurements referenced in the "Additional Measurement List" has been setup without including the IE "measurement validity":

2> the UE behaviour is not specified.

1> if the result of this MEASUREMENT CONTROL message is such that more than one additional measurement of the same type will be referenced in the IE "Additional Measurement List" in the MEASUREMENT_IDENTITY variable:

2> the UE behaviour is not specified.

1> if the UE has no IE "Additional Measurement List" stored in the variable MEASUREMENT_IDENTITY associated with the identity indicated by the IE "measurement identity":

2> store the received IE "Additional Measurement List" in the variable MEASUREMENT_IDENTITY.

If the IE "Additional Measurement List" is received in a MEASUREMENT CONTROL message with the IE "Measurement command" value set to "modify", and the UE has an IE "Additional Measurement List" stored in the variable MEASUREMENT_IDENTITY associated with the identity indicated by the IE "measurement identity", the UE shall:

- 1> replace the information stored in "Additional Measurement List" in variable MEASUREMENT_IDENTITY associated to the identity indicated by the IE "measurement identity" with the one received in the MEASUREMENT CONTROL message.

If the IE "Additional Measurement List" is not received in a MEASUREMENT CONTROL message and the IE "Measurement command" has the value "modify" and the UE has an IE "Additional Measurement List" stored in the variable MEASUREMENT_IDENTITY associated with the identity indicated by the IE "measurement identity", the UE shall:

- 1> leave the IE "Additional Measurement List" stored in the variable MEASUREMENT_IDENTITY associated with the identity indicated by the IE "measurement identity" unchanged.

If, at any time during the life-time of a measurement, any measurement referenced in the Additional Measurement List does not exist, the UE shall:

- 1> remove this measurement identity from the Additional Measurement List.

NOTE: A measurement referenced in the Additional Measurement List which is updated with a measurement command set to "modify", or replaced with a measurement command set to "setup", continues to exist.

If the measurement configured with the MEASUREMENT CONTROL message triggers a measurement report, the UE shall:

- 1> also include the reporting quantities for the measurements referenced by the additional measurement identities. The contents of the IE "Additional Measured results" are completely determined by the measurement configuration of the referenced additional measurement.

8.6.7.23 Dedicated Priority Information

The UE shall:

- 1> store IE "Dedicated Priority Information";

If the CHOICE "Action" has the value "Clear dedicated priorities", the UE shall:

- 1> clear the variable PRIORITY_INFO_LIST;
- 1> stop timer T322, if it is running;
- 1> set the value of IE "Priority status" in the variable PRIORITY_INFO_LIST to "sys_info_priority".
- 1> if the UE is not in CELL_DCH state:
 - 2> take the actions as described in subclause 8.1.1.6.19 using stored System information Block type 19.

If the CHOICE "Action" has the value "Configure dedicated priorities", the UE shall:

- 1> clear the variable PRIORITY_INFO_LIST;
- 1> stop timer T322, if it is running;
- 1> set the value of IE "Priority status" in the variable PRIORITY_INFO_LIST to "dedicated_priority";
- 1> for each occurrence of the IE "Priority Level List":
 - 2> create a new entry in the IE "Priority Info List" in the variable PRIORITY_INFO_LIST, and in that new entry:
 - 3> set the CHOICE "Radio Access Technology" to the value received in the IE "Priority Level List";
 - 3> set the IE "priority" to the value received in the IE "Priority Level List";
 - 3> set the values in IE "Frequency List" or "BCCH ARFCN" to the values received in the IE "Priority Level List".

NOTE: If the "Priority Level List" IEs contain, more than 16 UARFCNs corresponding to UTRAN FDD frequencies, more than 16 UARFCNs corresponding to UTRAN TDD frequencies, more than 32 EARFCNs or more than 3 occurrences of "GSM cell group", the UE behaviour is undefined.

- 1> set the IE "E-UTRA detection" to the value received in the IE "Priority Level List".
- 1> if the IE "T322" is present:
 - 2> start timer T322 using the value signalled in this IE.
- 1> if the UE is not in CELL_DCH state:
 - 2> take the actions as described in subclause 8.1.1.6.19 using stored System information Block type 19.

8.6.7.24 Adjacent frequency index

If the IE "Adjacent frequency index" is received by the UE, the UE shall:

- 1> if prior to the reception of the message, any of the variables "Adjacent frequency info", "Inter-band frequency info" or "Frequency info list for enhanced measurement" are stored in CELL_INFO_LIST, then for each of the stored variables:
 - 2> stop all inter-frequency measurement reporting on the cells that belong to the frequency derived from the stored variable. Each stopped measurement is restarted when a MEASUREMENT CONTROL message is received with the corresponding measurement identity.
 - 2> clear the stored variable.
- 1> Extract the frequency information of the element contained in the IE "New inter-frequency cells" that is indexed by the IE "Adjacent frequency index".
- 1> Store this frequency information in the variable "Adjacent frequency info" in CELL_INFO_LIST.

If the IE "Adjacent frequency index" is received by the UE and the UE does not support adjacent frequency measurements without compressed mode:

- 1> The UE behaviour is unspecified.

If any two or more of the IE "Adjacent frequency index", the IE "Inter-band frequency index" or the IE "Frequency index list for enhanced measurement" are received in the same message:

- 1> The UE behaviour is unspecified.

8.6.7.24a Inter-band frequency index

If the IE "Inter-band frequency index" is received by the UE, the UE shall:

- 1> if prior to the reception of the message, any of the variables "Adjacent frequency info", "Inter-band frequency info" or "Frequency info list for enhanced measurement" are stored in CELL_INFO_LIST, then for each of the stored variables:
 - 2> stop all inter-frequency measurement reporting on the cells that belong to the frequency derived from the stored variable. Each stopped measurement is restarted when a MEASUREMENT CONTROL message is received with the corresponding measurement identity.
 - 2> clear the stored variable.
- 1> Extract the frequency information of the element contained in the IE "New inter-frequency cells" that is indexed by the IE "Inter-band frequency index".
- 1> Store this frequency information in the variable "Inter-band frequency info" in CELL_INFO_LIST.

If the IE "Inter-band frequency index" is received by the UE and the UE does not support inter-band frequency measurements without compressed mode:

- 1> The UE behaviour is unspecified.

If any two or more of the IE "Adjacent frequency index", the IE "Inter-band frequency index" or the IE "Frequency index list for enhanced measurement" are received in the same message:

- 1> The UE behaviour is unspecified.

8.6.7.25 Idle Interval Information (TDD only)

If the IE "Idle Interval Information" is received by the UE, the UE shall:

- 1> store this information and execute the inter-RAT measurement during the idle interval, if needed;
- 1> the SFN that the idle interval exists should fulfil the following equation:

$$\text{Offset} = \text{SFN} \bmod (2^k)$$

Where:

- k is the coefficient parameter to calculate the idle interval period;
- Offset is the idle interval position in a period.

8.6.7.26 CELL_DCH measurement occasion info LCR

If the IE "CELL_DCH measurement occasion info LCR" is included in a Radio Bearer Control message or a CELL UPDATE CONFIRM message or a MEASUREMENT CONTROL message, the UE shall:

- 1> if pattern sequence corresponding to IE "Pattern sequence identifier" is already active (according to "Status Flag") in the variable DCH_MOPS_IDENTITY) and the "Status Flag" in this message is set to "deactivate" for the corresponding pattern sequence:
 - 2> if the IE "Activation time" is included in the message:
 - 3> deactivate this pattern sequence at the beginning of the frame, indicated by IE "Activation time" (see subclause 8.6.3.1) received in this message, when the new configuration received in this message is taken into use.
 - 2> else
 - 3> deactivate the pattern sequence as soon as possible after the reception of the message.
- 1> set each pattern sequence to the variable DCH_MOPS_IDENTITY according to the IE "Pattern sequence identifier";
- 1> update into the variable DCH_MOPS_IDENTITY the configuration information defined by IE group "Measurement occasion pattern sequence parameters";
- 1> after the instant in which the message is to be executed without the IE "Activation time", or at the beginning of the frame indicated by IE "Activation time" as specified in subclause 8.6.3.1:
 - 2> activate the stored pattern sequence corresponding to each IE "Pattern sequence identifier" for which the "Status Flag" in the variable DCH_MOPS_IDENTITY is set to "activate"; and
 - 2> calculate the concerned CELL_DCH measurement occasion as specified in subclause 8.5.11a, and start the measurement at the frame calculated CELL_DCH measurement occasion.

8.6.7.27 Frequency index list for enhanced measurement

If the IE "Frequency index list for enhanced measurement" is received by the UE, the UE shall:

- 1> if prior to the reception of the message, any of the variables "Adjacent frequency info", "Inter-band frequency info" or "Frequency info list for enhanced measurement" is stored in CELL_INFO_LIST, then for each of the stored variables:

- 2> stop all inter-frequency measurement reporting on the cells that belong to the frequency derived from the stored variable. Each stopped measurement is restarted when a MEASUREMENT CONTROL message is received with the corresponding measurement identity.
- 2> clear the stored variable.
- 1> for each of the IE "Frequency index for enhanced measurement" included in the IE "Frequency index list for enhanced measurement":
 - 2> extract the frequency information of the element contained in the IE "New inter-frequency cells" that is indexed by the IE "Frequency index for enhanced measurement";
 - 2> store this frequency information in the variable "Frequency info list for enhanced measurement" in CELL_INFO_LIST.

If the IE "Frequency index list for enhanced measurement" is received by the UE and the UE does not support enhanced inter-frequency measurements without compressed mode:

- 1> The UE behaviour is unspecified.

If any two or more of the IE "Adjacent frequency index", the IE "Inter-band frequency index" or the IE "Frequency index list for enhanced measurement" are received in the same message:

- 1> The UE behaviour is unspecified.

8.6.7.28 E-UTRA measurement for CELL_FACH

The IE "E-UTRA measurement for CELL_FACH" is used to control the E-UTRA measurements and reporting in CELL_FACH state.

For FDD if the IE "E-UTRA measurement for CELL_FACH" is received by the UE in a MEASUREMENT CONTROL message, UE shall:

- 1> if the IE "Measurement command" has the value "setup":
 - 2> if any of the IE's "Report criteria", "Measurement quantity", "E-UTRA frequencies for measurement" or "Reporting Threshold" is not received, the UE shall:
 - 3> clear all stored measurement control information related associated to this measurement identity in variable MEASUREMENT_IDENTITY;
 - 3> set the variable CONFIGURATION_INCOMPLETE to TRUE.
 - 2> if the IE "Report criteria" is set to "Periodical reporting":
 - 3> the UE shall assume "Amount of reporting" is set to 1.
 - 2> for each occurrence of the IE "E-UTRA frequencies for measurement":
 - 3> create a new entry in the IE "E-UTRA Frequency Info List" in the variable EUTRA_FREQUENCY_INFO_LIST_FACH, and in that new entry:
 - 4> store the IE "EARFCN".
 - 4> if the value of the IE "EARFCN" is 65535, the UE shall:
 - 5> overwrite the previously stored value in the IE "EARFCN" with the value received in the IE "EARFCN extension".
 - 2> begin measurements according to the stored control information for this measurement identity.
 - 1> if the IE "Measurement command" has the value "modify":
 - 2> if the IE "Report criteria" is set to "Periodical reporting":
 - 3> the UE shall assume "Amount of reporting" is set to 1.

- 2> replace the IEs "Report criteria" and "Measurement quantity" stored in variable MEASUREMENT_IDENTITY associated to the identity indicated by the IE "measurement identity" with the IEs "Report criteria" and "Measurement quantity" received in the MEASUREMENT CONTROL message.
- 2> for each of the IEs "Measurement quantity", "E-UTRA frequencies for measurement" and "Reporting Threshold", the UE shall:
 - 3> replace all instances of the IEs listed above (and all their children) stored in variable MEASUREMENT_IDENTITY associated to the identity indicated by the IE "measurement identity" with the IEs received in the MEASUREMENT CONTROL message;
- 2> update the variable EUTRA_FREQUENCY_INFO_LIST_FACH according to the received IE "E-UTRA frequencies for measurement".
- 1> if the UE is in CELL_FACH state:
 - 2> if the measurements of type E-UTRA measurement for CELL_FACH associated with the variable MEASUREMENT_IDENTITY has been stored:
 - 3> UE shall begin the measurements and reporting on the E-UTRA frequencies stored in the variable EUTRA_FREQUENCY_INFO_LIST;

8.6.7.29 Dedicated WLAN Offload Information

If the IE "Dedicated WLAN Offload Information" is included and the UE will be in CELL_FACH or CELL_DCH state after completion of this procedure, the UE shall:

- 1> if the CHOICE "Configuration info" is set to "Continue", the UE shall:
 - 2> keep the stored information in the variable WLAN_OFFLOAD_INFO and use the stored information as specified in [4].
- 1> if the CHOICE "Configuration info" is set to "New Configuration", the UE shall:
 - 2> store the IE "Dedicated WLAN Offload Information" in the variable WLAN_OFFLOAD_INFO, replacing any previously stored information;
 - 2> use the information stored in the variable WLAN_OFFLOAD_INFO as specified in [4], and forward it to the upper layers.

If the IE "Dedicated WLAN Offload Information" is not included and the UE will be in CELL_FACH or CELL_DCH state, after completion of this procedure, the UE shall:

- 1> clear the variable WLAN_OFFLOAD_INFO;
- 1> if the UE will be in another state than CELL_DCH state:
 - 2> use the information stored in the variable SYSTEM_INFO_WLAN_OFFLOAD_INFO as specified in [4], and forward it to the upper layers.

8.6.7.30 T330 expiry

The UE shall:

- 1> if T330 expires:
 - 2> clear the variable WLAN_OFFLOAD_INFO;
 - 2> use the information stored in the variable SYSTEM_INFO_WLAN_OFFLOAD_INFO as specified in [4], and forward it to the upper layers.

8.6.7.31 Filtered UE power headroom reporting information

If the IE "Filtered UE power headroom reporting information" is included, the UE shall:

1> pass the received reporting information to the lower layers.

8.6.8 Void

8.6.8a Other Information elements

8.6.8a.1 ETWS information

If RRC is configured from upper layers to receive primary notification for ETWS, and if the IE "ETWS information" is received in a PAGING TYPE 1 or a SYSTEM INFORMATION CHANGE INDICATION message, an ETWS capable UE shall:

1> forward the IE "ETWS information" to upper layers.

NOTE: The UE may receive the IE "ETWS information" also in an ETWS PRIMARY NOTIFICATION WITH SECURITY message. The UE behaviour is specified in subclause 8.1.17.4.

8.6.9 MBMS specific information elements

The UE shall perform the generic actions defined in this subclause only for the information elements corresponding with services that are included in variable MBMS_ACTIVATED_SERVICES.

8.6.9.1 Continue MCCH Reading

If the "Continue MCCH Reading" is included the UE shall:

1> if the IE "Continue MCCH reading" is set to "TRUE":

2> continue receiving the MBMS MODIFIED SERVICES INFORMATION from MCCH in the next modification period and act upon it as specified in subclause 8.7.3.4.

8.6.9.1a MBMS dynamic persistence level

If the IE "MBMS dynamic persistence level" is included the UE shall:

1> Apply the dynamic persistence level in place of that broadcast in SIB 7 for MBMS related PRACH transmissions that are made within the modification period in which this IE was received.

8.6.9.2 MBMS PL Service Restriction Information

The UE shall:

1> if the UE receives a Radio Bearer Control message or a CELL UPDATE CONFIRM message:

2> if the IE "MBMS PL Service Restriction Information" is included:

3> set the variable MBMS_PL_SERVICE_RESTRICTION_INFO_DEDICATED to TRUE.

2> else:

3> set the variable MBMS_PL_SERVICE_RESTRICTION_INFO_DEDICATED to FALSE.

1> if the UE receives a Radio Bearer Control message or a CELL UPDATE CONFIRM message or an MBMS GENERAL INFORMATION message:

2> perform the MBMS frequency selection procedure as specified in subclause 8.5.27.

8.6.9.3 MBMS L1 combining schedule

If the IE "MBMS L1 combining schedule" is included the UE may:

- 1> apply L1 combining between the concerned neighbouring cell' S-CCPCH and the corresponding current cell's S-CCPCH for the periods indicated by this IE.

8.6.9.3a MBMS Number of neighbour cells

The UE may:

- 1> apply the number of neighbour cells to identify if all MBMS NEIGHBOURING CELL P-T-M RB INFORMATION messages have been received from MCCH.

8.6.9.4 MBMS Preferred frequency information

If the IE "MBMS Preferred frequency information" is included the UE shall:

- 1> if HCS is not used, and the IE "Qoffmbms" is not present for the MBMS preferred frequency:
 - 2> consider the cells on the MBMS preferred frequency having a Qoffmbms equal to "infinity".
- 1> if HCS is used, and the IE "HCS_OFFmbms" is not present for the MBMS preferred frequency:
 - 2> consider the cells on the MBMS preferred frequency having the highest HCS priority level.
- 1> perform the MBMS frequency selection procedure as specified in subclause 8.5.27.

8.6.9.4a Void

8.6.9.4b MBMS p-t-m activation time

Upon reception of the IE "MBMS p-t-m activation time", for the services included in the IE "Modified service list" in the MBMS MODIFIED SERVICES INFORMATION message, and, if the IE "MBMS all unmodified p-t-m services" is included in the MBMS MODIFIED SERVICES INFORMATION message, for the services included in the IE "Unmodified services list" included in the MBMS UNMODIFIED SERVICES INFORMATION message, the UE shall:

- 1> if the IE "MBMS required UE action" for this service is set to "Acquire PTM RB info":
 - 2> for the current cell:
 - 3> stop using any old configuration on TTIs that are after or contain the time instant as indicated by the IE "MBMS p-t-m activation time";
 - 3> start using the configuration for the S-CCPCH received for that p-t-m bearer in the same modification period as the IE "MBMS p-t-m activation time" on TTIs that are after or that contain the time instant as indicated by the IE "MBMS p-t-m activation time".
 - 2> for neighbouring cells:
 - 3> for the neighbouring cells for which the IE "MBMS transmission time difference" is included:
 - 4> stop using any old configuration on TTIs corresponding to the TTIs of the cell wherein the UE is reading the MCCH from and where the new p-t-m radio bearer information is valid according to the above;
 - 4>> start using the configuration for the S-CCPCH received for that p-t-m bearer in the same modification period as the IE "MBMS p-t-m activation time" on TTIs corresponding to the TTIs of the cell wherein the UE is reading the MCCH from and where the new p-t-m radio bearer information is valid according to the above.
 - 3> for the neighbouring cells for which the IE "MBMS transmission time difference" is not included:
 - 4> stop using any old configuration on TTIs that are after or contain the time instant as indicated by the IE "MBMS p-t-m activation time".

- 4> start using the configuration for the S-CCPCH received for that p-t-m bearer in the same modification period as the IE "MBMS p-t-m activation time" on TTIs that are after the time instant as indicated by the IE "MBMS p-t-m activation time".

8.6.9.5 MBMS RB list released to change transfer mode

If the IE "MBMS RB list released to change transfer mode" is included the UE shall:

- 1> perform the service prioritisation procedure as specified in subclause 8.5.26, taking into account that the MBMS service(s) for which the radio bearers are released will be provided via p-t-m radio bearer(s).

8.6.9.6 MBMS Required UE action

If the IE "MBMS required UE action" is included and concerns an MBMS activated service the UE shall:

- 1> if the "MBMS required UE action" is set to 'None':
 - 2> take no action with respect to this IE.
- 1> if the IE "MBMS required UE action" is set to 'Acquire counting info' or set to 'Acquire counting info– PTM RBs unmodified':
 - 2> perform the MBMS counting procedure as specified in subclause 8.7.4;

NOTE: If upper layers indicate that an MBMS transmission has already been received correctly, the UE will continue as if the information about the concerned MBMS transmission was not included in the message. This implies that the UE does not respond to counting for a transmission already received correctly.

- 1> if the IE "MBMS required UE action" is set to 'Acquire PTM RB info'; or
- 1> if the IE "MBMS required UE action" is set to 'Acquire counting info– PTM RBs unmodified' and the UE is not receiving a p-t-m RB for the concerned service:
 - 2> continue acquiring the MBMS COMMON P-T-M RB INFORMATION, MBMS CURRENT CELL P-T-M RB INFORMATION and the MBMS NEIGHBOURING CELL P-T-M RB INFORMATION messages without delaying reading of MCCH until the next modification period and without stopping at the end of the modification period, in accordance with subclause 8.7.1.3
 - 2> act upon the MBMS COMMON P-T-M RB INFORMATION, MBMS CURRENT CELL P-T-M RB INFORMATION and the MBMS NEIGHBOURING CELL P-T-M RB INFORMATION message, if received, in accordance with subclause 8.7.5;
- 1> if the IE "MBMS required UE action" is set to 'Request PTP RB':
 - 2> if the UE is in idle mode:
 - 3> indicate to upper layers that establishment of a PS signalling connection is required to receive the concerned MBMS [5], unless the UE has already requested p-t-p RB establishment in the current modification period, and use the establishment cause set to 'MBMS ptp RB request' in the RRC connection establishment procedure.
 - 2> if the UE is in URA_PCH, CELL_PCH or CELL_FACH states:
 - 3> indicate to upper layers to initiate a service request procedure [5] to receive the concerned MBMS service;
 - 3> perform the cell update procedure with cause "MBMS ptp RB request", as specified in subclause 8.3.1.2, unless the UE has already requested p-t-p RB establishment in the current modification period.
 - 2> if the UE is in CELL_DCH:
 - 3> indicate to upper layers to initiate a service request procedure [5] to receive the concerned MBMS service.
- 1> if the IE "MBMS required UE action" is set to 'Release PTM RB':

- 2> stop receiving the concerned MBMS service;
- 2> for 1.28 Mcps TDD, if the IE "MBMS PTM RB Release Cause" is present to indicate the actual MBMS PTM RB release cause to UE:
 - 3> pass the value of the IE "MBMS PTM RB Release Cause" to upper layers.
- 2> if the UE is in a state other than CELL_DCH (for FDD) or if the UE is in Idle mode, URA_PCH or CELL_PCH state (for TDD); and
- 2> if the UE decides not to receive an MBMS service indicated on the MCCH; and
- 2> if the variable MBMS_PREV_FREQUENCY_INFO is not empty:
 - 3> if any frequency in SIB11 or SIB12 has the same frequency stored in the variable MBMS_PREV_FREQUENCY_INFO:
 - 4> select a suitable UTRA cell in that frequency.
 - 4> if no suitable UTRA cell in that frequency is found:
 - 5> select a suitable UTRA cell in another frequency.
 - 3> if no frequency in SIB11 or SIB12 has the same frequency stored in the variable MBMS_PREV_FREQUENCY_INFO.
 - 4> select a frequency randomly among the inter-frequencies indicated in SIB11 or SIB12.
 - 5> select a suitable UTRA cell in the selected frequency
 - 5> if no suitable UTRA cell in the selected frequency is found:
 - 6> select a suitable UTRA cell in another frequency.
 - 3> clear the variable MBMS_PREV_FREQUENCY_INFO.
 - 2> clear all service specific information applicable for the concerned service.

NOTE: The UE is only required to acquire the relevant SIB11 or SIB12, according to what is specified in subclauses 8.1.1.6.11 and 8.1.1.6.12.

8.6.9.6a MBMS re- acquire MCCH

If the UE receives the IE " MBMS re- acquire MCCH", the UE shall:

- 1> perform the MCCH acquisition procedure as specified in subclause 8.7.2.

8.6.9.7 MBMS Service transmissions info list

If the UE receives the IE "MBMS Service transmissions info list", the UE may:

- 1> discontinue reception of the S-CCPCH on which the IE was received, except for the service transmissions indicated by this IE for the concerned scheduling period.

8.6.9.8 MBMS Short transmission ID

If the IE "MBMS short transmission ID" is included the UE shall:

- 1> if the value of the "MBMS short transmission ID" is less than or equal to the number of services identified by the IE "Modified services list" included in the MBMS MODIFIED SERVICES INFORMATION message acquired in the same modification period as the one in which the "MBMS short transmission ID" is received:
- 2> consider the "MBMS short transmission ID" to be an index to the list of services contained in the IE "Modified services list" and apply the MBMS transmission identity specified for this entry.

- 1> otherwise:

- 2> compile a list of available MBMS services, as included in the MBMS MODIFIED SERVICES INFORMATION and the MBMS UNMODIFIED SERVICES INFORMATION messages acquired in the same modification period as the one in which the "MBMS short transmission ID" is received:
- 3> concatenate the services contained in IE "Modified services list" included in the MBMS MODIFIED SERVICES INFORMATION and the services contained in IE "Unmodified services list" included in the MBMS UNMODIFIED SERVICES INFORMATION.
- 2> consider the 'MBMS short transmission ID' to be the index of the entry in the list of available services and apply the MBMS transmission identity specified for this entry.

8.6.9.9 MBMS Transmission identity

If the IE "MBMS transmission identity" is included the UE shall:

- 1> if upper layers indicate that the MBMS transmission has already been received correctly:
 - 2> ignore the information about this MBMS transmission i.e. continue as if the information about the concerned MBMS transmission was not included in the message.
- 1> otherwise:
 - 2> act upon the information about the concerned MBMS transmission as specified elsewhere.

The UE behaviour is unspecified if an MBMS transmission identity appears more than once in the combined list of transmissions i.e. the IE is included more than once in the MBMS MODIFIED SERVICES INFORMATION or in the MBMS UNMODIFIED SERVICES INFORMATION, or once in both message.

8.6.9.9a MBMS transmission time difference

The IE "MBMS transmission time difference" indicates the time difference between the transmissions on the current and the neighbour cell i.e. indicating the TTIs that can be L1- combined. The UE shall:

- 1> derive the parameter Neighbor_Start from the IE MBMS transmission time difference as follows:

$$\text{MBMS transmission time difference} = (\text{Neighbor_Start} / \text{Max_TTI_Size}) \bmod 4$$

where Neighbor_Start is the CFN of the first radio frame in a TTI on the neighbour cell that may be combined with the TTI on the current cell of which the CFN of the first radio frame equals 0 while Max_TTI_Size is the largest TTI size on the S-CCPCHs to be soft combined;

- 1> in case of partial soft combining, derive the CFN of the first radio frame in a TTI on the neighbour cell that may be combined assuming the same time difference applies.

The maximum delay between S-CCPCH clusters that the UE may combine is set by UE performance requirements.

NOTE: The MBMS transmission time difference is semi-static; it does not vary within or between L1 combining periods nor when full combining is used.

8.6.9.9ab MBSFN cluster frequency

If the cell is operating in MBSFN mode according to subclause 8.1.1.6.3 the UE shall:

- 1> if for two or more services included in variable MBMS_ACTIVATED_SERVICES the IE "MBSFN cluster frequency" is available:
 - 2> request from upper layers the priorities of the different MBMS services included in variable MBMS_ACTIVATED_SERVICES for which the IE "MBSFN cluster frequency" is available;
 - 2> if the IE "MBSFN cluster frequency" is available for the service with the highest priority included in variable MBMS_ACTIVATED_SERVICES:
 - 3> tune to the frequency indicated in the IE "MBSFN cluster frequency" of that service.

8.6.9.9ac MBSFN frequency list

For FDD and 3.84/7.68 Mcps TDD this IE may be included in system information block 11 in a cell which is not providing MBMS service in MBSFN mode in order to provide information about frequencies providing MBMS service in MBSFN mode. For 1.28 Mcps TDD this IE shall be included in system information block 11 in a cell which is not providing MBMS service in MBSFN only mode but is associated with one or more cells in MBSFN only mode, in order to provide information about frequencies providing MBMS service in MBSFN only mode, and this IE also provides information about the secondary frequencies providing MBMS service in non-MBSFN only mode of current multi-frequency cell.

If the IE "MBSFN frequency list" is included in system information block 11, a UE may consider that all frequencies on which FDD or 3.84/7.68 Mcps TDD cells providing MBMS service in MBSFN mode are listed in the IE "MBSFN frequency list". If the IE "IMB indication" is included in the IE "MBSFN frequency list", the UE shall consider that the cells on the corresponding frequencies are 3.84 Mcps TDD IMB cells providing MBMS service in MBSFN mode.

If the IE "MBSFN frequency list" is included in system information block 11 and no frequency is included in the IE "MBSFN frequency list" a UE may consider that no cell operating in MBSFN mode is available.

For FDD and 3.84/7.68 Mcps TDD if the IE "MBSFN frequency list" is not included in system information block 11 and if services are listed in the variable MBMS_ACTIVATED_SERVICES a UE supporting reception of MBMS service in MBSFN mode shall search for cells providing MBMS service in MBSFN mode.

For 1.28 Mcps TDD the IE "Cell parameter ID" in the IE "MBSFN frequency list" included in system information block 11 indicates the cell which is providing MBMS service in MBSFN only mode on the corresponding frequency; if the IE "Cell parameter ID" is not included in the IE "MBSFN frequency list", a UE may consider that the corresponding frequency is the secondary frequency providing MBMS service in non-MBSFN only mode of current multi-frequency cell.

8.6.9.9ad MBSFN inter frequency neighbour list

For FDD, 3.84 Mcps TDD IMB and 3.84/7.68 Mcps TDD, this IE may be signalled in the "MBMS GENERAL INFORMATION" message received in the cells providing MBMS service in MBSFN mode. If the IE "MBSFN inter frequency neighbour list" is included and the UE does not receive a service from this MBSFN cluster, the UE shall:

- 1> consider that MBMS services transmitted in MBSFN mode are available on these frequencies;
- 1> if IE "IMB indication" is included:
 - 2> consider that the cells on the corresponding frequencies are 3.84 Mcps TDD IMB cells providing MBMS service in MBSFN mode.
- 1> if "MBSFN services notified" is indicated for a frequency listed in the IE "MBSFN inter frequency neighbour list":
 - 2> consider that available services provided on this frequency are notified on the current frequency.
- 1> if at least one frequency is listed for which "MBSFN services not notified" is indicated in the IE "MBSFN inter frequency neighbour list":
 - 2> if the IE "All MBSFN services notified" is included for one frequency, as defined in [21] for FDD and [22] for TDD, on which the UE supports reception in MBSFN mode:
 - 3> attempt to receive notifications on one of the frequencies for which the IE "All MBSFN services notified" is included according to subclause 8.7.3.
 - 2> else:
 - 3> attempt to receive notifications on all frequencies for which the IE "MBSFN services not notified" is indicated as specified in subclause 8.7.3 on that band.

NOTE 1: The UE may not be able to receive frequencies listed in the IE "MBSFN inter frequency neighbour list" on a different band compared to the band on which the information is sent (this depends on UE capabilities).

NOTE 2: The indications for different frequencies (i.e. "MBSFN services notified", "MBSFN services not notified", "All MBSFN services notified") in the MBMS GENERAL INFORMATION message can be different depending on the frequency in which the MBMS GENERAL INFORMATION message has been received.

8.6.9.9ae MBSFN TDM Information

If the IE "MBSFN TDM Information List" is included, the UE shall:

- 1> assume that the MBMS service identified in IE "MBMS short transmission ID" can be received only in frame(s) with the CFN fulfilling the following equation:

$$(CFN \text{ div } N) \bmod \text{TDM_Rep} = \text{TDM_Offset} + i, i = 0 \text{ to } \text{TDM_Length} - 1$$

where

- N is the TTI (in number of 10ms frames) of the FACH
- TDM_Rep is the repetition period
- TDM_Offset is the offset
- TDM_Length is the number of TTIs the MBMS Service is transmitted, starting from TDM_Offset
- CFN is set according to subclause 8.5.15.3 (Initialisation for CELL_FACH).

8.6.9.9b MCCH configuration information

If the IE "MCCH configuration information" is included the UE shall:

- 1> Consider an access information period to start from the frame with the SFN value fulfilling the following equation (where m is the modification period coefficient and a is the access info period coefficient):

$$\text{SFN} \bmod 2^{(m-a)} = 0$$

- 1> Consider a repetition period to start from the frame with the SFN value fulfilling the following equation (where m is the modification period coefficient and r is the repetition period coefficient):

$$\text{SFN} \bmod 2^{(m-r)} = 0$$

- 1> Consider a modification period to start from the frame with the SFN value fulfilling the following equation (where m is the modification period coefficient):

$$\text{SFN} \bmod 2^m = 0$$

- 1> configure the RLC entity in the UE used for receiving MCCH in accordance with 8.6.4.9;

- 1> configure the MAC entity in the UE, used for receiving MCCH, for receiving TCTF field unless the IE 'TCTF presence' is received;

8.6.9.10 Next scheduling period

If the IE "Next scheduling period" is included for an MBMS service the UE may:

- 1> discontinue reception of the given MBMS service for the number of scheduling periods indicated by this IE.

8.6.9.11 TDD MBSFN Information

For TDD if the UE receives "TDD MBSFN Information" (via System Information Block type 5) then the UE shall assume that any CCTrCH configured to use the timeslots indicated by this IE shall use MBSFN Burst Type.

8.6.9.12 Network Standard Time Information

For 1.28Mcps TDD, when UE receives "Network Standard Time Information" via MBMS general information, the UE can adjust its local time settings according to the values in "Network Standard Time Information". The adjustment process is as following:

- 1) Compare currently SFN and "Correlative SFN", get a difference;
- 2) Add this difference to "Network Standard Time"

The result is the precise standard time in currently SFN, and then UE can maintain this standard time. How often does UE do this adjustment is a UE implementation.

8.7 MBMS specific procedures

8.7.1 Reception of MBMS control information

8.7.1.1 General

The procedure for receiving MBMS control information is used by a UE to receive information from UTRAN concerning the way it provides MBMS services the UE has activated. The procedure applies to all UEs supporting MBMS, irrespective of its state (idle, URA_PCH, CELL_PCH, CELL_FACH and CELL_DCH).

Most MBMS control information is provided on the MCCH. The information on MCCH is transmitted using a fixed schedule, which is common for all services. MCCH information other than MBMS ACCESS INFORMATION message is transmitted periodically based on a repetition period. This MCCH information is repeated a configurable number of times with exactly the same content; the period in which the content of MCCH information other than MBMS ACCESS INFORMATION message remains unchanged is called the modification period. MBMS ACCESS INFORMATION message may be transmitted more frequently, based on the Access Info period. The transmissions of MBMS ACCESS INFORMATION message within a modification period need not have exactly the same content (the value of some parameters eg. IE 'Access probability factor – Idle' may change). Nevertheless, the transmissions of MBMS ACCESS INFORMATION message within a modification period should concern the same MBMS service(s), although information for a service may be removed eg. upon completion of the counting for that service.

The general principles are illustrated in figure 8.7.1-1, in which different colours indicate potentially different content of the MCCH information.

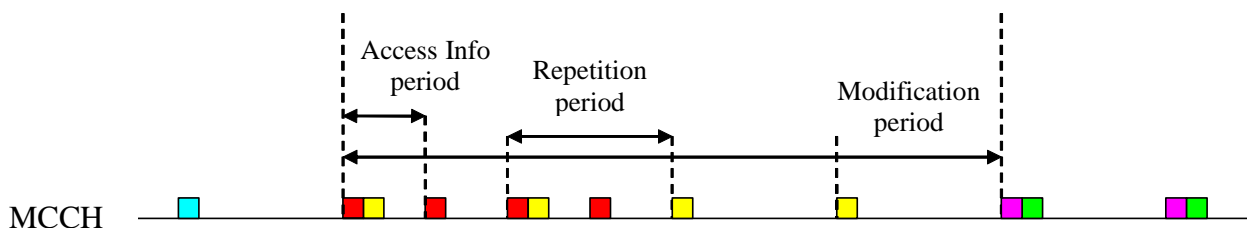

Figure 8.7.1-1: Scheduling of MCCH Information

For services provided via a p-t-m radio bearer scheduling information may be provided on an MSCH mapped on the same S-CCPCH as the p-t-m radio bearer(s). For some of the services provided p-t-m this scheduling information may be provided by signalling an MBMS SCHEDULING INFORMATION message at every scheduling period, while for others the MBMS SCHEDULING INFORMATION message may be signalled less frequently i.e. after a multiple of the scheduling period. In general, the UE is neither required to acquire MSCH information nor to act on it.

In case the UE shall acquire MCCH information that is scheduled at the same time as MSCH information, the reception of the MCCH information shall take precedence.

In order to minimise the time the UE needs to read MCCH upon notification as specified in 8.7.3 to acquire the required information, UTRAN should schedule the MCCH messages in a specific order ie. any message that needs to be read by any UE due to the reception of the MBMS MODIFIED SERVICES INFORMATION message should be scheduled prior to the remaining messages. More specifically, the UE may assume that UTRAN schedules the MCCH messages in the following order:

MBMS MODIFIED SERVICES INFORMATION,

followed by messages that needs to be read by any UE due to the content of the MBMS MODIFIED SERVICES INFORMATION message in the following order: MBMS GENERAL INFORMATION, MBMS COMMON P-T-M RB INFORMATION, MBMS CURRENT CELL P-T-M RB INFORMATION, one or more MBMS NEIGHBOURING CELL P-T-M RB INFORMATION,

MBMS UNMODIFIED SERVICES INFORMATION,

followed by messages that do not need to be read by any UE due to the content of the MBMS MODIFIED SERVICES INFORMATION message in the following order: MBMS GENERAL INFORMATION, MBMS COMMON P-T-M RB INFORMATION, MBMS CURRENT CELL P-T-M RB INFORMATION, one or more MBMS NEIGHBOURING CELL P-T-M RB INFORMATION

8.7.1.2 Initiation

The requirements concerning which MBMS control information the UE shall acquire in the different cases is specified in other subclauses. This section specifies common requirements concerning the reception of MCCH information and MSCH information.

8.7.1.3 UE requirements on reading of MCCH information

When requested to acquire MBMS control information other than the MBMS ACCESS INFORMATION message , the UE shall:

- 1> if requested to start reading MCCH at the next modification period:
 - 2> start reading MCCH at the beginning of the next modification period.
- 1> otherwise
 - 2> start reading MCCH at the beginning of the next repetition period.
- 1> if requested to stop reading MCCH at the end of the modification period:
 - 2> continue reading MCCH until the required MBMS control information is received or until the UE detects a TTI in which no MCCH information is transmitted, whichever is first;
 - 2> continue reading MCCH in this manner at every subsequent repetition period, until the information is received correctly or until the end of the modification period.
- 1> otherwise:
 - 2> continue reading MCCH until the required MBMS control information is received or until the UE detects a TTI in which no MCCH information is transmitted, whichever is first;
 - 2> continue reading MCCH in this manner at every subsequent repetition period, until the information is received correctly.

NOTE 1: The UE may combine information received at different repetition periods within a modification period.

When requested to acquire the MBMS ACCESS INFORMATION message, the UE shall:

- 1> if requested to start reading MCCH at the next modification period:
 - 2> start reading MCCH at the beginning of the next modification period.
- 1> otherwise:
 - 2> start reading MCCH at the beginning of the next access info period.
- 1> continue reading MCCH in this manner at every subsequent access info period, until the message is received correctly or until the end of the modification period.

If the UE is CELL_DCH and has a compressed mode pattern that overlaps with the period in which it needs to read MCCH, the UE may temporarily refrain from receiving MCCH unless it is capable of simultaneous operation. If the UE

is CELL_FACH and has a measurement occasion that overlaps with the period in which it needs to read MCCH, the UE may temporarily refrain from receiving MCCH unless it is capable of simultaneous operation. A UE in CELL_FACH may omit performing measurements during a measurement occasion in order to receive MCCH provided that this does not prevent it from fulfilling the measurement performance requirements as specified in [19]. In Idle mode as well as in CELL_PCH and URA_PCH states the UE may temporarily refrain from receiving MCCH if needed to fulfil the measurements performance requirements as specified in [19].

NOTE 2: The UTRAN should endeavour to ensure that for each UE in CELL_FACH the assigned measurement occasions do not overlap constantly with the periodic MCCH transmissions.

If the UE selects to another cell, the UE shall re-establish the RLC entity used for MCCH reception.

8.7.1.4 UE requirements on reading of MSCH information

If the UE supports reception of MSCH, UE shall:

- 1> if the UE needs to acquire MCCH information that is transmitted at the same time as the MSCH information and the UE does not support simultaneous reception:
 - 2> refrain from reading MSCH.

If the UE supports reception of MSCH, UE should:

- 1> start reading MSCH at the beginning of the next scheduling period;
- 1> continue reading MSCH until the required MBMS control information is received or until the UE detects a TTI in which no MSCH information is transmitted, whichever is first.

8.7.2 MCCH acquisition

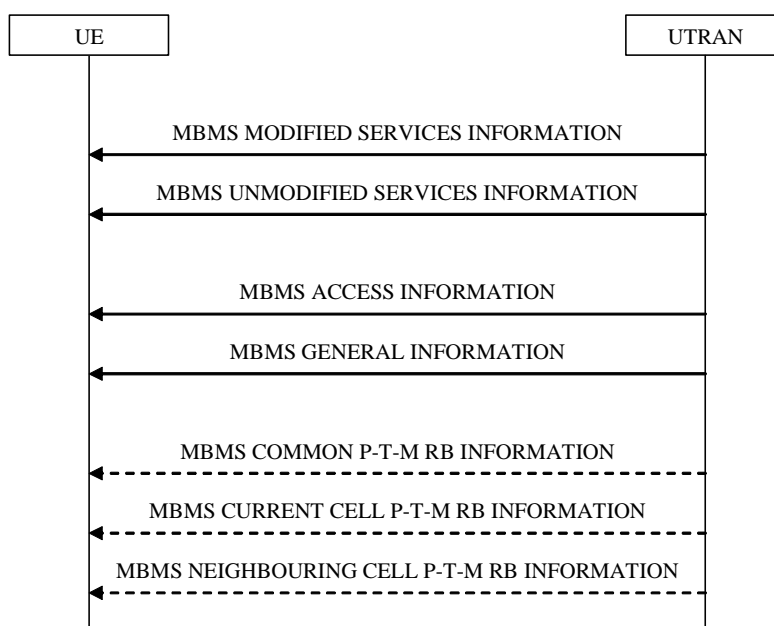

Figure 8.7.2-1: MCCH acquisition, normal

8.7.2.1 General

The UE applies the MCCH acquisition procedure to determine the MBMS services available in the cell and to initiate reception of the services that the UE has activated. The procedure applies to all UEs supporting MBMS, irrespective of their state (idle, URA_PCH, CELL_PCH, CELL_FACH and CELL_DCH). The UE may also apply the MCCH acquisition procedure to inform NAS of other available services that are not activated.

For 1.28 Mcps TDD, if the cell is operating in MBSFN mode, the MCCH will be deployed on the MBSFN Special Timeslot [30].

8.7.2.2 Initiation

If the variable `MBMS_ACTIVATED_SERVICES` is not empty, the UE shall apply the MCCH acquisition procedure upon selecting (eg. upon power on) or re-selecting a cell supporting MBMS or an MBSFN cluster, upon change of MBMS controlling cell (eg. due to an active set update or hard handover), upon entering UTRA from another RAT, upon release of a MBMS P-T-M RB for the purpose of changing transfer mode, upon return from loss of coverage and upon receiving an indication from upper layers that the set of activated services has changed.

8.7.2.3 MCCH information to be acquired by the UE

The UE shall detect the available MBMS services by acquiring the `MBMS MODIFIED SERVICES INFORMATION` and the `MBMS UNMODIFIED SERVICES INFORMATION` messages without delaying reading of MCCH until the next modification period and without stopping at the end of the modification period, in accordance with subclause 8.7.1.3.

For cells not operating in MBSFN mode as indicated in subclause 8.1.1.6.3 the UE shall immediately acquire the `MBMS ACCESS INFORMATION` and the `MBMS GENERAL INFORMATION` messages ie. it shall not delay reception of these messages until it has completed the acquisition of the `MBMS MODIFIED SERVICES INFORMATION` and the `MBMS UNMODIFIED SERVICES INFORMATION` messages. Likewise for cells not operating in MBSFN mode as indicated in subclause 8.1.1.6.3, the UE should immediately acquire the `MBMS CURRENT CELL P-T-M RB INFORMATION` and `MBMS NEIGHBOURING CELL P-T-M RB INFORMATION` messages.

For cells operating in MBSFN mode as indicated in subclause 8.1.1.6.3 the UE shall immediately acquire the `MBMS GENERAL INFORMATION` messages ie. it shall not delay reception of these messages until it has completed the acquisition of the `MBMS MODIFIED SERVICES INFORMATION` and the `MBMS UNMODIFIED SERVICES INFORMATION` messages. Likewise for cells operating in MBSFN mode as indicated in subclause 8.1.1.6.3, the UE should immediately acquire the `MBMS CURRENT CELL P-T-M RB INFORMATION`.

The UE shall continue acquiring the above messages until it has received a consistent set of MCCH information eg. both the `MBMS MODIFIED SERVICES INFORMATION` and the `MBMS UNMODIFIED SERVICES INFORMATION` message should be acquired in the same modification period.

8.7.2.4 Reception of the `MBMS MODIFIED SERVICES INFORMATION` and the `MBMS UNMODIFIED SERVICES INFORMATION` by the UE

If the UE is receiving an MBMS service that is not included in variable `MBMS_ACTIVATED_SERVICES` and that is using a p-t-m radio bearer, the UE shall:

- 1> stop receiving the concerned MBMS service and clear all service specific information applicable for the concerned service.
- 1> if the UE is in a state other than `CELL_DCH` (for FDD) or if the UE is in Idle mode, `URA_PCH` or `CELL_PCH` state (for TDD); and
- 1> if the UE does not decide to receive an MBMS service; and
- 1> if the variable `MBMS_PREV_FREQUENCY_INFO` is not empty:
 - 2> if any frequency in `SIB11` or `SIB12` has the same frequency stored in the variable `MBMS_PREV_FREQUENCY_INFO`:
 - 3> select a suitable UTRA cell in that frequency;
 - 3> if no suitable UTRA cell in that frequency is found:
 - 4> select a suitable UTRA cell in another frequency.
 - 2> if no frequency in `SIB11` or `SIB12` has the same frequency stored in the variable `MBMS_PREV_FREQUENCY_INFO`:
 - 3> select a frequency randomly among the inter-frequencies indicated in `SIB11` or `SIB12`:
 - 4> select a suitable UTRA cell in the selected frequency;

4> if no suitable UTRA cell in the selected frequency is found:

5> select a suitable UTRA cell in another frequency.

2> clear the variable MBMS_PREV_FREQUENCY_INFO.

NOTE: The UE is only required to acquire the relevant SIB11 or SIB12, according to what is specified in subclauses 8.1.1.6.11 and 8.1.1.6.12.

Upon completing the reception of the MBMS MODIFIED SERVICES INFORMATION and the MBMS UNMODIFIED SERVICES INFORMATION messages, the UE shall

- 1> act as follows for each of the services included in these messages provided that the service is included in variable MBMS_ACTIVATED_SERVICES and upper layers indicate that the session has not yet been received correctly (referred to as 'applicable services');
- 1> act upon all received information elements as specified in subclause 8.6, unless specified otherwise in the following;
 - 1> if one or more preferred frequency applies for the applicable services:
 - 2> delay acting upon the "MBMS Preferred frequency information" until receiving the relevant MCCH information i.e. the MBMS GENERAL INFORMATION message;
 - 2> act upon the "MBMS Preferred frequency information" as specified in subclause 8.6.9.4 for the service(s) that upper layers indicate to have highest priority.
- 1> perform the MBMS frequency selection procedure as specified in subclause 8.5.27;
- 1> if the UE receives an MBMS service using a p-t-m radio bearer and the received messages do not contain an IE "MBMS required UE action" set to "Acquire PTM RB info" or set to "Acquire counting info- PTM RBs unmodified" for that service then the UE shall:
 - 2> stop receiving the concerned MBMS service and clear all service specific information applicable for the concerned service.

8.7.2.5 Reception of the other MBMS messages by the UE

For cells not operating in MBSFN mode as indicated in subclause 8.1.1.6.3, upon receiving the MBMS ACCESS INFORMATION message, the UE shall act as specified in subclause 8.7.4.3.

Upon receiving the MBMS GENERAL INFORMATION message, the UE should store all relevant IEs included in this message. The UE shall also:

- 1> act upon all received information elements as specified in subclause 8.6, unless specified otherwise in the following.

For cells not operating in MBSFN mode as indicated in subclause 8.1.1.6.3, upon receiving the MBMS CURRENT CELL P-T-M RB INFORMATION and MBMS NEIGHBOURING CELL P-T-M RB INFORMATION messages, the UE shall act as specified in subclauses 8.7.5.3 and subclause 8.7.5.4 respectively.

For cells operating in MBSFN mode as indicated in subclause 8.1.1.6.3 upon receiving the MBMS CURRENT CELL P-T-M RB INFORMATION message, the UE shall act as specified in subclauses 8.7.5.3.

The procedure ends.

8.7.3 MBMS Notification

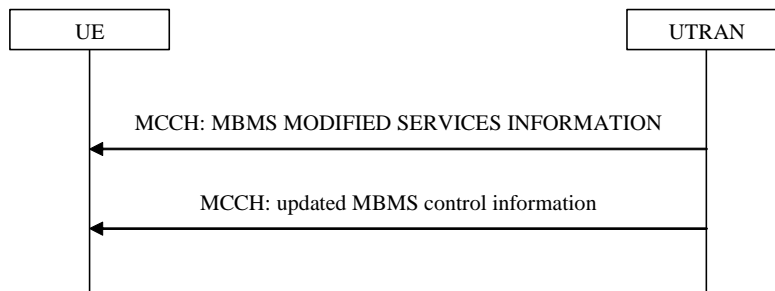

Figure 8.7.3-1: MBMS notification on MCCH

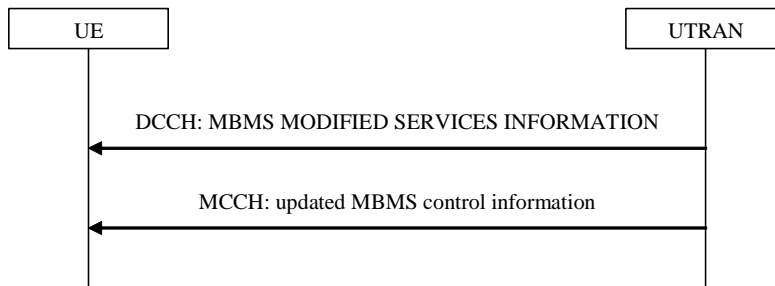

Figure 8.7.3-2: MBMS notification on DCCH

8.7.3.1 General

The MBMS notification procedure is used by the UE to respond to a notification provided by UTRAN, indicating a change applicable for one or more MBMS services the UE has activated. The procedure applies to all UEs supporting MBMS, irrespective of their state (idle and connected mode: URA_PCH, CELL_PCH, CELL_FACH and CELL_DCH). The actual notification mechanism to be used depends on the UE state.

Reception of the MBMS MODIFIED SERVICES INFORMATION message on DCCH is optional for a UE capable of reading MCCH in CELL_DCH.

8.7.3.2 Initiation

UTRAN initiates the notification procedure to inform UEs about a change applicable for one or more MBMS services available in a cell. Some types of MBMS service changes e.g. the establishment of a p-t-m radio bearer, involve a modification of MCCH messages other than the MBMS MODIFIED SERVICES INFORMATION message.

NOTE 1: On MCCH, the MBMS MODIFIED SERVICES INFORMATION as well as the MBMS UNMODIFIED SERVICES INFORMATION messages are signalled even if no services are contained in the message.

NOTE 2: A service remains in the MBMS MODIFIED SERVICES INFORMATION message until it enters a 'steady state', upon which it moves to the MBMS UNMODIFIED SERVICES INFORMATION message. In case counting is used, the service remains in the MBMS MODIFIED SERVICES INFORMATION message through the moment UTRAN has decided the transfer mode.

8.7.3.3 Receiving the MBMS Notification information

8.7.3.3.1 Reception via MCCH

The UE may:

- 1> monitor the MBMS notification Indicator Channel (MICH);
- 1> if a notification on the MICH for one or more of the MBMS services included in the variable MBMS_ACTIVATED_SERVICES is detected:

2> acquire the MBMS MODIFIED SERVICES INFORMATION message with delaying the reading of MCCH until the next modification period and with stopping at the end of the modification period, in accordance with subclause 8.7.1.3;

2> handle the MBMS MODIFIED SERVICES INFORMATION message as specified in subclause 8.7.3.4.

The UE shall:

1> if in idle mode, URA_PCH, CELL_PCH or CELL_FACH state:

2> if not monitoring MICH during the current or the previous modification period:

3> acquire the MBMS MODIFIED SERVICES INFORMATION message from MCCH at the start of every modification period, in accordance with subclause 8.7.1.3;

3> handle the MBMS MODIFIED SERVICES INFORMATION message as specified in subclause 8.7.3.4.

1> if in CELL_DCH state:

2> if receiving an MBMS service that is provided via a p-t-m radio bearer and not monitoring MICH:

3> acquire the MBMS MODIFIED SERVICES INFORMATION message from MCCH at the start of every modification period, in accordance with subclause 8.7.1.3;

3> handle the MBMS MODIFIED SERVICES INFORMATION message as specified in subclause 8.7.3.4.

8.7.3.3.2 Void

8.7.3.3.3 Reception via DCCH

Notification via DCCH is used to notify the UE about the start of a session for which a PL applies, to notify the UE about the establishment of a p-t-m radio bearer and to request a UE in PMM_idle state to establish a PMM connection to enable reception of a service provided via a p-t-p radio bearer.

Upon receiving the MBMS MODIFIED SERVICES INFORMATION message via DCCH, a UE in CELL_DCH shall:

1> handle the MBMS MODIFIED SERVICES INFORMATION message as specified in subclause 8.7.3.4.

8.7.3.4 UE action upon receiving MBMS MODIFIED SERVICES INFORMATION message

Upon receiving the MBMS MODIFIED SERVICES INFORMATION message, if the IE "MIB Value tag" is present, the UE should check it to ensure that the stored system information blocks are up to date. If the received IE "MIB Value tag" does not match the value tag stored in the variable VALUE_TAG for the master information block the UE should not consider any MBMS configuration stored or received to be valid, until the stored system information blocks are up to date.

Upon receiving the MBMS MODIFIED SERVICES INFORMATION message, the UE shall act as follows for each of the services included in this messages provided that the service is included in variable MBMS_ACTIVATED_SERVICES and upper layers indicate that the session has not yet been received correctly (referred to as 'applicable services'):

1> if the IE "MBMS all unmodified p-t-m services" is included in the MBMS MODIFIED SERVICES INFORMATION messages:

2> for all services listed in the message UNMODIFIED SERVICES INFORMATION, provided that the service is included in variable MBMS_ACTIVATED_SERVICES, upper layers indicate that the session has not yet been received correctly (referred to as 'applicable services') and the IE "MBMS required UE action" in the message MBMS UNMODIFIED SERVICES INFORMATION is set to "Acquire PTM RB info":

3> continue acquiring the MBMS UNMODIFIED SERVICES INFORMATION, MBMS COMMON P-T-M RB INFORMATION, MBMS CURRENT CELL P-T-M RB INFORMATION, and for FDD and

3.84/7.68 Mcps TDD cells not operating in MBSFN mode as indicated in subclause 8.1.1.6.3 the MBMS NEIGHBOURING CELL P-T-M RB INFORMATION messages without delaying reading of MCCH until the next modification period and without stopping at the end of the modification period, in accordance with subclause 8.7.1.3;

- 3> act upon the MBMS UNMODIFIED SERVICES INFORMATION MBMS COMMON P-T-M RB INFORMATION, MBMS CURRENT CELL P-T-M RB INFORMATION and for FDD and 3.84/7.68 Mcps TDD cells not operating in MBSFN mode as indicated in subclause 8.1.1.6.3 the MBMS NEIGHBOURING CELL P-T-M RB INFORMATION message, if received, in accordance with subclause 8.7.5, and assuming the p-t-m configuration indicated in these messages is valid immediately, unless the IE "MBMS p-t-m activation time" is included in the MBMS MODIFIED SERVICES INFORMATION message.
- 2> if the UE receives an MBMS service using a p-t-m radio bearer and the messages MBMS UNMODIFIED SERVICES INFORMATION and MBMS MODIFIED SERVICES INFORMATION do not contain an IE "MBMS required action" set to "Acquire PTM RB info" or set to "Acquire counting info – PTM RBs unmodified" for that service then the UE shall:
 - 3> stop receiving the concerned MBMS service and clear all service specific information applicable for the concerned service.
 - 3> if the UE is in a state other than CELL_DCH (for FDD) or if the UE is in Idle mode, URA_PCH or CELL_PCH state (for TDD); and
 - 3> if the UE does not decide to receive an MBMS service; and
 - 3> if the variable MBMS_PREV_FREQUENCY_INFO is not empty:
 - 4> if any frequency in SIB11 or SIB12 has the same frequency stored in the variable MBMS_PREV_FREQUENCY_INFO:
 - 5> select a suitable UTRA cell in that frequency;
 - 5> if no suitable UTRA cell in that frequency is found:
 - 6> select a suitable UTRA cell in another frequency.
 - 4> if no frequency in SIB11 or SIB12 has the same frequency stored in the variable MBMS_PREV_FREQUENCY_INFO:
 - 5> select a frequency randomly among the inter-frequencies indicated in SIB11 or SIB12:
 - 6> select a suitable UTRA cell in the selected frequency;
 - 6> if no suitable UTRA cell in the selected frequency is found:
 - 7> select a suitable UTRA cell in another frequency.
 - 4> clear the variable MBMS_PREV_FREQUENCY_INFO.

NOTE: The UE is only required to acquire the relevant SIB11 or SIB12, according to what is specified in subclauses 8.1.1.6.11 and 8.1.1.6.12.

- 1> act upon all received information elements as specified in subclause 8.6, unless specified otherwise in the following
 - 1> if one or more preferred frequency applies for the applicable services:
 - 2> acquire the MBMS GENERAL INFORMATION message.
 - 1> perform the MBMS frequency selection procedure as specified in subclause 8.5.27;
 - 1> the procedure ends.

8.7.3.5 UE fails to receive MBMS Notification information

If the UE fails to receive the MBMS MODIFIED SERVICES INFORMATION message within the current modification period, the UE shall:

- 1> Acquire the MBMS MODIFIED SERVICES INFORMATION and the MBMS UNMODIFIED SERVICES INFORMATION messages without delaying reading of MCCH until the next modification period and with stopping at the end of that modification period, in accordance with subclause 8.7.1.3;
- 1> act upon the received MBMS MODIFIED SERVICES INFORMATION and the MBMS UNMODIFIED SERVICES INFORMATION messages as specified in subclause 8.7.2.4.

8.7.4 MBMS counting

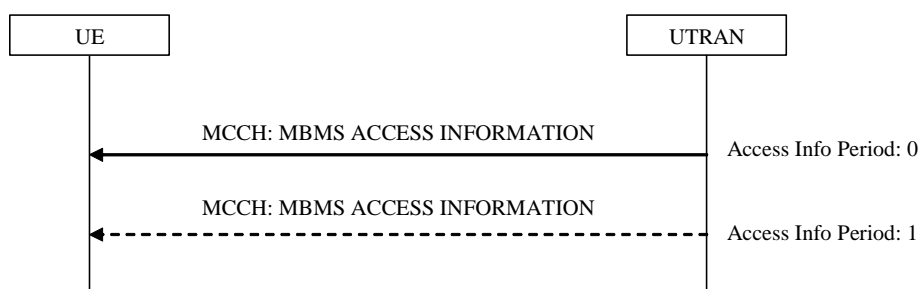

Figure 8.7.4-1: MBMS counting, normal

8.7.4.1 General

The MBMS counting procedure is used by the UE to inform UTRAN about its interest to receive an MBMS transmission. The procedure applies to UEs supporting MBMS that are in idle mode or in connected mode for cells not operating in MBSFN mode as indicated in subclause 8.1.1.6.3. In connected mode the procedure applies to the URA_PCH, CELL_PCH and/ or CELL_FACH states dependent upon the value of the IE "Connected mode counting scope".

8.7.4.2 Initiation

The UE initiates the MBMS counting procedure for an MBMS transmission upon receiving an MBMS MODIFIED SERVICES message including IE "MBMS required UE action" with the value set to 'Acquire counting info' or set to "Acquire counting info- PTM RBs unmodified".

8.7.4.3 Reception of the MBMS ACCESS INFORMATION

For cells not operating in MBSFN mode as indicated in subclause 8.1.1.6.3 the UE shall acquire the MBMS ACCESS INFORMATION message without delaying reading of MCCH until the next modification period in accordance with subclause 8.7.1.3. If the procedure the UE would apply to respond to counting (Idle mode: RRC connection establishment, connected mode: Cell update) is ongoing, the UE may defer acquiring the MBMS ACCESS INFORMATION message until this procedure has completed.

The UE behaviour upon receiving an MBMS ACCESS INFORMATION message that is contained in more than one TTI is not specified.

Upon receiving the MBMS ACCESS INFORMATION message for cells not operating in MBSFN mode as indicated in subclause 8.1.1.6.3 including one or more MBMS service(s) it has joined and/or including one or more MBMS Selected Services, the UE shall for each joined and/or selected service:

- 1> if the UE is in idle mode:
 - 2> draw a random number, "rand", uniformly distributed in the range: $0 \leq \text{rand} < 1$
 - 2> if 'rand' is lower than the value indicated by the IE 'Access probability factor-Idle' for the concerned service:

- 3> indicate to upper layers that establishment of an RRC connection is required to receive the concerned MBMS service, with the establishment cause set to 'MBMS reception';
 - 3> if the above condition applies for more than one service, initiate a single indication to upper layers;
 - 3> if the RRC connection establishment succeeds, the procedure ends.
- 2> otherwise:
 - 3> if the message triggering the MBMS counting procedure included the IE "Continue MCCH reading" with a value set to TRUE:
 - 4> continue acquiring further MBMS ACCESS INFORMATION messages without delaying reading of MCCH until the next modification period and without stopping at the end of the modification period, in accordance with subclause 8.7.1.3.
 - 3> otherwise:
 - 4> continue acquiring further MBMS ACCESS INFORMATION messages without delaying reading of MCCH until the next modification period and with stopping at the end of the modification period, in accordance with subclause 8.7.1.3.
 - 1> if the UE is in URA_PCH state, CELL_PCH or CELL_FACH state and the IE "Connected mode counting scope" indicates that counting is applicable for this UE state:
 - 2> draw a random number, "rand", uniformly distributed in the range: $0 \leq \text{rand} < 1$.
 - 2> if 'rand' is lower than the value indicated by the IE 'Access probability factor-connected' for the concerned service:
 - 3> if a cell update has not been successfully transmitted for this service in the current modification period:
 - 4> initiate the cell update procedure with 'Cell update cause' set to "MBMS reception", in accordance with subclause 8.3.1;
 - 4> if the above condition applies for more than one service, initiate a single cell update;
 - 4> if the cell update procedure succeeds,
 - 5> the procedure ends.
 - 2> otherwise:
 - 3> if the message triggering the MBMS counting procedure included the IE "Continue MCCH reading" with a value set to TRUE:
 - 4> continue acquiring further MBMS ACCESS INFORMATION messages without delaying reading of MCCH until the next modification period and without stopping at the end of the modification period, in accordance with subclause 8.7.1.3.
 - 3> otherwise:
 - 4> continue acquiring further MBMS ACCESS INFORMATION messages without delaying reading of MCCH until the next modification period and with stopping at the end of the modification period, in accordance with subclause 8.7.1.3.
 - 1> otherwise:
 - 2> the procedure ends;

Upon receiving the MBMS ACCESS INFORMATION message not including an MBMS service(s) the UE has joined or selected:

 - 1> the procedure ends;

8.7.4.4 Termination of the MBMS counting procedure

If the UE detects that the MBMS ACCESS INFORMATION message is not provided at an access info period; OR

If the UE receives an MBMS ACCESS INFORMATION message not including an MBMS service the UE has joined or selected, the UE shall:

- 1> terminate the MBMS counting procedure.

If the UE receives an RRC CONNECTION REJECT message with Rejection Cause 'unspecified' and including the MBMS "Counting completion" IE, the UE shall:

- 1> consider the MBMS counting procedure ended for the MBMS service(s) for which the UE has initiated the MBMS counting response;
- 1> indicate to upper layers that the establishment of an RRC connection with the establishment cause set to 'MBMS reception' shall be aborted.

8.7.4.5 Failure of the counting response procedure

If the counting response procedure (RRC connection establishment or Cell update) fails, the UE shall:

- 1> if the failure occurs in the same modification period as the one in which the UE initiated the counting response procedure; or
- 1> if the message triggering the MBMS counting procedure included the IE "Continue MCCH reading" with a value set to TRUE that is applicable in the modification period in which the UE detects the failure:
 - 2> continue acquiring further MBMS ACCESS INFORMATION messages without delaying reading of MCCH until the next modification period and without stopping at the end of the modification period, in accordance with subclause 8.7.1.3.
- 1> otherwise:
 - 2> the procedure ends.

8.7.5 MBMS p-t-m radio bearer configuration

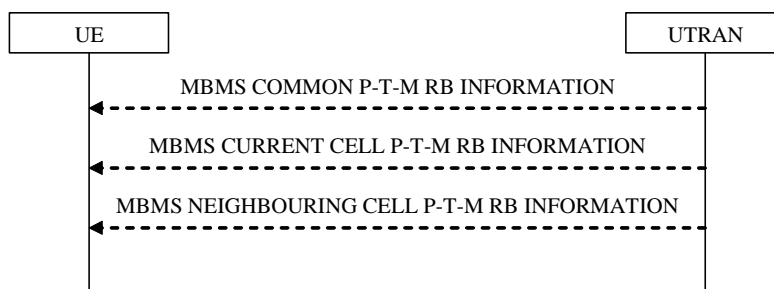

Figure 8.7.5-1: MBMS p-t-m radio bearer modification, normal

8.7.5.1 General

The MBMS p-t-m radio bearer configuration procedure is used by the UE to acquire the (modified) radio bearer configuration for one or more activated MBMS services. The procedure applies to all UEs supporting MBMS, irrespective of their state (idle and connected mode: URA_PCH, CELL_PCH, CELL_FACH and CELL_DCH).

8.7.5.2 Initiation

The UE applies the MBMS p-t-m radio bearer configuration procedure whenever it detects that one of the activated services is provided by means of a p-t-m radio bearer. This may occur as part of the MCCH acquisition or the MBMS Notification procedure.

8.7.5.3 Reception of the MBMS Current Cell PTM RB information

Upon completing the reception of the MBMS COMMON P-T-M RB INFORMATION and the MBMS CURRENT CELL P-T-M RB INFORMATION messages for an activated MBMS service, the UE shall:

- 1> if the UE is already receiving an MTCH and does not have the capability to receive the new service in addition:
 - 2> the UE behaviour is undefined.

NOTE: In this case, the UE may request upper layers to prioritise the services and only receive the service(s) prioritised by upper layers.

- 1> act upon all received information elements as specified in subclause 8.6, unless specified otherwise in the following;
 - 1> if the UE previously received the service by means of a p-t-m radio bearer from a cell belonging to another MBMS cell group:
 - 2> re-establish RLC;
 - 2> re-initialise PDCP.
- 1> start immediately to use the indicated configuration unless specified otherwise;
- 1> start or continue receiving the indicated p-t-m radio bearers depending on its UE capabilities.

The UE shall continue acquiring the above messages until it has received a consistent set of MCCH information i.e. the MBMS MODIFIED SERVICES INFORMATION message, MBMS UNMODIFIED SERVICES INFORMATION message, MBMS COMMON P-T-M RB INFORMATION and the MBMS CURRENT CELL P-T-M RB INFORMATION message should be acquired in the same modification period.

8.7.5.4 Reception of the MBMS Neighbouring Cell PTM RB information

Upon receiving the MBMS NEIGHBOURING CELL P-T-M RB INFORMATION message for an activated MBMS service for a cell not operating in MBSFN mode as indicated in subclause 8.1.1.6.3, the UE shall:

- 1> start immediately to use the indicated neighbouring cells and configuration, or a subset of them, for L1- or L2 combining or Chip combining (1.28Mcps TDD only) unless specified otherwise;
- 1> start or continue receiving the indicated p-t-m radio bearers from the selected neighbouring cells depending on its UE capabilities.

The UE shall apply MBMS NEIGHBOURING CELL P-T-M RB INFORMATION only in combination with an MBMS MODIFIED SERVICES INFORMATION message, MBMS UNMODIFIED SERVICES INFORMATION message, MBMS COMMON P-T-M RB INFORMATION and MBMS CURRENT CELL P-T-M RB INFORMATION message acquired in the same modification period.

8.7.6 MBMS modification request

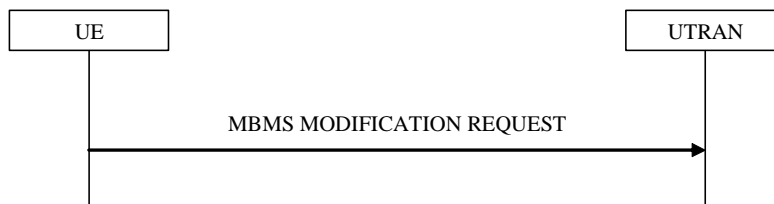

Figure 8.7.6-1: MBMS modification request, normal

8.7.6.1 General

The MBMS modification request procedure is used by the UE to request UTRAN to release the p-t-p radio bearers of one or more MBMS services the UE is receiving. The procedure is also used to request to be moved to a preferred

frequency applicable for one or more (prioritised) activated MBMS services the UE, and to indicate the UE MBMS Selected Services. The procedure applies to all UEs supporting MBMS, that are in CELL_DCH, CELL_PCH, URA_PCH or CELL_FACH state.

8.7.6.2 Initiation

A UE entering CELL_DCH shall initiate the MBMS modification request procedure in the following cases:

- 1> if the UE has any MBMS Selected Service; and
- 1> if the IE "MCCH configuration information" was received in System Information Block Type 5 or System Information Block Type 5bis prior to entering CELL_DCH.

A UE completing an RRC Connection Setup procedure shall initiate the MBMS modification request procedure in the following cases:

- 1> if the UE has any MBMS Selected Service; and
- 1> if the IE "MCCH configuration information" was received in System Information Block Type 5 or System Information Block Type 5bis prior to completing the RRC Connection Setup procedure.

A UE in CELL_DCH shall initiate the MBMS modification request procedure in the following cases:

- 1> the preferred frequency applicable for the MBMS service prioritised by upper layers is different from the currently used frequency;
- 1> upper layers request to discontinue reception of an MBMS service provided via a p-t-p radio bearer e.g. because this inhibits reception of a higher priority service;
- 1> upon a change in selection of the MBMS Selected Services.

NOTE: The above case may occur upon receiving a dedicated notification or in other cases eg. a change of transfer mode from p-t-p to p-t-m for the UE's highest priority MBMS service.

A UE in CELL_FACH, CELL_PCH or URA_PCH state shall initiate the MBMS modification request procedure in the following cases:

- 1> upon a change in selection of the MBMS Selected Services that are indicated on MCCH; and
- 1> if the IE "Indicate changes in MBMS Selected Services" that is included in the MBMS GENERAL INFORMATION message is set to TRUE.

If the UE is required to initiate the MBMS modification request procedure as specified in the conditions above, the UE shall:

- 1> transmit an MBMS MODIFICATION REQUEST message with the contents as specified in subclause 8.7.6.2a.

If applicable, the UE shall use a single MBMS MODIFICATION REQUEST message to request a move to the preferred frequency and/or to request release of radio bearers corresponding with lower priority MBMS services provided p-t-p and/or to report the MBMS Selected Services.

8.7.6.2a MBMS MODIFICATION REQUEST message contents to set

The UE shall set the contents of the MBMS MODIFICATION REQUEST message as follows:

- 1> if the preferred frequency applicable for the MBMS service prioritised by upper layers is different from the currently used frequency:
 - 2> include the IE "MBMS preferred frequency request" and set it to the prioritised MBMS service identity;
- 1> if upper layers request to discontinue reception of an MBMS service provided via a p-t-p radio bearer:
 - 2> include the p-t-p radio bearers used for the corresponding MBMS services within the IE "MBMS RB list requested to be released".
- 1> if the UE enters CELL_DCH; or

- 1> if the UE completes the RRC connection establishment procedure; or
- 1> if there is a change in selection of one or more of the MBMS Selected Services:
 - 2> if the UE has not selected any MBMS Selected Service:
 - 3> include the IE "MBMS Selected Service Info" and set the Status to 'None'.
 - 2> otherwise:
 - 3> include the IE "MBMS Selected Service Info" and set the Status to 'Some';
 - 3> include the IE "Support of MBMS service change for a ptp RB";
 - 3> for each MBMS Selected Service:
 - 4> order the MBMS Selected Services such that those selected with a higher priority are listed in the IE "MBMS Selected Services Full" before those selected with a lower priority;
 - 4> include the IE "MBMS Selected Service ID" within the IE "MBMS Selected Services Full".

8.7.6.3 Reception of a MBMS MODIFICATION REQUEST message by the UTRAN

Upon reception of a MBMS MODIFICATION REQUEST message, the UTRAN may take further action depending on the contents of the received message.

The procedure ends.

8.7.7 MBMS service scheduling

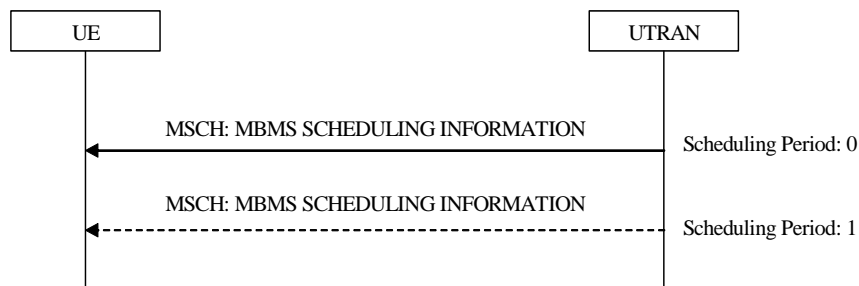

Figure 8.7.7-1: MBMS service scheduling, normal

8.7.7.1 General

The MBMS service scheduling procedure is used by the UE that is receiving one or more activated MBMS services to acquire the MBMS scheduling information for the MBMS services. The procedure applies to all UEs that are receiving an MBMS service provided via a p-t-m radio bearer, irrespective of their state (idle and connected mode: URA_PCH, CELL_PCH, CELL_FACH and CELL_DCH).

8.7.7.2 Initiation

The UE may initiate the MBMS service scheduling procedure for any scheduling period of the concerned MBMS service while receiving an SCCPCH carrying an MBMS service.

8.7.7.3 Reception of the MBMS scheduling information

Upon receiving the MBMS SCHEDULING INFORMATION message, the UE should:

- 1> act as follows for each of the services included in these messages provided that the service is included in variable MBMS_ACTIVATED_SERVICES;

- 1> act upon all received information elements as specified in subclause 8.6, unless specified otherwise in the following.

The procedure ends.

9 Handling of unknown, unforeseen and erroneous protocol data

9.1 General

This subclause specifies procedures for the handling of unknown, unforeseen, and erroneous protocol data by the receiving entity. These procedures are called "error handling procedures", but in addition to provide recovery mechanisms for error situations they define a compatibility mechanism for future extensions of the protocol.

The error handling procedures specified in this subclause shall apply to all RRC messages. When there is a specific handling for messages received on different logical channels this is specified.

For system information received on the BCCH, the error handling procedures are applied on the BCCH message SYSTEM INFORMATION, the re-assembled system information segments as well as the system information blocks (including the master information block and the scheduling blocks), with specific error handling as specified below.

When the UE receives an RRC message, it shall set the variable `PROTOCOL_ERROR_REJECT` to FALSE and then perform the checks in the order as defined below.

The error cases specified in the following include the handling upon reception of spare values. This behaviour also applies in case the actual value of the IE results from mapping the originally sent IE value. Moreover, in certain error cases, as specified in the following, default values apply. In this case, the default values specified within the ASN.1, the tabular and the procedure specifications apply.

9.2 ASN.1 violation or encoding error

If the UE receives an RRC message on the DCCH for which the encoded message does not result in any valid abstract syntax value [49] (or "encoding error"), it shall perform the following. The UE shall:

- 1> set the variable `PROTOCOL_ERROR_REJECT` to TRUE;
- 1> transmit an RRC STATUS message on the uplink DCCH. The IE "Protocol error information" shall contain an IE "Protocol error cause" set to "ASN.1 violation or encoding error";
- 1> when RRC STATUS message has been submitted to lower layers for transmission:
 - 2> continue with any ongoing processes and procedures as if the invalid message had not been received.

NOTE In this case, the UE does not perform procedure specific error handling according to clause 8.

If the UE receives an RRC message sent via a radio access technology other than UTRAN, for which the encoded message does not result in any valid abstract syntax, the UE shall:

- 1> set the variable `PROTOCOL_ERROR_REJECT` to TRUE;
- 1> set the IE "Protocol error cause" in the variable `PROTOCOL_ERROR_INFORMATION` to "ASN.1 violation or encoding error";
- 1> perform procedure specific error handling according to clause 8.

If a reassembled set of system information segments received in messages on the BCCH does not result in any valid abstract syntax value, the UE shall:

- 1> ignore the reassembled set of system information segments;

- 1> treat the rest of each message containing the ignored system information segments as if those segments were not present.

If the UE receives an RRC message on the BCCH, PCCH, CCCH, MCCH, MSCH or SHCCH for which the encoded message does not result in any valid abstract syntax value, it shall ignore the message.

9.3 Unknown or unforeseen message type

If a UE receives an RRC message on the DCCH with a message type not defined for the DCCH it shall:

- 1> set the variable `PROTOCOL_ERROR_REJECT` to `TRUE`;
- 1> transmit an RRC `STATUS` message on the uplink DCCH. The IE "Protocol error information" shall contain an IE "Protocol error cause" set to "Message type non-existent or not implemented";
- 1> when the RRC `STATUS` message has been submitted to lower layers for transmission:
 - 2> continue with any ongoing processes and procedures as if the invalid message had not been received.

If the UE receives an RRC message on the BCCH, PCCH, CCCH, MCCH, MSCH or SHCCH with a message type not defined for the logical channel type the message was received on, it shall ignore the message.

9.3a Unsolicited received message

If the UE receives any of the following messages:

- an RRC `CONNECTION SETUP` message addressed to the UE on the CCCH; or
- an RRC `CONNECTION REJECT` message addressed to the UE on the CCCH; or
- a UE `CAPABILITY INFORMATION CONFIRM` message on the DCCH; or
- a `CELL UPDATE CONFIRM` message addressed to the UE on the CCCH or on the DCCH; or
- a `URA UPDATE CONFIRM` message addressed to the UE on the CCCH or on the DCCH

and no procedure is ongoing according to clause 8 which expects the message to be received:

the UE shall:

- 1> ignore the received message.

9.3b Unexpected critical message extension

If the UE receives an RRC message on the DCCH, or addressed to the UE on the CCCH or on the SHCCH, or sent via a radio access technology other than UTRAN, containing an undefined critical message extension, the UE shall:

- 1> set the variable `PROTOCOL_ERROR_REJECT` to `TRUE`;
- 1> set the IE "Protocol error cause" in the variable `PROTOCOL_ERROR_INFORMATION` to "Message extension not comprehended";
- 1> if the IE "Message Type" of the received message is not present in the table "Rejected transactions" in the variable `TRANSACTIONS`:
 - 2> store the IE "Message type" of the received message in the table "Rejected transactions" in the variable `TRANSACTIONS`; and
 - 2> set the IE "RRC transaction identifier" to zero in that table entry.
- 1> perform procedure specific error handling according to clause 8.

If the UE receives an RRC message on the BCCH, MCCH, MSCH or PCCH, containing an undefined critical message extension, the UE shall:

- 1> ignore the message.

9.4 Unknown or unforeseen information element value, mandatory information element

If the UE receives an RRC message on the DCCH, or addressed to the UE on the CCCH or on the SHCCH, or sent via a radio access technology other than UTRAN, with a mandatory IE having a value, including choice, reserved for future extension (spare) or a value not used in this version of the specification (e.g. a dummy value), the UE shall:

- 1> if a default value of the IE is defined:
 - 2> treat the rest of the message using the default value of the IE.
- 1> if no default value of the IE is defined:
 - 2> set the variable `PROTOCOL_ERROR_REJECT` to `TRUE`;
 - 2> set the IE "Protocol error cause" in the variable `PROTOCOL_ERROR_INFORMATION` to "Information element value not comprehended";
 - 2> perform procedure specific error handling according to clause 8.

If the UE receives a system information block on the BCCH with a mandatory IE having a value reserved for future extension (spare) or a value not used in this version of the specification (e.g. a dummy value), the UE shall:

- 1> if a default value of the IE is defined:
 - 2> treat the rest of the system information block using the default value of the IE.
- 1> if no default value of the IE is defined:
 - 2> ignore the system information block.

If the UE receives an RRC message on the BCCH, MCCH, MSCH or PCCH with a mandatory IE having a value reserved for future extension (spare) or a value not used in this version of the specification (e.g. a dummy value), the UE shall:

- 1> if a default value of the IE is defined:
 - 2> treat the rest of the message using the default value of the IE.
- 1> if no default value of the IE is defined:
 - 2> ignore the message.

9.5 Conditional information element error

If the UE receives an RRC message on the DCCH, BCCH, PCCH, MCCH, MSCH or addressed to the UE on the CCCH or on the SHCCH, or sent via a radio access technology other than UTRAN, for which the specified conditions for absence of a conditional IE are met and that IE is present, the UE shall:

- 1> ignore the IE;
- 1> treat the rest of the message as if the IE was not present.

If the UE receives an RRC message on the DCCH, or addressed to the UE on the CCCH or on the SHCCH, or sent via a radio access technology other than UTRAN, for which the specified conditions for presence of a conditional IE are met and that IE is absent, the UE shall:

- 1> set the variable `PROTOCOL_ERROR_REJECT` to `TRUE`;

1> set the IE "Protocol error cause" in the variable `PROTOCOL_ERROR_INFORMATION` to "Information element missing";

1> perform procedure specific error handling according to clause 8.

If the UE receives a system information block on the BCCH for which the specified conditions for presence of a conditional IE are met and that IE is absent, the UE shall:

1> ignore the system information block.

If the UE receives an RRC message on the BCCH, MCCH, MSCH or PCCH for which the specified conditions for presence of a conditional IE are met and that IE is absent, the UE shall:

1> ignore the message.

9.6 Unknown or unforeseen information element value, conditional information element

If the UE receives an RRC message on the DCCH, or addressed to the UE on the CCCH or on the SHCCH, or sent via a radio access technology other than UTRAN, for which the specified conditions for presence of a conditional IE are met, that IE is present, and that IE has a value, including choice, reserved for future extension (spare) or a value not used in this version of the specification (e.g. a dummy value), the UE shall:

1> if a default value of the IE is defined:

2> treat the rest of the message using the default value of the IE.

1> if no default value of the IE is defined:

2> set the variable `PROTOCOL_ERROR_REJECT` to TRUE;

2> set the IE "Protocol error cause" in the variable `PROTOCOL_ERROR_INFORMATION` to "Information element value not comprehended";

2> perform procedure specific error handling according to clause 8.

If the UE receives a system information block on the BCCH for which the specified conditions for presence of a conditional IE are met, that IE is present, and that IE has a value, including choice, reserved for future extension (spare) or a value not used in this version of the specification (e.g. a dummy value), the UE shall:

1> if a default value of the IE is defined:

2> treat the rest of the system information block using the default value of the IE.

1> if no default value of the IE is defined:

2> ignore the system information block.

If the UE receives an RRC message on the BCCH, MCCH, MSCH or PCCH for which the specified conditions for presence of a conditional IE are met, that IE is present, and that IE has a value, including choice, reserved for future extension (spare) or a value not used in this version of the specification (e.g. a dummy value), the UE shall:

1> if a default value of the IE is defined:

2> treat the rest of the message using the default value of the IE.

1> if no default value of the IE is defined:

2> ignore the message.

9.7 Unknown or unforeseen information element value, optional information element

If the UE receives an RRC message on the DCCH, or addressed to the UE on the CCCH or on the SHCCH, or sent via a radio access technology other than UTRAN, with an optional IE having a value, including choice, reserved for future extension (spare) or a value not used in this version of the specification (e.g. a dummy value), it shall:

- 1> ignore the value of the IE;
- 1> treat the rest of the message as if the IE was not present.

If the UE receives a system information block on the BCCH with an optional IE having a value, including choice, reserved for future extension (spare) or a value not used in this version of the specification (e.g. a dummy value), it shall:

- 1> ignore the value of the IE;
- 1> treat the rest of the system information block as if the IE was not present.

If the UE receives an RRC message on the BCCH, MCCH or MSCH or PCCH with an optional IE having a value, including choice, reserved for future extension (spare) or a value not used in this version of the specification (e.g. a dummy value), it shall:

- 1> ignore the value of the IE;
- 1> treat the rest of the message as if the IE was not present.

9.8 Unexpected non-critical message extension

If the UE receives an RRC message on the DCCH, or addressed to the UE on the CCCH or on the SHCCH, or sent via a radio access technology other than UTRAN, containing an undefined non-critical message extension, the UE shall:

- 1> if the non critical extension is included in the "Variable Length Extension Container":
 - 2> ignore the content of the extension and the contents of this container after the not comprehended extension, and continue decoding the rest of the message.
- 1> otherwise:
 - 2> ignore the content of the extension and the message contents after the extension, but treat the parts of the message up to the extension normally.

If the UE receives a system information block on the BCCH containing an undefined non-critical message extension, the UE shall:

- 1> ignore the content of the extension and the system information block contents after the extension, but treat the parts of the system information block up to the extension normally.

If the UE receives an RRC message on the BCCH, MCCH or MSCH or PCCH, containing an undefined non-critical message extension, the UE shall:

- 1> ignore the content of the extension and the message contents after the extension, but treat the parts of the message up to the extension normally.

9.9 Handling of errors in nested information elements

An erroneous IE may be included in another IE, which may be included in another IE and so on. This subclause specifies the handling of errors in mandatory IEs as well as for conditional IEs for which the specified conditions for presence are met, that are nested in another IE.

In case the UE receives an IE (IE1) that includes a mandatory IE (IE1-1) having a value, including choice, reserved for future extension (spare) or a value not used in this version of the specification (e.g. a dummy value), the UE shall:

1> consider IE1 to have an undefined value; and

1> apply the corresponding generic error handling to IE1.

In case there are many IE nesting levels, in all of which the IE is mandatory while no default value is defined, this treatment may need to be repeated several times. The following example illustrates the general principle.

ExampleMessage ::=	SEQUENCE {	
ie1	IE1	OPTIONAL,
ie2	IE2	
}		
IE1 ::=	SEQUENCE {	
ie1-1	INTEGER (1..16),	
-- ie1-1 values 13..16 are spare and should not be used in this version of the protocol		
ie1-2	IE1-2	OPTIONAL,
ie1-3	IE1-3	
}		

If in the above example, UTRAN would include ie1 and set ie1-1 to value 13, the UE experiences an error in a mandatory IE. The guideline outlined in the previous then means that the UE shall not discard the entire message but instead consider "ie1" to have an unknown value. Since IE1 is optional, the generic error handling would be to ignore "ie1".

In case the UE receives an IE (IE1) that includes a list of another IE (IE1-1) for which one or more entries in the list have a value, including choice, reserved for future extension (spare) or a value not used in this version of the specification (e.g. a dummy value), the UE shall:

1> consider the list as if these entries were not included.

NOTE: In case the above generic error handling procedures do not result in the desired behaviour, the introduction of spares may need to be reconsidered.

10 Message and information element functional definition and content

10.1 General

The function of each Radio Resource Control message together with message contents in the form of a list of information elements is defined in subclause 10.2.

Functional definitions of the information elements are then described in subclause 10.3.

Information elements are marked as either MP - Mandatory present, MD - Mandatory with default value, OP - Optional, CV - Conditional on value or CH - Conditional on history (see Table 10.1 with information extracted from [14]).

Table 10.1: Meaning of abbreviations used in RRC messages and information elements

Abbreviation	Meaning
MP	Mandatory present A value for that information is always needed, and no information is provided about a particular default value. If ever the transfer syntax allows absence (e.g., due to extension), then absence leads to an error diagnosis.
MD	Mandatory with default value A value for that information is always needed, and a particular default value is mentioned (in the 'Semantical information' column). This opens the possibility for the transfer syntax to use absence or a special pattern to encode the default value.

Abbreviation	Meaning
CV	<p>Conditional on value</p> <p>The need for a value for that information depends on the value of some other IE or IEs, and/or on the message flow (e.g., channel, SAP). The need is specified by means of a condition, the result of which may be that the information is mandatory present, mandatory with default value, not needed or optional.</p> <p>If one of the results of the condition is that the information is mandatory present, the transfer syntax must allow for the presence of the information. If in this case the information is absent an error is diagnosed.</p> <p>If one of the results of the condition is that the information is mandatory with default value, and a particular default value is mentioned (in the 'Semantical information' column), the transfer syntax may use absence or a special pattern to encode the default value.</p> <p>If one of the results of the condition is that the information is not needed, the transfer syntax must allow encoding the absence. If in this case the information is present, it will be ignored. In specific cases however, an error may be diagnosed instead.</p> <p>If one of the results of the condition is that the information is optional, the transfer syntax must allow for the presence of the information. In this case, neither absence nor presence of the information leads to an error diagnosis.</p>
CH	<p>Conditional on history</p> <p>The need for a value for that information depends on information obtained in the past (e.g., from messages received in the past from the peer). The need is specified by means of a condition, the result of which may be that the information is mandatory present, mandatory with default value, not needed or optional.</p> <p>The handling of the conditions is the same as described for CV.</p>
OP	<p>Optional</p> <p>The presence or absence is significant and modifies the behaviour of the receiver. However whether the information is present or not does not lead to an error diagnosis.</p>

10.1.1 Protocol extensions

RRC messages may be extended in future versions of this protocol, either by adding values for choices, enumerated and size constrained types or by adding information elements. An important aspect concerns the behaviour of a UE, conforming to this revision of the standard, upon receiving a not comprehended future extension. The details of this error handling behaviour are provided in clause 9.

NOTE 1: By avoiding the need for partial decoding (skipping uncomprehended IEs to continue decoding the remainder of the message), the RRC protocol extension mechanism also avoids the overhead of length determinants for extensions. "Variable length extension containers" (i.e. non critical extension containers that have their abstract syntax defined using the ASN.1 type "BIT STRING") have been defined to support the introduction of extensions to a release after the subsequent release is frozen (and UEs based on that subsequent release may appear). For this container a length determinant is used, which facilitates partial decoding of the container as well as the decoding of the extensions included after the container.

Two kinds of protocol extensions are distinguished: non-critical and critical extensions. In general, a receiver shall process a message including not comprehended non-critical extensions as if the extensions were absent. However, a receiver shall entirely reject a message including not comprehended critical extensions (there is no partial rejection) and notify the sender, as specified in clause 9.

The general mechanism for adding critical extensions is by defining a new version of the message, which is indicated at the beginning of the message.

The UE shall always comprehend the complete transfer syntax specified for the protocol version it supports; if the UE comprehends the transfer syntax defined within protocol version A for message 1, it shall also comprehend the transfer syntax defined within protocol version A for message 2.

The following table shows for which messages only non-critical extensions may be added, for which messages both critical and non-critical extensions may be added and for which messages neither critical nor non-critical extensions may be added.

NOTE 2: Critical extensions can only be added to certain downlink messages.

Extensions	Message
Critical and non-critical extensions	ACTIVE SET UPDATE 10.2.1 ASSISTANCE DATA DELIVERY 10.2.4 CELL CHANGE ORDER FROM UTRAN 10.2.5 CELL UPDATE CONFIRM 10.2.8 COUNTER CHECK 10.2.9 DOWNLINK DIRECT TRANSFER 10.2.11 HANDOVER TO UTRAN COMMAND 10.2.16a HANDOVER FROM UTRAN COMMAND 10.2.15 LOGGING MEASUREMENT CONFIGURATION 10.2.16da MEASUREMENT CONTROL 10.2.17 PHYSICAL CHANNEL RECONFIGURATION 10.2.22 PHYSICAL SHARED CHANNEL ALLOCATION 10.2.25 RADIO BEARER RECONFIGURATION 10.2.27 RADIO BEARER RELEASE 10.2.30 RADIO BEARER SETUP 10.2.33 RRC CONNECTION REJECT 10.2.36 RRC CONNECTION RELEASE 10.2.37 RRC CONNECTION SETUP 10.2.40 SECURITY MODE COMMAND 10.2.43 SIGNALLING CONNECTION RELEASE 10.2.46 TRANSPORT CHANNEL RECONFIGURATION 10.2.50 UE CAPABILITY ENQUIRY 10.2.55 UE CAPABILITY INFORMATION CONFIRM 10.2.57 UE INFORMATION REQUEST 10.2.57a UPLINK PHYSICAL CHANNEL CONTROL 10.2.59 URA UPDATE CONFIRM 10.2.61 UTRAN MOBILITY INFORMATION 10.2.62
Non-critical extensions only	ACTIVE SET UPDATE COMPLETE 10.2.2 ACTIVE SET UPDATE FAILURE 10.2.3 CELL CHANGE ORDER FROM UTRAN FAILURE 10.2.6 CELL UPDATE 10.2.7 COUNTER CHECK RESPONSE 10.2.10 ETWS PRIMARY NOTIFICATION WITH SECURITY 10.2.12a HANDOVER TO UTRAN COMPLETE 10.2.16b INITIAL DIRECT TRANSFER 10.2.16c HANDOVER FROM UTRAN FAILURE 10.2.16 MBMS ACCESS INFORMATION 10.2.16e MBMS COMMON P-T-M RB INFORMATION 10.2.16f MBMS CURRENT CELL P-T-M RB INFORMATION 10.2.16g MBMS GENERAL INFORMATION 10.2.16h MBMS MODIFICATION REQUEST 10.2.16i MBMS MODIFIED SERVICES INFORMATION 10.2.16j MBMS NEIGHBOURING CELL P-T-M RB INFORMATION 10.2.16k MBMS SCHEDULING INFORMATION 10.2.16L MBMS UNMODIFIED SERVICES INFORMATION 10.2.16m MEASUREMENT CONTROL FAILURE 10.2.18 MEASUREMENT REPORT 10.2.19 PAGING TYPE 1 10.2.20 PAGING TYPE 2 10.2.21 PHYSICAL CHANNEL RECONFIGURATION COMPLETE 10.2.23 PHYSICAL CHANNEL RECONFIGURATION FAILURE 10.2.24 PUSCH CAPACITY REQUEST 10.2.26 RADIO BEARER RECONFIGURATION COMPLETE 10.2.28 RADIO BEARER RECONFIGURATION FAILURE 10.2.29 RADIO BEARER RELEASE COMPLETE 10.2.31 RADIO BEARER RELEASE FAILURE 10.2.32

Extensions	Message
	RADIO BEARER SETUP COMPLETE 10.2.34 RADIO BEARER SETUP FAILURE 10.2.35 RRC CONNECTION RELEASE COMPLETE 10.2.38 RRC CONNECTION REQUEST 10.2.39 RRC CONNECTION SETUP COMPLETE 10.2.41 RRC STATUS 10.2.42 SECURITY MODE COMPLETE 10.2.44 SECURITY MODE FAILURE 10.2.45 SIGNALLING CONNECTION RELEASE INDICATION 10.2.47 Master Information Block 10.2.48.8.1 System Information Block type 1 to System Information Block type 24 10.2.48.8.4 to 10.2.48.8.27 SYSTEM INFORMATION CHANGE INDICATION 10.2.49 TRANSPORT CHANNEL RECONFIGURATION COMPLETE 10.2.51 TRANSPORT CHANNEL RECONFIGURATION FAILURE 10.2.52 TRANSPORT FORMAT COMBINATION CONTROL 10.2.53 TRANSPORT FORMAT COMBINATION CONTROL FAILURE 10.2.54 UE CAPABILITY INFORMATION 10.2.56 UE INFORMATION RESPONSE 10.2.57b UPLINK DIRECT TRANSFER 10.2.58 URA UPDATE 10.2.60 UTRAN MOBILITY INFORMATION CONFIRM 10.2.63 UTRAN MOBILITY INFORMATION FAILURE 10.2.64
No extensions	CELL UPDATE FDD 10.2.7a SYSTEM INFORMATION 10.2.48 SYSTEM INFORMATION 2 10.2.48b First Segment 10.2.48.1 First Segment 2 10.2.48.1a Subsequent or last Segment 10.2.48.3 Subsequent Segment 2 10.2.48.3a or last Segment 2 10.2.48.4a Complete SIB 10.2.48.6 Complete SIB 2 10.2.48.6a

NOTE 3: For the SYSTEM INFORMATION message protocol extensions are only possible at the level of system information blocks.

10.1.1.1 Non-critical extensions

10.1.1.1.1 Extension of an information element with additional values or choices

In future versions of this protocol, non-critical values may be added to choices, enumerated and size constrained types.

For choices, enumerated and size constrained types it is possible to indicate how many non-critical spare values need to be reserved for future extension. In this case, the tabular format should indicate the number of spare values that are needed. The value range defined in ASN.1 for the extensible IE should include the number of spares that are needed, since a value outside the range defined for this IE will result in a general ASN.1 violation error.

For downlink messages, spare values may be defined for non-critical information elements for which the need is specified to be MD or OP (or CV case leading to MD or OP). In this case, a receiver not comprehending the received spare value shall consider the information element to have the default value or consider it to be absent respectively.

For uplink messages spare values may be defined for all information elements, including those for which the need is specified to be MP (or CV case leading to MP).

In all cases at most one spare should be defined for choices. In this case, information elements applicable to the spare choices shall be added to the end of the message.

10.1.1.1.2 Extension of a message with additional information elements

In future versions of this protocol, non-critical information elements may be added to RRC messages. These additional information elements shall be normally appended at the end of the message; the transfer syntax specified in this revision of the standard facilitates this. A receiver conformant to this revision of the standard shall accept such extension, and proceed as if it was not included.

A transmitter conformant to this version of the standard shall not include an extension reserved for introducing non critical extensions in later versions of the standard; i.e. the corresponding parameter defined in the ASN.1 shall be absent.

NOTE: If an extension, reserved for future non-critical extensions, is included (even if it is empty), this may result in transfer syntax errors when received by an implementation conforming to a later version of the standard.

Extensions to a release that are introduced after the subsequent release is frozen may however be inserted prior to the end of the message. To facilitate this, "variable length extension containers" have been introduced in most messages.

10.1.1.2 Critical extensions

10.1.1.2.1 Extension of an information element with additional values or choices

In versions of this protocol, choices, enumerated and size constrained types may be extended with critical values. For extension with critical values the general critical extension mechanism is used, i.e. for this no spare values are reserved since backward compatibility is not required.

10.1.1.2.2 Extension of a message with additional information elements

In future versions of this protocol, RRC messages may be extended with new information elements. Since messages including critical extensions are rejected by receivers not comprehending them, these messages may be modified completely, e.g. IEs may be inserted at any place and IEs may be removed or redefined.

10.2 Radio Resource Control messages

10.2.1 ACTIVE SET UPDATE

NOTE: Only for FDD.

This message is used by UTRAN to add, replace or delete radio links in the active set of the UE.

RLC-SAP: AM or UM

Logical channel: DCCH

Direction: UTRAN → UE

Information Element/Group name	Need	Multi	Type and reference	Semantics description	Version
Message Type	MP		Message Type		
UE information elements					
RRC transaction identifier	MP		RRC transaction identifier 10.3.3.36		
Integrity check info	CH		Integrity check info 10.3.3.16		
Activation time	MD		Activation time 10.3.3.1	Default value is "now".	
New U-RNTI	OP		U-RNTI 10.3.3.47		
New H-RNTI	OP		H-RNTI 10.3.3.14a		REL-6
New Primary E-RNTI	OP		E-RNTI 10.3.3.10a		REL-6

Information Element/Group name	Need	Multi	Type and reference	Semantics description	Version
New Secondary E-RNTI	OP		E-RNTI 10.3.3.10a		REL-6
CN information elements					
CN Information info	OP		CN Information info 10.3.1.3		
Phy CH information elements					
DTX-DRX timing information	OP		DTX-DRX timing information 10.3.6.34b		REL-7
DTX-DRX Information	OP		DTX-DRX Information 10.3.6.34a		REL-7
HS-SCCH less Information	OP		HS-SCCH less Information 10.3.6.36a b		REL-7
MIMO parameters	OP		MIMO parameter s 10.3.6.41a		REL-7
MIMO mode with four transmit antennas parameters	OP		MIMO mode with four transmit antennas parameter s 10.3.6.142		REL-11
DCH Enhancements info FDD	OP		DCH Enhancem ents info FDD 10.3.6.149		REL-12
Uplink radio resources					
Maximum allowed UL TX power	MD		Maximum allowed UL TX power 10.3.6.39	Default value is the existing "maximum UL TX power.	
Uplink secondary cell info FDD	OP		Uplink secondary cell info FDD 10.3.6.115	FDD only	REL-9
E-DCH reconfiguration information on secondary UL frequency	OP		E-DCH reconfigura tion information on secondary UL frequency 10.3.6.121	FDD only	REL-9
Uplink CLTD info FDD	OP		Uplink CLTD info FDD 10.3.6.125	FDD only	REL-11
F-TPICH reconfiguration info	OP		F-TPICH reconfigura tion info 10.3.6.128	FDD only	REL-11

Information Element/Group name	Need	Multi	Type and reference	Semantics description	Version
Uplink OLTD info FDD	OP		Uplink OLTD info FDD 10.3.6.126	FDD only	REL-11
Downlink radio resources					
Radio link addition information	OP	1 to <maxRL-1>		Radio link addition information required for each RL to add	
>Radio link addition information	MP		Radio link addition information 10.3.6.68		
Radio link addition information on secondary UL frequency	OP		Radio link addition information on secondary UL frequency 10.3.6.119	FDD only	REL-9
Serving Cell Change Parameters	CV- <i>TargetCellPreconf</i>		Serving Cell Change Parameters 10.3.6.74b		REL-8
Radio link removal information	OP	1 to <maxRL>		Radio link removal information required for each RL to remove	
>Radio link removal information	MP		Radio link removal information 10.3.6.69		
Radio link removal information on secondary UL frequency	OP		Radio link removal information on secondary UL frequency 10.3.6.120	FDD only	REL-9
TX Diversity Mode	MD		TX Diversity Mode 10.3.6.86	Default value is the TX diversity mode currently used in all or part of the active set.	

Information Element/Group name	Need	Multi	Type and reference	Semantics description	Version
DPC Mode	OP		Enumerated (Single TPC, TPC triplet in soft)	"Single TPC" is DPC_Mode=0 and "TPC triplet in soft" is DPC_mode=1 in [29].	REL-5
Serving HS-DSCH cell information	OP		Serving HS-DSCH cell information 10.3.6.74a		REL-6
E-DCH reconfiguration information	OP		E-DCH reconfiguration information 10.3.6.69a		REL-6
UL 16QAM configuration	OP		UL 16QAM configuration 10.3.6.86o		REL-7
UL 64QAM configuration	OP		UL 64QAM configuration 10.3.6.86b		REL-11
Uplink MIMO info FDD	OP		Uplink MIMO info FDD 10.3.6.145	FDD only	REL-11
E-DCH reconfiguration information same serving cell	OP		E-DCH reconfiguration information same serving cell 10.3.6.69b	This IE is not present if the serving E-DCH cell is changed with this message.	REL-7
E-TFC Boost Info	OP		E-TFC Boost Info 10.3.6.106	Absence of this IE means that boosting of E-DPCCH is disabled	REL-7
E-DPDCH power interpolation	OP		Boolean	TRUE means E-DPDCH power interpolation formula is used, FALSE means E-DPDCH power extrapolation formula is used for the computation of the gain factor β_{ed} according to [29]. Absence of this IE means that E-DPDCH power extrapolation formula is used for the computation of the gain factor β_{ed} according to [29].	REL-7
Downlink secondary cell info FDD	OP		Downlink secondary cell info FDD 10.3.6.31a	FDD only	REL-8
Additional downlink secondary cell info list FDD	OP	2			REL-10

Information Element/Group name	Need	Multi	Type and reference	Semantics description	Version
>Downlink secondary cell info FDD	OP		Downlink secondary cell info FDD 10.3.6.31a	FDD only	REL-10
Additional downlink secondary cell info list FDD 2	OP	4			REL-11
>Downlink secondary cell info FDD	OP		Downlink secondary cell info FDD 10.3.6.31a	FDD only	REL-11
DPCCH2 info FDD	OP		DPCCH2 info FDD 10.3.6.148	FDD only	REL-12

Condition	Explanation
<i>TargetCellPreconf</i>	This IE is mandatory present if Radio Links are added and at least one added Radio Link contains the IE Target cell preconfiguration.

10.2.2 ACTIVE SET UPDATE COMPLETE

NOTE: For FDD only.

This message is sent by UE when active set update has been completed.

RLC-SAP: AM

Logical channel: DCCH

Direction: UE→UTRAN

Information Element/Group name	Need	Multi	Type and reference	Semantics description
Message Type	MP		Message Type	
UE information elements				
RRC transaction identifier	MP		RRC transaction identifier 10.3.3.36	
Integrity check info	CH		Integrity check info 10.3.3.16	

10.2.3 ACTIVE SET UPDATE FAILURE

NOTE: Only for FDD.

This message is sent by UE if the update of the active set has failed, e.g. because the radio link is not a part of the active set.

RLC-SAP: AM

Logical channel: DCCH

Direction: UE→UTRAN

Information Element/Group name	Need	Multi	Type and reference	Semantics description
Message Type	MP		Message Type	
UE information elements				
RRC transaction identifier	MP		RRC transaction identifier 10.3.3.36	
Integrity check info	CH		Integrity check info 10.3.3.16	
Failure cause	MP		Failure cause and error information 10.3.3.14	

10.2.4 ASSISTANCE DATA DELIVERY

This message is sent by UTRAN to convey UE positioning assistance data to the UE.

RLC-SAP: AM

Logical channel: DCCH

Direction: UTRAN→UE

Information Element/Group name	Need	Multi	Type and reference	Semantics description	Version
Message Type	MP		Message Type		
UE information elements					
RRC transaction identifier	MP		RRC transaction identifier 10.3.3.36		
Integrity check info	CH		Integrity check info 10.3.3.16		
Measurement Information elements					
UE positioning OTDOA assistance data for UE-based	OP		UE positioning OTDOA assistance data for UE-based 10.3.7.103a		
UE positioning GPS assistance data	OP		UE positioning GPS assistance data 10.3.7.90		
UE positioning GANSS assistance data	OP		UE positioning GANSS assistance data 10.3.7.90b		REL-7

10.2.5 CELL CHANGE ORDER FROM UTRAN

This message is used to order a cell change from UTRA to another radio access technology, e.g., GSM.

RLC-SAP: AM

Logical channel: DCCH

Direction: UTRAN→UE

Information Element/Group name	Need	Multi	Type and reference	Semantics description	Version
Message Type	MP		Message Type		
UE information elements					
RRC transaction identifier	MP		RRC transaction identifier 10.3.3.36		
Integrity check info	CH		Integrity check info 10.3.3.16		
Activation time	MD		Activation time 10.3.3.1	Default value is "now"	
RB Information elements					
RAB information list	OP	1 to <maxRA Bsetup>		This IE should not be included in this version of the protocol.	
>RAB info	MP		RAB info 10.3.4.8		
Other information elements					
Target cell description	MP				
>CHOICE <i>Radio Access Technology</i>	MP			Two spare values are needed.	
>>GSM					
>>>BSIC	MP		BSIC 10.3.8.2		
>>>Band Indicator	MP		Enumerated (DCS 1800 band used, PCS 1900 band used)	Indicates how to interpret the BCCH ARFCN	
>>>BCCH ARFCN	MP		Integer (0..1023)	[45]	
>>>NC mode	OP		Bit string(3)	Includes bits b1-b3 of the NC mode IE specified in [43]. b1 is the least significant bit. NOTE: The Bit string should be extended to 4 bits in a later version of the message.	
>>>CHOICE <i>GERAN System Info type</i>	OP				REL-5
>>>>SI			GERAN system information 10.3.8.4f	See [44]	REL-5
>>>>PSI			GERAN system information 10.3.8.4f	See [44]	REL-5
>>IS-2000					

10.2.6 CELL CHANGE ORDER FROM UTRAN FAILURE

This message is sent on the RRC connection used before the Cell change order from UTRAN was executed. The message indicates that the UE has failed to seize the new channel in the other radio access technology.

RLC-SAP: AM

Logical channel: DCCH

Direction: UE→UTRAN

Information Element/Group name	Need	Multi	Type and reference	Semantics description
Message Type	MP		Message Type	
UE information elements				
RRC transaction identifier	MP		RRC transaction identifier 10.3.3.36	
Integrity check info	CH		Integrity check info 10.3.3.16	
Other information elements				
Inter-RAT change failure	MP		Inter-RAT change failure 10.3.8.5	

10.2.7 CELL UPDATE

This message is used by the UE to initiate a cell update procedure.

RLC-SAP: TM

Logical channel: CCCH

Direction: UE→UTRAN

Information Element/Group name	Need	Multi	Type and reference	Semantics description	Version
Message Type	MP		Message Type		
UE information elements					
U-RNTI	MP		U-RNTI 10.3.3.47		
RRC transaction identifier	CV- <i>Failure</i>		RRC transaction identifier 10.3.3.36		
Integrity check info	CH		Integrity check info 10.3.3.16		
START list	MP	1 to <maxCN domains >		START [40] values for all CN domains.	
>CN domain identity	MP		CN domain identity 10.3.1.1		

Information Element/Group name	Need	Multi	Type and reference	Semantics description	Version
>START	MP		START 10.3.3.38	START value to be used in this CN domain.	
AM_RLC error indication(RB2, RB3 or RB4)	MP		Boolean	TRUE indicates AM_RLC unrecoverable error [16] occurred on RB2, RB3 or RB4 in the UE	
AM_RLC error indication(RB>4)	MP		Boolean	TRUE indicates AM_RLC unrecoverable error [16] occurred on RB>4 in the UE	
Cell update cause	MP		Cell update cause 10.3.3.3		
Traffic volume indicator	OP		Enumerated (TRUE)	This IE shall be set to TRUE when the criteria for event based traffic volume measurement reporting is fulfilled. Absence of this element means not fulfilled.	REL-6
Failure cause	OP		Failure cause and error information 10.3.3.14		
RB timer indicator	MP		RB timer indicator 10.3.3.28		

Information Element/Group name	Need	Multi	Type and reference	Semantics description	Version
Establishment cause	OP		Establishment cause 10.3.3.11		REL-5
CS Call Type	CV- ConversationalCS		Enumerated (speech, video, other)	One spare value is needed	REL-7
HS-PDSCH in CELL_FACH	OP		Enumerated (TRUE)	The absence of this IE indicates that the UE does not support HS-PDSCH reception in CELL_FACH state. Note 1.	REL-7
Support of common E-DCH	OP		Enumerated (TRUE)	The absence of this IE indicates that the UE does not support E-DCH enhanced random access in CELL_FACH state and Idle mode. Note 1.	REL-8
Support of HS-DSCH DRX operation	OP		Enumerated (TRUE)	The absence of this IE indicates that the UE does not support HS-DSCH DRX operation in CELL_FACH state.	REL-8
Support of MAC-i/is	OP		Enumerated (TRUE)	The absence of this IE indicates that the UE does not support MAC-i/is operation.	REL-8
Support of SPS operation	OP		Enumerated (TRUE)	The absence of this IE indicates that the UE does not support SPS operation.	REL-8
Support of control channel DRX operation	OP		Enumerated (TRUE)	The absence of this IE indicates that the UE does not support control channel DRX operation.	REL-8
UE Mobility State Indicator	MD		Enumerated (High-mobilityDetected)	Absence of this IE implies that, according to [4] either the High mobility state is not applicable or it has not been detected by the UE.	REL-7
Capability change indicator	OP		Enumerated (TRUE)	TRUE indicates that the UE capability has changed compared to the value stored in the variable UE_CAPABILITY_TRANSFERRED.	REL-7
Reconfiguration Status Indicator	OP		Enumerated (TRUE)	TRUE indicates a reconfiguration procedure is ongoing within the UE or a response message has been submitted to RLC and the UE is waiting for the layer 2 ACK.	REL-6

Information Element/Group name	Need	Multi	Type and reference	Semantics description	Version
MBMS Selected Services	OP		MBMS Selected Services Short 10.3.9a.7d		REL-6
Support for Two DRX schemes in URA_PCH and CELL_PCH	OP		Enumerated (TRUE)	The absence of this IE indicates that the UE does not support Two DRX schemes in URA_PCH and CELL_PCH	REL-7
Security Revert Status Indicator	OP		Enumerated (Reverted Back, Normal Operation)	Reverted Back indicates this UE has reverted back to the old security configuration by aborting the ongoing security mode command. Normal Operation indicates this UE has not reverted back to the old security configuration by aborting an ongoing security mode command. The absence of this IE indicates that the UE does not support reporting of security revert status.	REL-10
Measurement information elements					
Measured results on RACH	OP		Measured results on RACH 10.3.7.45		
Other Information elements					REL-10
Logged Meas Available	OP		Enumerated (TRUE)	Indicates the UE has logged measurements to report to the network	REL-10
ANR Logging Results Available	OP		Enumerated (TRUE)	True indicates the UE has ANR logging results to report to the Network.	REL-10

NOTE 1: For 1.28 Mcps TDD, UE supporting HS-PDSCH in CELL_FACH always supports E-DCH enhanced random access in CELL_FACH state and Idle mode, and vice versa. And UE supporting HS-PDSCH reception in CELL_FACH state always supports HS-DSCH reception in CELL_PCH and URA_PCH state and CELL_FACH HS-DSCH DRX operation.

Condition	Explanation
<i>Failure</i>	This IE is mandatory present if the IE "Failure cause" is present and not needed otherwise.
<i>ConversationalCS</i>	This IE is mandatory present if the IE "Establishment cause" has the value "Originating Conversational Call" or "Emergency Call" and a CS call is being initiated. Otherwise it is not needed.

10.2.7a CELL UPDATE FDD

NOTE: Only for FDD.

This message is used by the UE to initiate a cell update procedure.

RLC-SAP: TM

Logical channel: CCCH

Direction: UE→UTRAN

Information Element/Group name	Need	Multi	Type and reference	Semantics description	Version
Integrity check info	CH		Integrity check info 10.3.3.16		
Message Type	MP		Message Type		
UE information elements					
U-RNTI	MP		U-RNTI 10.3.3.47		
START list	MP	1 to <maxCN domains >		START [40] values for all CN domains.	
>CN domain identity	MP		CN domain identity 10.3.1.1		
>START	MP		START 10.3.3.38	START value to be used in this CN domain.	
AM_RLC error indication(RB2, RB3 or RB4)	MP		Boolean	TRUE indicates AM_RLC unrecoverable error [16] occurred on RB2, RB3 or RB4 in the UE	
AM_RLC error indication(RB>4)	MP		Boolean	TRUE indicates AM_RLC unrecoverable error [16] occurred on RB>4 in the UE	
Cell update cause	MP		Cell update cause 10.3.3.3		
Failure cause	OP		Failure cause and error informatio n 10.3.3.14		
RRC transaction identifier	CV- <i>Failure</i>		RRC transactio n identifier 10.3.3.36		
RB timer indicator	MP		RB timer indicator 10.3.3.28		

Information Element/Group name	Need	Multi	Type and reference	Semantics description	Version
Establishment cause	OP		Establishment cause 10.3.3.11		
Traffic volume indicator	OP		Enumerated (TRUE)	This IE shall be set to TRUE when the criteria for event based traffic volume measurement reporting is fulfilled. Absence of this element means not fulfilled.	
Reconfiguration Status Indicator	OP		Enumerated (TRUE)	TRUE indicates a reconfiguration procedure is ongoing within the UE or a response message has been submitted to RLC and the UE is waiting for the layer 2 ACK.	
CS Call Type	CV- Conversational CS		Enumerated (speech, video, other)	One spare value is needed	
HS-PDSCH in CELL_FACH	OP		Enumerated (TRUE)	The absence of this IE indicates that the UE does not support HS-PDSCH reception in CELL_FACH state.	
UE Mobility State Indicator	MD		Enumerated (High-mobility Detected)	Absence of this IE implies that, according to [4] either the High mobility state is not applicable or it has not been detected by the UE.	
Capability change indicator	OP		Enumerated (TRUE)	TRUE indicates that the UE capability has changed compared to the value stored in the variable UE_CAPABILITY_TRANSFERRED.	
Support of common E-DCH	OP		Enumerated (TRUE)	The absence of this IE indicates that the UE does not support E-DCH enhanced random access in CELL_FACH state and Idle mode.	
Support of HS-DSCH DRX operation	OP		Enumerated (TRUE)	The absence of this IE indicates that the UE does not support HS-DSCH DRX operation in CELL_FACH state.	
Support of MAC-i/is	OP		Enumerated (TRUE)	The absence of this IE indicates that the UE does not support MAC-i/is operation.	
Security Revert Status Indicator	OP		Enumerated (Reverted Back, Normal Operation)	Reverted Back indicates this UE has reverted back to the old security configuration by aborting the ongoing security mode command. Normal Operation indicates this	

Information Element/Group name	Need	Multi	Type and reference	Semantics description	Version
				UE has not reverted back to the old security configuration by aborting an ongoing security mode command. The absence of this IE indicates that the UE does not support reporting of security revert status.	
Measurement information elements					
Measured results on RACH	OP		Measured results on RACH FDD 10.3.7.45 a		
Other Information elements					
Logged Meas Available	OP		Enumerated (TRUE)	Indicates the UE has logged measurements to report to the network	
ANR Logging Results Available	OP		Enumerated (TRUE)	True indicates the UE has ANR logging results to report to the Network.	

Condition	Explanation
<i>Failure</i>	This IE is mandatory present if the IE "Failure cause" is present and not needed otherwise.
<i>ConversationalCS</i>	This IE is mandatory present if the IE "Establishment cause" has the value "Originating Conversational Call" or "EmergencyCall" and a CS call is being initiated. Otherwise it is not needed.

10.2.8 CELL UPDATE CONFIRM

This message confirms the cell update procedure and can be used to reallocate new RNTI information for the UE valid in the new cell.

RLC-SAP: UM

Logical channel: CCCH or DCCH

Direction: UTRAN→UE

Information Element/Group name	Need	Multi	Type and reference	Semantics description	Version
Message Type	MP		Message Type		
UE Information Elements					
U-RNTI	CV-CCCH		U-RNTI 10.3.3.47		
RRC transaction identifier	MP		RRC transaction identifier 10.3.3.36		
Integrity check info	CH		Integrity check info 10.3.3.16		

Information Element/Group name	Need	Multi	Type and reference	Semantics description	Version
Integrity protection mode info	OP		Integrity protection mode info 10.3.3.19	The UTRAN should not include this IE unless it is performing an SRNS relocation or a cell reselection from GERAN <i>lu mode</i>	
Ciphering mode info	OP		Ciphering mode info 10.3.3.5	The UTRAN should not include this IE unless it is performing either an SRNS relocation or a cell reselection from GERAN <i>lu mode</i> , and a change in ciphering algorithm.	
Activation time	MD		Activation time 10.3.3.1	Default value is "now"	
New U-RNTI	OP		U-RNTI 10.3.3.47		
New C-RNTI	OP		C-RNTI 10.3.3.8		
New DSCH-RNTI	OP		DSCH-RNTI 10.3.3.9a	Should not be set in FDD. If received, the UE behaviour is unspecified.	
New H-RNTI	OP		H-RNTI 10.3.3.14a		REL-5
New Primary E-RNTI	OP		E-RNTI 10.3.3.10a		REL-6
New Secondary E-RNTI	OP		E-RNTI 10.3.3.10a	FDD only	REL-6
RRC State Indicator	MP		RRC State Indicator 10.3.3.35a		
UTRAN DRX cycle length coefficient	OP		UTRAN DRX cycle length coefficient 10.3.3.49		
Wait time	OP		Wait time 10.3.3.50		
RLC re-establish indicator (RB2, RB3 and RB4)	MP		RLC re-establish indicator 10.3.3.35	Should not be set to TRUE if IE "Downlink counter synchronisation info" is included in message.	
RLC re-establish indicator (RB5 and upwards)	MP		RLC re-establish indicator 10.3.3.35	Should not be set to TRUE if IE "Downlink counter synchronisation info" is included in message.	
CN Information Elements					
CN Information info	OP		CN Information info 10.3.1.3		
UTRAN Information Elements					
URA identity	OP		URA identity 10.3.2.6		
RNC support for change of UE capability	OP		Boolean	Should be included if the	REL-7

Information Element/Group name	Need	Multi	Type and reference	Semantics description	Version
				message is used to perform an SRNS relocation	
RB information elements					
RAB information for setup	CV-CS		RAB information for setup 10.3.4.10	RAB identity shall be identical to the one currently configured and UE behaviour is unspecified otherwise.	
RB information to release list	OP	1 to <maxRB>			
>RB information to release	MP		RB information to release 10.3.4.19		
RB information to reconfigure list	OP	1 to <maxRB>			
>RB information to reconfigure	MP		RB information to reconfigure 10.3.4.18		
RB information to be affected list	OP	1 to <maxRB>			
>RB information to be affected	MP		RB information to be affected 10.3.4.17		
Downlink counter synchronisation info	OP				
>RB with PDCP information list	OP	1 to <maxRBall RABs>			
>>RB with PDCP information	MP		RB with PDCP information 10.3.4.22	This IE is needed for each RB having PDCP in the case of lossless SRNS relocation	
	OP				REL-5
>>PDCP context relocation info	OP		PDCP context relocation info 10.3.4.1a	This IE is needed for each RB having PDCP and performing PDCP context relocation	REL-5
PDCP ROHC target mode	OP		PDCP ROHC target mode 10.3.4.2a		REL-5
TrCH Information Elements					
Uplink transport channels					
UL Transport channel information common for all transport channels	OP		UL Transport channel information common for all transport channels 10.3.5.24		

Information Element/Group name	Need	Multi	Type and reference	Semantics description	Version
Deleted TrCH information list	OP	1 to <maxTrCH >			
>Deleted UL TrCH information	MP		Deleted UL TrCH information 10.3.5.5		
Added or Reconfigured TrCH information list	OP	1 to <maxTrCH >			
>Added or Reconfigured UL TrCH information	MP		Added or Reconfigured UL TrCH information 10.3.5.2		
Downlink transport channels					
DL Transport channel information common for all transport channels	OP		DL Transport channel information common for all transport channels 10.3.5.6		
Deleted TrCH information list	OP	1 to <maxTrCH >			
>Deleted DL TrCH information	MP		Deleted DL TrCH information 10.3.5.4		
Added or Reconfigured TrCH information list	OP	1 to <maxTrCH >			
>Added or Reconfigured DL TrCH information	MP		Added or Reconfigured DL TrCH information 10.3.5.1		
PhyCH information elements					
Frequency info	OP		Frequency info 10.3.6.36		
Multi-frequency Info	OP		Multi-frequency Info 10.3.6.39a	This IE is used for 1.28 Mcps TDD only	REL-7
DTX-DRX timing information	OP		DTX-DRX timing information 10.3.6.34b		REL-7
DTX-DRX Information	OP		DTX-DRX Information 10.3.6.34a		REL-7
HS-SCCH less Information	OP		HS-SCCH less Information 10.3.6.36ab		REL-7
MIMO parameters	OP		MIMO parameters 10.3.6.41a		REL-7
MIMO mode with four transmit antennas parameters	OP		MIMO mode with four transmit antennas parameters 10.3.6.142		REL-11

Information Element/Group name	Need	Multi	Type and reference	Semantics description	Version
DCH Enhancements info FDD	OP		DCH Enhancements info FDD 10.3.6.149		REL-12
Control Channel DRX information	OP		Control Channel DRX information 1.28 Mcps TDD 10.3.6.107	This IE is used for 1.28 Mcps TDD only	REL-8
SPS Information	OP		SPS information 1.28 Mcps TDD 10.3.6.110	This IE is used for 1.28 Mcps TDD only	REL-8
MU-MIMO info	OP		MU-MIMO info 1.28 Mcps TDD 10.3.6.122	This IE is used for 1.28 Mcps TDD only	REL-10
Non-rectangular resource allocation indicator	OP		Enumerated(TRUE)	For 1.28 Mcps TDD only. The absence of this IE indicates that the non-rectangular resource allocation is not used.	REL-12
Non-rectangular resource specific timeslots set	CV- <i>Non-rectangular Resource Allocation</i>		Bit string (7)	For 1.28 Mcps TDD only. The value 1 of a bit indicates the corresponding timeslot in which the channelization codes are assigned by physical control channel. The value 0 of a bit indicates the corresponding timeslot in which all channelization codes are assigned when the timeslot is scheduled to the UE. The first/leftmost bit of the bit string is for TS0.	REL-12
Uplink radio resources					
Maximum allowed UL TX power	MD		Maximum allowed UL TX power 10.3.6.39	Default value is the existing maximum UL TX power	
Uplink DPCH info	OP		Uplink DPCH info 10.3.6.88		
E-DCH Info	OP		E-DCH Info 10.3.6.97		REL-6

Information Element/Group name	Need	Multi	Type and reference	Semantics description	Version
Uplink secondary cell info FDD	OP		Uplink secondary cell info FDD 10.3.6.115	FDD only	REL-9
Multi-carrier E-DCH Info for LCR TDD	OP		Multi-carrier E-DCH Info for LCR TDD 10.3.6.97a	1.28Mcps TDD only	REL-10
Uplink CLTD info FDD	OP		Uplink CLTD info FDD 10.3.6.125	FDD only	REL-11
Uplink OLTD info FDD	OP		Uplink OLTD info FDD 10.3.6.126	FDD only	REL-11
Other TTI E-DCH Configuration Information	OP		Other TTI E-DCH Configuration Information 10.3.6.152	FDD only	REL-12
Filtered UE power headroom reporting information	OP		Filtered UE power headroom reporting information 10.3.7.140	FDD only	REL-12
Downlink radio resources					
Downlink HS-PDSCH Information	OP		Downlink HS_PDSCH Information 10.3.6.23a		REL-5
Downlink information common for all radio links	OP		Downlink information common for all radio links 10.3.6.24		
Downlink information per radio link list	OP	1 to <maxRL>		Send downlink information for each radio link to be set-up	
>Downlink information for each radio link	MP		Downlink information for each radio link 10.3.6.27		
Downlink secondary cell info FDD	OP		Downlink secondary cell info FDD 10.3.6.31a	FDD only	REL-8
Additional downlink secondary cell info list FDD	OP	2			REL-10
>Downlink secondary cell info FDD	OP		Downlink secondary cell info FDD 10.3.6.31a	FDD only	REL-10
Additional downlink secondary cell info list FDD 2	OP	4			REL-11
>Downlink secondary cell info FDD	OP		Downlink secondary cell info FDD 10.3.6.31a	FDD only	REL-11
Common E-RGCH info FDD	OP		Common E-RGCH info FDD 10.3.6.138	FDD only	REL-11
MBMS PL Service Restriction Information	OP		Enumerated (TRUE)		REL-6

Information Element/Group name	Need	Multi	Type and reference	Semantics description	Version
CELL_DCH measurement occasion info LCR	OP		CELL_DCH measurement occasion info LCR 10.3.7.126		REL-9
WLAN Information Elements					
Dedicated WLAN Offload Information	OP		Dedicated WLAN Offload Information 10.3.2.10		REL-12

Condition	Explanation
<i>CCCH</i>	This IE is mandatory present when CCCH is used and ciphering is not required and not needed otherwise.
<i>CS</i>	This IE is optionally present only if CS domain RAB mapping is reconfigured between DCH and E-DCH/HS-DSCH and shall not be present otherwise.
<i>Non-rectangularResourceAllocation</i>	This IE is optionally present if non-rectangular resource allocation is configured. Otherwise, it is not needed.

10.2.9 COUNTER CHECK

This message is used by the UTRAN to indicate the current COUNT-C MSB values associated to each radio bearer utilising UM or AM RLC mode and to request the UE to compare these to its COUNT-C MSB values and to report the comparison results to UTRAN.

RLC-SAP: AM

Logical channel: DCCH

Direction: UTRAN→UE

Information Element/Group name	Presence	Multi	IE type and reference	Semantics description
Message Type	MP			
UE information elements				
RRC transaction identifier	MP		RRC transaction identifier 10.3.3.36	
Integrity check info	CH		Integrity check info 10.3.3.16	
RB information elements				
RB COUNT-C MSB information	MP	1 to < maxRBallRABs >		For each RB (excluding signalling radio bearers) using UM or AM RLC.
>RB COUNT-C MSB information	MP		RB COUNT-C MSB information 10.3.4.14	

10.2.10 COUNTER CHECK RESPONSE

This message is used by the UE to respond to a COUNTER CHECK message.

RLC-SAP: AM

Logical channel: DCCH

Direction: UE→UTRAN

Information Element/Group name	Presence	Multi	IE type and reference	Semantics description
Message Type	MP			
UE information elements				
RRC transaction identifier	MP		RRC transaction identifier 10.3.3.36	
Integrity check info	CH		Integrity check info 10.3.3.16	
RB information elements				
RB COUNT-C information	OP	1 to < maxRBAllR ABs >		
>RB COUNT-C information	MP		RB COUNT-C information 10.3.4.15	

10.2.11 DOWNLINK DIRECT TRANSFER

This message is sent by UTRAN to transfer higher layer messages.

RLC-SAP: AM

Logical channel: DCCH

Direction: UTRAN -> UE

Information Element/Group name	Need	Multi	Type and reference	Semantics description
Message Type	MP		Message Type	
UE information elements				
RRC transaction identifier	MP		RRC transaction identifier 10.3.3.36	
Integrity check info	CH		Integrity check info 10.3.3.16	
CN information elements				
CN Domain Identity	MP		Core Network Domain Identity 10.3.1.1	
NAS message	MP		NAS message 10.3.1.8	

10.2.12 Void

10.2.12a ETWS PRIMARY NOTIFICATION WITH SECURITY

This message is used by UTRAN to send ETWS information to the UE.

RLC-SAP: AM or UM

Logical channel: DCCH

Direction: UTRAN → UE

Information Element/Group name	Need	Multi	Type and reference	Semantics description	Version
Message Type	MP		Message Type		REL-8
Other Information elements					REL-8
ETWS information	MP		ETWS information 10.3.8.4ea		REL-8

10.2.13 Void

10.2.14 Void

10.2.15 HANDOVER FROM UTRAN COMMAND

This message is used for handover from UMTS to another system e.g. GSM. One or several messages from the other system can be included in the Inter-RAT message information element in this message. These messages are structured and coded according to that systems specification.

RLC-SAP: AM

Logical channel: DCCH

Direction: UTRAN→UE

Information Element/Group name	Need	Multi	Type and reference	Semantics description	Version
Message Type	MP		Message Type		
UE information elements					
RRC transaction identifier	MP		RRC transaction identifier 10.3.3.36		
Integrity check info	CH		Integrity check info 10.3.3.16		
SR-VCC Info	CV-SRVCC		SR-VCC info 10.3.4.24a		REL-8
rSR-VCC info	CV-rSRVCC		rSR-VCC Info 10.3.3.36a		REL-11
Activation time	MD		Activation time 10.3.3.1	Default value is "now"	
RB information elements					

Information Element/Group name	Need	Multi	Type and reference	Semantics description	Version
RAB information list	OP	1 to <maxRABsetup>		For each RAB to be handed over. In handover to GERAN <i>lu mode</i> the RAB information is included in the GERAN <i>lu</i> message below.	
>RAB info	MP		RAB info 10.3.4.8		
RAB info to replace	CV-SRVCC		RAB info to replace 10.3.4.11a		REL-8
Other information elements					
CHOICE <i>System type</i>	MP			This IE indicates which specification to apply, to decode the transported messages	
>GSM					
>>Frequency band	MP		Enumerated (GSM/DSS 1800 band used), GSM/PCSS 1900 band used)		
>>CHOICE <i>GSM message</i>					
>>>Single GSM message	MP		Bit string (no explicit size constraint)	Formatted and coded according to GSM specifications The first/leftmost/most significant bit of the bit string contains bit 8 of the first octet of the GSM message.	
>>>GSM message List	MP	1.to.<maxInterSystemMessages>	Bit string (1..512)	Formatted and coded according to GSM specifications. The first/leftmost/most significant bit of the bit string contains bit 8 of the first octet of the GSM message.	
>>CHOICE <i>GERAN System Info type</i>	OP				REL-6
>>>SI	MP		GERAN system information 10.3.8.4f	See [44]	REL-6
>>>PSI	MP		GERAN system information 10.3.8.4f	See [44]	REL-6

Information Element/Group name	Need	Multi	Type and reference	Semantics description	Version
>GERAN lu					REL-5
>>Frequency band	MP		Enumerated (GSM/DCS 1800 band used), GSM/PC S 1900 band used)		REL-5
>>CHOICE GERAN lu message					REL-5
>>>Single GERAN lu message	MP		Bit string (no explicit size constraint)	The first/leftmost/most significant bit of the bit string contains bit 8 of the first octet of the message.	REL-5
>>>GERAN lu message List	MP	1 to <maxInterSysMessages>	Bit string (1..32768)	The first/leftmost/most significant bit of the bit string contains bit 8 of the first octet of the message.	REL-5
>cdma2000					
>>cdma2000MessageList	MP	1.to.<maxInterSysMessages>			
>>>MSG_TYPE(s)	MP		Bit string (8)	Formatted and coded according to cdma2000 specifications. The MSG_TYPE bits are numbered b0 to b7. The first/leftmost/most significant bit of the bit string contains bit 7 of the MSG_TYPE.	
>>>cdma2000Messagepayload(s)	MP		Bit string (1..512)	Formatted and coded according to cdma2000 specifications. The first/leftmost/most significant bit of the bit string contains the bit 7 of the first octet of the cdma2000 message.	
>E-UTRA					REL-8
>>E-UTRA message	MP		Octet string	Formatted and coded according to E-UTRA specifications The first/leftmost/most significant bit of the octet string contains bit 8 of the first octet of the E-UTRA message.	REL-8

Condition	Explanation
SRVCC	This IE is mandatory present when an SR-VCC procedure is initiated and not needed otherwise.
rSRVCC	This IE is mandatory present when an rSR-VCC procedure is initiated and not needed otherwise.

10.2.16 HANDOVER FROM UTRAN FAILURE

This message is sent on the RRC connection used before the Inter-RAT Handover was executed. The message indicates that the UE has failed to seize the new channel in the other system.

RLC-SAP: AM

Logical channel: DCCH

Direction: UE→UTRAN

Information Element/Group name	Need	Multi	Type and reference	Semantics description	Version
Message Type	MP		Message Type		
UE information elements					
RRC transaction identifier	MP		RRC transaction identifier 10.3.3.36		
Integrity check info	CH		Integrity check info 10.3.3.16		
Other information elements					
Inter-RAT handover failure	OP		Inter-RAT handover failure 10.3.8.6		
CHOICE <i>System type</i>	OP			This IE indicates which specification to apply to decode the transported messages	
>GSM					
>>GSM message List	MP	1.to.<maxInterSysMessages>	Bit string (1..512)	Formatted and coded according to GSM specifications. The first/leftmost/most significant bit of the bit string contains bit 8 of the first octet of the GSM message.	
>GERAN lu					REL-5
>>GERAN lu message List	MP	1 to <maxInterSysMessages>	Bit string (1..32768)	The first/leftmost/most significant bit of the bit string contains bit 8 of the first octet of the message.	REL-5
>cdma2000					
>>cdma2000MessageList	MP	1.to.<maxInterSysMessages>			
>>>MSG_TYPE(s)	MP		Bit string (8)	Formatted and coded according to cdma2000 specifications. The MSG_TYPE bits are numbered b0 to b7. The first/leftmost/most significant bit of the bit string contains bit 7 of the MSG_TYPE.	

Information Element/Group name	Need	Multi	Type and reference	Semantics description	Version
>>>cdma2000Messagepayload(s)	MP		Bit string (1..512)	Formatted and coded according to cdma2000 specifications. The first/leftmost/most significant bit of the bit string contains bit 7 of the first octet of the cdma2000 message.	
>E-UTRA					REL-8
>>E-UTRA message	OP		Octet string	Formatted and coded according to E-UTRA specifications. The first/leftmost/most significant bit of the octet string contains bit 8 of the first octet of the E-UTRA message.	REL-8

10.2.16a HANDOVER TO UTRAN COMMAND

This message is sent to the UE via other system to make a handover to UTRAN.

RLC-SAP: N/A (Sent through a different RAT)

Logical channel: N/A (Sent through a different RAT)

Direction: UTRAN → UE

Information Element/Group name	Need	Multi	Type and reference	Semantics description	Version
New U-RNTI	MP		U-RNTI Short 10.3.3.48		
Ciphering algorithm	OP		Ciphering algorithm 10.3.3.4		
RNC support for change of UE capability	MP		Boolean		REL-7
New H-RNTI	OP		H-RNTI 10.3.3.14a		REL-6
New Primary E-RNTI	OP		E-RNTI 10.3.3.10a		REL-6
New Secondary E-RNTI	OP		E-RNTI 10.3.3.10a	FDD only	REL-6
Specification mode information elements					REL-8
Default configuration for CELL_FACH	OP		Default configuration for CELL_FACH 10.3.4.0a		REL-8
CHOICE <i>specification mode</i>	MP				
>Complete specification					
RB information elements					
>>Signalling RB information to setup list	MP	1 to <maxSRBsetup>		For each signalling radio bearer established	

Information Element/Group name	Need	Multi	Type and reference	Semantics description	Version
>>>Signalling RB information to setup	MP		Signalling RB information to setup 10.3.4.24		
>>RAB information to setup list	OP	1 to <maxRABsetup>		For each RAB established	
>>>RAB information for setup	MP		RAB information for setup 10.3.4.10		
Uplink transport channels					
>>UL Transport channel information common for all transport channels	MP		UL Transport channel information common for all transport channels 10.3.5.24		
>>Added or Reconfigured TrCH information	MP	1 to <maxTrCH>			
>>>Added or Reconfigured UL TrCH information	MP		Added or Reconfigured UL TrCH information 10.3.5.2		
Downlink transport channels					
>>DL Transport channel information common for all transport channels	MP		DL Transport channel information common for all transport channels 10.3.5.6		
>>Added or Reconfigured TrCH information	MP	1 to <maxTrCH>			
>>>Added or Reconfigured DL TrCH information	MP		Added or Reconfigured DL TrCH information 10.3.5.1		
Uplink radio resources					
>>Uplink DPCH info	MP		Uplink DPCH info 10.3.6.88		
>>E-DCH Info	OP		E-DCH Info 10.3.6.97		REL-6
>>Uplink secondary cell info FDD	OP		Uplink secondary cell info FDD 10.3.6.115	FDD only	REL-11
Downlink radio resources (Complete specification)					
>>Downlink HS-PDSCH Information	OP		Downlink HS-PDSCH Information 10.3.6.23a		REL-6
>>Downlink information common for all radio links	MP		Downlink information common for all radio links		

Information Element/Group name	Need	Multi	Type and reference	Semantics description	Version
			10.3.6.24		
>>Downlink information per radio link	MP	1 to <maxRL>			
>>>Downlink information for each radio link	MP		Downlink information for each radio link 10.3.6.27		
>>Downlink secondary cell info FDD	OP		Downlink secondary cell info FDD for Handover to UTRAN 10.3.6.31b	FDD only	REL-11
>>Additional downlink secondary cell info list FDD	OP	2			REL-11
>>>Downlink secondary cell info FDD	OP		Downlink secondary cell info FDD for Handover to UTRAN 10.3.6.31b	FDD only	REL-11
PhyCH information elements (Complete specification)					
>>DCH Enhancements info FDD	OP		DCH Enhancements info FDD 10.3.6.149		REL-12
>Preconfiguration					
>>CHOICE <i>Preconfiguration mode</i>	MP				
>>>Predefined configuration	MP		Predefined configuration identity 10.3.4.5	NOTE 1	
>>>Default configuration					
>>>>Default configuration mode	MP		Enumerated (FDD, TDD)	Indicates whether the FDD or TDD version of the default configuration shall be used	
>>>>Default configuration identity	MP		Default configuration identity 10.3.4.0		
>>RAB info	OP		RAB info Post 10.3.4.9	One RAB is established	
>>CHOICE <i>mode</i>	MP				
>>>FDD					
>>>>Uplink DPCH info	MP		Uplink DPCH info Post 10.3.6.89		
>>>CHOICE <i>tdd</i>					
>>>>1.28 Mcps TDD and 7.64 Mcps TDD					
>>>>> Uplink DPCH info	MP		Uplink DPCH info 10.3.6.88		

Information Element/Group name	Need	Multi	Type and reference	Semantics description	Version
Downlink radio resources (Preconfiguration)					
>>>>3.84 Mcps TDD					
>>>>>Uplink DPCH info	MP		Uplink DPCH info Post 10.3.6.89		
>>Downlink information common for all radio links	MP		Downlink information common for all radio links Post 10.3.6.25		
>>Downlink information per radio link	MP	1 to <maxRL>		Send downlink information for each radio link to be set-up. In TDD MaxRL is 1.	
>>>Downlink information for each radio link	MP		Downlink information for each radio link Post 10.3.6.28		
>>CHOICE <i>mode</i>	MP				
>>>FDD				(no data)	
>>>TDD					
>>>>>Primary CCPCH Tx Power	MP		Primary CCPCH Tx Power 10.3.6.59		
Frequency info	MP		Frequency info 10.3.6.36		
Multi-frequency Info	OP		Multi-frequency Info 10.3.6.39a	This IE is used for 1.28 Mcps TDD only	REL-7
Maximum allowed UL TX power	MP		Maximum allowed UL TX power 10.3.6.39		

NOTE 1: Predefined configurations are not used in case of handover from E-UTRAN.

10.2.16b HANDOVER TO UTRAN COMPLETE

This message is sent by the UE when a handover to UTRAN has been completed.

RLC-SAP: AM

Logical channel: DCCH

Direction: UE → UTRAN

Information Element/Group name	Need	Multi	Type and reference	Semantics description	Version
Message Type	MP		Message Type		
UE Information elements					
START list	CH	1 to <maxCNdomains>		START [40] values for all CN domains.	
>CN domain identity	MP		CN domain identity 10.3.1.1		
>START	MP		START 10.3.3.38		
RB Information elements					
COUNT-C activation time	OP		Activation time 10.3.3.1	Used for radio bearers mapped on RLC-TM.	
Other Information elements					
Logged Meas Available	OP		Enumerated (TRUE)	Indicates the UE has logged measurements to report to the network	REL-10
Connection Establishment Failure Info Available	OP		Enumerated (TRUE)	True indicates the UE has logged measurements from a RRC connection establishment failure to report to the network	REL-11

10.2.16c INITIAL DIRECT TRANSFER

This message is used to initiate a signalling connection based on indication from the upper layers, and to transfer a NAS message.

RLC-SAP: AM

Logical channel: DCCH

Direction: UE -> UTRAN

Information Element/Group name	Need	Multi	Type and reference	Semantics description	Version
Message Type	MP		Message Type		
UE information elements					
Integrity check info	CH		Integrity check info 10.3.3.16		
PLMN identity	OP		PLMN identity 10.3.1.11	This IE indicates the PLMN to which the UE requests the signalling connection to be established.	REL-6
Support of CSG	OP		Enumerated (TRUE)	The absence of this IE indicates that the UE does not support access control based on CSG	REL-8
CN information elements					
CN domain identity	MP		CN domain identity 10.3.1.1		
Intra Domain NAS Node Selector	MP		Intra Domain NAS Node Selector 10.3.1.6		
NAS message	MP		NAS message 10.3.1.8		
START	OP		START 10.3.3.38	START value to be used in the CN domain as indicated in the IE "CN domain identity". This IE shall always be present in this version of the protocol.	
Establishment cause	OP		Establishment cause 10.3.3.11		Rel-5
CS Call Type	CV- ConversationalCS		Enumerated (speech, video, other)	One spare value is needed	REL-7
Measurement information elements					
Measured results on RACH	OP		Measured results on RACH 10.3.7.45		
MBMS joined information	OP				REL-6
>P-TMSI	OP		P-TMSI (GSM-MAP) 10.3.1.13		REL-6

Condition	Explanation
<i>ConversationalCS</i>	This IE is mandatory present if the IE "Establishment cause" has the value "Originating Conversational Call" or "Emergency Call", the IE "CN domain identity" has the value "CS domain" and the UE is in CELL_FACH state. Otherwise it is not needed.

10.2.16d INTER RAT HANDOVER INFO

This message is sent by the UE via another radio access technology to provide information to the target RNC when preparing for a handover to UTRAN.

RLC-SAP: N/A (Sent through a different RAT)

Logical channel: N/A (Sent through a different RAT)

Direction: UE → UTRAN

Information Element/Group Name	Need	Multi	Type and reference	Semantics description	Version
Radio Bearer IEs					
Predefined configuration status information	OP		Predefined configuration status information 10.3.4.5a		
Predefined configuration status information compressed	OP		Predefined configuration status information compressed 10.3.4.5b		REL-5
UE Information elements					
UE security information	OP		UE security information 10.3.3.42b		
UE security information2	OP		UE security information2 10.3.3.42c		REL-6
UE Specific Behaviour Information 1 interRAT	OP		UE Specific Behaviour Information 1 interRAT 10.3.3.52	This IE shall not be included in this version of the protocol	
UE capability container	OP				
>UE radio access capability	MP		UE radio access capability 10.3.3.42		
>UE radio access capability extension	MP		UE radio access capability extension 10.3.3.42a	Although this IE is not always required, the need has been set to MP to align with the ASN.1	

Information Element/Group Name	Need	Multi	Type and reference	Semantics description	Version
UE radio access capability compressed	OP		UE radio access capability compressed 10.3.3.42o		REL-5
UE radio access capability comp 2	<i>CV-Fdd</i>		UE radio access capability comp 2 10.3.3.42oa		REL-6
UE radio access capability comp for 1.28 Mcps	<i>CV-128Tdd</i>		UE radio access capability comp for 1.28 Mcps TDD 10.3.3.42ob		REL-8
Support for F-DPCH	<i>CV-Support ForHS</i>		Enumerated (TRUE)	Presence of this information element indicates that F-DPCH is supported by the UE. Absence of this information element indicates that F-DPCH is not supported	REL-12

Condition	Explanation
<i>Fdd</i>	This IE is mandatory present for FDD, otherwise it is not needed.
<i>128Tdd</i>	This IE is mandatory present for 1.28 Mcps TDD, otherwise it is not needed.
<i>SupportForHS</i>	This IE is mandatory present if the UE supports HS-PDSCH, otherwise it is not needed.

10.2.16da LOGGING MEASUREMENT CONFIGURATION

This message is used to configure logged measurements

RLC-SAP: AM

Logical channel: DCCH

Direction: UTRAN→UE

Information Element/Group name	Need	Multi	Type and reference	Semantics description	Version
Message Type	MP		Message Type		REL-10
UE information elements					REL-10
RRC transaction identifier	MP		RRC transaction identifier 10.3.3.36		REL-10
Integrity check info	CH		Integrity check info 10.3.3.16		REL-10
Other Information Elements					REL-10
Logged Measurements Configuration Info	OP		Logged Measurements		REL-10

Information Element/Group name	Need	Multi	Type and reference	Semantics description	Version
			Configuratio n Info 10.3.7.132		
Logged ANR configuration Info	OP		Logged ANR Configuratio n Info 10.3.7.42a		REL-10

10.2.16e MBMS ACCESS INFORMATION

This message is transmitted periodically by UTRAN to inform UEs that have joined or selected a particular MBMS service about the need to establish an RRC connection or to perform a cell update. While the message contents may change within a modification period, all occurrences of the information within a modification period concern the same MBMS service(s). If the cell on which this message is sent is operating in MBSFN mode as indicated in subclause 8.1.1.6.3 the UE behaves as if this message would not have been received.

RLC-SAP: UM

Logical channel: MCCH

Direction: UTRAN → UE

Information Element/Group name	Need	Multi	Type and reference	Semantics description	Version
Message type	MP		Message Type		REL-6
Service list	MP	1 to <maxMBMSserv Count>			REL-6
>MBMS short transmission ID	MP		MBMS Short transmission identity 10.3.9a.10	Reference/ index to a transmission listed in the MBMS MODIFIED SERVICES INFORMATION or MBMS UNMODIFIED SERVICES INFORMATION	REL-6
>Access probability factor - Idle	MP		Integer (0 to 960 by step of 32, 1000)	Access probability factor for UEs in idle mode. The actual Access Probability (AP) is a function of the Access Probability Factor (APF): $AP (APF) = 2^{-(APF/100)}$	REL-6
>Access probability factor – connected	MD		Integer (0 to 960 by step of 32, 1000)	Access probability factor for UEs in connected mode. The actual Access Probability (AP) is a function of the Access Probability Factor (APF): $AP (APF) = 2^{-(APF/100)}$ Default value is the value included in IE "Access probability factor - Idle"	REL-6
>Connected mode counting scope	MP				REL-6
>>URA_PCH	MP		BOOLEAN	TRUE means that UEs in URA_PCH state shall participate in counting	REL-6
>>CELL_PCH	MP		BOOLEAN	TRUE means that UEs in CELL_PCH state shall participate in counting	REL-6
>> CELL_FACH	MP		BOOLEAN	TRUE means that UEs in CELL_FACH state shall participate in counting	REL-6

10.2.16f MBMS COMMON P-T-M RB INFORMATION

This message is transmitted periodically by UTRAN to inform UEs about the p-t-m RB configuration information that may be common between different services, applicable in the current and/ or in neighbouring cells. The message contents does not change within a modification period.

RLC-SAP: UM

Logical channel: MCCH

Direction: UTRAN → UE

Information Element/Group name	Need	Multi	Type and reference	Semantics description	Version
Message type	MP		Message Type		REL-6
RB information list	MP	1 to <maxMB MS-CommonRB>			REL-6
>RB identity	MP		MBMS Common RB identity 10.3.9a.3		REL-6
>PDCP info	MP		PDCP info 10.3.4.2		REL-6
>RLC info	MP		RLC info MBMS 10.3.4.23a		REL-6
TrCh information for each TrCh	MP	1 to <maxMB MS-CommonTrCh>			REL-6
>Transport channel identity	MP		MBMS Common TrCh identity 10.3.9a.4		REL-6
>TFCS	MP		Transport format set 10.3.5.23		REL-6
TrCh information for each CCTrCh	OP	1 to <maxMB MS-CommonCCTrCh>		The list needs not include the CCTrCh for which the default TFCS for MBMS applies, as specified in subclause 14.10.1.	REL-6
>CCTrCH identity	MP		MBMS Common CCTrCh identity 10.3.9a.1		REL-6
>TFCS	MP		Transport format combination set 10.3.5.20		REL-6
PhyCh information	MP	1 to <maxMB MS-CommonPhyCh>			REL-6
>PhyCh identity	MP		MBMS Common PhyCh identity 10.3.9a.2		REL-6
>CHOICE <i>mode</i>	MP				REL-8
>>FDD or TDD					REL-8

Information Element/Group name	Need	Multi	Type and reference	Semantics description	Version
>>>Secondary CCPCH info MBMS	MP		Secondary CCPCH info MBMS 10.3.6.71a		REL-6
>>3.84 Mcps TDD IMB				3.84 Mcps TDD IMB is a subset of 3.84 Mcps TDD.	REL-8
>>>Secondary CCPCH frame type 2 info	MP		Secondary CCPCH frame type 2 info 10.3.6.114		REL-8
LCR TDD MBSFN information	OP		LCR TDD MBSFN Information 10.3.6.78c	1.28 Mcps TDD only: included only if some timeslots of the secondary frequency of a multi-frequency cell are designated to MBSFN.	REL-7

10.2.16g MBMS CURRENT CELL P-T-M RB INFORMATION

This message is transmitted periodically by UTRAN to inform UEs about the PTM RB configuration used to in a cell, in case one or more MBMS service is provided using p-t-m radio bearers. The message contents does not change within a modification period.

RLC-SAP: UM

Logical channel: MCCH

Direction: UTRAN → UE

Information Element/Group name	Need	Multi	Type and reference	Semantics description	Version
Message type	MP		Message Type	Current cell PTM RB info	REL-6
S-CCPCH list	OP	1 to <maxSC CPCH>		Absent in case MTCH are only mapped to the S-CCPCH(s) included in SIB type 5 or 5bis	REL-6
>S-CCPCH identity	OP		MBMS Current cell S-CCPCH identity 10.3.9a.5	When L1- or L2 combining applies, this identity is used to refer to this S-CCPCH within the NEIGHBOURING CELL P-T-M RB INFORMATION message If the cell is operating in MBSFN mode as indicated in subclause 8.1.1.6.3 the UE behaviour upon reception of this IE is unspecified. When Chip combining (1.28Mcps TDD only) applies, this identity is used to refer to the S-CCPCH within the NEIGHBOURING CELL P-T-M RB INFORMATION message	REL-6
>Secondary CCPCH info	MP		MBMS Common PhyCh identity 10.3.9a.2	Refers to a configuration in the common RB info	REL-6
>MBMS Soft Combining Timing Offset	CV-Soft-FDD		MBMS Soft Combining Timing Offset 10.3.9a.10a	Timing offset applied in the CFN calculation in sub-clause 8.5.15.5. The default value is 0 ms. If the cell is operating in MBSFN mode as indicated in subclause 8.1.1.6.3 the UE behaviour upon reception of this IE is unspecified.	REL-6
>TrCh information common for all TrCh	MD		MBMS Common CCTrCh identity 10.3.9a.1	Refers to a (TFCS) configuration in the common RB info The default value of the TFCS is specified in subclause 14.10.1	REL-6
>TrCH information list	MP	1 to <maxFA CHPCH >		List of FACH transport channels carrying one or more MTCH and optionally one MSCH	REL-6
>>TrCh information	MP		MBMS Common TrCh identity 10.3.9a.4	Refers to a (TFS) configuration in the common RB info	REL-6
>>RB information list	OP	1 to <maxRB perTrCh >		The IE is absent if temporarily no RBs are mapped to this TrCh or if the TrCH only carries MSCH	REL-6
>>>RB information	MP		MBMS p-t-m RB information 10.3.9a.7a		REL-6
>>MSCH configuration information	OP		MSCH configuration information 10.3.9a.16		REL-6

Information Element/Group name	Need	Multi	Type and reference	Semantics description	Version
S-CCPCH in SIB type 5	OP	1 to <maxSC CPCH>		Every S-CCPCH's included in SIB type 5 or 5bis may carry MTCH If the cell is operating in MBSFN mode as indicated in subclause 8.1.1.6.3 the UE behaviour upon reception of this IE is unspecified.	REL-6
>S-CCPCH identity			Integer (1..maxS CCPCH)	Index of the S-CCPCH within the list included in SIB type 5 or 5bis	REL-6
>TrCH information list	MP	1 to <maxFA CHPCH >		List of FACH transport channels carrying one or more MTCH and optionally one MSCH	REL-6
>>TrCh identity	MP		Integer (1..maxF ACHPCH)	Index of the FACH within the list of TrChs defined for that S-CCPCH as included in SIB type 5 or 5bis	REL-6
>>RB information list	OP	1 to <maxRB perTrCh >		The IE is absent if this TrCh only carries MSCH	REL-6
>>>RB information	MP		MBMS p-t-m RB information 10.3.9a.7a		REL-6
>>MSCH configuration information	OP		MSCH configuration information 10.3.9a.16	Included if the TrCH carries MSCH	REL-6
MBSFN TDM Info List	CV-Mbsfn		MBSFN TDM Information List 10.3.9a.12b		REL-7

Condition	Explanation
<i>Soft-FDD</i>	This IE is used only for FDD. It is mandatory default for FDD if the IE "L1 combining" is included in MBMS NEIGHBOURING CELL P-T-M RB INFORMATION. Otherwise it is not needed.
<i>Mbsfn</i>	The IE is optionally present if the cell supports MBSFN, and not needed otherwise.

10.2.16h MBMS GENERAL INFORMATION

This message is transmitted periodically by UTRAN to inform UEs about the general MBMS (configuration) information. The message contents does not change within a modification period.

RLC-SAP: UM

Logical channel: MCCH

Direction: UTRAN → UE

Information Element/Group name	Need	Multi	Type and reference	Semantics description	Version
Message type	MP		Message Type		REL-6
MBMS preferred frequency information	OP		MBMS preferred frequency information 10.3.7.43a	If the cell is operating in MBSFN mode as indicated in subclause 8.1.1.6.3 the UE behaviour upon reception of this IE is unspecified.	REL-6
MBMS timers and counters	MP		MBMS specific timers and counters 10.3.9a.11		REL-6
MICH configuration information	MP		MICH configuration information 10.3.9a.14		REL-6
Cell group identity	MP		Bit string (12)	Identifies the group of cells for which the same common RLC and PDCP entity is used as the current cell	REL-6
Default MSCH configuration information	OP		MSCH configuration information 10.3.9a.16	The default MSCH configuration	REL-6
Indicate changes in MBMS Selected Services	MP		Boolean	TRUE means the UE indicates changes in MBMS Selected Services while in URA_PCH, CELL_PCH or in CELL_FACH. Default value is FALSE. If the cell is operating in MBSFN mode as indicated in subclause 8.1.1.6.3 the UE behaves as if this IE has the value FALSE. NOTE 1.	REL-6
MBSFN inter frequency neighbour list	OP		MBSFN inter frequency neighbour list 10.3.7.43b	May be included for FDD and 3.84/7.68 Mcps TDD if the cell is operating in MBSFN mode	Rel-7
Network Standard Time Information	OP		Network standard time information 10.3.9a.17	Only for 1.28 Mcps TDD	Rel-8

NOTE 1: The default value is used when the non-critical extension v6b0NonCriticalExtensions is not included.

10.2.16i MBMS MODIFICATION REQUEST

The UE transmits this message to request UTRAN to take certain actions to improve the UE's ability to receive its (prioritised) activated MBMS services and/ or sessions.

RLC-SAP: AM

Logical channel: DCCH

Direction: UE → UTRAN

Information Element/Group name	Need	Multi	Type and reference	Semantics description	Version
Message type	MP		Message Type		REL-6
UE information elements					REL-6
Integrity check info	CH		Integrity check info 10.3.3.16		REL-6
MBMS information elements					REL-6
MBMS preferred frequency request	OP		MBMS service identity 10.3.9a.8	The MBMS preferred frequency the UE would like to be moved to. The MBMS preferred frequency is identified by the identity of the MBMS service the UE would like to receive.	REL-6
MBMS RB list requested to be released	OP	1 to <maxRB >		RBs of lower priority MBMS services inhibiting reception of a higher priority service	REL-6
>RB information to release	MP		RB information to release 10.3.4.19		REL-6
MBMS Selected Service Info	MP		MBMS Selected Service Info 10.3.9a.7 b	NOTE 1.	REL-6
Support of MBMS service change for a ptp RB	OP		Enumerated (TRUE)	In this version of the specification, this IE has no meaning but it shall be included upon the conditions specified in subclause 8.7.6.2a.	REL-6

NOTE 1: The default value is used when the non-critical extension v6b0NonCriticalExtensions is not included.

10.2.16j MBMS MODIFIED SERVICES INFORMATION

This information is transmitted periodically by UTRAN to inform UEs about a change applicable for one or more MBMS services available in the current cell and possibly in neighbouring cells.

RLC-SAP: AM (DCCH only) or UM

Logical channel: MCCH, DCCH

Direction: UTRAN → UE

Information Element/Group name	Need	Multi	Type and reference	Semantics description	Version
Message type	MP		Message Type		REL-6
UE information elements					REL-6
Integrity check info	CV-DCCHC H		Integrity check info 10.3.3.16	Integrity check info is included if integrity protection is applied	REL-6
MBMS information elements					REL-6
Modified service list	OP	1.. <maxMB MSserv Modif>			REL-6
>MBMS Transmission identity	MP		MBMS Transmission identity 10.3.9a.1 2		REL-6
>MBMS required UE action	MP		Enumerated (None, Acquire counting info, Acquire counting info – PTM RBs unmodified, Acquire PTM RB info, RequestPTP RB, Release PTM RB)	Indicates required UE action upon receiving the message. When sent on the DCCH, only the following values apply: None, Acquire PTM RB info, request PTP RB). If the cell is operating in MBSFN mode as indicated in subclause 8.1.1.6.3 all values except "Acquire PTM RB info" and "Release PTM RB" are handled as if "None" was received.	REL-6
>MBMS PTM RB Release Cause	CV- <i>PTM_RB_RELEASE_LC R_TDD</i>		Enumerated (NormalRelease, Out of MBMS Service Coverage in RAN, Network Abnormal Release)	Indicates the PTM RB Release cause. For 1.28 Mcps TDD only.	REL-7
>MBMS preferred frequency	OP			Indicates the frequency that UEs shall consider as the preferred frequency. If the cell is operating in MBSFN mode as indicated in subclause 8.1.1.6.3 the UE behaviour upon reception of this IE is unspecified.	REL-6
>>PFL index	CV- <i>MCCH</i>		Integer (1.. <maxMB MS- Freq>)	Index pointing to an entry in the list included in MBMS GENERAL INFORMATION. If the cell is operating in MBSFN mode as indicated in subclause 8.1.1.6.3 the UE behaviour upon reception of this IE is unspecified.	REL-6
>>PFL info	CV- <i>DCCH</i>		Frequency info 10.3.6.36		REL-6

Information Element/Group name	Need	Multi	Type and reference	Semantics description	Version
>Continue MCCH reading	MP		BOOLEAN	MCCH in- band notification. Indicates whether or not the UE should continue reading MCCH in the next modification period. Not applicable when sent on the DCCH	REL-6
>MBSFN cluster frequency	CV-MBSFN		Integer (1..<max MBSFNclusters>)	For FDD and 3.84/7.68 Mcps TDD index pointing to a frequency indicated in the IE "MBSFN inter frequency neighbour list " in MBMS General Information. Default: the current MBSFN cluster. For 1.28 Mcps TDD index pointing to a frequency indicated in the SIB 11. Default: the current MBSFN cluster.	REL-7
MBMS re- acquire MCCH	CV-MCCHOP		Enumerated (TRUE)		REL-6
MBMS dynamic persistence level	CV-MCCHOP		Dynamic persistence level 10.3.6.35	If the cell is operating in MBSFN mode as indicated in subclause 8.1.1.6.3 the UE behaviour upon reception of this IE is unspecified	REL-6
End of modified MCCH information	CV-MCCHOP		Integer (1..16)	If present: the UE may assume that, in each repetition period, all the MCCH information preceding the MBMS UNMODIFIED SERVICES INFORMATION message is transmitted within the indicated number of TTIs.	REL-6
MBMS number of neighbour cells	MP		Integer (0..32)	Indicates the number of MBMS NEIGHBOURING CELL P-T-M RB INFORMATION messages that are contained within the MCCH transmission. Not applicable when sent on the DCCH. If the cell is operating in MBSFN mode as indicated in subclause 8.1.1.6.3 the UE behaves as if the value 0 was received.	REL-6
MBMS all unmodified p-t-m services	CV-MCCHOP		Enumerated (TRUE)	TRUE means that the UE should re-acquire the PtM information for all services listed in the message MBMS UNMODIFIED SERVICES INFORMATION with the IE "MBMS required UE action" set to "Acquire PTM RB info"	REL-6
MBMS p-t-m activation time	CV-MCCHOP		MBMS p-t-m activation time 10.3.9a.70		REL-6
MIB Value tag	OP		MIB Value tag 10.3.8.9	Indicates the matching System Information.	REL-7

Condition	Explanation
<i>MCCH</i>	This IE is mandatory present if the message is sent via MCCH and not needed otherwise.
<i>DCCH</i>	This IE is mandatory present if the message is sent via DCCH and not needed otherwise.
<i>MCCHOP</i>	This IE is optionally present if the message is sent via MCCH and not needed otherwise.
<i>DCCHCH</i>	This IE is present conditionnaly on history if the message is sent via DCCH and not present otherwise.
<i>MBSFN</i>	This IE is mandatory default when the cell on which this IE is sent is operating in MBSFN mode according to subclause 8.1.1.6.3. Otherwise the IE is not needed.
<i>PTM_RB_RELEASE_LCR_TDD</i>	This IE is optionally present if the IE "MBMS required UE action" has the value "Release PTM RB". Otherwise it is not needed. For 1.28 Mcps TDD only.

10.2.16k MBMS NEIGHBOURING CELL P-T-M RB INFORMATION

This message is transmitted periodically by UTRAN to inform UEs about the p-t-m RB configuration used to in neighbouring cells, indicating the UE may perform selection and/ or soft combining. The message content does not change within a modification period. If the cell is operating in MBSFN mode as indicated in subclause 8.1.1.6.3 the UE behaviour upon reception of this message is unspecified.

RLC-SAP: UM

Logical channel: MCCH

Direction: UTRAN → UE

Information Element/Group name	Need	Multi	Type and reference	Semantics description	Version
Message type	MP		Message Type		REL-6
Neighbouring cell identity	MP		Integer (0..<max CellMeas -1>)	The intra-frequency cell id of the cell obtained from the IE 'Intra-frequency Cell Info list' in SIB 11/SIB 11bis. In case the intra-frequency cell id is omitted in the IE 'Intra-frequency Cell Info list' in SIB 11/SIB 11bis, it refers to the index (starting at zero) in the CELL_INFO_LIST as if the CELL_INFO_LIST was constructed from SIB11/SIB11bis only, see 8.6.7.3.	REL-6
Neighbouring cell's S-CCPCH list	MP	1 to <maxSC CPCH>			REL-6
>CHOICE <i>PhyCh</i>	MP				REL-7
>>By reference					REL-7
>>>Secondary CCPCH info	MP		MBMS Common PhyCh identity 10.3.9a.2	S-CCPCH configuration used in neighbouring cell. Refers to a configuration in the common RB info of the current cell	REL-6
>>Extended				FDD only	REL-7
>>>Secondary CCPCH info	OP		MBMS Common PhyCh identity 10.3.9a.2	Referenced S-CCPCH configuration used in neighbouring cell. Refers to a configuration in the common RB info of the current cell	REL-7
>>>Secondary CCPCH info MBMS Diff	MP		Secondary CCPCH info MBMS Diff 10.3.6.71 b	Differential S-CCPCH configuration. Physical configuration parameters in this IE replace the corresponding parameters in the referenced S-CCPCH configuration. If the referenced S-CCPCH configuration is absent, the full set of parameters is needed.	REL-7
>Secondary CCPCH Power Offset Difference	MD		Integer (-6, -3, 3, 6)	Difference ($P_n - O_f$) between the S-CCPCH power offset (P_n) of the neighboring cell S-CCPCH and the S-CCPCH power offset (O_f) of the serving cell that is going to be combined to this neighbour cell S-CCPCH, in dB. Default value is 0. Note 3 and 4.	REL-6
>L1 combining	OP			L2- combining applies if the IE is absent	REL-6
>>CHOICE <i>mode</i>	MP				REL-6
>>>FDD					REL-6
>>>>MBMS Soft Combining Timing Offset	MP		MBMS Soft Combining Timing Offset 10.3.9a.1 0a	Timing offset applied in the CFN calculation in subclause 8.5.15.5	REL-6
>>>>MBMS transmission time difference	MP		Integer (0..3)	Indicates the time difference between the TTIs on the current and the neighbouring cell's SCCPCH that can be L1-combined	REL-6

Information Element/Group name	Need	Multi	Type and reference	Semantics description	Version
>>>>MBMS L1 combining schedule	OP		MBMS L1 combining schedule 10.3.9a.7	If included partial layer 1 combining applies, in which case this IE indicates when L1-combining applies. If the IE is absent, L1 combining applies continuously	REL-6
>>>TDD				(no data)	REL-6
				If L1 combining is configured, for 1.28Mcps TDD UE, MBMS data reception shall be implemented by means of chip combine receiver [55].	REL-7
>CHOICE L23 configuration	MP				REL-6
>>SameAs Current cell				Apart from the physical channel configuration and the MSCH configuration information, the same configuration as for the indicated S-CCPCH used in the current cell applies. The MSCH is mapped on the same transport channel as in the current cell.	REL-6
>>>Current cell's S-CCPCH	MP		MBMS Current cell S-CCPCH identity 10.3.9a.5	Reference to the S-CCPCH in the current cell which uses exactly the same configuration (excluding MSCH configuration).	REL-6
>>>MSCH configuration information	OP		MSCH configuration information 10.3.9a.16		REL-6
>>Different					REL-6
>>>TrCh information for common for all TrCh	MD		MBMS Common CTrCh identity 10.3.9a.1	Refers to a (TFCS) configuration in the common RB info The default value of the TFCS is specified in subclause 14.10.1	REL-6
>>>TrCH information list	MP	1 to <maxFACHPCH >		List of FACH transport channels carrying one or more MTCH and optionally one MSCH	REL-6
>>>>TrCh information	MP		MBMS Common TrCh identity 10.3.9a.4	Refers to a (TFS) configuration in the common RB info	REL-6
>>>>TrCh combining status	MP		BOOLEAN	Value TRUE means that TrCh combining is used for this transport channel (TDD only). Note 2. The IE shall be ignored in FDD mode.	REL-6
>>>>>RB information list	OP	1 to <maxRB perTrCh >		The IE is only present for the radio bearers for which selection (FDD) or transport channel (TDD) combining applies.	REL-6
>>>>>>RB information	MP		MBMS p-t-m RB information 10.3.9a.7a		REL-6

Information Element/Group name	Need	Multi	Type and reference	Semantics description	Version
>>>>MSCH configuration information	OP		MSCH configuration information 10.3.9a.16	Included if the TrCH carries MSCH	REL-6

NOTE 1: The signalling supports the option that UTRAN maps one service to L1 combining slots for some neighbours and to the L2 combining slots for other neighbours ie. the use of different combining schemes for different neighbours

NOTE 2: Transport combining can only be indicated when the complete L2 configuration is provided for the neighbouring cell (i.e. using L2 configuration choice “different”). Fortunately, a scenario in which the neighbouring cell configuration is different from the current cell is regarded as the typical scenario for using transport combining.

NOTE 3: For FDD, an S-CCPCH power offset is defined as the offset between the transmitted power of the data part of one S-CCPCH and the transmitted power of the P-CPICH of a given cell ($P_{s-ccpch} - P_{p-cpich}$). For TDD, an S-CCPCH power offset is defined as the offset between one S-CCPCH and the P-CCPCH of a given cell ($P_{s-ccpch} - P_{p-ccpch}$).

NOTE 4: The Secondary CCPCH Power Offset Difference IE gives the UE an indication of the S-CCPCH power on the neighbouring cells that may be used to complete the neighbouring cell ranking based on P-CPICH power for FDD or P-CCPCH for TDD.

10.2.16L MBMS SCHEDULING INFORMATION

This message is transmitted periodically by UTRAN to inform UEs when the MBMS services, provided on the same S-CCPCH as the message is sent, are scheduled to be transmitted. The UE may use the scheduling information to discontinue receiving the concerned S-CCPCH. The message is transmitted in accordance with the MSCH configuration applicable for the corresponding S-CCPCH.

RLC-SAP: UM

Logical channel: MSCH

Direction: UTRAN → UE

Information Element/Group name	Need	Multi	Type and reference	Semantics description	Version
Message type	MP		Message Type		REL-6
Service scheduling info list	MP	1 to <maxMB MSserv Sched>			REL-6
>MBMS Transmission identity	MP		MBMS Transmission identity 10.3.9a.1 2		REL-6
>MBMS Service transmissions info list	OP	1 to <maxMB MSTransmis>		One or more sets of scheduling information comprising of the beginning and duration of an MBMS service transmission for one scheduling period	REL-6
>>Start	MP		Integer (0..1020) by step of 4	Indicates the start of the transmission relative to the start of the TTI in which the MBMS SCHEDULING INFORMATION message was received. In number of radio frames (i.e. the value 0 would correspond to the start of the MBMS transmission being in the same TTI as the MBMS Scheduling Information message.) See note 1.	REL-6
>>Duration	MP		Integer (4..1024) by step of 4	In number of radio frames	REL-6
>Next scheduling period	MP		Integer (0..31)	Number of scheduling periods (see 10.3.9a.16), after the current scheduling period, in which no data will be transmitted for the concerned service. If the Next scheduling period is set to 0, data may be transmitted for the concerned service in the scheduling period immediately following the current scheduling period	REL-6

NOTE: If UTRAN sets the value of the IE "Start" to a value less than or equal to 16 then the UE may not successfully receive the start of the MTCH transmission.

10.2.16m MBMS UNMODIFIED SERVICES INFORMATION

This message is transmitted periodically by UTRAN to inform UEs about the MBMS services, available in the current cell and possibly in neighbouring cells, that have not changed if the IE "MBMS all unmodified p-t-m services" is not included in the MBMS MODIFIED SERVICES INFORMATION message in this modification period. The message is repeated every repetition period while its contents does not change within a modification period.

RLC-SAP: UM

Logical channel: MCCH

Direction: UTRAN → UE

Information Element/Group name	Need	Multi	Type and reference	Semantics description	Version
Message type	MP		Message Type		REL-6
Unmodified services list	OP	1 to <maxMB MSserv Unmodif >		If the IE "MBMS all unmodified p-t-m services" is included in the MBMS MODIFIED SERVICES INFORMATION message in this modification period, the services with the IE "MBMS required UE action" set to "Acquire PTM RB info" in the message MBMS UNMODIFIED SERVICES INFORMATION should be considered as modified.	REL-6
>MBMS Transmission identity	MP		MBMS Transmission identity 10.3.9a.1 2		REL-6
>MBMS required UE action	MP		Enumerated (None, Acquire PTM RB info, Request PTP RB)	Indication of the UE action required to receive the service. If the cell is operating in MBSFN mode as indicated in subclause 8.1.1.6.3 all values except "Acquire PTM RB info" are handled as if "None" was received.	REL-6
>MBMS preferred frequency	OP		Integer (1.. <maxMB MS-Freq>)	Information about the frequency that UEs shall consider as the preferred frequency layer for cell re-selection during a session for an activated MBMS service, as specified in [25.304]. Index pointing to an entry in the list included in MBMS GENERAL INFORMATION. If the cell is operating in MBSFN mode as indicated in subclause 8.1.1.6.3 the UE behaviour upon reception of this IE is unspecified.	REL-6
>MBSFN cluster frequency	CV- MBSFN		Integer (1..<max MBSFNclusters>)	For FDD and 3.84/7.68 Mcps TDD index pointing to a frequency indicated in the IE "MBSFN inter frequency neighbour list " in MBSFN General Information. Default: the current MBSFN cluster. For 1.28 Mcps TDD index pointing to a frequency indicated in the SIB 11. Default: the current MBSFN cluster.	REL-7

Condition	Explanation
MBSFN	This IE is mandatory present when the cell on which this IE is sent is operating in MBSFN mode according to subclause 8.1.1.6.3. Otherwise the IE is not needed.

10.2.17 MEASUREMENT CONTROL

This message is sent by UTRAN to setup, modify or release a measurement in the UE.

RLC-SAP: AM

Logical channel: DCCH

Direction: UTRAN→UE

Information Element/Group name	Need	Multi	Type and reference	Semantics description	Version
Message Type	MP		Message Type		
UE information elements					
RRC transaction identifier	MP		RRC transaction identifier 10.3.3.36		
Integrity check info	CH		Integrity check info 10.3.3.16		
Measurement Information elements					
Measurement Identity	CV- <i>command2</i>		Measurement Identity 10.3.7.48		
Measurement Command	MP		Measurement Command 10.3.7.46		
Release Some Measurements	CV- <i>command3</i>		Release some measurements 10.3.7.46b		REL-12
Measurement Reporting Mode	OP		Measurement Reporting Mode 10.3.7.49		
Additional measurements list	OP		Additional measurements list 10.3.7.1		
CHOICE <i>Measurement type</i>	CV- <i>command</i>				
>Intra-frequency measurement			Intra-frequency measurement 10.3.7.36		
>Inter-frequency measurement			Inter-frequency measurement 10.3.7.16		
>Inter-RAT measurement			Inter-RAT measurement 10.3.7.27		
>UE positioning measurement			UE positioning measurement 10.3.7.100		
>Traffic Volume measurement			Traffic Volume measurement 10.3.7.68		
>Quality measurement			Quality measurement 10.3.7.56		
>UE internal measurement			UE internal measurement 10.3.7.77		
>CSG Proximity detection			CSG Proximity detection 10.3.7.123		REL-9
>E-UTRA measurement for CELL_FACH			E-UTRA measurement for CELL_FACH 10.3.7.137		REL-11

Information Element/Group name	Need	Multi	Type and reference	Semantics description	Version
CELL_DCH measurement occasion info LCR	OP		CELL_DCH measurement occasion info LCR 10.3.7.126		REL-9
Measurement Scaling Factor	<i>CV_Measurement</i>		Enumerated (SF_UTRA_CF1, SF_UTRA_CF2)	The Measurement Scaling Factor is used to scale the measurement performance for UTRA/E-UTRA frequencies configured in CELL_DCH as specified in [19]. Even if no UTRA or E-UTRA frequency is configured for reduced measurement performance, the network may configure a scaling factor and configure any of the scaling factor values [19].	REL-12
Physical channel information elements					
DPCH compressed mode status info	OP		DPCH compressed mode status info 10.3.6.34		

Condition	Explanation
<i>Command2</i>	The IE is mandatory present if the IE "Measurement Command" is set to "Setup", "Modify" or "Release", otherwise the IE is not needed.
<i>Command3</i>	The IE is mandatory present if the IE "Measurement Command" is set to "ReleaseSome", otherwise the IE is not needed.
<i>Command</i>	The IE is mandatory present if the IE "Measurement command" is set to "Setup", optional if the IE "Measurement command" is set to "modify", otherwise the IE is not needed.
<i>Measurement</i>	The IE is optionally present if the IE "Inter-frequency measurement" and/or IE "Inter-RAT measurement" is present, otherwise the IE is not needed.

10.2.18 MEASUREMENT CONTROL FAILURE

This message is sent by UE, if it cannot initiate a measurement as instructed by UTRAN.

RLC-SAP: AM

Logical channel: DCCH

Direction: UE→UTRAN

Information Element/Group name	Need	Multi	Type and reference	Semantics description	Version
Message Type	MP		Message Type		
UE information elements					
RRC transaction identifier	MP		RRC transaction identifier 10.3.3.36		
Integrity check info	CH		Integrity check info 10.3.3.16		
Failure cause	MP		Failure cause and error information 10.3.3.14		
Measurement identity	OP		Measurement identity 10.3.7.48		REL-12

10.2.19 MEASUREMENT REPORT

This message is used by UE to transfer measurement results to the UTRAN.

RLC-SAP: AM or UM

Logical channel: DCCH

Direction: UE→UTRAN

Information Element/Group name	Need	Multi	Type and reference	Semantics description	Version
Message Type	MP		Message Type		
UE information elements					
Integrity check info	CH		Integrity check info 10.3.3.16		
Activation time	CV- <i>PreConf</i>		Activation time 10.3.3.1		REL-8
Measurement Information Elements					
Measurement identity	MP		Measurement identity 10.3.7.48		
Measured Results	OP		Measured Results 10.3.7.44		
Measured Results on secondary UL frequency	OP		Measured Results on secondary UL frequency 10.3.7.118		REL-9
Measured Results on RACH	OP		Measured Results on RACH 10.3.7.45		
Additional Measured results	OP	1 to <maxAdditional Meas>			
>Measured Results	MP		Measured Results 10.3.7.44		
Additional Measured results on secondary UL frequency	OP	1 to <maxAdditional Meas>			REL-9
>Measured Results	MP		Measured Results on secondary UL frequency 10.3.7.118		
Event results	OP		Event results 10.3.7.7		
Event results on secondary UL frequency	OP		Cell measurement event results on secondary UL frequency 10.3.7.117		REL-9
Inter-RAT cell info indication	CV- <i>IRAT</i>		Integer (0..3)		REL-5

E-UTRA Measured Results	OP		E-UTRA Measured Results 10.3.7.6c		REL-8
E-UTRA Event Results	OP		E-UTRA Event Results 10.3.7.6a		REL-8
E-UTRA results for CELL_FACH	OP		E-UTRA results for CELL_FACH 10.3.7.138		REL-11
CSG Proximity Indication	OP		10.3.7.122		REL-9
Other Information elements					Rel-10
Logged Meas Available	OP		Enumerated (TRUE)	Indicates the UE has logged measurements to report to the network	Rel-10
ANR Logging Results Available	OP		Enumerated (TRUE)	True indicates the UE has ANR logging results to report to the Network.	REL-10

Condition	Explanation
<i>IRAT</i>	The IE is optionally present if at least one of the IE "Inter-RAT measured results list" and the IE "Inter-RAT measurement event results" is included in the message. Otherwise, the IE is not needed.
<i>PreConf</i>	The IE is mandatory if the table "Target cell preconfigurations" in the variable includes the cell that triggered the event and the IE "Activation time offset" is different from 0. Otherwise, the IE is not needed.

10.2.20 PAGING TYPE 1

This message is used to send information on the paging channel. One or several UEs, in idle or connected mode, can be paged in one message, which also can contain other information.

RLC-SAP: TM

Logical channel: PCCH

Direction: UTRAN → UE

Information Element/Group name	Need	Multi	Type and reference	Semantics description	Version
Message Type	MP		Message Type		
UE Information elements					
Paging record list	OP	1 to <maxPage1>			
>Paging record	MP		Paging record 10.3.3.23		
Other information elements					
BCCH modification info	OP		BCCH modification info 10.3.8.1		

ETWS information	OP		ETWS information 10.3.8.4e a		REL-8
------------------	----	--	------------------------------------	--	-------

If the encoded message does not fill a transport block, the RRC layer shall add padding according to subclause 12.1.

10.2.21 PAGING TYPE 2

This message is used to page a UE in connected mode, when using the DCCH for CN originated paging.

RLC-SAP: AM

Logical channel: DCCH

Direction: UTRAN → UE

Information Element/Group name	Need	Multi	Type and reference	Semantics description
Message Type	MP		Message Type	
UE information elements				
RRC transaction identifier	MP		RRC transaction identifier 10.3.3.36	
Integrity check info	CH		Integrity check info 10.3.3.16	
Paging cause	MP		Paging cause 10.3.3.22	
CN Information elements				
CN domain identity	MP		CN domain identity 10.3.1.1	
Paging Record Type Identifier	MP		Paging Record Type Identifier 10.3.1.10	

10.2.22 PHYSICAL CHANNEL RECONFIGURATION

This message is used by UTRAN to assign, replace or release a set of physical channels used by a UE.

RLC-SAP: AM or UM

Logical channel: DCCH

Direction: UTRAN → UE

Information Element/Group name	Need	Multi	Type and reference	Semantics description	Version
Message Type	MP		Message Type		
UE Information Elements					
RRC transaction identifier	MP		RRC transaction identifier 10.3.3.36		
Integrity check info	CH		Integrity check info 10.3.3.16		

Information Element/Group name	Need	Multi	Type and reference	Semantics description	Version
Integrity protection mode info	OP		Integrity protection mode info 10.3.3.19	The UTRAN should not include this IE unless it is performing an SRNS relocation	
Ciphering mode info	OP		Ciphering mode info 10.3.3.5	The UTRAN should not include this IE unless it is performing an SRNS relocation and a change in ciphering algorithm	
Activation time	MD		Activation time 10.3.3.1	Default value is "now"	
Delay restriction flag	OP		Enumerated (TRUE)	This IE is always set to TRUE and included if the activation time is restricted according to subclause 8.6.3.1	REL-6
New U-RNTI	OP		U-RNTI 10.3.3.47		
New C-RNTI	OP		C-RNTI 10.3.3.8		
New DSCH-RNTI	OP		DSCH-RNTI 10.3.3.9a	Should not be set in FDD. If received the UE behaviour is unspecified.	
New H-RNTI	OP		H-RNTI 10.3.3.14a		REL-5
New Primary E-RNTI	OP		E-RNTI 10.3.3.10a		REL-6
New Secondary E-RNTI	OP		E-RNTI 10.3.3.10a	FDD only	REL-6
RRC State Indicator	MP		RRC State Indicator 10.3.3.35a		
UE Mobility State Indicator	CV-FACH_PCH		Enumerated (High-mobilityDetected)	Absence of this IE implies that, according to [4], the UE shall consider itself being in the mobility state the UE has maintained in CELL_DCH state or being not in high mobility state after the state transition, if applicable.	REL-7
UTRAN DRX cycle length coefficient	OP		UTRAN DRX cycle length coefficient 10.3.3.49		
CN Information Elements					
CN Information info	OP		CN Information info 10.3.1.3		
UTRAN mobility information elements					

Information Element/Group name	Need	Multi	Type and reference	Semantics description	Version
URA identity	OP		URA identity 10.3.2.6		
RNC support for change of UE capability	OP		Boolean	Should be included if the message is used to perform an SRNS relocation	REL-7
Reconfiguration in response to requested change of UE capability	OP		Enumerated (TRUE)		REL-7
RB information elements					
Downlink counter synchronisation info	OP				
>RB with PDCP information list	OP	1 to <maxRBall RABs>			
>>RB with PDCP information	MP		RB with PDCP information 10.3.4.22	This IE is needed for each RB having PDCP in the case of lossless SRNS relocation	
	OP				REL-5
>>PDCP context relocation info	OP		PDCP context relocation info 10.3.4.1a	This IE is needed for each RB having PDCP and performing PDCP context relocation	REL-5
Downlink transport channels					
HARQ Info	OP		HARQ info 10.3.5.7a		REL-8 REL-7
PhyCH information elements					
Frequency info	OP		Frequency info 10.3.6.36		
Multi-frequency Info	OP		Multi-frequency Info 10.3.6.39a	This IE is used for 1.28 Mcps TDD only	REL-7
DTX-DRX timing information	OP		DTX-DRX timing information 10.3.6.34b		REL-7
DTX-DRX Information	OP		DTX-DRX Information 10.3.6.34a		REL-7
HS-SCCH less Information	OP		HS-SCCH less Information 10.3.6.36ab		REL-7
MIMO parameters	OP		MIMO parameters 10.3.6.41a		REL-7
MIMO mode with four transmit antennas parameters	OP		MIMO mode with four transmit antennas parameters 10.3.6.142		REL-11
DCH Enhancements info FDD	OP		DCH Enhancements info FDD 10.3.6.149		REL-12

Information Element/Group name	Need	Multi	Type and reference	Semantics description	Version
Control Channel DRX information	OP		Control Channel DRX information 1.28 Mcps TDD 10.3.6.107	This IE is used for 1.28 Mcps TDD only	REL-8
SPS Information	OP		SPS information 1.28 Mcps TDD 10.3.6.110	This IE is used for 1.28 Mcps TDD only	REL-8
MU-MIMO info	OP		MU-MIMO info 1.28 Mcps TDD 10.3.6.122	This IE is used for 1.28 Mcps TDD only	REL-10
Non-rectangular resource allocation indicator	OP		Enumerated(TRUE)	For 1.28 Mcps TDD only. The absence of this IE indicates that the non-rectangular resource allocation is not used.	REL-12
Non-rectangular resource specific timeslots set	<i>CV-Non-rectangular Resource Allocation</i>		Bit string (7)	For 1.28 Mcps TDD only. The value 1 of a bit indicates the corresponding timeslot in which the channelization codes are assigned physical control channel. The value 0 of a bit indicates the corresponding timeslot in which all channelization codes are assigned when the timeslot is scheduled to the UE. The first/leftmost bit of the bit string is for TS0.	REL-12
Uplink radio resources					
Maximum allowed UL TX power	MD		Maximum allowed UL TX power 10.3.6.39	Default value is the existing value of the maximum allowed UL TX power	
Uplink DPCH info	OP		Uplink DPCH info 10.3.6.88		
E-DCH Info	OP		E-DCH Info 10.3.6.97		REL-6
Uplink secondary cell info FDD	OP		Uplink secondary cell info FDD 10.3.6.115	FDD only	REL-9
Multi-carrier E-DCH Info for LCR TDD	OP		Multi-carrier E-DCH Info	1.28Mcps TDD only	REL-10

Information Element/Group name	Need	Multi	Type and reference	Semantics description	Version
			for LCR TDD 10.3.6.97a		
Uplink CLTD info FDD	OP		Uplink CLTD info FDD 10.3.6.125	FDD only	REL-11
Uplink OLTD info FDD	OP		Uplink OLTD info FDD 10.3.6.126	FDD only	REL-11
Downlink radio resources					
Downlink HS-PDSCH Information	OP		Downlink HS_PDSCH Information 10.3.6.23a		REL-5
Downlink information common for all radio links	OP		Downlink information common for all radio links 10.3.6.24		
Downlink information per radio link list	OP	1 to <maxRL>		Send downlink information for each radio link	
>Downlink information for each radio link	MP		Downlink information for each radio link 10.3.6.27		
Downlink secondary cell info FDD	OP		Downlink secondary cell info FDD 10.3.6.31a	FDD only	REL-8
Additional downlink secondary cell info list FDD	OP	2			REL-10
>Downlink secondary cell info FDD	OP		Downlink secondary cell info FDD 10.3.6.31a	FDD only	REL-10
Additional downlink secondary cell info list FDD 2	OP	4			REL-11
>Downlink secondary cell info FDD	OP		Downlink secondary cell info FDD 10.3.6.31a	FDD only	REL-11
Common E-RGCH info FDD	OP		Common E-RGCH info FDD 10.3.6.138	FDD only	REL-11
DPCCH2 info FDD	OP		DPCCH2 info FDD 10.3.6.148	FDD only	REL-12
MBMS PL Service Restriction Information	OP		Enumerated (TRUE)		REL-6
CELL_DCH measurement occasion info LCR	OP		CELL_DCH measurement occasion info LCR 10.3.7.126		REL-9

Condition	Explanation
<i>FACH_PCH</i>	This IE is mandatory default when a transition from CELL_DCH to CELL_FACH, URA_PCH or CELL_PCH is requested by the message and is not needed otherwise.
<i>Non-rectangularResourceAllocation</i>	This IE is optionally present if non-rectangular resource allocation is configured. Otherwise, it is not needed.

10.2.23 PHYSICAL CHANNEL RECONFIGURATION COMPLETE

This message is sent from the UE when a physical channel reconfiguration has been done.

RLC-SAP: AM

Logical channel: DCCH

Direction: UE → UTRAN

Information Element/Group name	Need	Multi	Type and reference	Semantics description	Version
Message Type	MP		Message Type		
UE information elements					
RRC transaction identifier	MP		RRC transaction identifier 10.3.3.36		
Integrity check info	CH		Integrity check info 10.3.3.16		
Uplink integrity protection activation info	OP		Integrity protection activation info 10.3.3.17		
CHOICE <i>mode</i>	MP				
>FDD				(no data)	
>TDD					
>>CHOICE <i>TDD option</i>	MP				REL-4
>>>3.84 Mcps TDD					REL-4
>>>>Uplink Timing Advance	OP		Uplink Timing Advance 10.3.6.95		
>>>>Extended Uplink Timing Advance	OP		Extended Uplink Timing Advance 10.3.6.95a		REL-7
>>>7.68 Mcps TDD					REL-7
>>>>Extended Uplink Timing Advance	OP		Extended Uplink Timing Advance 10.3.6.95a		REL-7
>>>1.28 Mcps TDD				(no data)	REL-4

Information Element/Group name	Need	Multi	Type and reference	Semantics description	Version
Other Information elements					REL-7
Deferred measurement control reading	OP		Enumerated (TRUE)	Indicates the UE has not read SIB11, SIB11bis, SIB11ter (if supported) and SIB12, if available.	REL-7
RB Information elements					
COUNT-C activation time	OP		Activation time 10.3.3.1	Used for radio bearers mapped on RLC-TM.	
Uplink counter synchronisation info	OP				
>RB with PDCP information list	OP	1 to <maxRBall RABs>			
>>RB with PDCP information	MP		RB with PDCP information 10.3.4.22		
>START list	MP	1 to <maxCNdo mains>		START [40] values for all CN domains.	
>>CN domain identity	MP		CN domain identity 10.3.1.1		
>>START	MP		START 10.3.3.38	START value to be used in this CN domain.	

10.2.24 PHYSICAL CHANNEL RECONFIGURATION FAILURE

This message is sent by UE if the configuration given by UTRAN is unacceptable or if the UE failed to assign, replace or release a set of physical channel(s).

RLC-SAP: AM

Logical channel: DCCH

Direction: UE→UTRAN

Information Element/Group name	Need	Multi	Type and reference	Semantics description
Message type	MP		Message type	
UE information elements				
RRC transaction identifier	OP		RRC transaction identifier 10.3.3.36	
Integrity check info	CH		Integrity check info 10.3.3.16	
Failure cause	MP		Failure cause and error information 10.3.3.14	

10.2.25 PHYSICAL SHARED CHANNEL ALLOCATION

NOTE: Only for TDD.

This message is used by UTRAN to assign physical resources to USCH/DSCH transport channels in TDD, for temporary usage by the UE.

RLC-SAP: UM on SHCCH, UM on DCCH

Logical channel: SHCCH or DCCH

Direction: UTRAN → UE

Information Element/Group name	Need	Multi	Type and reference	Semantics description
Message Type	MP		Message type	
DSCH-RNTI	OP		DSCH-RNTI 10.3.3.9a	
RRC transaction identifier	MP		RRC transaction identifier 10.3.3.36	
Uplink timing advance Control	MD		Uplink Timing Advance Control 10.3.6.96	Default value is the existing value for uplink timing advance
PUSCH capacity allocation info	OP		PUSCH Capacity Allocation info 10.3.6.64	
PDSCH capacity allocation info	OP		PDSCH Capacity Allocation info 10.3.6.42	
Confirm request	MD		Enumerated(No Confirm, Confirm PDSCH, Confirm PUSCH)	Default value is No Confirm
Traffic volume report request	OP		Integer (0 .. 255)	Indicates the number of frames between start of the allocation period and sending measurement report. The value should be less than the value for Allocation Duration.
ISCP Timeslot list	OP	1 to maxTS		
>Timeslot number	MP		Timeslot number 10.3.6.84	Timeslot numbers, for which the UE shall report the timeslot ISCP in PUSCH CAPACITY REQUEST message.
Request P-CCPCH RSCP	MP		Boolean	TRUE indicates that a Primary CCPCH RSCP measurement shall be reported by the UE in PUSCH CAPACITY REQUEST message.

10.2.26 PUSCH CAPACITY REQUEST

NOTE: Only for TDD.

This message is used by the UE for request of PUSCH resources to the UTRAN.

RLC-SAP: TM

Logical channel: SHCCH

Direction: UE → UTRAN

Information Element/Group name	Need	Multi	Type and reference	Semantics description
Message Type	MP		Message Type	
DSCH-RNTI	OP		DSCH-RNTI 10.3.3.9a	
RRC transaction identifier	CV-ProtErr		RRC transaction identifier 10.3.3.36	
Traffic Volume	OP		Traffic Volume, measured results list 10.3.7.67	
Timeslot list	OP	1 to maxTS		
>Timeslot number	MP		Timeslot number 10.3.6.84	
>Timeslot ISCP	MP		Timeslot ISCP info 10.3.7.65	
Primary CCPCH RSCP	OP		Primary CCPCH RSCP info 10.3.7.54	
CHOICE <i>Allocation confirmation</i>	OP			
>PDSCH Confirmation			Integer(1..hi PDSCHidentities)	
>PUSCH Confirmation			Integer(1..hi PUSCHidentities)	
Protocol error indicator	MD		Protocol error indicator 10.3.3.27	Default value is FALSE
Protocol error information	CV-ProtErr		Protocol error information 10.3.8.12	

Condition	Explanation
<i>ProtErr</i>	This IE is mandatory present if the IE "Protocol error indicator" has the value TRUE. Otherwise it is not needed.

10.2.27 RADIO BEARER RECONFIGURATION

This message is sent from UTRAN to reconfigure parameters related to a change of QoS or to release and setup a radio bearer used for ptp transmission of MBMS services of the broadcast type. This procedure can also change the multiplexing of MAC, reconfigure transport channels and physical channels. This message is also used to perform a handover from GERAN *Iu mode* to UTRAN.

RLC-SAP: AM or UM or sent through GERAN *Iu mode*

Logical channel: DCCH or sent through GERAN *Iu mode*

Direction: UTRAN → UE

Information Element/Group name	Need	Multi	Type and reference	Semantics description	Version
Message Type	MP		Message Type		
UE Information elements					
RRC transaction identifier	MP		RRC transaction identifier 10.3.3.36		
Integrity check info	CH		Integrity check info 10.3.3.16		
Integrity protection mode info	OP		Integrity protection mode info 10.3.3.19	The UTRAN should not include this IE unless it is performing an SRNS relocation or a handover from GERAN <i>Iu mode</i>	
Ciphering mode info	OP		Ciphering mode info 10.3.3.5	The UTRAN should not include this IE unless it is performing either an SRNS relocation or a handover from GERAN <i>Iu mode</i> and a change in ciphering algorithm	
Activation time	MD		Activation time 10.3.3.1	Default value is "now"	
Delay restriction flag	OP		Enumerated (TRUE)	This IE is always set to TRUE and included if the activation time is restricted according to subclause 8.6.3.1	REL-6
New U-RNTI	OP		U-RNTI 10.3.3.47		
New C-RNTI	OP		C-RNTI 10.3.3.8		
New DSCH-RNTI	OP		DSCH-RNTI 10.3.3.9a	Should not be set in FDD. If received The UE behaviour is unspecified.	
New H-RNTI	OP		H-RNTI 10.3.3.14a		REL-5
New Primary E-RNTI	OP		E-RNTI 10.3.3.10a		REL-6
New Secondary E-RNTI	OP		E-RNTI 10.3.3.10a	FDD only	REL-6
RRC State Indicator	MP		RRC State Indicator 10.3.3.35a		

Information Element/Group name	Need	Multi	Type and reference	Semantics description	Version
UE Mobility State Indicator	CV-FACH_PCH		Enumerated (High-mobilityDetected)	Absence of this IE implies that, according to [4], the UE shall consider itself being in the mobility state the UE has maintained in CELL_DCH state or being not in high mobility state after the state transition, if applicable.	REL-7
UTRAN DRX cycle length coefficient	OP		UTRAN DRX cycle length coefficient 10.3.3.49		
Access Group identity	OP		Integer (0..15)		REL-12
CN information elements					
CN Information info	OP		CN Information info 10.3.1.3		
UTRAN mobility information elements					
RNC support for change of UE capability	OP		Boolean	Should be included if the message is used to perform an SRNS relocation	REL-7
Reconfiguration in response to requested change of UE capability	OP		Enumerated (TRUE)		REL-7
URA identity	OP		URA identity 10.3.2.6		
Specification mode information elements					
Default configuration for CELL_FACH	CV-SRNS_RELLOCATION		Default configuration for CELL_FACH 10.3.4.0a		REL-8
CHOICE specification mode	MP				REL-5
>Complete specification					
RB information elements					
>>RAB information to reconfigure list	OP	1 to <maxRABsetup >			
>>>RAB information to reconfigure	MP		RAB information to reconfigure 10.3.4.11		

Information Element/Group name	Need	Multi	Type and reference	Semantics description	Version
>>RAB information for MBMS ptp bearer list	OP	1 to <maxMBMS servSelect >			REL-6
>>>RAB information for MBMS ptp bearer	MP		RAB information for MBMS ptp bearer 10.3.4.9a		REL-6
>>RB information to reconfigure list	MP	1to <maxRB>		Although this IE is not always required, need is MP to align with ASN.1	
	OP				REL-4
>>>RB information to reconfigure	MP		RB information to reconfigure 10.3.4.18		
>>RB information to be affected list	OP	1 to <maxRB>			
>>>RB information to be affected	MP		RB information to be affected 10.3.4.17		
>>RB with PDCP context relocation info list	OP	1 to <maxRBall RABs>		This IE is needed for each RB having PDCP and performing PDCP context relocation	REL-5
>>>PDCP context relocation info	MP		PDCP context relocation info 10.3.4.1a		REL-5
>>PDCP ROHC target mode	OP		PDCP ROHC target mode 10.3.4.2a		REL-5
>>UM RLC re-establishment RB List	OP	1 to <maxRB>			REL-10
>>>RB bearer to be re-established	MP		RB identity, 10.3.4.16	UE behaviour is unspecified if RB identity in this IE indicates a value, which is less than or equal to 4 or indicates a radio bearer, which does not use UM RLC or is not associated with PS domain.	REL-10
TrCH Information Elements					
Uplink transport channels					
>>UL Transport channel information common for all transport channels	OP		UL Transport channel information common for all transport channels 10.3.5.24		

Information Element/Group name	Need	Multi	Type and reference	Semantics description	Version
>>Deleted TrCH information list	OP	1 to <maxTrCH >			
>>>Deleted UL TrCH information	MP		Deleted UL TrCH information 10.3.5.5		
>>Added or Reconfigured TrCH information list	OP	1 to <maxTrCH >			
>>>Added or Reconfigured UL TrCH information	MP		Added or Reconfigured UL TrCH information 10.3.5.2		
Downlink transport channels					
>>DL Transport channel information common for all transport channels	OP		DL Transport channel information common for all transport channels 10.3.5.6		
>>Deleted TrCH information list	OP	1 to <maxTrCH >			
>>>Deleted DL TrCH information	MP		Deleted DL TrCH information 10.3.5.4		
>>Added or Reconfigured TrCH information list	OP	1 to <maxTrCH >			
>>>Added or Reconfigured DL TrCH information	MP		Added or Reconfigured DL TrCH information 10.3.5.1		
>Preconfiguration					REL-5
>>CHOICE <i>Preconfiguration mode</i>	MP			This value only applies in case the message is sent through GERAN <i>lu mode</i>	
>>>Predefined configuration identity	MP		Predefined configuration identity 10.3.4.5		
>>>>Default configuration					
>>>>>Default configuration mode	MP		Enumerated (FDD, TDD)	Indicates whether the FDD or TDD version of the default configuration shall be used	
>>>>>Default configuration identity	MP		Default configuration identity 10.3.4.0		
PhyCH information elements					
Frequency info	OP		Frequency info 10.3.6.36		
Multi-frequency Info	OP		Multi-frequency	This IE is used for 1.28 Mcps TDD only	REL-7

Information Element/Group name	Need	Multi	Type and reference	Semantics description	Version
			Info 10.3.6.39a		
DTX-DRX timing information	OP		DTX-DRX timing information 10.3.6.34b		REL-7
DTX-DRX Information	OP		DTX-DRX Information 10.3.6.34a		REL-7
HS-SCCH less Information	OP		HS-SCCH less Information 10.3.6.36ab		REL-7
MIMO parameters	OP		MIMO parameters 10.3.6.41a		REL-7
MIMO mode with four transmit antennas parameters	OP		MIMO mode with four transmit antennas parameters 10.3.6.142		REL-11
DCH Enhancements info FDD	OP		DCH Enhanceme nts info FDD 10.3.6.149		REL-12

Information Element/Group name	Need	Multi	Type and reference	Semantics description	Version
Control Channel DRX information	OP		Control Channel DRX information 1.28 Mcps TDD 10.3.6.107	This IE is used for 1.28 Mcps TDD only	REL-8
SPS Information	OP		SPS information 1.28 Mcps TDD 10.3.6.110	This IE is used for 1.28 Mcps TDD only	REL-8
MU-MIMO info	OP		MU-MIMO info 1.28 Mcps TDD 10.3.6.122	This IE is used for 1.28 Mcps TDD only	REL-10
Non-rectangular resource allocation indicator	OP		Enumerated(TRUE)	For 1.28 Mcps TDD only. The absence of this IE indicates that the non-rectangular resource allocation is not used.	REL-12
Non-rectangular resource specific timeslots set	<i>CV-Non-rectangular Resource Allocation</i>		Bit string (7)	For 1.28 Mcps TDD only. The value 1 of a bit indicates the corresponding timeslot in which the channelization codes are assigned by physical control channel. The value 0 of a bit indicates the corresponding timeslot in which all channelization codes are assigned when the timeslot is scheduled to the UE. The first/leftmost bit of the bit string is for TS0.	REL-12
Uplink radio resources					
Maximum allowed UL TX power	MD		Maximum allowed UL TX power 10.3.6.39	Default value is the existing maximum UL TX power	
Uplink DPCH info	OP		Uplink DPCH info 10.3.6.88		
E-DCH Info	OP		E-DCH Info 10.3.6.97		REL-6
Uplink secondary cell info FDD	OP		Uplink secondary cell info FDD 10.3.6.115	FDD only	REL-9
Multi-carrier E-DCH Info for LCR TDD	OP		Multi-carrier E-DCH Info	1.28Mcps TDD only	REL-10

Information Element/Group name	Need	Multi	Type and reference	Semantics description	Version
			for LCR TDD 10.3.6.97a		
Uplink CLTD info FDD	OP		Uplink CLTD info FDD 10.3.6.125	FDD only	REL-11
Uplink OLTD info FDD	OP		Uplink OLTD info FDD 10.3.6.126	FDD only	REL-11
Other TTI E-DCH Configuration Information	OP		Other TTI E-DCH Configuration Information 10.3.6.152	FDD only	REL-12
Filtered UE power headroom reporting information	OP		Filtered UE power headroom reporting information 10.3.7.140	FDD only	REL-12
Downlink radio resources					
Downlink HS-PDSCH Information	OP		Downlink HS-PDSCH Information 10.3.6.23a		REL-5
Downlink information common for all radio links	OP		Downlink information common for all radio links 10.3.6.24		
Downlink information per radio link list	MP	1 to <maxRL>		Although this IE is not always required, need is MP to align with ASN.1	
	OP				REL-4
>Downlink information for each radio link	MP		Downlink information for each radio link 10.3.6.27		
Downlink secondary cell info FDD	OP		Downlink secondary cell info FDD 10.3.6.31a	FDD only	REL-8
Additional downlink secondary cell info list FDD	OP	2			REL-10
>Downlink secondary cell info FDD	OP		Downlink secondary cell info FDD 10.3.6.31a	FDD only	REL-10
Additional downlink secondary cell info list FDD 2	OP	4			REL-11
>Downlink secondary cell info FDD	OP		Downlink secondary cell info FDD 10.3.6.31a	FDD only	REL-11
Common E-RGCH info FDD	OP		Common E-RGCH info FDD 10.3.6.138	FDD only	REL-11
DPCCH2 info FDD	OP		DPCCH2 info FDD 10.3.6.148	FDD only	REL-12
MBMS PL Service Restriction Information	OP		Enumerated (TRUE)		REL-6

Information Element/Group name	Need	Multi	Type and reference	Semantics description	Version
CELL_DCH measurement occasion info LCR	OP		CELL_DCH measurement occasion info LCR 10.3.7.126		REL-9

Condition	Explanation
<i>FACH_PCH</i>	This IE is mandatory default when a transition from CELL_DCH to CELL_FACH, URA_PCH or CELL_PCH is requested by the message and is not needed otherwise.
<i>SRNS_RELOCATION</i>	This IE is optional if the message is used to perform an SRNS relocation and is not needed otherwise.
<i>Non-rectangularResourceAllocation</i>	This IE is optionally present if non-rectangular resource allocation is configured. Otherwise, it is not needed.

10.2.28 RADIO BEARER RECONFIGURATION COMPLETE

This message is sent from the UE when a RB and signalling link reconfiguration has been done.

RLC-SAP: AM

Logical channel: DCCH

Direction: UE → UTRAN

Information Element/Group name	Need	Multi	Type and reference	Semantics description	Version
Message Type	MP		Message Type		
UE information elements					
RRC transaction identifier	MP		RRC transaction identifier 10.3.3.36		
Integrity check info	CH		Integrity check info 10.3.3.16		
Uplink integrity protection activation info	OP		Integrity protection activation info 10.3.3.17		
<i>CHOICE mode</i>	MP				
>FDD				(no data)	
>TDD					
>>CHOICE <i>TDD option</i>	MP				REL-4
>>>3.84 Mcps TDD					REL-4
>>>>Uplink Timing Advance	OP		Uplink Timing Advance 10.3.6.95		
>>>>Extended Uplink Timing Advance	OP		Extended Uplink Timing Advance 10.3.6.95a		REL-7
>>>>7.68 Mcps TDD					REL-7

Information Element/Group name	Need	Multi	Type and reference	Semantics description	Version
>>>>Extended Uplink Timing Advance	OP		Extended Uplink Timing Advance 10.3.6.95a		REL-7
>>>1.28 Mcps TDD				(no data)	REL-4
Other Information elements					REL-7
Deferred measurement control reading	OP		Enumerated (TRUE)	Indicates the UE has not read SIB11, SIB11bis, SIB11ter (if supported) and SIB12, if available.	REL-7
RB Information elements					
COUNT-C activation time	OP		Activation time 10.3.3.1	Used for radio bearers mapped on RLC-TM.	
Uplink counter synchronisation info	OP				
>RB with PDCP information list	OP	1 to <maxRBall RABs>			
>>RB with PDCP information	MP		RB with PDCP information 10.3.4.22		
>START list	MP	1 to <maxCNdo mains>		START [40] values for all CN domains.	
>>CN domain identity	MP		CN domain identity 10.3.1.1		
>>START	MP		START 10.3.3.38	START value to be used in this CN domain.	

10.2.29 RADIO BEARER RECONFIGURATION FAILURE

This message is sent by UE if the configuration given by UTRAN is unacceptable or if the UE failed to establish the physical channel(s).

RLC-SAP: AM

Logical channel: DCCH

Direction: UE→UTRAN

Information Element/Group name	Need	Multi	Type and reference	Semantics description
Message Type	MP		Message Type	
UE information elements				
RRC transaction identifier	MP		RRC transaction identifier 10.3.3.36	
Integrity check info	CH		Integrity check info 10.3.3.16	
Failure cause	MP		Failure cause and error information 10.3.3.14	
RB information elements				
Radio bearers for which reconfiguration would have succeeded List	OP	1 to <maxRB>		
>Radio bearer for which reconfiguration would have succeeded	MP		RB identity, 10.3.4.16	

10.2.30 RADIO BEARER RELEASE

This message is used by UTRAN to release a radio bearer. It can also include modifications to the configurations of transport channels and/or physical channels. It can simultaneously indicate release of a signalling connection when UE is connected to more than one CN domain.

RLC-SAP: AM or UM

Logical channel: DCCH

Direction: UTRAN → UE

Information Element/Group name	Need	Multi	Type and reference	Semantics description	Version
Message Type	MP		Message Type		
UE Information Elements					
RRC transaction identifier	MP		RRC transaction identifier 10.3.3.36		
Integrity check info	CH		Integrity check info 10.3.3.16		
Integrity protection mode info	OP		Integrity protection mode info 10.3.3.19	The UTRAN should not include this IE unless it is performing an SRNS relocation.	
Ciphering mode info	OP		Ciphering mode info 10.3.3.5	The UTRAN should not include this IE unless it is performing an SRNS relocation and a change in ciphering algorithm.	
Activation time	MD		Activation time 10.3.3.1	Default value is "now"	
New U-RNTI	OP		U-RNTI 10.3.3.47		
New C-RNTI	OP		C-RNTI 10.3.3.8		

Information Element/Group name	Need	Multi	Type and reference	Semantics description	Version
New DSCH-RNTI	OP		DSCH-RNTI 10.3.3.9a	Should not be set in FDD. If received the UE behaviour is unspecified.	
New H-RNTI	OP		H-RNTI 10.3.3.14a		REL-5
New Primary E-RNTI	OP		E-RNTI 10.3.3.10a		REL-6
New Secondary E-RNTI	OP		E-RNTI 10.3.3.10a	FDD only	REL-6
RRC State Indicator	MP		RRC State Indicator 10.3.3.35a		
UE Mobility State Indicator	CV- FACH_PC H		Enumerated (High-mobilityDetected)	Absence of this IE implies that, according to [4], the UE shall consider itself being in the mobility state the UE has maintained in CELL_DCH state or being not in high mobility state after the state transition, if applicable.	REL-7
UTRAN DRX cycle length coefficient	OP		UTRAN DRX cycle length coefficient 10.3.3.49		
Access Group identity	OP		Integer (0..15)		REL-12
CN Information Elements					
CN Information info	OP		CN Information info 10.3.1.3		
Signalling Connection release indication	OP		CN domain identity 10.3.1.1		
UTRAN mobility information elements					
URA identity	OP		URA identity 10.3.2.6		
RNC support for change of UE capability	OP		Boolean	Should be included if the message is used to perform an SRNS relocation	REL-7
RB Information Elements					
RAB information to reconfigure list	OP	1 to <maxRABsetup>			
>RAB information to reconfigure	MP		RAB information to reconfigure 10.3.4.11		
RB information to release list	MP	1 to <maxRB>			
>RB information to release	MP		RB information to release 10.3.4.19		
RB information to reconfigure list	OP	1to <maxRB>			REL-6
>RB information to reconfigure	MP		RB information to reconfigure 10.3.4.18		REL-6
RB information to be affected list	OP	1 to <maxRB>			

Information Element/Group name	Need	Multi	Type and reference	Semantics description	Version
>RB information to be affected	MP		RB information to be affected 10.3.4.17		
Downlink counter synchronisation info	OP				
>RB with PDCP information list	OP	1 to <maxRBall RABs>			
>>RB with PDCP information	MP		RB with PDCP information 10.3.4.22	This IE is needed for each RB having PDCP in the case of lossless SRNS relocation	
	OP				REL-5
>RB with PDCP context relocation info list	OP	1 to <maxRBall RABs>			REL-5
>>PDCP context relocation info	MP		PDCP context relocation info 10.3.4.1a	This IE is needed for each RB having PDCP and performing PDCP context relocation	REL-5
TrCH Information Elements					
Uplink transport channels					
UL Transport channel information common for all transport channels	OP		UL Transport channel information common for all transport channels 10.3.5.24		
Deleted TrCH information list	OP	1 to <maxTrCH >			
>Deleted UL TrCH information	MP		Deleted UL TrCH information 10.3.5.5		
Added or Reconfigured TrCH information list	OP	1 to <maxTrCH >			
>Added or Reconfigured UL TrCH information	MP		Added or Reconfigured UL TrCH information 10.3.5.2		
Downlink transport channels					
DL Transport channel information common for all transport channels	OP		DL Transport channel information common for all transport channels 10.3.5.6		
Deleted TrCH information list	OP	1 to <maxTrCH >			
>Deleted DL TrCH information	MP		Deleted DL TrCH information 10.3.5.4		
Added or Reconfigured TrCH information list	OP	1 to <maxTrCH >			

Information Element/Group name	Need	Multi	Type and reference	Semantics description	Version
>Added or Reconfigured DL TrCH information	MP		Added or Reconfigured DL TrCH information 10.3.5.1		
PhyCH information elements					
Frequency info	OP		Frequency info 10.3.6.36		
Multi-frequency Info	OP		Multi-frequency Info 10.3.6.39a	This IE is used for 1.28 Mcps TDD only	REL-7
DTX-DRX timing information	OP		DTX-DRX timing information 10.3.6.34b		REL-7
DTX-DRX Information	OP		DTX-DRX Information 10.3.6.34a		REL-7
HS-SCCH less Information	OP		HS-SCCH less Information 10.3.6.36ab		REL-7
MIMO parameters	OP		MIMO parameters 10.3.6.41a		REL-7
MIMO mode with four transmit antennas parameters	OP		MIMO mode with four transmit antennas parameters 10.3.6.142		REL-11
DCH Enhancements info FDD	OP		DCH Enhancements info FDD 10.3.6.149		REL-12
Control Channel DRX information	OP		Control Channel DRX information 1.28 Mcps TDD 10.3.6.107	This IE is used for 1.28 Mcps TDD only	REL-8
SPS Information	OP		SPS information 1.28 Mcps TDD 10.3.6.110	This IE is used for 1.28 Mcps TDD only	REL-8
MU-MIMO info	OP		MU-MIMO info 1.28 Mcps TDD 10.3.6.122	This IE is used for 1.28 Mcps TDD only	REL-10
Non-rectangular resource allocation indicator	OP		Enumerated(TRUE)	For 1.28 Mcps TDD only. The absence of this IE indicates that the non-rectangular resource allocation is not used.	REL-12

Information Element/Group name	Need	Multi	Type and reference	Semantics description	Version
Non-rectangular resource specific timeslots set	CV- <i>Non-rectangular Resource Allocation</i>		Bit string (7)	For 1.28 Mcps TDD only. The value 1 of a bit indicates the corresponding timeslot in which the channelization codes are assigned by physical control channel. The value 0 of a bit indicates the corresponding timeslot in which all channelization codes are assigned when the timeslot is scheduled to the UE. The first/leftmost bit of the bit string is for TS0.	REL-12
Uplink radio resources					
Maximum allowed UL TX power	MD		Maximum allowed UL TX power 10.3.6.39	Default value is the existing maximum UL TX power	
Uplink DPCH info	OP		Uplink DPCH info 10.3.6.88		
E-DCH Info	OP		E-DCH Info 10.3.6.97		REL-6
Uplink secondary cell info FDD	OP		Uplink secondary cell info FDD 10.3.6.115	FDD only	REL-9
Multi-carrier E-DCH Info for LCR TDD	OP		Multi-carrier E-DCH Info for LCR TDD 10.3.6.97a	1.28Mcps TDD only	REL-10
Uplink CLTD info FDD	OP		Uplink CLTD info FDD 10.3.6.125	FDD only	REL-11
Uplink OLTDD info FDD	OP		Uplink OLTDD info FDD 10.3.6.126	FDD only	REL-11
Other TTI E-DCH Configuration Information	OP		Other TTI E-DCH Configuration Information 10.3.6.152	FDD only	REL-12
Filtered UE power headroom reporting information	OP		Filtered UE power headroom reporting information 10.3.7.140	FDD only	REL-12
Downlink radio resources					
Downlink HS-PDSCH Information	OP		Downlink HS-PDSCH Information 10.3.6.23a		REL-5
Downlink information common for all radio links	OP		Downlink information common for all radio links 10.3.6.24		
Downlink information per radio link list	OP	1 to <maxRL>		Send downlink information for each radio link to be set-up	
>Downlink information for each radio link	MP		Downlink information for each		

Information Element/Group name	Need	Multi	Type and reference	Semantics description	Version
			radio link 10.3.6.27		
Downlink secondary cell info FDD	OP		Downlink secondary cell info FDD 10.3.6.31a	FDD only	REL-8
Additional downlink secondary cell info list FDD	OP	2			REL-10
>Downlink secondary cell info FDD	OP		Downlink secondary cell info FDD 10.3.6.31a	FDD only	REL-10
Additional downlink secondary cell info list FDD 2	OP	4			REL-11
>Downlink secondary cell info FDD	OP		Downlink secondary cell info FDD 10.3.6.31a	FDD only	REL-11
Common E-RGCH info FDD	OP		Common E-RGCH info FDD 10.3.6.138	FDD only	REL-11
MBMS PL Service Restriction Information	OP		Enumerated (TRUE)		REL-6
MBMS RB list released to change transfer mode	OP	1 to <maxRB>			REL-6
>RB information to release	MP		RB information to release 10.3.4.19		REL-6
CELL_DCH measurement occasion info LCR	OP		CELL_DCH measurement occasion info LCR 10.3.7.126		REL-9

Condition	Explanation
FACH_PCH	This IE is mandatory default when a transition from CELL_DCH to CELL_FACH, URA_PCH or CELL_PCH is requested by the message and is not needed otherwise.
<i>Non-rectangularResourceAllocation</i>	This IE is optionally present if non-rectangular resource allocation is configured. Otherwise, it is not needed.

10.2.31 RADIO BEARER RELEASE COMPLETE

This message is sent from the UE when radio bearer release has been completed.

RLC-SAP: AM

Logical channel: DCCH

Direction: UE → UTRAN

Information Element/Group name	Need	Multi	Type and reference	Semantics description	Version
Message Type	MP		Message Type		
UE information elements					

Information Element/Group name	Need	Multi	Type and reference	Semantics description	Version
RRC transaction identifier	MP		RRC transaction identifier 10.3.3.36		
Integrity check info	CH		Integrity check info 10.3.3.16	Integrity check info is included if integrity protection is applied	
Uplink integrity protection activation info	OP		Integrity protection activation info 10.3.3.17		
CHOICE <i>mode</i>	MP				
>FDD				(no data)	
>TDD					
>>CHOICE <i>TDD option</i>	MP				REL-4
>>>3.84 Mcps TDD					REL-4
>>>>Uplink Timing Advance	OP		Uplink Timing Advance 10.3.6.95	This information element shall be present in case of handover procedure if timing advance is enabled. Calculated timing advance value for the new cell after handover in a synchronous TDD network	
>>>>Extended Uplink Timing Advance	OP		Extended Uplink Timing Advance 10.3.6.95a		REL-7
>>>>7.68 Mcps TDD					REL-7
>>>>>Extended Uplink Timing Advance	OP		Extended Uplink Timing Advance 10.3.6.95a	This information element shall be present in case of handover procedure if timing advance is enabled. Calculated timing advance value for the new cell after handover in a synchronous TDD network	REL-7
>>>>>1.28 Mcps TDD				(no data)	REL-4
Other Information elements					REL-7
Deferred measurement control reading	OP		Enumerated (TRUE)	Indicates the UE has not read SIB11, SIB11bis, SIB11ter (if supported) and SIB12, if available.	REL-7
RB Information elements					
COUNT-C activation time	OP		Activation time 10.3.3.1	Used for radio bearers mapped on RLC-TM.	
Uplink counter synchronisation info	OP				

Information Element/Group name	Need	Multi	Type and reference	Semantics description	Version
>RB with PDCP information list	OP	1 to <maxRBall RABs>		This IE is needed for each RB having PDCP in the case of lossless SRNS relocation	
>>RB with PDCP information	MP		RB with PDCP information 10.3.4.22		
>START list	MP	1 to <maxCNdo mains>		START [40] values for all CN domains.	
>>CN domain identity	MP		CN domain identity 10.3.1.1		
>>START	MP		START 10.3.3.38	START value to be used in this CN domain.	

10.2.32 RADIO BEARER RELEASE FAILURE

This message is sent by UE if the configuration given by UTRAN is unacceptable or if radio bearer cannot be released.

RLC-SAP: AM

Logical channel: DCCH

Direction: UE→UTRAN

Information Element/Group name	Need	Multi	Type and reference	Semantics description
Message Type	MP		Message Type	
UE information elements				
RRC transaction identifier	MP		RRC transaction identifier 10.3.3.36	
Integrity check info	CH		Integrity check info 10.3.3.16	
Failure cause	MP		Failure cause and error information 10.3.3.14	
RB information elements				
Radio bearers for which reconfiguration would have succeeded	OP	1 to <maxRB>		
>Radio bearer for which reconfiguration would have been succeeded	MP		RB identity, 10.3.4.16	

10.2.33 RADIO BEARER SETUP

This message is sent by UTRAN to the UE to establish new radio bearer(s). It can also include modifications to the configurations of transport channels and/or physical channels.

RLC-SAP: AM or UM

Logical channel: DCCH

Direction: UTRAN → UE

Information Element/Group name	Need	Multi	Type and reference	Semantics description	Version
Message Type	MP		Message Type		
UE Information Elements					
RRC transaction identifier	MP		RRC transaction identifier 10.3.3.36		
Integrity check info	CH		Integrity check info 10.3.3.16		
Integrity protection mode info	OP		Integrity protection mode info 10.3.3.19	The UTRAN should not include this IE unless it is performing an SRNS relocation or an SR-VCC	
Ciphering mode info	OP		Ciphering mode info 10.3.3.5	The UTRAN should not include this IE unless it is performing an SRNS relocation and a change in ciphering algorithm or it is performing an SR-VCC	
SR-VCC info	CV-SRVCC		SR-VCC info 10.3.4.24a		REL-8
Activation time	MD		Activation time 10.3.3.1	Default value is "now"	
New U-RNTI	OP		U-RNTI 10.3.3.47		
New C-RNTI	OP		C-RNTI 10.3.3.8		
New DSCH-RNTI	OP		DSCH-RNTI 10.3.3.9a	Should not be set in FDD. If received the UE behaviour is unspecified.	
New H-RNTI	OP		H-RNTI 10.3.3.14a		REL-5
New Primary E-RNTI	OP		E-RNTI 10.3.3.10a		REL-6
New Secondary E-RNTI	OP		E-RNTI 10.3.3.10a	FDD only	REL-6
RRC State Indicator	MP		RRC State Indicator 10.3.3.35a		
UTRAN DRX cycle length coefficient	OP		UTRAN DRX cycle length coefficient 10.3.3.49		
Access Group identity	OP		Integer (0..15)		REL-12
CN Information Elements					
CN Information info	OP		CN Information info 10.3.1.3		
UTRAN mobility information elements					

Information Element/Group name	Need	Multi	Type and reference	Semantics description	Version
URA identity	OP		URA identity 10.3.2.6		
RNC support for change of UE capability	OP		Boolean	Should be included if the message is used to perform an SRNS relocation	REL-7
RB Information Elements					
CHOICE specification mode	MP				REL-6
>Complete specification				In this version of the specification, only this value is specified	REL-6
>>Signalling RB information to setup list	OP	1 to <maxSRBs etup>		For each signalling radio bearer established	
>>>Signalling RB information to setup	MP		Signalling RB information to setup 10.3.4.24		
>>RAB information to setup list	OP	1 to <maxRABs etup>		For each RAB established	
>>>RAB information for setup	MP		RAB information for setup 10.3.4.10		
>>RAB information to reconfigure list	OP	1 to <maxRABsetup >			REL-6
>>>RAB information to reconfigure	MP		RAB information to reconfigure 10.3.4.11		REL-6
>>RB information to reconfigure list	OP	1to <maxRB>			REL-6
>>>RB information to reconfigure	MP		RB information to reconfigure 10.3.4.18		REL-6
>>RB information to be affected list	OP	1 to <maxRB>			
>>>RB information to be affected	MP		RB information to be affected 10.3.4.17		
>>Downlink counter synchronisation info	OP				
>>>RB with PDCP information list	OP	1 to <maxRBall RABs>			
>>>>RB with PDCP information	MP		RB with PDCP information 10.3.4.22	This IE is needed for each RB having PDCP in the case of lossless SRNS relocation	
	OP				REL-5
>>>>PDCP context relocation info	OP		PDCP context relocation	This IE is needed for each RB having PDCP and	REL-5

Information Element/Group name	Need	Multi	Type and reference	Semantics description	Version
			info 10.3.4.1a	performing PDCP context relocation	
>>PDCP ROHC target mode	OP		PDCP ROHC target mode 10.3.4.2a		REL-5
TrCH Information Elements					
Uplink transport channels					
>>UL Transport channel information common for all transport channels	OP		UL Transport channel information common for all transport channels 10.3.5.24		
>>Deleted TrCH information list	OP	1 to <maxTrCH >			
>>>Deleted UL TrCH information	MP		Deleted UL TrCH information 10.3.5.5		
>>Added or Reconfigured TrCH information list	OP	1 to <maxTrCH >			
>>>Added or Reconfigured UL TrCH information	MP		Added or Reconfigured UL TrCH information 10.3.5.2		
Downlink transport channels					
>>DL Transport channel information common for all transport channels	OP		DL Transport channel information common for all transport channels 10.3.5.6		
>>Deleted TrCH information list	OP	1 to <maxTrCH >			
>>>Deleted DL TrCH information	MP		Deleted DL TrCH information 10.3.5.4		
>>Added or Reconfigured TrCH information list	OP	1 to <maxTrCH >			
>>>Added or Reconfigured DL TrCH information	MP		Added or Reconfigured DL TrCH information 10.3.5.1		
PhyCH information elements					
Frequency info	OP		Frequency info 10.3.6.36		
Multi-frequency Info	OP		Multi-frequency Info 10.3.6.39a	This IE is used for 1.28 Mcps TDD only	REL-7

Information Element/Group name	Need	Multi	Type and reference	Semantics description	Version
DTX-DRX timing information	OP		DTX-DRX timing information 10.3.6.34b		REL-7
DTX-DRX Information	OP		DTX-DRX Information 10.3.6.34a		REL-7
HS-SCCH less Information	OP		HS-SCCH less Information 10.3.6.36ab		REL-7
MIMO parameters	OP		MIMO parameters 10.3.6.41a		REL-7
MIMO mode with four transmit antennas parameters	OP		MIMO mode with four transmit antennas parameters 10.3.6.142		REL-11
DCH Enhancements info FDD	OP		DCH Enhancements info FDD 10.3.6.149		REL-12
Control Channel DRX information	OP		Control Channel DRX information 1.28 Mcps TDD 10.3.6.107	This IE is used for 1.28 Mcps TDD only	REL-8
SPS Information	OP		SPS information 1.28 Mcps TDD 10.3.6.110	This IE is used for 1.28 Mcps TDD only	REL-8
MU-MIMO info	OP		MU-MIMO info 1.28 Mcps TDD 10.3.6.122	This IE is used for 1.28 Mcps TDD only	REL-10
Non-rectangular resource allocation indicator	OP		Enumerated(TRUE)	For 1.28 Mcps TDD only. The absence of this IE indicates that the non-rectangular resource allocation is not used.	REL-12

Information Element/Group name	Need	Multi	Type and reference	Semantics description	Version
Non-rectangular resource specific timeslots set	CV- <i>Non-rectangular Resource Allocation</i>		Bit string (7)	For 1.28 Mcps TDD only. The value 1 of a bit indicates the corresponding timeslot in which the channelization codes are assigned by physical control channel. The value 0 of a bit indicates the corresponding timeslot in which all channelization codes are assigned when the timeslot is scheduled to the UE. The first/leftmost bit of the bit string is for TS0.	REL-12
Uplink radio resources					
Maximum allowed UL TX power	MD		Maximum allowed UL TX power 10.3.6.39	Default value is the existing maximum UL TX power	
Uplink DPCH info	OP		Uplink DPCH info 10.3.6.88		
E-DCH Info	OP		E-DCH Info 10.3.6.97		REL-6
Uplink secondary cell info FDD	OP		Uplink secondary cell info FDD 10.3.6.115	FDD only	REL-9
Multi-carrier E-DCH Info for LCR TDD	OP		Multi-carrier E-DCH Info for LCR TDD 10.3.6.97a	1.28Mcps TDD only	REL-10
Uplink CLTD info FDD	OP		Uplink CLTD info FDD 10.3.6.125	FDD only	REL-11
Uplink OLTD info FDD	OP		Uplink OLTD info FDD 10.3.6.126	FDD only	REL-11
Other TTI E-DCH Configuration Information	OP		Other TTI E-DCH Configuration Information 10.3.6.152	FDD only	REL-12
Filtered UE power headroom reporting information	OP		Filtered UE power headroom reporting information 10.3.7.140	FDD only	REL-12
Downlink radio resources					
Downlink HS-PDSCH Information	OP		Downlink HS-PDSCH Information 10.3.6.23a		REL-5

Information Element/Group name	Need	Multi	Type and reference	Semantics description	Version
Downlink information common for all radio links	OP		Downlink information common for all radio links 10.3.6.24		
Downlink information per radio link list	OP	1 to <maxRL>		Send downlink information for each radio link	
>Downlink information for each radio link	MP		Downlink information for each radio link 10.3.6.27		
Downlink secondary cell info FDD	OP		Downlink secondary cell info FDD 10.3.6.31a	FDD only	REL-8
Additional downlink secondary cell info list FDD	OP	2			REL-10
>Downlink secondary cell info FDD	OP		Downlink secondary cell info FDD 10.3.6.31a	FDD only	REL-10
Additional downlink secondary cell info list FDD 2	OP	4			REL-11
>Downlink secondary cell info FDD	OP		Downlink secondary cell info FDD 10.3.6.31a	FDD only	REL-11
Common E-RGCH info FDD	OP		Common E-RGCH info FDD 10.3.6.138	FDD only	REL-11
MBMS PL Service Restriction Information	OP		Enumerated (TRUE)		REL-6
CELL_DCH measurement occasion info LCR	OP		CELL_DCH measurement occasion info LCR 10.3.7.126		REL-9

Condition	Explanation
<i>SRVCC</i>	This IE is mandatory if an SR-VCC procedure is initiated and not needed otherwise.
<i>Non-rectangularResourceAllocation</i>	This IE is optionally present if non-rectangular resource allocation is configured. Otherwise, it is not needed.

10.2.34 RADIO BEARER SETUP COMPLETE

This message is sent by the UE to confirm the establishment of the radio bearer.

RLC-SAP: AM

Logical channel: DCCH

Direction: UE → UTRAN

Information Element/Group name	Need	Multi	Type and reference	Semantics description	Version
Message Type	MP		Message Type		

Information Element/Group name	Need	Multi	Type and reference	Semantics description	Version
UE information elements					
RRC transaction identifier	MP		RRC transaction identifier 10.3.3.36		
Integrity check info	CH		Integrity check info 10.3.3.16		
Uplink integrity protection activation info	OP		Integrity protection activation info 10.3.3.17		
CHOICE <i>mode</i>	OP				
>FDD				(no data)	
>TDD					
>>CHOICE <i>TDD option</i>	MP				REL-4
>>>3.84 Mcps TDD					REL-4
>>>>Uplink Timing Advance	OP		Uplink Timing Advance 10.3.6.95	This information element shall be present in case of handover procedure if timing advance is enabled. Calculated timing advance value for the new cell after handover in a synchronous TDD network	
>>>>Extended Uplink Timing Advance	OP		Extended Uplink Timing Advance 10.3.6.95a		REL-7
>>>7.68 Mcps TDD					REL-7
>>>>Extended Uplink Timing Advance	OP		Extended Uplink Timing Advance 10.3.6.95a	This information element shall be present in case of handover procedure if timing advance is enabled. Calculated timing advance value for the new cell after handover in a synchronous TDD network	REL-7
>>>1.28 Mcps TDD				(No data)	REL-4
START	OP		START 10.3.3.38	This information element is not needed for transparent mode RBs if prior to this procedure there exists one RB using RLC-TM.	

Information Element/Group name	Need	Multi	Type and reference	Semantics description	Version
Other information elements					REL-7
Deferred measurement control reading	OP		Enumerated (TRUE)	Indicates the UE has not read SIB11, SIB11bis, SIB11ter (if supported) and SIB12, if available.	REL-7
RB Information elements					
COUNT-C activation time	OP		Activation time 10.3.3.1	Used for radio bearers mapped on RLC-TM.	
Uplink counter synchronisation info	OP				
>RB with PDCP information list	OP	1 to <maxRBall RABs>		This IE is needed for each RB having PDCP in the case of lossless SRNS relocation	
>>RB with PDCP information	MP		RB with PDCP information 10.3.4.22		
>START list	MP	1 to <maxCNdo mains>		START [40] values for all CN domains.	
>>CN domain identity	MP		CN domain identity 10.3.1.1		
>>START	MP		START 10.3.3.38	START value to be used in this CN domain.	

10.2.35 RADIO BEARER SETUP FAILURE

This message is sent by UE, if it does not support the configuration given by UTRAN.

RLC-SAP: AM

Logical channel: DCCH

Direction: UE→UTRAN

Information Element/Group name	Need	Multi	Type and reference	Semantics description
Message Type	MP		Message Type	
UE information elements				
RRC transaction identifier	MP		RRC transaction identifier 10.3.3.36	
Integrity check info	CH		Integrity check info 10.3.3.16	
Failure cause	MP		Failure cause and error information 10.3.3.14	
RB information elements				
Radio bearers for which reconfiguration would have succeeded	OP	1 to <maxRB>		
>Radio bearer for which reconfiguration would have succeeded	MP		RB identity, 10.3.4.16	

10.2.36 RRC CONNECTION REJECT

The network transmits this message when the requested RRC connection cannot be accepted.

RLC-SAP: UM

Logical channel: CCCH

Direction: UTRAN → UE

Information Element/Group name	Need	Multi	Type and reference	Semantics description	Version
Message Type	MP		Message Type		
UE information elements					
RRC transaction identifier	MP		RRC transaction identifier 10.3.3.36		
Initial UE identity	MP		Initial UE identity 10.3.3.15		
Rejection cause	MP		Rejection cause 10.3.3.31		
Wait time	MP		Wait time 10.3.3.50		
Redirection info	OP		Redirection info 10.3.3.29	The UE shall ignore any unsupported frequencies included in this IE.	
Counting completion	OP		Enumerated (TRUE)	This field may be present if the Rejection Cause is set to "unspecified" otherwise it shall be ignored.	REL-6
Extended Wait Time	OP		Extended Wait Time 10.3.3.12a		REL-10

10.2.37 RRC CONNECTION RELEASE

This message is sent by UTRAN to release the RRC connection. The message also releases the signalling connection and all radio bearers between the UE and UTRAN.

RLC-SAP: UM

Logical channel: CCCH or DCCH

Direction: UTRAN→UE

Information Element/Group name	Need	Multi	Type and reference	Semantics description	Version
Message Type	MP		Message Type		
UE information elements					
CHOICE identity type	CV- CCCH				REL-5
>U-RNTI			U-RNTI 10.3.3.47		
> Group identity		1 to <maxUR NTIgroup>			REL-5
>>Group release information	MP		Group release information 10.3.3.140		REL-5
RRC transaction identifier	MP		RRC transaction identifier 10.3.3.36		
Integrity check info	CV- DCCH		Integrity check info 10.3.3.16	Integrity check info is included if integrity protection is applied	
N308	CH- Cell_DCH		Integer(1..8)		
Release cause	MP		Release cause 10.3.3.32		
UE Mobility State Indicator	CV- DCCH_ MD		Enumerated (High-mobilityDetected)	Absence of this IE implies that, according to [4] the UE shall consider itself being in the mobility state the UE has maintained in CELL_DCH state or being not in high-mobility state when entering in Idle Mode, if applicable.	REL-7
Extended Wait Time	OP		Extended Wait Time 10.3.3.12a		REL-10
Other information elements					
Rplmn information	OP		Rplmn information 10.3.8.15		
Redirection info	OP		Redirection info 10.3.3.29		REL-6

Condition	Explanation
<i>CCCH</i>	This IE is mandatory present when CCCH is used and not needed otherwise.
<i>DCCH</i>	This IE is mandatory present when DCCH is used and not needed otherwise.
<i>DCCH_MD</i>	This IE is mandatory default when DCCH is used and not needed otherwise.
<i>Cell_DCH</i>	This IE is mandatory present when UE is in CELL_DCH state and not needed otherwise.

10.2.38 RRC CONNECTION RELEASE COMPLETE

This message is sent by UE to confirm that the RRC connection has been released.

RLC-SAP: AM or UM

Logical channel: DCCH

Direction: UE → UTRAN

Information Element/Group name	Need	Multi	Type and reference	Semantics description
Message Type	MP		Message Type	
UE information elements				
RRC transaction identifier	MP		RRC transaction identifier 10.3.3.36	
Integrity check info	CH		Integrity check info 10.3.3.16	
Error indication	OP		Failure cause and error information 10.3.3.14	

10.2.39 RRC CONNECTION REQUEST

RRC Connection Request is the first message transmitted by the UE when setting up an RRC Connection to the network.

RLC-SAP: TM

Logical channel: CCCH

Direction: UE → UTRAN

Information Element/Group name	Need	Multi	Type and reference	Semantics description	Version
Message Type	MP		Message Type		
Radio Bearer IEs					
Predefined configuration status information	MP		Boolean	TRUE indicates the UE has all pre-configurations stored with the same value tag as broadcast in the cell in which the RRC connection establishment is initiated	REL-5
UE information elements					
Initial UE identity	MP		Initial UE identity 10.3.3.15		
Establishment cause	MP		Establishment cause 10.3.3.11		
Protocol error indicator	MD		Protocol error indicator 10.3.3.27	Default value is FALSE	
>UE Specific Behaviour Information 1 idle	OP		UE Specific Behaviour Information 1 idle 10.3.3.51	This IE shall not be included in this version of the protocol	
Domain indicator	MP		CN domain identity 10.3.1.1		REL-6
CS Call type	CV-CS- <i>Domain</i>		Enumerated (speech, video, other)	One spare value is needed	REL-6
UE capability indication	OP		Enumerated (HS-DSCH, HS-DSCH+E-DCH)	Absence of this IE implies that neither HS-DSCH nor E-DCH are supported by the UE	REL-6
MBMS Selected Services	OP		MBMS Selected Services Short 10.3.9a.7d		REL-6
UE Mobility State Indicator	MD		Enumerated (High-mobilityDetected)	Absence of this IE implies that, according to [4] either the High mobility state is not applicable or it has not been detected by the UE.	REL-7

Support for F-DPCH	CV- SupportFor HS		Enumerated (TRUE)	Presence of this information element indicates that F-DPCH is supported by the UE. Absence of this information element indicates that F-DPCH is not supported	REL-6
Support for Enhanced F-DPCH	OP		Enumerated (TRUE)	The absence of this IE indicates that the UE does not support enhanced F-DPCH	REL-7
HS-PDSCH in CELL_FACH	OP		Enumerated (TRUE)	The absence of this IE indicates that the UE does not support HS-PDSCH reception in CELL_FACH state. Note 1	REL-7
MAC-ehs support	OP		Enumerated (TRUE)	The presence of this IE indicates that UE supports MAC-ehs, octet aligned transport block table, the use of special value of HE field to indicate end of an SDU for RLC AM and different HS-SCCHs in contiguous TTIs. The absence of this IE indicates that the UE does not support either MAC-ehs, octet aligned transport block table or the use of special value of HE field to indicate end of an SDU for RLC AM or different HS-SCCHs in contiguous TTIs.	REL-7
DPCCH Discontinuous Transmission support	OP		Enumerated (TRUE)	The absence of this IE indicates that the UE does not support DPCCH Discontinuous Transmission	REL-7
Support of common E-DCH	OP		Enumerated (TRUE)	The absence of this IE indicates that the UE does not support E-DCH enhanced random access in CELL_FACH state and Idle mode. Note 1	REL-8

Multi cell support	OP		Enumerated (TRUE)	The absence of this IE indicates that the UE does not support dual cell operations on adjacent frequencies	REL-8
Dual cell MIMO support	OP		Enumerated (TRUE)	The absence of this IE indicates that the UE does not support dual cell with MIMO operation on adjacent frequencies.	REL-9
More than two cell or MIMO mode with four transmit antennas support	OP		Enumerated (higher rate, lower rate)	For FDD, the absence of this IE indicates that the UE does not support multi-cell operation on more than two cells. For 1.28 Mcps TDD, the absence of this IE indicates that the UE does not support MU-MIMO. If present, higher rate indicates uplink and downlink MU-MIMO, lower rate indicates uplink MU-MIMO	REL-10
				For FDD, the absence of this IE indicates that the UE does not support multi-cell operation on more than two cells or MIMO mode with four transmit antennas. For 1.28 Mcps TDD, the absence of this IE indicates that the UE does not support MU-MIMO. If present, higher rate indicates uplink and downlink MU-MIMO, lower rate indicates uplink MU-MIMO	REL-11
Pre-redirectio n info	OP		Pre-redirectio n info 10.3.3.25a	The presence of this IE indicates the UE support of radio access technologies that the UE could be directed to, and that the UE was not redirected from EUTRA.	REL-8

Support of MAC-i/is	OP		Enumerated (TRUE)	The absence of this IE indicates that the UE does not support MAC-i/is operation.	REL-8
Support of SPS operation	OP		Enumerated (TRUE)	For 1.28 Mcps TDD only. The absence of this IE indicates that the UE does not support SPS operation.	REL-8
Support for CS Voice over HSPA	OP		Enumerated (TRUE)	The IE indicates the UE's support for CS Voice over HSPA, if set.	REL-8
System Information Container Stored Indicator	OP		Enumerated (TRUE)	The presence of this IE indicates that the UE is accessing the cell using System Information stored in the variable SYSTEM_INFORMATION_CONTAINER	REL-9
Support of the first Frequency Band	OP		Enumerated (TRUE)	The presence of this IE indicates the UE supports the 1 st band broadcasted in SIB5/5bis. For 1.28 Mcps TDD, the IE also indicates support band e if no band is broadcasted in SIB5/5bis.	REL-10
Support of the second Frequency Band	OP		Enumerated (TRUE)	The presence of this IE indicates the UE supports the 2 nd band broadcasted in SIB5/5bis. For 1.28 Mcps TDD, the IE also indicates support band f if no band is broadcasted in SIB5/5bis.	REL-10
CSFB Indication	OP		Enumerated (TRUE)	The presence of this IE indicates that the RRC Connection Request is due to CSFB call initiated in E-UTRA.	
Measurement information elements					
Measured results on RACH	OP		Measured results on RACH 10.3.7.45		
Access stratum release indicator	MP		Enumerated(REL-4,		REL-4

			REL-5, REL-6, REL-7, REL-8, REL-9, REL-10, REL-11, REL-12)	Absence of the IE implies R99. The IE also indicates the release of the RRC transfer syntax supported by the UE. 7 spare values are needed.	REL-5 REL-6 REL-7 REL-8 REL-9 REL-10 REL-11 REL-12
--	--	--	---	---	---

NOTE 1: For 1.28 Mcps TDD, UE supporting HS-PDSCH in CELL_FACH always supports E-DCH enhanced random access in CELL_FACH state and Idle mode, and vice versa.

Condition	Explanation
<i>CS-Domain</i>	This IE is mandatory present if the IE "Domain indicator" has the value "CS domain". Otherwise it is not needed.
<i>SupportForHS</i>	This IE is mandatory present if the UE supports HS-PDSCH, otherwise it is not needed.

If the encoded message does not fill a transport block, the RRC layer shall insert padding according to subclause 12.1.

10.2.40 RRC CONNECTION SETUP

This message is used by the network to accept the establishment of an RRC connection for a UE, including assignment of signalling link information, transport channel information and optionally physical channel information.

RLC-SAP: UM

Logical channel: CCCH

Direction: UTRAN → UE

Information Element/Group name	Need	Multi	Type and reference	Semantics description	Version
Message Type	MP		Message Type		
UE Information Elements					
Initial UE identity	MP		Initial UE identity 10.3.3.15		
RRC transaction identifier	MP		RRC transaction identifier 10.3.3.36		
Activation time	MD		Activation time 10.3.3.1	Default value is "now"	
New U-RNTI	MP		U-RNTI 10.3.3.47		
New C-RNTI	OP		C-RNTI 10.3.3.8		
New H-RNTI	OP		H-RNTI 10.3.3.14a		REL-6
New Primary E-RNTI	OP		E-RNTI 10.3.3.10a		REL-6
New Secondary E-RNTI	OP		E-RNTI 10.3.3.10a	FDD only	REL-6
RRC State Indicator	MP		RRC State Indicator 10.3.3.35a		

Information Element/Group name	Need	Multi	Type and reference	Semantics description	Version
UTRAN DRX cycle length coefficient	MP		UTRAN DRX cycle length coefficient 10.3.3.49		
Capability update requirement	MD		Capability update requirement 10.3.3.2	Default value is defined in subclause 10.3.3.2	
RNC support for change of UE capability	MP		Boolean		REL-7
Specification mode information elements					REL-8
Default configuration for CELL_FACH	OP		Default configuration for CELL_FACH 10.3.4.0a		REL-8
<i>CHOICE specification mode</i>	MP				REL-5
>Complete specification					
RB Information Elements					
>>Signalling RB information to setup list	MP	3 to 4			
>>>Signalling RB information to setup	MP		Signalling RB information to setup 10.3.4.24		
TrCH Information Elements					
Uplink transport channels					
>>UL Transport channel information common for all transport channels	OP		UL Transport channel information common for all transport channels 10.3.5.24		
>>Added or Reconfigured TrCH information list	MP	1 to <maxTrCH >		Although this IE is not required when the IE "RRC state indicator" is set to "CELL_FACH", need is MP to align with ASN.1	
	OP				REL-4
>>>Added or Reconfigured UL TrCH information	MP		Added or Reconfigured UL TrCH information 10.3.5.2		
Downlink transport channels					
>>DL Transport channel information common for all transport channels	OP		DL Transport channel information common for all transport channels 10.3.5.6		
>>Added or Reconfigured TrCH information list	MP	1 to <maxTrCH >		Although this IE is not required when the IE "RRC state indicator" is set to "CELL_FACH", need is MP to align with ASN.1	
	OP				REL-4

Information Element/Group name	Need	Multi	Type and reference	Semantics description	Version
>>>Added or Reconfigured DL TrCH information	MP		Added or Reconfigured DL TrCH information 10.3.5.1		
>Preconfiguration					REL-5
>>CHOICE <i>Preconfiguration mode</i>	MP				REL-5
>>>Predefined configuration identity	MP		Predefined configuration identity 10.3.4.5		REL-5
>>>Default configuration					REL-5
>>>>Default configuration mode	MP		Enumerated (FDD, TDD)	Indicates whether the FDD or TDD version of the default configuration shall be used	REL-5
>>>>Default configuration identity	MP		Default configuration identity 10.3.4.0		REL-5
PhyCH information elements					
Frequency info	OP		Frequency info 10.3.6.36		
Multi-frequency Info	OP		Multi-frequency Info 10.3.6.39a	This IE is used for 1.28 Mcps TDD only	REL-7

Information Element/Group name	Need	Multi	Type and reference	Semantics description	Version
DTX-DRX timing information	OP		DTX-DRX timing information 10.3.6.34b		REL-7
DTX-DRX Information	OP		DTX-DRX Information 10.3.6.34a		REL-7
HS-SCCH less Information	OP		HS-SCCH less Information 10.3.6.36ab		REL-7
SPS Information	OP		SPS information 1.28 Mcps TDD 10.3.6.110	This IE is used for 1.28 Mcps TDD only	REL-8
MU-MIMO info	OP		MU-MIMO info 1.28 Mcps TDD 10.3.6.122	This IE is used for 1.28 Mcps TDD only	REL-10
Non-rectangular resource allocation indicator	OP		Enumerated(TRUE)	For 1.28 Mcps TDD only. The absence of this IE indicates that the non-rectangular resource allocation is not used.	REL-12
Non-rectangular resource specific timeslots set	<i>CV-Non-rectangular Resource Allocation</i>		Bit string (7)	For 1.28 Mcps TDD only. The value 1 of a bit indicates the corresponding timeslot in which the channelization codes are assigned by physical control channel. The value 0 of a bit indicates the corresponding timeslot in which all channelization codes are assigned when the timeslot is scheduled to the UE. The first/leftmost bit of the bit string is for TS0.	REL-12
Uplink radio resources					
Maximum allowed UL TX power	MD		Maximum allowed UL TX power 10.3.6.39	Default value is the existing maximum UL TX power	
Uplink DPCH info	OP		Uplink DPCH info 10.3.6.88		
E-DCH Info	OP		E-DCH Info 10.3.6.97		REL-6
Downlink radio resources					

Information Element/Group name	Need	Multi	Type and reference	Semantics description	Version
Downlink HS-PDSCH Information	OP		Downlink HS-PDSCH information 10.3.6.23a		REL-6
Downlink information common for all radio links	OP		Downlink information common for all radio links 10.3.6.24		
Downlink information per radio link list	OP	1 to <maxRL>		Send downlink information for each radio link to be set-up	
>Downlink information for each radio link	MP		Downlink information for each radio link 10.3.6.27		
Downlink secondary cell info FDD	OP		Downlink secondary cell info FDD 10.3.6.31a	FDD only	REL-8
Additional downlink secondary cell info list FDD	OP	2			REL-10
>Downlink secondary cell info FDD	OP		Downlink secondary cell info FDD 10.3.6.31a	FDD only	REL-10
Common E-RGCH info FDD	OP		Common E-RGCH info FDD 10.3.6.138	FDD only	REL-11

Condition	Explanation
<i>Non-rectangularResourceAllocation</i>	This IE is optionally present if non-rectangular resource allocation is configured. Otherwise, it is not needed.

10.2.41 RRC CONNECTION SETUP COMPLETE

This message confirms the establishment of the RRC Connection by the UE.

RLC-SAP: AM

Logical channel: DCCH

Direction: UE → UTRAN

Information Element/Group name	Need	Multi	Type and reference	Semantics description	Version
Message Type	MP		Message Type		
UE Information Elements					
RRC transaction identifier	MP		RRC transaction identifier 10.3.3.36		
START list	MP	1 to <maxCNdomains>		START [40] values for all CN domains.	
>CN domain identity	MP		CN domain identity 10.3.1.1		

Information Element/Group name	Need	Multi	Type and reference	Semantics description	Version
>START	MP		START 10.3.3.38	START value to be used in this CN domain.	
UE radio access capability	OP		UE radio access capability 10.3.3.42		
UE radio access capability extension	OP		UE radio access capability extension 10.3.3.42a		
Other information elements					
UE system specific capability	OP	1 to <maxInterSy sMessages>			
>Inter-RAT UE radio access capability	MP		Inter-RAT UE radio access capability 10.3.8.7		
Deferred measurement control reading	OP		Enumerated (TRUE)	Indicates the UE has not read SIB11, SIB11bis, SIB11ter (if supported) and SIB12, if available.	REL-7
Logged Meas Available	OP		Enumerated (TRUE)	Indicates the UE has logged measurements to report to the network	REL-10
ANR Logging Results Available	OP		Enumerated (TRUE)	True indicates the UE has ANR logging results to report to the Network.	REL-10
Connection Establishment Failure Info Available	OP		Enumerated (TRUE)	True indicates the UE has logged measurements from a RRC connection establishment failure to report to the network.	REL-11

10.2.41a RRC FAILURE INFO

This message is sent by the UE via another radio access technology to provide information about the cause for failure to perform the requested operation.

RLC-SAP: N/A (Sent through a different RAT)

Logical channel: N/A (Sent through a different RAT)

Direction: UE → UTRAN

Information Element/Group Name	Need	Multi	Type and reference	Semantics description
Other Information elements				
Failure cause	MP		Failure cause 10.3.3.13	
Protocol error information	CV- <i>ProtErr</i>		Protocol error information 10.3.8.12	

Condition	Explanation
<i>ProtErr</i>	Presence is mandatory if the IE "Failure cause" has the value "Protocol error"; otherwise the element is not needed in the message.

10.2.42 RRC STATUS

This message is sent to indicate a protocol error.

RLC-SAP: AM

Logical channel: DCCH

Direction: UE→UTRAN

Information Element/Group name	Need	Multi	Type and reference	Semantics description
Message Type	MP		Message Type	
UE information elements				
Integrity check info	CH		Integrity check info 10.3.3.16	Integrity check info is included if integrity protection is applied
Identification of received message	CV- <i>Message identified</i>			
>Received message type	MP		Message Type	
>RRC transaction identifier	MP		RRC transaction identifier 10.3.3.36	
Other information elements				
Protocol error information	MP		Protocol error information 10.3.8.12	

Condition	Explanation
<i>Message identified</i>	This IE is mandatory present if the IE "Protocol error cause" in the IE "Protocol error information" has any other value than "ASN.1 violation or encoding error" or "Message type non-existent or not implemented" and not needed otherwise.

10.2.43 SECURITY MODE COMMAND

This message is sent by UTRAN to start or reconfigure ciphering and/or integrity protection parameters.

RLC-SAP: AM

Logical channel: DCCH

Direction: UTRAN to UE

Information Element/Group name	Need	Multi	Type and reference	Semantics description
Message Type	MP		Message Type	
UE information elements				
RRC transaction identifier	MP		RRC transaction identifier 10.3.3.36	
Integrity check info	MP		Integrity check info 10.3.3.16	
Security capability	MP		Security capability 10.3.3.37	
Ciphering mode info	OP		Ciphering mode info 10.3.3.5	Only present if ciphering shall be controlled
Integrity protection mode info	OP		Integrity protection mode info 10.3.3.19	Only present if integrity protection shall be controlled
CN Information elements				
CN domain identity	MP		CN domain identity 10.3.1.1	Indicates which ciphering and integrity protection keys are applicable
Other information elements				
UE system specific security capability	CH	1 to <maxInter SysMessages>		This IE is included if the IE "Inter-RAT UE radio access capability" was included in RRC CONNECTION SETUP COMPLETE message
>Inter-RAT UE security capability	MP		Inter-RAT UE security capability 10.3.8.8a	

10.2.44 SECURITY MODE COMPLETE

This message is sent by UE to confirm the reconfiguration of ciphering and/or integrity protection.

RLC-SAP: AM

Logical channel: DCCH

Direction: UE to UTRAN

Information Element/Group name	Need	Multi	Type and reference	Semantics description
Message Type	MP		Message Type	
UE information elements				
RRC transaction identifier	MP		RRC transaction identifier 10.3.3.36	
Integrity check info	MP		Integrity check info 10.3.3.16	
Uplink integrity protection activation info	OP		Integrity protection activation info 10.3.3.17	
RB Information elements				
Radio bearer uplink ciphering activation time info	OP		RB activation time info 10.3.4.13	

10.2.45 SECURITY MODE FAILURE

This message is sent to indicate a failure to act on a received SECURITY MODE COMMAND message.

RLC-SAP: AM

Logical channel: DCCH

Direction: UE→UTRAN

Information Element/Group name	Need	Multi	Type and reference	Semantics description
Message Type	MP		Message Type	
UE information elements				
RRC transaction identifier	MP		RRC transaction identifier 10.3.3.36	
Integrity check info	CH		Integrity check info 10.3.3.16	
Failure cause	MP		Failure cause and error information 10.3.3.14	

10.2.46 SIGNALLING CONNECTION RELEASE

This message is used to notify the UE that its ongoing signalling connection to a CN domain has been released.

RLC-SAP: AM

Logical channel: DCCH

Direction: UTRAN→UE

Information Element/Group name	Need	Multi	Type and reference	Semantics description
Message Type	MP		Message Type	
UE information elements				
RRC transaction identifier	MP		RRC transaction identifier 10.3.3.36	
Integrity check info	CH		Integrity check info 10.3.3.16	Integrity check info is included if integrity protection is applied
Extended Wait Time	OP		Extended Wait Time 10.3.3.12a	
CN information elements				
CN domain identity	MP		CN domain identity 10.3.1.1	

10.2.47 SIGNALLING CONNECTION RELEASE INDICATION

This message is used by the UE to indicate to UTRAN the release of an existing signalling connection.

RLC-SAP: AM

Logical channel: DCCH

Direction: UE→UTRAN

Information Element/Group name	Need	Multi	Type and reference	Semantics description	Version
Message Type	MP		Message type		
UE Information Elements					
Integrity check info	CH		Integrity check info 10.3.3.16		
CN information elements					
CN domain identity	MP		CN domain identity 10.3.1.1		
Signalling Connection Release Indication Cause	MP		Signalling Connection Release Indication Cause 10.3.3.7a	NOTE1	REL-8

NOTE1: For the sake of backward compatibility, when the cause value is set to a value other than "UE Requested PS Data session end" according to 8.1.14.2: in this release of the specification, the UE may exclude this IE by not including the ASN.1 non-critical extension where it is referenced, alternatively, if the UE includes this IE it shall set it to "any Other Cause".

10.2.48 SYSTEM INFORMATION

This message is used by the UTRAN to convey system information blocks to the UE.

RLC-SAP: TM

Logical channel: BCCH

Direction: UTRAN→UE

Information Element/Group name	Need	Multi	Type and reference	Semantics description
SFNprime	CV- <i>channel2</i>		Integer(0..40 94 by step of 2)	SFN=SFNprime (for first 10ms frame of 20ms TTI), SFN=SFNprime+1 (for last 10ms frame of 20ms TTI)
CHOICE <i>Segment combination</i>	MP			Five spares are needed
>Combination 1				(no data)
>Combination 2				
>>First Segment	MP		First Segment, 10.2.48.1	
>Combination 3				
>>Subsequent Segment	MP		Subsequent Segment, 10.2.48.3	
>Combination 4				
>>Last segment	MP		Last segment (short),10.2. 48.5	
>Combination 5				NOTE 2
>>Last segment	MP		Last Segment (short)10.2.4 8.5	
>>First Segment	MP		First Segment (short), 10.2.48.2	
>Combination 6				NOTE 2
>>Last Segment	MP		Last Segment (short), 10.2.48.5	
>>Complete list	MP	1 to maxSIBper Msg		NOTE 1
>>>Complete	MP		Complete SIB (short),10.2. 48.7	
>Combination 7				NOTE 2
>>Last Segment	MP		Last Segment (short), 10.2.48.5	
>>Complete list	MP	1..< maxSIBper Msg>		NOTE 1
>>>Complete	MP		Complete SIB (short),10.2. 48.7	
>>First Segment	MP		First Segment (short),	

Information Element/Group name	Need	Multi	Type and reference	Semantics description
			10.2.48.2	
>Combination 8				NOTE 2
>>Complete list	MP	1 to maxSIBper Msg		NOTE 1
>>>Complete	MP		Complete SIB (short),10.2.48.7	
>Combination 9				NOTE 2
>>Complete list	MP	1..MaxSIB perMsg		NOTE 1
>>>Complete	MP		Complete SIB (short),10.2.48.7	
>>First Segment	MP		First Segment (short), 10.2.48.2	
>Combination 10				
>>>Complete SIB of size 215 to 226	MP		Complete SIB,10.2.48.6	
>Combination 11				
>>Last segment of size 215 to 222	MP		Last segment,10.2.48.4	
NOTE 1: If Combination 6 - 9 contains a Master information block, the Master information block shall be located as the first IE in the list.				
NOTE 2: If one of the combinations 5 to 9 is used, the IE "SIB type" = "Extension Type" should not occur more than once in that message, otherwise the UE behaviour is unspecified.				

Condition	Explanation
<i>channel2</i>	This IE is mandatory present if the channel is BCH, otherwise it is not needed.

If the encoded message does not fill a transport block, the RRC layer shall insert padding according to subclause 12.1. Padding is needed e.g. if the remaining space is insufficient to start a new First Segment (which requires several bits for SIB type, SEG_COUNT and SIB data).

10.2.48a System Information Container

This message is sent via another radio access technology to provide information to the UE.

- RLC-SAP: N/A (Sent through a different RAT)
- Logical channel: N/A (Sent through a different RAT)
- Direction: A different RAT → UE

Information Element/Group Name	Need	Multi	Type and reference	Semantics description	Version
MIB	MP		Master Information Block 10.2.48.8.1		REL-9
SysInfoTypeSB1	OP		Scheduling Block 1 10.2.48.8.2		REL-9

Information Element/Group Name	Need	Multi	Type and reference	Semantics description	Version
SysInfoTypeSB2	OP		Scheduling Block 2 10.2.48.8.3		REL-9
SysInfoType1	MP		System Information Block type 1 10.2.48.8.4		REL-9
SysInfoType3	MP		System Information Block type 3 10.2.48.8.6		REL-9
SysInfoType5	MP		System Information Block type 5 or 5bis 10.2.48.8.8		REL-9
SysInfoType7	MP		System Information Block type 7 10.2.48.8.10		REL-9
SysInfoType11	OP		System Information Block type 11 10.2.48.8.14		REL-9
SysInfoType11bis	OP		System Information Block type 11bis 10.2.48.8.14 a		REL-9
SysInfoType11ter	OP		System Information Block type 11ter 10.2.48.8.14 b		REL-12
SysInfoType12	OP		System Information Block type 12 10.2.48.8.15		REL-9
SysInfoType22	OP		System Information Block type 22 10.2.48.8.25		REL-11

10.2.48b SYSTEM INFORMATION 2

This message is used by the UTRAN to convey system information blocks to the UE. This message is used on the second system information broadcast channel (BCH on SCCPCH).

RLC-SAP: TM

Logical channel: BCCH

Direction: UTRAN→UE

Information Element/Group name	Need	Multi	Type and reference	Semantics description	Version
CHOICE <i>Segment combination</i>	MP			Six spares are needed	
>Combination 2					

Information Element/Group name	Need	Multi	Type and reference	Semantics description	Version
>>First Segment 2	MP		First Segment 2 10.2.48.1a		REL-12
>Combination 3					
>>Subsequent Segment 2	MP		Subsequent Segment 2 10.2.48.3a		REL-12
>Combination 4					
>>Last segment 2	MP		Last Segment (short) 2 10.2.48.5a		REL-12
>Combination 5					
>>Last segment 2	MP		Last Segment (short) 2 10.2.48.5a		REL-12
>>First Segment 2	MP		First Segment (short) 2 10.2.48.2a		REL-12
>Combination 6					
>>Last Segment 2	MP		Last Segment (short) 2 10.2.48.5a		REL-12
>>Complete list 2	MP	1 to maxSIBper Msg		NOTE 1	
>>>Complete 2	MP		Complete SIB (short) 2 10.2.48.7a		REL-12
>Combination 7					
>>Last Segment 2	MP		Last Segment (short) 2 10.2.48.5a		REL-12
>>Complete list 2	MP	1..< maxSIBper Msg>		NOTE 1	
>>>Complete 2	MP		Complete SIB (short) 2 10.2.48.7a		REL-12
>>First Segment 2	MP		First Segment (short) 2 10.2.48.2a		REL-12
>Combination 8					
>>Complete list 2	MP	1 to maxSIBper Msg		NOTE 1	
>>>Complete 2	MP		Complete SIB (short) 2 10.2.48.7a		REL-12
>Combination 9					
>>Complete list 2	MP	1..MaxSIB perMsg		NOTE 1	
>>>Complete 2	MP		Complete SIB (short) 2 10.2.48.7a		REL-12
>>First Segment 2	MP		First Segment (short) 2 10.2.48.2a		REL-12
>Combination 10					
>>Complete SIB of size 225 to 236	MP		Complete SIB 2 10.2.48.6a		REL-12
>Combination 11					
>>Last segment of size 225 to 232	MP		Last Segment 2 10.2.48.4a		REL-12
NOTE 1: If Combination 6 - 9 contains aScheduling Block 3, the Scheduling Block 3 shall be located as the first IE in the list.					

If the encoded message does not fill a transport block, the RRC layer shall insert padding according to subclause 12.1. Padding is needed e.g. if the remaining space is insufficient to start a new First Segment (which requires several bits for SIB type, SEG_COUNT and SIB data).

10.2.48.1 First Segment

This segment type is used to transfer the first segment of a segmented system information block. The IE is used when the first segment fills the entire transport block (Combination 2).

Information Element/Group name	Need	Multi	Type and reference	Semantics description
Other information elements				
SIB type	MP		SIB Type, 10.3.8.21	
SEG_COUNT	MP		SEG COUNT, 10.3.8.17	
SIB data fixed	MP		SIB data fixed, 10.3.8.19	

10.2.48.1a First Segment 2

This segment type is used to transfer the first segment of a segmented system information block. The IE is used when the first segment fills the entire transport block (Combination 2). This segment type is used on the second system information broadcast channel (BCH on SCCPCH).

Information Element/Group name	Need	Multi	Type and reference	Semantics description
Other information elements				
SIB type	MP		SIB and SB type 2, 10.3.8.22ab	
SEG_COUNT	MP		SEG COUNT, 10.3.8.17	
SIB data fixed	MP		SIB data fixed 2, 10.3.8.19a	

10.2.48.2 First Segment (short)

This segment type is used to transfer the first segment of a segmented system information block. The IE is used when the first segment is concatenated after other segments in a transport block (Combination 5, 7 and 9).

Information Element/Group name	Need	Multi	Type and reference	Semantics description
Other information elements				
SIB type	MP		SIB Type, 10.3.8.21	
SEG_COUNT	MP		SEG COUNT, 10.3.8.17	
SIB data variable	MP		SIB data variable, 10.3.8.20	

10.2.48.2a First Segment (short) 2

This segment type is used to transfer the first segment of a segmented system information block. The IE is used when the first segment is concatenated after other segments in a transport block (Combination 5, 7 and 9). This segment type is used on the second system information broadcast channel (BCH on SCCPCH).

Information Element/Group name	Need	Multi	Type and reference	Semantics description
Other information elements				
SIB type	MP		SIB and SB type 2, 10.3.8.22ab	
SEG_COUNT	MP		SEG COUNT, 10.3.8.17	
SIB data variable	MP		SIB data variable 2, 10.3.8.20o	

10.2.48.3 Subsequent Segment

This segment type is used to transfer a subsequent segment of a segmented system information block.

Information Element/Group name	Need	Multi	Type and reference	Semantics description
Other information elements				
SIB type	MP		SIB Type, 10.3.8.21	
Segment index	MP		Segment Index, 10.3.8.18	
SIB data fixed	MP		SIB data fixed, 10.3.8.19	

10.2.48.3a Subsequent Segment 2

This segment type is used to transfer a subsequent segment of a segmented system information block. This segment type is used on the second system information broadcast channel (BCH on SCCPCH).

Information Element/Group name	Need	Multi	Type and reference	Semantics description
Other information elements				
SIB type	MP		SIB and SB type 2, 10.3.8.22ab	
Segment index	MP		Segment Index, 10.3.8.18	
SIB data fixed	MP		SIB data fixed 2, 10.3.8.19a	

10.2.48.4 Last Segment

This segment type is used to transfer the last segment of a segmented system information block. The IE is used when the last segment has a length, excluding length denominator, from 215 through 222 (Combination 11).

Information Element/Group name	Need	Multi	Type and reference	Semantics description
Other information elements				
SIB type	MP		SIB Type, 10.3.8.21	
Segment index	MP		Segment Index, 10.3.8.18	
SIB data fixed	MP		SIB data fixed, 10.3.8.19	In case the SIB data is less than 222 bits, padding shall be used. The same padding bits shall be used as defined in clause 12.1

10.2.48.4a Last Segment 2

This segment type is used to transfer the last segment of a segmented system information block. The IE is used when the last segment has a length, excluding length denominator, from 225 through 232 (Combination 11). This segment type is used on the second system information broadcast channel (BCH on SCCPCH).

Information Element/Group name	Need	Multi	Type and reference	Semantics description
Other information elements				
SIB type	MP		SIB and SB type 2, 10.3.8.22ab	
Segment index	MP		Segment Index, 10.3.8.18	
SIB data fixed	MP		SIB data fixed 2, 10.3.8.19a	In case the SIB data is less than 232 bits, padding shall be used. The same padding bits shall be used as defined in clause 12.1

10.2.48.5 Last Segment (short)

This segment type is used to transfer the last segment of a segmented system information block. The IE is used when the last segment has a length, excluding length denominator, of upto 214 bits (Combination 4, 5, 6 and 7).

Information Element/Group name	Need	Multi	Type and reference	Semantics description
Other information elements				
SIB type	MP		SIB Type, 10.3.8.21	
Segment index	MP		Segment Index, 10.3.8.18	
SIB data variable	MP		SIB data variable, 10.3.8.20	

10.2.48.5a Last Segment (short) 2

This segment type is used to transfer the last segment of a segmented system information block. The IE is used when the last segment has a length, excluding length denominator, of upto 224 bits (Combination 4, 5, 6 and 7). This segment type is used on the second system information broadcast channel (BCH on SCCPCH).

Information Element/Group name	Need	Multi	Type and reference	Semantics description
Other information elements				
SIB type	MP		SIB and SB type 2, 10.3.8.22ab	
Segment index	MP		Segment Index, 10.3.8.18	
SIB data variable	MP		SIB data variable 2, 10.3.8.20o	

10.2.48.6 Complete SIB

This segment type is used to transfer a non-segmented system information block. The IE is used when the complete SIB has a length, excluding length denominator, from 215 through 226 (Combination 10).

Information Element/Group name	Need	Multi	Type and reference	Semantics description
Other information elements				
SIB type	MP		SIB Type, 10.3.8.21	
SIB data fixed	MP		Bit string (226)	The first/leftmost/most significant bit of the bit string contains the first bit of the segment. In case the SIB data is less than 226 bits, padding shall be used. The same padding bits shall be used as defined in clause 12.1

10.2.48.6a Complete SIB 2

This segment type is used to transfer a non-segmented system information block. The IE is used when the complete SIB has a length, excluding length denominator, from 225 through 236 (Combination 10). This segment type is used on the second system information broadcast channel (BCH on SCCPCH).

Information Element/Group name	Need	Multi	Type and reference	Semantics description
Other information elements				
SIB type	MP		SIB and SB type 2, 10.3.8.22ab	
SIB data fixed	MP		Bit string (236)	The first/leftmost/most significant bit of the bit string contains the first bit of the segment. In case the SIB data is less than 236 bits, padding shall be used. The same padding bits shall be used as defined in clause 12.1

10.2.48.7 Complete SIB (short)

This segment type is used to transfer a non-segmented system information block. The IE is used when the complete SIB has a length, excluding length denominator, of upto 214 bits (Combination 6, 7, 8 and 9).

Information Element/Group name	Need	Multi	Type and reference	Semantics description
Other information elements				
SIB type	MP		SIB Type, 10.3.8.21	
SIB data variable	MP		SIB data variable, 10.3.8.20	

10.2.48.7a Complete SIB (short) 2

This segment type is used to transfer a non-segmented system information block. The IE is used when the complete SIB has a length, excluding length denominator, of upto 224 bits (Combination 6, 7, 8 and 9). This segment type is used on the second system information broadcast channel (BCH on SCCPCH).

Information Element/Group name	Need	Multi	Type and reference	Semantics description
Other information elements				
SIB type	MP		SIB and SB type 2, 10.3.8.22ab	
SIB data variable	MP		SIB data variable 2, 10.3.8.20o	

10.2.48.8 System Information Blocks

The IE "SIB data" within the IEs, "First Segment", "Subsequent or last Segment" and "Complete SIB" contains either complete system information block or a segment of a system information block. The actual system information blocks are defined in the following clauses.

10.2.48.8.1 Master Information Block

Information Element/Group name	Need	Multi	Type and reference	Semantics description	Version
Other information elements					
MIB Value tag	MP		MIB Value tag 10.3.8.9		
CN information elements					
Supported PLMN types	MP		PLMN Type 10.3.1.12		
PLMN Identity	CV-GSM		PLMN Identity 10.3.1.11		
Multiple PLMN List	OP		Multiple PLMN List 10.3.1.7a	If present, this IE specifies the PLMNs of the cell. If absent, the IE "PLMN Identity" specifies the PLMN of the cell.	REL-6
ANSI-41 information elements					
ANSI-41 Core Network Information	CV-ANSI-41		ANSI-41 Core Network Information 10.3.9.1		
References to other system information blocks and scheduling blocks	MP		References to other system information blocks and scheduling blocks 10.3.8.14		
CSG Indicator	OP		Enumerated (TRUE)	If present, the cell is a CSG cell (see [4]). If absent, the cell is not a CSG cell.	REL-8
SB3 information	OP		SB3 information 10.3.8.14a		REL-12

Condition	Explanation
<i>GSM</i>	The IE is mandatory present if the IE "Supported PLMN Types" is set to 'GSM-MAP' or 'GSM-MAP AND ANSI-41', and not needed otherwise
<i>ANSI-41</i>	The IE is mandatory present if the IE "Supported PLMN Types" is set to 'ANSI-41' or 'GSM-MAP AND ANSI-41', and not needed otherwise

10.2.48.8.2 Scheduling Block 1

Information Element/Group name	Need	Multi	Type and reference	Semantics description
References to other system information blocks	MP		References to other system information blocks 10.3.8.13	

10.2.48.8.3 Scheduling Block 2

Information Element/Group name	Need	Multi	Type and reference	Semantics description
References to other system information blocks	MP		References to other system information blocks 10.3.8.13	

10.2.48.8.3a Scheduling Block 3

This segment type is used on the second system information broadcast channel (BCH on SCCPCH).

Information Element/Group name	Need	Multi	Type and reference	Semantics description	Version
SB3 value tag	MP		Cell Value tag 2 10.3.8.4o		REL-12
References to other system information blocks	MP		References to other system information blocks 2 10.3.8.13a		REL-12

10.2.48.8.4 System Information Block type 1

The system information block type 1 contains NAS system information as well as UE timers and counters to be used in idle mode and in connected mode.

Information Element/Group name	Need	Multi	Type and reference	Semantics description
CN information elements				
CN common GSM-MAP NAS system information	MP		NAS system information (GSM-MAP) 10.3.1.9	
CN domain system information list	MP	1 to <maxCNdomains>		Send CN information for each CN domain.
>CN domain system information	MP		CN domain system information 10.3.1.2	
UE information				
UE Timers and constants in idle mode	MD		UE Timers and constants in idle mode 10.3.3.44	The UE behaviour is unspecified if this IE is absent.
UE Timers and constants in connected mode	MD		UE Timers and constants in connected mode 10.3.3.43	Default value means that for all timers and constants - For parameters with need MD, the defaults specified in 10.3.3.43 apply and - For parameters with need OP, the parameters are absent

10.2.48.8.5 System Information Block type 2

The system information block type 2 contains the URA identity.

Information Element/Group name	Need	Multi	Type and reference	Semantics description
UTRAN mobility information elements				
URA identity list	MP	1 ..<maxU RA>		
>URA identity	MP		URA identity 10.3.2.6	

10.2.48.8.6 System Information Block type 3

The system information block type 3 contains parameters for cell selection and re-selection.

Information Element/Group name	Need	Multi	Type and reference	Semantics description	Version
SIB4 Indicator	MP		Boolean	TRUE indicates that SIB4 is broadcast in the cell. When the UE receives SIB3 in the System Information Container message, this IE is interpreted as FALSE.	
UTRAN mobility information elements					
Cell identity	MP		Cell identity 10.3.2.2		
Cell selection and re-selection info	MP		Cell selection and re-selection info for SIB3/4 10.3.2.3		
Cell Access Restriction	MP		Cell Access Restriction 10.3.2.1		
Domain Specific Access Restriction Parameters For PLMN Of MIB	OP		Domain Specific Access Restriction Parameters 10.3.1.3c	This IE specifies the Domain Specific Access Restriction Parameters for UEs which has chosen the PLMN in the IE "PLMN identity" of the Master Information Block. If the cell is operating in MBSFN mode as indicated in subclause 8.1.1.6.3 the UE behaviour upon reception of this IE is unspecified.	REL-6
Domain Specific Access Restriction For Shared Network	OP			If the cell is operating in MBSFN mode as indicated in subclause 8.1.1.6.3 the UE behaviour upon reception of this IE is unspecified.	REL-6
>CHOICE <i>barring representation</i>	MP				REL-6
>>Domain Specific Access Restriction List					REL-6
>>>Domain Specific Access Restriction Parameters For Operator1	OP		Domain Specific Access Restriction Parameters 10.3.1.3c	This IE specifies the Domain Specific Access Restriction Parameters for UEs which has chosen the first PLMN in the IE "multiplePLMNs" in the IE "Multiple PLMN List" of the Master Information Block.	REL-6
>>>Domain Specific Access Restriction Parameters For Operator2	OP		Domain Specific Access Restriction Parameters 10.3.1.3c	This IE specifies the Domain Specific Access Restriction Parameters for UEs which has chosen the second PLMN in the IE "multiplePLMNs" in the IE "Multiple PLMN List" of the Master Information Block.	REL-6
>>>Domain Specific Access Restriction Parameters For Operator3	OP		Domain Specific Access Restriction Parameters 10.3.1.3c	This IE specifies the Domain Specific Access Restriction Parameters for UEs which has chosen the third PLMN in the IE "multiplePLMNs" in the IE "Multiple PLMN List" of the Master Information Block.	REL-6
>>>Domain Specific Access Restriction Parameters For Operator4	OP		Domain Specific Access Restriction Parameters 10.3.1.3c	This IE specifies the Domain Specific Access Restriction Parameters for UEs which has chosen the fourth PLMN in the IE "multiplePLMNs" in the IE "Multiple PLMN List" of the Master Information Block.	REL-6

>>>Domain Specific Access Restriction Parameters For Operator5	OP		Domain Specific Access Restriction Parameters 10.3.1.3c	This IE specifies the Domain Specific Access Restriction Parameters for UEs which has chosen the fifth PLMN in the IE "multiplePLMNs" in the IE "Multiple PLMN List" of the Master Information Block.	REL-6
>>Domain Specific Access Restriction Parameters For All					REL-6
>>>Domain Specific Access Restriction Parameters			Domain Specific Access Restriction Parameters 10.3.1.3c	This IE specifies the common Domain Specific Access Restriction Parameters applied to all PLMNs in the IE "multiplePLMNs" in the IE "Multiple PLMN List" of the Master Information Block.	REL-6
Deferred measurement control reading support	OP			If present, the UE may apply deferred reading of SIB11, SIB11bis, SIB11ter (if supported), SIB12, SIB18 and SIB19. If not present, deferred reading may not be applied.	REL-7
>CHOICE <i>mode</i>	OP			If absent, the default reporting quantities are: "CPICH RSCP" (FDD) and "Primary CCPCH RSCP" (TDD).	REL-7
>>FDD					REL-7
>>>Intra-frequency reporting quantity SIB3	MP		Enumerated(CPICH Ec/N0, CPICH RSCP)		REL-7
>>TDD					REL-7
>>>Reporting quantity list	MP	1 to 2			REL-7
>>>>Intra-frequency reporting quantity SIB3	MP		Enumerated (Primary CCPCH RSCP, Timeslot ISCP)		REL-7
MBSFN only service	OP		Enumerated (TRUE)	Indicates if the cell provides only MBMS services in MBSFN mode	REL-7
Paging Permission with Access Control Parameters For PLMN Of MIB	OP		Paging Permission with Access Control Parameters 10.3.1.10a	This IE specifies the Paging Permission With Access Control Parameters for UEs which has chosen the PLMN in the IE "PLMN identity" of the Master Information Block. If the cell is operating in MBSFN mode as indicated in subclause 8.1.1.6.3 the UE behaviour upon reception of this IE is unspecified.	REL-8
Paging Permission with Access Control For Shared Network	OP			If the cell is operating in MBSFN mode as indicated in subclause 8.1.1.6.3 the UE behaviour upon reception of this IE is unspecified.	REL-8
>CHOICE <i>barring representation</i>	MP				REL-8
>>Paging Permission with Access Control List					REL-8

>>>Paging Permission with Access Control Parameters For Operator1	OP		Paging Permission with Access Control Parameters 10.3.1.10a	This IE specifies the Paging Permission with Access Control Parameters for UEs which has chosen the first PLMN in the IE "multiplePLMNs" in the IE "Multiple PLMN List" of the Master Information Block.	REL-8
>>>Paging Permission with Access Control Parameters For Operator2	OP		Paging Permission with Access Control Parameters 10.3.1.10a	This IE specifies the Paging Permission with Access Control Parameters for UEs which has chosen the second PLMN in the IE "multiplePLMNs" in the IE "Multiple PLMN List" of the Master Information Block.	REL-8
>>>Paging Permission with Access Control Parameters For Operator3	OP		Paging Permission with Access Control Parameters 10.3.1.10a	This IE specifies the Paging Permission with Access Control Parameters for UEs which has chosen the third PLMN in the IE "multiplePLMNs" in the IE "Multiple PLMN List" of the Master Information Block.	REL-8
>>>Paging Permission with Access Control Parameters For Operator4	OP		Paging Permission with Access Control Parameters 10.3.1.10a	This IE specifies the Paging Permission with Access Control Parameters for UEs which has chosen the fourth PLMN in the IE "multiplePLMNs" in the IE "Multiple PLMN List" of the Master Information Block.	REL-8
>>>Paging Permission with Access Control Parameters For Operator5	OP		Paging Permission with Access Control Parameters 10.3.1.10a	This IE specifies the Paging Permission with Access Control Parameters for UEs which has chosen the fifth PLMN in the IE "multiplePLMNs" in the IE "Multiple PLMN List" of the Master Information Block.	REL-8
>>Paging Permission with Access Control Parameters For All					REL-8
>>>Paging Permission with Access Control Parameters	MP		Paging Permission with Access Control Parameters 10.3.1.10a	This IE specifies the common Paging Permission with Access Control Parameters applied to all PLMNs in the IE "multiplePLMNs" in the IE "Multiple PLMN List" of the Master Information Block.	REL-8
CSG Identity	OP		CSG Identity 10.3.2.8		REL-8
CSG PSC Split Information	OP		CSG PSC Split Information 10.3.2.9	This IE specifies the Primary Scrambling Code reservation information for CSG Cells.	REL-8
IMS Emergency Support Indicator	OP		Enumerated (supported)	This IE specifies the support of IMS emergency call in the cell for limited service mode UE	REL-9

10.2.48.8.7 System Information Block type 4

The system information block type 4 contains parameters for cell selection and re-selection to be used in connected mode.

Information Element/Group name	Need	Multi	Type and reference	Semantics description
UTRAN mobility information elements				
Cell identity	MP		Cell identity 10.3.2.2	
Cell selection and re-selection info	MP		Cell selection and re-selection info for SIB3/4 10.3.2.3	
Cell Access Restriction	MP		Cell Access Restriction 10.3.2.1	

10.2.48.8.8 System Information Block type 5 and 5bis

The system information block type 5 contains parameters for the configuration of the common physical channels in the cell. System information block type 5bis uses the same structure as System information block type 5. System information block type 5bis is sent instead of system information block type 5 in cells that use Band IV or Band IX or Band X if it is broadcasted.

Information Element/Group name	Need	Multi	Type and reference	Semantics description	Version
SIB6 Indicator	MP		Boolean	TRUE indicates that SIB6 is broadcast in the cell. When the UE receives SIB5 in the System Information Container message, this IE is interpreted as FALSE	
SIB22 Indicator	MP		Boolean	TRUE indicates that SIB22 is broadcast in the cell.	REL-11
PhyCH information elements					
PICH Power offset	MP		PICH Power offset 10.3.6.50	If the cell is operating in MBSFN mode as indicated in subclause 8.1.1.6.3 the UE behaves as if this IE would not have been received.	
CHOICE <i>mode</i>	MP				
>FDD					
>>AICH Power offset	MP		AICH Power offset 10.3.6.3	If the cell is operating in MBSFN mode as indicated in subclause 8.1.1.6.3 the UE behaves as if this IE would not have been received.	
>TDD					
>>PUSCH system information	OP		PUSCH system information 10.3.6.66	If the cell is operating in MBSFN mode as indicated in subclause 8.1.1.6.3 the UE behaviour upon reception of this IE is unspecified.	

Information Element/Group name	Need	Multi	Type and reference	Semantics description	Version
>>PUSCH system information VHCR	OP		PUSCH system information VHCR 10.3.6.66a	Only for 7.68 Mcps TDD If the cell is operating in MBSFN mode as indicated in subclause 8.1.1.6.3 the UE behaviour upon reception of this IE is unspecified.	REL-7
>>PDSCH system information	OP		PDSCH system information 10.3.6.46	If the cell is operating in MBSFN mode as indicated in subclause 8.1.1.6.3 the UE behaviour upon reception of this IE is unspecified.	
>>TDD open loop power control	MP		TDD open loop power control 10.3.6.79	If the cell is operating in MBSFN mode as indicated in subclause 8.1.1.6.3 the UE behaves as if this IE would not have been received.	
Primary CCPCH info	OP		Primary CCPCH info 10.3.6.57	Note 1	
PRACH system information list	MP		PRACH system information list 10.3.6.55	If the cell is operating in MBSFN mode as indicated in subclause 8.1.1.6.3 the UE behaves as if this IE would not have been received.	
Common E-DCH system info	OP		Common E-DCH system info 10.3.6.9a		REL-8
Secondary CCPCH system information	MP		Secondary CCPCH system information 10.3.6.72	Note 2 If the cell is operating in MBSFN mode as indicated in subclause 8.1.1.6.3 the UE behaves as if this IE would not have been received.	
CBS DRX Level 1 information	CV- <i>CTCH</i>		CBS DRX Level 1 information 10.3.8.3		

Information Element/Group name	Need	Multi	Type and reference	Semantics description	Version
Frequency band indicator	OP		Frequency band indicator 10.3.6.35 b		REL-6
Frequency band indicator 2	OP		Frequency band indicator 2 10.3.6.35 c		REL-6
Frequency band indicator 3	OP		Frequency band indicator 3 10.3.6.35 ca		REL-10
Frequency Bands Indicator Support	OP				REL-10
>CHOICE <i>mode</i>					
>>FDD					
>>>Frequency bands indicator for redirection	MP	1 to <maxFreqBandsIndicatorSupport>		The presence of this IE indicates one or two bands for redirection.	REL-10
>>>>CHOICE frequency bands indicator					REL-10
>>>>>Frequency bands indicator 1 for redirection			Frequency band indicator 10.3.6.35 b		REL-10
>>>>>Frequency bands indicator 2 for redirection			Frequency band indicator 2 10.3.6.35 c		REL-10
>>>>>Frequency bands indicator 3 for redirection			Frequency band indicator 3 10.3.6.35 ca		REL-10
>>TDD					
>>>Frequency bands indicator for 1.28Mcps TDD	MP	1 to <maxFreqBandsIndicatorSupport>		The presence of this IE indicates one or two bands for RF capability.	REL-10
>>>>Frequency bands indicator for TDD	MP		Frequency band indicator for TDD 10.3.6.35 d		REL-10

Information Element/Group name	Need	Multi	Type and reference	Semantics description	Version
Multiple Frequency Band indicator list	OP	1 to <maxMultipleFrequencyBandsFDD>		A list of additional frequency bands which the cell belong to. The order of appearance of the additional supported frequency bands in the list indicates their priority i.e from higher to lower. If the UE supports the frequency band indicated explicitly or implicitly in accordance with subclause 8.1.1.6.5, it shall apply that frequency band. Otherwise, the UE shall apply the first listed band which it supports in the IE "Multiple Frequency Band indicator list".	REL-10
>CHOICE frequency bands indicator	MP				REL-10
>>Frequency band indicator			Frequency band indicator 10.3.6.35 b		REL-10
>>Frequency band indicator 2			Frequency band indicator 2 10.3.6.35 c		REL-10
>>Frequency band indicator 3			Frequency band indicator 3 10.3.6.35 ca		REL-10
HSDPA cell Indicator	MD		Enumerated (HSDPA Capable Cell)	Default is 'HSDPA capability not indicated'. 'HSDPA Capable Cell' means that the UE may consider this cell as part of the HSDPA coverage area for display indication only. This indication shall not be used for any other purpose. If the cell is operating in MBSFN mode as indicated in subclause 8.1.1.6.3 the UE behaves as if this IE would not have been received.	REL-6

Information Element/Group name	Need	Multi	Type and reference	Semantics description	Version
E-DCH cell Indicator	MD		Enumerated (E-DCH Capable Cell)	Default is 'E-DCH capability not indicated'. 'E-DCH Capable Cell' means that the UE may consider this cell as part of the E-DCH coverage area for display indication only. This indication shall not be used for any other purpose. If the cell is operating in MBSFN mode as indicated in subclause 8.1.1.6.3 the UE behaves as if this IE would not have been received.	REL-6
Secondary CCPCH system information MBMS	OP		Secondary CCPCH system information MBMS 10.3.6.72a	Included if MCCH is on an S-CCPCH used only for MBMS. Note 2	REL-6
CHOICE <i>mode</i>	OP				REL-7
>FDD					REL-7
>>HS-DSCH common system information	MP		HS-DSCH common system information 10.3.6.36c	Included if cell supports HS-DSCH reception in CELL_FACH and during IDLE to RRC Connection state transition.	REL-7
>>HS-DSCH paging system information	OP		HS-DSCH paging system information 10.3.6.36d	Included if cell supports for UEs in RRC Connected state paging message reception on HS-DSCH.	REL-7
>TDD					REL-7
>>HS-DSCH common system information	MP		HS-DSCH common system information 1.28Mcps TDD 10.3.6.36ca	Included if cell supports HS-DSCH reception in CELL_FACH and during IDLE to RRC Connection state transition.	REL-8
>>HS-DSCH paging system information	OP		HS-DSCH paging system information 1.28Mcps TDD 10.3.6.36da	Included if cell supports for UEs in RRC Connected state paging message reception on HS-DSCH.	REL-8

Information Element/Group name	Need	Multi	Type and reference	Semantics description	Version
TDD MBSFN information	OP		TDD MBSFN Information 10.3.6.78b	TDD only: included only if some timeslots are designated to MBSFN.	REL-7
HS-DSCH DRX in CELL_FACH Information	OP		HS-DSCH DRX in CELL_FACH Information 10.3.6.36g		REL-8
HS-DSCH DRX in CELL_FACH Information 1.28 Mcps TDD	OP		HS-DSCH DRX in CELL_FACH Information 1.28 Mcps TDD 10.3.6.36h		REL-8
Second Frequency info	OP		Integer (0 .. 16383)	Note 3	REL-8
Treset Usage Indicator	OP		Enumerated (TRUE)	Only for 1.28 Mcps TDD. The presence of this IE means the timer Treset is not valid when the dedicated H-RNTI is configured in CELL_FACH and CELL_PCH.	REL-8
UpPCH Position Info	CV-Frequency		Integer (0 .. 127)	Only for 1.28 Mcps TDD.	REL-8
Cell Update message with optimised encoding	OP		Enumerated (TRUE)	Only for FDD. The presence of this IE means that UE shall use the Rel-11 asn1 message type for Cell Update, if the UE supports this message type.	REL-11

NOTE 1: DL scrambling code of the Primary CCPCH is the same as the one for Primary CPICH (FDD only).

NOTE 2: There is only one MCCH in a cell, which may either be mapped on to an S-CCPCH also used for non-MBMS purposes or to an S-CCPCH dedicated to MBMS. In the first case the MCCH configuration is specified within the IE "Secondary CCPCH system information", in the latter case the MCCH configuration is provided within the IE "Secondary CCPCH system information MBMS".

NOTE 3: This IE is used in 1.28 Mcps TDD multi-frequency cell to indicate the secondary frequency at which enhanced E-DCH transmission and HS-PDSCH reception for 1.28 Mcps TDD is supported and to indicate that corresponding IEs: "Common E-DCH system info", "HS-DSCH common system information" (TDD) and "HS-DSCH DRX in CELL_FACH Information 1.28 Mcps TDD" can apply for this frequency. The absence of "Frequency info" means that enhanced E-DCH access transmission and HS-PDSCH reception and above IEs apply for primary frequency. For 1.28 Mcps TDD only.

Condition	Explanation
<i>CTCH</i>	The IE is mandatory present if the IE "CTCH indicator" is equal to TRUE for at least one FACH, otherwise the IE is not needed in the message
<i>Frequency</i>	The IE is optional if the IE "Frequency info" is present, otherwise the IE is not needed.

10.2.48.8.9 System Information Block type 6

The system information block type 6 contains parameters for the configuration of the common and shared physical channels to be used in connected mode.

Information Element/Group name	Need	Multi	Type and reference	Semantics description	Version
PhyCH information elements					
PICH Power offset	MP		PICH Power offset 10.3.6.50		
CHOICE <i>mode</i>	MP				
>FDD					
>>AICH Power offset	MP		AICH Power offset 10.3.6.3		
>TDD					
>>PUSCH system information	OP		PUSCH system information 10.3.6.66		
>>PUSCH system information VHCR	OP		PUSCH system information VHCR 10.3.6.66a	Only for 7.68 Mcps TDD	REL-7
>>PDSCH system information	OP		PDSCH system information 10.3.6.46		
>>TDD open loop power control	MP		TDD open loop power control 10.3.6.79		
Primary CCPCH info	OP		Primary CCPCH info 10.3.6.57	Note 1	
PRACH system information list	OP		PRACH system information list 10.3.6.55		
Secondary CCPCH system information	OP		Secondary CCPCH system information 10.3.6.72		

Information Element/Group name	Need	Multi	Type and reference	Semantics description	Version
CBS DRX Level 1 information	CV- <i>CTCH</i>		CBS DRX Level 1 information 10.3.8.3		
Frequency band indicator	OP		Frequency band indicator 10.3.6.35 b		REL-6
Frequency band indicator 2	OP		Frequency band indicator 2 10.3.6.35 c		REL-6
Frequency band indicator 3	OP		Frequency band indicator 3 10.3.6.35 ca		REL-10
Multiple Frequency Band indicator list	OP	1 to < maxMultipleFrequencyBandsFDD >		A list of additional frequency bands which the cell belongs to. The order of appearance of the additional supported frequency bands in the list indicates their priority i.e from higher to lower. If the UE supports the frequency band indicated explicitly or implicitly in accordance with subclause 8.1.1.6.6, it shall apply that frequency band. Otherwise, the UE shall apply the first listed band which it supports in the IE "Multiple Frequency Band indicator list".	REL-10
>CHOICE frequency bands indicator	MP				REL-10
>>Frequency band indicator			Frequency band indicator 10.3.6.35 b		REL-10
>>Frequency band indicator 2			Frequency band indicator 2 10.3.6.35 c		REL-10
>>Frequency band indicator 3			Frequency band indicator 3 10.3.6.35 ca		REL-10

NOTE 1: DL scrambling code of the Primary CCPCH is the same as the one for Primary CPICH (FDD only).

Condition	Explanation
<i>CTCH</i>	The IE is mandatory present if the IE "CTCH indicator" is equal to TRUE for at least one FACH, otherwise the IE is not needed

10.2.48.8.10 System Information Block type 7

The system information block type 7 contains the fast changing parameters UL interference and Dynamic persistence level.

Information Element/Group name	Need	Multi	Type and reference	Semantics description
CHOICE <i>mode</i>	MP			
>FDD				
>>UL interference	MP		UL interference 10.3.6.87	
>TDD				(no data)
PhyCH information elements				
PRACHs listed in system information block type 5	MP	1 to <maxPRACH>		The order of the PRACHs is the same as in system information block type 5 or 5bis.
>Dynamic persistence level	MP		Dynamic persistence level 10.3.6.35	
PRACHs listed in system information block type 6	OP	1 to <maxPRA CH>		The order of the PRACHs is the same as in system information block type 6.
>Dynamic persistence level	MP		Dynamic persistence level 10.3.6.35	
Expiration Time Factor	MD		Expiration Time Factor 10.3.3.12	Default is 1.

10.2.48.8.11 Void

10.2.48.8.12 Void

10.2.48.8.13 Void

10.2.48.8.14 System Information Block type 11

The system information block type 11 contains measurement control information to be used in the cell.

Information Element/Group name	Need	Multi	Type and reference	Semantics description	Version
SIB12 Indicator	MP		Boolean	TRUE indicates that SIB12 is broadcast in the cell.	
Measurement information elements					

Information Element/Group name	Need	Multi	Type and reference	Semantics description	Version
FACH measurement occasion info	OP		FACH measurement occasion info 10.3.7.8	If the cell is operating in MBSFN mode as indicated in subclause 8.1.1.6.3 the UE behaviour upon reception of this IE is unspecified.	
Measurement control system information	MP		Measurement control system information 10.3.7.47	For 1.28 Mcps TDD if the cell is operating in MBSFN only mode the UE behaviour upon reception of this IE is unspecified.	
Measurement Scaling Factor	OP		Enumerated(SF_UTRA_CF1, SF_UTRA_CF2)	The Measurement Scaling Factor is used to scale the measurement performance for UTRA/E-UTRA frequencies configured in CELL_FACH as specified in [19]. Even if no UTRA or E-UTRA frequency is configured for reduced measurement performance, the network may configure a scaling factor and configure any of the scaling factor values [19].	REL-12
MBSFN frequency list	OP		MBSFN frequency list 10.3.9a.12a	If present contains all neighbouring frequencies of MBSFN clusters operating in MBSFN mode as indicated in subclause 8.1.1.6.3. If the cell is operating in MBSFN mode as indicated in subclause 8.1.1.6.3 the UE behaviour upon reception of this IE is unspecified.	

10.2.48.8.14a System Information Block type 11bis

The system information block type 11bis contains measurement control information to be used in the cell in addition to System Information Block type 11 and optionally UTRAN mobility information for CSG cells.

Information Element/Group name	Need	Multi	Type and reference	Semantics description	Version
Measurement information elements					REL-6
Measurement control system information extension	OP		Measurement control system information extension 10.3.7.47a		REL-6
UTRAN mobility information elements					REL-8
CSG PSC Split Information	OP		CSG PSC Split Information 10.3.2.9	This IE specifies the Primary Scrambling Code reservation information for CSG Cells.	REL-8
Dedicated CSG frequency list	OP	1 to <maxDedicatedCSGFreq>		This IE specifies the frequencies dedicated for CSG cells only.	REL-8
>Dedicated CSG frequency	MP		Frequency Info 10.3.6.36		REL-8

10.2.48.8.14b System Information Block type 11ter

The system information block type 11ter contains measurement control information to be used in the cell in addition to System Information Block type 11 and System Information Block type 11bis.

Information Element/Group name	Need	Multi	Type and reference	Semantics description	Version
Measurement information elements					REL-12
Measurement control system information inter-frequency extension	OP		Inter-frequency cell info list extension 10.3.7.47b		REL-12

10.2.48.8.15 System Information Block type 12

The system information block type 12 contains measurement control information to be used in connected mode.

Information Element/Group name	Need	Multi	Type and reference	Semantics description
Measurement information elements				
FACH measurement occasion info	OP		FACH measurement occasion info 10.3.7.8	
Measurement control system information	MP		Measurement control system information 10.3.7.47	

10.2.48.8.16 System Information Block type 13

The system information block type 13 contains ANSI-41 system information.

Information Element/Group name	Need	Multi	Type and reference	Semantics description
Other information elements				
CN Information Elements				
CN Domain system information list	MP	1 to <maxCNdomains>		Send CN information for each CN domain.
>CN Domain system information	MP		CN Domain system information 10.3.1.2	
UE Information				
UE timers and constants in idle mode	MD		UE timers and constants in idle mode 10.3.3.44	The UE behaviour is unspecified if this IE is absent.
Capability update requirement	MD		Capability update requirement 10.3.3.2	Default value is defined in subclause 10.3.3.2

10.2.48.8.16.1 System Information Block type 13.1

The system information block type 13.1 contains the ANSI-41 RAND information.

Information Element/Group name	Need	Multi	Type and reference	Semantics description
ANSI-41 information elements				
ANSI-41 RAND information	MP		ANSI-41 RAND information 10.3.9.6	

10.2.48.8.16.2 System Information Block type 13.2

The system information block type 13.2 contains the ANSI-41 User Zone Identification information.

Information Element/Group name	Need	Multi	Type and reference	Semantics description
ANSI-41 information elements				
ANSI-41 User Zone Identification information	MP		ANSI-41 User Zone Identification information 10.3.9.7	

10.2.48.8.16.3 System Information Block type 13.3

The system information block type 13.3 contains the ANSI-41 Private Neighbour List information.

Information Element/Group name	Need	Multi	Type and reference	Semantics description
ANSI-41 information elements				
ANSI-41 Private Neighbour List information	MP		ANSI-41 Private Neighbour List information 10.3.9.5	

10.2.48.8.16.4 System Information Block type 13.4

The system information block type 13.4 contains the ANSI-41 Global Service Redirection information.

Information Element/Group name	Need	Multi	Type and reference	Semantics description
ANSI-41 information elements				
ANSI-41 Global Service Redirection information	MP		ANSI-41 Global Service Redirection information 10.3.9.2	

10.2.48.8.17 System Information Block type 14

NOTE: Only for 3.84 Mcps TDD and 7.68 Mcps TDD.

The system information block type 14 contains parameters for common and dedicated physical channel uplink outer loop power control information to be used in both idle and connected mode.

Information Element/Group name	Need	Multi	Type and reference	Semantics description
PhyCH information elements				
Individual Timeslot interference list	MP	1 to <maxTS>		
>Individual Timeslot interference	MP		Individual Timeslot interference 10.3.6.38	
Expiration Time Factor	MD		Expiration Time Factor 10.3.3.12	Default is 1.

10.2.48.8.18 System Information Block type 15

The system information block type 15 contains information useful for UE-based or UE-assisted positioning methods.

Information Element/Group name	Need	Multi	Type and Reference	Semantics description
GPS Data ciphering info	OP		UE positioning Ciphering info 10.3.7.86	If this IE is present then the SIB types 15.1, 15.2 & 15.3 are ciphered in accordance with the Data Assistance Ciphering Algorithm specified in [18]
Reference position	MP		Ellipsoid point with altitude and uncertainty ellipsoid 10.3.8.4c	approximate position where the UE is located
GPS reference time	MP		UE positioning GPS reference time 10.3.7.96	
Satellite information	OP	1 to <maxSat>		This IE is present whenever bad (failed/failing) satellites are detected by UTRAN [18].
>BadSatID	MP		Enumerated(0..63)	

10.2.48.8.18.0 System Information Block type 15bis

The system information block type 15bis contains information useful for UE-based or UE-assisted positioning methods. The content of this SIB is common to all GANSS.

Information Element/Group name	Need	Type and Reference	Semantics description	Version
Reference position	MP	Ellipsoid point with altitude and uncertainty ellipsoid 10.3.8.4c	approximate position where the UE is located	REL-7
GANSS reference time	MP	UE positioning GANSS reference time 10.3.7.96o		REL-7
GANSS ionospheric model	OP	UE positioning GANSS ionospheric model 10.3.7.92a		REL-7
GANSS additional ionospheric model	OP	UE positioning GANSS additional ionospheric model 10.3.7.92b		REL-8
GANSS Earth orientation parameters	OP	UE positioning GANSS Earth orientation parameters 10.3.7.92c		REL-8

10.2.48.8.18.1 System Information Block type 15.1

The system information block type 15.1 contains information useful for UE positioning DGPS Corrections. The DGPS Corrections message contents are based on a Type-1 message of DGPS specified in [13].

Information Element/Group name	Need	Multi	Type and Reference	Semantics description
DGPS corrections	MP		UE positioning GPS DGPS corrections 10.3.7.91	

10.2.48.8.18.1a System Information Block type 15.1bis

The system information block type 15.1bis contains information useful for UE positioning DGANSS Corrections. The DGANSS Corrections message contents are based on a Type-1 message of DGANSS specified in [13]. The content of this SIB is GNSS specific.

Information Element/Group name	Need	Type and Reference	Semantics description	Version
DGANSS corrections	MP	UE positioning DGANSS corrections 10.3.7.91b		REL-7

10.2.48.8.18.1b System Information Block type 15.1ter

The system information block type 15.1ter contains information useful for UE positioning DBDS corrections and UE positioning BDS Ionospheric Grid Model. The content of DBDS Corrections and BDS Ionospheric Grid Model are based on the NAV message specified in [86]. The content of this SIB is for BDS only.

Information Element/Group name	Need	Type and Reference	Semantics description	Version
DBDS corrections	OP	UE positioning DBDS corrections 10.3.7.92e		REL-12
BDS Ionospheric Grid Model	OP	UE positioning BDS Ionospheric Grid Model 10.3.7.92d		REL-12

10.2.48.8.18.2 System Information Block type 15.2

The system information block type 15.2 contains information useful for GPS Navigation Model. These IE fields are based on information extracted from the subframes 1 to 3 of the GPS navigation message [12].

Information Element/Group name	Need	Multi	Type and Reference	Semantics description
Transmission TOW	MP		Integer (0..604799)	The approximate GPS time-of-week when the message is broadcast. in seconds
SatID	MP		Integer (0..63)	Satellite ID
GPS Ephemeris and Clock Correction Parameters	MP		UE positioning GPS Ephemeris and Clock Correction parameters 10.3.7.91a	

10.2.48.8.18.2a System Information Block type 15.2bis

The system information block type 15.2bis contains information useful for GANSS Navigation Model. The content of this SIB is GNSS specific.

Information Element/Group name	Need	Type and Reference	Semantics description	Version
GANSS Navigation Model	MP	UE positioning GANSS navigation model 10.3.7.94a		REL-7

10.2.48.8.18.2b System Information Block type 15.2ter

The system information block type 15.2ter contains information useful for GANSS Navigation Model. The content of this SIB is GNSS specific.

Information Element/Group name	Need	Type and Reference	Semantics description	Version
GANSS additional navigation models	MP	UE positioning GANSS additional navigation models 10.3.7.94b		REL-8

10.2.48.8.18.3 System Information Block type 15.3

The system information block type 15.3 contains information useful for ionospheric delay, UTC offset, and Almanac. These IEs contain information extracted from the subframes 4 and 5 of the GPS navigation message, [12].

Information Element/Group name	Need	Multi	Type and Reference	Semantics description
Transmission TOW	MP		Integer (0..604799)	The approximate GPS time-of-week when the message is broadcast. in seconds
GPS Almanac and Satellite Health	OP		UE positioning GPS almanac 10.3.7.89	
GPS ionospheric model	OP		UE positioning GPS ionospheric model 10.3.7.92	
GPS UTC model	OP		UE positioning GPS UTC model 10.3.7.97	
SatMask	CV- <i>Almanac</i>		Bit string(1..32)	indicates the satellites that contain the pages being broadcast in this data set
LSB TOW	CV- <i>Almanac</i>		Bit string(8)	

Condition	Explanation
<i>Almanac</i>	This IE is mandatory present if the IE "GPS Almanac and Satellite Health" is present

10.2.48.8.18.3a System Information Block type 15.3bis

The system information block type 15.3bis contains information useful for GANSS time model, UTC offset and Almanac, as well as auxiliary information. The content of this SIB is GNSS specific.

Information Element/Group name	Need	Multi	Type and Reference	Semantics description	Version
GANSS Almanac	OP		UE positioning GANSS almanac 10.3.7.89a		REL-7
GANSS time models	OP	1 to <maxGANSS-1>			REL-7
>GANSS time model	OP		UE positioning GANSS time model 10.3.7.97a		REL-7
GANSS UTC model	OP		UE positioning GANSS UTC model 10.3.7.97c		REL-7
GANSS additional UTC models	OP		UE positioning GANSS additional UTC models 10.3.7.97d		REL-8
GANSS auxiliary information	OP		UE positioning GANSS auxiliary information 10.3.7.97f		REL-8

10.2.48.8.18.4 System Information Block type 15.4

The system information block type 15.4 contains ciphering information for System Information Block type 15.5 and information useful for OTDOA UE-assisted Positioning method.

Information Element/Group name	Need	Multi	Type and Reference	Semantics description
OTDOA Data ciphering info	OP		UE positioning Ciphering info 10.3.7.86	If this IE is present then the for UE-based the System Information Block type 15.5 is ciphered in accordance with the Data Assistance Ciphering Algorithm specified in [18]
OTDOA assistance data for UE-assisted	MP		UE positioning OTDOA assistance data for UE-assisted 10.3.7.103	

10.2.48.8.18.4a System Information Block type 15.5

The system information block type 15.5 contains information useful for OTDOA UE-based Positioning method.

Information Element/Group name	Need	Multi	Type and Reference	Semantics description
OTDOA assistance data for UE-based	MP		UE positioning OTDOA assistance data for UE-based 10.3.7.103a	

10.2.48.8.18.5 System Information Block type 15.6

The system information block type 15.6 contains information useful for acquisition of GNSS signals. The content of this SIB is GNSS specific.

Information Element/Group name	Need	Multi	Type and Reference	Semantics description	Version
GNSS TOD	MP		Integer (0..86399)	GNSS Time of Day in seconds where GNSS reference measurement information is valid.	REL-7
GNSS reference measurement information	MP		UE positioning GNSS reference measurement information 10.3.7.88b		REL-7

10.2.48.8.18.6 System Information Block type 15.7

The system information block type 15.7 contains data bits which can be used for data wipe-off. The content of this SIB is GNSS specific.

Information Element/Group name	Need	Multi	Type and Reference	Semantics description	Version
GNSS data bit assistance	MP		UE positioning GNSS data bit assistance 10.3.7.97b		REL-7

10.2.48.8.18.7 System Information Block type 15.8

The system information block type 15.8 contains ciphering information and real-time integrity information. The content of this SIB is GNSS specific.

Information Element/Group name	Need	Multi	Type and Reference	Semantics description	Version
GNSS Data ciphering info	OP		UE positioning Ciphering info 10.3.7.86	If this IE is present then the SIB types 15.1bis, 15.1ter, 15.2bis, 15.2ter, 15.3bis, 15.6 and 15.7 are ciphered in accordance with the Data Assistance Ciphering Algorithm specified in [18]	REL-7
GNSS real-time integrity	OP		UE positioning GNSS real-time integrity 10.3.7.95b		REL-7

10.2.48.8.19 System Information Block type 16

The system information block type 16 contains radio bearer, transport channel and physical channel parameters to be stored by UE in idle and connected mode for use during handover to UTRAN.

Information Element/Group name	Need	Multi	Type and Reference	Semantics description
RB information elements				
Predefined RB configuration	MP		Predefined RB configuration 10.3.4.7	
TrCH Information Elements				
Predefined TrCH configuration	MP		Predefined TrCH configuration 10.3.5.9	
PhyCH Information Elements				
Predefined PhyCH configuration	MP		Predefined PhyCH configuration 10.3.6.56	

10.2.48.8.20 System Information Block type 17

NOTE: Only for TDD.

The system information block type 17 contains fast changing parameters for the configuration of the shared physical channels to be used in connected mode.

Information Element/Group name	Need	Multi	Type and reference	Semantics description	Version
PhyCH information elements					
PUSCH system information	OP		PUSCH system information 10.3.6.66		
PUSCH system information VHCR	OP		PUSCH system information VHCR 10.3.6.66a	Only for 7.68 Mcps TDD	REL-7
PDSCH system information	OP		PDSCH system information 10.3.6.46		

10.2.48.8.21 System Information Block type 18

The System Information Block type 18 contains PLMN identities of neighbouring cells to be considered in idle mode as well as in connected mode.

Information Element/Group name	Need	Multi	Type and reference	Semantics description	Version
Idle mode PLMN identities	OP		PLMN identities of neighbour cells 10.3.7.53a		
Connected mode PLMN identities	OP		PLMN identities of neighbour cells 10.3.7.53a		
Idle mode PLMN identities for SIB 11bis	OP		PLMN identities of neighbour cells 10.3.7.53a		REL-6
Connected mode PLMN identities for SIB 11bis	OP		PLMN identities of neighbour cells 10.3.7.53a		REL-6
Idle mode PLMN identities for SIB 11ter	OP		PLMN identities of neighbour cells for SIB 11ter 10.3.7.53b		REL-12
Connected mode PLMN identities for SIB 11ter	OP		PLMN identities of neighbour cells for SIB 11ter 10.3.7.53b		REL-12

10.2.48.8.22 System Information Block type 19

The system information block type 19 contains Inter-RAT frequency and priority information to be used in the cell.

Information Element/Group name	Need	Multi	Type and reference	Semantics description	Version
UTRA priority info list	MP		UTRA priority info list 10.3.7.113		REL-8
GSM priority info list	OP		GSM priority info list 10.3.7.114		REL-8
GSM ScalingFactor for Treselection	OP		Real (0.25..4 by step of 0.25)	If present, it is used by the UE as scaling factor for $Treselection_s$ or $Treselection_{s,PCH}$ or $Treselection_{s,FACH}$ for inter-RAT absolute priority based cell reselection evaluation to GSM [4]. It replaces Inter-RAT ScalingFactor for Treselection in SIB3/4, if available.	REL-11
E-UTRA frequency and priority info list	OP		E-UTRA frequency and priority info list 10.3.7.115		REL-8
E-UTRA ScalingFactor for Treselection	OP		Real (0.25..4 by step of 0.25)	If present, it is used by the UE as scaling factor for $Treselection_s$ or $Treselection_{s,PCH}$ or $Treselection_{s,FACH}$ for inter-RAT absolute priority based cell reselection evaluation to E-UTRA [4]. It replaces Inter-RAT ScalingFactor for Treselection in SIB3/4, if available.	REL-11
E-UTRA frequency RACH reporting information	OP		E-UTRA frequency RACH reporting information 10.3.7.139		REL-11

Information Element/Group name	Need	Multi	Type and reference	Semantics description	Version
CELL_FACH Absolute Priority Measurement Indicator	OP		Enumerated (High Priority Layers, All Layers)	<p>High Priority Layers means that absolute priority measurements are only required in CELL_FACH state on higher priority layers when Srxlev and Squal of the serving cell are above Sprioritysearch1 and Sprioritysearch2.</p> <p>All Layers means that absolute priority measurements are always required in CELL_FACH state according to the rules in [4] and requirements in [19]. A UE that indicates FGI3 but not FGI4 shall behave as if High priority Layers is indicated.</p>	REL-11

10.2.48.8.23 System Information Block type 20

The system information block type20 contains HNBBName.

Information Element/Group name	Need	Multi	Type and reference	Semantics description	Version
HNB Name	OP		HNB Name 10.3.8.4m		REL-8

10.2.48.8.24 System Information Block type 21

The system information block type 21 contains parameters for EAB.

Information Element/Group name	Need	Multi	Type and reference	Semantics description	Version
EAB Parameters	OP			If the cell is operating in MBSFN mode as indicated in subclause 8.1.1.6.3, the UE behaviour upon reception of this IE is unspecified.	REL-11
>CHOICE <i>barring representation</i>	MP				REL-11
>>EAB Parameters Per PLMN List		1 to 6		The number of instances of this IE is the number of instances of the IE "Multiple PLMNs" in the IE "Multiple PLMN List" of the MIB plus one. The first instance of this IE specifies the EAB Parameters for UEs which have chosen the PLMN in the IE "PLMN identity" of the MIB, the second instance specifies the EAB Parameters for UEs which have chosen the first PLMN in the IE "Multiple PLMNs" in the IE "Multiple PLMN List" of the MIB, the third instance specifies the EAB Parameters for UEs which have chosen the second PLMN in the IE "Multiple PLMNs" in the IE "Multiple PLMN List" of the MIB, and so on.	REL-11
>>>Domain Specific EAB Parameters	OP		Domain Specific EAB Parameters 10.3.1.3d	Absence of this IE means that no extended access barring applies for the corresponding PLMN	REL-11
>>EAB Parameters For All			Domain Specific EAB Parameters 10.3.1.3d	This IE specifies the common EAB Parameters applicable for all PLMNs, including the PLMN in the IE "PLMN identity" of the MIB and the PLMNs in the IE "Multiple PLMNs" in the IE "Multiple PLMN List" of the MIB.	REL-11

10.2.48.8.25 System Information Block type 22

NOTE: Only for FDD.

The system information block type 22 contains information for Concurrent deployment of 2ms and 10ms TTI in a cell, NodeB triggered HS-DPCCH transmission, Fallback to R99 PRACH, TTI alignment, Per HARQ process activation and de-activation and HS-DSCH DRX operation with second DRX cycle in CELL_FACH. Further, it contains control parameters related to the PRACH access preamble.

Information Element/Group name	Need	Multi	Type and reference	Semantics description	Version
PRACH preamble control parameters extension list Type 1 (for Enhanced Uplink)	OP		PRACH preamble control parameters extension list for Type 1 (for Enhanced Uplink) 10.3.6.135	Control parameters of the physical signal. This and/or parameters in IE "PRACH preamble control parameters (for Enhanced Uplink)" is used for access by UE's supporting concurrent deployment when the outcome of the common E-DCH TTI selection is 10ms. Also used for access if "E-DCH Transmission Time Interval" is equal to 10ms when concurrent deployment is not used, by UEs that support either NodeB triggered HS-DPCCH transmission or HS-DSCH DRX operation with second DRX cycle or Fallback to R99 PRACH. See subclause 8.5.45, 8.5.73 and 8.5.74.	REL-11
PRACH preamble control parameters extension list Type 2 (for Enhanced Uplink)	OP		PRACH preamble control parameters extension list (for Enhanced Uplink) 10.3.6.134	Control parameters of the physical signal. Used for access by UE's supporting only concurrent deployment, and by UEs supporting TTI alignment and Per HARQ process if the IE "Common E-DCH Resource Configuration Information List Extension" is not present, when the outcome of the common E-DCH TTI selection is 2ms. See subclause 8.5.45 and 8.5.73.	REL-11

Information Element/Group name	Need	Multi	Type and reference	Semantics description	Version
PRACH preamble control parameters extension list Type 3 (for Enhanced Uplink)	OP		PRACH preamble control parameters extension list (for Enhanced Uplink) 10.3.6.134	Control parameters of the physical signal. Used for access by UE's supporting TTI alignment and Per HARQ process if the IE "Common E-DCH Resource Configuration Information List Extension" is present, when the outcome of the common E-DCH TTI selection is 2ms. See subclause 8.5.45, and 8.5.73.	REL-11
Concurrent Deployment of 2ms and 10ms TTI	OP		Concurrent Deployment of 2ms and 10ms TTI 10.3.5.25		REL-11
NodeB triggered HS-DPCCH Transmission	OP		NodeB triggered HS-DPCCH Transmission 10.3.6.130		REL-11
Fallback R99 PRACH info	OP		Fallback R99 PRACH info 10.3.6.141		REL-11
Common E-DCH Resource Configuration Information List Extension	OP		Common E-DCH Resource Configuration Information List Extension 10.3.6.140		REL-11
HS-DSCH DRX in CELL_FACH with second DRX cycle Information	OP		HS-DSCH DRX in CELL_FACH with second DRX cycle Information 10.3.6.139		Rel-11
Cell reselection indication reporting	OP		Enumerated (TRUE)		REL-12

10.2.48.8.26 System Information Block type 23

The system information block type 23 contains information for RAN-assisted WLAN interworking.

Information Element/Group name	Need	Multi	Type and reference	Semantics description	Version
CHOICE <i>WLAN representation</i>	MP				REL-12
>WLAN Offload Information Per PLMN List		1 to 6		The number of instances of this IE is the number of instances of the IE "Multiple PLMNs" in the IE "Multiple PLMN List" of the MIB plus one. The first instance of this IE specifies the WLAN Offload Information for UEs which have chosen the PLMN in the IE "PLMN identity" of the MIB, the second instance specifies the WLAN Offload Information for UEs which have chosen the first PLMN in the IE "Multiple PLMNs" in the IE "Multiple PLMN List" of the MIB, the third instance specifies the WLAN Offload Information for UEs which have chosen the second PLMN in the IE "Multiple PLMNs" in the IE "Multiple PLMN List" of the MIB, and so on.	REL-12
>>WLAN Offload Information	OP		WLAN Offload Information 10.3.9b.3	Absence of this IE means that no WLAN Offload Information applies for the corresponding PLMN.	REL-12
>WLAN Offload Information common for all PLMN				This IE specifies the common WLAN Offload Information configuration applicable for all PLMNs, including the PLMN in the IE "PLMN identity" of the MIB and the PLMNs in the IE "Multiple PLMNs" in the IE "Multiple PLMN List" of the MIB.	REL-12
>>WLAN Offload Information	OP		WLAN Offload Information 10.3.9b.3	Absence of this IE means that no WLAN Offload Information applies for all PLMNs.	REL-12

10.2.48.8.27 System Information Block type 24

NOTE: Only for FDD.

The system information block type 24 contains information for controlling access in CELL_FACH state, CELL_PCH state and URA_PCH state.

Information Element/Group name	Need	Multi	Type and reference	Semantics description	Version
DTCH transmission blocking	OP		Bit string(maxNumAccessGroups)	Bit 0 is the first/leftmost bit of the bit string. Bit n corresponds to the n-th defined Access Group. Value '1' for a bit means UEs in that Access Group are blocked for DTCH transmission in CELL_FACH state, and for DCCH/CCCH due to uplink DTCH transmission in CELL_PCH state and URA_PCH state.	REL-12
Expiration Time Factor 2	MD		Expiration Time Factor 2 10.3.3.12b	Default is 1.	REL-12

10.2.49 SYSTEM INFORMATION CHANGE INDICATION

This message is used to send information on FACH or HS-DSCH (FDD and 1.28 Mcps TDD only) to the UEs in state CELL_FACH, CELL_PCH (FDD and 1.28 Mcps TDD only), or CELL_DCH(TDD only) about coming modification of the system information.

RLC-SAP: TM

Logical channel: BCCH

Direction: UTRAN → UE

Information Element/Group name	Need	Multi	Type and reference	Semantics description	Version
Message Type	MP		Message Type		
Other information elements					
BCCH modification info	MP		BCCH modification info 10.3.8.1		
ETWS information	OP		ETWS information 10.3.8.4e a		REL-8

If the encoded message does not fill a transport block, the RRC layer shall insert padding according to subclause 12.1.

10.2.50 TRANSPORT CHANNEL RECONFIGURATION

This message is used by UTRAN to configure the transport channel of a UE. This also includes a possible reconfiguration of physical channels. The message can also be used to assign a TFC subset and reconfigure physical channel.

RLC-SAP: AM or UM

Logical channel: DCCH

Direction: UTRAN → UE

Information Element/Group name	Need	Multi	Type and reference	Semantics description	Version
Message Type	MP		Message Type		
UE Information Elements					
RRC transaction identifier	MP		RRC transaction identifier 10.3.3.36		
Integrity check info	CH		Integrity check info 10.3.3.16		
Integrity protection mode info	OP		Integrity protection mode info 10.3.3.19	The UTRAN should not include this IE unless it is performing an SRNS relocation	
Ciphering mode info	OP		Ciphering mode info 10.3.3.5	The UTRAN should not include this IE unless it is performing an SRNS relocation and a change in ciphering algorithm	
Activation time	MD		Activation time 10.3.3.1	Default value is "now"	
Delay restriction flag	OP		Enumerated (TRUE)	This IE is always set to TRUE and included if the activation time is restricted according to subclause 8.6.3.1	REL-6
New U-RNTI	OP		U-RNTI 10.3.3.47		
New C-RNTI	OP		C-RNTI 10.3.3.8		
New DSCH-RNTI	OP		DSCH-RNTI 10.3.3.9a	Should not be set in FDD. If received the UE behaviour is unspecified.	
New H-RNTI	OP		H-RNTI 10.3.3.14a		REL-5
New Primary E-RNTI	OP		E-RNTI 10.3.3.10a		REL-6
New Secondary E-RNTI	OP		E-RNTI 10.3.3.10a	FDD only	REL-6
RRC State Indicator	MP		RRC State Indicator 10.3.3.35a		

Information Element/Group name	Need	Multi	Type and reference	Semantics description	Version
UE Mobility State Indicator	CV-FACH_PCH		Enumerated (High-mobilityDetected)	Absence of this IE implies that, according to [4], the UE shall consider itself being in the mobility state the UE has maintained in CELL_DCH state or being not in high mobility state after the state transition, if applicable.	REL-7
UTRAN DRX cycle length coefficient	OP		UTRAN DRX cycle length coefficient 10.3.3.49		
CN Information Elements					
CN Information info	OP		CN Information info 10.3.1.3		
UTRAN mobility information elements					
URA identity	OP		URA identity 10.3.2.6		
RNC support for change of UE capability	OP		Boolean	Should be included if the message is used to perform an SRNS relocation	REL-7
Reconfiguration in response to requested change of UE capability	OP		Enumerated (TRUE)		REL-7
RB information elements					
Downlink counter synchronisation info	OP				
>RB with PDCP information list	OP	1 to <maxRBall RABs>			
>>RB with PDCP information	MP		RB with PDCP information 10.3.4.22	This IE is needed for each RB having PDCP in the case of lossless SRNS relocation	
	OP				REL-5
>>PDCP context relocation info	OP		PDCP context relocation info 10.3.4.1a	This IE is needed for each RB having PDCP and performing PDCP context relocation	REL-5
TrCH Information Elements					
Uplink transport channels					
UL Transport channel information common for all transport channels	OP		UL Transport channel information common for all transport channels 10.3.5.24		
Added or Reconfigured TrCH information list	OP	1 to <maxTrCH >			

Information Element/Group name	Need	Multi	Type and reference	Semantics description	Version
>Added or Reconfigured UL TrCH information	MP		Added or Reconfigured UL TrCH information 10.3.5.2		
Downlink transport channels					
DL Transport channel information common for all transport channels	OP		DL Transport channel information common for all transport channels 10.3.5.6		
Added or Reconfigured TrCH information list	OP	1 to <maxTrCH >			
>Added or Reconfigured DL TrCH information	MP		Added or Reconfigured DL TrCH information 10.3.5.1		
PhyCH information elements					
Frequency info	OP		Frequency info 10.3.6.36		
Multi-frequency Info	OP		Multi-frequency Info 10.3.6.39a	This IE is used for 1.28 Mcps TDD only	REL-7
DTX-DRX timing information	OP		DTX-DRX timing information 10.3.6.34b		REL-7
DTX-DRX Information	OP		DTX-DRX Information 10.3.6.34a		REL-7
HS-SCCH less Information	OP		HS-SCCH less Information 10.3.6.36ab		REL-7
MIMO parameters	OP		MIMO parameters 10.3.6.41a		REL-7
MIMO mode with four transmit antennas parameters	OP		MIMO mode with four transmit antennas parameters 10.3.6.142		REL-11
DCH Enhancements info FDD	OP		DCH Enhancements info FDD 10.3.6.149		REL-12

Information Element/Group name	Need	Multi	Type and reference	Semantics description	Version
Control Channel DRX information	OP		Control Channel DRX information 1.28 Mcps TDD 10.3.6.107	This IE is used for 1.28 Mcps TDD only	REL-8
SPS Information	OP		SPS information 1.28 Mcps TDD 10.3.6.110	This IE is used for 1.28 Mcps TDD only	REL-8
MU-MIMO info	OP		MU-MIMO info 1.28 Mcps TDD 10.3.6.122	This IE is used for 1.28 Mcps TDD only	REL-10
Non-rectangular resource allocation indicator	OP		Enumerated(TRUE)	For 1.28 Mcps TDD only. The absence of this IE indicates that the non-rectangular resource allocation is not used.	REL-12
Non-rectangular resource specific timeslots set	CV- <i>Non-rectangular Resource Allocation</i>		Bit string (7)	For 1.28 Mcps TDD only. The value 1 of a bit indicates the corresponding timeslot in which the channelization codes are assigned by physical control channel. The value 0 of a bit indicates the corresponding timeslot in which all channelization codes are assigned when the timeslot is scheduled to the UE. The first/leftmost bit of the bit string is for TS0.	REL-12
Uplink radio resources					
Maximum allowed UL TX power	MD		Maximum allowed UL TX power 10.3.6.39	Default value is the existing maximum UL TX power	
Uplink DPCH info	OP		Uplink DPCH info 10.3.6.88		
E-DCH Info	OP		E-DCH Info 10.3.6.97		REL-6
Uplink secondary cell info FDD	OP		Uplink secondary cell info FDD 10.3.6.115	FDD only	REL-9
Multi-carrier E-DCH Info for LCR TDD	OP		Multi-carrier E-DCH Info	1.28Mcps TDD only	REL-10

Information Element/Group name	Need	Multi	Type and reference	Semantics description	Version
			for LCR TDD 10.3.6.97a		
Uplink CLTD info FDD	OP		Uplink CLTD info FDD 10.3.6.125	FDD only	REL-11
Uplink OLTD info FDD	OP		Uplink OLTD info FDD 10.3.6.126	FDD only	REL-11
Other TTI E-DCH Configuration Information	OP		Other TTI E- DCH Configuratio n Information 10.3.6.152	FDD only	REL-12
Filtered UE power headroom reporting information	OP		Filtered UE power headroom reporting information 10.3.7.140	FDD only	REL-12
Downlink radio resources					
Downlink HS-PDSCH Information	OP		Downlink HS-PDSCH Information 10.3.6.23a		REL-5
Downlink information common for all radio links	OP		Downlink information common for all radio links 10.3.6.24		
Downlink information per radio link list	OP	1 to <maxRL>		Send downlink information for each radio link	
>Downlink information for each radio link	MP		Downlink information for each radio link 10.3.6.27		
Downlink secondary cell info FDD	OP		Downlink secondary cell info FDD 10.3.6.31a	FDD only	REL-8
Additional downlink secondary cell info list FDD	OP	2			REL-10
>Downlink secondary cell info FDD	OP		Downlink secondary cell info FDD 10.3.6.31a	FDD only	REL-10
Additional downlink secondary cell info list FDD 2	OP	4			REL-11
>Downlink secondary cell info FDD	OP		Downlink secondary cell info FDD 10.3.6.31a	FDD only	REL-11
Common E-RGCH info FDD	OP		Common E- RGCH info FDD 10.3.6.138	FDD only	REL-11
DPCCH2 info FDD	OP		DPCCH2 info FDD 10.3.6.148	FDD only	REL-12
MBMS PL Service Restriction Information	OP		Enumerated (TRUE)		REL-6
CELL_DCH measurement occasion info LCR	OP		CELL_DCH measuremen t occasion info LCR		REL-9

Information Element/Group name	Need	Multi	Type and reference	Semantics description	Version
			10.3.7.126		

Condition	Explanation
<i>FACH_PCH</i>	This IE is mandatory default when a transition from CELL_DCH to CELL_FACH, URA_PCH or CELL_PCH is requested by the message and is not needed otherwise.
<i>Non-rectangularResourceAllocation</i>	This IE is optionally present if non-rectangular resource allocation is configured. Otherwise, it is not needed.

10.2.51 TRANSPORT CHANNEL RECONFIGURATION COMPLETE

This message is sent from the UE when a transport channel reconfiguration has been done.

RLC-SAP: AM

Logical channel: DCCH

Direction: UE → UTRAN

Information Element/Group name	Need	Multi	Type and reference	Semantics description	Version
Message Type	MP		Message Type		
UE information elements					
RRC transaction identifier	MP		RRC transaction identifier 10.3.3.36		
Integrity check info	CH		Integrity check info 10.3.3.16		
Uplink integrity protection activation info	OP		Integrity protection activation info 10.3.3.17		
<i>CHOICE mode</i>	OP				
>FDD				(no data)	
>TDD					
>>CHOICE <i>TDD option</i>	MP				REL-4
>>>3.84 Mcps TDD					REL-4
>>>>Uplink Timing Advance	OP		Uplink Timing Advance 10.3.6.95		
>>>>Extended Uplink Timing Advance	OP		Extended Uplink Timing Advance 10.3.6.95a		REL-7
>>>7.68 Mcps TDD					REL-7
>>>>Extended Uplink Timing Advance	OP		Extended Uplink Timing Advance 10.3.6.95a		REL-7
>>>1.28 Mcps TDD				(no data)	REL-4

Information Element/Group name	Need	Multi	Type and reference	Semantics description	Version
Other information elements					REL-7
Deferred measurement control reading	OP		Enumerated (TRUE)	Indicates the UE has not read SIB11, SIB11bis, SIB11ter (if supported) and SIB12, if available.	REL-7
RB Information elements					
COUNT-C activation time	OP		Activation time 10.3.3.1	Used for radio bearers mapped on RLC-TM. Only applicable if the UE is moving to CELL_DCH state due to this procedure	
Uplink counter synchronisation info	OP				
>RB with PDCP information list	OP	1 to <maxRBall RABs>			
>>RB with PDCP information	MP		RB with PDCP information 10.3.4.22		
>START list	MP	1 to <maxCNdo mains>		START [40] values for all CN domains.	
>>CN domain identity	MP		CN domain identity 10.3.1.1		
>>START	MP		START 10.3.3.38	START value to be used in this CN domain.	

10.2.52 TRANSPORT CHANNEL RECONFIGURATION FAILURE

This message is sent by UE if the configuration given by UTRAN is unacceptable or if the UE failed to establish the physical channel(s).

RLC-SAP: AM

Logical channel: DCCH

Direction: UE→UTRAN

Information Element/Group name	Need	Multi	Type and reference	Semantics description
Message Type	MP		Message Type	
UE information elements				
RRC transaction identifier	MP		RRC transaction identifier 10.3.3.36	
Integrity check info	CH		Integrity check info 10.3.3.16	
Failure cause	MP		Failure cause and error information 10.3.3.14	

10.2.53 TRANSPORT FORMAT COMBINATION CONTROL

This message is sent by UTRAN to control the uplink transport format combination within the allowed transport format combination set. This message has different structures depending if the message is sent on transparent (TM) or non-transparent mode (AM or UM).

RLC-SAP: AM or UM

Logical channel: DCCH

Direction: UTRAN→UE

Information Element/Group name	Need	Multi	Type and reference	Semantics description	Version
Message Type	MP		Message Type		
UE information elements					
RRC transaction identifier	MP		RRC transaction identifier 10.3.3.36		
Integrity check info	CH		Integrity check info 10.3.3.16		
TrCH information elements					
CHOICE <i>mode</i>	MP				
>FDD				(no data)	
>TDD					
>>TFCS Id	OP		Transport Format Combination Set Identity 10.3.5.21		
DPCH/PUSCH TFCS in uplink	MP		Transport Format Combination subset 10.3.5.22	NOTE 1	
Activation time for TFC subset	MD		Activation time 10.3.3.1	Default value is "now"	
TFC Control duration	OP		TFC Control duration 10.3.6.80		
UL AMR rate	OP		Enumerated(t0, t1, t2, t3, t4, t5, t6, t7, t8)	Indicates the bit rate as defined in [62] and [63].	REL-8
NOTE 1: If the IE "UL AMR rate" is included, no DCH is configured on the uplink and the IE "DPCH/PUSCH TFCS in uplink" is not set to "Full transport format combination set" the UE behaviour is unspecified.					

In case of transparent mode signalling the following message structure shall be used:

RLC-SAP: TM

Logical channel: DCCH

Direction: UTRAN→UE

Information Element/Group name	Need	Multi	Type and reference	Semantics description
TFC subset identity	MP		INTEGER (0..7)	

The encoding of this message is specified in subclause 12.4.1.1.

10.2.54 TRANSPORT FORMAT COMBINATION CONTROL FAILURE

This message is sent to indicate that a received TRANSPORT FORMAT COMBINATION CONTROL message could not be handled by the UE.

RLC-SAP: AM

Logical channel: DCCH

Direction: UE→UTRAN

Information Element/Group name	Need	Multi	Type and reference	Semantics description
Message Type	MP		Message Type	
UE information elements				
RRC transaction identifier	MP		RRC transaction identifier 10.3.3.36	
Integrity check info	CH		Integrity check info 10.3.3.16	
Failure cause	MP		Failure cause and error information 10.3.3.14	

10.2.55 UE CAPABILITY ENQUIRY

The UE CAPABILITY ENQUIRY is used by the UTRAN to enquire inter-RAT classmarks from the UE.

RLC-SAP: AM or UM

Logical channel: DCCH

Direction: UTRAN → UE

Information Element/Group name	Need	Multi	Type and reference	Semantics description
Message Type	MP		Message Type	
UE information elements				
RRC transaction identifier	MP		RRC transaction identifier 10.3.3.36	
Integrity check info	CH		Integrity check info 10.3.3.16	Integrity check info is included if integrity protection is applied
Capability update requirement	MP		Capability update requirement 10.3.3.2	

10.2.56 UE CAPABILITY INFORMATION

This message is sent by UE to convey UE specific capability information to the UTRAN.

RLC-SAP: AM

Logical channel: DCCH

Direction: UE → UTRAN

Information Element/Group name	Need	Multi	Type and reference	Semantics description
Message Type	MP		Message Type	
UE information elements				
RRC transaction identifier	OP		RRC transaction identifier 10.3.3.36	
Integrity check info	CH		Integrity check info 10.3.3.16	Integrity check info is included if integrity protection is applied
UE radio access capability	OP		UE radio access capability 10.3.3.42	
UE radio access capability extension	OP		UE radio access capability extension 10.3.3.42a	
Other information elements				
UE system specific capability	OP	1 to <maxInter SysMessages>		
>Inter-RAT UE radio access capability	MP		Inter-RAT UE radio access capability 10.3.8.7	

10.2.57 UE CAPABILITY INFORMATION CONFIRM

This message is sent by UTRAN to confirm that UE capability information has been received.

RLC-SAP: AM or UM

Logical channel: DCCH

Direction: UTRAN → UE

Information Element/Group name	Need	Multi	Type and reference	Semantics description
Message Type	MP		Message Type	
UE information elements				
RRC transaction identifier	MP		RRC transaction identifier 10.3.3.36	
Integrity check info	CH		Integrity check info 10.3.3.16	Integrity check info is included if integrity protection is applied

Information Element/Group name	Need	Multi	Type and reference	Semantics description
Acceptance of requested change of capability	OP		Enumerated (Refused, Accepted, Accepted with reconfiguration to follow)	Included if the message was sent in response to a UE request for a capability change in connected mode

10.2.57a UE INFORMATION REQUEST

This message is used by UTRAN to request data such as Logged Measurements from the UE.

RLC-SAP: AM

Logical channel: DCCH

Direction: UTRAN→UE

Information Element/Group name	Need	Multi	Type and reference	Semantics description	Version
Message Type	MP		Message Type		REL-10
UE information elements					REL-10
RRC transaction identifier	MP		RRC transaction identifier 10.3.3.36		REL-10
Integrity check info	CH		Integrity check info 10.3.3.16		REL-10
Other Information Elements					REL-10
Logged Measurements Report Request	OP		Enumerated (TRUE)	This IE indicates that the UE shall report logged measurements to the network if available.	REL-10
Logged ANR Report Request	OP		Enumerated (TRUE)		REL-10
Connection Establishment Failure Request	OP		Enumerated (TRUE)		REL-11

10.2.57b UE INFORMATION RESPONSE

This message is used by the UE to transfer data such as Logged Measurements to the UTRAN.

RLC-SAP: AM

Logical channel: DCCH

Direction: UE→UTRAN

Information Element/Group name	Need	Multi	Type and reference	Semantics description	Version
Message Type	MP		Message Type		REL-10
UE information elements					REL-10
RRC transaction identifier	MP		RRC transaction identifier 10.3.3.36		REL-10
Integrity check info	CH		Integrity check info 10.3.3.16		REL-10
Other Information Elements					REL-10
Logged Meas Report	OP		Logged Meas Report 10.3.7.131		REL-10
Logged ANR Report Info	OP		Logged ANR Report Info 10.3.7.42b		REL-10
Connection Establishment Failure Report	OP		Connection Establishment Failure Report 10.3.7.132a		REL-11

10.2.58 UPLINK DIRECT TRANSFER

This message is used to transfer NAS messages for an existing signalling connection.

RLC-SAP: AM

Logical channel: DCCH

Direction: UE ->UTRAN

Information Element/Group name	Need	Multi	Type and reference	Semantics description
Message Type	MP		Message Type	
UE information elements				
Integrity check info	CH		Integrity check info 10.3.3.16	Integrity check info is included if integrity protection is applied
CN information elements				
CN domain identity	MP		CN domain identity 10.3.1.1	
NAS message	MP		NAS message 10.3.1.8	
Measurement information elements				
Measured results on RACH	OP		Measured results on RACH 10.3.7.45	

10.2.59 UPLINK PHYSICAL CHANNEL CONTROL

NOTE: Only for TDD.

This message is used to transfer uplink physical channel parameters to the UE.

RLC-SAP: AM or UM

Logical channel: DCCH

Direction: UTRAN→UE

Information Element/Group name	Need	Multi	Type and Reference	Semantics description	Version
Message Type	MP		Message Type		
UE information elements					
RRC transaction identifier	MP		RRC transaction identifier 10.3.3.36		
Integrity check info	OP		Integrity check info 10.3.3.16		
PhyCH information elements					
CCTrCH power control info	OP		CCTrCH power control info 10.3.6.8	Power control information for one CCTrCH	
Special Burst Scheduling	OP		Special Burst Scheduling 10.3.6.75a	UL Special Burst generation period in radio frames	
CHOICE <i>TDD option</i>	MP				REL-4
>3.84 Mcps TDD					REL-4
>>Alpha	OP		Alpha 10.3.6.5		
>>Timing Advance Control	OP		UL Timing Advance Control 10.3.6.96		
>>PRACH Constant Value	OP		Constant value TDD 10.3.6.11a	Operator controlled PRACH Margin	
>>PUSCH Constant Value	OP		Constant value TDD 10.3.6.11a	Operator controlled PUSCH Margin	
>>UE positioning related parameters	CV-IPDLs				REL-4
>>>IPDL-Alpha	MP		Alpha 10.3.6.5		REL-4
>>>Max power increase	MP		Integer (0..3)	In dB	REL-4
>> HS-SICH power control info	OP		HS-SICH Power Control Info 10.3.6.36b	Only applies to TDD 3.84 Mcps	REL-5
>7.68 Mcps TDD					REL-7
>>Alpha	OP		Alpha 10.3.6.5		REL-7
>>Timing Advance Control	OP		UL Timing Advance Control 10.3.6.96		REL-7
>>PRACH Constant Value	OP		Constant value TDD 10.3.6.11a	Operator controlled PRACH Margin	REL-7
>>PUSCH Constant Value	OP		Constant value TDD 10.3.6.11a	Operator controlled PUSCH Margin	REL-7
>>UE positioning related parameters	CV-IPDLs				REL-4
>>>IPDL-Alpha	MP		Alpha 10.3.6.5		REL-4

Information Element/Group name	Need	Multi	Type and Reference	Semantics description	Version
>>>Max power increase	MP		Integer (0..3)	In dB	REL-4
>> HS-SICH power control info	OP		HS-SICH Power Control Info 10.3.6.36b	Only applies to TDD 7.68 Mcps	REL-5
>1.28 Mcps TDD					REL-4
>>Uplink synchronisation parameters	MD			Default: Uplink synchronisation step size 1. Uplink synchronisation frequency 1.	REL-4
>>>Uplink synchronisation step size	MP		Integer(1..8)	This parameter specifies the step size to be used for the adjustment of the uplink transmission timing	REL-4
>>>Uplink synchronisation frequency	MP		Integer(1..8)	This parameter specifies the frequency of the adjustment of the uplink transmission timing	REL-4
>>PRX _{HS-SICH}	OP		Integer (-120..-58 by step of 1)	In dBm. Desired power level for HS-SICH.	REL-6
>>TPC step size	OP		Integer (1, 2, 3)	In dB. For HS-SICH	REL-6

Condition	Explanation
<i>IPDLs</i>	This IE is present only if idle periods are applied

10.2.60 URA UPDATE

This message is used by the UE to initiate a URA update procedure.

RLC-SAP: TM

Logical channel: CCCH

Direction: UE→UTRAN

Information Element/Group name	Need	Multi	Type and reference	Semantics description	Version
Message Type	MP		Message Type		
UE information elements					
U-RNTI	MP		U-RNTI 10.3.3.47		
RRC transaction identifier	CV- <i>ProtErr</i>		RRC transaction identifier 10.3.3.36		
Integrity check info	CH		Integrity check info 10.3.3.16		
URA update cause	MP		URA update cause 10.3.3.46		

Information Element/Group name	Need	Multi	Type and reference	Semantics description	Version
Protocol error indicator	MD		Protocol error indicator 10.3.3.27	Default value is FALSE	
HS-PDSCH in CELL_PCH and URA_PCH	OP		Enumerated (TRUE)	This IE indicates whether the UE supports HS-PDSCH reception in CELL_PCH and URA_PCH states. The absence of this IE indicates that the UE does not support HS-PDSCH reception in CELL_PCH or URA_PCH states.	REL-7
HS-PDSCH in CELL_FACH	OP		Enumerated (TRUE)	This IE indicates whether the UE supports HS-PDSCH reception in CELL_FACH state. The absence of this IE indicates that the UE does not support HS-PDSCH reception in CELL_FACH state.	REL-7
Support of HS-DSCH DRX operation	OP		Enumerated (TRUE)	The absence of this IE indicates that the UE does not support HS-DSCH DRX operation in CELL_FACH state.	REL-8
Support of common E-DCH	OP		Enumerated (TRUE)	The absence of this IE indicates that the UE does not support E-DCH enhanced random access in CELL_FACH state and Idle mode.	REL-8
Support of MAC-i/is	OP		Enumerated (TRUE)	This IE indicates whether the UE supports MAC-i/is operation.	REL-8
Support for Two DRX schemes in URA_PCH and CELL_PCH	OP		Enumerated (TRUE)	The absence of this IE indicates that the UE does not support Two DRX schemes in URA_PCH and CELL_PCH	REL-7
Other information elements					
Protocol error information	CV-ProtErr		Protocol error information 10.3.8.12		
Other Information elements					
Logged Meas Available	OP		Enumerated (TRUE)	Indicates the UE has logged measurements to report to the network	Rel-10
ANR Logging Results Available	OP		Enumerated (TRUE)	True indicates the UE has ANR logging results to report to the Network.	REL-10

Condition	Explanation
<i>ProtErr</i>	The IE is mandatory present if the IE "Protocol error indicator" has the value TRUE and not needed otherwise.

10.2.61 URA UPDATE CONFIRM

This message confirms the URA update procedure and can be used to reallocate new RNTI information for the UE valid after the URA update.

RLC-SAP: UM

Logical channel: CCCH or DCCH

Direction: UTRAN→UE

Information Element/Group name	Need	Multi	Type and reference	Semantics description	Version
Message Type	MP		Message Type		
UE information elements					
U-RNTI	CV-CCCH		U-RNTI 10.3.3.47		
RRC transaction identifier	MP		RRC transaction identifier 10.3.3.36		
Integrity check info	CH		Integrity check info 10.3.3.16	Integrity check info is included if integrity protection is applied	
Integrity protection mode info	OP		Integrity protection mode info 10.3.3.19	The UTRAN should not include this IE unless it is performing an SRNS relocation	
Ciphering mode info	OP		Ciphering mode info 10.3.3.5	The UTRAN should not include this IE unless it is performing an SRNS relocation and a change in ciphering algorithm	
New U-RNTI	OP		U-RNTI 10.3.3.47		
New C-RNTI	OP		C-RNTI 10.3.3.8		
New H-RNTI	OP		H-RNTI 10.3.3.14a		REL-8
New Primary E-RNTI	OP		E-RNTI 10.3.3.10a		REL-8
RRC State Indicator	MP		RRC State Indicator 10.3.3.35a		
UTRAN DRX cycle length coefficient	OP		UTRAN DRX cycle length coefficient 10.3.3.49		
CN Information Elements					
CN Information info	OP		CN Information info 10.3.1.3		
UTRAN mobility information elements					
URA identity	OP		URA identity 10.3.2.6		
RNC support for change of UE capability	OP		Boolean	Should be included if the message is used to perform an SRNS relocation	REL-7
RB information elements					
Downlink counter synchronisation info	OP				
>RB with PDCP information list	OP	1 to <maxRBall RABs>			

Information Element/Group name	Need	Multi	Type and reference	Semantics description	Version
>>RB with PDCP information	MP		RB with PDCP information 10.3.4.22	This IE is needed for each RB having PDCP in the case of lossless SRNS relocation	
	OP				REL-5
>>PDCP context relocation info	OP		PDCP context relocation info 10.3.4.1a	This IE is needed for each RB having PDCP and performing PDCP context relocation	REL-5

Condition	Explanation
CCCH	This IE is mandatory present when CCCH is used and not needed otherwise.

10.2.62 UTRAN MOBILITY INFORMATION

This message is used by UTRAN to allocate a new RNTI and to convey other UTRAN mobility related information to a UE.

RLC-SAP: AM or UM

Logical channel: DCCH

Direction: UTRAN→UE

Information Element/Group name	Need	Multi	Type and reference	Semantics description	Version
Message Type	MP		Message Type		
UE Information Elements					
Integrity check info	CH		Integrity check info 10.3.3.16		
RRC transaction identifier	MP		RRC transaction identifier 10.3.3.36		
Integrity protection mode info	OP		Integrity protection mode info 10.3.3.19	The UTRAN should not include this IE unless it is performing an SRNS relocation	
Ciphering mode info	OP		Ciphering mode info 10.3.3.5	The UTRAN should not include this IE unless it is performing an SRNS relocation and a change in ciphering algorithm	
New U-RNTI	OP		U-RNTI 10.3.3.47		
New C-RNTI	OP		C-RNTI 10.3.3.8		

Information Element/Group name	Need	Multi	Type and reference	Semantics description	Version
New H-RNTI	OP		H-RNTI 10.3.3.14a		REL-7
New Primary E-RNTI	OP		E-RNTI 10.3.3.10a		REL-8
UE Timers and constants in connected mode	OP		UE Timers and constants in connected mode 10.3.3.43		
Dedicated priority information	OP		Dedicated priority information 10.3.2.7		REL-8
Measurement Release Enhancement	OP		Measurement Release Enhancement 10.3.7.46a		REL-12
CN Information Elements					
CN Information info	OP		CN Information info full 10.3.1.3a		
Domain Specific Access Restriction Parameters Update	CV- <i>Cell_DCH</i>		Domain Specific Access Restriction Parameters Update 10.3.1.3c		REL-12
Paging Permission with Access Control Parameters Update	CV- <i>Cell_DCH</i>		Paging Permission with Access Control Parameters Update 10.3.1.10a		REL-12
UTRAN Information Elements					
URA identity	OP		URA identity 10.3.2.6		
RNC support for change of UE capability	OP		Boolean	Should be included if the message is used to perform an SRNS relocation	REL-7
RB Information elements					
Downlink counter synchronisation info	OP				
>RB with PDCP information list	OP	1 to <maxRBall RABs>			
>>RB with PDCP information	MP		RB with PDCP information 10.3.4.22	This IE is needed for each RB having PDCP in the case of lossless SRNS relocation	
	OP				REL-5
>>PDCP context relocation info	OP		PDCP context relocation info 10.3.4.1a	This IE is needed for each RB having PDCP and performing PDCP context relocation	REL-5
WLAN Information Elements					

Information Element/Group name	Need	Multi	Type and reference	Semantics description	Version
Dedicated WLAN Offload Information	OP		Dedicated WLAN Offload Information 10.3.2.10		REL-12

Condition	Explanation
<i>Cell_DCH</i>	This IE is optionally present when UE is in CELL_DCH state and not needed otherwise.

10.2.63 UTRAN MOBILITY INFORMATION CONFIRM

This message is used to confirm the new UTRAN mobility information for the UE.

RLC-SAP: AM

Logical channel: DCCH

Direction: UE→UTRAN

Information Element/Group name	Need	Multi	Type and reference	Semantics description	Version
Message Type	MP		Message Type		
UE information elements					
RRC transaction identifier	MP		RRC transaction identifier 10.3.3.36		
Integrity check info	CH		Integrity check info 10.3.3.16		
Uplink integrity protection activation info	OP		Integrity protection activation info 10.3.3.17		
Other Information Elements					REL-7
Deferred measurement control reading	OP		Enumerated (TRUE)	Indicates the UE has not read SIB11, SIB11bis, SIB11ter (if supported) and SIB12.	REL-7
Logged Meas Available	OP		Enumerated (TRUE)	Indicates the UE has logged measurements to report to the network	REL-10
RB Information elements					
COUNT-C activation time	OP		Activation time 10.3.3.1	Used for radio bearers mapped on RLC-TM. Only applicable if the UE is moving to CELL_DCH state due to this procedure	
Uplink counter synchronisation info	OP				
>RB with PDCP information list	OP	1 to <maxRB allRABs>		This IE is needed for each RB having PDCP in the case of lossless SRNS relocation	
>>RB with PDCP information	MP		RB with PDCP information 10.3.4.22		
>START list	MP	1 to <maxCN		START [40] values for all CN domains.	

Information Element/Group name	Need	Multi	Type and reference	Semantics description	Version
		domains >			
>>CN domain identity	MP		CN domain identity 10.3.1.1		
>>START	MP		START 10.3.3.38	START value to be used in this CN domain.	

10.2.64 UTRAN MOBILITY INFORMATION FAILURE

This message is sent to indicate a failure to act on a received UTRAN MOBILITY INFORMATION message.

RLC-SAP: AM

Logical channel: DCCH

Direction: UE→UTRAN

Information Element/Group name	Need	Multi	Type and reference	Semantics description
Message Type	MP		Message Type	
UE information elements				
RRC transaction identifier	MP		RRC transaction identifier 10.3.3.36	
Integrity check info	CH		Integrity check info 10.3.3.16	
Failure cause	MP		Failure cause and error information 10.3.3.14	

10.3 Information element functional definitions

10.3.1 CN Information elements

10.3.1.1 CN domain identity

Identifies the type of core network domain.

Information Element/Group name	Need	Multi	Type and reference	Semantics description
CN domain identity	MP		Enumerated (CS domain, PS domain)	

10.3.1.2 CN Domain System Information

Information Element/Group name	Need	Multi	Type and reference	Semantics description
CN domain identity	MP		CN domain identity 10.3.1.1	
CHOICE <i>CN Type</i>	MP			

Information Element/Group name	Need	Multi	Type and reference	Semantics description
>GSM-MAP				
>>CN domain specific NAS system information	MP		NAS system information (GSM-MAP) 10.3.1.9	
>ANSI-41				
>>CN domain specific NAS system information	MP		ANSI-41 NAS system information, 10.3.9.4	
CN domain specific DRX cycle length coefficient	MP		CN domain specific DRX cycle length coefficient, 10.3.3.6	

10.3.1.3 CN Information info

Information Element/Group name	Need	Multi	Type and reference	Semantics description	Version
PLMN identity	OP		PLMN identity 10.3.1.11		
CN common GSM-MAP NAS system information	OP		NAS system information (GSM-MAP) 10.3.1.9		
CN domain related information	OP	1 to <maxCNdo mains>			
>CN domain identity	MP		CN domain identity 10.3.1.1		
>CN domain specific GSM-MAP NAS system info	MP		NAS system information (GSM-MAP) 10.3.1.9		
Primary PLMN identity	OP		PLMN identity 10.3.1.11		REL-6

10.3.1.3a CN Information info full

Information Element/Group name	Need	Multi	Type and reference	Semantics description	Version
PLMN identity	OP		PLMN identity 10.3.1.11		
CN common GSM-MAP NAS system information	OP		NAS system information (GSM-MAP) 10.3.1.9		
CN domain related information	OP	1 to <maxCNdomains>			
>CN domain identity	MP		CN domain identity 10.3.1.1		
>CN domain specific GSM-MAP NAS system info	MP		NAS system information (GSM-MAP) 10.3.1.9		
>CN domain specific DRX cycle length coefficient	MP		CN domain specific DRX cycle length coefficient, 10.3.3.6		
Primary PLMN identity	OP		PLMN identity 10.3.1.11		REL-6

10.3.1.3b Domain Specific Access Restriction

Information Element/Group name	Need	Multi	Type and reference	Semantics description	Version
CHOICE <i>restriction status</i>	MP				REL-6
>no restriction				(no data) This means 'no Access Class is barred'	REL-6
>restriction					REL-6
>>Domain Specific Access Class Barred List	MD	<MaxAC>		The first instance of the parameter corresponds to Access Class 0, the second to Access Class 1 and so on up to Access Class 15. UE reads this IE of its access class stored in SIM. The default value is the IE "Access Class Barred list" contained in the IE "Cell Access Restriction" of the System Information Block Type 3.	REL-6
>>>Access Class Barred	MP		Enumerated (barred, not barred)		REL-6

10.3.1.3c Domain Specific Access Restriction Parameters

This IE specifies domain specific access class restriction parameters for CS and PS domain.

Information Element/Group name	Need	Multi	Type and reference	Semantics description	Version
CS Domain Specific Access Restriction	MP		Domain Specific Access Restriction 10.3.1.3b	This IE contains Domain Specific Access Restriction Parameters for CS domain.	REL-6
PS Domain Specific Access Restriction	MP		Domain Specific Access Restriction 10.3.1.3b	This IE contains Domain Specific Access Restriction Parameters for PS domain.	REL-6

10.3.1.3d Domain Specific EAB Parameters

Information Element/Group name	Need	Multi	Type and reference	Semantics description	Version
CS Domain Specific EAB Parameters	OP		EAB Configuration 10.3.1.3e	This IE contains Domain Specific EAB Parameters for CS domain.	REL-11
PS Domain Specific EAB Parameters	OP		EAB Configuration 10.3.1.3e	This IE contains Domain Specific EAB Parameters for PS domain.	REL-11
Common EAB Parameters	CV- <i>Common</i>		EAB Configuration 10.3.1.3e	This IE contains Domain Specific EAB Parameters for both CS domain and PS domain.	REL-11

Condition	Explanation
<i>Common</i>	The IE is mandatory present if neither the IE "CS Domain Specific EAB Parameters" nor the IE "PS Domain Specific EAB Parameters" is present. Otherwise, the IE is not needed.

10.3.1.3e EAB Configuration

Information Element/Group name	Need	Multi	Type and reference	Semantics description	Version
EAB Category	MP		Enumerated(a, b, c)	This IE identifies the category of UEs for which EAB applies. Value 'a' corresponds to all UEs, value 'b' corresponds to the UEs that are neither in their HPLMN nor in a PLMN that is equivalent to it, and value 'c' corresponds to the UEs that are neither in the PLMN listed as most preferred PLMN of the country where the UEs are roaming in the operator-defined PLMN selector list on the SIM, nor in their HPLMN nor in a PLMN that is equivalent to their HPLMN, see [75].	REL-11

Information Element/ Group name	Need	Multi	Type and reference	Semantics description	Version
EAB Access Class Barred List	MP	10		The first instance of this IE corresponds to Access Class 0, the second instance corresponds to Access Class 1, and so on up to Access Class 9. UE reads its Access Class stored in the SIM.	REL-11
>Access Class Barred	MP		Enumerated(barred, not barred)		REL-11

10.3.1.4 IMEI

This IE contains an International Mobile Equipment Identity. Setting specified in [11].

Information Element/Group name	Need	Multi	Type and reference	Semantics description
IMEI	MP	15		The first element contains the first IMEI digit, the second element the second IMEI digit and so on.
>IMEI digit	MP		INTEGER(0. .15)	

10.3.1.5 IMSI (GSM-MAP)

This IE contains an International Mobile Subscriber Identity, used towards a GSM-MAP type of PLMN. Setting specified in [11].

Information Element/Group name	Need	Multi	Type and reference	Semantics description
IMSI	MP	6 to 21		The first element contains the first IMSI digit, the second element the second IMSI digit and so on. Although normally upto 15 digits are used for this IE, a bigger length is used to support future extension.
>IMSI digit	MP		INTEGER(0. .9)	

10.3.1.6 Intra Domain NAS Node Selector

This IE carries information to be used to route the establishment of a signalling connection to a CN node within a CN domain.

Information Element/Group name	Need	Multi	Type and reference	Semantics description
CHOICE <i>version</i>	MP			
>R99				This choice shall also be used by mobiles that are compliant to this version of the protocol
>>CHOICE <i>CN type</i>	MP			
>>>GSM-MAP				
>>>>CHOICE <i>Routing basis</i>	MP			
>>>>>local (P)TMSI				TMSI allocated in the current LA or PTMSI allocated in the current RA

Information Element/Group name	Need	Multi	Type and reference	Semantics description
>>>>>Routing parameter	MP		Bit string (10)	The TMSI/ PTMSI consists of 4 octets (32bits). This can be represented by a string of bits numbered from b0 to b31, with bit b0 being the least significant The "Routing parameter" bit string consists of bits b14 through b23 of the TMSI/ PTMSI. The first/leftmost/most significant bit of the bit string contains bit b23 of the TMSI/PTMSI.
>>>>>(P)TMSI of same PLMN, different (RA)LA; or, PTMSI mapped from a valid GUTI allocated by same PLMN				TMSI allocated in another LA of this PLMN or PTMSI allocated in another RA this PLMN; or, PTMSI mapped from a valid GUTI [11] (GUTI allocated in same PLMN)
>>>>>Routing parameter	MP		Bit string (10)	The TMSI/ PTMSI consists of 4 octets (32bits). This can be represented by a string of bits numbered from b0 to b31, with bit b0 being the least significant The "Routing parameter" bit string consists of bits b14 through b23 of the TMSI/ PTMSI. The first/leftmost/most significant bit of the bit string contains bit b23 of the TMSI/ PTMSI.
>>>>>(P)TMSI of different PLMN; or, PTMSI mapped from a valid GUTI allocated by a different PLMN				TMSI or a PTMSI allocated in another PLMN; or, PTMSI mapped from a valid GUTI [11] (GUTI allocated in another PLMN)
>>>>>Routing parameter	MP		Bit string (10)	The TMSI/ PTMSI consists of 4 octets (32bits). This can be represented by a string of bits numbered from b0 to b31, with bit b0 being the least significant. The "Routing parameter" bit string consists of bits b14 through b23 of the TMSI/ PTMSI. The first/leftmost/most significant bit of the bit string contains bit b23 of the TMSI/ PTMSI.
>>>>>IMSI(response to IMSI paging)				NAS identity is IMSI
>>>>>Routing parameter	MP		Bit string (10)	The "Routing parameter" bit string consists of DecimalToBinary [(IMSI div 10) mod 1000]. The first/leftmost bit of the bit string contains the most significant bit of the result.
>>>>>IMSI(cause UE initiated event)				NAS identity is IMSI

Information Element/Group name	Need	Multi	Type and reference	Semantics description
>>>>>Routing parameter	MP		Bit string (10)	The "Routing parameter" bit string consists of DecimalToBinary [(IMSI div 10) mod 1000]. The first/leftmost bit of the bit string contains the most significant bit of the result.
>>>>>IMEI				NAS parameter is IMEI
>>>>>Routing parameter	MP		Bit string (10)	The "Routing parameter" bit string consists of DecimalToBinary [(IMEI div 10) mod 1000]. The first/leftmost bit of the bit string contains the most significant bit of the result.
>>>>>Spare 1			Bit string (10)	This choice shall not be used in this version
>>>>>Spare 2			Bit string (10)	This choice shall not be used in this version
>>>ANSI-41			Bit string (14)	All bits shall be set to 0
>Later			Bit string(15)	This bit string shall not be sent by mobiles that are compliant to this version of the protocol.

10.3.1.7 Location Area Identification

Identifies uniquely a location area for a GSM-MAP type of PLMN. Setting specified in [5].

Information Element/Group name	Need	Multi	Type and reference	Semantics description
PLMN identity	MP		PLMN identity 10.3.1.11	
LAC	MP		Bit string(16)	The first/leftmost bit of the bit string contains the most significant bit of the LAC..

10.3.1.7oa Location/Registration Parameters

Information Element/Group name	Need	Multi	Type and reference	Semantics description	Version
CHOICE <i>restriction status</i>	MP				REL-8
>no restriction				(no data) This means 'no Access Class is barred'	REL-8
>restriction					REL-8
>>Location/Registration Access Class Barred List	MP	15		The first ten instance of the parameter corresponds to Access Class 0 to 9, and eleventh to fifteenth instance of the parameter corresponds to Access Class 11 to 15, respectively. UE reads this IE of its access class stored in SIM (except for Access Class 10).	REL-8
>>>Access Class Barred	MP		Enumerated(barred, not barred)		REL-8

10.3.1.7a Multiple PLMN List

This information element identifies the multiple Public Land Mobile Networks (for a GSM-MAP type of PLMN) of a cell in a shared network.

Information Element/Group name	Need	Multi	Type and reference	Semantics description	Version
MIB PLMN Identity	MP		Boolean	The PLMN identity IE 10.3.1.11, broadcasted in the MIB, shall be included in the multiple PLMN list if and only if this IE is TRUE.	REL-6
Multiple PLMNs	MP	1 to 5			REL-6
>PLMN identity with Optional MCC			PLMN identity with Optional MCC 10.3.1.11a		REL-6

10.3.1.8 NAS message

A non-access stratum message to be transferred transparently through UTRAN.

Information Element/Group name	Need	Multi	Type and reference	Semantics description
NAS message	MP		Octet string (1..4095)	The first octet contains octet 1 [17] of the NAS message, the second octet contains octet 2 of the NAS message and so on.

10.3.1.9 NAS system information (GSM-MAP)

This information element contains system information that belongs to the non-access stratum for a GSM-MAP type of PLMN. This information is transparent to RRC. It may contain either information specific to one CN domain (CS or PS) or information common for both CN domains.

Information Element/Group name	Need	Multi	Type and reference	Semantics description
GSM-MAP NAS system information	MP		Octet string(1..8)	The first octet contains octet 1 [5] of the NAS system information element, the second octet contains octet 2 of the NAS system information element and so on.

10.3.1.10 Paging record type identifier

Information Element/Group name	Need	Multi	Type and reference	Semantics description
Paging record type identifier	MP		Enumerated (IMSI (GSM-MAP), TMSI (GSM-MAP)/P-TMSI, IMSI (DS-41), TMSI (DS-41))	

10.3.1.10a Paging Permission with Access Control Parameters

Information Element/Group name	Need	Multi	Type and reference	Semantics description	Version
Paging Response Restriction Indication	MP		Enumerated (All, CS, PS, None)		REL-8
Location/Registration Restriction Indicator	MP		Enumerated (All, CS, PS)		REL-8
Location/Registration	MP		Location /Registration Parameters 10.3.1.7oa		REL-8

10.3.1.11 PLMN identity

This information element identifies a Public Land Mobile Network for a GSM-MAP type of PLMN. Setting of digits is defined in [11].

Information Element/Group name	Need	Multi	Type and reference	Semantics description
MCC	MP	3		The first element contains the first MCC digit, the second element the second MCC digit and so on.
>MCC digit	MP		INTEGER(0..9)	
MNC	MP	2 to 3		The first element contains the first MNC digit, the second element the second MNC digit and so on.
>MNC digit	MP		INTEGER(0..9)	

10.3.1.11a PLMN identity with Optional MCC

This information element is a PLMN identity in subclause 10.3.1.11 where MCC is optional. It is used in a shared network and inserted in the Multiple PLMN List in subclause 10.3.1.7a.

Information Element/ Group name	Need	Multi	Type and reference	Semantics description	Version
MCC	MD	3		The first element contains the first MCC digit, the second element the second MCC digit and so on.	REL-6
>MCC digit	MP		Integer (0..9)		REL-6
MNC	MP	2 to 3		The first element contains the first MNC digit, the second element the second MNC digit and so on.	REL-6
>MNC digit	MP		Integer (0..9)		REL-6

10.3.1.12 PLMN Type

Identifies the type of Public Land Mobile Network (PLMN). This IE shall be used to control the interpretation of network dependent messages and information elements in the RRC protocol.

Information Element/Group name	Need	Multi	Type and reference	Semantics description
PLMN Type	MP		Enumerated (GSM-MAP, ANSI-41, GSM-MAP and ANSI- 41)	One spare value is needed.

10.3.1.13 P-TMSI (GSM-MAP)

This IE contains a Packet Temporary Mobile Subscriber Identity, used towards a GSM-MAP type of PLMN.

Information Element/Group name	Need	Multi	Type and reference	Semantics description
P-TMSI	MP		Bit string (32)	Setting specified in [11]. The first/leftmost bit of the bit string contains the most significant bit of the P-TMSI.

10.3.1.14 RAB identity

This information element uniquely identifies a radio access bearer within a CN domain.

Information Element/Group name	Need	Multi	Type and reference	Semantics description
CHOICE <i>RAB identity type</i>	MP			
>RAB identity (GSM-MAP)			Bit string (8)	Formatted according to [5]. The first/leftmost bit of the bit string contains the most significant bit of the RAB identity. In case of a radio bearer setup for an MBMS selected service, the RAB identity is set to the value reserved for 'MBMS Broadcast mode', see [5].
>RAB identity (ANSI-41)			Bit string (8)	The first/leftmost bit of the bit string contains the most significant bit of the RAB identity.

CHOICE <i>NAS binding info type</i>	Condition under which the given <i>RAB identity type</i> is chosen
RAB identity (GSM-MAP)	PLMN is of type GSM-MAP
RAB identity (ANSI-41)	PLMN is of type ANSI-41

10.3.1.15 Routing Area Code

Identifies a routing area within a location area for a GSM-MAP type of PLMN.

Information Element/Group name	Need	Multi	Type and reference	Semantics description
Routing Area Code	MP		Bit string(8)	Setting specified in [11]. The first/leftmost bit of the bit string contains the most significant bit of the Routing Area Code.

10.3.1.16 Routing Area Identification

Identifies uniquely a routing area for a GSM-MAP type of PLMN. Setting specified in [11].

Information Element/Group name	Need	Multi	Type and reference	Semantics description
LAI	MP		Location area identification 10.3.1.7	
RAC	MP		Routing area code 10.3.1.15	

10.3.1.17 TMSI (GSM-MAP)

This IE contains a Temporary Mobile Subscriber Identity, used towards a GSM-MAP type of PLMN.

Information Element/Group name	Need	Multi	Type and reference	Semantics description
TMSI (GSM-MAP)	MP		Bit string (32)	Setting specified in [11]. The first/leftmost bit of the bit string contains the most significant bit of the TMSI.

10.3.2 UTRAN mobility Information elements

10.3.2.1 Cell Access Restriction

Indicates the restrictions to cell access.

Information Element/Group name	Need	Multi	Type and reference	Semantics description	Version
Cell Barred	MP		Enumerated(not barred, barred)	If the cell is operating in MBSFN mode as indicated in subclause 8.1.1.6.3 and the value in this IE is different from "barred" the UE behaviour is unspecified.	
Intra-frequency cell re-selection indicator	<i>CV-Barred</i>		Enumerated(not allowed, allowed)		
T_{barred}	<i>CV-Barred</i>		Integer (10,20,40,80,160,320,640,1280)	[4] [s]	
Cell Reserved for operator use	MP		Enumerated(reserved, not reserved)		
Cell Reservation Extension	MP		Enumerated(reserved, not reserved)		
Cell Reserved for CSG	<i>CV-CSG</i>		Enumerated(TR UE)		REL-8
Access Class Barred list	<i>CV-SIB3-MD</i>	maxAC		Default is no access class barred is applied. The first instance of the parameter corresponds to Access Class 0, the second to Access Class 1 and so on up to Access Class 15. UE reads this IE of its access class stored in SIM.	
>Access Class Barred	MP		Enumerated (barred, not barred)		

Condition	Explanation
<i>Barred</i>	The IE is mandatory present if the IE "Cell Barred" has the value "Barred"; otherwise the element is not needed in the message.
<i>SIB3-MD</i>	The IE is mandatory and has a default value if the IE "Cell Access Restriction" is included in SIB 3. Otherwise the IE is not needed.
<i>CSG</i>	The IE is optional present if the cell is a CSG cell and the IE "Cell Reservation Extension" has the value "reserved". Otherwise the IE is not needed. The IE is not included in System Information Block type 4.

10.3.2.2 Cell identity

This information element identifies a cell unambiguously within a PLMN.

NOTE: This information element may carry any implementation dependent identity that unambiguously identifies a cell within a PLMN. For GAN to UTRAN HO the Cell id is encoded as required in [9].

Information Element/Group name	Need	Multi	Type and reference	Semantics description
Cell identity	MP		bit string(28)	

10.3.2.3 Cell selection and re-selection info for SIB3/4

Information Element/Group name	Need	Multi	Type and reference	Semantics description	Version
Mapping Info	OP		Mapping info 10.3.2.5	For FDD, 3.84 Mcps TDD and 7.68 Mcps TDD, this IE should not be sent.	
Cell selection and reselection quality measure	MP		Enumerated (CPICH Ec/N0, CPICH RSCP)	Choice of measurement (CPICH Ec/N0 or CPICH RSCP) to use as quality measure Q for FDD cells. This IE is also sent to the UE in SIB11/12. Both occurrences of the IE should be set to the same value.	
CHOICE mode	MP				
>FDD					
>>S _{intrasearch}	OP		Integer (-32..20 by step of 2)	If a negative value is received the UE shall consider the value to be 0. [4] [dB]	
>>S _{intersearch}	OP		Integer (-32..20 by step of 2)	If a negative value is received the UE shall consider the value to be 0. [4] [dB]	
>>S _{searchHCS}	OP		Integer (-105..91 by step of 2)	If a negative value is received the UE shall consider the value to be 0. [4] [dB]	
>>RAT List	OP	1 to <maxOtherRAT>			
>>>RAT identifier	MP		Enumerated (GSM, cdma2000)		
>>>S _{search,RAT}	MP		Integer (-32..20 by step of 2)	In case the value 20 is received the UE shall consider this IE as if it was absent according to [4] If a negative value is received the UE shall consider the value to be 0. [dB]	
>>>S _{HCS,RAT}	OP		Integer (-105..91 by step of 2)	If a negative value is received the UE shall consider the value to be 0. [4] [dB]	
>>>S _{limit,SearchRAT}	MP		Integer (-32..20 by step of 2)	If a negative value is received the UE shall consider the value to be 0. [4] [dB]	
>>Qqualmin	MP		Integer (-24..0)	Ec/N0, [dB]	

>>Qrxlevmin	MP		Integer (-115..-25 by step of 2)	RSCP, [dBm]	
>>DeltaQrxlevmin	CV-Delta		Integer(-4..-2 by step of 2)	If present, the actual value of Qrxlevmin = Qrxlevmin + DeltaQrxlevmin	REL-5
>>Qqualmin-offset	CV-SIB3		Integer (1..16)	Ec/NO, [dB] The default value is 0	REL-7
>>Qrxlevmin-offset	CV-SIB3		Integer (2..16 by step of 2)	RSCP, [dB] The default value is 0	REL-7
>>Tx Fail Params	CV-SIB3op				REL-12
>>>ConnEst Fail Count	MP		Enumerated (1, 2, 3, 4)	Number of times that the UE detects RRC Connection Establishment failure on the same cell before applying ConnEst Fail Qoffset,temp. [4]	REL-12
>>>Offset Validity	MP		Enumerated (30, 60, 120, 240, 300, 420, 600, 900)	Length of time UE uses the ConnEst Fail Qoffset,temp before the offset is removed from the cell. [4] [s]	REL-12
>>>ConnEst Fail Qoffset,temp	OP		Integer (0..15)	Temporary cell selection/reselection offset used for this cell if RRC Connection Establishment fails. Absence of the IE means that the UE shall apply the value of infinity. [4] [dB]	REL-12
>TDD					
>>S _{intrasearch}	OP		Integer (-105..-91 by step of 2)	If a negative value is received the UE shall consider the value to be 0. [4] [dB]	
>>S _{intersearch}	OP		Integer (-105..-91 by step of 2)	If a negative value is received the UE shall consider the value to be 0. [4] [dB]	
>>S _{searchHCS}	OP		Integer (-105..-91 by step of 2)	If a negative value is received the UE shall consider the value to be 0. [4] [dB]	
>>RAT List	OP	1 to <maxOtherRAT >			
>>>RAT identifier	MP		Enumerated (GSM, cdma2000)		

>>>S _{search,RAT}	MP		Integer (-105..91 by step of 2)	In case the value 91 is received the UE shall consider this IE as if it was absent according to [4] If a negative value is received the UE shall consider the value to be 0. [dB]	
>>>S _{HCS,RAT}	OP		Integer (-105..91 by step of 2)	If a negative value is received the UE shall consider the value to be 0. [4] [dB]	
>>>S _{limit,SearchRAT}	MP		Integer (-105..91 by step of 2)	If a negative value is received the UE shall consider the value to be 0. [4] [dB]	
>>Q _{rxlevmin}	MP		Integer (-115..-25 by step of 2)	RSCP, [dBm]	
>>Delta _{Q_{rxlevmin}}	CV-Delta		Integer(-4..-2 by step of 2)	If present, the actual value of Q _{rxlevmin} = Q _{rxlevmin} + Delta _{Q_{rxlevmin}}	REL-5
>>Q _{rxlevmin} -offset	CV-SIB3		Integer (2..16 by step of 2)	RSCP, [dB] The default value is 0	REL-7
Q _{hyst1_s}	MP		Integer (0..40 by step of 2)	[4] [dB]	
Q _{hyst1_{s,PCH}}	CV-SIB4		Integer (0..40)	If present, it is used as Q _{hyst1_s} for UE in CELL_PCH or URA_PCH state [4] [dB]	REL-5
Q _{hyst1_{s,FACH}}	CV-SIB4		Integer (0..40)	If present, it is used as Q _{hyst1_s} for UE in CELL_FACH state [4] [dB]	REL-5
Q _{hyst2_s}	CV-FDD-Quality-Measure		Integer (0..40 by step of 2)	Default value is Q _{hyst1_s} [4] [dB]	
Q _{hyst2_{s,PCH}}	CV-SIB4-FDD-Quality-Measure		Integer (0..40)	If present, it is used as Q _{hyst2_s} for UE using CPICH Ec/No quality measure in CELL_PCH or URA_PCH state. Default value is Q _{hyst1_{s,PCH}} [4] [dB]	REL-5
Q _{hyst2_{s,FACH}}	CV-SIB4-FDD-Quality-Measure		Integer (0..40)	If present, it is used as Q _{hyst2_s} for UE using CPICH Ec/No quality measure in CELL_FACH state. Default value is Q _{hyst1_{s,FACH}} [4] [dB]	REL-5

Treselections	MP		Integer (0..31)	[s]	
Treselection _{s,PCH}	CV-SIB4		Integer (0..31)	If present, it is used as Treselection _s for UE in CELL_PCH or URA_PCH state [4] [s]	REL-5
Treselection _{s,FACH}	CV-SIB4		Real (0..6.2 by step of 0.2)	If present, it is used as Treselection _s for UE in CELL_FACH state [4] [s]	REL-5
Speed dependent ScalingFactor for Treselection	OP		Real (0..1 by step of 0.1)	This IE is used by the UE in high mobility state as scaling factor for Treselection _s or Treselection _{s,PCH} or Treselection _{s,FACH} [4]. If present and HCS is used, the UE behaviour is unspecified.	REL-5
Inter-frequency ScalingFactor for Treselection	OP		Real (1..4.75 by step of 0.25)	If present, it is used by the UE as scaling factor for Treselection _s or Treselection _{s,PCH} or Treselection _{s,FACH} for inter-frequency cell reselection evaluation [4]. If present and HCS is used, the UE behaviour is unspecified.	REL-5
Inter-RAT ScalingFactor for Treselection	OP		Real (1..4.75 by step of 0.25)	If present, it is used by the UE as scaling factor for Treselection _s or Treselection _{s,PCH} or Treselection _{s,FACH} for inter-RAT cell reselection evaluation [4]. If present and HCS is used, the UE behaviour is unspecified.	REL-5
Non-HCS_T _{CRmax}	MD		Enumerated (not used, 30, 60, 120, 180, 240)	[s] Default value is 'not used'.	REL-5
Non-HCS_N _{CR}	CV-UE speed detector MD		Integer (1..16)	Default value = 8	REL-5
Non-HCS_T _{CRmaxHyst}	CV-UE speed detector MP		Enumerated (not used, 10, 20, 30, 40, 50, 60, 70)	[s]	REL-5
HCS Serving cell Information	OP		HCS Serving cell information 10.3.7.12		
Maximum allowed UL TX power	MP		Maximum allowed UL TX power 10.3.6.39	[dBm] UE_TXPWR_MAX_RACH in [4].	

Condition	Explanation
<i>FDD-Quality-Measure</i>	The IE is not needed if the IE "Cell selection and reselection quality measure" has the value CPICH RSCP, otherwise the IE is mandatory and has a default value.
<i>Delta</i>	This IE is optional if the value of Qrxlevmin is below – 115dBm. It is not needed otherwise.
<i>SIB3</i>	This IE is mandatory default if the IE "Cell selection and re-selection info for SIB3/4" is included in SIB type 3. It is not needed otherwise.
<i>SIB3op</i>	This IE is optional if the IE "Cell selection and re-selection info for SIB3/4" is included in SIB type 3. It is not needed otherwise.
<i>SIB4</i>	This IE is optional if the IE "Cell selection and re-selection info for SIB3/4" is included in SIB type 4. It is not needed otherwise.
<i>SIB4-FDD-Quality-Measure</i>	This IE is optional if the IE "Cell selection and re-selection info for SIB3/4" is included in SIB type 4, and the IE "Cell selection and reselection quality measure" has the value CPICH Ec/N0. It is not needed otherwise.
<i>UE Speed detector_MD (non-HCS)</i>	This IE is not needed if non-HCS_TCRmax equals 'not used', else it is mandatory default.
<i>UE Speed detector_MP (non-HCS)</i>	This IE is not needed if non-HCS_TCRmax equals 'not used', else it is mandatory present.

10.3.2.4 Cell selection and re-selection info for SIB11/12

Information Element/Group name	Need	Multi	Type and reference	Semantics description	Version
Qoffset1 _{s,n}	MD		Integer(-50..50)	Default value is 0. [dB]	
Qoffset2 _{s,n}	CV-FDD-Quality-Measure		Integer(-50..50)	Default value is 0. [dB]	
Maximum allowed UL TX power	MD		Maximum allowed UL TX power 10.3.6.39	According to UE_TXPWR_MAX_RACH in [4], [dBm]. If applied to FDD or TDD cells, the default is the Maximum allowed UL TX power for the serving cell. If applied to a GSM cell, the default is the UE maximum output power applicable for this GSM cell, according to the UE's radio access capability.	
HCS neighbouring cell information	OP		HCS Neighbouring cell information 10.3.7.11		
CHOICE mode >FDD	MP				

Information Element/Group name	Need	Multi	Type and reference	Semantics description	Version
>>Qqualmin	CV-FDD-Serving-Cell		Integer (-24..0)	Ec/No, [dB] Default value is Qqualmin for the serving cell	
>>Qrxlevmin	MD		Integer (-115..-25 by step of 2)	RSCP, [dBm] Default value is Qrxlevmin for the serving cell	
>>DeltaQrxlevmin	CV-Delta		Integer(-4..-2 by step of 2)	If present, the actual value of Qrxlevmin = Qrxlevmin + DeltaQrxlevmin	REL-5
>TDD					
>>Qrxlevmin	MD		Integer (-115..-25 by step of 2)	RSCP, [dBm] Default value is Qrxlevmin for the serving cell	
>> DeltaQrxlevmin	CV-Delta		Integer(-4..-2 by step of 2)	If present, the actual value of Qrxlevmin = Qrxlevmin + DeltaQrxlevmin	REL-5
>GSM					
>>Qrxlevmin	MD		Integer (-115..-25 by step of 2)	GSM RSSI, [dBm] Default value is Qrxlevmin for the serving cell	

Condition	Explanation
<i>FDD-Quality-Measure</i>	This IE is mandatory and has a default value for Intra/Inter Frequency Cells if the IE "Cell selection and reselection quality measure" has the value CPICH Ec/No. Otherwise the IE is absent.
<i>FDD-Serving-Cell</i>	This IE is mandatory and has a default value if the serving cell is an FDD cell. Otherwise the IE is mandatory present.
<i>Delta</i>	This IE is optional if Qrxlevmin is present and the value of Qrxlevmin is below -115dBm. It is not needed otherwise.

10.3.2.5 Mapping Info

Information Element/Group name	Need	Multi	Type and Reference	Semantics description	Version
Mapping List	MP	1 to <MaxRAT>			
>RAT	MP		Enumerated (UTRA FDD, UTRA TDD 3.84 Mcps, UTRA TDD 1.28 Mcps, GSM, cdma2000)		UTRA TDD 1.28 Mcps is included for REL-4.
>Mapping Function Parameter List	MP	1 to <maxMeas Intervals>			
>>Function type	MP			Type of the function within the interval.	

Information Element/Group name	Need	Multi	Type and Reference	Semantics description	Version
			Enumerated (linear, function type 2, function type 3, function type 4)	For 1.28Mcps TDD only. If IE "RAT" is set to "UTRA TDD 3.84 Mcps", the IE should be interpreted as: Enumerated (frequency scope1, frequency scope2, frequency scope3, RSCP threshold).	REL-11
>>Map_parameter_1	MD		Integer (0..99)	Parameter describing the mapping function between the quality measurement and the representing quality value, see [4]. Default value is zero for the first interval or otherwise the value of Map_parameter_2 of the interval before.	
				For 1.28Mcps TDD only. See Note1/Note2	REL-11
			Integer (0..127)	For 1.28 Mcps TDD, the parameter is used to indicate the uplink access location of the serving cell.	REL-7
>>Map_parameter_2	MP		Integer (0..99)	Parameter describing the mapping function between the quality measurement and the representing quality value, see [4].	
				For 1.28Mcps TDD only. See Note1	REL-11

Information Element/Group name	Need	Multi	Type and Reference	Semantics description	Version
>>Upper_limit	CV- <i>MaxInt</i>		Integer (1..MaxMeas)	Upper limit of interval for which the Map_parameter_1 and Map_parameter_2 are valid. MaxMeas = 25 if RAT = UTRA FDD / CPICH Ec/N0, MaxMeas = 91 if RAT = UTRA TDD 3.84 Mcps or if RAT = UTRA TDD 1.28 Mcps or if RAT = UTRA FDD/ CPICH RSCP, MaxMeas = 63 if RAT = GSM.	UTRA TDD 1.28 Mcps is included for REL-4.
				For 1.28Mcps TDD only. See Note1	REL-11

Condition	Explanation
<i>MaxInt</i>	This IE is mandatory present if Mapping Function Parameter List has not reached maxMeasIntervals and is not needed otherwise.
Note1:	If IE "function type" is set to "frequency scope1", for "Map_parameter_1" and "Map_parameter_2", this value is interpreted as the frequency which applies to the mapping relationship: (0, 99)-> (9400, 9499); for "Upper_limit", this value is interpreted as the frequency which applies to the mapping relationship: (1, 91)-> (9400, 9490). If IE "function type" is set to "frequency scope2", for "Map_parameter_1" and "Map_parameter_2", this value is interpreted as the frequency which applies to the mapping relationship: (0, 99)-> (9500, 9599); for "Upper_limit", this value is interpreted as the frequency which applies to the mapping relationship: (1, 91)-> (9500, 9590). If IE "function type" is set to "frequency scope3", for "Map_parameter_1" and "Map_parameter_2", only the value among (0, 75) is valid and interpreted as frequency which applies to the mapping relationship: (0, 75)-> (10050, 10125); for "Upper_limit", only the value among (1, 75) is valid and interpreted as frequency which applies to the mapping relationship: (1, 75)-> (10050, 10124).
Note2:	If IE "function type" is set to "RSCP threshold", only the value among (0, 90) is valid and interpreted as P-CCPCH RSCP value which applies to the mapping relationship: (0, 90)-> (-115, -25);

10.3.2.6 URA identity

Gives the identity of the UTRAN Registration Area. It can be used to indicate to the UE which URA it shall use in case of overlapping URAs.

Information Element/Group name	Need	Multi	Type and reference	Semantics description
URA identity	MP		bit string(16)	

10.3.2.7 Dedicated priority Information

This IE indicates priority information for GERAN, UTRAN and E-UTRAN for reselections.

Information Element/Group name	Need	Multi	Type and Reference	Semantics description	Version
CHOICE <i>Action</i>	MP				REL-8
>Clear dedicated priorities			NULL		REL-8
>Configure dedicated priorities					REL-8
>>T322	OP		Integer (5, 10, 20, 30, 60, 120, 180)	Time in minutes for which the configured dedicated priorities are valid. When the timer expires the UE should revert to using the priorities signalled in system information. Absence of this IE means that the configured dedicated priorities are valid until the next update. One spare value needed.	REL-8
>>Priority Level List	OP	1 to <maxPrio>			REL-8
>>>priority	OP		Integer (0.. <maxPrio-1>)	If this IE is absent then the UE behaviour is unspecified. 0 is the lowest priority and maxPrio-1 is the highest.	REL-8
>>>CHOICE Radio Access Technology	MP				REL-8
>>>>UTRA FDD					REL-8
>>>>>Frequency List	MP	1 to <maxNumFDDFreqs>			REL-8
>>>>>>UARFCN	MP		Integer(0 .. 16383)	UARFCN of the downlink carrier frequency [25.101]	REL-8
>>>>UTRA TDD					REL-8
>>>>>Frequency List	MP	1 to <maxNumTDDFreqs>			REL-8
>>>>>>UARFCN	MP		Integer(0 .. 16383)	UARFCN of the downlink carrier frequency [25.101]	REL-8
>>>>E-UTRA					REL-8
>>>>>Frequency List		1 to <maxNumEUTRAFreqs>			REL-8

Information Element/Group name	Need	Multi	Type and Reference	Semantics description	Version
>>>>>EARFCN	MP		Integer(0 .. 65535)	EARFCN of the downlink carrier frequency [64]. If the IE indicates a value of 65535, then the EARFCN for this instance should be read from the corresponding instance of IE "EARFCN extension".	REL-8
>>>>>EARFCN extension	OP		Integer(65536 .. 262143)	EARFCN of the downlink carrier frequency [64].	REL-11
>>>>GSM					REL-8
>>>>>GSM cell group	MP		GSM cell group 10.3.7.9a		REL-8
>>E-UTRA detection	MP		Boolean	'TRUE' means that the UE may detect the presence of a E-UTRA cell and report to NAS	REL-8

NOTE: It is always ensured by the UTRAN that priorities for different Radio Access Technologies are always different (e.g. a GERAN group of cells cannot have the same priority as a UTRA or E-UTRA frequency).

NOTE: It is always ensured by the UTRAN that priorities for which both $Thresh_{x,high2}$ and $Thresh_{x,low2}$ are provided are always different from the priorities for which both $Thresh_{x,high2}$ and $Thresh_{x,low2}$ are not provided.

10.3.2.8 CSG Identity

Information Element/Group name	Need	Multi	Type and reference	Semantics description	Version
CSG Identity	MP		Bit string(27)	As defined in [76]	REL-8

10.3.2.9 CSG PSC Split Information

Information Element/Group name	Need	Multi	Type and reference	Semantics description	Version
Start PSC	MP		Integer (0..504 by step of 8)	The value of this IE specifies the start PSC of the first PSC range (NOTE 1).	REL-8
Number of PSCs	MP		Enumerated (5, 10, 15, 20, 30, 40, 50, 64, 80, 120, 160, 256, alltheRest)	This IE specifies the number of PSCs reserved for CSG cells in each PSC range. "alltheRest" indicates all values from Start PSC to 511. Three spare values are needed.	REL-8

Information Element/Group name	Need	Multi	Type and reference	Semantics description	Version
PSC Range 2 Offset	CV- <i>alltheRest</i>		Integer (8..504 by step of 8)	If this IE is included, the UE shall calculate the second PSC range (NOTE 2). If this IE is not included, the UE shall consider the second PSC range to be not present.	REL-8
NOTE 1: Let the IE "Start PSC" = s. and "Number of PSCs" = n. The complete set of (n) PSC values in range 1 is defined as: {s, ((s + 1) mod 512), ((s + 2) mod 512) ... ((s + n-1) mod 512)}.					
NOTE 2: Let the IEs "Start PSC" + "Number of PSCs" - 1 + "PSC Range 2 Offset" = s. and "Number of PSCs" = n. The complete set of (n) PSC values in range 2 is defined as: {(s mod 512), ((s + 1) mod 512), ((s + 2) mod 512) ... ((s + n-1) mod 512)}.					

Condition	Explanation
<i>alltheRest</i>	This IE is optionally present if the value of IE "Number of PSCs" is not set to "alltheRest". Otherwise, it is not needed.

10.3.2.10 Dedicated WLAN Offload Information

This IE indicates dedicated information for RAN-assisted WLAN interworking.

Information Element/Group name	Need	Multi	Type and Reference	Semantics description	Version
CHOICE Configuration info	MP				REL-12
>Continue			(no data)		REL-12
>New configuration					REL-12
>>T330	OP		Integer (5, 10, 20, 30, 60, 120, 180)	Time in minutes. One spare value is needed.	REL-12
>>WLAN Offload Information	MP		WLAN Offload Information 10.3.9b.3		REL-12

10.3.3 UE Information elements

10.3.3.1 Activation time

Activation Time defines the frame number/time at which the operation/changes caused by the related message shall take effect. Values between 0 and 255 indicate the absolute value of CFN (Connection Frame Number) of that frame number/time.

Information Element/Group name	Need	Multi	Type and reference	Semantics description
Activation time	MP		Integer(0..255)	CFN [10]

10.3.3.2 Capability Update Requirement

This IE indicates to the UE which specific capabilities to transfer to the network.

Information Element/Group name	Need	Multi	Type and reference	Semantics description	Version
UE radio access FDD capability update requirement	MP		Boolean	TRUE indicates update required	

Information Element/Group name	Need	Multi	Type and reference	Semantics description	Version
UE radio access 3.84 Mcps TDD capability update requirement	MP		Boolean	TRUE indicates update required	Name changed in REL-4
UE radio access 7.68 Mcps TDD capability update requirement	MP		Boolean	TRUE indicates update required	REL-7
UE radio access 1.28 Mcps TDD capability update requirement	MP		Boolean	TRUE indicates update required	REL-4
System specific capability update requirement list	OP	1 to <maxSystemCapability>		In this version, a maximum size of 4 of the list shall be applied and any items after the 4 th item in the list shall be ignored.	
>System specific capability update requirement	MP		Enumerated (GSM	Five spare values needed.	REL-5
			, GERAN lu		REL-8
, E-UTRA)					REL-10
Requested E-UTRA Frequency Band list	CV- <i>BCHopt</i>	1 to 16			
>E-UTRA Frequency band	MP		Integer (1..256)	As defined in [64]. The value of 64 is reserved and shall not be used	REL-10

Condition	Explanation
<i>BCHopt</i>	This IE is not needed when sent in SYSTEM INFORMATION. Otherwise, the IE is optional

Default value is:

"UE radio capability FDD update requirement" = FALSE

"UE radio capability 3.84 Mcps TDD update requirement" = FALSE

"UE radio capability 7.68 Mcps TDD update requirement" = FALSE

"UE radio capability 1.28 Mcps TDD update requirement" = FALSE

"System specific capability update requirement" not present

"Requested E-UTRA Frequency Band list" not present.

10.3.3.3 Cell update cause

Indicates the cause for cell update.

Information Element/Group name	Need	Multi	Type and reference	Semantics description	Version
Cell update cause	MP		Enumerated (cell reselection, periodical cell update, uplink data transmission, paging response, re-entered service area, radio link failure, RLC unrecoverable error,	One spare value is needed.	REL-6
			MBMS reception, MBMS ptp RB request)		

10.3.3.4 Ciphering Algorithm

Information Element/Group name	Need	Multi	Type and reference	Semantics description	Version
Ciphering algorithm	MP		Enumerated (UEA0, UEA1		REL-7
			, UEA2)		

10.3.3.5 Ciphering mode info

This information element contains the ciphering specific security mode control information.

Information Element/Group name	Need	Multi	Type and reference	Semantics description
Ciphering mode command	MP		Enumerated (start/restart)	
Ciphering algorithm	MP		Ciphering algorithm 10.3.3.4	
Ciphering activation time for DPCH	OP		Activation time 10.3.3.1	Used for radio bearers mapped on RLC-TM. Only applicable if the UE is already in CELL_DCH state
Radio bearer downlink ciphering activation time info	OP		RB activation time info, 10.3.4.13	Used for radio bearers mapped on RLC-AM or RLC-UM The UTRAN should not include this IE in a message other than a SECURITY MODE COMMAND

10.3.3.6 CN domain specific DRX cycle length coefficient

A coefficient in the formula to count the paging occasions to be used by a specific UE (specified in [4]).

Information Element/Group name	Need	Multi	Type and reference	Semantics description
CN domain specific DRX cycle length coefficient	MP		Integer(6...9)	Refers to 'k' in the formula as specified in [4], Discontinuous reception

10.3.3.7 Void

10.3.3.7a Common E-RNTI info

NOTE: For 1.28 Mcps TDD only.

This IE defines the common E-RNTI used in enhanced CELL_FACH and Idle mode. Each instance in the IE "Common E-RNTI information" is related to an E-RUCCH which is defined in the PRACH system information in System Information Block 5. The first instance in IE "Common E-RNTI information" is related to the first instance of E-RUCCH in the PRACH system information in System Information Block 5 in the order of their appearances, the second instance in IE "Common E-RNTI information" is related to the second instance of E-RUCCH in the PRACH system information in System Information Block 5 and so on.

From each instance in the IE "Common E-RNTI information", we can compile a common E-RNTI list which is related to a certain E-RUCCH. For each E-RUCCH, there are a number of common E-RNTI groups related to it; up to 2 common E-RNTIs allocated in each group. The common E-RNTI list related to a certain E-RUCCH is derived in incremental manner with start code indicated by IE "Starting E-RNTI". The "Starting E-RNTI" corresponds to the first E-RNTI in the first group; if the "Number of E-RNTI per group" is bigger than one, then the second E-RNTI in the first group is derived by the first E-RNTI plus 1; the first E-RNTI in the second group is derived by the last of E-RNTI of the first group plus 1... the whole common E-RNTI list related to the E-RUCCH is compiled in this manner.

Information Element/Group name	Need	Multi	Type and reference	Semantics description	Version
Common E-RNTI information	MP	1 to <maxERUCCH>			REL-8
>Starting E-RNTI	MP		E-RNTI 10.3.3.10a	Indicates the starting code of E-RNTI related to a certain E-RUCCH.	REL-8
>Number of group	MP		Integer(1..maxERNTIgroup)	Indicates the number of common E-RNTI groups related to the E-RUCCH.	REL-8
>Number of E-RNTI per group	MP		Integer (1..maxERNTIperGroup)	Indicates the number of common E-RNTIs in the group.	REL-8

10.3.3.8 C-RNTI

The cell RNTI (C-RNTI) identifies a UE having a RRC connection within a cell.

Information Element/Group name	Need	Multi	Type and reference	Semantics description
C-RNTI	MP		bit string(16)	

10.3.3.8a CSG proximity indication capability

Information Element/Group name	Need	Multi	Type and reference	Semantics description	Version
Support of intra-frequency proximity indication	OP		Enumerated (TRUE)	The absence of this IE indicates that the UE does not support intra-frequency proximity indication	REL-9
Support of inter-frequency proximity indication	OP		Enumerated (TRUE)	The absence of this IE indicates that the UE does	REL-9

Information Element/Group name	Need	Multi	Type and reference	Semantics description	Version
				not support inter-frequency proximity indication	
Support of E-UTRA proximity indication	OP		Enumerated (TRUE)	The absence of this IE indicates that the UE does not support E-UTRA proximity indication	REL-9

10.3.3.9 Void

10.3.3.9a DSCH-RNTI

In TDD, the DSCH-RNTI identifies a UE in CELL_DCH or CELL_FACH using a DSCH or USCH within the cell.

Information Element/Group name	Need	Multi	Type and reference	Semantics description
DSCH-RNTI	MP		bit string(16)	

10.3.3.10 Void

10.3.3.10a E-RNTI

Information Element/Group name	Need	Multi	Type and reference	Semantics description	Version
E-RNTI	MP		bit string(16)		REL-6

10.3.3.11 Establishment cause

Cause for an RRC connection establishment request.

Information Element/Group name	Need	Multi	Type and reference	Semantics description	Version
Establishment cause	MP		Enumerated(Originating Conversational Call, Originating Streaming Call, Originating Interactive Call, Originating Background Call, Originating Subscribed traffic Call, Terminating Conversational Call, Terminating Streaming Call, Terminating Interactive Call, Terminating Background Call, Emergency Call, Inter-RAT cell re-selection, Inter-RAT cell change order, Registration, Detach, Originating High Priority Signalling, Originating Low Priority Signalling, Call re-establishment, Terminating High Priority Signalling, Terminating Low Priority Signalling, Terminating – cause unknown, MBMS reception, MBMS ptp RB request,	Nine spare values are needed.	
			Delay Tolerant Access)		REL-10

10.3.3.12 Expiration Time Factor

Information Element/Group name	Need	Multi	Type and reference	Semantics description
Expiration Time Factor	MP		Enumerated(2times, 4times, 8times, 16times, 32times, 64times, 128times, 256times)	

10.3.3.12a Extended Wait Time

The field defines the wait time for Delay Tolerant access request, to be passed to the UE upper layers.

Information Element/Group name	Need	Multi	Type and reference	Semantics description
Extended Wait time	MP		Integer(1..1800)	Value in seconds

10.3.3.12b Expiration Time Factor 2

Information Element/Group name	Need	Multi	Type and reference	Semantics description	Version
Expiration Time Factor 2	MP		Integer (0..15)		REL-12

10.3.3.13 Failure cause

Cause for failure to perform the requested procedure.

Information Element/Group name	Need	Multi	Type and reference	Semantics description
Failure cause	MP		Enumerated (configuration unsupported, physical channel failure, incompatible simultaneous reconfiguration, protocol error, compressed mode runtime error, cell update occurred, invalid configuration, configuration incomplete, unsupported measurement, MBMS session already received correctly, lower priority MBMS service)	Five spare values are needed.

10.3.3.14 Failure cause and error information

Cause for failure to perform the requested procedure.

Information Element/Group name	Need	Multi	Type and reference	Semantics description
Failure cause	MP		Failure cause 10.3.3.13	
Protocol error information	CV- <i>ProtErr</i>		Protocol error information 10.3.8.12	
Deleted TGPSI	CV- <i>CompModeErr</i>		TGPSI 10.3.6.82	

Condition	Explanation
<i>ProtErr</i>	The IE is mandatory present if the IE "Failure cause" has the value "Protocol error"; otherwise it is not needed in the message.
<i>CompModeErr</i>	The IE is mandatory present if the IE "Failure cause" has the value "Compressed mode runtime error"; otherwise it is not needed in the message

10.3.3.14o Group release information

Contains addressing information to perform a release of a group of RRC connections.

Information Element/Group name	Need	Multi	Type and reference	Semantics description	Version
U-RNTI group	MP		U-RNTI group 10.3.3.47a		REL-5

10.3.3.14a H-RNTI

The H-RNTI identifies an UE having a HS-PDSCH assignment within a cell.

Information Element/Group name	Need	Multi	Type and reference	Semantics description	Version
H-RNTI	MP		bit string(16)		REL-5

10.3.3.14b IMS Voice capability

Information Element/Group name	Need	Multi	Type and reference	Semantics description	Version
Voice over UTRA PS HS Support	OP		Enumerated (TRUE)	Absence of this IE means that the UE does not support IMS voice	REL-9
SRVCC Support from UTRA to UTRA	OP		Enumerated (TRUE)	Absence of this IE means that the UE does not support SRVCC from UTRA PS HS to UTRA CS	REL-9
SRVCC Support from UTRA to GERAN	OP		Enumerated (TRUE)	Absence of this IE means that the UE does not support SRVCC from UTRA PS HS to GERAN CS	REL-9
rSRVCC support from UTRA CS to E-UTRAN FDD	OP		Enumerated (TRUE)	Absence of this IE means that the UE does not support rSRVCC from UTRA CS to E-UTRAN FDD	REL-11
rSRVCC support from UTRA CS to E-UTRAN TDD	OP		Enumerated (TRUE)	Absence of this IE means that the UE does not support rSRVCC from UTRA CS to E-UTRAN TDD	REL-11

10.3.3.15 Initial UE identity

This information element identifies the UE at a request of an RRC connection.

Information Element/Group name	Need	Multi	Type and reference	Semantics description
CHOICE <i>UE id type</i>	MP			
>IMSI (GSM-MAP)			IMSI (GSM-MAP) 10.3.1.5	
>TMSI and LAI (GSM-MAP)				

>>TMSI (GSM-MAP)	MP		TMSI (GSM-MAP) 10.3.1.17	
>>LAI (GSM-MAP)	MP		Location Area Identification 10.3.1.7	
>P-TMSI and RAI (GSM-MAP)				
>>P-TMSI (GSM-MAP)	MP		P-TMSI (GSM-MAP) 10.3.1.13	
>>RAI (GSM-MAP)	MP		Routing Area Identification 10.3.1.16	
>IMEI			IMEI 10.3.1.4	
>ESN (DS-41)			Bit string (SIZE (32))	TIA/EIA/IS-2000-4
>IMSI (DS-41)			Octet string (SIZE (5..7))	TIA/EIA/IS-2000-4
>IMSI and ESN (DS-41)				TIA/EIA/IS-2000-4
>>IMSI (DS-41)	MP		Octet string (SIZE (5..7))	TIA/EIA/IS-2000-4
>>ESN (DS-41)	MP		Bit string (SIZE (32))	TIA/EIA/IS-2000-4
>TMSI (DS-41)			Octet string (SIZE (2..17))	TIA/EIA/IS-2000-4 Although normally upto 12 digits are used for this IE, a bigger length is used to support future extension.

10.3.3.16 Integrity check info

The Integrity check info contains the RRC message sequence number needed in the calculation of XMAC-I [40] and the calculated MAC-I.

Information Element/Group name	Need	Multi	Type and reference	Semantics description
Message authentication code	MP		bit string(32)	MAC-I [40]. The first/leftmost bit of the bit string contains the most significant bit of the MAC-I. The 27 MSB of the IE shall be set to zero and the 5 LSB of the IE shall be set to the value of the IE "RB identity" for the used signalling radio bearer when the encoded RRC message is used as the MESSAGE parameter in the integrity protection algorithm.
RRC Message sequence number	MP		Integer (0..15)	The local RRC hyper frame number (RRC HFN) is concatenated with the RRC message sequence number to form the input parameter COUNT-I for the integrity protection algorithm. The IE value shall be set to zero when the encoded RRC message is used as the MESSAGE parameter in the integrity protection algorithm.

10.3.3.17 Integrity protection activation info

This IE contains the time, in terms of RRC sequence numbers, when a new integrity protection configuration shall be activated for the signalling radio bearers.

Information Element/Group name	Need	Multi	Type and reference	Semantics description
RRC message sequence number list	MP	4 to 5		The RRC sequence number when a new integrity protection configuration shall be applied, for signalling radio bearers in the order RB0, RB1, RB2, RB3, RB4. The value for RB1 shall be ignored if this IE was included in a RRC message sent on RB1. The value for RB2 shall be ignored if this IE was included in a RRC message sent on RB2.
>RRC message sequence number	MP		Integer (0..15)	

10.3.3.18 Integrity protection Algorithm

Information Element/Group name	Need	Multi	Type and reference	Semantics description	Version
Integrity protection algorithm	MP		Enumerated (UIA1		
			, UIA2)		REL-7

10.3.3.19 Integrity protection mode info

Information Element/Group name	Need	Multi	Type and reference	Semantics description
Integrity protection mode command	MP		Enumerated(start, modify)	
Downlink integrity protection activation info	<i>CV-modify</i>		Integrity protection activation info 10.3.3.17	
Integrity protection algorithm	OP		Integrity protection algorithm 10.3.3.18	
Integrity protection initialisation number	<i>CV-start</i>		Bit string(32)	FRESH [40]. The first/leftmost bit of the bit string contains the most significant bit of the FRESH.

Condition	Explanation
<i>Start</i>	The IE is mandatory present if the IE "Integrity protection mode command" has the value "start ", otherwise it is not needed in the message.
<i>Modify</i>	The IE is mandatory present if the IE "Integrity protection mode command" has the value "modify" and not needed otherwise.

10.3.3.19a Void

10.3.3.20 Void

10.3.3.21 Measurement capability

Information Element/Group name	Need	Multi	Type and reference	Semantics description	Version
Inter-frequency detected set measurements	<i>CV-not_iRAT_HoInfo</i>		Enumerated (TRUE)	TRUE means that the UE is able to measure inter-frequency detected cells.	REL-10
Cells excluded from detected set measurements	<i>CV-not_iRAT_HoInfo</i>		Enumerated (TRUE)	TRUE means that the UE is able to exclude cells from detected set measurements.	REL-11
Wideband RSRQ FDD measurements	<i>CV-not_iRAT_HoInfo</i>		Enumerated (TRUE)	TRUE means that the UE is able to perform wideband RSRQ FDD measurements.	REL-11
Wideband RSRQ TDD measurements	<i>CV-not_iRAT_HoInfo</i>		Enumerated (TRUE)	TRUE means that the UE is able to perform wideband RSRQ TDD measurements.	REL-11
Event 2g reporting on a configured secondary downlink frequency	<i>CV-not_iRAT_HoInfo</i>		Enumerated (TRUE)	TRUE means that the UE is able to perform event 2g reporting on a configured secondary downlink frequency.	REL-12
Enhanced UPH reporting	<i>CV-not_iRAT_HoInfo</i>		Enumerated (TRUE)	TRUE means that the UE is able to perform reporting of filtered UPH measurement.	REL-12
Increased UE carrier monitoring UTRA	<i>CV-not_iRAT_HoInfo</i>		Enumerated (TRUE)	TRUE means that the UE supports increased number of UTRA carrier monitoring in connected and idle mode as defined in [19].	REL-12
Increased UE carrier monitoring E-UTRA	<i>CV-not_iRAT_HoInfo</i>		Enumerated (TRUE)	TRUE means that the UE supports increased number of E-UTRA carrier monitoring in connected and idle mode as defined in [74].	REL-12
Extended RSRQ lower value range	<i>CV-not_iRAT_HoInfo</i>		Enumerated (TRUE)	TRUE means that the UE supports the extended RSRQ lower value range from -34dB to -19.5dB.	REL-12
RSRQ measurement on all symbols	<i>CV-not_iRAT_HoInfo</i>		Enumerated (TRUE)	TRUE means that the UE supports the RSRQ measurement on all OFDM symbols and the extended upper RSRQ value range from -3dB to 2.5dB.	REL-12
Need for downlink compressed mode					

Information Element/Group name	Need	Multi	Type and reference	Semantics description	Version
FDD measurements	MP		Boolean	TRUE means that the UE requires DL compressed mode in order to perform measurements on FDD	
3.84 Mcps TDD measurements	CV- <i>3.84_Mcps_tdd_sup</i>		Boolean	TRUE means that the UE requires DL compressed mode in order to perform measurements on 3.84 Mcps TDD	Name changed in REL-4
7.68 Mcps TDD measurements	CV- <i>7.68_Mcps_tdd_sup</i>		Boolean	TRUE means that the UE requires DL compressed mode in order to perform measurements on 7.68 Mcps TDD	REL-7
1.28 Mcps TDD measurements	CV- <i>1.28_Mcps_tdd_sup</i>		Boolean	TRUE means that the UE requires DL compressed mode in order to perform measurements on 1.28 Mcps TDD	REL-4
GSM measurements	CV- <i>gsm_sup</i>				
>GSM 900	MP		Boolean	TRUE means that the UE requires DL compressed mode in order to perform measurements on GSM 900	
>DCS 1800	MP		Boolean	TRUE means that the UE requires DL compressed mode in order to perform measurements on DCS 1800	
>GSM 1900	MP		Boolean	TRUE means that the UE requires DL compressed mode in order to perform measurements on GSM 1900	
Multi-carrier measurement	CV- <i>mc_sup</i>		Boolean	TRUE means that the UE requires DL compressed mode in order to perform measurements on multi-carrier	

Information Element/Group name	Need	Multi	Type and reference	Semantics description	Version
Adjacent Frequency measurements without compressed mode	CV- <i>not_iRAT_</i> <i>HoInfo</i>		Enumerated (TRUE)	TRUE means that the UE does not require compressed mode for adjacent frequency measurements.	REL-8
Inter-band Frequency measurements without compressed mode	CV- <i>not_iRAT_</i> <i>HoInfo</i>		Enumerated (TRUE)	TRUE means that the UE does not require compressed mode for Inter-band measurements for the band combinations reported in the IE "Radio Access Capability Band Combination List".	REL-9
Enhanced inter-frequency measurements without compressed mode	CV- <i>not_iRAT_</i> <i>HoInfo</i>		Enumerated (TRUE)	TRUE means that the UE does not require compressed mode for measurements on two additional frequencies	REL-10
Frequency specific compressed mode	CV- <i>not_iRAT_</i> <i>HoInf</i>		Enumerated (TRUE)	TRUE means that for the dual band operation the UE can apply compressed mode only to the configured frequencies, which belong to the frequency band other than the serving HS-DSCH cell.	REL-10
Inter-frequency measurements on configured carriers without compressed mode	CV- <i>not_iRAT_</i> <i>HoInf</i>		Enumerated (TRUE)	TRUE means that the UE does not require compressed mode for measurements on the frequencies which are configured for HS-DSCH operation and associated with the secondary serving HS-DSCH cells.	REL-11
Need for uplink compressed mode					
FDD measurements	MP		Boolean	TRUE means that the UE requires UL compressed mode in order to perform measurements on FDD	

Information Element/Group name	Need	Multi	Type and reference	Semantics description	Version
3.84 Mcps TDD measurements	CV- 3.84_Mcps _tdd_sup		Boolean	TRUE means that the UE requires UL compressed mode in order to perform measurements on 3.84 Mcps TDD	Name changed in REL-4
7.68 Mcps TDD measurements	CV- 7.68_Mcps _tdd_sup		Boolean	TRUE means that the UE requires UL compressed mode in order to perform measurements on 7.68 Mcps TDD	REL-7
1.28 Mcps TDD measurements	CV- 1.28_Mcps _tdd_sup		Boolean	TRUE means that the UE requires DL compressed mode in order to perform measurements on 1.28 Mcps TDD	REL-4
GSM measurements	CV- gsm_sup				
>GSM 900	MP		Boolean	TRUE means that the UE requires UL compressed mode in order to perform measurements on GSM 900	
>DCS 1800	MP		Boolean	TRUE means that the UE requires UL compressed mode in order to perform measurements on DCS 1800	
>GSM 1900	MP		Boolean	TRUE means that the UE requires UL compressed mode in order to perform measurements on GSM 1900	
Multi-carrier measurement	CV- mc_sup		Boolean	TRUE means that the UE requires UL compressed mode in order to perform measurements on multi-carrier	

Condition	Explanation
<i>3.84_Mcps_tdd_sup</i>	The IE is mandatory present if an IE "TDD RF capability" is present with the IE "Chip rate capability" set to "3.84 Mcps". Otherwise this field is not needed in the message.
<i>7.68_Mcps_tdd_sup</i>	The IE is mandatory present if an IE "TDD RF capability" is present with the IE "Chip rate capability" set to "7.68 Mcps". Otherwise this field is not needed in the message.
<i>1.28_Mcps_tdd_sup</i>	The IE is mandatory present if an IE "TDD RF capability" is present with the IE "Chip rate capability" set to "1.28 Mcps". Otherwise this field is not needed in the message.
<i>gsm_sup</i>	The IE is mandatory present if the IE "Inter-RAT UE radio access capability" indicates support for GSM900, GSM1800 and/or GSM1900. Otherwise this field is not needed in the message.
<i>mc_sup</i>	The IE is mandatory present if the IE "Support of multi-carrier" has the value TRUE. Otherwise this field is not needed in the message.
<i>not_iRAT_HoInfo</i>	The IE is not needed in the INTER RAT HANDOVER INFO message. Otherwise, it is optionally present.

10.3.3.21a Measurement capability extension

This IE may be used to replace the measurement capability information provided within IE "Measurement capability".

Information Element/Group name	Need	Multi	Type and reference	Semantics description	Version
FDD measurements	MP	1 to <maxFreqBands FDD>		The network should ignore the entry that includes the 'extension indicator'.	
		1 to <maxFreqBands FDD2>			REL-6
		1 to <maxFreqBands FDD3>			REL-10
>FDD Frequency band	CV- <i>fd2</i>		Enumerated(Band I, Band II,	The default value is the same as indicated in the IE "Frequency band" included in the IE " UE radio access capability extension". Band numbering is defined in [21].	
			Band III,		REL-5
			Band VI, Band IV, Band V, Band VII, extension indicator)	The default value is the same as R99, if the IE "FDD Frequency band 2" below is not included. The setting of the value 'extension indicator' by the UE is not specified in the specification.	REL-6

Information Element/Group name	Need	Multi	Type and reference	Semantics description	Version
>FDD Frequency band 2	CV- <i>fdd1</i>		Enumerated(Band VIII, Band IX, Band X, Band XI, Band XII, Band XIII, Band XIV, Band XIX, Band XXI, Band XX, Band XXII, extension Indicator)	The default value is the same as indicated in the IE "Frequency band 2" included in the IE " UE radio access capability extension", if the IE "FDD Frequency band" above is not included. The setting of the value 'extension indicator' by the UE is not specified in the specification. Four spare values are needed	REL-6
>FDD Frequency band 3	OP		Enumerated (Band XXV, Band XXVI, Band XXXII, extension indicator)	If the IE is not present the value is the same as indicated in the IE "Frequency band 3" if included in the IE " UE radio access capability extension". The setting of the value 'extension indicator' by the UE is not specified in the specification. Sixty spare values are needed	REL-10
>Need for DL compressed mode	MP		Boolean	TRUE means that the UE requires DL compressed mode in order to perform measurements on the FDD frequency band indicated by the IE "FDD Frequency band"	
>Need for UL compressed mode	MP		Boolean	TRUE means that the UE requires UL compressed mode in order to perform measurements on the FDD frequency band indicated by the IE "FDD Frequency band"	
TDD measurements	CV- <i>tdd_sup</i>	1 to <maxFreqBands TDD>			
>TDD Frequency band	MP		Enumerated(a, b, c)		REL-7
			Enumerated(a, b, c, d)		
>Need for DL compressed mode	MP		Boolean	TRUE means that the UE requires DL compressed mode in order to perform measurements on TDD frequency band indicated by the IE "TDD Frequency band"	

Information Element/Group name	Need	Multi	Type and reference	Semantics description	Version
>Need for UL compressed mode	MP		Boolean	TRUE means that the UE requires UL compressed mode in order to perform measurements on TDD frequency band indicated by the IE "TDD Frequency band"	
GSM measurements	CV- <i>gsm_sup</i>	1 to <maxFreqBands GSM>			
>GSM Frequency band	MP		Enumerated(GSM450, GSM480, GSM850, GSM900P, GSM900E, GSM1800, GSM1900)	as defined in [45]. Nine spare values are needed.	
>Need for DL compressed mode	MP		Boolean	TRUE means that the UE requires DL compressed mode in order to perform measurements on GSM frequency band indicated by the IE "GSM Frequency band"	
>Need for UL compressed mode	MP		Boolean	TRUE means that the UE requires UL compressed mode in order to perform measurements on GSM frequency band indicated by the IE "GSM Frequency band"	
Multi-carrier measurement	CV- <i>mc_sup</i>				
>Need for DL compressed mode	MP		Boolean	TRUE means that the UE requires DL compressed mode in order to perform measurements on multi-carrier	
>Need for UL compressed mode	MP		Boolean	TRUE means that the UE requires UL compressed mode in order to perform measurements on multi-carrier	
E-UTRA measurements	CV- <i>utra_sup</i>	1 to <maxFreqBands EUTRA>		Note 1	REL-8

Information Element/Group name	Need	Multi	Type and reference	Semantics description	Version
>E-UTRA Frequency band	MP		Integer (1..64)	As defined in [64]. If the IE indicates a value of 64, then the E-UTRA Frequency band for this instance should be read from the corresponding instance of IE "E-UTRA Frequency band extension" in the E-UTRA measurements extension.	REL-8
>Need for compressed mode	MP		Boolean	TRUE means that the UE requires DL and UL compressed mode in order to perform measurements on E-UTRA frequency band indicated by the IE "E-UTRA Frequency band"	REL-8
E-UTRA measurements extension	CV-extended_utra_sup	1 to <maxFreqBands EUTRA>		Note 1	REL-11
>E-UTRA Frequency band extension	MP		Integer (65..256)	As defined in [64]. Note 2	REL-11
E-UTRA measurements extension 1	CV-extended_meas_utra_sup	1 to <maxFreqBands EUTRA-ext>		Note 1	REL-11
>E-UTRA Frequency band extension 1	MP		Integer (1..256)	As defined in [64]. The value of 64 is reserved and shall not be used.	REL-11
>Need for compressed mode	MP		Boolean	TRUE means that the UE requires DL and UL compressed mode in order to perform measurements on E-UTRA frequency band indicated by the IE "E-UTRA Frequency band extension 1"	REL-11
Note 1:	Indicates E-UTRA bands supported and the need for compressed mode, E-UTRAN measurement support may be separately indicated as specified in Annex E.				
Note 2:	If the corresponding instance of IE "E-UTRA Frequency band" does not indicate the reserved value of 64, then the UE can signal any valid value of IE "E-UTRA Frequency band extension".				

Condition	Explanation
<i>tdd_sup</i>	The IE is mandatory present if the IE "Multi-mode capability" has the value "TDD" or "FDD/TDD". Otherwise this field is not needed in the message.
<i>gsm_sup</i>	The IE is mandatory present if the IE "Support of GSM" has the value TRUE. Otherwise this field is not needed in the message.
<i>mc_sup</i>	The IE is mandatory present if the IE "Support of multi-carrier" has the value TRUE. Otherwise this field is not needed in the message.
<i>utra_sup</i>	At least one of these IEs is mandatory present if the IE "Support of E-UTRA" has the value TRUE. Otherwise these fields are not needed in the message.
<i>extended_utra_sup</i>	At least one of these IEs is mandatory present if the IE "Support of E-UTRA" has the value TRUE and the UE supports a E-UTRA frequency band greater than 64. Otherwise these fields are not needed in the message.
<i>extended_meas_utra_sup</i>	At least one of these IEs is mandatory present if the IE "Support of E-UTRA" has the value TRUE and the UE needs to report E-UTRA measurement capability for more than 16 E-UTRA bands. Otherwise these fields are not needed in the message.
<i>fdd1</i>	The IE is mandatory default if the IE "FDD Frequency band" is not included in the message. Otherwise this field is not needed in the message.
<i>fdd2</i>	The IE is mandatory default if the IE "FDD Frequency band 2" is not included in the message. Otherwise this field is not needed in the message.

10.3.3.21b Measurement capability TDD

This IE is only used for TDD if the UE is a multi-RAT capable which also supports E-UTRA.

Information Element/Group name	Need	Multi	Type and reference	Semantics description	Version
E-UTRA measurements	CV- <i>eutra_sup</i>	1 to <maxFreqBands EUTRA>		Note 1	REL-8
>E-UTRA Frequency band	MP		Integer (1..64)	As defined in [64]. If the IE indicates a value of 64, then the E-UTRA Frequency band for this instance should be read from the corresponding instance of IE "E-UTRA Frequency band extension" in the E-UTRA measurements extension.	REL-8
>Need for Idle Interval	MP		Boolean	TRUE means that the UE requires idle interval in order to perform measurements on E-UTRA frequency band indicated by the IE "E-UTRA Frequency band"	REL-8
E-UTRA measurements extension	CV- <i>extended_eutra_sup</i>	1 to <maxFreqBands EUTRA>		Note 1	REL-11
>E-UTRA Frequency band extension	MP		Integer (65..256)	As defined in [64]. Note 2	REL-11
Note 1: Indicates E-UTRA bands supported and the need for idle interval, E-UTRAN measurement support may be separately indicated as specified in Annex E.					
Note 2: If the corresponding instance of IE "E-UTRA Frequency band" does not indicate the reserved value of 64, then the UE can signal any valid value of IE "E-UTRA Frequency band extension".					

Condition	Explanation
<i>eutra_sup</i>	At least one of these IEs is mandatory present if the IE "Support of E-UTRA" has the value TRUE. Otherwise these fields are not needed in the message.
<i>extended_eutra_sup</i>	At least one of these IEs is mandatory present if the IE "Support of E-UTRA" has the value TRUE and the UE supports a E-UTRA frequency band greater than 64. Otherwise these fields are not needed in the message.

10.3.3.21ba Multiflow capability

Information Element/Group name	Need	Multi	Type and reference	Semantics description	Version
--------------------------------	------	-------	--------------------	-----------------------	---------

Support for Multiflow with MIMO operation in different bands	OP		Enumerated(single-stream, dual-stream)	Absence of this IE means that a UE does not support MIMO with Multiflow in different bands. Otherwise, it indicates whether a UE support single-stream or dual-stream MIMO.	REL-11
Longer HARQ processing time	OP		Enumerated(TRUE)	Presence of this IE indicates that a UE needs more time to generate the HARQ feedback with Multiflow and MIMO as described in [26], sub-clause 7.7.2.	REL-11

10.3.3.21bb Multiflow per band capability

Information Element/Group name	Need	Multi	Type and reference	Semantics description	Version
--------------------------------	------	-------	--------------------	-----------------------	---------

Number of cells	MP		Integer(2..8)	Total number of cells that can be configured to a UE as a part of Multiflow configuration. In this version of the specification, the maximum value is 4.	REL-11
Number of frequencies	MP		Integer(1..4)	Total number of frequencies, across which the Multiflow can be configured. In this version of the specification, the maximum value is 2.	REL-11
MIMO support	OP		Enumerated(single-stream, dual-stream)	Absence of this IE means that a UE does not support MIMO with Multiflow. Otherwise, it indicates whether a UE support single-stream or dual-stream MIMO.	REL-11
Non-contiguous multi-cell	OP			Presence of this IE indicates that a UE supports Multiflow operation with non-contiguous cells.	REL-11
>Gap size	MP		Enumerated(fiveMHz, tenMHz, anyGapSize)	This IE indicates the maximum gap size between the aggregated cells. "fiveMHz" indicates that UE supports 5 MHz gap size. "tenMHz" indicates that UE supports 10 MHz gap size and 5 MHz gap size. "anyGapSize" indicates that UE supports any multiple of 5 MHz gap size. 5 spare values are required.	REL-11

10.3.3.21c Neighbour Cell SI acquisition capability

Information Element/Group name	Need	Multi	Type and reference	Semantics description	Version
Support of intra-frequency SI acquisition for HO	OP		Enumerated (TRUE)	The absence of this IE indicates	REL-9

Information Element/Group name	Need	Multi	Type and reference	Semantics description	Version
				that the UE does not support intra-frequency SI acquisition for HO	
Support of inter-frequency SI acquisition for HO	OP		Enumerated (TRUE)	The absence of this IE indicates that the UE does not support inter-frequency SI acquisition for HO	REL-9
Support of E-UTRA SI acquisition for HO	OP		Enumerated (TRUE)	The absence of this IE indicates that the UE does not support E-UTRA SI acquisition for HO	REL-9

10.3.3.22 Paging cause

Cause for a CN originated page.

Information Element/Group name	Need	Multi	Type and reference	Semantics description
Paging cause	MP		Enumerated(Terminating Conversational Call, Terminating Streaming Call, Terminating Interactive Call, Terminating Background Call, Terminating High Priority Signalling, Terminating Low Priority Signalling, Terminating – cause unknown)	One spare value is needed.

10.3.3.23 Paging record

Information Element/Group name	Need	Multi	Type and reference	Semantics description	Version
CHOICE <i>Used paging identity</i>	MP				
>CN identity					
>>Paging cause	MP		Paging cause 10.3.3.22		
>>CN domain identity	MP		CN domain identity 10.3.1.1		
>>CHOICE <i>UE Identity</i>	MP			Three spare values are needed.	

Information Element/Group name	Need	Multi	Type and reference	Semantics description	Version
>>>IMSI (GSM-MAP)			IMSI (GSM-MAP) 10.3.1.5		
>>>TMSI (GSM-MAP)			TMSI (GSM-MAP) 10.3.1.17		
>>>P-TMSI (GSM-MAP)			P-TMSI (GSM-MAP) 10.3.1.13		
>>>IMSI (DS-41)			Octet string (SIZE (5..7))	TIA/EIA/IS-2000-4	
>>>TMSI (DS-41)			Octet string (SIZE (2..17))	TIA/EIA/IS-2000-4	
>UTRAN single UE identity					
>>U-RNTI	MP		U-RNTI 10.3.3.47		
>>CN originated page to connected mode UE	OP				
>>>Paging cause	MP		Paging cause 10.3.3.22		
>>>CN domain identity	MP		CN domain identity 10.3.1.1		
>>>Paging record type identifier	MP		Paging record type identifier 10.3.1.10		
>>RRC connection release information	MP		RRC connection release information 10.3.3.35o		REL-5
>UTRAN group identity		1 to <maxURNTIgroup>			REL-5
>>RRC connection release information	MP		RRC connection release information 10.3.3.35o		REL-5
>>Group release information	MP		Group release information 10.3.3.14o		REL-5

Condition	Explanation
CHOICE Used paging identity	Condition under which the given used paging identity is chosen
CN identity	For CN originating pages (for idle mode UEs)
UTRAN single UE identity	For UTRAN originating pages (for connected mode UEs), addressing a single UE
UTRAN group identity	For UTRAN originating pages (for connected mode UEs), addressing a group of UEs

10.3.3.24 PDCP capability

Indicates which algorithms and which value range of their parameters are supported by the UE.

Information Element/Group name	Need	Multi	Type and reference	Semantics description	Version
Support for lossless SRNS relocation	MP		Boolean	TRUE means supported	

Information Element/Group name	Need	Multi	Type and reference	Semantics description	Version
Support for lossless DL RLC PDU size change	CV- <i>not_iRAT_HoInfo2</i>		Boolean	TRUE means supported Default value is FALSE	REL-5
Support for RFC2507	MP		Boolean	TRUE means supported	
>Max HC context space	MP		Integer(1024, 2048, 4096, 8192, 16384, 32768, 65536, 131072)	Note 1	REL-5
Support for RFC 3095	CV- <i>not_iRAT_HoInfo</i>		Boolean	TRUE means header compression according to IETF ROHC standard [83], [84] is supported	REL-4
>Maximum number of ROHC context sessions	MD		Integer(2, 4, 8, 12, 16, 24, 32, 48, 64, 128, 256, 512, 1024, 16384)	Default value is 16.	REL-4
>Reverse decompression depth	MD		Integer (0..65535)	Default value is 0 (reverse decompression is not supported).	REL-4
>Support for RFC 3095 context relocation	MP		Boolean	TRUE means supported	REL-5
Support for CS Voice over HSPA	CV- <i>not_iRAT_HoInfo3</i>		Enumerated (TRUE)	The IE indicates the UE's support for CS Voice over HSPA, if set.	REL-8
Note 1: The IE "Max HC context space" values 16384, 32768, 65536 and 131072 are not used in the INTER RAT HANDOVER INFO message.					

Condition	Explanation
<i>not_iRAT_HoInfo</i>	The IE is optionally present in the INTER RAT HANDOVER INFO message. Otherwise, it is mandatory present.
<i>not_iRAT_HoInfo2</i>	The IE is not needed in the INTER RAT HANDOVER INFO message. Otherwise, it is mandatory default.
<i>not_iRAT_HoInfo3</i>	The IE is not needed in the INTER RAT HANDOVER INFO message. Otherwise, it is optionally present.

10.3.3.25 Physical channel capability

Information Element/Group name	Need	Multi	Type and Reference	Semantics description	Version
Downlink physical channel capability information elements					
FDD downlink physical channel capability	CH- <i>fd</i> <i>req</i> <i>_su</i> <i>p</i>				
>Max no DPCH codes	MP		Integer (1..8)	Maximum number of DPCH codes to be simultaneously received	
>Max no physical channel bits received	MP		Integer (1200, 2400, 3600, 4800, 7200, 9600, 14400, 19200, 28800, 38400, 48000, 57600, 67200, 76800)	Maximum number of physical channel bits received in any 10 ms interval (DPCH, S-CCPCH)	
>Support for SF 512 and 80 ms TTI for DPCH	MP		Boolean	TRUE means supported	
>Support for DCH Enhancements	CV- <i>not_iRAT_</i> <i>HoInfo2</i>		Enumerated (Basic, Full)	The absence of this IE indicates that the UE does not support DCH Enhancements	REL-12
>Simultaneous support for DCH Enhancements and Compressed Mode operation	CV- <i>not_iRAT_</i> <i>HoInfo2</i>		Enumerated (TRUE)	The absence of this IE indicates that the UE does not support simultaneous operation of DCH Enhancements and Compressed Mode.	REL-12
>Simultaneous support for DCH Enhancements and DPCCH Discontinuous Transmission	CV- <i>not_iRAT_</i> <i>HoInfo2</i>		Enumerated (TRUE)	The absence of this IE indicates that the UE does not support simultaneous operation of DCH Enhancements and DPCCH Discontinuous Transmission.	REL-12
>Support of Enhanced Serving Cell Change for Event 1c	CV- <i>not_iRAT_</i> <i>HoInfo2</i>		Enumerated (TRUE)	The absence of this IE indicates that the UE does not support Enhanced Serving Cell Change for Event 1c operation.	REL-12
>Support of DPCCH2	CV- <i>not_iRAT_</i> <i>HoInfo2</i>		Enumerated (TRUE)	The absence of this IE indicates that the UE does not support DPCCH2 transmission.	REL-12
>CHOICE <i>Support of HS-PDSCH</i>	CV- <i>not_iRAT_</i> <i>HoInfo</i>				REL-5
>>Supported					REL-5

Information Element/Group name	Need	Multi	Type and Reference	Semantics description	Version
>>>HS-DSCH physical layer category	MP		Integer (1..64)	As defined in [35]. Values 13..64 are spares. See Note 5.	REL-5
>>>HS-DSCH physical layer category extension	OP		Integer (1..20)	As defined in [35]. See Note 6.	REL-7
>>>HS-DSCH physical layer category extension 2	OP		Integer (21..24)	As defined in [35]. See Note 12. Absence of this IE means that dual cell operation is not supported.	REL-8
>>>HS-DSCH physical layer category extension 3	OP		Integer (25..28)	As defined in [35]. See Note 13. Absence of this IE means that dual cell operation is not supported with MIMO.	REL-9
>>>HS-DSCH physical layer category extension 4	OP		Integer (29,30)	As defined in [35]. See Note 16. Absence of this IE means the multi-cell operation on three cells is not supported.	REL-10
>>>HS-DSCH physical layer category extension 5	OP		Integer (31,32)	As defined in [35]. See Note 17. Absence of this IE means the multi-cell operation on four cells is not supported.	REL-10
>>>HS-DSCH physical layer category extension 6	OP		Integer (33,34)	As defined in [35]. See Note 18. Absence of this IE means the multi-cell operation on five and /or six cells is not supported.	REL-11
>>>HS-DSCH physical layer category extension 7	OP		Integer (35,36)	As defined in [35]. See Note 19. Absence of this IE means the multi-cell operation on seven and/or eight cells is not supported.	REL-11
>>>HS-DSCH physical layer category extension 8	OP		Integer (37,38)	As defined in [35]. See Note 20. Absence of this IE means the MIMO mode with four transmit antennas operation is not supported.	REL-11
>>>HS-SCCHless HS-DSCH operation support	OP		Enumerated (TRUE)	The absence of this IE indicates that the UE does not support HS-SCCHless HS-DSCH operation.	REL-7

Information Element/Group name	Need	Multi	Type and Reference	Semantics description	Version
>>>Enhanced F-DPCH support	OP		Enumerated (TRUE)	The absence of this IE indicates that the UE does not support enhanced F-DPCH	REL-7
>>>HS-PDSCH in CELL_FACH	OP		Enumerated (TRUE)	The absence of this IE indicates that the UE does not support HS-PDSCH reception in CELL_FACH	REL-7
>>>HS-PDSCH in CELL_PCH and URA_PCH	OP		Enumerated (TRUE)	The absence of this IE indicates that the UE does not support HS-PDSCH in neither CELL_PCH nor URA_PCH states.	REL-7
>>>Target Cell Pre-Configuration	OP		Enumerated (TRUE)	The absence of this IE indicates that the UE does not support HS-SCCH reception in target cell	REL-8
>>>Support of HS-DSCH DRX operation	OP		Enumerated (TRUE)	The absence of this IE indicates that the UE does not support HS-DSCH DRX operation	REL-8
>>>Support of MIMO only with single stream restriction	OP		Enumerated (TRUE)	The presence of this IE means that the UE supports MIMO only with single stream restriction.	REL-9
>>> Non-contiguous multi-cell with MIMO	OP		Enumerated (TRUE)	The presence of this IE means that the UE supports non-contiguous multi-cell with MIMO in the frequency bands where it supports non-contiguous multi-cell operation.	REL-11
>>>Support of MIMO mode with four transmit antennas only with dual stream restriction	OP		Enumerated (TRUE)	The presence of this IE means that the UE supports MIMO mode with four transmit antennas operation only with dual stream restriction.	REL-11
>>>Support of NodeB triggered HS-DPCCH transmission	OP		Enumerated (TRUE)	The absence of this IE indicates that the UE does not support NodeB triggered HS-DPCCH transmission	REL-11

Information Element/Group name	Need	Multi	Type and Reference	Semantics description	Version
>>>Support of HS-DSCH DRX operation with second DRX cycle	OP		Enumerated (TRUE)	The absence of this IE indicates that the UE does not support HS-DSCH DRX operation with second DRX cycle in CELL_FACH state.	REL-11
>>Unsupported				(no data)	REL-5
>DRX enhancements	CV- <i>not_iRAT_HoInfo2</i>		Enumerated (TRUE)	The absence of this IE indicates that the UE does not support DRX enhancements.	REL-12
>HS-DPCCH overhead reduction	CV- <i>not_iRAT_HoInfo2</i>		Enumerated (TRUE)	The absence of this IE indicates that the UE does not support HS-DPCCH overhead reduction for multi-RAB with DCH.	REL-12
3.84 Mcps TDD downlink physical channel capability	CH- <i>3.84_Mcps_tdd_req_s up</i>				Name changed in REL-4
>Maximum number of timeslots per frame	MP		Integer (1..14)		
>Maximum number of physical channels per frame	MP		Integer (1..224)		
>Minimum SF	MP		Integer (1, 16)		
>Support of PDSCH	MP		Boolean	TRUE means supported	
>CHOICE <i>Support of HS-PDSCH</i>	CV- <i>not_iRAT_HoInfo</i>				REL-5
>>Supported					REL-5
>>>HS-DSCH physical layer category	MP		Integer (1..64)	As defined in [35]	REL-5
>>Unsupported				(no data)	REL-5
>Maximum number of physical channels per timeslot	MP		Integer (5..16)		
7.68 Mcps TDD downlink physical channel capability	CH- <i>7.68_Mcps_tdd_req_s up</i>				REL-7
>Maximum number of timeslots per frame	MP		Integer (1..14)		REL-7
>Maximum number of physical channels per frame	MP		Integer (1..448)		REL-7
>Minimum SF	MP		Integer (1, 32)		REL-7
>Support of PDSCH	MP		Boolean	TRUE means supported	REL-7
>CHOICE <i>Support of HS-PDSCH</i>	CV- <i>not_iRAT_HoInfo</i>				REL-7
>>Supported					REL-7
>>>HS-DSCH physical layer category	MP		Integer (1..64)	As defined in [35]	REL-7
>>Unsupported				(no data)	REL-7
>Maximum number of physical channels per timeslot	MP		Integer (1..32)		REL-7

Information Element/Group name	Need	Multi	Type and Reference	Semantics description	Version
1.28 Mcps TDD downlink physical channel capability	CH- 1.28_Mcps _tdd_req_s up				REL-4
>Maximum number of timeslots per subframe	MP		Integer (1..6)		REL-4
>Maximum number of physical channels per subframe	MP		Integer (1..96)		REL-4
>Minimum SF	MP		Integer (1, 16)		REL-4
>Support of PDSCH	MP		Boolean	TRUE means supported	REL-4
>CHOICE Support of HS-PDSCH	CV- not_iRAT_ HoInfo				REL-5
>>Supported					REL-5
>>>HS-DSCH physical layer category	MP		Integer (1..64)	As defined in [35]. Values 16..64 are spares. See Note 8.	REL-5
>>>HS-DSCH physical layer category extension	OP		Integer (1..64)	As defined in [35]. See Note 6.	REL-8
>>>Multi-carrier HS-DSCH physical layer category	OP		Integer (1..64)	As defined in [35]. Absent if downlink multiple carrier is not supported. Values 45..64 are spares. See Note 10.	REL-7
>>>Multi-carrier HS-DSCH physical layer category extension	OP		Integer (1..36)	As defined in [35]. Absent if downlink multiple carrier is not supported. See Note 11.	REL-8
>>>Multi-carrier HS-DSCH physical layer category extension2	OP		Integer (37..64)	This IE shall be used if the Multi-carrier HS-DSCH physical layer category is larger than 36. Values 45..64 are spares. See Note 11.	REL-10
>>>Support of SF Mode For HS-PDSCH dual stream	OP		Enumerated (SF1, SF1/SF16)	For, 1.28 Mcps TDD only The absence of this IE indicates that the UE does not support MIMO.	REL-8
>>Unsupported				(no data)	REL-5
>Maximum number of physical channels per timeslot	MP		Integer (1..16)		REL-4
>Support of 8PSK	MP		Boolean	TRUE means supported	REL-4
>Support of non-rectangular resource allocation	CV- not_iRAT_ HoInfo2		Enumerated (TRUE)	For 1.28 Mcps TDD only. The absence of this IE indicates that the UE does not support the non-rectangular resource allocation.	REL-12

Information Element/Group name	Need	Multi	Type and Reference	Semantics description	Version
Uplink physical channel capability information elements					
FDD uplink physical channel capability	CH- <i>fdd_req_su</i> <i>p</i>				
>Maximum number of DPDCH bits transmitted per 10 ms	MP		Integer (600, 1200, 2400, 4800, 9600, 19200, 28800, 38400, 48000, 57600)		
>Support of cell reselection indication reporting	CV- <i>not_iRAT_</i> <i>HoInfo2</i>		Enumerated (TRUE)	The absence of this IE indicates that the UE does not support the report of Cell Reselection Indication during common E-DCH transmission.	REL-12
>Support of Serving E-DCH cell decoupling	CV- <i>not_iRAT_</i> <i>HoInfo2</i>		Enumerated (TRUE)	The absence of this IE indicates that the UE does not support Serving E-DCH cell decoupling operation.	REL-12
>Support of Radio Links without DPCH/F-DPCH	CV- <i>not_iRAT_</i> <i>HoInfo2</i>		Enumerated (TRUE)	The absence of this IE indicates that the UE does not support Radio Links without DPCH/F-DPCH.	REL-12
>CHOICE <i>Support of E-DCH</i>	CV- <i>not_iRAT_</i> <i>HoInfo</i>				REL-6
>>Supported					REL-6
>>>E-DCH physical layer category	MP		Integer (1..16)	As defined in [35] in Rel-6. Values 7 to 16 are spares. See Note 4.	REL-6
>>>E-DCH physical layer category extension	OP		Integer (7)	As defined in [35].	REL-7
>>>E-DCH physical layer category extension 2	OP		Integer (8..9)	As defined in [35]. See Note 14. Absence of this IE means that Dual Cell E-DCH operation is not supported.	REL-9
>>>E-DCH physical layer category extension 3	OP		Integer (10..12)	As defined in [35]. See Note 21. Absence of this IE means that neither 64 QAM in the uplink nor UL MIMO operation is supported.	REL-11

Information Element/Group name	Need	Multi	Type and Reference	Semantics description	Version
>>>DPCCH Discontinuous Transmission support	OP		Enumerated (TRUE)	The absence of this IE indicates that the UE does not support DPCCH Discontinuous Transmission	REL-7
>>>Slot Format #4 support	OP		Enumerated (TRUE)	The absence of this IE indicates that the UE does not support Slot Format #4	REL-7
>>Unsupported				(no data)	REL-6
>Access Groups based access control	CV-not_iRAT_HoInfo2		Enumerated (TRUE)	The absence of this IE indicates that the UE does not support control of DTCH transmissions in CELL_FACH and CELL_PCH.	REL-12
>Enhanced TTI switching	CV-not_iRAT_HoInfo2		Enumerated (TRUE)	The absence of this IE indicates that the UE does not support Enhanced TTI switching.	REL-12
>Implicit Grant handling	CV-not_iRAT_HoInfo2		Enumerated (TRUE)	The absence of this IE indicates that the UE does not support Implicit Grants on the Secondary Uplink frequency.	REL-12
>DTX enhancements	CV-not_iRAT_HoInfo2		Enumerated (TRUE)	The absence of this IE indicates that the UE does not support DTX enhancements.	REL-12
3.84 Mcps TDD uplink physical channel capability	CH-3.84_Mcps_tdd_req_s_up				Name changed in REL-4
>Maximum Number of timeslots per frame	MP		Integer (1..14)		
>Maximum number of physical channels per timeslot	MP		Integer (1, 2)		
>Minimum SF	MP		Integer (1, 2, 4, 8)		
>Support of PUSCH	MP		Boolean	TRUE means supported	
>CHOICE <i>Support of E-DCH</i>	CV-not_iRAT_HoInfo				REL-7
>>Supported					REL-7
>>>E-DCH physical layer category	MP		Integer (1..16)	As defined in [35]	REL-7
>>Unsupported				(no data)	REL-7
7.68 Mcps TDD uplink physical channel capability	CH-7.68_Mcps_tdd_req_s_up				REL-7
>Maximum Number of timeslots per frame	MP		Integer (1..14)		REL-7
>Maximum number of physical channels per timeslot	MP		Integer (1, 2)		REL-7

Information Element/Group name	Need	Multi	Type and Reference	Semantics description	Version
>Minimum SF	MP		Integer (1, 2, 4, 8)		REL-7
>Support of PUSCH	MP		Boolean	TRUE means supported	REL-7
>CHOICE <i>Support of E-DCH</i>	CV- <i>not_iRAT_</i> <i>HoInfo</i>				REL-7
>>Supported					REL-7
>>>E-DCH physical layer category	MP		Integer (1..16)	As defined in [35]	REL-7
>>Unsupported				(no data)	REL-7
1.28 Mcps TDD uplink physical channel capability	CH- <i>1.28_Mcps_</i> <i>_tdd_req_s</i> <i>up</i>				REL-4
>Maximum Number of timeslots per subframe	MP		Integer (1..6)		REL-4
>Maximum number of physical channels per timeslot	MP		Integer (1, 2, 3, 4)		REL-4 REL-7
>Minimum SF	MP		Integer (1, 2, 4, 8, 16)		REL-4
>Support of PUSCH	MP		Boolean	TRUE means supported	REL-4
>Support of 8PSK	MP		Boolean	TRUE means supported	REL-4
>CHOICE <i>Support of E-DCH</i>	CV- <i>not_iRAT_</i> <i>HoInfo</i>				REL-7
>>Supported					REL-7
>>>E-DCH physical layer category	MP		Integer (1..6)	As defined in [35] In case of multi-carrier E-DCH, this IE indicates the capability for each single carrier.	REL-7
>>>Multi-carrier E-DCH physical layer category	OP		Integer (1..8)	As defined in [35] Absent if multiple carrier E-DCH is not supported. See Note 15.	REL-10
>>>Maximum number of Carriers for Multi-carrier E-DCH	OP		Enumerated (nf-2, nf-3, nf-6)	One spare value is needed.	REL-10
>>Unsupported				(no data)	REL-7
NOTE 1: Void.					
NOTE 2: Void.					
NOTE 3: Void.					
NOTE 4: All UEs supporting E-DCH should signal a category between 1 and 6 for this IE even if the UE physical capability category is above 6.					
NOTE 5: All UEs supporting HS-DSCH should signal a category between 1 and 12 for this IE even if the UE physical capability category is above 12. This IE corresponds to the HS-DSCH category supported by the UE when MAC-ehs is not configured.					
NOTE 6: This IE corresponds to the HS-DSCH category supported by the UE when MAC-ehs is configured.					
NOTE 7: Void					
NOTE 8: All UEs supporting HS-DSCH should signal a category between 1 and 15 for this IE even if the UE physical capability category is above 15. This IE corresponds to the HS-DSCH category supported by the UE when MAC-ehs is not configured.					
NOTE 9: Void.					
NOTE 10: All UEs supporting multi-carrier HS-DSCH should signal a category between 1 and 18 or 39, 40, 43, 44 for this IE. This IE corresponds to the multi-carrier HS-DSCH category supported by the UE when MAC-ehs is not configured.					

Information Element/Group name	Need	Multi	Type and Reference	Semantics description	Version
NOTE 11: This IE corresponds to the multi-carrier HS-DSCH category supported by the UE when MAC-e-hs is configured.					
NOTE 12: This IE corresponds to the HS-DSCH category supported by the UE when dual cell operation is configured.					
NOTE 13: This IE corresponds to the HS-DSCH category supported by the UE when dual cell operation is configured with MIMO.					
NOTE 14: This IE corresponds to the E-DCH category supported by the UE when Dual Cell E-DCH operation is configured.					
NOTE 15: This IE corresponds to the E-DCH category supported by the UE when Multi-carrier E-DCH operation is configured.					
NOTE 16: This IE corresponds to the HS-DSCH category supported by the UE when it is configured with multi-cell operation on three cells.					
NOTE 17: This IE corresponds to the HS-DSCH category supported by the UE when it is configured with multi-cell operation on four cells.					
NOTE 18: This IE corresponds to the HS-DSCH category supported by the UE when it is configured with multi-cell operation on five and/or six cells.					
NOTE 19: This IE corresponds to the HS-DSCH category supported by the UE when it is configured with multi-cell operation on seven and/or eight cells.					
NOTE 20: This IE corresponds to the HS-DSCH category supported by the UE when MIMO mode with four transmit antennas operation is configured.					
NOTE 21: This IE corresponds to the E-DCH category supported by the UE when MIMO mode and/or 64QAM is configured.					

Condition	Explanation
<i>3.84_Mcps_tdd_req_sup</i>	The IE is mandatory present if the IE "TDD RF capability" is present with the IE "Chip rate capability" set to "3.84 Mcps" and a 3.84 Mcps TDD capability update has been requested in a previous message. Otherwise this field is not needed in the message.
<i>7.68_Mcps_tdd_req_sup</i>	The IE is mandatory present if the IE "TDD RF capability" is present with the IE "Chip rate capability" set to "7.68 Mcps" and a 7.68 Mcps TDD capability update has been requested in a previous message. Otherwise this field is not needed in the message.
<i>1.28_Mcps_tdd_req_sup</i>	The IE is mandatory present if the IE "TDD RF capability" is present with the IE "Chip rate capability" set to "1.28 Mcps" and a 1.28 Mcps TDD capability update has been requested in a previous message. Otherwise this field is not needed in the message.
<i>fdd_req_sup</i>	The IE is mandatory present if the IE "Multi-mode capability" has the value "FDD" or "FDD/TDD" and a FDD capability update has been requested in a previous message. Otherwise this field is not needed in the message.
<i>not_iRAT_HoInfo</i>	The CHOICE <i>Support of HS-PDSCH</i> is not needed in the INTER RAT HANDOVER INFO message. Otherwise, it is mandatory present.
<i>not_iRAT_HoInfo</i>	The CHOICE <i>Support of E-DCH</i> is not needed in the INTER RAT HANDOVER INFO message. Otherwise, it is mandatory present.
<i>not_iRAT_HoInfo2</i>	The IE is not needed in the INTER RAT HANDOVER INFO message. Otherwise, it is optional.

10.3.3.25a Pre-redirectio info

Information Element/Group name	Need	Multi	Type and Reference	Semantics description	Version
Support of E-UTRA FDD	MP		Boolean		REL-8
Support of E-UTRA TDD	MP		Boolean		REL-8

10.3.3.26 Protocol error cause

This IE indicates the cause for a message or information that was not comprehended.

Information Element/Group name	Need	Multi	Type and reference	Semantics description
Protocol error cause	MP		Enumerated (ASN.1 violation or encoding error, Message type non-existent or not implemented, Message not compatible with receiver state, Information element value not comprehended, Information element missing, Message extension not comprehended)	Two spare values are needed.

10.3.3.27 Protocol error indicator

This IE indicates whether a message was transmitted due to a protocol error or not.

Information Element/Group name	Need	Multi	Type and Reference	Semantics description
Protocol error indicator	MP		Boolean	TRUE means a protocol error occurred. FALSE means a protocol error did not occur.

10.3.3.28 RB timer indicator

This IE is used to indicate to UTRAN if the timers T314 or T315 has expired in the UE.

Information Element/Group name	Need	Multi	Type and reference	Semantics description
T314 expired	MP		Boolean	TRUE means that the timer has expired or the stored value is zero. FALSE means that the timer has not expired.
T315 expired	MP		Boolean	TRUE means that the timer has expired or the stored value is zero. FALSE means that the timer has not expired.

10.3.3.29 Redirection info

This IE is used to redirect the UE to another frequency or other system. With the Release 6 version a list of cells may be provided to the UE, where cell selection shall be started.

Information Element/Group name	Need	Multi	Type and reference	Semantics description	Version
CHOICE <i>Redirection Information</i>	MP				
>Frequency info			Frequency info 10.3.6.36		
>Inter-RAT info			Inter-RAT info 10.3.7.25		

10.3.3.30 Re-establishment timer

This information element indicates which timer to associate with RAB.

Information Element/Group name	Need	Multi	Type and reference	Semantics description
Re-establishment timer	MP		Enumerated(useT314, useT315)	

10.3.3.31 Rejection cause

Cause for rejection of RRC connection establishment request.

Information Element/Group name	Need	Multi	Type and reference	Semantics description
Rejection cause	MP		Enumerated(congestion, unspecified)	

10.3.3.32 Release cause

Cause for release of RRC connection.

Information Element/Group name	Need	Multi	Type and reference	Semantics description
Release cause	MP		Enumerated (normal event, unspecified, pre-emptive release, congestion, re-establishment reject, directed signalling connection re-establishment, user inactivity)	One spare value is needed.

10.3.3.32a RF Capability Compressed

Information Element/Group name	Need	Multi	Type and reference	Semantics description	Version
CHOICE <i>FDD</i>	MP				REL-5
>Supported					REL-5
>>RF capability band FDD list Compressed	MP	1..<maxf reqband sFDD>			REL-5
		1..<maxf reqband sFDD2>			REL-6
		1..<maxf reqband sFDD3>			REL-10
>>>RF Capability Band FDD Compressed	MP		Enumerated (not supported, default TxRx separation)	TX/RX frequency separation capability for the supported frequency band(s). Default is the TX/RX frequency separation defined in [21] for each frequency band. Two spare values are needed.	REL-5
>Not supported			NULL		REL-5
CHOICE <i>TDD-3.84Mcps</i>	MP				REL-5
>Supported					REL-5
>>Radio Frequency Band TDD List	MP		Enumerated (a, b, c, a+b, a+c, b+c, a+b+c)	As defined in [22]. One spare value needed	REL-5
			Enumerated (a, b, c, d, a+b, a+c, a+d, b+c, b+d, c+d, a+b+c, a+b+d, a+c+d, b+c+d, a+b+c+d)		REL-7
>Not supported			NULL		REL-5
CHOICE <i>TDD-7.68Mcps</i>	MP				REL-7
>Supported					REL-7
>>Radio Frequency Band TDD List	MP		Enumerated (a, b, c, d, a+b, a+c, a+d, b+c, a+b+c, a+b+d, a+c+d, b+c+d, a+b+c+d)	As defined in [22]. One spare value needed	REL-7
>Not supported			NULL		REL-7
CHOICE <i>TDD-1.28Mcps</i>	MP				REL-5
>Supported					REL-5
>>Radio Frequency Band TDD List	MP		Enumerated (a, b, c, a+b, a+c, b+c, a+b+c)	As defined in [22]. One spare value needed	REL-5
			Enumerated (a, b, c, d, a+b, a+c, a+d, b+c, b+d, c+d, a+b+c, a+b+d, a+c+d, b+c+d, a+b+c+d)		REL-7
>Not supported			NULL		REL-5

10.3.3.33 RF capability FDD

Information Element/Group name	Need	Multi	Type and Reference	Semantics description	Version
UE power class	MP		Enumerated(1..4)	As defined in [21]	

Information Element/Group name	Need	Multi	Type and Reference	Semantics description	Version
Tx/Rx frequency separation	MP		Enumerated(default TxRx separation)	Default is the TX/RX frequency separation defined in [21] for each frequency band. Two spare values are needed.	
Support of Multiple Frequency Band Indicators	CV- <i>not_iRAT_HoInfo</i>		Enumerated (TRUE)	FDD only. Absence of this IE means that the UE does not support the signalling requirements of multiple radio frequency bands, as defined in [85], and the UE does not understand the UARFCN signalling for all bands, that overlap with the band(s) supported by the UE.	REL-10

Condition	Explanation
<i>not_iRAT_HoInfo</i>	The IE is not needed in the INTER RAT HANDOVER INFO message. Otherwise, it is optional.

10.3.3.33a RF capability FDD extension

Information Element/Group name	Need	Multi	Type and Reference	Semantics description
UE power class extension	MP		Enumerated(1..4)	As defined in [21]. A UE with UE power class 3bis signals the value 3. Four spare values are needed
Tx/Rx frequency separation	MP		Enumerated(default TxRx separation)	Default is the TX/RX frequency separation defined in [21] for each frequency band. Two spare values are needed.

10.3.3.33b RF capability TDD

Information Element/Group name	Need	Multi	Type and Reference	Semantics description	Version
UE power class	MP		Enumerated (1..4)	as defined in [22]	
Radio frequency bands	MP		Enumerated(a, b, c, a+b, a+c, b+c, a+b+c)	as defined in [22]. One spare value needed.	REL-7
			Enumerated (a, b, c, d, a+b, a+c, a+d, b+c, b+d, c+d, a+b+c, a+b+d, a+c+d, b+c+d, a+b+c+d, Notabcd)		as defined in [22]. The value "Notabcd" indicate that the UE does not support neither one of the bands a, b, c nor d.
				as defined in [22].	REL-8
Radio frequency bands extension list	OP	1 to <maxFreqBandsTDD-ext>		as defined in [22].	REL-8
>Radio frequency bands ext	MP		Enumerated (e, f, g, h, i, j, k, l, m, n, o, p)	as defined in [22]. Band g to band p are reserved for future use.	REL-8
Chip rate capability	MP		Enumerated (3.84Mcps, 1.28Mcps, 7.68 Mcps)	as defined in [22]	
					REL-7

10.3.3.33c RF capability TDD 1.28 Mcps

Information Element/Group name	Need	Multi	Type and Reference	Semantics description	Version
Radio frequency bands	MP		Enumerated(a, b, c, a+b, a+c, b+c, a+b+c)	as defined in [22]. One spare value needed.	
			Enumerated (a, b, c, d, a+b, a+c, a+d, b+c, b+d, c+d, a+b+c, a+b+d, a+c+d, b+c+d, a+b+c+d)		REL-7

10.3.3.34 RLC capability

Information Element/Group name	Need	Multi	Type and Reference	Semantics description	Version
Total RLC AM buffer size	MP		Integer (10, 50, 100, 150, 500, 1000,	Total receiving and transmitting RLC AM buffer and MAC-hs/ehs reordering buffer capability in kBytes. Note 1. Note 2.	
			200, 300, 400, 750,		REL-5
			1150, 1250,		REL-9
			1500, 1800, 2300, 2550,	Total receiving and transmitting RLC AM buffer and MAC-hs/ehs reordering buffer capability in kBytes. Note 2. Four Spare values are needed.	Rel-10
			3400, 3500, 4400, 4500, 5000)		REL-11
Maximum RLC AM Window Size	MP		Integer(20 47,4095)	Maximum supported RLC TX and RX window in UE	
Maximum number of AM entities	MP		Integer (4,5,6,8,1 6,30)		
Support for Two logical channel Configuration	CV- <i>not_iRA</i> <i>T_HoInfo</i>		Boolean	TRUE means supported	REL-7
Note 1: The IE "Total RLC AM buffer size" values 200, 300, 400 and 750 are not used in the INTER RAT HANDOVER INFO message.					
Note 2: The IE "Total RLC AM buffer size" values 1150, 1250, 1500, 1800, 2300, 2550, 3400, 3500, 4400, 4500 and 5000 are not used in the INTER RAT HANDOVER INFO message.					

Condition	Explanation
<i>not_iRAT_HoInfo</i>	The IE is not needed in the INTER RAT HANDOVER INFO message. Otherwise, it is mandatory present.

10.3.3.35 RLC re-establish indicator

This IE is used to re-configure AM RLC on c-plane and u-plane.

Information Element/Group name	Need	Multi	Type and reference	Semantics description
RLC re-establish indicator	MP		Boolean	TRUE means re-establish required FALSE means re-establish not required

10.3.3.35a RRC State Indicator

Indicates to a UE the RRC state to be entered.

Information Element/Group name	Need	Multi	Type and reference	Semantics description
RRC State indicator	MP		Enumerated(CELL_DCH, CELL_FACH, CELL_PCH, URA_PCH)	

10.3.3.35o RRC connection release information

Indicates whether the UE shall perform a release of the RRC connection.

Information Element/Group name	Need	Multi	Type and reference	Semantics description	Version
CHOICE <i>Release indicator</i>	MD			Default value is "No release"	REL-5
>No release					REL-5
>Release					REL-5
>>Release cause	MP		Release cause 10.3.3.32		REL-5

10.3.3.36 RRC transaction identifier

This IE contains an identification of the RRC procedure transaction local for the type of the message this IE was included within.

Information Element/Group name	Need	Multi	Type and reference	Semantics description	Version
CHOICE <i>RRC Tr Id type</i>	MP				REL-5
> <i>Normal</i>					
>>RRC transaction identifier	MP		Integer (0..3)		
> <i>Extended</i>					REL-5
>>RRC transaction identifier	MP		Integer (0..15)		REL-5

CHOICE <i>RRC Tr Id type</i>	Condition under which the given <i>RRC Tr Id type</i> is chosen
<i>Normal</i>	All cases where the <i>RRC Tr Id type: Extended</i> is not chosen.
<i>Extended</i>	Optional in the MEASUREMENT CONTROL message. Mandatory in the MEASUREMENT CONTROL FAILURE message.

10.3.3.36a rSR-VCC Info

This IE contains information that allows the calculation of the CK and IK for the PS domain and the uplink traffic transmission information, due to an rSR-VCC procedure.

Information Element/Group name	Need	Multi	Type and reference	Semantics description	Version
NONCE	OP		Bit string (128)		REL-11
IMS information	MP		Octet String(SIZE(1..32))	Contains ATGW transfer details as defined in [24.237]	REL-11

10.3.3.37 Security capability

Information Element/Group name	Need	Multi	Type and reference	Semantics description	Version
Ciphering algorithm capability	MP				
>UEA0	MP		Boolean		
>UEA1	MP		Boolean		
>UEA2	MP		Boolean	The value TRUE means that UEA2 is fully interoperability tested. If fully interoperability tested, also "Security capability indication" of "UE radio access capability compressed" shall be set to TRUE.	REL-7
>Spare	MP	13	Boolean	Shall be set to FALSE by UEs complying with this version of the protocol.	
Integrity protection algorithm capability	MP				
>UIA1	MP		Boolean	The value TRUE means that UIA1, Kasumi, is supported	
>UIA2	MP		Boolean	The value TRUE means that UIA2 is fully interoperability tested. If fully interoperability tested, also "Security capability indication" of "UE radio access capability compressed" shall be set to TRUE.	REL-7
>Spare	MP	14	Boolean	Shall be set to FALSE by UEs complying with this version of the protocol.	

10.3.3.37a Signalling Connection Release Indication Cause

This IE is used to indicate to the UTRAN that there is no more PS data for a prolonged period.

Information Element/Group name	Need	Multi	Type and Reference	Semantics description	Version
Signalling Connection Release Indication Cause	MP		Enumerated (UE Requested PS Data session end, any other cause)		REL-8

10.3.3.38 START

There is a START value per CN domain. The START is used to initialise the 20 MSBs of all hyper frame numbers (MAC-d HFN, RLC UM HFN, RLC AM HFN, RRC HFN) for a CN domain.

Information Element/Group name	Need	Multi	Type and Reference	Semantics description
START	MP		Bit string (20)	START [40]. The first/leftmost bit of the bit string contains the most significant bit of the START.

10.3.3.39 Void

10.3.3.40 Transport channel capability

Information Element/Group name	Need	Multi	Type and Reference	Semantics description
Downlink transport channel capability information elements				
Max no of bits received	MP		Integer(640, 1280, 2560, 3840, 5120, 6400, 7680, 8960, 10240, 20480, 40960, 81920, 163840)	Maximum sum of number of bits of all transport blocks received at an arbitrary time instant
Max convolutionally coded bits received	MP		Integer(640, 1280, 2560, 3840, 5120, 6400, 7680, 8960, 10240, 20480, 40960, 81920, 163840)	Maximum sum of number of bits of all convolutionally coded transport blocks received at an arbitrary time instant
Max turbo coded bits received	CV- <i>turbo_dec_sup</i>		Integer(640, 1280, 2560, 3840, 5120, 6400, 7680, 8960, 10240, 20480, 40960, 81920, 163840)	Maximum sum of number of bits of all turbo coded transport blocks received at an arbitrary time instant
Maximum number of simultaneous transport channels	MP		Integer(4, 8, 16, 32)	
Maximum number of simultaneous CCTrCH	MP		Integer (1..8)	
Max no of received transport blocks	MP		Integer(4, 8, 16, 32, 48, 64, 96, 128, 256, 512)	Maximum total number of transport blocks received within TTIs that end at within the same 10ms interval
Maximum number of TFC	MP		Integer(16, 32, 48, 64, 96, 128, 256, 512, 1024)	
Maximum number of TF	MP		Integer(32, 64, 128, 256, 512, 1024)	
Support for turbo decoding	MP		Boolean	TRUE means supported
Uplink transport channel capability information elements				
Max no of bits transmitted	MP		Integer(640, 1280, 2560, 3840, 5120, 6400, 7680, 8960, 10240, 20480, 40960, 81920, 163840)	Maximum sum of number of bits of all transport blocks transmitted at an arbitrary time instant

Information Element/Group name	Need	Multi	Type and Reference	Semantics description
Max convolutionally coded bits transmitted	MP		Integer(640, 1280, 2560, 3840, 5120, 6400, 7680, 8960, 10240, 20480, 40960, 81920, 163840)	Maximum sum of number of bits of all convolutionally coded transport blocks transmitted at an arbitrary time instant
Max turbo coded bits transmitted	CV- <i>turbo_enc_sup</i>		Integer(640, 1280, 2560, 3840, 5120, 6400, 7680, 8960, 10240, 20480, 40960, 81920, 163840)	Maximum sum of number of bits of all turbo coded transport blocks transmitted at an arbitrary time instant
Maximum number of simultaneous transport channels	MP		Integer(4, 8, 16, 32)	
Maximum number of simultaneous CCTrCH of DCH type	CH- <i>tdd_req_sup</i>		Integer (1..8)	
Max no of transmitted transport blocks	MP		Integer(4, 8, 16, 32, 48, 64, 96, 128, 256, 512)	Maximum total number of transport blocks transmitted within TTIs that start at the same time
Maximum number of TFC	MP		Integer(16, 32, 48, 64, 96, 128, 256, 512, 1024)	
Maximum number of TF	MP		Integer(32, 64, 128, 256, 512, 1024)	
Support for turbo encoding	MP		Boolean	TRUE means supported

Condition	Explanation
<i>turbo_dec_sup</i>	The IE is mandatory present if the IE "Support of turbo decoding" = TRUE. Otherwise this field is not needed in the message.
<i>turbo_enc_sup</i>	The IE is mandatory present if the IE "Support of turbo encoding" = TRUE. Otherwise this field is not needed in the message.
<i>tdd_req_sup</i>	The IE is mandatory present if the IE "Multi-mode capability" has the value "TDD" or "FDD/TDD" and a TDD capability update has been requested in a previous message. Otherwise this field is not needed in the message.

10.3.3.41 UE multi-mode/multi-RAT capability

Information Element/Group name	Need	Multi	Type and Reference	Semantics description	Version
Multi-RAT capability					
Support of GSM	MP		Boolean		
Support of multi-carrier	MP		Boolean		
Multi-mode capability	MP		Enumerated (TDD, FDD, FDD/TDD)		
Support of UTRAN to GERAN NACC	CV-not_iRAT_HoInfo		Boolean		REL-5
Support of Handover to GAN	CV-not_iRAT_HoInfo2		Enumerated (DoesSupportHandoverToGAN)	Absence of this IE means that the UE does not support Handover to GAN.	REL-6
Support of Inter-RAT PS handover	CV-not_iRAT_HoInfo2		Enumerated (DoesSupportInter-RAT-PS-Handover)	Absence of this IE means that the UE does not support Inter-RAT PS Handover to GERAN	REL-6
Support of PS Handover to GAN	CV-not_iRAT_HoInfo2		Enumerated (DoesSupportPSHandoverToGAN)	Absence of this IE means that the UE does not support PS Handover to GAN.	REL-7
Support of E-UTRA FDD	CV-not_iRAT_HoInfo2		Enumerated (DoesSupportEUTRAFDD)	Absence of this IE means that the UE does not support E-UTRA FDD	REL-8
Support of Inter-RAT PS Handover to E-UTRA FDD	CV-not_iRAT_HoInfo2		Enumerated (DoesSupportInter-RAT-PS-HandoverToEUTRAFDD)	Absence of this IE means that the UE does not support Inter-RAT PS Handover to E-UTRA FDD	REL-8
Support of E-UTRA TDD	CV-not_iRAT_HoInfo2		Enumerated (DoesSupportEUTRATDD)	Absence of this IE means that the UE does not support E-UTRA TDD	REL-8
Support of Inter-RAT PS Handover to E-UTRA TDD	CV-not_iRAT_HoInfo2		Enumerated (DoesSupportInter-RAT-PS-HandoverToEUTRATDD)	Absence of this IE means that the UE does not support Inter-RAT PS Handover to E-UTRA TDD	REL-8
EUTRA Feature Group Indicators	CV-not_iRAT_HoInfo2		Bit string (4)	The definitions of the bits are described in Annex E	REL-8

Support of E-UTRA Multiple Frequency Band Indicators	CV- <i>not_iRAT_HoInfo2</i>		Enumerated (TRUE)	Absence of this IE means that the UE does not support the signalling requirements of multiple radio frequency bands in E-UTRA, as defined in [67], and the UE does not understand the EARFCN signalling for all bands, that overlap with the band(s) supported by the UE.	REL-10
Support of E-UTRA FDD measurements and reporting in CELL_FACH	CV- <i>not_iRAT_HoInfo2</i>		Enumerated (DoesSupportEUTRAmeasurementsandreportinginCELLFACH)	Absence of this IE means that the UE does not support E-UTRA measurement for CELL_FACH for E-UTRA FDD	REL-11
Support of E-UTRA TDD measurements and reporting in CELL_FACH	CV- <i>not_iRAT_HoInfo2</i>		Enumerated (DoesSupportEUTRAmeasurementsandreportinginCELLFACH)	Absence of this IE means that the UE does not support E-UTRA measurement for CELL_FACH for E-UTRA TDD	REL-11
Support of RAN-assisted WLAN interworking based on RAN rules	CV- <i>not_iRAT_HoInfo2</i>		Enumerated (TRUE)	Absence of this IE means that the UE does not support RAN-assisted WLAN interworking based on access network selection and traffic steering rules.	REL-12
Support of RAN-assisted WLAN interworking based on ANDSF policies	CV- <i>not_iRAT_HoInfo2</i>		Enumerated (TRUE)	Absence of this IE means that the UE does not support RAN-assisted WLAN interworking based on ANDSF policies.	REL-12

Condition	Explanation
<i>not_iRAT_HoInfo</i>	The IE is not needed in the INTER RAT HANDOVER INFO message. Otherwise, it is mandatory present.
<i>not_iRAT_HoInfo2</i>	The IE is not needed in the INTER RAT HANDOVER INFO message. Otherwise, it is optional.

NOTE: The UE sets the capability of Inter-RAT PS Handover (by means of the IE "Support of Inter-RAT PS handover") to the same value as the corresponding GERAN capability in [5].

10.3.3.42 UE radio access capability

Information Element/Group name	Need	Multi	Type and reference	Semantics description	Version	
Access stratum release indicator	MP		Enumerated(R99)	Indicates the release of the UE according to [35]. The IE also indicates the release of the RRC transfer syntax supported by the UE.		
	CV- <i>not_rrc_co</i> <i>nnectionSe</i> <i>tupComple</i> <i>te</i>			Enumerated(REL-4, REL-5, REL-6, REL-7, REL-8, REL-9, REL-10, REL-11, REL-12)	7 spare values are needed.	REL-4
						REL-5
						REL-6
						REL-7
						REL-8
						REL-9
						REL-10
						REL-11
REL-12						
DL capability with simultaneous HS-DSCH configuration	CV- <i>not_iRAT_</i> <i>HoInfo</i>		Enumerated(32kbps, 64kbps, 128kbps, 384kbps)		REL-5	
PDCP capability	MP		PDCP capability 10.3.3.24			
RLC capability	MP		RLC capability 10.3.3.34			
Transport channel capability	MP		Transport channel capability 10.3.3.40			
RF capability FDD	OP		RF capability FDD 10.3.3.33			
RF capability TDD	OP		RF capability TDD 10.3.3.33b	One "TDD RF capability" entity shall be included for every Chip rate capability supported.		
		1 to 2		Note 1	REL-4	
RF capability TDD 1.28 Mcps	CV- <i>iRAT_</i> <i>HoIn</i> <i>fo</i>		RF capability TDD 1.28 Mcps 10.3.3.33c	Note 1	REL-4	
Physical channel capability	MP		Physical channel capability 10.3.3.25			
UE multi-mode/multi-RAT capability	MP		UE multi-mode/multi-RAT capability 10.3.3.41			
Security capability	MP		Security capability 10.3.3.37			

Information Element/Group name	Need	Multi	Type and reference	Semantics description	Version
UE positioning capability	MP		UE positioning capability 10.3.3.45		
Measurement capability	OP		Measurement capability 10.3.3.21		
Measurement capability TDD	OP		Measurement capability TDD 10.3.3.21b		REL-8
Device type	MD		Enumerated (DoesNotBenefitFromBatteryConsumptionOptimisation)	<p>Absence of this value means that the device does benefit from NW-based battery consumption optimisation.</p> <p>UE may set the value to DoesNotBenefitFromBatteryConsumptionOptimisation when it does not foresee to particularly benefit from NW-based</p> <p>The IE is not needed in the INTER RAT HANDOVER INFO message.</p>	REL-6
Support for System Information Block type 11bis	OP		Enumerated (TRUE)		REL-6
				The IE shall be present and set to TRUE	REL-7

Information Element/Group name	Need	Multi	Type and reference	Semantics description	Version
Support for F-DPCH	CV- SupportFor HS		Enumerated (TRUE)	Presence of this information element indicates that F-DPCH is supported by the UE. Absence of this information element indicates that F-DPCH is not supported	REL-6
MAC-ehs support	OP		Enumerated (TRUE)	The presence of this IE indicates that UE supports MAC-ehs, the use of special value of HE field to indicate end of an SDU for RLC AM, octet aligned transport block table and different HS-SCCHs in contiguous TTIs. The absence of this IE indicates that the UE does not support either MAC-ehs, octet aligned transport block table or the use of special value of HE field to indicate end of an SDU for RLC AM or different HS-SCCHs in contiguous TTIs.	REL-7
UE specific capability Information LCR TDD	OP		Enumerated (NF, TriRxUniTx, TriRxTriTx, HexRxUniTx , HexRxTriTx, HexRxHexT,	For 1.28 Mcps TDD only	REL-7
			TwoRxUniTx Discontiguous, TwoRxTwoTxDiscontiguous, TwoRxUniTx Contiguous, TwoRxTwoTxContiguous)	TwoRxUniTxDiscontiguous and TwoRxTwoTxDiscontiguous mean that the UE is capable of supporting two non-adjacent carriers. TwoRxUniTxContiguous and TwoRxTwoTxContiguous mean that the UE is only capable of supporting two adjacent carriers. 6 spare values needed. Note 3.	REL-10

Information Element/Group name	Need	Multi	Type and reference	Semantics description	Version
Support for E-DPCCH Power Boosting	OP		Enumerated (TRUE)	The absence of this IE indicates that the E-DPCCH Power Boosting is not supported. The presence of this IE indicates that the E-DPCCH Power Boosting is supported by the UE.	REL-7
Support of common E-DCH	CV-not_iRAT_HoInfo		Enumerated (TRUE)	The absence of this IE indicates that the UE does not support E-DCH enhanced random access in CELL_FACH state and Idle mode.	REL-8
Support of MAC-i/is	CV-not_iRAT_HoInfo		Enumerated (TRUE)	The absence of this IE indicates that the UE does not support MAC-i/is operation.	REL-8
Support of Common E-RGCH based interference control	CV-not_iRAT_HoInfo		Enumerated (TRUE)	The absence of this IE indicates that the UE does not support Common E-RGCH based interference control in CELL_FACH state.	REL-11
Support of Fallback to R99 PRACH	CV-not_iRAT_HoInfo		Enumerated (TRUE)	The absence of this IE indicates that the UE does not support Fallback to R99 PRACH in CELL_FACH state and IDLE mode.	REL-11
Support of Concurrent deployment	CV-not_iRAT_HoInfo		Enumerated (TRUE)	The absence of this IE indicates that the UE does not support Concurrent deployment of 2ms and 10ms TTI in a cell in CELL_FACH state and IDLE mode.	REL-11
Support of TTI alignment and Per HARQ process	CV-not_iRAT_HoInfo		Enumerated (TRUE)	The absence of this IE indicates that the UE does not support TTI alignment and Per HARQ process activation and deactivation in CELL_FACH state and IDLE mode.	REL-11

Information Element/Group name	Need	Multi	Type and reference	Semantics description	Version
Support of SPS operation	CV- <i>not_iRAT_</i> <i>HoInfo</i>		Enumerated (TRUE)	For 1.28 Mcps TDD only. The absence of this IE indicates that the UE does not support SPS operation.	REL-8
Support of Control Channel DRX operation	CV- <i>not_iRAT_</i> <i>HoInfo</i>		Enumerated (TRUE)	For 1.28 Mcps TDD only. The absence of this IE indicates that the UE does not support Control Channel DRX operation	REL-8
Support of CSG	CV- <i>not_iRAT_</i> <i>HoInfo</i>		Enumerated (TRUE)	The absence of this IE indicates that the UE does not support access control based on CSG	REL-8
Support for Two DRX schemes in URA_PCH and CELL_PCH	OP		Enumerated (TRUE)	The absence of this IE indicates that the UE does not support Two DRX schemes in URA_PCH and CELL_PCH	REL-7
Support for E-DPDCH power interpolation formula	OP		Enumerated (TRUE)	The absence of this IE indicates that the UE does not support E-DPDCH power interpolation formula when 16QAM is not configured	REL-7
Support for absolute priority based cell re-selection in UTRAN	OP		Enumerated (TRUE)	The absence of this IE indicates that the UE does not support absolute priority based cell re-selection to UTRA inter-frequency	REL-8
Support of MU-MIMO	OP		Enumerated (Uplink, Uplink and Downlink)	The absence of this IE indicates that the UE does not support MU-MIMO. This IE is used for 1.28 Mcps TDD only	REL-10
Radio Access Capability Band Combination List	OP	1 to 16		The absence of this IE indicates that the UE does not support Dual Band Operation.	REL-9
>Band Combination	MP		Integer(1..256)	The integer value n indicates that the n^{th} DB-DC Configuration (A,B) in table 5.0AA in [21] is supported by the UE.	REL-9

Information Element/Group name	Need	Multi	Type and reference	Semantics description	Version
>Support for Dual Band Dual Cell E-DCH operation	OP		Enumerated (TRUE)	The absence of this IE indicates that the UE does not support dual band dual cell E-DCH operation on the corresponding band combination indicated by the IE "Band Combination".	REL-13
>Supported Carrier Combination	OP			Absence of this IE means that the UE only supports the carrier combination (1,1) for this band combination (A,B). If carrier combination (X,Y) is supported, then carrier combination (M,N) is supported, where $1 \leq M \leq X$ and $1 \leq N \leq Y$, so the corresponding value for that carrier combination (M,N) should be set to TRUE. Carrier combination (X,Y) for a band combination (A,B) refers to a block of X contiguous carriers in Band A and a block of Y contiguous carriers in Band B.	REL-10
>>Carrier Combination (1,2)	MP		Boolean	The value TRUE means that carrier combination (1,2) is supported for this band combination (A,B).	REL-10
>>Carrier Combination (2,1)	MP		Boolean	The value TRUE means that carrier combination (2,1) is supported for this band combination (A,B).	REL-10
>>Carrier Combination (1,3)	MP		Boolean	The value TRUE means that carrier combination (1,3) is supported for this band combination (A,B).	REL-10
>>Carrier Combination (3,1)	MP		Boolean	The value TRUE means that carrier combination (3,1) is supported for this band combination (A,B).	REL10

Information Element/Group name	Need	Multi	Type and reference	Semantics description	Version
>>Carrier Combination (2,2)	MP		Boolean	The value TRUE means that carrier combination (2,2) is supported for this band combination (A,B).	REL-10
>>Carrier Combination (1,4)	MP		Boolean	The value TRUE means that carrier combination (1,4) is supported for this band combination (A,B).	REL-11
>>Carrier Combination (4,1)	MP		Boolean	The value TRUE means that carrier combination (4,1) is supported for this band combination (A,B).	REL-11
>>Carrier Combination (1,5)	MP		Boolean	The value TRUE means that carrier combination (1,5) is supported for this band combination (A,B).	REL-11
>>Carrier Combination (5,1)	MP		Boolean	The value TRUE means that carrier combination (5,1) is supported for this band combination (A,B).	REL11
>>Carrier Combination (1,6)	MP		Boolean	The value TRUE means that carrier combination (1,6) is supported for this band combination (A,B).	REL-11
>>Carrier Combination (6,1)	MP		Boolean	The value TRUE means that carrier combination (6,1) is supported for this band combination (A,B).	REL-11
>>Carrier Combination (1,7)	MP		Boolean	The value TRUE means that carrier combination (1,7) is supported for this band combination (A,B).	REL-11
>>Carrier Combination (7,1)	MP		Boolean	The value TRUE means that carrier combination (7,1) is supported for this band combination (A,B).	REL-11
>>Carrier Combination (2,3)	MP		Boolean	The value TRUE means that carrier combination (2,3) is supported for this band combination (A,B).	REL11
>>Carrier Combination (3,2)	MP		Boolean	The value TRUE means that carrier combination (3,2) is supported for this band combination (A,B).	REL-11

Information Element/Group name	Need	Multi	Type and reference	Semantics description	Version
>>Carrier Combination (2,4)	MP		Boolean	The value TRUE means that carrier combination (2,4) is supported for this band combination (A,B).	REL-11
>>Carrier Combination (4,2)	MP		Boolean	The value TRUE means that carrier combination (4,2) is supported for this band combination (A,B).	REL-11
>>Carrier Combination (2,5)	MP		Boolean	The value TRUE means that carrier combination (2,5) is supported for this band combination (A,B).	REL-11
>>Carrier Combination (5,2)	MP		Boolean	The value TRUE means that carrier combination (5,2) is supported for this band combination (A,B).	REL11
>>Carrier Combination (2,6)	MP		Boolean	The value TRUE means that carrier combination (2,6) is supported for this band combination (A,B).	REL-11
>>Carrier Combination (6,2)	MP		Boolean	The value TRUE means that carrier combination (6,2) is supported for this band combination (A,B).	REL-11
>>Carrier Combination (3,3)	MP		Boolean	The value TRUE means that carrier combination (3,3) is supported for this band combination (A,B).	REL-11
>>Carrier Combination (3,4)	MP		Boolean	The value TRUE means that carrier combination (3,4) is supported for this band combination (A,B).	REL-11
>>Carrier Combination (4,3)	MP		Boolean	The value TRUE means that carrier combination (4,3) is supported for this band combination (A,B).	REL11
>>Carrier Combination (4,4)	MP		Boolean	The value TRUE means that carrier combination (4,4) is supported for this band combination (A,B).	REL11
>>Carrier Combination (3,5)	MP		Boolean	The value TRUE means that carrier combination (3,5) is supported for this band combination (A,B).	REL-11

Information Element/Group name	Need	Multi	Type and reference	Semantics description	Version
>>Carrier Combination (5,3)	MP		Boolean	The value TRUE means that carrier combination (5,3) is supported for this band combination (A,B).	REL-11
>Supported Multiflow Combination	OP			Presence of this IE indicates that UE supports Multiflow for this band combination. Note 5.	REL-11
>>Number of cells in band A	MP		Integer(1..6)	Total number of cells in band A that can be configured to a UE as a part of Multiflow configuration. In this version of the specification, the maximum value is 2.	REL-11
>>Number of frequencies in band A	MP		Integer(1..3)	Total number of frequencies in band A, across which the Multiflow can be configured. In this version of the specification, the maximum value is 1.	REL-11
>>Number of cells in band B	MP		Integer(1..6)	Total number of cells in band B that can be configured to a UE as a part of Multiflow configuration. In this version of the specification, the maximum value is 2.	REL-11
>>Number of frequencies in band B	MP		Integer(1..3)	Total number of frequencies in band B, across which the Multiflow can be configured. In this version of the specification, the maximum value is 1.	REL-11
Support of multi-cell configuration in inter-RAT handover	CV- <i>iRAT_HoIn fo</i>		Enumerated (TRUE)		REL-11

Information Element/Group name	Need	Multi	Type and reference	Semantics description	Version
Support of TX Diversity on DL Control Channels by MIMO Capable UE when MIMO operation is active	CV-not_iRAT_HoInfo		Enumerated (TRUE)	The absence of this IE indicates that the MIMO capable UE does not support TX diversity on DL Control Channels (HS-SCCH, F-DPCH, E-AGCH, E-HICH, E-RGCH) when MIMO is active, P-CPICH is configured on antenna 1, and S-CPICH on antenna 2.	REL-7
				The absence of this IE indicates that the MIMO capable UE does not support TX diversity on DL Control Channels (HS-SCCH, F-DPCH, E-AGCH, E-HICH, E-RGCH, F-TPICH) when MIMO is active, P-CPICH is configured on antenna 1, and S-CPICH on antenna 2.	REL-11
Support of enhanced TS0	OP		Enumerated (TRUE)	For 1.28 Mcps TDD only. The absence of this IE indicates that the UE does not support the enhanced TS0	REL-9
Support for cell-specific Tx diversity configuration for dual-cell operation	CV-Dual_Cell_HSDPA_supported		Enumerated (TRUE)	The absence of this IE indicates that the UE does not support cell-specific Tx diversity configuration when configured for dual-cell operation.	REL-8
CSG proximity indication capability	CV-not_iRAT_HoInfo		CSG proximity indication capability 10.3.3.8a		REL-9
Neighbour Cell SI acquisition capability	CV-not_iRAT_HoInfo		Neighbour Cell SI acquisition capability 10.3.3.21c		REL-9

Information Element/Group name	Need	Multi	Type and reference	Semantics description	Version
Extended measurements Support	CV-not_iRAT_HoInfo		Enumerated (TRUE)	TRUE means that the UE supports the extended measurement identity range 17 to 32.	REL-9
Support for dual cell with MIMO operation in different bands	CV-not_iRAT_HoInfo		Enumerated (TRUE)	The absence of this IE indicates that the UE does not support dual cell with MIMO operation in different bands	REL-10
UE based network performance measurements parameters	CV-not_iRAT_HoInfo		UE based network performance measurements parameters 10.3.3.53		REL-10
Support of UTRAN ANR	CV-not_iRAT_HoInfo		Enumerated (TRUE)	The absence of this IE indicates that the UE does not support UTRAN ANR.	REL-10
IMS Voice capability	CV-not_iRAT_HoInfo		IMS Voice capability 10.3.3.14b		REL-9
Multiflow capability	CV-not_iRAT_HoInfo		UE Multiflow capability 10.3.3.21ba		REL-11
Support of MAC-ehs window size extension	OP		Enumerated (TRUE)	For 1.28 Mcps TDD only, the absence of this IE indicates that the UE does not support IE "MAC-ehs window size extension". Note 4.	REL-9

Information Element/Group name	Need	Multi	Type and reference	Semantics description	Version
Support of UM RLC re-establishment via reconfiguration	<i>CV-not_iRAT_HoInfo</i>		Enumerated (TRUE)	The absence of this IE indicates that the UE does not support UM RLC re-establishment via reconfiguration.	REL-10
Support of HS-DPCCH power offset extension	<i>CV-not_iRAT_HoInfo</i>		Enumerated (TRUE)	The absence of this IE indicates that the UE does not support the HS-DPCCH power offset extension.	REL-11
Support of STTD on DL Control Channels when Multiflow operation is active	<i>CV-not_iRAT_HoInfo</i>		Enumerated (TRUE)	The absence of this IE indicates that a Multiflow capable UE does not support STTD on DL Control Channels (HS-SCCH, F-DPCH, E-AGCH, E-HICH, E-RGCH, F-TPICH) when Multiflow operation is active.	REL-11
Support of F-TPICH feedback from the Multiflow assisting cell	<i>CV-not_iRAT_HoInfo</i>		Enumerated (TRUE)	The absence of this IE indicates that the UE does not support reception of the F-TPICH feedback from the Multiflow assisting cell.	REL-12
Support of DSAC and PPAC update in CELL_DCH	<i>CV-not_iRAT_HoInfo</i>		Enumerated (TRUE)	The absence of this IE indicates that the UE does not support DSAC and PPAC update in CELL_DCH.	REL-12
Note 1:	The second entity of the "RF capability TDD" is not needed in the INTER RAT HANDOVER INFO message: if both TDD 3.84/7.68 Mcps and TDD 1.28 Mcps are supported, the "RF capability TDD 1.28 Mcps" entity shall be used for TDD 1.28 Mcps; the "UE power class" in the "RF capability TDD" entity shall apply for both chip rates.				
Note 2:	For 1.28 Mcps TDD, UE supporting E-DCH enhanced random access in CELL_FACH state and Idle mode always supports HS-PDSCH reception in CELL_FACH, CELL_PCH and URA_PCH state and CELL_FACH HS-DSCH DRX operation.				
Note 3:	Two non-adjacent carriers can be in the same band or in two different bands.				
Note 4:	This IE should always be set to "TRUE" in this version of the specification.				
Note 5:	If the Multiflow scenario dual-band three cells on two frequencies is supported in band combination A&B (2 cells in band A and 1 cell in band B), then it is also supported in band combination B&A (2 cells in band B and 1 cell in band A).				

Condition	Explanation
<i>not_rrc_connectionSetupComplete</i>	The IE is not needed in the RRC CONNECTION SETUP COMPLETE message. Otherwise the IE is mandatory present.
<i>not_iRAT_HoInfo</i>	The IE is not needed in the INTER RAT HANDOVER INFO message. Otherwise, it is optional.
<i>iRAT_HoInfo</i>	The IE is optional in the INTER RAT HANDOVER INFO message. Otherwise, the IE is not needed.
<i>Dual_Cell_HSDPA_supported</i>	This IE is optionally present if Dual-Cell HSDPA is supported. Otherwise it is not needed. The IE is not needed in the INTER RAT HANDOVER INFO message. Otherwise, it is optional.
<i>SupportForHS</i>	This IE is mandatory present if the UE supports HS-PDSCH, otherwise it is not needed. The IE is not needed in the INTER RAT HANDOVER INFO message.

10.3.3.42o UE radio access capability compressed

Information Element/Group name	Need	Multi	Type and reference	Semantics description	Version
Access stratum release indicator	MP		Enumerated (R99, REL-4, REL-5, REL-6, REL-7, REL-8, REL-9, REL-10, REL-11, REL-12)	7 spare values are needed.	REL-5
					REL-6
					REL-7
					REL-8
					REL-9
					REL-10
					REL-11
REL-12					
Total AM RLC buffer size exceeds 10 kByte	MP		BOOLEAN		REL-5
RF capability compressed	MP		RF capability compressed 10.3.3.32a		REL-5
Support for System Information Block type 11bis	OP		Enumerated (TRUE)		REL-6
				The IE shall be present and set to TRUE	REL-7
MAC-ehs support	OP		Enumerated (TRUE)	The presence of this IE indicates that UE supports MAC-ehs, the use of special value of HE field to indicate end of an SDU for RLC AM, octet aligned transport block table and different HS-SCCHs in contiguous TTIs. Absent if either MAC-ehs, octet aligned transport block table or the use of special value of HE field to indicate end of an SDU for RLC AM or different HS-SCCHs in contiguous TTIs are not supported	REL-7

Information Element/Group name	Need	Multi	Type and reference	Semantics description	Version
Security capability indication	OP		Enumerated (TRUE)	TRUE indicates UE security capabilities beyond R99 requirements, see 10.3.3.37	REL-7
GANSS support indication	OP		Enumerated (TRUE)	TRUE indicates that the UE supports GANSS	REL-7

10.3.3.42oa UE radio access capability comp 2

Information Element/Group name	Need	Multi	Type and reference	Semantics description	Version
FDD physical channel capability for HS-PDSCH/E-DCH	OP			Absent if HS-PDSCH and E-DCH are not supported	REL-6
>DL capability with simultaneous HS-DSCH configuration	OP		Enumerated (32, 64, 128, 384)	Unit: kbps. This IE is always required, but the need is set to OP to align with ASN.1	REL-6
>HS-DSCH physical layer category	MP		Integer (1..64)	As defined in [35]. Values 13..64 are spare.	REL-6
>HS-DSCH physical layer category extension	OP		Integer (1..20)	As defined in [35]. See Note 1.	REL-7
>HS-DSCH physical layer category extension 2	OP		Integer (21..24)	As defined in [35]. See Note 2.	REL-8
>HS-DSCH physical layer category extension 3	OP		Integer (25..28)	As defined in [35]. See Note 3.	REL-9
>HS-DSCH physical layer category extension 4	OP		Integer (29,30)	As defined in [35]. See Note 4.	REL-10
>HS-DSCH physical layer category extension 5	OP		Integer (31,32)	As defined in [35]. See Note 5.	REL-10
>HS-DSCH physical layer category extension 6	OP		Integer (33,34)	As defined in [35]. See Note 6.	REL-11
>HS-DSCH physical layer category extension 7	OP		Integer (35,36)	As defined in [35]. See Note 7.	REL-11
>HS-DSCH physical layer category extension 8	OP		Integer (37,38)	As defined in [35]. See Note 8.	REL-11
>CHOICE Support of E-DCH	MP				REL-6
>>Supported					REL-6
>>>E-DCH physical layer category	MP		Integer (1..16)	As defined in [35]	REL-6
>>>E-DCH physical layer category extension	OP		Integer (7)	As defined in [35].	REL-7
>>>E-DCH physical layer category extension 2	OP		Integer (8..9)	As defined in [35].	REL-9
>>>E-DCH physical layer category extension 3	OP		Integer(10..12)	As defined in [35].	REL-11
>>Unsupported				(no data)	REL-6

Information Element/Group name	Need	Multi	Type and reference	Semantics description	Version
Support for F-DPCH	CV- SupportF orHS		Enumerated (TRUE)		REL-6
				Presence of this information element indicates that F-DPCH is supported by the UE. Absence of this information element indicates that F-DPCH is not supported	REL-7
HS-SCCHless HS-DSCH operation support	OP		Enumerated (TRUE)	The absence of this IE indicates that the UE does not support HS-SCCHless HS-DSCH operation.	REL-7
Enhanced F-DPCH support	OP		Enumerated (TRUE)	The absence of this IE indicates that the UE does not support enhanced F-DPCH	REL-7
HS-PDSCH in CELL_FACH	OP		Enumerated (TRUE)	The absence of this IE indicates that the UE does not support HS-PDSCH reception in CELL_FACH	REL-7
HS-PDSCH in CELL_PCH and URA_PCH	OP		Enumerated (TRUE)	The absence of this IE indicates that the UE does not support HS-PDSCH in neither CELL_PCH nor URA_PCH states.	REL-7
DPCCH Discontinuous Transmission support	OP		Enumerated (TRUE)	The absence of this IE indicates that the UE does not support DPCCH Discontinuous Transmission	REL-7
Slot Format #4 support	OP		Enumerated (TRUE)	The absence of this IE indicates that the UE does not support Slot Format #4	REL-7
Support for CS Voice over HSPA	OP		Enumerated (TRUE)	The IE indicates the UE's support for CS Voice over HSPA, if set.	REL-8
Support for E-DPCCH Power Boosting	OP		Enumerated (TRUE)	The absence of this IE indicates that the E-DPCCH Power Boosting is not supported. The presence of this IE indicates that the E-DPCCH Power Boosting is supported by the UE.	REL-7

Information Element/Group name	Need	Multi	Type and reference	Semantics description	Version
Support of MAC-i/is	OP		Enumerated (TRUE)	The absence of this IE indicates that the UE does not support MAC-i/is operation.	REL-8
Support of TX Diversity on DL Control Channels by MIMO Capable UE when MIMO operation is active	OP		Enumerated (TRUE)	The absence of this IE indicates that the MIMO capable UE does not support TX diversity on DL Control Channels (HS-SCCH, F-DPCH, E-AGCH, E-HICH, E-RGCH) when MIMO is active, P-CPICH is configured on antenna 1, and S-CPICH on antenna 2.	REL-7
				The absence of this IE indicates that the MIMO capable UE does not support TX diversity on DL Control Channels (HS-SCCH, F-DPCH, E-AGCH, E-HICH, E-RGCH, F-TPICH) when MIMO is active, P-CPICH is configured on antenna 1, and S-CPICH on antenna 2.	REL-11
Support of HS-DPCCH power offset extension	OP		Enumerated (TRUE)	The absence of this IE indicates that the UE does not support the HS-DPCCH power offset extension.	REL-11
Support of DSAC and PPAC update in CELL_DCH	OP		Enumerated (TRUE)	The absence of this IE indicates that the UE does not support DSAC and PPAC update in CELL_DCH.	REL-12
Support for DCH Enhancements	OP		Enumerated (Basic, Full)	The absence of this IE indicates that the UE does not support DCH Enhancements	REL-12
Simultaneous support for DCH Enhancements and Compressed Mode operation	OP		Enumerated (TRUE)	The absence of this IE indicates that the UE does not support simultaneous operation of DCH Enhancements and Compressed Mode.	REL-12

Information Element/Group name	Need	Multi	Type and reference	Semantics description	Version
Simultaneous support for DCH Enhancements and DPCCH Discontinuous Transmission	OP		Enumerated (TRUE)	The absence of this IE indicates that the UE does not support simultaneous operation of DCH Enhancements and DPCCH Discontinuous Transmission.	REL-12

NOTE 1: This IE corresponds to the HS-DSCH category supported by the UE when MAC-ehs is configured.

NOTE 2: This IE corresponds to the HS-DSCH category supported by the UE when dual cell operation is configured.

NOTE 3: This IE corresponds to the HS-DSCH category supported by the UE when dual cell operation with MIMO on adjacent frequencies or in different bands is configured.

NOTE 4: This IE corresponds to the HS-DSCH category supported by the UE when it is configured with multi-cell operation on three cells.

NOTE 5: This IE corresponds to the HS-DSCH category supported by the UE when it is configured with multi-cell operation on four cells.

NOTE 6: This IE corresponds to the HS-DSCH category supported by the UE when it is configured with multi-cell operation on five or six cells.

NOTE 7: This IE corresponds to the HS-DSCH category supported by the UE when it is configured with multi-cell operation on seven or eight cells.

NOTE 8: This IE corresponds to the HS-DSCH category supported by the UE when MIMO mode with four transmit antennas operation is configured.

Condition	Explanation
<i>not_IRAT_HoInfo</i>	The IE is not needed in the INTER RAT HANDOVER INFO message. Otherwise, it is optional.
<i>SupportForHS</i>	This IE is mandatory present if the UE supports HS-PDSCH, otherwise it is not needed. The IE is not needed in the INTER RAT HANDOVER INFO message.

10.3.3.42ob UE radio access capability comp for 1.28 Mcps TDD

Information Element/Group name	Need	Multi	Type and reference	Semantics description	Version
1.28 Mcps TDD physical channel capability for HS-PDSCH/E-DCH	OP			Absent if HS-PDSCH and E-DCH are not supported	REL-8

Information Element/Group name	Need	Multi	Type and reference	Semantics description	Version
>Support of SF Mode For HS-PDSCH dual stream	OP		Enumerated (SF1, SF1/SF16)	For 1.28 Mcps TDD only The absence of this IE indicates that the UE does not support MIMO.	REL-8
Support of common E-DCH	OP		Enumerated (TRUE)	The absence of this IE indicates that the UE does not support E-DCH enhanced random access in CELL_FACH state and Idle mode.	REL-8
Support of MAC-i/is	OP		Enumerated (TRUE)	The absence of this IE indicates that the UE does not support MAC-i/is operation.	REL-8
Support of Control Channel DRX operation	OP		Enumerated (TRUE)	For 1.28 Mcps TDD only. The absence of this IE indicates that the UE does not support Control Channel DRX operation	REL-8
Support of SPS operation	OP		Enumerated (TRUE)	For 1.28 Mcps TDD only. The absence of this IE indicates that the UE does not support SPS operation.	REL-8
Radio frequency bands extension list	OP	1 to <maxFreqBandsTDD-ext>		as defined in [22].	REL-8
>Radio frequency bands ext	MP		Enumerated (e, f, g, h, i, j, k, l, m, n, o, p)	as defined in [22]. Band g to band p are reserved for future use.	REL-8
NOTE 1: All UEs supporting HS-DSCH should signal a category between 1 and 15 for this IE even if the UE physical capability category is above 15. This IE corresponds to the HS-DSCH category supported by the UE when MAC-ehs is not configured.					
NOTE 2: This IE corresponds to the HS-DSCH category supported by the UE when MAC-ehs is configured.					
NOTE 3: All UEs supporting multi-carrier HS-DSCH should signal a category between 1 and 18 for this IE even if the UE physical capability category is above 18. This IE corresponds to the multi-carrier HS-DSCH category supported by the UE when MAC-ehs is not configured.					
NOTE 4: This IE corresponds to the multi-carrier HS-DSCH category supported by the UE when MAC-ehs is configured.					

10.3.3.42a UE radio access capability extension

Information Element/Group name	Need	Multi	Type and reference	Semantics description	Version
Frequency band specific capability list	MP	1 to <maxFreqbandsFDD>		The network should ignore the entry that includes the 'extension indicator'.	REL-6
		1 to <maxFreqbandsFDD2>			

Information Element/Group name	Need	Multi	Type and reference	Semantics description	Version
		1 to <maxFrequencyBands>			REL-10
>Frequency band	MP		Enumerated(Band I, Band II,		
			Band III,		REL-5
			Band VI, Band IV, Band V, Band VII, extension indicator)	The setting of the value 'extension indicator' by the UE is not specified in the specification.	REL-6
>Frequency band 2	OP		Enumerated(Band VIII, Band IX, Band X, Band XI, Band XII, Band XIII, Band XIV, Band XIX, Band XXI, Band XX, Band XXII, extension Indicator)	This IE indicates the supported frequency bands Band VIII and beyond. The setting of the value 'extension indicator' by the UE is not specified in the specification. Four spare values are needed	REL-6
>Frequency band 3	OP		Enumerated (Band XXV, Band XXVI, extension Indicator)	This IE indicates the supported frequency bands Band XXIII and beyond. The setting of the value 'extension indicator' by the UE is not specified in the specification. Sixty One spare values are needed	REL-10
>RF capability FDD extension	MD		RF capability FDD extension 10.3.3.33a	the default values are the same values as in the immediately preceding IE "RF capability FDD extension"; the first occurrence is MP	
>Measurement capability extension	MP		Measurement capability extension 10.3.3.21a		
>Additional Secondary Cells	OP		Enumerated(a1, a2)	The number of additional secondary serving cells supported by the UE. The absence of this IE means that the UE does not support multi-cell operation on three cells or multi-cell operation on four cells.	REL-10

Information Element/Group name	Need	Multi	Type and reference	Semantics description	Version
>Additional Secondary Cells 2	OP		Enumerated(a3, a4, a5, a6)	The number of additional secondary serving cells supported by the UE. The absence of this IE means that the UE does not support multi-cell operation on five cells or multi-cell operation on six cells or multi-cell operation on seven cells or multi-cell operation on eight cells.	REL-11
>Non-contiguous multi-cell	OP	1 to <maxNonContiguousMultiCellCombinations>		The presence of this IE indicates that the UE supports the non-contiguous multi-cell HSDPA operation on two, three or four cells.	REL-10
>>Aggregated cells	MP		Enumerated(nc-2c, nc-3c, nc-4c)	This IE indicates the maximum number of cells supported in non-contiguous multi-cell operation. "nc-2c" indicates that UE supports 2 cells. "nc-3c" indicates that UE supports 2 and 3 cells. "nc-4c" indicates that UE supports 2, 3, and 4 cells.	REL-10
>>Gap size	MP		Enumerated(fiveMHz, tenMHz, anyGapSize)	This IE indicates the maximum gap size between the aggregated cells. "fiveMHz" indicates that UE supports 5 MHz gap size. "tenMHz" indicates that UE supports 10 MHz gap size and 5 MHz gap size. "anyGapSize" indicates that UE supports any multiple of 5 MHz gap size. 5 spare values are required.	REL-10

Information Element/Group name	Need	Multi	Type and reference	Semantics description	Version
>>Non-contiguous multi-cell Combination (2,2)	CV-NC-4C		Enumerated(TR UE)	The presence of this IE indicates that the UE supports an equal number of contiguous cells on each side of the gap. The absence of this IE indicates that the carrier combination (2,2) is not supported.	REL-10
>>Non-contiguous multi-cell Combination (3,1) (1,3)	CV-NC-4C		Enumerated(TR UE)	The presence of this IE indicates that UE supports a different number of contiguous cells on each side of the gap. The absence of this IE indicates that neither the carrier combination (3,1) nor the carrier combination (1,3) are supported.	REL-10
>Support of uplink closed loop transmit diversity	OP		Enumerated(TR UE)	Absence of this IE indicates that uplink CLTD is not supported on this frequency band.	REL-11
>Support of uplink open loop transmit diversity	OP		Enumerated(TR UE)	Absence of this IE indicates that uplink OLTD is not supported.	REL-11
>Multiflow per band capability	OP		Multiflow per band capability 10.3.3.21bb		REL-11
>Support of Uplink MIMO	OP		Enumerated(TR UE)	Absence of this IE indicates that UL MIMO is not supported in this frequency band.	REL-11
>MIMO mode with four transmit antennas per band capability	OP		Enumerated(TR UE)	Absence of this IE indicates that MIMO mode with four transmit antennas is not supported on this frequency band.	REL-11
>Frequency specific compressed mode for non-contiguous operation	OP		Enumerated(TR UE)	Absence of this IE indicates that the frequency specific compressed mode for non-contiguous operation is not supported in this band.	REL-11

Condition	Explanation
NC-4C	This IE is optional when the IE "aggregated cells" is set to "nc-4c". Otherwise it is not needed. When the IE "aggregated cells" is set to "nc-4c", at least one of the optional IE shall be included.

10.3.3.42b UE security information

Upon receiving a UE information request from another system, the UE shall indicate the requested security information. The UE security information includes the following RRC information.

Information Element/Group name	Need	Multi	Type and reference	Semantics description
UE information elements				
START-CS	MP		START 10.3.3.38	START values to be used in this CN domain.

10.3.3.42c UE security information2

Upon receiving a UE information request from another system, the UE shall indicate the requested security information. The UE security information includes the following RRC information.

Information Element/Group name	Need	Multi	Type and reference	Semantics description	Version
START-PS	MP		START 10.3.3.38	START values to be used in this CN domain.	Rel-6

10.3.3.43 UE Timers and Constants in connected mode

This information element specifies timer- and constants values used by the UE in connected mode.

Information Element/Group name	Need	Multi	Type and reference	Semantics description	Version
T301	MD		Integer(100, 200 .. 2000 by step of 200, 3000, 4000, 6000, 8000)	Value in milliseconds. Default value is 2000. This IE should not be used by the UE in this release of the protocol. One spare value is needed.	
N301	MD		Integer(0..7)	Default value is 2. This IE should not be used by the UE in this release of the protocol.	
T302	MD		Integer(100, 200... 2000 by step of 200, 3000, 4000, 6000, 8000)	Value in milliseconds. Default value is 4000. One spare value is needed.	
N302	MD		Integer(0..7)	Default value is 3.	
T304	MD		Integer(100, 200, 400, 1000, 2000)	Value in milliseconds. Default value is 2000. Three spare values are needed.	

Information Element/Group name	Need	Multi	Type and reference	Semantics description	Version
N304	MD		Integer(0..7)	Default value is 2..	
T305	MD		Integer(5, 10, 30, 60, 120, 360, 720, infinity)	Value in minutes. Default value is 30. Infinity means no update	
T307	MD		Integer(5, 10, 15, 20, 30, 40, 50)	Value in seconds. Default value is 30. One spare value is needed.	
T308	MD		Integer(40, 80, 160, 320)	Value in milliseconds. Default value is 160.	
T309	MD		Integer(1..8)	Value in seconds. Default value is 5.	
T310	MD		Integer(40..320 by step of 40)	Value in milliseconds. Default value is 160.	
N310	MD		Integer(0..7)	Default value is 4.	
T311	MD		Integer(250..2000 by step of 250)	Value in milliseconds. Default value is 2000.	
T312	MD		Integer (0..15)	Value in seconds. Default value is 1. The value 0 is not used in this version of the specification.	
N312	MD		Integer (1, 2, 4, 10, 20, 50, 100, 200, 400, 600, 800, 1000)	Default value is 1.	
T313	MD		Integer (0..15)	Value in seconds. Default value is 3.	
N313	MD		Integer (1, 2, 4, 10, 20, 50, 100, 200)	Default value is 20.	
T314	MD		Integer(0, 2, 4, 6, 8, 12, 16, 20)	Value in seconds. Default value is 12.	
T315	MD		Integer (0,10, 30, 60, 180, 600, 1200, 1800)	Value in seconds. Default value is 180.	
N315	MD		Integer (1, 2, 4, 10, 20, 50, 100, 200, 400, 600, 800, 1000)	Default value is 1.	
T316	MD		Integer(0, 10, 20, 30, 40, 50, infinity)	Value in seconds. Default value is 30. One spare value is needed.	

Information Element/Group name	Need	Multi	Type and reference	Semantics description	Version
T317	MD			Default value is infinity.	
			Enumerated (infinity, infinity, infinity, infinity, infinity, infinity, infinity)	All the values are changed to "infinity" in the Rel-5.	REL-5
T323	OP		Enumerated (0, 5, 10, 20, 30, 60, 90, 120)	Value in seconds. The use of 0secs indicates no need to apply the inhibit timer. See Note 1	REL-8

NOTE 1: If T323 is configured or cleared via non-critical extensions of UTRAN MOBILITY INFORMATION message, UTRAN should explicitly signal the other timers and constants in the same message. Otherwise the T323 configuration change is not applied to UE.

10.3.3.44 UE Timers and Constants in idle mode

This information element specifies timer- and constant values used by the UE in idle mode.

Information Element/Group name	Need	Multi	Type and reference	Semantics description
T300	MP		Integer(100, 200... 2000 by step of 200, 3000, 4000, 6000, 8000)	Value in milliseconds. Default value is 1000. Use of Default is described in 10.2.48.8.4 and in 10.2.48.8.16.
N300	MP		Integer(0..7)	Default value is 3. Use of Default is described in 10.2.48.8.4 and in 10.2.48.8.16.
T312	MP		Integer(0 .. 15)	Value in seconds. Default value is 1. Use of Default is described in 10.2.48.8.4 and in 10.2.48.8.16. The value 0 is not used in this version of the specification.
N312	MP		Integer (1, 2, 4, 10, 20, 50, 100, 200, 400, 600, 800, 1000)	Default value is 1. Use of Default is described in 10.2.48.8.4 and in 10.2.48.8.16.

10.3.3.45 UE positioning capability

Information Element/Group name	Need	Multi	Type and reference	Semantics description	Version
Standalone location method(s) supported	MP		Boolean	Defines if a UE can measure its location by some means unrelated to UTRAN TRUE means supported	
UE based OTDOA supported	MP		Boolean	TRUE means supported	
Network Assisted GPS support	MP		Enumerated ('Network based', 'UE based', 'Both', 'None')	Defines if the UE supports network based or UE based GPS methods.	
Network Assisted GANSS support List	CV-not_iRAT_HoInfo	1 to <maxGANSS>		Absent if GANSS is not supported	REL-7
>GANSS ID	OP		Enumerated(Absence of this IE means Galileo. Eight spare values needed.	REL-7
			SBAS, Modernized_GPS, QZSS, GLONASS,	Absence of this IE means Galileo. Four spare values needed.	REL-8
			BDS)	Absence of this IE means Galileo. Three spare values needed.	REL-12
>SBAS IDs	CV-GANSS-ID-SBAS		Bit String(8)	Defines the specific SBAS(s) supported. This is represented using a bit string with one bit per SBAS as defined in NOTE 1 where a one value indicates support and a zero value no support.	REL-8
>GANSS mode	MP		Enumerated ('Network based', 'UE based', 'Both', 'None')	Defines if the UE supports network based or UE based GANSS methods	REL-7
>GANSS Signal ID	OP		10.3.3.45a	Absence of this field means the default value as defined in 10.3.3.45a for the GANSS identified by GANSS ID.	REL-7
>GANSS Signal IDs	OP		Bit String(8)	Defines if a UE has the capability to perform measurements on more than one GANSS signal and which signals are supported. This is represented using a bit string with one bit per signal as defined in NOTE 2 where a one value indicates support and a zero value no support.	REL-8

>Support for GANSS timing of cell frames measurement	MP		Boolean	Defines if a UE has the capability to perform the UE GANSS timing of cell frames measurement. TRUE means capable	REL-7
>Support for GANSS Carrier-Phase Measurement	OP		Boolean	Defines if a UE has the capability to perform the UE GANSS Carrier-Phase Measurement. TRUE means capable	REL-7
>Support for non-native assistance choices	OP		Enumerated (TRUE)	Absence of this element means not supported and presence means the UE supports assistance data choices in formats not defined in the ICD of a particular GANSS. Multiple choices exist for assistance data elements defined in 10.3.7.89a, 10.3.7.94a/b, 10.3.7.97d.	REL-8
GANSS support indication	CV- <i>iRAT_HoInfo</i>		Enumerated (TRUE)	TRUE indicates that the UE supports GANSS	REL-7
Support for GPS timing of cell frames measurement	MP		Boolean	Defines if a UE has the capability to perform the UE GPS timing of cell frames measurement [7]. TRUE means capable	
Support for IPDL	MP		Boolean	Defines if a UE has the capability to use IPDL to enhance its 'SFN-SFN observed time difference –type 2' measurement. TRUE means supported	
Support for Rx-Tx time difference type2 measurement	MP		Boolean	TRUE means supported	
Support for UP assisted GPS measurement validity in CELL_PCH and URA_PCH states	CV-GPSSupported		Enumerated (TRUE)		
Support for SFN-SFN observed time difference type 2 measurement	OP		Enumerated (TRUE)	Absence of this element means not supported and presence means supported.	

Condition	Explanation
<i>GPSSupported</i>	This IE is mandatory present if the IE "Network Assisted GPS support" is set to 'Network based', 'UE based' or 'Both'. Otherwise, it is not needed.
<i>not_iRAT_HoInfo</i>	These IEs are not needed in the INTER RAT HANDOVER INFO message. Otherwise, they are optionally present.
<i>iRAT_HoInfo</i>	This IE is optionally present in the INTER RAT HANDOVER INFO message. Otherwise, the IE is not needed.
<i>GANSS-ID-SBAS</i>	This IE is mandatory present if the IE "GANSS ID" is "SBAS" and not needed otherwise.

NOTE 1: Coding of SBAS IDs:

SBAS IDs Bit String(8)							
Bit 1 (MSB)	Bit 2	Bit 3	Bit 4	Bit 5	Bit 6	Bit 7	Bit 8 (LSB)
WAAS	EGNOS	MSAS	GAGAN	-	-	-	-

NOTE 2: Coding of GANSS Signal IDs:

GANSS	GANSS Signal IDs Bit String(8)							
	Bit 1 (MSB)	Bit 2	Bit 3	Bit 4	Bit 5	Bit 6	Bit 7	Bit 8 (LSB)
Galileo	E1	E5a	E5b	E6	E5a+E5b	-	-	-
Modernized GPS	L1C	L2C	L5	-	-	-	-	-
SBAS	L1	-	-	-	-	-	-	-
QZSS	QZS-L1	QZS-L1C	QZS-L2C	QZS-L5	-	-	-	-
GLONASS	G1	G2	G3	-	-	-	-	-
BDS	B1I	-	-	-	-	-	-	-

10.3.3.45a GANSS Signal Id

The GANSS Signal ID encodes the identification of the signal for each GANSS. It depends on the GANSS Id.

Information Element/Group name	Need	Multi	Type and reference	Semantics description	Version
GANSS Signal Identity per Signal Id	MD		INTEGER (0..7)	See NOTE 1	REL-7

NOTE 1:

GNSS Id	Value	Explanation	Version
Default: Galileo	Default Value	Galileo E1	REL-7
	0	Galileo E5A	
	1	Galileo E5B	
	2	Galileo E6	
	3	Galileo E5A + E5B	
4-7	Reserved		
Modernized GPS	Default Value	GPS L1C	REL-8
	0	GPS L2C	
	1	GPS L5	
	2-7	Reserved	
SBAS	Default Value	L1	
	0-7	Reserved	
QZSS	Default Value	QZS-L1	
	0	QZS-L1C	
	1	QZS-L2C	
	2	QZS-L5	
	3-7	Reserved	
GLONASS	Default Value	GLONASS G1	
	0	GLONASS G2	
	1	GLONASS G3	
	2-7	Reserved	
BDS	Default Value	B1I	REL-12
	0-7	Reserved	

10.3.3.46 URA update cause

Indicates the cause for s URA update.

Information Element/Group name	Need	Multi	Type and reference	Semantics description
URA update cause	MP		Enumerated(change of URA, periodic URA update)	One spare value is needed.

10.3.3.47 U-RNTI

The U-RNTI (UTRAN Radio Network Temporary Identity) is allocated to a UE having a RRC connection and identifies the UE within UTRAN.

Information Element/Group name	Need	Multi	Type and reference	Semantics description
SRNC identity	MP		bit string(12)	<p>The SRNC ID unique in PLMN is encoded to SRNC identity IE in descending order from b31 . The b31 is the most significant bit.</p> <p>If the SRNC ID is more than 12 bits as defined in [57], the remaining bits are included as most significant bits of S-RNTI IE.</p> <p>If the UE ID unique in SRNS encoded in S-RNTI IE is more than 20 bits as defined in [57], the most significant bits are included as the least significant bits of SRNC ID.</p>
S-RNTI	MP		bit string(20)	<p>The UE ID unique in SRNS is encoded to the S-RNTI IE in descending order.</p> <p>If the S-RNTI IE is more than 20 bits as defined in [57], the remaining bits are included as the least significant bits of SRNC ID.</p> <p>If the SRNC ID is more than 12 bits as defined in [57], S-RNTI include both part of the SRNC ID and the UE-ID. The least significant bits encode the UE-ID to the S-RNTI IE in descending order. The b0 is the least significant bit.</p>

10.3.3.47a U-RNTI group

The U-RNTI group is used to identify a group of UEs having an RRC connection.

Information Element/Group name	Need	Multi	Type and reference	Semantics description	Version
CHOICE <i>group discriminator</i>	MP				REL-5
>All				(no data)	REL-5
>U-RNTI mask					REL-5
>>U-RNTI	MP		U-RNTI 10.3.3.47	The bits that are less significant than the bit position indicated by the U-RNTI bit mask index shall be ignored.	REL-5
>>U-RNTI bit mask index	MP		Enumerated(b1, b2,..b31)	Values b1 to b31 indicate bit positions in the S-RNTI and in the SRNC identity.	REL-5

10.3.3.48 U-RNTI Short

The U-RNTI (UTRAN Radio Network Temporary Identity) is allocated to a UE having a RRC connection and identifies the UE within UTRAN.

Information Element/Group name	Need	Multi	Type and reference	Semantics description
SRNC identity	MP		bit string(12)	The SRNC identity bits are numbered b20 to b31, where b20 is the least significant bit. If the SRNC ID is more than 12 bits as defined in [57], the remaining bits are included as most significant bits of S-RNTI 2 IE.
S-RNTI 2	MP		bit string(10)	The UE ID is encoded in S-RNTI 2 in descending order. If the SRNC ID is more than 12 bits as defined in [57], S-RNTI include both part of the SRNC ID and the UE-ID. The least significant bits encode the UE-ID to the S-RNTI IE in descending order. The b0 is the least significant bit.

10.3.3.49 UTRAN DRX cycle length coefficient

A coefficient in the formula to count the paging occasions to be used by a specific UE (specified in [4]).

Information Element/Group name	Need	Multi	Type and reference	Semantics description	Version
DRX cycle length coefficient	MP		Integer(3..9)	Refers to 'k' in the formula as specified in [4], Discontinuous reception	
DRX cycle length coefficient 2	MD		Integer(3..9)	Refers to 'k' in the formula as specified in [4], Discontinuous reception. The default value is "same as DRX cycle length coefficient".	REL-7
Time for DRX cycle 2	MD		Integer(80, 160, 320, 640, 1280, 2560, 5120)	Values in milliseconds. The default value is 0 ms.	REL-7

10.3.3.50 Wait time

Wait time defines the time period the UE has to wait before repeating the rejected procedure.

Information Element/Group name	Need	Multi	Type and reference	Semantics description
Wait time	MP		Integer(0..15)	Wait time in seconds The value 0 indicates that repetition is not allowed. Wait time should be set to zero if the IE "Extended Wait Time" is present in the RRC Connection Reject message.

10.3.3.51 UE Specific Behaviour Information 1 idle

This IE indicates the UE conformance typically for RRC connection establishment from idle mode.

Information Element/Group name	Need	Multi	Type and Reference	Semantics description
UE Specific Behaviour Information 1 idle	MP		bit string(4)	

10.3.3.52 UE Specific Behaviour Information 1 interRAT

This IE indicates the UE conformance typically for RRC connection establishment from another RAT.

Information Element/Group name	Need	Multi	Type and Reference	Semantics description
UE Specific Behaviour Information 1 interRAT	MP		bit string(8)	

10.3.3.53 UE based network performance measurements parameters

Information Element/Group name	Need	Multi	Type and Reference	Semantics description	Version
Support of Logged Measurements Idle PCH	OP		Enumerated (TRUE)	The absence of this IE indicates that the UE does not support logged measurements in Idle mode, URA_PCH or CELL_PCH states.	REL-10

10.3.4 Radio Bearer Information elements

10.3.4.0a Common RB mapping info

NOTE: For FDD and 1.28 Mcps TDD only.

A multiplexing option between a logical channel and a MAC-ehs queue.

Information Element/Group name	Need	Multi	Type and reference	Semantics description	Version
Logical channel identity	MP		Integer(1..15)	Note	REL-7
MAC-ehs queue identity	MP		MAC-ehs Queue Id 10.3.5.7f		REL-7

NOTE: the IE "Logical channel identity" conveys the value to be used in the "LCH-ID" field of the MAC-ehs header [15] associated with the MAC-ehs reordering queue identified by the IE "MAC-ehs queue identity".

10.3.4.0 Default configuration identity

This information element identifies a default radio parameter configuration. The corresponding default configurations are specified in subclause 13.7.

Information Element/Group name	Need	Multi	Type and reference	Semantics description	Version
Default configuration identity	MP		Integer (0..10,	See NOTE 1	
			11,		REL-4
			13,	Default configuration ID 2 is not used.	REL-5
			12, 14, 15, 16		REL-6
			17,	Used only in RRC Connection Setup message.	REL-6
			18..22,	See NOTE 1	REL-6
			23,	Default configuration 23 shall not be used in this version of the specification.	REL-9
			24,		REL-10
25..31)	Reserved for future extension	REL-10			
NOTE 1: For TDD, default configuration identities 0, 1, 5, 6, 7 and 22 are only valid from REL-10.					

10.3.4.0a Default configuration for CELL_FACH

This information element identifies a default radio parameter configuration for CELL_FACH. The corresponding default configurations are specified in subclause 13.8.

Information Element/Group name	Need	Multi	Type and reference	Semantics description	Version
Default configuration mode	MP		Enumerated (FDD, TDD)	Indicates whether the FDD or TDD version of the default configuration shall be used	REL-8
Default configuration identity for CELL_FACH	MP		Integer (0,		REL-8
			1..15)	Reserved for future extension	REL-8

10.3.4.1 Downlink RLC STATUS info

Information Element/Group name	Need	Multi	Type and reference	Semantics description	Version
Timer_Status_Prohibit	OP		Integer(10..50 by step of 10, 550..1000 by step of 50)	Minimum time in ms between STATUS reports	
Missing PDU Indicator	MP		Boolean	Value TRUE indicates that UE should send a STATUS report for each missing PDU that is detected	
Timer_STATUS_periodic	OP		Integer(100, 200, 300, 400, 500, 750, 1000, 2000)	Time in milliseconds	

Information Element/Group name	Need	Multi	Type and reference	Semantics description	Version
Timer_Reordering	CV- <i>Multiflow</i>		Integer(50,100,150,200,400,600,800,1000)	Time in milliseconds for which a UE should wait upon encountering a gap in the RLC sequence numbers. NOTE1.	REL-11
NOTE1: If this IE is included for SRB0 or SRB1, then the UE behaviour is unspecified.					

Condition	Explanation
<i>Multiflow</i>	The IE is optional when the Multiflow operation is configured, otherwise it is not needed.

10.3.4.1a PDCP context relocation info

This information element indicates that the header compression context relocation is to be performed during SRNS relocation for the given radio bearer.

Information Element/Group name	Need	Multi	Type and reference	Semantics description	Version
RB identity	MP		RB identity 10.3.4.16		REL-5
Downlink RFC 3095 context relocation indication	MP		Boolean	TRUE means RFC 3095 context relocation is performed in downlink	REL-5
Uplink RFC 3095 context relocation indication	MP		Boolean	TRUE means RFC 3095 context relocation is performed in uplink	REL-5

10.3.4.2 PDCP info

The purpose of the PDCP info IE is to indicate which algorithms shall be established and to configure the parameters of each of the algorithms.

Information Element/Group name	Need	Multi	Type and reference	Semantics description	Version
Support for lossless SRNS relocation or for lossless DL RLC PDU size change	CV- <i>LosslessCriteria</i>		Boolean	TRUE means support	
Max PDCP SN window size	CV- <i>Lossless</i>		Enumerated(s n255, sn65535)	Maximum PDCP sequence number window size. The handling of sequence number when the Max PDCP SN window size is 255 is specified in [23].	
PDCP PDU header	MP		Enumerated (present, absent)	Whether a PDCP PDU header is existent or not.	
Header compression information	OP	1 to <maxPDC PAlgoTyp e>			

Information Element/Group name	Need	Multi	Type and reference	Semantics description	Version
>CHOICE <i>algorithm type</i>	MP			Note 1	
>>RFC 2507				Header compression according to IETF standard RFC 2507	
>>>F_MAX_PERIOD	MD		Integer (1..65535)	Largest number of compressed non-TCP headers that may be sent without sending a full header. Default value is 256.	
>>>F_MAX_TIME	MD		Integer (1..255)	Compressed headers may not be sent more than F_MAX_TIME seconds after sending last full header. Default value is 5.	
>>>MAX_HEADER	MD		Integer (60..65535)	The largest header size in octets that may be compressed. Default value is 168.	
>>>TCP_SPACE	MD		Integer (3..255)	Maximum CID value for TCP connections. Default value is 15.	
>>>NON_TCP_SPACE	MD		Integer (3..65535)	Maximum CID value for non-TCP connections. Default value is 15.	
>>>EXPECT_REORDERING	MD		Enumerated (reordering not expected, reordering expected)	Whether the algorithm shall reorder PDCP SDUs or not. Default value is "reordering not expected".	
>>RFC 3095				Header compression according to IETF ROHC standard [83], [84].	REL-4

Information Element/Group name	Need	Multi	Type and reference	Semantics description	Version
>>>Profiles	MP	1 to <maxRO HC-Profiles>		Profiles supported by both compressor and decompressor in both UE and UTRAN. Profile 0 shall always be supported.	REL-4
>>>>Profile instance	MP		Integer(1.. 3)	1 = 0x0001, 2 = 0x0002, 3 = 0x0003 (see [52])	REL-4
>>>Uplink	OP			Indicates the necessary information elements for Uplink.	REL-4
>>>>Max_CID	MD		Integer (1.. 16383)	Highest context ID number to be used by the UE compressor. Default value is 15.	REL-4
>>>Downlink	OP			Indicates the necessary information elements for Downlink.	REL-4
>>>>Max_CID	MD		Integer (1.. 16383)	Highest context ID number to be used by the UE decompressor. Default value is 15.	REL-4
>>>>Reverse-Decompression_Depth	MD		Integer (0..65535)	Determines whether reverse decompression should be used or not and the maximum number of packets that can be reverse decompressed by the UE decompressor. Default value is 0 (reverse decompression shall not be used).	REL-4
Note 1: If several occurrences of the same algorithm type are included in the same IE "header compression information", the UE behaviour is unspecified.					

Condition	Explanation
<i>LosslessCriteria</i>	This IE is mandatory present if the IE "RLC mode" is "Acknowledged", the IE "In-sequence delivery " is TRUE and the IE "SDU Discard Mode" is "No discard" and not needed otherwise.
<i>Lossless</i>	This IE is mandatory present if the IE "Support for lossless SRNS relocation or for lossless RLC PDU size change" Is TRUE, otherwise it is not needed.

10.3.4.2a PDCP ROHC target mode

Information Element/Group name	Need	Multi	Type and Reference	Semantics description	Version
Target Mode	MP		Enumerated (O-mode, R-mode)	The UE shall only transit to the signalled mode for operation of ROHC as described in [36].	REL-5

10.3.4.3 PDCP SN info

Information Element/Group name	Need	Multi	Type and Reference	Semantics description
Receive PDCP sequence number	MP		Integer(0..65535)	The PDCP sequence number, which the sender of the message is expecting next to be received.

10.3.4.4 Polling info

Information Element/Group name	Need	Multi	Type and reference	Semantics description
Timer_poll_prohibit	OP		Integer(10..550 by step of 10, 600..1000 by step of 50)	Minimum time between polls in ms
Timer_poll	OP		Integer(10..550 by step of 10, 600..1000 by step of 50)	Time in ms.
Poll_PDU	OP		Integer(1,2,4,8,16,32,64,128)	Number of PDUs, interval between pollings
Poll_SDU	OP		Integer(1,4,16,64)	Number of SDUs, interval between pollings
Last transmission PDU poll	MP		Boolean	TRUE indicates that poll is made at last PDU in transmission buffer
Last retransmission PDU poll	MP		Boolean	TRUE indicates that poll is made at last PDU in retransmission buffer
Poll_Window	OP		Integer(50,60,70,80,85,90,95,99)	Percentage of transmission window, threshold for polling
Timer_poll_periodic	OP		Integer(100, 200, 300, 400, 500, 750, 1000, 2000)	Time in milliseconds Timer for periodic polling.

10.3.4.5 Predefined configuration identity

This information element identifies a pre-defined radio parameter configuration.

Information Element/Group name	Need	Multi	Type and reference	Semantics description
Predefined radio configuration identity	MP		Integer (0..15)	

10.3.4.5a Predefined configuration status information

Another system may provide the UE with one or more predefined UTRAN configurations, comprising of radio bearer, transport channel and physical channel parameters. If requested, the UE shall indicate the configurations it has stored. The predefined configuration status information should include the following RRC information.

Information Element/Group name	Need	Multi	Type and reference	Semantics description
RB information elements				
Predefined configurations		maxPredef ConfigCount		The list is in order of preconfiguration identity
>Predefined configuration value tag	OP		Predefined configuration value tag 10.3.4.6	The UE shall include the value tag if it has stored the concerned configuration

Multi Bound	Explanation
MaxPredefConfigCount	Maximum number of predefined configurations

10.3.4.5b Predefined configuration status information compressed

Another system may provide the UE with one or more predefined UTRAN configurations, comprising of radio bearer, transport channel and physical channel parameters. If requested, the UE shall indicate the configurations it has stored. The compressed predefined configuration status information should include the following RRC information.

Information Element/Group name	Need	Multi	Type and reference	Semantics description	Version
Sets with different value tags	MP				REL-5
>Pre-defined configuration set with different value tags	MP	1..2			REL-5
>>Start position	MD		INTEGER (0..10)	Default value is 0, corresponding with the first pre-defined configuration. The pre-defined configuration where the consecutive sequence of pre-defined configurations begins.	REL-5
>>Pre-defined configuration value tag list	MP	6..<max PredefC onfig>	Pre-defined configuration value tag 10.3.4.6	Value Tags for each pre-defined configuration starting from the lowest.	REL-5
Other Entries	OP				REL-5
>Pre-defined configuration list with variable size	MP	1..<max PredefC onfig>		List of other pre-defined configurations not included within the Sets with different value tags, in consecutive order starting with the lowest. If there are stored pre-defined configurations positioned after a pre-defined configuration that is not stored, the UE shall indicate the not-stored pre-defined configuration by explicitly indicating it to be absent. If there are no stored pre-defined configurations positioned after a pre-defined configuration that is not stored, then the UE may totally omit these pre-defined configurations from the IE, i.e. reduce the size of the list to correspond to the last position that contained a stored pre-defined configuration.	REL-5
>>Predefined configuration value tag	OP		Predefined configuration value tag 10.3.4.6	The UE shall include the value tag if it has stored the concerned configuration	REL-5

10.3.4.6 Predefined configuration value tag

This information element is used to identify different versions of a radio bearer configuration as may be used within one PLMN e.g. to support different UTRAN implementations.

Information Element/Group name	Need	Multi	Type and Reference	Semantics description
Predefined configuration value tag	MP		Integer(0..15)	

10.3.4.7 Predefined RB configuration

This information element concerns a pre- defined configuration of radio bearer parameters

Information Element/Group name	Need	Multi	Type and Reference	Semantics description
UE information elements				
Re-establishment timer	MP		Re-establishment timer 10.3.3.30	Only one RAB supported
Signalling radio bearer information				
Signalling RB information to setup List	MP	1 to <maxSRBs setup>		For each signalling radio bearer
>Signalling RB information to setup	MP		Signalling RB information to setup 10.3.4.24	
RB information				
RB information to setup list	MP	1 to <maxRBperRAB>		Only one RAB supported
>RB information to setup	MP		RB information to setup 10.3.4.20	

10.3.4.8 RAB info

This IE contains information used to uniquely identify a radio access bearer.

Information Element/Group name	Need	Multi	Type and reference	Semantics description	Version
RAB identity	MP		RAB identity 10.3.1.14		
MBMS Service Identity	CV- Message		MBMS service ID 10.3.9a.8a	Included when establishing a RB for a MBMS service of the broadcast type; NOTE 1	REL-6
MBMS Session identity	CV- Message		MBMS Session identity 10.3.9a.9		REL-6
CN domain identity	MP		CN domain identity 10.3.1.1		
NAS Synchronization Indicator	OP		NAS Synchronization indicator 10.3.4.12		
Re-establishment timer	MP		Re-establishment timer 10.3.3.30		
NOTE 1: Only the "MBMS Service ID" part of the MBMS service identity is signalled in this IE. The UE should consider that the "PLMN identity" part of the MBMS service identity equals the PLMN identity of an MBMS service with the same "MBMS Service ID" stored in the variable ACTIVATED_MBMS_SERVICES. If there is no such MBMS service or more than one such MBMS service, the UE behaviour is unspecified.					

Condition	Explanation
Message	This IE is optionally present in the RADIO BEARER SETUP and the SRNS RELOCATION INFO messages and not needed otherwise.

10.3.4.9 RAB info Post

This IE contains information used to uniquely identify a radio access bearer.

Information Element/Group name	Need	Multi	Type and reference	Semantics description
RAB identity	MP		RAB identity 10.3.1.14	
CN domain identity	MP		CN domain identity 10.3.1.1	
NAS Synchronization Indicator	OP		NAS Synchronization indicator 10.3.4.12	

10.3.4.9a RAB information for MBMS ptp bearers

Information Element/Group name	Need	Multi	Type and reference	Semantics description	Version
RB identity	MP		RB identity 10.3.4.16		REL-7
MBMS Service Identity	MP		MBMS Service ID 10.3.9a.8a	Indicates that this radio bearer is used for a different MBMS service.	REL-7
MBMS Session Identity	OP		MBMS Session identity 10.3.9a.9	Indicates that this radio bearer is used for a different session of the MBMS service.	REL-7

10.3.4.10 RAB information for setup

Information Element/Group name	Need	Multi	Type and reference	Semantics description	Version
RAB info	MP		RAB info 10.3.4.8		
CS-HSPA information	CV-CS				REL-8
>UL AMR rate	MD		Enumerated (t0, t1, t2, t3, t4, t5, t6, t7, t8)	Indicates the bit rate as defined in [62] and [63]. In case NAS Synchronization Indicator indicates AMR, default value is "t7". In case NAS Synchronization Indicator indicates AMR-WB, default value is "t8". 7 spare values are needed.	REL-8
>Max CS delay	MP		Integer (20..200 by step of 10)	Indicates the maximum possible delay for CS voice frames Unit is ms	REL-8
RAB info to replace	CV-SRVCC		RAB info to replace 10.3.4.11a		REL-8
RB information to setup list	MP	1 to <maxRBpe rRAB>			
>RB information to setup	MP		RB information to setup 10.3.4.20		

Condition	Explanation
CS	This IE is mandatory if the IE "CN domain identity" has the value "CS domain" and the RAB is mapped on HS-DSCH/E-DCH. It is not needed otherwise.
SRVCC	This IE is mandatory if the RAB is established as part of an SR-VCC procedure and the message is not HANDOVER TO UTRAN COMMAND message and not needed otherwise.

10.3.4.11 RAB information to reconfigure

Information Element/Group name	Need	Multi	Type and reference	Semantics description	Version
RAB identity	MP		RAB Identity 10.3.1.14		
CN domain identity	MP		CN domain identity 10.3.1.1		
NAS synchronization indicator	MP		NAS Synchronization info 10.3.4.12	Note 1	
CS-HSPA information	CV-CS				REL-8
>UL AMR rate	MD		Enumerated(t0, t1, t2, t3, t4, t5, t6, t7, t8)	Indicates the bit rate as defined in [62] and [63]. In case NAS Synchronization Indicator indicates AMR, default value is "t7". In case NAS Synchronization Indicator indicates AMR-WB, default value is "t8". 7 spare values are needed.	REL-8
>Max CS delay	MP		Integer(20..200 by step of 10)	Indicates the maximum possible delay for CS voice frames Unit is ms	REL-8

Condition	Explanation
CS	This IE is mandatory if the IE "CN domain identity" has the value "CS domain" and the RAB is mapped on HS-DSCH/E-DCH. It is not needed otherwise.

NOTE 1: This IE is only relevant for the CS domain.

10.3.4.11a RAB info to replace

This IE contains information to identify a radio access bearer to be replaced with a new radio access bearer as part of SR-VCC procedures. This IE is not included in case SR-VCC from LTE to UMTS.

Information Element/Group name	Need	Multi	Type and reference	Semantics description	Version
RAB identity	MP		RAB identity 10.3.1.14		REL-8
CN domain identity	MP		CN domain identity 10.3.1.1		REL-8

10.3.4.12 NAS Synchronization indicator

A container for non-access stratum information to be transferred transparently through UTRAN.

Information Element/Group name	Need	Multi	Type and reference	Semantics description
NAS Synchronization indicator	MP		Bit string(4)	The first/leftmost bit of the bit string contains the most significant bit of the NAS Synchronization indicator.

10.3.4.13 RB activation time info

This IE contains the time, in terms of RLC sequence numbers, when a certain configuration shall be activated, for a number of radio bearers.

Information Element/Group name	Need	Multi	Type and reference	Semantics description
Radio bearer activation time	MP	1 to <maxRB>		
>RB identity	MP		RB identity 10.3.4.16	
>RLC sequence number	MP		Integer (0..4095)	RLC SN [16] . Used for radio bearers mapped on RLC AM and UM

10.3.4.14 RB COUNT-C MSB information

The MSB of the COUNT-C values of the radio bearer.

Information Element/Group name	Needed	Multi	Type and reference	Semantics description
RB identity	MP		RB identity 10.3.4.16	
COUNT-C-MSB-uplink	MP		Integer (0.. $2^{25}-1$)	25 MSBs from COUNT-C associated to this RB
COUNT-C-MSB-downlink	MP		Integer (0.. $2^{25}-1$)	25 MSBs from COUNT-C associated to this RB

10.3.4.15 RB COUNT-C information

The COUNT-C values of the radio bearer.

Information Element/Group name	Needed	Multi	Type and reference	Semantics description
RB identity	MP		RB identity 10.3.4.16	
COUNT-C-uplink	MP		Integer (0.. $2^{32}-1$)	
COUNT-C-downlink	MP		Integer (0.. $2^{32}-1$)	

10.3.4.16 RB identity

An identification number for the radio bearer affected by a certain message.

Information Element/Group name	Need	Multi	Type and reference	Semantics description
RB identity	MP		Integer(1..32)	Values 1-4 shall only be used for signalling radio bearers. The IE value minus one shall be used as BEARER in the ciphering algorithm.

10.3.4.17 RB information to be affected

Information Element/Group name	Need	Multi	Type and reference	Semantics description
RB identity	MP		RB identity 10.3.4.16	
RB mapping info	MP		RB mapping info 10.3.4.21	

10.3.4.18 RB information to reconfigure

Information Element/Group name	Need	Multi	Type and reference	Semantics description
RB identity	MP		RB identity 10.3.4.16	
PDCP info	OP		PDCP info 10.3.4.2	
PDCP SN info	OP		PDCP SN info 10.3.4.3	PDCP sequence number info from the network. Present only in case of lossless SRNS relocation.
RLC info	OP		RLC info 10.3.4.23	
RB mapping info	OP		RB mapping info 10.3.4.21	
RB stop/continue	OP		Enumerated(stop, continue)	

10.3.4.19 RB information to release

Information Element/Group name	Need	Multi	Type and reference	Semantics description
RB identity	MP		RB identity 10.3.4.16	

10.3.4.20 RB information to setup

Information Element/Group name	Need	Multi	Type and reference	Semantics description
RB identity	MP		RB identity 10.3.4.16	
PDCP info	OP		PDCP info 10.3.4.2	
CHOICE <i>RLC info type</i>	MP			
>RLC info			RLC info 10.3.4.23	
>Same as RB			RB identity 10.3.4.16	Identity of RB with exactly the same RLC info IE values
RB mapping info	MP		RB mapping info 10.3.4.21	

NOTE: This information element is included within IE "Predefined RB configuration".

10.3.4.21 RB mapping info

A multiplexing option for each possible transport channel MAC-d flow or E-DCH MAC-d flow this RB can be multiplexed on.

Information Element/Group name	Need	Multi	Type and reference	Semantics description	Version
Information for each multiplexing option	MP	1 to <maxRBmuxOptions>			
>RLC logical channel mapping indicator	CV-UL-RLCLogicalChannels		Boolean	TRUE indicates that the first logical channel shall be used for data PDUs and the second logical channel shall be used for control PDUs. FALSE indicates that control and data PDUs can be sent on either of the two logical channels. This parameter is not used in this release and shall be set to TRUE.	
>Number of uplink RLC logical channels	CV-UL-RLC info	1 to MaxLoCHperRLC		1 or 2 logical channels per RLC entity or radio bearer RLC [16]	
>>CHOICE <i>Uplink transport channel type</i>					REL-6
>>>DCH, RACH, USCH					REL-6
>>>>Uplink transport channel type	MP		Enumerated(DCH,RACH,USCH)	USCH is TDD only	
>>>>ULTransport channel identity	CV-UL-DCH/USCH		Transport channel identity 10.3.5.18	This is the ID of a DCH or USCH (TDD only) that this RB could be mapped onto.	
>>>>Logical channel identity	OP		Integer(1..15)	This parameter is used to distinguish logical channels multiplexed by MAC on a transport channel.	
>>>>CHOICE <i>RLC size list</i>	MP			The RLC sizes that are allowed for this logical channel.	
>>>>>All			Null	All RLC sizes listed in the <i>Transport Format Set</i> . 10.3.5.23	

Information Element/Group name	Need	Multi	Type and reference	Semantics description	Version
>>>>>Configured			Null	The RLC sizes configured for this logical channel in the <i>Transport Format Set</i> . 10.3.5.23 if present in this message or in the previously stored configuration otherwise	
>>>>>Explicit List		1 to <maxTF>		Lists the RLC sizes that are valid for the logical channel.	
>>>>>>RLC size index	MP		Integer(1..maxTF)	The integer number is a reference to the RLC size which arrived at that position in the <i>Transport Format Set</i> 10.3.5.23	
>>>>E-DCH				Note 4	REL-6
>>>>>Logical channel identity	MP		Integer(1..15)	This parameter is used to distinguish logical channels multiplexed by MAC on a transport channel	REL-6
>>>>>E-DCH MAC-d flow identity	MP		E-DCH MAC-d flow identity 10.3.5.7e		REL-6
>>>>>CHOICE RLC PDU size	MP				REL-8
>>>>>>Fixed size					REL-8
>>>>>>>DDI	MP		Integer (0..62)	If more than 1 UL RLC PDU size is configured for this RB, the different sizes will use subsequent DDI values starting from this DDI value. Value "0x3F" is reserved Note 6	REL-6
>>>>>>>>RLC PDU size list	MP	1 to <maxRLC PDUsizePerLogChan>			REL-6
>>>>>>>>>RLC PDU size	MP		Integer(16..5000 by step of 8)	Unit is bits	REL-6
>>>>>>>>>>Flexible size					REL-8
>>>>>>>>>>>Length indicator size	CV-UL-RLC AM mode		Enumerated (7-bit, 15-bit)		REL-8
>>>>>>>>>>>>Minimum UL RLC PDU size	MP		Integer (16..12040 by step of 8)	Unit is bits	REL-8

Information Element/Group name	Need	Multi	Type and reference	Semantics description	Version
>>>>>Largest UL RLC PDU size	MP		Integer (16..12040 by step of 8)	Unit is bits	REL-8
>>>>Include in Scheduling Info	MP		Boolean	Indicates whether or not this logical channel is to be considered when performing scheduling info reporting, as per [15]	REL-6
>>MAC logical channel priority	MP		Integer(1..8)	This is priority between a user's different RBs (or logical channels). [15]	
>Downlink RLC logical channel info	<i>CV-DL-RLC info</i>				
>>Number of downlink RLC logical channels	<i>MD</i>	1 to MaxLoCHperRLC		1 or 2 logical channels per RLC entity or radio bearer RLC [16] Default value is that parameter values for DL are exactly the same as for corresponding UL logical channel. In case two multiplexing options are specified for the UL, the first options shall be used as default for the DL. As regards to the IE "Channel type", rule is specified in 8.6.4.8.	
>>>Downlink transport channel type	MP		Enumerated(DCH,FACH, DSCH,DCH+ DSCH , HS-DSCH, DCH + HS-DSCH)	Note 3 Note 4	REL-5
>>>DL DCH Transport channel identity	<i>CV-DL-DCH</i>		Transport channel identity 10.3.5.18		
>>>DL DSCH Transport channel identity	<i>CV-DL-DSCH</i>		Transport channel identity 10.3.5.18		
>>>CHOICE DL MAC header type	<i>CV-DL-HS-DSCH</i>			Depending on the MAC-hs/ehs type of header selected for HS-DSCH	REL-7
>>>>MAC-hs					REL-7

Information Element/Group name	Need	Multi	Type and reference	Semantics description	Version
>>>>DL HS-DSCH MAC-d flow identity	MP		MAC-d flow identity 10.3.5.7c		REL-5
>>>>MAC-ehs					REL-7
>>>>DL HS-DSCH MAC-ehs Queue Id	MP		MAC-ehs Queue Id 10.3.5.7f	Note 5	REL-7
>>>Logical channel identity	OP		Integer(1..15)	16 is reserved Note 5	
Note 3:	The IE "Downlink transport channel type" values "DSCH" and "DCH+DSCH" should not be used for FDD. If received the UE behaviour is unspecified.				
Note 4:	If included in System Information Block Type 16, the values 'HS-DSCH' and 'DCH + HS-DSCH' do not apply for the IE "Downlink transport channel type". Furthermore, if included in System Information Block Type 16, the value "E-DCH" for the IE "Uplink transport channel type" does not apply.				
Note 5:	If the IE "Downlink transport channel type" is "HS-DSCH" or "DCH + HS-DSCH" and the DL MAC header type is "MAC-ehs", the IE "Logical channel identity" conveys the value to be used in the "LCH-ID" field of the MAC-ehs header [15], associating the logical channel with the MAC-ehs reordering queue identified by the IE "DL HS-DSCH MAC-ehs Queue Id".				
Note 6:	If the radio bearer has a multiplexing option configured with the UL MAC header type of "MAC-i/is" then this value is ignored.				

Condition	Explanation
<i>UL-RLC info</i>	If "CHOICE <i>Uplink RLC mode</i> " in the IE "RLC info" that applies for that RB (i.e. either the one stored or received in the same message for the RB for which the "RB mapping info" was received, or the one stored or received in the same message for the RB pointed at in the IE "Same as RB" in the IE "RB information to setup" stored or received in the same message) is present this IE is mandatory present. Otherwise the IE is not needed.
<i>DL-RLC info</i>	If "CHOICE <i>Downlink RLC mode</i> " in the IE "RLC info" that applies for that RB (i.e. either the one stored or received in the same message for the RB for which the "RB mapping info" was received, or the one stored or received in the same message for the RB pointed at in the IE "Same as RB" in the IE "RB information to setup" stored or received in the same message) is present this IE is mandatory present. Otherwise the IE is not needed.
<i>UL-RLCLogicalChannels</i>	If "Number of uplink RLC logical channels" in IE "RB mapping info" is 2, then this IE is mandatory present. Otherwise this IE is not needed.
<i>UL-DCH/USCH</i>	If IE "Uplink transport channel type" is equal to "DCH" or "USCH" (TDD only) this IE is mandatory present. Otherwise the IE is not needed.
<i>DL-DCH</i>	If IE "Downlink transport channel type" is equal to "DCH", "DCH+DSCH" or "DCH + HS-DSCH" this IE is mandatory present. Otherwise the IE is not needed.
<i>DL-DSCH</i>	If IE "Downlink transport channel type" is equal to "DSCH" or "DCH+DSCH" this IE is mandatory present. Otherwise the IE is not needed.
<i>DL-HS-DSCH</i>	If IE "Downlink transport channel type" is equal to "HS-DSCH" or "DCH + HS-DSCH" this IE is mandatory present. Otherwise the IE is not needed.

UL-RLC AM mode	If "CHOICE Uplink RLC mode" in the IE "RLC info" that applies for that RB (i.e. either the one stored or received in the same message for the RB for which the "RB mapping info" was received, or the one stored or received in the same message for the RB pointed at in the IE "Same as RB" in the IE "RB information to setup" stored or received in the same message) is "AM RLC" this IE is mandatory present. Otherwise the IE is not needed.
----------------	---

10.3.4.22 RB with PDCP information

Information Element/Group name	Need	Multi	Type and reference	Semantics description	Version
RB identity	MP		RB identity 10.3.4.16		
PDCP SN info	MP		PDCP SN info 10.3.4.3	PDCP sequence number info from the sender of the message for lossless SRNS relocation.	
				PDCP sequence number info from the sender of the message for lossless SRNS relocation or for lossless DL RLC PDU size change.	REL-5

10.3.4.23 RLC info

Information Element/Group name	Need	Multi	Type and reference	Semantics description	Version
CHOICE <i>Uplink RLC mode</i>	OP			Indicates if Acknowledged, Unacknowledged or Transparent mode RLC shall be used.	
>AM RLC					
>>Transmission RLC discard	MP		Transmission RLC discard 10.3.4.25		
>>Transmission window size	MP		Integer(1,8,16,32,64,128,256,512,768,1024,1536,2047,2560,3072,3584,4095)	Maximum number of RLC PUs sent without getting them acknowledged. This parameter is needed if acknowledged mode is used. UE shall also assume that the UTRAN receiver window is equal to this value.	
>>Timer_RST	MP		Integer(50, 100, 150, 200, 250, 300, 350, 400, 450, 500, 550, 600, 700, 800, 900, 1000)	Elapsed time in milliseconds. It is used to trigger the retransmission of RESET PDU.	
>>Max_RST	MP		Integer(1, 4, 6, 8, 12, 16, 24, 32)	Defined in [16]. If other values than 1 are used for SRB2 the UE behaviour is unspecified.	
>>Polling info	OP		Polling info 10.3.4.4		
>UM RLC					
>>Transmission RLC discard	CV-CS-HSPA		Transmission RLC	NOTE 3	

Information Element/Group name	Need	Multi	Type and reference	Semantics description	Version
			discard 10.3.4.25		
>TM RLC					
>>Transmission RLC discard	OP		Transmission RLC discard 10.3.4.25		
>>Segmentation indication	MP		Boolean	TRUE indicates that segmentation is performed.	
CHOICE <i>Downlink RLC mode</i>	OP			Indicates if Acknowledged, Unacknowledged or Transparent mode RLC shall be used	
>AM RLC					
>>CHOICE <i>DL RLC PDU size</i>	MP				REL-7
>>>Fixed size					REL-7
>>>>DL RLC PDU size	MP		Integer(16..5000 by step of 8)	Unit is bits	REL-5
>>>Flexible size				NOTE 1	REL-7
>>>>Length indicator size	MP		Enumerated (7-bit, 15-bit)		REL-7
>>In-sequence delivery	MP		Boolean	TRUE indicates that RLC shall preserve the order of higher layer PDUs when these are delivered. FALSE indicates that receiving RLC entity could allow SDUs to be delivered to the higher layer in different order than submitted to RLC sublayer at the transmitting side.	
>>Receiving window size	MP		Integer(1,8,16,32,64,128,256,512,768,1024,1536,2047,2560,3072,3584,4095)	Maximum number of RLC PUs allowed to be received. This parameter is needed if acknowledged mode is used. UE shall also assume that the UTRAN transmitter window is equal to this value	
>>Downlink RLC status Info	MP		Downlink RLC status info 10.3.4.1		
>UM RLC					
>>DL UM RLC LI size	MP		Integer(7, 15)	Size in bits to use for the downlink RLC UM LI.	REL-5
>>DL Reception Window Size	CV- <i>Not-SIB16o</i>		Integer(32, 48, 64, 80, 96, 112)		REL-6
>TM RLC					
>>Segmentation indication	MP		Boolean	TRUE indicates that segmentation is performed.	
One sided RLC re-establishment	MP		Boolean	TRUE indicates that only one side of the AM RLC entity is re-established.	REL-5
Alternative E-bit interpretation	CV- <i>Not-SIB16o</i>		Enumerated (TRUE)	The absence of this IE implies: "normal E-bit interpretation".	REL-6

Information Element/Group name	Need	Multi	Type and reference	Semantics description	Version
Use special value of HE field	<i>CV-Not-SIB16o</i>		Enumerated (TRUE)	The absence of this IE implies: "do not use special value of the HE field in the uplink RLC entity".	REL-7
NOTE 1: If included in SIB type 16, the "Flexible size" does not apply for downlink RLC PDU size (AM RLC).					
NOTE 2: Void.					
NOTE 3: If this IE is absent and the radio bearer is connected to a CS domain radio access bearer, the UE behaviour is unspecified.					

Condition	Explanation
<i>Not-SIB16o</i>	If included in SYSTEM INFORMATION BLOCK TYPE 16, this IE is not needed. Otherwise the IE is optional
<i>CS-HSPA</i>	This IE is mandatory present If the radio bearer is connected to a CS domain radio access bearer, Otherwise the IE is optional.

NOTE: This information element is included within IE "Predefined RB configuration".

10.3.4.23a RLC info MBMS

The IE RLC info MBMS is used for point-to-multipoint radio bearers, featuring only the downlink RLC UMD.

Information Element/Group name	Need	Multi	Type and reference	Semantics description	Version
DL UM RLC LI size	MP		Integer (7, 15)	Size in bits to use for the downlink RLC UM LI.	REL-6
DL Duplication Avoidance and Reordering info	<i>CV-MTCH</i>		UM Duplication Avoidance and Reordering info 10.3.4.26		REL-6
DL Out of sequence delivery info	<i>CV-MCCH</i>		UM Out of sequence delivery info 10.3.4.27		REL-6

Condition	Explanation
<i>MTCH</i>	If the IE concerns MTCH (see Note 1), this IE is optional. Otherwise the IE is not needed.
<i>MCCH</i>	If the IE concerns MCCH, this IE is optional. Otherwise the IE is not needed.

NOTE 1: The UE behaviour is unspecified if this IE is received with regard to an MTCH configured for MBSFN operation. A network should not send this IE with regard to an MTCH configured for MBSFN operation.

10.3.4.24 Signalling RB information to setup

Information Element/Group name	Need	Multi	Type and reference	Semantics description
RB identity	MD		RB identity 10.3.4.16	Default value is specified in subclause 8.6.4.1
CHOICE <i>RLC info type</i>	MP			
>RLC info			RLC info 10.3.4.23	
>Same as RB			RB identity 10.3.4.16	Identity of RB with exactly the same RLC info IE values
RB mapping info	MP		RB mapping info 10.3.4.21	

NOTE: This information element is included within IE "Predefined RB configuration".

10.3.4.24a SR-VCC Info

This IE contains information that allows the calculation of the CK and IK for the CS domain, due to a SR-VCC procedure.

Information Element/Group name	Need	Multi	Type and reference	Semantics description	Version
NONCE	OP		Bit string (128)		REL-8

10.3.4.25 Transmission RLC Discard

Information Element/Group name	Need	Multi	Type and reference	Semantics description
CHOICE <i>SDU Discard Mode</i>	MP			Different modes for discharge the RLC buffer on the transmitter side; "Timer based with explicit signalling", "Timer based without explicit signalling", "Discard after Max_DAT retransmissions" or "No_discard". For unacknowledged mode and transparent mode, only Timer based without explicit signalling is applicable. If "No_discard" is used, reset procedure shall be done after Max_DAT retransmissions
>Timer based explicit				
>>Timer_MRW	MP		Integer(50,60, 70, 80, 90, 100, 120, 140, 160, 180, 200, 300, 400, 500, 700, 900)	Elapsed time in milliseconds. It is used to trigger the retransmission of a STATUS PDU containing an MRW SUFI field

Information Element/Group name	Need	Multi	Type and reference	Semantics description
>>Timer_discard	MP		Integer(100, 250, 500, 750, 1000, 1250, 1500, 1750, 2000, 2500, 3000, 3500, 4000, 4500, 5000, 7500)	Elapsed time in milliseconds before a SDU is discarded.
>>MaxMRW	MP		Integer(1, 4, 6, 8, 12, 16, 24, 32)	Defined in [16]
>Timer based no explicit				
>>Timer_discard	MP		Integer(10,20,30,40,50,60,70,80,90,100)	Elapsed time in milliseconds before a SDU is discarded.
>Max DAT retransmissions				
>>Max_DAT	MP		Integer(1, 2, 3, 4, 5, 6, 7, 8, 9, 10, 15, 20, 25, 30, 35, 40)	Defined in [16]
>>Timer_MRW	MP		Integer(50, 60, 70, 80, 90, 100, 120, 140, 160, 180, 200, 300, 400, 500, 700, 900)	Elapsed time in milliseconds. It is used to trigger the retransmission of a STATUS PDU containing an MRW SUFI field
>>MaxMRW	MP		Integer(1, 4, 6, 8, 12, 16, 24, 32)	Defined in [16]
>No discard				
>>Max_DAT	MP		Integer(1, 2, 3, 4, 5, 6, 7, 8, 9, 10, 15, 20, 25, 30, 35, 40)	Defined in [16]

CHOICE SDU Discard Mode	Condition under which the given SDU Discard Mode is chosen
Timer based explicit	If the modes for discharge of the RLC buffer on the transmitter side is "Timer based with explicit signalling"
Timer based no explicit	If the modes for discharge of the RLC buffer on the transmitter side is "Timer based without explicit signalling" For unacknowledged mode, only Timer based without explicit signalling is applicable.
Max DAT retransmissions	If the modes for discharge of the RLC buffer on the transmitter side is "Discard after Max_DAT retransmissions"
No discard	If the modes for discharge the of RLC buffer on the transmitter side is "Reset procedure shall be done after Max_DAT retransmissions"

10.3.4.26 UM Duplication Avoidance and Reordering info

Information Element/Group name	Need	Multi	Type and reference	Semantics description	Version
Timer_DAR	MP		Integer(40, 80, 120, 160, 240, 320, 480, 640, 960, 1280, 1920, 2560, 3840, 5120)	Timer (in milliseconds) when PDUs are released to the upper layers even though there are outstanding PDUs with lower RLC SN values.	REL-6
Window size DAR	MP		Integer(4, 8, 16, 32, 40, 48, 56, 64)		REL-6

10.3.4.27 UM Out of sequence delivery info

Information Element/Group name	Need	Multi	Type and reference	Semantics description	Version
Timer_OSD	CV- <i>notMCCH</i>		Integer (40, 80, 120, 160, 240, 320, 480, 640, 960, 1280, 1920, 2560, 3840, 5120)		REL-6
Window size OSD	MP		Integer(8, 16, 32, 40, 48, 56, 64)		REL-6

NOTE: This timer used to flush the buffer is configured at RRC level and indicated via a local primitive.

Condition	Explanation
<i>notMCCH</i>	If this concerns a logical channel other than MCCH then this IE is mandatory otherwise it is not needed. In the latter case Timer_OSD takes the value of the IE Modification Period as indicated within the IE MCCH configuration information

10.3.5 Transport CH Information elements

10.3.5.1 Added or Reconfigured DL TrCH information

Information Element/Group name	Need	Multi	Type and reference	Semantics description	Version
Downlink transport channel type	MP		Enumerated(DCH, DSCH, HS-DSCH)	Note 2	
DL Transport channel identity	MP		Transport channel identity 10.3.5.18	Note 3	REL-5
	CV- <i>not HS-DSCH</i>				REL-5
CHOICE <i>DL parameters</i>					
>Explicit					
>>TFS	MP		Transport Format Set 10.3.5.23		
>SameAsUL					

Information Element/Group name	Need	Multi	Type and reference	Semantics description	Version
>>Uplink transport channel type	MP		Enumerated(DCH,USCH)	USCH is TDD only	
>>UL TrCH identity	MP		Transport channel identity 10.3.5.18	Same TFS applies as specified for indicated UL TrCH	
>HS-DSCH					REL-5
>>HARQ Info	OP		HARQ info 10.3.5.7a	For 1.28 Mcps TDD, if HARQ Information is included in the IE DL MultiCarrier Information, this IE shall not be present.	REL-5
>>CHOICE DL MAC header type	OP				REL-7
>>>MAC-hs					REL-7
>>>>Added or reconfigured MAC-d flow	MP		Added or reconfigured MAC-d flow 10.3.5.1a		REL-5
>>>MAC-ehs					REL-7
>>>>Added or reconfigured MAC-ehs reordering queue	MP		Added or reconfigured MAC-ehs reordering queue 10.3.5.1c		REL-7
DCH quality target	OP		Quality target 10.3.5.10		
Note 1: Void					
Note 2: The IE "Downlink transport channel type" value "DSCH" should not be used for FDD. If received the UE behaviour is unspecified.					
Note 3: If included in SIB type 16, the value 'HS-DSCH' does not apply for the IE "Downlink transport channel type".					

Condition	Explanation
<i>NotHS-DSCH</i>	If the downlink transport channel type is DCH or DSCH then this IE is mandatory otherwise it is not needed.

10.3.5.1a Added or reconfigured MAC-d flow

This IE is used in relation to the MAC-d flows mapped to the HS-DSCH transport channel.

Information Element/Group name	Need	Multi	Type and reference	Semantics description	Version
MAC-hs queue to add or reconfigure list	OP	<1 to maxQueue ID>			REL-5
>MAC-hs queue Id	MP		Integer(0..7)	The MAC-hs queue ID is unique across all MAC-d flows.	REL-5
>MAC-d Flow Identity	MP		MAC-d Flow Identity 10.3.5.7c		REL-5
>T1	MP		Integer(10, 20, 30, 40, 50, 60, 70, 80, 90, 100, 120, 140, 160, 200, 300, 400)	Timer (in milliseconds) when PDUs are released to the upper layers even though there are outstanding PDUs with lower TSN values.	REL-5
>MAC-hs window size	MP		Integer(4, 6, 8, 12, 16, 24, 32)	The set of values is used for Multi-carrier case in 1.28 Mcps TDD mode for 9bits TSN option.	REL-5
			Integer(32, 64, 96, 128, 160, 192, 256)		REL-7
>MAC-d PDU size Info	OP	<1 to max MACdPDU sizes>		Mapping of the different MAC-d PDU sizes configured for the HS-DSCH to the MAC-d PDU size index in the MAC-hs header.	REL-5
>>MAC-d PDU size	MP		Integer (1..5000)		REL-5
>>MAC-d PDU size index	MP		Integer(0..7)		REL-5
MAC-hs queue to delete list	OP	<1 to maxQueue ID>			REL-5
>MAC-hs queue Id	MP		Integer(0..7)	The MAC-hs queue ID is unique across all MAC-d flows.	REL-5

10.3.5.1b Added or reconfigured E-DCH MAC-d flow

This IE is used in relation to MAC-d flows mapped to the E-DCH transport channel.

Information Element/Group name	Need	Multi	Type and reference	Semantics description	Version
E-DCH MAC-d flow identity	MP		E-DCH MAC-d flow identity 10.3.5.7e		REL-6
E-DCH MAC-d flow power offset	OP		Integer(0..6)	Only allowed to be absent when already defined for this E-DCH MAC-d flow, unit is dB	REL-6
E-DCH MAC-d flow maximum number of retransmissions	OP		Integer (0..15)	Only allowed to be absent when already defined for this E-DCH MAC-d flow	REL-6
E-DCH MAC-d flow retransmission timer	<i>CV-Tdd128</i>		Enumerated (10, 15, 20, 25, 30, 35, 40, 45, 50, 55, 60, 65, 70, 75, 80, 85, 90, 95, 100, 110, 120, 140, 160, 200, 240, 280, 320, 400, 480, 560)	Unit: ms	REL-7
E-DCH MAC-d flow multiplexing list	OP		Bitstring (maxE-DCHMACdFlow)	Indicates, if this is the first MAC-d flow for which PDUs are placed in the MAC-e or MAC-i PDU, the other MAC-d flows from which MAC-d PDUs are allowed to be included in the same MAC-e or MAC-i PDU. Bit 0 is for MAC-d flow 0, Bit 1 is for MAC-d flow 1, ... Value '1' for a bit means multiplexing is allowed. Bit 0 is the first/leftmost bit of the bit string. NOTE: The bit that corresponds to the MAC-d flow itself is ignored.	REL-6
CHOICE transmission grant type	OP			Only allowed to be absent when already defined for this E-DCH MAC-d flow	REL-6
>Non-scheduled transmission grant info					REL-6
>>CHOICE mode	MP				REL-7
>>>FDD					REL-7
>>>>Max MAC-e PDU contents size	MP		Integer (1..19982)		REL-6

>>>>2ms non-scheduled transmission grant HARQ process allocation	MD		Bitstring (8)	MAC-d PDUs for this MAC-d flow are only allowed to be transmitted in those processes for which the bit is set to "1". Bit 0 corresponds to HARQ process 0, bit 1 corresponds to HARQ process 1,... Default value is: transmission in all HARQ processes is allowed. Bit 0 is the first/leftmost bit of the bit string.	REL-6
>>>TDD			NULL	No data	REL-7
>Scheduled transmission grant info			NULL		REL-6

Condition	Explanation
<i>Tdd128</i>	This IE is mandatory present for 1.28Mcps TDD, otherwise it is not needed.

10.3.5.1c Added or reconfigured MAC-ehs reordering queue

This IE is used in relation to the MAC-ehs reordering queues mapped to the HS-DSCH transport channel.

Information Element/Group name	Need	Multi	Type and reference	Semantics description	Version
MAC-ehs queue to add or reconfigure list	OP	<1 to maxQueue ID>			REL-7
>MAC-ehs queue Id	MP		MAC-ehs Queue Id 10.3.5.7f		REL-7
>T1	MP		Integer (10, 20, 30, 40, 50, 60, 70, 80, 90, 100, 120, 140, 160, 200, 300, 400)	Timer (in milliseconds) when PDUs are released to the upper layers even though there are outstanding PDUs with lower TSN values.	REL-7
>Treset	MD		Integer (1, 2, 3, 4)	Timer in multiples of T1 values (milliseconds). Used when MAC-ehs reordering queue is reset in CELL_FACH and CELL_PCH (FDD only). Default value is 2	REL-7
>MAC-ehs window size	MP		Enumerated (4, 6, 8, 12, 16, 24, 32,	Six spare values are needed.	REL-7
			64, 128,		REL-9
			256)		REL-11
>MAC-ehs window size extension	OP		Enumerated(96,160,196,256)	For 1,28Mcps TDD only, The set of values is used for Multi-carrier case for 9bits TSN option. If this IE is present, UE should ignore the IE "MAC-ehs window size"	REL-9

10.3.5.2 Added or Reconfigured UL TrCH information

Information Element/Group name	Need	Multi	Type and reference	Semantics description	Version
Uplink transport channel type	MP		Enumerated(DCH,USCH)	USCH is TDD only	
			,E-DCH)	Note 1	REL-6
UL Transport channel identity	MP		Transport channel identity 10.3.5.18		
	<i>CV-NotE-DCH</i>				REL-6
<i>CHOICE UL parameters</i>					REL-6
>DCH,USCH					REL-6
>>TFS	MP		Transport Format Set 10.3.5.23		
>E-DCH					REL-6
>>UL MAC header type	OP		Enumerated (MAC-i/is)	If this IE is present, MAC-i/is header type [15] is used, else MAC-e/es header type [15] is used.	REL-8
>>CHOICE mode	MP				REL-7
>>>FDD					REL-7
>>>>E-DCH Transmission Time Interval	MP		Enumerated(2,10)	Unit is ms.	REL-6
>>>>TDD				No data	REL-7
>>HARQ info for E-DCH	MP		HARQ Info for E-DCH 10.3.5.7d		REL-6
>>Added or reconfigured E-DCH MAC-d flow list	OP	<1 to maxE-DCHMACd Flow>			REL-6
>>>Added or reconfigured E-DCH MAC-d flow	MP		Added or reconfigured E-DCH MAC-d flow 10.3.5.1b		REL-6
Note 1: If included in System Information Block Type 16, the values 'E-DCH' does not apply for the IE "Uplink transport channel type".					

Condition	Explanation
<i>NotE-DCH</i>	If the uplink transport channel type is DCH or USCH then this IE is mandatory otherwise it is not needed.

NOTE: This information element is included within IE "Predefined RB configuration".

10.3.5.2a Additional Dynamic Transport Format Information for CCCH

Information Element/Group name	Need	Multi	Type and reference	Semantics description	Version
RLC Size	MP		Integer (48..4968)	Unit is bits For FDD, values are restricted to: Integer (48..296 by step of 8, 312..1320 by step of 16, 1384..4968 by step of 64)	Rel-6
Number of Transport blocks	MP		Integer (1)	NOTE 1	Rel-6

NOTE 1: The "Integer (1)" type does not result in bits in the transfer syntax and is not needed in the ASN.1.

10.3.5.2b Additional RACH TFCS for CCCH

Information Element/Group name	Need	Multi	Type and reference	Semantics description	Version
Power offset Information	MP		Power Offset Information 10.3.5.8	The actual TFCS is specified in 8.6.5.12a	Rel-6

10.3.5.3 Void

10.3.5.3a Common MAC-ehs reordering queue list

NOTE: For FDD and 1.28 Mcps TDD only.

This IE defines common MAC-ehs priority queue parameters, which can be used for CCCH and SRB1 reception.

Information Element/Group name	Need	Multi	Type and reference	Semantics description	Version
MAC-ehs queue to configure list	MP	<1 to maxComm onQueueel D>			REL-7
>MAC-ehs queue Id	MP		MAC-ehs Queue Id 10.3.5.7f		REL-7
>T1	MP		Integer (10, 20, 30, 40, 50, 60, 70, 80, 90, 100, 120, 140, 160, 200, 300, 400)	Timer (in milliseconds) when PDUs are released to the upper layers even though there are outstanding PDUs with lower TSN values.	REL-7
>Treset	MD		Integer (1, 2, 3, 4)	Timer in multiples of T1 values (milliseconds). Used when MAC-ehs reordering queue is reset in CELL_FACH and CELL_PCH (FDD and 1.28 Mcps TDD only). Default value is 2	REL-7
>MAC-ehs window size	MP		Integer (4, 6, 8, 12, 16, 24, 32)		REL-7

10.3.5.3b Common E-DCH MAC-d flows

This IE is used in relation to MAC-d and MAC-c (for FDD) flows mapped to the E-DCH transport channels.

NOTE: Only for FDD and 1.28 Mcps TDD.

Information Element/Group name	Need	Multi	Type and reference	Semantics description	Version
Configured E-DCH MAC-d flow list	MP	1 to <maxE-DCHMACdFlow>			REL-8
>E-DCH MAC-d flow identity	MP		E-DCH MAC-d Flow Identity 10.3.5.7e	NOTE 1	REL-8
>E-DCH MAC-d flow power offset	MP		Integer(0..6)		REL-8
>E-DCH MAC-d flow maximum number of retransmissions	MP		Integer (0..15)		REL-8
>E-DCH MAC-d flow multiplexing list	CV- NotCCCHFDD		Bitstring (maxE-DCHMACdFlow)	Indicates, if this is the first MAC-d flow for which PDUs are placed in the MAC-i PDU, the other MAC-d flows from which MAC-d PDUs are allowed to be included in the same MAC-i PDU. Bit 0 is for MAC-d flow 0, Bit 1 is for MAC-d flow 1, ... Value '1' for a bit means multiplexing is allowed. Bit 0 is the first/leftmost bit of the bit string. NOTE: The bit that corresponds to the MAC-d flow itself is ignored.	REL-8
>E-DCH MAC-d flow retransmission timer	CV- <i>Tdd128</i>		Enumerated (10, 15, 20, 25, 30, 35, 40, 45, 50, 55, 60, 65, 70, 75, 80, 85, 90, 95, 100, 110, 120, 140, 160, 200, 240, 280, 320, 400, 480, 560)	Unit: ms	REL-8

NOTE 1: For FDD, E-DCH MAC-d flow identity 7 is reserved for CCCH transmission.

Condition	Explanation
<i>Tdd128</i>	This IE is mandatory present for 1.28 Mcps TDD, otherwise it is not needed.
<i>NotCCCHFDD</i>	This IE is not needed for the E-DCH MAC-d flow reserved for CCCH transmission for FDD, otherwise it is optional.

10.3.5.4 Deleted DL TrCH information

Information Element/Group name	Need	Multi	Type and reference	Semantics description	Version
Downlink transport channel type	MP		Enumerated (DCH,DSCH, HS-DSCH)	Note 1	
					REL-5
DL Transport channel identity	MP		Transport channel identity 10.3.5.18		
					REL-5
CHOICE DL MAC header type	CV- <i>HS-DSCH</i>				REL-7
>MAC-hs					REL-7
>>DL HS-DSCH MAC-d flow identity	MP		MAC-d flow identity 10.3.5.7c		REL-5
>MAC-ehs					REL-7
>>DL HS-DSCH MAC-ehs reordering queue	MP		MAC-ehs Queue Id 10.3.5.7f		REL-7
Note 1: The IE "Downlink transport channel type" value " DSCH " should not be used for FDD. If received the UE behaviour is unspecified.					

Condition	Explanation
<i>NotHS-DSCH</i>	If the downlink transport channel type is DCH or DSCH then this IE is mandatory otherwise it is not needed.
<i>HS-DSCH</i>	If the downlink transport channel type is HS-DSCH then this IE is mandatory otherwise it is not needed.

10.3.5.5 Deleted UL TrCH information

Information Element/Group name	Need	Multi	Type and reference	Semantics description	Version
Uplink transport channel type	MP		Enumerated (DCH,USCH, E-DCH)	USCH is TDD only	
					REL-6
UL Transport channel identity	MP		Transport channel identity 10.3.5.18		
					REL-6
E-DCH MAC-d flow identity	CV- <i>E-DCH</i>		E-DCH MAC-d flow identity 10.3.5.7e		REL-6

Condition	Explanation
<i>NotE-DCH</i>	If the uplink transport channel type is DCH or USCH then this IE is mandatory otherwise it is not needed.
<i>E-DCH</i>	If the uplink transport channel type is E-DCH then this IE is mandatory otherwise it is not needed.

10.3.5.6 DL Transport channel information common for all transport channels

Information Element/Group name	Need	Multi	Type and reference	Semantics description	Version
SCCPCH TFCS	OP		Transport Format Combination Set 10.3.5.20	This IE should not be included in this version of the protocol.	
CHOICE <i>mode</i>	MP			Although this IE is not always required, need is MP to align with ASN.1	
	OP				REL-4
>FDD					
>>CHOICE <i>DL parameters</i>	OP				
>>>Explicit					
>>>>DL DCH TFCS	MP		Transport Format Combination Set 10.3.5.20	Although this IE is not always required, need is MP to align with ASN.1	
	OP				REL-4
>>>SameAsUL				(no data) See note 2	
>TDD					
>>Individual DL CCTrCH information	OP	1 to <maxCCTrCH>			
>>>DL TFCS Identity	MP		Transport format combination set identity 10.3.5.21	Identifies a special CCTrCH for shared or dedicated channels.	
>>>CHOICE <i>DL parameters</i>	MP				
>>>>Independent					
>>>>>DL TFCS	MP		Transport format combination set 10.3.5.20		
>>>>>SameAsUL				See note 2	
>>>>>>UL DCH TFCS Identity	MP		Transport format combination set identity 10.3.5.21	Same TFCS applies as specified for the indicated UL DCH TFCS identity except for information applicable for UL only	

NOTE 1: This information element is included within IE "Predefined TrCh configuration".

NOTE 2: The UTRAN should only use the choice "SameAsUL" if the transport channel numbering, the number of TFs in the TFS of each transport channel, and the TFCS are identical in the uplink and downlink.

10.3.5.7 Void

10.3.5.7a HARQ Info

This IE is used in relation to the HS-DSCH transport channel.

Information Element/Group name	Need	Multi	Type and reference	Semantics description	Version
Number of Processes	MP		Integer (1..8,		REL-5
			12, 14, 16,	NOTE 1, NOTE 2	REL-7
			24,28,32)		REL-11
<i>CHOICE Memory Partitioning</i>	MP				REL-5
>Implicit				UE shall apply memory partitioning of equal size across all HARQ processes	REL-5
>Explicit					REL-5
>>Memory size	MP	<1 to MaxHProc esses>			REL-5
>>>Process Memory size	MP		Integer(800 . . 16000 by step of 800, 17600 .. 32000 by step of 1600, 36000 .. 80000 by step of 4000, 88000 .. 160000 by step of 8000, 176000 .. 304000 by step of 16000)	Maximum number of soft channel bits available in the virtual IR buffer [27]	REL-5
>>Additional memory sizes for MIMO	OP	<1 to MaxHProc esses>		NOTE 2	REL-7
>>>Process Memory size	MP		Integer (800 .. 16000 by step of 800, 17600 .. 32000 by step of 1600, 36000 .. 80000 by step of 4000, 88000 .. 160000 by step of 8000, 176000 .. 304000 by step of 16000)	Maximum number of soft channel bits available in the virtual IR buffer [27]	REL-7
>>Additional memory sizes for 3 rd MIMO stream	OP	<1 to MaxHProc esses>		NOTE 2	REL-11

>>>Process Memory size	MP		Integer (800 .. 16000 by step of 800, 17600 .. 32000 by step of 1600, 36000 .. 80000 by step of 4000, 88000 .. 160000 by step of 8000, 176000 .. 304000 by step of 16000)	Maximum number of soft channel bits available in the virtual IR buffer [27]	REL-11
>>Additional memory sizes for 4 th MIMO stream	OP	<1 to MaxHPProcesses>		NOTE 2	REL-11
>>>Process Memory size	MP		Integer (800 .. 16000 by step of 800, 17600 .. 32000 by step of 1600, 36000 .. 80000 by step of 4000, 88000 .. 160000 by step of 8000, 176000 .. 304000 by step of 16000)	Maximum number of soft channel bits available in the virtual IR buffer [27]	REL-11
NOTE 1: If the IE "Number of processes" is not set to one of the values 12, 14 or 16 and either the IE "MIMO parameters" (10.3.6.41a) is included and the IE "MIMO operation" is set to either "start" or "continue", the UE behaviour is unspecified. If the IE "Number of processes" is set to one of the values 12, 14, or 16 and the IE "MIMO parameters" (10.3.6.41a) is not included, the UE behaviour is unspecified.					
NOTE 2: The values of the IE "Number of processes" greater than 8 and the IE "Additional memory sizes for MIMO" are not needed in SIB type 5 and SIB type 5bis.					

10.3.5.7b Void

10.3.5.7c MAC-d Flow Identity

Information Element/Group name	Need	Multi	Type and reference	Semantics description	Version
MAC-d flow identity	MP		Integer (0..7)		REL-5

10.3.5.7d HARQ Info for E-DCH

This IE is used in relation to the E-DCH transport channel.

Information Element/Group name	Need	Multi	Type and reference	Semantics description	Version
CHOICE <i>mode</i>	MP				REL-7
>FDD					REL-7
>>HARQ RV Configuration	MP		Enumerated (rv0, rvtable)	If "rv0" is indicated, the UE shall only use E_DCH RV index 0. If "rvtable" is indicated, the UE shall use an RSN based RV index as specified in [27]	REL-6
>TDD					REL-7
>>HARQ RV Configuration	MP		Enumerated (rv0, rvtable)	If "rv0" is indicated, the UE shall only use E_DCH RV index 0. If "rvtable" is indicated, the UE shall use an RSN based RV index as specified in [31]	REL-7

10.3.5.7e E-DCH MAC-d Flow Identity

Information Element/Group name	Need	Multi	Type and reference	Semantics description	Version
E-DCH MAC-d flow identity	MP		Integer (0..maxE-DCHMACdFlow-1)		REL-6

10.3.5.7f MAC-ehs Queue Id

Information Element/Group name	Need	Multi	Type and reference	Semantics description	Version
MAC-ehs queue id	MP		Integer (0..7)		REL-7

10.3.5.8 Power Offset Information

Information Element/Group name	Need	Multi	Type and reference	Semantics description
CHOICE <i>Gain Factors</i>	MP			
>Signalled Gain Factors				
>>CHOICE <i>mode</i>				
>>>FDD				
>>>>Gain Factor β_c	MP		Integer (0.. 15)	For UL DPCCH or control part of PRACH
>>>TDD				(no data)
>>Gain Factor β_d	MP		Integer (0..15)	For UL DPDCH or data part of PRACH and all uplink channels in TDD
>>Reference TFC ID	OP		Integer (0..3)	If this TFC is a reference TFC, indicates the reference ID.
>Computed Gain Factors				

Information Element/Group name	Need	Multi	Type and reference	Semantics description
>>Reference TFC ID	MP		Integer (0.. 3)	Indicates the reference TFC Id of the TFC to be used to calculate the gain factors for this TFC. In case of using computed gain factors, at least one signalled gain factor is necessary for reference.
CHOICE <i>mode</i>	MP			
>FDD				
>>Power offset P _{p-m}	OP		Integer(-5..10)	In dB. Power offset between the last transmitted preamble and the control part of the message (added to the preamble power to receive the power of the message control part) Needed only for PRACH
>TDD				(no data)

CHOICE <i>Gain Factors</i>	Condition under which the way to signal the <i>Gain Factors</i> is chosen
<i>Signalled Gain Factors</i>	The values for gain factors β_c (only in FDD mode) and β_d are signalled directly for a TFC.
<i>Computed Gain Factors</i>	The gain factors β_c (only in FDD mode) and β_d are computed for a TFC, based on the signalled settings for the associated reference TFC.

10.3.5.9 Predefined TrCH configuration

This information element concerns a pre- defined configuration of transport channel parameters.

Information Element/Group name	Need	Multi	Type and Reference	Semantics description
UL Transport channel information common for all transport channels	MP		UL Transport channel information common for all transport channels 10.3.5.24	
Added or Reconfigured TrCH information				
Added or Reconfigured UL TrCH information	MP	1 to <maxTrCH preconf>		
>Added or Reconfigured UL TrCH information	MP		Added or Reconfigured UL TrCH information 10.3.5.2	
DL Transport channel information common for all transport channels	MP		DL Transport channel information common for all transport channels 10.3.5.6	
Downlink transport channels				
Added or Reconfigured DL TrCH information	MP	1 to <maxTrCH preconf>		
>Added or Reconfigured DL TrCH information	MP		Added or Reconfigured DL TrCH information 10.3.5.1	

10.3.5.10 Quality Target

Information Element/Group name	Need	Multi	Type and reference	Semantics description
BLER Quality value	MP		Real(-6.3 ..0 by step of 0.1)	Signalled value is Log10(Transport channel BLER quality target)

10.3.5.11 Semi-static Transport Format Information

Information Element/Group name	Need	Multi	Type and reference	Semantics description	Version
Transmission time interval	MP		Integer(10, 20, 40, 80, dynamic)	In ms. The value dynamic is only used in TDD mode. For FDD DCH, the value "80" is applicable only when SF=512.	

Information Element/Group name	Need	Multi	Type and reference	Semantics description	Version
			5)	5 is only applicable for the RACH in 1.28 Mcps TDD	REL-4
Type of channel coding	MP		Enumerated(No coding, Convolutional, Turbo)	The option "No coding" is only valid for TDD.	
Coding Rate	CV-Coding		Enumerated(1/2, 1/3)		
Rate matching attribute	MP		Integer(1..hi RM)		
CRC size	MP		Integer(0, 8, 12, 16, 24)	in bits	

Condition	Explanation
<i>Coding</i>	This IE is mandatory present if IE "Type of channel coding" is "Convolutional" and not needed otherwise.

10.3.5.12 Void

10.3.5.13 TFCS Explicit Configuration

Information Element/Group name	Need	Multi	IE type and reference	Semantics description
<i>CHOICE TFCS representation</i>	MP			
>Complete reconfiguration				
>>TFCS complete reconfiguration information	MP		TFCS Reconfiguration/Addition information 10.3.5.15	
>Addition				
>>TFCS addition information	MP		TFCS Reconfiguration/Addition information 10.3.5.15	
>Removal				
>>TFCS removal information	MP		TFCS Removal Information 10.3.5.16	
>Replace				
>>TFCS removal information	MP		TFCS Removal Information 10.3.5.16	
>>TFCS addition information	MP		TFCS Reconfiguration/Addition information 10.3.5.15	

10.3.5.14 Void

10.3.5.15 TFCS Reconfiguration/Addition Information

Information Element/Group name	Need	Multi	IE type and reference	Semantics description	Version
CHOICE <i>CTFC Size</i>	MP				
>2 bit CTFC					
>>CTFC information	MP	1 to <maxTFC>			
>>>2bit CTFC	MP		Integer(0..3)		
>>>Power offset Information	OP		Power Offset Information 10.3.5.8	Needed only for uplink physical channels.	
>>>Power offset Information 10ms Mode	CV-Mess age		Power offset Information 10ms Mode 10.3.5.27	FDD only. Needed only for uplink physical channels. If not included, the corresponding TFC shall not be considered for 10ms Mode.	REL-12
>4 bit CTFC					
>>CTFC information	MP	1 to <maxTFC>			
>>>4bit CTFC	MP		Integer(0..15)		
>>>Power offset Information	OP		Power Offset Information 10.3.5.8	Needed only for uplink physical channels.	
>>>Power offset Information 10ms Mode	CV-Mess age		Power offset Information 10ms Mode 10.3.5.27	FDD only. Needed only for uplink physical channels. If not included, the corresponding TFC shall not be considered for 10ms Mode.	REL-12
>6 bit CTFC					
>>CTFC information	MP	1 to <maxTFC>			
>>>6 bit CTFC	MP		Integer(0..63)		
>>>Power offset Information	OP		Power Offset Information 10.3.5.8	Needed only for uplink physical channels.	
>>>Power offset Information 10ms Mode	CV-Mess age		Power offset Information 10ms Mode 10.3.5.27	FDD only. Needed only for uplink physical channels. If not included, the corresponding TFC shall not be considered for 10ms Mode.	REL-12
>8 bit CTFC					
>>CTFC information	MP	1 to <MaxTFC>			
>>>8 bit CTFC	MP		Integer(0..255)		
>>>Power offset Information	OP		Power Offset Information 10.3.5.8	Needed only for uplink physical channels.	
>>>Power offset Information 10ms Mode	CV-Mess age		Power offset Information 10ms Mode 10.3.5.27	FDD only. Needed only for uplink physical channels. If not included, the corresponding TFC shall not be considered for 10ms Mode.	REL-12

Information Element/Group name	Need	Multi	IE type and reference	Semantics description	Version
>12 bit CTFC					
>>CTFC information	MP	1 to <maxTFC>			
>>>12 bit CTFC	MP		Integer(0..4095)		
>>>Power offset Information	OP		Power Offset Information 10.3.5.8	Needed only for uplink physical channels.	
>>>Power offset Information 10ms Mode	CV-Mess age		Power offset Information 10ms Mode 10.3.5.27	FDD only. Needed only for uplink physical channels. If not included, the corresponding TFC shall not be considered for 10ms Mode.	REL-12
>16 bit CTFC					
>>CTFC information	MP	1 to <maxTFC>			
>>>16 bit CTFC	MP		Integer(0..65535)		
>>>Power offset Information	OP		Power Offset Information 10.3.5.8	Needed only for uplink physical channels.	
>>>Power offset Information 10ms Mode	CV-Mess age		Power offset Information 10ms Mode 10.3.5.27	FDD only. Needed only for uplink physical channels. If not included, the corresponding TFC shall not be considered for 10ms Mode.	REL-12
>24 bit CTFC					
>>CTFC information	MP	1 to <MaxTFC>			
>>>24 bit CTFC	MP		Integer(0..16777215)		
>>>Power offset Information	OP		Power Offset Information 10.3.5.8	Needed only for uplink physical channels.	
>>>Power offset Information 10ms Mode	CV-Mess age		Power offset Information 10ms Mode 10.3.5.27	FDD only. Needed only for uplink physical channels. If not included, the corresponding TFC shall not be considered for 10ms Mode.	REL-12

Condition	Explanation
Message	This IE is not needed if the IE "Uplink Transport channel information common for all transport channels" is included in RRC CONNECTION SETUP or SYSTEM INFORMATION BLOCK TYPE 16 messages. Otherwise it is optional.

10.3.5.16 TFCS Removal Information

Information Element/Group name	Need	Multi	IE type and reference	Semantics description
Removal TFCI information	MP	1 to <maxTFC>		
>TFCI	MP		Transport Format Combination (TFC) 10.3.5.19	In TDD 0 is a reserved value

10.3.5.17 Void

10.3.5.18 Transport channel identity

This information element is used to distinguish transport channels. Transport channels of different type (RACH, USCH, FACH/PCH, DSCH or DCH) have separate series of identities. This also holds for uplink and downlink transport channel identities (i.e. for DCH). Depending on in which context a transport channel identity n that is sent, it will have different meaning

Information Element/Group name	Need	Multi	Type and reference	Semantics description
Transport channel identity	MP		Integer(1..32)	

10.3.5.19 Transport Format Combination (TFC)

Information Element/Group name	Need	Multi	Type and reference	Semantics description
Transport format combination	MP		Integer (0..1023)	

10.3.5.20 Transport Format Combination Set

Indicates the allowed combinations of already defined Transport formats and the mapping between these allowed TFCs and the corresponding TFCI values.

For TDD, different coded composite transport channels have independent transport format combination sets and thus independent TFCI values.

Information Element/Group name	Need	Multi	IE type and reference	Semantics description
TFCI Field 1 Information	MP		TFCS explicit Configuration 10.3.5.13	

10.3.5.21 Transport Format Combination Set Identity

NOTE: Only for TDD.

Information Element/Group name	Need	Multi	Type and reference	Semantics description
TFCS ID	MD		Integer (1..8)	Indicates the identity of every TFCS within a UE. Default value is 1.
Shared Channel Indicator	MP		Boolean	TRUE indicates the use of shared channels. Default is FALSE.

10.3.5.22 Transport Format Combination Subset

Indicates which Transport format combinations in the already defined Transport format combination set are allowed.

Information Element/Group name	Need	Multi	Type and reference	Semantics description
<i>CHOICE Subset representation</i>	MP			
>Minimum allowed Transport format combination index			Transport format combination 10.3.5.19	
>Allowed transport format combination list		1 to <maxTFC>		
>>Allowed transport format combination	MP		Transport format combination 10.3.5.19	
>Non-allowed transport format combination list		1 to <maxTFC>		
>>Non-allowed transport format combination	MP		Transport format combination 10.3.5.19	
>Restricted TrCH information		1 to <maxTrCH >		
>>Uplink transport channel type	MP		Enumerated(DCH, USCH)	USCH is TDD only
>>Restricted UL TrCH identity	MP		Transport channel identity 10.3.5.18	
>>Allowed TFIs	OP	1 to <maxTF>		
>>>Allowed TFI	MP		Integer(0..31)	
>Full transport format combination set				(No data)

10.3.5.23 Transport Format Set

Information Element/Group name	Need	Multi	Type and reference	Semantics description	Version
<i>CHOICE Transport channel type</i>	MP				
>Dedicated transport channels				The transport channel that is configured with this TFS is of type DCH	
>>Dynamic Transport Format Information	MP	1 to <maxTF>			
>>>RLC Size	MP		Integer(16..5000 by step of 8)	Unit is bits	

Information Element/Group name	Need	Multi	Type and reference	Semantics description	Version
>>>Number of TBs and TTI List	MP	1 to <maxTF>		Present for every valid number of TB's (and TTI) for this RLC Size.	
>>>>Transmission Time Interval	CV-dynamicTTI		Integer(10,20,40,80)	Unit is ms.	
>>>>Number of Transport blocks	MP		Integer(0..512)		
>>>CHOICE <i>Logical Channel List</i>	MP			The logical channels that are allowed to use this RLC Size	
>>>>ALL			Null	All logical channels mapped to this transport channel.	
>>>>Configured			Null	The logical channels configured to use this RLC size in the <i>RB mapping info</i> . 10.3.4.21 if present in this message or in the previously stored configuration otherwise	
>>>>Explicit List		1 to 15		Lists the logical channels that are allowed to use this RLC size.	
>>>>>RB Identity	MP		RB identity 10.3.4.16		
>>>>>LogicalChannel	CH-UL-RLCLogicalChannels		Integer(0..1)	Indicates the relevant UL logical channel for this RB. "0" corresponds to the first, "1" corresponds to the second UL logical channel configured for this RB in the IE "RB mapping info".	
>>Semi-static Transport Format Information	MP		Semi-static Transport Format Information 10.3.5.11		
>Common transport channels				The transport channel that is configured with this TFS is of a type not equal to DCH	
>>Dynamic Transport Format Information	MP	1 to <maxTF>		Note	
>>>RLC Size	MP		Integer (48..4968)	Unit is bits. For FDD, values are restricted to: Integer (48..296 by step of 8, 312..1320 by step of 16, 1384..4968 by step of 64).	
>>>Number of TBs and TTI List	MP	1 to <maxTF>		Present for every valid number of TB's (and TTI) for this RLC Size.	
>>>>Number of Transport blocks	MP		Integer(0..512)		
>>>>CHOICE <i>mode</i>	MP				
>>>>>FDD				(no data)	
>>>>>TDD					
>>>>>>Transmission Time Interval	CV-dynamicTTI		Integer(10,20,40,80)	Unit is ms.	
>>>>CHOICE <i>Logical Channel List</i>	MP			The logical channels that are allowed to use this RLC Size.	
>>>>>ALL			Null	All logical channels mapped to this transport channel.	

Information Element/Group name	Need	Multi	Type and reference	Semantics description	Version
>>>>Configured			Null	The logical channels configured to use this RLC size in the <i>RB mapping info</i> . 10.3.4.21 if present in this message or in the previously stored configuration otherwise	
>>>>Explicit List		1 to 15		Lists the logical channels that are allowed to use this RLC size.	
>>>>>RB Identity	MP		RB identity 10.3.4.16		
>>>>>LogicalChannel	CV-UL- RLCLogical Channels		Integer(0..1)	Indicates the relevant UL logical channel for this RB. "0" corresponds to the first, "1" corresponds to the second UL logical channel configured for this RB in the IE "RB mapping info".	
>>Semi-static Transport Format Information	MP		Semi-static Transport Format Information 10.3.5.11		

Condition	Explanation
<i>dynamicTTI</i>	This IE is mandatory present if dynamic TTI usage is indicated in IE Transmission Time Interval in Semi-static Transport Format Information. Otherwise it is not needed.
<i>UL-RLCLogicalChannels</i>	If "Number of uplink RLC logical channels" in IE "RB mapping info" in this message is 2 or the IE "RB mapping info" is not present in this message and 2 UL logical channels are configured for this RB, then this IE is mandatory present. Otherwise this IE is not needed.

10.3.5.24 UL Transport channel information common for all transport channels

Information Element/Group name	Need	Multi	Type and reference	Semantics description	Version
PRACH TFCS	OP		Transport format combination set 10.3.5.20	This IE should not be included in this version of the protocol.	
CHOICE <i>mode</i>	OP				
>FDD					

>>TFC subset	MD		Transport Format Combination Subset 10.3.5.22	Default value is the complete existing set of transport format combinations	
>>UL DCH TFCS	MP		Transport format combination set 10.3.5.20		
>TDD					
>>Individual UL CCTrCH information	OP	1 to <maxCCTrCH>			
>>>UL TFCS Identity	MP		Transport format combination set identity 10.3.5.21	Identifies a special CCTrCH for shared or dedicated channels.	
>>>UL TFCS	MP		Transport format combination set 10.3.5.20		
>>>TFC subset	MD		Transport Format Combination Subset 10.3.5.22	Default value is the complete existing set of transport format combinations	
TFC subset list	OP	1 to <maxTFCsub>		The maximum number of elements in the TFC subset list is 8.	REL-4
>CHOICE <i>mode</i>	MP				REL-4
>>FDD				(no data)	REL-4
>>TDD					REL-4
>>>TFCS Id	OP		Transport Format Combination Set Identity 10.3.5.21		REL-4
>TFC subset	MD		Transport Format Combination Subset 10.3.5.22		REL-4

NOTE: This information element is included within IE "Predefined TrCh configuration".

10.3.5.25 Concurrent Deployment of 2ms and 10ms TTI

NOTE: Only for FDD.

Information Element/Group name	Need	Multi	Type and reference	Semantics description	Version
CHOICE <i>TTI selection</i>	MP			This IE indicates whether common E-DCH TTI selection is fixed or a threshold based common E-DCH selection criteria is used.	REL-11
>Fixed					REL-11
>>Fixed common E-DCH TTI selection	MP		Enumerated (2ms,10ms)		REL-11
>Threshold based					REL-11
>>Common E-DCH TTI selection threshold	MP		Integer (0..15)	In terms of dB.	REL-11
Concurrent TTI partition index	MP		Integer (0..maxEDCHs-1)		REL-11
Common E-DCH system info parameters for Concurrent TTI	OP		Common E-DCH system info parameters for Concurrent TTI 10.3.6.131	Common E-DCH parameters used to replace those listed in the IE "Common E-DCH system info" of the System Information Block Type 5/5bis, if the TTI applied on E-DPDCH (as per subclause 8.5.45) is different from the TTI signalled in the IE "E-DCH Transmission Time Interval".	REL-11

10.3.5.26 Common E-DCH MAC-d flow info for Concurrent TTI

This IE is used in relation to MAC-d and MAC-c flows mapped to the E-DCH transport channels.

NOTE: Only for FDD.

Information Element/Group name	Need	Multi	Type and reference	Semantics description	Version
Configured E-DCH MAC-d flow list	MP	1 to <maxE-DCHMACdFlows>		NOTE 1 NOTE 4	REL-11
>E-DCH MAC-d flow identity	MP		E-DCH MAC-d Flow Identity 10.3.5.7e		REL-11
>E-DCH MAC-d flow power offset	MD		Integer(0..6)	NOTE 2	REL-11
>E-DCH MAC-d flow maximum number of retransmissions	MD		Integer (0..15)	NOTE 2	REL-11
<p>NOTE 1: E-DCH MAC-d flow identities that are present in "Common E-DCH MAC-d flows" of the System Information Block Type 5/5bis but do not appear in this list shall use value included in "Common E-DCH MAC-d flows".</p> <p>NOTE 2: Default value is the value for the flow with the same "E-DCH MAC-d flow identity" included in the IE "Common E-DCH MAC-d flows" of the System Information Block Type 5/5bis.</p> <p>NOTE 4: For E-DCH MAC-d flows that are present in this list, the IE "E-DCH MAC-d flow multiplexing list" shall use the corresponding value for the flow with the same "E-DCH MAC-d flow identity" included in the IE "Common E-DCH MAC-d flows" of the System Information Block Type 5/5bis.</p>					

NOTE 3: For FDD, E-DCH MAC-d flow identity 7 is reserved for CCCH transmission.

10.3.5.27 Power Offset Information 10ms Mode

NOTE: For FDD only.

Information Element/Group name	Need	Multi	Type and reference	Semantics description	Version
CHOICE <i>Gain Factors</i>	MP				REL-12
>Signalled Gain Factors					
>>Gain Factor β_c	MP		Integer (0.. 15)	For UL DPCCH	REL-12
>>Gain Factor β_d	MP		Integer (0..15)	For UL DPDCH	REL-12
>>Reference TFC ID	OP		Integer (0..3)	If this TFC is a reference TFC, indicates the reference ID.	REL-12
>Computed Gain Factors					
>>Reference TFC ID	MP		Integer (0.. 3)	Indicates the reference TFC Id of the TFC to be used to calculate the gain factors for this TFC. In case of using computed gain factors, at least one signalled gain factor is necessary for reference.	REL-12

CHOICE <i>Gain Factors</i>	Condition under which the way to signal the <i>Gain Factors</i> is chosen
<i>Signalled Gain Factors</i>	The values for gain factors β_c and β_d are signalled directly for a TFC.
<i>Computed Gain Factors</i>	The gain factors β_c and β_d are computed for a TFC, based on the signalled settings for the associated reference TFC.

10.3.6 Physical CH Information elements

10.3.6.1 AC-to-ASC mapping

Information Element/Group name	Need	Multi	Type and reference	Semantics description
AC-to-ASC mapping table	MP	maxASCmap		
>AC-to-ASC mapping	MP		Integer(0...7)	Mapping of Access Classes to Access Service Classes (see subclause 8.5.13.)

10.3.6.2 AICH Info

NOTE: Only for FDD.

Information Element/Group name	Need	Multi	Type and reference	Semantics description
Channelisation code	MP		Integer(0..255)	SF is fixed and equal to 256
STTD indicator	MP		STTD Indicator 10.3.6.78	
AICH transmission timing	MP		Enumerated (0, 1)	See parameter AICH_Transmission_Timing in [26]

10.3.6.3 AICH Power offset

NOTE: Only for FDD.

This parameter is used to indicate the power level of AICH channel. This is the power per transmitted Acquisition Indicator, Extended Acquisition Indicator minus power of the Primary CPICH.

Information Element/Group name	Need	Multi	Type and reference	Semantics description
AICH Power offset	MP		Integer(-22..+5)	Offset in dB

10.3.6.4 Allocation period info

NOTE: Only for TDD.

Parameters used by UE to determine period of shared channel allocation.

Information Element/Group name	Need	Multi	Type and reference	Semantics description
Allocation Activation Time	MP		Integer (0..255)	Start the allocation period at the given CFN.
Allocation Duration	MP		Integer (1..256)	Total number of frames for the allocation period.

10.3.6.5 Alpha

Information Element/Group name	Need	Multi	Type and reference	Semantics description
Alpha Value	MP		Enumerated(0, 1/8, 2/8, 3/8, 4/8, 5/8, 6/8, 7/8, 1)	

10.3.6.6 ASC setting

Information Element/Group name	Need	Multi	Type and reference	Semantics description	Version
CHOICE mode	MP				
>FDD					
>>Available signature Start Index	MP		Integer(0..15)		
>>Available signature End Index	MP		Integer(0..15)		

Information Element/Group name	Need	Multi	Type and reference	Semantics description	Version
>>Assigned Sub-Channel Number	MP		Bit string(4)	This IE defines the subchannel assignment as specified in 8.6.6.29. The first/leftmost bit of the bit string contains the most significant bit of the Assigned Sub-Channel Number..	
>TDD					
>>CHOICE <i>TDD option</i>	MP				REL-4
>>>3.84 Mcps TDD					REL-4
>>>>Available Channelisation codes indices	MD		Bit string(8)	Each bit indicates availability of a channelisation code index, where the channelisation code indices are numbered "channelisation code index 0" to "channelisation code index 7". The value 1 of a bit indicates that the channelisation code index is available for the ASC this IE is associated to. The value 0 of a bit indicates that the channelisation code index is not available for the ASC this IE is associated to. Default is that all channelisation codes defined in PRACH Info are available.	
>>>>7.68 Mcps TDD					REL-7

Information Element/Group name	Need	Multi	Type and reference	Semantics description	Version
>>>>Available Channelisation codes indices	MD		Bit string(16)	Each bit indicates availability of a channelisation code index, where the channelisation code indices are numbered "channelisation code index 0" to "channelisation code index 15". The value 1 of a bit indicates that the channelisation code index is available for the ASC this IE is associated to. The value 0 of a bit indicates that the channelisation code index is not available for the ASC this IE is associated to. Default is that all channelisation codes defined in PRACH Info are available.	REL-7
>>>1.28 Mcps TDD >>>>Available SYNC_UL codes indices	MD		Bit string(8)	Each bit indicates availability of a SYNC_UL code index, where the SYNC_UL code indices are numbered "SYNC_UL code index 0" to "SYNC_UL code index 7". The value 1 of a bit indicates that the SYNC_UL code index is available for the ASC this IE is associated to. The value 0 of a bit indicates that the SYNC_UL code index is not available for the ASC this IE is associated to. Default is that all SYNC_UL codes defined in SYNC_UL Info are available.	REL-4 REL-4
>>CHOICE <i>subchannel size</i>	MP				
>>>Size1					
>>>>Available Subchannels	MP		null	Indicates that all Subchannels are available	
>>>Size2					

Information Element/Group name	Need	Multi	Type and reference	Semantics description	Version
>>>>Available Subchannels	MD		Bit string (2)	NOTE	
>>>Size4					
>>>>Available Subchannels	MD		Bit string (4)	NOTE	
>>>Size8					
>>>>Available Subchannels	MD		Bit string (8)	NOTE	
>>>Size16					
>>>>Available Subchannels	MD		Bit string (16)	NOTE	

NOTE: Each bit indicates availability of a subchannel, where the subchannels are numbered subchannel 0, subchannel 1 etc. The value 1 of a bit indicates that the subchannel is available for the ASC this IE is associated with. The value 0 of a bit indicates that the subchannel is not available for the ASC this IE is associated with. Default value of the IE is that all subchannels within the size are available for the ASC this IE is associated with.

10.3.6.7 Void

10.3.6.8 CCTrCH power control info

Parameters used by UE to set the SIR target value for uplink open loop power control in TDD.

Information Element/Group name	Need	Multi	Type and Reference	Semantics description
TFCS Identity	OP		Transport Format Combination Set Identity 10.3.5.21	TFCS Identity of this CCTrCH. Default value is 1.
Uplink DPCH power control info	MP		Uplink DPCH power control info 10.3.6.91	

10.3.6.8a Cell and Channel Identity info

NOTE: Only for TDD.

Information Element/Group name	Need	Multi	Type and Reference	Semantics description
Burst type	MP		Enumerated (Type1, Type2)	Identifies the channel in combination with the Midamble shift and slot number. It is not used in 1.28 Mcps TDD and may be set to either value. This IE should be ignored by the receiver.
Midamble Shift	MP		Integer (0...15)	
Time Slot	MP		Timeslot number 10.3.6.84	This IE is present only if no IPDL scheme is configured in the reference cell. Otherwise the slot is defined by the IPDL configuration.
Cell parameters ID	MP		Cell parameters ID 10.3.6.9	Identifies the cell

10.3.6.9 Cell parameters Id

Information Element/Group name	Need	Multi	Type and Reference	Semantics description
Cell parameter Id	MP		Integer(0..127)	

10.3.6.9a Common E-DCH system info

NOTE: Only for FDD and 1.28 Mcps TDD.

Information Element/Group name	Need	Multi	Type and reference	Semantics description	Version
--------------------------------	------	-------	--------------------	-----------------------	---------

UL interference for common E-DCH	OP		UL interference 10.3.6.87		REL-8
Common E-DCH MAC-d flows	MP		Common E-DCH MAC-d flows 10.3.5.3b		REL-8
CHOICE <i>mode</i>	MP				REL-8
>FDD					REL-8
>>PRACH preamble control parameters (for Enhanced Uplink)	MP		PRACH preamble control parameters (for Enhanced Uplink) 10.3.6.54a	Control parameters of the physical signal.	REL-8
>>Initial Serving grant value	MP		Integer (0..37)	(0..37) indicates E-DCH serving grant index as defined in [15].	REL-8
>>E-DCH Transmission Time Interval	MP		Enumerated (2,10)	Unit is ms.	REL-8
>>E-AGCH Info	MP		E-AGCH Info 10.3.6.100		REL-8
>>HARQ info for E-DCH	MP		HARQ info for E-DCH 10.3.5.7d		REL-8
>>Uplink DPCH power control info	MP		Uplink DPCH power control info for Common E-DCH 10.3.6.91a		REL-8
>>E-DPCCH info	MP		E-DPCCH Info 10.3.6.98		REL-8
>>E-DPDCH info	MP		E-DPDCH info 10.3.6.99		REL-8
>>F-DPCH TPC command error rate target	MP		Real (0.01..0.1 by step of 0.01).	Downlink F-DPCH information. The actual value of dl-FDPCH-TPCcommandErrorRate = IE value * 0.01	REL-8
>>Additional E-DCH transmission back off	MP		Integer (0..15)	In terms of TTIs.	REL-8
>>Maximum E-DCH resource allocation for CCCH	MP		Enumerated (8, 12, 16, 20, 24, 32, 40, 80)	In terms of TTIs.	REL-8
>>Maximum period for collision resolution phase	MP		Integer (8..24)	In terms of TTIs.	REL-8
>>E-DCH transmission continuation back off	MP		Enumerated (0, 4, 8, 16, 24, 40, 80, infinity)	In terms of TTIs. If set to "infinity", implicit common E-DCH resource release is disabled.	REL-8

>>ACK/NACK support on HS-DPCCH	MP		Boolean	TRUE indicates that HS-DPCCH shall be used when a common E-DCH resource is allocated to the UE for DTCH/DCCH transmission after collision resolution. FALSE indicates that HS-DPCCH shall not be used	REL-8
>>Measurement Feedback Info	OP		Measurement Feedback Info 10.3.6.40a		REL-8
>>Common E-DCH Resource Configuration information list	MP	1 to <maxEDCHs>			REL-8
>>>Soffset	MD		Integer(0..9)	(0..9) indicates symbol offset as defined in [26] NOTE3	REL-8
>>>F-DPCH Code number	CV-Short		Integer (0..255)	If this IE is not present, the value is equal to the last occurrence of this IE.	REL-8
>>>E-RGCH Information	OP		E-RGCH Info for Common E-DCH 10.3.6.123		REL-8
>>>E-HICH info	MP		E-HICH info for Common E-DCH 10.3.6.124		REL-8
>>>Uplink DPCH code info	MP		Uplink DPCH code info for Common E-DCH 10.3.6.87b		REL-8
>TDD					REL-8
>>CHOICE <i>TDD option</i>	MP				REL-8
>>>7.68 Mcps TDD			NULL		REL-8
>>>3.84 Mcps TDD			NULL		REL-8
>>>1.28 Mcps TDD					REL-8
>>>>E-RUCCH Info	MP		E-RUCCH Info 1.28 Mcps TDD 10.3.6.103a		REL-8
>>>>E-PUCH info	MP		E-PUCH Info 1.28 Mcps TDD 10.3.6.104a	Note1	REL-8
>>>>E-HICH info	MP		E-HICH info 1.28 Mcps TDD 10.3.6.101a	Note1	REL-8
>>>>E-AGCH Info	MP		E-AGCH Info 1.28 Mcps TDD 10.3.6.100a	Note1	REL-8
>>>>HARQ info for E-DCH	MP		HARQ info for E-DCH 10.3.5.7d		REL-8
>>>>CCCH transmission info	MP			Note2	REL-8
>>>>>Common E-RNTI info	MP		Common E-RNTI info 10.3.3.7a		REL-8

>>>>HARQ maximum number of retransmissions	MP		Integer (0..7)		REL-8
>>>>HARQ retransmission timer	MP		Enumerated (10, 15, 20, 25, 30, 35, 40, 45, 50, 55, 60, 65, 70, 75, 80, 85, 90, 95, 100, 110, 120, 140, 160)	Unit: ms	REL-8
>>>>HARQ power offset	MP		Integer(0..6)		REL-8
<p>NOTE3: The default value is defined by: $Soffset = (offset + common\ E\text{-}DCH\ resource\ list\ position) \bmod 10$ where "offset" is the value of the last instance of the IE "Soffset". If the IE "Soffset" was not present in the first occurrence, "offset" is equal to zero. "common E-DCH resource list position" indicates the Common E-DCH resource Configuration Information number by order of appearance. The value of the "common E-DCH resource list position" is zero for the first occurrence.</p>					

Condition	Explanation
Short	This IE is mandatory present for the first occurrence. Otherwise, this IE is optional.

NOTE1: These IEs correspond to the HS-DSCH configuration for CELL_FACH, CELL_PCH and URA_PCH state.

NOTE2: These IEs correspond to CCCH transmission configuration for CELL_FACH state on the primary frequency and secondary frequency.

10.3.6.10 Common timeslot info

Information Element/Group name	Need	Multi	Type and reference	Semantics description
2 nd interleaving mode	MD		Enumerated(Frame, Timeslot)	Frame timeslot related interleaving. Default value is "Frame"
TFCI coding	MD		Integer(4,8,16,32)	Describes the amount of bits for the TFCI bits code word as described in [31]. Defaults is no TFCI bit: In case of 8 PSK in 1.28Mcps TDD: 4 corresponds to 6 TFCI code word bits. 8 corresponds to 12 TFCI code word bits. 16 corresponds to 24 TFCI code word bits. 32 corresponds to 48 TFCI code word bits.
Puncturing limit	MP		Real(0.40..1.0 by step of 0.04)	
Repetition period	MD		Integer(1, 2,4,8,16,32,64)	Default is continuous allocation. Value 1 indicate continuous
Repetition length	MP		Integer(1.. Repetition period -1)	NOTE: This is empty if repetition period is set to 1.

10.3.6.10a Common timeslot info MBMS

Information Element/Group name	Need	Multi	Type and reference	Semantics description
2 nd interleaving mode	MD		Enumerated(Frame, Timeslot)	Frame timeslot related interleaving. Default value is "Frame"
TFCI coding	MD		Integer(4,8,16,32)	Describes the amount of bits for the TFCI bits code word as described in [31]. Defaults is no TFCI bit: In case of 8 PSK in 1.28Mcps TDD: 4 corresponds to 6 TFCI code word bits. 8 corresponds to 12 TFCI code word bits. 16 corresponds to 24 TFCI code word bits. 32 corresponds to 48 TFCI code word bits.
Puncturing limit	MP		Real(0.40..1.0 by step of 0.04)	

10.3.6.11 Constant value

NOTE: Only for FDD.

This constant value is used by the UE to calculate the initial output power on PRACH according to the Open loop power control procedure.

Information Element/Group name	Need	Multi	Type and reference	Semantics description
Constant value	MP		Integer (-35..-10)	In dB

10.3.6.11a Constant value TDD

NOTE: Only for 3.84 Mcps TDD and 7.68 Mcps TDD.

3.84 Mcps TDD and 7.68 Mcps TDD constant values are used for open loop power control of PRACH, USCH, HS-SICH and UL DPCH as defined in subclause 8.5.7.

Information Element/Group name	Need	Multi	Type and reference	Semantics description
TDD Constant value	MP		Integer (-35..+10)	In dB

10.3.6.12 Void

10.3.6.13 Void

10.3.6.14 Void

10.3.6.15 Void

10.3.6.16 Default DPCH Offset Value

Indicates the default offset value within interleaving size at a resolution of 512chip (1/5 slot) in FDD and a resolution of one frame in TDD to offset CFN in the UE. This is used to distribute discontinuous transmission periods in time and also to distribute NodeB-RNC transmission traffics in time. Even though the CFN is offset by DOFF, the start timing of the interleaving will be the timing that "CFN mod (interleaving size)"=0 (e.g. interleaving size: 2,4,8) in both UE and SRNC.

Information Element/Group name	Need	Multi	Type and reference	Semantics description
CHOICE <i>mode</i>				
>FDD				
>>Default DPCH Offset Value (DOFF)	MP		Integer (0..306688 by step of 512)	Number of chips=. 0 to 599 time 512 chips, see [10].
>TDD				
>>Default DPCH Offset Value (DOFF)	MP		Integer(0..7)	Number of frames; See [10]

10.3.6.17 Downlink channelisation codes

NOTE: Only for 1.28 Mcps TDD and 3.84 Mcps TDD.

Information Element/Group name	Need	Multi	Type and reference	Semantics description
CHOICE <i>codes representation</i>	MP			
>Consecutive codes				
>>First channelisation code	MP		Enumerated ((16/1)...(16/16))	If a TFCI exists in this timeslot, it is mapped to the channelisation code as defined in [30].
>>Last channelisation code	MP		Enumerated ((16/1)...(16/16))	If this is the same as First channelisation code, only one code is used by the physical layer.
>Bitmap				
>>Channelisation codes bitmap	MP		Bit string(chCode16-SF16, chCode15-SF16, chCode14-SF16, chCode13-SF16, chCode12-SF16, chCode11-SF16, chCode10-SF16, chCode9-SF16, chCode8-SF16, chCode7-SF16, chCode6-SF16, chCode5-SF16, chCode4-SF16, chCode3-SF16, chCode2-SF16, chCode1-SF16) SIZE (16)	Each bit indicates the availability of a channelisation code for SF16, where the channelisation codes are numbered as channelisation code 1 (SF16) to channelisation code 16 (SF16). (For SF 16, a 1 in the bitmap means that the corresponding code is used, a 0 means that the corresponding code is not used.) If all bits are set to zero, SF 1 shall be used. For dedicated MBSFN frequency timeslot, if the first half in the bit pattern is set to 1010101000000000, the first channelisation code with SF 2 shall be used; if the second half of bit pattern is set to 0000000010101010, the second channelisation code with SF 2 shall be used; if all bits are set to 1010101010101010, both the first and second channelisation codes with SF2 shall be used.

10.3.6.17a Downlink channelisation codes VHCR

NOTE: Only for 7.68 Mcps TDD VHCR

Information Element/Group name	Need	Multi	Type and reference	Semantics description	Version
CHOICE <i>codes representation</i>	MP				REL-7
>Consecutive codes					REL-7
>>First channelisation code	MP		Enumerated ((32/1)...(32/3 2))	If a TFCI exists in this timeslot, it is mapped to the channelisation code as defined in [30].	REL-7
>>Last channelisation code	MP		Enumerated ((32/1)...(32/3 2))	If this is the same as First channelisation code, only one code is used by the physical layer.	REL-7
>Bitmap					REL-7
>>Channelisation codes bitmap	MP		Bit string(32)	Each bit indicates the availability of a channelisation code for SF32, where the channelisation codes are numbered as channelisation code 1 (SF32) to channelisation code 32 (SF32). (For SF 32, a 1 in the bitmap means that the corresponding code is used, a 0 means that the corresponding code is not used.) If all bits are set to zero, SF 1 shall be used.	REL-7

10.3.6.18 Downlink DPCH info common for all RL

Information Element/Group name	Need	Multi	Type and reference	Semantics description	Version
Timing Indication	MP		Enumerated(Initialise, Maintain)	NOTE	
Timing maintained Synchronization indicator	CV- <i>Synch</i>		Enumerated (FALSE)	FALSE indicates that no synchronisation procedure shall be performed for timing maintained inter-frequency hard handover [29]. Absence of this element means that the synchronization procedure A shall be used.	REL-6
Downlink DPCH power control information	OP		Downlink DPCH power control information 10.3.6.23		
MAC-d HFN initial value	CV- <i>Message</i>		Bit string(24)		REL-4
CHOICE <i>mode</i>	MP				
>FDD					
>>Power offset $P_{\text{Pilot-DPDCH}}$	MP		Integer(0..24)	Power offset equals $P_{\text{Pilot}} - P_{\text{DPDCH}}$, range 0..6 dB, in steps of 0.25 dB	

Information Element/Group name	Need	Multi	Type and reference	Semantics description	Version
>>Downlink rate matching restriction information	OP		Downlink rate matching restriction information 10.3.6.31	If this IE is set to "absent", no Transport CH is restricted in TFI.	
>>Spreading factor	MP		Integer(4, 8, 16, 32, 64, 128, 256, 512)		
>>Fixed or Flexible Position	MP		Enumerated (Fixed, Flexible)		
>>TFCI existence	MP		Boolean	TRUE indicates that TFCI is used. When spreading factor is less than or equal to 64, FALSE indicates that TFCI is not used and therefore DTX is used in the TFCI field.	
>>CHOICE SF	MP				
>>>SF = 256					
>>>>Number of bits for Pilot bits	MP		Integer (2,4,8, 0)	In bits In bits. For FDD only. NOTE 2.	REL-12
>>>SF = 128					
>>>>Number of bits for Pilot bits	MP		Integer(4, 8, 0)	In bits In bits. For FDD only.	REL-12
>>>Otherwise				(no data). In ASN.1 choice "Otherwise" is not explicitly available as all values are available, it is implied by the use of any value other than 128 or 256.	
>TDD				(no data)	

CHOICE SF	Condition under which the given SF is chosen
SF=128	"Spreading factor" is set to 128
SF=256	"Spreading factor" is set to 256
Otherwise	"Spreading factor" is set to a value distinct from 128 and 256

Condition	Explanation
<i>Message</i>	This IE is not needed if the IE "Downlink DPCH info common for all RL" is included in RRC CONNECTION SETUP or HANDOVER TO UTRAN COMMAND messages. Otherwise it is optional.
<i>Synch</i>	The IE is not needed in the CELL UPDATE CONFIRM, HANDOVER TO UTRAN COMMAND and the RRC CONNECTION SETUP messages or if the IE "Timing Indication" is set to "Initialise" or if the IE "Frequency Info" is not included. Otherwise, it is optional.

NOTE: Within the HANDOVER TO UTRAN COMMAND message, only value "initialise" is applicable.

NOTE 2: Within the RRC CONNECTION SETUP message, the value 0 is not applicable.

10.3.6.19 Downlink DPCH info common for all RL Post

Information Element/Group name	Need	Multi	Type and reference	Semantics description
Downlink DPCH power control information	OP		Downlink DPCH power control information 10.3.6.23	

10.3.6.20 Downlink DPCH info common for all RL Pre

Information Element/Group name	Need	Multi	Type and reference	Semantics description
CHOICE <i>mode</i>	MP			
>FDD				
>>Spreading factor	MP		Integer(4, 8, 16, 32, 64, 128, 256, 512)	Defined in CHOICE SF512-Andpilot with "number of its for pilot bits" in ASN.1
>>Fixed or Flexible Position	MP		Enumerated (Fixed, Flexible)	
>>TFCI existence	MP		Boolean	TRUE indicates that TFCI is used. When spreading factor is less than or equal to 64, FALSE indicates that TFCI is not used and therefore DTX is used in the TFCI field.
>>CHOICE <i>SF</i>	MP			
>>>SF = 256				
>>>>Number of bits for Pilot bits	MP		Integer (2,4,8)	In bits
>>>SF = 128				
>>>>Number of bits for Pilot bits	MP		Integer(4,8)	In bits
>>>Otherwise				(no data)
>TDD				
>>Common timeslot info	MP		Common Timeslot Info 10.3.6.10	

CHOICE <i>SF</i>	Condition under which the given <i>SF</i> is chosen
SF=128	"Spreading factor" is set to 128
SF=256	"Spreading factor" is set to 256
Otherwise	"Spreading factor" is set to a value distinct from 128 and 256

10.3.6.21 Downlink DPCH info for each RL

Information Element/Group name	Need	Multi	Type and reference	Semantics description	Version
CHOICE <i>mode</i>	MP				
>FDD					
>>Primary CPICH usage for channel estimation	MP		Primary CPICH usage for channel estimation 10.3.6.62		
>>DPCH frame offset	MP		Integer(0..38144 by	Offset (in number of chips) between the	

Information Element/Group name	Need	Multi	Type and reference	Semantics description	Version
			step of 256)	beginning of the P-CCPCH frame and the beginning of the DPCH frame This is called $\tau_{DPCH,n}$ in [26]	
>>Secondary CPICH info	OP		Secondary CPICH info 10.3.6.73		
>>DL channelisation code	MP	1 to <maxDPCH-DLchan >		For the purpose of physical channel mapping [27] the DPCHs are numbered, starting from DPCH number 1, according to the order that they are contained in this IE.	
>>>Secondary scrambling code	MD		Secondary scrambling code 10.3.6.74	Default is the same scrambling code as for the Primary CPICH	
>>>Spreading factor	MP		Integer(4, 8, 16, 32, 64, 128, 256, 512)	Defined in CHOICE SF512-AndCodenumbr with "code number" in ASN.1	
>>>Code number	MP		Integer(0.. Spreading factor - 1)		
>>>Scrambling code change	CH-SF/2		Enumerated (code change, no code change)	Indicates whether the alternative scrambling code is used for compressed mode method 'SF/2'.	
>>TPC combination index	MP		TPC combination index 10.3.6.85		
>>Power offset $P_{TPC-DPDCH}$	OP		Integer (0..24)	Power offset equals $P_{TPC} - P_{DPDCH}$, range 0..6 dB, in steps of 0.25 dB	REL-5
>>Power offset PO_{SRB}	OP		Integer (0..24)	Power offset to be applied under conditions defined in [29]. Range 0..6dB in steps of 0.25dB.	REL-12
>>Closed loop timing adjustment mode	CH- <i>TxDiversity Mode</i>		Integer(1, 2)	It is present if Tx Diversity is used in the radio link.	
>1.28 Mcps TDD or 3.84 Mcps TDD					
>>DL CCTrCh List	OP	1..<max CCTrCH >		DL physical channels to establish or reconfigure list.	
>>>TFCS ID	MD		Integer(1.. 8)	Identity of this CCTrCh. Default value is 1	
>>>Time info	MP		Time Info 10.3.6.83		
>>>Common timeslot info	MD		Common Timeslot Info 10.3.6.10	Default is the current Common timeslot info	
>>>Downlink DPCH timeslots and codes	MD		Downlink Timeslots	Default is to use the old timeslots and codes.	

Information Element/Group name	Need	Multi	Type and reference	Semantics description	Version
			and Codes 10.3.6.32		
>>>UL CcTrCH TPC List	MD	0..<max CcTrCH >		UL CcTrCH identities for TPC commands associated with this DL CcTrCH. Default is previous list or all defined UL CcTrCHs. This list is not required for 1.28 Mcps TDD and is to be ignored by the UE.	
>>>>UL TPC TFCS Identity	MP		Transport Format Combination Set Identity 10.3.5.21		
>>DL CcTrCH List to Remove	OP	1..<max CcTrCH >		DL physical channels to remove list.	
>>>TFCS ID	MP		Integer(1..8)		
>7.68 Mcps TDD	CV- Message				REL-7
>>DL CcTrCh List	OP	1..<max CcTrCH >		DL physical channels to establish or reconfigure list.	REL-7
>>>TFCS ID	MD		Integer(1..8)	Identity of this CcTrCh. Default value is 1	REL-7
>>>Time info	MP		Time Info 10.3.6.83		REL-7
>>>Common timeslot info	MD		Common Timeslot Info 10.3.6.10	Default is the current Common timeslot info	REL-7
>>>>Downlink DPCH timeslots and codes VHCR	MD		Downlink Timeslots and Codes VHCR 10.3.6.32 a	Default is to use the old timeslots and codes.	REL-7
>>>>UL CcTrCH TPC List	MD	0..<max CcTrCH >		UL CcTrCH identities for TPC commands associated with this DL CcTrCH. Default is previous list or all defined UL CcTrCHs. This list is not required for 1.28 Mcps TDD and is to be ignored by the UE.	REL-7
>>>>>UL TPC TFCS Identity	MP		Transport Format Combination Set Identity 10.3.5.21		REL-7
>>DL CcTrCH List to Remove	OP	1..<max CcTrCH >		DL physical channels to remove list.	REL-7
>>>TFCS ID	MP		Integer(1..8)		REL-7

Condition	Explanation
<i>SF/2</i>	The information element is mandatory present if the UE has a compressed mode pattern sequence configured in variable TGPS_IDENTITY or included in the message including IE "Downlink DPCH info for each RL", which is using compressed mode method "SF/2". Otherwise the IE is not needed.
<i>TxDiversity Mode</i>	This IE is mandatory present if any TX Diversity Mode is used on the radio link, i.e. if STTD or "closed loop mode 1" is used on the radio link. Otherwise the IE is not needed.
<i>Message</i>	This CHOICE is not needed in the ACTIVE SET UPDATE message, otherwise it is optional.

10.3.6.22 Downlink DPCH info for each RL Post

Information Element/Group name	Need	Multi	Type and reference	Semantics description
CHOICE <i>mode</i>	MP			
>FDD				
>>Primary CPICH usage for channel estimation	MP		Primary CPICH usage for channel estimation 10.3.6.62	
>>Secondary scrambling code	MD		Secondary scrambling code 10.3.6.74	Default is the same scrambling code as for the Primary CPICH
>>CHOICE <i>Spreading factor</i>	MP		Integer(4, 8, 16, 32, 64, 128, 256, 512)	Defined in CHOICE SF512-AndCodenumbr with "code number" in ASN.1
>>Code number	MP		Integer(0.. Spreading factor - 1)	
>>Scrambling code change	CH-SF/2		Enumerated (code change, no code change)	Indicates whether the alternative scrambling code is used for compressed mode method 'SF/2'.
>>TPC combination index	MP		TPC combination index 10.3.6.85	
>1.28 Mcps TDD or 3.84 Mcps TDD				
>>Downlink DPCH timeslots and codes	MP		Downlink Timeslots and Codes 10.3.6.32	
>7.68 Mcps TDD				REL-7
>>Downlink DPCH timeslots and codes VHCR	MP		Downlink Timeslots and Codes VHCR 10.3.6.32a	REL-7

Condition	Explanation
<i>SF/2</i>	The information element is mandatory present if the UE has a compressed mode pattern sequence configured in variable TGPS_IDENTITY or included in the message including IE "Downlink DPCH info for each RL Post", which is using compressed mode method "SF/2". Otherwise the IE is not needed.

10.3.6.23 Downlink DPCH power control information

Information Element/Group name	Need	Multi	Type and reference	Semantics description
CHOICE <i>mode</i>	MP			
>FDD				
>>DPC Mode	MP		Enumerated (Single TPC, TPC triplet in soft)	"Single TPC" is DPC_Mode=0 and "TPC triplet in soft" is DPC_mode=1 in [29].
>TDD				
>>TPC Step Size	OP		Integer (1, 2, 3)	In dB

10.3.6.23oa Downlink F-DPCH info common for all RL

NOTE: For FDD only.

Information Element/Group name	Need	Multi	Type and reference	Semantics description	Version
Timing Indication	MP		Enumerated (Initialise, Maintain)		REL-6
Timing maintained Synchronization indicator	CV- <i>Synch</i>		Enumerated (FALSE)	FALSE indicates that no synchronisation procedure shall be performed for timing maintained inter-frequency hard handover [29]. Absence of this element means that the synchronization procedure A shall be used.	REL-6
Downlink F-DPCH power control information	OP		Downlink DPCH power control information 10.3.6.23		REL-6
TPC command error rate target	MP		Real (0.01..0.1 by step of 0.01)		REL-6

Condition	Explanation
<i>Synch</i>	The IE is not needed in the CELL UPDATE CONFIRM, HANDOVER TO UTRAN COMMAND and the RRC CONNECTION SETUP messages or if the IE "Timing Indication" is set to "Initialise" or if the IE "Frequency Info" is not included. Otherwise, it is optional.

10.3.6.23ob Downlink F-DPCH info for each RL

NOTE: For FDD only.

Information Element/Group name	Need	Multi	Type and reference	Semantics description	Version
Primary CPICH usage for channel estimation	MP		Primary CPICH usage for channel estimation 10.3.6.62		REL-6
F-DPCH frame offset	MP		Integer (0..38144 by step of 256)	Offset (in number of chips) between the beginning of the P-CCPCH frame and the beginning of the F-DPCH frame This is called $T_{F-DPCH,n}$ in [26]	REL-6
F-DPCH slot format	OP		Integer (0..9 by steps of 1)	Slot format used by F-DPCH in [26]. Absence of this element means that slot format 0 is applied.	REL-7
Secondary CPICH info	OP		Secondary CPICH info 10.3.6.73		REL-6
Secondary scrambling code	MD		Secondary scrambling code 10.3.6.74	Default is the same scrambling code as for the Primary CPICH	REL-6
Code number	MP		Integer (0..255)		REL-6
TPC combination index	MP		TPC combination index 10.3.6.85		REL-6
STTD indication	CV- <i>NoHOtoUTRAN</i>		Enumerated (TRUE)	This IE shall be set to TRUE when STTD is used. Absence of this element means STTD is not used.	REL-6

Condition	Explanation
<i>NoHOtoUTRAN</i>	This IE is not needed in the HANDOVER TO UTRAN COMMAND and it is optional in all the other messages in which the IE "Downlink F-DPCH info for each RL" can be included.

10.3.6.23a Downlink HS-PDSCH Information

Information Element/Group name	Need	Multi	Type and reference	Semantics description	Version
HS-SCCH Info	OP		HS-SCCH Info 10.3.6.36a	For 1.28 Mcps TDD, if IE DL Multi-Carrier Information is present, ignore this IE.	REL-5
Measurement Feedback Info	OP		Measurement Feedback Info 10.3.6.40a		REL-5
CHOICE mode	MP				REL-5
>TDD					
>>CHOICE <i>TDD option</i>	MP				REL-5
>>>3.84 Mcps					
>>>>HS-PDSCH Timeslot Configuration	OP		HS-PDSCH Timeslot Configuration 10.3.6.36o		REL-5
>>>7.68 Mcps					REL-7
>>>>HS-PDSCH Timeslot Configuration VHCR	OP		HS-PDSCH Timeslot Configuration VHCR 10.3.6.36oa		REL-7
>>> 1.28 Mcps					
>>>> HS-PDSCH Midamble Configuration	OP		HS-PDSCH Midamble Configuration 10.3.6.36oo	For 1.28 Mcps TDD, if IE DL Multi-Carrier Information is present, ignore this IE.	REL-5
>>>> DL Multi-Carrier Information	OP		DL Multi-Carrier Information 10.3.6.28a		REL-7
>>>> Out of Sync window	MD		Enumerated (40, 80, 160, 320, 640)	Value in milliseconds. Default value is 160. Three spare values needed.	REL-8
>>>>TS0 Indicator	OP		Enumerated (TRUE)	Absence of this IE means that the enhanced TS0 is not used. The presence of this IE means that the first bit of timeslot information on HS-SCCH is used to indicate TS0.	REL-9
>>>>TS0 channelization codes	CV- <i>TS0Non-rectangular Resource Allocation Specific Timeslots</i>		Downlink channelization codes 10.3.6.17	For 1.28Mcps TDD only. This IE indicates the channelization codes in TS0 that are configured for HS-PDSCH channel.	REL-12
>FDD					

>>Downlink 64QAM configured	OP		Enumerated (TRUE)	Absence of this IE means that the HS-SCCH does not use the 64QAM format. The presence of this IE means the UE uses the octet aligned table [15].	REL-7
>>HS-DSCH TB size table	CV- <i>Not64QAM</i>		Enumerated (octet aligned)	If this IE is present, octet aligned table [15] is used, else bit aligned table [15] is used. NOTE 1	REL-7
NOTE 1: This rule applies only if the IE "Downlink HS-PDSCH information" is present in the received message. The UE behaviour is unspecified if the IE "HS-DSCH TB size table" is present in the corresponding ASN.1 non-critical extension when the IE "Downlink HS-PDSCH information" is absent in the received message.					

Condition	Explanation
<i>Not64QAM</i>	This IE is optionally present if 64QAM is not configured and MAC-ehs is configured. Otherwise it is not needed.
<i>TS0Non-rectangularResourceAllocationSpecificTimeslots</i>	In messages other than HANDOVER TO UTRAN COMMAND, this IE is mandatory present if both of non-rectangular resource allocation indicator and TS0 indicator are configured and non-rectangular resource specific timeslots set is not configured. Otherwise, it is not needed.

10.3.6.24 Downlink information common for all radio links

Information Element/Group name	Need	Multi	Type and reference	Semantics description	Version
CHOICE <i>DPCH info</i>	OP				REL-6
>Downlink DPCH info common for all RL	MP		Downlink DPCH info common for all RL 10.3.6.18		
>Downlink F-DPCH info common for all RL	MP		Downlink F-DPCH info common for all RL 10.3.6.23oa		REL-6
CHOICE <i>mode</i>	MP				
>FDD					
>>DPCH compressed mode info	OP		DPCH compressed mode info 10.3.6.33		
>>TX Diversity Mode	MD		TX Diversity Mode 10.3.6.86	Default value is the existing value of TX Diversity mode	
>TDD				(no data)	
>>CHOICE <i>TDD option</i>	MP				REL-4
>>>3.84 Mcps TDD				(no data)	REL-4
>>>7.68 Mcps TDD				(no data)	REL-7
>>>1.28 Mcps TDD					REL-4
>>>>TSTD indicator	MP		TSTD indicator 10.3.6.85a		REL-4
Default DPCH Offset Value	OP		Default DPCH Offset Value, 10.3.6.16		
MAC-hs reset indicator	CV- <i>messageType</i>		Enumerated (TRUE)	TRUE Indicates the MAC-hs/ehs entity needs to be reset.	REL-5
Post-verification period	OP		Enumerated (TRUE)	TRUE indicates that a post-verification period shall be used [29]. Absence of this element means that a post-verification period shall not be used.	REL-6
MAC-hs reset indicator for Multiflow assisting cells	CV- <i>messageType</i>		Enumerated (TRUE)	TRUE indicates that the MAC-hs/ehs entity related to the assisting cells needs to be reset.	REL-11

Condition	Explanation
<i>MessageType</i>	The IE is not needed in the HANDOVER TO UTRAN COMMAND and the RRC CONNECTION SETUP messages. Otherwise, it is optional.

10.3.6.25 Downlink information common for all radio links Post

Information Element/Group name	Need	Multi	Type and reference	Semantics description
Downlink DPCH info common for all RL	MP		Downlink DPCH info common for all RL Post 10.3.6.19	

10.3.6.26 Downlink information common for all radio links Pre

Information Element/Group name	Need	Multi	Type and reference	Semantics description
Downlink DPCH info common for all RL	MP		Downlink DPCH info common for all RL Pre 10.3.6.20	

10.3.6.27 Downlink information for each radio link

Information Element/Group name	Need	Multi	Type and reference	Semantics description	Version
CHOICE <i>mode</i>	MP				
>FDD					
>>Primary CPICH info	MP		Primary CPICH info 10.3.6.60		
>>Serving HS-DSCH radio link indicator	MP		Boolean	The value TRUE indicates that this radio link is the serving HS-DSCH radio link	REL-5
>>Serving E-DCH radio link indicator	MP		Boolean	The value TRUE indicates that this radio link is the serving E-DCH radio link	REL-6
>TDD					
>>Primary CCPCH info	MP		Primary CCPCH info 10.3.6.57		
Cell ID	OP		Cell ID 10.3.2.2		REL-4
CHOICE <i>DPCH info</i>	OP				REL-6
>Downlink DPCH info for each RL			Downlink DPCH info for each RL 10.3.6.21		
>Downlink F-DPCH info for each RL			Downlink F-DPCH info for each RL 10.3.6.23ob		REL-6
>Radio Links without DPCH/F-DPCH info			Radio Links without DPCH/F-DPCH info 10.3.6.147		REL-12
E-AGCH Info	OP		E-AGCH Info 10.3.6.100		REL-6
E-ROCH Info	OP		E-ROCH Info FDD 10.3.6.146		REL-11
CHOICE <i>mode</i>					REL-7
>FDD					REL-7
>>CHOICE <i>E-HICH Information</i>	OP				REL-6
>>>E-HICH Information	MP		E-HICH Info 10.3.6.101		REL-6
>>>E-HICH release indicator				(no data)	REL-6
>>>Secondary TB E-HICH release indicator				(no data)	REL-11
>>CHOICE <i>E-RGCH Information</i>	OP				REL-6
>>>E-RGCH Information	MP		E-RGCH Info 10.3.6.102		REL-6
>>>E-RGCH release indicator				(no data)	REL-6
>>CHOICE <i>F-TPICH Info</i>	OP				REL-11
>>>F-TPICH Info			F-TPICH Info 10.3.6.127		REL-11
>>>F-TPICH release indicator				(no data)	REL-11
>TDD				(no data)	REL-7
>>E-HICH Information	OP		E-HICH Info 10.3.6.101		REL-7

10.3.6.28 Downlink information for each radio link Post

Information Element/Group name	Need	Multi	Type and reference	Semantics description	Version
Choice mode	MP				
>FDD					
>>Primary CPICH info	MP		Primary CPICH info 10.3.6.60		
>TDD					
>>Primary CCPCH info	MP		Primary CCPCH info post 10.3.6.58		
Downlink DPCH info for each RL	MP		Downlink DPCH info for each RL Post 10.3.6.22		

10.3.6.28a DL Multi-Carrier Information (1.28 Mcps TDD only)

Information Element/Group name	Need	Multi	Type and reference	Semantics description	Version
TSN-Length	OP		Enumerated (tsn-6bits, tsn-9bits)		REL-7
Multi-Carrier number	OP		Integer(1..maxTDD128Carrier)		REL-7
DI-HSPDSCH-MultiCarrier-Information	OP	1 to <maxTDD128Carrier>		The number of HS-SCCH Sets shall not be larger than UE Multi-Carrier capability	REL-7
>Carrier-Uarfcn	MP		Integer(0..16383)		REL-7
>HARQ Info	OP		HARQ info 10.3.5.7a		REL-7
>HS-PDSCH Midamble Configuration	OP		HS-PDSCH Midamble Configuration 10.3.6.36oo		REL-7
>HS-SCCH Set Configuration	OP	1 to <maxHS-SCCHs>			REL-7
>>HS-SCCH-Receive-Uarfcn	MP		Integer(0..16383)		REL-7
>>Timeslot number	MP		Integer (0..6)		REL-7
>>First Channelisation code	MP		Enumerated ((16/1)..(16/16))		REL-7
>>Second Channelisation code	MP		Enumerated ((16/1)..(16/16))		REL-7
>>Midamble Allocation mode	MP		Enumerated (Default midamble, Common midamble, UE specific midamble)		REL-7
>>Midamble Shift	CV-UE		Integer (0..15)		REL-7
>>Midamble configuration	MP		Integer (2, 4, 6, 8, 10, 12, 14, 16)		REL-7
>>BLER target	MP		Real (-3.15..0 by step of 0.05)	Signalled value is Log10(HS-SCCH BLER quality target). The UE shall use the BLER target signalled in the first occurrence of the HS-SCCH Set Configuration.	REL-7
>>HS-SICH configuration					REL-7
>>>Timeslot number	MP		Integer (0..6)		REL-7
>>>Channelisation code	MP		Enumerated ((16/1)..(16/16))		REL-7

>>>Midamble Allocation mode	MP		Enumerated (Default midamble, UE specific midamble)		REL-7
>>>Midamble configuration	MP		Integer (2, 4, 6, 8, 10, 12, 14, 16)		REL-7
>>>Midamble Shift	CV-UE		Integer (0..15)		REL-7
>>>Ack-Nack Power Offset	MP		Integer (-7..8 by step of 1)	dB.	REL-7
>>>PRX _{HS-SICH}	MP		Integer (-120..-58 by step of 1)	dBm. Desired power level for HS-SICH.	REL-7
>>>TPC step size	MP		Integer (1, 2, 3)	dB.	REL-7

Condition	Explanation
UE	This IE is mandatory present when the value of the IE "Midamble Allocation Mode" is "UE specific midamble" and not needed otherwise.

10.3.6.29 Void

10.3.6.30 Void

10.3.6.31 Downlink rate matching restriction information

This IE indicates which TrCH is restricted in TFI.

Information Element/Group name	Need	Multi	Type and reference	Semantics description
Restricted TrCH information	OP	1 to <maxTrCH>		
>Downlink transport channel type	MP		Enumerated(DCH)	
>Restricted DL TrCH identity	MP		Transport channel identity 10.3.5.18	
>Allowed TFIs	MP	1 to <maxTF>		
>>Allowed TFI	MP		Integer(0..31)	

10.3.6.31a Downlink secondary cell info FDD

Information Element/Group name	Need	Multi	Type and reference	Semantics description	Version
--------------------------------	------	-------	--------------------	-----------------------	---------

CHOICE Configuration info	MP				REL-8
>Continue			(no data)	Used in reconfigurations without interruption of dual cell operation.	REL-8
>New configuration					REL-8
>>New H-RNTI	MP		H-RNTI 10.3.3.14a		REL-8
>>Downlink 64QAM configured	OP		Enumerated (TRUE)	Absence of this IE means that the secondary cell HS-SCCH does not use the 64QAM format. The presence of this IE means the UE uses the octet aligned table [15].	REL-8
>>HS-DSCH TB size table	CV- <i>Not64QAM</i>		Enumerated (octet aligned)	If this IE is present, octet aligned table [15] is used, else bit aligned table [15] is used.	REL-8
>>Primary CPICH info	MP		Primary CPICH Info 10.3.6.60		REL-8
>>DL Scrambling Code	MD		Secondary scrambling code 10.3.6.74	DL Scrambling code to be applied for HS-DSCH and HS-SCCH. Default is same scrambling code as for the primary CPICH.	REL-8
>>HS-SCCH Channelisation Code Information	MP	1 to <maxHSS CCHs >		Note 1	REL-8
>>>HS-SCCH Channelisation Code	MP		Integer (0..127)		REL-8
>>Measurement Power Offset	MP		Real (-6 .. 13 by step of 0.5)	The measurement power offset, Γ , in dB, as described in [29].	REL-8
>>Measurement Power Offset_1	OP		Real (-6 .. 13 by step of 0.5)	The measurement power offset, Γ_1 , in dB, as described in [29].	REL-11
>>UARFCN downlink (Nd)	MP		Integer(0 .. 16383)	[21]	REL-8
>>Different Tx diversity mode configuration from serving HS-DSCH cell	OP		Enumerated (Different)	The presence of this IE means that the Tx diversity Mode is different to the Diversity Mode indicated in the serving HS-DSCH cell. Absence of this IE means that the same Tx diversity mode is used as that used for the serving HS-DSCH cell. Note 2	REL-8

>>Multiflow configuration	OP		10.3.6.129 Multiflow configuration info	If present, provides the Multiflow specific configuration information for this cell.	REL-11
Secondary cell MIMO parameters	OP		10.3.6.72b Secondary cell MIMO parameters	FDD only	REL-9
Secondary cell MIMO mode with four transmit antennas parameters	OP		Secondary cell MIMO mode with four transmit antennas parameters 10.3.6.144	FDD only	REL-11
Note 1: The list of HS-SCCH(s) is assumed to be indexed starting from one.					
Note 2: The UE behaviour is unspecified if the IE "Different Tx diversity mode configuration from serving HS-DSCH cell" is present and the IE "CHOICE Configuration info" is not set to "New configuration" in the received message.					

Condition	Explanation
<i>Not64QAM</i>	This IE is optionally present if 64QAM is not configured and MAC-ehs is configured. Otherwise it is not needed.

10.3.6.31b Downlink secondary cell info FDD for Handover to UTRAN

Information Element/Group name	Need	Multi	Type and reference	Semantics description	Version
CHOICE Configuration info	MP				REL-11
>Continue			(no data)	Note 1.	REL-11
>New configuration					REL-11
>>New H-RNTI	MP		H-RNTI 10.3.3.14a		REL-11
>>Primary CPICH info	MP		Primary CPICH Info 10.3.6.60		REL-11
>>DL Scrambling Code	MD		Secondary scrambling code 10.3.6.74	DL Scrambling code to be applied for HS-DSCH and HS-SCCH. Default is same scrambling code as for the primary CPICH.	REL-11
>>HS-SCCH Channelisation Code Information	MP	1 to <maxHSS CCHs >		Note 2	REL-11
>>>HS-SCCH Channelisation Code	MP		Integer (0..127)		REL-11
>>Measurement Power Offset	MP		Real (-6 .. 13 by step of 0.5)	The measurement power offset, Γ , in dB, as described in [29].	REL-11
>>UARFCN downlink (Nd)	MP		Integer(0 .. 16383)	[21]	REL-11
>>Different Tx diversity mode configuration from serving HS- DSCH cell	OP		Enumerated (Different)	The presence of this IE means that the Tx diversity Mode is different to the Diversity Mode indicated in the serving HS-	REL-11

				DSCH cell. Absence of this IE means that the same Tx diversity mode is used as that used for the serving HS-DSCH cell. Note 3
Note 1: The value "Continue" should not be set.				
Note 2: The list of HS-SCCH(s) is assumed to be indexed starting from one.				
Note 3: The UE behaviour is unspecified if the IE "Different Tx diversity mode configuration from serving HS-DSCH cell" is present and the IE "CHOICE Configuration info" is not set to "New configuration" in the received message.				

10.3.6.32 Downlink Timeslots and Codes

NOTE: Only for 1.28 Mcps TDD and 3.84 Mcps TDD.

Information Element/Group name	Need	Multi	Type and reference	Semantics description
First Individual timeslot info	MP		Individual timeslot info 10.3.6.37	Individual timeslot info for the first timeslot used by the physical layer.
First timeslot channelisation codes	MP		Downlink channelisation codes 10.3.6.17	These codes shall be used by the physical layer in the timeslot given in First Individual timeslot info.
CHOICE <i>more timeslots</i>	MP			
>No more timeslots				(no data)
>Consecutive timeslots				
>>Number of additional timeslots	MP		Integer(1..maxTS-1)	The timeslots used by the physical layer shall be timeslots: N mod maxTS (N+1) mod maxTS ... (N+k) mod maxTS in that order, where N is the timeslot number in the First individual timeslot info and k the Number of additional timeslots. The additional timeslots shall use the same parameters (e.g. channelisation codes, midamble shifts etc.) as the first timeslot.
>Timeslot list				
>>Additional timeslot list	MP	1 to <maxTS-1>		The first instance of this parameter corresponds to the timeslot that shall be used second by the physical layer, the second to the timeslot that shall be used third and so on.
>>>CHOICE <i>parameters</i>	MP			
>>>>Same as last				
>>>>>Timeslot number	MP		Timeslot Number 10.3.6.84	The physical layer shall use the same parameters (e.g. channelisation codes, midamble shifts etc.) for this timeslot as for the last one.
>>>>>New parameters				
>>>>>>Individual timeslot info	MP		Individual timeslot info 10.3.6.37	

Information Element/Group name	Need	Multi	Type and reference	Semantics description
>>>>Channelisation codes	MP		Downlink channelisation codes 10.3.6.17	

10.3.6.32a Downlink Timeslots and Codes VHCR

NOTE: Only for 7.68 Mcps TDD.

Information Element/Group name	Need	Multi	Type and reference	Semantics description	Version
First Individual timeslot info	MP		Individual timeslot info 10.3.6.37	Individual timeslot info for the first timeslot used by the physical layer.	REL-7
First timeslot channelisation codes VHCR	MP		Downlink channelisation codes VHCR 10.3.6.17a	These codes shall be used by the physical layer in the timeslot given in First Individual timeslot info.	REL-7
CHOICE <i>more timeslots</i>	MP				REL-7
>No more timeslots				(no data)	REL-7
>Consecutive timeslots					REL-7
>>Number of additional timeslots	MP		Integer(1..maxTS-1)	The timeslots used by the physical layer shall be timeslots: N mod maxTS (N+1) mod maxTS ... (N+k) mod maxTS in that order, where N is the timeslot number in the First individual timeslot info and k the Number of additional timeslots. The additional timeslots shall use the same parameters (e.g. channelisation codes, midamble shifts etc.) as the first timeslot.	REL-7
>Timeslot list					REL-7
>>Additional timeslot list	MP	1 to <maxTS-1>		The first instance of this parameter corresponds to the timeslot that shall be used second by the physical layer, the second to the timeslot that shall be used third and so on.	REL-7
>>>CHOICE <i>parameters</i>	MP				REL-7
>>>>Same as last					REL-7
>>>>>Timeslot number	MP		Timeslot Number 10.3.6.84	The physical layer shall use the same parameters (e.g. channelisation codes, midamble shifts etc.) for this timeslot as for the last one.	REL-7
>>>>>New parameters					REL-7
>>>>>Individual timeslot info	MP		Individual timeslot info 10.3.6.37		REL-7
>>>>>Channelisation codes VHCR	MP		Downlink channelisation codes VHCR 10.3.6.17a		REL-7

10.3.6.33 DPCH compressed mode info

NOTE: Only for FDD.

This information element indicates the parameters of the compressed mode to be used by the UE in order to perform inter-frequency and inter-RAT measurements.

Information Element/Group name	Need	Multi	Type and reference	Semantics description	Version
Transmission gap pattern sequence	MP	1 to <maxTGPS>			
>TGPSI	MP		TGPSI 10.3.6.82		
>TGPS Status Flag	MP		Enumerated(activate, deactivate)	This flag indicates whether the Transmission Gap Pattern Sequence shall be activated or deactivated.	
>TGCFN	CV-Active		Integer (0..255)	Connection Frame Number of the first frame of the first pattern within the Transmission Gap Pattern Sequence.	
>Transmission gap pattern sequence configuration parameters	OP				
>>TGMP	MP		Enumerated(TDD measurement, FDD measurement, GSM carrier RSSI measurement, GSM Initial BSIC identification, GSM BSIC re-confirmation, Multi-carrier measurement,	Transmission Gap pattern sequence Measurement Purpose.	REL-8
			E-UTRA measurement)	One spare value is needed	
>>Frequency specific compressed mode	CV-Active-FDD		Enumerated (TRUE)	TRUE means that the frequency specific compressed mode is configured.	REL-10
>>TGPRC	MP		Integer (1..511, Infinity)	The number of transmission gap patterns within the Transmission Gap Pattern Sequence.	
>>TGSN	MP		Integer (0..14)	Transmission Gap Starting Slot Number The slot number of the first transmission gap slot within the TGCFN.	
>>TGL1	MP		Integer(1..14)	The length of the first Transmission Gap within the transmission gap pattern expressed in number of slots	
>>TGL2	MD		Integer (1..14)	The length of the second Transmission Gap within the transmission gap pattern. If omitted, then TGL2=TGL1. The value of TGL2 shall be ignored if TGD is set to "undefined"	

Information Element/Group name	Need	Multi	Type and reference	Semantics description	Version
>>TGD	MP		Integer(15..269, undefined)	Transmission gap distance indicates the number of slots between starting slots of two consecutive transmission gaps within a transmission gap pattern. If there is only one transmission gap in the transmission gap pattern, this parameter shall be set to undefined.	
>>TGPL1	MP		Integer (1..144)	The duration of transmission gap pattern 1.	
>>RPP	MP		Enumerated (mode 0, mode 1).	Recovery Period Power control mode during the frame after the transmission gap within the compressed frame. Indicates whether normal PC mode or compressed PC mode is applied	
>>ITP	MP		Enumerated (mode 0, mode 1).	Initial Transmit Power is the uplink power control method to be used to compute the initial transmit power after the compressed mode gap.	
>>CHOICE <i>UL/DL mode</i>	MP				
>>>DL only				Compressed mode used in DL only	
>>>>Downlink compressed mode method	MP		Enumerated (SF/2, higher layer scheduling)	Method for generating downlink compressed mode gap. If F-DPCH is configured this IE shall not be used by the UE	
>>>>UL only				Compressed mode used in UL only	
>>>>Uplink compressed mode method	MP		Enumerated (SF/2, higher layer scheduling)	Method for generating uplink compressed mode gap	
>>>>UL and DL				Compressed mode used in UL and DL	
>>>>Downlink compressed mode method	MP		Enumerated (SF/2, higher layer scheduling)	Method for generating downlink compressed mode gap. If F-DPCH is configured this IE shall not be used by the UE	
>>>>Uplink compressed mode method	MP		Enumerated (SF/2, higher layer scheduling)	Method for generating uplink compressed mode gap	
>>Downlink frame type	MP		Enumerated (A, B)	If F-DPCH is configured this IE shall not be used by the UE	
>>DeltaSIR1	MP		Real(0..3 by step of 0.1)	Delta in DL SIR target value to be set in the UE during the frame containing the start of the first transmission gap in the transmission gap pattern (without including the effect of the bit-rate increase).	

Information Element/Group name	Need	Multi	Type and reference	Semantics description	Version
				If F-DPCH is configured this IE shall not be used by the UE	
>>DeltaSIRafter1	MP		Real(0..3 by step of 0.1)	Delta in DL SIR target value to be set in the UE one frame after the frame containing the start of the first transmission gap in the transmission gap pattern. If F-DPCH is configured this IE shall not be used by the UE	
>>DeltaSIR2	OP		Real(0..3 by step of 0.1)	Delta in DL SIR target value to be set in the UE during the frame containing the start of the second transmission gap in the transmission gap pattern (without including the effect of the bit-rate increase) When omitted, DeltaSIR2 = DeltaSIR1. If F-DPCH is configured this IE shall not be used by the UE	
>>DeltaSIRafter2	OP		Real(0..3 by step of 0.1)	Delta in DL SIR target value to be set in the UE one frame after the frame containing the start of the second transmission gap in the transmission gap pattern. When omitted, DeltaSIRafter2 = DeltaSIRafter1. If F-DPCH is configured this IE shall not be used by the UE	
>>N Identify abort	CV-Initial BSIC		Integer(1..128)	Indicates the maximum number of repeats of patterns that the UE shall use to attempt to decode the unknown BSIC of the GSM cell in the initial BSIC identification procedure	
>>T Reconfirm abort	CV-Re-confirm BSIC		Real(0.5..10.0 by step of 0.5)	Indicates the maximum time allowed for the re-confirmation of the BSIC of one GSM cell in the BSIC re-confirmation procedure. The time is given in steps of 0.5 seconds.	

Condition	Explanation
<i>Active</i>	This IE is mandatory present when the value of the IE "TGPS Status Flag" is "Activate" and not needed otherwise.
<i>Active-FDD</i>	This IE can be included only for FDD measurements. It is optional present when the value of the IE "TGPS Status Flag" is "Activate" and not needed otherwise.
<i>Initial BSIC</i>	This IE is mandatory present when the value of the IE "TGMP" is set to "GSM Initial BSIC identification" and not needed otherwise.
<i>Re-confirm BSIC</i>	This IE is mandatory present when the value of the IE "TGMP" is set to "GSM BSIC re-confirmation" and not needed otherwise.

10.3.6.34 DPCH Compressed Mode Status Info

This information element indicates status information of the compressed mode used by the UE in order to perform inter-frequency and inter-RAT measurements.

Information Element/Group name	Need	Multi	Type and reference	Semantics description
TGPS reconfiguration CFN	MP		Integer (0..255)	
Transmission gap pattern sequence	MP	1 to <maxTGP S>		
>TGPSI	MP		TGPSI 10.3.6.82	Transmission Gap Pattern Sequence Identifier
>TGPS Status Flag	MP		Enumerated(activate, deactivate)	This flag indicates whether the Transmission Gap Pattern Sequence it shall be activated or deactivated.
>TGCFN	CV-Active		Integer (0..255)	Connection Frame Number of the first frame of the first pattern within the Transmission Gap Pattern Sequence.
>Frequency specific compressed mode	CV-Active-OP		Enumerated (TRUE)	TRUE means that the frequency specific compressed mode is configured.

Condition	Explanation
<i>Active</i>	This IE is mandatory present when the value of the IE "TGPS Status Flag" is "Activate" and not needed otherwise.
<i>Active-OP</i>	This IE is optional present when the value of the IE "TGPS Status Flag" is "Activate" and not needed otherwise.

10.3.6.34a DTX-DRX information

NOTE: For FDD only.

Information Element/Group name	Need	Multi	Type and reference	Semantics description	Version
DTX Information	OP				REL-7
>CHOICE <i>E-DCH TTI length</i>	MP				REL-7
>>10 ms					REL-7
>>>UE DTX cycle 1	MP		Enumerated (1, 5, 10, 20)	Units of subframes.	REL-7

>>>UE DTX cycle 2	MP		Enumerated (5, 10, 20, 40, 80, 160)	Units of subframes. Two spare values are needed.	REL-7
>>>MAC DTX cycle	MP		Enumerated (5, 10, 20)	Units of subframes. One spare value is needed.	REL-7
>>2 ms					REL-7
>>>UE DTX cycle 1	MP		Enumerated (1, 4, 5, 8, 10, 16, 20)	Units of subframes. One spare value is needed.	REL-7
>>>UE DTX cycle 2	MP		Enumerated (4, 5, 8, 10, 16, 20, 32, 40, 64, 80, 128, 160)	Units of subframes. Four spare values are needed.	REL-7
>>>MAC DTX cycle	MP		Enumerated (1, 4, 5, 8, 10, 16, 20)	Units of subframes. One spare value is needed.	REL-7
>Inactivity Threshold for UE DTX cycle 2	MP		Enumerated (1, 4, 8, 16, 32, 64, 128, 256)	Units of E-DCH TTIs. Eight spare values are needed.	REL-7
>Default SG in DTX Cycle 2	OP		Integer (0..37,38)	Serving Grant value to be used at the transition in DTX-Cycle-2. (0..37) indicates E-DCH serving grant index as defined in [15]; index 38 means zero grant.	REL-7
>UE DTX long preamble length	MD		Enumerated (4, 15)	Units of slots Default value is 2 slots	REL-7
>MAC Inactivity Threshold	MP		Enumerated (1, 2, 4, 8, 16, 32, 64, 128, 256, 512, Infinity)	Units of E-DCH TTIs. Five spare values are needed.	REL-7
>CQI DTX Timer	MP		Enumerated (0, 1, 2, 4, 8, 16, 32, 64, 128, 256, 512, Infinity)	Units of subframes. Four spare values are needed.	REL-7
>UE DPCCH burst_1	MP		Enumerated (1, 2, 5)	Units of sub-frames. One spare value is needed.	REL-7
>UE DPCCH burst_2	MP		Enumerated (1, 2, 5)	Units of sub-frames. One spare value is needed.	REL-7
DTX Information for secondary uplink frequency	OP				REL-12
>CHOICE <i>E-DCH TTI length</i>	MP				REL-12
>>10 ms			NULL		REL-12
>>2 ms					REL-12
>>>UE DTX cycle 1 secondary	MD		Enumerated (1, 4, 5, 8, 10, 16, 20)	Units of subframes. Default value is the value included in the IE "UE DTX cycle 1". One spare value is needed.	REL-12
>>>UE DTX cycle 2 secondary	MP		Enumerated (4, 5, 8, 10, 16, 20, 32, 40, 64, 80, 128, 160, 256, 320, 512, 640, 1024, 1280)	Units of subframes. Fourteen spare values are needed.	REL-12
>Inactivity Threshold for UE DTX cycle 2 secondary	MD		Enumerated (1, 4, 8, 16,	Units of E-DCH TTIs.	REL-12

			32, 64, 128, 256)	Default value is the value included in the IE "Inactivity Threshold for UE DTX cycle 2". Eight spare values are needed.	
>UE DTX long preamble length secondary	MD		Enumerated (4, 15)	Units of slots. Default value is the value included in the IE "UE DTX long preamble length".	REL-12
>UE DPCCH burst 1 secondary	MD		Enumerated (1, 2, 5)	Units of sub-frames. Default value is the value included in the IE "UE DPCCH burst_1". One spare value is needed.	REL-12
>UE DPCCH burst 2 secondary	MD		Enumerated (1, 2, 5)	Units of sub-frames. Default value is the value included in the IE "UE DPCCH burst_2". One spare value is needed.	REL-12
DRX Information	OP				REL-7
>UE DRX cycle	MP		Enumerated (4, 5, 8, 10, 16, 20)	Units of subframes. Two spare values are needed.	REL-7
>UE DRX cycle 2	OP		Enumerated (4, 5, 8, 10, 16, 20, 32, 40, 64, 80)	Units of subframes. Six spare values are needed.	REL-12
>Inactivity Threshold for UE DRX cycle	MP		Enumerated (0, 1, 2, 4, 8, 16, 32, 64, 128, 256, 512)	Units of subframes. Five spare values are needed.	REL-7
>Inactivity Threshold for UE DRX cycle 2	OP		Enumerated (0, 1, 2, 4, 8, 16, 32, 64, 128, 256, 512)	Units of subframes. Five spare values are needed.	REL-12
>Inactivity Threshold for UE Grant Monitoring	MP		Enumerated (0, 1, 2, 4, 8, 16, 32, 64, 128, 256)	Units of E-DCH TTIs. Six spare values are needed.	REL-7
>UE DRX Grant Monitoring	MP		Boolean		REL-7
Uplink DPCCH slot format information	MP		Enumerated (1, 4)	Slot format # to be used on UL DPCCH [26]. One spare value is needed.	REL-7

10.3.6.34b DTX-DRX timing information

NOTE: For FDD only.

Information Element/Group name	Need	Multi	Type and reference	Semantics description	Version
CHOICE <i>timing</i>	MP				REL-7
>Continue			(no data)	Used in reconfigurations without interruption of DTX-DRX and HS-SCCH less.	REL-7
>New timing					REL-7
>>Enabling Delay	MP		Enumerated (0, 1, 2, 4, 8, 16, 32, 64, 128)	In radio frames. Seven spare values are needed.	REL-7
>>UE DTX DRX Offset	MP		Integer (0..159)	Units of subframes. Offset of the DTX and DRX cycles at the given TTI.	REL-7
Note: Only the values of the IE "UE DTX DRX Offset" that fulfill the equation $UE\ DTX\ DRX\ Offset \bmod 5=0$ can be configured with 10ms E-DCH TTI. The UE behaviour is not specified if any other values are used with 10ms TTI.					

10.3.6.35 Dynamic persistence level

Information Element/Group name	Need	Multi	Type and reference	Semantics description
Dynamic persistence level	MP		Integer(1..8)	Level shall be mapped to a dynamic persistence value in the range 0 .. 1. The mapping is described in subclause 8.5.12.

10.3.6.35a FPACH info

NOTE: Only for 1.28 Mcps TDD.

Information Element/Group name	Need	Multi	Type and reference	Semantics description	Version
Timeslot number	MP		Integer(0..6)		REL-4
Channelisation code	MP		Enumerated((16/1)..(16/16))		REL-4
Midamble Shift and burst type	MP		Midamble shift and burst type 10.3.6.41		REL-4
WT	MP		Integer(1..4)	The number of sub-frames, following the sub-frame in which the SYNC UL is transmitted, in which the FPACH can be transmitted.	REL-4

10.3.6.35b Frequency band indicator

Information Element/Group name	Need	Multi	Type and reference	Semantics description	Version
Frequency band indicator	MP		Enumerated(Band I, Band II, Band III, Band IV, Band V, Band VI, Band VII, extension indicator)		REL-6

10.3.6.35c Frequency band indicator 2

Information Element/Group name	Need	Multi	Type and reference	Semantics description	Version
Frequency band indicator 2	MP		Enumerated(Band VIII, Band IX, Band X, Band XI, Band XII, Band XIII, Band XIV, Band XV, Band XVI, Band XVII, Band XVIII, Band XIX, Band XX, Band XXI, Band XXII, extension indicator)	Band XV – Band XVIII and Band XXII are yet to be defined in this version of the specification	REL-6

10.3.6.35ca Frequency band indicator 3

Information Element/Group name	Need	Multi	Type and reference	Semantics description	Version
Frequency band indicator 3	MP		Enumerated (Band XXV, Band XXVI, extension indicator)	Sixty One spare values are needed.	REL-10

10.3.6.35d Frequency band indicator for TDD

Information Element/Group name	Need	Multi	Type and reference	Semantics description	Version
Frequency band indicator	MP		Enumerated(Band a, Band b, Band c, Band d, Band e, Band f, reserved, reserved)		REL-10

10.3.6.36 Frequency info

Information Element/Group name	Need	Multi	Type and reference	Semantics description
CHOICE <i>mode</i>	MP			
>FDD				
>>UARFCN uplink (Nu)	OP		Integer(0..16383)	If this IE is not present, the default duplex distance defined for the operating frequency band shall be used [21]
>>UARFCN downlink (Nd)	MP		Integer(0 .. 16383)	[21]
>TDD				
>>UARFCN (Nt)	MP		Integer(0 .. 16383)	[22]

10.3.6.36oo HS-PDSCH Midamble Configuration

NOTE: Only for TDD 1.28 Mcps.

Information Element/Group name	Need	Multi	Type and reference	Semantics description	Version
Midamble Allocation Mode	MP		Enumerated(Default midamble, Common midamble, UE specific midamble)	This midamble allocation mode applies to all HS-PDSCH resources assigned to the UE.	REL-5
Midamble Configuration	MP		Integer(2, 4, 6, 8, 10, 12, 14, 16)	This configuration applies to all HS-PDSCH resources assigned to the UE.	REL-5
Midamble Shift	CV-UE		Integer(0..15)	This shift, when present, applies to all HS-PDSCH resources assigned to the UE.	REL-5

Condition	Explanation
UE	This IE is mandatory present when the value of the IE "Midamble Allocation Mode" is "UE specific midamble" and not needed otherwise.

10.3.6.36o HS-PDSCH Timeslot Configuration

NOTE: Only for TDD 3.84 Mcps.

Information Element/Group name	Need	Multi	Type and reference	Semantics description	Version
HS-PDSCH Timeslot Configuration List	MP	1 to <maxTS-1>			REL-5
>Timeslot Number	MP		Integer (0..14)		REL-5
>CHOICE Burst Type	MP				REL-5
>>Type 1					REL-5
>>>Midamble Allocation Mode	MP		Enumerated (Default midamble, Common midamble, UE specific midamble)		REL-5
>>>Midamble configuration burst type 1 and 3	MP		Integer (4, 8, 16)	As defined in [30]	REL-5
>>>Midamble Shift	CV-UE		Integer (0..15)		REL-5
>>Type 2					REL-5
>>>Midamble Allocation Mode	MP		Enumerated (Default midamble, Common midamble, UE specific midamble)		REL-5
>>>Midamble configuration burst type 2	MP		Integer (3, 6)	As defined in [30]	REL-5
>>>Midamble Shift	CV-UE		Integer (0..5)		REL-5

Condition	Explanation
<i>UE</i>	This IE is mandatory present when the value of the IE "Midamble Allocation Mode" is "UE specific midamble" and not needed otherwise.

10.3.6.36oa HS-PDSCH Timeslot Configuration VHCR

NOTE: Only for TDD 7.68 Mcps.

Information Element/Group name	Need	Multi	Type and reference	Semantics description	Version
HS-PDSCH Timeslot Configuration List	MP	1 to <maxTS-1>			REL-7
>Timeslot Number	MP		Integer (0..14)		REL-7
>CHOICE Burst Type	MP				REL-7
>>Type 1					REL-7
>>>Midamble Allocation Mode	MP		Enumerated (Default midamble, Common midamble, UE specific midamble)		REL-7
>>>Midamble configuration burst type 1 and 3	MP		Integer (4, 8, 16)	As defined in [30]	REL-7
>>>Midamble Shift	CV-UE		Integer (0..15)		REL-7
>>Type 2					REL-7
>>>Midamble Allocation Mode	MP		Enumerated (Default midamble, Common midamble, UE specific midamble)		REL-7
>>>Midamble configuration burst type 2	MP		Integer (4, 8)	As defined in [30]	REL-7
>>>Midamble Shift	CV-UE		Integer (0..7)		REL-7

Condition	Explanation
<i>UE</i>	This IE is mandatory present when the value of the IE "Midamble Allocation Mode" is "UE specific midamble" and not needed otherwise.

10.3.6.36a HS-SCCH Info

Information Element/Group name	Need	Multi	Type and reference	Semantics description	Version
CHOICE mode	MP				REL-5
>FDD					REL-5
>>DL Scrambling Code	MD		Secondary scrambling code 10.3.6.74	DL Scrambling code to be applied for HS-DSCH and HS-SCCH. Default is same scrambling code as for the primary CPICH.	REL-5
>>HS-SCCH Channelisation Code Information	MP	1 to <maxHSS CCHs >		Note 2	REL-5
>>>HS-SCCH Channelisation Code	MP		Integer (0..127)		REL-5
>TDD					REL-5
>>CHOICE <i>TDD option</i>	MP				REL-5
>>>3.84 Mcps					REL-5
>>>> Ack-Nack Power Offset	MP		Integer (-7..8 by step of 1)	dB Note 1	REL-5
>>>> HS-SICH Power Control Info	MP		HS-SICH Power Control Info 10.3.6.36b		REL-5
>>>> BLER target	MP		Real (-3.15..0 by step of 0.05)	Signalled value is Log10(HS-SCCH BLER quality target). This IE is Not Present in REL-5.	REL-6
>>>> $D_{hs-sync}$	OP		Integer (-20..+10)	Value in dB set to indicate the dB difference between the maximum allowed HS-SCCH physical channel transmit power [33] and the beacon reference power (it is one means of controlling the area of HS-DSCH operation within the cell).	REL-6
>>>>HS-SCCH Set Configuration	MP	1 to <maxHSS CCHs>			REL-5
>>>>>Timeslot number	MP		Integer (0..14)		REL-5
>>>>>Channelisation code	MP		Enumerated ((16/1) ..(16/16))		REL-5
>>>>>Midamble Allocation mode	MP		Enumerated (Default midamble, Common midamble, UE specific midamble)	HS-SCCH always uses burst type 1.	REL-5
>>>>>Midamble configuration	MP		Integer (4, 8, 16)		REL-5
>>>>>Midamble Shift	CV-UE		Integer(0..15)		REL-5

>>>>>BLER target	MP		Real (-3.15..0 by step of 0.05)	Signalled value is Log10(HS-SCCH BLER quality target). This IE is not present in REL-6 and beyond.	REL-5
>>>>>HS-SICH configuration					REL-5
>>>>>Timeslot number	MP		Integer (0..14)		REL-5
>>>>>Channelisation code	MP		Enumerated ((16/1) ..(16/16))		REL-5
>>>>>Midamble Allocation mode	MP		Enumerated (Default midamble, UE specific midamble)	HS-SICH always uses burst type 1.	REL-5
>>>>>Midamble configuration	MP		Integer (4, 8, 16)		REL-5
>>>>>Midamble Shift	CV-UE		Integer (0..15)		REL-5
>>>7.68 Mcps					REL-7
>>>>Ack-Nack Power Offset	MP		Integer (-7..8 by step of 1)	dB	REL-7
>>>>HS-SICH Power Control Info	MP		HS-SICH Power Control Info 10.3.6.36b		REL-7
>>>>BLER target	MP		Real (-3.15..0 by step of 0.05)	Signalled value is Log10(HS-SCCH BLER quality target).	REL-7
>>>>D _{hs-sync}	OP		Integer (-20..+10)	Value in dB set to indicate the dB difference between the maximum allowed HS-SCCH physical channel transmit power [33] and the beacon reference power (it is one means of controlling the area of HS-DSCH operation within the cell).	REL-7
>>>>D _{hs-sync}	OP		Integer (-20..+10)	Value in dB set to indicate the dB difference between the maximum allowed HS-SCCH physical channel transmit power [33] and the beacon reference power (it is one means of controlling the area of HS-DSCH operation within the cell).	REL-7
>>>>HS-SCCH Set Configuration	MP	1 to <maxHS-SCCHs>			REL-7

>>>>>Timeslot number	MP		Integer (0..14)		REL-7
>>>>>Channelisation code	MP		Enumerated ((32/1)..(32/32))		REL-7
>>>>>Midamble Allocation mode	MP		Enumerated (Default midamble, Common midamble, UE specific midamble)	HS-SCCH always uses burst type 1.	REL-7
>>>>>Midamble configuration	MP		Integer (4, 8, 16)		REL-7
>>>>>Midamble Shift	CV-UE		Integer(0..15)		REL-7
>>>>>HS-SICH configuration					REL-5
>>>>>>Timeslot number	MP		Integer (0..14)		REL-5
>>>>>>Channelisation code	MP		Enumerated ((32/1)..(32/32))		REL-5
>>>>>>Midamble Allocation mode	MP		Enumerated (Default midamble, UE specific midamble)	HS-SICH always uses burst type 1.	REL-5
>>>>>>Midamble configuration	MP		Integer (4, 8, 16)		REL-5
>>>>>>Midamble Shift	CV-UE		Integer (0..15)		REL-5
>>>>1.28 Mcps					REL-5
>>>>>Ack-Nack Power Offset	MP		Integer (-7..8 by step of 1)	dB. This IE is Not Present in REL-5.	REL-6
>>>>>PRX _{HS-SICH}	MP		Integer (-120..-58 by step of 1)	Note dBm. Desired power level for HS-SICH. This IE is Not Present in REL-5	REL-6
>>>>>TPC step size	MP		Enumerated (1, 2, 3)	dB. TPC step size for HS-SICH. One spare value. This IE is Not Present in REL-5.	REL-6
>>>>>BLER target	MP		Real (-3.15..0 by step of 0.05)	Signalled value is Log ₁₀ (HS-SCCH BLER quality target). This IE is Not Present in REL-5.	REL-6
>>>>>HS-SCCH TPC step size	CV- NoDPCH_ EAGCH		Enumerated (1, 2, 3)	dB. One spare value.	REL-8
>>>>>Power Control GAP	MD		Integer (1...255)	Unit: Number of subframes Default value is 1.	REL-7

>>>>Pathloss compensation switch	MD		Boolean	TRUE: UE shall perform the pathloss compensation for HS-SICH power control when HS-SICH transmission gap is less than "Power Control GAP". FALSE: UE shall not consider the pathloss compensation for HS-SICH power control. Default value is FALSE.	REL-7
>>>HS-SCCH Set Configuration	MP	1 to <maxHSS CCHs>			REL-5
>>>>Timeslot number	MP		Integer (0..6)		REL-5
>>>>First Channelisation code	MP		Enumerated ((16/1) ..(16/16))		REL-5
>>>>Second Channelisation code	MP		Enumerated ((16/1) ..(16/16))		REL-5
>>>>Midamble Allocation mode	MP		Enumerated (Default midamble, Common midamble, UE specific midamble)		REL-5
>>>> Midamble Shift	CV-UE		Integer (0..15)		REL-5
>>>>Midamble configuration	MP		Integer (2, 4, 6, 8, 10, 12, 14, 16)		REL-5
>>>>BLER target	MP		Real (-3.15..0 by step of 0.05)	Signalled value is Log ₁₀ (HS-SCCH BLER quality target). This IE is not present in REL-6 and beyond.	REL-5
>>>>HS-SICH configuration					REL-5
>>>>>Timeslot number	MP		Integer (0..6)		REL-5
>>>>>Channelisation code	MP		Enumerated ((16/1) ..(16/16))		REL-5
>>>>>Midamble Allocation mode	MP		Enumerated (Default midamble, UE specific midamble)		REL-5
>>>>>Midamble configuration	MP		Integer (2, 4, 6, 8, 10, 12, 14, 16)		REL-5
>>>>>Midamble Shift	CV-UE		Integer (0..15)		REL-5

>>>>>Ack-Nack Power Offset	MP		Integer (-7..8 by step of 1)	dB. This IE is not present in REL-6 and beyond. Note	REL-5
>>>>>PRX _{HS-SICH}	MP		Integer (-120..-58 by step of 1)	dBm. Desired power level for HS-SICH. This IE is not present in REL-6 and beyond.	REL-5
>>>>>TPC step size	MP		Enumerated (1, 2, 3)	dB. One spare value. This IE is not present in REL-6 and beyond.	REL-5
<p>Note 1: Ack-Nack Power Offset is the difference in the desired RX power between HS-SICH transmissions conveying an acknowledgement and transmissions conveying a negative acknowledgement signalled to the UE in IE "HS-SCCH Info".</p> <p>Note 2: The list of HS-SCCH(s) is assumed to be indexed starting from one.</p>					

Condition	Explanation
<i>UE</i>	This IE is mandatory present when the value of the IE "Midamble Allocation Mode" is "UE specific midamble" and not needed otherwise.
<i>NoDPCH_EAGCH</i>	This IE is mandatory present when neither DPCH nor E-AGCH is configured and not needed otherwise.

10.3.6.36ab HS-SCCH less information

NOTE: For FDD only

Information Element/Group name	Need	Multi	Type and reference	Semantics description	Version
CHOICE <i>HS-SCCH less operation</i>	MP				REL-7
>Continue HS-SCCH less operation			(no data)		REL-7
>New HS-SCCH less operation					REL-7
>>HS-PDSCH Code Index	MP		Integer (1..15)	Index of first HS-PDSCH code	REL-7
>>Transport Block Size List		1..<maxHS-SCCHLe ssTrBlk >			REL-7
>>>Transport Block Size Index	MP		Integer (1..90)	Index of the MAC-hs or MAC-ehs transport block size as described in appendix A of [15]	REL-7
>>>HS-PDSCH Second Code Support	MP		Boolean	Indicates whether the second HS-PDSCH code is used for this TB size. If TRUE, the HS-PDSCH second code index value is the value of IE "HS-PDSCH Code Index" incremented by 1.	REL-7

10.3.6.36b HS-SICH Power Control Info

This IE is used to transfer HS-SICH power control info to the UE and only applies to TDD 3.84 Mcps and 7.68 Mcps.

Information Element/Group name	Need	Multi	Type and reference	Semantics description	Version
UL target SIR	MP		Real (-11..20 by step of 0.5)	dB	REL-5
HS-SICH Constant value	MP		Constant value 10.3.6.11	NOTE 1	REL-5

NOTE 1: Alignment to ASN.1: the IE "Constant value TDD" (10.3.6.11a) should have been used to provide the correct value range. The IE "Constant value" (10.3.6.11) is used to keep compatibility with REL-5.

10.3.6.36c HS-DSCH common system information

NOTE: For FDD only.

Information Element/Group name	Need	Multi	Type and reference	Semantics description	Version
CCCH mapping info	MP		Common RB mapping info 10.3.4.0a		REL-7
SRB1 mapping info	MD		Common RB mapping info 10.3.4.0a	Note	REL-7
Common MAC-ehs reordering queue list	MP		Common MAC-ehs reordering queue list 10.3.5.3a		REL-7
HS-SCCH system info	MP		HS-SCCH system info 10.3.6.36e		REL-7
HARQ system Info	MP		HARQ Info 10.3.5.7a		REL-7
Common H-RNTI Information	MP	1 to <maxCommonHRNTI>			REL-7
>Common H-RNTI	MP		H-RNTI 10.3.3.14a		REL-7
BCCH specific H-RNTI	MP		H-RNTI 10.3.3.14a		REL-7

NOTE: The default values for the "SRB1 mapping info" are 1 for the Logical channel identity and 0 for the MAC-ehs queue identity.

10.3.6.36ca HS-DSCH common system information 1.28Mcps TDD

NOTE: For 1.28 Mcps TDD only.

Information Element/Group name	Need	Multi	Type and reference	Semantics description	Version
CCCH mapping info	MP		Common RB mapping info 10.3.4.0a		REL-8
SRB1 mapping info	MD		Common RB mapping info 10.3.4.0a	Note 1	REL-8
Common MAC-ehs reordering queue list	MP		Common MAC-ehs reordering queue list 10.3.5.3a		REL-8
HS-SCCH system info	MP		HS-SCCH system info 1.28Mcps TDD 10.3.6.36ea	Note 2	REL-8
HARQ system Info	MP		HARQ Info 10.3.5.7a		REL-8
HS-PDSCH Midamble Configuration	MP		HS-PDSCH Midamble Configuration 10.3.6.36oo		REL-8
Common H-RNTI Information	MP	1 to <maxCommonHRNTI >			REL-8
>Common H-RNTI	MP		H-RNTI 10.3.3.14a		REL-8
BCCH specific H-RNTI	MP		H-RNTI 10.3.3.14a		REL-8

NOTE 1: The default values for the "SRB1 mapping info" are 1 for the Logical channel identity and 0 for the MAC-ehs queue identity.

NOTE 2: These IEs correspond to the HS-DSCH configuration for CELL_FACH, CELL_PCH state.

10.3.6.36d HS-DSCH paging system information

These parameters enable the UE in CELL_PCH and URA_PCH to receive transmissions on HSDPA cell resources.

NOTE: Only for FDD.

Information Element/Group name	Need	Multi	Type and reference	Semantics description	Version
DL Scrambling Code	MD		Secondary scrambling code 10.3.6.74	DL Scrambling code to be applied for HS-DSCH and HS-SCCH. Default is same scrambling code as for the primary CPICH.	REL-7
PICH for HSDPA supported paging list	MP	1 to <maxSCC PCH>			REL-7
>HSDPA associated PICH info	MP		PICH info 10.3.6.49		REL-7
>HS-PDSCH Channelisation Code	MP		Integer (0..15)	HS-PDSCH channel, associated with the PICH for HS-SCCH less PAGING TYPE 1 message transmission.	REL-7
Number of PCCH transmissions	MP		Integer (1..5)	number of subframes used to transmit the PAGING TYPE 1.	REL-7
Transport Block Size List	MP	1 to 2			REL-7
>Transport Block Size Index	MP		Integer (1..32)	Index of value range 1 to 32 of the MAC-ehs transport block size as described in appendix A of [15]	REL-7

10.3.6.36da HS-DSCH paging system information 1.28Mcps TDD

These parameters enable the UE in CELL_PCH and URA_PCH to receive PCCH, DCCH/DTCH transmissions on HSDPA cell resources.

NOTE: Only for 1.28 Mcps TDD.

Information Element/Group name	Need	Multi	Type and reference	Semantics description	Version
PICH for HS-DSCH list	MP	1 to <maxSCC PCH>			REL-8
>CHOICE Configuration Mode	MP				REL-8
>>Implicit				The choice Indicates the PICH is shared with PCH.	REL-8
>>>Occurrence sequence number in S-CCPCH systme Info	MD		Integer (1..maxSCCPC H)	Indicates the occurrence sequecne number of "PICH Info" in Secondary CCPCH System Information. Default value implys the first occurrence or the only occurrence of "PICH Info" in Secondary CCPCH System Information.	REL-8
>>Explicit					REL-8
>>>HSDPA associated PICH info	MP		PICH info 10.3.6.49		REL-8
DTCH/DCCH Reception window size	MP		Integer (1..16)	Number of subframe for UE to detect the HS-SCCH	REL-8
PCCH related information	OP			See Note 1	REL-8
>Paging associated HS-PDSCH info	MP	1 to <maxSCC PCH>		See Note 3	REL-8
>>HS-PDSCH Midamble Configuration	MP		HS-PDSCH Midamble Configuratio n 10.3.6.36oo		REL-8
>>Timeslot Resource Related Informationl	MP		Bit string (6)	Each bit indicates availability of a timeslot, where the bit 0 corresponds to TS0, the bit 1 is TS2, the bit 2 is TS3... bit 6 corresponds to TS6. The value 1 of a bit indicates that the corresponding timeslot is available. Bit 0 is the first/leftmost bit of the bit string.	REL-8
>>Code Resource Information	MP			Note 2	REL-8
>>>Start code	MP		Enumerated((16/1)..(16/1 6))		REL-8
>>>Stop code	MP		Enumerated((16/1)..(16/1 6))		REL-8

>Paging Sub-Channel Size	MP		Integer (1..3)	number of frames for a Paging sub-channel	REL-8
>Transport Block Size List	MP	1 to 2			REL-8
>>Transport Block Size Index	MP		Integer (1..32)	Index of value range 1 to 32 of the MAC-e-hs transport block size as described in Table 9.2.3.3.8 [15]	REL-8

NOTE 1: The IE is not signalled when the "PICH info" is present in "Secondary CCPCH system information" in SIB5 and SIB6.

NOTE 2: HS-PDSCH channelisation codes are allocated contiguously from a signalled start code to a signalled stop code, and the allocation includes both the start and stop code. If a value of Start code = 16 and Stop code = 1 is signalled, a spreading factor of SF=1 shall be used for the HS-PDSCH resources.

NOTE 3: The timing between PICH and the paging associated HS-PDSCH is specified in [30]. UE should receive the HS-PDSCH based on the timing specification.

10.3.6.36e HS-SCCH system info

These parameters enable the UE to receive transmission on HSDPA cell resources, when the UE is not in CELL_DCH.

NOTE: for FDD only.

Information Element/Group name	Need	Multi	Type and reference	Semantics description	Version
DL Scrambling Code	MD		Secondary scrambling code 10.3.6.74	DL Scrambling code to be applied for HS-DSCH and HS-SCCH. Default is same scrambling code as for the primary CPICH.	REL-7
HS-SCCH Channelisation Code Information	MP	1 to <maxHSS CCHs>			REL-7
>HS-SCCH Channelisation Code	MP		Integer (0..127) (NOTE)		REL-7

NOTE: UTRAN should use the first indexed HS-SCCH Channelisation code for the BCCH specific H-RNTI to indicate system information change information. Otherwise UE behaviour is unspecified.

10.3.6.36ea HS-SCCH system info 1.28Mcps TDD

These parameters enable the UE to receive transmission on HSDPA cell resources on primary frequency or secondary frequency, when the UE is not in CELL_DCH.

NOTE: for 1.28 Mcps TDD only.

Information Element/Group name	Need	Multi	Type and reference	Semantics description	Version
HS-SCCH Set Configuration	MP	1 to <maxHSS CCHs>			REL-8
>Timeslot number	MP		Integer (0..6)		REL-8
>First Channelisation code	MP		Enumerated ((16/1) ..(16/16))		REL-8
>Second Channelisation code	MP		Enumerated ((16/1) ..(16/16))		REL-8
>Midamble Allocation mode	MP		Enumerated (Default midamble, Common midamble, UE specific midamble)		REL-8
>Midamble Shift	CV-UE		Integer (0..15)		REL-8
>Midamble configuration	MP		Integer (2, 4, 6, 8, 10, 12, 14, 16)		REL-8
>HS-SICH configuration	MP				REL-8
>>Timeslot number	MP		Integer (0..6)		REL-8
>>Channelisation code	MP		Enumerated ((16/1) ..(16/16))		REL-8
>>Midamble Allocation mode	MP		Enumerated (Default midamble, UE specific midamble)		REL-8
>>Midamble Shift	CV-UE		Integer (0..15)		REL-8
>>Midamble configuration	MP		Integer (2, 4, 6, 8, 10, 12, 14, 16)		REL-8
$PRX_{HS-SICH}$	MP		Integer (-120..-58 by step of 1)	dBm. Desired power level for HS-SICH.	REL-8
Ack-Nack Power Offset	MP		Integer (-7..8 by step of 1)	dB.	REL-8
TPC step size	MP		Enumerated (1, 2, 3)	dB. TPC step size for HS-SICH. One spare value.	REL-8
BLER target	MP		Real (-3.15..0 by step of 0.05)	Signalled value is $\text{Log}_{10}(\text{HS-SCCH BLER quality target})$.	REL-8
Power Control GAP	MD		Integer (1...255)	Unit: Number of subframes Default value is 1.	REL-8

Pathloss compensation switch	MD		Boolean	TRUE: UE shall perform the pathloss compensation for HS-SICH power control when HS-SICH transmission gap is less than "Power Control GAP". FALSE: UE shall not consider the pathloss compensation for HS-SICH power control. Default value is FALSE.	REL-8
------------------------------	----	--	---------	--	-------

Condition	Explanation
<i>UE</i>	This IE is mandatory present when the value of the IE "Midamble Allocation Mode" is "UE specific midamble" and not needed otherwise.

NOTE: UTRAN should use the first indexed HS-SCCH Channelisation code for the BCCH specific H-RNTI to indicate system information change information on primary frequency or secondary frequency. Otherwise UE behaviour is unspecified.

10.3.6.36f Void

10.3.6.36g HS-DSCH DRX in CELL_FACH information

These parameters configure the UE in CELL_FACH state to discontinuously receive HS-DSCH.

NOTE: Only for FDD.

Information Element/Group name	Need	Multi	Type and reference	Semantics description	Version
T321	MP		Enumerated (100, 200, 400, 800)	Determines the time the UE waits until initiating DRX operation, in ms.	REL-8
HS-DSCH DRX cycle _{FACH}	MP		Enumerated (4, 8, 16, 32)	Determines the length of the DRX Cycle during DRX operation, in frames	REL-8
HS-DSCH Rx burst _{FACH}	MP		Enumerated (1, 2, 4, 8, 16)	Determines the period within the DRX Cycle that the UE continuously receives HS-DSCH, in frames. Three spare values are needed	REL-8
DRX Interruption by HS-DSCH data	MP		Boolean	TRUE means that the DRX operation can be interrupted by HS-DSCH data. FALSE means that the DRX operation cannot be interrupted by HS-DSCH data	REL-8

10.3.6.36h HS-DSCH DRX in CELL_FACH information 1.28Mcps TDD

These parameters configure the UE in CELL_FACH state to discontinuously receive HS-DSCH.

NOTE: Only for 1.28 Mcps TDD.

Information Element/Group name	Need	Multi	Type and reference	Semantics description	Version
T321	MP		Enumerated (100, 200, 400, 800)	Determines the time the UE waits until initiating DRX operation, in ms.	REL-8
DRX cycle _{FACH}	MP		Enumerated (4, 8, 16, 32)	Determines the length of the DRX Cycle during DRX operation, in frames	REL-8
Rx burst _{FACH}	MP		Enumerated (1, 2, 4, 8, 16)	Determines the period within the DRX Cycle that the UE continuously receives HS-DSCH, in frames. Three spare values are needed	REL-8

10.3.6.37 Individual timeslot info

Information Element/Group name	Need	Multi	Type and reference	Semantics description	Version
Timeslot number	MP		Timeslot number 10.3.6.84	Timeslot within a frame	
TFCI existence	MP		Boolean	TRUE indicates that the TFCI exists. It shall be coded in the physical channel defined in [30] of this timeslot.	
Midamble Shift and burst type	MP		Midamble shift and burst type 10.3.6.41	For 1.28 Mcps TDD, if the cell is operating in MBSFN mode, the UE shall ignore the contents of this IE.	
<i>CHOICE TDD option</i>	MP				REL-4
>3.84 Mcps TDD				(no data)	REL-4
>7.68 Mcps TDD				(no data)	REL-7
>1.28 Mcps TDD					REL-4
>>Modulation	MP		Enumerated(QPSK, 8PSK)		REL-4
>>SS-TPC Symbols	MP		Enumerated(0, 1, 16/SF)	Denotes amount of SS and TPC bits send in this timeslot	REL-4
>>Additional TPC-SS Symbols	OP		Integer(1..15)	Specifies the number of additional codes in this timeslot that carry TPC and SS symbols as specified in [33]	REL-4

10.3.6.38 Individual Timeslot interference

Parameters used by the UE for uplink open loop power control in TDD.

Information element	Need	Multi	Type and reference	Semantics description
Timeslot number	MP		Timeslot number 10.3.6.84	
UL Timeslot Interference	MP		UL Interference TDD 10.3.6.87a	

10.3.6.39 Maximum allowed UL TX power

This information element indicates the maximum allowed uplink transmit power.

Information Element	Need	Multi	Type and reference	Semantics description
Maximum allowed UL TX power	MP		Integer(-50..33)	In dBm

10.3.6.39a Multi-frequency Info (1.28 Mcps TDD only)

IE/Group Name	Presence	Multi	IE Type and Reference	Semantics Description	Version
Second Frequency Info	OP		Integer (0 .. 16383)	1.28 Mcps TDD only	REL-7
FPACH Frequency Info	OP		Integer (0 .. 16383)	1.28 Mcps TDD only	REL-7
UpPCH Position Info	OP		Integer (0 .. 127)	Only for 1.28 Mcps TDD, if UpPCH occupies UpPTS, the parameter is not needed. Or the parameter is calculated for the uplink access position of a cell	REL-7

10.3.6.40 Void

10.3.6.40a Measurement Feedback Info

Information Element/Group name	Need	Multi	Type and reference	Semantics description	Version
CHOICE <i>mode</i>	MP				REL-5
>FDD					REL-5
>>Measurement Power Offset	MP		Real (-6 .. 13 by step of 0.5)	The measurement power offset, Γ , in dB, as described in [29].	REL-5
>>CQI Feedback cycle, k	MP		Integer (0, 2, 4, 8, 10, 20, 40, 80, 160, 16, 32, 64)	In milliseconds.	REL-5
				In milliseconds.	REL-7

>>HS-DPCCH reduction configuration	CV- Message				REL-12
>>>HS-DPCCH reduction type	OP		Enumerated (Type1, Type2)	The Type of HS-DPCCH reduction the UE shall apply. Absence of this IE means that the UE shall apply both HS-DPCCH reduction Type1 and HS-DPCCH reduction Type2.	REL-12
>>>CQI Feedback cycle2, k	MP		Enumerated (0, 8, 10, 16, 20, 32, 40, 64, 80, 160)	In milliseconds. Six spare values are needed.	REL-12
>>>CQI cycle switch timer	MP		Enumerated (4, 8, 16, 32, 64, 128, 256, 512, Infinity)	Units of subframes. Seven spare values are needed.	REL-12
>>CQI repetition factor	MP		Integer (1..4)		REL-5
>>CQI repetition factor for Multiflow assisting cells	CV- Multiflow		Integer (1..4)	If present, this IE indicates that all the assisting cells use the CQI repetition factor indicated by this IE.	REL-11
>> Δ_{cqi}	MP		Integer (0..8	Refer to quantization of the power offset in [28]	REL-5
			9..10)		REL-11
>TDD				(no data)	REL-5

Condition	Explanation
Message	This IE is not needed in the HANDOVER TO UTRAN COMMAND message. Otherwise it is optional.
Multiflow	The IE is optional when the Multiflow operation is configured, otherwise it is not needed.

10.3.6.41 Midamble shift and burst type

NOTE: Only for TDD.

This information element indicates burst type and midamble allocation. Three different midamble allocation schemes exist:

- Default midamble: the midamble shift is selected by layer 1 depending on the associated channelisation code (DL and UL)
- Common midamble: the midamble shift is chosen by layer 1 depending on the number of channelisation codes (possible in DL only)
- UE specific midamble: a UE specific midamble is explicitly assigned (DL and UL).

Information Element/Group name	Need	Multi	Type and reference	Semantics description	Version
CHOICE <i>TDD option</i>	MP				REL-4
>3.84 Mcps TDD					REL-4

Information Element/Group name	Need	Multi	Type and reference	Semantics description	Version
>>CHOICE <i>Burst Type</i>	MP				
>>>Type 1					
>>>>Midamble Allocation Mode	MP		Enumerated (Default midamble, Common midamble, UE specific midamble)		
>>>>Midamble configuration burst type 1 and 3	MP		Integer(4, 8, 16)	As defined in [30]	
>>>>Midamble Shift	CV-UE		Integer(0..15)		
>>>Type 2					
>>>>Midamble Allocation Mode	MP		Enumerated (Default midamble, Common midamble, UE specific midamble)		
>>>>Midamble configuration burst type 2	MP		Integer(3, 6)	As defined in [30]	
>>>>Midamble Shift	CV-UE		Integer(0..5)		
>>>Type 3					
>>>>Midamble Allocation Mode	MP		Enumerated (Default midamble, UE specific midamble)		
>>>>Midamble configuration burst type 1 and 3	MP		Integer(4, 8, 16)	As defined in [30]	
>>>>Midamble Shift	CV-UE		Integer (0..15)	NOTE: Burst Type 3 is only used in uplink.	
>>> MBSFN Burst Type				(no data) DL only	REL-7
>7.68 Mcps TDD					REL-7
>>CHOICE <i>Burst Type</i>	MP				REL-7
>>>Type 1					REL-7
>>>>Midamble Allocation Mode	MP		Enumerated (Default midamble, Common midamble, UE specific midamble)		REL-7
>>>>Midamble configuration burst type 1 and 3	MP		Integer(4, 8, 16)	As defined in [30]	REL-7
>>>>Midamble Shift	CV-UE		Integer(0..15)		REL-7
>>>Type 2					REL-7
>>>>Midamble Allocation Mode	MP		Enumerated (Default midamble, Common midamble, UE specific midamble)		REL-7
>>>>Midamble configuration burst type 2	MP		Integer(4, 8)	As defined in [30]	REL-7
>>>>Midamble Shift	CV-UE		Integer(0..7)		REL-7
>>>Type 3					REL-7

Information Element/Group name	Need	Multi	Type and reference	Semantics description	Version
>>>>Midamble Allocation Mode	MP		Enumerated (Default midamble, UE specific midamble)		REL-7
>>>>Midamble configuration burst type 1 and 3	MP		Integer(4, 8, 16)	As defined in [30]	REL-7
>>>>Midamble Shift	CV-UE		Integer (0..15)	NOTE: Burst Type 3 is only used in uplink.	REL-7
>>> MBSFN Burst Type				(no data) DL only	REL-7
>1.28 Mcps TDD					REL-4
>>Midamble Allocation Mode	MP		Enumerated (Default midamble, Common midamble, UE specific midamble)		REL-4
>>Midamble configuration	MP		Integer(2, 4, 6, 8, 10, 12, 14, 16)	As defined in [30]	REL-4
>>Midamble Shift	CV-UE		Integer (0..15)		REL-4

Condition	Explanation
UE	This IE is mandatory present when the value of the IE "Midamble Allocation Mode" is "UE-specific midamble" and not needed otherwise.

10.3.6.41a MIMO parameters

Information Element/Group name	Need	Multi	Type and reference	Semantics description	Version
MIMO operation	MP		Enumerated (start, continue)		REL-7
CHOICE mode	MP				REL-8
>FDD					REL-8
>>MIMO N_cqi_typeA/M_cqi ratio	OP		Enumerated(1/2, 2/3, 3/4, 4/5, 5/6, 6/7, 7/8, 8/9, 9/10, 1/1)		REL-7
>>MIMO pilot configuration	OP		MIMO pilot configuration 10.3.6.41b		REL-7
>>Precoding weight set restriction	OP		Enumerated (TRUE)	If present and MIMO operation is set to start, the UE starts using precoding weight set restriction.	REL-7

Information Element/Group name	Need	Multi	Type and reference	Semantics description	Version
>TDD					REL-8
>>CHOICE <i>TDD option</i>	MP				REL-8
>>>1.28 Mcps TDD					REL-8
>>>>MIMO SF Mode for HS-PDSCH dual stream	MP		Enumerated (SF1, SF1/SF16)		REL-8
>>>>HS-SICH Reference Signal Info	OP	<1 to maxHSSC CHs >		The order of the list corresponds to the order of HS-SCCHs in HS-SCCH info	REL-8
>>>>> Reference Signal Midamble configuration	MP		Integer (2, 4, 6, 8, 10, 12, 14, 16)	Midamble Allocation mode is UE specific midamble allocation	REL-8
>>>>>Reference Signal Midamble Shift	MP		Integer (0..15)	The allocated midamble shift.	REL-8
>>>>>Reference Signal Timeslot number	MP		Integer (1..5)		REL-8
>>>>3.84 Mcps TDD or 7.68 Mcps TDD				(no data)	REL-8

10.3.6.41b MIMO pilot configuration

Information Element/Group name	Need	Multi	Type and reference	Semantics description	Version
CHOICE <i>Second CPICH pattern</i>	MP				REL-7
>Antenna2 P-CPICH				(no data)	REL-7
>Antenna1 S-CPICH					REL-7
>>Channelisation code	MP		Integer (0..255)		REL-7
>> Power Offset for S-CPICH for MIMO	OP		Integer(-6 .. 0)	Power offset relative to the P-CPICH Tx power in dB	REL-7

10.3.6.41c Non-scheduled transmission grant info (TDD only)

Information Element/Group name	Need	Multi	Type and reference	Semantics description	Version
CHOICE <i>TDD Option</i>					REL-7
>3.84/7.68 Mcps TDD					REL-7
>>Timeslot Resource Related InformationI	MP		Bit string (13)	Bitmap indicating which of the timeslots configured for E-DCH are allocated for non-scheduled transmissions	REL-7
>>Power Resource Related Information	MP		Integer (1..32)	Specifies the maximum allowed E-PUCH resource that the UE may use [15].	REL-7
>>Activation Time	MP		Activation time 10.3.3.1		REL-7
>>Repetition period and length	MD			Default is "Repetition period" = 1 (continuous)	REL-7
>>>Repetition period	MP		Integer (1, 2, 4, 8, 16, 32, 64)	Periodicity in terms of TTIs for which resource is allocated. 1= continuous dallocation, 2 indicates every other TTI, 4 = every 4 th , 8 every 8 th etc.	REL-7
>>>Repetition Length	MP		Integer (1..Repetition period-1)	TTI in which resource is assigned. If Repetition period = 1 then value is ignored	REL-7
>>Code Resource Information	MP		Enumerated ((1/1),(2/1),(2/2),(4/1)..(4/4),(8/1)..(8/8),(16/1)..(16/16))		REL-7
>1.28 Mcps TDD					REL-7
>>N _{E-UCCH}	MD		Integer (1..8)	Number of E-UCCH and TPC instances within an E-DCH TTI. Default = 1.	REL-7
>>N _{E-HICH}	CV-Scheduled E-PUCH		Integer(4..15)	Minimum number of slots between start last active slot of E-DCH TTI and start of ACK/NACK on E-HICH.	REL-7
>>Timeslot Resource Related InformationI	MP		Bit string (5)	Bitmap indicating which of the timeslots configured for E-DCH are allocated for non-scheduled transmissions	REL-7

>>Power Resource Related Information	MP		Integer (1..32)	Indicates 0-31 PRRI index defined in [31], which specifies the maximum allowed E-PUCH resource that the UE may use [15].	REL-7
>>Activation Time	MP		Activation time 10.3.3.1	Specifies the E-PUCH Offset in Radio Frame level.	REL-7
>>Subframe number	MP		Integer (0..1)	Specifies the E-PUCH Offset in subframe level.	REL-7
>>Repetition period and length	MD			Default is "Repetition period" = 1 (continuous)	REL-7
>>>Repetition period	MP		Integer (1, 2, 4, 8, 16, 32, 64)	Periodicity in terms of TTIs for which resource is allocated. 1= continuous allocation, 2 indicates every other TTI, 4 = every 4 th , 8 every 8 th etc.	REL-7
>>>Repetition Length	MP		Integer (1..Repetition period-1)	TTI in which resource is assigned. If Repetition period = 1 then value is ignored	REL-7
>>Code Resource Information	MP		Enumerated ((1/1), (2/1),(2/2),(4/1)..(4/4),(8/1)..(8/8),(16/1)..(16/16))		REL-7
>>E-HICH Information	MP				REL-7
>>>Timeslot number	MP		Integer (0..6)		REL-7
>>>Channelisation code	MP		Enumerated ((16/1)..(16/16))		REL-7
>>>Midamble Allocation mode	MP		Enumerated (Default midamble, UE specific midamble)		REL-7
>>>Midamble configuration	MP		Integer (2, 4, 6, 8, 10, 12, 14, 16)		REL-7
>>>Midamble Shift	CV-UE specific		Integer (0..15)		REL-7
>>>Signature Sequence Group Index	MP		Integer (0..19)		REL-7
>>T-SI-NST	CV-E-RUCCH info		Enumerated (everyEDCH TTI, 20,40,60,80, 160,200)	Values in ms. If T-SI-NST expires then UE should include scheduling information in the next new non-scheduled MAC-e PDU or MAC-i PDU.	REL-7

Condition	Explanation
<i>Scheduled E-PUCH</i>	If NE-HICH is given in scheduled E-PUCH information, this IE is not needed, otherwise it is mandatory
<i>UE specific</i>	If UE specific midamble allocation mode is configured, this IE is mandatory, otherwise it is not needed.
<i>E-RUCCH info</i>	This IE is optionally present if the IE "E-RUCCH Info" is not included, otherwise the IE is not needed.

10.3.6.42 PDSCH Capacity Allocation info

NOTE: Only for TDD.

Information Element/Group name	Need	Multi	Type and reference	Semantics description
PDSCH allocation period info	MP		Allocation Period Info 10.3.6.4	
<i>CHOICE Configuration</i>	MP			
>Old configuration				
>>TFCS ID	MD		Integer(1..8)	Default is 1.
>>PDSCH Identity	MP		Integer(1..hi PDSCHidentities)	
>New configuration				
>>PDSCH Info	MP		PDSCH Info 10.3.6.44	
>>PDSCH Identity	OP		Integer(1..hi PDSCHidentities)	
>>PDSCH power control info	OP		PDSCH power control info 10.3.6.45	

10.3.6.43 Void

10.3.6.44 PDSCH info

NOTE: Only for TDD.

Information Element/Group name	Need	Multi	Type and reference	Semantics description	Version
TFCS ID	MD		Integer(1..8)	TFCS to be used. Default value is 1.	
Common timeslot info	OP		Common timeslot info 10.3.6.10		
PDSCH timeslots and codes for 1.28 Mcps TDD or 3.84 Mcps TDD	OP		Downlink Timeslots and Codes 10.3.6.32	Default is to use the old timeslots and codes.	
PDSCH timeslots and codes for 7.68 Mcps TDD	OP		Downlink Timeslots and Codes VHR 10.3.6.32a	Default is to use the old timeslots and codes.	REL-7

10.3.6.45 PDSCH Power Control info

NOTE: Only for TDD.

Information Element/Group name	Need	Multi	Type and reference	Semantics description
TPC Step Size	OP		Integer (1, 2, 3)	In dB
UL CcTrCH TPC List	OP	1..<maxCC TrCH>		UL CcTrCH identities for TPC commands associated with this DL CcTrCH. This list is not used in 1.28 Mcps TDD.
>UL TPC TFCS Identity	MP		Transport Format Combination Set Identity 10.3.5.21	

10.3.6.46 PDSCH system information

NOTE: Only for TDD.

Information Element/Group name	Need	Multi	Type and reference	Semantics description	Version
PDSCH information	MP	1 to <maxPD SCH>			
>PDSCH Identity	MP		Integer(1..hiPDSCHidentities)		
>PDSCH info	MP		PDSCH info 10.3.6.44		
>SFN Time Info	CH-Block17		SFN Time Info 10.3.6.75		
>DSCH TFS	OP		Transport format set 10.3.5.23		
>DSCH Transport Channels	OP	1 to <maxTr CH>		If PDSCH is configured for 3.84Mcps TDD in Rel-5 or for 7.68 Mcps in Rel-7 this IE may be included.	REL-5
>> DSCH Transport channel identity	MP		Transport channel identity 10.3.5.18		REL-5
>>DSCH TFS	MP		Transport format set 10.3.5.23		REL-5
>DSCH TFCS	OP		Transport Format Combination Set 10.3.5.20		

Condition	Explanation
Block17	This IE is not needed in System Information Block 17. Otherwise it is optional.

10.3.6.47 Void

10.3.6.48 Persistence scaling factors

This IE defines scaling factors associated with ASC 2 – ASC 7 to be applied to the dynamic persistence value.

Information Element/Group name	Need	Multi	Type and reference	Semantics description
Access Service Class	MP	1 to maxASCpersist		multiplicity corresponds to the number of PRACH partitions minus 2
>Persistence scaling factor	MP		Real(0.9..0.2, by step of 0.1)	Scaling factors in the range 0,...,1

10.3.6.49 PICH Info

Information Element/Group name	Need	Multi	Type and reference	Semantics description	Version
CHOICE mode	MP				
>FDD					

>>Channelisation code	MP		Integer(0..255)	SF is fixed and equal to 256	
>>Number of PI per frame	MP		Integer (18, 36, 72, 144)		
>>STTD indicator	MP		STTD Indicator 10.3.6.78		
>TDD					
>>Timeslot number	MD		Timeslot number 10.3.6.84	Default value is the timeslot used by the SCCPCH carrying the associated PCH.	
>>Midamble shift and burst type	MP		Midamble shift and burst type 10.3.6.41		
>>CHOICE <i>TDD option</i>	MP				REL-4
>>>3.84 Mcps TDD					REL-4
>>>>Channelisation code	MD		Enumerated ((16/1)...(16/16))	Default value is the channelisation code used by the SCCPCH carrying the associated PCH.	
>>>>7.68 Mcps TDD					REL-7
>>>>Channelisation code	MD		Enumerated ((32/1)...(32/32))	Default value is the channelisation code used by the SCCPCH carrying the associated PCH.	REL-7
>>>>1.28 Mcps TDD					REL-4
>>>>>Codes list	MP	1..2		The IE shall always be set to 2 to align with [30]	REL-4
>>>>>>Channelisation code	MP		Enumerated ((16/1)...(16/16))		REL-4
>>Repetition period/length	MD		Enumerated((4/2),(8/2), (8/4),(16/2), (16/4), (32/2),(32/4), (64/2),(64/4))	Default value is "(64/2)".	
>>Offset	MP		Integer (0...Repetition period -1)	SFN mod Repetitionperiod = Offset.	
>>Paging indicator length	MD		Integer (4, 8, 16)	Indicates the length of one paging indicator in Bits. Default value is 4.	
>>N _{GAP}	MD		Integer(2, 4, 8)	Number of frames between the last frame carrying PICH for this Paging Occasion and the first frame carrying paging messages for this Paging Occasion. Default value is 4.	
>>N _{PCH}	MD		Integer(1 .. 8)	Number of paging groups. Default value is 2.	

10.3.6.50 PICH Power offset

This is the power transmitted on the PICH minus power of the Primary CPICH in FDD and Primary CCPCH Tx Power in TDD.

Information Element/Group name	Need	Multi	Type and reference	Semantics description
PICH Power offset	MP		Integer(-10 .. +5)	Offset in dB

10.3.6.50a PLCCH Info

NOTE: Only for 1.28 Mcps TDD

Information Element/Group name	Need	Multi	Type and reference	Semantics description
PLCCH sequence number	M		Integer(1..14)	
Timeslot number	M		Integer(0..6)	
Channelisation Code	M		Enumerated((16/1)..(16/16))	
TPC command target rate	M		Real(0.01..0.1 by steps of 0.01)	Transmit Power Control command target rate

10.3.6.51 PRACH Channelisation Code List

NOTE: Only for 3.84 Mcps TDD.

Information Element/Group name	Need	Multi	Type and reference	Semantics description	Version
CHOICE SF	MP				
>SF16					
>>Channelisation Code List	MP	1 to 8			
>>>Channelisation code	MP		Enumerated((16/1)..(16/16))	There is a 1:1 mapping between spreading code and midamble shift defined in [30] for channelisation codes (16/1) to (16/8). NOTE: channelisation codes (16/9) to (16/16) are not to be used.	
>SF8					
>>Channelisation Code List	MP	1 to 8			
>>>Channelisation Code	MP		Enumerated(8/1)..(8/8))		

10.3.6.51a PRACH Channelisation Code 1.28 Mcps TDD

NOTE: Only for 1.28 Mcps TDD.

Information Element/Group name	Need	Multi	Type and reference	Semantics description	Version
Channelisation Code List	MP	1 to 4			REL-4
>Channelisation Code	MP		Enumerated((4/1)..(4/4),(8/1)..(8/8),(16/1)..(16/16))		REL-4

10.3.6.51b PRACH Channelisation Code List VHCR

NOTE: Only for 7.68 Mcps TDD.

Information Element/Group name	Need	Multi	Type and reference	Semantics description	Version
CHOICE <i>SF</i>	MP				REL-7
>SF32					REL-7
>>Channelisation Code List	MP	1 to 16			REL-7
>>>Channelisation code	MP		Enumerated((32/1)..(32/32))	There is a 1:1 mapping between spreading code and midamble shift defined in [30] for channelisation codes (32/1) to (32/16). NOTE: channelisation codes (32/17) to (32/32) are not to be used.	REL-7
>SF16					REL-7
>>Channelisation Code List	MP	1 to 16			REL-7
>>>Channelisation code	MP		Enumerated((16/1)..(16/16))	There is a 1:1 mapping between spreading code and midamble shift defined in [30] for channelisation codes (16/1) to (16/16).	REL-7

10.3.6.52 PRACH info (for RACH)

Information Element/Group name	Need	Multi	Type and reference	Semantics description	Version
CHOICE <i>mode</i>	MP				
>FDD					

>>Available Signature	MP		Bit string(16)	Each bit indicates availability for a signature, where the signatures are numbered "signature 0" up to "signature 15". The value 1 of a bit indicates that the corresponding signature is available and the value 0 that it is not available.	
>>Available SF	MP		Integer (32,64,128,256)	In chips per symbol Defines the minimum allowed SF (i.e. the maximum rate)	
>>Preamble scrambling code number	MP		Integer (0 .. 15)	Identification of scrambling code see [28]	
>>Puncturing Limit	MP		Real(0.40..1.00 by step of 0.04)		
>>>Available Sub Channel Number	MP		Bit string(12)	Each bit indicates availability for a subchannel, where the subchannels are numbered "subchannel 0" to "subchannel 11". The value 1 of a bit indicates that the corresponding subchannel is available and the value 0 indicates that it is not available.	
>TDD					
>>CHOICE <i>TDD option</i>	MP				REL-4
>>>3.84 Mcps TDD					REL-4
>>>>Timeslot number	MP		Timeslot number 10.3.6.84		
>>>>PRACH Channelisation Code List	MP		PRACH Channelisation Code List 10.3.6.51		
>>>>PRACH Midamble	MP		Enumerated (Direct, Direct/Inverted)	Direct or direct and inverted midamble are used for PRACH	
>>>>PNBSCH allocation	OP		PNBSCH allocation 10.3.8.10a	Identifies frames used for cell synchronisation purposes	REL-4
>>>>7.68 Mcps TDD					REL-7
>>>>>Timeslot number	MP		Timeslot number 10.3.6.84		REL-7

>>>>PRACH Channelisation Code List VHCR	MP		PRACH Channelisation Code List VHCR 10.3.6.51b		REL-7
>>>>PRACH Midamble	MP		Enumerated (Direct, Direct/Inverted)	Direct or direct and inverted midamble are used for PRACH	REL-7
>>>>PNBSCH allocation	OP		PNBSCH allocation 10.3.8.10a	Identifies frames used for cell synchronisation purposes	REL-7
>>>1.28 Mcps TDD					REL-4
>>>>SYNC_UL info	MP		SYNC_UL info 10.3.6.78a		REL-4
>>>>PRACH Definition	MP	1..<maxPRACH_FPA CH>			REL-4
>>>>>Timeslot number	MP		Timeslot number 10.3.6.84		REL-4
>>>>>PRACH Channelisation Code	MP		PRACH Channelisation Code 1.28 Mcps TDD 10.3.6.51a		REL-4
>>>>>Midamble Shift and burst type	MP		Midamble shift and burst type 10.3.6.41		REL-4
>>>>>FPACH info	MP		FPACH info 10.3.6.35a		REL-4

10.3.6.53 PRACH partitioning

Information Element/Group name	Need	Multi	Type and reference	Semantics description
Access Service class	MP	1 to maxASC		If only "NumASC+1" (with, NumASC+1 < maxASC) ASCs are listed, the remaining (NumASC+2 through maxASC) ASCs are unspecified.
>ASC Setting	MD		ASC setting 10.3.6.6	The default values are same as the previous ASC. If the "default" is used for the first ASC, the default values are all available signatures and "all available subchannels" for FDD and "all available channelisation codes" and "all available subchannels" with "subchannel size=Size 1" in TDD.

10.3.6.54 PRACH power offset

NOTE: Only for FDD.

Information Element/Group name	Need	Multi	Type and reference	Semantics description
Power Ramp Step	MP		Integer (1..8)	Power step when no acquisition indicator is received in dB
Preamble Retrans Max	MP		Integer (1..64)	Maximum number of preambles in one preamble ramping cycle

10.3.6.54a PRACH preamble control parameters (for Enhanced Uplink)

Information Element/Group name	Need	Multi	Type and reference	Semantics description	Version
--------------------------------	------	-------	--------------------	-----------------------	---------

Available Signature	MD		Bit string(16)	The default value is the inverse of the bitstring indicated in the IE "Available Signature" in the IE "PRACH Info (for RACH)" in the first occurrence in list "PRACH system information list" in SIB5 or SIB5bis. Each bit indicates availability for a signature. Each available signature on the AICH is associated with one Common E-DCH Resource Configuration in the "Common E-DCH resource configuration information list".	REL-8
E-AI Indication	MP		BOOLEAN	TRUE: E-AIs are in use on the AICH. FALSE: E-AIs are not in use on the AICH.	REL-8
Preamble scrambling code number	MD		Integer (0 .. 15)	The default value is the value indicated in the IE "Preamble scrambling code number" in the IE "PRACH Info (for RACH)" in the first occurrence in list "PRACH system information list" in SIB5 or SIB5bis. Identification of scrambling code, see [28]	REL-8
Available Sub Channel Number	MD		Bit string(12)	The default value is the same value indicated in the IE "Available Sub Channel Number" in the IE "PRACH system information list" in the first occurrence in list "PRACH system information list" in SIB5 or SIB5bis. Each bit indicates availability for a subchannel, where the subchannels are numbered "subchannel 0" to "subchannel 11". The value 1 of a bit indicates that the corresponding subchannel is available and the value 0 indicates that it is not available.	REL-8

PRACH partitioning	MD		PRACH partitioning 10.3.6.53	Default value is the value of "PRACH partitioning" in the first occurrence in list "PRACH system information list" in SIB5 or SIB5bis.	REL-8
Persistence scaling factors	OP		Persistence scaling factors 10.3.6.48	This IE shall not be present if only ASC 0 and ASC 1 are defined. If this IE is absent, default value is the value of "Persistence scaling factors" in the first occurrence in list "PRACH system information list" in SIB5 or SIB5bis, if value exists	REL-8
AC-to-ASC mapping	MD		AC-to-ASC mapping 10.3.6.1	Default value is the value of "AC-to-ASC mapping" in the first occurrence in list "PRACH system information list" in SIB5 or SIB5bis.	REL-8
Primary CPICH TX power	MD		Primary CPICH TX power 10.3.6.61	Default value is the value of "Primary CPICH TX power" in the first occurrence in list "PRACH system information list" in SIB5 or SIB5bis.	REL-8
Constant value	MD		Constant value 10.3.6.11	Default value is the value of "Constant value" in the first occurrence in list "PRACH system information list" in SIB5 or SIB5bis	REL-8
PRACH power offset	MD		PRACH power offset 10.3.6.54	Default value is the value of "PRACH power offset" in the first occurrence in list "PRACH system information list" in SIB5 or SIB5bis	REL-8
PRACH transmission parameters	MD		RACH transmission parameters 10.3.6.67	Default value is the value of "RACH transmission parameters" in the first occurrence in list "PRACH system information list" in SIB5 or SIB5bis.	REL-8
AICH info	MD		AICH info 10.3.6.2	Default value is the value of "AICH info" in the first occurrence in list "PRACH system information list" in SIB5 or SIB5bis.	REL-8
Power offset P_{p-e}	MP		Integer(-5..10)	In dB. Power offset between the last transmitted preamble and the initial DPCCH transmission as defined in [26]	REL-8

10.3.6.55 PRACH system information list

Information element	Need	Multi	Type and reference	Semantics description	Version
PRACH system information	MP	1 .. <maxPRACH>			
>PRACH info	MP		PRACH info (for RACH) 10.3.6.52		
>Transport channel identity	MP		Transport channel identity 10.3.5.18		
>RACH TFS	MD		Transport format set 10.3.5.23	Default value is the value of "RACH TFS" for the previous PRACH in the list NOTE: The first occurrence is then MP). NOTE: For TDD in this release there is a single TF within the RACH TFS.	
>Additional RACH TFS for CCCH	OP		Additional Dynamic Transport Format Information for CCCH 10.3.5.2a	FDD only	REL-6
>RACH TFCS	MD		Transport Format Combination Set 10.3.5.20	Default value is the value of "RACH TFCS" for the previous PRACH in the list. NOTE: The first occurrence is then MP). NOTE: For TDD in this release there is no TFCS required.	
>Additional RACH TFCS for CCCH	CV-Add-RACH-TFS		Additional RACH TFCS for CCCH 10.3.5.2b		REL-6
>PRACH partitioning	MD		PRACH partitioning 10.3.6.53	Default value is the value of "PRACH partitioning" for the previous PRACH in the list (note : the first occurrence is then MP)	
>Persistence scaling factors	OP		Persistence scaling factors 10.3.6.48	This IE shall not be present if only ASC 0 and ASC 1 are defined. If this IE is absent, value is the value of "Persistence scaling factors" for the previous PRACH in the list if value exists	
>AC-to-ASC mapping	CV-SIB5-MD		AC-to-ASC mapping 10.3.6.1	Only present in SIB 5 and in SIB 5bis. Default value is the value of "AC-to-ASC mapping" for the previous PRACH in the list. NOTE: The first occurrence is then MP in SIB5 and in SIB5bis.	
>CHOICE <i>mode</i>	MP				
>>FDD					

Information element	Need	Multi	Type and reference	Semantics description	Version
>>>Primary CPICH TX power	MD		Primary CPICH TX power 10.3.6.61	Default value is the value of "Primary CPICH TX power" for the previous PRACH in the list. NOTE: The first occurrence is then MP.	
>>>Constant value	MD		Constant value 10.3.6.11	Default value is the value of "Constant value" for the previous PRACH in the list. NOTE: The first occurrence is then MP.	
>>>PRACH power offset	MD		PRACH power offset 10.3.6.54	Default value is the value of "PRACH power offset" for the previous PRACH in the list. NOTE: The first occurrence is then MP.	
>>>RACH transmission parameters	MD		RACH transmission parameters 10.3.6.67	Default value is the value of "RACH transmission parameters" for the previous PRACH in the list. NOTE: The first occurrence is then MP.	
>>>AICH info	MD		AICH info 10.3.6.2	Default value is the value of "AICH info" for the previous PRACH in the list. NOTE: The first occurrence is then MP.	
>>TDD				(no data)	

Condition	Explanation
<i>SIB5-MD</i>	The information element is present only in SIB 5 and in SIB5bis. In SIB 5 and in SIB 5bis it is mandatory with default.
<i>Add-RACH-TFS</i>	The information element is MP if the IE "Additional RACH TFS for CCCH" is included. Otherwise the information element is not needed.

NOTE: If the setting of the PRACH information results in that a combination of a signature, preamble scrambling code and subchannel corresponds to a RACH with different TFS and/or TFCS, then for that combination only the TFS/TFCS of the PRACH listed first is valid, where PRACHs listed in System Information Block type 5 or 5bis shall be counted first.

10.3.6.56 Predefined PhyCH configuration

This information element concerns a pre- defined configuration of physical channel parameters.

Information Element/Group name	Need	Multi	Type and Reference	Semantics description
Uplink radio resources				
Uplink DPCH info	MP		Uplink DPCH info Pre 10.3.6.90	
Downlink radio resources				
Downlink information common for all radio links	OP		Downlink information common for all radio links Pre 10.3.6.26	

10.3.6.57 Primary CCPCH info

Information Element/Group name	Need	Multi	Type and reference	Semantics description	Version
CHOICE <i>mode</i>	MP				
>FDD					
>>TX Diversity indicator	MP		Boolean	TRUE indicates that transmit diversity is used.	
>TDD					
>>CHOICE <i>TDD option</i>	MP				REL-4
>>>3.84 and 7.68 Mcps TDD					REL-4
>>>>CHOICE <i>SyncCase</i>	OP				
>>>>>Sync Case 1					
>>>>>>Timeslot	MP		Integer (0...14)	PCCPCH timeslot	
>>>>>>Sync Case 2					
>>>>>>>Timeslot	MP		Integer(0..6)		
>>>1.28 Mcps TDD					REL-4
>>>>TSTD indicator	MP		TSTD indicator 10.3.6.85a		REL-4
>>Cell parameters ID	OP		Cell parameters Id 10.3.6.9	The Cell parameters ID is described in [32].	
>>SCTD indicator	MP		SCTD indicator 10.3.6.70a		

10.3.6.58 Primary CCPCH info post

NOTE: Only for TDD

Information Element/Group name	Need	Multi	Type and reference	Semantics description	Version
CHOICE <i>TDD option</i>	MP				REL-4
>3.84 Mcps TDD					REL-4
>>CHOICE <i>SyncCase</i>	MP				
>>>Sync Case 1					
>>>>Timeslot	MP		Integer (0...14)	PCCPCH timeslot	
>>>>Sync Case 2					
>>>>>Timeslot	MP		Integer(0..6)		
>7.68 Mcps TDD					REL-7
>>CHOICE <i>SyncCase</i>	MP				REL-7
>>>Sync Case 1					REL-7
>>>>Timeslot	MP		Integer (0...14)	PCCPCH timeslot	REL-7
>>>>Sync Case 2					REL-7
>>>>>Timeslot	MP		Integer(0..6)		REL-7
>1.28 Mcps TDD					REL-4
>>TSTD indicator	MP		TSTD indicator 10.3.6.85a		REL-4
Cell parameters ID	MP		Cell parameters Id 10.3.6.9	The Cell parameters ID is described in [32].	
SCTD indicator	MP		SCTD indicator 10.3.6.70a		

10.3.6.59 Primary CCPCH TX Power

NOTE: Only for TDD.

Information Element/group name	Need	Multi	Type and reference	Semantics description
Primary CCPCH Tx Power	MP		Integer(6..43)	In dBm

10.3.6.60 Primary CPICH info

NOTE: Only for FDD.

Information Element/Group name	Need	Multi	Type and reference	Semantics description
Primary scrambling code	MP		Integer(0..511)	

10.3.6.61 Primary CPICH Tx power

NOTE: Only for FDD.

Information Element/Group name	Need	Multi	Type and reference	Semantics description
Primary CPICH Tx Power	MP		Integer(-10..50)	Power in dBm.

10.3.6.62 Primary CPICH usage for channel estimation

NOTE: Only for FDD.

Information Element/Group name	Need	Multi	Type and Reference	Semantics description
Primary CPICH usage for channel estimation	MP		Enumerated(Primary CPICH may be used, Primary CPICH shall not be used)	

10.3.6.63 PUSCH info

NOTE: Only for 1.28 Mcps and 3.84 Mcps TDD.

Information Element/Group name	Need	Multi	Type and reference	Semantics description
TFCS ID	MD		Integer(1..8)	Default value is 1
Common timeslot info	OP		Common timeslot info 10.3.6.10	
PUSCH timeslots and codes	OP		Uplink Timeslots and Codes 10.3.6.94	

10.3.6.63a PUSCH info VHCR

NOTE: Only 7.68 Mcps TDD (REL-7).

Information Element/Group name	Need	Multi	Type and reference	Semantics description	Version
TFCS ID	MD		Integer(1..8)	Default value is 1	REL-7
Common timeslot info	OP		Common timeslot info 10.3.6.10		REL-7
PUSCH timeslots and codes VHCR	OP		Uplink Timeslots and Codes VHCR 10.3.6.94b		REL-7

10.3.6.64 PUSCH Capacity Allocation info

NOTE: Only for TDD.

Information Element/Group name	Need	Multi	Type and reference	Semantics description	Version
CHOICE <i>PUSCH allocation</i>	MP				
>PUSCH allocation pending				(no data)	
>PUSCH allocation assignment					
>>PUSCH allocation period info	MP		Allocation Period Info 10.3.6.4		
>>PUSCH power control info	OP		PUSCH power control info 10.3.6.65		
>>CHOICE <i>Configuration</i>	MP				
>>>Old configuration					
>>>>TFCS ID	MD		Integer(1..8)	Default is 1.	
>>>>PUSCH Identity	MP		Integer(1..hiPUSCHidentities)		
>>>>New 1.28 Mcps TDD or 3.84 Mcps TDD configuration					
>>>>PUSCH info	MP		PUSCH info 10.3.6.63		
>>>>PUSCH Identity	OP		Integer(1..hiPUSCHidentities)		
>>>>New 7.68 Mcps TDD configuration					REL-7
>>>>PUSCH info VHCR	MP		PUSCH info VHCR 10.3.6.63a		REL-7
>>>>PUSCH Identity	OP		Integer(1..hiPUSCHidentities)		REL-7

10.3.6.65 PUSCH power control info

NOTE: Only for TDD.

Interference level measured for a frequency at the UTRAN access point used by UE to set PUSCH output power.

Information Element/Group name	Need	Multi	Type and reference	Semantics description	Version
UL target SIR	MP		Real (-11 .. 20 by step of 0.5 dB)	For 1.28 Mcps TDD this parameter represents PRXPUSCHdes with range Integer(-120...-58 by step of 1) dBm	REL-4
CHOICE TDD option	MP				REL-4
>3.84 Mcps TDD				(no data)	REL-4
>7.68 Mcps TDD				(no data)	REL-7
>1.28 Mcps TDD					REL-4
>>TPC Step Size	OP		Integer (1, 2, 3)	In dB	REL-4
>>Beacon PL Est.	OP		Enumerated (TRUE)	The presence of this IE indicates that the UE may take into account path loss estimated from beacon function physical channels. The absence indicates that UE may not take into account path loss estimated from beacon function physical channels	REL-6

10.3.6.66 PUSCH system information

NOTE: Only for 1.28 Mcps or 3.84 Mcps TDD.

Information Element/Group name	Need	Multi	Type and reference	Semantics description	Version
PUSCH information	MP	1 to <maxPUSCH>			
>PUSCH Identity	MP		Integer(1.. hiPUSCHidentities)		
>PUSCH info	MP		PUSCH info 10.3.6.63		
>SFN Time Info	CH-Block17		SFN Time Info 10.3.6.75		
>USCH TFS	OP		Transport format set 10.3.5.23		

Information Element/Group name	Need	Multi	Type and reference	Semantics description	Version
>USCH Transport Channels	OP	1 to <maxTrCH>		If PUSCH is configured for 3.84 Mcps TDD in Rel-5 this IE may be included.	REL-5
>> USCH Transport channel identity	MP		Transport channel identity 10.3.5.18		REL-5
>>USCH TFS	MP		Transport format set 10.3.5.23		REL-5
>USCH TFCS	OP		Transport Format Combination Set 10.3.5.20		

Condition	Explanation
<i>Block17</i>	This IE is not needed in System Information Block 17. Otherwise it is optional.

10.3.6.66a PUSCH system information VHCR

NOTE: Only for 7.68 Mcps TDD (REL-7).

Information Element/Group name	Need	Multi	Type and reference	Semantics description	Version
PUSCH information	MP	1 to <maxPUSCH>			REL-7
>PUSCH Identity	MP		Integer(1..hiPUSCHidentities)		REL-7
>PUSCH info VHCR	MP		PUSCH info VHCR 10.3.6.63a		REL-7
>SFN Time Info	CH- <i>Block17</i>		SFN Time Info 10.3.6.75		REL-7
>USCH TFS	OP		Transport format set 10.3.5.23		REL-7

Information Element/Group name	Need	Multi	Type and reference	Semantics description	Version
>USCH Transport Channels	OP	1 to <maxTr CH>		If PUSCH is configured for 7.68 Mcps TDD in Rel-7 this IE may be included.	REL-7
>> USCH Transport channel identity	MP		Transport channel identity 10.3.5.18		REL-7
>>USCH TFS	MP		Transport format set 10.3.5.23		REL-7
>USCH TFCS	OP		Transport Format Combination Set 10.3.5.20		REL-7

Condition	Explanation
<i>Block17</i>	This IE is not needed in System Information Block 17. Otherwise it is optional.

10.3.6.67 RACH transmission parameters

NOTE: Only for FDD.

Information Element/Group name	Need	Multi	Type and reference	Semantics description
Mmax	MP		Integer(1..32)	Maximum number of preamble cycles
NB01min	MP		Integer(0..50)	Sets lower bound for random back-off
NB01max	MP		Integer(0..50)	Sets upper bound for random back-off

10.3.6.68 Radio link addition information

Information Element/Group name	Need	Multi	Type and reference	Semantics description	Version
Primary CPICH info	MP		Primary CPICH info 10.3.6.60		
Cell ID	OP		Cell ID 10.3.2.2		REL-4
CHOICE <i>DPCH info</i>	MP				REL-6
>Downlink DPCH info for each RL			Downlink DPCH info for each RL 10.3.6.21		
>Downlink F-DPCH info for each RL			Downlink F-F-DPCH info for each RL 10.3.6.23ob		REL-6
>Radio Links without DPCH/F-DPCH info			Radio Links without DPCH/F-DPCH info 10.3.6.147		REL-12
E-HICH Information	OP		E-HICH Info 10.3.6.101		REL-6

Information Element/Group name	Need	Multi	Type and reference	Semantics description	Version
E-RGCH Information	OP		E-RGCH Info 10.3.6.102		REL-6
F-TPICH info	OP		F-TPICH Info 10.3.6.127		REL-11
Target cell preconfiguration information	OP		Target cell preconfiguration information 10.3.6.79a		REL-8

10.3.6.69 Radio link removal information

Information Element/Group name	Need	Multi	Type and reference	Semantics description
Primary CPICH info	MP		Primary CPICH info 10.3.6.60	

10.3.6.69a E-DCH reconfiguration information

NOTE: Only for FDD.

Information Element/Group name	Need	Multi	Type and reference	Semantics description	Version
E-DCH RL Info new serving cell	OP				REL-6
>Primary CPICH info	MP		Primary CPICH info 10.3.6.60	Indicates scheduling E-DCH cell from the active set cells.	REL-6
>E-AGCH Info	MP		E-AGCH Info 10.3.6.100		REL-6
>E-ROCH Info	OP		E-ROCH Info FDD 10.3.6.146		REL-11

Information Element/Group name	Need	Multi	Type and reference	Semantics description	Version
>Serving Grant	OP				REL-6
>>Serving Grant value	OP		Integer (0..37,38)	(0..37) indicates E-DCH serving grant index as defined in [15]; index 38 means zero grant.	REL-6
>>Primary/Secondary Grant Selector	MP		Enumerated (primary, secondary)	Indicates whether the Serving Grant is received with a Primary E-RNTI or Secondary E-RNTI.	REL-6
>E-DPCCH/DPCCH power offset	OP		Integer (0..8)	Refer to quantization of the power offset in [28].	REL-6
>Reference E-TFCIs	OP	1 to 8		See [29].	REL-6
>>Reference E-TFCI	MP		Integer (0..127)		REL-6
>>Reference E-TFCI PO	MP		Integer (0..29, 30, 31)	Refer to quantization of the power offset in [28]. Values 30 and 31 are only used for E-TFCI > ETFCI Boost	REL-6 REL-7
>Power Offset for Scheduling Info	OP		Integer (0..6)	Only used when no MACd PDU's are included in the same MAC-e or MAC-i PDU. Unit is in dB.	REL-6
>3-Index-Step Threshold	OP		Integer (0..37)	Refers to an index in the "SG-Table" (see [15]). NOTE 1	REL-6
>2-Index-Step Threshold	OP		Integer (0..37)	Refers to an index in the "SG-Table" (see [15]). NOTE 1	REL-6
>E-HICH Information	OP		E-HICH Info 10.3.6.101	This IE is not present if the serving E-DCH cell is added to the active set with this message.	REL-6
>CHOICE E-RGCH Information	OP			This IE is not present if the serving E-DCH cell is added to the active set with this message	REL-6
>>E-RGCH Information	MP		E-RGCH Info 10.3.6.102		REL-6
>>E-RGCH release indicator				(no data)	REL-6

Information Element/Group name	Need	Multi	Type and reference	Semantics description	Version
E-DCH RL Info other cells	OP	1 to <maxEDC HRL>		This IE is not allowed to include information on a RL added by this message, except in the case of an update to target cell preconfiguration information.	REL-6
>Primary CPICH info	MP		Primary CPICH info 10.3.6.60		REL-6
>CHOICE E-HICH Information	OP				REL-6
>>E-HICH Information	MP		E-HICH Info 10.3.6.101		REL-6
>>E-HICH release indicator				(no data)	REL-6
>>Secondary TB E-HICH release indicator				(no data)	REL-11
>CHOICE E-RGCH Information	OP				REL-6
>>E-RGCH Information	MP		E-RGCH Info 10.3.6.102		REL-6
>>E-RGCH release indicator				(no data)	REL-6
NOTE 1: If the 3-index-Step Threshold value is greater than 2-index-Step Threshold, the UE behaviour is unspecified.					

10.3.6.69b E-DCH reconfiguration information same serving cell

NOTE: Only for FDD.

Information Element/Group name	Need	Multi	Type and reference	Semantics description	Version
E-DPCCH/DPCCH power offset	OP		Integer (0..8)	This IE is not present if the serving E-DCH cell is changed with this message. Refer to quantization of the power offset in [28].	REL-7
Reference E-TFCIs	OP	1 to 8		This IE is not present if the serving E-DCH cell is changed with this message. See [29].	REL-7
>Reference E-TFCI	MP		Integer (0..127)		REL-7
>Reference E-TFCI PO	MP		Integer (0..29,	Refer to quantization of the power offset in [28].	REL-7
			30, 31)	Values 30 and 31 are only used for E-TFCI > ETFCI Boost	REL-7

10.3.6.70 Void

10.3.6.70a SCTD indicator

NOTE: Only for TDD

Information Element/Group name	Need	Multi	Type and reference	Semantics description
SCTD indicator	MP		Boolean	TRUE indicates that SCTD is used

10.3.6.71 Secondary CCPCH info

Information Element/Group name	Need	Multi	Type and reference	Semantics description	Version
CHOICE <i>mode</i>	MP				
>FDD					
>>Secondary scrambling code	OP		Secondary scrambling code 10.3.6.74	May only be sent for SCCPCH channels not carrying the PCH.	
>>STTD indicator	MP		STTD Indicator 10.3.6.78		
>>Spreading factor	MP		Integer(4, 8, 16, 32, 64, 128, 256)		
>>Code number	MP		Integer(0..Spreading factor - 1)		
>>Pilot symbol existence	MP		Boolean	TRUE means the existence.	
>>TFCI existence	MP		Boolean	TRUE indicates that TFCI is used. When spreading factor is less than or equal to 64, FALSE indicates that TFCI is not used and therefore DTX is used in the TFCI field.	
>>Fixed or Flexible Position	MP		Enumerated (Fixed, Flexible)		
>>Timing Offset	MD		Integer(0..38144 by step of 256)	Chip Delay of the Secondary CCPCH relative to the Primary CCPCH. Default value is 0.	
>1.28 Mcps TDD or 3.84 Mcps TDD					
>>Offset	MP		Integer (0...Repetition Period -1)	SFN modulo Repetition period = offset. Repetition period is the one indicated in the accompanying Common timeslot info IE	
>>Common timeslot info	MP		Common timeslot info 10.3.6.10		

Information Element/Group name	Need	Multi	Type and reference	Semantics description	Version
>>Individual timeslot info	MP		Individual timeslot info 10.3.6.37		
>>>Code List	MP	1 to 16			
>>>>Channelisation Code	MP		Enumerated((16/1)..(16/16))		
>7.68 Mcps TDD					REL-7
>>Offset	MP		Integer (0...Repetition Period -1)	SFN modulo Repetition period = offset. Repetition period is the one indicated in the accompanying Common timeslot info IE	REL-7
>>>Common timeslot info	MP		Common timeslot info 10.3.6.10		REL-7
>>>>Individual timeslot info	MP		Individual timeslot info 10.3.6.37		REL-7
>>>>>Code List	MP	1 to 32			REL-7
>>>>>>Channelisation Code	MP		Enumerated((32/1)..(32/32))		REL-7

10.3.6.71a Secondary CCPCH info MBMS

Information Element/Group name	Need	Multi	Type and reference	Semantics description	Version
CHOICE <i>mode</i>	MP				REL-6
>FDD					REL-6
>>Secondary scrambling code	OP		Secondary scrambling code 10.3.6.74	May only be sent for SCCPCH channels not carrying the PCH.	REL-6
>>STTD indicator	MP		STTD Indicator 10.3.6.78	If the cell is operating in MBSFN mode as indicated in subclause 8.1.1.6.3, the UE behaviour upon reception of this IE is unspecified.	REL-6
>>Spreading factor	MP		Integer(4, 8, 16, 32, 64, 128, 256)		REL-6
>>Code number	MP		Integer(0..Spreading factor – 1)		REL-6
>>Timing Offset	MD		Integer(0..38144 by step of 256)	Chip Delay of the Secondary CCPCH relative to the Primary CCPCH. Default value is 0.	REL-6
>>CHOICE Modulation	CV-MBSFN				REL-7
>>>QPSK	MP			(no data)	REL-7
>>>16QAM	MP				REL-7
>>>>CPICH secondary CCPCH power offset	MP		Integer(-11..4)		REL-7
>1.28/3.84 Mcps TDD					REL-6
>> Common timeslot info MBMS	MP		Common timeslot info MBMS 10.3.6.10a	Interleaving mode, TFCI coding and puncturing limit for Secondary CCPCH info MBMS	REL-6
>>Downlink Timeslots and Codes	MP		Downlink timeslots and codes 10.3.6.32	One or more timeslots and codes for S-CCPCH supporting MBMS MTCH	REL-6
>> MBSFN Special Time Slot	OP		Time Slot LCR Extension 10.3.6.83a	For 1.28 Mcps TDD MBSFN only mode, this IE indicates the SCCPCH is deployed on the MBSFN Special Time Slot [30]. The IE 'Timeslot number' in 'Downlink Timeslots and Codes' shall be ignored if this IE appears.	REL-7
>>Modulation	MP		Enumerated (QPSK, 16QAM)		REL-7
>7.68 Mcps TDD					REL-7
>>Common timeslot info MBMS	MP		Common timeslot info MBMS 10.3.6.10a	Interleaving mode, TFCI coding and puncturing limit for Secondary CCPCH info MBMS	REL-7

Information Element/Group name	Need	Multi	Type and reference	Semantics description	Version
>>Downlink Timeslots and Codes VHCR	MP		Downlink timeslots and codes VHCR 10.3.6.32a	One or more timeslots and codes for S-CCPCH supporting MBMS MTCH	REL-7
>>Modulation	MP		Enumerated (QPSK, 16QAM)		REL-7
>3.84 Mcps TDD MBSFN IMB					REL-8
>>Secondary scrambling code	OP		Secondary scrambling code 10.3.6.74	Not applicable: if present, the UE behaviour is unspecified	REL-8
>>STTD indicator	MP		STTD Indicator 10.3.6.78	Not applicable: the UE behaviour is unspecified	REL-8
>>Spreading factor	MP		Integer (4, 8, 16, 32, 64, 128, 256)	SF = 256; other values not applicable	REL-8
>>Code number	MP		Integer (0..Spreading factor – 1)	Only code numbers 2 to 15 are applicable	REL-8
>>Timing Offset	MD		Integer (0..38144 by step of 256)	Not applicable: if present, the UE behaviour is unspecified	REL-8
>>CHOICE Modulation	CV-MBSFN				REL-8
>>>QPSK	MP			(no data)	REL-8
>>>16QAM	MP			Not applicable: the UE behaviour is unspecified	REL-8
>>>>CPICH secondary CCPCH power offset	MP		Integer (-11..4)		REL-8

Condition	Explanation
<i>MBSFN</i>	This IE is mandatory present when the cell on which this IE is sent is operating in MBSFN mode according to subclause 8.1.1.6.3. Otherwise the IE is not needed.

NOTE: For FDD, the S-CCPCH signalled in this IE is always configured with flexible position, TFCI is always present and pilot is always absent.

10.3.6.71b Secondary CCPCH info MBMS Diff

Information Element/Group name	Need	Multi	Type and reference	Semantics description	Version
Secondary scrambling code	OP		Secondary scrambling code 10.3.6.74	May only be sent for SCCPCH channels not carrying the PCH.	REL-7
STTD indicator	MP		STTD Indicator 10.3.6.78		REL-7
Spreading factor	OP		Integer(4, 8, 16, 32, 64, 128, 256)		REL-7
Code number	OP		Integer(0..Sp reading factor – 1)		REL-7
Timing Offset	OP		Integer(0..38144 by step of 256)	Chip Delay of the Secondary CCPCH relative to the Primary CCPCH.	REL-7

NOTE: For FDD, the S-CCPCH signalled in this IE is always configured with flexible position, TFCI is always present and pilot is always absent.

10.3.6.72 Secondary CCPCH system information

Information element	Need	Multi	Type and reference	Semantics description	Version
Secondary CCPCH system information list	MP	1 to <maxSCC PCH>			
>Secondary CCPCH info	MP		Secondary CCPCH info 10.3.6.71	Note 1	
>TFCS	MD		Transport format combination set 10.3.5.20	For FACHs and PCH Default value is the value of "TFCS" for the previous SCCPCH in the list. NOTE: The first occurrence is then MP.	
>FACH/PCH information list	MD	1 to <maxFAC HPCH>		Default value is the value of "FACH/PCH" for the previous SCCPCH in the list. NOTE: The first occurrence is then MP.	
>>TFS	MP		Transport format set 10.3.5.23	For each FACH and PCH Note 2	
>>Transport channel identity	MP		Transport channel identity 10.3.5.18		
>>CTCH indicator	MP		Boolean	The value TRUE indicates that a CTCH is mapped on the FACH, and FALSE that no CTCH is mapped.	
>PICH info	OP		PICH info 10.3.6.49	PICH info is present only when PCH is multiplexed on Secondary CCPCH	
MCCH configuration information	CV-SIB type 5		MCCH configuration information 10.3.9a.13	Included if MCCH is on an S-CCPCH used also for Non-MBMS Note 3	REL-6

NOTE 1: The secondary CCPCHs carrying a PCH shall be listed first.

NOTE 2: TFS for PCH shall be the first "FACH/PCH information" in the list if a PCH exists for the respective secondary CCPCH.

NOTE 3: If the IE "MCCH configuration information is included", it applies to the last S-CCPCH in the IE "Secondary CCPCH system information list" and to the last FACH included in the IE "FACH/PCH information list".

Condition	Explanation
SIB type 5	The IE is optional if the IE "Secondary CCPCH system information" is included in the SIB type 5 or 5bis, otherwise the IE is not needed in the message

10.3.6.72a Secondary CCPCH system information MBMS

Information element	Need	Multi	Type and reference	Semantics description	Version
Secondary CCPCH system information	MP			An S-CCPCH carrying MCCH and possibly also MTCH and MSCH	REL-6
>Secondary CCPCH info MBMS	MP		Secondary CCPCH info MBMS 10.3.6.71a		REL-6
>TFCS	MP		Transport format combination set 10.3.5.20		REL-6
>FACH carrying MCCH	MP				REL-6
>>TFS	MP		Transport format set 10.3.5.23		REL-6
>>MCCH configuration information	MP		MCCH configuration information 10.3.9a.13		REL-6
>FACH carrying MTCH list	OP	1 to <maxFAC HPCH>			REL-6
>>TFS	MP		Transport format set 10.3.5.23		REL-6
>Scheduling information	OP				REL-6
>>FACH carrying MSCH	MP		Transport format set 10.3.5.23	Transport channel carrying MSCH	REL-6

10.3.6.72b Secondary cell MIMO parameters

Information Element/Group name	Need	Multi	Type and reference	Semantics description	Version
CHOICE <i>Configuration info</i>	MP				REL-9
>Continue			(no data)	(no data)Used in reconfigurations without interruption of dual cell operation with MIMO.	REL-9
>New configuration					REL-9
>> MIMO N_cqi_typeA/M_cqi ratio	OP		Enumerated(1/2, 2/3, 3/4, 4/5, 5/6, 6/7, 7/8, 8/9, 9/10, 1/1)		REL-9
>>MIMO pilot configuration	OP		MIMO pilot configuration 10.3.6.41b		REL-9
>>Precoding weight set restriction	OP		Enumerated (TRUE)	If present, the UE applies precoding weight set restriction to this secondary cell.	REL-9

10.3.6.73 Secondary CPICH info

NOTE: Only for FDD.

Information Element/Group name	Need	Multi	Type and reference	Semantics description
Secondary scrambling code	MD		Secondary scrambling code 10.3.6.74	Default is the same scrambling code as for the Primary CPICH
Channelisation code	MP		Integer(0..255)	SF=256

10.3.6.74 Secondary scrambling code

Information Element/Group name	Need	Multi	Type and reference	Semantics description
Secondary scrambling code	MP		Integer(1..15)	

10.3.6.74a Serving HS-DSCH cell information

Information Element/Group name	Need	Multi	Type and reference	Semantics description	Version
Δ_{ACK}	OP		Integer(0..8	Refer to quantization of the power offset in [28]	REL-6
			9..10)		REL-11
Δ_{NACK}	OP		Integer(0..8	Refer to quantization of the power offset in [28]	REL-6
			9..10)		REL-11
HARQ_preamble_mode	MP		Integer(0, 1)	1 indicates that preamble and postamble are used on the HS-DPCCH – see [29]	REL-6
Primary CPICH info	OP		Primary CPICH info 10.3.6.60	Indicate the new HS-DSCH serving cell	REL-6
Downlink HS-PDSCH Information	OP		Downlink HS_PDSCH Information 10.3.6.23a		REL-6
HARQ Info	OP		HARQ info 10.3.5.7a		REL-6
MAC-hs reset indicator	OP		Enumerated (TRUE)	TRUE Indicates the MAC-hs/ehs entity needs to be reset.	REL-6
MAC-hs reset indicator for Multiflow assisting cells	OP		Enumerated (TRUE)	TRUE indicates that the MAC-hs/ehs entity related to the assisting cells needs to be reset.	REL-11

10.3.6.74b Serving Cell Change Parameters

The IE "Serving Cell Change Parameters" is used prepare the UE for enhanced serving cell change.

Information Element/Group name	Need	Multi	Type and reference	Semantics description	Version
Serving Cell Change MAC reset	MP		Boolean	TRUE means the MAC-hs/ehs entity needs to be reset, FALSE means TPC combination Index is used to determine if MAC-hs/ehs reset is needed, 8.2.2.3	REL-8
Serving Cell Change Message Type	MP		Enumerated (RadioBearerSetup, RadioBearerReconfiguration, TransportChannelReconfiguration, PhysicalChannelReconfiguration)	The reconfiguration procedure configuration used for Target cell preconfiguration, 8.2.2.4	REL-8
Serving Cell Change Transaction Id	MP		Integer (0..3)	Transaction Id that shall be used as the RRC Transaction Identifier with the corresponding response message configured by the IE "Serving Cell Change Message Type"	REL-8
Enhanced Serving Cell Change for Event 1c Support Indicator	OP		Enumerated (TRUE)	TRUE means that Enhanced Serving Cell Change for Event 1c is enabled	REL-12

10.3.6.75 SFN Time info

Information Element/Group name	Need	Multi	Type and reference	Semantics description
Activation time SFN	MP		Integer (0..4095)	System frame number start of the physical channel existence.
Duration	MP		Integer(1..4096)	Total number of frames the physical channel will exist.

10.3.6.75a Special Burst Scheduling

NOTE: Only for TDD.

Information Element/Group name	Need	Multi	Type and reference	Semantics description
Special Burst Generation Period	MP		Integer (0..7)	Value represents number of radio frames 0 = 2 frames, 1 = 4 frames, 2 = 8 frames, 3 = 16 frames, 4 = 32 frames, 5 = 64 frames, 6 = 128 frames, 7 =256 frames

10.3.6.76 Void

10.3.6.77 Void

10.3.6.78 STTD indicator

NOTE: Only for FDD

Indicates whether STTD is used or not.

Information Element/Group name	Need	Multi	Type and reference	Semantics description
STTD Indicator	MP		Boolean	TRUE means that STTD is used

10.3.6.78o SYNC_UL codes bitmap

NOTE: Only for 1.28 Mcps TDD.

Information Element/ Group name	Need	Multi	Type and reference	Semantics description	Version
SYNC_UL codes bitmap	MP		Bitstring(8)	Each bit indicates availability of a SYNC_UL code, where the SYNC_UL codes are numbered "code 0" to "code 7". The value 1 of a bit indicates that the corresponding SYNC_UL code can be used. The value 0 of a bit indicates that the corresponding SYNC_UL code can not be used.	REL-7

10.3.6.78a SYNC_UL info

NOTE: Only for 1.28 Mcps TDD.

Information Element/ Group name	Need	Multi	Type and reference	Semantics description	Version
SYNC_UL codes bitmap	MP		SYNC_UL codes bitmap 10.3.6.78o		REL-4
PRX _{UpPCHdes}	MP		Integer(-120...-58 by step of 1)	In dBm	REL-4
Power Ramp Step	MP		Integer(0,1,2,3)	In dB	REL-4
Max SYNC_UL Transmissions	MP		Integer(1,2,4,8)	Maximum numbers of SYNC_UL transmissions in a power ramping sequence.	REL-4

Information Element/ Group name	Need	Multi	Type and reference	Semantics description	Version
Mmax	MP		Integer(1..32)	Maximum number of synchronisation attempts.	REL-4
E-RUCCH SYNC_UL codes bitmap	MP		SYNC_UL codes bitmap 10.3.6.78o		REL-7

10.3.6.78b TDD MBSFN Information

NOTE: Only for TDD

This information indicates which timeslots are assigned to TDD MBSFN and the scrambling codes assigned to each timeslot.

Information Element/Group name	Need	Multi	Type and reference	Semantics description	Version
Time slot list	MP	1.. <maxTS>			REL-7
>Timeslot Number	MP		Timeslot Number 10.3.6.84		REL-7
>Cell parameters ID	MP		Cell parameters Id 10.3.6.9		REL-7

10.3.6.78c LCR TDD MBSFN Information

NOTE: Only for 1.28Mcps TDD

This information indicates which timeslots of the secondary frequency of a multi-frequency cell are assigned to 1.28Mcps TDD MBSFN and the scrambling codes related to each timeslot.

Information Element/Group name	Need	Multi	Type and reference	Semantics description	Version
Time slot info list	MP	1 to <maxMBSFNclusters >			REL-7
>Frequency index	MP		Integer (1..<maxMBSFNclusters>)	For 1.28 Mcps TDD index pointing to a frequency indicated in the SIB 11.	REL-7
>Time slot list	MP	1 to <maxTS>			REL-7
>>Timeslot Number	MP		Timeslot Number 10.3.6.84		REL-7
>>Cell parameters ID	MP		Cell parameters Id 10.3.6.9		REL-7

10.3.6.78d SYNC_UL info for E-RUCCH

NOTE: Only for 1.28 Mcps TDD.

Information Element/Group name	Need	Multi	Type and reference	Semantics description	Version
PRXUpPCHdes	CV- <i>Synchronisation parameters</i>		Integer(-120...-58 by step of 1)	In dBm	REL-7
Power Ramp Step	CV- <i>Synchronisation parameters</i>		Integer(0,1,2,3)	In dB	REL-7
Max SYNC_UL Transmissions	CV- <i>Synchronisation parameters</i>		Integer(1,2,4,8)	Maximum numbers of SYNC_UL transmissions in a power ramping sequence.	REL-7
Mmax	MP		Integer(1..32)	Maximum number of synchronisation attempts.	REL-7
E-RUCCH SYNC_UL codes bitmap	MP		SYNC_UL codes bitmap 10.3.6.78o		REL-7

Condition	Explanation
<i>Synchronisation parameters</i>	This IE is mandatory present if the IE "Synchronisation parameters" does not exist, Otherwise it is not needed.

10.3.6.79 TDD open loop power control

This information element contains parameters for open loop power control setting for TDD.

Information Element/Group name	Need	Multi	Type and reference	Semantics description	Version
Primary CCPCH Tx Power	MP		Primary CCPCH Tx Power 10.3.6.59	For path loss calculation	
CHOICE <i>TDD option</i>	MP				REL-4
>3.84 Mcps TDD					REL-4
>>Alpha	OP		Alpha 10.3.6.5		
>>PRACH Constant Value	MP		Constant Value TDD 10.3.6.11a	Operator controlled PRACH Margin	
>>DPCH Constant Value	MP		Constant Value TDD 10.3.6.11a	Operator controlled UL DPCH Margin	
>>PUSCH Constant Value	OP		Constant Value TDD 10.3.6.11a	Operator controlled PUSCH Margin	
>>UE positioning related parameters	CV- <i>IPDLs</i>				REL-4
>>>IPDL-Alpha	MP		Alpha 10.3.6.5		REL-4
>>>Max power increase	MP		Integer (0..3)	In db	REL-4
>7.68 Mcps TDD					REL-7
>>Alpha	OP		Alpha 10.3.6.5		REL-7
>>PRACH Constant Value	MP		Constant Value TDD 10.3.6.11a	Operator controlled PRACH Margin	REL-7

Information Element/Group name	Need	Multi	Type and reference	Semantics description	Version
>>DPCH Constant Value	MP		Constant Value TDD 10.3.6.11a	Operator controlled UL DPCH Margin	REL-7
>>PUSCH Constant Value	OP		Constant Value TDD 10.3.6.11a	Operator controlled PUSCH Margin	REL-7
>>UE positioning related parameters	<i>CV-IPDLs</i>				REL-7
>>>IPDL-Alpha	MP		Alpha 10.3.6.5		
>>>Max power increase	MP		Integer (0..3)	In db	REL-7
>1.28 Mcps TDD				(no data)	REL-4

Condition	Explanation
<i>IPDLs</i>	This IE is present only if idle periods are applied

10.3.6.79a Target cell preconfiguration information

Information Element/Group name	Need	Multi	Type and reference	Semantics description	Version
Activation time offset	OP		Interger (0..255)	If present, the "Activation time offset" IE is used by UE to calculate Activation time for inclusion in measurement report for event 1d or 1c.	REL-8
New H-RNTI	MP		H-RNTI 10.3.3.14a		REL-8
New Primary E-RNTI	OP		E-RNTI 10.3.3.10a		REL-8
New Secondary E-RNTI	OP		E-RNTI 10.3.3.10a		REL-8
Serving HS-DSCH cell information	MP		Serving HS-DSCH cell information 10.3.6.74a		REL-8
E-DCH reconfiguration information	MP		E-DCH reconfiguration information 10.3.6.69a		REL-8
DTX-DRX timing information	OP		DTX-DRX timing information 10.3.6.34b		REL-8
DTX-DRX Information	OP		DTX-DRX Information 10.3.6.34a		REL-8
HS-SCCH less Information	OP		HS-SCCH less Information 10.3.6.36ab		REL-8
MIMO parameters	OP		MIMO parameters 10.3.6.41a		REL-8
MIMO mode with four transmit antennas parameters	OP		MIMO mode with four transmit antennas parameters 10.3.6.142		REL-11
Downlink secondary cell info FDD	OP		Downlink secondary cell info FDD 10.3.6.31a		REL-8
Additional downlink secondary cell info list FDD	OP	2			REL-10
>Downlink secondary cell info FDD	OP		Downlink secondary cell info FDD 10.3.6.31a	FDD only	REL-10

Information Element/Group name	Need	Multi	Type and reference	Semantics description	Version
Additional downlink secondary cell info list FDD 2	OP	4			REL-11
>Downlink secondary cell info FDD	OP		Downlink secondary cell info FDD 10.3.6.31a	FDD only	REL-11
Uplink secondary cell info FDD	OP		Uplink secondary cell info FDD 10.3.6.115	FDD only	REL-9
E-DCH reconfiguration information on secondary UL frequency	OP		E-DCH reconfiguration information on secondary UL frequency 10.3.6.121	FDD only	REL-9
Uplink CLTD info FDD	OP		Uplink CLTD info FDD 10.3.6.125	FDD only	REL-11
F-TPICH reconfiguration info	OP		F-TPICH reconfiguration info 10.3.6.128		REL-11
Uplink OLT D info FDD	OP		Uplink OLT D info FDD 10.3.6.126	FDD only	REL-11
UL 16QAM configuration	OP		UL 16QAM configuration 10.3.6.86o		REL-11
UL 64QAM configuration	OP		UL 64QAM configuration 10.3.6.86b		REL-11
Uplink MIMO info FDD	OP		Uplink MIMO info FDD 10.3.6.145	FDD only	REL-11
DPCCH2 info FDD	OP		DPCCH2 info FDD 10.3.6.148	FDD only	REL-12

10.3.6.80 TFC Control duration

Information Element/Group name	Need	Multi	Type and reference	Semantics description
TFC Control duration	MP		Integer (1, 2, 4, 8, 16, 24, 32, 48, 64, 128, 192, 256, 512)	Defines the period in multiples of 10 ms frames for which the defined TFC sub-set is to be applied.

10.3.6.81 Void

10.3.6.82 TGPSI

Information Element/Group name	Need	Multi	Type and reference	Semantics description
TGPSI	MP		Integer(1..M)	Transmission Gap Pattern

Information Element/Group name	Need	Multi	Type and reference	Semantics description
			axTGPS)	Sequence Identifier Establish a reference to the compressed mode pattern sequence. Up to <MaxTGPS> simultaneous compressed mode pattern sequences can be used.

10.3.6.83 Time info

Information Element/Group name	Need	Multi	Type and reference	Semantics description
Activation time	MD		Activation time 10.3.3.1	Frame number start of the physical channel existence. Default value is "Now"
Duration	MD		Integer(1..4096, infinite)	Total number of frames the physical channel will exist. Default value is "infinite".

10.3.6.83a Time Slot LCR Extension

IE/Group Name	Presence	Range	IE Type and Reference	Semantics Description
Time Slot LCR Extension			ENUMERATED (TS7, ...)	TS7 indicates the MBSFN Special Timeslot for 1.28 Mcps TDD MBSFN Dedicated Carrier. Three spare values are reserved.

10.3.6.84 Timeslot number

Information Element/Group name	Need	Multi	Type and reference	Semantics description	Version
CHOICE <i>TDD option</i>	MP				REL-4
>3.84 Mcps TDD					REL-4
>>Timeslot number	MP		Integer(0..14)	Timeslot within a frame	
>7.68 Mcps TDD					REL-7
>>Timeslot number	MP		Integer(0..14)	Timeslot within a frame	REL-7
>1.28 Mcps TDD					REL-4
>>Timeslot number	MP		Integer(0..6)	Timeslot within a subframe	REL-4

10.3.6.85 TPC combination index

NOTE: Only for FDD.

Information Element/Group name	Need	Multi	Type and reference	Semantics description	Version
TPC combination index	MP		Integer(0..5)	Radio links with the same index have TPC bits, which for the UE are known to be the same.	
				Radio links that are part of the E-DCH active set and with the same index have acknowledgement feedback signals on the E-HICH which for the UE are known to be the same.	REL-6
				Radio links with the same index have TPI bits, which for the UE are known to be the same.	REL-11

10.3.6.85a TSTD indicator

NOTE: Only for 1.28 Mcps TDD.

Information Element/Group name	Need	Multi	Type and reference	Semantics description	Version
TSTD indicator	MD		Boolean	Default value is TRUE	REL-4

10.3.6.86 TX Diversity Mode

NOTE: Only for FDD.

Information Element/Group name	Need	Multi	Type and reference	Semantics description
Tx diversity Mode	MP		Enumerated (none, STTD, closed loop mode1)	

10.3.6.86o UL 16QAM configuration

NOTE: Only for FDD.

Information Element/Group name	Need	Multi	Type and reference	Semantics description	Version
UL 16QAM settings	CV- 2msTTI		UL 16QAM settings 10.3.6.86a	Presence of this IE indicates that the UE should operate in 16QAM mode; absence indicates that the UE is not to operate in 16QAM mode. See Note 2.	REL-7
MAC-es/e reset indicator	OP		Enumerated (TRUE)	TRUE Indicates the MAC-es/e or MAC-i/is entity needs to be reset.	REL-7
E-TFCI table index	OP		Integer (0..1)	Indicates which standardised E-TFCI TB size table shall be used. See Note 1.	REL-7
NOTE 1: If the UE is operating in 16QAM mode, the value of "E-TFCI table index" is increased by 2, and indices in the SG-Table refer to Scheduling Grant Table 2 in [15].					
NOTE 2: If this IE is not present, the indices signaled on the E-AGCH refer to the Mapping of Absolute Grant Value Table 16B in [27].					

Condition	Explanation
2msTTI	This IE is present only if 2ms TTI is configured, otherwise it is not needed.

10.3.6.86a UL 16QAM settings

Information Element/Group name	Need	Multi	Type and reference	Semantics description	Version
BetaEd gain E-AGCH table selection	MP		Integer (0..1)	The value 0 indicates that the indices signaled on the E-AGCH refer to the Mapping of Absolute Grant Value Table 16B in [27], and the value 1 indicates Mapping using Absolute Grant Value Table 16B.1 in [27].	REL-7

10.3.6.86b UL 64QAM configuration

NOTE: Only for FDD.

Information Element/Group name	Need	Multi	Type and reference	Semantics description	Version
UL 64QAM settings	OP		UL 64QAM settings 10.3.6.86c	Presence of this IE indicates that the UE should operate in 64QAM mode; absence indicates that the UE is not to operate in 64QAM mode.	REL-11
MAC-is/i reset indicator	OP		Enumerated (TRUE)	TRUE Indicates that MAC-i/is entity needs to be reset.	REL-11

10.3.6.86c UL 64QAM settings

Information Element/Group name	Need	Multi	Type and reference	Semantics description	Version
BetaEd gain E-AGCH table selection	MP		Integer (0..1)	The value 0 indicates that the indices signaled on the E-AGCH refer to the Mapping of Absolute Grant Value Table 16B in [27], and the value 1 indicates Mapping using Absolute Grant Value Table 16B.1 in [27].	REL-11

10.3.6.87 UL interference

Information Element/Group name	Need	Multi	Type and reference	Semantics description
UL interference	MP		Integer (-110..-70)	In dBm

NOTE: In TDD, this IE is a timeslot specific value.

10.3.6.87a UL interference TDD

NOTE: Only for TDD.

Information Element/Group name	Need	Multi	Type and reference	Semantics description
TDD UL interference	MP		Integer (-110..-52)	In dBm

NOTE: This IE is a timeslot specific value.

10.3.6.87b Uplink DPCH code info for Common E-DCH

Information Element/Group name	Need	Multi	Type and reference	Semantics description	Version
Scrambling code type	MP		Enumerated(short, long)		REL-8
Scrambling code number	CV-Short		Integer(0..16777215)	NOTE1	REL-8
NOTE1: If this IE is not included, the value is given by: Scrambling code number = (offset + common E-DCH resource list position) mod 16777216 where "offset" is the value of the last occurrence of the IE "scrambling code number". "common E-DCH resource list position" indicates the Common E-DCH resource Configuration Information number by order of appearance. The value of the "common E-DCH resource list position" is zero for the first occurrence.					

Condition	Explanation
Short	This IE is mandatory present for the first occurrence. Otherwise, this IE is optional.

10.3.6.88 Uplink DPCH info

Information Element/Group name	Need	Multi	Type and reference	Semantics description	Version
Uplink DPCH power control info	OP		Uplink DPCH power control info 10.3.6.91		
CHOICE <i>mode</i>	MP				
>FDD					
>>Scrambling code type	MP		Enumerated(short, long)		
>>Scrambling code number	MP		Integer(0..16777215)		
>>Number of DPDCH	MD		Integer(1..maxDPDCH-UL, 0)	Default value is 1. Number of DPDCH is 1 in HANDOVER TO UTRAN COMMAND. Value 0 may only be used if target configuration has no uplink DPDCH.	REL-6
>>Spreading factor	CV- DPDCH present		Integer(4, 8, 16, 32, 64, 128, 256)	Minimum allowed SF of the channelisation code for data part	
>>TFCI existence	MP		Boolean	TRUE means existence.	
>>Number of FBI bits	OP		Integer (1, 2)	In bits.	
>>Number of TPC bits	CV- Neither TFCI nor FBI present		Integer (4)	In bits	REL-7
>>Puncturing Limit	CV- DPDCH present		Real(0.40 ..1 by step of 0.04)		
>TDD					
>>Uplink Timing Advance Control	OP		Uplink Timing Advance Control 10.3.6.96		
>>UL CCTrCH List	OP	1 to <maxCC TrCH>		UL physical channels to establish or reconfigure list.	
>>>TFCS ID	MD		Integer(1..8)	Default value is 1.	
>>>UL target SIR	MP		Real (-11 .. 20 by step of 0.5dB)	In dB For 1.28 Mcps TDD this parameter represents PRX _{DPCHdes} with range Integer(-120...-58 by step of 1) dBm	REL-4
>>>Time info	MP		Time info 10.3.6.83		
>>>Common timeslot info	MD		Common timeslot info 10.3.6.10	Default is the current Common timeslot info	
>>> CHOICE TDD option					REL-7
>>>> 3.84 Mcps TDD					REL-7

Information Element/Group name	Need	Multi	Type and reference	Semantics description	Version
>>>>Uplink DPCH timeslots and codes	MD		Uplink Timeslots and Codes 10.3.6.94	Default is to use the old timeslots and codes.	
>>>>7.68 Mcps TDD					REL-7
>>>>Uplink DPCH timeslots and codes VHCR	MD		Uplink Timeslots and Codes VHCR 10.3.6.94 b	Default is to use the old timeslots and codes	REL-7
>>>> 1.28 Mcps TDD					REL-7
>>>>Uplink DPCH timeslots and codes LCR	MD		Uplink Timeslots and Codes LCR 10.3.6.94 a	Default is to use the old timeslots and codes.	REL-7
>>UL CTrCH List to Remove	OP	1..<max CTrCH >		UL physical channels to remove list	
>>>TFCS ID	MP		Integer(1..8)		

Condition	Explanation
<i>DPDCHpresent</i>	This IE is mandatory if the target configuration includes a DPDCH, otherwise it is not needed.
<i>Neither TFCI nor FBI present</i>	This IE is optional if the IE "TFCI existence" is set to FALSE and the IE "Number of FBI bits" is not present, otherwise it is not needed.

10.3.6.89 Uplink DPCH info Post

Information Element/Group name	Need	Multi	Type and reference	Semantics description	Version
Uplink DPCH power control info	MP		Uplink DPCH power control info Post 10.3.6.92		
CHOICE <i>mode</i>	MP				
>FDD					
>>Scrambling code type	MP		Enumerated(short, long)		
>>Reduced scrambling code number	MP		Integer(0..81 91)	Sub-range of values for initial use upon handover to UTRAN.	
>>Spreading factor	MP		Integer(4, 8, 16, 32, 64, 128, 256)	SF of the channelisation code for data part There is only one DPDCH for this case	
>1.28 Mcps TDD and 3.84 Mcps TDD					
>>Uplink Timing Advance Control	OP		Uplink Timing Advance Control 10.3.6.96		
>>Uplink DPCH timeslots and codes	MP		Uplink Timeslots and Codes 10.3.6.94		
>7.68 Mcps TDD					REL-7
>>Uplink Timing Advance Control	OP		Uplink Timing Advance Control 10.3.6.96		REL-7
>>Uplink DPCH timeslots and codes	MP		Uplink Timeslots and Codes VHCR 10.3.6.94b		REL-7

10.3.6.90 Uplink DPCH info Pre

Information Element/Group name	Need	Multi	Type and reference	Semantics description	Version
Uplink DPCH power control info	OP		Uplink DPCH power control info Pre 10.3.6.93		
CHOICE <i>mode</i>	MP				
>FDD					
>>TFCI existence	MP		Boolean	TRUE means existence. Default value is TRUE See NOTE 1.	
>>Number of TPC bits	CV- <i>No TFCI</i>		Integer (4)	In bits	REL-7
>>Puncturing Limit	MP		Real(0.40 ..1 by step of 0.04)		
>TDD					
>>Common timeslot info	MP		Common Timeslot Info 10.3.6.10		
NOTE 1: Number of FBI bits is not signalled but 0 is implied as transmit diversity cannot be setup here.					

Condition	Explanation
Single	This IE is mandatory present if the IE "Number of DPDCH" is "1" and not needed otherwise.
<i>No TFCI</i>	This IE is optional if the IE "TFCI existence" is set to FALSE, otherwise it is not needed.

10.3.6.91 Uplink DPCH power control info

Parameters used by UE to set DPCH initial output power and to use for closed-loop power control in FDD and 1.28 Mcps TDD and parameters for uplink open loop power control in 3.84 Mcps TDD and 7.68 Mcps TDD.

Information Element/Group name	Need	Multi	Type and reference	Semantics description	Version
CHOICE <i>mode</i>	MP				
>FDD					
>>DPCCH Power offset	MP		Integer(-164,..-6 by step of 2)	In dB	
>>PC Preamble	MP		Integer (0..7)	In number of frames	
>>SRB delay	MP		Integer(0..7)	In number of frames	
>>Power Control Algorithm	MP		Enumerated (algorithm 1, algorithm 2)	Specifies algorithm to be used by UE to interpret TPC commands	
>>TPC step size	CV- <i>algo</i>		Integer (1, 2)	In dB	
>> Δ_{ACK}	OP		Integer (0..8)	Refer to quantization of the power offset in [28]	REL-5
			9..10)		REL-11

Information Element/Group name	Need	Multi	Type and reference	Semantics description	Version
>> Δ NACK	OP		Integer (0..8	refer to quantization of the power offset in [28]	REL-5
			9..10)		REL-11
>>Ack-Nack repetition factor	OP		Integer(1..4)		REL-5
>>Ack-Nack repetition factor for Multiflow assisting cells	CV- <i>Multiflow</i>		Integer(1..4)	If present, this IE indicates that all the assisting cells use the Ack-Nack repetition factor indicated by this IE. Absence of this IE indicates that there is no Ack-Nack repetition for multiflow assisting cell(s).	REL-11
>>HARQ_preamble_mode	MP		Integer (0, 1)	1 indicates that preamble and postamble are used on the HS-DPCCH – see [29]	REL-6
>TDD					
>>UL target SIR	OP		Real (-11 .. 20 by step of 0.5dB)	In dB For 1.28 Mcps TDD this parameter represents PRX _{DPCHdes} with range Integer(-120...-58 by step of 1) dBm	REL-4
>>CHOICE <i>UL OL PC info</i>	MP				
>>>Broadcast UL OL PC info			Null	No data	
>>>Individually Signalled	OP				
>>>>CHOICE <i>TDD option</i>	MP				REL-4
>>>>>3.84 Mcps TDD					REL-4
>>>>>Individual timeslot interference info	MP	1 to <maxTS>			
>>>>>>Individual timeslot interference	MP		Individual timeslot interference 10.3.6.38		
>>>>>>DPCH Constant Value	MP		Constant Value TDD 10.3.6.11a	Quality Margin	
>>>>>>7.68 Mcps TDD					REL-7
>>>>>>Individual timeslot interference info	MP	1 to <maxTS>			REL-7
>>>>>>>Individual timeslot interference	MP		Individual timeslot interference 10.3.6.38		REL-7
>>>>>>>DPCH Constant Value	MP		Constant Value TDD 10.3.6.11a	Quality Margin	REL-7
>>>>>>>1.28 Mcps TDD					REL-4

Information Element/Group name	Need	Multi	Type and reference	Semantics description	Version
>>>>>Beacon PL Est.	CV-houtran		Enumerated (TRUE)	The presence of this IE indicates that the UE may take into account path loss estimated from beacon function physical channels. The absence indicates that UE may not take into account path loss estimated from beacon function physical channels	REL-6
>>>>>TPC step size	MP		Integer(1,2,3)		REL-4
>>>>Primary CCPCH Tx Power	OP		Primary CCPCH Tx Power 10.3.6.59	For Pathloss Calculation	

Condition	Explanation
<i>algo</i>	The IE is mandatory present if the IE "Power Control Algorithm" is set to "algorithm 1", otherwise the IE is not needed
<i>houtran</i>	This IE is optional in Cell Update Confirm, Physical Channel Reconfiguration, Radio Bearer Reconfiguration, Radio Bearer Release, Radio Bearer Setup, Transport Channel Reconfiguration and Uplink Physical Channel Control. The IE is not included in the Handover To UTRAN Command
<i>Multiflow</i>	The IE is optional when the Multiflow operation is configured, otherwise it is not needed.

10.3.6.91a Uplink DPCH power control info for Common E-DCH

Parameters used by UE to set DPCH initial output power and to use for closed-loop power control in FDD when Enhanced Uplink in CELL_FACH state and Idle mode is applied.

Information Element/Group name	Need	Multi	Type and reference	Semantics description	Version
Power Control Algorithm	MP		Enumerated (algorithm 1, algorithm 2)	Specifies algorithm to be used by UE to interpret TPC commands	REL-8
TPC step size	CV- <i>algo</i>		Integer (1, 2)	In dB	REL-8
Δ_{ACK}	OP		Integer (0..8)	Refer to quantization of the power offset in [28]	REL-8
Δ_{NACK}	OP		Integer (0..8)	refer to quantization of the power offset in [28]	REL-8
Ack-Nack repetition factor	OP		Integer(1..4)		REL-8

Condition	Explanation
<i>algo</i>	The IE is mandatory present if the IE "Power Control Algorithm" is set to "algorithm 1", otherwise the IE is not needed

10.3.6.92 Uplink DPCH power control info Post

Parameters used by UE to set DPCH initial output power and to use for closed-loop power control.

Information Element/Group name	Need	Multi	Type and reference	Semantics description	Version
CHOICE <i>mode</i>	MP				
>FDD					
>>DPCCH Power offset	MP		Integer(-110...-50 by step of 4)	In dB	
>>PC Preamble	MP		Integer (0..7)	in number of frames	
>>SRB delay	MP		Integer (0..7)	In number of frames	
>TDD					
>>UL target SIR	MP		Real (-11 .. 20 by step of 0.5dB)	In dB For 1.28 Mcps TDD this parameter represents PRX _{DPCHdes} with range Integer(-120...-58 by step of 1) dBm	REL-4
>>CHOICE <i>TDD option</i>	MP				REL-4
>>>3.84 Mcps TDD					REL-4
>>>>UL Timeslot Interference	MP		UL Interference TDD 10.3.6.87a		
>>>>7.68 Mcps TDD					REL-7
>>>>UL Timeslot Interference	MP		UL Interference TDD 10.3.6.87a		REL-7
>>>>1.28 Mcps TDD				(no data)	REL-4

Condition	Explanation
<i>algo</i>	The IE is mandatory present if the IE "Power Control Algorithm" is set to "algorithm 1", otherwise the IE is not needed

10.3.6.93 Uplink DPCH power control info Pre

Parameters used by UE to set DPCH initial output power and to use for closed-loop power control in FDD and parameters for uplink open loop power control in 3.84 Mcps TDD and 7.68 Mcps TDD.

Information Element/Group name	Need	Multi	Type and reference	Semantics description	Version
CHOICE <i>mode</i>	MP				
>FDD					
>>Power Control Algorithm	MP		Enumerated (algorithm 1, algorithm 2)	Specifies algorithm to be used by UE to interpret TPC commands	

Information Element/Group name	Need	Multi	Type and reference	Semantics description	Version
>>TPC step size	CV- <i>algo</i>		Integer (1, 2)	In dB	
>TDD				(No data)	
>>CHOICE <i>TDD option</i>	MP				REL-4
>>>3.84 Mcps TDD					REL-4
>>DPCH Constant Value	MP		Constant Value TDD 10.3.6.11a	Quality Margin	
>>>7.68 Mcps TDD					REL-7
>>DPCH Constant Value	MP		Constant Value TDD 10.3.6.11a	Quality Margin	REL-7
>>>1.28 Mcps TDD				(no data)	REL-4

Condition	Explanation
<i>algo</i>	The IE is mandatory present if the IE "Power Control Algorithm" is set to "algorithm 1", otherwise the IE is not needed

10.3.6.94 Uplink Timeslots and Codes

NOTE: Only for 1.28 Mcps TDD and 3.84 Mcps TDD.

Information Element/Group name	Need	Multi	Type and reference	Semantics description
Dynamic SF usage	MP		Boolean	
First Individual timeslot info	MP		Individual timeslot info 10.3.6.37	Individual timeslot info for the first timeslot used by the physical layer.
First timeslot Code List	MP	1..2		Code list used in the timeslot. given in First individual timeslot info.
>Channelisation Code	MP		Enumerated((1/1),(2/1),(2/2),(4/1)..(4/ 4),(8/1)..(8/8) ,(16/1)..(16/1 6))	
CHOICE <i>more timeslots</i>	MP			
>No more timeslots				(no data)
>Consecutive timeslots				
>>Number of additional timeslots	MP		Integer(1..m axTS-1)	The timeslots used by the physical layer shall be timeslots: N mod maxTS (N+1) mod maxTS ... (N+k) mod maxTS in that order, where N is the timeslot number in the First individual timeslot info and k the Number of additional timeslots. The additional timeslots shall use the same parameters (e.g. channelisation codes, midamble shifts etc.) as the first timeslot.
>Timeslot list				
>>Additional timeslot list	MP	1 to <maxTS- 1>		The first instance of this parameter corresponds to the timeslot that shall be used second by the physical layer,

Information Element/Group name	Need	Multi	Type and reference	Semantics description
				the second to the timeslot that shall be used third and so on.
>>>CHOICE <i>parameters</i>	MP			
>>>>Same as last				
>>>>>Timeslot number	MP		Timeslot Number 10.3.6.84	This physical layer shall use the same parameters (e.g. channelisation codes, midamble shifts etc.) for this timeslot as for the last one.
>>>>>New parameters				
>>>>>Individual timeslot info	MP		Individual timeslot info 10.3.6.37	
>>>>>Code List	MP	1..2		
>>>>>>Channelisation Code	MP		Enumerated((1/1),(2/1),(2/2),(4/1)..(4/4),(8/1)..(8/8),(16/1)..(16/16))	

10.3.6.94a Uplink Timeslots and Codes LCR

NOTE: Only for 1.28 Mcps TDD

Information Element/Group name	Need	Multi	Type and reference	Semantics description
Dynamic SF usage	MP		Boolean	
First Individual timeslot info	MP		Individual timeslot info 10.3.6.37	Individual timeslot info for the first timeslot used by the physical layer.
First timeslot Code List	MP	1..2		Code list used in the timeslot. given in First individual timeslot info.
>Channelisation Code	MP		Enumerated((1/1),(2/1),(2/2),(4/1)..(4/4),(8/1)..(8/8),(16/1)..(16/16))	
>PLCCH Info	CV-no_DL_DPCH		PLCCH Info 10.3.6.50a	
CHOICE <i>more timeslots</i>	MP			
>No more timeslots				(no data)
>Consecutive timeslots				

Information Element/Group name	Need	Multi	Type and reference	Semantics description
>>Number of additional timeslots	MP		Integer(1..maxTS-1)	The timeslots used by the physical layer shall be timeslots: N mod maxTS (N+1) mod maxTS ... (N+k) mod maxTS in that order, where N is the timeslot number in the First individual timeslot info and k the Number of additional timeslots. The additional timeslots shall use the same parameters (e.g. channelisation codes, midamble shifts etc.) as the first timeslot.
>Timeslot list				
>>Additional timeslot list	MP	1 to <maxTS-1>		The first instance of this parameter corresponds to the timeslot that shall be used second by the physical layer, the second to the timeslot that shall be used third and so on.
>>>CHOICE <i>parameters</i>	MP			
>>>>Same as last				
>>>>>Timeslot number	MP		Timeslot Number 10.3.6.84	This physical layer shall use the same parameters (e.g. channelisation codes, midamble shifts etc.) for this timeslot as for the last one.
>>>>>New parameters				
>>>>>Individual timeslot info	MP		Individual timeslot info 10.3.6.37	
>>>>>Code List	MP	1..2		
>>>>>>Channelisation Code	MP		Enumerate d((1/1),(2/1),(2/2),(4/1)..(4/4),(8/1)..(8/8),(16/1)..(16/16))	
>>>>>>PLCCH Info	CV-no_DL_DPCH		PLCCH Info 10.3.6.50a	Default is same as set of parameter values as assigned to last timeslot

Condition	Explanation
<i>No_DL_DPCH</i>	This IE is mandatory present for 1.28 Mcps TDD only in the case that Uplink Timeslots and Codes are assigned for UL DPCH and no DL DPCH is allocated to the UE.

10.3.6.94b Uplink Timeslots and Codes VHCR

NOTE: Only for 7.68 Mcps TDD

Information Element/Group name	Need	Multi	Type and reference	Semantics description	Version
Dynamic SF usage	MP		Boolean		REL-7
First Individual timeslot info	MP		Individual timeslot info 10.3.6.37	Individual timeslot info for the first timeslot used by the physical layer.	REL-7
First timeslot Code List	MP	1..2		Code list used in the timeslot. given in First individual timeslot info.	REL-7
>Channelisation Code	MP		Enumerated((1/1),(2/1),(2/2),(4/1)..(4/4),(8/1)..(8/8.16/1) .. (16/16).(32/1)..(32/32))		REL-7
CHOICE <i>more timeslots</i>	MP				REL-7
>No more timeslots				(no data)	REL-7
>Consecutive timeslots					REL-7
>>Number of additional timeslots	MP		Integer(1..maxTS-1)	The timeslots used by the physical layer shall be timeslots: N mod maxTS (N+1) mod maxTS ... (N+k) mod maxTS in that order, where N is the timeslot number in the First individual timeslot info and k the Number of additional timeslots. The additional timeslots shall use the same parameters (e.g. channelisation codes, midamble shifts etc.) as the first timeslot.	REL-7
>Timeslot list					REL-7
>>Additional timeslot list	MP	1 to <maxTS-1>		The first instance of this parameter corresponds to the timeslot that shall be used second by the physical layer, the second to the timeslot that shall be used third and so on.	REL-7
>>>CHOICE <i>parameters</i>	MP				REL-7
>>>>Same as last					REL-7
>>>>>Timeslot number	MP		Timeslot Number 10.3.6.84	This physical layer shall use the same parameters (e.g. channelisation codes, midamble shifts etc.) for this timeslot as for the last one.	REL-7
>>>>>New parameters					REL-7

Information Element/Group name	Need	Multi	Type and reference	Semantics description	Version
>>>>Individual timeslot info	MP		Individual timeslot info 10.3.6.37		REL-7
>>>>Code List	MP	1..2			REL-7
>>>>>Channelisation Code	MP		Enumerated((1/1),(2/1),(2/2),(4/1)..(4/4),(8/1)..(8/8) .(16/1)..(16/16).(32/1) ..(32/32))		REL-7

10.3.6.95 Uplink Timing Advance

NOTE: Only for 3.84 Mcps TDD.

Information Element/Group name	Need	Multi	Type and reference	Semantics description	Version
UL Timing Advance	MP		Integer (0..63)	Absolute timing advance value to be used to avoid large delay spread at the NodeB	

10.3.6.95a Extended Uplink Timing Advance

NOTE: Only for 3.84 and 7.68 Mcps TDD.

Information Element/Group name	Need	Multi	Type and reference	Semantics description	Version
CHOICE <i>TDD mode</i>					REL-7
>3.84 Mcps TDD					REL-7
>>Extended UL Timing Advance	MP		Integer (0..255)	Absolute timing advance value to be used to avoid large delay spread at the NodeB	REL-7
>7.68.Mcps TDD					REL-7
>>Extended UL Timing Advance	MP		Integer (0..511)	Absolute timing advance value to be used to avoid large delay spread at the NodeB	REL-7

10.3.6.96 Uplink Timing Advance Control

NOTE: Only for TDD

Information Element/Group name	Need	Multi	Type and reference	Semantics description	Version
CHOICE <i>Timing Advance</i>	MP				
>Disabled			Null	Indicates that no timing advance is applied	
>Enabled					
>>CHOICE <i>TDD option</i>	MP				REL-4
>>>3.84 Mcps TDD					REL-4

Information Element/Group name	Need	Multi	Type and reference	Semantics description	Version
>>>>UL Timing Advance	MD		Uplink Timing Advance 10.3.6.95	Absolute timing advance value to be used to avoid large delay spread at the NodeB. Default value is the existing value for uplink timing advance.	
>>Extended Timing Advance	OP		Extended UL Timing Advance Control 10.3.6.95a		REL-7
>>>>Activation Time	OP		Activation Time 10.3.3.1	Frame number timing advance is to be applied. This IE is required when a new UL Timing Advance adjustment is specified and Activation Time is not otherwise specified in the RRC message.	
>>>7.68 Mcps TDD					REL-7
>>>>Extended UL Timing Advance	MD		Extended Uplink Timing Advance 10.3.6.95a	Absolute timing advance value to be used to avoid large delay spread at the NodeB. Default value is the existing value for uplink timing advance.	REL-7
>>>>Activation Time	OP		Activation Time 10.3.3.1	Frame number timing advance is to be applied. This IE is required when a new UL Timing Advance adjustment is specified and Activation Time is not otherwise specified in the RRC message.	REL-7
>>1.28 Mcps TDD				(no data)	REL-4
>>>Uplink synchronisation parameters	MD			Default: Uplink synchronisation step size is 1. Uplink synchronisation frequency is 1.	REL-4
>>>>Uplink synchronisation step size	MP		Integer(1..8)	This parameter specifies the step size to be used for the adjustment of the uplink transmission timing	REL-4

Information Element/Group name	Need	Multi	Type and reference	Semantics description	Version
>>>>Uplink synchronisation frequency	MP		Integer(1..8)	This parameter specifies the frequency of the adjustment of the uplink transmission timing	REL-4
>>>Synchronisation parameters	CV- <i>HandoverType</i>				
>>>>SYNC_UL codes bitmap	MP		SYNC_UL codes bitmap 10.3.6.78o		REL-4
>>>>FPACH info	MP		FPACH info 10.3.6.35a		REL-4
>>>>PRX _{UpPCHdes}	MP		Integer(-120...-58 by step of 1)	In dBm	REL-4
>>>>SYNC_UL procedure	MD			Default is: Max SYNC_UL Transmission is 2. Power Ramp Step is 2.	REL-4
>>>>>Max SYNC_UL Transmissions	MP		Integer(1,2,4,8)	Maximum numbers of SYNC_UL transmissions in a power ramping sequence.	REL-4
>>>>>Power Ramp Step	MP		Integer(0,1,2,3)	In dB	REL-4

Condition	Explanation
<i>HandoverType</i>	This IE is mandatory present if it is inter-RAT handover, otherwise it is optional.

10.3.6.97 E-DCH Info

Information Element/Group name	Need	Multi	Type and reference	Semantics description	Version
MAC-es/e reset indicator	OP		Enumerated (TRUE)	TRUE Indicates the MAC-es/e or MAC-i/is entity needs to be reset.	REL-6
CHOICE <i>mode</i>	MP				REL-7
>FDD					REL-7
>>E-DPCCH info	OP		E-DPCCH Info 10.3.6.98		REL-6
>>E-DPDCH info	OP		E-DPDCH info 10.3.6.99		REL-6
>>Uplink MIMO info	OP		Uplink MIMO Info FDD 10.3.6.145		REL-11
>>Scheduled Transmission configuration	OP				REL-6
>>>2ms scheduled transmission grant HARQ process allocation	MD		Bitstring (8)	MAC-d PDUs belonging to MAC-d flows not configured with a "Max MAC-e PDU contents size" are only allowed to be transmitted in those processes for which the bit is set to "1". Bit 0 corresponds to HARQ process 0, bit 1 corresponds to HARQ process 1,... Default value is: transmission in all HARQ processes is allowed. Bit 0 is the first/leftmost bit of the bit string.	REL-6
>>>Serving Grant	OP				REL-6
>>>>Serving Grant value	MP		Integer (0..37,38)	(0..37) indicates E-DCH serving grant index as defined in [15]; index 38 means zero grant.	REL-6
>>>>Primary/Secondary Grant Selector	MP		Enumerated ("primary", "secondary")	Indicates whether the Serving Grant is received with a Primary E-RNTI or Secondary E-RNTI	REL-6
>>UL 16QAM settings	OP		UL 16QAM settings 10.3.6.86a	Presence of this IE indicates that the UE should operate in 16QAM mode; absence indicates that the UE is not to operate in 16QAM mode. See Note 1.	REL-7

>>UL 64QAM settings	OP		UL 64QAM settings 10.3.6.86c	Presence of this IE indicates that the UE should operate in 64QAM mode; absence indicates that the UE is not to operate in 64QAM mode.	REL-11
>TDD					REL-7
>>E-RUCCH info	OP		E-RUCCH Info 10.3.6.103		REL-7
>>E-PUCH info	OP		E-PUCH Info 10.3.6.104		REL-7
>>Non-scheduled transmission grant info	OP		Non-scheduled transmission grant info 10.3.6.41c		REL-7
NOTE 1: If this IE is not present, the indices signaled on the E-AGCH refer to the Mapping of Absolute Grant Value Table 16B in [27].					

10.3.6.97a Multi-carrier E-DCH Info for LCR TDD

Information Element/Group name	Need	Multi	Type and reference	Semantics description	Version
CHOICE <i>Configuration info</i>	MP				REL-10
>Continue				(no data)	REL-10
>New configuration					REL-10
>>TSN-Length	OP		Enumerated (tsn-14bits)	The presence of this IE indicates the length of TSN shall be 14 bits, otherwise, the length of TSN shall be 6 bits.	REL-10
>>Uplink Multi-carrier E-DCH Information List	OP	1 to <maxTDD12 8Carrier-1>			REL-10
>>>UARFCN	MP		Integer(0..16 383)		REL-10
>>>PRXdes_base	MP		Integer (-112..-50 by step of 1)	dBm. Reference desired power level for E-PUCH	REL-10
>>>E-PUCH info	MD		E-PUCH Info for multi-carrier E-DCH 1.28Mcps TDD 10.3.6.104b	Default value is the value of the previous " E- PUCH info " in the list. Default value of first occurrence is the value of "E- PUCH info" in the IE "E-DCH info".	REL-10
>>>E-AGCH Info	MD		E-AGCH Info 1.28Mcps TDD 10.3.6.100a	Default value is the value of the previous " E- AGCH Info " in the list. Default value of first occurrence is the value of "E- AGCH Info" in the IE "Downlink information for each radio link".	REL-10
>>>E-HICH Info	MD		E-HICH Info 1.28Mcps TDD 10.3.6.101a	Default value is the value of the previous " E-HICH Information " in the list. Default value of first occurrence is the value of "E- HICH Information" in the IE "Downlink information for each radio link".	REL-10
>>Uplink Multi-carrier E-DCH Delete List	CV- <i>serving_cel l_change</i>	1 to <maxTDD12 8Carrier-1>			REL-10
>>>UARFCN	MP		Integer(0..16 383)		REL-10

Condition	Explanation
<i>-serving_cell_change</i>	This IE is not needed in the serving cell change. Otherwise, the IE is Optional

10.3.6.98 E-DPCCH Info

Information Element/Group name	Need	Multi	Type and reference	Semantics description	Version
E-DPCCH/DPCCH power offset	MP		Integer (0..8)	Refer to quantization of the power offset in [28]	REL-6
Happy bit delay condition	MP		Enumerated (2ms, 10ms, 20ms, 50ms, 100ms, 200ms, 500ms, 1000ms)	To be used when determining the setting of the happy bit (see [15])	REL-6
E-TFC Boost Info	OP		E-TFC Boost Info 10.3.6.106	Absence of this IE means that boosting of E-DPCCH is disabled	REL-7
E-DPDCH power interpolation	OP		Boolean	TRUE means E-DPDCH power interpolation formula is used, FALSE means E-DPDCH power extrapolation formula is used for the computation of the gain factor β_{ed} according to [29]. Absence of this IE means that E-DPDCH power extrapolation formula is used for the computation of the gain factor β_{ed} according to [29].	REL-7

10.3.6.99 E-DPDCH Info

Information Element/Group name	Need	Multi	Type and reference	Semantics description	Version
E-TFCI table index	MP		Integer (0..1)	Indicates which standardised E-TFCI TB size table shall be used. See Note 3.	REL-6
E-DCH minimum set E-TFCI	MD		Integer (0..127)	See [15]; Absence means no E-DCH minimum set	REL-6
Reference E-TFCIs	MP	1 to 8		See [29]	REL-6
>Reference E-TFCI	MP		Integer (0..127)		REL-6
>Reference E-TFCI PO	MP		Integer (0..29,	Refer to quantization of the power offset in [28]	REL-6
			30, 31)	Values 30 and 31 are only used for E-TFCI > ETFCI Boost	REL-7
Minimum reduced E-DPDCH gain factor	OP		Enumerated (8/15, 11/15, 15/15, 21/15, 30/15, 42/15, 60/15, 84/15)	$\beta_{ed,k, reduced, min}$ [29]; the default value is 8/15. If the configurable reduced E-DPDCH gain factor is not supported by the UE, the default value is used.	REL-8

Maximum channelisation codes	MP		Enumerated (sf256, sf128, sf64, sf32, sf16, sf8, sf4, 2sf4, 2sf2, 2sf2and2sf4)		REL-6
PL _{non-max}	MP		Real (0.44 ..1.0 by step of 0.04)	As defined in [27]	REL-6
Scheduling Information Configuration	MP				REL-6
>Periodicity for Scheduling Info – no grant	MD		Enumerated (everyEDCHT Tl,4,10,20,50,100,200,500,1000)	Values in ms. Default value is “no report” NOTE 1.	REL-6
>Periodicity for Scheduling Info – grant	MD		Enumerated (everyEDCHT Tl,4,10,20,50,100,200,500,1000)	Values in ms. Default value is “no report” NOTE 1.	REL-6
>Power Offset for Scheduling Info	MP		Integer (0..6)	Only used when no MACd PDUs are included in the same MAC-e or MAC-i PDU. Unit is in dB.	REL-6
3-Index-Step Threshold	MD		Integer (0..37)	Refers to an index in the “SG-Table” (see [15]). Default value is 0. NOTES 2, 3.	REL-6
2-Index-Step Threshold	MD		Integer (0..37)	Refers to an index in the “SG-Table” (see [15]). Default value is 0. NOTES 2, 3.	REL-6
<p>NOTE 1: If the Periodicity is set to 4ms and the E-DCH TTI is set to 10ms, the UE shall interpret the periodicity value as 10ms.</p> <p>NOTE 2: If the 3-index-Step Threshold value is greater than 2-index-Step Threshold, the UE behaviour is unspecified.</p> <p>NOTE 3: If the UE is operating in 16QAM mode, the value of “E-TFCI table index” is increased by 2, and indices in the SG-Table refer to Scheduling Grant Table 2 in [15]. If the UE is operating in 64QAM mode, the UE shall use E-TFCI table 4 as specified in [15] irrespective of the value of “E-TFCI table index, and indices in the SG-Table refer to Scheduling Grant Table 2 in [15].</p>					

10.3.6.100 E-AGCH Info

Includes the configuration for the E-DCH related Absolute Grant Channel.

Information Element/Group name	Need	Multi	Type and reference	Semantics description	Version
CHOICE <i>mode</i>	MP				REL-7
>FDD					REL-7
>>E-AGCH Channelisation Code	MP		Integer (0..255)		REL-6
>TDD					REL-7
>>CHOICE TDD Option	MP				REL-7
>>>3.84 Mcps TDD					REL-7
>>>>Long Term Grant Indicator	MD		Boolean	FALSE = Short Term TRUE = Long Term Default = FALSE (Short Term)	REL-7
>>>>Length of TTRI field	MP		Integer(1..12)	Indicated length of the bitmap used to indicate which of the timeslots configured for E-DCH are allocated	REL-7
>>>>E-AGCH set configuration	MP	<1 to maxNumE-AGCH>			REL-7
>>>>>TS number	MP		Integer(0..14)		REL-7
>>>>>Channelisation code	MP		Enumerated(16/1, 16/2,....16/16)		REL-7
>>>>>CHOICE Burst Type					REL-7
>>>>>>Type 1					REL-7
>>>>>>>Midamble allocation mode	MP		Enumerated(Default, Common, UE specific)		REL-7
>>>>>>>Midamble configuration burst type 1	MP		Enumerated(4, 8, 16)		REL-7
>>>>>>>Midamble shift	CV-UE specific		Integer(0..15)		REL-7
>>>>>>>Type 2					
>>>>>>>>Midamble allocation mode	MP		Enumerated(Default, Common, UE specific)		REL-7
>>>>>>>>Midamble configuration burst type 2	MP		Enumerated(3, 6)		REL-7
>>>>>>>>Midamble shift	CV-UE specific		Integer(0..5)		REL-7
>>>>E-AGCH BLER target	MP		Real(-3.15 to 0 step 0.05)		REL-7
>>>7.68 Mcps TDD					REL-7
>>>>Long Term Grant Indicator	MD		Boolean	FALSE = Short Term TRUE = Long Term Default = FALSE (Short Term)	REL-7
>>>>Length of TTRI field	MP		Integer(1..12)	Indicated length of the bitmap used to indicate which of the timeslots configured for E-DCH are allocated	REL-7
>>>>E-AGCH set configuration	MP	<1 to maxNumE-AGCH>			REL-7

>>>>>TS number	MP		Integer(0..14)		REL-7
>>>>>Channelisation code	MP		Enumerated(32/1, 32/2, ..., 32/32)		REL-7
>>>>>CHOICE Burst Type					REL-7
>>>>>>Type 1					REL-7
>>>>>>>Midamble allocation mode	MP		Enumerated(Default, Common, UE specific)		REL-7
>>>>>>>Midamble configuration burst type 1	MP		Enumerated(4, 8, 16)		REL-7
>>>>>>>Midamble shift	CV-UE specific		Integer(0..15)		REL-7
>>>>>>>Type 2					
>>>>>>>>Midamble allocation mode	MP		Enumerated(Default, Common, UE specific)		REL-7
>>>>>>>>Midamble configuration burst type 2	MP		Enumerated(3, 6)		REL-7
>>>>>>>>Midamble shift	CV-UE specific		Integer(0..5)		REL-7
>>>>>E-AGCH BLER target	MP		Real(-3.15 to 0 step 0.05)		REL-7
>>>>1.28 Mcps TDD					REL-7
>>>>>RDI Indicator	MP		Boolean	TRUE indicates a RDI field is present on E-AGCH type 1,	REL-7
>>>>>TPC step size	MP		Integer (1, 2, 3)	dB.	REL-7
>>>>>E-AGCH set configuration	MP	<1 to maxNumE-AGCH>			REL-7
>>>>>>Timeslot number	MP		Integer (0..6)		REL-7
>>>>>>>First Channelisation code	MP		Enumerated ((16/1) ..(16/16))		REL-7
>>>>>>>Second Channelisation code	MP		Enumerated ((16/1) ..(16/16))		REL-7
>>>>>>>>Midamble Allocation mode	MP		Enumerated (Default midamble, Common midamble, UE specific midamble)		REL-7
>>>>>>>>Midamble configuration	MP		Integer (2, 4, 6, 8, 10, 12, 14, 16)		REL-7
>>>>>>>> Midamble Shift	CV-UE specific		Integer (0..15)		REL-7
>>>>>>>>E-AGCH BLER target	MP		Real(-3.15 to 0 step 0.05)		REL-7
>>>>>>>>E-AGCH Inactivity Monitor Threshold	MD		Enumerated (0, 1, 2, 4, 8, 16, 32, 64, 128, 256, 512, infinity)	Units of subframes. Default value is "8". Four spare values are needed.	REL-8

10.3.6.100a E-AGCH Info 1.28Mcps TDD

Includes the configuration for the E-DCH related Absolute Grant Channel.

Information Element/Group name	Need	Multi	Type and reference	Semantics description	Version
RDI Indicator	MP		Boolean	TRUE indicates a RDI field is present on E-AGCH type 1,	REL-8
TPC step size	MP		Integer (1, 2, 3)	dB.	REL-8
E-AGCH set configuration	MP	<1 to maxNumE-AGCH>			REL-8
>Timeslot number	MP		Integer (0..6)		REL-8
>First Channelisation code	MP		Enumerated ((16/1) ..(16/16))		REL-8
>Second Channelisation code	MP		Enumerated ((16/1) ..(16/16))		REL-8
>Midamble Allocation mode	MP		Enumerated (Default midamble, Common midamble, UE specific midamble)		REL-8
>Midamble configuration	MP		Integer (2, 4, 6, 8, 10, 12, 14, 16)		REL-8
>Midamble Shift	CV-UE specific		Integer (0..15)		REL-8
E-AGCH BLER target	MP		Real(-3.15 to 0 step 0.05)		REL-8

Condition	Explanation
UE specific	This IE is mandatory present when the value of the IE "Midamble Allocation Mode" is "UE specific midamble" and not needed otherwise.

10.3.6.101 E-HICH Info

Includes the configuration for the E-DCH related HARQ Acknowledgement Indicator Channel.

Information Element/Group name	Need	Multi	Type and reference	Semantics description	Version
CHOICE <i>mode</i>	MP				REL-7
>FDD					REL-7
>>Channelisation Code	MP		Integer (0..127)		REL-6
>>Signature Sequence	MP		Integer (0..39)		REL-6
>>Secondary TB Signature Sequence	OP		Integer (0..39)	The second E-HICH signature used to acknowledge the UL MIMO secondary stream transport block.	REL-11
>TDD					REL-7
>>CHOICE <i>TDD Option</i>	MP				REL-7
>>>3.84 Mcps TDD					REL-7
>>>>N _{E-HICH}	MP		Integer(4..44)	Minimum number of slots between start last active slot of E-DCH TTI and start of ACK/NACK on E-HICH (see[?])	REL-7
>>>>TS number	MP		Integer(0..14)		REL-7
>>>>Channelisation Code	MP		Enumerated(16/1, 16/2,..16/16)		REL-7
>>>>Burst type	MP		Enumerated(Type1, Type2)		REL-7
>>>>Midambe allocation mode	MP		Enumerated(Default, Common)		REL-7
>>>>7.68 Mcps TDD					REL-7
>>>>N _{E-HICH}	MP		Integer(4..44)	Minimum number of slots between start last active slot of E-DCH TTI and start of ACK/NACK on E-HICH (see[?])	REL-7
>>>>TS number	MP		Integer(0..14)		REL-7
>>>>Channelisation Code	MP		Enumerated(32/1, 32/2,..32/32)		REL-7
>>>>Burst type	MP		Enumerated(Type1, Type2)		REL-7
>>>>Midambe allocation mode	MP		Enumerated(Default, Common)		REL-7
>>>>1.28 Mcps TDD					REL-7
>>>> N _{E-HICH}	MP		Integer (4..15)	Minimum number of slots between start last active slot of E-DCH TTI and start of ACK/NACK on E-HICH	REL-7
>>>>E-HICH set configuration		<1 to maxNumE-HICH>			REL-7
>>>>>EI	MP		Integer (0..3)		REL-7

>>>>Timeslot number	MP		Integer (0..6)		REL-7
>>>>Channelisation code	MP		Enumerated ((16/1) ..(16/16))		REL-7
>>>>Midamble Allocation mode	MP		Enumerated (Default midamble, UE specific midamble)		REL-7
>>>>Midamble configuration	MP		Integer (2, 4, 6, 8, 10, 12, 14, 16)		REL-7
>>>>Midamble Shift	CV-UE specific		Integer (0..15)		REL-7

10.3.6.101a E-HICH Info 1.28Mcps TDD

Includes the configuration for the E-DCH related HARQ Acknowledgement Indicator Channel.

Information Element/Group name	Need	Multi	Type and reference	Semantics description	Version
NE-HICH	MP		Integer (4..15)	Minimum number of slots between start last active slot of E-DCH TTI and start of ACK/NACK on E-HICH	REL-8
E-HICH set configuration	MP	<1 to maxNumE-HICH>			REL-8
>EI	MP		Integer (0..3)		REL-8
>Timeslot number	MP		Integer (0..6)		REL-8
>Channelisation code	MP		Enumerated ((16/1) ..(16/16))		REL-8
>Midamble Allocation mode	MP		Enumerated (Default midamble, UE specific midamble)		REL-8
>Midamble configuration	MP		Integer (2, 4, 6, 8, 10, 12, 14, 16)		REL-8
>Midamble Shift	CV-UE specific		Integer (0..15)		REL-8

Condition	Explanation
UE specific	This IE is mandatory present when the value of the IE "Midamble Allocation Mode" is "UE specific midamble" and not needed otherwise.

10.3.6.102 E-RGCH Info (FDD only)

Includes the configuration for the E-DCH related Relative Grant Channel. The E-RGCH is using the same channelisation code as configured for the E-HICH channel (see subclause 10.3.6.101).

Information Element/Group name	Need	Multi	Type and reference	Semantics description	Version
Signature Sequence	MP		Integer(0..39)		REL-6
RG combination index	MP		Integer(0..5)	Cells with an index equal to the index of the Serving E-DCH cell belong to the Serving E-DCH RLS. The E-RGCH from these cells have RG commands which for the UE are known to be the same as the RG commands from the Serving E-DCH cell.	REL-6

10.3.6.103 E-RUCCH Info (TDD only)

Information Element/Group name	Need	Multi	Type and reference	Semantics description	Version
CHOICE TDD mode					REL-7
>3.84/7.68 Mcps TDD					REL-7
>>E-RUCCH constant value	MP		Integer (-35..10)	Power to be used	REL-7
>>E-RUCCH persistence scaling factor	MP		Real(0.9..0.2 by step of 0.1)		REL-7
>>T-RUCCH	MD		Integer(40..320 by step of 40)	Default =200ms If T-RUCH expires before Grant is received then uE should send scheduling information again on E-RUCH	REL-7
>>E-RUCCH timeslot number	MD		Timeslot number 10.3.6.84	Default is same as PRACH timeslot number	REL-7
>>E-RUCCH midamble	MD		Enumerated(Direct, Direct/Inverted)	Default is as PRACH midamble	REL-7
>>T-Adv	MD		Enumerated(1, 2, 4, 8, 16, 32, 128, infinity)	Default is 1 second	REL-7
>>T-SCHED	MD		Enumerated(0, 40ms, 80ms, 160ms, 250ms, 1sec, 2sec, 4sec)	Default is 0 second (include Scheduling Information in every MAC-e PDU)	REL-7
>>CHOICE TDD option					REL-7
>>>3.84 Mcps TDD					REL-7
>>>>CHOICE SF	MP				REL-7
>>>>>SF16					REL-7
>>>>>>Channelisation Code List	MP	1 to 8			REL-7
>>>>>>>Channelisation code	MP		Enumerated((16/1)..(16/8))	There is a 1:1 mapping between spreading code and midamble shift defined in [30] for channelisation codes (16/1) to (16/8). NOTE: channelisation codes (16/9) to (16/16) are not to be used.	REL-7
>>>>>>>SF8					REL-7
>>>>>>>>Channelisation Code List	MP	1 to 8			REL-7
>>>>>>>>>Channelisation Code	MP		Enumerated(8/1)..(8/8))		REL-7
>>>>7.68 Mcps TDD					REL-7
>>>>>CHOICE SF	MP				REL-7
>>>>>>>SF32					REL-7
>>>>>>>>>Channelisation Code List	MP	1 to 16			REL-7

>>>>>>Channelisation code	MP		Enumerated ((32/1)..(32/16))	There is a 1:1 mapping between spreading code and midamble shift defined in [30] for channelisation codes (32/1) to (32/16). NOTE: channelisation codes (32/17) to (32/32) are not to be used.	REL-7
>>>>>SF16					REL-7
>>>>>>Channelisation Code List	MP	1 to 16			REL-7
>>>>>>>Channelisation Code	MP		Enumerated((16/1)..(16/16))		REL-7
>1.28 Mcps TDD					REL-7
>>T-RUCCH	MD		Enumerated (20, 40, 60, 80, 120, 160, 200, 240, 280, 320, 400, 500, 600, 800, 1000, 2000)	Default = 120 ms If T-RUCCH expires before Grant is received then UE should send scheduling information again on E-RUCCH	REL-7
>>N-RUCCH	MD		Integer (0...7)	Default = 3 Maximum number of retransmissions of scheduling information on E-RUCCH	REL-7
>>T-WAIT	MD		Enumerated (everyEDCH TTI, 40, 80, 160, 320, 640, 1000, 2000)	Values in ms. Default = 40ms If T-WAIT expires then UE should send scheduling information on E-RUCCH	REL-7
>>T-SI	MD		Enumerated (everyEDCH TTI, 20, 40, 60, 80, 160, 200)	Values in ms. Default = 40ms If periodic T-SI expires then UE should include scheduling information in a new MAC-e PDU	REL-7
>>Extended Estimation Window	OP		Integer (2..5)	Values in 5ms TTI. Indicates how many next consecutive 5ms TTIs the UE should estimate whether there is a Grant valid before sending Scheduling Information via E-RUCCH	REL-7

>>E-RUCCH Access Service class	OP	1 to <maxASC >		If only "NumASC+1" (with, NumASC+1 < maxASC) ASCs are listed, the remaining (NumASC+2 through maxASC) ASCs are unspecified.	REL-7
>>>E-RUCCH ASC Setting	MD		ASC setting 10.3.6.6	The default values are same as the PRACH ASC. If the "default" is used for the first ASC, the default values are all available signatures and "all available sub-channels" for FDD and "all available channelisation codes" and "all available subchannels" with "subchannel size=Size 1" in TDD.	REL-7
>>E-RUCCH persistence scaling factor list	OP	1 to <maxASCp persist>		multiplicity corresponds to the number of E-RUCCH ASCs minus 2	REL-7
>>>Persistence scaling factor	MP		Real(0.9..0.2 by step of 0.1)		REL-7
>>SYNC_UL info	OP		SYNC_UL info for E-RUCCH 10.3.6.78d		REL-7
>>PRACH Information	OP	1..<maxPRACH_FPA CH>			REL-7
>>>Timeslot number	MP		Timeslot number 10.3.6.84		REL-7
>>> Channelisation Code List	MP	1 to 2			REL-7
>>>> Channelisation Code	MP		Enumerated ((4/1)..(4/4),(8/1)..(8/8),(16/1)..(16/16))		REL-7
>>>Midamble Shift and burst type	MP		Midamble shift and burst type 10.3.6.41		REL-7
>>>>FPACH info	OP		FPACH info 10.3.6.35a		REL-7

10.3.6.103a E-RUCCH Info 1.28Mcps TDD

Information Element/Group name	Need	Multi	Type and reference	Semantics description	Version
T-RUCCH	MD		Enumerated (20, 40, 60, 80, 120, 160, 200, 240, 280, 320, 400, 500, 600, 800, 1000, 2000)	Default = 120 ms If T-RUCCH expires before Grant is received then UE should send scheduling information again on E-RUCCH	REL-8
N-RUCCH	MD		Integer (0...7)	Default = 3 Maximum number of retransmissions of scheduling information on E-RUCCH	REL-8
T-WAIT	MD		Enumerated (everyEDCH TTI, 40, 80, 160, 320, 640, 1000, 2000)	Values in ms. Default = 40ms If T-WAIT expires then UE should send scheduling information on E-RUCCH	REL-8
T-SI	MD		Enumerated (everyEDCH TTI, 20, 40, 60, 80, 160, 200)	Values in ms. Default = 40ms If periodic T-SI expires then UE should include scheduling information in a new MAC-e PDU	REL-8
Extended Estimation Window	OP		Integer (2..5)	Values in 5ms TTI. Indicates how many next consecutive 5ms TTIs the UE should estimate whether there is a Grant valid before sending Scheduling Information via E-RUCCH	REL-8
E-RUCCH Access Service class	OP	1 to <maxASC >		If only "NumASC+1" (with, NumASC+1 < maxASC) ASCs are listed, the remaining (NumASC+2 through maxASC) ASCs are unspecified. The IE is only included when E-DCH is configured on secondary frequency for a specific UE	REL-8

>E-RUCCH ASC Setting	MD		ASC setting 10.3.6.6	The default values are same as the PRACH ASC. If the "default" is used for the first ASC, the default values are all available signatures and "all available sub-channels" for FDD and "all available channelisation codes" and "all available subchannels" with "subchannel size=Size 1" in TDD.	REL-8
E-RUCCH persistence scaling factor list	OP	1 to <maxASCp ersist>		multiplicity corresponds to the number of E-RUCCH ASCs minus 2	REL-8
>Persistence scaling factor	MP		Real(0.9..0.2 by step of 0.1)		REL-8
SYNC_UL info	OP		SYNC_UL info for E- RUCCH 10.3.6.78d		REL-8
PRACH Information	OP	1..<maxPR ACH_FPA CH>			REL-8
>Timeslot number	MP		Timeslot number 10.3.6.84		REL-8
> Channelisation Code List	MP	1 to 2			REL-8
>>Channelisation Code	MP		Enumerated ((4/1)..(4/4),(8/1)..(8/8),(1 6/1)..(16/16))		REL-8
>Midamble Shift and burst type	MP		Midamble shift and burst type 10.3.6.41		REL-8
>FPACH info	OP		FPACH info 10.3.6.35a		REL-8

10.3.6.104 E-PUCH Info (TDD only)

Information Element/Group name	Need	Multi	Type and reference	Semantics description	Version
E-TFCS information	MP		E-TFCS info 10.3.6.105		REL-7
CHOICE TDD mode					REL-7
>3.84/7.68 Mcps TDD					REL-7
>>N _{E-UCCH}	MD		Integer(1..12)	No of slots that are required to carry TPC and TFCI (consecutively allocated slots beginning with the first). Default = 1 (first allocated slot).	REL-7
>>E-PUCH constant value	MP		Integer (-35..10)	Power to be used	REL-7
>>E-PUCH TS configuration list	MP	<1 to maxTS-2>			REL-7
>>>TS number	MP		Integer(0..14)		REL-7
>>>CHOICE <i>Burst Type</i>	MP				REL-7
>>>>Type 1					REL-7
>>>>>Midamble allocation mode	MP		Enumerated(Default, UE specific)		REL-7
>>>>>Midamble configuration burst type 1	MP		Enumerated(4, 8, 16)		REL-7
>>>>>Midamble shift	CV-UE specific		Integer (0..15)		REL-7
>>>>>Type 2					REL-7
>>>>>Midamble allocation mode	MP		Enumerated(Default, UE specific)		REL-7
>>>>>Midamble configuration burst type 2	MP		Enumerated(3, 6)		REL-7
>>>>>Midamble shift	CV-UE specific		Integer (0..5)		REL-7
>>E-PUCH code hopping	MP		Boolean		REL-7
>>E-PUCH TPC step size	MP		Integer (1,2,3)		REL-7
>>Minimum allowed code rate	MP		Integer (0..63)	Maps 0.055 to 1.0 in steps of 0.015	REL-7
>>Maximum allowed code rate	MP		Integer (0..63)	Maps 0.055 to 1.0 in steps of 0.015	REL-7
>1.28 Mcps TDD					REL-7
>>SNPL Reporting Type	OP		Enumerated (type1, type2)		REL-7
>>PRXdes_base	MP		Integer (-112..-50 by step of 1)	dBm. Reference desired power level for E-PUCH	REL-7
>>Beacon PL Est.	MD		Boolean	TRUE indicates that the UE may take into account path loss estimated from beacon function physical channels. Default value is FALSE	REL-7
>>TPC step size	MP		Integer (1, 2, 3)	dB.	REL-7

>>Pebase power control gap	MD		Integer (1...255)	Unit: Number of subframes, Default value is 1. Value 255 represents infinite in which case closed loop power control shall always be used.	REL-7
>>Uplink synchronisation parameters	MD			Default: Uplink synchronisation step size 1. Uplink synchronisation frequency 1.	REL-7
>>>Uplink synchronisation step size	MP		Integer (1..8)	This parameter specifies the step size to be used for the adjustment of the uplink transmission timing	REL-7
>>>Uplink synchronisation frequency	MP		Integer (1..8)	This parameter specifies the frequency of the adjustment of the uplink transmission timing	REL-7
>>E-PUCH TS configuration list	MP	<1 to maxTS-LCR-1>			REL-7
>>>TS number	MP		Integer (1..5)		REL-7
>>>Midamble shift and burst type	MP				REL-7
>>>>Midamble Allocation Mode	MP		Enumerated (Default midamble, UE specific midamble)		REL-7
>>>>Midamble configuration	MP		Integer (2, 4, 6, 8, 10, 12, 14, 16)	As defined in [30]	REL-7
>>>>Midamble Shift	CV-UE specific		Integer (0..15)		REL-7
>>Minimum allowed code rate	MP		Integer (0..63)	Maps 0.055 to 1.0 in steps of 0.015	REL-7
>>Maximum allowed code rate	MP		Integer (0..63)	Maps 0.055 to 1.0 in steps of 0.015	REL-7
>>Maximum number of retransmissions for Scheduling Info	MP		Integer (0..15)	Only used when no MAC-d PDUs are included in the same MAC-e PDU or MAC-i PDU.	REL-7
>>Retransmission Timer for Scheduling Info	MP		Enumerated (10, 15, 20, 25, 30, 35, 40, 45, 50, 55, 60, 65, 70, 75, 80, 85, 90, 95, 100, 110, 120, 140, 160, 200, 240, 280, 320, 400, 480, 560)	Only used when no MAC-d PDUs are included in the same MAC-e PDU or MAC-i PDU. Unit is ms.	REL-7

Power Offset for Scheduling Info	OP		Integer (0..6)	If present, this IE should be ignored for LCR TDD. Only used when no MACd PDUs are included in the same MACe PDU. Unit is in dB.	REL-7
----------------------------------	----	--	----------------	--	-------

Condition	Explanation
<i>UE specific</i>	This IE is mandatory present when the value of the IE "Midamble Allocation Mode" is "UE specific midamble" and not needed otherwise.

10.3.6.104a E-PUCH Info 1.28Mcps TDD

Information Element/Group name	Need	Multi	Type and reference	Semantics description	Version
E-TFCS information	MP		E-TFCS info 10.3.6.105		REL-8
SNPL Reporting Type	OP		Enumerated (type1, type2)		REL-8
PRXdes_base	MP		Integer (-112..-50 by step of 1)	dBm. Reference desired power level for E-PUCH	REL-8
Beacon PL Est.	MD		Boolean	TRUE indicates that the UE may take into account path loss estimated from beacon function physical channels. Default value is FALSE	REL-8
TPC step size	MP		Integer (1, 2, 3)	dB.	REL-8
Pebase power control gap	MD		Integer (1...255)	Unit: Number of subframes, Default value is 1. Value 255 represents infinite in which case closed loop power control shall always be used.	REL-8
Uplink synchronisation parameters	MD			Default: Uplink synchronisation step size 1. Uplink synchronisation frequency 1.	REL-8
>Uplink synchronisation step size	MP		Integer (1..8)	This parameter specifies the step size to be used for the adjustment of the uplink transmission timing	REL-8
>Uplink synchronisation frequency	MP		Integer (1..8)	This parameter specifies the frequency of the adjustment of the uplink transmission timing	REL-8
E-PUCH TS configuration list	MP	<1 to maxTS- LCR-1>			REL-8
>TS number	MP		Integer (1..5)		REL-8
>Midamble shift and burst type	MP				REL-8
>>Midamble Allocation Mode	MP		Enumerated (Default midamble, UE specific midamble)		REL-8
>>Midamble configuration	MP		Integer (2, 4, 6, 8, 10, 12, 14, 16)	As defined in [30]	REL-8
>>Midamble Shift	CV-UE specific		Integer (0..15)		REL-8
Minimum allowed code rate	MP		Integer (0..63)	Maps 0.055 to 1.0 in steps of 0.015	REL-8

Maximum allowed code rate	MP		Integer (0..63)	Maps 0.055 to 1.0 in steps of 0.015	REL-8
Maximum number of retransmissions for Scheduling Info	MP		Integer (0..15)	Only used when no MAC-d PDUs are included in the same MAC-i PDU.	REL-8
Retransmission Timer for Scheduling Info	MP		Enumerated (10, 15, 20, 25, 30, 35, 40, 45, 50, 55, 60, 65, 70, 75, 80, 85, 90, 95, 100, 110, 120, 140, 160, 200, 240, 280, 320, 400, 480, 560)	Only used when no MAC-d PDUs are included in the same MAC-i PDU. Unit is ms.	REL-8

10.3.6.104b E-PUCH Info for multi-carrier E-DCH 1.28Mcps TDD

Information Element/Group name	Need	Multi	Type and reference	Semantics description	Version
E-PUCH TS configuration list	MP	<1 to maxTS-LCR-1>			REL-10
>TS number	MP		Integer (1..5)		REL-10
>Midamble shift and burst type	MP				REL-10
>>Midamble Allocation Mode	MP		Enumerated (Default midamble, UE specific midamble)		REL-10
>>Midamble configuration	MP		Integer (2, 4, 6, 8, 10, 12, 14, 16)	As defined in [30]	REL-10
>>Midamble Shift	CV-UE specific		Integer (0..15)		REL-10

Condition	Explanation
<i>UE specific</i>	If UE specific midamble allocation mode is configured, this IE is mandatory, otherwise it is not needed.

10.3.6.105 E-TFCS info (TDD only)

IE/Group Name	Presence	Multi	IE Type and Reference	Semantics Description	Version
Reference Beta Information QPSK list	MP	<1 to 8>			REL-7
>Reference Code Rate	MP		Integer (0..10)	Unit: - Range: 0..1 Step: 0.1	REL-7
>Reference Beta	MP		Integer (-15..16)	Unit range -15db to +16db	REL-7
Reference Beta Information 16QAM list	MP	<1 to 8>			REL-7
>Reference Code Rate	MP		Integer (0..10)	Unit: - Range: 0..1 Step: 0.1	REL-7
>Reference Beta	MP		Integer (-15..16)	Unit range -15db to +16db	REL-7

10.3.6.106 E-TFC Boost Info

Information Element/Group name	Need	Multi	Type and reference	Semantics description	Version
E-TFCI boost	MP		Integer (0..127)	E-TFCI threshold beyond which boosting of E-DPCCH is enabled	REL-7
Delta T2TP	CV- <i>E-TFCI boost127</i>		Integer (0..6)		REL-7

Condition	Explanation
<i>E-TFCI boost127</i>	If E-TFCI-Boost is set to 127 this IE is not needed, otherwise it is mandatory.

10.3.6.107 Control Channel DRX information 1.28Mcps TDD

NOTE: For 1.28 Mcps TDD only.

Information Element/Group name	Need	Multi	Type and reference	Semantics description	Version
CHOICE <i>Control Channel DRX operation</i>	MP				REL-8
>Continue Control Channel DRX operation					REL-8
>>Enabling Delay	OP		Enumerated (0, 1, 2, 4, 8, 16, 32, 64, 128, infinity)	In radio frames. Six spare values are needed.	REL-8
>New Control Channel DRX operation					REL-8
>>HS-SCCH DRX information	MP		HS-SCCH DRX information 1.28 Mcps TDD 10.3.6.108		REL-8
>>E-AGCH DRX Information	OP		E-AGCH DRX information 1.28 Mcps TDD 10.3.6.109		REL-8
>>Enabling Delay	MP		Enumerated (0, 1, 2, 4, 8, 16, 32, 64, 128, infinity)	In radio frames. Six spare values are needed.	REL-8

10.3.6.108 HS-SCCH DRX information 1.28 Mcps TDD

NOTE: For 1.28 Mcps TDD only.

Information Element/Group name	Need	Multi	Type and reference	Semantics description	Version
HS-SCCH DRX cycle	MP		Enumerated (1, 2, 4, 8, 16, 32, 64)	Units of subframes. One spare value is needed.	REL-8
Inactivity Threshold for HS-SCCH DRX cycle	OP		Enumerated (1, 2, 4, 8, 16, 32, 64, 128, 256, 512, infinity)	Units of subframes. Five spare values are needed.	REL-8
HS-SCCH DRX Offset	MP		Integer (0..63)	Units of subframes. Offset of the HS-SCCH DRX cycles.	REL-8

10.3.6.109 E-AGCH DRX information 1.28 Mcps TDD

NOTE: For 1.28 Mcps TDD only.

Information Element/Group name	Need	Multi	Type and reference	Semantics description	Version
CHOICE <i>E-AGCH DRX information type</i>	MP				REL-8
>Same as HS-SCCH				(no data) Indicate the E-AGCH DRX Cycle and Offset are the same as the HS-SCCH DRX Cycle and Offset, and the E-AGCH Inactivity Monitor Threshold is absent	REL-8
>E-AGCH DRX parameters					REL-8
>>E-AGCH DRX cycle	MP		Enumerated (1, 2, 4, 8, 16, 32, 64)	Units of subframes. One spare value is needed.	REL-8
>>E-AGCH Inactivity Monitor Threshold	OP		Enumerated (0, 1, 2, 4, 8, 16, 32, 64, 128, 256, 512, infinity)	Units of subframes. Four spare values are needed. If it is absent, the same IE in the IE "E-AGCH Info" is used as E-AGCH inactivity monitor threshold.	REL-8
>>E-AGCH DRX Offset	MP		Integer (0..63)	Units of subframes. Offset of the E-AGCH DRX cycles.	REL-8

10.3.6.110 SPS information 1.28 Mcps TDD

NOTE: For 1.28 Mcps TDD only.

Information Element/Group name	Need	Multi	Type and reference	Semantics description	Version
E-DCH SPS information	OP		E-DCH SPS information 1.28 Mcps TDD 10.3.6.111		REL-8
HS-DSCH SPS information	OP		HS-DSCH SPS information 1.28 Mcps TDD 10.3.6.112		REL-8

10.3.6.111 E-DCH SPS information 1.28 Mcps TDD

NOTE: For 1.28 Mcps TDD only.

Information Element/Group name	Need	Multi	Type and reference	Semantics description	Version
CHOICE <i>E-DCH SPS operation</i>	MP				REL-8
>Continue <i>E-DCH SPS operation</i>				(no data)	REL-8
>New <i>E-DCH SPS operation</i>					REL-8
>> <i>E-HICH Information</i>	MP				REL-8
>>> <i>CHOICE Configuration Mode</i>	MP				REL-8
>>>> <i>Implicit</i>					REL-8
>>>>> <i>EI</i>	OP		Integer (0..3)	If the IE does not exist, UE shall use the same configuration as the <i>E-HICH</i> for non-schedule transmission	REL-8
>>>>> <i>Explicit</i>					REL-8
>>>>> <i>Timeslot number</i>	MP		Integer (0..6)		REL-8
>>>>> <i>Channelisation code</i>	MP		Enumerated ((16/1)..(16/16))		REL-8
>>>>> <i>Midamble Allocation mode</i>	MP		Enumerated (Default midamble, UE specific midamble)		REL-8
>>>>> <i>Midamble configuration</i>	MP		Integer (2, 4, 6, 8, 10, 12, 14, 16)		REL-8
>>>>> <i>Midamble Shift</i>	<i>CV-UE specific</i>		Integer (0..15)		REL-8
>>> <i>Signature Sequence Group Index</i>	MP		Integer (0..19)		REL-8
>> <i>Transmission Pattern List</i>	OP	1..<maxEDC HTxPattern-TDD128>			REL-8
>>> <i>Repetition period</i>	MP		Integer (1, 2, 4, 8, 16, 32)	Value 1 indicate continuous	REL-8
>>> <i>Repetition length</i>	MP		Integer (1..Repetition period – 1)	NOTE: This is empty if repetition period is set to 1.	REL-8
>> <i>Initial SPS info for E-DCH</i>	OP				REL-8
>>> <i>N_{E-UCCH}</i>	MD		Integer (1..8)	Number of <i>E-UCCH</i> and <i>TPC</i> instances within an <i>E-DCH</i> TTI. Default = 1.	REL-8
>>>> <i>Code Resource Information</i>	MP		Enumerated ((1/1), (2/1), (2/2), (4/1)..(4/4), (8/1)..(8/8), (16/1)..(16/16))	As defined in [31], indicating which of the Channel Codes configured for <i>E-DCH</i> are allocated for <i>SPS</i> resource	REL-8
>>>> <i>Timeslot Resource Related Information_l</i>	MP		Bit string (5)	As defined in [31], indicating which of the timeslots configured for <i>E-DCH</i> are allocated for <i>SPS</i> resource	REL-8
>>>> <i>Power Resource Related Information</i>	MP		Integer (1..32)	Indicates 0-31 <i>PRRI</i> index defined in [31], which specifies the maximum allowed <i>E-PUCH</i> resource that the UE may use [15].	REL-8
>>>> <i>Activation Time</i>	MP		Activation time 10.3.3.1	Specifies the <i>E-PUCH</i> Offset in Radio Frame level.	REL-8

Information Element/Group name	Need	Multi	Type and reference	Semantics description	Version
>>>Subframe number	MP		Integer (0..1)	Specifies the E-PUCH Offset in subframe level.	REL-8
>>>Initial Tx pattern Index	MP		Integer (0..maxEDCHTx Pattern-TDD128-1)		REL-8

Condition	Explanation
<i>UE specific</i>	If UE specific midamble allocation mode is configured, this IE is mandatory, otherwise it is not needed.

10.3.6.112 HS-DSCH SPS information 1.28 Mcps TDD

NOTE: For 1.28 Mcps TDD only.

Information Element/Group name	Need	Multi	Type and reference	Semantics description	Version
CHOICE <i>HS-DSCH SPS operation</i>	MP				REL-8
>Continue HS-DSCH SPS operation				(no data)	REL-8
>New HS-DSCH SPS operation					REL-8
>>Transport Block Size List	OP	1..<maxTbsForHSDSCH-TDD128>			REL-8
>>>Transport Block Size Index	MP		Integer (1..63)	Index of the MAC-hs transport block size as described in [15]	REL-8
>>Receive Pattern List	OP	1..<maxRXPatterForHSDSCH-TDD128>			REL-8
>>>Repetition period	MP		Integer (1, 2, 4, 8, 16, 32)	Value 1 indicate continuous	REL-8
>>>Repetition length	MP		Integer (1..Repetition period – 1)	NOTE: This is empty if repetition period is set to 1.	REL-8
>>HARQ Info for Semi-Persistent Scheduling	OP				REL-8
>>>Number of Processes	MP		Integer (1..8)		REL-8
>>>Process Memory size	MP		Integer (800 .. 16000 by step of 800, 17600 .. 32000 by step of 1600, 36000 .. 80000 by step of 4000, 88000 .. 160000 by step of 8000, 176000 .. 304000 by step of 16000)	Maximum number of soft channel bits available in the virtual IR buffer [27]	REL-8
>>HS-SICH List	MP	1..<maxHSSICH-TDD128>			REL-8
>>>CHOICE <i>Configuration Mode</i>	MP				REL-8
>>>>Implicit					REL-8
>>>>>HS-SCCH Index	MP		Integer (1..maxHSSCC Hs)		REL-8
>>>>>Explicit					REL-8
>>>>>Timeslot number	MP		Integer (0..6)		REL-8
>>>>>Channelisation code	MP		Enumerated ((16/1) ..(16/16))		REL-8
>>>>>Midamble Allocation mode	MP		Enumerated (Default midamble, UE specific midamble)		REL-8
>>>>>Midamble configuration	MP		Integer (2, 4, 6, 8, 10, 12, 14, 16)		REL-8
>>>>>Midamble Shift	CV-UE		Integer (0..15)		REL-8

Information Element/Group name	Need	Multi	Type and reference	Semantics description	Version
>>Initial SPS info for HS-DSCH	OP				REL-8
>>>Timeslot Information	MP		Bit string (5)	As defined in [31], indicating which of the timeslots configured for HS-PDSCH are allocated for SPS resource	REL-8
>>>Code Resource Information	MP			Note 1	REL-8
>>>>Start code	MP		Enumerated ((16/1)..(16/16))		REL-8
>>>>Stop code	MP		Enumerated ((16/1)..(16/16))		REL-8
>>>Activation Time	MP		Activation time 10.3.3.1	Specifies the HS-PDSCH Offset in Radio Frame level.	REL-8
>>>Subframe number	MP		Integer (0..1)	Specifies the HS-PDSCH Offset in subframe level.	REL-8
>>>Initial Transport Block Size Index	MP		Integer (0..maxTbsForHSDSCH-TDD128-1)		REL-8
>>>Initial Rx pattern Index	MP		Integer (0..maxRxPatternForHSDSCH-TDD128-1)		REL-8
>>>HS-SICH Index	MP		Integer (0..maxHSSICH-TDD128-1)		REL-8
>>>Modulation	MP		Enumerated (QPSK, 16QAM)		REL-8

Condition	Explanation
<i>UE specific</i>	If UE specific midamble allocation mode is configured, this IE is mandatory, otherwise it is not needed.

NOTE 1: HS-PDSCH channelisation codes are allocated contiguously from a signalled start code to a signalled stop code, and the allocation includes both the start and stop code. If a value of Start code = 16 and Stop code = 1 is signalled, a spreading factor of SF=1 shall be used for the HS-PDSCH resources.

10.3.6.113 Downlink channelisation codes MBSFN IMB

NOTE: 3.84 Mcps TDD MBSFN IMB only.

Information Element/Group name	Need	Multi	Type and reference	Semantics description	Version
First channelisation code	MP		Integer (1..15)	Channelisation code (F) for SF16	REL-8
Last channelisation code	OP		Integer (1..15)	Channelisation code (L) for SF16; If present: consecutive codes from F to L (modulo 16, excluding code 0) are used; If absent: only one code (F) is used	REL-8

10.3.6.114 Secondary CCPCH frame type 2 info

NOTE: 3.84 Mcps TDD MBSFN IMB only.

Information Element/Group name	Need	Multi	Type and reference	Semantics description	Version
Sub-frame number	MP		Integer (0..4)		REL-8
Downlink channelisation codes	MP		Downlink channelisation codes MBSFN IMB 10.3.6.113		REL-8
CHOICE <i>modulation</i>	MP				REL-8
>QPSK				(no data)	REL-8
>16QAM					REL-8
>>CPICH secondary CCPCH power offset	MP		Integer (-11..4)	In dB	REL-8

10.3.6.115 Uplink secondary cell info FDD

NOTE: For FDD only.

Information Element/Group name	Need	Multi	Type and reference	Semantics description	Version
CHOICE Configuration info	MP				REL-9
>Continue			(no data)	Uplink secondary cell info parameters remain unchanged.	REL-9
>New configuration					REL-9
>>Secondary serving E-DCH cell info	OP		Secondary serving E-DCH cell info 10.3.6.116		REL-9
>>Secondary E-DCH info common	OP		Secondary E-DCH info common 10.3.6.117		REL-9
>>Downlink information per radio link list on secondary UL frequency	OP		Downlink information per radio link list on secondary UL frequency 10.3.6.118		REL-9

10.3.6.116 Secondary serving E-DCH cell info

NOTE: For FDD only.

Information Element/Group name	Need	Multi	Type and reference	Semantics description	Version
Primary E-RNTI	OP		E-RNTI 10.3.3.10a		REL-9
Secondary E-RNTI	OP		E-RNTI 10.3.3.10a		REL-9

10.3.6.117 Secondary E-DCH info common

NOTE: For FDD only.

Information Element/Group name	Need	Multi	Type and reference	Semantics description	Version
--------------------------------	------	-------	--------------------	-----------------------	---------

Frequency info	MP		Frequency info 10.3.6.36		REL-9
Scrambling code type	MP		Enumerated(short, long)		REL-9
Scrambling code number	MP		Integer(0..16 777215)		REL-9
2ms scheduled transmission grant HARQ process allocation	MD		Bitstring (8)	MAC-d PDUs are only allowed to be transmitted in those processes for which the bit is set to "1". Bit 0 corresponds to HARQ process 0, bit 1 corresponds to HARQ process 1,... Default value is: transmission in all HARQ processes is allowed. Bit 0 is the first/leftmost bit of the bit string.	REL-9
Serving Grant	OP				REL-9
>Primary/Secondary Grant Selector	MP		Enumerated ("primary", "secondary")	Indicates whether the Serving Grant is received with a Primary E-RNTI or Secondary E- RNTI	REL-9
Minimum reduced E-DPDCH gain factor	OP		Enumerated (8/15, 11/15, 15/15, 21/15, 30/15, 42/15, 60/15, 84/15)	$\beta_{ed,k, reduced, min}$ [29]; the default value is 8/15. If the configurable reduced E- DPDCH gain factor is not supported by the UE, the default value is used.	REL-9
E-DCH minimum set E-TFCI	OP		Integer (0..127)	See [15]; Absence means no E-DCH minimum set on secondary uplink frequency	REL-9
Minimum TEBS threshold	CV- <i>Implicit</i>		Enumerated(2, 4, 8, 16, 32, 64, 128, 256, 512, 1024, 2K, 4K, 8K, 16K, 32K, 64K, 128K, 256K, 512K, 1024K)	In bytes And N Kbytes = N*1024 bytes. Twelve spare values are needed.	REL-12
Implicit Grant handling	CV- <i>Message</i>		Enumerated (TRUE)	Absence of this information element means that the UE is not configured for Implicit Grant handling on the secondary uplink frequency.	REL-12

DPCCH Power offset for secondary UL frequency	MP		Integer (0..7 by step of 1)	In dB The power offset between the initial DPCCH power level on secondary UL frequency when it is activated and the current DPCCH power level on primary UL frequency.	REL-9
PC Preamble	MP		Integer (0..7)	In number of frames	REL-9
DPCCH Power Reset after DTX on secondary uplink frequency	CV- Message		DPCCH Power Reset after DTX on secondary uplink frequency 10.3.6.151		REL-12

Condition	Explanation
<i>Message</i>	This IE is not needed if the IE "Uplink secondary cell info FDD" is included in HANDOVER TO UTRAN COMMAND message. Otherwise it is optional.
<i>Implicit</i>	This IE is optional if the IE "Implicit Grant handling" is present in the message. Otherwise it is not needed.

10.3.6.118 Downlink information per radio link list on secondary UL frequency

NOTE: For FDD only.

Information Element/Group name	Need	Multi	Type and reference	Semantics description	Version
Downlink information for each radio link on secondary UL frequency		1 to <maxEDC HRL>			REL-9
>Primary CPICH info	MP		Primary CPICH info 10.3.6.60		REL-9
>Cell ID	OP		Cell ID 10.3.2.2		REL-9
>Downlink F-DPCH info for each RL on secondary UL frequency	MP		Downlink F-DPCH info for each RL 10.3.6.23ob		REL-9
>E-AGCH Info	OP		E-AGCH Info 10.3.6.100		REL-9
>E-HICH Information	OP		E-HICH Info 10.3.6.101		REL-9
>CHOICE <i>E-RGCH Information</i>	OP				REL-9
>>E-RGCH Information			E-RGCH Info 10.3.6.102		REL-9
>>E-RGCH release indicator				(no data)	REL-9
>Secondary serving E-DCH radio link indicator	CV- Message		Enumerated (TRUE)	TRUE indicates that this radio link is the secondary serving E-DCH radio link	REL-12
>Radio Links without DPCH/F-DPCH indicator	CV- Message2			(no data)	REL-12

Condition	Explanation
Message	This IE is not needed if the IE "Uplink secondary cell info FDD" is included in HANDOVER TO UTRAN COMMAND message. Otherwise it is optional.
Message2	This IE is not needed if the IE "Uplink secondary cell info FDD" is included in HANDOVER TO UTRAN COMMAND message, or if the IE "Uplink secondary cell info FDD" is included as part of Target cell preconfiguration information in the ACTIVE SET UPDATE message. Otherwise it is optional.

10.3.6.119 Radio link addition information on secondary UL frequency

NOTE: For FDD only.

Information Element/Group name	Need	Multi	Type and reference	Semantics description	Version
Radio link addition information list on secondary UL frequency		1 to <maxEDC HRL-1>			REL-9
>Primary CPICH info	MP		Primary CPICH info 10.3.6.60		REL-9
>Cell ID	OP		Cell ID 10.3.2.2		REL-9
>Downlink F-DPCH info for each RL on secondary UL frequency	MP		Downlink F-DPCH info for each RL 10.3.6.23ob		REL-9
>E-HICH Information	MP		E-HICH Info 10.3.6.101		REL-9
>E-RGCH Information	OP		E-RGCH Info 10.3.6.102		REL-9
>Radio Links without DPCH/F-DPCH indicator	OP			(no data)	REL-12

10.3.6.120 Radio link removal information on secondary UL frequency

NOTE: For FDD only.

Information Element/Group name	Need	Multi	Type and reference	Semantics description	Version
Radio link removal information list on secondary UL frequency		1 to <maxEDC HRL>			REL-9
>Primary CPICH info	MP		Primary CPICH info 10.3.6.60		REL-9

10.3.6.121 E-DCH reconfiguration information on secondary UL frequency

NOTE: For FDD only.

Information Element/Group name	Need	Multi	Type and reference	Semantics description	Version
--------------------------------	------	-------	--------------------	-----------------------	---------

E-DCH RL Info for new secondary serving E-DCH cell	OP				REL-9
>E-AGCH Info	MP		E-AGCH Info 10.3.6.100		REL-9
>E-HICH Information	OP		E-HICH Info 10.3.6.101	This IE is not present if the secondary serving E-DCH cell is added to the secondary E-DCH active set with this message.	REL-9
>CHOICE E-RGCH Information	OP			This IE is not present if the secondary serving E-DCH cell is added to the secondary E-DCH active set with this message.	REL-9
>>E-RGCH Information	MP		E-RGCH Info 10.3.6.102		REL-9
>>E-RGCH release indicator				(no data)	REL-9
E-DCH RL Info for other cells	OP	1 to <maxEDC HRL>		This IE is not allowed to include information on a RL added by this message, except in the case of an update to target cell preconfiguration information.	REL-9
>Primary CPICH info	MP		Primary CPICH info 10.3.6.60		REL-9
>E-HICH Information	OP		E-HICH Info 10.3.6.101		REL-9
>CHOICE E-RGCH Information	OP				REL-9
>>E-RGCH Information	MP		E-RGCH Info 10.3.6.102		REL-9
>>E-RGCH release indicator				(no data)	REL-9

10.3.6.122 MU-MIMO info 1.28 Mcps TDD

For 1.28 Mcps TDD only

Information Element/Group name	Need	Multi	Type and reference	Semantics description	Version
CHOICE MU-MIMO info	MP				REL-10
>Continue			(no data)		REL-10
>New configuration					REL-10
>>MU-MIMO operation	MP		Enumerated (Uplink, Downlink, Uplink and Downlink)	One spare value is needed.	REL-10
>>Standalone midamble info	OP				REL-10
>>>Midamble configuration	MP		Integer (2, 4, 6, 8, 10, 12, 14, 16)	Midamble Allocation mode is UE specific midamble allocation	REL-10

Information Element/Group name	Need	Multi	Type and reference	Semantics description	Version
>>>Midamble shift	MP		Integer (0..15)	The allocated midamble shift.	REL-10
>>>Timeslot information	MP		Bit string (5)	Each bit indicates availability of a timeslot, where the timeslot is numbered "Timeslot 1" to "Timeslot 5". The value 1 of a bit indicates that the corresponding timeslot is available. "Timeslot 1" is the first/leftmost bit of the bit string.	REL-10
>>>Activation time	MP		Activation time 10.3.3.1	Specifies the standalone midamble channel Offset in Radio Frame level.	REL-10
>>>Subframe number	MP		Integer (0..1)	Specifies the standalone midamble channel Offset in subframe level.	REL-10
>>>Repetition period	MP		Enumerated (1, 2, 4, 8, 16, 32, 64)	Value 1 indicates continuous, in subframe level. One spare value is needed.	REL-10
>>>Reference beta	CV-UL_E-DCH		Integer (-15..16)	In dB.	REL-10

Condition	Explanation
UL_E-DCH	This IE is mandatory present if IE "uplink transport channel type" is equal to "E-DCH". Otherwise it is not needed.

10.3.6.123 E-RGCH Info for Common E-DCH

Includes the configuration for the E-DCH related Relative Grant Channel to be used with common E-DCH in CELL_FACH and Idle mode. The E-RGCH is using the same channelisation code as configured for the E-HICH channel (see subclause 10.3.6.124).

Information Element/Group name	Need	Multi	Type and reference	Semantics description	Version
Signature Sequence	MD		Integer(0..39)	NOTE1	REL-8
NOTE1: The default value is defined by: Signature Sequence = (offset + common E-DCH resource list position) mod 40 where "offset" is the value of the last occurrence of the IE "Signature Sequence". If "Signature Sequence" is not present in the first occurrence, "offset" is equal to zero. "common E-DCH resource list position" indicates the Common E-DCH resource Configuration Information number by order of appearance. The value of the "common E-DCH resource list position" is zero for the first occurrence.					

10.3.6.124 E-HICH Info for Common E-DCH

Includes the configuration for the E-DCH related HARQ Acknowledgement Indicator Channel.

Information Element/Group name	Need	Multi	Type and reference	Semantics description	Version
Channelisation Code	CV-Short		Integer (0..127)	If this IE is not present, the value is equal to the last occurrence of this IE.	REL-8
Signature Sequence	MD		Integer (0..39)	NOTE1	REL-8
NOTE1: The default value is defined by: Signature Sequence = (offset + common E-DCH resource list position) mod 40 where "offset" is the value of the last occurrence of the IE "Signature Sequence". If "Signature Sequence" is not present in the first occurrence, "offset" is equal to zero. "common E-DCH resource list position" indicates the Common E-DCH resource Configuration Information number by order of appearance. The value of the "common E-DCH resource list position" is zero for the first occurrence.					

Condition	Explanation
<i>Short</i>	This IE is mandatory present for the first occurrence. Otherwise, this IE is optional.

10.3.6.125 Uplink CLTD info FDD

Information Element/Group name	Need	Multi	Type and Reference	Semantics description	Version
CHOICE Configuration info	MP				REL-11
>Continue			(no data)	Used in reconfigurations without interruption of uplink CLTD operation.	REL-11
>New configuration					
>>S-DPCCH info	MP				REL-11
>>>S-DPCCH/DPCCH power offset	MP		Integer (0..6)	Refer to quantization of the power offset in [28].	REL-11
>>Initial CLTD activation state	CV- <i>InitConfig</i>		Enumerated (first state, second state)	Indicates the CLTD activation state as described in [27].	REL-11
>>Primary CPICH info	CV- <i>DCHorMultiflow</i>		Primary CPICH Info 10.3.6.60	Indicates the cell that determines the precoding weights amongst the active set cells.	REL-11

Condition	Explanation
<i>DCHorMultiflow</i>	If Uplink CLTD operation is configured, this IE is mandatory present if HS-DSCH is not configured and only DCH is configured. If the Multiflow operation and Uplink CLTD are simultaneously configured, then this IE is optional and indicates the Multiflow assisting serving HS-DSCH cell.
<i>InitConfig</i>	This IE is mandatory present in the initial uplink CLTD configuration. Otherwise it is optional.

10.3.6.126 Uplink OLTD info FDD

Information Element/Group name	Need	Multi	Type and reference	Semantics description	Version
Uplink OLTD activation	MP		Enumerated (TRUE)		REL-11

10.3.6.127 F-TPICH info

NOTE: Only for FDD.

Information Element/Group name	Need	Multi	Type and reference	Semantics description	Version
F-TPICH slot format	MP		Integer (0..9)	Slot format used by F-TPICH in [26].	REL-11
F-TPICH code number	MP		Integer (0..255)		REL-11
F-TPICH frame offset	MP		Integer (0..38144 by step of 256)	Offset (in number of chips) between the beginning of the P-CCPCH frame and the beginning of the F-TPICH frame. This is called $\tau_{F-TPICH,m}$ in [26].	REL-11

NOTE: The UTRAN should configure the F-TPICH info either only for the RL transmitted from the cell which determines the precoding weights, or for all the RL(s) within the RLS that the cell which determines the precoding weights belongs to, otherwise the UE behaviour is not specified.

10.3.6.128 F-TPICH reconfiguration info

NOTE: Only for FDD.

Information Element/Group name	Need	Multi	Type and reference	Semantics description	Version
F-TPICH info new cell that determines the precoding weights	OP			This IE is not present if the cell is added to the active set with this message.	REL-11

Information Element/Group name	Need	Multi	Type and reference	Semantics description	Version
>F-TPICH info	MP		F-TPICH Info 10.3.6.127		REL-11
F-TPICH info other cells	OP	1 to <maxRL>		This IE is not allowed to include information on a RL added by this message, except in the case of an update to target cell preconfiguration information.	REL-11
>Primary CPICH info	MP		Primary CPICH info 10.3.6.60		REL-11
>CHOICE <i>F-TPICH Info</i>	MP				REL-11
>>F-TPICH Info			F-TPICH Info 10.3.6.127		REL-11
>>F-TPICH release indicator				(no data)	REL-11

10.3.6.129 Multiflow configuration info

Information Element/Group name	Need	Multi	Type and reference	Semantics description	Version
Multiflow cell	MP		Enumerated(intra-NodeB,inter-NodeB)	Presence of this IE indicates that Multiflow is configured. "intra-NodeB" means that this cell belongs to the same Node B as the serving HS-DSCH cell and should be associated to the same MAC-ehs entity. "inter-NodeB" indicates that this is the inter-Node B cell and should be associated with the second MAC-ehs entity.	REL-11
Multiflow time reference cell	OP		Enumerated(TRUE)	Presence of this IE indicates that this cell is the time reference for the UL HS-DPCCH channel.	REL-11

10.3.6.130 NodeB triggered HS-DPCCH Transmission

NOTE: Only for FDD.

Information Element/Group name	Need	Multi	Type and reference	Semantics description	Version
HS-DPCCH transmission continuation back off	OP		Enumerated (10, 20, 30, 40, 80, 160, 320, 800)	In terms of ms. If not present, implicit common E-DCH resource release based on HS-DPCCH transmission continuation back off is disabled.	REL-11

10.3.6.131 Common E-DCH system info parameters for Concurrent TTI

NOTE: Only for FDD.

Information Element/Group name	Need	Multi	Type and reference	Semantics description	Version
--------------------------------	------	-------	--------------------	-----------------------	---------

Common E-DCH MAC-d flow info for Concurrent TTI	OP		Common E-DCH MAC-d flow info for Concurrent TTI 10.3.5.26		REL-11
Initial Serving grant value	MD		Integer (0..37)	(0..37) indicates E-DCH serving grant index as defined in [15]. NOTE 1	REL-11
E-AGCH Info	MD		E-AGCH Info 10.3.6.100	NOTE 1	REL-11
Uplink DPCH power control info for Concurrent TTI	OP		Uplink DPCH power control info for Concurrent TTI 10.3.6.132		REL-11
E-DPCCH/DPCCH power offset	MD		Integer (0..8)	Refer to quantization of the power offset in [28]. Default value is the value included in the IE "E-DPCCH Info" included in the IE "Common E-DCH System Info" of the System Information Block Type 5/5bis	REL-11
E-DPDCH info	MP		E-DPDCH info 10.3.6.99		REL-11
Additional E-DCH transmission back off	MD		Integer (0..15)	In terms of TTIs. NOTE 1	REL-11
Maximum E-DCH resource allocation for CCCH	MD		Enumerated (8, 12, 16, 20, 24, 32, 40, 80)	In terms of TTIs. NOTE 1	REL-11
Maximum period for collision resolution phase	MD		Integer (8..24)	In terms of TTIs. NOTE 1	REL-11
E-DCH transmission continuation back off	MD		Enumerated (0, 4, 8, 16, 24, 40, 80, infinity)	In terms of TTIs. If set to "infinity", implicit common E-DCH resource release is disabled. NOTE 1	REL-11
Measurement Feedback Info for Concurrent TTI	OP		Measurement Feedback Info for Concurrent TTI 10.3.6.133		REL-11
NOTE 1: Default value is the value included in the IE "Common E-DCH system info" of the System Information Block Type 5/5bis.					

10.3.6.132 Uplink DPCH power control info for Concurrent TTI

NOTE: Only for FDD.

Information Element/Group name	Need	Multi	Type and reference	Semantics description	Version
Δ_{ACK}	OP		Integer (0..8)	Refer to quantization of the power offset in [28]	REL-11
Δ_{NACK}	OP		Integer (0..8)	refer to quantization of the power offset in [28]	REL-11
Ack-Nack repetition factor	OP		Integer(1..4)		REL-11
NOTE: The IE's "Power Control Algorithm" and "TPC step size" shall use the corresponding values included in the IE "Uplink DPCH power control info" of the System Information Block Type 5/5bis.					

10.3.6.133 Measurement Feedback Info for Concurrent TTI

NOTE: Only for FDD.

Information Element/Group name	Need	Multi	Type and reference	Semantics description	Version
CQI Feedback cycle, k	OP		Integer (0, 2, 4, 8, 10, 16, 20, 32, 40, 64, 80, 160)	In milliseconds.	REL-11
CQI repetition factor	OP		Integer (1..4)		REL-11
Δ_{CQI}	OP		Integer (0..8)	Refer to quantization of the power offset in [28]	REL-11
NOTE: The IE "Measurement Power Offset" shall use the value included in the IE "Measurement Feedback Info" of the System Information Block Type 5/5bis.					

10.3.6.134 PRACH preamble control parameters extension list (for Enhanced Uplink)

NOTE: Only for FDD.

Information Element/Group name	Need	Multi	Type and reference	Semantics description	Version
PRACH preamble control parameters list (for Enhanced Uplink)	MP	1 to <maxPRACH_E UL>			REL-11
>PRACH preamble control parameters (for Enhanced Uplink)	MP		PRACH preamble control parameters extension (for Enhanced Uplink) 10.3.6.136	Control parameters of the physical signal.	REL-11
>Weight	OP		Real (0.2..1 by step of 0.2)	Probability of selecting this occurrence of PRACH preamble control parameters.	REL-11
NOTE 1: A weight given by: $1 - (\text{sum of the values of the IE "Weight" across all occurrences})$, shall be used as value of the L th occurrence of the IE "Weight", where L is as defined in sub-clause 8.5.73.					

NOTE 2: The sum of the values of the IE "Weight" across all occurrences in this IE should be less than 1.

10.3.6.135 PRACH preamble control parameters extension list for Type 1 (for Enhanced Uplink)

NOTE: Only for FDD.

Information Element/Group name	Need	Multi	Type and reference	Semantics description	Version
PRACH preamble control parameters list (for Enhanced Uplink)	MP	1 to <maxPRACH_E UL>			REL-11
>PRACH preamble control parameters (for Enhanced Uplink)	MP		PRACH preamble control parameters extension (for Enhanced Uplink) 10.3.6.136	Control parameters of the physical signal.	REL-11
>Weight	OP		Real (0.2..1 by step of 0.2)	Probability of selecting this occurrence of PRACH preamble control parameters.	REL-11
NOTE 1: A weight given by: $1 - (\text{sum of the values of the IE "Weight" across all occurrences})$, shall be used as value of the K^{th} occurrence of the IE "Weight", where K is as defined in sub-clause 8.5.73 and 8.5.74.					

NOTE 2: The sum of the values of the IE "Weight" across all occurrences in this IE should be less than or equal to 1.

10.3.6.136 PRACH preamble control parameters extension (for Enhanced Uplink)

NOTE: Only for FDD.

Information Element/Group name	Need	Multi	Type and reference	Semantics description	Version
Available Signature	MP		Bit string(16)	Each bit indicates availability for a signature. Each available signature on the AICH is associated with one Common E-DCH Resource Configuration in the "Common E-DCH resource configuration information list".	REL-11
Preamble scrambling code number	MP		Integer (0 .. 15)	Identification of scrambling code, see [28]	REL-11
AICH info	MD		AICH Info compressed 10.3.6.137	Default value is the value of "AICH info" in the first occurrence in list "PRACH system information list" in SIB5 or SIB5bis.	REL-11
NOTE: The value of the IE's "E-AI indication", "Available Sub Channel Number", "PRACH partitioning", "Persistence scaling factors", "AC-to-ASC mapping", "Primary CPICH TX power", "Constant value", "PRACH power offset", "PRACH transmission parameters", "Power offset Pp-e" are used from the IE "PRACH preamble control parameters (for Enhanced Uplink)".					

10.3.6.137 AICH Info compressed

NOTE: Only for FDD.

Information Element/Group name	Need	Multi	Type and reference	Semantics description
Channelisation code	MP		Integer(0..255)	SF is fixed and equal to 256
NOTE: The value of the IE's "STTD indicator" and "AICH transmission timing" are used from the IE "AICH info" in the first occurrence in the list "PRACH system information list" in SIB5 or SIB5bis.				

10.3.6.138 Common E-RGCH info FDD

NOTE: Only for FDD.

Information Element/Group name	Need	Multi	Type and Reference	Semantics description	Version
--------------------------------	------	-------	--------------------	-----------------------	---------

CHOICE Configuration info	MP				REL-11
>Continue			(no data)	Used in reconfigurations without change to the Common E-RGCH configuration.	REL-11
>New configuration					
>>E-RGCH Neighbour Cell List	MP		Bitstring (maxCellMeas)	Indicates whether the UE should evaluate a cell for performing E-RGCH reception. Bit 0 is for the first cell in "New intra-frequency cells" in the "Intra-frequency cell info list" included in system information, Bit 1 is for the second cell in "New intra-frequency cells" in the "Intra-frequency cell info list" included in system information, ... Value '1' for a bit means UE should evaluate the cell. Bit 0 is the first/leftmost bit of the bit string. NOTE: The bit that corresponds to the serving cell itself is ignored.	REL-11
>>>Common E-RGCH channel configuration list	MP	1 to <maxCellMeas >		List of E-RGCH information of cells that a UE should evaluate for performing E-RGCH reception. The first entry in the list corresponds to the first/leftmost bit of value '1' in E-RGCH Neighbour Cell List. The second entry in the list corresponds to the second bit of value '1' in the E-RGCH Neighbour Cell List. ...	REL-11
>>>>Channelisation Code	CV-Common		Integer (0..127)	If this IE is not present, the value is equal to the last occurrence of this IE.	REL-11

>>>Signature Sequence	CV- <i>Common</i>		Integer (0..39)	If this IE is not present, the value is equal to the last occurrence of this IE.	REL-11
>>Minimum Serving Grant	MD		Integer (0..37)	(0..37) indicates E-DCH serving grant index as defined in [15]. Default value is Initial Serving grant value broadcasted in the Common E-DCH system info.	REL-11
>>Reporting Range Constant	MP		Real(0..14.5 by step of 0.5)	In dB.	REL-11
>>Filter coefficient	MP		Filter coefficient 10.3.7.9	Filter coefficient	REL-11

Condition	Explanation
<i>Common</i>	This IE is mandatory present for the first occurrence. Otherwise, this IE is optional.

10.3.6.139 HS-DSCH DRX in CELL_FACH with second DRX cycle information

These parameters configure the UE in CELL_FACH state to discontinuously receive HS-DSCH with second DRX cycle.

NOTE: Only for FDD.

Information Element/Group name	Need	Multi	Type and reference	Semantics description	Version
HS-DSCH second DRX cycle _{FACH}	MP		Enumerated (4, 8, 16, 32, 64, 128, 256, 512)	Determines the length of the DRX Cycle during second DRX operation, in frames.	REL-11
CHOICE <i>DRX level</i>	MP			This IE indicates whether both the 1 st and the 2 nd DRX cycle are used (2-level DRX) or only the 2 nd DRX cycle is used (1-level DRX)	REL-11
>1-level DRX					REL-11
>>HS-DSCH second Rx burst _{FACH}	MD		Enumerated (1, 2)	Determines the period within the second DRX Cycle that the UE continuously receives HS-DSCH, in frames. Default value is the value included in the IE "HS-DSCH Rx burst _{FACH} " of the System Information Block Type 5/5bis.	REL-11
>>T329	MD		Enumerated (0.5, 1, 2, 4)	Determines the time the UE waits until initiating second DRX operation, in seconds. The default value is T321 (ms) contained in the IE "HS-DSCH DRX in CELL_FACH information" of the System Information Block Type 5/5bis.	REL-11
>2-level DRX					REL-11
>>T328	MD		Enumerated (20, 40, 60, 80)	Determines the time the UE waits until initiating first DRX operation, in ms. The default value is T321 (ms) contained in the IE "HS-DSCH DRX in CELL_FACH information" of the System Information Block Type 5/5bis.	REL-11

>>HS-DSCH first Rx burst _{FACH}	MD		Enumerated (0.4, 0.8)	Determines the period within the first DRX Cycle that the UE continuously receives HS-DSCH, in frames. Default value is the value included in the IE "HS-DSCH Rx burst _{FACH} " of the System Information Block Type 5/5bis.	REL-11
>>HS-DSCH first DRX cycle _{FACH}	MD		Enumerated (2, 4, 8, 16, 32, 64)	Determines the length of the DRX Cycle during first DRX operation, in frames. Default value is the value included in the IE "HS-DSCH DRX cycle _{FACH} " of the System Information Block Type 5/5bis.	REL-11
>>HS-DSCH second Rx burst _{FACH}	MD		Enumerated (1, 2)	Determines the period within the second DRX Cycle that the UE continuously receives HS-DSCH, in frames. Default value is the value included in the IE "HS-DSCH Rx burst _{FACH} " of the System Information Block Type 5/5bis.	REL-11
>>T329	MD		Enumerated (0.5, 1, 2, 4)	Determines the time the UE waits until initiating second DRX operation, in seconds. The default value is T321 (ms) contained in the IE "HS-DSCH DRX in CELL_FACH information" of the System Information Block Type 5/5bis.	REL-11

10.3.6.140 Common E-DCH Resource Configuration Information List Extension

NOTE: Only for FDD.

Information Element/Group name	Need	Multi	Type and reference	Semantics description	Version
--------------------------------	------	-------	--------------------	-----------------------	---------

Scheduled Transmission configuration	OP				REL-11
>Configuration for 2 ms TTI common E-DCH resources	MP	1 to <maxEDCHs>			REL-11
>>2ms HARQ process allocation	MD		Bitstring (8)	Bit 0 is the first/leftmost bit of the bit string. MAC-c or MAC-d PDUs for this common E-DCH MAC-d flow are only allowed to be transmitted in those processes for which the bit is set to "1". Bit 0 corresponds to HARQ process 0, bit 1 corresponds to HARQ process 1,... NOTE1	REL-11
Offset	OP		Integer(0..29)	(0..29) indicates cell offset as defined in [26]	REL-11
NOTE1: The default value is equal to the same value of the last occurrence. The default value of the first occurrence is that transmission in the first HARQ processes is allowed.					

10.3.6.141 Fallback R99 PRACH info

NOTE: Only for FDD.

Information Element/Group name	Need	Multi	Type and Reference	Semantics description	Version
CCCH Fallback	MP		BOOLEAN		REL-11
DCCH Fallback	MP		BOOLEAN		REL-11

10.3.6.142 MIMO mode with four transmit antennas parameters

Information Element/Group name	Need	Multi	Type and reference	Semantics description	Version
CHOICE <i>Configuration info</i>	MP				REL-11
>Continue			(no data)	Used in reconfigurations without interruption of MIMO mode with four transmit antennas.	REL-11
>New configuration					REL-11
>>MIMO mode with four transmit antennas N_cqi_typeA/M_cqi ratio	OP		Enumerated(1/2, 2/3, 3/4, 4/5, 5/6, 6/7, 7/8, 8/9, 9/10, 1/1)		REL-11
>>MIMO mode with four transmit antennas pilot configuration	OP		MIMO mode with four transmit antennas pilot configuration 10.3.6.143		REL-11
>>Precoding weight set restriction	OP		Bit string (64)	The first/leftmost bit contains the most significant bit, where a bit value of zero indicates that the precoding indices reporting is not allowed, as defined in [29].	REL-11

10.3.6.143 MIMO mode with four transmit antennas pilot configuration

Information Element/Group name	Need	Multi	Type and reference	Semantics description	Version
Antenna2 S-CPICH	OP				REL-11
>Channelisation code	MP		Integer (0..255)		REL-11
>Power Offset for S-CPICH for MIMO mode with four transmit antennas on Antenna2	OP		Integer(-6 .. 0)	Power offset relative to the P-CPICH Tx power in dB	REL-11
Antenna3and4	OP				REL-11
>Antenna3and4 S-CPICH	OP				REL-11
>>Antenna3 S-CPICH	OP				REL-11
>>>Channelisation code	MP		Integer (0..255)		REL-11
>>Antenna4 S-CPICH	OP				REL-11
>>>Channelisation code	MP		Integer (0..255)		REL-11
>>Common Power Offset for S-CPICH for MIMO mode with four transmit antennas on Antenna3 and 4	OP		Integer(-12 .. 0)	Power offset relative to the P-CPICH Tx power in dB	REL-11
>Antenna3and4 D-CPICH	OP				REL-11
>>Antenna3 D-CPICH	OP				REL-11
>>>Channelisation code	MP		Integer (0..255)		REL-11
>>Antenna4 D-CPICH	OP				REL-11
>>>Channelisation code	MP		Integer		REL-11

Information Element/Group name	Need	Multi	Type and reference	Semantics description	Version
			(0..255)		
>>Common Power Offset for D-CPICH for MIMO mode with four transmit antennas on Antenna3 and 4	OP		Integer(-12 .. 0)	Power offset relative to the P-CPICH Tx power in dB	REL-11
>>Initial status of D-CPICH	OP		Enumerated(activated)	The absence of this IE indicates that the initial status of D-CPICH is deactivated.	REL-11

10.3.6.144 Secondary cell MIMO mode with four transmit antennas parameters

Information Element/Group name	Need	Multi	Type and reference	Semantics description	Version
CHOICE <i>Configuration info</i>	MP				REL-11
>Continue			(no data)	Used in reconfigurations without interruption of MIMO mode with four transmit antennas operation.	REL-11
>New configuration					REL-11
>> MIMO mode with four transmit antennas N_cqi_typeA/M_cqi ratio	OP		Enumerated(1/2, 2/3, 3/4, 4/5, 5/6, 6/7, 7/8, 8/9, 9/10, 1/1)		REL-11
>>MIMO mode with four transmit antennas pilot configuration	OP		MIMO mode with four transmit antennas pilot configuration 10.3.6.143		REL-11
>>Precoding weight set restriction	OP		Bit string (64)	The first/leftmost bit contains the most significant bit, where a bit value of zero indicates that the precoding indices reporting is not allowed, as defined in [29].	REL-11

10.3.6.145 Uplink MIMO info FDD

Information Element/Group name	Need	Multi	Type and Reference	Semantics description	Version
--------------------------------	------	-------	--------------------	-----------------------	---------

CHOICE Configuration Info					REL-11
>Continue			(no data)	Used in reconfigurations without interruption of uplink MIMO operation.	REL-11
>New configuration					
>>S-E-DPCCH Power Offset	MP		Integer (0..17)	This IE provides an index for the $\Delta_{S-E-DPCCH}$ power offset mapping, as specified in [9] subclause 4.2.1.5.	REL-11
>>Minimum E-TFCI for Rank2 Transmission	MP		Integer (0..127)		REL-11
>>Inter-stream Interference Compensation Index	OP		Integer (0..15)	If present, this IE provides an index for the inter-stream interference compensation factor Δ_{ISI} , as specified in [28] subclause 4.2.1.3.	REL-11

10.3.6.146 E-ROCH info FDD

Information Element/Group name	Need	Multi	Type and Reference	Semantics description	Version
Channelization Code	MP		Integer (0..255)		REL-11
E-ROCH E-RNTI	MP		E-RNTI 10.3.3.10a		REL-11

10.3.6.147 Radio Links without DPCH/F-DPCH info

Information Element/Group name	Need	Multi	Type and Reference	Semantics description	Version
Frame offset	MP		Integer (0..38144 by step of 256)	Offset (in number of chips) between the beginning of the P-CCPCH frame and the beginning of the DPCH/F-DPCH frame This is called $\tau_{DPCH,n}$ or $\tau_{F-DPCH,n}$ in [26]	REL-12

10.3.6.148 DPCCH2 info FDD

Information Element/Group name	Need	Multi	Type and Reference	Semantics description	Version
--------------------------------	------	-------	--------------------	-----------------------	---------

CHOICE Configuration Info	MP				REL-12
>Continue			(no data)	Used in reconfigurations without change to the DPCCH2 configuration.	REL-12
>New configuration					REL-12
>>DPCCH2 info	OP				REL-12
>>>DPCCH2 Tx Power offset	MP		Integer (0..20)	In dB	REL-12
>>F-DPCH info	OP				REL-12
>>>F-DPCH slot format	OP		Integer (0..9)	Slot format used by F-DPCH for DPCCH2 in [26].	REL-12
>>>Code number	OP		Integer (0..255)		REL-12
>>>TPC command error rate target	OP		Real (0.01..0.1 by step of 0.01)		REL-12
>>Extended E-DPCCH/DPCCH power offset	OP		Integer (9..15)	Refer to quantization of the power offset in [28]	REL-12
>>Designated non-serving HS-DSCH cell info	OP				REL-12
>>>Primary CPICH info	MP		Primary CPICH info 10.3.6.60		REL-12

10.3.6.149 DCH Enhancements info FDD

NOTE: For FDD only.

Information Element/Group name	Need	Multi	Type and Reference	Semantics description	Version
--------------------------------	------	-------	--------------------	-----------------------	---------

CHOICE Configuration info	MP				REL-12
>Continue			(no data)	Used in reconfigurations without interruption of DCH Enhancements operation. Note 1.	REL-12
>New configuration					REL-12
>>CHOICE UL Transmission Mode	MP				REL-12
>>>10ms only			(no data)	All TFC's are always transmitted in 10ms Mode	REL-12
>>>20ms only			(no data)	All TFC's are always transmitted in 20ms Mode	REL-12
>>>10ms or 20ms				TFC's can be transmitted in 10ms Mode or 20ms Mode as per Uplink Transmission Mode Switching procedure described in [15].	REL-12
>>>>Uplink Transmission Mode switching parameters	MP		Uplink Transmission Mode Switching Parameters 10.3.6.150	K, L, M parameters used for Transmission Mode Switching procedure described in [15].	REL-12
>>CHOICE DL FET Mode	MP				REL-12
>>>Basic			(no data)	In this mode, the ACK/NACK field in UL DPCCH does not indicate whether DL DPCH has been successfully decoded.	REL-12
>>>Full				In this mode, the ACK/NACK field in UL DPCCH is used to indicate whether DL DPCH has been successfully decoded.	REL-12
>>>>Early DCH quality target	MP		Quality target 10.3.5.10		REL-12
>>>>Early DCH quality target slot	MP		Integer (11.. 28)		REL-12
>>>>TrCh Concatenation Info	MP	1 to <maxNrOfConcatTrCH>		Provides the list of DL Transport Channels of type DCH that are subject to concatenation in the physical layer.	REL-12

>>>>>DCH ID	MP		Transport channel identity 10.3.5.18	DL transport channel type = DCH	REL-12
Note 1: The value "Continue" should not be set when the "DCH Enhancements info FDD" IE is included in the HANDOVER TO UTRAN COMMAND message.					

Condition	Explanation
<i>MCM_opt</i>	This IE is OPTIONAL when sent in SYSTEM INFORMATION. Otherwise, the IE is not needed.

10.3.6.150 Uplink Transmission Mode Switching Parameters

NOTE: For FDD only.

Information Element/Group name	Need	Multi	Type and Reference	Semantics description	Version
K	MP		Integer (1..32)	See [19].	REL-12
L	MP		Integer (1..32)	See [19].	REL-12
M	MP		Integer (1..32)	See [19].	REL-12

10.3.6.151 DPCCH Power Reset after DTX on secondary uplink frequency

Information Element/Group name	Need	Multi	Type and reference	Semantics description	Version
Filter coefficient	MP		Integer (0..5)		REL-12
Secondary Power Offset After Gap	MP		Integer (-8..20) by steps of 2	Unit is in dB. An offset which is applied to a filtered DPCCH transmit power taken from the primary uplink frequency. [29]	REL-12
Inactivity Threshold for Reset DPCCH Power	OP		Enumerated (10, 20, 30, 40, 50, 60, 80, 120)	Value in ms. The inactivity gap allowed on DPCCH after which the power for secondary uplink frequency is determined as an offset of the transmit power on primary uplink frequency. [29] Absence of this IE means that the UE shall apply a threshold of infinity for the inactivity gap on the DPCCH	REL-12

10.3.6.152 Other TTI E-DCH Configuration Information

Information Element/Group name	Need	Multi	Type and reference	Semantics description	Version
CHOICE Configuration info	MP				REL-12
>Continue			(no data)		REL-12
>New configuration					REL-12
>>E-DCH Info	MP		E-DCH Info 10.3.6.97		REL-12
>>Added or Reconfigured UL TrCH information	MP		Added or Reconfigured UL TrCH information 10.3.5.2		REL-12
>>DTX-DRX Information	OP		DTX-DRX Information 10.3.6.34a		REL-12
>>DTX-DRX timing information	OP		DTX-DRX timing information 10.3.6.34b		REL-12
Activation delay	MD		Enumerated (0, 1, 2, 3, 4, 5)	In radio frames. Default value is 0. Two spare values are needed.	REL-12

10.3.7 Measurement Information elements

10.3.7.1 Additional measurements list

Information Element/Group name	Need	Multi	Type and reference	Semantics description
Additional measurements	MP	1 to <MaxAdditionalMeas>		
>Additional measurement identity	MP		Measurement identity 10.3.7.48	

10.3.7.2 Cell info

Includes non-frequency related cell info used in the IE "inter-frequency cell info list" and "intra frequency cell info list".

Information Element/Group name	Need	Multi	Type and reference	Semantics description	Version
Cell individual offset	MD		Real(-10..10 by step of 0.5)	In dB Default value is 0 dB Used to offset measured quantity value If the cell from which this IE has been received is operating in MBSFN mode as indicated in subclause 8.1.1.6.3 the UE behaves as if this IE would not have been received.	

Reference time difference to cell	OP		Reference time difference to cell 10.3.7.60	In chips. This IE is absent for serving cell. If the cell from which this IE has been received is operating in MBSFN mode as indicated in subclause 8.1.1.6.3 the UE behaviour upon reception of this IE is unspecified.	
Read SFN indicator	MP		Boolean	TRUE indicates that read of SFN is requested for the target cell If the cell from which this IE has been received is operating in MBSFN mode as indicated in subclause 8.1.1.6.3 the UE behaves as if this IE would not have been received.	
CHOICE <i>mode</i>	MP				
>FDD					
>>Primary CPICH info	OP		Primary CPICH info 10.3.6.60	This IE is absent only if measuring RSSI only (broadband measurement.)	
>>Primary CPICH Tx power	OP		Primary CPICH Tx power 10.3.6.61	Required if calculating pathloss.	
>>TX Diversity Indicator	MP		Boolean	TRUE indicates that transmit diversity is used.	
>TDD					
>>Primary CCPCH info	MP		Primary CCPCH info 10.3.6.57		
>>Primary CCPCH TX power	OP		Primary CCPCH TX power 10.3.6.59		
>>Timeslot list	OP	1 to <maxTS>		The UE shall report Timeslot ISCP values according the order of the listed Timeslot numbers.	

				If the cell from which this IE has been received is operating in MBSFN mode as indicated in subclause 8.1.1.6.3 the UE behaviour upon reception of this IE is unspecified.	
>>>CHOICE <i>TDD option</i>	MP				REL-4
>>>>3.84 Mcps TDD					REL-4
>>>>>Timeslot number	MP		Integer (0...14)	Timeslot numbers, for which the UE shall report Timeslot ISCP	
>>>>>Burst Type	MD		Enumerated (Type1, Type2)	Use for Timeslot ISCP measurements only. Default value is "Type1"	
>>>>>7.68 Mcps TDD					REL-7
>>>>>Timeslot number	MP		Integer (0...14)	Timeslot numbers, for which the UE shall report Timeslot ISCP	REL-7
>>>>>Burst Type	MD		Enumerated (Type1, Type2)	Use for Timeslot ISCP measurements only. Default value is "Type1"	REL-7
>>>>>1.28 Mcps TDD					REL-4
>>>>>Timeslot number	MP		Integer (0...6)	Timeslot numbers, for which the UE shall report Timeslot ISCP	REL-4
Cell Selection and Re-selection Info	CV- <i>BCHopt</i>		Cell Selection and Re-selection for SIB11/12Info 10.3.2.4	This IE is absent for the serving cell. If the cell from which this IE has been received is operating in MBSFN mode as indicated in subclause 8.1.1.6.3 the UE behaviour upon reception of this IE is unspecified.	

Condition	Explanation
<i>BCHopt</i>	This IE is Optional when sent in SYSTEM INFORMATION or for 1.28 Mcps TDD when sent in the MEASUREMENT CONTROL, Otherwise, the IE is not needed

10.3.7.3 Cell measured results

Includes non-frequency related measured results for a cell.

Information Element/Group name	Need	Multi	Type and reference	Semantics description	Version
Cell Identity	OP		Cell Identity 10.3.2.2		
CSG PLMN List	CV-CSG	1 to 6			REL-12
>CSG PLMN Identity	MP		PLMN identity 10.3.1.11		REL-12
CSG Identity	CV-CSG		CSG Identity 10.3.2.8		REL-9
CSG Member indication	CV-CSG		Enumerated(member)		REL-9
Cell synchronisation information	OP		Cell synchronisation information 10.3.7.6		
CHOICE <i>mode</i>	MP				
>FDD					
>>Primary CPICH info	MP		Primary CPICH info 10.3.6.60		
>>CPICH Ec/No	OP		Integer(0..49)	According to CPICH_Ec/No in [19] and [20]. Fourteen spare values are needed.	
>>CPICH RSCP	OP		Integer(0..91)	According to CPICH_RSCP in [19] and [20]. Thirty-six spare values are needed.	
>>Delta _{CPICH RSCP}	CV-RSCP		Integer(-5..-1)	If present, the actual value of CPICH RSCP = CPICH RSCP+ Delta _{CPICH RSCP}	REL-5
>>Pathloss	OP		Integer(46..158)	In dB. Fifteen spare values are needed.	
>TDD					
>>Cell parameters Id	MP		Cell parameters Id 10.3.6.9		
>>Proposed TGSN	OP		Integer (0..14)	Proposal for the next TGSN	
>>Primary CCPCH RSCP	OP		Primary CCPCH RSCP info 10.3.7.54		
>>Pathloss	OP		Integer(46..158)	In dB. Fifteen spare values are needed.	
>>Timeslot list	OP	1 to <maxTS>			
>>>Timeslot ISCP	MP		Timeslot ISCP Info 10.3.7.65	The UE shall report the Timeslot ISCP in the same order as indicated in the cell info	

Condition	Explanation
RSCP	This IE is mandatory if the IE "Cell measured results" is included in the IE "Measured Results" (i.e. not included in the IE "Additional Measured Results") and if CPICH RSCP is present and if the value of the CPICH RSCP is below 0. It is not needed otherwise.
CSG	This IE is optionally present if the target cell's Primary scrambling code (as determined from <i>Primary CPICH info</i> IE) is found in the CELL_INFO_CSG_LIST set of PSCs. Otherwise it is not needed.

10.3.7.4 Cell measurement event results

Includes non-frequency related cell reporting quantities.

Information Element/Group name	Need	Multi	Type and reference	Semantics description
CHOICE <i>mode</i>	MP			
>FDD				
>>Primary CPICH info	MP	1 to <maxCellMeas>	Primary CPICH info 10.3.6.60	
>TDD				
>>Primary CCPCH info	MP	1 to <maxCellMeas>	Primary CCPCH info 10.3.6.57	

10.3.7.5 Cell reporting quantities

Includes non-frequency related cell reporting quantities.

For all boolean types TRUE means inclusion in the report is requested.

Information Element/Group name	Need	Multi	Type and reference	Semantics description
Cell synchronisation information reporting indicator	MP		Boolean	
Cell Identity reporting indicator	MP		Boolean	
CHOICE <i>mode</i>	MP			
>FDD				
>>CPICH Ec/N0 reporting indicator	MP		Boolean	
>>CPICH RSCP reporting indicator	MP		Boolean	
>>Pathloss reporting indicator	MP		Boolean	
>TDD				
>>Timeslot ISCP reporting indicator	MP		Boolean	
>>Proposed TGSN Reporting required	MP		Boolean	
>>Primary CCPCH RSCP reporting indicator	MP		Boolean	
>>Pathloss reporting indicator	MP		Boolean	

10.3.7.6 Cell synchronisation information

The IE "Cell synchronisation information" contains the OFF and Tm as defined in [7] and [8] and the four most significant bits of the difference between the 12 least significant bits of the RLC Transparent Mode COUNT-C in the UE and the SFN of the measured cell. It is notified to SRNC by Measurement Report message or Measurement Information Element in other RRC messages

Information Element/Group name	Need	Multi	Type and reference	Semantics description
CHOICE <i>mode</i>	MP			
>FDD				
>>COUNT-C-SFN frame difference	OP			
>>>COUNT-C-SFN high	MP		Integer(0..3840 by step of 256)	in frames
>>>OFF	MP		Integer(0..255)	in frames
>>Tm	MP		Integer(0..38399)	in chips
>TDD				
>>COUNT-C-SFN frame difference	OP			
>>>COUNT-C-SFN high	MP		Integer(0..3840 by step of 256)	in frames
>>>OFF	MP		Integer(0..255)	in frames

10.3.7.6a E-UTRA event results

Information Element/Group name	Need	Multi	Type and reference	Semantics description	Version
Inter-RAT event identity	MP		Inter-RAT event identity 10.3.7.24		REL-8
E-UTRA events results list	MP	1 to <maxReported EUTRAFreqs>			REL-8
		1 to <maxReported EUTRAFreqs-ext>			REL-12
>E-UTRA Carrier Frequency	MP		Integer (0..65535)	EARFCN of the downlink carrier frequency [64]. If the IE indicates a value of 65535, then the EARFCN for this instance should be read from the corresponding instance of IE "EARFCN extension" in the E-UTRA events results extension list.	REL-8
>Reported cells	MP	1 to <maxReported EUTRACellPer Freq>			REL-8
>>Physical Cell Identity	MP		Integer (0..503)		REL-8
E-UTRA events results extension list	OP	1 to <maxReported EUTRAFreqs>			REL-11
		1 to <maxReported EUTRAFreqs-ext>			REL-12
>EARFCN extension	OP		Integer (65536..262143)	EARFCN of the downlink carrier frequency [64].	REL-11

10.3.7.6b E-UTRA frequency list

Contains the information for the list of measurement objects for E-UTRA measurements.

Information Element/Group name	Need	Multi	Type and reference	Semantics description	Version
CHOICE <i>E-UTRA frequency removal</i>	MP				REL-8
>Remove all frequencies				(no data)	REL-8
>Remove some frequencies					REL-8
>>Removed frequencies	MP	1 to <maxNumEUTRAFreqs>			REL-8
>>>E-UTRA frequencies	MP		Integer (0..65535)	EARFCN of the downlink carrier frequency [64]. If the IE indicates a value of 65535, then the EARFCN for this instance should be read from the corresponding instance of IE "EARFCN extension".	REL-8
>>>EARFCN extension	OP		Integer (65536..262143)	EARFCN of the downlink carrier frequency [64].	REL-11
>Remove no frequencies				(no data)	REL-8
New frequencies	OP	1 to <maxNumEUTRAFreqs>			REL-8
>E-UTRA carrier frequency	MP		Integer (0..65535)	EARFCN of the downlink carrier frequency [64]. If the IE indicates a value of 65535, then the EARFCN for this instance should be read from the corresponding instance of IE "EARFCN extension". It is always ensured by the UTRAN that more than one measurement object for the same physical frequency is not configured regardless of the EARFCN used to indicate this.	REL-8
>EARFCN extension	OP		Integer (65536..262143)	EARFCN of the downlink carrier frequency [64]. It is always ensured by the UTRAN that more than one measurement object for the same physical frequency is not configured regardless of the EARFCN used to indicate this.	REL-11

Information Element/Group name	Need	Multi	Type and reference	Semantics description	Version
>Reduced measurement performance	OP		Enumerated (TRUE)	TRUE indicates that the frequency is configured for reduced measurement performance [19]. Absence indicates that the frequency is configured for normal measurement performance [19].	REL-12
>Measurement Bandwidth	MD		Enumerated (6, 15, 25, 50, 75, 100)	Measurement bandwidth information common for all neighbouring cells on the carrier frequency. It is defined by the parameter Transmission Bandwidth Configuration, N_{RB} [36.104]. The values indicate the number of resource blocks over which the UE could measure. Default value is 6.	REL-8
>Blacklisted cells list	OP	1 to <maxEUTRACellPerFreq>		A list of blacklisted cells can be signalled per frequency	REL-8
>>Physical Cell identity	MP		Integer (0..503)		REL-8
>Wideband RSRQ measurements	CV-WB-RSRQ		Enumerated (TRUE)	If this field is present, the UE shall use a wider bandwidth when performing RSRQ measurements according to TS 36.133 [74].	REL-11
E-UTRA SI Acquisition	OP		10.3.7.127		REL-9
RSRQ measurement on all symbols	OP		Boolean	TRUE means that RSRQ measurement on all OFDM symbols is configured. If wideband RSRQ measurement is enabled for the frequency, the UE shall, when performing RSRQ measurements, perform RSRQ measurement on all OFDM symbols with wider bandwidth for concerned frequency; FALSE or absence of this field means that the UE shall, when performing RSRQ measurements, perform RSRQ measurement only on CRS symbols;	REL-12

Condition	Explanation
<i>WB-RSRQ</i>	The field is optionally present if the measurement bandwidth indicated by <i>Measurement Bandwidth</i> is 50 resource blocks or larger. Otherwise it is not needed.

10.3.7.6c E-UTRA measured results

Information Element/Group name	Need	Multi	Type and reference	Semantics description	Version
E-UTRA measured results list	MP	1 to <maxReported EUTRAFreqs>			REL-8
		1 to <maxReported EUTRAFreqs-ext>			REL-12
>E-UTRA Carrier Frequency	MP		Integer (0..65535)	EARFCN of the downlink carrier frequency [64]. If the IE indicates a value of 65535, then the EARFCN for this instance should be read from the corresponding instance of IE "EARFCN extension" in the E-UTRA measured results extension list.	REL-8
>Measured E-UTRA cells	MP	1 to <maxReported EUTRACellPer Freq>			REL-8
>>Physical Cell Identity	MP		Integer (0..503)		REL-8
>>RSRP	OP		Integer (0..97)	This shall be reported if the "Inter-RAT measurement quantity" IE is set to 'RSRP' or the "Inter-RAT reporting quantity" IE is set to 'both'. RSRP is mapped to a value between 0 and 97 [36.133].	REL-8

>>RSRQ	OP		Integer (0..33)	This quantity shall be reported if the "Inter-RAT measurement quantity" IE is set to 'RSRQ' or the "Inter-RAT reporting quantity" IE is set to 'both'. RSRQ_00 to RSRQ_33 in [36.133] are mapped to the value between 0 and 33. RSRQ_34 in [36.133] is mapped to the value 33. If the IE indicates a value of 0 and the RSRQ Extension IE is present, then the RSRQ for this instance should be read from the corresponding instance of IE "RSRQ extension", the range is from -30 to -1. If the IE indicates a value of 33 and the RSRQ Extension IE is present, then the RSRQ for this instance should be read from the corresponding instance of IE "RSRQ extension", the range is from 35 to 46.	REL-8
>>RSRQ Extension	OP		Integer (-30..46)	RSRQ_-30 to RSRQ_-1 in [36.133] are mapped to the value between -30 and -1. RSRQ_35 to RSRQ_46 in [36.133] are mapped to the value between 35 and 46.	REL-12
>>E-UTRA Results for SI Acquisition	OP		10.3.7.128		REL-9
E-UTRA measured results extension list	OP	1 to <maxReported EUTRAFreqs>			REL-11
		1 to <maxReported EUTRAFreqs-ext>			REL-12
>EARFCN extension	OP		Integer (65536..262143)	EARFCN of the downlink carrier frequency [64].	REL-11

10.3.7.7 Event results

Information Element/Group name	Need	Multi	Type and reference	Semantics description
CHOICE <i>event result</i>	MP			One spare value is needed.
>Intra-frequency measurement event results			Intra-frequency measurement event results 10.3.7.37	

Information Element/Group name	Need	Multi	Type and reference	Semantics description
>Inter-frequency measurement event results			Inter-frequency measurement event results 10.3.7.17	
>Inter-RAT measurement event results			Inter-RAT measurement event results 10.3.7.28	For IS-2000 results, include fields of the <i>Pilot Strength Measurement Message</i> from subclause 2.7.2.3.2.5 of TIA/EIA/IS-2000.5
>Traffic volume measurement event results			Traffic volume measurement event results 10.3.7.69	
>Quality measurement event results			Quality measurement event results 10.3.7.57	
>UE internal measurement event results			UE internal measurement event results 10.3.7.78	
>UE positioning measurement event results			UE positioning measurement event results 10.3.7.101	

CHOICE event result	Condition under which the given event result is chosen
Intra-frequency measurement event results	If measurement type = intra-frequency measurement
Inter-frequency measurement event results	If measurement type = inter-frequency measurement
Inter-RAT measurement event results	If measurement type = inter-RAT measurement
Traffic volume measurement event results	If measurement type = traffic volume measurement
Quality measurement event results	If measurement type = Quality measurement
UE internal measurement event results	If measurement type = UE internal measurement
UE positioning measurement event results	If measurement type = UE positioning measurement

10.3.7.8 FACH measurement occasion info

Information Element/Group name	Need	Multi	Type and reference	Semantics description	Version
FACH Measurement occasion cycle length coefficient	OP		Integer(1..12)		
Inter-frequency FDD measurement indicator	MP		Boolean	TRUE means that measurements are required	
Inter-frequency TDD 3.84 Mcps measurement indicator	MP		Boolean	TRUE means that measurements are required	REL-4
Inter-frequency TDD 7.68 Mcps measurement indicator	MP		Boolean	TRUE means that measurements are required	REL-7
Inter-frequency TDD 1.28 Mcps measurement indicator	MP		Boolean	TRUE means that measurements are required	REL-4

Information Element/Group name	Need	Multi	Type and reference	Semantics description	Version
Inter-RAT measurement indicators	OP	1 to <maxOther RAT>			
>RAT type	MP		Enumerated(GSM, IS2000)	NOTE 1	
NOTE1: If "CELL_FACH Absolute Priority Measurement Indicator" is received in SIB19 then measurement occasions configured for GSM shall be used by the UE for GSM and/or EUTRAN measurements according to the rules in [4]					

10.3.7.9 Filter coefficient

Information Element/Group name	Need	Multi	Type and reference	Semantics description
Filter coefficient	MD		Integer(0, 1, 2, 3, 4, 5, 6, 7, 8, 9, 11, 13, 15, 17, 19)	Default value is 0

10.3.7.9a GSM cell group

This IE encodes a list of GSM cells specified by their ARFCN values [45].

Information Element/Group name	Need	Multi	Type and reference	Semantics description	Version
Starting ARFCN	MP		Integer (0..1023)	First ARFCN value in the set	REL-8
Band Indicator	MP		Enumerated (dcs1800, pcs1900)	GSM BAND_INDICATOR [45]	REL-8
CHOICE <i>Following ARFCNs</i>	MP				REL-8
>Explicit list					REL-8
>>List of ARFCNs	MP	0 to 31	Integer (0..1023)	Following ARFCN values	REL-8
>Equally spaced					REL-8
>>ARFCN spacing	MP		Integer (1..8)	Increment "d" ARFCN values	REL-8
>>Number of following ARFCNs	MP		Integer (0..31)	Number "n" of following ARFCN values, NOTE 1	REL-8
>Variable bitmap format					REL-8
>>Bitmap	MP		Octet string (1..16)	NOTE 2	REL-8
>Continuous range					REL-8
>>Ending ARFCN	MP		Integer (0..1023)	Last ARFCN value in the set, NOTE 3	REL-8
NOTE 1: Let the IE "Starting ARFCN" = s. The complete set of (n+1) ARFCN values is defined as: {s, ((s + d) mod 1024), ((s + 2*d) mod 1024) ... ((s + n*d) mod 1024)}.					
NOTE 2: Bitmap representing the following ARFCN values in the set. Let the IE "Starting ARFCN" = s. The first bit of the first octet in the bitmap corresponds to ARFCN = ((s + 1) mod 1024), the next bit to the ARFCN = ((s + 2) mod 1024), and so on. If the bitmap consist of N octets, the last bit of octet N corresponds to ARFCN = ((s + 8*N) mod 1024). The complete set of ARFCN values consists of ARFCN = s and the ARFCN values, where the corresponding bit in the bitmap is set to "1".					
NOTE 3: Let the IEs "Starting ARFCN" = s and "Ending ARFCN" = t. The complete set of ARFCN values is defined as: {s, ((s + 1) mod 1024), ((s + 2) mod 1024) ... ((t - 1) mod 1024), t}.					

10.3.7.10 HCS Cell re-selection information

Information Element/Group name	Need	Multi	Type and reference	Semantics description
Penalty_time	MD		Integer(0, 10, 20, 30, 40, 50, 60)	Default value is 0 which means = not used In seconds
Temporary_offsets	<i>CV-Penalty used</i>			
>Temporary_offset1	MP		Integer(3, 6, 9, 12, 15, 18, 21, inf)	[dB]
>Temporary_offset2	<i>CV-FDD-Quality-Measure</i>		Integer(2, 3, 4, 6, 8, 10, 12, inf)	[dB]

Condition	Explanation
<i>Penalty used</i>	This IE is not needed if the IE "Penalty time" equals "not used", else it is mandatory present.
<i>FDD-Quality-Measure</i>	This IE is not needed if the IE "Cell selection and reselection quality measure" has the value CPICH RSCP, otherwise the IE is mandatory present. This conditional presence is implemented in ASN.1 by the use of a specific RSCP and EcN0 variant of 10.3.7.10.

10.3.7.11 HCS neighbouring cell information

Information Element/Group name	Need	Multi	Type and reference	Semantics description
HCS_PRIO	MD		Integer (0..7)	Default value = 0
Qhcs	MD		Qhcs 10.3.7.54a	Default value = 0
HCS Cell Re-selection Information	MP		HCS Cell Re-selection Information 10.3.7.10	

10.3.7.12 HCS Serving cell information

Information Element/Group name	Need	Multi	Type and Reference	Semantics description
HCS_PRIO	MD		Integer (0..7)	Default value = 0
Qhcs	MD		Qhcs 10.3.7.54a	Default value = 0
T _{CRmax}	MD		Enumerated(not used, 30, 60, 120, 180, 240)	[s] Default value is not used
NCR	<i>CV-UE speed detector</i>		Integer(1..16)	Default value = 8
T _{CRmaxHyst}	<i>CV-UE speed detector</i>		Enumerated(not used, 10, 20, 30, 40, 50, 60, 70)	[s]

Condition	Explanation
<i>UE Speed detector</i>	This IE is not needed if T _{CRmax} equals 'not used', else it is mandatory present.

10.3.7.12a Idle Interval Information

NOTE: Used for TDD only. If the multi-RAT UE needs idle interval for E-UTRAN measurements in CELL_DCH state, this IE may be configured.

Information Element/Group name	Need	Multi	Type and reference	Semantics description	Version
k	MD		Integer (2..3)	This IE is the coefficient parameter to calculate the idle interval period. Default value is 2. The actual idle interval period equal to 2^k radio frames.	REL-8
Offset	MD		Integer (0..7)	The idle interval position in the period. Default value is 0.	REL-8

10.3.7.13 Inter-frequency cell info list

Contains the information for the list of measurement objects for an inter-frequency measurement.

Information Element/Group name	Need	Multi	Type and reference	Semantics description	Version
CHOICE <i>Inter-frequency cell removal</i>	OP				
>Remove all inter-frequency cells				No data	
>Remove some inter-frequency cells					
>>Removed inter-frequency cells	MP	1 .. <maxCellMeas>			
		1 .. <maxCellMeas-ext>		NOTE 2	REL-12
>>>Inter-frequency cell id	MP		Integer(0 .. <maxCellMeas>-1)		
			Integer(0 .. <maxCellMeas-ext>-1)	NOTE 2	REL-12
>No inter-frequency cells removed				No data	
New inter-frequency cells	OP	1 to <maxCellMeas>			
		1 to <maxCellMeas-ext>		NOTE 2	REL-12
>Inter-frequency cell id	MD		Integer(0 .. <maxCellMeas>-1)		
			Integer(0 .. <maxCellMeas-ext>-1)	NOTE 2	REL-12
>Frequency info	MD		Frequency info 10.3.6.36	Default value is the value of the previous "frequency info" in the list. It is always ensured by the UTRAN that more than one measurement object for the same physical frequency is not configured regardless of the UARFCN used to indicate this. NOTE: The first occurrence is then MP.	
>Cell info	MP		Cell info 10.3.7.2		
>CHOICE <i>mode specific info</i>	MP				REL-7
>>No information				No data for FDD, TDD 3.84 Mcps or TDD 7.68 Mcps	REL-7
>>>TDD 1.28 Mcps					REL-7

>>>Intra-SecondaryFrequency Indicator	MP		Boolean	TRUE means the inter frequency neighbour cell has a secondary frequency which is the same as the current working frequency of UE.	REL-7
>>>SNPL Monitor Set Indicator	OP		Bit string(5)	Each bit indicates whether the inter frequency neighbour cell has a secondary frequency which is the same as the frequency of a specific E-DCH carrier of UE. Bit0 indicate the E-DCH carrier with lowest UARFCN, and Bit1 indicate the E-DCH carrier with the second lowest UARFCN, Bit n indicate the E-DCH carrier with the n+1 lowest UARFCN. the Primary E-DCH carrier shall not be considered in the bitmap.	REL-10
Reduced measurement performance frequency list	CV-Measure	1 to <maxRMPf frequencies >			REL-12
>Reduced measurement performance	MP		BOOLEAN	TRUE indicates that the frequency is configured for reduced measurement performance [19]. FALSE indicates that the frequency is configured for normal measurement performance [19]. The ith entry in the Reduced measurement performance frequency list corresponds to the ith frequency signalled in the "New inter-frequency cells" list.	REL-12
Cells for measurement	CV-BCHopt	1 to <maxCellMeas>			

		1 to <maxCellMeas-ext>			REL-12
>Inter-frequency cell id	MP		Integer(0 .. <maxCellMeas>-1)		
			Integer(0 .. <maxCellMeas-ext>-1)		REL-12
CSG Inter-frequency cell info	CV- BCHopt		10.3.7.120		REL-9
Inter-frequency SI Acquisition	CV- BCHopt		10.3.7.124		REL-9
Multiple Frequency Info List FDD	CV- MCM_opt	1 to <maxNum FDDFreqs >		Each entry in the list corresponds to a UARFCN listed in the "New inter-frequency cells" IE (common to all those cells sharing the same "Frequency info" value). See NOTE 1.	REL-10
>Multiple Frequency bands Indicator List FDD	OP	1 to< maxMultipl eFrequencyBandsFD D >		Indicates, per neighbour UARFCN, a list of frequency bands which the cells belong to. Absence of this IE indicates that there are no Multiple Bands for the particular UARFCN.	REL-10
>>CHOICE frequency bands indicator	MP				REL-10
>>>Frequency band indicator			Frequency band indicator 10.3.6.35b		REL-10
>>>Frequency band indicator 2			Frequency band indicator 2 10.3.6.35c		REL-10
>>>Frequency band indicator 3			Frequency band indicator 3 10.3.6.35ca		REL-10

NOTE 1: The UTRAN should signal the "Frequency info" IE only once in "New Inter-frequency cells" for each UARFCN i.e. for the first Inter-frequency neighbour cell using that UARFCN. For each subsequent Inter-frequency neighbour cell having the same UARFCN, the "Frequency info" should not be included, but rather the Mandatory Default (MD) value will be used. See Annex G.2.

NOTE 2: Not applicable when sent in SYSTEM INFORMATION.

Condition	Explanation
<i>BCHopt</i>	This IE is not needed when sent in SYSTEM INFORMATION. Otherwise, the IE is Optional
<i>MCM_opt</i>	This IE is OPTIONAL when sent in SYSTEM INFORMATION. Otherwise, the IE is not needed.
<i>Measure</i>	The IE is optional present in System Information Block type 11, 11bis, 11ter, 12 and MEASUREMENT CONTROL message. Otherwise the IE is not needed.

10.3.7.14 Inter-frequency event identity

Information Element/Group name	Need	Multi	Type and reference	Semantics description
Inter-frequency event identity	MP		Enumerated(2a, 2b, 2c, 2d, 2e, 2f, 2g)	One spare value is needed.

10.3.7.15 Inter-frequency measured results list

Information Element/Group name	Need	Multi	Type and reference	Semantics description
Inter-frequency measurement results	OP	1 to <maxFreq>		
>Frequency info	MD		Frequency info 10.3.6.36	Default value is the value of the previous "frequency info" in the list. NOTE: The first occurrence is then MP.
>UTRA carrier RSSI	OP		Integer(0..76)	According to UTRA_carrier_RSSI_LEV in [19] and [20]. Fifty-one spare values are needed.
>Inter-frequency cell measurement results	OP	1 to <maxCellMeas>		Only cells for which all reporting quantities are available should be included.
>>Cell measured results	MP		Cell measured results 10.3.7.3	

10.3.7.16 Inter-frequency measurement

Information Element/Group name	Need	Multi	Type and reference	Semantics description	Version
Inter-frequency measurement objects list	MP		Inter-frequency cell info list 10.3.7.13		
Inter-frequency measurement quantity	OP		Inter-frequency measurement quantity 10.3.7.18		
Inter-frequency reporting quantity	OP		Inter-frequency reporting quantity 10.3.7.21		
Reporting cell status	CV-reporting		Reporting cell status 10.3.7.61		
Measurement validity	OP		Measurement validity 10.3.7.51		
Inter-frequency set update	OP		Inter-frequency set update 10.3.7.22		

Information Element/Group name	Need	Multi	Type and reference	Semantics description	Version
Adjacent frequency index	OP		Integer (0..<maxCell Meas-1>)	Index to an element in the IE "New inter-frequency cell" containing a cell on the adjacent frequency; index = 0 corresponds to the first element in the IE	REL-8
			Integer (0..<maxCell Meas-ext-1>)		REL-12
Inter-band frequency index	OP		Integer (0..<maxCell Meas-1>)	Index to an element in the IE "New inter-frequency cell" containing a cell on an inter-band frequency; index = 0 corresponds to the first element in the IE	REL-9
			Integer (0..<maxCell Meas-ext-1>)		REL-12
Frequency index list for enhanced measurement	OP	1..<maxFreqMeasurementWithoutCM>			REL-10
>Frequency index for enhanced measurement	MP		Integer (0..<maxCell Meas-1>)	Index to an element in the IE "New inter-frequency cell"; index = 0 corresponds to the first element in the IE	REL-10
			Integer (0..<maxCell Meas-ext-1>)		REL-12
CHOICE <i>report criteria</i>	MP				
>Intra-frequency measurement reporting criteria			Intra-frequency measurement reporting criteria 10.3.7.39		
>Inter-frequency measurement reporting criteria			Inter-frequency measurement reporting criteria 10.3.7.19		
>Periodical reporting criteria			Periodical reporting criteria 10.3.7.53		
>No reporting				(no data) Chosen when this measurement only is used as additional measurement to another measurement	

Condition	Explanation
<i>reporting</i>	This IE is optional if the CHOICE " <i>report criteria</i> " is equal to "periodical reporting criteria" or "No reporting", otherwise the IE is not needed

10.3.7.17 Inter-frequency measurement event results

This IE contains the measurement event results that are reported to UTRAN for inter-frequency measurements.

Information Element/Group name	Need	Multi	Type and reference	Semantics description	Version
Inter-frequency event identity	MP		Inter-frequency event identity 10.3.7.14		
Inter-frequency cells	OP	1 to <maxFreq>			
>Frequency info	MP		Frequency info 10.3.6.36		
>Non frequency related measurement event results	MP		Cell measurement event results 10.3.7.4		
Detected Set Trigger	OP		Enumerated(True)	Indicates whether or not inclusion of detected set cells triggered the event.	REL-10

10.3.7.18 Inter-frequency measurement quantity

The quantity the UE shall measure in case of inter-frequency measurement. It also includes the filtering of the measurements.

Information Element/Group name	Need	Multi	Type and reference	Semantics description
CHOICE <i>reporting criteria</i>	MP			
>Intra-frequency reporting criteria				
>>Intra-frequency measurement quantity	MP		Intra-frequency measurement quantity 10.3.7.38	
>Inter-frequency reporting criteria				
>>Filter coefficient	MP		Filter coefficient 10.3.7.9	
>>CHOICE <i>mode</i>	MP			
>>>FDD				
>>>>Measurement quantity for frequency quality estimate	MP		Enumerated(CPICH Ec/N0, CPICH RSCP)	
>>>TDD				
>>>>Measurement quantity for frequency quality estimate	MP		Enumerated(Primary CCPCH RSCP)	

10.3.7.19 Inter-frequency measurement reporting criteria

The triggering of the event-triggered reporting for an inter-frequency measurements. All events concerning inter-frequency measurements are labelled 2x where x is a,b,c, ...

Event 2a: Change of best frequency.

Event 2b: The estimated quality of the currently used frequency is below a certain threshold **and** the estimated quality of a non-used frequency is above a certain threshold.

Event 2c: The estimated quality of a non-used frequency is above a certain threshold.

Event 2d: The estimated quality of the currently used frequency is below a certain threshold.

Event 2e: The estimated quality of a non-used frequency is below a certain threshold.

Event 2f: The estimated quality of the currently used frequency is above a certain threshold.

Event 2g: Change of best cell on a configured secondary downlink frequency.

Information Element/Group name	Need	Multi	Type and reference	Semantics description	Version
Parameters required for each event	OP	1 to <maxMeasEvent>			
>Inter-frequency event identity	MP		Inter-frequency event identity 10.3.7.14		
>Threshold used frequency	CV- clause 0		Integer(-115..0)	Ranges used depend on measurement quantity. CPICH Ec/No -24..0dB CPICH/Primary CCPCH RSCP -115..-25dBm	
			Integer (-120..0)	Ranges used depend on measurement quantity. CPICH Ec/No -24..0dB CPICH/Primary CCPCH RSCP -120..-25dBm	REL-6
>DeltaThreshold used frequency	CV- clause 3		Integer(-5..-1)	If present, the actual value of Threshold used frequency = Threshold used frequency + DeltaThreshold used frequency	REL-5
				Not used in Release 6 and later	REL-6
>W used frequency	CV- clause 2		Real(0, 0.1..2.0 by step of 0.1)		
>Hysteresis	MP		Real(0, 0.5..14.5 by step of 0.5)	In event 2a, 2b, 2c, 2d, 2e, 2f, 2g	
>Time to trigger	MP		Time to trigger 10.3.7.64	Indicates the period of time during which the event condition has to be satisfied, before sending a Measurement Report. Time in ms.	
>Reporting cell status	OP		Reporting cell status 10.3.7.61		
>Parameters required for each non-used frequency	OP	1 to <maxFrequency>		In this release, the first listed threshold, W and triggering condition parameter shall apply to all non-used frequencies.	

Information Element/Group name	Need	Multi	Type and reference	Semantics description	Version
>>Threshold non used frequency	CV- clause 1		Integer(-115..0)	Ranges used depend on measurement quantity. CPICH Ec/No -24..0dB CPICH/Primary CCPCH RSCP -115..-25dBm. This IE is not needed if the IE "Inter-frequency event identity" is set to 2a. However, it is specified to be mandatory to align with the ASN.1.	
			Integer (-120..0)	Ranges used depend on measurement quantity. CPICH Ec/No -24..0dB CPICH/Primary CCPCH RSCP -120..-25dBm This IE is not needed if the IE "Inter-frequency event identity" is set to 2a.	REL-6
>> DeltaThreshold non used frequency	CV- clause 4		Integer(-5..-1)	If present, the actual value of Threshold non used frequency = Threshold non used frequency + DeltaThreshold non used frequency	REL-5
				Not used in Release 6 and later	REL-6
>>W non-used frequency	CV- clause 1		Real(0, 0.1..2.0 by step of 0.1)		
>>Triggering Condition non-used frequency detected cells	CV- clause 4		Enumerated(true)	If present the UE shall include detected set cells in the event evaluation	REL-10
>Use CIO	CV- clause 6		Enumerated(TRUE)	If present the UE shall use cell individual offset for event evaluation.	REL-12
Blacklisted cells in non-used frequency	CV- clause 5	1 to <maxFrequency>		If present the UE should exclude indicated cells in the event evaluation when non-used frequency detected cells is enabled.	REL-12
>Frequency info	MP		Frequency info 10.3.6.36		REL-12
>Cells to be excluded in non-used frequency detected cells	MP	1 to <maxExcludedDetectedSetCells>			REL-12
>>Primary CPICH info	MP		Primary CPICH info 10.3.6.60		REL-12

Condition	Explanation
Clause 0	This IE is mandatory present if the IE "Inter frequency event identity" is set to 2b, 2d, or 2f, otherwise the IE is not needed.
Clause 1	This IE is mandatory present if the IE "Inter frequency event identity" is set to 2a, 2b, 2c or 2e, otherwise the IE is not needed
Clause 2	This IE is mandatory present if the IE "Inter-frequency event identity" is set to 2a, 2b, 2d or 2f, otherwise the IE is not needed.
Clause 3	This IE is optional if the IE "Inter frequency event identity" is set to 2b, 2d, or 2f. Otherwise the IE is not needed. Note that in order to align with the ASN.1, this IE is always included when the IE "Delta _{Threshold non used frequency} " is present, but the value shall be ignored if the "Inter-frequency event identity" is not set to 2b, 2d or 2f.
Clause 4	This IE is optional if the IE "Inter frequency event identity" is set to 2a, 2b, 2c or 2e. Otherwise the IE is not needed.
Clause 5	This IE is optional if the IE "Triggering Condition non-used frequency detected cells" is present. Otherwise the IE is not needed.
Clause 6	This IE is optional if the IE "Inter frequency event identity" is set to 2g. Otherwise the IE is not needed.

10.3.7.20 Inter-frequency measurement system information

Information Element/Group name	Need	Multi	Type and reference	Semantics description	Version
Inter-frequency cell info list	OP		Inter-frequency cell info list 10.3.7.13		
Inter-frequency RACH reporting information	OP		Inter-frequency RACH reporting information 10.3.7.20a		REL-6

10.3.7.20a Inter-frequency RACH reporting information

Contains the reporting configuration information for an inter-frequency measurement report, which is sent on the RACH.

Information Element/Group name	Need	Multi	Type and reference	Semantics description	Version
CHOICE <i>mode</i>	MP				REL-6
>FDD					REL-6
>> Inter-frequency RACH reporting quantity	MP		Enumerated(CPICH Ec/N0, CPICH RSCP)		REL-6
>TDD					REL-6
>>Reporting quantity list	MP	1 to 2			REL-6
>>> Inter-frequency RACH reporting quantity	MP		Enumerated(Primary CCPCH RSCP)		REL-6

Information Element/Group name	Need	Multi	Type and reference	Semantics description	Version
Inter-frequency RACH reporting threshold	MP		Integer(-115..0)	Ranges used depend on measurement quantity. CPICH Ec/No - 24..0dB CPICH/Primary CCPCH RSCP - 115..-25dBm.	REL-6
Maximum number of inter-frequency RACH reporting cells	MP		Integer(1..8)	Indicates the total number for all non-used frequencies	REL-6

10.3.7.21 Inter-frequency reporting quantity

Information Element/Group name	Need	Multi	Type and reference	Semantics description
UTRA Carrier RSSI	MP		Boolean	TRUE means report is requested.
Frequency quality estimate	MP		Boolean	TRUE means that report is requested. This parameter is not used in this release and should be set to FALSE. It shall be ignored by the UE.
Non frequency related cell reporting quantities	MP		Cell reporting quantities 10.3.7.5	

10.3.7.22 Inter-frequency SET UPDATE

NOTE 1: Only for FDD.

This information makes it possible to use events defined for Intra-frequency measurement within the same non-used frequency for Inter-frequency measurement reporting criteria.

Information Element/group name	Need	Multi	Type and reference	Semantics description
UE autonomous update mode	MP		Enumerated (On with no reporting)	Required for backwards compatibility with a UE not supporting this revision of the standard

10.3.7.23 Inter-RAT cell info list

Contains the information for the list of measurement objects for an inter-RAT measurement.

Information Element/Group name	Need	Multi	Type and reference	Semantics description	Version
CHOICE <i>Inter-RAT cell removal</i>	MP				
>Remove all inter-RAT cells				(no data)	
>Remove some inter-RAT cells					
>>Removed inter-RAT cells	MP	1 to <maxCellMeas>			
>>>Inter-RAT cell id	MP		Integer(0 .. <maxCellMeas> - 1)		
>Remove no inter-RAT cells				(no data)	

Information Element/Group name	Need	Multi	Type and reference	Semantics description	Version
New inter-RAT cells	MP	1 to <maxCellMeas>		Although this IE is not always required, need is MP to align with ASN.1	
	OP				REL-4
>Inter-RAT cell id	OP		Integer(0 .. <maxCellMeas> - 1)		
>CHOICE <i>Radio Access Technology</i>	MP				
>>GSM					
>>>Cell individual offset	MP		Integer (-50..50)	In dB Used to offset measured quantity value	
>>>Cell selection and re-selection info	OP		Cell selection and re-selection info for SIB11/12 10.3.2.4	See subclause 8.6.7.3	
>>>BSIC	MP		BSIC 10.3.8.2		
>>>Band indicator	MP		Enumerated (DCS 1800 band used, PCS 1900 band used)	Indicates how to interpret the BCCH ARFCN	
>>>BCCH ARFCN	MP		Integer (0..1023)	[45]	
>>IS-2000					
>>>System specific measurement info	MP		enumerated (frequency, timeslot, colour code, output power, PN offset)	For IS-2000, use fields from TIA/EIA/IS-2000.5, subclause 3.7.3.3.2.27, <i>Candidate Frequency Neighbour List Message</i>	
>>None			(no data)	This value has been introduced to handle the case when IE "New inter-RAT cells" is not required	
Cells for measurement	OP	1 to <maxCellMeas>			
>Inter-RAT cell id	MP		Integer(0 .. <maxCellMeas>-1)		
Inter-RAT cell info indication	CV- <i>Message</i>		Integer (0..3)	NOTE 1 and 2	REL-5

Condition	Explanation
<i>Message</i>	The IE is optionally present in the MEASUREMENT CONTROL and in the SRNS RELOCATION INFO messages, otherwise the IE is not needed.

NOTE 1: The UTRAN may choose not to use the "Inter-RAT cell info indication" value "0" in the MEASUREMENT CONTROL message, to distinguish that case from those cases where the UE receives the IE "Inter-RAT cell info list" in SIB11 or SIB12.

NOTE 2: In case of an SRNS relocation, if the UE has been sent the "Inter-RAT cell info indication" in the MEASUREMENT CONTROL message and the IE "Inter-RAT cell info list" is included in the SRNS RELOCATION INFO sent from the source RNC to the target RNC, the "Inter-RAT cell info indication" should be included in the IE "Inter-RAT cell info list".

NOTE 3: If the UTRAN configures a UE with a "Inter-RAT cell info list" containing a set of GSM cells where one or more cell(s) belong to DCS 1800 band and one or more cell(s) belong to PCS 1900 band, the UE behaviour is unspecified.

10.3.7.24 Inter-RAT event identity

Information Element/Group name	Need	Multi	Type and reference	Semantics description
Inter-RAT event identity	MP		Enumerated (3a, 3b, 3c, 3d)	

10.3.7.25 Inter-RAT info

Inter-RAT info defines the target system for redirected cell selection.

Information Element/Group name	Need	Multi	Type and reference	Semantics description	Version
Inter-RAT info	MP		Enumerated (GSM, E-UTRA)		REL-8
GSM target cell info	CV-GSM		GSM target cell info 10.3.8.4g		REL-6
E-UTRA target info	CV-E-UTRA		E-UTRA target info 10.3.8.4L		REL-8

Condition	Explanation
GSM	This IE is optionally present if the IE "Inter-RAT info" is set to 'GSM' and not needed otherwise.
E-UTRA	This IE is mandatory present if the IE "Inter-RAT info" is set to 'E-UTRA' and not needed otherwise.

10.3.7.26 Inter-RAT measured results list

Information Element/Group name	Need	Multi	Type and reference	Semantics description
Inter-RAT measurement results	OP	1 to <maxOther RAT-16>		
>CHOICE <i>system</i>	MP			One spare value is needed.
>>GSM				
>>>Measured GSM cells	MP	1 to <maxReportedGSMCells>		
>>>>GSM carrier RSSI	OP		bit string(6)	RXLEV is mapped to a value between 0 and 63, [46]. When mapping the RXLEV value to the RSSI bit string, the first/leftmost bit of the bit string contains the most significant bit.
>>>>CHOICE <i>BSIC</i>	MP			
>>>>>Verified BSIC				
>>>>>>inter-RAT cell id	MP		Integer(0..<maxCellMeasurements>-1)	
>>>>>>Non verified BSIC				
>>>>>>>BCCH ARFCN	MP		Integer (0..1023)	[45]

10.3.7.27 Inter-RAT measurement

Information Element/Group name	Need	Multi	Type and reference	Semantics description	Version
CHOICE <i>Inter-RAT measurement objects</i>	OP				REL-8
>Inter-RAT cell info list	MP		Inter-RAT cell info list 10.3.7.23		
>E-UTRA frequency list	MP		E-UTRA frequency list 10.3.7.6b		REL-8
Inter-RAT measurement quantity	OP		Inter-RAT measurement quantity 10.3.7.29		
Inter-RAT reporting quantity	OP		Inter-RAT reporting quantity 10.3.7.32		
Reporting cell status	CV-reporting		Reporting cell status 10.3.7.61		
CHOICE <i>report criteria</i>	MP				
>Inter-RAT measurement reporting criteria			Inter-RAT measurement reporting criteria 10.3.7.30		
>Periodical reporting criteria			Periodical reporting criteria 10.3.7.53		
>No reporting				(no data) Chosen when this measurement only is used as additional measurement to another measurement	
Idle Interval Information	OP		Idle Interval Information 10.3.7.12a	This IE is used for TDD only.	REL-8

Condition	Explanation
<i>reporting</i>	This IE is optional if the CHOICE " <i>report criteria</i> " is equal to "periodical reporting criteria" or "No reporting", otherwise the IE is not needed

10.3.7.28 Inter-RAT measurement event results

This IE contains the measurement event results that are reported to UTRAN for inter-RAT measurements.

Information Element/Group name	Need	Multi	Type and reference	Semantics description
Inter-RAT event identity	MP		Inter-RAT event identity 10.3.7.24	
Cells to report	MP	1 to <maxCellMeas>		
>CHOICE BSIC	MP			
>>Verified BSIC				
>>>inter-RAT cell id	MP		Integer(0..<maxCellMeas>-1)	
>>Non verified BSIC				
>>>BCCH ARFCN	MP		Integer (0..1023)	[45]

10.3.7.29 Inter-RAT measurement quantity

The quantity the UE shall measure in case of inter-RAT measurement. It also includes the filtering of the measurements.

Information Element/Group name	Need	Multi	Type and reference	Semantics description	Version
Measurement quantity for UTRAN quality estimate	OP		Intra-frequency measurement quantity 10.3.7.38		
CHOICE <i>system</i>	MP				
>GSM					
>>Measurement quantity	MP		Enumerated (GSM Carrier RSSI)		
>>Filter coefficient	MP		Filter coefficient 10.3.7.9		
>>BSIC verification required	MP		Enumerated (required, not required)		
>IS2000					
>>TADD E_c/I_0	MP		Integer (0..63)	Admission criteria for neighbours, see subclause 2.6.6.2.6 of TIA/EIA/IS-2000.5	
>>TCOMP E_c/I_0	MP		Integer (0..15)	Admission criteria for neighbours, see subclause 2.6.6.2.5.2 of TIA/EIA/IS-2000.5	

Information Element/Group name	Need	Multi	Type and reference	Semantics description	Version
>>SOFT SLOPE	OP		Integer (0..63)	Admission criteria for neighbours, see subclause 2.6.6.2.3 and 2.6.6.2.5.2 of TIA/EIA/IS-2000.5	
>>ADD_INTERCEPT	OP		Integer (0..63)	Admission criteria for neighbours, see subclause 2.6.6.2.5.2 of TIA/EIA/IS-2000.5	
>E-UTRA					REL-8
>>Measurement quantity	MP		Enumerated (RSRP, RSRQ)	This IE indicates the quantity that the UE uses to determine the event trigger.	REL-8
>>Filter coefficient	MP		Filter coefficient 10.3.7.9		REL-8

10.3.7.30 Inter-RAT measurement reporting criteria

The triggering of the event-triggered reporting for an inter-RAT measurement. All events concerning inter-RAT measurements are labelled 3x where x is a,b,c, ...

Event 3a: The estimated quality of the currently used UTRAN frequency is below a certain threshold **and** the estimated quality of the other system is above a certain threshold.

Event 3b: The estimated quality of other system is below a certain threshold.

Event 3c: The estimated quality of other system is above a certain threshold.

Event 3d: Change of best cell in other system.

Information Element/Group name	Need	Multi	Type and reference	Semantics description	Version
Parameters required for each event	OP	1 to <maxMeas Event>			
>Inter-RAT event identity	MP		Inter-RAT event identity 10.3.7.24		
>Threshold own system	CV— <i>clause 0</i>		Integer (-115..0)		
>W	CV— <i>clause 0</i>		Real(0, 0.1..2.0 by step of 0.1)	In event 3a	
>Threshold other system	CV— <i>clause 1</i>		Integer (-115..0)	In event 3a, 3b, 3c If the other system is EUTRA, the range used depends on: if measurement quantity is RSRQ, range should be (-39..-6), the actual value = Threshold other system/2 [dB], if measurement quantity is RSRP, range should be (-115..-19), the actual value = Threshold other system - 25 [dBm]	REL-12
			Integer (-115..6)	In event 3a, 3b, 3c If the other system is EUTRA, the range used depends on: if measurement quantity is RSRQ, range should be (-68..6), the actual value = Threshold other system/2 [dB], if measurement quantity is RSRP, range should be (-115..-19), the actual value = Threshold other system - 25 [dBm]	
>Hysteresis	MP		Real(0..7.5 by step of 0.5)		
>Time to trigger	MP		Time to trigger 10.3.7.64	Indicates the period of time during which the event condition has to be satisfied, before sending a Measurement Report.	
>Reporting cell status	OP		Reporting cell status 10.3.7.61		

Condition	Explanation
<i>Clause 0</i>	The IE is mandatory present if the IE "Inter-RAT event identity" is set to "3a", otherwise the IE is not needed
<i>Clause 1</i>	The IE is mandatory present if the IE "Inter-RAT event identity" is set to 3a, 3b or 3c, otherwise the IE is not needed

10.3.7.31 Inter-RAT measurement system information

Information Element/Group name	Need	Multi	Type and reference	Semantics description
Inter-RAT cell info list	OP		Inter-RAT cell info list 10.3.7.23	

10.3.7.32 Inter-RAT reporting quantity

For all boolean types TRUE means inclusion in the report is requested.

Information Element/Group name	Need	Multi	Type and reference	Semantics description	Version
UTRAN estimated quality	MP		Boolean	This parameter is not used in this release and should be set to FALSE.	
CHOICE <i>system</i>	MP				
>GSM					
>>GSM Carrier RSSI Reporting indicator	MP		Boolean		
>E-UTRA					REL-8
>>Reporting quantity	MP		Enumerated ('measurement quantity', 'both')	This IE indicates the quantity that the UE reports; if this IE is set to 'measurement quantity' the UE reports either RSRP or RSRQ which is indicated in the "measurement quantity" (see subclause 10.3.7.29); if this IE is set to 'both', the UE reports both RSRP and RSRQ.	REL-8

10.3.7.33 Intra-frequency cell info list

Contains the information for the list of measurement objects for an intra-frequency measurement.

Information Element/Group name	Need	Multi	Type and reference	Semantics description	Version
CHOICE <i>Intra-frequency cell removal</i>	OP			Absence of this IE is equivalent to choice "Remove no intra-frequency cells".	
>Remove all intra-frequency cells				(no data)	
>Remove some intra-frequency cells					
>>Removed intra-frequency cells	MP	1 to <maxCellMeas>			
>>>Intra-frequency cell id	MP		Integer(0 .. <maxCellMeas> - 1)		
>Remove no intra-frequency cells				(no data)	
New intra-frequency cells	OP	1 to <maxCellMeas>		This information element must be present when "Intra-frequency cell info list" is included in the system information	
>Intra-frequency cell id	OP		Integer(0 .. <maxCellMeas> - 1)		
>Cell info	MP		Cell info 10.3.7.2	This IE must be included for the serving cell when the IE "Intra frequency cell info list" is included in System Information Block type 11.	
>CHOICE <i>mode specific info</i>	MP				REL-10
>>No information				No data for FDD, TDD 3.84 Mcps or TDD 7.68 Mcps	REL-10
>>TDD 1.28 Mcps					REL-10
>>> SNPL Monitor Set Indicator	OP		Bit string(5)	Each bit indicates whether the intra frequency neighbour cell has a secondary frequency which is the same as the frequency of a specific E-DCH carrier of UE. Bit0 indicate the E-DCH carrier with lowest UARFCN, Bit1 indicate the E-DCH carrier with the second lowest ... Bit n indicate the E-DCH carrier with the n+1 lowest UARFCN, the E-DCH carrier on the Primary E-DCH carrier shall not be considered in the bitmap.	REL-10
Cells for measurement	CV- <i>BCHopt</i>	1 to <maxCellMeas>			
>Intra-frequency cell id	MP		Integer(0 .. <maxCellMeas>-1)		
CSG Intrafrequency cell info	CV- <i>BCHopt</i>		10.3.7.121		REL-9
Intra-frequency SI Acquisition	CV- <i>BCHopt</i>		10.3.7.125		REL-9

Condition	Explanation
<i>BCHopt</i>	This IE is not needed when sent in SYSTEM INFORMATION. Otherwise, the IE is Optional

10.3.7.34 Intra-frequency event identity

Information Element/Group name	Need	Multi	Type and reference	Semantics description	Version
Intra-frequency event identity	MP		Enumerated (1a,1b,1c,1d,1e,1f,1g,1h,1i,	Seven spare values are needed.	REL-6
			1j)	Six spare values are needed.	

10.3.7.35 Intra-frequency measured results list

Information Element/Group name	Need	Multi	Type and reference	Semantics description	Version
Intra-frequency measurement results	OP	1 to <maxCellMeas>			
>Cell measured results	MP		Cell measured results 10.3.7.3	Only cells for which all reporting quantities are available should be included.	

10.3.7.36 Intra-frequency measurement

Information Element/Group name	Need	Multi	Type and reference	Semantics description	Version
Intra-frequency measurement objects list	OP		Intra-frequency cell info list 10.3.7.33		
Intra-frequency measurement objects list on secondary UL frequency	OP		Intra-frequency cell info list on secondary UL frequency 10.3.7.116		REL-9
Intra-frequency measurement quantity	OP		Intra-frequency measurement quantity 10.3.7.38		
Intra-frequency reporting quantity	OP		Intra-frequency reporting quantity 10.3.7.41		
Reporting cell status	CV-reporting		Reporting cell status 10.3.7.61		
Measurement validity	OP		Measurement validity 10.3.7.51		
CHOICE <i>report criteria</i>	OP			NOTE 1	
	MP				REL-6
	OP				REL-7

Information Element/Group name	Need	Multi	Type and reference	Semantics description	Version
>Intra-frequency measurement reporting criteria			Intra-frequency measurement reporting criteria 10.3.7.39		
>Periodical reporting criteria			Periodical reporting criteria 10.3.7.53		
>No reporting				(no data) Chosen when this measurement only is used as additional measurement to another measurement	
Periodical reporting criteria for the secondary UL Frequency	OP		Periodical reporting criteria on secondary UL frequency 10.3.7.136		REL-10

Condition	Explanation
<i>reporting</i>	This IE is optional if the CHOICE " <i>report criteria</i> " is equal to "periodical reporting criteria" or "No reporting", otherwise the IE is not needed

NOTE 1: The IE "report criteria" is optional in all releases except Rel-6. In Rel-6 the IE "report criteria" is mandatory present in order to align the tabular format with the Rel-6 ASN.1.

10.3.7.37 Intra-frequency measurement event results

This IE contains the measurement event results that are reported to UTRAN for intra-frequency measurements.

Information Element/Group name	Need	Multi	Type and reference	Semantics description	Version
Intra-frequency event identity	MP		Intra-frequency event identity 10.3.7.34		
Cell measurement event results	MP		Cell measurement event results 10.3.7.4		

10.3.7.38 Intra-frequency measurement quantity

The quantity the UE shall measure in case of intra-frequency measurement. It also includes the filtering of the measurements.

Information Element/Group name	Need	Multi	Type and reference	Semantics description
Filter coefficient	MP		Filter coefficient 10.3.7.9	

Information Element/Group name	Need	Multi	Type and reference	Semantics description
CHOICE <i>mode</i>	MP			
>FDD				
>>Measurement quantity	MP		Enumerated(CPICH Ec/N0, CPICH RSCP, Pathloss)	
>TDD				
>>Measurement quantity list	MP	1 to 4		
>>>Measurement quantity	MP		Enumerated(Primary CCPCH RSCP, Pathloss, Timeslot ISCP)	

10.3.7.39 Intra-frequency measurement reporting criteria

The triggering of the event-triggered reporting for an intra-frequency measurement. All events concerning intra-frequency measurements are labelled 1x where x is a, b, c....

Event 1a: A Primary CPICH enters the Reporting Range (FDD only).

Event 1b: A Primary CPICH leaves the Reporting Range (FDD only).

Event 1c: A Non-active Primary CPICH becomes better than an active Primary CPICH (FDD only).

Event 1d: Change of best cell (FDD only).

Event 1e: A Primary CPICH becomes better than an absolute threshold (FDD only).

Event 1f: A Primary CPICH becomes worse than an absolute threshold (FDD only).

Event 1g: Change of best cell in TDD.

Event 1h: Timeslot ISCP below a certain threshold (TDD only).

Event 1i: Timeslot ISCP above a certain threshold (TDD only).

Event 1j: A Non-active E-DCH but active DCH Primary CPICH becomes better than an active E-DCH Primary CPICH (FDD only).

Information Element/Group name	Need	Multi	Type and reference	Semantics description	Version
Parameters required for each event	OP	1 to <maxMeasureasEvent >			
>Intra-frequency event identity	MP		Intra-frequency event identity 10.3.7.34		
>Triggering condition 1	CV- <i>clause 0</i>		Enumerated(Active set cells, Monitored set cells, Active set cells and monitored set cells)	Indicates which cells can trigger the event	

Information Element/Group name	Need	Multi	Type and reference	Semantics description	Version
>Triggering condition 2	CV- clause 6		Enumerated(Active set cells, Monitored set cells, Active set cells and monitored set cells, Detected set cells, Detected set cells and monitored set cells)	Indicates which cells can trigger the event	REL-5
	CV- clause 10				
>Reporting Range Constant	CV- clause 2		Real(0..14.5 by step of 0.5)	In dB. In event 1a,1b.	
>Cells forbidden to affect Reporting range	CV- clause 1	1 to <maxCellMeas>		In event 1a,1b	
>>CHOICE mode	MP				
>>>FDD					
>>>>Primary CPICH info	MP		Primary CPICH info 10.3.6.60		
>>>TDD					
>>>>Primary CCPCH info	MP		Primary CCPCH info 10.3.6.57		
>W	CV- clause 2		Real(0.0..2.0 by step of 0.1)		
>Hysteresis	MP		Real(0..7.5 by step of 0.5)	In dB.	
>Threshold used frequency	CV- clause 3		Integer (-115..165)	Range used depend on measurement quantity. CPICH RSCP -115..-25 dBm CPICH Ec/No -24..0 dB Pathloss 30..165dB ISCP -115..-25 dBm	REL-6
			Integer (-120..165)	Range used depend on measurement quantity. CPICH RSCP -120..-25 dBm CPICH Ec/No -24..0 dB Pathloss 30..165dB ISCP -120..-25 dBm	
>DeltaThreshold used frequency	CV- clause 8		Integer(-5..-1)	If present, the actual value of Threshold used frequency = Threshold used frequency + DeltaThreshold used frequency	REL-5
				Not used in Release 6 and later	REL-6
>Reporting deactivation threshold	CV- clause 4		Integer(0, 1, 2, 3, 4, 5, 6, 7)	In event 1a Indicates the maximum number of cells allowed	

Information Element/Group name	Need	Multi	Type and reference	Semantics description	Version
				in the active set in order for event 1a to occur. 0 means not applicable	
>Replacement activation threshold	CV- clause 5		Integer(0, 1, 2, 3, 4, 5, 6, 7)	In event 1c Indicates the minimum number of cells allowed in the active set in order for event 1c to occur. 0 means not applicable	
				In event 1j Indicates the minimum number of cells allowed in the E-DCH active set in order for event 1j to occur. For event 1j values 5, 6 and 7 are not applicable. 0 means not applicable	REL-6
>Time to trigger	MP		Time to trigger 10.3.7.64	Indicates the period of time during which the event condition has to be satisfied, before sending a Measurement Report. Time in ms	
>Amount of reporting	CV- clause 7		Integer(1, 2, 4, 8, 16, 32, 64, Infinity)	In case the IE "Intra-frequency reporting criteria" is included in the IE "Inter-frequency measurement", this IE is not needed.	
>Reporting interval	CV- clause 7		Integer(0, 250, 500, 1000, 2000, 4000, 8000, 16000)	Indicates the interval of periodical reporting when such reporting is triggered by an event. Interval in milliseconds. 0 means no periodical reporting. In case the IE "Intra-frequency reporting criteria" is included in the IE "Inter-frequency measurement", this IE is not needed.	
>Reporting cell status	OP		Reporting cell status 10.3.7.61		

Information Element/Group name	Need	Multi	Type and reference	Semantics description	Version
>Periodical reporting information-1b	CV- clause 9		Periodical reporting info-1b 10.3.7.53 aa	In case the IE "Intra-frequency reporting criteria" is included in the IE "Inter-frequency measurement", this IE is not needed.	REL-5
>Use CIO	CV- clause 10		Boolean	TRUE indicates that the cell individual offset shall be used for event evaluation	REL-5
Reporting criteria for secondary UL Frequency	CV- Clause 11		Intra-frequency measurement reporting criteria on secondary UL frequency 10.3.7.11 9		REL-9
Cells to be excluded in detected set cells	CV- Clause 12	1 to < maxExcludedDetectedSet Cells >		If present the UE should exclude indicated cells in the event evaluation when intra-frequency detected set is enabled.	REL-11
>Primary CPICH info	MP		Primary CPICH info 10.3.6.60		

Condition	Explanation
Clause 0	The IE is mandatory present if the IE "Intra-frequency event identity" is set to "1b" or "1f", otherwise the IE is not needed.
Clause 1	The IE is optional if the IE "Intra-frequency event identity" is set to "1a" or "1b", otherwise the IE is not needed.
Clause 2	The IE is mandatory present if the IE "Intra-frequency event identity" is set to "1a" or "1b", otherwise the IE is not needed.
Clause 3	The IE is mandatory present if the IE "Intra-frequency event identity" is set to, "1e", "1f", "1h" or "1i", otherwise the IE is not needed.
Clause 4	The IE is mandatory present if the IE "Intra-frequency event identity" is set to "1a", otherwise the IE is not needed.
Clause 5	The IE is mandatory present if the IE "Intra-frequency event identity" is set to "1c" or 1j, otherwise the IE is not needed.
Clause 6	The IE is mandatory present if the IE "Intra-frequency event identity" is set to "1a" or "1e", otherwise the IE is not needed.
Clause 7	The IE is mandatory present if the IE "Intra-frequency event identity" is set to "1a", "1c" or 1j, otherwise the IE is not needed.
Clause 8	The IE is optional if the IE "Intra-frequency event identity" is set to "1e", "1f", "1h" or "1i". Otherwise the IE is not needed.
Clause 9	The IE is optional if the IE "Intra-frequency event identity" is set to "1b", otherwise the IE is not needed.
Clause 10	The IE is optional if the IE "Intra-frequency event identity" is set to "1d", otherwise the IE is not needed.
Clause 11	The IE is not needed when sent in SYSTEM INFORMATION or when IE "Intra-frequency measurement reporting criteria" is included in the IE "Inter-frequency measurement", otherwise the IE is optional.
Clause 12	The IE is optional if the intra-frequency detected set is configured to trigger the measurement event, otherwise the IE is not needed.

10.3.7.40 Intra-frequency measurement system information

Information Element/Group name	Need	Multi	Type and reference	Semantics description
Intra-frequency measurement identity	MD		Measurement identity 10.3.7.48	The intra-frequency measurement identity has default value 1. If the cell is operating in MBSFN mode as indicated in subclause 8.1.1.6.3 the UE behaviour upon reception of this IE is unspecified.
Intra-frequency cell info list	OP		Intra-frequency cell info list 10.3.7.33	
Intra-frequency measurement quantity	OP		Intra-frequency measurement quantity 10.3.7.38	If the cell is operating in MBSFN mode as indicated in subclause 8.1.1.6.3 the UE behaviour upon reception of this IE is unspecified.
Intra-frequency reporting quantity for RACH Reporting	OP		Intra-frequency reporting quantity for RACH Reporting 10.3.7.42	If the cell is operating in MBSFN mode as indicated in subclause 8.1.1.6.3 the UE behaviour upon reception of this IE is unspecified.
Maximum number of reported cells on RACH	OP		Maximum number of reported cells on RACH 10.3.7.43	If the cell is operating in MBSFN mode as indicated in subclause 8.1.1.6.3 the UE behaviour upon reception of this IE is unspecified.
Reporting information for state CELL_DCH	OP		Reporting information for state CELL_DCH 10.3.7.62	Note 1 If the cell is operating in MBSFN mode as indicated in subclause 8.1.1.6.3 the UE behaviour upon reception of this IE is unspecified.

NOTE 1: The reporting of intra-frequency measurements is activated when state CELL_DCH is entered.

10.3.7.41 Intra-frequency reporting quantity

Contains the reporting quantity information for an intra-frequency measurement.

Information Element/Group name	Need	Multi	Type and reference	Semantics description
Reporting quantities for active set cells	MP		Cell reporting quantities 10.3.7.5	
Reporting quantities for monitored set cells	MP		Cell reporting quantities 10.3.7.5	
Reporting quantities for detected set cells	OP		Cell reporting quantities 10.3.7.5	

10.3.7.42 Intra-frequency reporting quantity for RACH reporting

Contains the reporting quantity information for an intra-frequency measurement report, which is sent on the RACH.

Information Element/Group name	Need	Multi	Type and reference	Semantics description	Version
SFN-SFN observed time difference reporting indicator	MP		Enumerated(No report, type 1, type 2)		
CHOICE <i>mode</i>	MP				
>FDD					
>>Reporting quantity	MP		Enumerated(CPICH Ec/N0, CPICH RSCP, Pathloss, No report)		
>>Reporting quantity 2	CV- <i>Current_Cell</i>		Enumerated(CPICH Ec/N0 and CPICH RSCP)	If this IE is present, the UE shall ignore the IE "Reporting quantity". One spare value.	REL-12
>TDD					
>>Reporting quantity list	MP	1 to 2			
>>>Reporting quantity	MP		Enumerated(Timeslot ISCP, Primary CCPCH RSCP, No report)		

Condition	Explanation
<i>Current_Cell</i>	This IE is optional for the current cell and is not needed otherwise.

10.3.7.42a Logged ANR Configuration Info

Parameters used to configure logged UTRAN ANR measurements.

Information Element/Group name	Need	Multi	Type and reference	Semantics description	Version
Logging Duration	MP		Enumerated (10 min, 30min, 1 hour, spare1, spare2)	Timer for logging duration. The timer is activated at the moment of configuration. When the timer expires the logging is stopped and the configuration is cleared.	REL-10
Intra-UTRA ANR	OP			Included if intra-UTRA ANR shall be performed	REL-10
>CHOICE <i>Absolute Threshold</i>	MP				REL-10
>>RSCP for ANR					
>>>RSCP	MD		Integer (-120..-25)	In dBm. Default value is -100. If present, it indicates CPICH RSCP for FDD, Primary CCPCH RSCP for TDD.	REL-10
>>Ec/N0 for ANR					
>>>Ec/N0	MD		Integer (-24..0)	In dB. Default value is -10. For FDD only	REL-10
>Logging Relative Threshold	OP		Integer (-4..16)	If present, it applies to RSCP by step of 2 and Ec/N0 by step of 1.	REL-10
Inter-RAT ANR for E-UTRA Indicator	OP		Enumerated (TRUE)	True indicates the UE needs to perform inter-RAT ANR to E-UTRA.	REL-10
Inter-RAT ANR for GSM Indicator	OP		Enumerated (TRUE)	True indicates the UE needs to perform inter-RAT ANR to GSM	REL-10

10.3.7.42b Logged ANR Report Info

Information Element/Group name	Need	Multi	Type and reference	Semantics description	Version
Logged ANR Report Info List		<i>1...MaxNumANRLoggedItems</i>			REL-10
>Serving PLMN Identity	MP		PLMN identity 10.3.1.11		REL-10
>Serving Cell	MP		Cell ID 10.3.2.2		REL-10
>CHOICE <i>logged cell info</i>	MP				REL-10
>>UTRAN					
>>>PLMN Identity	MP		PLMN identity 10.3.1.11		REL-10
>>>Cell Identity	MP		Cell ID 10.3.2.2		REL-10
>>>UARFCN	MP		Integer(0..16383)		REL-10
>>>Cell parameter ID	<i>CV-Tdd</i>		Cell parameter Id 10.3.6.9		REL-10
>>>Primary Scrambling Code	<i>CV-Fdd</i>		Primary CPICH info 10.3.6.60		REL-10
>>E-UTRA					
>>>PLMN Identity	MP		PLMN identity 10.3.1.11		REL-10
>>>Tracking Area Code	MP		Bit string (16)	Setting specified in [67]. The first/leftmost bit of the bit string contains the most significant bit of the Tracking Area Code.	REL-10
>>>Cell Identity	MP		Bit string (28)	Formatted and coded according to [67]. The first/leftmost bit of the bit string contains the most significant bit of the Cell Identity.	REL-10
>>>EARFCN	MP		Integer (0..65535)	EARFCN of the downlink carrier frequency [64]. If the IE indicates a value of 65535, then the EARFCN for this instance should be read from the corresponding instance of IE "EARFCN extension" in the Logged ANR Report Info extension List.	REL-10
>>>Physical Cell identity	MP		Integer (0..503)		REL-10
>>GSM					
>>>PLMN Identity	MP		PLMN identity 10.3.1.11		REL-10

>>>LAC	MP		Bit string(16)	The first/leftmost bit of the bit string contains the most significant bit of the LAC..	REL-10
>>>Cell Identity	MP		Bit string (16)	Formatted and coded according to [11]. The first/leftmost bit of the bit string contains the most significant bit of the Cell Identity.	REL-10
>>>BCCH ARFCN	MP		Integer (0..1023)	[45]	REL-10
>>>Band Indicator	MP		Enumerated (DCS 1800 band used, PCS 1900 band used)	Indicates how to interpret the BCCH ARFCN	REL-10
>>>BSIC	MP		BSIC 10.3.8.2		REL-10
Logged ANR Report Info extension List	OP	1 to <MaxNum ANRLoggedItems>			REL-11
>>>EARFCN extension	MP		Integer (65536..262143)	EARFCN of the downlink carrier frequency [64]	REL-11

Condition	Explanation
<i>Fdd</i>	This IE is mandatory present for FDD, otherwise it is not needed.
<i>Tdd</i>	This IE is mandatory present for TDD, otherwise it is not needed.

10.3.7.43 Maximum number of reported cells on RACH

Contains the maximum number of intra-frequency cells to be reported on RACH.

Information Element/Group name	Need	Multi	Type and reference	Semantics description
Maximum number of reported cells	MP		Enumerated (no report, current cell, current cell + best neighbour, current cell+2 best neighbours, ..., current cell+6 best neighbours)	

10.3.7.43a MBMS preferred frequency information

Information Element/Group name	Need	Multi	Type and reference	Semantics description	Version
MBMS preferred frequency list	MP	1 to <maxMBMS-Freq>			REL-6
>MBMS preferred frequency	OP		Integer(1 .. <maxMBMS-Freq>)	Absence of this information element means the currently used frequency. Value n corresponds with the n th frequency included in the IE New inter-frequency cells that is specified within SIB 11	REL-6
>CHOICE Layer convergence information	MP				REL-6
>>No HCS					REL-6
>>>Qoffmbms	MP		Enumerated (4, 8, 12, 16, 20, 30, 40, infinity)	The offset in decibel [dB] added to cells on this MBMS preferred frequency	REL-6
>>HCS					REL-6
>>>HCS_OFF _{mbms}	MP		Integer (0..7)	Offset added to the normal HCS priority level of cells on this MBMS preferred frequency	REL-6
>MBMS PL Service Restriction Information	OP		Enumerated (TRUE)	Included if some service restrictions apply for this preferred frequency e.g. congestion	REL-6

10.3.7.43b MBSFN inter frequency neighbour list

Information Element/Group name	Need	Multi	Type and reference	Semantics description	Version
MBSFN inter frequency neighbour list	MP	1 to <maxMBSFNclusters>			REL-7
>MBSFN frequency	MP		Frequency info 10.3.6.36		REL-7
>IMB indication	OP		Enumerated (TRUE)	If present: 3.84 Mcps TDD MBSFN IMB is applied on this frequency.	REL-8
>CHOICE MBSFN services notification	MP				REL-7
>>MBSFN services notified				(no data)	REL-7
>>MBSFN services not notified					REL-7
>>>All MBSFN services notified	OP		Enumerated (TRUE)		REL-7

10.3.7.44 Measured results

Contains the measured results of the quantity indicated optionally by Reporting Quantity in Measurement Control. "Measured results" can be used for both event trigger mode and periodical reporting mode. For intra-frequency and

inter-frequency measurements the list shall be in the order of the value of the measurement quantity (the first cell shall be the best cell). The "best" FDD cell has the largest value when the measurement quantity is "Ec/No" or "RSCP". On the other hand, the "best" cell has the smallest value when the measurement quantity is "Pathloss". The "best" TDD cell has the largest value when measurement quantity is "Primary CCPCH RSCP". For intra-frequency measurements, the ordering shall be applied to all cells included in the IE "Measured results". For inter-frequency measurements, the ordering shall be applied to all cells on the same frequency included in the IE "Measured results". For other measurements, the order of reported measurement objects is not specified.

Information Element/Group name	Need	Multi	Type and reference	Semantics description
CHOICE <i>Measurement</i>	MP			One spare value is needed.
>Intra-frequency measured results list			Intra-frequency measured results list 10.3.7.35	
>Inter-frequency measured results list			Inter-frequency measured results list 10.3.7.15	
>Inter-RAT measured results list			Inter-RAT measured results list 10.3.7.26	
>Traffic volume measured results list			Traffic volume measured results list 10.3.7.67	
>Quality measured results list			Quality measured results list 10.3.7.55	
>UE Internal measured results			UE Internal measured results 10.3.7.76	
>UE positioning measured results			UE positioning measured results 10.3.7.99	

10.3.7.45 Measured results on RACH

For measurements on used frequency, this IE contains the measured results on RACH of the quantity indicated by Reporting quantity in the IE "Intra-frequency reporting quantity for RACH Reporting" in system information broadcast on BCH. The list, measurement results for monitored cells (not including the current cell) shall be in the order of the value of the measurement quantity as indicated by Reporting Quantity in the IE "Intra-frequency reporting quantity for RACH Reporting" (the first cell shall be the best cell).

For measurements on non-used frequencies, this IE includes the best cell on each non-used frequency, in order of decreasing quality and up to a maximum number as specified by the IE "Maximum number of inter-frequency RACH reporting cells". If the UE supports Increased UE carrier monitoring UTRA, then:

- 1> if all the inter-frequency cells in the variable CELL_INFO_LIST belong to the legacy cell ID range (0.. maxCellMeas-1), then the best cell on each non-used frequency are included into the Rel-6 version of this IE;
- 1> if all the inter-frequency cells in the variable CELL_INFO_LIST belong to both legacy cell ID range (0.. maxCellMeas-1) and extended cell ID range (maxCellMeas.. maxCellMeas-ext-1), then:
 - 2> the Rel-12 version of this IE includes the best cell on each non-used frequency constructed from the list of cells belonging to both legacy and extended cell ID range; and

- 2> the Rel-6 version of this IE includes the best cell on each non-used frequency constructed from the list of cells belonging only to the legacy cell ID range.

The "best" FDD cell has the largest value when the measurement quantity is "Ec/No" or "RSCP". On the other hand, the "best" cell has the smallest value when the measurement quantity is "Pathloss". The "best" TDD cell has the largest value when measurement quantity is "Primary CCPCH RSCP".

For measurements on E-UTRA frequencies, this IE includes a bit string, of which the i-th bit should be set to 1 only if the quantity of the i-th E-UTRA frequency configured for measurement and reporting on RACH in the IE "E-UTRA frequency list indicator" received in System Information Block Type 19 exceeds the threshold specified by

- 1> if the "E-UTRA frequency RACH reporting quantity" is set to RSRP:
 - 2> the threshold specified by the IE "E-UTRA frequency RACH reporting threshold".
- 1> if the "E-UTRA frequency RACH reporting quantity" is set to RSRQ:
 - 2> the threshold specified by the IE "E-UTRA frequency RACH reporting threshold" minus the offset "EUTRA-RSRQ-offsetWB" and "EUTRA-RSRQ-OnAllSymbolsOffset", if stored in the variable PRIORITY_INFO_LIST for that frequency.

If the threshold is not exceeded, set the corresponding bit to 0.

Information Element/group name	Need	Multi	Type and reference	Semantics description	Version
Measurement result for current cell	MP				
>CHOICE <i>mode</i>	MP				
>>FDD					
>>>CHOICE <i>measurement quantity</i>	MP			One spare value is needed.	
>>>>CPICH Ec/No			Integer(0..49)	In dB. According to CPICH_Ec/No in [19]. Fourteen spare values are needed.	
>>>>CPICH RSCP			Integer(0..91)	In dBm. According to CPICH_RSCP_LEV in [19]. Thirty-six spare values are needed.	
>>>>Pathloss			Integer(46..158)	In dB. Fifteen spare values are needed.	
>>>>CPICH Ec/No and CPICH RSCP					REL-12
>>>>>CPICH Ec/No	MP		Integer(0..49)	In dB. According to CPICH_Ec/No in [19]. Fourteen spare values are needed.	REL-12
>>>>>CPICH RSCP	MP		Integer(0..91)	In dBm. According to CPICH_RSCP_LEV in [19]. Thirty-six spare values are needed.	REL-12
>>TDD					
>>>CHOICE <i>TDD option</i>	MP				REL-4
>>>>3.84 Mcps TDD					REL-4
>>>>>Timeslot List	OP	1 to 14			
>>>>>>Timeslot ISCP	MP		Timeslot ISCP info 10.3.7.65	The UE shall report the Timeslot ISCP in the same order as indicated in the cell info	
>>>7.68 Mcps TDD					REL-7
>>>>Timeslot List	OP	1 to 14			REL-7
>>>>>Timeslot ISCP	MP		Timeslot ISCP info 10.3.7.65	The UE shall report the Timeslot ISCP in the same order as indicated in the cell info	REL-7
>>>>1.28 Mcps TDD					REL-4
>>>>>Timeslot List	OP	1 to 6			REL-4
>>>>>>Timeslot ISCP	MP		Timeslot ISCP info 10.3.7.65	The UE shall report the Timeslot ISCP in the same order as indicated in the cell info	REL-4

Information Element/group name	Need	Multi	Type and reference	Semantics description	Version
>>>Primary CCPCH RSCP	OP		Primary CCPCH RSCP info 10.3.7.54		
Measurement results for monitored cells on used frequency	OP	1 to 8			
>SFN-SFN observed time difference	OP		SFN-SFN observed time difference 10.3.7.63		
>CHOICE <i>mode</i>	MP				
>>FDD					
>>>Primary CPICH info	MP		Primary CPICH info 10.3.6.60		
>>>CHOICE <i>measurement quantity</i>	OP			One spare value is needed.	
>>>>CPICH Ec/NO			Integer(0..49)	In dB. According to CPICH_Ec/No in [19]. Fourteen spare values are needed.	
>>>>CPICH RSCP			Integer(0..91)	In dBm. According to CPICH_RSCP_LEV in [19]. Thirty-six spare values are needed.	
>>>>Pathloss			Integer(46..158)	In dB. Fifteen spare values are needed.	
>>TDD					
>>>Cell parameters Id	MP		Cell parameters Id 10.3.6.9		
>>>Primary CCPCH RSCP	MP		Primary CCPCH RSCP info 10.3.7.54		
Measurement results for monitored cells on non-used frequencies	OP				REL-6
>Inter-frequency cell indication-SIB11	MP		Integer (0..1)		REL-6
>Inter-frequency cell indication-SIB12	MP		Integer (0..1)		REL-6
>Inter-frequency cell list	MP	1 to <maxFreq>			REL-6
>>Inter-frequency cell id	MP		Integer(0 .. <maxCellMeas>-1)		REL-6
			Integer(0 .. <maxCellMeas-ext>-1)		REL-12
Measurement results for E-UTRA frequencies	OP				REL-11
> E-UTRA frequency indication-SIB19	MP		Integer (0..1)		REL-11

Information Element/group name	Need	Multi	Type and reference	Semantics description	Version
> E-UTRA frequency indicator	MP		Bit string(maxN umEUTRAFreqs_FACH)	Bit 0 is the first/leftmost bit of the bit string. Each bit indicates whether the radio quality of an E-UTRA frequency is above the reporting threshold or not, where a one value indicates above and a zero value not. Bit n corresponds to the n-th E-UTRA frequency configured for measurement and reporting on RACH in the IE "E-UTRA frequency list indicator" received in SIB19.	REL-11
			Bit string(maxN umEUTRAFreqs_FACH-ext)	Bit 0 is the first/leftmost bit of the bit string. Each bit indicates whether the radio quality of an E-UTRA frequency is above the reporting threshold or not, where a one value indicates above and a zero value not. Bit n corresponds to the n-th E-UTRA frequency configured for measurement and reporting on RACH in the IE "E-UTRA frequency list indicator" received in SIB19.	REL-12

NOTE: Monitored cells consist of neighbouring cells.

10.3.7.45a Measured results on RACH FDD

NOTE 1: Only for FDD.

For measurements on used frequency, this IE contains the measured results on RACH of the quantity indicated by Reporting quantity in the IE "Intra-frequency reporting quantity for RACH Reporting" in system information broadcast on BCH. The list, measurement results for monitored cells (not including the current cell) shall be in the order of the value of the measurement quantity as indicated by Reporting Quantity in the IE "Intra-frequency reporting quantity for RACH Reporting" (the first cell shall be the best cell).

For measurements on non-used frequencies, this IE includes the best cell on each non-used frequency, in order of decreasing quality and up to a maximum number as specified by the IE "Maximum number of inter-frequency RACH reporting cells".

The "best" FDD cell has the largest value when the measurement quantity is "Ec/No" or "RSCP". On the other hand, the "best" cell has the smallest value when the measurement quantity is "Pathloss".

For measurements on E-UTRA frequencies, this IE includes a bit string, of which the i-th bit should be set to 1 only if the quantity of the i-th E-UTRA frequency configured for measurement and reporting on RACH in the IE "E-UTRA frequency list indicator" received in System Information Block Type 19 exceeds the threshold specified by

- 1> if the "E-UTRA frequency RACH reporting quantity" is set to RSRP
 - 2> the threshold specified by the IE "E-UTRA frequency RACH reporting threshold".
- 1> if the "E-UTRA frequency RACH reporting quantity" is set to RSRQ
 - 2> the threshold specified by the IE "E-UTRA frequency RACH reporting threshold" minus the offset "EUTRA-RSRQ-offsetWB" and "EUTRA-RSRQ-OnAllSymbolsOffset", if stored in the variable PRIORITY_INFO_LIST for that frequency.

If the threshold is not exceeded, set the corresponding bit to 0.

Information Element/group name	Need	Multi	Type and reference	Semantics description	Version
Measurement result for current cell	MP				
>CHOICE <i>measurement quantity</i>	MP			One spare value is needed.	
>>CPICH Ec/N0			Integer(0..49)	In dB. According to CPICH_Ec/No in [19]. Fourteen spare values are needed.	
>>CPICH RSCP			Integer(0..91)	In dBm. According to CPICH_RSCP_LE V in [19]. Thirty-six spare values are needed.	
>>Pathloss			Integer(46..158)	In dB. Fifteen spare values are needed.	
>>CPICH Ec/N0 and CPICH RSCP					REL-12
>>>CPICH Ec/N0	MP		Integer(0..49)	In dB. According to CPICH_Ec/No in [19]. Fourteen spare values are needed.	REL-12
>>>CPICH RSCP	MP		Integer(0..91)	In dBm. According to CPICH_RSCP_LE V in [19]. Thirty-six spare values are needed.	REL-12
Measurement results for monitored cells on used frequency	OP	1 to 8			
>SFN-SFN observed time difference	OP		SFN-SFN observed time difference 10.3.7.63		
>Primary CPICH info	MP		Primary CPICH info 10.3.6.60		
>CHOICE <i>measurement quantity</i>	OP			One spare value is needed.	
>>CPICH Ec/N0			Integer(0..49)	In dB. According to CPICH_Ec/No in [19]. Fourteen spare values are needed.	
>>CPICH RSCP			Integer(0..91)	In dBm. According to CPICH_RSCP_LE V in [19]. Thirty-six spare values are needed.	
>>Pathloss			Integer(46..158)	In dB. Fifteen spare values are needed.	

Information Element/group name	Need	Multi	Type and reference	Semantics description	Version
Measurement results for monitored cells on non-used frequencies	OP				
>Inter-frequency cell indication-SIB11	MP		Integer (0..1)		
>Inter-frequency cell indication-SIB12	MP		Integer (0..1)		
>Inter-frequency cell list	MP	1 to <maxFreq >			
>>Inter-frequency cell id	MP		Integer(0 .. <maxCellMeas>-1)		
Measurement results for E-UTRA frequencies	OP				
> E-UTRA frequency indication-SIB19	MP		Integer (0..1)		
> E-UTRA frequency indicator	MP		Bit string(maxNumEUTRAFreqs_FACH)	Bit 0 is the first/leftmost bit of the bit string. Each bit indicates whether the radio quality of an E-UTRA frequency is above the reporting threshold or not, where a one value indicates above and a zero value not. Bit n corresponds to the n-th E-UTRA frequency configured for measurement and reporting on RACH in the IE "E-UTRA frequency list indicator" received in SIB19.	

NOTE: Monitored cells consist of neighbouring cells.

10.3.7.46 Measurement Command

Information Element/Group name	Need	Multi	Type and reference	Semantics description	Version
Measurement command	MP		Enumerated(Setup, Modify, Release)		
			ReleaseAll, ReleaseSome)		REL-12

10.3.7.46a Measurement release enhancement

Information Element/Group name	Need	Multi	Type and reference	Semantics description	Version
Choice <i>mode</i>	MP				REL-12
>Release all measurements			(no data)		REL-12
>Release some measurements			Release some measurements 10.3.7.46b		REL-12

10.3.7.46b Release some measurements

Information Element/Group name	Need	Multi	Type and reference	Semantics description	Version
Released measurements	MP	1 to < maxMeasIdentity>			REL-12
>Measurement Identity	MP		Measurement identity 10.3.7.48		REL-12

10.3.7.47 Measurement control system information

Information element/Group name	Need	Multi	Type and reference	Semantics description
Use of HCS	MP		Enumerated (Not used, used)	Indicates if the serving cell belongs to a HCS structure If the cell is operating in MBSFN mode as indicated in subclause 8.1.1.6.3 the UE behaves as if this IE would not have been received.
Cell selection and reselection quality measure	MP		Enumerated (CPICH Ec/N0, CPICH RSCP)	Choice of measurement (CPICH Ec/N0 or CPICH RSCP) to use as quality measure Q. NOTE: For TDD, each choice of this parameter represents PCCPCH RSCP. If the cell is operating in MBSFN mode as indicated in subclause 8.1.1.6.3 the UE behaves as if this IE would not have been received
Intra-frequency measurement system information	OP		Intra-frequency measurement system information 10.3.7.40	
Inter-frequency measurement system information	OP		Inter-frequency measurement system information 10.3.7.20	If the cell is operating in MBSFN mode as indicated in subclause 8.1.1.6.3 the UE behaviour upon reception of this IE is unspecified.
Inter-RAT measurement system information	OP		Inter-RAT measurement system information 10.3.7.31	If the cell is operating in MBSFN mode as indicated in subclause 8.1.1.6.3 the UE behaviour upon reception of this IE is unspecified.
Traffic volume measurement system information	OP		Traffic volume measurement system information 10.3.7.73	If the cell is operating in MBSFN mode as indicated in subclause 8.1.1.6.3 the UE behaviour upon reception of this IE is unspecified.

Condition	Explanation
MBSFN	This IE is mandatory present in a cell operating in MBSFN mode.

10.3.7.47a Measurement control system information extension

Information element/Group name	Need	Multi	Type and reference	Semantics description	Version
Intra-frequency cell info list	OP				REL-6
>New intra-frequency cells	MP	1 to <maxCellMeas>			REL-6
>>Intra-frequency cell id	OP		Integer(0 .. <maxCellMeas> - 1)		REL-6
>>Cell info	MP		Cell info 10.3.7.2		REL-6
Inter-frequency cell info list	OP				REL-6
>New inter-frequency cells	MP	1 to <maxCellMeas>			REL-6
>>Frequency Info	MD		Frequency info 10.3.6.36	Default value is the value of the previous "frequency info" in the list. NOTE: The first occurrence is then MP. It is always ensured by the UTRAN that more than one entry for the same physical frequency is not configured regardless of the UARFCN used to indicate this.	REL-6
>>Inter-frequency cell id	OP		Integer(0 .. <maxCellMeas> - 1)		REL-6
>>Cell info	MP		Cell info 10.3.7.2		REL-6
Reduced measurement performance frequency list	OP	1 to <maxRMPfrequencies>			REL-12
>Reduced measurement performance	MP		BOOLEAN	TRUE indicates that the frequency is configured for reduced measurement performance [19]. FALSE indicates that the frequency is configured for normal measurement performance [19]. The ith entry in the Reduced measurement performance frequency list corresponds to the ith frequency signalled in the "New inter-frequency cells" list.	REL-12
Inter-RAT cell info list	OP				REL-6

>>New inter-RAT cells	MP	1 to <maxCellMeas>			REL-6
>>Inter-RAT cell id	OP		Integer(0 .. <maxCellMeas> - 1)		REL-6
>>CHOICE <i>Radio Access Technology</i>	MP				REL-6
>>>GSM					REL-6
>>>>Cell individual offset	MP		Integer (-50..50)	In dB Used to offset measured quantity value	REL-6
>>>>Cell selection and re-selection info	OP		Cell selection and re-selection info for SIB11/12 10.3.2.4	See subclause 8.6.7.3	REL-6
>>>>BSIC	MP		BSIC 10.3.8.2		REL-6
>>>>Band indicator	MP		Enumerated (DCS 1800 band used, PCS 1900 band used)	Indicates how to interpret the BCCH ARFCN	REL-6
>>>>BCCH ARFCN	MP		Integer (0..1023)	[45]	REL-6
>>>IS-2000					REL-6
>>>>System specific measurement info	MP		enumerated (frequency, timeslot, colour code, output power, PN offset)	For IS-2000, use fields from TIA/EIA/IS-2000.5, subclause 3.7.3.3.2.27, <i>Candidate Frequency Neighbour List Message</i>	REL-6
>>>None			(no data)	This value has been introduced to handle the case when IE "New inter-RAT cells" is not required	REL-6
Multiple Frequency Info List FDD	CV-MCM_opt	1 to <maxNumFDDFreqs>		Each entry in the list corresponds to a UARFCN listed in the "New inter-frequency cells" IE (common to all those cells sharing the same "Frequency info" value).	REL-10
>Multiple Frequency bands Indicator List FDD	OP	1 to <maxMultipleFrequencyBandsFDD>		Indicates, per neighbour UARFCN, a list of frequency bands which the cells belong to. Absence of this IE indicates that there are no Multiple Bands for the particular UARFCN.	REL-10

>>CHOICE frequency bands indicator	MP				REL-10
>>>Frequency band indicator			Frequency band indicator 10.3.6.35b		REL-10
>>>Frequency band indicator 2			Frequency band indicator 2 10.3.6.35c		REL-10
>>>Frequency band indicator 3			Frequency band indicator 3 10.3.6.35ca		REL-10

Condition	Explanation
<i>MCM_opt</i>	This IE is OPTIONAL when sent in SYSTEM INFORMATION. Otherwise, the IE is not needed.

10.3.7.47b Inter-frequency cell info list extension

Information element/Group name	Need	Multi	Type and reference	Semantics description	Version
Inter-frequency cell info list	OP				REL-12
>New inter-frequency cells	MP	1 to <maxCellMeas-ext2>			REL-12
>>Frequency Info	MD		Frequency info 10.3.6.36	Default value is the value of the previous "frequency info" in the list. NOTE: The first occurrence is then MP. It is always ensured by the UTRAN that more than one entry for the same physical frequency is not configured regardless of the UARFCN used to indicate this.	REL-12
>>Inter-frequency cell id	OP		Integer(0 .. <maxCellMeas-ext> - 1)		REL-12
>>Cell info	MP		Cell info 10.3.7.2		REL-12
Reduced measurement performance frequency list	OP	1 to <maxRMPfrequencies>			REL-12
>Reduced measurement performance	MP		BOOLEAN	TRUE indicates that the frequency is configured for reduced measurement performance [19]. FALSE indicates that the frequency is configured for normal measurement performance [19]. The ith entry in the Reduced measurement performance frequency list corresponds to the ith frequency signalled in the "New inter-frequency cells" list.	REL-12
Multiple Frequency Info List FDD	CV-MCM_opt	1 to <maxNumFDDFreqs>		Each entry in the list corresponds to a UARFCN listed in the "New inter-frequency cells" IE (common to all those cells sharing the same "Frequency info" value).	REL-12

>Multiple Frequency bands Indicator List FDD	OP	1 to<maxMultipleFrequencyBandsFDD >		Indicates, per neighbour UARFCN, a list of frequency bands which the cells belong to. Absence of this IE indicates that there are no Multiple Bands for the particular UARFCN.	REL-12
>>CHOICE frequency bands indicator	MP				REL-12
>>>Frequency band indicator			Frequency band indicator 10.3.6.35b		REL-12
>>>Frequency band indicator 2			Frequency band indicator 2 10.3.6.35c		REL-12
>>>Frequency band indicator 3			Frequency band indicator 3 10.3.6.35ca		REL-12

Condition	Explanation
<i>MCM_opt</i>	This IE is OPTIONAL when sent in SYSTEM INFORMATION. Otherwise, the IE is not needed.

10.3.7.48 Measurement Identity

A reference number that is used by the UTRAN at modification and release of the measurement, and by the UE in the measurement report.

Information Element/Group name	Need	Multi	Type and reference	Semantics description	Version
Measurement identity	MP		Integer(1..16		
			17..32)		REL-9

NOTE: The specific handling of the Measurement Identity for UEs supporting the measurement identity extension is captured in ASN.1

10.3.7.49 Measurement reporting mode

Contains the type of Measurement Report transfer mode and the indication of periodical/event trigger.

Information Element/Group name	Need	Multi	Type and reference	Semantics description
Measurement Report Transfer Mode	MP		enumerated (Acknowledged mode RLC, Unacknowledged mode RLC)	
Periodical Reporting / Event Trigger Reporting Mode	MP		Enumerated (Periodical reporting, Event trigger)	

10.3.7.50 Measurement Type

Information Element/Group name	Need	Multi	Type and reference	Semantics description
Measurement Type	MP		Enumerated(Intra-frequency, Inter-frequency, Inter-RAT, Traffic volume, Quality, UE internal, UE positioning, CSG proximity)	

10.3.7.51 Measurement validity

Information Element/Group name	Need	Multi	Type and reference	Semantics description
UE state	MP		Enumerated(CELL_DCH, all states except CELL_DCH, all states)	

10.3.7.52 Void

10.3.7.53 Periodical reporting criteria

Contains the periodical reporting criteria information. It is necessary only in the periodical reporting mode.

Information Element/Group name	Need	Multi	Type and reference	Semantics description	Version
Amount of reporting	MD		Integer(1, 2, 4, 8, 16, 32, 64, Infinity)	The default value is infinity.	
Reporting interval	MP		Integer(250, 500, 1000, 2000, 3000, 4000, 6000, 8000, 12000, 16000, 20000, 24000, 28000, 32000, 64000)	Indicates the interval of periodical report. Interval in milliseconds. If this IE is configured for SI acquisition, then it specifies the maximum time the UE can take for SI acquisition.	

10.3.7.53aa Periodical reporting info-1b

Information Element/Group name	Need	Multi	Type and reference	Semantics description	Version
Amount of reporting	MP		Integer(1, 2, 4, 8, 16, 32, 64, Infinity)		REL-5
Reporting interval	MP		Integer(0, 250, 500, 1000, 2000, 4000, 8000, 16000)	Indicates the interval of periodical reporting when such reporting is triggered by an event. Interval in milliseconds. 0 means no periodical reporting.	REL-5

10.3.7.53a PLMN identities of neighbour cells

This IE contains the PLMN identities of neighbour cells.

Information Element/Group name	Need	Multi	Type and reference	Semantics description	Version
PLMNs of intra-frequency cells list	OP	1 to <maxCellsMeas>		NOTE	
>PLMN identity	OP		PLMN identity 10.3.1.11	Action when not present is specified in subclause 8.1.1.6.18.	
PLMNs of inter-frequency cells list	OP	1 to <maxCellsMeas>		NOTE	
>PLMN identity	OP		PLMN identity 10.3.1.11	Action when not present is specified in subclause 8.1.1.6.18.	
PLMNs of inter-RAT cells list	OP	1 to <maxCellsMeas>			
>PLMN identity	OP		PLMN identity 10.3.1.11	Action when not present is specified in subclause 8.1.1.6.18.	

Information Element/Group name	Need	Multi	Type and reference	Semantics description	Version
Multiple PLMNs of intra-frequency cells list	OP	1 to <maxCeIIMeas>			REL-8
>Multiple PLMN list	OP	1 to 6		Action when not present is specified in subclause 8.1.1.6.18.	REL-8
>> PLMN identity with Optional MCC	MP		PLMN identity with Optional MCC 10.3.1.11 a		REL-8
Multiple PLMNs of inter-frequency cells list	OP	1 to <maxCeIIMeas>			REL-8
>Multiple PLMN list	OP	1 to 6		Action when not present is specified in subclause 8.1.1.6.18.	REL-8
>> PLMN identity with Optional MCC	MP		PLMN identity with Optional MCC 10.3.1.11 a		REL-8

NOTE: The IE "PLMNs of intra-frequency cells list" and/or the IE "PLMNs of inter-frequency cells list" can be used when each entry in those lists is either empty or includes a single PLMN identity. If multiple PLMNs need to be indicated in a non-empty entry, the network uses the IE "Multiple PLMNs of intra-frequency cells list" and/or the IE "Multiple PLMNs of inter-frequency cells list" instead.

10.3.7.53b PLMN identities of neighbour cells for SIB 11ter

This IE contains the PLMN identities of inter-frequency neighbour cells.

Information Element/Group name	Need	Multi	Type and reference	Semantics description	Version
PLMNs of inter-frequency cells list	OP	1 to <maxCeIIMeas-ext>		In this version of the specification, the maximum value is 48. NOTE	REL-12
>PLMN identity	OP		PLMN identity 10.3.1.11	Action when not present is specified in subclause 8.1.1.6.18.	REL-12
Multiple PLMNs of inter-frequency cells list	OP	1 to <maxCeIIMeas-ext>		In this version of the specification, the maximum value is 48.	REL-12
>Multiple PLMN list	OP	1 to 6		Action when not present is specified in subclause 8.1.1.6.18.	REL-12
>> PLMN identity with Optional MCC	MP		PLMN identity with Optional MCC 10.3.1.11 a		REL-12

NOTE: The IE "PLMNs of inter-frequency cells list" can be used when each entry in those lists is either empty or includes a single PLMN identity. If multiple PLMNs need to be indicated in a non-empty entry, the network uses the IE "Multiple PLMNs of inter-frequency cells list" instead.

10.3.7.54 Primary CCPCH RSCP info

NOTE: Only for TDD

Information Element/Group name	Need	Multi	IE type and reference	Semantics description	Version
Primary CCPCH RSCP	MP		Integer(0..91)	According to P-CCPCH_RSCP_LEV in [19] and [20]. Thirty-six spare values are needed.	
Delta _{Primary} CCPCH RSCP	CV-Rel5		Integer(-5..-1)	If present, the actual value of Primary CCPCH RSCP = Primary CCPCH RSCP + Delta _{Primary} CCPCH RSCP	REL-5

Condition	Explanation
Rel5	This IE is mandatory if the value of Primary CCPCH RSCP is below 0. Otherwise the IE is not needed.

10.3.7.54a Qhcs

Information Element/Group name	Need	Multi	Type and Reference	Semantics description	Version
Qhcs	MP		Integer(0..99)	Qhcs, mapped from CPICH Ec/No (FDD), see [4] [dB] 0: -24 1: -23.5 2: -23 3: -22.5 ... 45: -1.5 46: -1 47: -0.5 48: 0 49: (spare) ... 98: (spare) 99: (spare)	

Information Element/Group name	Need	Multi	Type and Reference	Semantics description	Version
				Qhcs, mapped from CPICH RSCP (FDD), see [4] [dBm] 0: -115 1: -114 2: -113 : 88: -27 89: -26 90: -(spare) 91: -(spare) : 98: -(spare) 99: -(spare)	
				Qhcs, mapped from PCCPCH RSCP (TDD), see [4] [dBm] 0: -115 1: -114 2: -113 : 88: -27 89: -26 90: -(spare) 91: -(spare) : 98: -(spare) 99: -(spare)	
				Qhcs level, mapped from Averaged received signal level RSSI (GSM), see [4] [dBm] 0: -110 1: -109 2: -108 : 61: -49 62: -48 63: -47 64: -46 65: -45 66: -44 67: -43 68: -42 69: -41 70: -40 71: -39 72: -38 73: -37 74: -(spare) : 98: -(spare) 99: -(spare)	
Delta _{Qhcs-RSCP}	CV-RSCP		Integer(-5..-1)	If present, the actual value of Qhcs = Qhcs + Delta _{Qhcs-RSCP}	REL-5

Condition	Explanation
<i>RSCP</i>	This IE is optional if Qhcs is mapped from CPICH RSCP or PCCPCH RSCP, and if the value of the RSCP is below 0 (-115dBm). It is not needed otherwise.

10.3.7.55 Quality measured results list

Information Element/Group name	Need	Multi	Type and reference	Semantics description
BLER measurement results	OP	1 to <maxTrCH >		
>DL Transport channel identity	MP		Transport channel identity 10.3.5.18	transport channel type = DCH
>DL Transport Channel BLER	OP		Integer (0..63)	According to BLER_LOG in [19] and [20]
CHOICE <i>mode</i>	MP			
>FDD				No data
>TDD				
>>SIR measurement results	OP	1 to <MaxCCTrCH>		SIR measurements for DL CCTrCH
>>>TFCS ID	MP		Integer(1...8)	
>>>Timeslot list	MP	1 to <maxTS>		for all timeslot on which the CCTrCH is mapped on
>>>>SIR	MP		Integer(0..63)	According to UE_SIR in [20]

10.3.7.56 Quality measurement

Information Element/Group name	Need	Multi	Type and reference	Semantics description
Quality reporting quantity	OP		Quality reporting quantity 10.3.7.59	
CHOICE <i>report criteria</i>	MP			
>Quality measurement reporting criteria			Quality measurement reporting criteria 10.3.7.58	Note Given this choice, the IE "DL Transport Channel BLER" shall be set to FALSE (see subclause 10.3.7.59)
>Periodical reporting criteria			Periodical reporting criteria 10.3.7.53	Note
>No reporting				Note (no data) Chosen when this measurement only is used as additional measurement to another measurement

NOTE: In this version of the specification, BLER as additional measurement is not supported.

10.3.7.57 Quality measurement event results

Information Element/Group name	Need	Multi	Type and reference	Semantics description
Transport channels causing the event	OP	1 to <maxTrCH >		
>DL Transport channel identity	MP		Transport channel identity 10.3.5.18	transport channel type = DCH

10.3.7.58 Quality measurement reporting criteria

Event 5a: Number of bad CRCs on a certain transport channel exceeds a threshold.

Information Element/Group name	Need	Multi	Type and reference	Semantics description
Parameters sent for each transport channel	MP	1 to <maxTrCH >		
>DL Transport channel identity	MP		Transport channel identity 10.3.5.18	transport channel type = DCH
>Total CRC	MP		Integer(1..512)	Number of CRCs
>Bad CRC	MP		Integer(1..512)	Number of CRCs
>Pending after trigger	MP		Integer(1..512)	Number of CRCs

10.3.7.59 Quality reporting quantity

Information Element/Group name	Need	Multi	Type and reference	Semantics description
DL Transport Channel BLER	MP		Boolean	TRUE means report requested
Transport channels for BLER reporting	<i>CV-BLER reporting</i>	1 to <maxTrCH >		The default, if no transport channel identities are present, is that the BLER is reported for all downlink transport channels
>DL Transport channel identity	MP		Transport channel identity 10.3.5.18	transport channel type = DCH
<i>CHOICE mode</i>	MP			
>FDD				No data
>TDD				
>>SIR measurement list	OP	1 to <maxCCTrCH >		SIR measurements shall be reported for all listed TFCS IDs
>>>TFCS ID	MP		Integer(1..8)	

Condition	Explanation
<i>BLER reporting</i>	This IE is not needed if the IE "DL Transport Channel BLER" is FALSE and optional if the IE "DL Transport Channel BLER" is TRUE

10.3.7.60 Reference time difference to cell

In the System Information message, the reference time difference to cell indicates the timing difference between the primary CCPCH of the current cell and the primary CCPCH of a neighbouring cell..

In the Measurement Control message, the reference time difference to cell indicates the timing difference between UE uplink transmission timing and the primary CCPCH of a neighbouring cell.

Information Element/Group name	Need	Multi	Type and reference	Semantics description
CHOICE <i>accuracy</i>	MP			
>40 chips				
>>Reference time difference	MP		Integer(0..38400 by step of 40)	In chips
>256 chips				
>>Reference time difference	MP		Integer(0..38400 by step of 256)	In chips
>2560 chips				
>>Reference time difference	MP		Integer(0..38400 by step of 2560)	In chips

10.3.7.61 Reporting Cell Status

Indicates maximum allowed number of cells to report and whether active set cells and/or virtual active set cells and/or monitored set cells and/or detected set cells on used frequency and/or monitored set cells and/or detected set cells on non used frequency should/should not be included in the IE "Measured results".

Information Element/Group name	Need	Multi	Type and reference	Semantics description	Version
CHOICE <i>reported cell</i>	MP				
>Report cells within active set				This choice is not valid for inter-RAT measurements. For inter-frequency measurements it is only valid for reporting events 2D and 2F. See NOTE 1.	
>>Maximum number of reported cells	MP		Integer(1..6)		
>Report cells within monitored set cells on used frequency				This choice is not valid for inter-RAT or inter-frequency measurements	
>>Maximum number of reported cells	MP		Integer(1..6)		
>Report cells within active set and/or monitored set cells on used frequency				This choice is not valid for inter-RAT or inter-frequency measurements	
>>Maximum number of reported cells	MP		Integer(1..6)		
>Report cells within detected set on used frequency				This choice is not valid for inter-RAT or inter-frequency measurements	
>>Maximum number of reported cells	MP		Integer(1..6)		
>Report cells within monitored set and/or detected set on used frequency				This choice is not valid for inter-RAT or inter-frequency measurements	

Information Element/Group name	Need	Multi	Type and reference	Semantics description	Version
>>Maximum number of reported cells	MP		Integer(1..6)		
>Report all active set cells + cells within monitored set on used frequency				This choice is not valid for inter-RAT or inter-frequency measurements	
>>Maximum number of reported cells	MP		Enumerated (virtual/active set cells+1, virtual/active set cells+2,, virtual/active set cells+6)		
>Report all active set cells + cells within detected set on used frequency				This choice is not valid for inter-RAT or inter-frequency measurements	
>>Maximum number of reported cells	MP		Enumerated (virtual/active set cells+1, virtual/active set cells+2,, virtual/active set cells+6)		
>Report all active set cells + cells within monitored set and/or detected set on used frequency				This choice is not valid for inter-RAT or inter-frequency measurements	
>>Maximum number of reported cells	MP		Enumerated (virtual/active set cells+1, virtual/active set cells+2,, virtual/active set cells+6)		
>Report cells within virtual active set				This choice is not valid for intra-frequency or inter-RAT measurements	
>>Maximum number of reported cells per reported non-used frequency	MP		Integer(1..6)		
>Report cells within monitored set on non-used frequency				This choice is not valid for intra-frequency or inter-RAT measurements	
>>Maximum number of reported cells per reported non-used frequency	MP		Integer(1..6)		
>Report cells within monitored and/or virtual active set on non-used frequency				This choice is not valid for intra-frequency or inter-RAT measurements	
>>Maximum number of reported cells per reported non-used frequency	MP		Integer(1..6)		

Information Element/Group name	Need	Multi	Type and reference	Semantics description	Version
>Report all virtual active set cells + cells within monitored set on non-used frequency				This choice is not valid for intra-frequency or inter-RAT measurements	
>>Maximum number of reported cells per reported non-used frequency	MP		Enumerated (virtual/active set cells+1, virtual/active set cells+2,, virtual/active set cells+6)		
>Report cells within active set or within virtual active set or of the other RAT				If this choice is selected for inter-RAT measurements, the UE shall report only cells of the other RAT. If this choice is selected for intra-frequency measurements, the UE shall report cells within the active set. If this choice is selected for inter-frequency measurements, the UE shall report cells within the virtual active set.	
>>Maximum number of reported cells	MP		Integer (1..12)		
>Report cells within active and/or monitored set on used frequency or within virtual active and/or monitored set on non-used frequency				This choice is not valid for inter-RAT measurements. If this choice is selected for intra-frequency measurements, the UE shall report cells within the active and/or monitored set. If this choice is selected for inter-frequency measurements, the UE shall report cells within the virtual active set and/or monitored set on non-used frequency.	
>>Maximum number of reported cells	MP		Integer(1..12)		
>Report all virtual active set cells + cells within monitored set and/or detected set on non-used frequency				This choice is not valid for inter-RAT or intra-frequency measurements	REL-10
>>Maximum number of reported cells	MP		Enumerated (virtual/active set cells+1, virtual/active set cells+2,, virtual/active set cells+6)		REL-10

NOTE 1: For Inter-frequency reporting events 2D and 2F, only CHOICE "Report cells within active set" is valid.

10.3.7.62 Reporting information for state CELL_DCH

Information Element/Group name	Need	Multi	Type and reference	Semantics description
Intra-frequency reporting quantity	MP		Intra-frequency reporting quantity 10.3.7.41	
Measurement Reporting Mode	MP		Measurement Reporting Mode 10.3.7.49	
CHOICE <i>report criteria</i>	MP			
>Intra-frequency measurement reporting criteria			Intra-frequency measurement reporting criteria 10.3.7.39	This IE may only contain measurement events from 1A to 1I, but not measurement event 1J.
>Periodical reporting criteria			Periodical reporting criteria 10.3.7.53	

10.3.7.63 SFN-SFN observed time difference

Information Element/Group name	Need	Multi	Type and reference	Semantics description	Version
CHOICE <i>type</i>	MP				
>Type 1			Integer(0..9830399)	According to T1_SFN-SFN_TIME in [19] and [20]. For FDD and 3.84 Mcps TDD and 7.68 Mcps TDD: 6946816 spare values are needed.	
			Integer(0..3276799)	For 1.28 Mcps TDD: 13500416 spare values are needed.	Rel-4
>Type 2			Integer(0..40961)	According to T2_SFN-SFN_TIME in [19] and [20]. 24574 spare values are needed.	
			Integer(0..27649)	For 1.28 Mcps TDD: 37886 spare values are needed.	Rel-4

10.3.7.64 Time to trigger

Information Element/Group name	Need	Multi	Type and reference	Semantics description
Time to trigger	MP		Integer(0, 10, 20, 40, 60, 80, 100, 120, 160, 200, 240, 320, 640, 1280, 2560, 5000)	Time in ms

10.3.7.65 Timeslot ISCP info

NOTE: Only for TDD

Information Element/Group name	Need	Multi	IE type and reference	Semantics description
Timeslot ISCP	MP		Integer (0..91)	According to UE_TS_ISCP_LEV in [20]. Thirty-six spare values are needed.

10.3.7.66 Traffic volume event identity

Information Element/Group name	Need	Multi	Type and reference	Semantics description
Traffic volume event identity	MP		Enumerated(4a, 4b)	

10.3.7.67 Traffic volume measured results list

Information Element/Group name	Need	Multi	Type and reference	Semantics description
Traffic volume measurement results	OP	1 to <maxRB>		
>RB Identity	MP		RB Identity 10.3.4.16	
>RLC Buffers Payload	OP		Enumerated(0, 4, 8, 16, 32, 64, 128, 256, 512, 1024, 2K, 4K, 8K, 16K, 32K, 64K, 128K, 256K, 512K, 1024K)	In bytes And N Kbytes = N*1024 bytes. Twelve spare values are needed.
>Average of RLC Buffer Payload	OP		Enumerated(0, 4, 8, 16, 32, 64, 128, 256, 512, 1024, 2K, 4K, 8K, 16K, 32K, 64K, 128K, 256K, 512K, 1024K)	In bytes And N Kbytes = N*1024 bytes. Twelve spare values are needed.
>Variance of RLC Buffer Payload	OP		Enumerated(0, 4, 8, 16, 32, 64, 128, 256, 512, 1024, 2K, 4K, 8K, 16K)	In bytes And N Kbytes = N*1024 bytes. Two spare values are needed.

10.3.7.68 Traffic volume measurement

Information Element/Group name	Need	Multi	Type and reference	Semantics description
Traffic volume measurement Object	OP		Traffic volume measurement Object 10.3.7.70	
Traffic volume measurement quantity	OP		Traffic volume measurement quantity 10.3.7.71	
Traffic volume reporting quantity	OP		Traffic volume reporting quantity 10.3.7.74	
Measurement validity	OP		Measurement validity 10.3.7.51	
<i>CHOICE report criteria</i>	MP			
>Traffic volume measurement reporting criteria			Traffic volume measurement reporting criteria 10.3.7.72	
>Periodical reporting criteria			Periodical reporting criteria 10.3.7.53	
>No reporting				(no data) Chosen when this measurement only is used as additional measurement to another measurement

10.3.7.69 Traffic volume measurement event results

Contains the event result for a traffic volume measurement.

Information Element/Group name	Need	Multi	Type and reference	Semantics description
Uplink transport channel type causing the event	MP		Enumerated(DCH,RACH, USCH)	USCH is TDD only. RACH is the currently configured default in the uplink. For 1.28 Mcps TDD, if E-DCH is configured to the UE, and the Uplink transport channel type is USCH and UL Transport Channel identity is 32, it means E-DCH TVM is configured.
UL Transport Channel identity	<i>CV-UL-DCH/USCH</i>		Transport channel identity 10.3.5.18	
Traffic volume event identity	MP		Traffic volume event identity 10.3.7.66	

Condition	Explanation
<i>UL-DCH/USCH</i>	If IE "Uplink transport channel type" is equal to "DCH" or "USCH" (TDD only) this IE is mandatory present. Otherwise the IE is not needed.

10.3.7.70 Traffic volume measurement object

Contains the measurement object information for a traffic volume measurement.

Information Element/Group name	Need	Multi	Type and reference	Semantics description
Traffic volume measurement objects	MP	1 to <maxTrCH >		
>Uplink transport channel type	MP		Enumerated(DCH,RACH, USCH)	USCH is TDD only. RACH is the currently configured default in the uplink. For 1.28 Mcps TDD, if E-DCH is configured to the UE, and the Uplink transport channel type is USCH and UL Transport Channel identity is 32, it means E-DCH TVM is configured.
>UL Target Transport Channel ID	CV-UL-DCH/USCH		Transport channel identity 10.3.5.18	

Condition	Explanation
<i>UL-DCH/USCH</i>	If IE "Uplink transport channel type" is equal to "DCH" or "USCH" (TDD only) this IE is mandatory present. Otherwise the IE is not needed.

10.3.7.71 Traffic volume measurement quantity

Contains the measurement quantity information for a traffic volume measurement.

Information Element/Group name	Need	Multi	Type and reference	Semantics description
Measurement quantity	MP		Enumerated(RLC buffer payload, Average RLC buffer payload, Variance of RLC buffer payload)	This parameter should be ignored.
Time Interval to take an average or a variance	CV-A/V		Integer(20, 40, ..260, by steps of 20)	In ms

Condition	Explanation
<i>A/V</i>	This IE is mandatory present when "Average RLC buffer" or "Variance of RLC buffer payload" is chosen and not needed otherwise.

10.3.7.72 Traffic volume measurement reporting criteria

Contains the measurement reporting criteria information for a traffic volume measurement.

Event 4a: Transport Channel Traffic Volume [15] exceeds an absolute threshold.

Event 4b: Transport Channel Traffic Volume [15] becomes smaller than an absolute threshold.

Information Element/Group name	Need	Multi	Type and reference	Semantics description
Parameters sent for each transport channel	OP	1 to <maxTrCH >		This IE is always required, need is OP to align with ASN.1
>Uplink transport channel type	OP		Enumerated(DCH,RACH, USCH)	USCH is TDD only. RACH is the currently configured default in the uplink. For 1.28 Mcps TDD, if E-DCH is configured to the UE, and the Uplink transport channel type is USCH and UL Transport Channel identity is 32, it means E-DCH TVM is configured.
>UL Transport Channel ID	CV-UL-DCH/USCH		Transport channel identity 10.3.5.18	
>Parameters required for each Event	OP	1 to <maxMeas parEvent>		
>>Traffic volume event identity	MP		Traffic volume event identity 10.3.7.66	
>>Reporting Threshold	MP		Enumerated(8,16,32,64,128,256,512,1024,2K,3K,4K,6K,8K,12K,16K,24K,32K,48K,64K,96K,128K,192K,256K,384K,512K,768K)	Threshold in bytes And N Kbytes = N*1024 bytes
>>Time to trigger	OP		Time to trigger 10.3.7.64	Indicates the period of time during which the event condition has to be satisfied, before sending a Measurement Report. Time in ms
>>Pending time after trigger	OP		Integer(250, 500, 1000, 2000, 4000, 8000, 16000)	Indicates the period of time during which it is forbidden to send any new measurement reports with the same Traffic volume event identity even if the triggering condition is fulfilled. Time in milliseconds
>>Tx interruption after trigger	OP		Integer (250, 500, 1000, 2000, 4000, 8000, 16000)	Time in milliseconds. Indicates how long the UE shall block DTCH transmissions on the RACH after a measurement report is triggered.

Condition	Explanation
<i>UL-DCH/USCH</i>	If IE "Uplink transport channel type" is equal to "DCH" or "USCH" (TDD only) this IE is optional. Otherwise the IE is not needed.

10.3.7.73 Traffic volume measurement system information

Information Element/Group name	Need	Multi	Type and reference	Semantics description
Traffic volume measurement identity	MD		Measurement identity 10.3.7.48	The traffic volume measurement identity has default value 4.
Traffic volume measurement object	OP		Traffic volume measurement object 10.3.7.70	
Traffic volume measurement quantity	OP		Traffic volume measurement quantity 10.3.7.71	
Traffic volume reporting quantity	OP		Traffic volume reporting quantity 10.3.7.74	
Measurement validity	OP		Measurement validity 10.3.7.51	
Measurement Reporting Mode	MP		Measurement Reporting Mode 10.3.7.49	
<i>CHOICE reporting criteria</i>	MP			
>Traffic volume measurement reporting criteria			Traffic volume measurement reporting criteria 10.3.7.72	
>Periodical reporting criteria			Periodical reporting criteria 10.3.7.53	

10.3.7.74 Traffic volume reporting quantity

Contains the reporting quantity information for a traffic volume measurement.

For all boolean types TRUE means inclusion in the report is requested.

Information Element/Group name	Need	Multi	Type and reference	Semantics description
RLC Buffer Payload for each RB	MP		Boolean	
Average of RLC Buffer Payload for each RB	MP		Boolean	
Variance of RLC Buffer Payload for each RB	MP		Boolean	

10.3.7.75 UE internal event identity

Information Element/Group name	Need	Multi	Type and reference	Semantics description
UE internal event identity	MP		Enumerated(6a,6b,6c,6d,6e, 6f, 6g)	

10.3.7.76 UE internal measured results

Information Element/Group name	Need	Multi	Type and reference	Semantics description	Version
CHOICE <i>mode</i>	MP				
>FDD					
>>UE Transmitted Power	OP		UE Transmitted Power info 10.3.7.85		
>>UE Rx-Tx report entries	OP	1 to <maxRL>			
>>>Primary CPICH info	MP		Primary CPICH info 10.3.6.60	Primary CPICH info for each cell included in the active set	
>>>UE Rx-Tx time difference type 1	MP		UE Rx-Tx time difference type 1 10.3.7.83	UE Rx-Tx time difference in chip for each RL included in the active set	
>TDD					
>>UE Transmitted Power list	OP	1 to <maxTS>		UE Transmitted Power for each used uplink timeslot in ascending timeslot number order	
>>>UE Transmitted Power	MP		UE Transmitted Power info 10.3.7.85		
>>CHOICE <i>TDD option</i>	MP				REL-4
>>>3.84 Mcps TDD					REL-4
>>>>Applied TA	OP		Uplink Timing Advance 10.3.6.95	Uplink timing advance applied by the UE	
>>>>Extended Applied TA	OP		Extended Uplink Timing Advance 10.3.6.95a	Uplink timing advance applied by the UE	REL-7
>>>7.68 Mcps TDD					REL-7
>>>>Extended Applied TA	OP		Extended Uplink Timing Advance 10.3.6.95a	Uplink timing advance applied by the UE	REL-7
>>>1.28 Mcps TDD					REL-4
>>>>T _{ADV}	OP		T _{ADV} info 10.3.7.112		REL-4

10.3.7.77 UE internal measurement

Information Element/Group name	Need	Multi	Type and reference	Semantics description
UE internal measurement quantity	OP		UE internal measurement quantity 10.3.7.79	
UE internal reporting quantity	OP		UE internal reporting quantity 10.3.7.82	
<i>CHOICE report criteria</i>	MP			
>UE internal measurement reporting criteria			UE internal measurement reporting criteria 10.3.7.80	
>Periodical reporting criteria			Periodical reporting criteria 10.3.7.53	
>No reporting				(no data) Chosen when this measurement only is used as additional measurement to another measurement

<i>CHOICE report criteria</i>	Condition under which the given <i>report criteria</i> is chosen
UE internal measurement reporting criteria	Chosen when UE internal measurement event triggering is required
Periodical reporting criteria	Chosen when periodical reporting is required
No reporting	Chosen when this measurement only is used as additional measurement to another measurement

10.3.7.78 UE internal measurement event results

This IE contains the measurement event results that are reported to UTRAN for UE internal measurements.

Information Element/Group name	Need	Multi	Type and reference	Semantics description
UE internal event identity	MP		UE internal event identity 10.3.7.75	
<i>CHOICE mode</i>	MP			
>FDD				
>Primary CPICH info	<i>CV-clause 1</i>		Primary CPICH info 10.3.6.60	
>TDD				(no data)

Condition	Explanation
<i>Clause 1</i>	This IE is mandatory present if the IE "UE internal event identity" is set to "6f" or "6g", otherwise the IE is not needed.

10.3.7.79 UE internal measurement quantity

The quantity the UE shall measure in case of UE internal measurement.

Information Element/Group name	Need	Multi	Type and reference	Semantics description	Version
CHOICE <i>mode</i>	MP				
>FDD					
>>Measurement quantity	MP		Enumerated(UE Transmitted Power, UTRA Carrier RSSI, UE Rx-Tx time difference)		
>TDD					
>>Measurement quantity	MP		Enumerated(UE Transmitted Power, UTRA Carrier RSSI,		
			T _{ADV})	Measurement on Timing Advance is for 1.28 Mcps TDD	REL-4
Filter coefficient	OP		Filter coefficient 10.3.7.9	If the IE "Measurement quantity" is set to "Rx-Tx time difference" and this IE is present, the UE behaviour is unspecified.	

10.3.7.80 UE internal measurement reporting criteria

The triggering of the event-triggered reporting for a UE internal measurement. All events concerning UE internal measurements are labelled 6x where x is a, b, c.... In TDD, the events 6a - 6d are measured and reported on timeslot basis.

Event 6a: The UE Transmitted Power becomes larger than an absolute threshold

Event 6b: The UE Transmitted Power becomes less than an absolute threshold

Event 6c: The UE Transmitted Power reaches its minimum value

Event 6d: The UE Transmitted Power reaches its maximum value

Event 6e: The UE RSSI reaches the UEs dynamic receiver range

Event 6f (FDD): The UE Rx-Tx time difference for a RL included in the active set becomes larger than an absolute threshold

Event 6f (1.28 Mcps TDD): The time difference indicated by T_{ADV} becomes larger than an absolute threshold

Event 6g: The UE Rx-Tx time difference for a RL included in the active set becomes less than an absolute threshold

Information Element/Group name	Need	Multi	Type and reference	Semantics description	Version
Parameters sent for each UE internal measurement event	OP	1 to <maxMeas Event>			
>UE internal event identity	MP		UE internal event identity 10.3.7.75		

Information Element/Group name	Need	Multi	Type and reference	Semantics description	Version
>Time-to-trigger	MP		Integer(0, 10, 20, 40, 60, 80, 100, 120, 160, 200, 240, 320, 640, 1280, 2560, 5000)	Time in ms. Indicates the period of time between the timing of event detection and the timing of sending Measurement Report.	
>UE Transmitted Power Tx power threshold	CV-clause 1		Integer(-50..33)	Power in dBm. In event 6a, 6b.	
>UE Rx-Tx time difference threshold	CV-clause 2		Integer(768..1280)	Time difference in chip. In event 6f, 6g.	
>T _{ADV} threshold	CV-clause 3		Real (0..63 step 0.125)	Time difference in chip. In event 6f	REL-4

Condition	Explanation
Clause 1	The IE is mandatory present if the IE "UE internal event identity" is set to "6a" or "6b", otherwise the IE is not needed.
Clause 2	In FDD, the IE is mandatory present if the IE "UE internal event identity" is set to "6f" or "6g", otherwise the IE is not needed.
Clause 3	In 1.28 Mcps TDD the IE is mandatory present if the IE "UE internal event identity" is set to "6f", otherwise the IE is not needed.

10.3.7.81 Void

10.3.7.82 UE Internal reporting quantity

For all boolean types TRUE means inclusion in the report is requested.

Information Element/Group name	Need	Multi	Type and reference	Semantics description	Version
UE Transmitted Power	MP		Boolean		
CHOICE <i>mode</i>	MP				
>FDD					
>>UE Rx-Tx time difference	MP		Boolean		
>TDD					
>>CHOICE <i>TDD option</i>					REL-4
>>>3.84 Mcps TDD					REL-4
>>>>Applied TA	MP		Boolean		
>>>>7.68 Mcps TDD					REL-7
>>>>Applied TA	MP		Boolean		REL-7
>>>>1.28 Mcps TDD					REL-4
>>>>T _{ADV} info	MP		Boolean		REL-4

10.3.7.83 UE Rx-Tx time difference type 1

The difference in time between the UE uplink DPCCH/DPDCH frame transmission and the first detected path (in time), of the downlink DPCH or F-DPCH frame from the measured radio link, as defined in [7]. This measurement is for FDD only.

Information Element/Group name	Need	Multi	Type and reference	Semantics description
UE Rx-Tx time difference type 1	MP		Integer(768..1280)	In chips. 511 spare values are needed.

10.3.7.84 UE Rx-Tx time difference type 2

The difference in time between the UE uplink DPCCH/DPDCH frame transmission and the first detected path (in time), of the downlink DPCH or F-DPCH frame from the measured radio link, as defined in [7].

Information Element/Group name	Need	Multi	Type and reference	Semantics description
UE Rx-Tx time difference type 2	MP		Integer (0..8191)	According to [19].

10.3.7.85 UE Transmitted Power info

Information Element/Group name	Need	Multi	IE type and reference	Semantics description
UE Transmitted Power	MP		Integer (0..104)	According to UE_TX_POWER in [19] and [20]

10.3.7.86 UE positioning Ciphering info

This IE contains information for the ciphering of UE positioning assistance data broadcast in System Information.

Information Element/Group name	Need	Multi	Type and Reference	Semantics description
Ciphering Key Flag	MP		Bit string(1)	
Ciphering Serial Number	MP		Integer(0..65535)	The serial number used in the DES ciphering algorithm

10.3.7.87 UE positioning Error

Information Element/Group name	Need	Multi	Type and Reference	Semantics description	Version
Error reason	MP		Enumerated(Not Enough OTDOA Cells, Not Enough GPS Satellites, Assistance Data Missing, Not Accomplished GPS Timing Of Cell Frames, Undefined Error, Request Denied By User, Not Processed And Timeout, Reference Cell Not Serving Cell,	Note 1	
			Not Enough GANSS Satellites, Not Accomplished GANSS Timing Of Cell Frames)	Note 1	REL-7
GPS Additional Assistance Data Request	CV- <i>GPSdataMissing</i>		UE positioning GPS Additional Assistance Data Request 10.3.7.88a		
GANSS Additional Assistance Data Request	CV- <i>GANSSdataMissing</i>		UE positioning GANSS Additional Assistance Data Request 10.3.7.88c		REL-7

NOTE 1: The following table describes each value of the IE "Error reason".

Value	Indication
Not Enough OTDOA Cells	There were not enough cells to be received.
Not Enough GPS Satellites	There were not enough GPS satellites to be received.
Assistance Data Missing	UE positioning GANSS or/and GPS assistance data missing.
Not Accomplished GPS Timing Of Cell Frames	UE was not able to accomplish the GPS timing of cell frames measurement.
Undefined Error	Undefined error.
Request Denied By User	UE positioning request denied by upper layers.
Not Processed And Timeout	UE positioning request not processed by upper layers and timeout.
Reference Cell Not Serving Cell	UE was not able to read the SFN of the reference cell.
Not Enough GANSS Satellites	There were not enough GANSS satellites to be received.
Not Accomplished GANSS Timing Of Cell Frames	UE was not able to accomplish the GANSS timing of cell frames measurement.

Condition	Explanation
<i>GPSdataMissing</i>	The IE is optional if the IE "Error reason" is "Assistance Data Missing" and not needed otherwise.
<i>GANSSdataMissing</i>	The IE is optional if the IE "Error reason" is "Assistance Data Missing" and not needed otherwise.

10.3.7.88 UE positioning GPS acquisition assistance

This IE contains parameters that enable fast acquisition of the GPS signals in UE-assisted GPS positioning.

Information Element/Group name	Need	Multi	Type and Reference	Semantics description	Version
GPS TOW msec	MP		Integer(0..6.048*10 ⁸ -1)	GPS Time of Week in milliseconds rounded down to the nearest millisecond unit. It is also the time when satellite information is valid.	
UTRAN GPS reference time	OP				
>UTRAN GPS timing of cell frames	MP		Integer(0 ... 2322431999999)	GPS timing of cell frames in steps of 1 chip.	
>CHOICE <i>mode</i>	OP				
>>FDD					
>>>Primary CPICH Info	MP		Primary CPICH Info 10.3.6.60	Identifies the reference cell for the GPS TOW-SFN relationship	
>>TDD					
>>>cell parameters id	MP		Cell parameters id 10.3.6.9	Identifies the reference cell for the GPS TOW-SFN relationship	
>SFN	MP		Integer(0..4095)	The SFN which the UTRAN GPS timing of cell frames time stamps.	
UE Positioning GPS ReferenceTime Uncertainty	OP		UE positioning GPS reference time uncertainty 10.3.7.96a		REL-7
Confidence	OP		Integer(0..100)	Confidence level (in percent) of the reference location area or volume used to calculate the Satellite information parameters (search windows).	REL-12
Satellite information	MP	1 to <maxSat>			

Information Element/Group name	Need	Multi	Type and Reference	Semantics description	Version
>SatID	MP		Integer (0..63)	Identifies the satellite and is equal to (SV ID No - 1) where SV ID No is defined in [12].	
>Doppler (0 th order term)	MP		Real(-5120..5117.5 by step of 2.5)	Hz	
>Extra Doppler	OP				
>>Doppler (1 st order term)	MP		Real (-0.966..0.483 by step of 0.023)	Hz/s	
>>Doppler Uncertainty	MP		Enumerated (12.5,25,50,100,200)	Hz. Three spare values are needed. The Doppler experienced by a stationary UE is in the range "Doppler – Doppler Uncertainty" to "Doppler + Doppler Uncertainty".	
>Extra Doppler Extension	OP			If this field is present, the "Extra Doppler" field should not be present.	REL-12
>>Doppler (1 st order term)	MP		Real (-0.966..0.483 by step of 0.023)	Hz/s	REL-12
>>Doppler Uncertainty Extension	MP		Enumerated (300, 400, 500, 600, 'No Information')	Hz. Three spare values are needed. The Doppler experienced by a stationary UE is in the range "Doppler – Doppler Uncertainty Extension" to "Doppler + Doppler Uncertainty Extension".	REL-12
>Code Phase	MP		Integer(0..1022)	GPS chips. Increasing binary values of the field signify increasing predicted pseudoranges.	
>Integer Code Phase	MP		Integer(0..19)	Number of code periods that have elapsed since the latest GPS bit boundary, in units of C/A code period.	
>GPS Bit number	MP		Integer(0..3)	Specifies GPS bit number modulo 4	
>Code Phase Search Window	MP		Integer(1023,1,2,3,4,6,8,12,16,24,32,48,64,96,128,192)	Expected code-phase is in the range "Code Phase – Code Phase Search Window" to "Code Phase + Code Phase Search Window".	
>Azimuth and Elevation	OP				
>>Azimuth	MP		Real(0..348.75 by step of 11.25)	Degrees An angle of x degrees means the satellite azimuth a is in the range $x \leq a < x+11.25$ degrees.	
>>Elevation	MP		Real(0..78.75 by step of 11.25)	Degrees An angle of y degrees means the satellite elevation e is in the range $y \leq e < y+11.25$ degrees except for $y=78.75$ where the range is extended to include 90 degrees.	

Information Element/Group name	Need	Multi	Type and Reference	Semantics description	Version
>>Azimuth LSB	MP		Real(0..10.546875 by step of 0.703125)	Degrees The full satellite azimuth is constructed as "Azimuth" + "Azimuth LSB". An azimuth angle of x degrees means the satellite azimuth a is in the range $x \leq a < x+0.703125$ degrees. Range 0-359.296875 deg.	REL-10
>>Elevation LSB	MP		Real(0..10.546875 by step of 0.703125)	Degrees The full satellite elevation is constructed as "Elevation" + "Elevation LSB". An elevation angle of y degrees means the satellite elevation e is in the range $y \leq e < y+0.703125$ degrees. Range 0-89.296875 deg.	REL-10

10.3.7.88a UE positioning GPS Additional Assistance Data Request

Information Element/Group name	Need	Multi	Type and Reference	Semantics description
Almanac	MP		Boolean	TRUE means requested
UTC Model	MP		Boolean	TRUE means requested
Ionospheric model	MP		Boolean	TRUE means requested
Navigation Model	MP		Boolean	TRUE means requested
DGPS Corrections	MP		Boolean	TRUE means requested
Reference Location	MP		Boolean	TRUE means requested
Reference Time	MP		Boolean	TRUE means requested
Acquisition Assistance	MP		Boolean	TRUE means requested
Real-Time Integrity	MP		Boolean	TRUE means requested
Navigation Model Additional data	CV- <i>Navigation Model</i>			
>GPS Week	MP		Integer (0..1023)	
>GPS_Toe	MP		Integer (0..167)	GPS time of ephemeris in hours of the latest ephemeris set contained by the UE. Eighty-eight spare values needed.
>T-Toe limit	MP		Integer (0..10)	ephemeris age tolerance of the UE to UTRAN in hours. Five spare values needed.
>Satellites list related data	MP	0 to <maxSat>		
>>SatID	MP		Integer (0..63)	Identifies the satellite and is equal to (SV ID No - 1) where SV ID No is defined in [12].
>>IODE	MP		Integer (0..255)	Issue of Data Ephemeris for SatID

Condition	Explanation
<i>Navigation Model</i>	This IE is mandatory present if "Navigation Model" is set to TRUE otherwise it is absent.

10.3.7.88b UE positioning GANSS reference measurement information

This IE provides reference code and Doppler measurement information of visible satellites of a GNSS constellation. The information enables fast acquisition of the GANSS signals in UE-assisted GANSS positioning. If the IE "UE positioning GPS acquisition assistance" is not included in IE "UE positioning measurement", the Satellite Information is valid at the time as given in the IE "UE positioning GANSS reference time" IE. I.e., if IE "UE positioning GANSS reference measurement information" is included in IE "UE positioning GANSS assistance data" and IE "UE positioning GPS acquisition assistance" is not included in IE "UE positioning measurement", the IE "UE positioning GANSS reference time" shall also be included. If the IE "UE positioning GPS acquisition assistance" is included in IE "UE positioning measurement", the IE "GPS TOW msec" and IE "UTRAN GPS reference time" included in IE "UE positioning GPS acquisition assistance" is also valid for the Satellite information in IE "UE positioning GANSS reference measurement information".

Information Element/Group name	Need	Multi	Type and Reference	Semantics description	Version
GANSS Signal ID	OP		GANSS Signal Id 10.3.3.45a	Absence of this field means the default value as defined in 10.3.3.45a for the GANSS identified by GANSS_ID. If this IE is asked by SIB 15.6, the GANSS shall be solved by the scheduling information.	REL-7
Confidence	OP		Integer(0..100)	Confidence level (in percent) of the reference location area or volume used to calculate the Satellite information parameters (search windows).	REL-12
Satellite information	MP	1 to <maxGANSSSat>			REL-7
>SatID	MP		Integer (0..63)	Identifies the satellite within a GANSS constellation. For coding description, see Note 2.	REL-7
>Doppler (0 th order term)	MP		Real(-1024..1023.5 by step of 0.5)	m/s Conversion between m/s and Hz shall be made by using the <i>nominal</i> wavelength of the assisted signal.	REL-7
>Extra Doppler	OP				REL-7
>>Doppler (1 st order term)	MP		Real (-0.2..0.1 by step of 1/210)	m/s ²	REL-7
>>Doppler Uncertainty	MP		Enumerated (40,20,10,5, 2.5)	m/s. The Doppler experienced by a stationary UE is in the range "Doppler – Doppler Uncertainty" to "Doppler + Doppler Uncertainty". Three spare values are needed.	REL-7
>Extra Doppler Extension	OP			If this field is present, the "Extra Doppler" field should not be present.	REL-12
>>Doppler (1 st order term)	MP		Real (-0.2..0.1 by step of 1/210)	m/s ²	REL-12
>>Doppler Uncertainty Extension	MP		Enumerated (60, 80, 100, 120, 'No Information')	m/s. The Doppler experienced by a stationary UE is in the range "Doppler – Doppler Uncertainty Extension" to "Doppler + Doppler Uncertainty Extension". Three spare values are needed.	REL-12
>Code Phase	MP		Integer(0..1023)	ms, scaling factor 2 ⁻¹⁰ <i>Nominal</i> chipping rate of the GNSS signal shall be used in conversion. Increasing binary values of the field signify increasing predicted code phases.	REL-7

Information Element/Group name	Need	Multi	Type and Reference	Semantics description	Version
>Integer Code Phase	MP		Integer(0..127)	ms. Integer code phase (expressed modulo 128 ms) . The satellite integer milli-seconds code phase currently being transmitted at the Reference Time included in either IE "UE positioning GANSS reference time" or IE "UE positioning GPS acquisition assistance", as seen by a receiver at the Reference Location is calculated as Reference Time (expressed in milli-seconds) minus (Integer_Code_Phase + (n×128 ms)), with n = ...-2,-1,0,1,2..... The UE can calculate the expected code phase as follows: Reference Time – Integer Code Phase + Code Phase.	REL-7
>Code Phase Search Window	MP		Bit string (5)	Coded expected code-phase is in the range "Code Phase – Code Phase Search Window" to "Code Phase + Code Phase Search Window". For coding description, see Note 1	REL-7
>Azimuth and Elevation	OP				REL-7
>>Azimuth	MP		Real(0..348.75 by step of 11.25)	Degrees An angle of x degrees means the satellite azimuth a is in the range $x \leq a < x+11.25$ degrees.	REL-7
>>Elevation	MP		Real(0..78.75 by step of 11.25)	Degrees An angle of y degrees means the satellite elevation e is in the range $y \leq e < y+11.25$ degrees except for y=78.75 where the range is extended to include 90 degrees.	REL-7
>>Azimuth LSB	MP		Real(0..10.546875 by step of 0.703125)	Degrees The full satellite azimuth is constructed as "Azimuth" + "Azimuth LSB". An azimuth angle of x degrees means the satellite azimuth a is in the range $x \leq a < x+0.703125$ degrees Range 0-359.296875 deg.	REL-10

Information Element/Group name	Need	Multi	Type and Reference	Semantics description	Version
>>Elevation LSB	MP		Real(0..10.546875 by step of 0.703125)	<p>Degrees</p> <p>The full satellite elevation is constructed as "Elevation" + "Elevation LSB".</p> <p>An elevation angle of y degrees means the satellite elevation e is in the range $y \leq e < y+0.703125$ degrees.</p> <p>Range 0-89.296875 deg.</p>	REL-10

NOTE 1: Code phase search window parameter format:

CODE_PHASE_SEARCH_WINDOW	Code Phase Search Window [ms]
'00000'	No information
'00001'	0,002
'00010'	0,004
'00011'	0,008
'00100'	0,012
'00101'	0,016
'00110'	0,024
'00111'	0,032
'01000'	0,048
'01001'	0,064
'01010'	0,096
'01011'	0,128
'01100'	0,164
'01101'	0,200
'01110'	0,250
'01111'	0,300
'10000'	0,360
'10001'	0,420
'10010'	0,480
'10011'	0,540
'10100'	0,600
'10101'	0,660
'10110'	0,720
'10111'	0,780
'11000'	0,850
'11001'	1,000
'11010'	1,150
'11011'	1,300
'11100'	1,450
'11101'	1,600
'11110'	1,800
'11111'	2,000

NOTE 2: Interpretation of SatID:

GNSS	Value of SatID	Interpretation of SatID
Galileo	'0' – '35'	Code No. 1 to 36
	'36' – '63'	Reserved
Modernized GPS	'0' – '62'	Satellite PRN Signal No. 1 to 63
	'63'	Reserved
SBAS	'0' – '38'	Satellite PRN Signal No. 120 to 158
	'39' – '63'	Reserved
QZSS	'0' – '4'	Satellite PRN Signal No. 193 to 197
	'5' – '63'	Reserved
GLONASS	'0' – '23'	Slot Number 1 to 24
	'24' – '63'	Reserved
BDS	'0' – '36'	Satellite ranging code number signal No.1 to 37 [86]
	'37' – '63'	Reserved

10.3.7.88c UE positioning GANSS additional assistance data request

Information Element/Group name	Need	Multi	Type and Reference	Semantics description	Version
GANSS Reference Time	MP		Boolean	TRUE means requested	REL-7
GANSS Reference Location	MP		Boolean	TRUE means requested	REL-7
GANSS Ionospheric model	MP		Boolean	TRUE means requested	REL-7
GANSS Additional Ionospheric Model	OP		Data ID Bit String(2)	If present, the UE requests the "UE positioning GANSS additional ionospheric model" for a "Data ID" as defined in 10.3.7.92b.	REL-8
GANSS Earth Orientation Parameters	OP		Enumerated (TRUE)	If present, the UE requests the "UE positioning GANSS Earth orientation parameters"	REL-8
GANSS Requested Generic Assistance Data	MP	1 to <maxGANSS>			REL-7
>GANSS ID	OP		Integer(0..7)	Absence of this IE means Galileo Values 0-7 reserved for future use.	REL-7
				Absence of this IE means Galileo. For coding description see NOTE 1 in 10.3.7.90b.	REL-8
>SBAS ID	CV-GANSS-ID-SBAS		UE positioning GANSS SBAS ID 10.3.7.97e		REL-8
>GANSS Real-Time Integrity	MP		Boolean	TRUE means requested	REL-7
>DGNSS Signal	OP		DGNSS Signal Id 10.3.7.88d	If present, the UE requests the "UE positioning DGNSS corrections"	REL-7
>DBDS Signal	CV-GANSS-ID-BDS		DGNSS Signal Id 10.3.7.88d	If present, the UE requests the "UE positioning DBDS corrections"	REL-12
>BDS Ionospheric Grid Model	CV-GANSS-ID-BDS		Enumerated (TRUE)	If present, the UE requests the "UE positioning BDS Ionospheric Grid Model"	REL-12
>GANSS Almanac	MP		Boolean	TRUE means requested	REL-7
				TRUE means requested. If "GANSS ID" indicates "Modernized GPS" or "QZSS" and IE "GANSS additional assistance data choices" is not included, the GANSS Almanac model requested is "Model-4" for Modernized GPS, and "Model-2" for QZSS, as defined in 10.3.7.89a.	REL-8
>GANSS Navigation Model	MP		Boolean	TRUE means requested	REL-7
>GANSS Additional Navigation Models	OP		Enumerated (TRUE)	If present, the UE requests the "UE positioning GANSS additional navigation models". If "GANSS ID" indicates "QZSS" and IE "GANSS additional assistance data choices" is not included, the GANSS orbit and clock model requested is "Model-2" as defined in 10.3.7.91e and 10.3.7.91f, respectively.	REL-8

Information Element/Group name	Need	Multi	Type and Reference	Semantics description	Version
>GANSS Time Model GNSS-GNSS	OP		BIT STRING (8)	The reference system for requested GANSS time model GNSS-GNSS is as indicated in IE "GANSS ID". The models are requested for each system with respective bit set to "1". Bit 0 is set for GPS, Bit 1 is set for Galileo. Other bits are reserved	REL-7
				Bit 2 is set for QZSS Bit 3 is set for GLONASS Other bits are reserved	REL-8
				Bit 4 is set for BDS Other bits are reserved	REL-12

Information Element/Group name	Need	Multi	Type and Reference	Semantics description	Version
>GANSS Reference Measurement Information	MP		Boolean	TRUE means requested	REL-7
>GANSS data bits	OP				REL-7
>>GANSS TOD	MP		INTEGER (0..86399)	This field contains the reference time modulo 86400 seconds of the first data bit of the requested data in integer seconds in GNSS specific system time of the GNSS indicated by IE "GANSS ID".	REL-7
>>>Data bit assistance	MP				REL-7
>>>>GANSS Signal ID	MP		DGANSS Signal Id 10.3.7.88d		REL-7
>>>>GANSS Data Bit Interval	MP		Integer (0..15)	This field represents the time length for which the Data Bit Assistance is requested. The Data Bit Assistance shall be relative to the time interval (GANSS TOD, GANSS TOD + Data Bit Interval). The Data Bit Interval r , expressed in seconds, is mapped to a binary number K with the following formula: $r = 0.1 * 2^K$ Value $K=15$ means that the time interval is not specified.	REL-7
>>>>Satellite Information	OP	1 to <maxGANSSSat>			REL-7
>>>>>Satellite ID	MP		Integer (0..63)	Identifies the satellite for which the Data Bit Assistance request is applicable and is as defined in Note 2 of 10.3.7.88b.	REL-7
>GANSS UTC model	MP		Boolean	TRUE means Requested	REL-7
>GANSS Additional UTC Models	OP		Enumerated (TRUE)	If present, the UE requests the "UE positioning GANSS additional UTC models"	REL-8
>GANSS Auxiliary Information	OP		Enumerated (TRUE)	If present, the UE requests the "UE positioning GANSS auxiliary information"	REL-8
>GANSS Navigation Model Additional data	CV-GANSSNavigation Model				REL-7
>>GANSS Week/Day	MP		Integer (0..4095)	If "GANSS ID" does not indicate "GLONASS", this IE defines the GANSS Week number of the assistance currently held by the MS. If "GANSS ID" is set to "GLONASS", this IE defines the calendar number of day within the four-year interval starting from 1 st of January in a leap year, as defined by the parameter N_T in [73] of the assistance currently held by the MS.	REL-7 REL-8

Information Element/Group name	Need	Multi	Type and Reference	Semantics description	Version
>>GANSS_Toe	MP		Integer (0..167)	If "GANSS ID" does not indicate "GLONASS", this IE defines the GANSS time of ephemeris in hours of the latest ephemeris set contained by the UE.	REL-7
				If "GANSS ID" is set to "GLONASS", this IE defines the time of ephemeris in units of 15 minutes of the latest ephemeris set contained by the UE (range 0 to 95 representing time values between 0 and 1425 minutes). In this case, values 96 to 167 shall not be used by the sender.	REL-8
>>T-Toe limit	MP		Integer (0..10)	If "GANSS ID" does not indicate "GLONASS", this IE defines the ephemeris age tolerance of the UE to UTRAN in units of hours. Five spare values needed.	REL-7
				If "GANSS ID" is set to "GLONASS", this IE defines the ephemeris age tolerance of the UE to UTRAN in units of 30 minutes (range 0 to 10 representing time values of 0 to 300 minutes).	REL-8
>>Satellites list related data	OP	1 to <maxGANSSSat>			REL-7
>>>SatID	MP		Integer (0..63)	Identifies the satellite and is as defined in Note 2 of 10.3.7.88b.	REL-7
>>>IOD	MP		Integer (0..1023)	10 LSBs of Issue of Data for SatID	REL-7
>GANSS additional assistance data choices	CV- Assistance Choices				REL-8
>>Orbit Model ID	OP		Integer (0..7)	This IE may be included if IE "GANSS Navigation Model" is set to TRUE or if the IE "GANSS Additional Navigation Models" is included and defines the non-native or non-default orbit model number as defined in 10.3.7.91c/10.3.7.91e.	REL-8
>>Clock Model ID	OP		Integer (0..7)	This IE may be included if IE "GANSS Navigation Model" is set to TRUE or if the IE "GANSS Additional Navigation Models" is included and defines the non-native or non-default clock model number as defined in 10.3.7.91d/10.3.7.91f.	REL-8
>>UTC Model ID	OP		Integer (0..7)	This IE may be included if IE "GANSS Additional UTC Models" is included and defines the non-native or non-default UTC model number as defined in 10.3.7.97d.	REL-8

Information Element/Group name	Need	Multi	Type and Reference	Semantics description	Version
>>Almanac Model ID	OP		Integer (0..7)	This IE may be included if IE "GANSS Almanac" set to TRUE and defines the non-native or non-default model number as defined in 10.3.7.89a.	REL-8

Condition	Explanation
<i>GANSS-ID-SBAS</i>	This IE is mandatory present if the IE "GANSS ID" is "SBAS" and not needed otherwise.
<i>GANSSNavigation Model</i>	The IE is mandatory present if the IE "GANSS Navigation Model" is set to TRUE or if the IE "GANSS Additional Navigation Models" is included and not needed otherwise.
<i>AssistanceChoices</i>	This IE is mandatory present if non-native or non-default assistance data choices are requested and not needed otherwise.
<i>GANSS-ID-BDS</i>	This IE is optionally present if the IE "GANSS ID" is "BDS" and not needed otherwise.

10.3.7.88d DGANSS Signal Id

The DGANSS signal Id refers to the signal for which differential corrections or data bit assistance are required. It depends on the GANSS ID. Each bit refers to a particular signal. When the bit is set to 1, this means that the differential corrections or data bit assistance are requested for this particular signal. Differential corrections or data bit assistance can be requested for several signals using the bit string.

Information Element/Group name	Need	Multi	Type and Reference	Semantics description	Version
DGANSS Signal Id	MP		BIT STRING (8)	See Note 1.	REL-7

NOTE 1:

GANSS Id	Bit number	Explanation	Version
Default : Galileo	0	Galileo E1	REL-7
	1	Galileo E5A	
	2	Galileo E5B	
	3	Galileo E6	
	4	spare	
	5	Spare	
	6	Spare	
	7	Spare	
Modernized GPS	0	L1C	REL-8
	1	L2C	
	2	L5	
	3	Spare	
	4	Spare	
	5	Spare	
	6	Spare	
	7	Spare	
SBAS	0	L1	
	1	Spare	
	2	Spare	
	3	Spare	
	4	Spare	
	5	Spare	
	6	Spare	
	7	Spare	
QZSS	0	QZS-L1	
	1	QZS-L1C	
	2	QZS-L2C	
	3	QZS-L5	
	4	Spare	
	5	Spare	
	6	Spare	
	7	Spare	
GLONASS	0	G1	
	1	G2	
	2	G3	
	3	Spare	
	4	Spare	
	5	Spare	
	6	Spare	
	7	spare	
BDS	0	B1I	REL-12
	1	Spare	
	2	Spare	
	3	Spare	
	4	Spare	
	5	Spare	
	6	Spare	
	7	Spare	

10.3.7.89 UE positioning GPS almanac

This IE contains a reduced-precision subset of the ephemeris and clock correction parameters.

Information Element/Group name	Need	Multi	Type and Reference	Semantics description	Version
WN _a	MP		Bit string(8)	Almanac Reference Week [12]	
Complete Almanac Provided	OP		Boolean	This field indicates whether the RNC provided almanac for the full GPS constellation or not. TRUE means complete GPS almanac is provided.	REL-10
Satellite information	MP	1 to <maxSat>			
>DataID	MP		Integer(0..3)	See [12]	
>SatID	MP		Enumerated(0..63)	Identifies the satellite and is equal to (SV ID No - 1) where SV ID No is defined in [12].	
>e	MP		Bit string(16)	Eccentricity [12]	
>t _{oa}	MP		Bit string(8)	Reference Time of Almanac [12]	
>δ _i	MP		Bit string(16)		
>OMEGADOT	MP		Bit string(16)	Longitude of Ascending Node of Orbit Plane at Weekly Epoch (semi-circles/sec) [12]	
>SV Health	MP		Bit string(8)		
>A ^{1/2}	MP		Bit string(24)	Semi-Major Axis (meters) ^{1/2} [12]	
>OMEGA ₀	MP		Bit string(24)	Longitude of Ascending Node of Orbit Plane at Weekly Epoch (semi-circles) [12]	
>M ₀	MP		Bit string(24)	Mean Anomaly at Reference Time (semi-circles) [12]	
>ω	MP		Bit string(24)	Argument of Perigee (semi-circles) [12]	
>af ₀	MP		Bit string(11)	apparent clock correction [12]	
>af ₁	MP		Bit string(11)	apparent clock correction [12]	
SV Global Health	OP		Bit string(364)	This enables GPS time recovery and possibly extended GPS correlation intervals. It is specified in page 25 of subframes 4 and 5 [12]	

10.3.7.89a UE positioning GANSS almanac

This IE contains a reduced-precision subset of the ephemeris and clock correction parameters.

Information Element/Group name	Need	Multi	Type and Reference	Semantics description	Version
Week Number	MP		Integer(0..255)	Almanac reference week , number of weeks since the beginning of GANSS specific system time (mod 256). Note, in case of Galileo, the almanac reference week number WNa natively contains only the 2 LSB's [61, section 5.1.10].	REL-7
				If "Model 5" or "Model 6" is included, the UE shall ignore the Week Number.	REL-8
Complete Almanac Provided	OP		Boolean	This field indicates whether the RNC provided almanac for the full GANSS constellation or not. TRUE means complete GANSS almanac is provided.	REL-10
Keplerian parameters ("Model 1")	OP			NOTE	REL-7
>T _{oa}	MP		Integer(0..613800 by step of 600)	Almanac Reference Time common to all satellites in GANSS Almanac using Keplerian Parameters given in GNSS specific system time [61].	REL-12
>IOD _a	MP		INTEGER(0..15)	Issue-Of -Data, common to all satellites [61]	REL-12
>Satellite information KP	MP	1 to <maxGANSSSat>		Almanacs are in the order of the SV IDs, the smallest ID first.	REL-7
>>SV ID	MP		Integer (0..63)	Satellite ID, as defined in Note 2 of 10.3.7.88b.	REL-7
>>e	MP		Bit string(11)	Eccentricity, dimensionless [61]	REL-7
>>δ _i	MP		Bit string(11)	Parameter δ _i , inclination at reference time relative to i ₀ =56°; semi-circles [61]	REL-7
>>OMEGADOT	MP		Bit string(11)	Parameter $\dot{\Omega}$, rate of change of right ascension (semi-circles/sec) [61].	REL-7
>>SV Status INAV	MP		Bit string(4)	This field contains the I/NAV signal health status [61, section 5.1.10], E5 _{bHS} and E1-B _{HS} , where E5 _{bHS} occupies the 2 MSBs and E1-B _{HS} the two LSBs.	REL-7
>>SV Status FNAV	OP		Bit string(2)	This field contains the F/NAV signal health status [61, section 5.1.10], E5 _{aHS} .	REL-12
>>delta A ^{1/2}	MP		Bit string(13)	Parameter Δ(a ^{1/2}), difference with respect to the square root of the nominal semi-major axis, (meters) ^{1/2} [61].	REL-12
>>OMEGA ₀	MP		Bit string(16)	Longitude of ascending node of orbital plane at weekly epoch (semi-circles) [61]	REL-7
>>M ₀	MP		Bit string(16)	Mean Anomaly at Reference Time (semi-circles) [61]	REL-7
>>ω	MP		Bit string(16)	Argument of Perigee (semi-circles) [61]	REL-7
>>af ₀	MP		Bit string(16)	Parameter af ₀ , satellite clock correction bias. Seconds [61]	REL-12
>>af ₁	MP		Bit string(13)	Parameter af ₁ , satellite clock correction linear, sec/sec [61]	REL-12

NAV Keplerian Parameters ("Model 2")	OP			NOTE	REL-8
>T _{oa}	MP		Integer(0..60 2112 by step of 4096)	Almanac Reference Time	REL-8
>Satellite information NAV-KP	MP	1 to <maxGAN SSSat>			REL-8
>>SV ID	MP		Integer (0..63)	Satellite ID, as defined in Note 2 of 10.3.7.88b.	REL-8
>>e	MP		Bit String(16)	Eccentricity, dimensionless [72]	REL-8
>> δ_i	MP		Bit String(16)	Correction to inclination, semi-circles [72]	REL-8
>>OMEGADOT	MP		Bit String(16)	Rate of right ascension, semi-circles/sec [72]	REL-8
>>SV Health	MP		Bit String(8)	Satellite health [72]	REL-8
>>A ^{1/2}	MP		Bit String(24)	Square root of the semi-major axis, meters ^{1/2} [72]	REL-8
>>OMEGA ₀	MP		Bit String(24)	Longitude of ascending node of orbit plane at weekly epoch, semi-circles [72]	REL-8
>> ω	MP		Bit String(24)	Argument of perigee semi-circles [72]	REL-8
>>M ₀	MP		Bit String(24)	Mean anomaly at reference time semi-circles [72]	REL-8
>>af ₀	MP		Bit String(11)	Apparent satellite clock correction seconds [72]	REL-8
>>af ₁	MP		Bit String(11)	Apparent satellite clock correction sec/sec [72]	REL-8
Reduced Keplerian Parameters ("Model 3")	OP			NOTE	REL-8
>T _{oa}	MP		Integer(0..60 2112 by step of 4096)	Almanac Reference Time	REL-8
>Satellite information RED-KP	MP	1 to <maxGAN SSSat>			REL-8
>>SV ID	MP		Integer (0..63)	Satellite ID, as defined in Note 2 of 10.3.7.88b.	REL-8
>> δ_A	MP		Bit String(8)	meters [68,69,70,72]	REL-8
>> Ω_0	MP		Bit String(7)	semi-circles [68,69,70,72]	REL-8
>> Φ_0	MP		Bit String(7)	semi-circles [68,69,70,72]	REL-8
>>L1 Health	MP		Bit String(1)	dimensionless [68,69,70,72]	REL-8
>>L2 Health	MP		Bit String(1)	dimensionless [68,69,70,72]	REL-8
>>L5 Health	MP		Bit String(1)	dimensionless [68,69,70,72]	REL-8
Midi Keplerian Parameters ("Model 4")	OP			NOTE	REL-8
>T _{oa}	MP		Integer(0..60 2112 by step of 4096)	Almanac Reference Time	REL-8
>Satellite information MIDI-KP	MP	1 to <maxGAN SSSat>			REL-8
>>SV ID	MP		Integer (0..63)	Satellite ID, as defined in Note 2 of 10.3.7.88b.	REL-8
>>e	MP		Bit String(11)	dimensionless [68,69,70,72]	REL-8
>> δ_i	MP		Bit String(11)	semi-circles [68,69,70,72]	REL-8
>> Ω_{dot}	MP		Bit String(11)	semi-circles/sec [68,69,70,72]	REL-8
>>sqrtA	MP		Bit String(17)	meters ^{1/2} [68,69,70,72]	REL-8
>> Ω_0	MP		Bit String(16)	semi-circles [68,69,70,72]	REL-8
>> ω	MP		Bit String(16)	semi-circles [68,69,70,72]	REL-8

>>M ₀	MP		Bit String(16)	semi-circles [68,69,70,72]	REL-8
>>a _{f0}	MP		Bit String(11)	seconds [68,69,70,72]	REL-8
>>a _{r1}	MP		Bit String(10)	sec/sec [68,69,70,72]	REL-8
>>L1 Health	MP		Bit String(1)	Dimensionless [68,69,70,72]	REL-8
>>L2 Health	MP		Bit String(1)	dimensionless [68,69,70,72]	REL-8
>>L5 Health	MP		Bit String(1)	dimensionless [68,69,70,72]	REL-8
GLONASS Keplerian Parameters ("Model 5")	OP			NOTE	REL-8
>Satellite information GLO-KP	MP	1 to <maxGAN SSSat>			REL-8
>>N ^A	MP		Bit String(11)	days [73]	REL-8
>>n ^A	MP		Bit String(5)	dimensionless [73]	REL-8
>>H _n ^A	MP		Bit String(5)	dimensionless [73]	REL-8
>>λ _n ^A	MP		Bit String(21)	semi-circles [73]	REL-8
>>t _n ^A	MP		Bit String(21)	seconds [73]	REL-8
>>Δi _n ^A	MP		Bit String(18)	semi-circles [73]	REL-8
>>ΔT _n ^A	MP		Bit String(22)	sec/orbit period [73]	REL-8
>>ΔT_DOT _n ^A	MP		Bit String(7)	sec/orbit period ² [73]	REL-8
>>ε _n ^A	MP		Bit String(15)	dimensionless [73]	REL-8
>>ω _n ^A	MP		Bit String(16)	semi-circles [73]	REL-8
>>τ _n ^A	MP		Bit String(10)	seconds [73]	REL-8
>>C _n ^A	MP		Bit String(1)	dimensionless [73]	REL-8
>>M _n ^A	OP		Bit String(2)	dimensionless [73]	REL-8
SBAS ECEF Parameters ("Model 6")	OP			NOTE	REL-8
>Satellite information SBAS-ECEF	MP	1 to <maxGAN SSSat>			REL-8
>>Data ID	MP		Bit String(2)	Dimensionless [71]	
>>SV ID	MP		Integer (0..63)	Satellite ID, as defined in Note 2 of 10.3.7.88b.	REL-8
>>Health	MP		Bit String(8)	Dimensionless [71]	REL-8
>>X _G	MP		Bit String(15)	meters [71]	REL-8
>>Y _G	MP		Bit String(15)	meters [71]	REL-8
>>Z _G	MP		Bit String(9)	meters [71]	REL-8
>>X _G Rate-of-Change	MP		Bit String(3)	meters/sec [71]	REL-8
>>Y _G Rate-of-Change	MP		Bit String(3)	meters/sec [71]	REL-8
>>Z _G Rate-of-Change	MP		Bit String(4)	meters/sec [71]	REL-8
>>t ₀	MP		Bit String(11)	seconds [71]	REL-8
BDS Keplerian Parameters ("Model 7")	OP			NOTE	REL-12
>Satellite information BDS-KP	MP	1 to <maxGAN SSSat>			REL-12
>>SV ID	MP		INTEGER (0..63)	Satellite ID, as defined in Note 2 of 10.3.7.88b.	REL-12
>>t _{0a}	MP		BIT STRING(8)	Almanac reference time (seconds) [86]	REL-12
>>A ^{1/2}	MP		BIT STRING(24)	Square root of semi-major axis (meters ^{1/2}) [86]	REL-12
>>e	MP		BIT STRING(17)	Eccentricity , dimensionless [86]	REL-12
>>ω	MP		BIT STRING(24)	Argument of Perigee (semi-circles) [86]	REL-12
>>M ₀	MP		BIT STRING(24)	Mean anomaly at reference time (semi-circles) [86]	REL-12
>>Ω ₀	MP		BIT STRING(24)	Longitude of ascending node of orbital plane computed according to reference time (semi-circles) [86]	REL-12
>>Ω_dot	MP		BIT STRING(17)	Rate of right ascension (semi-circles/sec) [86]	REL-12

>> δ_i	MP		BIT STRING(16)	Correction of orbit reference inclination at reference time (semi-circles) [86]	REL-12
>> a_0	MP		BIT STRING(11)	Satellite clock bias (seconds) [86]	REL-12
>> a_1	MP		BIT STRING(11)	Satellite clock rate (sec/sec) [86]	REL-12
>>Hea	CV-SV-ID		BIT STRING(9)	Satellite Health Information dimensionless [86]	REL-12

NOTE: This IE shall contain exactly one of the optional fiels indicated by "NOTE".

Condition	Explanation
SV-ID	This IE is mandatory present if the IE "SV ID" is between 0 and 29 and not needed otherwise

10.3.7.90 UE positioning GPS assistance data

This IE contains GPS assistance data.

Information Element/Group name	Need	Multi	Type and Reference	Semantics description
UE positioning GPS reference time	OP		UE positioning GPS reference time 10.3.7.96	
UE positioning GPS reference UE position	OP		Ellipsoid point with altitude and uncertainty ellipsoid 10.3.8.4c	A priori knowledge of UE 3-D position.
UE positioning GPS DGPS corrections	OP		UE positioning GPS DGPS corrections 10.3.7.91	
UE positioning GPS navigation model	OP		UE positioning GPS navigation model 10.3.7.94	
UE positioning GPS ionospheric model	OP		UE positioning GPS ionospheric model 10.3.7.92	
UE positioning GPS UTC model	OP		UE positioning GPS UTC model 10.3.7.97	
UE positioning GPS almanac	OP		UE positioning GPS almanac 10.3.7.89	
UE positioning GPS acquisition assistance	OP		UE positioning GPS acquisition	

Information Element/Group name	Need	Multi	Type and Reference	Semantics description
			assistance 10.3.7.88	
UE positioning GPS real-time integrity	OP		UE positioning GPS real- time integrity 10.3.7.95	

10.3.7.90a Void

10.3.7.90b UE positioning GANSS assistance data

This IE contains GANSS assistance data.

Information Element/Group name	Need	Multi	Type and Reference	Semantics description	Version
UE positioning GANSS reference time	OP		UE positioning GANSS reference time 10.3.7.96o		REL-7
UE positioning GANSS reference UE position	OP		Ellipsoid point with altitude and uncertainty ellipsoid 10.3.8.4c	A priori knowledge of UE 3-D position.If IE "UE positioning GPS assistance data" is present, this IE should not be included to both IEs. The reference UE position is provided in WGS-84 reference system.	REL-7
UE positioning GANSS ionospheric model	OP		UE positioning GANSS ionospheric model 10.3.7.92a		REL-7
UE positioning GANSS additional ionospheric model	OP		UE positioning GANSS additional ionospheric model 10.3.7.92b		REL-8
UE positioning GANSS Earth orientation parameters	OP		UE positioning GANSS Earth orientation parameters 10.3.7.92c		REL-8
GANSS Generic Assistance Data	OP	1 to <maxGANSS>			REL-7
>GANSS ID	OP		Integer(0..7)	Absence of this IE means Galileo Values 0-7 reserved for future use.	REL-7
				Absence of this IE means Galileo. For coding description see NOTE 1.	REL-8
>UE positioning GANSS SBAS ID	CV- GANSS-ID -SBAS		UE positioning GANSS SBAS ID 10.3.7.97e		REL-8
>GANSS Time Models	OP	1 to <maxGANSS-1>			REL-7
>>GANSS Time Model	MP		UE positioning GANSS time model 10.3.7.97a		REL-7
>UE positioning DGANSS corrections	OP		UE positioning DGANSS corrections 10.3.7.91b		REL-7

Information Element/Group name	Need	Multi	Type and Reference	Semantics description	Version
>UE positioning DBDS corrections	CV- GANSS-ID -BDS		UE positioning DBDS corrections 10.3.7.92e		REL-12
>UE positioning BDS Ionospheric Grid Model	CV- GANSS-ID -BDS		UE positioning BDS Ionospheric Grid Model 10.3.7.92d		REL-12
>UE positioning GANSS navigation model	OP		UE positioning GANSS navigation model 10.3.7.94a	NOTE	REL-7
>UE positioning GANSS additional navigation models	OP		UE positioning GANSS additional navigation models 10.3.7.94b	NOTE	REL-8
>UE positioning GANSS real-time integrity	OP		UE positioning GANSS real- time integrity 10.3.7.95b		REL-7
>UE positioning GANSS data bit assistance	OP		UE positioning GANSS data bit assistance 10.3.7.97b		REL-7
>UE positioning GANSS reference measurement information	OP		UE positioning GANSS reference measuremen t information 10.3.7.88b		REL-7
>UE positioning GANSS almanac	OP		UE positioning GANSS almanac 10.3.7.89a		REL-7
>UE positioning GANSS UTC model	OP		UE positioning GANSS UTC model 10.3.7.97c		REL-7
>UE positioning GANSS additional UTC models	OP		UE positioning GANSS additional UTC models 10.3.7.97d		REL-8
>UE positioning GANSS auxiliary information	OP		UE positioning GANSS auxiliary information 10.3.7.97f		REL-8

NOTE: If included, only one of the optional fiels indicated by "NOTE" shall be present.

Condition	Explanation
GANSS-ID-SBAS	The IE is mandatory present if the IE "GANSS ID" is "SBAS" and not needed otherwise.
GANSS-ID-BDS	The IE is optionally present if the IE "GANSS ID" is "BDS" and not needed otherwise.

NOTE 1: Coding of GANSS ID

Value of GANSS ID	GANSS	Version
0	SBAS	REL-8
1	Modernized GPS	
2	QZSS	
3	GLONASS	
4	BDS	REL-12
5-7	Reserved for future use	

10.3.7.91 UE positioning GPS DGPS corrections

This IE contains DGPS corrections to be used by the UE.

Information Element/Group name	Need	Multi	Type and Reference	Semantics description	Version
GPS TOW sec	MP		Integer(0..604799)	seconds GPS time-of-week when the DGPS corrections were calculated	
Status/Health	MP		Enumerated(UDRE scale 1.0, UDRE scale 0.75, UDRE scale 0.5, UDRE scale 0.3, UDRE scale 0.2, UDRE scale 0.1, no data, invalid data)		
DGPS information	CV- Status/Health	1 to <maxSat>		If the Cipher information is included these fields are ciphered.	
>SatID	MP		Enumerated (0..63)	Identifies the satellite and is equal to (SV ID No - 1) where SV ID No is defined in [12].	
>IODE	MP		Integer(0..255)		
>UDRE	MP		Enumerated(UDRE ≤ 1.0 m, 1.0m < UDRE ≤ 4.0m, 4.0m < UDRE ≤ 8.0m, 8.0m < UDRE)	The value in this field shall be multiplied by the UDRE Scale Factor in the IE Status/Health to determine the final UDRE estimate for the particular satellite.	

Information Element/Group name	Need	Multi	Type and Reference	Semantics description	Version
>PRC	MP		Real(-655.04..655.04 by step of 0.32)	meters (different from [13])	
>RRC	MP		Real(-4.064..4.064 by step of 0.032)	meters/sec (different from [13])	
>Delta PRC2	MP		Integer(-127..127)	In this version of the protocol this IE should be set to zero and the UE shall ignore it	
>Delta RRC2	MP		Real(-0.224..0.224 by step of 0.032)	In this version of the protocol this IE should be set to zero and the UE shall ignore it	
>Delta PRC3	OP		Integer(-127..127)	This IE should not be included in this version of the protocol and if received the UE shall ignore it	
>Delta RRC3	OP		Real(-0.224..0.224 by step of 0.032)	This IE should not be included in this version of the protocol and if received the UE shall ignore it	
>UDRE Growth Rate	OP		Enumerated(UDRE growth 1.5, UDRE growth 2, UDRE growth 4, UDRE growth 6, UDRE growth 8, UDRE growth 10, UDRE growth 12, UDRE growth 16)	This field provides an estimate of the growth rate of uncertainty ($1-\sigma$) in the corrections. The UDRE at time value specified in the <i>Time of Validity for UDRE Growth Rate</i> field is the value of this field times the value of UDRE.	REL-9
>Time of Validity for UDRE Growth Rate	OP		Enumerated(val20sec, val40sec, val80sec, val160sec, val320sec, val640sec, val1280sec, val2560sec)	This field specifies the time when the <i>UDRE Growth Rate</i> field applies.	REL-9

Condition	Explanation
<i>Status/Health</i>	This IE is mandatory present if "status" is not equal to "no data" or "invalid data", otherwise the IE is not needed.

10.3.7.91a UE positioning GPS Ephemeris and Clock Correction parameters

This IE contains information for GPS ephemeris and clock correction.

Information Element/Group name	Need	Multi	Type and Reference	Semantics description
C/A or P on L2	MP		Bit string(2)	Code(s) on L2 Channel [12]
URA Index	MP		Bit string(4)	User Range Accuracy [12]
SV Health	MP		Bit string(6)	[12]
IODC	MP		Bit string(10)	Issue of Data, Clock [12]
L2 P Data Flag	MP		Bit string(1)	[12]
SF 1 Reserved	MP		Bit string(87)	[12]
TGD	MP		Bit string(8)	Estimated group delay differential [12]
t_{oc}	MP		Bit string(16)	apparent clock correction [12]
af_2	MP		Bit string(8)	apparent clock correction [12]
af_1	MP		Bit string(16)	apparent clock correction [12]
af_0	MP		Bit string(22)	apparent clock correction [12]
C_{rs}	MP		Bit string(16)	Amplitude of the Sine Harmonic Correction Term to the Orbit Radius (meters) [12]
Δn	MP		Bit string(16)	Mean Motion Difference From Computed Value (semi-circles/sec) [12]
M_0	MP		Bit string(32)	Mean Anomaly at Reference Time (semi-circles) [12]
C_{uc}	MP		Bit string(16)	Amplitude of the Cosine Harmonic Correction Term To The Argument Of Latitude (radians) [12]
e	MP		Bit string(32)	c
C_{us}	MP		Bit string(16)	Amplitude of the Sine Harmonic Correction Term To The Argument Of Latitude (radians) [12]
$(A)^{1/2}$	MP		Bit string(32)	Semi-Major Axis (meters) ^{1/2} [12]
t_{oe}	MP		Bit string(16)	Reference Time Ephemeris [12]
Fit Interval Flag	MP		Bit string(1)	[12]
AODO	MP		Bit string(5)	Age Of Data Offset [12]
C_{ic}	MP		Bit string(16)	Amplitude of the Cosine Harmonic Correction Term To The Angle Of Inclination (radians) [12]
$OMEGA_0$	MP		Bit string(32)	Longitude of Ascending Node of Orbit Plane at Weekly Epoch (semi-circles) [12]
C_{is}	MP		Bit string(16)	Amplitude of the Sine Harmonic Correction Term To The Angle Of Inclination (radians) [12]
i_0	MP		Bit string(32)	Inclination Angle at Reference Time (semi-circles) [12]
C_{rc}	MP		Bit string(16)	Amplitude of the Cosine Harmonic Correction Term to the Orbit Radius (meters) [12]
ω	MP		Bit string(32)	Argument of Perigee (semi-circles) [12]
$OMEGA\dot{}$	MP		Bit string(24)	Longitude of Ascending Node of Orbit Plane at Weekly Epoch (semi-circles/sec) [12]
\dot{i}	MP		Bit string(14)	Rate of Inclination Angle (semi-circles/sec) [12]

10.3.7.91b UE positioning DGANSS corrections

This IE contains DGANSS corrections to be used by the UE.

Information Element/Group name	Need	Multi	Type and Reference	Semantics description	Version
DGANSS Reference Time	MP		Integer(0..3570 by step of 30)	Seconds. Time in GNSS system time (modulo 3600 s) when the DGANSS corrections were calculated	REL-7
DGANSS information	MP	1 to <maxSgnType>			REL-7
>GANSS Signal ID	OP		GANSS Signal Id 10.3.3.45a	Absence of this field means the default value as defined in 10.3.3.45a for the GANSS identified by GANSS_ID.	REL-7
>Status/Health	MP		Enumerated(UDRE scale 1.0, UDRE scale 0.75, UDRE scale 0.5, UDRE scale 0.3, UDRE scale 0.2, UDRE scale 0.1, no data, invalid data)		REL-7
>DGANSS signal information	CV-Status/Health	1 to <maxGANSSSat>		If the Cipher information is included these fields are ciphered.	REL-7
>>SatID	MP		Integer (0..63)	Identifies the satellite and is as defined in Note 2 of 10.3.7.88b.	REL-7
>>IOD	MP		Bit string(10)	10 LSBs of Issue of Data field, which contains the identity of the GANSS Navigation Model.	REL-7
>>UDRE	MP		Enumerated(UDRE ≤ 1.0 m, 1.0m < UDRE ≤ 4.0m, 4.0m < UDRE ≤ 8.0m, 8.0m < UDRE)	The value in this field shall be multiplied by the UDRE Scale Factor in the IE Status/Health to determine the final UDRE estimate for the particular satellite.	REL-7
>>PRC	MP		Real(-655.04..655.04 by step of 0.32)	meters Pseudo-range corrections are provided with respect to GNSS specific geodetic datum (e.g., PZ-90.02 if GANSS ID indicates GLONASS).	REL-7
>>RRC	MP		Real(-4.064..4.064 by step of 0.032)	meters/sec Pseudo-range rate corrections are provided with respect to GNSS specific geodetic datum (e.g., PZ-90.02 if GANSS ID indicates GLONASS).	REL-7

Information Element/Group name	Need	Multi	Type and Reference	Semantics description	Version
>>UDRE Growth Rate	OP		Enumerated(UDRE growth 1.5, UDRE growth 2, UDRE growth 4, UDRE growth 6, UDRE growth 8, UDRE growth 10, UDRE growth 12, UDRE growth 16)	This field provides an estimate of the growth rate of uncertainty ($1-\sigma$) in the corrections. The UDRE at time value specified in the <i>Time of Validity for UDRE Growth Rate</i> field is the value of this field times the value of UDRE.	REL-9
>>Time of Validity for UDRE Growth Rate	OP		Enumerated(val20sec, val40sec, val80sec, val160sec, val320sec, val640sec, val1280sec, val2560sec)	This field specifies the time when the <i>UDRE Growth Rate</i> field applies.	REL-9

Condition	Explanation
<i>Status/Health</i>	This IE is mandatory present if "status" is not equal to "no data" or "invalid data", otherwise the IE is not needed.

10.3.7.91c UE positioning GANSS orbit model

This IE contains information for GANSS orbit model parameters.

Information Element/Group name	Need	Multi	Type and Reference	Semantics description	Version
Keplerian Parameters ("Model 1")	OP			NOTE	REL-7
>t _{oe}	MP		Bit String(14)	Time-of-Ephemeris in seconds, scale factor 60 [61]	REL-7
> ω	MP		Bit string(32)	Argument of Perigee (semi-circles) [61]	REL-7
> Δn	MP		Bit string(16)	Mean Motion Difference From Computed Value (semi-circles/sec) [61]	REL-7
>M ₀	MP		Bit string(32)	Mean Anomaly at Reference Time (semi-circles) [61]	REL-7
>OMEGAdot	MP		Bit string(24)	Rate of change of right ascension (semi-circles/sec) [61]	REL-7
>e	MP		Bit string(32)	Eccentricity, scale factor 2 ⁻³³ [61]	REL-7
>ldot	MP		Bit string(14)	Rate of change of Inclination Angle (semi-circles/sec) [61]	REL-7
>sqrtA	MP		Bit String(32)	Square root of Semi-Major Axis in (meters) ^{1/2} , scale factor 2 ⁻¹⁹ [61]	REL-7
>i ₀	MP		Bit string(32)	Inclination Angle at Reference Time (semi-circles) [61]	REL-7
>OMEGA ₀	MP		Bit string(32)	Longitude of Ascending Node of Orbit Plane at Weekly Epoch (semi-circles) [61]	REL-7
>C _{rs}	MP		Bit string(16)	Amplitude of the Sine Harmonic Correction Term to the Orbit Radius (meters) [61]	REL-7
>C _{is}	MP		Bit string(16)	Amplitude of the Sine Harmonic Correction Term To The Angle Of Inclination (radians) [61]	REL-7
>C _{us}	MP		Bit string(16)	Amplitude of the Sine Harmonic Correction Term To The Argument Of Latitude (radians) [61]	REL-7
>C _{rc}	MP		Bit string(16)	Amplitude of the Cosine Harmonic Correction Term to the Orbit Radius (meters) [61]	REL-7
>C _{ic}	MP		Bit string(16)	Amplitude of the Cosine Harmonic Correction Term To The Angle Of Inclination (radians) [61]	REL-7
>C _{uc}	MP		Bit string(16)	Amplitude of the Cosine Harmonic Correction Term To The Argument Of Latitude (radians) [61]	REL-7

NOTE: This IE shall contain exactly one of the optional fields indicated by "NOTE".

10.3.7.91d UE positioning GANSS clock model

The IE contains fields needed to model the GANSS clock parameters.

Information Element/Group name	Need	Multi	Type and Reference	Semantics description	Version
Satellite clock model ("Model 1")	MP	1 to <maxSatClockModels>		There may be more than one clock model included if defined in SIS ICD (i.e., two for Galileo) [61].	REL-7
>toC	MP		BIT STRING(14)	Clock correction data reference Time of Week in seconds. Scale factor 60 seconds [61].	REL-7
>a12	MP		BIT STRING (6)	SV clock drift rate correction coefficient, sec/sec ² , scale factor 2 ⁻⁵⁹ [61].	REL-12
>a11	MP		BIT STRING (21)	Parameter a_{f1} , SV clock drift correction coefficient, sec/sec, scale factor 2 ⁻⁴⁶ [61].	REL-12
>a10	MP		BIT STRING (31)	Parameter a_{f0} , SV clock bias correction coefficient, sec, scale factor 2 ⁻³⁴ [61].	REL-12
>TGD	OP		BIT STRING (10)	Broadcast Group Delay (BGD), sec, scale factor 2 ⁻³² [61].	REL-7
>SISA	MP		BIT STRING (8)	Signal-In-Space Accuracy (SISA), defined in [61] section 5.1.11.	REL-12
>Model ID	OP		Integer(0..1)	NOTE 1	REL-7

NOTE 1: Coding of Model ID:

GNSS	Value	Explanation
Galileo	0	I/Nav (E1,E5b)
	1	F/Nav (E1,E5a)

10.3.7.91e UE positioning GANSS additional orbit models

This IE contains information for GANSS orbit model parameters.

Information Element/Group name	Need	Multi	Type and Reference	Semantics description	Version
NAV-Keplerian Parameters ("Model 2")	OP			NOTE	REL-8
>URA Index	MP		Bit String(4)	SV accuracy (dimensionless) [72]	REL-8
>Fit Interval Flag	MP		Bit String(1)	Fit interval indication (dimensionless) [72]	REL-8
> t_{oe}	MP		Bit String(16)	Time of ephemeris (seconds) [72]	REL-8
> ω	MP		Bit String(32)	Argument of perigee (semi-circles) [72]	REL-8
> Δn	MP		Bit String(16)	Mean motion difference from computed value (semi-circles/sec) [72]	REL-8
> M_0	MP		Bit String(32)	Mean anomaly at reference time (semi-circles) [72]	REL-8
>OMEGAdot	MP		Bit String(24)	Rate of right ascension (semi-circles/sec) [72]	REL-8
>e	MP		Bit String(32)	Eccentricity (dimensionless) [72]	REL-8
>Idot	MP		Bit String(14)	Rate of inclination angle (semi-circles/sec) [72]	REL-8
>sqrtA	MP		Bit String(32)	Square root of semi-major axis (meters ^{1/2}) [72]	REL-8
> i_0	MP		Bit String(32)	Inclination angle at reference time (semi-circles) [72]	REL-8
>OMEGA ₀	MP		Bit String(32)	Longitude of ascending node of orbit plane at weekly epoch (semi-circles) [72]	REL-8
>C _{rs}	MP		Bit String(16)	Amplitude of sine harmonic correction term to the orbit radius (meters) [72]	REL-8
>C _{is}	MP		Bit String(16)	Amplitude of sine harmonic correction term to the angle of inclination (radians) [72]	REL-8
>C _{us}	MP		Bit String(16)	Amplitude of sine harmonic correction term to the argument of latitude (radians) [72]	REL-8
>C _{rc}	MP		Bit String(16)	Amplitude of cosine harmonic correction term to the orbit radius (meters) [72]	REL-8
>C _{ic}	MP		Bit String(16)	Amplitude of cosine harmonic correction term to the angle of inclination (radians) [72]	REL-8
>C _{uc}	MP		Bit String(16)	Amplitude of cosine harmonic correction term to the argument of latitude (radians) [72]	REL-8
CNAV/CNAV-2 Keplerian Parameters ("Model 3")	OP			NOTE	REL-8
> t_{op}	MP		Bit String(11)	Data predict time of week (seconds) [68,69,70,72]	REL-8
>URA _{oe} Index	MP		Bit String(5)	SV accuracy (dimensionless) [68,69,70,72]	REL-8
> ΔA	MP		Bit String(26)	Semi-major axis difference at reference time (meters) [68,69,70,72]	REL-8

Information Element/Group name	Need	Multi	Type and Reference	Semantics description	Version
>A_dot	MP		Bit String(25)	Chane rate in semi-major axis (meters/sec) [68,69,70,72]	REL-8
> Δn_0	MP		Bit String(17)	Mean motion difference from computed value at reference time (semi-circles/sec) [68,69,70,72]	REL-8
> Δn_0_dot	MP		Bit String(23)	Rate of mean motion difference from computed value (semi-circles/sec ²) [68,69,70,72]	REL-8
>M _{0-n}	MP		Bit String(33)	Mean anomaly at reference time (semi-circles) [68,69,70,72]	REL-8
>e _n	MP		Bit String(33)	Eccentricity (dimensionless) [68,69,70,72]	REL-8
> ω_n	MP		Bit String(33)	Argument of perigee (semi-circles) [68,69,70,72]	REL-8
> Ω_{0-n}	MP		Bit String(33)	Reference right ascension angle (semi-circles) [68,69,70,72]	REL-8
> $\Delta\Omega_dot$	MP		Bit String(17)	Rate of right ascension difference (semi-circles/sec) [68,69,70,72]	REL-8
>i _{0-n}	MP		Bit String(33)	Inclination angle at reference time (semi-circles) [68,69,70,72]	REL-8
>i _{0-n_dot}	MP		Bit String(15)	Rate of inclination angle (semi-circles/sec) [68,69,70,72]	REL-8
>C _{is-n}	MP		Bit String(16)	Amplitude of sine harmonic correction term to the angle of inclination (radians) [68,69,70,72]	REL-8
>C _{ic-n}	MP		Bit String(16)	Amplitude of cosine harmonic correction term to the angle of inclination (radians) [68,69,70,72]	REL-8
>C _{rs-n}	MP		Bit String(24)	Amplitude of sine harmonic correction term to the orbit radius (meters) [68,69,70,72]	REL-8
>C _{rc-n}	MP		Bit String(24)	Amplitude of cosine harmonic correction term to the orbit radius (meters) [68,69,70,72]	REL-8
>C _{us-n}	MP		Bit String(21)	Amplitude of sine harmonic correction term to the argument of latitude (radians) [68,69,70,72]	REL-8
>C _{uc-n}	MP		Bit String(21)	Amplitude of cosine harmonic correction term to the argument of latitude (radians) [68,69,70,72]	REL-8
GLONASS Earth-Centered, Earth-fixed Parameters ("Model 4")	OP			NOTE	REL-8
>E _n	MP		Bit String(5)	Age of data (days) [73]	REL-8
>P1	MP		Bit String(2)	Time interval between two adjacent values of t _b (minutes) [73]	REL-8

Information Element/Group name	Need	Multi	Type and Reference	Semantics description	Version
>P2	MP		Bit String(1)	Change of t_b flag (dimensionless) [73]	REL-8
>M	OP		Bit String(2)	Type of satellite (dimensionless) [73]	REL-8
> $x_n(t_b)$	MP		Bit String(27)	x-coordinate of satellite at time t_b (kilometers) [73]	REL-8
> $\dot{x}_n(t_b)$	MP		Bit String(24)	x-coordinate of satellite velocity at time t_b (kilometers/sec) [73]	REL-8
> $\ddot{x}_n(t_b)$	MP		Bit String(5)	x-coordinate of satellite acceleration at time t_b (kilometers/sec ²) [73]	REL-8
> $y_n(t_b)$	MP		Bit String(27)	y-coordinate of satellite at time t_b (kilometers) [73]	REL-8
> $\dot{y}_n(t_b)$	MP		Bit String(24)	y-coordinate of satellite velocity at time t_b (kilometers/sec) [73]	REL-8
> $\ddot{y}_n(t_b)$	MP		Bit String(5)	y-coordinate of satellite acceleration at time t_b (kilometers/sec ²) [73]	REL-8
> $z_n(t_b)$	MP		Bit String(27)	z-coordinate of satellite at time t_b (kilometers) [73]	REL-8
> $\dot{z}_n(t_b)$	MP		Bit String(24)	z-coordinate of satellite velocity at time t_b (kilometers/sec) [73]	REL-8
> $\ddot{z}_n(t_b)$	MP		Bit String(5)	z-coordinate of satellite acceleration at time t_b (kilometers/sec ²) [73]	REL-8
SBAS Earth-Centered, Earth-fixed Parameters ("Model 5")	OP			NOTE	REL-8
> t_0	CV-ClockModel		Bit String(13)	Time of applicability (seconds) [71]	REL-8
>Accuracy	MP		Bit String(4)	(dimensionless) [71]	REL-8
> X_G	MP		Bit String(30)	(meters) [71]	REL-8
> Y_G	MP		Bit String(30)	(meters) [71]	REL-8
> Z_G	MP		Bit String(25)	(meters) [71]	REL-8
> X_G Rate-of-Change	MP		Bit String(17)	(meters/sec) [71]	REL-8
> Y_G Rate-of-Change	MP		Bit String(17)	(meters/sec) [71]	REL-8
> Z_G Rate-of-Change	MP		Bit String(18)	(meters/sec) [71]	REL-8
> X_G Acceleration	MP		Bit String(10)	(meters/sec ²) [71]	REL-8
> Y_G Acceleration	MP		Bit String(10)	meters/sec ²) [71]	REL-8
> Z_G Acceleration	MP		Bit String(10)	meters/sec ²) [71]	REL-8
BDS Keplerian Parameters ("Model 6")	OP			NOTE	REL-12
>AODE	MP		Bit String(5)	Age of data,ephemeris (dimensionless) [86]	REL-12
>URA Index	MP		Bit String(4)	SV accuracy (dimensionless) [86]	REL-12
> t_{oe}	MP		BIT STRING (17)	Ephemeris reference time (seconds) [86]	REL-12
> $A^{1/2}$	MP		BIT STRING (32)	Square root of semi-major axis (meters ^{1/2}) [86]	REL-12
>e	MP		BIT STRING (32)	Eccentricity (dimensionless) [86]	REL-12
> ω	MP		BIT STRING (32)	Argument of perigee (semi-circles) [86]	REL-12
> Δn	MP		BIT STRING (16)	Mean motion difference from computed value (semi-circles/sec) [86]	REL-12

Information Element/Group name	Need	Multi	Type and Reference	Semantics description	Version
>M ₀	MP		BIT STRING (32)	Mean anomaly at reference time (semi-circles) [86]	REL-12
>Ω ₀	MP		BIT STRING (32)	Longitude of ascending node of orbital of plane computed according to reference time (semi-circles) [86]	REL-12
>Ω _{dot}	MP		BIT STRING (24)	Rate of right ascension (semi-circles/sec) [86]	REL-12
>i ₀	MP		BIT STRING (32)	Inclination angle at reference time (semi-circles) [86]	REL-12
>ldot	MP		BIT STRING (14)	Rate of inclination angle (semi-circles/sec) [86]	REL-12
>C _{uc}	MP		BIT STRING (18)	Amplitude of cosine harmonic correction term to the argument of latitude (radians) [86]	REL-12
>C _{us}	MP		BIT STRING (18)	Amplitude of sine harmonic correction term to the argument of latitude (radians) [86]	REL-12
>C _{rc}	MP		BIT STRING (18)	Amplitude of cosine harmonic correction term to the orbit radius (meters) [86]	REL-12
>C _{rs}	MP		BIT STRING (18)	Amplitude of sine harmonic correction term to the orbit radius (meters) [86]	REL-12
>C _{ic}	MP		BIT STRING (18)	Amplitude of cosine harmonic correction term to the angle of inclination (radians) [86]	REL-12
>C _{is}	MP		BIT STRING (18)	Amplitude of sine harmonic correction term to the angle of inclination (radians) [86]	REL-12

NOTE: This IE shall contain exactly one of the optional fiels indicated by "NOTE".

Condition	Explanation
<i>ClockModel</i>	This IE is mandatory present if UE positioning GANSS additional clock models "Model 5" is not included in UE positioning GANSS additional navigation models, otherwise the IE is not needed.

10.3.7.91f UE positioning GANSS additional clock models

The IE contains fields needed to model the GANSS clock parameters.

Information Element/Group name	Need	Multi	Type and Reference	Semantics description	Version
NAV-Clock Model ("Model 2")	OP			NOTE	REL-8
>t _{oc}	MP		Bit String(16)	Time of clock (seconds) [72]	REL-8
>a _{f2}	MP		Bit String(8)	Clock correction polynomial coefficient (sec/sec ²) [72]	REL-8
>a _{f1}	MP		Bit String(16)	Clock correction polynomial coefficient (sec/sec) [72]	REL-8
>a _{f0}	MP		Bit String(22)	Clock correction polynomial coefficient (seconds) [72]	REL-8
>T _{GD}	MP		Bit String(8)	Group delay (seconds) [72]	REL-8
CNAV/CNAV-2 Clock Model ("Model 3")	OP			NOTE	REL-8
>t _{oc}	MP		Bit String(11)	Clock data reference time of week (seconds) [68, 69, 70, 72]	REL-8
>t _{op}	MP		Bit String(11)	Clock data predict time of week (seconds) [68, 69, 70, 72]	REL-8
>URA _{oc} Index	MP		Bit String(5)	SV clock accuracy index (dimensionless) [68, 69, 70, 72]	REL-8
>URA _{oc1} Index	MP		Bit String(3)	SV clock accuracy change index (dimensionless) [68, 69, 70, 72]	REL-8
>URA _{oc2} Index	MP		Bit String(3)	SV clock accuracy change rate index (dimensionless) [68, 69, 70, 72]	REL-8
>a _{f2-n}	MP		Bit String(10)	SV clock drift rate correction coefficient (sec/sec ²) [68, 69, 70, 72]	REL-8
>a _{f1-n}	MP		Bit String(20)	SV clock drift correction coefficient (sec/sec) [68, 69, 70, 72]	REL-8
>a _{f0-n}	MP		Bit String(26)	SV clock bias correction coefficient (seconds) [68, 69, 70, 72]	REL-8
>T _{GD}	MP		Bit String(13)	Group delay correction (seconds) [68, 69, 70, 72]	REL-8
>ISC _{L1CP}	OP		Bit String(13)	Inter signal group delay correction (seconds) [70, 72]	REL-8
>ISC _{L1CD}	OP		Bit String(13)	Inter signal group delay correction (seconds) [70, 72]	REL-8
>ISC _{L1C/A}	OP		Bit String(13)	Inter signal group delay correction (seconds) [68, 69, 72]	REL-8
>ISC _{L2C}	OP		Bit String(13)	Inter signal group delay correction (seconds) [68, 69, 72]	REL-8
>ISC _{L5I5}	OP		Bit String(13)	Inter signal group delay correction (seconds) [69, 72]	REL-8
>ISC _{L5Q5}	OP		Bit String(13)	Inter signal group delay correction (seconds) [69, 72]	REL-8
GLONASS Satellite Clock Model ("Model 4")	OP			NOTE	REL-8

> $\tau_n(t_b)$	MP		Bit String(22)	Satellite clock offset (seconds) [73]	REL-8
> $\gamma_n(t_b)$	MP		Bit String(11)	Relative frequency offset from nominal value (dimensionless) [73]	REL-8
> $\Delta\tau_n$	OP		Bit String(5)	Time difference between transmission in G2 and G1 (seconds) [73]	REL-8
SBAS Satellite Clock Model ("Model 5")	OP			NOTE	REL-8
> t_0	MP		Bit String(13)	(seconds) [71]	REL-8
> a_{Gf_0}	MP		Bit String(12)	(seconds) [71]	REL-8
> a_{Gf_1}	MP		Bit String(8)	(sec/sec) [71]	REL-8
BDS Satellite Clock Model ("Model 6")	OP			NOTE	REL-12
>AODC	MP		BIT STRING (5)	Age of data,clock (dimensionless) [86]	REL-12
>toc	MP		BIT STRING (17)	Time of clock (seconds) [86]	REL-12
>a0	MP		BIT STRING (24)	Clock correction polynomial coefficient (seconds) [86]	REL-12
>a1	MP		BIT STRING (22)	Clock correction polynomial coefficient (sec/sec) [86]	REL-12
>a2	MP		BIT STRING (11)	Clock correction polynomial coefficient (sec/sec ²) [86]	REL-12
>TGD1	MP		BIT STRING (10)	Equipment Group Delay Differential (seconds) [86]	REL-12

NOTE: This IE shall contain exactly one of the optional fiels indicated by "NOTE".

10.3.7.92 UE positioning GPS ionospheric model

The IE contains fields needed to model the propagation delays of the GPS signals through the ionosphere.

Information Element/Group name	Need	Multi	Type and Reference	Semantics description
α_0	MP		Bit string(8)	Note 1
α_1	MP		Bit string(8)	Note 1
α_2	MP		Bit string(8)	Note 1
α_3	MP		Bit string(8)	Note 1
β_0	MP		Bit string(8)	Note 2
β_1	MP		Bit string(8)	Note 2
β_2	MP		Bit string(8)	Note 2
β_3	MP		Bit string(8)	Note 2

NOTE 1: The parameters α_n are the coefficients of a cubic equation representing the amplitude of the vertical delay [12].

NOTE 2: The parameters β_n are the coefficients of a cubic equation representing the period of the ionospheric model [12].

10.3.7.92a UE positioning GANSS ionospheric model

The IE contains fields needed to model the propagation delays of the GANSS signals through the ionosphere.

Information Element/Group name	Need	Multi	Type and Reference	Semantics description	Version
a_{i0}	MP		Bit string(11)	Effective Ionisation Level 1 st order parameter. This parameter is used as defined in [61]	REL-12
a_{i1}	MP		Bit string(11)	Effective Ionisation Level 2 nd order parameter. This parameter is used as defined in [61]	REL-12
a_{i2}	MP		Bit string(14)	Effective Ionisation Level 3 rd order parameter. This parameter is used as defined in [61]	REL-12
GANSS Ionosphere Regional Storm Flags	OP				REL-7
>Storm Flag 1	MP		Boolean	This parameter is used as defined in [61]	REL-7
>Storm Flag 2	MP		Boolean	This parameter is used as defined in [61]	REL-7
>Storm Flag 3	MP		Boolean	This parameter is used as defined in [61]	REL-7
>Storm Flag 4	MP		Boolean	This parameter is used as defined in [61]	REL-7
>Storm Flag 5	MP		Boolean	This parameter is used as defined in [61]	REL-7

10.3.7.92b UE positioning GANSS additional ionospheric model

This IE contains parameters to model the propagation delays of the GANSS signals through the ionosphere.

Information Element/Group name	Need	Multi	Type and Reference	Semantics description	Version
Data ID	MP		Bit String(2)	The value '11' indicates that the parameters have been generated by QZSS, and the parameters have been specialized and are applicable within the area defined in [72]. The value '01' indicates that the parameters have been generated by BDS, and UE shall use these parameters according to the description given in 5.2.4.7 in [86]. When Data ID has the value '00' it indicates the parameters are applicable worldwide [72]. All other values for Data ID are reserved.	REL-8
α_0	MP		Bit string(8)	seconds [72]	REL-8
α_1	MP		Bit string(8)	sec/semi-circle [72]	REL-8
α_2	MP		Bit string(8)	sec/(semi-circle) ² [72]	REL-8
α_3	MP		Bit string(8)	sec/(semi-circle) ³ [72]	REL-8
β_0	MP		Bit string(8)	seconds [72]	REL-8
β_1	MP		Bit string(8)	sec/semi-circle [72]	REL-8
β_2	MP		Bit string(8)	sec/(semi-circle) ² [72]	REL-8
β_3	MP		Bit string(8)	sec/(semi-circle) ³ [72]	REL-8

10.3.7.92c UE positioning GANSS Earth orientation parameters

This IE provides parameters to construct the ECEF and ECI coordinate transformation as defined in [68]. The Earth Orientation Parameters (EOP) indicate the relationship between the Earth's rotational axis and WGS-84 reference system.

Information Element/Group name	Need	Multi	Type and Reference	Semantics description	Version
t _{EOP}	MP		Bit String(16)	EOP data reference time (seconds) [68]	REL-8
PM_X	MP		Bit String(21)	X-axis polar motion value at reference time (arc-seconds) [68]	REL-8
PM_X_dot	MP		Bit String(15)	X-axis polar motion drift at reference time (arc-seconds/day) [68]	REL-8
PM_Y	MP		Bit String(21)	Y-axis polar motion value at reference time (arc-seconds) [68]	REL-8
PM_Y_dot	MP		Bit String(15)	Y-axis polar motion drift at reference time (arc-seconds/day) [68]	REL-8
ΔUT1	MP		Bit String(31)	UT1-UTC difference at reference time (seconds) [68]	REL-8
ΔUT1_dot	MP		Bit String(19)	Rate of UT1-UTC difference at reference time (seconds/day) [68]	REL-8

10.3.7.92d UE positioning BDS Ionospheric Grid Model

This IE contains BDS Ionospheric Grid information to calculate the propagation delays of the B1I signal through the ionosphere.

Information Element/Group name	Need	Multi	Type and Reference	Semantics description	Version
BDS Reference Time	MP		Integer(0..3570 by step of 30)	Seconds. Time in BDS system time (modulo 3600 s) when the BDS Ionospheric Grid Information is valid.	REL-12
BDS Ionospheric Grid Information	MP	1 to <maxI GPInfo >		Ionospheric information for upto 16 grid points will be included in this version of the specification.	REL-12
>IGP number	MP		INTEGER (1..320)	Ionospheric grid point number (dimensionless) [86].	REL-12
>Vertical Delay	MP		BIT STRING (9)	Vertical Delay at Ionospheric Grid Points ,(meters) [86]	REL-12
>GIVEI	MP		BIT STRING (4)	Grid Ionospheric Vertical Error Index (dimensionless) [86].	REL-12

10.3.7.92e UE positioning DBDS corrections

This IE contains the BDS differential corrections to be used by UE.

Information Element/Group name	Need	Multi	Type and Reference	Semantics description	Version
DBDS Reference Time	MP		Integer(0..3570 by step of 30)	Seconds. Time in BDS system time (modulo 3600 s) when the DBDS corrections are valid.	REL-12
DBDS information	MP	1 to <maxSgnType>			REL-12
>DBDS Signal ID	OP		GANSS Signal Id 10.3.3.45a	Absence of this field means the B11	REL-12
>DBDS signal information	MP	1 to <maxGANSSSat>			REL-12
>>SatID	MP		Integer (0..63)	Identifies the satellite and is as defined in Note 2 of 10.3.7.88b.	
>>UDREI	MP		Integer (0..15)	User Differential Range Error Index (dimensionless) [86].	REL-12
>>RURAI	MP		Integer (0..15)	BDS Regional User Range Accuracy Index, (dimensionless) [86].	REL-12
>>>Δt	MP		BIT STRING (13)	Equivalent Clock Correction (meters) [86]	REL-12

10.3.7.93 UE positioning GPS measured results

Information Element/Group name	Need	Multi	Type and Reference	Semantics description	Version
CHOICE <i>Reference Time</i>	MP				
>UTRAN reference time					
>>UE GPS timing of cell frames	MP		Integer(0..37158911999999)	GPS Time of Week in units of 1/16 th UMTS chips according to [19]. 33209832177664 spare values are needed.	
>>CHOICE <i>mode</i>	MP				
>>>FDD					
>>>>Primary CPICH Info	MP		Primary CPICH Info 10.3.6.60	Identifies the reference cell for the GPS TOW-SFN relationship.	
>>>TDD					
>>>>cell parameters id	MP		Cell parameters id 10.3.6.9	Identifies the reference cell for the GPS TOW-SFN relationship.	
>>Reference SFN	MP		Integer(0..4095)	The SFN for which the location is valid. This IE indicates the SFN at which the UE timing of cell frames is captured.	
>GPS reference time only					
>>GPS TOW msec	MP		Integer(0..6.048*10 ⁸ -1)	GPS Time of Week in milliseconds (rounded down to the nearest millisecond unit).	
UE Positioning GPS ReferenceTime Uncertainty	OP		UE positioning GPS reference time uncertainty 10.3.7.96a		REL-7
Measurement Parameters	MP	1 to <maxSat>			

Information Element/Group name	Need	Multi	Type and Reference	Semantics description	Version
>Satellite ID	MP		Enumerated(0..63)	Identifies the satellite and is equal to (SV ID No - 1) where SV ID No is defined in [12].	
>C/N ₀	MP		Integer(0..63)	the estimate of the carrier-to-noise ratio of the received signal from the particular satellite used in the measurement. It is given in units of dB-Hz (typical levels will be in the range of 20 – 50 dB-Hz).	
>Doppler	MP		Integer(-32768..32768)	Hz, scale factor 0.2.	
>Whole GPS Chips	MP		Integer(0..1022)	Unit in GPS chips. Whole value of the UE GPS code-phase measurement, where increasing binary values of the field signify increasing measured pseudoranges. The UE GPS code-phase measurement is divided into the fields "Whole GPS Chips" and "Fractional GPS Chips".	
>Fractional GPS Chips	MP		Integer(0..(2 ¹⁰ -1))	Scale factor 2 ⁻¹⁰ Fractional value of the UE GPS code-phase measurement.	
>Multipath Indicator	MP		Enumerated(NM, low, medium, high)	Note 1.	
>Pseudorange RMS Error	MP		Enumerated(range index 0..range index 63)	Note 2.	

NOTE 1: The following table gives the mapping of the multipath indicator field.

Value	Multipath Indication
NM	Not measured
Low	MP error < 5m
Medium	5m < MP error < 43m
High	MP error > 43m

NOTE 2: The following table gives the bitmapping of the Pseudorange RMS Error field.

Range Index	Mantissa	Exponent	Floating-Point value, x _i	Pseudorange value, P
0	000	000	0.5	P < 0.5
1	001	000	0.5625	0.5 ≤ P < 0.5625
I	X	Y	0.5 * (1 + x/8) * 2 ^y	x _{i-1} ≤ P < x _i
62	110	111	112	104 ≤ P < 112
63	111	111	--	112 ≤ P

10.3.7.93a UE positioning GANSS measured results

Information Element/Group name	Need	Multi	Type and Reference	Semantics description	Version
CHOICE Reference Time	MP				REL-7
>UTRAN reference time					REL-7
>>UE GANSS timing of cell frames	MP		Integer(0..86399999999750 by step of 250)	GANSS Time of Day in ns	REL-7
>>GANSS Time Id	OP		INTEGER (0..7)	Absence means Galileo. For coding description see NOTE 2.	
>>GANSS TOD Uncertainty	OP		Integer(0..127)	Coding as in 10.3.7.96a	REL-7
>>CHOICE mode	MP				REL-7
>>>FDD					REL-7
>>>>Primary CPICH Info	MP		Primary CPICH Info 10.3.6.60	Identifies the reference cell for the GANSS TOD-SFN relationship.	REL-7
>>>>TDD					REL-7
>>>>>cell parameters id	MP		Cell parameters id 10.3.6.9	Identifies the reference cell for the GANSS TOD-SFN relationship.	REL-7
>>Reference SFN	MP		Integer(0..4095)	The SFN for which the location is valid. This IE indicates the SFN at which the UE timing of cell frames is captured.	REL-7
>GANSS reference time only					REL-7
>>GANSS Time Id	OP		INTEGER (0..7)	Absence means Galileo. For coding description see NOTE 2.	
>>GANSS TOD msec	MP		Integer(0..3599999)	GANSS Time of Day (modulo 1 hour) in milliseconds (rounded down to the nearest millisecond unit).	REL-7
>>GANSS TOD Uncertainty	OP		Integer(0..127)	Coding as in 10.3.7.96a	REL-7
GANSS Generic Measurement Information	MP	1 to <maxGANSS>			REL-7
>GANSS ID	OP		Integer(0..7)	Absence of this IE means Galileo. For coding description, see Note 1 in 10.3.7.90b.	REL-7
>GANSS Signal Measurement Information	MP	1 to <maxSgnType>			REL-7
>>GANSS Signal ID	OP		GANSS Signal Id 10.3.3.45a	Absence of this field means the default value as defined in 10.3.3.45a for the GANSS identified by GANSS_ID.	REL-7

Information Element/Group name	Need	Multi	Type and Reference	Semantics description	Version
>>GANSS Code Phase Ambiguity	OP		Integer (0..31)	The "GANSS Code Phase Ambiguity" field gives the ambiguity of the code phase measurement. It is given in ms and is an integer between 0 and 31. The Total Code Phase for a satellite k (Satk) is given modulo this "GANSS Code Phase Ambiguity" and is reconstructed with: $\text{Code_Phase_Tot}(\text{Satk}) = \text{Code_Phase}(\text{Satk}) + \text{Integer Code Phase}(\text{Satk})$ If there is no code phase ambiguity, the "GANSS Code Phase Ambiguity" shall be set to 0. The field is optional. If "GANSS Code Phase Ambiguity" and "GANSS Code Phase Ambiguity Extension" is absent, the default value is 1ms.	REL-7
>>GANSS Code Phase Ambiguity Extension	OP		Integer(32..127)	If the total GANSS code phase ambiguity is greater than 31 ms, then this field shall be used. The definition is the same as for the "GANSS Code Phase Ambiguity" field except the value range is from 32 to 127 ms.	REL-8
>>GANSS Measurement Parameters	MP	1 to <maxGANSSSat>			REL-7
>>>Satellite ID	MP		Integer (0..63)	Identifies the satellite and is as defined in Note 2 of 10.3.7.88b.	REL-7
>>>C/N ₀	MP		Integer(0..63)	The estimate of the carrier-to-noise ratio of the received signal from the particular satellite used in the measurement. It is given in units of dB-Hz (typical levels will be in the range of 20 – 50 dB-Hz).	REL-7
>>>Multipath Indicator	MP		Enumerated(NM, low, medium, high)	Coding as in 10.3.7.93	REL-7
>>>Carrier Quality Indicaton	OP		Bit string(2)	Note 1	REL-7
>>>GANSS Code Phase	MP		Integer(0..2 ²¹ -1)	Scale factor 2 ⁻²¹ Code phase for the particular satellite signal at the time of measurement in the units of milliseconds. Increasing binary values of the field signify increasing measured pseudoranges. GNSS specific code phase measurements (e.g. chips) are converted into unit of ms by dividing the measurements by the nominal values of the measured signal chipping rate.	REL-7

Information Element/Group name	Need	Multi	Type and Reference	Semantics description	Version
>>>GANSS Integer Code Phase	OP		Integer(0..63)	In ms Indicates the integer millisecond part of the code phase, that is expressed modulo the GANSS Code Phase Ambiguity.	REL-7
>>>GANSS Integer Code Phase Extension	OP		Integer(64..127)	If the total GANSS integer code phase is greater than 63 ms, then this field shall be used. The definition is the same as for the GANSS Integer Code Phase field except the value range is from 64 to 127 ms.	REL-8
>>>Code Phase RMS Error	MP		Enumerated(range index 0..range index 63)	Coding as in Note 2 of 10.3.7.93	REL-7
>>>Doppler	MP		Integer(-32768..32767)	m/s, scale factor 0.04. Doppler measured by the UE for the particular satellite signal	REL-7
>>>ADR	OP		Integer(0..33554431)	Meters, scale factor 2^{-10} ADR measurement measured by the UE for the particular satellite signal.	REL-7

NOTE 1: Coding of Carrier quality indication:

MSB	LSB	Explanation
0		Carrier phase not continuous
1		Carrier phase continuous
	0	Data direct
	1	Data Inverted

NOTE 2: Coding of GANSS Time Id:

Value of GANSS Time id	Explanation	Version
0	GPS system time	REL-8
1	QZSS system time	
2	GLONASS system time	
3	BDS system time	REL-12
4-7	Reserved	

10.3.7.94 UE positioning GPS navigation model

This IE contain information required to manage the transfer of precise navigation data to the GPS-capable UE.

Information Element/Group name	Need	Multi	Type and Reference	Semantics description
Satellite information	MP	1 to <maxSat>		
>SatID	MP		Enumerated(0..63)	Identifies the satellite and is equal to (SV ID No - 1) where SV ID No is defined in [12].
>Satellite Status	MP		Enumerated(NS_NN, ES_SN, ES_NN, REVD)	NOTE

Information Element/Group name	Need	Multi	Type and Reference	Semantics description
>GPS Ephemeris and Clock Correction parameters	CV- Satellite status		UE positioning GPS Ephemeris and Clock Correction parameters 10.3.7.91a	

NOTE: The UE shall interpret enumerated symbols as follows.

Value	Indication
NS_NN	New satellite, new Navigation Model
ES_SN	Existing satellite, same Navigation Model
ES_NN	Existing satellite, new Navigation Model
REVD	Reserved

Condition	Explanation
<i>Satellite status</i>	The IE is not needed if the IE "Satellite status" is ES_SN and mandatory present otherwise.

10.3.7.94a UE positioning GANSS navigation model

This IE contains information required to manage the transfer of precise navigation data to the GANSS-capable UE.

Information Element/Group name	Need	Multi	Type and Reference	Semantics description	Version
Non-Broadcast Indication	OP		Enumerated (TRUE)	If this IE is present, GANSS navigation model is not derived from satellite broadcast	REL-7
Satellite information	MP	1 to <maxGAN SSSat>			REL-7
>SatID	MP		Integer (0..63)	Identifies the satellite and is as defined in Note 2 of 10.3.7.88b.	REL-7
>SV Health	MP		Bit string(9)	NOTE	REL-12
>IOD	MP		Bit string(10)		REL-7
>GANSS Clock Model	MP		UE positioning GANSS clock model 10.3.7.91d		REL-7
> GANSS Orbit Model	MP		UE positioning GANSS orbit model 10.3.7.91c		REL-7

NOTE: The Health values are GNSS specific. For Galileo, the UE shall interpret the bit string as follows [61]:

Parameter	Bit	Type	Explanation
E5a Data Validity Status	0	Boolean	
E5b Data Validity Status	1	Boolean	
E1-B Data Validity Status	2	Boolean	
E5a Signal Health Status	3-4	Bit string	
E5b Signal Health Status	5-6	Bit string	
E1-B Signal Health Status	7-8	Bit string	

10.3.7.94b UE positioning GANSS additional navigation models

This IE contains information required to manage the transfer of precise navigation data to the GANSS-capable UE.

Information Element/Group name	Need	Multi	Type and Reference	Semantics description	Version
Non-Broadcast Indication	OP		Enumerated (TRUE)	If this IE is present, GANSS navigation model is not derived from satellite broadcast	REL-8
Satellite information	MP	1 to <maxGAN SSSat>			REL-8
>SatID	MP		Integer (0..63)	Identifies the satellite and is as defined in Note 2 of 10.3.7.88b.	REL-8
>SV Health	MP		Bit string(6)	NOTE 1	REL-8
>IOD	MP		Bit string(11)	NOTE 2	REL-8
>GANSS additional clock models	MP		UE positioning GANSS additional clock models 10.3.7.91f		REL-8
>GANSS additional orbit models	MP		UE positioning GANSS additional orbit models 10.3.7.91e		REL-8

NOTE 1: The SV Health values are GNSS specific as identified by the GANSS ID :

GANSS	SV Health Bit String(6)					
	Bit 1 (MSB)	Bit 2	Bit 3	Bit 4	Bit 5	Bit 6 (LSB)
Modernized GPS	L1C Health [70]	L1 Health [68,69]	L2 Health [68,69]	L5 Health [68,69]	'0' (reserved)	'0' (reserved)
SBAS	Ranging On (0), Off(1) [71]	Corrections On (0), Off (1) [71]	Integrity On (0), Off(1) [71]	'0' (reserved)	'0' (reserved)	'0' (reserved)
QZSS QZS-L1	SV Health [72]					
QZSS QZS-L1C/L2C/L5	L1C Health [72]	L1 Health [72]	L2 Health [72]	L5 Health [72]	'0' (reserved)	'0' (reserved)
GLONASS	B _n (MSB) [73, page 23]	F _T [73, Table 4.4]				'0' (reserved)
BDS	B1I Health (SatH1) [86]	'0' (reserved)	'0' (reserved)	'0' (reserved)	'0' (reserved)	'0' (reserved)

NOTE 2: The IOD values are GNSS specific as identified by the GANSS ID :

GANSS	IOD Bit String(11)										
	Bit 1 (MSB)	Bit 2	Bit 3	Bit 4	Bit 5	Bit 6	Bit 7	Bit 8	Bit 9	Bit 10	Bit 11 (LSB)
Modernized GPS	t _{oe} (seconds, scale factor 300, range 0 – 604500) [68, 69, 70]										
SBAS	'0'	'0'	'0'	Issue of Data ([71], Message Type 9)							
QZSS QZS-L1	'0'	Issue of Data, Clock [72]									
QZSS QZS-L1C/L2C/L5	t _{oe} (seconds, scale factor 300, range 0 – 604500) [72]										
GLONASS	'0'	'0'	'0'	'0'	t _b (minutes, scale factor 15, range 0 – 1425) [73]						
BDS	11 MSB bits of t _{oe} (seconds, scale factor 512, range 0 – 604672) [86]										

10.3.7.95 UE positioning GPS real-time integrity

This IE contains parameters that describe the real-time status of the GPS constellation.

Information Element/Group name	Need	Multi	Type and Reference	Semantics description
Satellite information	MP	1 to <maxSat>		
>BadSatID	MP		Enumerated(0..63)	Identifies the satellite and is equal to (SV ID No - 1) where SV ID No is defined in [12].

10.3.7.95a Void

10.3.7.95b UE positioning GANSS real-time integrity

This IE contains parameters that describe the real-time status of the GANSS constellation.

Information Element/Group name	Need	Multi	Type and Reference	Semantics description	Version
Satellite information	MP	1 to <maxGANSSSat>			REL-7
>Bad GANSS SatID	MP		Integer (0..63)	Identifies the satellite and is as defined in Note 2 of 10.3.7.88b.	REL-7
>Bad GANSS Signal ID	OP		Bit string (8)	Absence of this IE means that all signals of the specific SV are bad. NOTE	REL-7

NOTE: Coding of Bad GANSS Signal ID

GNSS	Bit	Explanation	Version
Galileo	1	E1	REL-7
	2	E5A	
	3	E5B	
	4	E6	
	5	E5A + E5B	
	6-8	Spare	
Modernized GPS	1	L1C	REL-8
	2	L2C	
	3	L5	
	4-8	Spare	
SBAS	1	L1	REL-8
	2-8	Spare	
QZSS	1	QZS-L1	REL-8
	2	QZS-L1C	
	3	QZS-L2C	
	4	QZS-L5	
	5-8	Spare	
GLONASS	1	G1	REL-8
	2	G2	
	3	G3	
	4-8	Spare	
BDS	1	B1I	REL-12
	2-8	Spare	

10.3.7.96 UE positioning GPS reference time

Information Element/Group name	Need	Multi	Type and Reference	Semantics description	Version
GPS Week	MP		Integer(0..1023)		
GPS Week Cycle Number	OP		Integer(0..7)	This field provides the number of 1024 GPS week cycles occurred since the GPS zero time-point (midnight of the night of January 5, 1980/morning of January 6, 1980). The first 1024 GPS weeks since the zero time-point is GPS Week Cycle Number 0.	REL-10
GPS TOW msec	MP		Integer(0..6.048*10 ⁸ -1)	GPS Time of Week in milliseconds (rounded down to the nearest millisecond unit).	
UTRAN GPS reference time	OP				
>UTRAN GPS timing of cell frames	MP		Integer(0..2322431999999)	UTRAN GPS timing of cell frames in steps of 1 chip	
>CHOICE <i>mode</i>	OP				
>>FDD					
>>>Primary CPICH Info	MP		Primary CPICH Info 10.3.6.60	Identifies the reference cell for the GPS TOW-SFN relationship	
>>TDD					
>>>cell parameters id	MP		Cell parameters id 10.3.6.9	Identifies the reference cell for the GPS TOW-SFN relationship	
>SFN	MP		Integer(0..4095)	The SFN which the UTRAN GPS timing of cell frames time stamps.	
UE Positioning GPS ReferenceTime Uncertainty	OP		UE positioning GPS reference time uncertainty 10.3.7.96a	NOTE 1	REL-7
SFN-TOW Uncertainty	OP		Enumerated (lessThan10, moreThan10)	This field indicates the uncertainty of the relation GPS TOW/SFN. lessThan10 means the relation is accurate to at least 10 ms. NOTE 1	
T _{UTRAN-GPS} drift rate	OP		Integer (0, 1, 2, 5, 10, 15, 25, 50, -1, -2, -5, -10, -15, -25, -50)	in 1/256 chips per sec.	
GPS TOW Assist	OP	1 to <maxSat>			
>SatID	MP		Enumerated(0..63)	Identifies the satellite and is equal to (SV ID No - 1) where SV ID No is defined in [12].	
>TLM Message	MP		Bit string(14)		
>TLM Reserved	MP		Bit string(2)		
>Alert	MP		Boolean		
>Anti-Spoof	MP		Boolean		
NOTE 1: If the IE "UE Positioning GPS ReferenceTime Uncertainty" is present, the IE "SFN-TOW Uncertainty" is not needed and shall be ignored.					

10.3.7.96o UE positioning GANSS reference time

Information Element/Group name	Need	Multi	Type and Reference	Semantics description	Version
GANSS Day	OP		Integer(0..8191)	The sequential number of days (with day count starting at 0) from the origin of the GNSS system time indicated by GANSS Time ID modulo 8192 days (about 22 years). If this field is not present and the UE cannot obtain GNSS system time information by other means, the UE behaviour is unspecified. NOTE.	REL-7
GANSS Day Cycle Number	OP		Integer(0..7)	This field provides the number of 8192 day cycles occurred since the GANSS zero time-point defined in NOTE below. The first 8192 GANSS days since the zero time-point is GANSS Day Cycle Number 0. When this field is included, the GANSS Day field shall be included as well.	REL-10
GANSS TOD	MP		Integer(0..86399)	GANSS Time of Day in seconds	REL-7
GANSS TOD Uncertainty	OP		Integer(0..127)	Coding as in subclause 10.3.7.96a	REL-7
GANSS Time ID	OP		Integer (0..7)	Absence of this IE means Galileo, values 0-7 are reserved for future use	REL-7
				Absence of this IE means Galileo, For coding description see NOTE 2 in 10.3.7.93a.	REL-8
UTRAN GANSS reference time	OP				REL-7
>UTRAN GANSS timing of cell frames	MP		Integer(0..999999750 by step of 250)	UTRAN GANSS timing of cell frames in steps of 250 ns. Indicates sub-second part of GANSS TOD	REL-7
>CHOICE <i>mode</i>	MP				REL-7
>>FDD					REL-7
>>>Primary CPICH Info	MP		Primary CPICH Info 10.3.6.60	Identifies the reference cell for the GANSS TOD-SFN relationship	REL-7
>>TDD					REL-7
>>>cell parameters id	MP		Cell parameters id 10.3.6.9	Identifies the reference cell for the GANSS TOD-SFN relationship	REL-7
>SFN	MP		Integer(0..4095)	The SFN which the UTRAN GANSS timing of cell frames time stamps.	REL-7
T _{UTRAN-GANSS} drift rate	OP		ENUMERATED (0, 1, 2, 5, 10, 15, 25, 50, -1, -2, -5, -10, -15, -25, -50)	in 1/256 chips per sec. One spare value needed.	REL-7

NOTE: Definition of GNSS system time origin:

GNSS	GNSS System Time Origin
Galileo System Time	13 seconds before midnight between 21 st August and 22 nd August 1999; i.e., GST was equal to 13 seconds at August 22, 1999; 00:00:00 UTC
GPS System Time	January 6, 1980; 00:00:00 UTC(USNO)
QZSS System Time	January 6, 1980; 00:00:00 UTC(USNO)
GLONASS System Time	December 31, 1995; 21:00:00 UTC(SU), which is local UTC Moscow January 1, 1996; 00:00:00, defined as UTC(SU) + 3 hours in [73]
BDS System Time	January 1, 2006; 00:00:00 UTC(NTSC)

10.3.7.96a UE positioning GPS reference time uncertainty

Information Element/Group name	Need	Multi	Type and reference	Semantics description	Version
UE Positioning GPS Reference Time Uncertainty	MP		Integer (0..127)	<p>This element provides the accuracy of the provided GPS time, or alternatively the accuracy of the provided relation between GPS and UTRAN time. If "GPS TOW" is the provided GPS time, or alternatively the GPS time corresponding to the UTRAN time provided, then the true GPS time lies in the interval ["GPS TOW" - "GPS Reference Time Uncertainty", "GPS TOW" + "GPS Reference Time Uncertainty"].</p> <p>The uncertainty r, expressed in microseconds, is mapped to a number K with the following formula:</p> $r = C * ((1+x)^K - 1)$ <p>with $C = 0.0022$ and $x = 0.18$.</p> <p>To encode any higher value of the uncertainty than that corresponding to $K=127$ in the formula above, or to indicate an undefined value of the "GPS TOW", the same value, $K=127$, shall be used.</p>	REL-7

NOTE: This IE is not needed in the SRNS RELOCATION INFO message.

10.3.7.97 UE positioning GPS UTC model

The UTC Model field contains a set of parameters needed to relate GPS time to Universal Time Coordinate (UTC).

Information Element/Group name	Need	Multi	Type and Reference	Semantics description
A_1	MP		Bit string(24)	sec/sec [12]
A_0	MP		Bit string(32)	seconds [12]
t_{ot}	MP		Bit string(8)	seconds [12]
WN_t	MP		Bit string(8)	weeks [12]
Δt_{LS}	MP		Bit string(8)	seconds [12]
WN_{LSF}	MP		Bit string(8)	weeks [12]
DN	MP		Bit string(8)	days [12]
Δt_{LSF}	MP		Bit string(8)	seconds [12]

10.3.7.97a UE positioning GANSS time model

The GANSS time model field contains a set of parameters needed to relate GANSS time for the GANSS indicated by "GANSS ID" to selected time reference indicated by "GNSS_TO_ID".

Information Element/Group name	Need	Multi	Type and Reference	Semantics description	Version
GANSS Time Model Reference Time	MP		Integer(0..604784 by step of 16)	GANSS reference time of week for GANSS Time Model, given in GNSS specific system time, with a 16s scale factor.	REL-7
T _{A0}	MP		Integer (-2147483648 .. 2147483647)	Seconds, scale factor 2 ⁻³⁵	REL-7
T _{A1}	OP		Integer (-8388608 .. 8388607)	sec/sec, scale factor 2 ⁻⁵¹	REL-7
T _{A2}	OP		Integer (-64 .. 63)	sec/sec ² , scale factor 2 ⁻⁶⁸	REL-7
GNSS_TO_ID	MP		Enumerated (GPS,	GNSS Time Offset ID Seven spare values needed.	REL-7
			Galileo, QZSS, GLONASS,	GNSS Time Offset ID Four spare values needed.	REL-8
			BDS)	GNSS Time Offset ID Three spare values needed.	REL-12
Week Number	OP		Integer(0..8191)	Reference week of GANSS Time Model given in GNSS specific system time	REL-7
Delta_T	OP		Integer(-128..127)	This field specifies the integer seconds of the GNSS-GNSS Time Offset. Scale factor 1 second.	REL-10

10.3.7.97b UE positioning GANSS data bit assistance

This element provides data bit assistance data for specific satellite signals for data wipe-off.

Information Element/Group name	Need	Multi	Type and Reference	Semantics description	Version
GANSS TOD	MP		Integer(0..59)	Reference time (modulo 1 minute) of the first bit of the data in IE "Data Bits", in seconds	REL-7
Data Bit Assistance List	MP	1 to <maxGANSSSat>		The following fields are present N_Sat times, with $1 \leq N_Sat \leq \text{maxGANSSSat}$	REL-7
>Satellite ID	MP		Integer (0..63)	Identifies the satellite and is as defined in Note 2 of 10.3.7.88b.	REL-7
>Data bit assistance Sgn List	MP	1 to <maxSgnType>		The following fields are present N_Sgn times, with $1 \leq N_Sgn \leq \text{maxSgnType}$	REL-7
>>GANSS Signal ID	MP		GANSS Signal ID 10.3.3.45a		REL-7
>>Data Bits	MP		Bit string (1..1024)	Raw data bits as transmitted from a specific satellite at the time indicated by GANSS_TOD. In case of Galileo, it contains the FEC encoded and interleaved modulation symbols. The logical levels 1 and 0 correspond to signal levels -1 and +1, respectively. N_BIT is the actual number of elements in Data bits: $1 \leq N_BIT \leq 1024$.	REL-7

				<p>In case of Modernized GPS L1C, it contains the encoded and interleaved modulation symbols as defined in [70] section 3.2.3.1.</p> <p>In case of Modernized GPS L2C, it contains either the NAV data modulation bits, the FEC encoded NAV data modulation symbols, or the FEC encoded CNAV data modulation symbols, dependent on the current signal configuration of this satellite as defined in [68, Table 3-III].</p> <p>In case of Modernized GPS L5, it contains the FEC encoded CNAV data modulation symbols as defined in [69].</p> <p>In case of SBAS, it contains the FEC encoded data modulation symbols as defined in [71].</p> <p>In case of QZSS QZS-L1, it contains the NAV data modulation bits as defined in [72] section 5.2. In case of QZSS QZS-L1C, it contains the encoded and interleaved modulation symbols as defined in [72] section 5.3. In case of QZSS QZS-L2C, it contains the encoded modulation symbols as defined in [72] section 5.5. In case of QZSS QZS-L5, it contains the encoded modulation symbols as defined in [72] section 5.6.</p> <p>In case of GLONASS, it contains the 100 sps differentially Manchester encoded modulation symbols as defined in [73] section 3.3.2.2.</p>	REL-8
				<p>In case of BDS, it contains the encoded and interleaved modulation symbols as defined in [86] section 5.1.3.</p>	REL-12

10.3.7.97c UE positioning GANSS UTC model

The UTC Model field contains a set of parameters needed to relate GANSS time to Universal Time Coordinate (UTC).

Information Element/Group name	Need	Multi	Type and Reference	Semantics description
A ₁	MP		Bit string(24)	
A ₀	MP		Bit string(32)	
t _{tot}	MP		Bit string(8)	
Δt _{LS}	MP		Bit string(8)	
WN _t	MP		Bit string(8)	
WN _{LSF}	MP		Bit string(8)	
DN	MP		Bit string(8)	
Δt _{LSF}	MP		Bit string(8)	

For a GANSS Id referring to Galileo, the definition and the unit of the elements are provided in [61].

10.3.7.97d UE positioning GANSS additional UTC models

This element contains several sets of parameters needed to relate GNSS system time to Universal Time Coordinate (UTC), as defined in [68, 69, 70, 71, 72, 73]. Only one parameter set can be included in one UE positioning GANSS additional UTC models and which set of parameters to include depends on the GANSS-ID and UE capabilities.

The UTC time standard, UTC(k), is GNSS specific. E.g., if GANSS ID indicates QZSS, UE positioning GANSS additional UTC models contains a set of parameters needed to relate QZST to UTC(NICT). If GANSS ID indicates Modernized GPS, UE positioning GANSS additional UTC models contains a set of parameters needed to relate GPS system time to UTC(USNO). If GANSS ID indicates GLONASS, UE positioning GANSS additional UTC models contains a set of parameters needed to relate GLONASS system time to UTC(RU). If GANSS ID indicates SBAS, UE positioning GANSS additional UTC models contains a set of parameters needed to relate SBAS network time for the SBAS indicated by SBAS ID to the UTC standard defined by the UTC Standard ID. If GANSS ID indicates BDS, UE positioning GANSS additional UTC models contains a set of parameters needed to relate BDS system time to UTC (NTSC).

Information Element/Group name	Need	Multi	Type and Reference	Semantics description	Version
Model-1	OP			NOTE	REL-8
>A _{0-n}	MP		Bit String(16)	Bias coefficient of GNSS time scale relative to UTC time scale (seconds) [68,69,70,72]	REL-8
>A _{1-n}	MP		Bit String(13)	Drift coefficient of GNSS time scale relative to UTC time scale (sec/sec) [68,69,70,72]	REL-8
>A _{2-n}	MP		Bit String(7)	Drift rate correction coefficient of GNSS time scale relative to UTC time scale (sec/sec ²) [68,69,70,72]	REL-8
>Δt _{LS}	MP		Bit String(8)	Current or past leap second count (seconds) [68,69,70,72]	REL-8
>t _{ot}	MP		Bit String(16)	Time data reference time of week (seconds) [68,69,70,72]	REL-8
>WN _{ot}	MP		Bit String(13)	Time data reference week number (weeks) [68,69,70,72]	REL-8
>WN _{LSF}	MP		Bit String(8)	Leap second reference week number (weeks) [68,69,70,72]	REL-8
>DN	MP		Bit String(4)	Leap second reference day number (days) [68,69,70,72]	REL-8
>Δt _{LSF}	MP		Bit String(8)	Current or future leap second count (seconds) [68,69,70,72]	REL-8
Model-2	OP			NOTE	REL-8
>N ^A	MP		Bit String(11)	Calendar day number within four-year period beginning since the leap year (days) [73]	REL-8
>τ _c	MP		Bit String(32)	GLONASS time scale correction to UTC(SU) (seconds) [73]	REL-8
>Delta UT1	OP				
>>B1	MP		Bit String(11)	Coefficient to determine ΔUT1 (seconds) [73]	REL-8
>>B2	MP		Bit String(10)	Coefficient to determine ΔUT1 (seconds/msd) [73]	REL-8
>KP	OP		Bit String(2)	Notification of expected leap second correction (dimensionless) [73]	REL-8
Model-3	OP			NOTE	REL-8
>A _{1WNT}	MP		Bit String(24)	sec/sec ([71], Message Type 12)	REL-8

>A _{OWNT}	MP		Bit String(32)	seconds ([71], Message Type 12)	REL-8
>t _{tot}	MP		Bit String(8)	seconds ([71], Message Type 12)	REL-8
>WN _t	MP		Bit String(8)	weeks ([71], Message Type 12)	REL-8
>Δt _{LS}	MP		Bit String(8)	seconds ([71], Message Type 12)	REL-8
>WN _{LSF}	MP		Bit String(8)	weeks ([71], Message Type 12)	REL-8
>DN	MP		Bit String(8)	days ([71], Message Type 12)	REL-8
>Δt _{LSF}	MP		Bit String(8)	seconds ([71], Message Type 12)	REL-8
>UTC Standard ID	MP		Bit String(3)	dimensionless NOTE 1	REL-8
Model-4	OP			NOTE	REL-12
>A _{OUTC}	MP		Bit String (32)	Seconds [86]	REL-12
>A _{1UTC}	MP		Bit String (24)	sec/sec [86]	REL-12
>Δt _{LS}	MP		Bit String (8)	Seconds [86]	REL-12
>WN _{LSF}	MP		Bit String (8)	Weeks [86]	REL-12
>DN	MP		Bit String (8)	Days [86]	REL-12
>Δt _{LSF}	MP		Bit String (8)	Seconds [86]	REL-12

NOTE: This IE shall contain exactly one of the optional fields indicated by "NOTE".

NOTE 1: Coding of UTC Standard ID:

Value of UTC Standard ID	UTC Standard
0	UTC as operated by the Communications Research Laboratory (CRL), Tokyo, Japan
1	UTC as operated by the National Institute of Standards and Technology (NIST)
2	UTC as operated by the U. S. Naval Observatory (USNO)
3	UTC as operated by the International Bureau of Weights and Measures (BIPM)
4-7	Reserved for future definition

10.3.7.97e UE positioning GANSS SBAS ID

Information Element/Group name	Need	Multi	Type and Reference	Semantics description	Version
SBAS ID	MP		Enumerated(WAAS, EGNOS, MSAS, GAGAN)	Four spare values are needed.	REL-8

10.3.7.97f UE positioning GANSS auxiliary information

Information Element/Group name	Need	Multi	Type and Reference	Semantics description	Version
CHOICE <i>GANSS-ID</i>					REL-8
>GANSS-ID-1				This choice may only be present if GANSS ID indicated "Modernized GPS"	REL-8

Information Element/Group name	Need	Multi	Type and Reference	Semantics description	Version
>>Aux Info List	MP	1 to <maxGANSS Sat>			REL-8
>>>Sat ID	MP		Integer(0..63)	Identifies the satellite and is as defined in Note 2 of 10.3.7.88b.	REL-8
>>>Signals Available	MP		Bit String(8)	This field indicates the ranging signals supported by the satellite indicated by Sat ID. This field is given as a bit string as shown in NOTE 1 for Modernized GPS. If a bit is set to '1' it indicates that the satellite identified by Sat ID transmits ranging signals according to the signal correspondence in NOTE 1. If a bit is set to '0' it indicates that the corresponding signal is not supported on the satellite identified by Sat ID	REL-8
>GANSS-ID-3				This choice may be present if GANSS ID indicated "GLONASS"	REL-8
>>Aux Info List	MP	1 to <maxGANSS Sat>			REL-8
>>>Sat ID	MP		Integer(0..63)	Identifies the satellite and is as defined in Note 2 of 10.3.7.88b.	REL-8
>>>Signals Available	MP		Bit String(8)	This field indicates the ranging signals supported by the satellite indicated by Sat ID. This field is given as a bit string as shown in NOTE 1 for GLONASS. If a bit is set to '1' it indicates that the satellite identified by Sat ID transmits ranging signals according to the signal correspondence in NOTE 1. If a bit is set to '0' it indicates that the corresponding signal is not supported on the satellite identified by Sat ID.	REL-8
>>>Channel Number	MP		Integer(-7..13)	This field indicates the GLONASS carrier frequency number of the satellite identified by Sat ID, as defined in [73].	REL-8

NOTE 1: Coding of Signals Available

GANSS ID	Signals Available Bit String(8)							
	Bit 1 (MSB)	Bit 2	Bit 3	Bit 4	Bit 5	Bit 6	Bit 7	Bit 8 (LSB)
1 Modernized GPS	L1C	L2C	L5	'0' Spare	'0' Spare	'0' Spare	'0' Spare	'0' Spare
3 GLONASS	G1	G2	G3	'0' Spare	'0' Spare	'0' Spare	'0' Spare	'0' Spare

10.3.7.98 UE positioning IPDL parameters

This IE contains parameters for the IPDL mode. The use of this parameters is described in [29].

Information Element/Group name	Need	Multi	Type and Reference	Semantics description	Version
CHOICE <i>mode</i>					REL-4
>FDD					REL-4
>>IP spacing	MP		Integer(5,7,10,15,20,30,40,50)	See [29]	
>>IP length	MP		Integer(5,10)	See [29]	
>>IP offset	MP		Integer(0..9)	See [29]	
>>Seed	MP		Integer(0..63)	See [29]	
>TDD					REL-4
>>IP spacing	MP		Integer(30,40,50,70,100)	See [33]	REL-4
>>IP_Start	MP		Integer(0..4095)	See [33]	REL-4
>>IP_Slot	MP		Integer(0..14)	See [33]	REL-4
>>IP_PCCPCH	CV-channel		Boolean	See [33]	REL-4
Burst mode parameters	OP				
>Burst Start	MP		Integer(0..15)	See [29] and [33]	
>Burst Length	MP		Integer(10..25)	See [29] and [33]	
>Burst freq	MP		Integer(1..16)	See [29] and [33]	

Condition	Explanation
<i>channel</i>	This IE is present only if the idle slot carries the PCCPCH

10.3.7.99 UE positioning measured results

Information Element/Group name	Need	Multi	Type and reference	Semantics description	Version
UE positioning OTDOA measured results	OP		UE positioning OTDOA measured results 10.3.7.105		
UE positioning Position estimate info	OP		UE positioning Position estimate info 10.3.7.109		
UE positioning GPS measured results	OP		UE positioning GPS measured results 10.3.7.93		
UE positioning error	OP		UE positioning error 10.3.7.87	Included if UE positioning error occurred	
UE positioning GANSS measured results	OP		UE positioning GANSS measured results 10.3.7.93a		REL-7

10.3.7.100 UE positioning measurement

Information Element/Group name	Need	Multi	Type and reference	Semantics description	Version
UE positioning reporting quantity	MP		UE positioning reporting quantity 10.3.7.111		
Measurement validity	OP		Measurement validity 10.3.7.51		
CHOICE <i>reporting criteria</i>	MP				
>UE positioning reporting criteria			UE positioning reporting criteria 10.3.7.110		
>Periodical reporting criteria			Periodical reporting criteria 10.3.7.53		
>No reporting				(no data)	
UE positioning OTDOA assistance data for UE-assisted	OP		UE positioning OTDOA assistance data for UE-assisted 10.3.7.103		

Information Element/Group name	Need	Multi	Type and reference	Semantics description	Version
UE positioning OTDOA assistance data for UE-based	OP		UE positioning OTDOA assistance data for UE-based 10.3.7.103a		
UE positioning GPS assistance data	OP		UE positioning GPS assistance data 10.3.7.90		
UE positioning GANSS assistance data	OP		UE positioning GANSS assistance data 10.3.7.90b		REL-7

10.3.7.101 UE positioning measurement event results

This IE contains the measurement event results that are reported to UTRAN for UE positioning measurements.

Information Element/Group name	Need	Multi	Type and Reference	Semantics description
CHOICE <i>Event ID</i>	MP			One spare value is needed.
>7a				
>>UE positioning Position estimate info	MP		UE positioning Position estimate info 10.3.7.109	
>7b				
>>UE positioning OTDOA measured results	MP		UE positioning OTDOA measured results 10.3.7.105	
>7c				
>>UE positioning GPS measurement	MP		UE positioning GPS measured results 10.3.7.93	
>7d				
>>UE positioning GANSS measurement	MP		UE positioning GANSS measured results 10.3.7.93a	

10.3.7.102 Void

10.3.7.103 UE positioning OTDOA assistance data for UE-assisted

Information Element/Group name	Need	Multi	Type and Reference	Semantics description
UE positioning OTDOA reference cell info for UE-assisted	OP		UE positioning OTDOA reference cell info 10.3.7.108	
UE positioning OTDOA neighbour cell list for UE-assisted	OP	1 to <maxCellMeas>		
>UE positioning OTDOA neighbour cell info for UE-assisted	MP		UE positioning OTDOA neighbour cell info 10.3.7.106	

10.3.7.103a UE positioning OTDOA assistance data for UE-based

Information Element/Group name	Need	Multi	Type and Reference	Semantics description
UE positioning OTDOA reference cell info for UE-based	OP		UE positioning OTDOA reference cell info for UE-based 10.3.7.108a	
UE positioning OTDOA neighbour cell list for UE-based	OP	1 to <maxCellMeas>		
>UE positioning OTDOA neighbour cell info for UE-based	MP		UE positioning OTDOA neighbour cell info for UE-based 10.3.7.106a	

10.3.7.104 Void

10.3.7.105 UE positioning OTDOA measured results

Information Element/Group name	Need	Multi	Type and Reference	Semantics description
SFN	MP		Integer(0..4095)	SFN during which the last measurement was performed
CHOICE <i>mode</i>				
>FDD				
>>Reference cell id	MP		Primary CPICH info 10.3.6.60	
>>UE Rx-Tx time difference type 2 info	MP			

Information Element/Group name	Need	Multi	Type and Reference	Semantics description
>>>UE Rx-Tx time difference type 2	MP		UE Rx-Tx time difference type 2 10.3.7.84	
>>>UE positioning OTDOA quality	MP		UE positioning OTDOA quality 10.3.7.107	Quality of the UE Rx-Tx time difference type 2 measurement from the reference cell.
>TDD				(no data)
>>Reference cell id	MP		Cell parameters ID 10.3.6.9	
Neighbours	OP	1 to <maxCellMeas>		
>CHOICE mode	MP			
>>FDD				
>>>Neighbour Identity	MD		Primary CPICH info 10.3.6.60	Default value is the same as in the first set of multiple sets.
>>>Frequency info	MD		Frequency info 10.3.6.36	Default value is the existing value of frequency information
>>>UE Rx-Tx time difference type 2 info	OP			Included for cell in the active set excluding the reference cell.
>>>>UE Rx-Tx time difference type 2	MP		UE Rx-Tx time difference type 2 10.3.7.84	
>>>>UE positioning OTDOA quality	MP		UE positioning OTDOA quality 10.3.7.107	Quality of the UE Rx-Tx time difference type 2 measurement from the neighbour cell.
>>TDD				
>>>Cell and Channel ID	MD		Cell and Channel Identity info 10.3.6.8a	Default value is the same as in the first set of multiple sets.
>>>UARFCN	MP		Integer (0..16383)	
>UE positioning OTDOA quality	MP		UE positioning OTDOA quality 10.3.7.107	Quality of the SFN-SFN observed time difference type 2 measurement from the neighbour cell.
>SFN-SFN observed time difference type 2	MP		SFN-SFN observed time difference 10.3.7.63	Gives the timing relative to the reference cell. Only type 2 is allowed.

10.3.7.106 UE positioning OTDOA neighbour cell info

This IE gives approximate cell timing in order to decrease the search window.

Information Element/Group name	Need	Multi	Type and Reference	Semantics description
CHOICE mode	MP			

Information Element/Group name	Need	Multi	Type and Reference	Semantics description
>FDD				
>>Primary CPICH info	MP		Primary CPICH info 10.3.6.60	
>TDD				
>>cell and channel ID	MP		Cell and Channel Identity info 10.3.6.8a	Identifies the channel to be measured on.
Frequency info	MD		Frequency info 10.3.6.36	Default value is the existing value of frequency information
IPDL parameters	CV-IPDLs		UE positioning IPDL parameters 10.3.7.98	
SFN offset	MP		Integer (0 .. 4095)	Although this IE is not always required, need is MP to align with ASN.1. Define Tref as the time of beginning of system frame number SFNref of the reference cell. Define Tnc as the beginning of a frame from the neighbour cell occurring immediately after the time Tref. Let the corresponding system frame number be SFNnc. Then SFNnc = SFNref-SFN offset modulo 4096.
SFN offset validity	MD		Enumerated (FALSE)	Absence of this element means SFN offset is valid. FALSE means SFN offset is not valid.
SFN-SFN relative time difference	MP		Integer(0..38399)	Gives the relative timing compared to the reference cell. Equal to $\lfloor (T_{nc} - T_{ref}) * (3.84 * 10^6) \rfloor$ where $\lfloor () \rfloor$ denotes rounding to the nearest lower integer. In chips, Tnc = the time of beginning of a system frame from the neighbour cell, Tref = the time of beginning of a system frame from the reference cell.
SFN-SFN drift	OP		Integer (0, -1, -2, -3, -4, -5, -8, -10, -15, -25, -35, -50, -65, -80, -100, 1, 2, 3, 4, 5, 8, 10, 15, 25, 35, 50, 65, 80, 100)	in 1/256 chips per second
Search Window Size	MP		Integer(20, 40, 80, 160, 320, 640, 1280, infinity)	In chips. If the value is X then the expected SFN-SFN observed time difference is in the range [RTD-X, RTD+X] where RTD is the value of the field SFN-SFN relative time difference.

Information Element/Group name	Need	Multi	Type and Reference	Semantics description
				Infinity means that the uncertainty is larger than 1280 chips.
CHOICE <i>PositioningMode</i>	MP			
>UE based				(no data)
>UE assisted				(no data)

Condition	Explanation
<i>IPDLs</i>	This IE is mandatory present if IPDLs are applied and not needed otherwise.

10.3.7.106a UE positioning OTDOA neighbour cell info for UE-based

This IE gives approximate cell timing in order to decrease the search window, as well as the cell locations and fine cell timing for UE based OTDOA.

Information Element/Group name	Need	Multi	Type and Reference	Semantics description	Version
UE positioning OTDOA neighbour cell info	MP		UE positioning OTDOA neighbour cell info 10.3.7.106		
Cell Position	MD			Default is the same as previous cell	
>Relative North	OP		Integer(-20000..20000)	Seconds of angle, scale factor 0.03. Relative position compared to reference cell.	
>Relative East	OP		Integer(-20000..20000)	Seconds of angle, scale factor 0.03. Relative position compared to reference cell.	
>Relative Altitude	OP		Integer(-4000..4000)	Relative altitude in meters compared to ref. cell.	
Fine SFN-SFN	MP		Real(0..0.9375 in steps of 0.0625)	Gives finer resolution	
UE positioning Relative Time Difference Quality	MP		UE positioning OTDOA quality 10.3.7.109a	Quality of the relative time difference between neighbour and reference cell.	
Round Trip Time	OP		Real (876.00 .. 2923.875 in steps of 0.0625)	In chips. Included if cell is in active set.	
Round Trip Time Extension	CV- <i>FDD</i>		Real (0 .. 4392.125 in steps of 0.0625)	In chips. Included if cell is in active set. Default = 0. NOTE.	REL-7
NOTE: Total Round Trip Time = IE "Round Trip Time" + IE "Round Trip Time Extension".					

Condition	Explanation
<i>FDD</i>	The IE is optionally present in FDD, otherwise it is not needed.

10.3.7.107 UE positioning OTDOA quality

Information Element/Group name	Need	Multi	Type and Reference	Semantics description
Std Resolution	MP		Bit string(2)	Std Resolution field includes the resolution used in Std of OTDOA Measurements field. Encoding on two bits as follows: '00' 10 meters '01' 20 meters '10' 30 meters '11' Reserved
Number of OTDOA Measurements	MP		Bit string(3)	The 'Number of OTDOA measurements' field indicates how many OTDOA measurements have been used in the UE to determine the sample standard deviation of the measurements. Following 3 bit encoding is used: '001' 5-9 '010' 10-14 '011' 15-24 '100' 25-34 '101' 35-44 '110' 45-54 '111' 55 or more Special case: '000': In this case the field 'Std of OTDOA measurements' contains the std of the reported SFN-SFN otd value = $\sqrt{E[(x-\mu)^2]}$, where x is the reported value and $\mu = E[x]$ is the expectation value (i.e. the true value) of x. This std can be used irrespective of the number of measurements and reporting of the number of measurements is not needed. Also other measurements such as Ec/No or Rx levels can be utilised in this case to evaluate the 'Std of OTDOA measurements' reported in this IE.

Information Element/Group name	Need	Multi	Type and Reference	Semantics description
Std of OTDOA Measurements	MP		Bit string(5)	Std of OTDOA Measurements field includes sample standard deviation of OTDOA measurements (when number of measurements is reported in 'Number of OTDOA measurements field') or standard deviation of the reported SFN-SFN otd value = $\sqrt{E[(x-\mu)^2]}$, where x is the reported value and $\mu = E[x]$ is the expectation value (i.e. the true value) of x (when '000' is given in 'Number of OTDOA measurements' field). Following linear 5 bit encoding is used: '00000' 0 - (R*1-1) meters '00001' R*1 – (R*2-1) meters '00010' R*2 – (R*3-1) meters ... '11111' R*31 meters or more where R is the resolution defined by Std Resolution field. E.g. R=20 m corresponds to 0-19 m, 20-39 m,...,620+ m.

10.3.7.108 UE positioning OTDOA reference cell info

This IE defines the cell used for time references in all OTDOA measurements.

Information Element/Group name	Need	Multi	Type and Reference	Semantics description
SFN	OP		Integer (0..4095)	Time stamp (SFN of Reference Cell) of the SFN-SFN relative time differences and SFN-SFN drift rates. Included if any SFN-SFN drift value is included in IE UE positioning OTDOA neighbour cell info.
CHOICE <i>mode</i>	MP			
>FDD				
>>Primary CPICH info	MP		Primary CPICH info 10.3.6.60	
>TDD				
>>cell and channel ID	MP		Cell and Channel Identity info 10.3.6.8a	Identifies the channel to be measured on.
Frequency info	MD		Frequency info 10.3.6.36	Default value is the existing value of frequency information. This IE shall always be set to default value
CHOICE <i>PositioningMode</i>	MP			
>UE based				
>UE assisted				(no data)
IPDL parameters	OP		UE positioning IPDL parameters 10.3.7.98	If this element is not included there are no idle periods present

10.3.7.108a UE positioning OTDOA reference cell info for UE-based

This IE defines the cell used for time references in all OTDOA measurements for UE-based methods.

Information Element/Group name	Need	Multi	Type and Reference	Semantics description	Version
UE positioning OTDOA reference cell info	MP		UE positioning OTDOA reference cell info 10.3.7.108		
CHOICE <i>Cell Position</i>	OP			The position of the antenna that defines the cell. Used for the UE based method.	
>Ellipsoid					
>>Ellipsoid point	MP		Ellipsoid point 10.3.8.4a		
>Ellipsoid with altitude					
>>Ellipsoid point with altitude	MP		Ellipsoid point with altitude 10.3.8.4b		
Round Trip Time	OP		Real (876.00 .. 2923.875 in steps of 0.0625)	In chips.	
Round Trip Time Extension	CV- FDD		Real (0 .. 4392.125 in steps of 0.0625)	In chips. Default = 0. NOTE.	REL-7
NOTE: Total Round Trip Time = IE "Round Trip Time" + IE "Round Trip Time Extension".					

Condition	Explanation
FDD	The IE is optionally present in FDD, otherwise it is not needed.

10.3.7.109 UE positioning position estimate info

The purpose of this IE is to provide the position estimate from the UE to the network, if the UE is capable of determining its own position.

Information Element/Group name	Need	Multi	Type and Reference	Semantics description	Version
CHOICE <i>Reference Time</i>	MP				
>UTRAN GPS reference time					
>>UE GPS timing of cell frames	MP		Integer(0.. 3715891199 9999)	GPS Time of Week in units of 1/16 th UMTS chips according to [19]. 33209832177664 spare values are needed.	
>>CHOICE <i>mode</i>	MP				
>>>FDD					
>>>>Primary CPICH Info	MP		Primary CPICH Info 10.3.6.60	Identifies the reference cell for the GPS TOW-SFN relationship	
>>>TDD					
>>cell parameters id	MP		Cell parameters id 10.3.6.9	Identifies the reference cell for the GPS TOW-SFN relationship.	
>>Reference SFN	MP		Integer(0..40 95)	The SFN for which the location is valid. This IE indicates the SFN at which the UE timing of cell frame is captured.	

Information Element/Group name	Need	Multi	Type and Reference	Semantics description	Version
>GPS reference time only					
>>GPS TOW msec	MP		Integer(0..6.048*10 ⁸ -1)	GPS Time of Week in milliseconds (rounded down to the nearest millisecond unit).	
>Cell timing					
>>SFN	MP		Integer(0..4095)	SFN during which the position was calculated.	
>>CHOICE <i>mode</i>	MP				
>>>FDD					
>>>>Primary CPICH Info	MP		Primary CPICH Info 10.3.6.60	Identifies the reference cell for SFN	
>>>TDD					
>>cell parameters id	MP		Cell parameters id 10.3.6.9	Identifies reference cell for SFN	
>UTRAN GANSS reference time					REL-7
>>UE GANSS timing of cell frames	MP		Integer(0..8639999999750 by step of 250)	GANSS Time of Day in ns	REL-7
>>GANSS Time ID	OP		Integer(0..7)	Absence of this field means Galileo. For coding description see NOTE 2 in 10.3.7.93a.	REL-7
>>GANSS TOD Uncertainty	OP		Integer(0..127)	Coding as in 10.3.7.96a	REL-7
>>CHOICE <i>mode</i>	MP				REL-7
>>>FDD					REL-7
>>>>Primary CPICH Info	MP		Primary CPICH Info 10.3.6.60	Identifies the reference cell for the GANSS TOD-SFN relationship	REL-7
>>>TDD					REL-7
>>>>cell parameters id	MP		Cell parameters id 10.3.6.9	Identifies the reference cell for the GANSS TOD-SFN relationship.	REL-7
>>Reference SFN	MP		Integer(0..4095)	The SFN for which the location is valid. This IE indicates the SFN at which the UE timing of cell frame is captured.	REL-7
>GANSS reference time only					REL-7
>>GANSS TOD msec	MP		Integer(0..3599999)	GANSS Time of Day in milliseconds (rounded down to the nearest millisecond unit).	REL-7
>>GANSS Time ID	OP		Integer(0..7)	Absence of this field means Galileo. For coding description see NOTE 2 in 10.3.7.93a.	REL-7
CHOICE <i>Position estimate</i>	MP			The position estimate is provided in WGS-84 reference system.	
>Ellipsoid Point			Ellipsoid Point; 10.3.8.4a		
>Ellipsoid point with uncertainty circle			Ellipsoid point with uncertainty circle 10.3.8.4d		
>Ellipsoid point with uncertainty ellipse			Ellipsoid point with uncertainty ellipse 10.3.8.4e		

Information Element/Group name	Need	Multi	Type and Reference	Semantics description	Version
>Ellipsoid point with altitude			Ellipsoid point with altitude 10.3.8.4b		
>Ellipsoid point with altitude and uncertainty ellipsoid			Ellipsoid point with altitude and uncertainty ellipsoid 10.3.8.4c		
Position Data	MP		Bit string(16)	For each bit, if set to '1', indicates that respective GNSS or position system was used for position calculation. Bit 0: OTDOA bit 1: GPS bit 2: Galileo bit 3-15: reserved	REL-7
				bit 3: SBAS bit 4: Modernized GPS bit 5: QZSS bit 6: GLONASS bit 7-15: reserved	REL-8
				bit 7: BDS	REL-12
				bit 8-15: reserved	
CHOICE <i>Velocity estimate</i>	OP				REL-7
>Horizontal Velocity			Horizontal Velocity 10.3.8.4h		REL-7
>Horizontal with Vertical Velocity			Horizontal with Vertical Velocity 10.3.8.4i		REL-7
>Horizontal Velocity with Uncertainty			Horizontal Velocity with Uncertainty 10.3.8.4j		REL-7
>Horizontal with Vertical Velocity and Uncertainty			Horizontal with Vertical Velocity and Uncertainty 10.3.8.4k		REL-7
UE Positioning GPS ReferenceTime Uncertainty	<i>CV-Tutran-gps</i>		UE positioning GPS reference time uncertainty 10.3.7.96a		REL-7

Condition	Explanation
<i>Tutran-gps</i>	This IE is optionally present if "UTRAN GPS reference time" is included and not needed otherwise.

10.3.7.109a UE positioning Relative Time Difference quality

Information Element/Group name	Need	Multi	Type and Reference	Semantics description
Relative Time Difference Std Resolution	MP		Bit string(2)	Std Resolution field includes the resolution used in Std of Relative Time Difference field. Encoding on two bits as follows: '00' 10 meters '01' 20 meters '10' 30 meters '11' Reserved
Std of Relative Time Difference	MP		Bit string(5)	Std of Relative Time difference field includes standard deviation of (SFN-SFN relative time difference + Fine SFN-SFN). Following linear 5 bit encoding is used: '00000' 0 - (R*1-1) meters '00001' R*1 – (R*2-1) meters '00010' R*2 – (R*3-1) meters ... '11111' R*31 meters or more where R is the resolution defined by Std Resolution field. E.g. R=20 m corresponds to 0-19 m, 20-39 m,...,620+ m.

10.3.7.110 UE positioning reporting criteria

The triggering of the event-triggered reporting for a UE positioning measurement.

Information Element/Group name	Need	Multi	Type and Reference	Semantics description	Version
Parameters required for each event	MP	1 to <maxMeas Event>		Note: need corrected to MP in Rel-7 to align with ASN.1.	
>Amount of reporting	MP		Integer(1, 2, 4, 8, 16, 32, 64,infinite)		
>Report first fix	MP		Boolean	If TRUE the UE reports the position once the measurement control is received, and then each time an event is triggered.	
>Measurement interval	MP		Integer(5,15,60,300,900,1800,3600,7200)	Indicates how often the UE should make the measurement In seconds	
>CHOICE Event ID	MP				
>>7a					
>>>Threshold Position Change	MP		Integer(10, 20,30,40,50,100,200, 300,500,1000,2000,5000,10000,20000,50000,100000)	Meters. Indicated how much the position should change compared to last reported position fix in order to trigger the event.	
>>7b					
>>>Threshold SFN-SFN change	MP		Real(0.25, 0.5,1,2,3,4, 5,10,20,50, 100,200,500,1000,2000,5000)	Chips. Indicates how much the SFN-SFN measurement of ANY measured cell is allowed to change before the event is triggered.	
>>7c					
>>>Threshold SFN-GPS TOW	MP		Integer(1,2,3,5,10,20, 50,100)	Time in ms. When the GPS TOW and SFN timer has drifted apart more than the specified value the event is triggered.	
				Time in micro seconds (NOTE 1).	REL-7
>>7d					REL-7
>>>Threshold SFN-GANSS TOW	MP		Integer(1,2,3,5,10,20, 50,100)	Time in micro seconds. When the GANSS TOW and SFN timer has drifted apart more than the specified value the event is triggered.	REL-7
NOTE 1: In previous versions of the protocol, the IE "Threshold SFN-GPS TOW" was provided in units of milli seconds. If the information is provided in units of micro seconds, the UE shall ignore any information provided in units of milli seconds.					

10.3.7.111 UE positioning reporting quantity

The purpose of the element is to express the allowed/required location method(s), and to provide information desired QoS.

Information Element/Group name	Need	Multi	Type and Reference	Semantics description	Version
Method Type	MP		Enumerated(UE assisted, UE based,		

Information Element/Group name	Need	Multi	Type and Reference	Semantics description	Version
			UE based is preferred but UE assisted is allowed, UE assisted is preferred but UE based is allowed)		
Positioning Methods	MP		Enumerated(OTDOA, GPS, OTDOA or GPS, Cell ID)		
Response Time	MP		Integer(1,2,4, 8, 16, 32, 64, 128)	This IE shall be ignored.	
Horizontal Accuracy	CV- <i>MethodType</i>		Bit string(7)	The uncertainty is derived from the "uncertainty code" k by $r = 10 \cdot (1.1^k - 1)$ in meters.	
Vertical Accuracy	CV- <i>MethodType</i>		Bit string(7)	The uncertainty is derived from the "uncertainty code" k by $r = 45 \cdot (1.025^k - 1)$ in meters.	
GPS timing of Cell wanted	MP		Boolean	If TRUE the SRNC wants the UE to report the SFN-GPS timing of the reference cell. This is however optional in the UE.	
Multiple Sets	MP		Boolean	This IE shall be ignored.	
Additional Assistance Data Request	MP		Boolean	TRUE indicates that the UE is requested to send the IE "GPS Additional Assistance Data Request" and/or the "IE "GANSS Additional Assistance Data Request" (if the IE "GANSS Positioning Methods" is included) when the IE "UE positioning Error" is present in the UE positioning measured results. FALSE indicates that the UE shall use the assistance data available.	
Environment Characterisation	OP		Enumerated(possibly heavy multipath and NLOS conditions, no or light multipath and usually LOS conditions, not defined or mixed environment)	One spare value is needed.	
Velocity Requested	OP		Enumerated (TRUE)	If this element is present the UE is requested to send a velocity estimate	REL-7

Information Element/Group name	Need	Multi	Type and Reference	Semantics description	Version
GANSS Positioning Methods	OP		Bit string(16)	For each bit, if set to '1', indicates that respective GNSS is allowed. bit 0: GPS bit 1: Galileo bit 2-15: reserved for future GNSSes Note 1	REL-7
				bit 2: SBAS (WAAS, EGNOS, MSAS, GAGAN) bit 3: Modernized GPS (L1C, L2C, L5) bit 4: QZSS bit 5: GLONASS bit 6-15: reserved for future GNSSes Note 1	REL-8
				bit 6: BDS bit 7-15: reserved for future GNSSes Note 1	REL-12
GANSS timing of Cell wanted	OP		Bit string(8)	Each bit refers to a GANSS. Bit 0 is for Galileo. Other bits are reserved. If one bit is set to one the SRNC wants the UE to report the SFN-GANSS timing of the reference cell. This is however optional in the UE.	REL-7
				Bit 1 is for Modernized GPS; Bit 2 is for QZSS; Bit 3 is for GLONASS; Other bits are reserved. If one bit is set to one the SRNC wants the UE to report the SFN-GANSS timing of the reference cell. This is however optional in the UE. If more than one bit is set to one, the UE will select the GANSS among the allowed GANSS for the SFN-GANSS timing of the reference cell in the measurement report.	Rel-8
				Bit 4 is for BDS; Other bits are reserved. If one bit is set to one the SRNC wants the UE to report the SFN-GANSS timing of the reference cell. This is however optional in the UE. If more than one bit is set to one, the UE will select the GANSS among the allowed GANSS for the SFN-GANSS timing of the reference cell in the measurement report.	REL-12

Information Element/Group name	Need	Multi	Type and Reference	Semantics description	Version
GANSS Carrier-Phase Measurement Requested	OP		Bit string(8)	Each bit refers to a GANSS. Bit 0 is for Galileo. Other bits are reserved. This is however optional in the UE.	REL-7
				Bit 1 is for SBAS; Bit 2 is for Modernized GPS; Bit 3 is for QZSS; Bit 4 is for GLONASS; Other bits are reserved. This is however optional in the UE.	Rel-8
				Bit 5 is for BDS; Other bits are reserved. This is however optional in the UE.	REL-12
GANSS Multi-frequency Measurement Requested	OP		Bit String(8)	Each bit refers to a GANSS. Bit 0 is for Galileo; Bit 1 is for SBAS; Bit 2 is for Modernized GPS; Bit 3 is for QZSS; Bit 4 is for GLONASS; Other bits are reserved. This is however optional in the UE.	REL-8
				Bit 5 is for BDS; Other bits are reserved. This is however optional in the UE.	REL-12

Condition	Explanation
<i>Method Type</i>	The IE is optional if the IE "Method Type" is "UE assisted"; otherwise it is mandatory present.

NOTE 1: Bit 0 of this bitmap shall not be the only one set to 1.

10.3.7.112 T_{ADV} info

NOTE: Only for 1.28 Mcps TDD.

T_{ADV} indicates the difference between the Rx timing and Tx timing of a UE.

Information Element/group name	Need	Multi	Type and reference	Semantics description	Version
T_{ADV}	MP		Integer (0..2047, 2048..8191)	As defined in [20].	REL-4
					REL-7
SFN	MP		Integer(0..4095)	SFN during which the T_{ADV} measurement was performed.	REL-4

10.3.7.113 UTRA priority info list

Contains priority based reselection information for UTRA.

Information Element/Group name	Need	Multi	Type and reference	Semantics description	Version
UTRA Serving Cell	MP				REL-8
>priority	MP		Integer (0..<maxPrio-1>)	0 is the lowest priority and maxPrio-1 is the highest	REL-8
>S _{prioritysearch1}	MP		Integer (0..62 by step of 2)	dB	REL-8
>S _{prioritysearch2}	MD		Integer (0..7 by step of 1)	dB, default value is 0	REL-8
>Thresh _{-serving,low}	MP		Integer (0..62 by step of 2)	RSCP, dB	REL-8
>Thresh _{-serving,low2}	MD		Integer (0..31)	Ec/N0, dB, default value is 0	REL-9
UTRAN FDD Frequencies	OP	1 to <maxNumFDDFreqs>			REL-8
>UARFCN	MP		Integer(0..16383)	It is always ensured by the UTRAN that more than one entry for the same physical frequency is not configured regardless of the UARFCN used to indicate this.	REL-8
>priority	MP		Integer (0..<maxPrio-1>)	0 is the lowest priority and maxPrio-1 is the highest.	REL-8
>Thresh _{x, high}	MP		Integer (0..62 by step of 2)	RSCP, dB	REL-8
>Thresh _{x, low}	MP		Integer (0..62 by step of 2)	RSCP, dB	REL-8
>QqualminFDD	MD		Integer (-24..0)	Ec/N0, [dB] Default value is Qqualmin for the serving cell	REL-8
>QrxlevminFDD	MD		Integer (-119..-25 by step of 2)	RSCP, [dBm] Default value is Qrxlevmin for the serving cell	REL-8
UTRAN TDD Frequencies	OP	1 to <maxNumTDDFreqs>			REL-8
>UARFCN	MP		Integer(0..16383)		REL-8
>priority	MP		Integer (0..<maxPrio-1>)	0 is the lowest priority and maxPrio-1 is the highest.	REL-8
>Thresh _{x, high}	MP		Integer (0..62 by step of 2)	RSCP, dB	REL-8
>Thresh _{x, low}	MP		Integer (0..62 by step of 2)	RSCP, dB	REL-8
>QrxlevminTDD	MD		Integer (-119..-25 by step of 2)	RSCP, [dBm] Default value is Qrxlevmin for the serving cell	REL-8

NOTE: The network should ensure that priorities for different Radio Access Technologies are always different.

10.3.7.114 GSM priority info list

Contains priority based reselection information for GSM.

Information Element/Group name	Need	Multi	Type and reference	Semantics description	Version
GSM Priority Info	MP	1 to <maxNum GSMCellGroup>			REL-8
>GSM cell group List	MP		GSM cell group 10.3.7.9a		REL-8
>priority	MP		Integer (0..<maxPrio-1>)	0 is the lowest priority and <maxPrio-1> is the highest.	REL-8
>QrxlevminGSM	MP		Integer (-115..-25 by step of 2)	GSM RSSI, [dBm]	REL-8
>Thresh _{x, high}	MP		Integer (0..62 by step of 2)	GSM RSSI, dB	REL-8
>Thresh _{x, low}	MP		Integer (0..62 by step of 2)	GSM RSSI, dB	REL-8

NOTE: The network should ensure that priorities for different Radio Access Technologies are always different.

10.3.7.115 E-UTRA frequency and priority info list

Contains information about neighbour E-UTRA frequencies (with associated blacklists), together with priority based reselection information.

Information Element/Group name	Need	Multi	Type and reference	Semantics description	Version
E-UTRA frequency and priority		1 to <maxNum EUTRAFreqs>			REL-8
>EARFCN	MP		Integer(0..65535)	EARFCN of the downlink carrier frequency [64]. For UTRAN FDD, it is always ensured by the UTRAN that more than one entry for the same physical frequency is not configured regardless of the EARFCN used to indicate this.	REL-8
>Measurement Bandwidth	MD		Enumerated(6, 15, 25, 50, 75, 100)	Measurement bandwidth information common for all neighbouring cells on the carrier frequency. It is defined by the parameter Transmission Bandwidth Configuration, N_{RB} [36.104]. The values indicate the number of resource blocks over which the UE could measure. Default value is 6.	REL-8
>priority	MP		Integer (0..<maxPriority-1>)	0 is the lowest priority and <maxPriority-1> is the highest.	REL-8
>QrxlevminEUTRA	MP		Integer (-140..-44 by step of 2)	RSRP, [dBm]	REL-8
>Thresh _{x, high}	MP		Integer (0..62 by step of 2)	RSRP, dB	REL-8
>Thresh _{x, low}	MP		Integer (0..62 by step of 2)	RSRP, dB	REL-8
>QqualminEUTRA	MD		Integer (-34..-3)	RSRQ, dB default value is negative infinity	REL-9
>Thresh _{x, high2}	OP		Integer (0..31)	RSRQ, dB	REL-9
>Thresh _{x, low2}	OP		Integer (0..31)	RSRQ, dB	REL-9

Information Element/Group name	Need	Multi	Type and reference	Semantics description	Version
>QqualminEUTRA-WB	CV-WB- RSRQ		Integer (-34..-3)	RSRQ, dB, If this IE is present, the UE shall, when performing RSRQ measurements, use a wider bandwidth in accordance with TS 36.133 [74]	REL-11
>QqualminRSRQ-OnAllSymbols	CV- Thresh2		Integer (-34..-3)	RSRQ, dB, If this IE is present, the UE shall, when performing RSRQ measurements, perform RSRQ measurement on all OFDM symbols in accordance with TS 25.215 [7] and TS 25.225 [8]	REL-12
>Blacklisted cells per freq list	OP	1 to <maxEUT RACellPer Freq>			REL-8
>>Physical Cell identity	MP		Integer (0..503)	A list of blacklisted cells can be signalled per frequency	REL-8
>E-UTRA detection	MP		Boolean	'TRUE' means that the UE may detect the presence of a E-UTRA cell and report to NAS. NOTE 1.	REL-8
>Reduced measurement performance	OP		Enumerated (TRUE)	TRUE indicates that the frequency is configured for reduced measurement performance [19]. Absense indicates that the frequency is configured for normal measurement performance [19].	REL-12
Number of applicable EARFCN	CV- EARFCNB ands		Integer (0..7)	The number N of EARFCN in "E-UTRA frequency and priority" which are applicable. If present this IE indicates the first N occurrences of EARFCN in "E-UTRA frequency and priority" which shall be read by UE.	REL-11
E-UTRA frequency and priority extension	OP	1 to <maxNum EUTRAFreqs>		NOTE 2	REL-11

Information Element/Group name	Need	Multi	Type and reference	Semantics description	Version
>EARFCN extension	MP		Integer (65536..262143)	EARFCN of the downlink carrier frequency [64]. For UTRAN FDD, it is always ensured by the UTRAN that more than one entry for the same physical frequency is not configured regardless of the EARFCN used to indicate this	REL-11
>Measurement Bandwidth	MD		Enumerated(6, 15, 25, 50, 75, 100)	Measurement bandwidth information common for all neighbouring cells on the carrier frequency. It is defined by the parameter Transmission Bandwidth Configuration, N_{RB} [36.104]. The values indicate the number of resource blocks over which the UE could measure. Default value is 6.	REL-11
>priority	MP		Integer (0..<maxPrio-1>)	0 is the lowest priority and maxPrio-1 is the highest.	REL-11
>QrxlevminEUTRA	MP		Integer (-140..-44 by step of 2)	RSRP, [dBm]	REL-11
>Thresh _{x, high}	MP		Integer (0..62 by step of 2)	RSRP, dB	REL-11
>Thresh _{x, low}	MP		Integer (0..62 by step of 2)	RSRP, dB	REL-11
>QqualminEUTRA	MD		Integer (-34..-3)	RSRQ, dB default value is negative infinity	REL-11
>Thresh _{x, high2}	OP		Integer (0..31)	RSRQ, dB	REL-11
>Thresh _{x, low2}	OP		Integer (0..31)	RSRQ, dB	REL-11
>QqualminEUTRA-WB	CV-WB-RSRQ		Integer (-34..-3)	RSRQ, dB, If this IE is present, the UE shall, when performing RSRQ measurements, use a wider bandwidth in accordance with TS 36.133 [74]	REL-11

Information Element/Group name	Need	Multi	Type and reference	Semantics description	Version
>QqualminRSRQ-OnAllSymbols	CV- Thresh2		Integer (-34..-3)	RSRQ, dB, If this IE is present, the UE shall, when performing RSRQ measurements, perform RSRQ measurement on all OFDM symbols in accordance with TS 25.215 [7] and TS 25.225 [8]	REL-12
>Blacklisted cells per freq list	OP	1 to <maxEUT RACellPer Freq>			REL-11
>>Physical Cell identity	MP		Integer (0..503)	A list of blacklisted cells can be signalled per frequency	REL-11
>E-UTRA detection	MP		Boolean	'TRUE' means that the UE may detect the presence of a E-UTRA cell and report to NAS. NOTE 1.	REL-11
>Reduced measurement performance	OP		Enumerated (TRUE)	TRUE indicates that the frequency is configured for reduced measurement performance [19]. Absence indicates that the frequency is configured for normal measurement performance [19].	REL-12
Multiple E-UTRA frequency info list	OP	1 to <maxNum EUTRAFreqs>		Each entry in the list corresponds to an entry in the "E-UTRA frequency and priority" IE, or an entry in the "E-UTRA frequency and priority extension" IE. NOTE 3.	REL-10
>Multiple E-UTRA frequency band indicator list	OP	1 to <maxMultipleFrequencyBandsEUTRA>		Indicates, per neighbour EARFCN, a list of frequency bands which the E-UTRA cells belong to. Absence of this IE indicates that there are no Multiple Bands for the particular EARFCN.	REL-10
>>E-UTRA Frequency band	MP		Integer (1..64)	As defined in [64].	REL-10

Information Element/Group name	Need	Multi	Type and reference	Semantics description	Version
Multiple E-UTRA frequency info extension list	OP	1 to <maxNumEUTRAFreqs>		Each entry in the list corresponds to an entry in the "E-UTRA frequency and priority" IE or the "E-UTRA frequency and priority extension" IE. NOTE 3	REL-11
>Multiple E-UTRA frequency band indicator extension list	OP	1 to <maxMultipleFrequencyBandsEUTRA>		Indicates, per neighbour EARFCN, a list of frequency bands which the E-UTRA cells belong to. Absence of this IE indicates that there are no Multiple Bands for the particular EARFCN.	REL-11
>>E-UTRA Frequency band extension	MP		Integer (65..256)	As defined in [64].	REL-11
NOTE 1: If the value of "E-UTRA detection" is not identical across the frequency layers, UE behaviour is unspecified.					
NOTE 2: The number of instances of IE "E-UTRA frequency and priority extension" shall be less than or equal to maxNumEUTRAFreqs – the value specified in IE "Number of applicable EARFCN"					
NOTE 3: The number of bands signalled in "Multiple E-UTRA frequency band indicator list" and "Multiple E-UTRA frequency band indicator extension list" combined, for the same occurrence of EARFCN or EARFCN extension, should be less than or equal to maxMultipleFrequencyBandsEUTRA.					

NOTE: The network should ensure that priorities for different Radio Access Technologies are always different.

NOTE: The network should ensure that priorities for which both $\text{Thresh}_{x,\text{high}2}$ and $\text{Thresh}_{x,\text{low}2}$ are provided are always different from the priorities for which both $\text{Thresh}_{x,\text{high}2}$ and $\text{Thresh}_{x,\text{low}2}$ are not provided.

Condition	Explanation
<i>EARFCNBands</i>	This IE is mandatory present when the IE "E-UTRA frequency and priority extension" is present, otherwise it is not needed.
<i>WB-RSRQ</i>	The field is optionally present if the measurement bandwidth indicated by <i>Measurement Bandwidth</i> is 50 resource blocks or larger. Otherwise it is not needed.
<i>Thresh2</i>	This IE is optionally present if both the IEs " $\text{Thresh}_{x,\text{high}2}$ " and " $\text{Thresh}_{x,\text{low}2}$ " are present, otherwise it is not needed. If this IE is present for any E-UTRA frequency, it is mandatory present for all the E-UTRA frequencies.

10.3.7.116 Intra-frequency cell info list on secondary UL frequency

NOTE: For FDD only.

Contains the information for the list of measurement objects for an intra-frequency measurement on secondary uplink frequency.

Information Element/Group name	Need	Multi	Type and reference	Semantics description	Version
CHOICE Intra-frequency cell removal	OP			Absence of this IE is equivalent to choice "Remove no intra-frequency cells".	REL-9
>Remove all intra-frequency cells				(no data)	REL-9
>Remove some intra-frequency cells					REL-9
>>Removed intra-frequency cells	MP	1 to <maxCellMeasOnSecULFreq >			REL-9
>>>Intra-frequency cell id	MP		Integer(0 .. <maxCellMeasOnSecULFreq > - 1)		REL-9
>Remove no intra-frequency cells				(no data)	REL-9
New intra-frequency cells	OP	1 to <maxCellMeasOnSecULFreq >			REL-9
>Intra-frequency cell id	OP		Integer(0 .. <maxCellMeasOnSecULFreq > - 1)		REL-9
>Cell info	MP		Cell info 10.3.7.2		REL-9
Cells for measurement	OP	1 to <maxCellMeasOnSecULFreq >			REL-9
>Intra-frequency cell id	MP		Integer(0 .. <maxCellMeasOnSecULFreq > - 1)		REL-9

10.3.7.117 Cell measurement event results on secondary UL frequency

NOTE: For FDD only.

Includes non-frequency related cell reporting quantities.

Information Element/Group name	Need	Multi	Type and reference	Semantics description	Version
Intra-frequency event identity	MP		Intra-frequency event identity 10.3.7.34		REL-9
CHOICE <i>mode</i>	MP				
> FDD					
>>Primary CPICH info	MP	1 to <maxCellMeasOnSecULFreq >	Primary CPICH info 10.3.6.60		REL-9
> Other				One spare value is needed	REL-9

10.3.7.118 Measured results on secondary UL frequency

NOTE: For FDD only.

Includes non-frequency related cell reporting quantities.

Information Element/Group name	Need	Multi	Type and reference	Semantics description	Version
Cell measured results on secondary UL frequency	MP	1 to < maxCellMeasOnSecULFreq >			REL-9
>Cell measured results	MP		Cell measured results 10.3.7.3	Only cells for which all reporting quantities are available should be included.	REL-9

10.3.7.119 Intra-frequency measurement reporting criteria on secondary UL frequency

NOTE: For FDD only.

Information Element/Group name	Need	Multi	Type and reference	Semantics description	Version
Frequency Info	MP		Frequency info 10.3.6.36	NOTE2	REL-9
Parameters required for each event	MP	1 to <maxMeasEventOnSecULFreq>			REL-9
>Intra-frequency event identity	MP		Intra-frequency event identity 10.3.7.34	NOTE1	REL-9
>Triggering condition 1	CV-clause 0		Enumerated(Active set cells, Monitored set cells, Active set cells and monitored set cells)	Indicates which cells can trigger the event	REL-9
>Triggering condition 2	CV-clause 6		Enumerated(Active set cells, Monitored set cells, Active set cells and monitored set cells, Detected set cells, Detected set cells and monitored set cells)	Indicates which cells can trigger the event	REL-9
>Reporting Range Constant	CV-clause 2		Real(0..14.5 by step of 0.5)	In dB. In event 1a,1b.	REL-9
>Cells forbidden to affect Reporting range on secondary UL frequency	CV-clause 1	1 to <maxCellMeasureOnSecULFreq >		In event 1a,1b	REL-9
>>Primary CPICH info	MP		Primary CPICH info 10.3.6.60		REL-9
>W	CV-clause 2		Real(0.0..2.0 by step of 0.1)		REL-9
>Hysteresis	MP		Real(0..7.5 by step of 0.5)	In dB.	REL-9
>Threshold used frequency	CV-clause 3		Integer (-120..165)	Range used depend on measurement quantity. CPICH RSCP -120..-25 dBm CPICH Ec/No -24..0 dB Pathloss 30..165dB ISCP -120..-25 dBm	REL-9
>Reporting deactivation threshold	CV-clause 4		Integer(0, 1, 2, 3, 4, 5, 6, 7)	In event 1a Indicates the maximum number of cells allowed in the active set in order for event 1a to occur. 0 means not applicable	REL-9

>Replacement activation threshold	CV-clause 5		Integer(0, 1, 2, 3, 4, 5, 6, 7)	In event 1c Indicates the minimum number of cells allowed in the active set in order for event 1c to occur. 0 means not applicable	REL-9
>Time to trigger	MP		Time to trigger 10.3.7.64	Indicates the period of time during which the event condition has to be satisfied, before sending a Measurement Report. Time in ms	REL-9
>Amount of reporting	CV-clause 7		Integer(1, 2, 4, 8, 16, 32, 64, Infinity)		REL-9
>Reporting interval	CV-clause 7		Integer(0, 250, 500, 1000, 2000, 4000, 8000, 16000)	Indicates the interval of periodical reporting when such reporting is triggered by an event. Interval in milliseconds. 0 means no periodical reporting.	REL-9
>Reporting cell status	OP		Reporting cell status 10.3.7.61		REL-9
>Periodical reporting information-1b	CV-clause 9		Periodical reporting info-1b 10.3.7.53aa		REL-9

Condition	Explanation
Clause 0	The IE is mandatory present if the IE "Intra-frequency event identity" is set to "1b" or "1f", otherwise the IE is not needed.
Clause 1	The IE is optional if the IE "Intra-frequency event identity" is set to "1a" or "1b", otherwise the IE is not needed.
Clause 2	The IE is mandatory present if the IE "Intra-frequency event identity" is set to "1a" or "1b", otherwise the IE is not needed.
Clause 3	The IE is mandatory present if the IE "Intra-frequency event identity" is set to "1e", "1f", otherwise the IE is not needed.
Clause 4	The IE is mandatory present if the IE "Intra-frequency event identity" is set to "1a", otherwise the IE is not needed.
Clause 5	The IE is mandatory present if the IE "Intra-frequency event identity" is set to "1c", otherwise the IE is not needed.
Clause 6	The IE is mandatory present if the IE "Intra-frequency event identity" is set to "1a" or "1e", otherwise the IE is not needed.
Clause 7	The IE is mandatory present if the IE "Intra-frequency event identity" is set to "1a", "1c", otherwise the IE is not needed.
Clause 9	The IE is optional if the IE "Intra-frequency event identity" is set to "1b", otherwise the IE is not needed.

NOTE1: Event 1d and 1j shall not be applied for the secondary uplink frequency.

NOTE2: If the IE "Frequency info" is different from the current downlink frequency associated with the secondary UL frequency, the UE behaviour is unspecified.

10.3.7.120 CSG Inter-frequency cell info

Information Element/Group name	Need	Multi	Type and reference	Semantics description	Version
CSG Frequency info	MP	1 to < maxFreq >			REL-9

Information Element/Group name	Need	Multi	Type and reference	Semantics description	Version
>Frequency info	MP		Frequency info 10.3.6.36		REL-9
>CSG Inter-frequency cell info for the frequency	MP		10.3.7.121a		REL-9

10.3.7.121 CSG Intra-frequency cell info

Information Element/Group name	Need	Multi	Type and reference	Semantics description	Version
CSG Intra-frequency cell info	MP		10.3.7.121a		REL-9

10.3.7.121a CSG cell info

Information Element/Group name	Need	Multi	Type and reference	Semantics description	Version
CSG cell info list	MP	1 to <maxMe asCSGR ange>			REL-9
>CHOICE <i>mode</i>	MP				REL-9
>>FDD					REL-9
>>>Start PSC	MP		Primary CPICH info 10.3.6.60	The value of this IE specifies the start PSC of the PSC range.	REL-9
>>>Number of PSCs	MP		Integer (1..512)	This IE specifies the number of PSCs.	REL-9

10.3.7.122 CSG Proximity Indication

Information Element/Group name	Need	Multi	Type and reference	Semantics description	Version
CSG Proximity Indication	MP		Enumerated (entering, leaving)		REL-9
CHOICE <i>Radio Access Technology</i>					REL-9
>UTRA					REL-9
>>CSG Frequency info for UTRA	MP		Frequency info 10.3.6.36	Indicates the UARFCN according to a band it previously considered suitable for accessing (one of) the CSG member cell(s), for which the proximity indication is sent.	REL-9
>E-UTRA					REL-9
>>CSG Frequency info for E-UTRA	MP		Integer (0..65535)	EARFCN of the downlink carrier frequency [64]. If the IE indicates a value of 65535, then the EARFCN for this instance should be read from the corresponding instance of IE "EARFCN extension". Indicates the EARFCN according to a band it previously considered suitable for accessing (one of) the CSG member	REL-9

Information Element/Group name	Need	Multi	Type and reference	Semantics description	Version
				cell(s), for which the proximity indication is sent.	
>>EARFCN extension	OP		Integer (65536..262143)	EARFCN of the downlink carrier frequency [64]. Indicates the EARFCN according to a band it previously considered suitable for accessing (one of) the CSG member cell(s), for which the proximity indication is sent.	REL-11

10.3.7.123 CSG Proximity detection

Information Element/Group name	Need	Multi	Type and reference	Semantics description	Version
UTRA CSG Proximity detection	MD		Enumerated (enable)	Absence of this IE implies that CSG proximity detection function for UTRA cells is disabled.	REL-9
E-UTRA CSG Proximity detection	MD		Enumerated (enable)	Absence of this IE implies that CSG proximity detection function for E-UTRA cells is disabled.	REL-9

10.3.7.124 Inter-frequency SI Acquisition

Information Element/Group name	Need	Multi	Type and reference	Semantics description	Version
Frequency info	MP		Frequency info 10.3.6.36		REL-9
CHOICE <i>mode</i>	MP				REL-9
>FDD					REL-9
>>Primary Scrambling Code	MP		Primary CPICH info 10.3.6.60		REL-9
>TDD			NULL		REL-9

10.3.7.125 Intra-frequency SI Acquisition

Information Element/Group name	Need	Multi	Type and reference	Semantics description	Version
CHOICE <i>mode</i>	MP				REL-9
>FDD					REL-9
>>Intra-frequency SI acquisition Info	MD	1 to <maxSlrequest>		Absence of this IE implies that UE should perform SI acquisition for all PSC ranges specified in the "CSG Intra-frequency cell info" IE. UE is at minimum required to acquire the SI of the strongest PSC in those configured PSC ranges.	REL-9
>>>Primary Scrambling Code	MP		Primary CPICH info 10.3.6.60		REL-9
>TDD			NULL		REL-9

10.3.7.126 CELL_DCH measurement occasion info LCR

NOTE: Only for 1.28 Mcps TDD in CELL_DCH state.

Information Element/Group name	Need	Multi	Type and reference	Semantics description	Version
CELL_DCH measurement occasion pattern sequence		1 to <maxDCHMeasurementOccasionPatternSequence>			
>Pattern sequence identifier	MP		Integer(0..maxDCHMeasurementOccasionPatternSequence-1)		REL-9
>Status Flag	MP		Enumerated(activate, deactivate)	This flag indicates whether the measurement occasion pattern sequence shall be activated or deactivated.	REL-9

Information Element/Group name	Need	Multi	Type and reference	Semantics description	Version
>Measurement purpose	OP		BIT STRING (5)	Measurement Purpose. Bit 0 is for Inter-frequency measurement. Bit 1 is for GSM carrier RSSI measurement. Bit 2 is for Initial BSIC identification. Bit 3 is for BSIC re-confirmation. Bit 4 is for E-UTRA measurement. The value 1 of a bit means that the measurement occasion pattern sequence is applicable for the corresponding type of measurement. Bit 0 is the first/leftmost bit of the bit string.	REL-9
>Measurement occasion pattern sequence parameters	OP				REL-9
>>k	MP		Integer(1..9)	CELL_DCH measurement occasion cycle length coefficient. The actual measurement occasion period equal to 2^k radio frames.	REL-9
>>Offset	MP		Integer(0..511)	In frames. The measurement occasion position in the measurement period.	REL-9
>>M_Length	MP		Integer(1..512)	The measurement occasion length in frames starting from the Offset.	REL-9
>>Timeslot Bitmap	MD		Bit string (7)	Bitmap indicating which of the timeslot(s) is/are allocated for measurement. Bit 0 is for timeslot 0. Bit 1 is for timeslot 1. Bit 2 is for timeslot 2. Bit 3 is for timeslot 3. Bit 4 is for timeslot 4. Bit 5 is for timeslot 5. Bit 6 is for timeslot 6. The value 0 of a bit means the corresponding timeslot is not used for measurement. The value 1 of a bit means the corresponding timeslot is used for measurement.	REL-9

Information Element/Group name	Need	Multi	Type and reference	Semantics description	Version
				Bit 0 is the first/leftmost bit of the bit string. Absence of this IE means all the timeslots can be used for measurement.	

10.3.7.127 E-UTRA SI Acquisition

Information Element/Group name	Need	Multi	Type and reference	Semantics description	Version
E-UTRA carrier frequency	MP		Integer (0..65535)	EARFCN of the downlink carrier frequency [64]. If the IE indicates a value of 65535, then the EARFCN for this instance should be read from the corresponding instance of IE "EARFCN extension"	REL-9
EARFCN extension	OP		Integer (65536..262143)	EARFCN of the downlink carrier frequency [64].	REL-11
Physical Cell identity	MP		Integer (0..503)		REL-9

10.3.7.128 E-UTRA Results for SI Acquisition

Information Element/Group name	Need	Multi	Type and reference	Semantics description	Version
CGI-Info	MP				REL-9
>PLMN Identity	MP		PLMN identity 10.3.1.11	This IE indicates the Primary PLMN	REL-9
>Cell Identity	MP		Bit string (28)	Formatted and coded according to [67]. The first/leftmost bit of the bit string contains the most significant bit of the Cell Identity.	REL-9
>Tracking Area Code	MP		Bit string (16)	Setting specified in [67]. The first/leftmost bit of the bit string contains the most significant bit of the Tracking Area Code.	REL-9
CSG Identity	OP		CSG Identity 10.3.2.8		REL-9
CSG Member indication	OP		Enumerated(member)		REL-9
CSG PLMN List	OP	1 to 5			REL-12
>CSG PLMN Identity	MP		PLMN identity 10.3.1.11		REL-12
Primary PLMN Suitable	OP		Enumerated(true)		REL-12

10.3.7.129 Logged Measurement Info-FDD

Information Element/Group name	Need	Multi	Type and reference	Semantics description	Version
Relative Time Stamp	MP		INTEGER (0..7200)	Indicates the time of logging measurement results, measured relative to the Absolute Time Info, in seconds.	REL-10
Logged Measurements Serving Cell	MP				REL-10
>PLMN Identity	MP		PLMN Identity 10.3.1.11		REL-11
>Cell ID	MP		Cell ID 10.3.2.2		REL-10

Information Element/Group name	Need	Multi	Type and reference	Semantics description	Version
>CPICH RSCP	MP		Integer(0..91)	CPICH RSCP of the serving Cell, when available In dBm. According to CPICH_RSCP_LEV in [19]. Thirty-six spare values are needed.	REL-10
>CPICH Ec/N0	MP		Integer(0..49)	CPICH Ec/N0 of the serving Cell, when available In dB. According to CPICH_Ec/No in [19]. Fourteen spare values are needed.	REL-10
Logged Measurements Intra Frequency Neighbouring Cells list	OP	1..MaxnumLoggedMeas		Measurements done on neighbouring cells	REL-10
>Primary CPICH info	MP		Primary CPICH info 10.3.6.60		REL-10
>CPICH RSCP	MP		Integer(0..91)	In dBm. According to CPICH_RSCP_LEV in [19]. Thirty-six spare values are needed.	REL-10
>CPICH Ec/N0	MP		Integer(0..49)	CPICH Ec/N0 of the serving Cell, when available In dB. According to CPICH_Ec/No in [19]. Fourteen spare values are needed.	REL-10
Logged Measurements Inter Frequency list	OP	1..MaxNumFDDF reqs		Measurements done on neighbouring cells	REL-10
>Frequency Info	MP		Frequency Info 10.3.6.36		REL-10
> Logged Measurements Inter-frequency Neighbouring Cells list	MP	1..MaxnumLoggedMeas			REL-10
>>Primary CPICH info	MP		Primary CPICH info 10.3.6.60		REL-10
>>CPICH RSCP	MP		Integer(0..91)	In dBm. According to CPICH_RSCP_LEV in [19]. Thirty-six spare values are needed.	REL-10
>>CPICH Ec/N0	MP		Integer(0..49)	CPICH Ec/N0 of the serving Cell, when available In dB. According to CPICH_Ec/No in [19]. Fourteen spare values are needed.	REL-10
Logged Measurements Inter-RAT Neighbour cells list	OP				REL-10
>Logged Measurements E-UTRA frequency list	OP	1..MaxNumEUTRAFreqs			REL-10

Information Element/Group name	Need	Multi	Type and reference	Semantics description	Version
>>E-UTRA Carrier Frequency	MP		Integer (0..65535)	EARFCN of the downlink carrier frequency [64]. If the IE indicates a value of 65535, then the EARFCN for this instance should be read from the corresponding instance of IE "EARFCN extension" in the Logged Measurements E-UTRA frequency extension list.	REL-10
>> Logged Measurements E-UTRA Frequency Neighbours List	MP	1..MaxnumLoggedMeas			REL-10
>>>Physical Cell Identity	MP		Integer (0..503)		REL-10
>>>RSRP	MP		Integer (0..97)	RSRP is mapped to a value between 0 and 97 [36.133].	REL-10
>>>RSRQ	MP		Integer (0..33)	RSRQ_00 to RSRQ_33 in [36.133] are mapped to the value between 0 and 33. RSRQ_34 in [36.133] is mapped to the value 33. If the IE indicates a value of 0 and the RSRQ Extension IE is present, then the RSRQ for this instance should be read from the corresponding instance of IE "RSRQ extension", the range is from -30 to -1. If the IE indicates a value of 33 and the RSRQ Extension IE is present, then the RSRQ for this instance should be read from the corresponding instance of IE "RSRQ extension", the range is from 35 to 46.	REL-10
>>>RSRQ Extension	OP		Integer (-30..46)	RSRQ_-30 to RSRQ_-1 in [36.133] are mapped to the value between -30 and -1. RSRQ_35 to RSRQ_46 in [36.133] are mapped to the value between 35 and 46.	REL-12
>>RSRQ Type	OP				REL-12
>>>All Symbols	MP		BOOLEAN	TRUE indicates use of all OFDM symbols when performing RSRQ measurements.	REL-12
>>>Wide band	MP		BOOLEAN	TRUE indicates use of a wider bandwidth when performing RSRQ measurements.	REL-12
>Logged Measurements E-UTRA frequency extension list	OP	1..MaxNumEUTRAFreqs			REL-11
>>EARFCN extension	OP		Integer (65535..262143)	EARFCN of the downlink carrier frequency [64].	REL-11

Information Element/Group name	Need	Multi	Type and reference	Semantics description	Version
>Logged Measurements GSM Neighbouring Cells list	OP	1..MaxnumLoggedMeas			REL-10
>>BSIC	MP		BSIC 10.3.8.2		REL-10
>>Band indicator	MP		Enumerated (DCS 1800 band used, PCS 1900 band used)	Indicates how to interpret the BCCH ARFCN	REL-10
>>BCCH ARFCN	MP		Integer (0..1023)	[45]	REL-10
>>GSM carrier RSSI	MP	Bit string(6)	RXLEV is mapped to a value between 0 and 63, [46]. When mapping the RXLEV value to the RSSI bit string, the first/leftmost bit of the bit string contains the most significant bit.		REL-10
CHOICE GNSS UE Position	OP			The position of the UE when the measurement is made	REL-10
>Ellipsoid					REL-10
>>Ellipsoid point	MP		Ellipsoid point 10.3.8.4a		REL-10
>Ellipsoid with altitude					REL-10
>>Ellipsoid point with altitude	MP		Ellipsoid point with altitude 10.3.8.4b		REL-10
>Ellipsoid with uncertainty circle					REL-11
>>Ellipsoid point with uncertainty circle	MP		Ellipsoid point with uncertainty circle 10.3.8.4d		REL-11
>Ellipsoid with uncertainty ellipse					REL-11
>> Ellipsoid point with uncertainty ellipse	MP		Ellipsoid point with uncertainty ellipse 10.3.8.4e		REL-11
>Ellipsoid with altitude and uncertainty ellipsoid					REL-11

Information Element/Group name	Need	Multi	Type and reference	Semantics description	Version
>>Ellipsoid point with altitude and uncertainty ellipsoid	MP		Ellipsoid point with altitude and uncertainty ellipsoid 10.3.8.4c		REL-11

10.3.7.129a Logged Connection Establishment Failure Info-FDD

Information Element/Group name	Need	Multi	Type and reference	Semantics description	Version
Access Information	MP				REL-11
>Number Of RRC Msg Transmitted	MP		Integer (0..8)	Number of times the RRC message is sent by the UE, e.g. after receiving ACK and AICH.	REL-11
Logged Measurements Failed Cell	MP				REL-11
>Cell ID	MP		Cell ID 10.3.2.2		REL-11
>CPICH RSCP	MP		Integer(0..91)	CPICH RSCP of the serving Cell, when available In dBm. According to CPICH_RSCP_LEV in [19]. Thirty-six spare values are needed.	REL-11
>CPICH Ec/N0	MP		Integer(0..49)	CPICH Ec/N0 of the serving Cell, when available In dB. According to CPICH_Ec/No in [19]. Fourteen spare values are needed.	REL-11
Logged Measurements Intra Frequency Neighbouring Cells list	OP	1..MaxnumLoggedMeas		Measurements done on neighbouring cells	REL-11
>Primary CPICH info	MP		Primary CPICH info 10.3.6.60		REL-11
>CPICH RSCP	MP		Integer(0..91)	In dBm. According to CPICH_RSCP_LEV in [19]. Thirty-six spare values are needed.	REL-11
>CPICH Ec/N0	MP		Integer(0..49)	CPICH Ec/N0 of the serving Cell, when available In dB. According to CPICH_Ec/No in [19]. Fourteen spare values are needed.	REL-11
Logged Measurements Inter Frequency list	OP	1..MaxNumFDDF reqs		Measurements done on neighbouring cells	REL-11
>Frequency Info	MP		Frequency Info 10.3.6.36		REL-11
>Logged Measurements Inter-frequency Neighbouring Cells list	MP	1..MaxnumLoggedMeas			REL-11
>>Primary CPICH info	MP		Primary CPICH info 10.3.6.60		REL-11
>>CPICH RSCP	MP		Integer(0..91)	In dBm. According to CPICH_RSCP_LEV in [19]. Thirty-six spare values are needed.	REL-11

Information Element/Group name	Need	Multi	Type and reference	Semantics description	Version
>>CPICH Ec/N0	MP		Integer(0..49)	CPICH Ec/N0 of the serving Cell, when available In dB. According to CPICH_Ec/No in [19]. Fourteen spare values are needed.	REL-11
Logged Measurements Inter-RAT Neighbour cells list	OP				REL-11
>Logged Measurements E-UTRA frequency list	OP	1..MaxNumEUTRAFreqs			REL-11
>>E-UTRA Carrier Frequency	MP		Integer (0..65535)	EARFCN of the downlink carrier frequency [64]. If the IE indicates a value of 65535, then the EARFCN for this instance should be read from the corresponding instance of IE "EARFCN extension" in the Logged Measurements E-UTRA frequency extension list.	REL-11
>>Logged Measurements E-UTRA Frequency Neighbours List	MP	1..MaxnumLoggedMeas			REL-11
>>>Physical Cell Identity	MP		Integer (0..503)		REL-11
>>>RSRP	MP		Integer (0..97)	RSRP is mapped to a value between 0 and 97 [36.133].	REL-11
>>>RSRQ	MP		Integer (0..33)	RSRQ_00 to RSRQ_33 in [36.133] are mapped to the value between 0 and 33. RSRQ_34 in [36.133] is mapped to the value 33. If the IE indicates a value of 0 and the RSRQ Extension IE is present, then the RSRQ for this instance should be read from the corresponding instance of IE "RSRQ extension", the range is from -30 to -1. If the IE indicates a value of 33 and the RSRQ Extension IE is present, then the RSRQ for this instance should be read from the corresponding instance of IE "RSRQ extension", the range is from 35 to 46.	REL-11
>>>RSRQ Extension	OP		Integer (-30..46)	RSRQ_-30 to RSRQ_-1 in [36.133] are mapped to the value between -30 and -1. RSRQ_35 to RSRQ_46 in [36.133] are mapped to the value between 35 and 46.	REL-12
>>RSRQ Type	OP				REL-12

Information Element/Group name	Need	Multi	Type and reference	Semantics description	Version
>>>All Symbols	MP		BOOLEAN	TRUE indicates use of all OFDM symbols when performing RSRQ measurements.	REL-12
>>>Wide band	MP		BOOLEAN	TRUE indicates use of a wider bandwidth when performing RSRQ measurements.	REL-12
>Logged Measurements E-UTRA frequency extension list	OP	1..MaxNumEUTRAFreqs			REL-11
>>EARFCN extension	OP		Integer (65535..262143)	EARFCN of the downlink carrier frequency [64].	REL-11
>Logged Measurements GSM Neighbouring Cells list	OP	1..MaxnumLoggedMeas			REL-11
>>BSIC	MP		BSIC 10.3.8.2		REL-11
>>Band indicator	MP		Enumerated (DCS 1800 band used, PCS 1900 band used)	Indicates how to interpret the BCCH ARFCN	REL-11
>>BCCH ARFCN	MP		Integer (0..1023)	[45]	REL-11
>>GSM carrier RSSI	MP	Bit string(6)	RXLEV is mapped to a value between 0 and 63, [46]. When mapping the RXLEV value to the RSSI bit string, the first/leftmost bit of the bit string contains the most significant bit.		REL-11
Location Information	OP			The position of the UE when the measurement is made	REL-11
>CHOICE <i>Location</i>	MP				REL-11
>>Ellipsoid					REL-11
>>>Ellipsoid point	MP		Ellipsoid point 10.3.8.4a		REL-11
>>Ellipsoid with altitude					REL-11
>>>Ellipsoid point with altitude	MP		Ellipsoid point with altitude 10.3.8.4b		REL-11
>>Ellipsoid with uncertainty circle					REL-11

Information Element/Group name	Need	Multi	Type and reference	Semantics description	Version
>>>Ellipsoid point with uncertainty circle	MP		Ellipsoid point with uncertainty circle 10.3.8.4d		REL-11
>>Ellipsoid with uncertainty ellipse					REL-11
>>>Ellipsoid point with uncertainty ellipse	MP		Ellipsoid point with uncertainty ellipse 10.3.8.4e		REL-11
>>Ellipsoid with altitude and uncertainty ellipsoid					REL-11
>>>Ellipsoid point with altitude and uncertainty ellipsoid	MP		Ellipsoid point with altitude and uncertainty ellipsoid 10.3.8.4c		REL-11
>Horizontal velocity	OP		Horizontal velocity 10.3.8.4h		REL-11

10.3.7.130 Logged Measurement Info-TDD

Information Element/Group name	Need	Multi	Type and reference	Semantics description	Version
Relative Time Stamp	MP		INTEGER (0..7200)	Indicates the time of logging measurement results, measured relative to the Absolute Time Info, in seconds.	REL-10
Logged Measurements Serving Cell	MP				REL-10
> PLMN Identity	MP		PLMN Identity 10.3.1.11		REL-11
>Cell ID	MP		Cell ID 10.3.2.2		REL-10

Information Element/Group name	Need	Multi	Type and reference	Semantics description	Version
>Primary CCPCH RSCP	MP		Integer(0..91)	In dBm. According to P-CCPCH_RSCP_LEV in [19] and [20]. Thirty-six spare values are needed.	REL-10
Logged Measurements Intra Frequency list	OP	1..MaxnumLoggedMeas		Measurements done on neighbouring cells	REL-10
>Cell parameters Id	MP		Cell parameters Id 10.3.6.9		REL-10
>Primary CCPCH RSCP	MP		Integer(0..91)	In dBm. According to P-CCPCH_RSCP_LEV in [19] and [20]. Thirty-six spare values are needed.	REL-10
Logged Measurements Inter Frequency Neighbouring Cells list	OP	1..MaxNumTDDFreqs		Measurements done on neighbouring cells	REL-10
>Frequency Info	MP		Frequency Info 10.3.6.36		REL-10
>Logged Measurements Inter-frequency Neighbouring Cells list	MP	1..MaxnumLoggedMeas			REL-10
>>Cell parameters Id	MP		Cell parameters Id 10.3.6.9		REL-10
>>Primary CCPCH RSCP	MP		Integer(0..91)	In dBm. According to P-CCPCH_RSCP_LEV in [19] and [20]. Thirty-six spare values are needed.	REL-10
Logged Measurements Inter-RAT Neighbour cells list	OP				REL-10
>Logged Measurements E-UTRA frequency list	OP	1..MaxNumEUTRAFreqs			REL-10
>>E-UTRA Carrier Frequency	MP		Integer (0..65535)	EARFCN of the downlink carrier frequency [64]. If the IE indicates a value of 65535, then the EARFCN for this instance should be read from the corresponding instance of IE "EARFCN extension" in the Logged Measurements E-UTRA frequency extension list.	REL-10
>>Logged Measurements E-UTRA Frequency Neighbours List	MP	1..MaxnumLoggedMeas			REL-10
>>>Physical Cell Identity	MP		Integer (0..503)		REL-10
>>>RSRP	MP		Integer (0..97)	RSRP is mapped to a value between 0 and 97 [36.133].	REL-10

Information Element/Group name	Need	Multi	Type and reference	Semantics description	Version
>>>RSRQ	MP		Integer (0..33)	RSRQ_00 to RSRQ_33 in [36.133] are mapped to the value between 0 and 33. RSRQ_34 in [36.133] is mapped to the value 33. If the IE indicates a value of 0 and the RSRQ Extension IE is present, then the RSRQ for this instance should be read from the corresponding instance of IE "RSRQ extension", the range is from -30 to -1. If the IE indicates a value of 33 and the RSRQ Extension IE is present, then the RSRQ for this instance should be read from the corresponding instance of IE "RSRQ extension", the range is from 35 to 46.	REL-10
>>>RSRQ Extension	OP		Integer (-30..46)	RSRQ_-30 to RSRQ_46 in [36.133] are mapped to the value between -30 and 46.	REL-12
>>RSRQ Type	OP				REL-12
>>>All Symbols	MP		BOOLEAN	TRUE indicates use of all OFDM symbols when performing RSRQ measurements.	REL-12
>>>Wide band	MP		BOOLEAN	TRUE indicates use of a wider bandwidth when performing RSRQ measurements.	REL-12
>Logged Measurements E-UTRA frequency extension list	OP	1..MaxNumEUTRAFreqs			REL-11
>>EARFCN extension	OP		Integer (65536..262143)	EARFCN of the downlink carrier frequency [64].	REL-11
>Logged Measurements GSM Neighbouring Cells list	OP	1..MaxnumLoggedMeas			REL-10
>>BSIC	MP		BSIC 10.3.8.2		REL-10
>>Band indicator	MP		Enumerated (DCS 1800 band used, PCS 1900 band used)	Indicates how to interpret the BCCH ARFCN	REL-10
>>BCCH ARFCN	MP		Integer (0..1023)	[45]	REL-10

Information Element/Group name	Need	Multi	Type and reference	Semantics description	Version
>>GSM carrier RSSI	MP	Bit string(6)	RXLEV is mapped to a value between 0 and 63, [46]. When mapping the RXLEV value to the RSSI bit string, the first/leftmost bit of the bit string contains the most significant bit.		REL-10
CHOICE <i>GNSS UE Position</i>	OP			The position of the UE when the measurement is made	REL-10
>Ellipsoid					REL-10
>>Ellipsoid point	MP		Ellipsoid point 10.3.8.4a		REL-10
>Ellipsoid with altitude					REL-10
>>Ellipsoid point with altitude	MP		Ellipsoid point with altitude 10.3.8.4b		REL-10
>Ellipsoid with uncertainty circle					REL-11
>>Ellipsoid point with uncertainty circle	MP		Ellipsoid point with uncertainty circle 10.3.8.4d		REL-11
>Ellipsoid with uncertainty ellipse					REL-11
>> Ellipsoid point with uncertainty ellipse	MP		Ellipsoid point with uncertainty ellipse 10.3.8.4e		REL-11
>Ellipsoid with altitude and uncertainty ellipsoid					REL-11
>>Ellipsoid point with altitude and uncertainty ellipsoid	MP		Ellipsoid point with altitude and uncertainty ellipsoid 10.3.8.4c		REL-11

10.3.7.130a Logged Connection Establishment Failure Info-TDD

Information Element/Group name	Need	Multi	Type and reference	Semantics description	Version
Access Information	MP				REL-11
>Number Of RRC Msg Transmitted	MP		Integer (0..8)	Number of times the RRC message is sent by the UE, e.g. after receiving FPACH.	REL-11
>FPACH Received	MP		BOOLEAN	TRUE indicates that FPACH has been successfully received at least once.	REL-11
>E-RUCCH Failure	OP		BOOLEAN	TRUE indicates the failure of the E-RUCCH transmission has been detected	REL-11
Logged Measurements Failed Cell	MP				REL-11
>Cell ID	MP		Cell ID 10.3.2.2		REL-11
>Primary CCPCH RSCP	MP		Integer(0..91)	In dBm. According to P-CCPCH_RSCP_LEV in [19] and [20]. Thirty-six spare values are needed.	REL-11
Logged Measurements Intra Frequency Cells list	OP	1.. MaxnumLoggedMeas		Measurements done on neighbouring cells	REL-11
>Cell parameters Id	MP		Cell parameters Id 10.3.6.9		REL-11
>Primary CCPCH RSCP	MP		Integer(0..91)	In dBm. According to P-CCPCH_RSCP_LEV in [19] and [20]. Thirty-six spare values are needed.	REL-11
Logged Measurements Inter Frequency Neighbouring Cells list	OP	1.. MaxNumTDDFreqs		Measurements done on neighbouring cells	REL-11
>Frequency Info	MP		Frequency Info 10.3.6.36		REL-11
>Logged Measurements Inter-frequency Neighbouring Cells list	MP	1.. MaxnumLoggedMeas			REL-11
>>Cell parameters Id	MP		Cell parameters Id 10.3.6.9		REL-11
>>Primary CCPCH RSCP	MP		Integer(0..91)	In dBm. According to P-CCPCH_RSCP_LEV in [19] and [20]. Thirty-six spare values are needed.	REL-11
Logged Measurements Inter-RAT Neighbour cells list	OP				REL-11
>Logged Measurements E-UTRA frequency list	OP	1.. MaxNumEUTRAFreqs			REL-11

Information Element/Group name	Need	Multi	Type and reference	Semantics description	Version
>>E-UTRA Carrier Frequency	MP		Integer (0..65535)	EARFCN of the downlink carrier frequency [64]. If the IE indicates a value of 65535, then the EARFCN for this instance should be read from the corresponding instance of IE "EARFCN extension" in the Logged Measurements E-UTRA frequency extension list.	REL-11
>>Logged Measurements E-UTRA Frequency Neighbours List	MP	1.. MaxnumLoggedMeas			REL-11
>>>Physical Cell Identity	MP		Integer (0..503)		REL-11
>>>RSRP	MP		Integer (0..97)	RSRP is mapped to a value between 0 and 97 [36.133].	REL-11
>>>RSRQ	MP		Integer (0..33)	RSRQ_00 to RSRQ_33 in [36.133] are mapped to the value between 0 and 33. RSRQ_34 in [36.133] is mapped to the value 33. If the IE indicates a value of 0 and the RSRQ Extension IE is present, then the RSRQ for this instance should be read from the corresponding instance of IE "RSRQ extension", the range is from -30 to -1. If the IE indicates a value of 33 and the RSRQ Extension IE is present, then the RSRQ for this instance should be read from the corresponding instance of IE "RSRQ extension", the range is from 35 to 46.	REL-11
>>>RSRQ Extension	OP		Integer (-30..46)	RSRQ_-30 to RSRQ_46 in [36.133] are mapped to the value between -30 and 46.	REL-12
>>RSRQ Type	OP				REL-12
>>>All Symbols	MP		BOOLEAN	TRUE indicates use of all OFDM symbols when performing RSRQ measurements.	REL-12
>>>Wide band	MP		BOOLEAN	TRUE indicates use of a wider bandwidth when performing RSRQ measurements.	REL-12
>Logged Measurements E-UTRA frequency extension list	OP	1.. MaxNumEUTRAFreqs			REL-11
>>EARFCN extension	OP		Integer (65536..262143)	EARFCN of the downlink carrier frequency [64].	REL-11
>Logged Measurements GSM Neighbouring Cells list	OP	1.. MaxnumLoggedMeas			REL-11

Information Element/Group name	Need	Multi	Type and reference	Semantics description	Version
>>BSIC	MP		BSIC 10.3.8.2		REL-11
>>Band indicator	MP		Enumerated (DCS 1800 band used, PCS 1900 band used)	Indicates how to interpret the BCCH ARFCN	REL-11
>>BCCH ARFCN	MP		Integer (0..1023)	[45]	REL-11
>>GSM carrier RSSI	MP	Bit string(6)	RXLEV is mapped to a value between 0 and 63, [46]. When mapping the RXLEV value to the RSSI bit string, the first/leftmost bit of the bit string contains the most significant bit.		REL-11
Location Information	OP			The position of the UE when the measurement is made	REL-11
>CHOICE <i>Location</i>	MP				REL-11
>>Ellipsoid					REL-11
>>>Ellipsoid point	MP		Ellipsoid point 10.3.8.4a		REL-11
>>Ellipsoid with altitude					REL-11
>>>Ellipsoid point with altitude	MP		Ellipsoid point with altitude 10.3.8.4b		REL-11
>Ellipsoid with uncertainty circle					REL-11
>>Ellipsoid point with uncertainty circle	MP		Ellipsoid point with uncertainty circle 10.3.8.4d		REL-11
>Ellipsoid with uncertainty ellipse					REL-11
>>Ellipsoid point with uncertainty ellipse	MP		Ellipsoid point with uncertainty ellipse 10.3.8.4e		REL-11
>Ellipsoid with altitude and uncertainty ellipsoid					REL-11
>>Ellipsoid point with altitude and uncertainty ellipsoid	MP		Ellipsoid point with altitude and uncertainty ellipsoid 10.3.8.4c		REL-11

Information Element/Group name	Need	Multi	Type and reference	Semantics description	Version
>Horizontal velocity	OP		Horizontal velocity 10.3.8.4h		REL-11

10.3.7.131 Logged Meas Report

Information Element/Group name	Need	Multi	Type and reference	Semantics description	Version
Absolute Time Info	MP		BIT STRING (SIZE(48)),	Indicates the reference to network absolute time <i>absoluteTimeInfo</i> provided at the point of measurement logging configuration. Format is YY-MM-DD HH:MM:SS using BCD encoding	REL-10
Trace reference	MP		Trace Reference 10.3.7.133	Parameter trace reference: See TS 32.422 [81]	REL-10
Trace recording session	MP		Trace Recording Session 10.3.7.134	Parameter trace recording session reference: See TS 32.422 [81]	REL-10
TCE Id	MP		TCE Id 10.3.7.135	Parameter TCE Id: See TS 32.422 [81]	REL-10
CHOICE mode	OP				REL-10
>FDD					REL-10
>>List of measurements FDD		1.. MaxLoggedMeasReport			REL-10
>>>Logged Measurement Info-FDD	MP		Logged Measurement Info-FDD 10.3.7.129		REL-10
>TDD					REL-10
>>List of measurements TDD		1.. MaxLoggedMeasReport			REL-10
>>>Logged Measurement Info-TDD	MP		Logged Measurement Info-TDD 10.3.7.130		REL-10
Logged Meas Available	OP		Enumerated (TRUE)	Indicates the UE has logged measurements to report to the network	REL-10

10.3.7.132 Logged Measurements Configuration Info

Parameters used to configure logged measurements.

Information Element/Group name	Need	Multi	Type and reference	Semantics description	Version
Absolute Time Info	MP		Bit Sting (48)	Indicates the reference to network absolute time <i>absoluteTimeInfo</i> provided at the point of measurement logging configuration. Format is YY-MM-DD HH:MM:SS using BCD encoding	REL-10

Logging Duration	MP		Enumerated (10 min, 20 min, 40 min, 1 hour, 1 hour 30 min, 2 hour)	Timer for logging duration. The timer is activated at the moment of configuration. When the timer expires the logging is stopped and the configuration is cleared. 2 spare values are needed.	REL-10
Logging Interval	MP		Enumerated (1.28, 2.56, 5.12, 10.24, 20.48, 30.72, 40.96, 61.44)	Indicates periodicity for storing measurement results. UE behaviour is unspecified when the UE is configured with a DRX period larger than the logging interval. In seconds.	REL-10
Trace reference	MP		Trace Reference 10.3.7.133	Parameter trace reference: See TS 32.422 [81]	REL-10
Trace recording session	MP		Trace Recording Session 10.3.7.134	Parameter trace recording session reference: See TS 32.422 [81]	REL-10
TCE Id	MP		TCE Id 10.3.7.135	Parameter TCE Id: See TS 32.422 [81]	REL-10
CHOICE Area Configuration	OP			Indicates area for which the UE is requested to perform logging. If absent, the configuration is valid in the RPLMN of the UE and the PLMNs provided in IE "PLMN Identity List", if present.	REL-10
>Cell IDList		1..32			REL-10
>>Cell ID	MP		Cell ID 10.3.2.2		REL-10
>>PLMN identity	OP		PLMN identity 10.3.1.11	Indicates the PLMN for which the Cell ID is applicable. If not present, the Cell ID is applicable in the RPLMN.	REL-11
>Location Area Code List		1..8			REL-10
>>LAI	MP		Location area identification 10.3.1.7		REL-10
>Routing Area Code List		1..8			REL-10
>>RAI	MP		Routing area identification 10.3.1.16		REL-10
PLMN Identity List	OP	1 to <MaxnumMDT PLMN>			REL-11
>PLMN identity	MP		PLMN identity 10.3.1.11		REL-11

10.3.7.132a Connection Establishment Failure Report

Information Element/Group name	Need	Multi	Type and reference	Semantics description	Version
Time Since Failure	MP		INTEGER (0..172800)	Indicates the elapsed time in seconds between Logging and reporting of Connection establishment failure info. If the elapsed time is greater than 172800s then UE shall use the value 172800.	REL-11
CHOICE mode	MP				REL-11
>FDD					REL-11
>>Logged Connection Establishment Failure Info-FDD	MP		Logged Connection Establishment Failure Info-FDD 10.3.7.129 a		REL-11
>TDD					REL-11
>>Logged Connection Establishment Failure Info-TDD	MP		Logged Connection Establishment Failure Info-TDD 10.3.7.130 a		REL-11

10.3.7.133 Trace Reference

Information Element/Group name	Need	Multi	Type and reference	Semantics description	Version
PLMN Identity	MP		PLMN identity 10.3.1.11	PLMN Identity	REL-10
Trace ID	MP		Octet string (3)		REL-10

10.3.7.134 Trace Recording Session

Information Element/Group name	Need	Multi	Type and reference	Semantics description	Version
Trace Recording Session	MP		Octet string (2)		REL-10

10.3.7.135 TCE Id

Information Element/Group name	Need	Multi	Type and reference	Semantics description	Version
TCE Id	MP		Octet string (1)		REL-10

10.3.7.136 Periodical reporting criteria on secondary UL frequency

Contains the periodical reporting criteria information. It is necessary only in the intra-frequency periodical reporting mode on the secondary uplink frequency.

Information Element/Group name	Need	Multi	Type and reference	Semantics description	Version
Frequency info	MP		Frequency info 10.3.6.36	NOTE1	REL-10
Periodical reporting criteria	MP		Periodical reporting criteria 10.3.7.53		REL-10
Reporting cell status	OP		Reporting cell status 10.3.7.61		REL-10

NOTE1: If the IE "Frequency info" is different from the current downlink frequency associated with the secondary UL frequency, the UE behaviour is unspecified.

10.3.7.137 E-UTRA measurement for CELL_FACH

NOTE: Only for FDD.

Information Element/Group name	Need	Multi	Type and reference	Semantics description	Version
E-UTRA frequencies for measurement	MP	1 to <maxNumEU TRAFreqs_F ACH>			REL-11
		1 to <maxNumEU TRAFreqs_F ACH-ext>			REL-12
>EARFCN	MP		Integer (0..65535)	EARFCN of the downlink carrier frequency [64]. If the IE indicates a value of 65535, then the EARFCN for this instance should be read from the corresponding instance of IE "EARFCN extension"	REL-11
>EARFCN extension	OP		Integer (65536..262143)	EARFCN of the downlink carrier frequency [64].	REL-11
Report criteria	MP		Enumerated (Event-triggered, Periodical reporting)		REL-11
Measurement quantity	MP		Enumerated (RSRP, RSRQ)	This IE indicates the quantity that the UE uses to determine the event trigger.	REL-11

Information Element/Group name	Need	Multi	Type and reference	Semantics description	Version
Reporting Threshold	MP		Integer (0..97)	In dB. Ranges used depend on measurement quantity: if measurement quantity is RSRQ, range should be (0..34), if measurement quantity is RSRP, range should be (0..97).	REL-11
			Integer (-30..-97)	In dB. Ranges used depend on measurement quantity: if measurement quantity is RSRQ, range should be (-30..46), if measurement quantity is RSRP, range should be (0..97).	REL-12

10.3.7.138 E-UTRA results for CELL_FACH

NOTE: Only for FDD.

Information Element/Group name	Need	Multi	Type and reference	Semantics description	Version
E-UTRA frequency indicator	MP		Bit string(max NumEUTRAFreqs_FACH)	Bit 0 is the first/leftmost bit of the bit string. Each bit indicates whether the radio quality of an E-UTRA frequency is above the reporting threshold or not, where a one value indicates above and a zero value not. Bit n corresponds to the n-th E-UTRA frequency in the list provided by the IE E-UTRA frequencies for measurement.	REL-11
			Bit string(max NumEUTRAFreqs_FACH-ext)	Bit 0 is the first/leftmost bit of the bit string. Each bit indicates whether the radio quality of an E-UTRA frequency is above the reporting threshold or not, where a one value indicates above and a zero value not. Bit n corresponds to the n-th E-UTRA frequency in the list provided by the IE E-UTRA frequencies for measurement.	REL-12

10.3.7.139 E-UTRA frequency RACH reporting information

NOTE: Only for FDD.

Contains the reporting configuration information for an E-UTRA frequency measurement report, which is sent on the RACH.

Information Element/Group name	Need	Multi	Type and reference	Semantics description	Version
E-UTRA frequency list indicator	MP		Bit string(maxNumEUTRAFreqs)	Bit 0 is the first/leftmost bit of the bit string. Each bit indicates the E-UTRA frequency that the UE is required to measure and report on RACH. Bit n corresponds to the n-th E-UTRA frequency received in SIB19. Value '1' for a bit means the corresponding E-UTRA frequency has been configured to measure and report on RACH. Max. 4 EUTRA frequencies shall be configured in this version of the specification.	REL-11
E-UTRA frequency list indicator2	OP		Bit string(maxNumEUTRAFreqs)	Bit 0 is the first/leftmost bit of the bit string. Each bit indicates the E-UTRA frequency that the UE is required to measure and report on RACH. Bit n corresponds to the n-th E-UTRA frequency received in SIB19. Value '1' for a bit means the corresponding E-UTRA frequency has been configured to measure and report on RACH.	REL-12
E-UTRA frequency RACH reporting quantity	MP		Enumerated (RSRP, RSRQ)		REL-11

Information Element/Group name	Need	Multi	Type and reference	Semantics description	Version
E-UTRA frequency RACH reporting threshold	MP		Integer (0..97)	In dB. Ranges used depend on measurement quantity: if measurement quantity is RSRQ, range should be (0..46), if measurement quantity is RSRP, range should be (0..97). In case measurement quantity is RSRQ, if the IE indicates a value of 0 and the "E-UTRA frequency RACH reporting threshold Extension" IE is present, then the RSRQ for this instance should be read from the corresponding instance of IE "E-UTRA frequency RACH reporting threshold Extension", the range is from -30 to -1.	REL-11
E-UTRA frequency RACH reporting threshold Extension	OP		Integer (-30..-1)		REL-12
RACH reporting priority	MD		Enumerated (IntraEUTRAInter, InterIntraEUTRA, InterEUTRAIntra, EUTRAIntraInter, EUTRAInterIntra)	The default value is that E-UTRA measurements shall be omitted first, followed by limiting the number of inter-frequency cells, before limiting the number of intra-frequency cells. Measurement result for the current cell shall be omitted last. Three spare values are needed.	REL-11

10.3.7.140 Filtered UE power headroom reporting information

Information Element/Group name	Need	Multi	Type and reference	Semantics description	Version
Time-to-trigger	MP		Integer(0, 10, 20, 40, 60, 80, 100, 120, 160, 200, 240, 320, 640, 1280, 2560, 5000)	Time in ms. Indicates the period of time between the detection of the triggering condition [15] and the sending of the Filtered UPH Report.	REL-12
Hysteresis1	OP		Real(0..7.5 by step of 0.5)		REL-12
Hysteresis2	OP		Real(0..7.5 by step of 0.5)		REL-12
UE Power Headroom threshold1	OP		Integer(-50..33)		REL-12
UE Power Headroom threshold2	OP		Integer(-50..33)		REL-12
Filter coefficient	OP		Filter coefficient 10.3.7.9		REL-12

10.3.8 Other Information elements

10.3.8.1 BCCH modification info

Indicates modification of the System Information on BCCH.

Information Element/Group name	Need	Multi	Type and reference	Semantics description	Version
MIB Value tag	MP		MIB Value tag 10.3.8.9		
BCCH modification time	OP		Integer (0..4088 in step of 8)	All SFN values in which MIB may be mapped are allowed.	
SB3 value tag	OP		Cell Value tag 2 10.3.8.4o		REL-12

10.3.8.2 BSIC

Information Element/Group name	Need	Multi	Type and reference	Semantics description
Base transceiver Station Identity Code (BSIC)	MP			[11]
>Network Colour Code (NCC)	MP		bit string(3)	The first/leftmost bit of the bit string contains the most significant bit of the NCC.
>Base Station Colour Code (BCC)	MP		bit string(3)	The first/leftmost bit of the bit string contains the most significant bit of the BCC.

10.3.8.3 CBS DRX Level 1 information

This information element contains the CBS discontinuous reception information to be broadcast for CBS DRX Level 1 calculations in the UE.

Information Element/Group name	Need	Multi	Type and reference	Semantics description	Version
Period of CTCH allocation (N)	MP		Integer (1..256)	$M_{TTI} \leq N \leq 256$, N multiple of M_{TTI}	
CBS frame offset (K)	MP		Integer (0..255)	$0 \leq K \leq N-1$, K multiple of M_{TTI}	
Period of BMC scheduling messages (P)	CV-SIB5		Integer (8, 16, 32, 64, 128, 256)		REL-6

Condition	Explanation
SIB5	The IE is optional when the IE "CBS DRX Level 1 information" in SIB5, otherwise the IE is not needed

10.3.8.4 Cell Value tag

Information Element/Group name	Need	Multi	Type and reference	Semantics description
Cell Value tag	MP		Integer (1..4)	

10.3.8.4o Cell Value tag 2

Information Element/Group name	Need	Multi	Type and reference	Semantics description
Cell Value tag 2	MP		Integer (1..16)	

10.3.8.4a Ellipsoid point

This IE contains the description of an ellipsoid point as in [24].

Information Element/Group name	Need	Multi	Type and Reference	Semantics description
Latitude sign	MP		Enumerated (North, South)	
Degrees Of Latitude	MP		Integer (0... $2^{23}-1$)	The IE value (N) is derived by this formula: $N \leq 2^{23} \times X / 90 < N+1$ X being the latitude in degree (0°.. 90°)
Degrees Of Longitude	MP		Integer (- 2^{23} ... $2^{23}-1$)	The IE value (N) is derived by this formula: $N \leq 2^{24} \times X / 360 < N+1$ X being the longitude in degree (-180°..+180°)

10.3.8.4b Ellipsoid point with Altitude

This IE contains the description of an ellipsoid point with altitude as in [24].

Information Element/Group name	Need	Multi	Type and Reference	Semantics description
Latitude sign	MP		Enumerated (North, South)	
Degrees Of Latitude	MP		Integer (0...2 ²³ -1)	The IE value (N) is derived by this formula: $N \leq 2^{23} X / 90 < N+1$ X being the latitude in degree (0°.. 90°)
Degrees Of Longitude	MP		Integer (-2 ²³ ...2 ²³ -1)	The IE value (N) is derived by this formula: $N \leq 2^{24} X / 360 < N+1$ X being the longitude in degree (-180°..+180°)
Altitude Direction	MP		Enumerated (Height, Depth)	
Altitude	MP		Integer (0..2 ¹⁵ -1)	The IE value (N) is derived by this formula: $N \leq a < N+1$ a being the altitude in metres

10.3.8.4c Ellipsoid point with Altitude and uncertainty ellipsoid

This IE contains the description of an ellipsoid point with altitude and uncertainty ellipsoid as in [24].

Information Element/Group name	Need	Multi	Type and Reference	Semantics description
Latitude sign	MP		Enumerated (North, South)	
Degrees Of Latitude	MP		Integer (0...2 ²³ -1)	The IE value (N) is derived by this formula: $N \leq 2^{23} X / 90 < N+1$ X being the latitude in degree (0°.. 90°)
Degrees Of Longitude	MP		Integer (-2 ²³ ...2 ²³ -1)	The IE value (N) is derived by this formula: $N \leq 2^{24} X / 360 < N+1$ X being the longitude in degree (-180°..+180°)
Altitude Direction	MP		Enumerated (Height, Depth)	
Altitude	MP		Integer (0..2 ¹⁵ -1)	The IE value (N) is derived by this formula: $N \leq a < N+1$ a being the altitude in metres
Uncertainty semi-major	MP		Integer (0...127)	The uncertainty r is derived from the "uncertainty code" k by $r = 10x(1.1^k - 1)$
Uncertainty semi-minor	MP		Integer (0...127)	The uncertainty r is derived from the "uncertainty code" k by $r = 10x(1.1^k - 1)$
Orientation of major axis	MP		Integer (0..89)	The IE value (N) is derived by this formula: $2N \leq a < 2(N+1)$ a being the orientation in degree (0°.. 179°)

Information Element/Group name	Need	Multi	Type and Reference	Semantics description
Uncertainty Altitude	MP		Integer(0..127)	The uncertainty in altitude, h , expressed in metres is mapped from the IE value (K), with the following formula: $h = C((1 + x)^K - 1)$ with $C = 45$ and $x = 0.025$.
Confidence	MP		Integer (0..100)	in percentage

10.3.8.4d Ellipsoid point with uncertainty Circle

This IE contains the description of an ellipsoid point with an uncertainty circle as in [24].

Information Element/Group name	Need	Multi	Type and Reference	Semantics description
Latitude sign	MP		Enumerated (North, South)	
Degrees Of Latitude	MP		Integer (0... $2^{23}-1$)	The IE value (N) is derived by this formula: $N \leq 2^{23} \quad X/90 < N+1$ X being the latitude in degree (0°.. 90°)
Degrees Of Longitude	MP		Integer (- 2^{23} ... $2^{23}-1$)	The IE value (N) is derived by this formula: $N \leq 2^{24} \quad X/360 < N+1$ X being the longitude in degree (-180°..+180°)
Uncertainty Code	MP		Integer (0...127)	The uncertainty r is derived from the "uncertainty code" k by $r = 10x(1.1^k - 1)$

10.3.8.4e Ellipsoid point with uncertainty Ellipse

This IE contains the description of an ellipsoid point with an uncertainty ellipse as in [24].

Information Element/Group name	Need	Multi	Type and Reference	Semantics description
Latitude sign	MP		Enumerated (North, South)	
Degrees Of Latitude	MP		Integer (0...2 ²³ -1)	The IE value (N) is derived by this formula: $N \leq 2^{23} X / 90 < N+1$ X being the latitude in degree (0°.. 90°)
Degrees Of Longitude	MP		Integer (-2 ²³ ...2 ²³ -1)	The IE value (N) is derived by this formula: $N \leq 2^{24} X / 360 < N+1$ X being the longitude in degree (-180°..+180°)
Uncertainty semi-major	MP		Integer (0...127)	The uncertainty <i>r</i> is derived from the "uncertainty code" <i>k</i> by $r = 10x(1.1^k - 1)$
Uncertainty semi-minor	MP		Integer (0...127)	The uncertainty <i>r</i> is derived from the "uncertainty code" <i>k</i> by $r = 10x(1.1^k - 1)$
Orientation of major axis	MP		Integer (0..89)	The IE value (N) is derived by this formula: $2N \leq a < 2(N+1)$ a being the orientation in degree (0°.. 179°)
Confidence	MP		Integer (0..100)	in percentage

10.3.8.4ea ETWS information

Indication of an ETWS primary notification. The ETWS warning type is used to notify upper layers.

Information Element/Group name	Need	Multi	Type and reference	Semantics description	Version
Warning Type	MP		Octet string (1..2)	IE "Warning Type" as defined in [77]	REL-8
Message Identifier	MP		Octet string (2)	IE "Message Identifier" as defined in [77]	REL-8
Serial Number	MP		Octet string (2)	IE "Serial Number" as defined in [77]	REL-8

10.3.8.4eb Void

10.3.8.4f GERAN system information

Information Element/Group name	Need	Multi	Type and reference	Semantics description	Version
>>> GERAN System Info	MP	1 to <maxGERAN SI>			REL-5

Information Element/Group name	Need	Multi	Type and reference	Semantics description	Version
>>>> GERAN system info block	MP		Octet string(1..23)	The first octet contains octet 1 of the GERAN system information block, the second octet contains octet 2 of the GERAN system information block and so on.	REL-5

10.3.8.4g GSM Target Cell Info

Information Element/Group name	Need	Multi	Type and reference	Semantics description	Version
GSM Target Cell Info List	MP	1 to <maxGSMTargetCells>			REL-6
>BCCH ARFCN	MP		Integer (0..1023)	[45]	REL-6
>Band indicator	MP		Enumerated (DCS 1800 band used, PCS 1900 band used)	Indicates how to interpret the BCCH ARFCN	REL-6
>BSIC	OP		BSIC 10.3.8.2		REL-6

10.3.8.4h Horizontal Velocity

This IE contains the description of a horizontal velocity as in [24].

Information Element/Group name	Need	Multi	Type and Reference	Semantics description
Bearing	MP		Integer (0...359)	The direction of movement is given in degrees where '0' represents North, '90' represents East, etc.
Horizontal Speed	MP		Integer (0... $2^{11}-1$)	The relationship between (N) and the horizontal speed (h) in kilometers per hour it describes is: $N \leq h < N + 0.5$, for (N=0) $N-0.5 \leq h < N + 0.5$, for (0<N< $2^{11}-1$) $N - 0.5 \leq h$, for (N = $2^{11}-1$)

10.3.8.4i Horizontal with Vertical Velocity

This IE contains the description of horizontal with vertical velocity as in [24].

Information Element/Group name	Need	Multi	Type and Reference	Semantics description
Vertical Speed direction	MP		ENUMERATED (upward, downward)	
Bearing	MP		Integer (0...359)	The direction of movement is given in degrees where '0' represents North, '90' represents East, etc.

Information Element/Group name	Need	Multi	Type and Reference	Semantics description
Horizontal Speed	MP		Integer (0...2 ¹¹ -1)	The relationship between (N) and the horizontal speed (h) in kilometers per hour it describes is: N ≤ h < N + 0.5, for (N=0) N-0.5 ≤ h < N + 0.5, for (0 < N < 2 ¹¹ -1) N - 0.5 ≤ h, for (N = 2 ¹¹ -1)
Vertical Speed	MP		Integer (0..255)	The relationship between (N) and the vertical speed (v) in kilometres per hour it describes is given by the formula: N ≤ v < N + 0.5, for (N=0) N-0.5 ≤ v < N + 0.5, for (0 < N < 2 ⁸ -1) N - 0.5 ≤ v, for (N = 2 ⁸ -1)

10.3.8.4j Horizontal Velocity with Uncertainty

This IE contains the description of horizontal velocity with uncertainty as in [24].

Information Element/Group name	Need	Multi	Type and Reference	Semantics description
Bearing	MP		Integer (0...359)	The direction of movement is given in degrees where '0' represents North, '90' represents East, etc.
Horizontal Speed	MP		Integer (0...2 ¹¹ -1)	The relationship between (N) and the horizontal speed (h) in kilometers per hour it describes is: N ≤ h < N + 0.5, for (N=0) N-0.5 ≤ h < N + 0.5, for (0 < N < 2 ¹¹ -1) N - 0.5 ≤ h, for (N = 2 ¹¹ -1)
Horizontal Uncertainty Speed	MP		Integer (0..255)	The IE value is encoded in increments of 1 kilometer per hour. The value of N give the uncertainty speed except for N=255 which indicates that the uncertainty is not specified

10.3.8.4k Horizontal with Vertical Velocity and Uncertainty

This IE contains the description of horizontal with vertical velocity and uncertainty as in [24].

Information Element/Group name	Need	Multi	Type and Reference	Semantics description
Vertical Speed direction	MP		ENUMERATED (upward, downward)	
Bearing	MP		Integer (0...359)	The direction of movement is given in degrees where '0' represents North, '90' represents East, etc.

Information Element/Group name	Need	Multi	Type and Reference	Semantics description
Horizontal Speed	MP		Integer (0...2 ¹¹ -1)	The relationship between (N) and the horizontal speed (h) in kilometers per hour it describes is: N ≤ h < N + 0.5, for (N=0) N-0.5 ≤ h < N + 0.5, for (0 < N < 2 ¹¹ -1) N - 0.5 ≤ h, for (N = 2 ¹¹ -1)
Vertical Speed	MP		Integer (0..255)	The relationship between (N) and the vertical speed (v) in kilometres per hour it describes is given by the formula: N ≤ v < N + 0.5, for (N=0) N-0.5 ≤ v < N + 0.5, for (0 < N < 2 ⁸ -1) N - 0.5 ≤ v, for (N = 2 ⁸ -1)
Horizontal Uncertainty Speed	MP		Integer (0..255)	The IE value is encoded in increments of 1 kilometer per hour. The value of N give the uncertainty speed except for N=255 which indicates that the uncertainty is not specified
Vertical Uncertainty Speed	MP		Integer (0..255)	The IE value is encoded in increments of 1 kilometer per hour. The value of N give the uncertainty speed except for N=255 which indicates that the uncertainty is not specified

10.3.8.4L E-UTRA Target Info

Information Element/Group name	Need	Multi	Type and reference	Semantics description	Version
E-UTRA Target Frequency Info List	MP	1 to <maxEUTRA targetFreqs>			REL-8
>DL Carrier frequency	MP		Integer (0..65535)	EARFCN of the downlink carrier frequency [64]. If the IE indicates a value of 65535, then the EARFCN for this instance should be read from the corresponding instance of IE "EARFCN extension" in the E-UTRA Target Frequency Info extension List.	REL-8

Information Element/Group name	Need	Multi	Type and reference	Semantics description	Version
>Blacklisted cells per freq list	OP	1 to <maxEUTRACellPerFreq>			REL-8
>>Physical Cell identity	MP		Integer (0..503)		REL-8
E-UTRA Target Frequency Info extension List	OP	1 to <maxEUTRATargetFreqs>			REL-11
>EARFCN extension	OP		Integer (65536..262143)	EARFCN of the downlink carrier frequency [64].	REL-11

10.3.8.4m HNB Name

This information element is used to carry the name of the home NodeB, coded in UTF-8 with variable number of bytes per character [75].

Information Element/Group name	Need	Multi	Type and reference	Semantics description	Version
HNB Name	MP		Octet string (1 to <maxHNBNameSize>)	Carries the name of the Home NodeB with a maximum of maxHNBNameSize octets, using UTF-8 coding.	REL-8

10.3.8.5 Inter-RAT change failure

Information Element/Group name	Need	Multi	Type and reference	Semantics description
Inter-RAT change failure cause	MP		Enumerated(Configuration unacceptable, physical channel failure, protocol error, unspecified)	Four spare values are needed.
Protocol error information	<i>CV-ProtErr</i>		Protocol error information 10.3.8.12	

Condition	Explanation
<i>ProtErr</i>	The IE is mandatory present if the IE "Inter-RAT change failure cause" has the value "Protocol error" and not needed otherwise.

10.3.8.6 Inter-RAT handover failure

Information Element/Group name	Need	Multi	Type and reference	Semantics description
Inter-RAT handover failure cause	MD		Enumerated(Configuration unacceptable, physical channel failure, protocol error, inter-RAT protocol error, unspecified)	Default value is "unspecified". Eleven spare values are needed.
Protocol error information	CV-ProtErr		Protocol error information 10.3.8.12	

Condition	Explanation
<i>ProtErr</i>	The IE is mandatory present if the IE "Inter-RAT handover failure cause" has the value "Protocol error" and not needed otherwise.

10.3.8.7 Inter-RAT UE radio access capability

This Information Element contains the inter-RAT UE radio access capability that is structured and coded according to the specification used for the corresponding system type.

Information Element/Group name	Need	Multi	Type and reference	Semantics description	Version
CHOICE <i>system</i>	MP				
>GSM					
>>Mobile Station Classmark 2	MP		Octet string (5)	This IE is formatted as 'TLV' and is coded in the same way as the <i>Mobile Station Classmark 2</i> information element in [5]. The first octet is the <i>Mobile station classmark 2 IEI</i> and its value shall be set to 33H (except in the case of NOTE 2). The second octet is the <i>Length of mobile station classmark 2</i> and its value shall be set to 3. The octet 3 contains the first octet of the value part of the <i>Mobile Station Classmark 2</i> information element, the octet 4 contains the second octet of the value part of the <i>Mobile Station Classmark 2</i> information element and so on. For each of these octets, the first/ leftmost/ most significant bit of the octet contains b8 of the corresponding octet of the <i>Mobile Station Classmark 2</i> . See NOTE 2.	
>>Mobile Station Classmark 3	MP		Octet string (1..32)	This IE is formatted as 'V' and is coded in the same way as the value part in the <i>Mobile station classmark 3</i> information element in [5]. The first octet contains octet 1 of the value part of <i>Mobile station classmark 3</i> , the second octet contains octet 2 of the value part of <i>Mobile station classmark 3</i> and so on.	

Information Element/Group name	Need	Multi	Type and reference	Semantics description	Version
				See NOTE 1, NOTE 2.	
>>MS Radio Access Capability	OP		Octet string (1..64)	This IE is formatted as 'V' and is coded in the same way as the value part in the <i>MS Radio Access Capability</i> information element in [5].	REL-6
>GERAN lu					REL-5
>>MS GERAN lu mode Radio Access Capability	MP		Bit string (1..170)	The first/leftmost/most significant bit of the bit string contains bit 8 of the first octet of the IE.	REL-5
>cdma2000					
>>cdma2000Message	MP	1.to.<maxInterSystemsMessages>			
>>>MSG_TYPE(s)	MP		Bit string (8)	Formatted and coded according to cdma2000 specifications. The first/leftmost/most significant bit of the bit string contains bit 7 of the MSG_TYPE.	
>>>cdma2000Messagepayload(s)	MP		Bit string (1..512)	Formatted and coded according to cdma2000 specifications. The first/leftmost/most significant bit of the bit string contains bit 7 of the first octet of the cdma2000 message.	
>E-UTRA					REL-8
>>UE E-UTRA Capability	MP		Octet string	Formatted and coded according to the <i>UE-EUTRA-Capability</i> information element in [67]. The first/leftmost/most significant bit of the first octet of the octetstring contains bit 8 of octet 1 of the <i>UE-EUTRA-Capability</i> IE.	REL-8
NOTE 1: The value part is specified by means of CSN.1, which encoding results in a bit string, to which final padding may be appended upto the next octet boundary [5]. The first/ leftmost/ most significant bit of the CSN.1 bit string is placed in the first/ leftmost/ most significant bit of the first octet. This continues until the last bit of the CSN.1 bit string, which is placed in the last/ rightmost/ least significant bit of the last octet.					
NOTE 2: The information in these IEs is optionally present in the INTER RAT HANDOVER INFO WITH INTER RAT CAPABILITIES message, otherwise it is mandatory present. If the information in the IEs "Mobile Station Classmark 2" and "Mobile Station Classmark 3" is not included, it is indicated by setting the first octet (IEI) of the IE "Mobile Station Classmark 2" to 00H. In this case, the receiver should ignore the value parts of the <i>Mobile Station Classmark 2</i> and the <i>Mobile Station Classmark 3</i> . The contents of those are set to zero.					

10.3.8.8 Void

10.3.8.8a Inter-RAT UE security capability

Information Element/Group name	Need	Multi	Type and reference	Semantics description	Version
CHOICE <i>system</i>	MP				
>GSM					
>>GSM security capability	MP			The value TRUE means that the indicated ciphering algorithm is supported.	
>>>A5/7 supported	MP		Boolean		
>>>A5/6 supported	MP		Boolean		
>>>A5/5 supported	MP		Boolean		
>>>A5/4 supported	MP		Boolean		
>>>A5/3 supported	MP		Boolean		
>>>A5/2 supported	MP		Boolean		
>>>A5/1 supported	MP		Boolean		

10.3.8.9 MIB Value tag

Information Element/Group name	Need	Multi	Type and reference	Semantics description	Version
MIB Value tag	MP		Integer (1..8)		
MIB Value tag extension	CV-MBMS		Integer (0..1)	NOTE 1	REL-12

NOTE 1: The MIB Value tag value equals IE "MIB Value tag" plus (IE "MIB Value tag extension" times 8).

Condition	Explanation
MBMS	This IE is not needed in MBMS MODIFIED SERVICES INFORMATION, otherwise it is optional.

10.3.8.10 PLMN Value tag

Information Element/Group name	Need	Multi	Type and reference	Semantics description
PLMN Value tag	MP		Integer (1..256)	

10.3.8.10a PNBSCH allocation

UTRAN may use this IE to provide silent periods in the cell that may be used for cell synchronisation purposes.

Information Element/Group name	Need	Multi	Type and reference	Semantics description	Version
Number of repetitions per SFN period	MP		Integer(2, 3, 4, 5, 6, 7, 8, 9, 10, 12, 14, 16, 18, 20, 24, 28, 32, 36, 40, 48, 56, 64, 72, 80)		REL-4

10.3.8.11 Predefined configuration identity and value tag

Information Element/Group name	Need	Multi	Type and reference	Semantics description
Predefined configuration identity	MP		Predefined configuration identity 10.3.4.5	
Predefined configuration value tag	MP		Predefined configuration value tag 10.3.4.6	

10.3.8.12 Protocol error information

This information element contains diagnostics information returned by the receiver of a message that was not completely understood.

Information Element/Group name	Need	Multi	Type and reference	Semantics description
CHOICE <i>diagnostics type</i>	MP			One spare value is needed.
>Protocol error cause			Protocol error cause 10.3.3.26	

10.3.8.13 References to other system information blocks

Information element/Group name	Need	Multi	Type and reference	Semantics description	Version
References to other system information blocks	MP	1 to <maxSIB>		System information blocks for which multiple occurrences are used, may appear more than once in this list	
>Scheduling information	MP		Scheduling information, 10.3.8.16	NOTE 1	
>SIB type SIBs only	MP		SIB Type SIBs only, 10.3.8.22		
References to other extension system information blocks	OP	1 to <maxSIB>		System information blocks for which multiple occurrences are used, may appear more than once in this list	REL-6
>Scheduling information	MP		Scheduling information, 10.3.8.16	NOTE 1	REL-6
>Extension SIB type	MP		SIB type extension 10.3.8.18b		REL-6
References to other extension system information blocks ²	OP	1 to <maxSIB>		System information blocks for which multiple occurrences are used, may appear more than once in this list	REL-8
>Scheduling information	MP		Scheduling information, 10.3.8.16	NOTE 1	REL-8
>Extension SIB type	MP		SIB type extension ² 10.3.8.18c		REL-8
References to GANSS system information blocks	OP	1 to <maxGANSS>			REL-8
>GANSS ID	OP		Integer (0..7)	Absence of this IE means Galileo. Coded as defined in NOTE 1 of 10.3.7.90b	REL-8
>SBAS ID	CV-GANSS-ID-SBAS		UE positioning GANSS SBAS ID 10.3.7.97e		REL-8
>GANSS system information blocks scheduling	MP	1 to <maxSIB>		System information blocks for which multiple occurrences are used, may appear more than once in this list	REL-8
>>Scheduling information	MP		Scheduling information, 10.3.8.16	NOTE 1	REL-8
>>GANSS SIB type	MP		GANSS SIB type 10.3.8.18d		REL-8

References to other extension system information blocks3	OP	1 to <maxSIB>		System information blocks for which multiple occurrences are used, may appear more than once in this list	REL-12
>Scheduling information	MP		Scheduling information, 10.3.8.16	NOTE 1	REL-12
>Extension SIB type	MP		SIB type extension 3 10.3.8.18ca		REL-12
NOTE 1: If this IE is present in the variable SYSTEM_INFORMATION_CONTAINER, the IE shall be discarded.					

Condition	Explanation
GANSS-ID-SBAS	This IE is mandatory present if the IE "GANSS ID" is "SBAS", and not needed otherwise.

10.3.8.13a References to other system information blocks 2

Information element/Group name	Need	Multi	Type and reference	Semantics description	Version
References to other system information blocks	MP	1 to <maxSIB2 >		System information blocks for which multiple occurrences are used, may appear more than once in this list	REL-12
>Scheduling information	MP		Scheduling information, 10.3.8.16	NOTE 1	REL-12
>SIB type SIBs only	MP		SIB type SIBs only 2 10.3.8.22ac		REL-12
NOTE 1: If this IE is present in the variable SYSTEM_INFORMATION_CONTAINER, the IE shall be discarded.					

10.3.8.14 References to other system information blocks and scheduling blocks

Information element/Group name	Need	Multi	Type and reference	Semantics description	Version
References to other system information blocks	MP	1 to <maxSIB>		System information blocks for which multiple occurrences are used, may appear more than once in this list	
>Scheduling information	MP		Scheduling information, 10.3.8.16	NOTE 1	
>SIB and SB type	MP		SIB and SB Type, 10.3.8.18a		
References to other extension system information blocks	OP	1 to <maxSIB>		System information blocks for which multiple occurrences are used, may appear more than once in this list	REL-6
>Scheduling information	MP		Scheduling information, 10.3.8.16	NOTE 1	REL-6
>Extension SIB type	MP		SIB type extension 10.3.8.18b		REL-6
References to other extension system information blocks ²	OP	1 to <maxSIB>		System information blocks for which multiple occurrences are used, may appear more than once in this list	REL-8
>Scheduling information	MP		Scheduling information, 10.3.8.16	NOTE 1	REL-8
>Extension SIB type	MP		SIB type extension ² 10.3.8.18c		REL-8
References to GANSS system information blocks	OP	1 to <maxGANSS>			REL-8
>GANSS ID	OP		Integer (0..7)	Absence of this IE means Galileo. Coded as defined in NOTE 1 of 10.3.7.90b	REL-8
>SBAS ID	CV-GANSS-ID-SBAS		UE positioning GANSS SBAS ID 10.3.7.97e		REL-8
>GANSS system information blocks scheduling	MP	1 to <maxSIB>		System information blocks for which multiple occurrences are used, may appear more than once in this list	REL-8
>>Scheduling information	MP		Scheduling information, 10.3.8.16	NOTE 1	REL-8
>>GANSS SIB type	MP		GANSS SIB type 10.3.8.18d		REL-8

References to other extension system information blocks3	OP	1 to <maxSIB>		System information blocks for which multiple occurrences are used, may appear more than once in this list	REL-12
>Scheduling information	MP		Scheduling information, 10.3.8.16	NOTE 1	REL-12
>SIB and SB type	MP		SIB type extension 3 10.3.8.18ca		REL-12
NOTE 1: If this IE is present in the variable SYSTEM_INFORMATION_CONTAINER, the IE shall be discarded.					

Condition	Explanation
GANSS-ID-SBAS	This IE is mandatory present if the IE "GANSS ID" is "SBAS", and not needed otherwise.

10.3.8.14a SB3 information

Information element/Group name	Need	Multi	Type and reference	Semantics description	Version
SEG_COUNT	MD		SEG COUNT 10.3.8.17	Default value is 1	REL-12
SIB_REP	MP		Integer (8, 16, 32, 64)		REL-12
BCH channelization code	MP		Integer(2..33)	Channelization code of the second system information broadcast channel (BCH mapped on S-CCPCH).	REL-12

10.3.8.15 Rplmn information

Contains information to provide faster RPLMN selection in the UE.

Information Element/Group name	Need	Multi	Type and reference	Semantics description	Version
GSM BA Range	OP	1 to maxNumG SMFreqRanges		GSM BA Range	
>GSM Lower Range (UARFCN)	MP		Integer(0..16 383)	Lower bound for range of GSM BA freqs	
>GSM Upper Range (UARFCN)	MP		Integer(0..16 383)	Upper bound for range of GSM BA freqs	
FDD UMTS Frequency list	OP	1 to maxNumF DDFreqs			
>UARFCN (Nlow)	MP		Integer(0..16 383)	[21]	
>UARFCN (Nupper)	OP		Integer(0..16 383)	[21] This IE is only needed when the FDD frequency list is specifying a range.	

Information Element/Group name	Need	Multi	Type and reference	Semantics description	Version
3.84 Mcps TDD UMTS Frequency list	OP	1 to maxNumT DDFreqs			
>UARFCN	MP		Integer(0..16 383)	[22]	
7.68 Mcps TDD UMTS Frequency list	OP	1 to maxNumT DDFreqs			REL-7
>UARFCN	MP		Integer(0..16 383)	[22]	REL-7
1.28 Mcps TDD UMTS Frequency list	OP	1 to maxNumT DDFreqs			REL-4
>UARFCN	MP		Integer(0..16 383)	[22]	REL-4
CDMA2000 UMTS Frequency list	OP	1 to maxNumC DMA200Freqs			
>BAND_CLASS	MP		Bit string(5 bits)	TIA/EIA/IS-2000 When mapping the BAND_CLASS to the bit string, the first/leftmost bit of the bit string contains the most significant bit..	
>CDMA_FREQ	MP		Bit string (11 bits)	TIA/EIA/IS-2000 When mapping the CDMA_FREQ to the bit string, the first/leftmost bit of the bit string contains the most significant bit..	

10.3.8.16 Scheduling information

Information Element/Group name	Need	Multi	Type and reference	Semantics description	Version
CHOICE Value tag	OP				
>PLMN Value tag			PLMN Value tag 10.3.8.10	This IE is included if the following conditions are fulfilled: the SIB type equals system information block type 1 Note: IE 'PLMN value tag' is used for SIB1 but the area scope for SIB 1 is Cell.	
>Predefined configuration identity and value tag			Predefined configuration identity and value tag 10.3.8.11	This IE is included if the following conditions are fulfilled: the SIB type equals system information block type 16	
>Cell Value tag			Cell Value tag 10.3.8.4	This IE is included if the following conditions are fulfilled: the SIB type does not equal system information block type 1; and the area scope for the system information block is set to "cell" in table 8.1.1; and a value tag is used to indicate changes in the system information block.	

Information Element/Group name	Need	Multi	Type and reference	Semantics description	Version
>Cell Value tag extension	OP		Integer(0..3)	This IE may be included if the following conditions are fulfilled: the SIB type equals system information block type 3, 5, 5bis, 21 or 22. NOTE 1.	REL-12
>SIB occurrence identity and value tag			SIB occurrence identity and value tag 10.3.8.20b	This IE is included if the following conditions are fulfilled: the SIB type equals system information block types 15.2, 15.2bis, 15.2ter, 15.3 and 15.3bis	
Scheduling	MP				
>SEG_COUNT	MD		SEG COUNT 10.3.8.17	Default value is 1	
	MD		SEG COUNT 10.3.8.17	Default value is size of SIB_POS offset info plus one when SIB_POS offset info is present, otherwise it is 1. NOTE 2.	REL-12
>SIB_REP	MP		Integer (4, 8, 16, 32, 64, 128, 256, 512, 1024, 2048, 4096)	Repetition period for the SIB in frames	
>SIB_POS	MP		Integer (0 ..Rep-2 by step of 2)	Position of the first segment Rep is the value of the SIB_REP IE	
>SIB_POS offset info	MD	1..15		see below for default value	
>>SIB_OFF	MP		Integer(2..32 by step of 2)	Offset of subsequent segments	
	MD		Integer(2..32 by step of 2)	Offset of subsequent segments. Default value is 2. NOTE 3.	REL-12

Field	Default value
SIB_POS offset info	The default value is that all segments are consecutive, i.e., that the SIB_OFF = 2 for all segments except when MIB segment/complete MIB is scheduled to be transmitted in between segments from same SIB. In that case, SIB_OFF=4 in between segments which are scheduled to be transmitted at $SFN_{prime} = 8 * n - 2$ and $8 * n + 2$, and SIB_OFF=2 for the rest of the segments.

NOTE 1: The Cell Value tag value equals IE "Cell Value tag" plus (IE "Cell Value tag extension" times 4).

NOTE 2: The UE behaviour is unspecified when no value is transmitted for system information that is not of REL-12 or later, and the system information consists of more than one segment.

NOTE 3: The UE behaviour is unspecified when no value is transmitted for system information that is not of REL-12 or later.

10.3.8.17 SEG COUNT

Information Element/Group name	Need	Multi	Type and reference	Semantics description
SEG_COUNT	MP		Integer (1..16)	Number of segments in the system information block

10.3.8.18 Segment index

Each system information segment has an individual segment index.

Information Element/Group name	Need	Multi	Type and reference	Semantics description
Segment index	MP		Integer (1..15)	Segments of a system information block are numbered starting with 0 for the first segment and 1 for the next segment, which can be the first subsequent segment or a last segment.

10.3.8.18a SIB and SB type

The SIB type identifies a specific system information block.

Information Element/Group name	Need	Multi	Type and reference	Semantics description
SIB and SB type	MP		Enumerated, see below	Two spare values are needed

List of enumerated values	Version
System Information Type 1, System Information Type 2, System Information Type 3, System Information Type 4, System Information Type 5, System Information Type 6, System Information Type 7, System Information Type 11, System Information Type 12, System Information Type 13, System Information Type 13.1, System Information Type 13.2, System Information Type 13.3, System Information Type 13.4, System Information Type 14, System Information Type 15, System Information Type 15.1, System Information Type 15.2, System Information Type 15.3, System Information Type 15.4, System Information Type 15.5, System Information Type 16, System Information Type 17, System Information Type 18, Scheduling Block 1, Scheduling Block 2, System Information Type 5bis	REL-6

10.3.8.18b SIB type extension

The SIB type identifies a specific extension system information block.

Information Element/Group name	Need	Multi	Type and reference	Semantics description	Version
SIB type extension	MP		Enumerated, see below		REL-6

List of enumerated values	Version
System Information Type 11bis	REL-6
System Information Type 15bis, System Information Type 15.1bis, System Information Type 15.2bis, System Information Type 15.3bis, System Information Type 15.6, System Information Type 15.7 System Information Type 15.8	REL-7

10.3.8.18c SIB type extension2

The SIB type identifies a specific extension system information block.

Information Element/Group name	Need	Multi	Type and reference	Semantics description	Version
SIB type extension2	MP		Enumerated, see below		REL-8

List of enumerated values	Version
System Information Type 19	REL-8
System Information Type 15.2ter	
System Information Type 20	
System Information Type 21	REL-11
System Information Type 22	REL-11
System Information Type 15.1ter	REL-12
System Information Type 23	REL-12
System Information Type 24	REL-12

10.3.8.18ca SIB type extension3

The SIB type identifies a specific extension system information block.

Information Element/Group name	Need	Multi	Type and reference	Semantics description	Version
SIB type extension3	MP		Enumerated, see below	Seven spare values are needed	REL-12

List of enumerated values	Version
System Information Type 11ter	REL-12

10.3.8.18d GANSS SIB type

The GANSS SIB type identifies a GANSS specific system information block.

Information Element/Group name	Need	Multi	Type and reference	Semantics description	Version
GANSS SIB type	MP		Enumerated, see below	Nine spare value is needed	REL-8

List of enumerated values	Version
System Information Type 15.1bis, System Information Type 15.2bis, System Information Type 15.2ter, System Information Type 15.3bis, System Information Type 15.6, System Information Type 15.7 System Information Type 15.8	REL-8

10.3.8.19 SIB data fixed

Contains the result of a master information block or a system information block after encoding and segmentation. The IE is used for segments with fixed length (segments filling an entire transport block).

Information Element/Group name	Need	Multi	Type and reference	Semantics description
SIB data fixed	MP		Bit string (222)	The first bit contains the first bit of the segment.

10.3.8.19a SIB data fixed 2

Contains the result of a system information block after encoding and segmentation. The IE is used for segments with fixed length (segments filling an entire transport block). The IE is used on the second system information broadcast channel (BCH on SCCPCH).

Information Element/Group name	Need	Multi	Type and reference	Semantics description
SIB data fixed	MP		Bit string (232)	The first bit contains the first bit of the segment.

10.3.8.20 SIB data variable

Contains either a complete system information block or a segment of a system information block. Contains the result of a master information block or a system information block after encoding and segmentation. The IE is used for segments with variable length. The system information blocks are defined in clauses 10.2.48.8.1 to 10.2.48.8.18.

Information Element/Group name	Need	Multi	Type and reference	Semantics description
SIB data variable	MP		Bit string (1..214)	The first bit contains the first bit of the segment.

10.3.8.20o SIB data variable 2

Contains either a complete system information block or a segment of a system information block. Contains the result of a system information block after encoding and segmentation. The IE is used for segments with variable length. The system information blocks are defined in clauses 10.2.48.8.1 to 10.2.48.8.18. The IE is used on the second system information broadcast channel (BCH on SCCPCH).

Information Element/Group name	Need	Multi	Type and reference	Semantics description
SIB data variable	MP		Bit string (1..224)	The first bit contains the first bit of the segment.

10.3.8.20a SIB occurrence identity

This information element identifies a SIB occurrence for System Information Block types 15.2, 15.2bis, 15.2ter, 15.3 and 15.3bis. For System Information Block type 15.2, 15.2bis and 15.2ter, this identity is assigned to the visible satellite only. Unused identities are claimed by newly rising satellites.

Information Element/Group name	Need	Multi	Type and reference	Semantics description
SIB occurrence identity	MP		Integer (0..15)	

10.3.8.20b SIB occurrence identity and value tag

Information Element/Group name	Need	Multi	Type and reference	Semantics description
SIB occurrence identity	MP		SIB occurrence identity 10.3.8.20a	
SIB occurrence value tag	MP		SIB occurrence value tag 10.3.8.20c	

10.3.8.20c SIB occurrence value tag

This information element is used to identify different versions of SIB occurrence for System Information Block types 15.2, 15.2bis, 15.2ter, 15.3 and 15.3bis.

Information Element/Group name	Need	Multi	Type and Reference	Semantics description
SIB occurrence value tag	MP		Integer(0..15)	

10.3.8.21 SIB type

The SIB type identifies a specific system information block.

Information Element/Group name	Need	Multi	Type and reference	Semantics description
SIB type	MP		Enumerated, see below	NOTE 1
NOTE 1: If the value "Extension Type" is signalled, the UE shall use the scheduling information in the MIB and, if present, in the SB1 and SB2 to identify the specific type of system information block.				

List of enumerated values	Version
Master information block, System Information Type 1, System Information Type 2, System Information Type 3, System Information Type 4, System Information Type 5, System Information Type 6, System Information Type 7, System Information Type 11, System Information Type 12, System Information Type 13, System Information Type 13.1, System Information Type 13.2, System Information Type 13.3, System Information Type 13.4, System Information Type 14, System Information Type 15, System Information Type 15.1, System Information Type 15.2, System Information Type 15.3, System Information Type 15.4, System Information Type 15.5, System Information Type 16, System Information Type 17, System Information Type 18, Scheduling Block 1, Scheduling Block 2,	
System Information Type 5bis, Extension Type	REL-6

10.3.8.22 SIB type SIBs only

The SIB type identifies a specific system information block.

Information Element/Group name	Need	Multi	Type and reference	Semantics description
SIB type SIBs only	MP		Enumerated, see below	Four spare values are needed

List of enumerated values	Version
System Information Type 1, System Information Type 2, System Information Type 3, System Information Type 4, System Information Type 5, System Information Type 6, System Information Type 7, System Information Type 11, System Information Type 12, System Information Type 13, System Information Type 13.1, System Information Type 13.2, System Information Type 13.3, System Information Type 13.4, System Information Type 14, System Information Type 15, System Information Type 15.1, System Information Type 15.2, System Information Type 15.3, System Information Type 15.4, System Information Type 15.5, System Information Type 16, System Information Type 17, System Information Type 18,	
System Information Type 5bis	REL-6

10.3.8.22ab SIB and SB type 2

The SIB and SB type 2 identifies a specific system information block or scheduling block on the second system information broadcast channel.

Information Element/Group name	Need	Multi	Type and reference	Semantics description
SIB and SB type 2	MP		Enumerated, see below	Twenty-one spare values are needed

List of enumerated values	Version
Scheduling Block 3, System Information Type 1, System Information Type 2, System Information Type 3, System Information Type 4, System Information Type 5, System Information Type 5bis, System Information Type 6, System Information Type 7, System Information Type 11, System Information Type 11bis, System Information Type 12, System Information Type 13, System Information Type 13.1, System Information Type 13.2, System Information Type 13.3, System Information Type 13.4, System Information Type 14, System Information Type 15, System Information Type 15bis, System Information Type 15.1, System Information Type 15.1bis, System Information Type 15.1ter, System Information Type 15.2, System Information Type 15.2bis, System Information Type 15.2ter, System Information Type 15.3, System Information Type 15.3bis, System Information Type 15.4, System Information Type 15.5, System Information Type 15.6, System Information Type 15.7, System Information Type 15.8, System Information Type 16, System Information Type 17, System Information Type 18, System Information Type 19, System Information Type 20, System Information Type 21, System Information Type 22, System Information Type 23, System Information Type 24, System Information Type 11ter	REL-12

10.3.8.22ac SIB type SIBs only 2

The SIB type identifies a specific system information block on the second system information broadcast channel.

Information Element/Group name	Need	Multi	Type and reference	Semantics description
SIB type SIBs only	MP		Enumerated, see below	Twenty-two spare values are needed

List of enumerated values	Version
System Information Type 1, System Information Type 2, System Information Type 3, System Information Type 4, System Information Type 5, System Information Type 5bis, System Information Type 6, System Information Type 7, System Information Type 11, System Information Type 11bis System Information Type 12, System Information Type 13, System Information Type 13.1, System Information Type 13.2, System Information Type 13.3, System Information Type 13.4, System Information Type 14, System Information Type 15, System Information Type 15bis, System Information Type 15.1, System Information Type 15.1bis, System Information Type 15.1ter, System Information Type 15.2, System Information Type 15.2bis, System Information Type 15.2ter, System Information Type 15.3, System Information Type 15.3bis, System Information Type 15.4, System Information Type 15.5, System Information Type 15.6, System Information Type 15.7 System Information Type 15.8, System Information Type 16, System Information Type 17, System Information Type 18, System Information Type 19, System Information Type 20, System Information Type 21, System Information Type 22, System Information Type 23, System Information Type 24, System Information Type 11ter	

10.3.8.23 UE History Information

Information element/Group name	Need	Multi	Type and reference	Semantics description	Version
UE inactivity period	MP		Integer (1..120)	Provides expired time since last u-plane activity. If the integer value x is between 1 and 59, it represents the expired time x in seconds. If the integer value x is between 60 and 119, it represents the expired time (x-59) in minutes. If integer value is set to 120, no u-plane activity has been for 60 minutes or more.	REL-8
UE Mobility State indicator	OP		Enumerated (High-mobilityDetected)	Absence of this IE implies that, according to [4] either the High mobility state is not applicable or it has not been detected by the UE.	REL-8
UL data volume history	OP		Data volume history 10.3.8.24		REL-8
DL data volume history	OP		Data volume history 10.3.8.24		REL-8

10.3.8.24 Data volume history

Information element/Group name	Need	Multi	Type and reference	Semantics description	Version
Data volume monitoring window	MP		Integer (1..120)	If the integer value x is between 1 and 59, it represents seconds. If the integer value is between 60 and 120, it represents the value minus 59 in minutes.	REL-8
Data transmission frequency	OP		Integer (100, 250, 500, 1000, 2000, 5000, 10000, 60000)	In ms	REL-8
>Data transmission frequency granularity	MP		Integer (100, 250, 500, 1000, 2000, 5000, 10000, 60000)	In ms	REL-8
>Number of data transmission occasions	MP		Integer (0..610)	Measure of data transmission frequency. The data volume monitoring window is organised in time periods of "Data transmission frequency granularity", and each transmission within such a period is counted.	REL-8
Data volume per RB	OP	1 to <maxRB>			REL-8
>RB identity	MP		RB identity 10.3.4.16		REL-8
>Data volume	MP		Integer (0..4294967295)	Data volume monitored during the data volume monitoring window, in byte.	REL-8

10.3.9 ANSI-41 Information elements

10.3.9.1 ANSI-41 Core Network Information

Information element/Group name	Need	Multi	Type and reference	Semantics description
P_REV	MP		P_REV 10.3.9.10	
MIN_P_REV	MP		MIN_P_REV 10.3.9.8	
SID	MP		SID 10.3.9.11	
NID	MP		NID 10.3.9.9	

10.3.9.2 ANSI-41 Global Service Redirection information

This Information Element contains ANSI-41 Global Service Redirection information.

Information Element/Group name	Need	Multi	Type and reference	Semantics description
ANSI-41 Global Service Redirection information	MP		ANSI-41 NAS parameter, 10.3.9.3	Formatted and coded according to the 3GPP2 document "G3G CDMA DS on ANSI-41"

10.3.9.3 ANSI-41 NAS parameter

This Information Element contains ANSI-41 User Zone Identification information.

Information Element/Group name	Need	Multi	Type and reference	Semantics description
ANSI-41 NAS parameter	MP		Bit string (size (1..2048))	The first bit contains the first bit of the ANSI-41 information.

10.3.9.4 ANSI-41 NAS system information

This Information Element contains ANSI-41 system information.

Information Element/Group name	Need	Multi	Type and reference	Semantics description
NAS (ANSI-41) system information	MP		ANSI-41 NAS parameter, 10.3.9.3	Formatted and coded according to the 3GPP2 document "G3G CDMA DS on ANSI-41"

10.3.9.5 ANSI-41 Private Neighbour List information

This Information Element contains ANSI-41 Private Neighbour List information.

Information Element/Group name	Need	Multi	Type and reference	Semantics description
ANSI-41 Private Neighbour List information	MP		ANSI-41 NAS parameter, 10.3.9.3	Formatted and coded according to the 3GPP2 document "G3G CDMA DS on ANSI-41"

10.3.9.6 ANSI-41 RAND information

This Information Element contains ANSI-41 RAND information.

Information Element/Group name	Need	Multi	Type and reference	Semantics description
ANSI-41 RAND information	MP		ANSI-41 NAS parameter, 10.3.9.3	Formatted and coded according to the 3GPP2 document "G3G CDMA DS on ANSI-41"

10.3.9.7 ANSI-41 User Zone Identification information

This Information Element contains ANSI-41 User Zone Identification information.

Information Element/Group name	Need	Multi	Type and reference	Semantics description
ANSI-41 User Zone Identification information	MP		ANSI-41 NAS parameter, 10.3.9.3	Formatted and coded according to the 3GPP2 document "G3G CDMA DS on ANSI-41"

10.3.9.8 MIN_P_REV

This Information Element contains minimum protocol revision level.

Information Element/Group name	Need	Multi	Type and reference	Semantics description
MIN_P_REV	MP		Bit string (8)	Minimum protocol revision level. The first/leftmost bit of the bit string contains the most significant bit of the MIN_P_REV.

10.3.9.9 NID

This Information Element contains Network identification.

Information Element/Group name	Need	Multi	Type and reference	Semantics description
NID	MP		Bit string (16)	Network identification. The first/leftmost bit of the bit string contains the most significant bit of the NID.

10.3.9.10 P_REV

This Information Element contains protocol revision level.

Information Element/Group name	Need	Multi	Type and reference	Semantics description
P_REV	MP		Bit string (8)	Protocol revision level. The first/leftmost bit of the bit string contains the most significant bit of the P_REV.

10.3.9.11 SID

This Information Element contains System identification.

Information Element/Group name	Need	Multi	Type and reference	Semantics description
SID	MP		Bit string (15)	System identification. The first/leftmost bit of the bit string contains the most significant bit of the SID.

10.3.9a MBMS Information elements

10.3.9a.1 MBMS Common CCTrCH identity

Identifies a Coded Composite Transport channel configuration included within the MBMS COMMON P-T-M RB INFORMATION message.

Information element/Group name	Need	Multi	Type and reference	Semantics description	Version
MBMS Common CCTrCh identity	MP		Integer (1..32)		REL-6

10.3.9a.2 MBMS Common PhyCh identity

Identifies a physical channel configuration included within the MBMS COMMON P-T-M RB INFORMATION message.

Information element/Group name	Need	Multi	Type and reference	Semantics description	Version
MBMS Common PhyCh identity	MP		Integer (1..32)		REL-6

10.3.9a.3 MBMS Common RB identity

Identifies a radio bearer channel configuration included within the MBMS COMMON P-T-M RB INFORMATION message.

Information element/Group name	Need	Multi	Type and reference	Semantics description	Version
MBMS Common RB identity	MP		Integer (1..32)		REL-6

10.3.9a.4 MBMS Common TrCh identity

Identifies a transport channel configuration included within the MBMS COMMON P-T-M RB INFORMATION message.

Information element/Group name	Need	Multi	Type and reference	Semantics description	Version
MBMS Common TrCh identity	MP		Integer (1..32)		REL-6

10.3.9a.5 MBMS Current cell S-CCPCH identity

Identifies one of the current cell's Secondary CCPCH's.

Information element/Group name	Need	Multi	Type and reference	Semantics description	Version
MBMS Current cell S-CCPCH identity	MP		Integer (1..maxSC CPCH)		REL-6

10.3.9a.6 Void

10.3.9a.7 MBMS L1 combining schedule

Includes information about the MBMS L1 combining schedule.

Information element/Group name	Need	Multi	Type and reference	Semantics description	Version
MBMS L1 combining cycle length	MP		Enumerated (32, 64, 128, 256, 512, 1024)	In number of radio frames	REL-6
MBMS L1 combining cycle offset	MD		Integer (0.. MBMS L1 combining cycle length - 4) by step of 4	Start of the L1 combining cycle (relative to the timing of the current cell) in number of radio frames. Default value is no offset	REL-6
MTCH L1- combining period list	MP	1 to < maxMBMS-L1CP>		One or more periods in which L1 combining is performed	REL-6
>Start	MP		Integer (0.. MBMS L1 combining cycle length - 4) by step of 4	Number of frames from the end of the previous combining period or the start of the cycle (for the first period)	REL-6
>Duration	MP		Integer (4.. MBMS L1 combining cycle length) by step of 4	Number of frames (see note)	REL-6

NOTE: The MTCH L1- combining period should indicate one or more complete TTIs.

10.3.9a.7o MBMS p-t-m activation time

Information Element/Group name	Need	Multi	Type and reference	Semantics description	Version
MBMS p-t-m activation time	MP		Integer (0..2047)	The 11 LSB of the SFN. Note 1 and 2.	REL-6
Note 1: The "MBMS p-t-m activation time" indicates the start of the 10 ms frame corresponding to the indicated SFN value and of the primary CCPCH of the cell where this IE is transmitted.					
Note 2: The range of the "MBMS p-t-m activation time" is from 10 ms after the beginning of the MCCH modification period wherein it is transmitted and to the end of next following MCCH modification period. The UE shall consider a value out of this range as expired.					

10.3.9a.7a MBMS p-t-m RB information

Includes information about an MBMS p-t-m radio bearers mapped on a TrCH.

Information element/Group name	Need	Multi	Type and reference	Semantics description	Version
RB information	<i>CV-Curr</i>		MBMS Common RB identity 10.3.9a.3		REL-6
MBMS short transmission ID	MP		MBMS Short transmission identity 10.3.9a.10		REL-6
MBMS logical channel identity	MP		Integer (1..15)	This identifier is used to distinguish different MTCH mapped on to a TrCh ("MBMS-Id" within the MAC header[15])	REL-6
L1 combining status	<i>CV-Neigh</i>		Boolean	The IE is only applicable in case of partial L1 combining, in which case value TRUE means that L1 combining is used for this radio bearer	REL-6

Condition	Explanation
<i>Curr</i>	The IE is mandatory present if the IE "MBMS p-t-m RB information list" is included in the MBMS CURRENT CELL P-T-M RB INFORMATION message and not needed otherwise
<i>Neigh</i>	The IE is mandatory present if the IE "MBMS p-t-m RB information list" is included in the MBMS NEIGHBOURING CELL P-T-M RB INFORMATION message and not needed otherwise

10.3.9a.7b MBMS Selected Service Info

This IE indicates whether the UE has any MBMS Selected Services, and if it does it includes the list of MBMS Selected Services.

Information element/Group name	Need	Multi	Type and reference	Semantics description	Version
CHOICE <i>Status</i>					
>None				(no data)	
>Some	MP		MBMS Selected Services Full 10.3.9a.7c		REL-6

10.3.9a.7c MBMS Selected Services Full

This IE provides the MBMS Selected Services by means of the full identity.

Information element/Group name	Need	Multi	Type and reference	Semantics description	Version
MBMS Selected Services	MP	1 to <maxMBMSservSelect>			REL-6
>MBMS Selected Service ID	MP		MBMS service identity 10.3.9a.8		REL-6

10.3.9a.7d MBMS Selected Services Short

This IE indicates the MBMS Selected Services by means of a short identity to identify the MBMS transmission by referencing the services included in the MBMS MODIFIED SERVICES INFORMATION and the MBMS UNMODIFIED SERVICES INFORMATION messages.

Information element/Group name	Need	Multi	Type and reference	Semantics description	Version
MBMS Selected Services	MP	1 to <maxMBMSservSelect>			REL-6
>MBMS Selected Service ID	MP		MBMS Short transmission identity 10.3.9a.10		REL-6
Modification period identity	MP		Integer (0..1)	Indicates the modification period the MBMS short transmission identities refer to	REL-6

10.3.9a.8 MBMS Service identity

Includes information about the identity of an MBMS service.

Information element/Group name	Need	Multi	Type and reference	Semantics description	Version
MBMS Service ID	MP		MBMS Service ID 10.3.9a.8a		REL-6
CHOICE <i>PLMN identity</i>	MP				REL-6
> <i>SameAsMIB</i>				(No data) The PLMN identity is the same as indicated by the IE "PLMN identity" in MIB	REL-6
> <i>SameAsMIB-MultiPLMN-Id</i>					REL-6
>>Multi PLMN id	MP		Integer (1..5)	The PLMN identity is one of the PLMN identities (1 to 5) in the IE "Multiple PLMN List" in MIB	REL-6
> <i>ExplicitPLMN-Id</i>					REL-6
>>PLMN identity	MP		PLMN identity 10.3.1.11		REL-6

10.3.9a.8a MBMS Service ID

Uniquely identifies an MBMS bearer service within a PLMN.

Information element/Group name	Need	Multi	Type and reference	Semantics description	Version
MBMS Service ID	MP		Octet string (3)	The content of the MBMS Service ID field is coded as octets 3 to 5 of the IE <i>Temporary Mobile Group Identity</i> [5]	REL-6

10.3.9a.9 MBMS Session identity

Includes information about the the identity of a session of an MBMS service.

Information element/Group name	Need	Multi	Type and reference	Semantics description	Version
MBMS Session ID	MP		Octet string (1)		REL-6

10.3.9a.10 MBMS Short transmission identity

Includes a short identity of the MBMS transmission identity, which concerns a session of a specific service.

Information element/Group name	Need	Multi	Type and reference	Semantics description	Version
MBMS short transmission identity	MP		Integer (1..maxMBMSservUnmodif)	Reference/ index to a transmission listed in the MBMS MODIFIED SERVICES INFORMATION or MBMS UNMODIFIED SERVICES INFORMATION	REL-6

10.3.9a.10a MBMS Soft Combining Timing Offset

Indicates the timing offset applied in the CFN calculation in sub-clause 8.5.15.5 for a secondary CCPCH carrying only MBMS logical channels. It is used for FDD only.

Information Element/Group name	Need	Multi	Type and reference	Semantics description	Version
>MBMS Soft Combining Timing Offset	MP		Integer (0, 10, 20, 40)	Timing offset applied in the CFN calculation in sub-clause 8.5.15.5, in ms.	REL-6

10.3.9a.11 MBMS specific timers and counters

Includes MBMS specific timers and counters.

Information element/Group name	Need	Multi	Type and reference	Semantics description	Version
T318	MD		Integer(25 0... 2000 by step of 250, 3000, 4000, 6000, 8000, 10000, 12000, 16000)	Value in milliseconds. Default value is 1000.	REL-6

10.3.9a.12 MBMS Transmission identity

Includes information about the MBMS transmission identity, which concerns a session of a specific service.

Information element/Group name	Need	Multi	Type and reference	Semantics description	Version
MBMS Service ID	MP		MBMS Service identity 10.3.9a.8		REL-6
MBMS Session ID	OP		MBMS Session identity 10.3.9a.9		REL-6

10.3.9a.12a MBSFN frequency list

Information Element/Group name	Need	Multi	Type and reference	Semantics description	Version
MBSFN frequency list	MP	0 to <maxMBS FNclusters >			REL-7
>MBSFN frequency	MP		Frequency info 10.3.6.36		REL-7
>IMB indication	OP		Enumerated (TRUE)	If present: 3.84 Mcps TDD MBSFN IMB is applied on this frequency.	REL-8
>Cell parameter ID	OP	<0..127>	Cell parameter Id 10.3.6.9	Only for 1.28 Mcps TDD [32]. NOTE 1	REL-7

NOTE 1: For 1.28 Mcps TDD the IE "Cell Parameter ID" indicates the cell which is providing MBMS service in MBSFN only mode on the corresponding frequency; if it is not included, the IE "MBSFN frequency" indicates the secondary frequency providing MBMS service in non-MBSFN only mode of current multi-frequency cell.

10.3.9a.12b MBSFN TDM Information List

Information element/Group name	Need	Multi	Type and reference	Semantics description	Version
MBSFN TDM Information List	MP	1 to <maxM BMSservUnmodified>			REL-7
>MBMS short transmission ID	MP		MBMS Short transmission identity 10.3.9a.10		REL-7
>TDM_Rep	MP		Integer (2..9)		REL-7
>TDM_Offset	MP		Integer (0..8)		REL-7
>TDM_Length	MP		Integer (1..8)		REL-7

10.3.9a.13 MCCH configuration information

Includes information about the MCCH configuration.

Information element/Group name	Need	Multi	Type and reference	Semantics description	Version
Access Info Period coefficient	MP		Integer (0..3)	Represents a , the access information coefficient. The number of repetitions per modification period equals 2^a while the actual access information period, in number of frames, equals $MP \text{ DIV } 2^a$	REL-6
Repetition Period coefficient	MP		Integer (0..3)	Represents r , the repetition period coefficient. The number of repetitions per modification period equals 2^r while the actual repetition period, in number of frames, equals $MP \text{ DIV } 2^r$	REL-6
Modification period coefficient	MP		Integer (7..10)	Represents m , the modification period coefficient. The actual modification period (MP), in number of frames, equals 2^m	REL-6
RLC info	MP		RLC info MBMS 10.3.4.23a		REL-6
TCTF presence	CV-MBMS		Enumerated (FALSE)	By default the TCTF is present even though the FACH only carries one logical channel (type). When this IE is included, the TCTF is absent	REL-6

Condition	Explanation
<i>MBMS</i>	This IE is not needed if the IE is contained within the IE "Secondary CCPCH system information", otherwise the IE is optional.

10.3.9a.14 MICH configuration information

Includes information about the MICH configuration.

Information element/Group name	Need	Multi	Type and reference	Semantics description	Version
MICH Power offset	MP		MICH Power offset 10.3.9a.15		REL-6
CHOICE <i>mode</i>	MP				REL-6
>FDD					REL-6
>>Channelisation code	MP		Integer (0..255)		REL-6
>>Number of NI per frame	MP		Integer (18, 36, 72, 144)		REL-6
>>STTD indicator	MP		STTD Indicator 10.3.6.78	If the cell is operating in MBSFN mode as indicated in subclause 8.1.1.6.3, the UE behaviour upon reception of this IE is unspecified.	REL-6
>TDD					REL-6
>>Timeslot number	MP		Timeslot number 10.3.6.84		REL-6
>>Midamble shift and burst type	MP		Midamble shift and burst type 10.3.6.41	For 1.28 Mcps TDD, if the cell is operating in MBSFN mode, the UE shall ignore the contents of this IE.	REL-6
>>CHOICE <i>TDD option</i>	MP				REL-6
>>>3.84 Mcps TDD					REL-6
>>>>Channelisation code	MP		Enumerated (16/1)...(16/16)		REL-6
>>>>7.68 Mcps TDD					REL-7
>>>>Channelisation code	MP		Enumerated (32/1)...(32/32)		REL-7
>>>>1.28 Mcps TDD					REL-6
>>>>>Codes list	MP	1 to 2			REL-6
>>>>>Channelisation code	MP		Enumerated (16/1)...(16/16)		REL-6
>>>>> MBSFN Special Time Slot	OP		Time Slot LCR Extension 10.3.6.83a	For 1.28 Mcps TDD MBSFN only mode, this IE indicates the SCCPCH is deployed on the MBSFN Special Time Slot [30]. The IE 'Timeslot number' shall be ignored if this IE appears.	REL-7
>>Repetition period/length	MD		Enumerated (4/2),(8/2), (8/4),(16/2), (16/4), (32/2),(32/4),(64/2),(64/4)	Default value is "(64/2)".	REL-6
>>Offset	MP		Integer (0...Repetition period - 1)	SFN mod Repetitionperiod = Offset.	REL-6

>>MBMS Notification indicator length	MD		Integer (4, 8, 16)	Indicates the length of one MBMS Notification indicator in bits. Default value is 4.	REL-6
>3.84 Mcps TDD MBSFN IMB					REL-8
>>Channelisation code	MP		Integer (0..255)	SF = 256; only the channelisation codes 2 to 15 are applicable	REL-8
>>Number of NI per frame	MP		Integer (16, 32, 64, 128)		REL-8

10.3.9a.15 MICH Power offset

This is the power transmitted on the MICH minus power of the Primary CPICH in FDD and Primary CCPCH Tx Power in TDD.

Information Element/Group name	Need	Multi	Type and reference	Semantics description	Version
MICH Power offset	MP		Integer(-10 .. +5)	Offset in dB	REL-6

10.3.9a.16 MSCH configuration information

Includes information about the MSCH configuration.

Information element/Group name	Need	Multi	Type and reference	Semantics description	Version
MSCH Scheduling information	MP			For FDD, scheduling information is provided starting at (SFN – (SCTO div 10ms)) mod MSCH_REP = MSCH_OFF For TDD, scheduling information is provided starting at SFN mod MSCH_REP = MSCH_OFF	REL-6
>Scheduling period	MD		Enumerated (32, 64, 128, 256, 512, 1024)	The period, in number of frames, between MBMS scheduling messages (MSCH_REP) Default value is the value included in the MBMS GENERAL INFORMATION message	REL-6
>Scheduling offset	MD		Integer (0..(MSCH_REP-1))	The position of MBMS scheduling messages relative to timing of the corresponding cell (MSCH_OFF) Default value is the value included in the MBMS GENERAL INFORMATION message	REL-6
>RLC info	MD		RLC info MBMS 10.3.4.23a	Default value is the one included in the MBMS GENERAL INFORMATION message	REL-6
TCTF presence	OP		Enumerated (FALSE)	By default the TCTF is present even though the FACH only carries one logical channel (type). When this IE is included, the TCTF is absent	REL-6

10.3.9a.17 Network Standard Time Information

NOTE: Only for 1.28Mcps TDD

This IE includes information about the Network Standard Time and a related SFN value. If Correlative SFN is absent, the default Correlative SFN is equal to zero, this means the "Network Standard Time" indicate the standard time value when SFN equal zero.

The "Network Standard Time" occupied 40 bits; the format refers to "ETSI EN 300 468 V1.5.1 (2003-05)".

Information Element/Group name	Need	Multi	Type and reference	Semantics description	Version
Network Standard Time	MP		BIT STRING (40)	Network Standard Time	REL-8
Correlative SFN	OP		Integer (0..4095)	System frame number which is correlative with Network Standard Time Information. If it is absent, Correlative SFN is equal to zero.	REL-8

10.3.9b WLAN Information elements

10.3.9b.1 WLAN Offload Configuration

This IE indicates information for RAN-assisted WLAN interworking.

Information Element/Group name	Need	Multi	Type and reference	Semantics description	Version
Threshold Serving RSCP	OP				REL-12
>Thresh _{ServingOffloadWLAN, Low}	MP		Integer (-119..-25 by step of 2)	RSCP, dBm	REL-12
>Thresh _{ServingOffloadWLAN, High}	MP		Integer (-119..-25 by step of 2)	RSCP, dBm	REL-12
Threshold Serving Ec/N0	OP				REL-12
>Thresh _{ServingOffloadWLAN, Low2}	MP		Integer (-24..0)	Ec/N0, dB	REL-12
>Thresh _{ServingOffloadWLAN, High2}	MP		Integer (-24..0)	Ec/N0, dB	REL-12
Threshold Channel Utilization	OP				REL-12
>Thresh _{ChUtilWLAN, Low}	MP		Integer (0..255)		REL-12
>Thresh _{ChUtilWLAN, High}	MP		Integer (0..255)		REL-12
Threshold Backhaul Bandwidth	OP				REL-12
>Thresh _{BackhRateDLWLAN, Low}	MP		WLAN Threshold Backhaul Rate 10.3.9b.4	Value in kbps.	REL-12
>Thresh _{BackhRateDLWLAN, High}	MP		WLAN Threshold Backhaul Rate 10.3.9b.4	Value in kbps.	REL-12
>Thresh _{BackhRateULWLAN, Low}	MP		WLAN Threshold Backhaul Rate 10.3.9b.4	Value in kbps.	REL-12
>Thresh _{BackhRateULWLAN, High}	MP		WLAN Threshold Backhaul Rate 10.3.9b.4	Value in kbps.	REL-12
Threshold Beacon RSSI	OP				REL-12
>Thresh _{BeaconRSSIWLAN, Low}	MP		Integer (0..255)	Actual value = IE value – 128 in dBm.	REL-12
>Thresh _{BeaconRSSIWLAN, High}	MP		Integer (0..255)	Actual value = IE value – 128 in dBm.	REL-12
Offload Preference Indicator	OP		Bitstring (16)	Parameter: OPI defined in [88]. Only applicable to RAN-assisted WLAN interworking based on ANDSF policies.	REL-12
T _{steeringWLAN}	OP		Integer (0..31)	Value in seconds. Only applicable to RAN-assisted WLAN interworking based on access network selection and traffic steering rules.	REL-12

10.3.9b.2 WLAN Identifier

This IE indicates the WLAN identifier for RAN-assisted WLAN interworking.

Information Element/Group name	Need	Multi	Type and reference	Semantics description	Version
SSID	OP		Octet string (1..32)	Service Set Identifier defined in IEEE 802.11-2012 [87].	REL-12
BSSID	OP		Octet string (6)	Basic Service Set Identifier defined in IEEE 802.11-2012 [87].	REL-12
HSSID	OP		Octet string (6)	Homogenous Extended Service Set Identifier defined in IEEE 802.11-2012 [87].	REL-12

10.3.9b.3 WLAN Offload Information

Information Element/Group name	Need	Multi	Type and reference	Semantics description	Version
WLAN Offload Configuration	CV- <i>Dedicated</i>		WLAN Offload Configuration 10.3.9b.1		REL-12
WLAN Identifier List	OP	1 to <maxWLANID>			REL-12
>WLAN Identifier	MP		WLAN Identifier 10.3.9b.2		REL-12

Condition	Explanation
<i>Dedicated</i>	The IE is mandatory present in the UTRAN MOBILITY INFORMATION or CELL UPDATE CONFIRM message. Otherwise the IE is optionally present.

10.3.9b.4 WLAN Threshold Backhaul Rate

Information Element/Group name	Need	Multi	Type and reference	Semantics description	Version
WLAN Threshold Backhaul Backhaul Rate	MP		Enumerated {r0, r4, r8, r16, r32, r64, r128, r256, r512, r1024, r2048, r4096, r8192, r16384, r32768, r65536, r131072, r262144, r524288, r1048576, r2097152, r4194304, r8388608, r16777216, r33554432, r67108864, r134217728, r268435456, r536870912, r1073741824, r2147483648, r4294967296}	Value in kbps.	REL-12

10.3.10 Multiplicity values and type constraint values

The following table includes constants that are either used as multi bounds (name starting with "max") or as high or low value in a type specification (name starting with "lo" or "hi"). Constants are specified only for values appearing more than once in the RRC specification. In case a constant is related to one or more other constants, an expression is included in the "value" column instead of the actual value.

Constant	Explanation	Value	Version
CN information			
maxCNdomains	Maximum number of CN domains	4	
UTRAN mobility information			
maxRAT	Maximum number of Radio Access Technologies	maxOtherRAT + 1	
maxOtherRAT	Maximum number of other Radio Access Technologies	15	
maxURA	Maximum number of URAs in a cell	8	
maxInterSysMessages	Maximum number of Inter System Messages	4	
maxRABsetup	Maximum number of RABs to be established	16	
maxDedicatedCSGfreq	Maximum number of dedicated CSG frequencies	4	REL-8
UE information			
maxtransactions	Maximum number of parallel RRC transactions in downlink	25	
maxPDCPaalgoType	Maximum number of PDCP algorithm types	8	
maxMultipleFrequencyBands FDD	Maximum number of additional frequency bands broadcasted in SIB5, SIB6, SIB11, SIB11bis, SIB11ter, SIB12	8	REL-10
maxMultipleFrequencyBands EUTRA	Maximum number of additional frequency bands broadcasted in SIB19	8	REL-10

Constant	Explanation	Value	Version
maxNumAccessGroups	Maximum number of Access Groups	16	REL-12
maxFreqBandsFDD	Maximum number of frequency bands as defined in [21] and treated by RRC	8	
maxFreqBandsFDD2	Maximum number of frequency bands as defined in [21] and treated by RRC	22	REL-6
maxFreqBandsFDD3	Maximum number of frequency bands as defined in [21] and treated by RRC	86	REL-10
maxFreqBandsFDD-ext	Used in asn.1 to signal additional bands maxFreqBandsFDD2 – (maxFreqBandsFDD-1)	15	REL-6
maxFreqBandsFDD-ext2	Used in asn.1 to signal additional bands maxFreqBandsFDD3 – maxFreqBandsFDD2	64	REL-10
maxFreqBandsFDD-ext3	Used in asn.1 to signal additional bands maxFreqBandsFDD3 – maxFreqBandsFDD	78	REL-10
maxFreqBandsTDD	Maximum number of frequency bands supported by the UE as defined in [22]	4	
maxFreqBandsTDD-ext	Maximum number of frequency bands supported by the UE as defined in [22]	16	REL-8
maxFreqBandsGSM	Maximum number of frequency bands supported by the UE as defined in [45]	16	
maxFreqBandsEUTRA	Maximum number of frequency bands supported by the UE as defined in [36.101]	16	REL-8
maxFreqBandsEUTRA-ext	Maximum number of frequency bands supported by the UE as defined in [36.101]	48	REL-11
maxFreqBandsIndicatorSupport	Maximum number of frequency bands broadcasted in SIB5/5bis	2	REL-10
maxPage1	Number of UEs paged in the Paging Type 1 message	8	
maxSystemCapability	Maximum number of system specific capabilities that can be requested in one message.	16	
MaxURNTIgroup	Maximum number of U-RNTI groups in one message	8	REL-5
maxCommonHRNTI	Maximum number of common H-RNTI per cell	4	REL-7
maxERNTIgroup	Maximum number of common E-RNTI group per cell (1.28 Mcps TDD)	32	REL-8
maxERNTIperGroup	Maximum number of common E-RNTI in a group (1.28 Mcps TDD)	2	REL-8
RB information			
maxPredefConfig	Maximum number of predefined configurations	16	
maxRB	Maximum number of RBs	32	
maxSRBsetup	Maximum number of signalling RBs to be established	8	
maxRBperRAB	Maximum number of RBs per RAB	8	
maxRBallRABs	Maximum number of non signalling RBs	27	
maxRBperTrCh	Maximum number of RB per TrCh	16	REL-6
maxRBMuxOptions	Maximum number of RB multiplexing options	8	
maxLoCHperRLC	Maximum number of logical channels per RLC entity	2	
maxRLCPDUsizePerLogChan	Maximum number of RLC PDU sizes per logical channel mapped on E-DCH	32	REL-6
MaxROHC-PacketSizes	Maximum number of packet sizes that are allowed to be produced by ROHC.	16	
MaxROHC-Profiles	Maximum number of profiles supported by ROHC on a given RB.	8	
maxRFC 3095-CID	Maximum number of available CID values per radio bearer	16384	REL-5
TrCH information			
maxCommonQueueID	Maximum number of common Mac-ehs queues	2	REL-7
maxE-DCHMACdFlow	Maximum number of E-DCH MAC-d flows	8	REL-6
MaxHProcesses	Maximum number of H-ARQ processes	8	REL-5
MaxHSDSCH_TB_index	Maximum number of TB set size configurations for the HS-DSCH.	64 (FDD and 1.28 MCPS TDD); 512 (3.84 Mcps TDD); 1024 (7.68 Mcps TDD)	REL-5

Constant	Explanation	Value	Version
maxMACdPDUSizes	Maximum number of MAC-d PDU sizes per queue permitted for MAC-hs	8	REL-5
maxTrCH	Maximum number of transport channels used in one direction (UL or DL)	32	
maxTrCHpreconf	Maximum number of preconfigured Transport channels, per direction	16	
maxNrOfConcatTrCH	Maximum number of DL Transport Channels of type DCH that are subject to concatenation in the physical layer	3	REL-12
maxCCTrCH	Maximum number of CCTrCHs	8	
maxQueueID	Maximum number of Mac-hs queues	8	REL-5
MaxTF	Maximum number of different transport formats that can be included in the Transport format set for one transport channel	32	
maxTFC	Maximum number of Transport Format Combinations	1024	
maxTFCsub	Maximum number of Transport Format Combinations Subset	1024	
maxSIBperMsg	Maximum number of complete system information blocks per SYSTEM INFORMATION message	16	
maxSIB	Maximum number of references to other system information blocks.	32	
maxSIB2	Maximum number of references to other system information blocks on second system information broadcast channel.	64	REL-12
maxSIB-FACH	Maximum number of references to system information blocks on the FACH	8	
PhyCH information			
maxHSSCCHs	Maximum number of HSSCCH codes that can be assigned to a UE	4	REL-5
maxHS-SCCHLessTrBlk	Maximum number of HS-DSCH Transport Block Sizes used for HS-SCCH-less operation	[4]	REL-7
maxTDD128Carrier	The maximum number of carriers for 1.28 Mcps TDD	6	REL-7
maxAC	Maximum number of access classes	16	
maxASC	Maximum number of access service classes	8	
maxASCmap	Maximum number of access class to access service classes mappings	7	
maxASCpersist	Maximum number of access service classes for which persistence scaling factors are specified	6	
maxPRACH	Maximum number of PRACHs in a cell	16	
maxEDCHs	Maximum number of common E-DCH resources in a cell	32	REL-8
maxPRACH_EUL	Maximum number of PRACH preamble control parameters (for Enhanced Uplink) in a cell	4	REL-11
MaxPRACH_FPACH	Maximum number of PRACH / FPACH pairs in a cell (1.28 Mcps TDD)	8	REL-4
maxFACHPCH	Maximum number of FACHs and PCHs mapped onto one secondary CCPCHs	8	
maxRL	Maximum number of radio links	8	
maxEDCHRL	Maximum number of E-DCH radio links	4	REL-6
maxSCCPCH	Maximum number of secondary CCPCHs per cell	16	
maxDPDCH-UL	Maximum number of DPDCHs per cell	6	
maxDPCH-DLchan	Maximum number of channelisation codes used for DL DPCH	8	
maxPUSCH	Maximum number of PUSCHs	(8)	
maxPDSCH	Maximum number of PDSCHs	8	
maxTS	Maximum number of timeslots used in one direction (UL or DL)	14 (3.84 Mcps TDD and 7.68 Mcps TDD)	
		6 (1.28 Mcps TDD)	REL-4
hiPUSCHidentities	Maximum number of PUSCH Identities	64	

Constant	Explanation	Value	Version
hiPDSCHidentities	Maximum number of PDSCH Identities	64	
maxNumE-AGCH	Maximum number of E-AGCHs (TDD)	4	REL-7
maxNumE-HICH	Maximum number of E-HICHs (1.28 Mcps TDD)	4	REL-7
maxERUCCH	Maximum number of E-RUCCH on primary frequency (1.28Mcps TDD)	256	REL-8
Measurement information			
maxTGPS	Maximum number of transmission gap pattern sequences	6	
maxAdditionalMeas	Maximum number of additional measurements for a given measurement identity	4	
maxExcludedDetectedSet Cells	Maximum number of cells that can be excluded from a detected set measurement	64	REL-11
maxNonContiguousMultiCell Combinations	Maximum number of non-contiguous multi-cell HSDPA combinations in one band	3	REL-10
maxMeasEvent	Maximum number of events that can be listed in measurement reporting criteria	8	
maxMeasEventOnSecULFreq	Maximum number of events that can be listed in measurement reporting criteria on the downlink frequency associated with secondary uplink frequency	8	REL-9
maxMeasIdentity	Maximum number of measurement identities that can be removed from variable MEASUREMENT_IDENTITY	32	REL-12
maxMeasParEvent	Maximum number of measurement parameters (e.g. thresholds) per event	2	
maxMeasIntervals	Maximum number of intervals that define the mapping function between the measurements for the cell quality Q of a cell and the representing quality value	1	
maxCellMeas	Maximum number of cells to measure	32	
maxCellMeas-ext	Maximum number of cells to measure	80	REL-12
maxCellMeas-ext2	Maximum number of cells to measure in SIB11ter	48	REL-12
maxMeasCSGRange	Maximum number of ranges of cells for CSG measurement	4	REL-9
maxSrequest	Maximum number of cell request for reading System Information	4	REL-9
maxCellMeasOnSecULFreq	Maximum number of cells to measure on the downlink frequency associated with the secondary uplink frequency	32	REL-9
maxReportedGSMCells	Maximum number of GSM cells to be reported	8	
maxReportedEUTRAFreqs	Maximum number of E-UTRA frequencies to report	4	REL-8
maxReportedEUTRAFreqs-ext	Maximum number of E-UTRA frequencies to report	8	REL-12
maxReportedEUTRACellperFreq	Maximum number of E-UTRA cells to report per frequency	4	REL-8
maxFreq	Maximum number of frequencies to measure	8	
maxFreqMeasWithoutCM	Maximum number of inter frequencies to measure without CM	2	REL-10
maxNumPrio	Maximum number of priorities to store	11	REL-8
maxPrio	Maximum number of RAT or Frequency Priority levels	8	REL-8
maxRMPfrequencies	Maximum number of UTRA inter-frequencies that the network can request to be measured with Reduced Measurement Performance.	8	REL-12
maxEUTRACellPerFreq	Maximum number of E-UTRA cells per frequency	16	REL-8
maxSat	Maximum number of satellites to measure	16	

Constant	Explanation	Value	Version
maxGANSSSat	Maximum number of GANSS satellites to measure	64	REL-7
maxGANSS	Maximum number of GANSS supported	8	REL-7
maxSgnType	Maximum number of additional signals in GANSS to measure	8	REL-7
maxSatClockModels	Maximum number of clock models in a GANSS	4	REL-7
maxSatAlmanacStorage	Maximum number of satellites for which to store GPS Almanac information	32	
HiRM	Maximum number that could be set as rate matching attribute for a transport channel	256	
maxDCHMeasurementOccasionPatternSequence	Maximum number of CELL_DCH measurement occasion pattern sequences	5	REL-9
maxIGPInfo	Maximum number of ionospheric grid points for BDS as defined in [86].	320	REL-12
Frequency information			
MaxFDDFreqList	Maximum number of FDD carrier frequencies to be stored in USIM	4	
MaxTDDFreqList	Maximum number of TDD carrier frequencies to be stored in USIM	4	
MaxFDDFreqCellList	Maximum number of neighbouring FDD cells to be stored in USIM	32	
MaxTDDFreqCellList	Maximum number of neighbouring TDD cells to be stored in USIM	32	
MaxGSMCellList	Maximum number of GSM cells to be stored in USIM	32	
Other information			
MaxGERANSI	Maximum number of GERAN SI blocks that can be provided as part of NACC information	8	REL-5
maxNumGSMFreqRanges	Maximum number of GSM Frequency Ranges to store	32	
MaxNumFDDFreqs	Maximum number of FDD centre frequencies to store	8	
MaxNumTDDFreqs	Maximum number of TDD centre frequencies to store	8	
maxNumCDMA200Freqs	Maximum number of CDMA2000 centre frequencies to store	8	

Constant	Explanation	Value	Version
maxGSMTARGETCells	Maximum number of GSM target cells	32	REL-6
maxNumGSMCellGroup	Maximum number of GSM frequency groups to store	16	REL-8
maxNumEUTRAFreqs	Maximum number of EUTRA centre frequencies to store	8	REL-8
maxNumEUTRAFreqs_FACH	Maximum number of EUTRA centre frequencies to store when in CELL_FACH	4	REL-11
maxNumEUTRAFreqs_FACH-ext	Maximum number of EUTRA centre frequencies to store when in CELL_FACH	8	REL-12
maxEUTRATargetFreqs	Maximum number of target E-UTRA frequencies	8	REL-8
maxHNBNameSize	Maximum number of octets for the HNB Name	48	REL-8
MBMS information			
maxMBMS-CommonCCTrCh	Maximum number of CCTrCh configurations included in the MBMS COMMON P-T-M RB INFORMATION message	32	REL-6
maxMBMS-CommonPhyCh	Maximum number of PhyCh configurations included in the MBMS COMMON P-T-M RB INFORMATION message	32	REL-6
maxMBMS-CommonRB	Maximum number of RB configurations included in the MBMS COMMON P-T-M RB INFORMATION message	32	REL-6
maxMBMS-CommonTrCh	Maximum number of TrCh configurations included in the MBMS COMMON P-T-M RB INFORMATION message	32	REL-6
maxMBMS-Freq	Maximum number of MBMS preferred frequencies	4	REL-6
maxMBMS-L1CP	Maximum number of periods in which layer 1 combining applies	4	REL-6
maxMBMSservCount	Maximum number of MBMS services in a Access Info message	8	REL-6
maxMBMSservModif	Maximum number of MBMS services in a MBMS MODIFIED SERVICES INFORMATION message	32	REL-6
maxMBMSservSched	Maximum number of MBMS services in a MBMS SCHEDULING INFORMATION message	16	REL-6
maxMBMSservSelect	Maximum number of MBMS Selected Services in a CELL UPDATE or RRC CONNECTION REQUEST message	8	REL-6
maxMBMSservUnmodif	Maximum number of MBMS services in a MBMS UNMODIFIED SERVICES INFORMATION message	64	REL-6
maxMBMSTransmis	Maximum number of transmissions for which scheduling information is provided within a scheduling period	4	REL-6
maxMBMS-Services	Maximum number of MBMS services the UE stores in the variable MBMS_ACTIVATED_SERVICES	64	REL-6
maxMBSFNclusters	Maximum number of MBSFN clusters indicated in system information	16	REL-7
Logged Measurement information			REL-10
MaxnumLoggedMeas	Maximum number of Cells or Frequencies that can be listed in Logged Measurement Report.	8	REL-10
MaxLoggedMeas	Maximum number of logged measurements entries that can be stored by the UE	4405	REL-10
MaxLoggedMeasReport	Maximum number of Logged Measurement Info sent in LoggedMeasReport	128	REL-10
MaxnumMDTPLMN	Maximum number of PLMNs in PLMN list for MDT	15	REL-11
ANR information			REL-10
MaxNumANRLoggedItems	Maximum number of entries in Logged ANR Report info	4	REL-10
WLAN information			REL-12
maxWLANID	Maximum number of WLAN identifiers	16	REL-12

10.3.11 Void

11 Message and Information element abstract syntax (with ASN.1)

This clause contains definitions for RRC PDUs and IEs using a subset of ASN.1 as specified in [14]. PDU and IE definitions are grouped into separate ASN.1 modules.

11.0 General

Some messages and/or IEs may include one or more IEs with name "dummy" that are included only in the ASN.1. The UE should avoid sending information elements that are named "dummy" to UTRAN. Likewise, UTRAN should avoid sending IEs with name "dummy" to the UE. If the UE anyhow receives an information element named "dummy", it shall ignore the IE and process the rest of the message as if the IE was not included.

NOTE: An IE with name "dummy" concerns an information element that was (erroneously) included in a previous version of the specification and has been removed by replacing it with a dummy with same type.

The UE shall only include the "variable length extension container" when it sends a non critical extension that according to this specification shall be transferred within this container.

If the abstract syntax of an IE is defined using the ASN.1 type "BIT STRING", and this IE corresponds to a functional IE definition in tabular format, in which the significance of bits is semantically defined, the following general rule shall be applied:

The bits in the ASN.1 bit string shall represent the semantics of the functional IE definition in decreasing order of bit significance;

- with the first (or leftmost) bit in the bit string representing the most significant bit; and
- with the last (or rightmost) bit in the bit string representing the least significant bit.

11.1 General message structure

```
Class-definitions DEFINITIONS AUTOMATIC TAGS ::=
```

```
BEGIN
```

```
IMPORTS
```

```

ActiveSetUpdate,
ActiveSetUpdateComplete,
ActiveSetUpdateFailure,
AssistanceDataDelivery,
CellChangeOrderFromUTRAN,
CellChangeOrderFromUTRANFailure,
CellUpdate,
CellUpdateFDD-r11,
CellUpdateConfirm-CCCH,
CellUpdateConfirm,
CounterCheck,
CounterCheckResponse,
DownlinkDirectTransfer,
ETWSPPrimaryNotificationWithSecurity,
HandoverToUTRANComplete,
InitialDirectTransfer,
HandoverFromUTRANCommand-EUTRA,
HandoverFromUTRANCommand-GERANIu,
HandoverFromUTRANCommand-GSM,
HandoverFromUTRANCommand-CDMA2000,
HandoverFromUTRANFailure,
LoggingMeasurementConfiguration,
MBMSAccessInformation,
```

```

MBMSCommonPTMRBInformation,
MBMSCurrentCellPTMRBInformation,
MBMSGeneralInformation,
MBMSModificationRequest,
MBMSModifiedServicesInformation,
MBMSNeighbouringCellPTMRBInformation,
MBMSSchedulingInformation,
MBMSUnmodifiedServicesInformation,
MeasurementControl,
MeasurementControlFailure,
MeasurementReport,
PagingType1,
PagingType2,
PhysicalChannelReconfiguration,
PhysicalChannelReconfigurationComplete,
PhysicalChannelReconfigurationFailure,
PhysicalSharedChannelAllocation,
PUSCHCapacityRequest,
RadioBearerReconfiguration,
RadioBearerReconfigurationComplete,
RadioBearerReconfigurationFailure,
RadioBearerRelease,
RadioBearerReleaseComplete,
RadioBearerReleaseFailure,
RadioBearerSetup,
RadioBearerSetupComplete,
RadioBearerSetupFailure,
RRCConnectionReject,
RRCConnectionRelease,
RRCConnectionRelease-CCCH,
RRCConnectionReleaseComplete,
RRCConnectionRequest,
RRCConnectionSetup,
RRCConnectionSetupComplete,
RRCStatus,
SecurityModeCommand,
SecurityModeComplete,
SecurityModeFailure,
SignallingConnectionRelease,
SignallingConnectionReleaseIndication,
SystemInformation-BCH,
SystemInformation2-BCH,
SystemInformation-FACH,
SystemInformationChangeIndication,
TransportChannelReconfiguration,
TransportChannelReconfigurationComplete,
TransportChannelReconfigurationFailure,
TransportFormatCombinationControl,
TransportFormatCombinationControlFailure,
UECapabilityEnquiry,
UECapabilityInformation,
UECapabilityInformationConfirm,
UEInformationRequest,
UEInformationResponse,
UplinkDirectTransfer,
UplinkPhysicalChannelControl,
URAUpdate,
URAUpdateConfirm,
URAUpdateConfirm-CCCH,
UTRANMobilityInformation,
UTRANMobilityInformationConfirm,
UTRANMobilityInformationFailure
FROM PDU-definitions

-- User Equipment IEs :
  IntegrityCheckInfo
FROM InformationElements;

--*****
--
-- Downlink DCCH messages
--
--*****

DL-DCCH-Message ::= SEQUENCE {
  integrityCheckInfo      IntegrityCheckInfo      OPTIONAL,
  message                 DL-DCCH-MessageType
}

```

```
DL-DCCH-MessageType ::= CHOICE {
    activeSetUpdate                ActiveSetUpdate,
    assistanceDataDelivery         AssistanceDataDelivery,
    cellChangeOrderFromUTRAN      CellChangeOrderFromUTRAN,
    cellUpdateConfirm             CellUpdateConfirm,
    counterCheck                  CounterCheck,
    downlinkDirectTransfer        DownlinkDirectTransfer,
    handoverFromUTRANCommand-GSM   HandoverFromUTRANCommand-GSM,
    handoverFromUTRANCommand-CDMA2000 HandoverFromUTRANCommand-CDMA2000,
    measurementControl            MeasurementControl,
    pagingType2                   PagingType2,
    physicalChannelReconfiguration PhysicalChannelReconfiguration,
    physicalSharedChannelAllocation PhysicalSharedChannelAllocation,
    radioBearerReconfiguration     RadioBearerReconfiguration,
    radioBearerRelease            RadioBearerRelease,
    radioBearerSetup              RadioBearerSetup,
    rrcConnectionRelease          RRCConnectionRelease,
    securityModeCommand           SecurityModeCommand,
    signallingConnectionRelease    SignallingConnectionRelease,
    transportChannelReconfiguration TransportChannelReconfiguration,
    transportFormatCombinationControl TransportFormatCombinationControl,
    ueCapabilityEnquiry           UECapabilityEnquiry,
    ueCapabilityInformationConfirm UECapabilityInformationConfirm,
    uplinkPhysicalChannelControl   UplinkPhysicalChannelControl,
    uraUpdateConfirm              URAUpdateConfirm,
    utranMobilityInformation       UTRANMobilityInformation,
    handoverFromUTRANCommand-GERANIu HandoverFromUTRANCommand-GERANIu,
    mbmsModifiedServicesInformation MBMSModifiedServicesInformation,
    etwsPrimaryNotificationWithSecurity ETWSPrimaryNotificationWithSecurity,
    handoverFromUTRANCommand-EUTRA HandoverFromUTRANCommand-EUTRA,
    ueInformationRequest          UEInformationRequest,
    loggingMeasurementConfiguration LoggingMeasurementConfiguration,
    spare1                        NULL
}

```

```
--*****
--
-- Uplink DCCH messages
--
--*****

```

```
UL-DCCH-Message ::= SEQUENCE {
    integrityCheckInfo      IntegrityCheckInfo      OPTIONAL,
    message                  UL-DCCH-MessageType
}

```

```
UL-DCCH-MessageType ::= CHOICE {
    activeSetUpdateComplete           ActiveSetUpdateComplete,
    activeSetUpdateFailure            ActiveSetUpdateFailure,
    cellChangeOrderFromUTRANFailure  CellChangeOrderFromUTRANFailure,
    counterCheckResponse              CounterCheckResponse,
    handoverToUTRANComplete           HandoverToUTRANComplete,
    initialDirectTransfer             InitialDirectTransfer,
    handoverFromUTRANFailure          HandoverFromUTRANFailure,
    measurementControlFailure         MeasurementControlFailure,
    measurementReport                 MeasurementReport,
    physicalChannelReconfigurationComplete PhysicalChannelReconfigurationComplete,
    physicalChannelReconfigurationFailure PhysicalChannelReconfigurationFailure,
    radioBearerReconfigurationComplete RadioBearerReconfigurationComplete,
    radioBearerReconfigurationFailure RadioBearerReconfigurationFailure,
    radioBearerReleaseComplete        RadioBearerReleaseComplete,
    radioBearerReleaseFailure         RadioBearerReleaseFailure,
    radioBearerSetupComplete          RadioBearerSetupComplete,
    radioBearerSetupFailure           RadioBearerSetupFailure,
    rrcConnectionReleaseComplete      RRCConnectionReleaseComplete,
    rrcConnectionSetupComplete        RRCConnectionSetupComplete,
    rrcStatus                          RRCStatus,
    securityModeComplete              SecurityModeComplete,
    securityModeFailure                SecurityModeFailure,
    signallingConnectionReleaseIndication SignallingConnectionReleaseIndication,
    transportChannelReconfigurationComplete TransportChannelReconfigurationComplete,
    transportChannelReconfigurationFailure TransportChannelReconfigurationFailure,

```

```

    transportFormatCombinationControlFailure
    ueCapabilityInformation          TransportFormatCombinationControlFailure,
    uplinkDirectTransfer            UECapabilityInformation,
    utranMobilityInformationConfirm UplinkDirectTransfer,
    utranMobilityInformationFailure UTRANMobilityInformationConfirm,
    mbmsModificationRequest        UTRANMobilityInformationFailure,
    ul-DCCH-MessageType-ext        MBMSModificationRequest,
}                                  UL-DCCH-MessageType-ext
}

UL-DCCH-MessageType-ext ::= CHOICE {
    ueInformationResponse          UEInformationResponse,
    spare15                        NULL,
    spare14                        NULL,
    spare13                        NULL,
    spare12                        NULL,
    spare11                        NULL,
    spare10                        NULL,
    spare9                         NULL,
    spare8                         NULL,
    spare7                         NULL,
    spare6                         NULL,
    spare5                         NULL,
    spare4                         NULL,
    spare3                         NULL,
    spare2                         NULL,
    spare1                         NULL
}

--*****
--
-- Downlink CCCH messages
--
--*****

DL-CCCH-Message ::= SEQUENCE {
    integrityCheckInfo            IntegrityCheckInfo            OPTIONAL,
    message                       DL-CCCH-MessageType
}

DL-CCCH-MessageType ::= CHOICE {
    cellUpdateConfirm             CellUpdateConfirm-CCCH,
    rrcConnectionReject          RRCCConnectionReject,
    rrcConnectionRelease         RRCCConnectionRelease-CCCH,
    rrcConnectionSetup           RRCCConnectionSetup,
    uraUpdateConfirm             URAUpdateConfirm-CCCH,
    -- dummy is not used in the specification. If received it is ignored by the UE.
    -- See TS 23.041 for handling of warning security information by Cell Broadcast Center.
    dummy                         ETWSPPrimaryNotificationWithSecurity,
    spare2                        NULL,
    spare1                        NULL
}

--*****
--
-- Uplink CCCH messages
--
--*****

UL-CCCH-Message ::= SEQUENCE {
    integrityCheckInfo            IntegrityCheckInfo            OPTIONAL,
    message                       UL-CCCH-MessageType
}

UL-CCCH-MessageType ::= CHOICE {
    cellUpdate                    CellUpdate,
    rrcConnectionRequest          RRCCConnectionRequest,
    uraUpdate                     URAUpdate,
    ul-CCCH-MessageType-r11       UL-CCCH-MessageType-r11
}

UL-CCCH-MessageType-r11 ::= CHOICE {
    cellUpdate                    CellUpdateFDD-r11,
    spare3                        NULL,
    spare2                        NULL,
    spare1                        NULL
}

```

```

--*****
--
-- PCCH messages
--
--*****

PCCH-Message ::= SEQUENCE {
    message          PCCH-MessageType
}

PCCH-MessageType ::= CHOICE {
    pagingType1          PagingType1,
    spare                NULL
}

--*****
--
-- Downlink SHCCH messages
--
--*****

DL-SHCCH-Message ::= SEQUENCE {
    message          DL-SHCCH-MessageType
}

DL-SHCCH-MessageType ::= CHOICE {
    physicalSharedChannelAllocation    PhysicalSharedChannelAllocation,
    spare                               NULL
}

--*****
--
-- Uplink SHCCH messages
--
--*****

UL-SHCCH-Message ::= SEQUENCE {
    message          UL-SHCCH-MessageType
}

UL-SHCCH-MessageType ::= CHOICE {
    puschCapacityRequest    PUSCHCapacityRequest,
    spare                   NULL
}

--*****
--
-- BCCH messages sent on FACH
--
--*****

BCCH-FACH-Message ::= SEQUENCE {
    message          BCCH-FACH-MessageType
}

BCCH-FACH-MessageType ::= CHOICE {
-- dummy is not used in this version of the specification, it should
-- not be sent and if received UE behaviour is unspecified.
    dummy                SystemInformation-FACH,
    systemInformationChangeIndication    SystemInformationChangeIndication,
    spare2               NULL,
    spare1               NULL
}

--*****
--
-- BCCH messages sent on BCH
--
--*****

BCCH-BCH-Message ::= SEQUENCE {
    message          SystemInformation-BCH
}

--*****
--
-- BCCH messages sent on BCH2

```

```

--
--*****
BCCH-BCH2-Message ::= SEQUENCE {
    message          SystemInformation2-BCH
}
--*****
--
-- MCCH messages
--
--*****

MCCH-Message ::= SEQUENCE {
    message          MCCH-MessageType
}

MCCH-MessageType ::= CHOICE {
    mbmsAccessInformation          MBMSAccessInformation,
    mbmsCommonPTMRBInformation    MBMSCommonPTMRBInformation,
    mbmsCurrentCellPTMRBInformation MBMSCurrentCellPTMRBInformation,
    mbmsGeneralInformation        MBMSGGeneralInformation,
    mbmsModifiedServicesInformation MBMSModifiedServicesInformation,
    mbmsNeighbouringCellPTMRBInformation MBMSNeighbouringCellPTMRBInformation,
    mbmsUnmodifiedServicesInformation MBMSUnmodifiedServicesInformation,
    spare9                         NULL,
    spare8                         NULL,
    spare7                         NULL,
    spare6                         NULL,
    spare5                         NULL,
    spare4                         NULL,
    spare3                         NULL,
    spare2                         NULL,
    spare1                         NULL
}
--*****
--
-- MSCH messages
--
--*****

MSCH-Message ::= SEQUENCE {
    message          MSCH-MessageType
}

MSCH-MessageType ::= CHOICE {
    mbmsSchedulingInformation    MBMSSchedulingInformation,
    spare3                      NULL,
    spare2                      NULL,
    spare1                      NULL
}

END

```

11.2 PDU definitions

```

--*****
--
-- TABULAR: The message type and integrity check info are not
-- visible in this module as they are defined in the class module.
-- Also, all FDD/TDD specific choices have the FDD option first
-- and TDD second, just for consistency.
--
--*****

PDU-definitions DEFINITIONS AUTOMATIC TAGS ::=

BEGIN

--*****
--
-- IE parameter types from other modules
--
--*****

```

IMPORTS

```
-- Core Network IEs :
  CN-DomainIdentity,
  CN-InformationInfo,
  CN-InformationInfo-r6,
  CN-InformationInfoFull,
  DomainSpecificAccessRestrictionParam-v670ext,
  NAS-Message,
  PagingRecordTypeID,
  PagingPermissionWithAccessControlParameters,
  PLMN-Identity,
-- UTRAN Mobility IEs :
  CellIdentity,
  CellIdentity-PerRL-List,
  DedicatedPriorityInformation,
  DedicatedPriorityInformation-r11,
  DedicatedWLANOffloadInformation,
  URA-Identity,
-- User Equipment IEs :
  AccessGroupIdentity,
  AccessStratumReleaseIndicator,
  ActivationTime,
  C-RNTI,
  CapabilityUpdateRequirement,
  CapabilityUpdateRequirement-r4,
  CapabilityUpdateRequirement-r4-ext,
  CapabilityUpdateRequirement-r5,
  CapabilityUpdateRequirement-v770ext,
  CapabilityUpdateRequirement-v860ext,
  CapabilityUpdateRequirement-vaj0ext,
  CapabilityUpdateRequirement-r7,
  CapabilityUpdateRequirement-r8,
  CapabilityUpdateRequirement-r12,
  CellUpdateCause,
  CellUpdateCause-ext,
  CipheringAlgorithm,
  CipheringAlgorithm-r7,
  CipheringModeInfo,
  CipheringModeInfo-r7,
  DelayRestrictionFlag,
  DL-PhysChCapabilityFDD-v380ext,
  DSCH-RNTI,
  E-RNTI,
  EstablishmentCause,
  ExtendedWaitTime,
  FailureCauseWithProtErr,
  FailureCauseWithProtErrTrId,
  FrequencyBandsIndicatorSupport,
  GroupReleaseInformation,
  H-RNTI,
  High-MobilityDetected,
  InitialUE-Identity,
  IntegrityProtActivationInfo,
  IntegrityProtectionModeInfo,
  IntegrityProtectionModeInfo-r7,
  N-308,
  PagingCause,
  PagingRecordList,
  PagingRecord2List-r5,
  PDCP-Capability-r4-ext,
  PDCP-Capability-v770ext,
  Pre-RedirectionInfo,
  ProtocolErrorIndicator,
  ProtocolErrorIndicatorWithMoreInfo,
  RadioFrequencyBandTDDList,
  Rb-timer-indicator,
  RedirectionInfo,
  RedirectionInfo-r6,
  RedirectionInfo-v860ext,
  RejectionCause,
  ReleaseCause,
  RF-CapabBandListFDDComp-ext2,
  RF-CapabilityComp,
  RRC-StateIndicator,
  RRC-TransactionIdentifier,
  RSR-VCC-Info,
  SecurityCapability,
```

```
SR-VCC-Info,
SR-VCC-SecurityRABInfo-v860ext,
START-Value,
STARTList,
SystemSpecificCapUpdateReq-v590ext,
U-RNTI,
U-RNTI-Short,
UESpecificBehaviourInformationIdle,
UESpecificBehaviourInformationInterRAT,
UE-CapabilityContainer-IEs,
UE-ConnTimersAndConstants,
UE-ConnTimersAndConstants-v3a0ext,
UE-ConnTimersAndConstants-v860ext,
UE-ConnTimersAndConstants-r5,
UE-ConnTimersAndConstants-r11,
UE-HSPA-Identities-r6,
UE-RadioAccessCapabBandFDDList2,
UE-RadioAccessCapabBandFDDList-ext,
UE-RadioAccessCapabBand-va40ext,
UE-RadioAccessCapability,
UE-RadioAccessCapability-v370ext,
UE-RadioAccessCapability-v380ext,
UE-RadioAccessCapability-v3a0ext,
UE-RadioAccessCapability-v3g0ext,
UE-RadioAccessCapability-v4b0ext,
UE-RadioAccessCapability-v590ext,
UE-RadioAccessCapability-v5c0ext,
UE-RadioAccessCapability-v650ext,
UE-RadioAccessCapability-v680ext,
UE-RadioAccessCapability-v7e0ext,
UE-RadioAccessCapability-v7f0ext,
UE-RadioAccessCapability-v860ext,
UE-RadioAccessCapability-v880ext,
UE-RadioAccessCapability-v890ext,
UE-RadioAccessCapability-v920ext,
UE-RadioAccessCapability-va40ext,
UE-RadioAccessCapability-va80ext,
UE-RadioAccessCapability-va60ext,
UE-RadioAccessCapability-vb50ext,
UE-RadioAccessCapability-vb70ext,
UE-RadioAccessCapability-vbc0ext,
UE-RadioAccessCapability-vd20ext,
UE-RadioAccessCapabilityComp,
UE-RadioAccessCapabilityComp-ext,
UE-RadioAccessCapabilityComp-v770ext,
UE-RadioAccessCapabilityComp2,
UE-RadioAccessCapabilityComp2-v770ext,
UE-RadioAccessCapabilityComp2-v7f0ext,
UE-RadioAccessCapabilityComp2-v860ext,
UE-RadioAccessCapabilityComp2-v920ext,
UE-RadioAccessCapabilityComp2-va40ext,
UE-RadioAccessCapabilityComp2-vb50ext,
UE-RadioAccessCapabilityComp2-vc50ext,
UE-RadioAccessCapabilityComp2-vd20ext,
UE-RadioAccessCapabilityComp-TDD128,
UE-RadioAccessCapabilityInfo-v770ext,
UE-RadioAccessCapabilityInfo-TDD128-v8b0ext,
UE-RadioAccessCapabilityInfo-TDD128-vb50ext,
UE-SecurityInformation,
UE-SecurityInformation2,
UE-SpecificCapabilityInformation-LCRTDD,
URA-UpdateCause,
UTRAN-DRX-CycleLengthCoefficient,
UTRAN-DRX-CycleLengthCoefficient-r7,
WaitTime,
-- Radio Bearer IEs :
DefaultConfigIdentity,
DefaultConfigIdentity-r4,
DefaultConfigIdentity-r5,
DefaultConfigIdentity-r6,
DefaultConfigForCellFACH,
DefaultConfigMode,
DL-CounterSynchronisationInfo,
DL-CounterSynchronisationInfo-r5,
PDCP-ROHC-TargetMode,
PredefinedConfigIdentity,
PredefinedConfigStatusList,
PredefinedConfigStatusListComp,
```



```
PredefinedConfigSetWithDifferentValueTag,
RAB-Info,
RAB-Info-r6,
RAB-Info-r7,
RAB-Info-Post,
RAB-InformationList,
RAB-InformationList-r6,
RAB-InformationReconfigList,
RAB-InformationReconfigList-r8,
RAB-InformationMBMSPTpList,
RAB-InformationSetup-r7,
RAB-InformationSetup-r8,
RAB-InformationSetup-v820ext,
RAB-InformationSetup-r11,
RAB-InformationSetupList,
RAB-InformationSetupList-r4,
RAB-InformationSetupList-r5,
RAB-InformationSetupList-r6-ext,
RAB-InformationSetupList-r6,
RAB-InformationSetupList-v6b0ext,
RAB-InformationSetupList-r7,
RAB-InformationSetupList-r8,
RAB-InformationSetupList-v820ext,
RAB-InformationSetupList-r11,
RB-ActivationTimeInfoList,
RB-COUNT-C-InformationList,
RB-COUNT-C-MSB-InformationList,
RB-IdentityList,
RB-InformationAffectedList,
RB-InformationAffectedList-r5,
RB-InformationAffectedList-r6,
RB-InformationAffectedList-r7,
RB-InformationAffectedList-r8,
RB-InformationChangedList-r6,
RB-InformationReconfigList,
RB-InformationReconfigList-r4,
RB-InformationReconfigList-r5,
RB-InformationReconfigList-r6,
RB-InformationReconfigList-r7,
RB-InformationReconfigList-r8,
RB-InformationReconfigList-r11,
RB-InformationReleaseList,
RB-PDCPContextRelocationList,
SRB-InformationSetupList,
SRB-InformationSetupList-r5,
SRB-InformationSetupList-r6,
SRB-InformationSetupList-r7,
SRB-InformationSetupList-r8,
SRB-InformationSetupList-r11,
SRB-InformationSetupList2,
SRB-InformationSetupList2-r6,
SRB-InformationSetupList2-r7,
SRB-InformationSetupList2-r8,
UL-AMR-Rate,
UL-CounterSynchronisationInfo,
-- Transport Channel IEs:
CPCH-SetID,
DL-AddReconfTransChInfo2List,
DL-AddReconfTransChInfoList,
DL-AddReconfTransChInfoList-r4,
DL-AddReconfTransChInfoList-r5,
DL-AddReconfTransChInfoList-r7,
DL-AddReconfTransChInfoList-r9,
DL-AddReconfTransChInfoList-TDD128-v9c0ext,
DL-AddReconfTransChInfoList-r11,
DL-CommonTransChInfo,
DL-CommonTransChInfo-r4,
DL-DeletedTransChInfoList,
DL-DeletedTransChInfoList-r5,
DL-DeletedTransChInfoList-r7,
DRAC-StaticInformationList,
HARQ-Info-r7,
HARQ-Info-r11,
PowerOffsetInfoShort,
TFC-Subset,
TFCS-Identity,
UL-AddReconfTransChInfoList,
UL-AddReconfTransChInfoList-r6,
```

UL-AddReconfTransChInfoList-r7,
UL-AddReconfTransChInfoList-r8,
UL-CommonTransChInfo,
UL-CommonTransChInfo-r4,
UL-CommonTransChInfo-r12,
UL-DeletedTransChInfoList,
UL-DeletedTransChInfoList-r6,
-- Physical Channel IEs :
AdditionalDLSecCellInfoListFDD,
AdditionalDLSecCellInfoListFDD-r11,
AdditionalDLSecCellInfoListFDD2,
AdditionalDLSecCellInfoHandoverToUtranListFDD,
Alpha,
BEACON-PL-Est,
CCTrCH-PowerControlInfo,
CCTrCH-PowerControlInfo-r4,
CCTrCH-PowerControlInfo-r5,
CCTrCH-PowerControlInfo-r7,
CommonERGCHInfoFDD,
ConstantValue,
ConstantValueTdd,
ControlChannelDRXInfo-TDD128-r8,
CPCH-SetInfo,
DCH-Enhancements-Info-FDD,
DHS-Sync,
DL-CommonInformation,
DL-CommonInformation-r4,
DL-CommonInformation-r5,
DL-CommonInformation-r6,
DL-CommonInformation-r7,
DL-CommonInformation-r8,
DL-CommonInformation-r10,
DL-CommonInformation-r11,
DL-CommonInformation-r12,
DL-CommonInformationPost,
DL-HSPDSCH-Information,
DL-HSPDSCH-Information-r6,
DL-HSPDSCH-Information-r7,
DL-HSPDSCH-Information-r8,
DL-HSPDSCH-Information-r8-ext,
DL-HSPDSCH-Information-r9,
DL-HSPDSCH-Information-r8-ext2,
DL-HSPDSCH-Information-r11,
DL-HSPDSCH-Information-r12,
DL-HSPDSCH-MultiCarrier-Information,
DL-InformationPerRL-List,
DL-InformationPerRL-List-r4,
DL-InformationPerRL-List-r5,
DL-InformationPerRL-List-r5bis,
DL-InformationPerRL-List-r6,
DL-InformationPerRL-List-r7,
DL-InformationPerRL-List-r8,
DL-InformationPerRL-List-v6b0ext,
DL-InformationPerRL-List-r11,
DL-InformationPerRL-List-r12,
DL-InformationPerRL-ListPostFDD,
DL-InformationPerRL-PostTDD,
DL-InformationPerRL-PostTDD-LCR-r4,
DL-MultiCarrier-Information,
DL-PDSCH-Information,
DL-SecondaryCellInfoFDD,
DL-SecondaryCellInfoFDD-v890ext,
DL-SecondaryCellInfoFDD-r9,
DL-SecondaryCellInfoFDD-r10,
DL-SecondaryCellInfoFDD-r11,
DL-SecondaryCellInfoFDD-HandoverToUtran,
DL-TPC-PowerOffsetPerRL-List,
DLUL-HSPA-Information-r8,
DLUL-HSPA-Information-r9,
DLUL-HSPA-Information-r10,
DPC-Mode,
DPCCH2InfoFDD,
DPCH-CompressedModeStatusInfo,
DPCH-CompressedModeStatusInfo-r10,
DTX-DRX-TimingInfo-r7,
DTX-DRX-Info-r7,
DTX-DRX-Info-r12,
DynamicPersistenceLevel,

E-DCH-ReconfigurationInfo,
E-DCH-ReconfigurationInfo-SecULFrequency,
E-DCH-ReconfigurationInfo-r7,
E-DCH-ReconfigurationInfo-r11,
E-DCH-RL-InfoSameServingCell,
E-TFC-Boost-Info-r7,
E-DPDCH-PowerInterpolation,
EUTRA-TargetFreqInfoList-vb50ext,
EXT-UL-TimingAdvance,
Feedback-cycle-r7,
FilteredUEPowerHeadroomReportInfo,
FrequencyInfo,
FrequencyInfoFDD,
FrequencyInfoTDD,
F-TPICH-ReconfigurationInfo,
HARQ-Preamble-Mode,
HS-DSCH-TBSizeTable,
HS-SCCH-LessInfo-r7,
HS-SICH-Power-Control-Info-TDD384,
HS-SICH-Power-Control-Info-TDD768,
MaxAllowedUL-TX-Power,
MIMO-Parameters-r7,
MIMO-Parameters-v7f0ext,
MIMO-Parameters-v7g0ext,
MIMO-Parameters-r8,
MIMO-Parameters-r9,
MIMO4x4-Parameters,
Multi-frequencyInfo-LCR-r7,
MU-MIMO-Info-TDD128,
Non-rectResAllocInd-TDD128,
Non-rectResSpecTSset-TDD128,
OpenLoopPowerControl-IPDL-TDD-r4,
PDSCH-CapacityAllocationInfo,
PDSCH-CapacityAllocationInfo-r4,
PDSCH-CapacityAllocationInfo-r7,
PDSCH-Identity,
PrimaryCPICH-Info,
PrimaryCCPCH-TX-Power,
PUSCH-CapacityAllocationInfo,
PUSCH-CapacityAllocationInfo-r4,
PUSCH-CapacityAllocationInfo-r7,
PUSCH-Identity,
PUSCH-SysInfoList-HCR-r5,
PDSCH-SysInfoList-HCR-r5,
RL-AdditionInformationList,
RL-AdditionInformationList-r6,
RL-AdditionInformationList-v6b0ext,
RL-AdditionInformationList-r7,
RL-AdditionInformationList-r8,
RL-AdditionInformationList-v890ext,
RL-AdditionInformationList-r9,
RL-AdditionInformationList-v950ext,
RL-AdditionInformationList-r10,
RL-AdditionInformationList-vb50ext,
RL-AdditionInformationList-r11,
RL-AdditionInformationList-r12,
RL-AdditionInformationList-SecULFreq,
RL-AdditionInformationList-SecULFreq-r12,
RL-RemovalInformationList,
RL-RemovalInformationList-SecULFreq,
SecondaryCellMIMOparametersFDD-v950ext,
Serving-HSDSCH-CellInformation,
Serving-HSDSCH-CellInformation-r7,
Serving-HSDSCH-CellInformation-r8,
Serving-HSDSCH-CellInformation-r9,
Serving-HSDSCH-CellInformation-r11,
Serving-HSDSCH-CellInformation-r12,
ServingCellChangeParameters,
ServingCellChangeParameters-r12,
SpecialBurstScheduling,
SPS-Information-TDD128-r8,
SSDT-Information,
SSDT-Information-r4,
SSDT-UL,
StandaloneMidambleInfo-TDD128,
TFC-ControlDuration,
TimeslotList,
TimeslotList-r4,

TimingMaintainedSynchInd,
TX-DiversityMode,
UL-16QAM-Config,
UL-64QAM-Config,
UL-ChannelRequirement,
UL-ChannelRequirement-r4,
UL-ChannelRequirement-r5,
UL-ChannelRequirementWithCPCH-SetID,
UL-ChannelRequirementWithCPCH-SetID-r4,
UL-ChannelRequirementWithCPCH-SetID-r5,
UL-CLTD-InfoFDD,
UL-MIMO-InfoFDD,
UL-DPCH-Info,
UL-DPCH-Info-r4,
UL-DPCH-Info-r5,
UL-DPCH-Info-r6,
UL-DPCH-Info-r7,
UL-DPCH-Info-r11,
UL-DPCH-InfoPostFDD,
UL-DPCH-InfoPostTDD,
UL-DPCH-InfoPostTDD-LCR-r4,
UL-EDCH-Information-ext,
UL-EDCH-Information-r6,
UL-EDCH-Information-r7,
UL-EDCH-Information-r8,
UL-EDCH-Information-r9,
UL-EDCH-Information-r11,
UL-MulticarrierEDCHInfo-TDD128,
UL-OLTD-InfoFDD,
UL-OtherTTIConfiguration-Information,
UL-SecondaryCellInfoFDD,
UL-SecondaryCellInfoFDD-r12,
UL-SynchronisationParameters-r4,
UL-TimingAdvance,
UL-TimingAdvanceControl,
UL-TimingAdvanceControl-r4,
UL-TimingAdvanceControl-r7,
UpPCHposition-LCR,
-- Measurement IEs :
AdditionalMeasurementID-List,
AdditionalMeasurementID-List-r9,
CellDCHMeasOccasionInfo-TDD128-r9,
CSGProximityIndication,
CSGProximityIndication-vb50ext,
DeltaRSCP,
Frequency-Band,
EventResults,
EventResults-v770ext,
EventResults-v860ext,
EventResults-va40ext,
EventResultsOnSecUlFreq,
EUTRA-EventResults,
EUTRA-EventResults-vb50ext,
EUTRA-EventResults-vc50ext,
EUTRA-MeasuredResults,
EUTRA-MeasuredResults-v920ext,
EUTRA-MeasuredResults-vb50ext,
EUTRA-MeasuredResults-vc50ext,
EUTRA-EventResultsForCELLFACH,
EUTRA-EventResultsForCELLFACH-vc50ext,
Inter-FreqEventCriteriaList-v590ext,
Intra-FreqEventCriteriaList-v590ext,
IntraFreqReportingCriteria-lb-r5,
IntraFreqEvent-ld-r5,
IntraFreqCellID,
InterFreqEventResults-LCR-r4-ext,
InterRATCellInfoIndication,
InterRATMeasurement-r11,
InterRATMeasurement-r12,
InterRAT-TargetCellDescription,
MeasuredResults,
MeasuredResults-v390ext,
MeasuredResults-v590ext,
MeasuredResults-v770ext,
MeasuredResults-v860ext,
MeasuredResults-v920ext,
MeasuredResults-vc50ext,
MeasuredResultsOnSecUlFreq,

MeasuredResultsOnSecULFreq-vc50ext,
MeasuredResultsListOnSecULFreq,
MeasuredResultsListOnSecULFreq-vc50ext,
MeasuredResultsList,
MeasuredResultsList-LCR-r4-ext,
MeasuredResultsList-v770ext,
MeasuredResultsList-v860ext,
MeasuredResultsList-v920ext,
MeasuredResultsList-vc50ext,
MeasuredResultsOnRACH,
MeasuredResultsOnRACHFDD-r11,
MeasuredResultsOnRACH-v7g0ext,
MeasuredResultsOnRACHinterFreq,
MeasuredResultsOnRACH-vc50ext,
MeasuredResultsOnRACH-EUTRAFreq,
MeasurementCommand,
MeasurementCommand-r4,
MeasurementCommand-r6,
MeasurementCommand-r7,
MeasurementCommand-r8,
MeasurementCommand-r9,
MeasurementCommand-r10,
MeasurementCommand-r11,
MeasurementReleaseEnhancement,
MeasurementCommand-r12,
MeasurementIdentity,
MeasurementIdentity-r9,
MeasurementIdentityExt,
MeasurementReportingMode,
MeasurementScalingFactor,
NewInterFreqCellList-v7b0ext,
NewInterFreqCellList-LCR-v8a0ext,
NewIntraFreqCellList-LCR-v8a0ext,
PeriodicalWithReportingCellStatusOnSecULFreq,
PrimaryCCPCH-RSCP,
SFN-Offset-Validity,
TimeslotListWithISCP,
TrafficVolumeMeasuredResultsList,
UE-Positioning-GPS-AssistanceData,
UE-Positioning-GPS-AssistanceData-v770ext,
UE-Positioning-GPS-AssistanceData-v920ext,
UE-Positioning-GPS-AssistanceData-va40ext,
UE-Positioning-GPS-AssistanceData-vc50ext,
UE-Positioning-GPS-ReferenceTimeUncertainty,
UE-Positioning-Measurement-v390ext,
UE-Positioning-OTDOA-AssistanceData,
UE-Positioning-OTDOA-AssistanceData-r4ext,
UE-Positioning-OTDOA-AssistanceData-UEB,
UE-Positioning-OTDOA-AssistanceData-UEB-ext,
UE-Positioning-OTDOA-MeasuredResultsTDD-ext,
UE-Positioning-GANSS-AssistanceData,
UE-Positioning-GANSS-AssistanceData-v860ext,
UE-Positioning-GANSS-AssistanceData-v920ext,
UE-Positioning-GANSS-AssistanceData-va40ext,
UE-Positioning-GANSS-AssistanceData-vc50ext,
-- Other IEs :
BCCH-ModificationInfo,
BCCH-ModificationInfo-vc50ext,
CDMA2000-MessageList,
CellValueTag2,
ETWS-Information,
ETWS-WarningSecurityInfo,
GSM-TargetCellInfoList,
GERANIu-MessageList,
GERAN-SystemInformation,
GSM-MessageList,
InterRAT-ChangeFailureCause,
InterRAT-HO-FailureCause,
InterRAT-UE-RadioAccessCapabilityList,
InterRAT-UE-RadioAccessCapability-v590ext,
InterRAT-UE-SecurityCapList,
IntraDomainNasNodeSelector,
MasterInformationBlock,
MIB-ValueTag,
ProtocolErrorMoreInformation,
RMP-Frequency-List,
Rplmn-Information,
Rplmn-Information-r4,

```

SegCount ,
SegmentIndex ,
SFN-Prime ,
SIB-Data-fixed ,
SIB-Data2-fixed ,
SIB-Data-variable ,
SIB-Data2-variable ,
SIB-Type ,
SIB-Type2 ,
SysInfoType1 ,
SysInfoType3 ,
SysInfoType5 ,
SysInfoType7 ,
SysInfoType11 ,
SysInfoType11bis ,
SysInfoType11ter ,
SysInfoType12 ,
SysInfoTypeSB1 ,
SysInfoTypeSB2 ,
SysInfoType22 ,
-- MBMS IEs:
MBMS-CellGroupIdentity-r6 ,
MBMS-CommonRBInformationList-r6 ,
MBMS-CurrentCell-SCCPCHList-r6 ,
MBMS-JoinedInformation-r6 ,
MBMS-MICHConfigurationInfo-r6 ,
MBMS-MICHConfigurationInfo-v770ext ,
MBMS-MICHConfigurationInfo-v890ext ,
MBMS-ModifiedServiceList-r6 ,
MBMS-ModifiedServiceList-LCR-v7c0ext ,
MBMS-ModifiedServiceList-v770ext ,
MBMS-MSCH-ConfigurationInfo-r6 ,
MBMS-NeighbouringCellSCCPCHList-r6 ,
MBMS-NeighbouringCellSCCPCHList-v770ext ,
MBMS-NumberOfNeighbourCells-r6 ,
MBMS-PhyChInformationList-r6 ,
MBMS-PhyChInformationList-r7 ,
MBMS-PhyChInformationList-IMB384 ,
MBMS-PL-ServiceRestrictInfo-r6 ,
MBMS-PreferredFrequencyList-r6 ,
MBMS-PTMActivationTime-r6 ,
MBMS-SelectedServiceInfo ,
MBMS-SelectedServicesShort ,
MBMS-ServiceAccessInfoList-r6 ,
MBMS-ServiceIdentity-r6 ,
MBMS-ServiceSchedulingInfoList-r6 ,
MBMS-SIBType5-SCCPCHList-r6 ,
MBMS-TimersAndCounters-r6 ,
MBMS-TranspChInfoForEachCCTrCh-r6 ,
MBMS-TranspChInfoForEachTrCh-r6 ,
MBMS-UnmodifiedServiceList-r6 ,
MBMS-UnmodifiedServiceList-v770ext ,
MBSFN-ClusterFrequency-r7 ,
MBSFN-InterFrequencyNeighbourList-r7 ,
MBSFN-InterFrequencyNeighbourList-v860ext ,
MBMS-NetworkStandardTimeInformation-LCR-v890ext ,
MBSFN-TDDInformation-LCR ,
MBSFN-TDM-Info-List ,
-- MDT IEs
  LoggedMeasurementsConfigurationInfo ,
  LoggedMeasurementsConfigurationInfo-r11 ,
  LoggedMeasReport ,
  LoggedMeasReport-vb50ext ,
  LoggedMeasReport-vc50ext ,
  ConnectionEstablishmentFailureReport ,
  ConnectionEstablishmentFailureReport-r11 ,
  ConnectionEstablishmentFailureReport-vc50ext ,
  RsrqType ,
-- UTRAN ANR IEs
  LoggedANRConfigurationInfo ,
  LoggedANRReportInfoList ,
  LoggedANRReportInfoList-vb50ext ,
-- WLAN Offload IEs
  WLANOffloadConfig ,
  WLANOffloadInformation

FROM InformationElements

```

```

maxSIBperMsg,
maxURNTI-Group
FROM Constant-definitions;

-- *****
--
-- ACTIVE SET UPDATE (FDD only)
--
-- *****

ActiveSetUpdate ::= CHOICE {
  r3
    SEQUENCE {
      activeSetUpdate-r3          ActiveSetUpdate-r3-IEs,
      laterNonCriticalExtensions SEQUENCE {
        -- Container for additional R99 extensions
        activeSetUpdate-r3-add-ext BIT STRING OPTIONAL,
        v4b0NonCriticalExtensions SEQUENCE {
          activeSetUpdate-v4b0ext ActiveSetUpdate-v4b0ext-IEs,
          v590NonCriticalExtensions SEQUENCE {
            activeSetUpdate-v590ext ActiveSetUpdate-v590ext-IEs,
            v690NonCriticalExtensions SEQUENCE {
              activeSetUpdate-v690ext ActiveSetUpdate-v690ext-IEs,
              nonCriticalExtensions SEQUENCE {} OPTIONAL
            } OPTIONAL
          } OPTIONAL
        } OPTIONAL
      } OPTIONAL
    } OPTIONAL
  },
  later-than-r3
    SEQUENCE {
      rrc-TransactionIdentifier RRC-TransactionIdentifier,
      criticalExtensions        CHOICE {
        r6
          SEQUENCE {
            activeSetUpdate-r6          ActiveSetUpdate-r6-IEs,
            activeSetUpdate-r6-add-ext BIT STRING OPTIONAL,
            v6b0NonCriticalExtensions SEQUENCE {
              activeSetUpdate-v6b0ext ActiveSetUpdate-v6b0ext-IEs,
              nonCriticalExtensions SEQUENCE {} OPTIONAL
            } OPTIONAL
          }
        },
      criticalExtensions CHOICE {
        r7
          SEQUENCE {
            activeSetUpdate-r7          ActiveSetUpdate-r7-IEs,
            activeSetUpdate-r7-add-ext BIT STRING OPTIONAL,
            v780NonCriticalExtensions SEQUENCE {
              activeSetUpdate-v780ext ActiveSetUpdate-v780ext-IEs,
              v7f0NonCriticalExtensions SEQUENCE {
                activeSetUpdate-v7f0ext ActiveSetUpdate-v7f0ext-IEs,
                v7g0NonCriticalExtensions SEQUENCE {
                  activeSetUpdate-v7g0ext ActiveSetUpdate-v7g0ext-IEs,
                  nonCriticalExtensions SEQUENCE {} OPTIONAL
                } OPTIONAL
              } OPTIONAL
            } OPTIONAL
          }
        } OPTIONAL
      },
      criticalExtensions CHOICE {
        r8
          SEQUENCE {
            activeSetUpdate-r8          ActiveSetUpdate-r8-IEs,
            -- Container for adding non critical extensions after freezing REL-9
            activeSetUpdate-r8-add-ext BIT STRING OPTIONAL,
            v890NonCriticalExtensions SEQUENCE {
              activeSetUpdate-v890ext ActiveSetUpdate-v890ext-IEs,
              v7g0NonCriticalExtensions SEQUENCE {
                activeSetUpdate-v7g0ext ActiveSetUpdate-v7g0ext-IEs,
                nonCriticalExtensions SEQUENCE {} OPTIONAL
              } OPTIONAL
            } OPTIONAL
          }
        },
      criticalExtensions CHOICE {
        r9
          SEQUENCE {
            activeSetUpdate-r9          ActiveSetUpdate-r9-IEs,
            -- Container for adding non critical extensions after freezing REL-10
            activeSetUpdate-r9-add-ext BIT STRING OPTIONAL,
            v950NonCriticalExtensions SEQUENCE {
              activeSetUpdate-v950ext ActiveSetUpdate-v950ext-IEs,
              nonCriticalExtensions SEQUENCE {} OPTIONAL
            } OPTIONAL
          }
        },
    }

```

```
criticalExtensions CHOICE {
  r10 SEQUENCE {
    activeSetUpdate-r10 ActiveSetUpdate-r10-IEs,
    -- Container for adding non critical extensions after freezing
    -- REL-11
    activeSetUpdate-r10-add-ext BIT STRING OPTIONAL,
    vb50NonCriticalExtensions SEQUENCE {
      activeSetUpdate-vb50ext ActiveSetUpdate-vb50ext-IEs,
      nonCriticalExtensions SEQUENCE {} OPTIONAL
    } OPTIONAL
  },
  criticalExtensions CHOICE {
    r11 SEQUENCE {
      activeSetUpdate-r11 ActiveSetUpdate-r11-IEs,
      -- Container for adding non critical extensions after freezing
      -- REL-12
      activeSetUpdate-r11-add-ext BIT STRING OPTIONAL,
      nonCriticalExtensions SEQUENCE {} OPTIONAL
    },
    criticalExtensions CHOICE {
      r12 SEQUENCE {
        activeSetUpdate-r12 ActiveSetUpdate-r12-IEs,
        -- Container for adding non critical extensions after
        -- REL-13
        activeSetUpdate-r12-add-ext BIT STRING OPTIONAL,
        nonCriticalExtensions SEQUENCE {} OPTIONAL
      },
      criticalExtensions SEQUENCE {}
    }
  }
}

ActiveSetUpdate-r3-IEs ::= SEQUENCE {
  -- User equipment IEs
  rrc-TransactionIdentifier RRC-TransactionIdentifier,
  -- dummy and dummy2 are not used in this version of the specification, they should
  -- not be sent and if received they should be ignored.
  dummy IntegrityProtectionModeInfo OPTIONAL,
  dummy2 CipheringModeInfo OPTIONAL,
  activationTime ActivationTime OPTIONAL,
  newU-RNTI U-RNTI OPTIONAL,
  -- Core network IEs
  cn-InformationInfo CN-InformationInfo OPTIONAL,
  -- Radio bearer IEs
  -- dummy3 is not used in this version of the specification, it should
  -- not be sent and if received it should be ignored.
  dummy3 DL-CounterSynchronisationInfo OPTIONAL,
  -- Physical channel IEs
  maxAllowedUL-TX-Power MaxAllowedUL-TX-Power OPTIONAL,
  rl-AdditionInformationList RL-AdditionInformationList OPTIONAL,
  rl-RemovalInformationList RL-RemovalInformationList OPTIONAL,
  tx-DiversityMode TX-DiversityMode OPTIONAL,
  -- dummy4 is not used in this version of the specification, it should
  -- not be sent and if received it should be ignored.
  dummy4 SSdT-Information OPTIONAL
}

ActiveSetUpdate-v4b0ext-IEs ::= SEQUENCE {
  -- Physical channel IEs
  -- dummy is not used in this version of the specification, it should
  -- not be sent and if received it should be ignored.
  dummy SSdT-UL OPTIONAL,
  -- The order of the RLs in IE cell-id-PerRL-List is the same as
  -- in IE RL-AdditionInformationList included in this message
  cell-id-PerRL-List CellIdentity-PerRL-List OPTIONAL
}

ActiveSetUpdate-v590ext-IEs ::= SEQUENCE {
  -- Physical channel IEs
  dpc-Mode DPC-Mode,
  dl-TPC-PowerOffsetPerRL-List DL-TPC-PowerOffsetPerRL-List OPTIONAL
}
```



```

}
ActiveSetUpdate-v690ext-IEs ::= SEQUENCE {
  -- Core network IEs
  primary-plmn-Identity          PLMN-Identity          OPTIONAL
}
ActiveSetUpdate-r6-IEs ::= SEQUENCE {
  -- User equipment IEs
  activationTime                 ActivationTime          OPTIONAL,
  newU-RNTI                     U-RNTI              OPTIONAL,
  newH-RNTI                     H-RNTI              OPTIONAL,
  newPrimary-E-RNTI             E-RNTI              OPTIONAL,
  newSecondary-E-RNTI           E-RNTI              OPTIONAL,
  -- Core network IEs
  cn-InformationInfo            CN-InformationInfo-r6  OPTIONAL,
  -- Physical channel IEs
  maxAllowedUL-TX-Power         MaxAllowedUL-TX-Power  OPTIONAL,
  rl-AdditionInformationList     RL-AdditionInformationList-r6  OPTIONAL,
  rl-RemovalInformationList     RL-RemovalInformationList  OPTIONAL,
  tx-DiversityMode              TX-DiversityMode       OPTIONAL,
  dpc-Mode                      DPC-Mode              OPTIONAL,
  serving-HSDSCH-CellInformation Serving-HSDSCH-CellInformation  OPTIONAL,
  e-dch-ReconfigurationInfo     E-DCH-ReconfigurationInfo  OPTIONAL
}
ActiveSetUpdate-v6b0ext-IEs ::= SEQUENCE {
  -- Physical channel IEs
  rl-AdditionInformation-list-v6b0ext  RL-AdditionInformation-list-v6b0ext  OPTIONAL
}
ActiveSetUpdate-r7-IEs ::= SEQUENCE {
  -- User equipment IEs
  activationTime                 ActivationTime          OPTIONAL,
  newU-RNTI                     U-RNTI              OPTIONAL,
  newH-RNTI                     H-RNTI              OPTIONAL,
  newPrimary-E-RNTI             E-RNTI              OPTIONAL,
  newSecondary-E-RNTI           E-RNTI              OPTIONAL,
  -- Core network IEs
  cn-InformationInfo            CN-InformationInfo-r6  OPTIONAL,
  -- Physical channel IEs
  dtx-drx-TimingInfo            DTX-DRX-TimingInfo-r7  OPTIONAL,
  dtx-drx-Info                  DTX-DRX-Info-r7       OPTIONAL,
  hs-scch-LessInfo              HS-SCCH-LessInfo-r7   OPTIONAL,
  mimoParameters                MIMO-Parameters-r7    OPTIONAL,
  maxAllowedUL-TX-Power         MaxAllowedUL-TX-Power  OPTIONAL,
  rl-AdditionInformationList     RL-AdditionInformationList-r7  OPTIONAL,
  rl-RemovalInformationList     RL-RemovalInformationList  OPTIONAL,
  tx-DiversityMode              TX-DiversityMode       OPTIONAL,
  dpc-Mode                      DPC-Mode              OPTIONAL,
  serving-HSDSCH-CellInformation Serving-HSDSCH-CellInformation-r7  OPTIONAL,
  e-dch-ReconfigurationInfo     E-DCH-ReconfigurationInfo-r7  OPTIONAL,
  ul-16QAM-Config              UL-16QAM-Config       OPTIONAL,
  e-dch-ReconfInfoSameCell      E-DCH-RL-InfoSameServingCell  OPTIONAL,
  e-TFC-Boost-Info              E-TFC-Boost-Info-r7   OPTIONAL,
  e-DPDCH-PowerInterpolation    E-DPDCH-PowerInterpolation  OPTIONAL
}
ActiveSetUpdate-v780ext-IEs ::= SEQUENCE {
  -- Physical channel IEs
  hs-DSCH-TBSizeTable           HS-DSCH-TBSizeTable    OPTIONAL
}
ActiveSetUpdate-v7f0ext-IEs ::= SEQUENCE {
  -- Physical channel IEs
  mimoParameters                MIMO-Parameters-v7f0ext  OPTIONAL
}
ActiveSetUpdate-v7g0ext-IEs ::= SEQUENCE {
  -- Physical channel IEs
  mimoParameters                MIMO-Parameters-v7g0ext  OPTIONAL
}
ActiveSetUpdate-r8-IEs ::= SEQUENCE {
  -- User equipment IEs
  activationTime                 ActivationTime          OPTIONAL,
  newU-RNTI                     U-RNTI              OPTIONAL,
  newH-RNTI                     H-RNTI              OPTIONAL,

```

newPrimary-E-RNTI	E-RNTI	OPTIONAL,
newSecondary-E-RNTI	E-RNTI	OPTIONAL,
-- Core network IEs		
cn-InformationInfo	CN-InformationInfo-r6	OPTIONAL,
-- Physical channel IEs		
dtx-drx-TimingInfo	DTX-DRX-TimingInfo-r7	OPTIONAL,
dtx-drx-Info	DTX-DRX-Info-r7	OPTIONAL,
hs-scch-LessInfo	HS-SCCH-LessInfo-r7	OPTIONAL,
mimoParameters	MIMO-Parameters-r8	OPTIONAL,
maxAllowedUL-TX-Power	MaxAllowedUL-TX-Power	OPTIONAL,
rl-AdditionInformationList	RL-AdditionInformationList-r8	OPTIONAL,
servingCellChangeParameters	ServingCellChangeParameters	OPTIONAL,
rl-RemovalInformationList	RL-RemovalInformationList	OPTIONAL,
tx-DiversityMode	TX-DiversityMode	OPTIONAL,
dpc-Mode	DPC-Mode	OPTIONAL,
serving-HSDSCH-CellInformation	Serving-HSDSCH-CellInformation-r8	OPTIONAL,
e-dch-ReconfigurationInfo	E-DCH-ReconfigurationInfo-r7	OPTIONAL,
ul-16QAM-Config	UL-16QAM-Config	OPTIONAL,
e-dch-ReconfInfoSameCell	E-DCH-RL-InfoSameServingCell	OPTIONAL,
e-TFC-Boost-Info	E-TFC-Boost-Info-r7	OPTIONAL,
e-DPDCH-PowerInterpolation	E-DPDCH-PowerInterpolation	OPTIONAL,
dl-SecondaryCellInfoFDD	DL-SecondaryCellInfoFDD	OPTIONAL
}		
ActiveSetUpdate-v890ext-IEs ::= SEQUENCE {		
-- Physical channel IEs		
dl-SecondaryCellInfoFDD-v890ext	DL-SecondaryCellInfoFDD-v890ext	OPTIONAL,
mimoParameters	MIMO-Parameters-v7f0ext	OPTIONAL,
rl-AdditionInformationList	RL-AdditionInformationList-v890ext	OPTIONAL
}		
ActiveSetUpdate-r9-IEs ::= SEQUENCE {		
-- User equipment IEs		
activationTime	ActivationTime	OPTIONAL,
newU-RNTI	U-RNTI	OPTIONAL,
newH-RNTI	H-RNTI	OPTIONAL,
newPrimary-E-RNTI	E-RNTI	OPTIONAL,
newSecondary-E-RNTI	E-RNTI	OPTIONAL,
-- Core network IEs		
cn-InformationInfo	CN-InformationInfo-r6	OPTIONAL,
-- Physical channel IEs		
dtx-drx-TimingInfo	DTX-DRX-TimingInfo-r7	OPTIONAL,
dtx-drx-Info	DTX-DRX-Info-r7	OPTIONAL,
hs-scch-LessInfo	HS-SCCH-LessInfo-r7	OPTIONAL,
mimoParameters	MIMO-Parameters-r9	OPTIONAL,
maxAllowedUL-TX-Power	MaxAllowedUL-TX-Power	OPTIONAL,
ul-SecondaryCellInfoFDD	UL-SecondaryCellInfoFDD	OPTIONAL,
e-dch-ReconfigurationInfo-SecULFrequency	E-DCH-ReconfigurationInfo-SecULFrequency	OPTIONAL,
rl-AdditionInformationList	RL-AdditionInformationList-r9	OPTIONAL,
rl-AdditionInformationList-SecULFreq	RL-AdditionInformationList-SecULFreq	OPTIONAL,
servingCellChangeParameters	ServingCellChangeParameters	OPTIONAL,
rl-RemovalInformationList	RL-RemovalInformationList	OPTIONAL,
rl-RemovalInformationList-SecULFreq	RL-RemovalInformationList-SecULFreq	OPTIONAL,
tx-DiversityMode	TX-DiversityMode	OPTIONAL,
dpc-Mode	DPC-Mode	OPTIONAL,
serving-HSDSCH-CellInformation	Serving-HSDSCH-CellInformation-r9	OPTIONAL,
e-dch-ReconfigurationInfo	E-DCH-ReconfigurationInfo-r7	OPTIONAL,
ul-16QAM-Config	UL-16QAM-Config	OPTIONAL,
e-dch-ReconfInfoSameCell	E-DCH-RL-InfoSameServingCell	OPTIONAL,
e-TFC-Boost-Info	E-TFC-Boost-Info-r7	OPTIONAL,
e-DPDCH-PowerInterpolation	E-DPDCH-PowerInterpolation	OPTIONAL,
dl-SecondaryCellInfoFDD	DL-SecondaryCellInfoFDD-r9	OPTIONAL
}		
ActiveSetUpdate-v950ext-IEs ::= SEQUENCE {		
-- Physical channel IEs		
secondaryCellMimoParameters	SecondaryCellMIMOparametersFDD-v950ext	OPTIONAL,
rl-AdditionInformationList	RL-AdditionInformationList-v950ext	OPTIONAL
}		
ActiveSetUpdate-r10-IEs ::= SEQUENCE {		
-- User equipment IEs		
activationTime	ActivationTime	OPTIONAL,
newU-RNTI	U-RNTI	OPTIONAL,
newH-RNTI	H-RNTI	OPTIONAL,

```

    newPrimary-E-RNTI          E-RNTI          OPTIONAL,
    newSecondary-E-RNTI       E-RNTI          OPTIONAL,
-- Core network IEs
  cn-InformationInfo          CN-InformationInfo-r6    OPTIONAL,
-- Physical channel IEs
  dtx-drx-TimingInfo         DTX-DRX-TimingInfo-r7    OPTIONAL,
  dtx-drx-Info               DTX-DRX-Info-r7         OPTIONAL,
  hs-scch-LessInfo           HS-SCCH-LessInfo-r7      OPTIONAL,
  mimoParameters             MIMO-Parameters-r9      OPTIONAL,
  maxAllowedUL-TX-Power      MaxAllowedUL-TX-Power    OPTIONAL,
  ul-SecondaryCellInfoFDD    UL-SecondaryCellInfoFDD  OPTIONAL,
  e-dch-ReconfigurationInfo-SecULFrequency
                                E-DCH-ReconfigurationInfo-SecULFrequency  OPTIONAL,
  rl-AdditionInformationList  RL-AdditionInformationList-r10  OPTIONAL,
  rl-AdditionInformationList-SecULFreq
                                RL-AdditionInformationList-SecULFreq  OPTIONAL,
  servingCellChangeParameters  ServingCellChangeParameters  OPTIONAL,
  rl-RemovalInformationList   RL-RemovalInformationList    OPTIONAL,
  rl-RemovalInformationList-SecULFreq
                                RL-RemovalInformationList-SecULFreq  OPTIONAL,
  tx-DiversityMode           TX-DiversityMode         OPTIONAL,
  dpc-Mode                   DPC-Mode                 OPTIONAL,
  serving-HSDSCH-CellInformation  Serving-HSDSCH-CellInformation-r9  OPTIONAL,
  e-dch-ReconfigurationInfo    E-DCH-ReconfigurationInfo-r7    OPTIONAL,
  ul-16QAM-Config            UL-16QAM-Config          OPTIONAL,
  e-dch-ReconfInfoSameCell    E-DCH-RL-InfoSameServingCell    OPTIONAL,
  e-TFC-Boost-Info           E-TFC-Boost-Info-r7      OPTIONAL,
  e-DPDCH-PowerInterpolation  E-DPDCH-PowerInterpolation  OPTIONAL,
  dl-SecondaryCellInfoFDD     DL-SecondaryCellInfoFDD-r10  OPTIONAL,
  additionalDLSecCellInfoListFDD  AdditionalDLSecCellInfoListFDD  OPTIONAL
}

ActiveSetUpdate-vb50ext-IEs ::= SEQUENCE {
  ulOLTDInfoFDD              UL-OLTD-InfoFDD          OPTIONAL,
  rl-AdditionInformationList  RL-AdditionInformationList-vb50ext  OPTIONAL
}

ActiveSetUpdate-r11-IEs ::= SEQUENCE {
-- User equipment IEs
  activationTime              ActivationTime             OPTIONAL,
  newU-RNTI                   U-RNTI                   OPTIONAL,
  newH-RNTI                   H-RNTI                   OPTIONAL,
  newPrimary-E-RNTI           E-RNTI                   OPTIONAL,
  newSecondary-E-RNTI         E-RNTI                   OPTIONAL,
-- Core network IEs
  cn-InformationInfo          CN-InformationInfo-r6    OPTIONAL,
-- Physical channel IEs
  dtx-drx-TimingInfo         DTX-DRX-TimingInfo-r7    OPTIONAL,
  dtx-drx-Info               DTX-DRX-Info-r7         OPTIONAL,
  hs-scch-LessInfo           HS-SCCH-LessInfo-r7      OPTIONAL,
  mimoParameters             MIMO-Parameters-r9      OPTIONAL,
  mimo4x4Parameters          MIMO4x4-Parameters       OPTIONAL,
  maxAllowedUL-TX-Power      MaxAllowedUL-TX-Power    OPTIONAL,
  ul-SecondaryCellInfoFDD    UL-SecondaryCellInfoFDD  OPTIONAL,
  e-dch-ReconfigurationInfo-SecULFrequency
                                E-DCH-ReconfigurationInfo-SecULFrequency  OPTIONAL,
  ul-CLTD-InfoFDD            UL-CLTD-InfoFDD          OPTIONAL,
  f-tpich-ReconfigurationInfo  F-TPICH-ReconfigurationInfo  OPTIONAL,
  ul-OLTD-InfoFDD            UL-OLTD-InfoFDD          OPTIONAL,
  rl-AdditionInformationList  RL-AdditionInformationList-r11  OPTIONAL,
  rl-AdditionInformationList-SecULFreq
                                RL-AdditionInformationList-SecULFreq  OPTIONAL,
  servingCellChangeParameters  ServingCellChangeParameters  OPTIONAL,
  rl-RemovalInformationList   RL-RemovalInformationList    OPTIONAL,
  rl-RemovalInformationList-SecULFreq
                                RL-RemovalInformationList-SecULFreq  OPTIONAL,
  tx-DiversityMode           TX-DiversityMode         OPTIONAL,
  dpc-Mode                   DPC-Mode                 OPTIONAL,
  serving-HSDSCH-CellInformation  Serving-HSDSCH-CellInformation-r11  OPTIONAL,
  e-dch-ReconfigurationInfo    E-DCH-ReconfigurationInfo-r11  OPTIONAL,
  ul-16QAM-Config            UL-16QAM-Config          OPTIONAL,
  ul-64QAM-Config            UL-64QAM-Config          OPTIONAL,
  ul-MIMO-InfoFDD            UL-MIMO-InfoFDD          OPTIONAL,
  e-dch-ReconfInfoSameCell    E-DCH-RL-InfoSameServingCell    OPTIONAL,
  e-TFC-Boost-Info           E-TFC-Boost-Info-r7      OPTIONAL,
  e-DPDCH-PowerInterpolation  E-DPDCH-PowerInterpolation  OPTIONAL,
  dl-SecondaryCellInfoFDD     DL-SecondaryCellInfoFDD-r11  OPTIONAL,

```

```

        additionalDLSecCellInfoListFDD      AdditionalDLSecCellInfoListFDD-r11  OPTIONAL,
        additionalDLSecCellInfoListFDD2    AdditionalDLSecCellInfoListFDD2    OPTIONAL
    }
}

ActiveSetUpdate-r12-IEs ::= SEQUENCE {
    -- User equipment IEs
    activationTime      ActivationTime      OPTIONAL,
    newU-RNTI           U-RNTI           OPTIONAL,
    newH-RNTI           H-RNTI           OPTIONAL,
    newPrimary-E-RNTI   E-RNTI           OPTIONAL,
    newSecondary-E-RNTI E-RNTI           OPTIONAL,
    -- Core network IEs
    cn-InformationInfo  CN-InformationInfo-r6  OPTIONAL,
    -- Physical channel IEs
    dtx-drx-TimingInfo DTX-DRX-TimingInfo-r7  OPTIONAL,
    dtx-drx-Info        DTX-DRX-Info-r12    OPTIONAL,
    hs-scch-LessInfo    HS-SCCH-LessInfo-r7  OPTIONAL,
    mimoParameters      MIMO-Parameters-r9  OPTIONAL,
    mimo4x4Parameters   MIMO4x4-Parameters  OPTIONAL,
    dch-Enhancements-Info-FDD DCH-Enhancements-Info-FDD  OPTIONAL,
    maxAllowedUL-TX-Power MaxAllowedUL-TX-Power  OPTIONAL,
    ul-SecondaryCellInfoFDD UL-SecondaryCellInfoFDD-r12  OPTIONAL,
    e-dch-ReconfigurationInfo-SecULFrequency E-DCH-ReconfigurationInfo-SecULFrequency  OPTIONAL,
    ul-CLTD-InfoFDD      UL-CLTD-InfoFDD      OPTIONAL,
    f-tpich-ReconfigurationInfo F-TPICH-ReconfigurationInfo  OPTIONAL,
    ul-OLTD-InfoFDD      UL-OLTD-InfoFDD      OPTIONAL,
    rl-AdditionInformationList RL-AdditionInformationList-r12  OPTIONAL,
    rl-AdditionInformationList-SecULFreq      RL-AdditionInformationList-SecULFreq-r12  OPTIONAL,
    servingCellChangeParameters ServingCellChangeParameters-r12  OPTIONAL,
    rl-RemovalInformationList RL-RemovalInformationList  OPTIONAL,
    rl-RemovalInformationList-SecULFreq      RL-RemovalInformationList-SecULFreq  OPTIONAL,
    tx-DiversityMode     TX-DiversityMode     OPTIONAL,
    dpc-Mode             DPC-Mode             OPTIONAL,
    serving-HSDSCH-CellInformation Serving-HSDSCH-CellInformation-r12  OPTIONAL,
    e-dch-ReconfigurationInfo E-DCH-ReconfigurationInfo-r11  OPTIONAL,
    ul-16QAM-Config      UL-16QAM-Config      OPTIONAL,
    ul-64QAM-Config      UL-64QAM-Config      OPTIONAL,
    ul-MIMO-InfoFDD      UL-MIMO-InfoFDD      OPTIONAL,
    e-dch-ReconfInfoSameCell E-DCH-RL-InfoSameServingCell  OPTIONAL,
    e-TFC-Boost-Info     E-TFC-Boost-Info-r7  OPTIONAL,
    e-DPDCH-PowerInterpolation E-DPDCH-PowerInterpolation  OPTIONAL,
    dl-SecondaryCellInfoFDD DL-SecondaryCellInfoFDD-r11  OPTIONAL,
    additionalDLSecCellInfoListFDD AdditionalDLSecCellInfoListFDD-r11  OPTIONAL,
    additionalDLSecCellInfoListFDD2 AdditionalDLSecCellInfoListFDD2  OPTIONAL,
    dPCCH2InfoFDD        DPCCH2InfoFDD        OPTIONAL
}
-- *****
--
-- ACTIVE SET UPDATE COMPLETE (FDD only)
--
-- *****

ActiveSetUpdateComplete ::= SEQUENCE {
    -- User equipment IEs
    rrc-TransactionIdentifier RRC-TransactionIdentifier,
    -- dummy is not used in this version of the specification, it should
    -- not be sent and if received it should be ignored.
    dummy IntegrityProtActivationInfo OPTIONAL,
    -- Radio bearer IEs
    -- dummy2 and dummy3 are not used in this version of the specification, they should
    -- not be sent and if received they should be ignored.
    dummy2 RB-ActivationTimeInfoList OPTIONAL,
    dummy3 UL-CounterSynchronisationInfo OPTIONAL,
    laterNonCriticalExtensions SEQUENCE {
        -- Container for additional R99 extensions
        activeSetUpdateComplete-r3-add-ext BIT STRING OPTIONAL,
        nonCriticalExtensions SEQUENCE {} OPTIONAL
    }
}
-- *****
--
-- ACTIVE SET UPDATE FAILURE (FDD only)
--
-- *****

```

```

ActiveSetUpdateFailure ::= SEQUENCE {
  -- User equipment IEs
  rrc-TransactionIdentifier      RRC-TransactionIdentifier,
  failureCause                   FailureCauseWithProtErr,
  laterNonCriticalExtensions     SEQUENCE {
    -- Container for additional R99 extensions
    activeSetUpdateFailure-r3-add-ext  BIT STRING      OPTIONAL,
    nonCriticalExtensions              SEQUENCE {} OPTIONAL
  } OPTIONAL
}

-- *****
--
-- ASSISTANCE DATA DELIVERY--
-- *****

AssistanceDataDelivery ::= CHOICE {
  r3 SEQUENCE {
    assistanceDataDelivery-r3 AssistanceDataDelivery-r3-IEs,
    v3a0NonCriticalExtensions SEQUENCE {
      assistanceDataDelivery-v3a0ext AssistanceDataDelivery-v3a0ext,
      laterNonCriticalExtensions SEQUENCE {
        -- Container for additional R99 extensions
        assistanceDataDelivery-r3-add-ext  BIT STRING      OPTIONAL,
        v4b0NonCriticalExtensions SEQUENCE {
          assistanceDataDelivery-v4b0ext AssistanceDataDelivery-v4b0ext-IEs,
          v770NonCriticalExtension SEQUENCE {
            assistanceDataDelivery-v770ext AssistanceDataDelivery-v770ext-IEs,
            v860NonCriticalExtension SEQUENCE {
              assistanceDataDelivery-v860ext AssistanceDataDelivery-v860ext-IEs,
              v920NonCriticalExtension SEQUENCE {
                assistanceDataDelivery-v920ext AssistanceDataDelivery-v920ext-IEs,
                va40NonCriticalExtension SEQUENCE {
                  assistanceDataDelivery-va40ext
                    AssistanceDataDelivery-va40ext-IEs,
                  vc50NonCriticalExtension SEQUENCE {
                    assistanceDataDelivery-vc50ext
                      AssistanceDataDelivery-vc50ext-IEs,
                    nonCriticalExtensions SEQUENCE {} OPTIONAL
                  } OPTIONAL
                } OPTIONAL
              } OPTIONAL
            } OPTIONAL
          } OPTIONAL
        } OPTIONAL
      } OPTIONAL
    } OPTIONAL
  },
  later-than-r3 SEQUENCE {
    rrc-TransactionIdentifier      RRC-TransactionIdentifier,
    criticalExtensions             SEQUENCE {}
  }
}

AssistanceDataDelivery-r3-IEs ::= SEQUENCE {
  -- User equipment IEs
  rrc-TransactionIdentifier      RRC-TransactionIdentifier,
  -- Measurement Information Elements
  ue-positioning-GPS-AssistanceData  UE-Positioning-GPS-AssistanceData      OPTIONAL,
  ue-positioning-OTDOA-AssistanceData-UEB  UE-Positioning-OTDOA-AssistanceData-UEB  OPTIONAL
}

AssistanceDataDelivery-v3a0ext ::= SEQUENCE {
  sfm-Offset-Validity           SFM-Offset-Validity      OPTIONAL
}

AssistanceDataDelivery-v4b0ext-IEs ::= SEQUENCE {
  ue-Positioning-OTDOA-AssistanceData-r4ext  UE-Positioning-OTDOA-AssistanceData-r4ext  OPTIONAL
}

AssistanceDataDelivery-v770ext-IEs ::= SEQUENCE {
  ue-Positioning-OTDOA-AssistanceData-UEB-ext  UE-Positioning-OTDOA-AssistanceData-UEB-ext  OPTIONAL,
  ue-Positioning-GPS-AssistanceData  UE-Positioning-GPS-AssistanceData-v770ext  OPTIONAL,
  ue-positioning-GANSS-AssistanceData  UE-Positioning-GANSS-AssistanceData  OPTIONAL
}

```

```

AssistanceDataDelivery-v860ext-IEs ::= SEQUENCE {
    ue-positioning-GANSS-AssistanceData-v860ext
        UE-Positioning-GANSS-AssistanceData-v860ext    OPTIONAL
}

AssistanceDataDelivery-v920ext-IEs ::= SEQUENCE {
    ue-positioning-GPS-AssistanceData-v920ext
        UE-Positioning-GPS-AssistanceData-v920ext    OPTIONAL,
    ue-positioning-GANSS-AssistanceData-v920ext
        UE-Positioning-GANSS-AssistanceData-v920ext    OPTIONAL
}

AssistanceDataDelivery-va40ext-IEs ::= SEQUENCE {
    ue-positioning-GPS-AssistanceData-va40ext
        UE-Positioning-GPS-AssistanceData-va40ext    OPTIONAL,
    ue-positioning-GANSS-AssistanceData-va40ext
        UE-Positioning-GANSS-AssistanceData-va40ext    OPTIONAL
}

AssistanceDataDelivery-vc50ext-IEs ::= SEQUENCE {
    ue-positioning-GPS-AssistanceData-vc50ext
        UE-Positioning-GPS-AssistanceData-vc50ext    OPTIONAL,
    ue-positioning-GANSS-AssistanceData-vc50ext
        UE-Positioning-GANSS-AssistanceData-vc50ext    OPTIONAL
}

-- *****
--
-- CELL CHANGE ORDER FROM UTRAN
--
-- *****

CellChangeOrderFromUTRAN ::= CHOICE {
    r3
        SEQUENCE {
            cellChangeOrderFromUTRAN-IEs
                CellChangeOrderFromUTRAN-r3-IEs,
            laterNonCriticalExtensions
                SEQUENCE {
                    -- Container for additional R99 extensions
                    cellChangeOrderFromUTRAN-r3-add-ext
                        BIT STRING    OPTIONAL,
                    v590NonCriticalExtensions
                        SEQUENCE {
                            cellChangeOrderFromUTRAN-v590ext
                                CellChangeOrderFromUTRAN-v590ext-IEs,
                            nonCriticalExtensions
                                SEQUENCE {} OPTIONAL
                        } OPTIONAL
                } OPTIONAL
        },
    later-than-r3
        SEQUENCE {
            rrc-TransactionIdentifier
                RRC-TransactionIdentifier,
            criticalExtensions
                SEQUENCE {}
        }
}

CellChangeOrderFromUTRAN-r3-IEs ::= SEQUENCE {
    -- User equipment IEs
    rrc-TransactionIdentifier
        RRC-TransactionIdentifier,
    -- dummy is not used in this version of the specification, it should
    -- not be sent and if received it should be ignored.
    dummy
        IntegrityProtectionModeInfo    OPTIONAL,
    activationTime
        ActivationTime    OPTIONAL,
    -- the IE rab-InformationList is not used in this version of the specification, it should
    -- not be sent and if received it should be ignored. The IE may be used in a later
    -- version of the protocol and hence it is not changed into a dummy
    rab-InformationList
        RAB-InformationList    OPTIONAL,
    interRAT-TargetCellDescription
        InterRAT-TargetCellDescription
}

CellChangeOrderFromUTRAN-v590ext-IEs ::= SEQUENCE {
    geran-SystemInfoType
        CHOICE {
            sI
                GERAN-SystemInformation,
            pSI
                GERAN-SystemInformation
        }
        OPTIONAL
}

-- *****
--
-- CELL CHANGE ORDER FROM UTRAN FAILURE
--
-- *****

CellChangeOrderFromUTRANFailure ::= CHOICE {

```

```

r3                SEQUENCE {
  cellChangeOrderFromUTRANFailure-r3
    CellChangeOrderFromUTRANFailure-r3-IEs,
  laterNonCriticalExtensions SEQUENCE {
    -- Container for additional R99 extensions
    cellChangeOrderFromUTRANFailure-r3-add-ext BIT STRING OPTIONAL,
    nonCriticalExtensions SEQUENCE {} OPTIONAL
  } OPTIONAL
},
-- dummy is not used in this version of the specification and it
-- should be ignored.
dummy            SEQUENCE {
  rrc-TransactionIdentifier RRC-TransactionIdentifier,
  criticalExtensions SEQUENCE {}
}
}

CellChangeOrderFromUTRANFailure-r3-IEs ::= SEQUENCE {
  -- User equipment IEs
  rrc-TransactionIdentifier RRC-TransactionIdentifier,
  -- dummy is not used in this version of the specification, it should
  -- not be sent and if received it should be ignored.
  dummy IntegrityProtectionModeInfo OPTIONAL,
  interRAT-ChangeFailureCause InterRAT-ChangeFailureCause
}

-- *****
--
-- CELL UPDATE
--
-- *****

CellUpdate ::= SEQUENCE {
  -- User equipment IEs
  u-RNTI U-RNTI,
  startList STARTList,
  am-RLC-ErrorIndicationRb2-3or4 BOOLEAN,
  am-RLC-ErrorIndicationRb5orAbove BOOLEAN,
  cellUpdateCause CellUpdateCause,
  -- TABULAR: RRC transaction identifier is nested in FailureCauseWithProtErrTrId
  failureCause FailureCauseWithProtErrTrId OPTIONAL,
  rb-timer-indicator Rb-timer-indicator,
  -- Measurement IEs
  measuredResultsOnRACH MeasuredResultsOnRACH OPTIONAL,
  laterNonCriticalExtensions SEQUENCE {
    -- Container for additional R99 extensions
    -- The cellUpdate-r3-add-ext can be omitted if its inclusion would result in the
    -- size of the message exceeding the maximum PDU size possible for CCCH
    -- transmission
    cellUpdate-r3-add-ext BIT STRING
      (CONTAINING CellUpdate-r3-add-ext-IEs) OPTIONAL,
  v590NonCriticalExtensions SEQUENCE {
    cellUpdate-v590ext CellUpdate-v590ext,
    v690NonCriticalExtensions SEQUENCE {
      cellUpdate-v690ext CellUpdate-v690ext-IEs,
      v6b0NonCriticalExtensions SEQUENCE {
        cellUpdate-v6b0ext CellUpdate-v6b0ext-IEs,
        v770NonCriticalExtensions SEQUENCE {
          cellUpdate-v770ext CellUpdate-v770ext-IEs,
          v860NonCriticalExtensions SEQUENCE {
            cellUpdate-v860ext CellUpdate-v860ext-IEs,
            -- The va40NonCriticalExtensions can be omitted if its inclusion
            -- would result in the size of the message exceeding the maximum PDU
            -- size possible for CCCH transmission
            va40NonCriticalExtensions SEQUENCE {
              cellUpdate-va40ext CellUpdate-va40ext-IEs,
              vb50NonCriticalExtensions SEQUENCE {
                cellUpdate-vb50ext CellUpdate-vb50ext-IEs,
                vc50NonCriticalExtensions SEQUENCE {
                  cellUpdate-vc50ext CellUpdate-vc50ext-IEs,
                  nonCriticalExtensions SEQUENCE {} OPTIONAL
                } OPTIONAL
              } OPTIONAL
            } OPTIONAL
          } OPTIONAL
        } OPTIONAL
      } OPTIONAL
    } OPTIONAL
  } OPTIONAL
} OPTIONAL
} OPTIONAL
}

```

```

    } OPTIONAL
  } OPTIONAL
}

CellUpdate-r3-add-ext-IEs ::= SEQUENCE {
  cellUpdate-v7e0ext          CellUpdate-v7e0ext-IEs,
  v7g0NonCriticalExtensions SEQUENCE {
    cellUpdate-v7g0ext          CellUpdate-v7g0ext-IEs,
    nonCriticalExtensions       SEQUENCE {} OPTIONAL
  } OPTIONAL
}

CellUpdate-v590ext ::= SEQUENCE {
  establishmentCause          EstablishmentCause OPTIONAL
}

CellUpdate-v690ext-IEs ::= SEQUENCE {
  -- User equipment IEs
  cellUpdateCause-ext        CellUpdateCause-ext          OPTIONAL,
  trafficVolumeIndicator     ENUMERATED { true }          OPTIONAL,
  -- Measurement IEs
  measuredResultsOnRACHinterFreq MeasuredResultsOnRACHinterFreq OPTIONAL,
  reconfigurationStatusIndicator ENUMERATED { true }      OPTIONAL
}

CellUpdate-v6b0ext-IEs ::= SEQUENCE {
  -- MBMS IEs
  -- The mbmsSelectedServices can be omitted if its inclusion would result in the
  -- size of the message exceeding the maximum PDU size possible for CCCH transmission
  mbmsSelectedServices       MBMS-SelectedServicesShort  OPTIONAL
}

CellUpdate-v770ext-IEs ::= SEQUENCE {
  -- User equipment IEs
  csCallType                  ENUMERATED { speech, video, other, spare } OPTIONAL,
  hspdschReception-CellFach  ENUMERATED { true }          OPTIONAL,
  ueMobilityStateIndicator    High-MobilityDetected        OPTIONAL,
  capabilityChangeIndicator   ENUMERATED { true }          OPTIONAL
}

CellUpdate-v7e0ext-IEs ::= SEQUENCE {
  -- User equipment IEs
  supportForTwoDRXSchemesInPCH ENUMERATED { true }          OPTIONAL
}

CellUpdate-v7g0ext-IEs ::= SEQUENCE {
  -- Measurement IEs
  measuredResultsOnRACH-v7g0ext MeasuredResultsOnRACH-v7g0ext OPTIONAL
}

CellUpdate-v860ext-IEs ::= SEQUENCE {
  -- User equipment IEs
  supportOfCommonEDCH         ENUMERATED { true }          OPTIONAL,
  supportOfFHS-DSCHDRXOperation ENUMERATED { true }          OPTIONAL,
  supportOfMACiis             ENUMERATED { true }          OPTIONAL,
  supportOfSPSOperation       ENUMERATED { true }          OPTIONAL,
  supportOfControlChannelDRXOperation ENUMERATED { true }    OPTIONAL
}

CellUpdate-va40ext-IEs ::= SEQUENCE {
  -- User equipment IEs
  securityRevertStatusIndicator ENUMERATED { revertedBack, normalOperation } OPTIONAL,
  -- Other IEs
  loggedMeasAvailable          ENUMERATED { true }          OPTIONAL,
  loggedANRResultsAvailable    ENUMERATED { true }          OPTIONAL
}

-- TABULAR: TDD related IEs, MBMS IEs, and supportForTwoDRXSchemesInPCH are omitted compared to
-- tabular for the purpose of coding optimisation
CellUpdateFDD-r11 ::= SEQUENCE {
  -- User equipment IEs
  u-RNTI          U-RNTI,
  startList       STARTList,
  am-RLC-ErrorIndicationRb2-3or4          BOOLEAN,
  am-RLC-ErrorIndicationRb5orAbove        BOOLEAN,
  cellUpdateCause          CellUpdateCause,
  -- TABULAR: RRC transaction identifier is nested in FailureCauseWithProtErrTrId

```



```

failureCause                FailureCauseWithProtErrTrId    OPTIONAL,
rb-timer-indicator          Rb-timer-indicator,
establishmentCause          EstablishmentCause      OPTIONAL,
trafficVolumeIndicator      ENUMERATED { true }    OPTIONAL,
reconfigurationStatusIndicator  ENUMERATED { true }    OPTIONAL,
csCallType                  ENUMERATED { speech, video, other, spare }  OPTIONAL,
hspdschReception-CellFach    ENUMERATED { true }    OPTIONAL,
ueMobilityStateIndicator     High-MobilityDetected  OPTIONAL,
capabilityChangeIndicator     ENUMERATED { true }    OPTIONAL,
supportOfCommonEDCH          ENUMERATED { true }    OPTIONAL,
supportOfHS-DSCHDRXOperation  ENUMERATED { true }    OPTIONAL,
supportOfMACiis              ENUMERATED { true }    OPTIONAL,
securityRevertStatusIndicator  ENUMERATED { revertedBack, normalOperation }  OPTIONAL,
spare4                       ENUMERATED { true }    OPTIONAL,
spare3                       ENUMERATED { true }    OPTIONAL,
spare2                       ENUMERATED { true }    OPTIONAL,
spare1                       ENUMERATED { true }    OPTIONAL,
-- Measurement IEs
measuredResultsOnRACH        MeasuredResultsOnRACHFDD-r11  OPTIONAL,
-- Other IEs
loggedMeasAvailable          ENUMERATED { true }    OPTIONAL,
loggedANRRResultsAvailable    ENUMERATED { true }    OPTIONAL
}

CellUpdate-vb50ext-IEs ::= SEQUENCE {
  -- Measurement IEs
  measuredResultsOnRACHEUTRAFreq  MeasuredResultsOnRACH-EUTRAFreq  OPTIONAL
}

CellUpdate-vc50ext-IEs ::= SEQUENCE {
  -- Measurement IEs
  measuredResultsOnRACH            MeasuredResultsOnRACH-vc50ext  OPTIONAL
}

-- *****
--
-- CELL UPDATE CONFIRM
--
-- *****

CellUpdateConfirm ::= CHOICE {
  r3 SEQUENCE {
    cellUpdateConfirm-r3          CellUpdateConfirm-r3-IEs,
    v3a0NonCriticalExtensions      SEQUENCE {
      cellUpdateConfirm-v3a0ext    CellUpdateConfirm-v3a0ext,
      laterNonCriticalExtensions    SEQUENCE {
        -- Container for additional R99 extensions
        cellUpdateConfirm-r3-add-ext  BIT STRING  OPTIONAL,
        v4b0NonCriticalExtensions      SEQUENCE {
          cellUpdateConfirm-v4b0ext    CellUpdateConfirm-v4b0ext-IEs,
          v590NonCriticalExtensions    SEQUENCE {
            cellUpdateConfirm-v590ext    CellUpdateConfirm-v590ext-IEs,
            v5d0NonCriticalExtensitions  SEQUENCE {
              cellUpdateConfirm-v5d0ext    CellUpdateConfirm-v5d0ext-IEs,
              v690NonCriticalExtensions    SEQUENCE {
                cellUpdateConfirm-v690ext    CellUpdateConfirm-v690ext-IEs,
                nonCriticalExtensions      SEQUENCE {}  OPTIONAL
              }
            }
          }
        }
      }
    }
  }
  OPTIONAL
}
  OPTIONAL
}
  OPTIONAL
},
later-than-r3 SEQUENCE {
  rrc-TransactionIdentifier      RRC-TransactionIdentifier,
  criticalExtensions              CHOICE {
    r4 SEQUENCE {
      cellUpdateConfirm-r4          CellUpdateConfirm-r4-IEs,
      v4d0NonCriticalExtensions      SEQUENCE {
        -- Container for adding non critical extensions after freezing REL-5
        cellUpdateConfirm-r4-add-ext  BIT STRING  OPTIONAL,
        v590NonCriticalExtensitions    SEQUENCE {
          cellUpdateConfirm-v590ext    CellUpdateConfirm-v590ext-IEs,
          v5d0NonCriticalExtensitions  SEQUENCE {
            cellUpdateConfirm-v5d0ext    CellUpdateConfirm-v5d0ext-IEs,
            v690NonCriticalExtensions    SEQUENCE {
              cellUpdateConfirm-v690ext    CellUpdateConfirm-v690ext-IEs,

```

```

        nonCriticalExtensions          SEQUENCE {}          OPTIONAL
    } OPTIONAL
} OPTIONAL
},
criticalExtensions                    CHOICE {
  r5                                    SEQUENCE {
    cellUpdateConfirm-r5                CellUpdateConfirm-r5-IEs,
    -- Container for adding non critical extensions after freezing REL-6
    cellUpdateConfirm-r5-add-ext        BIT STRING          OPTIONAL,
    v5d0NonCriticalExtensstions        SEQUENCE {
      cellUpdateConfirm-v5d0ext          CellUpdateConfirm-v5d0ext-IEs,
      v690NonCriticalExtensions          SEQUENCE {
        cellUpdateConfirm-v690ext        CellUpdateConfirm-v690ext-IEs,
        nonCriticalExtensions            SEQUENCE {}          OPTIONAL
      } OPTIONAL
    } OPTIONAL
  } OPTIONAL
},
criticalExtensions                    CHOICE {
  r6                                    SEQUENCE {
    cellUpdateConfirm-r6                CellUpdateConfirm-r6-IEs,
    -- Container for adding non critical extensions after freezing REL-7
    cellUpdateConfirm-r6-add-ext        BIT STRING          OPTIONAL,
    v6b0NonCriticalExtensions          SEQUENCE {
      cellUpdateConfirm-v6b0ext          CellUpdateConfirm-v6b0ext-IEs,
      nonCriticalExtensions              SEQUENCE {}          OPTIONAL
    } OPTIONAL
  } OPTIONAL
},
criticalExtensions                    CHOICE {
  r7                                    SEQUENCE {
    cellUpdateConfirm-r7                CellUpdateConfirm-r7-IEs,
    -- Container for adding non critical extensions after freezing REL-8
    cellUpdateConfirm-r7-add-ext        BIT STRING
    (CONTAINING CellUpdateConfirm-r7-add-ext-IEs) OPTIONAL,
    v780NonCriticalExtensions          SEQUENCE {
      cellUpdateConfirm-v780ext          CellUpdateConfirm-v780ext-IEs,
      v860NonCriticalExtensions          SEQUENCE {
        cellUpdateConfirm-v860ext        CellUpdateConfirm-v860ext-IEs,
        nonCriticalExtensions            SEQUENCE {}          OPTIONAL
      } OPTIONAL
    } OPTIONAL
  } OPTIONAL
},
criticalExtensions                    CHOICE {
  r8                                    SEQUENCE {
    cellUpdateConfirm-r8                CellUpdateConfirm-r8-IEs,
    -- Container for adding non critical extensions after freezing REL-9
    cellUpdateConfirm-r8-add-ext        BIT STRING          OPTIONAL,
    v7d0NonCriticalExtensions          SEQUENCE {
      cellUpdateConfirm-v7d0ext          CellUpdateConfirm-v7d0ext-IEs,
      v7f0NonCriticalExtensions          SEQUENCE {
        cellUpdateConfirm-v7f0ext        CellUpdateConfirm-v7f0ext-IEs,
        v890NonCriticalExtensions        SEQUENCE {
          cellUpdateConfirm-v890ext      CellUpdateConfirm-v890ext-IEs,
          v7g0NonCriticalExtensions      SEQUENCE {
            cellUpdateConfirm-v7g0ext    CellUpdateConfirm-v7g0ext-IEs,
            v8a0NonCriticalExtensions    SEQUENCE {
              cellUpdateConfirm-v8a0ext  CellUpdateConfirm-v8a0ext-IEs,
              nonCriticalExtensions      SEQUENCE {}
            }
          }
        }
      }
    }
  } OPTIONAL
} OPTIONAL
},
criticalExtensions                    CHOICE {
  r9                                    SEQUENCE {
    cellUpdateConfirm-r9                CellUpdateConfirm-r9-IEs,
    -- Container for adding non critical extensions after
    -- freezing REL-10
    cellUpdateConfirm-r9-add-ext        BIT STRING          OPTIONAL,
    v950NonCriticalExtensions          SEQUENCE {
      cellUpdateConfirm-v950ext          CellUpdateConfirm-v950ext-

```

IEs,

```

v9c0ext-IEs,
    v9c0NonCriticalExtensions SEQUENCE {
        cellUpdateConfirm-v9c0ext CellUpdateConfirm-
            nonCriticalExtensions SEQUENCE {} OPTIONAL
    } OPTIONAL
},
criticalExtensions CHOICE {
    r10 SEQUENCE {
        cellUpdateConfirm-r10 CellUpdateConfirm-r10-IEs,
        -- Container for adding non critical extensions after
        -- freezing REL-11
        cellUpdateConfirm-r10-add-ext BIT STRING OPTIONAL,
        v9c0NonCriticalExtensions SEQUENCE {
            cellUpdateConfirm-v9c0ext CellUpdateConfirm-
                vb50NonCriticalExtensions SEQUENCE {
                    cellUpdateConfirm-vb50ext
                        CellUpdateConfirm-vb50ext-IEs,
                    nonCriticalExtensions SEQUENCE {} OPTIONAL
                } OPTIONAL
            } OPTIONAL
    },
    criticalExtensions CHOICE {
        r11 SEQUENCE {
            cellUpdateConfirm-r11 CellUpdateConfirm-r11-IEs,
            -- Container for adding non critical extensions after
            -- freezing REL-12
            cellUpdateConfirm-r11-add-ext
                BIT STRING OPTIONAL,
            nonCriticalExtensions SEQUENCE {} OPTIONAL
        },
        criticalExtensions CHOICE {
            r12 SEQUENCE {
                cellUpdateConfirm-r12 CellUpdateConfirm-r12-IEs,
                -- Container for adding non critical extensions
                -- after freezing REL-13
                cellUpdateConfirm-r12-add-ext
                    BIT STRING OPTIONAL,
                nonCriticalExtensions SEQUENCE {} OPTIONAL
            },
            criticalExtensions SEQUENCE {}
        }
    }
}

CellUpdateConfirm-r3-IEs ::= SEQUENCE {
-- User equipment IEs
    rrc-TransactionIdentifier RRC-TransactionIdentifier,
    integrityProtectionModeInfo IntegrityProtectionModeInfo OPTIONAL,
    cipheringModeInfo CipheringModeInfo OPTIONAL,
    activationTime ActivationTime OPTIONAL,
    new-U-RNTI U-RNTI OPTIONAL,
    new-C-RNTI C-RNTI OPTIONAL,
    rrc-StateIndicator RRC-StateIndicator,
    utran-DRX-CycleLengthCoeff UTRAN-DRX-CycleLengthCoefficient OPTIONAL,
    rlc-Re-establishIndicatorRb2-3or4 BOOLEAN,
    rlc-Re-establishIndicatorRb5orAbove BOOLEAN,
-- CN information elements
    cn-InformationInfo CN-InformationInfo OPTIONAL,
-- UTRAN mobility IEs
    ura-Identity URA-Identity OPTIONAL,
-- Radio bearer IEs
    rb-InformationReleaseList RB-InformationReleaseList OPTIONAL,
    rb-InformationReconfigList RB-InformationReconfigList OPTIONAL,
    rb-InformationAffectedList RB-InformationAffectedList OPTIONAL,
    dl-CounterSynchronisationInfo DL-CounterSynchronisationInfo OPTIONAL,
-- Transport channel IEs
    ul-CommonTransChInfo UL-CommonTransChInfo OPTIONAL,
    ul-deletedTransChInfoList UL-DeletedTransChInfoList OPTIONAL,
}

```

```

    ul-AddReconfTransChInfoList      UL-AddReconfTransChInfoList      OPTIONAL,
    modeSpecificTransChInfo          CHOICE {
        fdd                          SEQUENCE {
            -- dummy and dummy2 are not used in this version of the specification, they should
            -- not be sent and if received they should be ignored.
            dummy                      CPCH-SetID                      OPTIONAL,
            dummy2                     DRAC-StaticInformationList    OPTIONAL
        },
        tdd                            NULL
    },
    dl-CommonTransChInfo              DL-CommonTransChInfo              OPTIONAL,
    dl-DeletedTransChInfoList         DL-DeletedTransChInfoList         OPTIONAL,
    dl-AddReconfTransChInfoList       DL-AddReconfTransChInfoList       OPTIONAL,
-- Physical channel IEs
    frequencyInfo                     FrequencyInfo                     OPTIONAL,
    maxAllowedUL-TX-Power              MaxAllowedUL-TX-Power            OPTIONAL,
    ul-ChannelRequirement              UL-ChannelRequirement            OPTIONAL,
    modeSpecificPhysChInfo            CHOICE {
        fdd                          SEQUENCE {
            -- dummy is not used in this version of specification, it should
            -- not be sent and if received it should be ignored.
            dummy                      DL-PDSCH-Information        OPTIONAL
        },
        tdd                            NULL
    },
    dl-CommonInformation               DL-CommonInformation             OPTIONAL,
    dl-InformationPerRL-List           DL-InformationPerRL-List         OPTIONAL
}

CellUpdateConfirm-v3a0ext ::= SEQUENCE {
    -- The IE "new-DSCH-RNTI" should not be included in FDD mode, and if received the UE behaviour
    -- is unspecified
    new-DSCH-RNTI                     DSCH-RNTI                       OPTIONAL
}

CellUpdateConfirm-v4b0ext-IEs ::= SEQUENCE {
    -- Physical channel IEs
    -- dummy is not used in this version of the specification, it should
    -- not be sent and if received it should be ignored.
    dummy                              SSDT-UL                          OPTIONAL,
    -- The order of the RLs in IE cell-id-PerRL-List is the same as
    -- in IE DL-InformationPerRL-List included in this message
    cell-id-PerRL-List                 CellIdentity-PerRL-List          OPTIONAL
}

CellUpdateConfirm-v590ext-IEs ::= SEQUENCE {
    -- Physical channel IEs
    dl-TPC-PowerOffsetPerRL-List       DL-TPC-PowerOffsetPerRL-List    OPTIONAL
}

CellUpdateConfirm-v5d0ext-IEs ::= SEQUENCE {
    --Radio Bearer IEs
    pdcp-ROHC-TargetMode               PDCP-ROHC-TargetMode            OPTIONAL
}

CellUpdateConfirm-r4-IEs ::= SEQUENCE {
    -- User equipment IEs
    integrityProtectionModeInfo         IntegrityProtectionModeInfo      OPTIONAL,
    cipheringModeInfo                   CipheringModeInfo                OPTIONAL,
    activationTime                       ActivationTime                    OPTIONAL,
    new-U-RNTI                           U-RNTI                          OPTIONAL,
    new-C-RNTI                           C-RNTI                          OPTIONAL,
    -- The IE "new-DSCH-RNTI" should not be included in FDD mode, and if received
    -- the UE behaviour is unspecified
    new-DSCH-RNTI                       DSCH-RNTI                       OPTIONAL,
    rrc-StateIndicator                   RRC-StateIndicator,             OPTIONAL,
    utran-DRX-CycleLengthCoeff          UTRAN-DRX-CycleLengthCoefficient OPTIONAL,
    rlc-Re-establishIndicatorRb2-3or4    BOOLEAN,
    rlc-Re-establishIndicatorRb5orAbove  BOOLEAN,
    -- CN information elements
    cn-InformationInfo                  CN-InformationInfo              OPTIONAL,
    -- UTRAN mobility IEs
    ura-Identity                         URA-Identity                    OPTIONAL,
    -- Radio bearer IEs
    rb-InformationReleaseList            RB-InformationReleaseList        OPTIONAL,
    rb-InformationReconfigList           RB-InformationReconfigList-r4    OPTIONAL,
    rb-InformationAffectedList           RB-InformationAffectedList        OPTIONAL,
    dl-CounterSynchronisationInfo        DL-CounterSynchronisationInfo    OPTIONAL,
    -- Transport channel IEs

```

```

ul-CommonTransChInfo          UL-CommonTransChInfo-r4          OPTIONAL,
ul-deletedTransChInfoList     UL-DeletedTransChInfoList         OPTIONAL,
ul-AddReconfTransChInfoList   UL-AddReconfTransChInfoList       OPTIONAL,
modeSpecificTransChInfo       CHOICE {
  fdd                           SEQUENCE {
    -- dummy and dummy2 are not used in this version of the specification, they should
    -- not be sent and if received they should be ignored.
    dummy                        CPCH-SetID          OPTIONAL,
    dummy2                       DRAC-StaticInformationList  OPTIONAL
  },
  tdd                           NULL
},
dl-CommonTransChInfo          DL-CommonTransChInfo-r4          OPTIONAL,
dl-DeletedTransChInfoList     DL-DeletedTransChInfoList         OPTIONAL,
dl-AddReconfTransChInfoList   DL-AddReconfTransChInfoList-r4    OPTIONAL,
-- Physical channel IEs
frequencyInfo                 FrequencyInfo                     OPTIONAL,
maxAllowedUL-TX-Power         MaxAllowedUL-TX-Power             OPTIONAL,
ul-ChannelRequirement         UL-ChannelRequirement-r4         OPTIONAL,
modeSpecificPhysChInfo        CHOICE {
  fdd                           SEQUENCE {
    -- dummy is not used in this version of specification, it should
    -- not be sent and if received it should be ignored.
    dummy                        DL-PDSCH-Information     OPTIONAL
  },
  tdd                           NULL
},
dl-CommonInformation          DL-CommonInformation-r4          OPTIONAL,
dl-InformationPerRL-List      DL-InformationPerRL-List-r4      OPTIONAL
}

CellUpdateConfirm-r5-IEs ::= SEQUENCE {
-- User equipment IEs
integrityProtectionModeInfo   IntegrityProtectionModeInfo       OPTIONAL,
cipheringModeInfo             CipheringModeInfo                  OPTIONAL,
activationTime                 ActivationTime                      OPTIONAL,
new-U-RNTI                     U-RNTI                            OPTIONAL,
new-C-RNTI                     C-RNTI                            OPTIONAL,
-- The IE "new-DSCH-RNTI" should not be included in FDD mode, and if received
-- the UE behaviour is unspecified
new-DSCH-RNTI                 DSCH-RNTI                         OPTIONAL,
new-H-RNTI                     H-RNTI                            OPTIONAL,
rrc-StateIndicator            RRC-StateIndicator,
utran-DRX-CycleLengthCoeff     UTRAN-DRX-CycleLengthCoefficient  OPTIONAL,
rlc-Re-establishIndicatorRb2-3or4  BOOLEAN,
rlc-Re-establishIndicatorRb5orAbove  BOOLEAN,
-- CN information elements
cn-InformationInfo             CN-InformationInfo                OPTIONAL,
-- UTRAN mobility IEs
ura-Identity                   URA-Identity                      OPTIONAL,
-- Radio bearer IEs
rb-InformationReleaseList      RB-InformationReleaseList          OPTIONAL,
rb-InformationReconfigList     RB-InformationReconfigList-r5      OPTIONAL,
rb-InformationAffectedList     RB-InformationAffectedList-r5      OPTIONAL,
dl-CounterSynchronisationInfo  DL-CounterSynchronisationInfo-r5  OPTIONAL,
-- Transport channel IEs
ul-CommonTransChInfo          UL-CommonTransChInfo-r4          OPTIONAL,
ul-deletedTransChInfoList     UL-DeletedTransChInfoList         OPTIONAL,
ul-AddReconfTransChInfoList   UL-AddReconfTransChInfoList       OPTIONAL,
modeSpecificTransChInfo       CHOICE {
  fdd                           SEQUENCE {
    -- dummy and dummy2 are not used in this version of the specification, they should
    -- not be sent and if received they should be ignored.
    dummy                        CPCH-SetID          OPTIONAL,
    dummy2                       DRAC-StaticInformationList  OPTIONAL
  },
  tdd                           NULL
},
dl-CommonTransChInfo          DL-CommonTransChInfo-r4          OPTIONAL,
dl-DeletedTransChInfoList     DL-DeletedTransChInfoList-r5      OPTIONAL,
dl-AddReconfTransChInfoList   DL-AddReconfTransChInfoList-r5    OPTIONAL,
-- Physical channel IEs
frequencyInfo                 FrequencyInfo                     OPTIONAL,
maxAllowedUL-TX-Power         MaxAllowedUL-TX-Power             OPTIONAL,
ul-ChannelRequirement         UL-ChannelRequirement-r5         OPTIONAL,
modeSpecificPhysChInfo        CHOICE {
  fdd                           SEQUENCE {
    -- dummy is not used in this version of specification, it should

```

```

        -- not be sent and if received it should be ignored.
        dummy                DL-PDSCH-Information                OPTIONAL
    },
    tdd                        NULL
},
dl-HSPDSCH-Information        DL-HSPDSCH-Information            OPTIONAL,
dl-CommonInformation          DL-CommonInformation-r5            OPTIONAL,
dl-InformationPerRL-List      DL-InformationPerRL-List-r5        OPTIONAL
}

CellUpdateConfirm-r6-IEs ::= SEQUENCE {
    -- User equipment IEs
    integrityProtectionModeInfo    IntegrityProtectionModeInfo    OPTIONAL,
    cipheringModeInfo              CipheringModeInfo                OPTIONAL,
    activationTime                  ActivationTime                    OPTIONAL,
    new-U-RNTI                      U-RNTI                          OPTIONAL,
    new-C-RNTI                      C-RNTI                          OPTIONAL,
    -- The IE "new-DSCH-RNTI" should not be included in FDD mode,
    -- and if received the UE behaviour is unspecified
    new-DSCH-RNTI                  DSCH-RNTI                        OPTIONAL,
    new-H-RNTI                      H-RNTI                          OPTIONAL,
    newPrimary-E-RNTI              E-RNTI                          OPTIONAL,
    newSecondary-E-RNTI            E-RNTI                          OPTIONAL,
    rrc-StateIndicator              RRC-StateIndicator,
    utran-DRX-CycleLengthCoeff      UTRAN-DRX-CycleLengthCoefficient    OPTIONAL,
    rlc-Re-establishIndicatorRb2-3or4    BOOLEAN,
    rlc-Re-establishIndicatorRb5orAbove    BOOLEAN,
    -- CN information elements
    cn-InformationInfo              CN-InformationInfo-r6            OPTIONAL,
    -- UTRAN mobility IEs
    ura-Identity                    URA-Identity                      OPTIONAL,
    -- Radio bearer IEs
    rb-InformationReleaseList        RB-InformationReleaseList        OPTIONAL,
    rb-InformationReconfigList        RB-InformationReconfigList-r6    OPTIONAL,
    rb-InformationAffectedList        RB-InformationAffectedList-r6    OPTIONAL,
    dl-CounterSynchronisationInfo    DL-CounterSynchronisationInfo-r5    OPTIONAL,
    pdcp-ROHC-TargetMode            PDCP-ROHC-TargetMode            OPTIONAL,
    -- Transport channel IEs
    ul-CommonTransChInfo            UL-CommonTransChInfo-r4          OPTIONAL,
    ul-deletedTransChInfoList        UL-DeletedTransChInfoList-r6     OPTIONAL,
    ul-AddReconfTransChInfoList      UL-AddReconfTransChInfoList-r6   OPTIONAL,
    dl-CommonTransChInfo            DL-CommonTransChInfo-r4          OPTIONAL,
    dl-DeletedTransChInfoList        DL-DeletedTransChInfoList-r5     OPTIONAL,
    dl-AddReconfTransChInfoList      DL-AddReconfTransChInfoList-r5   OPTIONAL,
    -- Physical channel IEs
    frequencyInfo                    FrequencyInfo                      OPTIONAL,
    maxAllowedUL-TX-Power            MaxAllowedUL-TX-Power            OPTIONAL,
    ul-DPCH-Info                    UL-DPCH-Info-r6                  OPTIONAL,
    ul-EDCH-Information              UL-EDCH-Information-r6           OPTIONAL,
    dl-HSPDSCH-Information          DL-HSPDSCH-Information-r6        OPTIONAL,
    dl-CommonInformation            DL-CommonInformation-r6          OPTIONAL,
    dl-InformationPerRL-List        DL-InformationPerRL-List-r6      OPTIONAL,
    -- MBMS IEs
    mbms-PL-ServiceRestrictInfo      MBMS-PL-ServiceRestrictInfo-r6   OPTIONAL
}

CellUpdateConfirm-v690ext-IEs ::= SEQUENCE {
    -- Core network IEs
    primary-plmn-Identity            PLMN-Identity                      OPTIONAL,
    -- Physical channel IEs
    -- The IE harq-Preamble-Mode should not be used in the r3 and r4 versions of the message
    -- If included in the r3 or r4 version of the message, the UE should ignore the IE
    harq-Preamble-Mode              HARQ-Preamble-Mode                OPTIONAL,
    beaconPLEst                      BEACON-PL-Est                     OPTIONAL,
    postVerificationPeriod            ENUMERATED { true }                OPTIONAL,
    dhs-sync                          DHS-Sync                           OPTIONAL,
    -- MBMS IEs
    mbms-PL-ServiceRestrictInfo      MBMS-PL-ServiceRestrictInfo-r6    OPTIONAL
}

CellUpdateConfirm-v6b0ext-IEs ::= SEQUENCE {
    -- Physical channel IEs
    dl-InformationPerRL-List-v6b0ext    DL-InformationPerRL-List-v6b0ext    OPTIONAL
}

CellUpdateConfirm-r7-IEs ::= SEQUENCE {
    -- User equipment IEs
    integrityProtectionModeInfo        IntegrityProtectionModeInfo-r7      OPTIONAL,

```

```

    cipheringModeInfo          CipheringModeInfo-r7          OPTIONAL,
    activationTime             ActivationTime              OPTIONAL,
    new-U-RNTI                 U-RNTI              OPTIONAL,
    new-C-RNTI                 C-RNTI              OPTIONAL,
    -- The IE "new-DSCH-RNTI" should not be included in FDD mode,
    -- and if received the UE behaviour is unspecified
    new-DSCH-RNTI             DSCH-RNTI              OPTIONAL,
    new-H-RNTI                 H-RNTI              OPTIONAL,
    newPrimary-E-RNTI         E-RNTI              OPTIONAL,
    newSecondary-E-RNTI       E-RNTI              OPTIONAL,
    rrc-StateIndicator         RRC-StateIndicator,
    utran-DRX-CycleLengthCoeff UTRAN-DRX-CycleLengthCoefficient-r7 OPTIONAL,
    waitTime                   WaitTime              OPTIONAL,
    rlc-Re-establishIndicatorRb2-3or4    BOOLEAN,
    rlc-Re-establishIndicatorRb5orAbove   BOOLEAN,
-- CN information elements
  cn-InformationInfo          CN-InformationInfo-r6          OPTIONAL,
-- UTRAN mobility IEs
  ura-Identity                URA-Identity              OPTIONAL,
  supportForChangeOfUE-Capability    BOOLEAN              OPTIONAL,
-- Radio bearer IEs
  rb-InformationReleaseList    RB-InformationReleaseList    OPTIONAL,
  rb-InformationReconfigList    RB-InformationReconfigList-r7    OPTIONAL,
  rb-InformationAffectedList    RB-InformationAffectedList-r7    OPTIONAL,
  dl-CounterSynchronisationInfo DL-CounterSynchronisationInfo-r5    OPTIONAL,
  pdcp-ROHC-TargetMode        PDCP-ROHC-TargetMode        OPTIONAL,
-- Transport channel IEs
  ul-CommonTransChInfo        UL-CommonTransChInfo-r4        OPTIONAL,
  ul-deletedTransChInfoList    UL-DeletedTransChInfoList-r6    OPTIONAL,
  ul-AddReconfTransChInfoList    UL-AddReconfTransChInfoList-r7    OPTIONAL,
  dl-CommonTransChInfo        DL-CommonTransChInfo-r4        OPTIONAL,
  dl-DeletedTransChInfoList    DL-DeletedTransChInfoList-r7    OPTIONAL,
  dl-AddReconfTransChInfoList    DL-AddReconfTransChInfoList-r7    OPTIONAL,
-- Physical channel IEs
  frequencyInfo                FrequencyInfo              OPTIONAL,
  multi-frequencyInfo          Multi-frequencyInfo-LCR-r7    OPTIONAL,
  dtx-drx-TimingInfo          DTX-DRX-TimingInfo-r7        OPTIONAL,
  dtx-drx-Info                DTX-DRX-Info-r7            OPTIONAL,
  hs-scch-LessInfo            HS-SCCH-LessInfo-r7          OPTIONAL,
  mimoParameters              MIMO-Parameters-r7          OPTIONAL,
  maxAllowedUL-TX-Power        MaxAllowedUL-TX-Power        OPTIONAL,
  ul-DPCH-Info                UL-DPCH-Info-r7            OPTIONAL,
  ul-EDCH-Information          UL-EDCH-Information-r7        OPTIONAL,
  dl-HSPDSCH-Information        DL-HSPDSCH-Information-r7      OPTIONAL,
  dl-CommonInformation          DL-CommonInformation-r7        OPTIONAL,
  dl-InformationPerRL-List      DL-InformationPerRL-List-r7    OPTIONAL,
-- MBMS IEs
  mbms-PL-ServiceRestrictInfo    MBMS-PL-ServiceRestrictInfo-r6    OPTIONAL
}

CellUpdateConfirm-r7-add-ext-IEs ::= SEQUENCE {
  cellUpdateConfirm-v7d0ext      CellUpdateConfirm-v7d0ext-IEs    OPTIONAL,
  v7f0NonCriticalExtensions      SEQUENCE {
    cellUpdateConfirm-v7f0ext      CellUpdateConfirm-v7f0ext-IEs,
    v7g0NonCriticalExtensions      SEQUENCE {
      cellUpdateConfirm-v7g0ext      CellUpdateConfirm-v7g0ext-IEs,
      nonCriticalExtensions          SEQUENCE {}    OPTIONAL
    }    OPTIONAL
  }    OPTIONAL
}

CellUpdateConfirm-v780ext-IEs ::= SEQUENCE {
  -- Physical channel IEs
  hs-DSCH-TBSizeTable            HS-DSCH-TBSizeTable            OPTIONAL
}

CellUpdateConfirm-v7d0ext-IEs ::= SEQUENCE {
  -- Physical channel IEs
  ul-EDCH-Information            UL-EDCH-Information-ext        OPTIONAL
}

CellUpdateConfirm-v7f0ext-IEs ::= SEQUENCE {
  -- Physical channel IEs
  mimoParameters                MIMO-Parameters-v7f0ext        OPTIONAL
}

CellUpdateConfirm-v7g0ext-IEs ::= SEQUENCE {
  -- Physical channel IEs

```

```

    mimoParameters                MIMO-Parameters-v7g0ext                OPTIONAL
}

CellUpdateConfirm-r8-IEs ::= SEQUENCE {
  -- User equipment IEs
  integrityProtectionModeInfo    IntegrityProtectionModeInfo-r7    OPTIONAL,
  cipheringModeInfo              CipheringModeInfo-r7              OPTIONAL,
  activationTime                  ActivationTime                      OPTIONAL,
  new-U-RNTI                      U-RNTI                            OPTIONAL,
  new-C-RNTI                      C-RNTI                            OPTIONAL,
  -- The IE "new-DSCH-RNTI" should not be included in FDD mode,
  -- and if received the UE behaviour is unspecified
  new-DSCH-RNTI                  DSCH-RNTI                          OPTIONAL,
  new-H-RNTI                      H-RNTI                            OPTIONAL,
  newPrimary-E-RNTI              E-RNTI                            OPTIONAL,
  newSecondary-E-RNTI            E-RNTI                            OPTIONAL,
  rrc-StateIndicator              RRC-StateIndicator,
  utran-DRX-CycleLengthCoeff      UTRAN-DRX-CycleLengthCoefficient-r7  OPTIONAL,
  waitTime                        WaitTime                            OPTIONAL,
  rlc-Re-establishIndicatorRb2-3or4  BOOLEAN,
  rlc-Re-establishIndicatorRb5orAbove  BOOLEAN,
  -- CN information elements
  cn-InformationInfo              CN-InformationInfo-r6              OPTIONAL,
  -- UTRAN mobility IEs
  ura-Identity                    URA-Identity                      OPTIONAL,
  supportForChangeOfUE-Capability  BOOLEAN                            OPTIONAL,
  -- Specification mode information
  -- dummy is not used in this version of the specification, it should
  -- not be sent and if received it should be ignored.
  dummy                            DefaultConfigForCellFACH          OPTIONAL,
  -- Radio bearer IEs
  rab-InformationSetup            RAB-InformationSetup-r8            OPTIONAL,
  rb-InformationReleaseList       RB-InformationReleaseList          OPTIONAL,
  rb-InformationReconfigList      RB-InformationReconfigList-r8     OPTIONAL,
  rb-InformationAffectedList      RB-InformationAffectedList-r8     OPTIONAL,
  dl-CounterSynchronisationInfo  DL-CounterSynchronisationInfo-r5  OPTIONAL,
  pdcp-ROHC-TargetMode           PCP-ROHC-TargetMode               OPTIONAL,
  -- Transport channel IEs
  ul-CommonTransChInfo           UL-CommonTransChInfo-r4           OPTIONAL,
  ul-deletedTransChInfoList       UL-DeletedTransChInfoList-r6      OPTIONAL,
  ul-AddReconfTransChInfoList     UL-AddReconfTransChInfoList-r8    OPTIONAL,
  dl-CommonTransChInfo           DL-CommonTransChInfo-r4           OPTIONAL,
  dl-DeletedTransChInfoList       DL-DeletedTransChInfoList-r7      OPTIONAL,
  dl-AddReconfTransChInfoList     DL-AddReconfTransChInfoList-r7    OPTIONAL,
  -- Physical channel IEs
  frequencyInfo                   FrequencyInfo                       OPTIONAL,
  multi-frequencyInfo             Multi-frequencyInfo-LCR-r7         OPTIONAL,
  dtx-drx-TimingInfo              DTX-DRX-TimingInfo-r7             OPTIONAL,
  dtx-drx-Info                    DTX-DRX-Info-r7                   OPTIONAL,
  hs-scch-LessInfo                HS-SCCH-LessInfo-r7               OPTIONAL,
  mimoParameters                  MIMO-Parameters-r8                OPTIONAL,
  maxAllowedUL-TX-Power            MaxAllowedUL-TX-Power              OPTIONAL,
  ul-DPCH-Info                    UL-DPCH-Info-r7                   OPTIONAL,
  ul-EDCH-Information              UL-EDCH-Information-r8             OPTIONAL,
  dl-HSPDSCH-Information           DL-HSPDSCH-Information-r8         OPTIONAL,
  dl-CommonInformation            DL-CommonInformation-r8           OPTIONAL,
  dl-InformationPerRL-List         DL-InformationPerRL-List-r8       OPTIONAL,
  dl-SecondaryCellInfoFDD         DL-SecondaryCellInfoFDD           OPTIONAL,
  controlChannelDRXInfo-TDD128    ControlChannelDRXInfo-TDD128-r8   OPTIONAL,
  sps-Information-TDD128          SPS-Information-TDD128-r8         OPTIONAL,
  -- MBMS IEs
  mbms-PL-ServiceRestrictInfo     MBMS-PL-ServiceRestrictInfo-r6    OPTIONAL
}

CellUpdateConfirm-v860ext-IEs ::= SEQUENCE {
  rab-InformationSetup             SEQUENCE {
    rab-InformationSetup-r7         RAB-InformationSetup-r7,
    rab-InformationSetup-v820ext    RAB-InformationSetup-v820ext
  }
  OPTIONAL
}

CellUpdateConfirm-v890ext-IEs ::= SEQUENCE {
  -- Physical channel IEs
  dl-SecondaryCellInfoFDD-v890ext  DL-SecondaryCellInfoFDD-v890ext    OPTIONAL,
  dl-HSPDSCH-Information            DL-HSPDSCH-Information-r8-ext      OPTIONAL
}

CellUpdateConfirm-v8a0ext-IEs ::= SEQUENCE {

```



```

-- Physical channel IEs
  dl-HSPDSCH-Information          DL-HSPDSCH-Information-r8-ext2    OPTIONAL
}

CellUpdateConfirm-r9-IEs ::= SEQUENCE {
-- User equipment IEs
  integrityProtectionModeInfo    IntegrityProtectionModeInfo-r7    OPTIONAL,
  cipheringModeInfo              CipheringModeInfo-r7              OPTIONAL,
  activationTime                  ActivationTime                      OPTIONAL,
  new-U-RNTI                      U-RNTI                            OPTIONAL,
  new-C-RNTI                      C-RNTI                            OPTIONAL,
  -- The IE "new-DSCH-RNTI" should not be included in FDD mode,
  -- and if received the UE behaviour is unspecified
  new-DSCH-RNTI                  DSCH-RNTI                          OPTIONAL,
  new-H-RNTI                      H-RNTI                            OPTIONAL,
  newPrimary-E-RNTI              E-RNTI                            OPTIONAL,
  newSecondary-E-RNTI            E-RNTI                            OPTIONAL,
  rrc-StateIndicator             RRC-StateIndicator,
  utran-DRX-CycleLengthCoeff     UTRAN-DRX-CycleLengthCoefficient-r7 OPTIONAL,
  waitTime                        WaitTime                          OPTIONAL,
  rlc-Re-establishIndicatorRb2-3or4    BOOLEAN,
  rlc-Re-establishIndicatorRb5orAbove    BOOLEAN,
-- CN information elements
  cn-InformationInfo              CN-InformationInfo-r6            OPTIONAL,
-- UTRAN mobility IEs
  ura-Identity                    URA-Identity                      OPTIONAL,
  supportForChangeOfUE-Capability    BOOLEAN                          OPTIONAL,
-- Specification mode information
  -- dummy is not used in this version of the specification, it should
  -- not be sent and if received it should be ignored.
  dummy                            DefaultConfigForCellFACH          OPTIONAL,
-- Radio bearer IEs
  rab-InformationSetup            RAB-InformationSetup-r8          OPTIONAL,
  rb-InformationReleaseList       RB-InformationReleaseList        OPTIONAL,
  rb-InformationReconfigList      RB-InformationReconfigList-r8    OPTIONAL,
  rb-InformationAffectedList      RB-InformationAffectedList-r8    OPTIONAL,
  dl-CounterSynchronisationInfo    DL-CounterSynchronisationInfo-r5 OPTIONAL,
  pdcp-ROHC-TargetMode           PDCP-ROHC-TargetMode            OPTIONAL,
-- Transport channel IEs
  ul-CommonTransChInfo           UL-CommonTransChInfo-r4         OPTIONAL,
  ul-deletedTransChInfoList       UL-DeletedTransChInfoList-r6    OPTIONAL,
  ul-AddReconfTransChInfoList     UL-AddReconfTransChInfoList-r8  OPTIONAL,
  dl-CommonTransChInfo           DL-CommonTransChInfo-r4         OPTIONAL,
  dl-DeletedTransChInfoList       DL-DeletedTransChInfoList-r7    OPTIONAL,
  dl-AddReconfTransChInfoList     DL-AddReconfTransChInfoList-r9  OPTIONAL,
-- Physical channel IEs
  frequencyInfo                   FrequencyInfo                      OPTIONAL,
  multi-frequencyInfo             Multi-frequencyInfo-LCR-r7       OPTIONAL,
  dtx-drx-TimingInfo             DTX-DRX-TimingInfo-r7           OPTIONAL,
  dtx-drx-Info                    DTX-DRX-Info-r7                 OPTIONAL,
  hs-scch-LessInfo               HS-SCCH-LessInfo-r7             OPTIONAL,
  mimoParameters                  MIMO-Parameters-r9              OPTIONAL,
  maxAllowedUL-TX-Power           MaxAllowedUL-TX-Power            OPTIONAL,
  ul-DPCH-Info                    UL-DPCH-Info-r7                 OPTIONAL,
  ul-EDCH-Information             UL-EDCH-Information-r9          OPTIONAL,
  ul-SecondaryCellInfoFDD         UL-SecondaryCellInfoFDD         OPTIONAL,
  dl-HSPDSCH-Information          DL-HSPDSCH-Information-r9       OPTIONAL,
  dl-CommonInformation            DL-CommonInformation-r8         OPTIONAL,
  dl-InformationPerRL-List        DL-InformationPerRL-List-r8     OPTIONAL,
  dl-SecondaryCellInfoFDD         DL-SecondaryCellInfoFDD-r9      OPTIONAL,
  controlChannelDRXInfo-TDD128    ControlChannelDRXInfo-TDD128-r8 OPTIONAL,
  sps-Information-TDD128          SPS-Information-TDD128-r8       OPTIONAL,
-- MBMS IEs
  mbms-PL-ServiceRestrictInfo     MBMS-PL-ServiceRestrictInfo-r6  OPTIONAL,
-- Measurement IEs for LCR
  cellDCHMeasOccasionInfo-TDD128  CellDCHMeasOccasionInfo-TDD128-r9 OPTIONAL
}

CellUpdateConfirm-v950ext-IEs ::= SEQUENCE {
-- Physical channel IEs
  secondaryCellMimoParameters     SecondaryCellMIMOparametersFDD-v950ext    OPTIONAL
}

CellUpdateConfirm-v9c0ext-IEs ::= SEQUENCE {
-- For 1.28Mcps TDD only
  dl-AddReconfTransChInfoList     DL-AddReconfTransChInfoList-TDD128-v9c0ext    OPTIONAL
}

```

```

CellUpdateConfirm-r10-IEs ::= SEQUENCE {
  -- User equipment IES
  integrityProtectionModeInfo      IntegrityProtectionModeInfo-r7      OPTIONAL,
  cipheringModeInfo                CipheringModeInfo-r7                OPTIONAL,
  -- dummy2 is not used in this version of the specification, it should
  -- not be sent.
  dummy2                            SR-VCC-Info                            OPTIONAL,
  activationTime                    ActivationTime                        OPTIONAL,
  new-U-RNTI                        U-RNTI                                OPTIONAL,
  new-C-RNTI                        C-RNTI                                OPTIONAL,
  -- The IE "new-DSCH-RNTI" should not be included in FDD mode,
  -- and if received the UE behaviour is unspecified
  new-DSCH-RNTI                    DSCH-RNTI                            OPTIONAL,
  new-H-RNTI                        H-RNTI                                OPTIONAL,
  newPrimary-E-RNTI                E-RNTI                                OPTIONAL,
  newSecondary-E-RNTI              E-RNTI                                OPTIONAL,
  rrc-StateIndicator                RRC-StateIndicator,
  utran-DRX-CycleLengthCoeff       UTRAN-DRX-CycleLengthCoefficient-r7  OPTIONAL,
  waitTime                          WaitTime                              OPTIONAL,
  rlc-Re-establishIndicatorRb2-3or4  BOOLEAN,
  rlc-Re-establishIndicatorRb5orAbove  BOOLEAN,
  -- CN information elements
  cn-InformationInfo                CN-InformationInfo-r6                OPTIONAL,
  -- UTRAN mobility IES
  ura-Identity                      URA-Identity                        OPTIONAL,
  supportForChangeOfUE-Capability  BOOLEAN                              OPTIONAL,
  -- Specification mode information
  -- dummy is not used in this version of the specification, it should
  -- not be sent and if received it should be ignored.
  dummy                              DefaultConfigForCellFACH            OPTIONAL,
  -- Radio bearer IES
  rab-InformationSetup              RAB-InformationSetup-r8             OPTIONAL,
  rb-InformationReleaseList         RB-InformationReleaseList           OPTIONAL,
  rb-InformationReconfigList        RB-InformationReconfigList-r8       OPTIONAL,
  rb-InformationAffectedList        RB-InformationAffectedList-r8       OPTIONAL,
  dl-CounterSynchronisationInfo     DL-CounterSynchronisationInfo-r5    OPTIONAL,
  pdcp-ROHC-TargetMode              PDCP-ROHC-TargetMode              OPTIONAL,
  -- Transport channel IES
  ul-CommonTransChInfo              UL-CommonTransChInfo-r4             OPTIONAL,
  ul-deletedTransChInfoList         UL-DeletedTransChInfoList-r6        OPTIONAL,
  ul-AddReconfTransChInfoList       UL-AddReconfTransChInfoList-r8      OPTIONAL,
  dl-CommonTransChInfo              DL-CommonTransChInfo-r4            OPTIONAL,
  dl-DeletedTransChInfoList         DL-DeletedTransChInfoList-r7        OPTIONAL,
  dl-AddReconfTransChInfoList       DL-AddReconfTransChInfoList-r9      OPTIONAL,
  -- Physical channel IES
  frequencyInfo                     FrequencyInfo                        OPTIONAL,
  multi-frequencyInfo               Multi-frequencyInfo-LCR-r7          OPTIONAL,
  dtx-drx-TimingInfo                DTX-DRX-TimingInfo-r7              OPTIONAL,
  dtx-drx-Info                       DTX-DRX-Info-r7                    OPTIONAL,
  hs-scch-LessInfo                  HS-SCCH-LessInfo-r7                OPTIONAL,
  mimoParameters                    MIMO-Parameters-r9                 OPTIONAL,
  maxAllowedUL-TX-Power              MaxAllowedUL-TX-Power              OPTIONAL,
  ul-DPCH-Info                       UL-DPCH-Info-r7                    OPTIONAL,
  ul-EDCH-Information                UL-EDCH-Information-r9              OPTIONAL,
  ul-SecondaryCellInfoFDD            UL-SecondaryCellInfoFDD            OPTIONAL,
  ul-MulticarrierEDCHInfo-TDD128     UL-MulticarrierEDCHInfo-TDD128     OPTIONAL,
  dl-HSPDSCH-Information             DL-HSPDSCH-Information-r9          OPTIONAL,
  dl-CommonInformation               DL-CommonInformation-r10            OPTIONAL,
  dl-InformationPerRL-List           DL-InformationPerRL-List-r8         OPTIONAL,
  dl-SecondaryCellInfoFDD            DL-SecondaryCellInfoFDD-r10        OPTIONAL,
  additionalDLSecCellInfoListFDD     AdditionalDLSecCellInfoListFDD     OPTIONAL,
  controlChannelDRXInfo-TDD128       ControlChannelDRXInfo-TDD128-r8    OPTIONAL,
  sps-Information-TDD128              SPS-Information-TDD128-r8          OPTIONAL,
  mu-MIMO-Info-TDD128                MU-MIMO-Info-TDD128                OPTIONAL,
  -- MBMS IES
  mbms-PL-ServiceRestrictInfo       MBMS-PL-ServiceRestrictInfo-r6     OPTIONAL,
  -- Measurement IES for LCR
  cellDCHMeasOccasionInfo-TDD128     CellDCHMeasOccasionInfo-TDD128-r9  OPTIONAL
}

CellUpdateConfirm-vb50ext-IEs ::= SEQUENCE {
  ulOLTDInfoFDD                      UL-OLTD-InfoFDD                      OPTIONAL
}

CellUpdateConfirm-r11-IEs ::= SEQUENCE {
  -- User equipment IES
  integrityProtectionModeInfo      IntegrityProtectionModeInfo-r7      OPTIONAL,
  cipheringModeInfo                CipheringModeInfo-r7                OPTIONAL,

```

```

-- dummy2 is not used in this version of the specification, it should
-- not be sent.
dummy2                SR-VCC-Info                OPTIONAL,
activationTime        ActivationTime                OPTIONAL,
new-U-RNTI            U-RNTI                      OPTIONAL,
new-C-RNTI            C-RNTI                      OPTIONAL,
-- The IE "new-DSCH-RNTI" should not be included in FDD mode,
-- and if received the UE behaviour is unspecified
new-DSCH-RNTI        DSCH-RNTI                    OPTIONAL,
new-H-RNTI            H-RNTI                      OPTIONAL,
newPrimary-E-RNTI    E-RNTI                      OPTIONAL,
newSecondary-E-RNTI  E-RNTI                      OPTIONAL,
rrc-StateIndicator    RRC-StateIndicator,         OPTIONAL,
utran-DRX-CycleLengthCoeff  UTRAN-DRX-CycleLengthCoefficient-r7  OPTIONAL,
waitTime              WaitTime                    OPTIONAL,
rlc-Re-establishIndicatorRb2-3or4    BOOLEAN,
rlc-Re-establishIndicatorRb5orAbove  BOOLEAN,
-- CN information elements
cn-InformationInfo    CN-InformationInfo-r6        OPTIONAL,
-- UTRAN mobility IEs
ura-Identity          URA-Identity                OPTIONAL,
supportForChangeOfUE-Capability  BOOLEAN        OPTIONAL,
-- Specification mode information
-- dummy is not used in this version of the specification, it should
-- not be sent and if received it should be ignored.
dummy                 DefaultConfigForCellFACH    OPTIONAL,
-- Radio bearer IEs
rab-InformationSetup  RAB-InformationSetup-r8      OPTIONAL,
rb-InformationReleaseList  RB-InformationReleaseList    OPTIONAL,
rb-InformationReconfigList  RB-InformationReconfigList-r11  OPTIONAL,
rb-InformationAffectedList  RB-InformationAffectedList-r8    OPTIONAL,
dl-CounterSynchronisationInfo  DL-CounterSynchronisationInfo-r5  OPTIONAL,
pdcp-ROHC-TargetMode    PCP-ROHC-TargetMode        OPTIONAL,
-- Transport channel IEs
ul-CommonTransChInfo  UL-CommonTransChInfo-r4                OPTIONAL,
ul-deletedTransChInfoList  UL-DeletedTransChInfoList-r6        OPTIONAL,
ul-AddReconfTransChInfoList  UL-AddReconfTransChInfoList-r8      OPTIONAL,
dl-CommonTransChInfo    DL-CommonTransChInfo-r4                OPTIONAL,
dl-DeletedTransChInfoList  DL-DeletedTransChInfoList-r7        OPTIONAL,
dl-AddReconfTransChInfoList  DL-AddReconfTransChInfoList-r11     OPTIONAL,
-- Physical channel IEs
frequencyInfo          FrequencyInfo                OPTIONAL,
multi-frequencyInfo    Multi-frequencyInfo-LCR-r7    OPTIONAL,
dtx-drx-TimingInfo     DTX-DRX-TimingInfo-r7                OPTIONAL,
dtx-drx-Info           DTX-DRX-Info-r7                    OPTIONAL,
hs-scch-LessInfo       HS-SCCH-LessInfo-r7                OPTIONAL,
mimoParameters         MIMO-Parameters-r9                OPTIONAL,
mimo4x4Parameters      MIMO4x4-Parameters                OPTIONAL,
maxAllowedUL-TX-Power  MaxAllowedUL-TX-Power                OPTIONAL,
ul-DPCH-Info           UL-DPCH-Info-r11                OPTIONAL,
ul-EDCH-Information    UL-EDCH-Information-r11             OPTIONAL,
ul-SecondaryCellInfoFDD  UL-SecondaryCellInfoFDD            OPTIONAL,
ul-MulticarrierEDCHInfo-TDD128  UL-MulticarrierEDCHInfo-TDD128    OPTIONAL,
ul-CLTD-InfoFDD        UL-CLTD-InfoFDD                    OPTIONAL,
ul-OLTD-InfoFDD        UL-OLTD-InfoFDD                    OPTIONAL,
dl-HSPDSCH-Information  DL-HSPDSCH-Information-r11         OPTIONAL,
dl-CommonInformation    DL-CommonInformation-r11           OPTIONAL,
dl-InformationPerRL-List  DL-InformationPerRL-List-r11       OPTIONAL,
dl-SecondaryCellInfoFDD  DL-SecondaryCellInfoFDD-r11        OPTIONAL,
additionalDLSecCellInfoListFDD  AdditionalDLSecCellInfoListFDD-r11  OPTIONAL,
additionalDLSecCellInfoListFDD2  AdditionalDLSecCellInfoListFDD2    OPTIONAL,
commonERGCHInfoFDD     CommonERGCHInfoFDD                OPTIONAL,
controlChannelDRXInfo-TDD128  ControlChannelDRXInfo-TDD128-r8    OPTIONAL,
sps-Information-TDD128  SPS-Information-TDD128-r8          OPTIONAL,
mu-MIMO-Info-TDD128    MU-MIMO-Info-TDD128                OPTIONAL,
-- MBMS IEs
mbms-PL-ServiceRestrictInfo  MBMS-PL-ServiceRestrictInfo-r6    OPTIONAL,
-- Measurement IEs for LCR
cellDCHMeasOccasionInfo-TDD128  CellDCHMeasOccasionInfo-TDD128-r9  OPTIONAL
}

CellUpdateConfirm-r12-IEs ::= SEQUENCE {
-- User equipment IEs
integrityProtectionModeInfo  IntegrityProtectionModeInfo-r7    OPTIONAL,
cipheringModeInfo            CipheringModeInfo-r7                OPTIONAL,
activationTime                ActivationTime                        OPTIONAL,
new-U-RNTI                    U-RNTI                              OPTIONAL,
new-C-RNTI                    C-RNTI                              OPTIONAL,

```

```

-- The IE "new-DSCH-RNTI" should not be included in FDD mode,
-- and if received the UE behaviour is unspecified
new-DSCH-RNTI          DSCH-RNTI          OPTIONAL,
new-H-RNTI            H-RNTI             OPTIONAL,
newPrimary-E-RNTI    E-RNTI             OPTIONAL,
newSecondary-E-RNTI  E-RNTI             OPTIONAL,
rrc-StateIndicator   RRC-StateIndicator,
utran-DRX-CycleLengthCoeff  UTRAN-DRX-CycleLengthCoefficient-r7 OPTIONAL,
waitTime            WaitTime            OPTIONAL,
rlc-Re-establishIndicatorRb2-3or4    BOOLEAN,
rlc-Re-establishIndicatorRb5orAbove  BOOLEAN,
-- CN information elements
  cn-InformationInfo          CN-InformationInfo-r6          OPTIONAL,
-- UTRAN mobility IES
  ura-Identity                URA-Identity                OPTIONAL,
  supportForChangeOfUE-Capability  BOOLEAN              OPTIONAL,
-- Specification mode information
-- Radio bearer IES
  rab-InformationSetup        RAB-InformationSetup-r8        OPTIONAL,
  rb-InformationReleaseList   RB-InformationReleaseList     OPTIONAL,
  rb-InformationReconfigList  RB-InformationReconfigList-r11  OPTIONAL,
  rb-InformationAffectedList  RB-InformationAffectedList-r8    OPTIONAL,
  dl-CounterSynchronisationInfo  DL-CounterSynchronisationInfo-r5  OPTIONAL,
  pdcp-ROHC-TargetMode      PDCP-ROHC-TargetMode      OPTIONAL,
-- Transport channel IES
  ul-CommonTransChInfo       UL-CommonTransChInfo-r12          OPTIONAL,
  ul-deletedTransChInfoList  UL-DeletedTransChInfoList-r6    OPTIONAL,
  ul-AddReconfTransChInfoList  UL-AddReconfTransChInfoList-r8    OPTIONAL,
  dl-CommonTransChInfo       DL-CommonTransChInfo-r4          OPTIONAL,
  dl-DeletedTransChInfoList  DL-DeletedTransChInfoList-r7    OPTIONAL,
  dl-AddReconfTransChInfoList  DL-AddReconfTransChInfoList-r11  OPTIONAL,
-- Physical channel IES
  frequencyInfo              FrequencyInfo                OPTIONAL,
  multi-frequencyInfo        Multi-frequencyInfo-LCR-r7      OPTIONAL,
  dtx-drx-TimingInfo         DTX-DRX-TimingInfo-r7      OPTIONAL,
  dtx-drx-Info               DTX-DRX-Info-r12          OPTIONAL,
  hs-scch-LessInfo           HS-SCCH-LessInfo-r7          OPTIONAL,
  mimoParameters             MIMO-Parameters-r9          OPTIONAL,
  mimo4x4Parameters          MIMO4x4-Parameters          OPTIONAL,
  dch-Enhancements-Info-FDD  DCH-Enhancements-Info-FDD    OPTIONAL,
  maxAllowedUL-TX-Power      MaxAllowedUL-TX-Power      OPTIONAL,
  ul-DPCH-Info               UL-DPCH-Info-r11          OPTIONAL,
  ul-EDCH-Information        UL-EDCH-Information-r11    OPTIONAL,
  ul-SecondaryCellInfoFDD    UL-SecondaryCellInfoFDD-r12  OPTIONAL,
  ul-MulticarrierEDCHInfo-TDD128  UL-MulticarrierEDCHInfo-TDD128  OPTIONAL,
  ul-CLTD-InfoFDD           UL-CLTD-InfoFDD          OPTIONAL,
  ul-OLTD-InfoFDD           UL-OLTD-InfoFDD          OPTIONAL,
  ul-OtherTTIConfiguration-Info  UL-OtherTTIConfiguration-Information  OPTIONAL,
  filteredUPHReportInfo      FilteredUEPowerHeadroomReportInfo  OPTIONAL,
  dl-HSPDSCH-Information     DL-HSPDSCH-Information-r12  OPTIONAL,
  dl-CommonInformation       DL-CommonInformation-r12  OPTIONAL,
  dl-InformationPerRL-List   DL-InformationPerRL-List-r12  OPTIONAL,
  dl-SecondaryCellInfoFDD    DL-SecondaryCellInfoFDD-r11  OPTIONAL,
  additionalDLSecCellInfoListFDD  AdditionalDLSecCellInfoListFDD-r11  OPTIONAL,
  additionalDLSecCellInfoListFDD2  AdditionalDLSecCellInfoListFDD2  OPTIONAL,
  commonERGCHInfoFDD        CommonERGCHInfoFDD        OPTIONAL,
  controlChannelDRXInfo-TDD128  ControlChannelDRXInfo-TDD128-r8  OPTIONAL,
  sps-Information-TDD128      SPS-Information-TDD128-r8  OPTIONAL,
  mu-MIMO-Info-TDD128        MU-MIMO-Info-TDD128        OPTIONAL,
  nonrectResAllocInd-TDD128  Non-rectResAllocInd-TDD128  OPTIONAL,
  nonrectResSpecTSset-TDD128  Non-rectResSpecTSset-TDD128  OPTIONAL,
-- MBMS IES
  mbms-PL-ServiceRestrictInfo  MBMS-PL-ServiceRestrictInfo-r6  OPTIONAL,
-- Measurement IES for LCR
  cellDCHMeasOccasionInfo-TDD128  CellDCHMeasOccasionInfo-TDD128-r9  OPTIONAL,
-- WLAN IES
  dedicatedWLANOffloadInformation  DedicatedWLANOffloadInformation  OPTIONAL
}

-- *****
--
-- CELL UPDATE CONFIRM for CCCH
--
-- *****

CellUpdateConfirm-CCCH ::= CHOICE {
  r3          SEQUENCE {
    -- User equipment IES

```

```

u-RNTI                U-RNTI,
-- The rest of the message is identical to the one sent on DCCH.
cellUpdateConfirm-r3    CellUpdateConfirm-r3-IEs,
laterNonCriticalExtensions SEQUENCE {
  -- Container for additional R99 extensions
  cellUpdateConfirm-CCCH-r3-add-ext BIT STRING OPTIONAL,
  v4b0NonCriticalExtensions SEQUENCE {
    cellUpdateConfirm-v4b0ext CellUpdateConfirm-v4b0ext-IEs,
    v590NonCriticalExtensions SEQUENCE {
      cellUpdateConfirm-v590ext CellUpdateConfirm-v590ext-IEs,
      v5d0NonCriticalExtensions SEQUENCE {
        cellUpdateConfirm-v5d0ext CellUpdateConfirm-v5d0ext-IEs,
        v690NonCriticalExtensions SEQUENCE {
          cellUpdateConfirm-v690ext CellUpdateConfirm-v690ext-IEs,
          nonCriticalExtensions SEQUENCE {} OPTIONAL
        } OPTIONAL
      } OPTIONAL
    } OPTIONAL
  } OPTIONAL
} OPTIONAL
},
later-than-r3          SEQUENCE {
  u-RNTI                U-RNTI,
  rrc-TransactionIdentifier RRC-TransactionIdentifier,
  criticalExtensions     CHOICE {
    r4                    SEQUENCE {
      -- The rest of the message is identical to the one sent on DCCH.
      cellUpdateConfirm-r4 CellUpdateConfirm-r4-IEs,
      v4d0NonCriticalExtensions SEQUENCE {
        -- Container for adding non critical extensions after freezing REL-5
        cellUpdateConfirm-CCCH-r4-add-ext BIT STRING OPTIONAL,
        v590NonCriticalExtensions SEQUENCE {
          cellUpdateConfirm-v590ext CellUpdateConfirm-v590ext-IEs,
          v5d0NonCriticalExtensions SEQUENCE {
            cellUpdateConfirm-v5d0ext CellUpdateConfirm-v5d0ext-IEs,
            v690NonCriticalExtensions SEQUENCE {
              cellUpdateConfirm-v690ext CellUpdateConfirm-v690ext-IEs,
              nonCriticalExtensions SEQUENCE {} OPTIONAL
            } OPTIONAL
          } OPTIONAL
        } OPTIONAL
      } OPTIONAL
    } OPTIONAL
  } OPTIONAL
},
criticalExtensions     CHOICE {
  r5                    SEQUENCE {
    cellUpdateConfirm-r5 CellUpdateConfirm-r5-IEs,
    cellUpdateConfirm-CCCH-r5-add-ext BIT STRING OPTIONAL,
    v5d0NonCriticalExtensions SEQUENCE {
      cellUpdateConfirm-v5d0ext CellUpdateConfirm-v5d0ext-IEs,
      v690NonCriticalExtensions SEQUENCE {
        cellUpdateConfirm-v690ext CellUpdateConfirm-v690ext-IEs,
        nonCriticalExtensions SEQUENCE {} OPTIONAL
      } OPTIONAL
    } OPTIONAL
  } OPTIONAL
},
criticalExtensions     CHOICE {
  r6                    SEQUENCE {
    cellUpdateConfirm-r6 CellUpdateConfirm-r6-IEs,
    cellUpdateConfirm-r6-add-ext BIT STRING OPTIONAL,
    v6b0NonCriticalExtensions SEQUENCE {
      cellUpdateConfirm-v6b0ext CellUpdateConfirm-v6b0ext-IEs,
      nonCriticalExtensions SEQUENCE {} OPTIONAL
    } OPTIONAL
  } OPTIONAL
},
criticalExtensions     CHOICE {
  r7                    SEQUENCE {
    cellUpdateConfirm-r7 CellUpdateConfirm-r7-IEs,
    cellUpdateConfirm-r7-add-ext BIT STRING
      (CONTAINING CellUpdateConfirm-r7-add-ext-IEs) OPTIONAL,
    v780NonCriticalExtensions SEQUENCE {
      cellUpdateConfirm-v780ext CellUpdateConfirm-v780ext-IEs,
      v860NonCriticalExtensions SEQUENCE {
        cellUpdateConfirm-v860ext CellUpdateConfirm-v860ext-IEs,
        nonCriticalExtensions SEQUENCE {} OPTIONAL
      } OPTIONAL
    } OPTIONAL
  } OPTIONAL
},
criticalExtensions     CHOICE {

```



```

-- *****
CounterCheck ::= CHOICE {
  r3 SEQUENCE {
    counterCheck-r3 CounterCheck-r3-IEs,
    laterNonCriticalExtensions SEQUENCE {
      -- Container for additional R99 extensions
      counterCheck-r3-add-ext BIT STRING OPTIONAL,
      nonCriticalExtensions SEQUENCE {} OPTIONAL
    } OPTIONAL
  },
  later-than-r3 SEQUENCE {
    rrc-TransactionIdentifier RRC-TransactionIdentifier,
    criticalExtensions SEQUENCE {}
  }
}

CounterCheck-r3-IEs ::= SEQUENCE {
  -- User equipment IEs
  rrc-TransactionIdentifier RRC-TransactionIdentifier,
  -- Radio bearer IEs
  rb-COUNT-C-MSB-InformationList RB-COUNT-C-MSB-InformationList
}

-- *****
--
-- COUNTER CHECK RESPONSE
--
-- *****

CounterCheckResponse ::= SEQUENCE {
  -- User equipment IEs
  rrc-TransactionIdentifier RRC-TransactionIdentifier,
  -- Radio bearer IEs
  rb-COUNT-C-InformationList RB-COUNT-C-InformationList OPTIONAL,
  laterNonCriticalExtensions SEQUENCE {
    -- Container for additional R99 extensions
    counterCheckResponse-r3-add-ext BIT STRING OPTIONAL,
    nonCriticalExtensions SEQUENCE {} OPTIONAL
  } OPTIONAL
}

-- *****
--
-- DOWNLINK DIRECT TRANSFER
--
-- *****

DownlinkDirectTransfer ::= CHOICE {
  r3 SEQUENCE {
    downlinkDirectTransfer-r3 DownlinkDirectTransfer-r3-IEs,
    laterNonCriticalExtensions SEQUENCE {
      -- Container for additional R99 extensions
      downlinkDirectTransfer-r3-add-ext BIT STRING OPTIONAL,
      nonCriticalExtensions SEQUENCE {} OPTIONAL
    } OPTIONAL
  },
  later-than-r3 SEQUENCE {
    rrc-TransactionIdentifier RRC-TransactionIdentifier,
    criticalExtensions SEQUENCE {}
  }
}

DownlinkDirectTransfer-r3-IEs ::= SEQUENCE {
  -- User equipment IEs
  rrc-TransactionIdentifier RRC-TransactionIdentifier,
  -- Core network IEs
  cn-DomainIdentity CN-DomainIdentity,
  nas-Message NAS-Message
}

-- *****
--
-- ETWS PRIMARY NOTIFICATION WITH SECURITY
--
-- *****

ETWSPrimaryNotificationWithSecurity ::= SEQUENCE {

```

```

-- Other IEs
  etws-Information          ETWS-Information,
  -- dummy is not used in the specification. If received it is ignored by the UE.
  -- See TS 23.041 for handling of warning security information by Cell Broadcast Center.
  dummy                    ETWS-WarningSecurityInfo          OPTIONAL,
-- Non critical extensions
  nonCriticalExtensions     SEQUENCE {}          OPTIONAL
}

-- *****
--
-- HANOVER TO UTRAN COMMAND
--
-- *****

HandoverToUTRANCommand ::= CHOICE {
  r3                      SEQUENCE {
    handoverToUTRANCommand-r3  HandoverToUTRANCommand-r3-IEs,
    nonCriticalExtensions      SEQUENCE {}          OPTIONAL
  },
  criticalExtensions      CHOICE {
    r4                      SEQUENCE {
      handoverToUTRANCommand-r4  HandoverToUTRANCommand-r4-IEs,
      nonCriticalExtensions      SEQUENCE {}          OPTIONAL
    },
    criticalExtensions      CHOICE {
      r5                      SEQUENCE {
        handoverToUTRANCommand-r5  HandoverToUTRANCommand-r5-IEs,
        nonCriticalExtensions      SEQUENCE {}          OPTIONAL
      },
      criticalExtensions    CHOICE {
        r6                      SEQUENCE {
          handoverToUTRANCommand-r6  HandoverToUTRANCommand-r6-IEs,
          v6b0NonCriticalExtensions  SEQUENCE {
            handoverToUTRANCommand-v6b0ext  HandoverToUTRANCommand-v6b0ext-IEs,
            nonCriticalExtensions          SEQUENCE {}          OPTIONAL
          }
        } OPTIONAL
      },
      criticalExtensions    CHOICE {
        r7                      SEQUENCE {
          handoverToUTRANCommand-r7  HandoverToUTRANCommand-r7-IEs,
          v780NonCriticalExtensions  SEQUENCE {
            handoverToUTRANCommand-v780ext  HandoverToUTRANCommand-v780ext-IEs,
            v820NonCriticalExtensions  SEQUENCE {
              handoverToUTRANCommand-v820ext  HandoverToUTRANCommand-v820ext-IEs,
              v7d0NonCriticalExtensions  SEQUENCE {
                handoverToUTRANCommand-v7d0ext
                HandoverToUTRANCommand-v7d0ext-IEs,
                nonCriticalExtensions          SEQUENCE {}          OPTIONAL
              }
            } OPTIONAL
          }
        } OPTIONAL
      }
    } OPTIONAL
  },
  criticalExtensions      CHOICE {
    r8                      SEQUENCE {
      handoverToUTRANCommand-r8  HandoverToUTRANCommand-r8-IEs,
      v7d0NonCriticalExtensions  SEQUENCE {
        handoverToUTRANCommand-v7d0ext  HandoverToUTRANCommand-v7d0ext-IEs,
        v890NonCriticalExtensions  SEQUENCE {
          handoverToUTRANCommand-v890ext
          HandoverToUTRANCommand-v890ext-IEs,
          v8a0NonCriticalExtensions  SEQUENCE {
            handoverToUTRANCommand-v8a0ext
            HandoverToUTRANCommand-v8a0ext-IEs,
            nonCriticalExtensions          SEQUENCE {}          OPTIONAL
          }
        } OPTIONAL
      }
    } OPTIONAL
  },
  criticalExtensions      CHOICE {
    r9                      SEQUENCE {
      handoverToUTRANCommand-r9  HandoverToUTRANCommand-r9-IEs,
      v9c0NonCriticalExtensions  SEQUENCE {
        handoverToUTRANCommand-v9c0ext
        HandoverToUTRANCommand-v9c0ext-IEs,
        nonCriticalExtensions          SEQUENCE {}          OPTIONAL
      }
    } OPTIONAL
  },
}

```



```

        criticalExtensions
    }
}

LaterCriticalExtensions
}
}
}
}
}

HandoverToUTRANCommand-r3-IEs ::= SEQUENCE {
-- User equipment IEs
new-U-RNTI                U-RNTI-Short,
-- dummy is not used in this version of specification, it should
-- not be sent and if received it should be ignored.
dummy                    ActivationTime                OPTIONAL,
cipheringAlgorithm       CipheringAlgorithm           OPTIONAL,
-- Radio bearer IEs
-- Specification mode information
specificationMode        CHOICE {
complete                 SEQUENCE {
    srb-InformationSetupList    SRB-InformationSetupList,
    rab-InformationSetupList    RAB-InformationSetupList    OPTIONAL,
    ul-CommonTransChInfo       UL-CommonTransChInfo,
    ul-AddReconfTransChInfoList UL-AddReconfTransChInfoList,
    dl-CommonTransChInfo       DL-CommonTransChInfo,
    dl-AddReconfTransChInfoList DL-AddReconfTransChInfoList,
    ul-DPCH-Info               UL-DPCH-Info,
    modeSpecificInfo           CHOICE {
        fdd                    SEQUENCE {
            -- dummy and dummy2 are not used in this version of specification,
            -- they should not be sent and if received they should be ignored.
            dummy                DL-PDSCH-Information OPTIONAL,
            dummy2              CPCH-SetInfo          OPTIONAL
        },
        tdd                    NULL
    },
    dl-CommonInformation       DL-CommonInformation,
    dl-InformationPerRL-List   DL-InformationPerRL-List,
    frequencyInfo             FrequencyInfo
},
preconfiguration           SEQUENCE {
-- All IEs that include an FDD/TDD choice are split in two IEs for this message,
-- one for the FDD only elements and one for the TDD only elements, so that one
-- FDD/TDD choice in this level is sufficient.
preConfigMode              CHOICE {
    predefinedConfigIdentity    PredefinedConfigIdentity,
    defaultConfig              SEQUENCE {
        defaultConfigMode      DefaultConfigMode,
        defaultConfigIdentity  DefaultConfigIdentity
    }
},
rab-Info                    RAB-Info-Post          OPTIONAL,
modeSpecificInfo            CHOICE {
    fdd                      SEQUENCE {
        ul-DPCH-Info           UL-DPCH-InfoPostFDD,
        dl-CommonInformationPost DL-CommonInformationPost,
        dl-InformationPerRL-List DL-InformationPerRL-ListPostFDD,
        frequencyInfo          FrequencyInfoFDD
    },
    tdd                      SEQUENCE {
        ul-DPCH-Info           UL-DPCH-InfoPostTDD,
        dl-CommonInformationPost DL-CommonInformationPost,
        dl-InformationPerRL      DL-InformationPerRL-PostTDD,
        frequencyInfo          FrequencyInfoTDD,
        primaryCCPCH-TX-Power  PrimaryCCPCH-TX-Power
    }
}
},
},
-- Physical channel IEs
maxAllowedUL-TX-Power      MaxAllowedUL-TX-Power
}

HandoverToUTRANCommand-r4-IEs ::= SEQUENCE {
-- User equipment IEs
new-U-RNTI                U-RNTI-Short,

```

```

    cipheringAlgorithm          CipheringAlgorithm          OPTIONAL,
-- Radio bearer IEs
-- Specification mode information
    specificationMode          CHOICE {
        complete                SEQUENCE {
            srb-InformationSetupList  SRB-InformationSetupList,
            rab-InformationSetupList  RAB-InformationSetupList-r4          OPTIONAL,
            ul-CommonTransChInfo     UL-CommonTransChInfo-r4,
            ul-AddReconfTransChInfoList  UL-AddReconfTransChInfoList,
            dl-CommonTransChInfo     DL-CommonTransChInfo-r4,
            dl-AddReconfTransChInfoList  DL-AddReconfTransChInfoList-r4,
            ul-DPCH-Info             UL-DPCH-Info-r4,
            modeSpecificInfo         CHOICE {
                fdd                SEQUENCE {
                    -- dummy and dummy2 are not used in this version of specification,
                    -- they should not be sent and if received they should be ignored.
                    dummy          DL-PDSCH-Information OPTIONAL,
                    dummy2        CPCH-SetInfo          OPTIONAL
                },
                tdd                NULL
            },
            dl-CommonInformation     DL-CommonInformation-r4,
            dl-InformationPerRL-List  DL-InformationPerRL-List-r4,
            frequencyInfo            FrequencyInfo
        },
        preconfiguration           SEQUENCE {
-- All IEs that include an FDD/TDD choice are split in two IEs for this message,
-- one for the FDD only elements and one for the TDD only elements, so that one
-- FDD/TDD choice in this level is sufficient.
            preConfigMode          CHOICE {
                predefinedConfigIdentity  PredefinedConfigIdentity,
                defaultConfig            SEQUENCE {
                    defaultConfigMode     DefaultConfigMode,
                    defaultConfigIdentity  DefaultConfigIdentity-r4
                }
            },
            rab-Info                RAB-Info-Post          OPTIONAL,
            modeSpecificInfo        CHOICE {
                fdd                SEQUENCE {
                    ul-DPCH-Info         UL-DPCH-InfoPostFDD,
                    dl-CommonInformationPost  DL-CommonInformationPost,
                    dl-InformationPerRL-List  DL-InformationPerRL-ListPostFDD,
                    frequencyInfo         FrequencyInfoFDD
                },
                tdd                CHOICE {
                    tdd384            SEQUENCE {
                        ul-DPCH-Info         UL-DPCH-InfoPostTDD,
                        dl-InformationPerRL  DL-InformationPerRL-PostTDD,
                        frequencyInfo         FrequencyInfoTDD,
                        primaryCCPCH-TX-Power  PrimaryCCPCH-TX-Power
                    },
                    tdd128            SEQUENCE {
                        ul-DPCH-Info         UL-DPCH-InfoPostTDD-LCR-r4,
                        dl-InformationPerRL  DL-InformationPerRL-PostTDD-LCR-r4,
                        frequencyInfo         FrequencyInfoTDD,
                        primaryCCPCH-TX-Power  PrimaryCCPCH-TX-Power
                    }
                }
            }
        },
        }
    },
-- Physical channel IEs
    maxAllowedUL-TX-Power        MaxAllowedUL-TX-Power
}

HandoverToUTRANCommand-r5-IEs ::= SEQUENCE {
-- User equipment IEs
    new-U-RNTI                  U-RNTI-Short,
    cipheringAlgorithm          CipheringAlgorithm          OPTIONAL,
-- Radio bearer IEs
-- Specification mode information
    specificationMode          CHOICE {
        complete                SEQUENCE {
            srb-InformationSetupList  SRB-InformationSetupList-r5,
            rab-InformationSetupList  RAB-InformationSetupList-r5          OPTIONAL,
            ul-CommonTransChInfo     UL-CommonTransChInfo-r4,
            ul-AddReconfTransChInfoList  UL-AddReconfTransChInfoList,
            dl-CommonTransChInfo     DL-CommonTransChInfo-r4,

```

```

dl-AddReconfTransChInfoList      DL-AddReconfTransChInfoList-r5,
ul-DPCH-Info                      UL-DPCH-Info-r5,
modeSpecificInfo                  CHOICE {
  fdd                             SEQUENCE {
    -- dummy and dummy2 are not used in this version of specification,
    -- they should not be sent and if received they should be ignored.
    dummy                          DL-PDSCH-Information OPTIONAL,
    dummy2                         CPCH-SetInfo          OPTIONAL
  },
  tdd                             NULL
},
dl-CommonInformation              DL-CommonInformation-r4,
dl-InformationPerRL-List          DL-InformationPerRL-List-r5,
frequencyInfo                    FrequencyInfo
},
preconfiguration                  SEQUENCE {
-- All IEs that include an FDD/TDD choice are split in two IEs for this message,
-- one for the FDD only elements and one for the TDD only elements, so that one
-- FDD/TDD choice in this level is sufficient.
  preConfigMode                   CHOICE {
    predefinedConfigIdentity       PredefinedConfigIdentity,
    defaultConfig                 SEQUENCE {
      defaultConfigMode           DefaultConfigMode,
      defaultConfigIdentity       DefaultConfigIdentity-r5
    }
  },
  rab-Info                        RAB-Info-Post          OPTIONAL,
  modeSpecificInfo                CHOICE {
    fdd                           SEQUENCE {
      ul-DPCH-Info               UL-DPCH-InfoPostFDD,
      dl-CommonInformationPost    DL-CommonInformationPost,
      dl-InformationPerRL-List    DL-InformationPerRL-ListPostFDD,
      frequencyInfo              FrequencyInfoFDD
    },
    tdd                           CHOICE {
      tdd384                     SEQUENCE {
        ul-DPCH-Info             UL-DPCH-InfoPostTDD,
        dl-InformationPerRL       DL-InformationPerRL-PostTDD,
        frequencyInfo            FrequencyInfoTDD,
        primaryCCPCH-TX-Power    PrimaryCCPCH-TX-Power
      },
      tdd128                     SEQUENCE {
        ul-DPCH-Info             UL-DPCH-InfoPostTDD-LCR-r4,
        dl-InformationPerRL       DL-InformationPerRL-PostTDD-LCR-r4,
        frequencyInfo            FrequencyInfoTDD,
        primaryCCPCH-TX-Power    PrimaryCCPCH-TX-Power
      }
    }
  }
},
},
-- Physical channel IEs
  maxAllowedUL-TX-Power          MaxAllowedUL-TX-Power
}

HandoverToUTRANCommand-r6-IEs ::= SEQUENCE {
-- User equipment IEs
  new-U-RNTI                     U-RNTI-Short,
  cipheringAlgorithm              CipheringAlgorithm          OPTIONAL,
-- Radio bearer IEs
-- Specification mode information
  specificationMode              CHOICE {
    complete                      SEQUENCE {
      srb-InformationSetupList    SRB-InformationSetupList-r6,
      rab-InformationSetupList     RAB-InformationSetupList-r6   OPTIONAL,
      ul-CommonTransChInfo        UL-CommonTransChInfo-r4,
      ul-AddReconfTransChInfoList UL-AddReconfTransChInfoList-r6,
      dl-CommonTransChInfo        DL-CommonTransChInfo-r4,
      dl-AddReconfTransChInfoList DL-AddReconfTransChInfoList-r5,
      ul-DPCH-Info                UL-DPCH-Info-r6,
      ul-EDCH-Information          UL-EDCH-Information-r6     OPTIONAL,
      dl-HSPDSCH-Information       DL-HSPDSCH-Information-r6  OPTIONAL,
      dl-CommonInformation         DL-CommonInformation-r6,
      dl-InformationPerRL-List     DL-InformationPerRL-List-r6,
      frequencyInfo               FrequencyInfo
    },
    preconfiguration              SEQUENCE {
      -- All IEs that include an FDD/TDD choice are split in two IEs for this message,

```

```

-- one for the FDD only elements and one for the TDD only elements, so that one
-- FDD/TDD choice in this level is sufficient.
preConfigMode CHOICE {
    predefinedConfigIdentity PredefinedConfigIdentity,
    defaultConfig SEQUENCE {
        defaultConfigMode DefaultConfigMode,
        defaultConfigIdentity DefaultConfigIdentity-r6
    }
},
rab-Info RAB-Info-Post OPTIONAL,
modeSpecificInfo CHOICE {
    fdd SEQUENCE {
        ul-DPCH-Info UL-DPCH-InfoPostFDD,
        dl-CommonInformationPost DL-CommonInformationPost,
        dl-InformationPerRL-List DL-InformationPerRL-ListPostFDD,
        frequencyInfo FrequencyInfoFDD
    },
    tdd CHOICE {
        tdd384 SEQUENCE {
            ul-DPCH-Info UL-DPCH-InfoPostTDD,
            dl-InformationPerRL DL-InformationPerRL-PostTDD,
            frequencyInfo FrequencyInfoTDD,
            primaryCCPCH-TX-Power PrimaryCCPCH-TX-Power
        },
        tdd128 SEQUENCE {
            ul-DPCH-Info UL-DPCH-InfoPostTDD-LCR-r4,
            dl-InformationPerRL DL-InformationPerRL-PostTDD-LCR-r4,
            frequencyInfo FrequencyInfoTDD,
            primaryCCPCH-TX-Power PrimaryCCPCH-TX-Power
        }
    }
},
},
},
},
-- Physical channel IEs
maxAllowedUL-TX-Power MaxAllowedUL-TX-Power
}

HandoverToUTRANCommand-v6b0ext-IEs ::= SEQUENCE {
    ue-hspa-identities UE-HSPA-Identities-r6 OPTIONAL
}

HandoverToUTRANCommand-r7-IEs ::= SEQUENCE {
    -- User equipment IEs
    new-U-RNTI U-RNTI-Short,
    cipheringAlgorithm CipheringAlgorithm-r7 OPTIONAL,
    supportForChangeOfUE-Capability BOOLEAN,
    new-H-RNTI H-RNTI OPTIONAL,
    new-Primary-E-RNTI E-RNTI OPTIONAL,
    new-Secondary-E-RNTI E-RNTI OPTIONAL,
    -- Radio bearer IEs
    -- Specification mode information
    specificationMode CHOICE {
        complete SEQUENCE {
            srb-InformationSetupList SRB-InformationSetupList-r7,
            rab-InformationSetupList RAB-InformationSetupList-r7 OPTIONAL,
            ul-CommonTransChInfo UL-CommonTransChInfo-r4,
            ul-AddReconfTransChInfoList UL-AddReconfTransChInfoList-r7,
            dl-CommonTransChInfo DL-CommonTransChInfo-r4,
            dl-AddReconfTransChInfoList DL-AddReconfTransChInfoList-r7,
            ul-DPCH-Info UL-DPCH-Info-r7,
            ul-EDCH-Information UL-EDCH-Information-r7 OPTIONAL,
            dl-HSPDSCH-Information DL-HSPDSCH-Information-r7 OPTIONAL,
            dl-CommonInformation DL-CommonInformation-r7,
            dl-InformationPerRL-List DL-InformationPerRL-List-r7,
            frequencyInfo FrequencyInfo,
            multi-frequencyInfo Multi-frequencyInfo-LCR-r7 OPTIONAL
        },
    },
    preconfiguration SEQUENCE {
        -- All IEs that include an FDD/TDD choice are split in two IEs for this message,
        -- one for the FDD only elements and one for the TDD only elements, so that one
        -- FDD/TDD choice in this level is sufficient.
        preConfigMode CHOICE {
            predefinedConfigIdentity PredefinedConfigIdentity,
            defaultConfig SEQUENCE {
                defaultConfigMode DefaultConfigMode,
                defaultConfigIdentity DefaultConfigIdentity-r6
            }
        }
    }
}

```

```

    },
    rab-Info
    modeSpecificInfo
        fdd
            ul-DPCH-Info
            dl-CommonInformationPost
            dl-InformationPerRL-List
            frequencyInfo
        },
        tdd
            tdd384
                ul-DPCH-Info
                dl-InformationPerRL
                frequencyInfo
                primaryCCPCH-TX-Power
            },
            tdd128
                ul-DPCH-Info
                dl-InformationPerRL
                frequencyInfo
                primaryCCPCH-TX-Power
                multi-frequencyInfo
            },
            tdd768
                ul-DPCH-Info
                dl-InformationPerRL
                frequencyInfo
                primaryCCPCH-TX-Power
        }
    }
},
-- Physical channel IEs
maxAllowedUL-TX-Power
    MaxAllowedUL-TX-Power
}

HandoverToUTRANCommand-v780ext-IEs ::= SEQUENCE {
-- Physical channel IEs
    hs-DSCH-TBSizeTable
        HS-DSCH-TBSizeTable
        OPTIONAL
}

HandoverToUTRANCommand-v7d0ext-IEs ::= SEQUENCE {
-- Physical channel IEs
    ul-EDCH-Information
        UL-EDCH-Information-ext
        OPTIONAL
}

HandoverToUTRANCommand-r8-IEs ::= SEQUENCE {
-- User equipment IEs
    new-U-RNTI
        U-RNTI-Short,
    cipheringAlgorithm
        CipheringAlgorithm-r7
        OPTIONAL,
    supportForChangeOfUE-Capability
        BOOLEAN,
    new-H-RNTI
        H-RNTI
        OPTIONAL,
    newPrimary-E-RNTI
        E-RNTI
        OPTIONAL,
    newSecondary-E-RNTI
        E-RNTI
        OPTIONAL,
-- Radio bearer IEs
-- Specification mode information
-- dummy is not used in this version of the specification, it should
-- not be sent and if received it should be ignored.
    dummy
        DefaultConfigForCellFACH
        OPTIONAL,
    specificationMode
        CHOICE {
            complete
                SEQUENCE {
                    srb-InformationSetupList
                        SRB-InformationSetupList-r8,
                    rab-InformationSetupList
                        RAB-InformationSetupList-r8
                        OPTIONAL,
                    ul-CommonTransChInfo
                        UL-CommonTransChInfo-r4,
                    ul-AddReconfTransChInfoList
                        UL-AddReconfTransChInfoList-r8,
                    dl-CommonTransChInfo
                        DL-CommonTransChInfo-r4,
                    dl-AddReconfTransChInfoList
                        DL-AddReconfTransChInfoList-r7,
                    ul-DPCH-Info
                        UL-DPCH-Info-r7,
                    ul-EDCH-Information
                        UL-EDCH-Information-r8
                        OPTIONAL,
                    dl-HSPDSCH-Information
                        DL-HSPDSCH-Information-r8
                        OPTIONAL,
                    dl-CommonInformation
                        DL-CommonInformation-r8,
                    dl-InformationPerRL-List
                        DL-InformationPerRL-List-r7,
                    frequencyInfo
                        FrequencyInfo,
                    multi-frequencyInfo
                        Multi-frequencyInfo-LCR-r7
                        OPTIONAL
                },
            preconfiguration
                SEQUENCE {
                    -- All IEs that include an FDD/TDD choice are split in two IEs for this message,

```



```

srb-InformationSetupList          SRB-InformationSetupList-r8,
rab-InformationSetupList          RAB-InformationSetupList-r8      OPTIONAL,
ul-CommonTransChInfo             UL-CommonTransChInfo-r4,
ul-AddReconfTransChInfoList      UL-AddReconfTransChInfoList-r8,
dl-CommonTransChInfo             DL-CommonTransChInfo-r4,
dl-AddReconfTransChInfoList      DL-AddReconfTransChInfoList-r9,
ul-DPCH-Info                     UL-DPCH-Info-r7,
ul-EDCH-Information              UL-EDCH-Information-r9      OPTIONAL,
dl-HSPDSCH-Information            DL-HSPDSCH-Information-r9  OPTIONAL,
dl-CommonInformation              DL-CommonInformation-r8,
dl-InformationPerRL-List          DL-InformationPerRL-List-r7,
frequencyInfo                    FrequencyInfo,
multi-frequencyInfo              Multi-frequencyInfo-LCR-r7    OPTIONAL
},
preconfiguration                  SEQUENCE {
-- All IEs that include an FDD/TDD choice are split in two IEs for this message,
-- one for the FDD only elements and one for the TDD only elements, so that one
-- FDD/TDD choice in this level is sufficient.
preConfigMode                    CHOICE {
  predefinedConfigIdentity        PredefinedConfigIdentity,
  defaultConfig                  SEQUENCE {
    defaultConfigMode            DefaultConfigMode,
    defaultConfigIdentity        DefaultConfigIdentity-r6,
    -- dummy is not used in this version of the specification, it should
    -- not be sent and if received it should be ignored
    dummy                        DLUL-HSPA-Information-r9    OPTIONAL
  }
},
rab-Info                          RAB-Info-Post            OPTIONAL,
modeSpecificInfo                  CHOICE {
  fdd                             SEQUENCE {
    ul-DPCH-Info                 UL-DPCH-InfoPostFDD,
    dl-CommonInformationPost      DL-CommonInformationPost,
    dl-InformationPerRL-List      DL-InformationPerRL-ListPostFDD,
    frequencyInfo                FrequencyInfoFDD
  },
  tdd                             CHOICE {
    tdd384                       SEQUENCE {
      ul-DPCH-Info               UL-DPCH-InfoPostTDD,
      dl-InformationPerRL         DL-InformationPerRL-PostTDD,
      frequencyInfo              FrequencyInfoTDD,
      primaryCCPCH-TX-Power      PrimaryCCPCH-TX-Power
    },
    tdd128                       SEQUENCE {
      ul-DPCH-Info               UL-DPCH-Info-r7,
      dl-InformationPerRL         DL-InformationPerRL-PostTDD-LCR-r4,
      frequencyInfo              FrequencyInfoTDD,
      primaryCCPCH-TX-Power      PrimaryCCPCH-TX-Power,
      multi-frequencyInfo        Multi-frequencyInfo-LCR-r7    OPTIONAL
    },
    tdd768                       SEQUENCE {
      ul-DPCH-Info               UL-DPCH-Info-r7,
      dl-InformationPerRL         DL-InformationPerRL-List-r7,
      frequencyInfo              FrequencyInfoTDD,
      primaryCCPCH-TX-Power      PrimaryCCPCH-TX-Power
    }
  }
},
},
},
},
-- Physical channel IEs
  maxAllowedUL-TX-Power          MaxAllowedUL-TX-Power
}

HandoverToUTRANCommand-v9c0ext-IEs ::= SEQUENCE {
-- For 1.28Mcps TDD only
  dl-AddReconfTransChInfoList    DL-AddReconfTransChInfoList-TDD128-v9c0ext    OPTIONAL
}

HandoverToUTRANCommand-LaterCriticalExtensions ::= CHOICE {
  r10                             SEQUENCE {
    handoverToUTRANCommand-r10    HandoverToUTRANCommand-r10-IEs,
    v9c0NonCriticalExtensions      SEQUENCE {
      handoverToUTRANCommand-v9c0ext
      HandoverToUTRANCommand-v9c0ext-IEs,
      nonCriticalExtensions        SEQUENCE {}    OPTIONAL
    }
  }    OPTIONAL
},

```

```

criticalExtensions          CHOICE {
  r11                      SEQUENCE {
    handoverToUTRANCommand-r11 HandoverToUTRANCommand-r11-IEs,
    -- Container for adding non critical extensions after freezing REL-12
    handoverToUTRANCommand-r11-add-ext BIT STRING OPTIONAL,
    vbc0NonCriticalExtensions          SEQUENCE {
      handoverToUTRANCommand-vbc0ext HandoverToUTRANCommand-vbc0ext-IEs,
      nonCriticalExtensions          SEQUENCE {} OPTIONAL
    } OPTIONAL
  },
  criticalExtensions          CHOICE {
    r12                      SEQUENCE {
      handoverToUTRANCommand-r12 HandoverToUTRANCommand-r12-IEs,
      -- Container for adding non critical extensions after freezing REL-13
      handoverToUTRANCommand-r12-add-ext BIT STRING OPTIONAL,
      nonCriticalExtensions          SEQUENCE {} OPTIONAL
    },
    criticalExtensions          SEQUENCE {}
  }
}
}

HandoverToUTRANCommand-r10-IEs ::= SEQUENCE {
  -- User equipment IEs
  new-U-RNTI          U-RNTI-Short,
  cipheringAlgorithm CipheringAlgorithm-r7          OPTIONAL,
  supportForChangeOfUE-Capability BOOLEAN,
  new-H-RNTI          H-RNTI          OPTIONAL,
  newPrimary-E-RNTI  E-RNTI          OPTIONAL,
  newSecondary-E-RNTI E-RNTI          OPTIONAL,
  -- Radio bearer IEs
  -- Specification mode information
  -- dummy is not used in this version of the specification, it should
  -- not be sent and if received UE behaviour is unspecified.
  dummy          DefaultConfigForCellFACH          OPTIONAL,
  specificationMode CHOICE {
    complete          SEQUENCE {
      srb-InformationSetupList SRB-InformationSetupList-r8,
      rab-InformationSetupList RAB-InformationSetupList-r8          OPTIONAL,
      ul-CommonTransChInfo     UL-CommonTransChInfo-r4,
      ul-AddReconfTransChInfoList UL-AddReconfTransChInfoList-r8,
      dl-CommonTransChInfo     DL-CommonTransChInfo-r4,
      dl-AddReconfTransChInfoList DL-AddReconfTransChInfoList-r9,
      ul-DPCH-Info             UL-DPCH-Info-r7,
      ul-EDCH-Information      UL-EDCH-Information-r9          OPTIONAL,
      dl-HSPDSCH-Information   DL-HSPDSCH-Information-r9          OPTIONAL,
      dl-CommonInformation     DL-CommonInformation-r10,
      dl-InformationPerRL-List DL-InformationPerRL-List-r7,
      frequencyInfo           FrequencyInfo,
      multi-frequencyInfo      Multi-frequencyInfo-LCR-r7          OPTIONAL
    },
    preconfiguration          SEQUENCE {
      -- All IEs that include an FDD/TDD choice are split in two IEs for this message,
      -- one for the FDD only elements and one for the TDD only elements, so that one
      -- FDD/TDD choice in this level is sufficient.
      preConfigMode          CHOICE {
        predefinedConfigIdentity PredefinedConfigIdentity,
        defaultConfig          SEQUENCE {
          defaultConfigMode      DefaultConfigMode,
          defaultConfigIdentity  DefaultConfigIdentity-r6,
          -- dummy is not used in this version of the specification, it should
          -- not be sent and if received it should be ignored
          dummy                  DLUL-HSPA-Information-r10          OPTIONAL
        }
      },
      rab-Info              RAB-Info-Post          OPTIONAL,
      modeSpecificInfo      CHOICE {
        fdd                  SEQUENCE {
          ul-DPCH-Info          UL-DPCH-InfoPostFDD,
          dl-CommonInformationPost DL-CommonInformationPost,
          dl-InformationPerRL-List DL-InformationPerRL-ListPostFDD,
          frequencyInfo         FrequencyInfoFDD
        },
        tdd                  CHOICE {
          tdd384              SEQUENCE {
            ul-DPCH-Info          UL-DPCH-InfoPostTDD,
            dl-InformationPerRL-List DL-InformationPerRL-PostTDD,
            frequencyInfo         FrequencyInfoTDD,

```



```

        primaryCCPCH-TX-Power          PrimaryCCPCH-TX-Power
    },
    tdd128                             SEQUENCE {
        ul-DPCH-Info                   UL-DPCH-Info-r7,
        dl-InformationPerRL             DL-InformationPerRL-PostTDD-LCR-r4,
        frequencyInfo                   FrequencyInfoTDD,
        primaryCCPCH-TX-Power           PrimaryCCPCH-TX-Power,
        multi-frequencyInfo             Multi-frequencyInfo-LCR-r7      OPTIONAL
    },
    tdd768                             SEQUENCE {
        ul-DPCH-Info                   UL-DPCH-Info-r7,
        dl-InformationPerRL             DL-InformationPerRL-List-r7,
        frequencyInfo                   FrequencyInfoTDD,
        primaryCCPCH-TX-Power           PrimaryCCPCH-TX-Power
    }
}
}
}
},
-- Physical channel IEs
maxAllowedUL-TX-Power                MaxAllowedUL-TX-Power
}

HandoverToUTRANCommand-r11-IEs ::= SEQUENCE {
-- User equipment IEs
new-U-RNTI                            U-RNTI-Short,
cipheringAlgorithm                     CipheringAlgorithm-r7      OPTIONAL,
supportForChangeOfUE-Capability        BOOLEAN,
new-H-RNTI                             H-RNTI                    OPTIONAL,
newPrimary-E-RNTI                      E-RNTI                    OPTIONAL,
newSecondary-E-RNTI                    E-RNTI                    OPTIONAL,
-- Radio bearer IEs
-- Specification mode information
defaultConfigForCellFACH                DefaultConfigForCellFACH  OPTIONAL,
specificationMode                       CHOICE {
    complete                             SEQUENCE {
        srb-InformationSetupList        SRB-InformationSetupList-r8,
        rab-InformationSetupList        RAB-InformationSetupList-r8  OPTIONAL,
        ul-CommonTransChInfo           UL-CommonTransChInfo-r4,
        ul-AddReconfTransChInfoList     UL-AddReconfTransChInfoList-r8,
        dl-CommonTransChInfo           DL-CommonTransChInfo-r4,
        dl-AddReconfTransChInfoList     DL-AddReconfTransChInfoList-r11,
        ul-DPCH-Info                   UL-DPCH-Info-r11,
        ul-EDCH-Information              UL-EDCH-Information-r11    OPTIONAL,
        dl-HSPDSCH-Information          DL-HSPDSCH-Information-r11  OPTIONAL,
        dl-CommonInformation            DL-CommonInformation-r10,
        dl-InformationPerRL-List        DL-InformationPerRL-List-r11,
        frequencyInfo                   FrequencyInfo,
        multi-frequencyInfo             Multi-frequencyInfo-LCR-r7  OPTIONAL
    },
    preconfiguration                     SEQUENCE {
        -- All IEs that include an FDD/TDD choice are split in two IEs for this message,
        -- one for the FDD only elements and one for the TDD only elements, so that one
        -- FDD/TDD choice in this level is sufficient.
        preConfigMode                   CHOICE {
            predefinedConfigIdentity     PredefinedConfigIdentity,
            defaultConfig                 SEQUENCE {
                defaultConfigMode        DefaultConfigMode,
                defaultConfigIdentity    DefaultConfigIdentity-r6
            }
        },
        rab-Info                         RAB-Info-Post             OPTIONAL,
        modeSpecificInfo                 CHOICE {
            fdd                           SEQUENCE {
                ul-DPCH-Info              UL-DPCH-InfoPostFDD,
                dl-CommonInformationPost   DL-CommonInformationPost,
                dl-InformationPerRL-List  DL-InformationPerRL-ListPostFDD,
                frequencyInfo             FrequencyInfoFDD
            },
            tdd                           CHOICE {
                tdd384                     SEQUENCE {
                    ul-DPCH-Info          UL-DPCH-InfoPostTDD,
                    dl-InformationPerRL    DL-InformationPerRL-PostTDD,
                    frequencyInfo          FrequencyInfoTDD,
                    primaryCCPCH-TX-Power PrimaryCCPCH-TX-Power
                },
                tdd128                     SEQUENCE {
                    ul-DPCH-Info          UL-DPCH-Info-r7,

```

```

        dl-InformationPerRL          DL-InformationPerRL-PostTDD-LCR-r4,
        frequencyInfo               FrequencyInfoTDD,
        primaryCCPCH-TX-Power       PrimaryCCPCH-TX-Power,
        multi-frequencyInfo         Multi-frequencyInfo-LCR-r7          OPTIONAL
    },
    tdd768                           SEQUENCE {
        ul-DPCH-Info                 UL-DPCH-Info-r7,
        dl-InformationPerRL          DL-InformationPerRL-List-r7,
        frequencyInfo               FrequencyInfoTDD,
        primaryCCPCH-TX-Power       PrimaryCCPCH-TX-Power
    }
}
}
},
-- Physical channel IEs
    maxAllowedUL-TX-Power           MaxAllowedUL-TX-Power
}

HandoverToUTRANCommand-vbc0ext-IEs ::= SEQUENCE {
    specificationMode               CHOICE {
        complete                     SEQUENCE {
            dl-SecondaryCellInfoFDD DL-SecondaryCellInfoFDD-HandoverToUtran  OPTIONAL,
            ulSecondaryCellInfoFDD  UL-SecondaryCellInfoFDD                OPTIONAL,
            additionalDLSecCellInfoHandoverToUtranListFDD
                AdditionalDLSecCellInfoHandoverToUtranListFDD            OPTIONAL
        }
    }
}

HandoverToUTRANCommand-r12-IEs ::= SEQUENCE {
    -- User equipment IEs
    new-U-RNTI                      U-RNTI-Short,
    cipheringAlgorithm              CipheringAlgorithm-r7          OPTIONAL,
    supportForChangeOfUE-Capability BOOLEAN,
    new-H-RNTI                      H-RNTI,                          OPTIONAL,
    newPrimary-E-RNTI              E-RNTI,                          OPTIONAL,
    newSecondary-E-RNTI            E-RNTI,                          OPTIONAL,
    -- Radio bearer IEs
    -- Specification mode information
    defaultConfigForCellFACH        DefaultConfigForCellFACH          OPTIONAL,
    specificationMode               CHOICE {
        complete                     SEQUENCE {
            srb-InformationSetupList SRB-InformationSetupList-r8,
            rab-InformationSetupList  RAB-InformationSetupList-r8    OPTIONAL,
            ul-CommonTransChInfo     UL-CommonTransChInfo-r12,
            dl-AddReconfTransChInfoList
                UL-AddReconfTransChInfoList-r8,
            dl-CommonTransChInfo     DL-CommonTransChInfo-r4,
            dl-AddReconfTransChInfoList
                DL-AddReconfTransChInfoList-r11,
            ul-DPCH-Info             UL-DPCH-Info-r11,
            ul-EDCH-Information       UL-EDCH-Information-r11    OPTIONAL,
            dl-HSPDSCH-Information    DL-HSPDSCH-Information-r11    OPTIONAL,
            dl-CommonInformation      DL-CommonInformation-r12,
            dl-InformationPerRL-List  DL-InformationPerRL-List-r12,
            -- Physical channel IEs
            dch-Enhancements-Info-FDD DCH-Enhancements-Info-FDD    OPTIONAL,
            frequencyInfo             FrequencyInfo,
            multi-frequencyInfo       Multi-frequencyInfo-LCR-r7    OPTIONAL,
            dl-SecondaryCellInfoFDD DL-SecondaryCellInfoFDD-HandoverToUtran  OPTIONAL,
            ulSecondaryCellInfoFDD  UL-SecondaryCellInfoFDD                OPTIONAL,
            additionalDLSecCellInfoHandoverToUtranListFDD
                AdditionalDLSecCellInfoHandoverToUtranListFDD            OPTIONAL
        }
    },
    preconfiguration                 SEQUENCE {
        -- All IEs that include an FDD/TDD choice are split in two IEs for this message,
        -- one for the FDD only elements and one for the TDD only elements, so that one
        -- FDD/TDD choice in this level is sufficient.
        preConfigMode                CHOICE {
            predefinedConfigIdentity  PredefinedConfigIdentity,
            defaultConfig              SEQUENCE {
                defaultConfigMode     DefaultConfigMode,
                defaultConfigIdentity DefaultConfigIdentity-r6
            }
        }
    },
    rab-Info                         RAB-Info-Post          OPTIONAL,
    modeSpecificInfo                 CHOICE {
        fdd                           SEQUENCE {
            ul-DPCH-Info               UL-DPCH-InfoPostFDD,

```



```

--
-- HANDOVER FROM UTRAN COMMAND
--
-- *****
HandoverFromUTRANCommand-GSM ::= CHOICE {
  r3          SEQUENCE {
    handoverFromUTRANCommand-GSM-r3
      HandoverFromUTRANCommand-GSM-r3-IEs,
      -- UTRAN should not include the IE laterNonCriticalExtensions when it sets the IE
      -- gsm-message included in handoverFromUTRANCommand-GSM-r3 to single-GSM-Message. The UE
      -- behaviour upon receiving a message with this combination of IE values is unspecified.
      laterNonCriticalExtensions SEQUENCE {
        -- Container for additional R99 extensions
        handoverFromUTRANCommand-GSM-r3-add-ext BIT STRING OPTIONAL,
        -- UTRAN may apply the r3 version of the message to perform PS handover
        -- for a single RAB only
        v690NonCriticalExtensions SEQUENCE {
          handoverFromUTRANCommand-GSM-v690ext HandoverFromUTRANCommand-GSM-v690ext-IEs,
          v860NonCriticalExtensions SEQUENCE {
            handoverFromUTRANCommand-GSM-v860ext
              HandoverFromUTRANCommand-GSM-v860ext-IEs,
              SEQUENCE {} OPTIONAL
            } OPTIONAL
          } OPTIONAL
        } OPTIONAL
      },
      later-than-r3 SEQUENCE {
        rrc-TransactionIdentifier RRC-TransactionIdentifier,
        criticalExtensions CHOICE {
          r6 SEQUENCE {
            handoverFromUTRANCommand-GSM-r6 HandoverFromUTRANCommand-GSM-r6-IEs,
            handoverFromUTRANCommand-GSM-r6-add-ext BIT STRING OPTIONAL,
            v860NonCriticalExtensions SEQUENCE {
              handoverFromUTRANCommand-GSM-v860ext
                HandoverFromUTRANCommand-GSM-v860ext-IEs,
                SEQUENCE {} OPTIONAL
              } OPTIONAL
            } OPTIONAL
          },
          criticalExtensions SEQUENCE {}
        }
      }
    }
  }
}

HandoverFromUTRANCommand-GSM-r3-IEs ::= SEQUENCE {
  -- User equipment IEs
  rrc-TransactionIdentifier RRC-TransactionIdentifier,
  activationTime ActivationTime OPTIONAL,
  -- Radio bearer IEs
  toHandoverRAB-Info RAB-Info OPTIONAL,
  -- Measurement IEs
  frequency-band Frequency-Band,
  -- Other IEs
  gsm-message CHOICE {
    -- In the single-GSM-Message case the following rules apply:
    -- 1> the GSM message directly follows the basic production; the final padding that
    -- results when PER encoding the abstract syntax value is removed prior to appending
    -- the GSM message.
    -- 2> the RRC message excluding the GSM part, does not contain a length determinant;
    -- there is no explicit parameter indicating the size of the included GSM message.
    -- 3> depending on need, final padding (all "0"s) is added to ensure the final result
    -- comprises a full number of octets
    single-GSM-Message SEQUENCE {},
    gsm-MessageList SEQUENCE {
      gsm-Messages GSM-MessageList
    }
  }
}

HandoverFromUTRANCommand-GSM-r6-IEs ::= SEQUENCE {
  -- User equipment IEs
  activationTime ActivationTime OPTIONAL,
  -- Radio bearer IEs
  toHandoverRAB-Info RAB-InformationList-r6 OPTIONAL,
  -- Measurement IEs
  frequency-band Frequency-Band,
  -- Other IEs
  gsm-message CHOICE {

```

```

-- In the single-GSM-Message case the following rules apply:
-- 1> the GSM message directly follows the basic production; the final padding that
-- results when PER encoding the abstract syntax value is removed prior to appending
-- the GSM message.
-- 2> the RRC message excluding the GSM part, does not contain a length determinant;
-- there is no explicit parameter indicating the size of the included GSM message.
-- 3> depending on need, final padding (all "0"s) is added to ensure the final result
-- comprises a full number of octets
single-GSM-Message          SEQUENCE {},
gsm-MessageList            SEQUENCE {
  gsm-Messages              GSM-MessageList
}
},
geran-SystemInfoType      CHOICE {
  sI                       GERAN-SystemInformation,
  pSI                      GERAN-SystemInformation
} OPTIONAL
}

HandoverFromUTRANCommand-GSM-v690ext-IEs ::= SEQUENCE {
  geran-SystemInfoType    CHOICE {
    sI                     GERAN-SystemInformation,
    pSI                    GERAN-SystemInformation
  }
} OPTIONAL
}

HandoverFromUTRANCommand-GSM-v860ext-IEs ::= SEQUENCE {
  sr-vcc-SecurityRABInfo  SR-VCC-SecurityRABInfo-v860ext  OPTIONAL
}

HandoverFromUTRANCommand-GERANIu ::= SEQUENCE {
  rrc-TransactionIdentifier RRC-TransactionIdentifier,
  handoverFromUTRANCommand-GERANIu CHOICE {
    r5 SEQUENCE {
      handoverFromUTRANCommand-GERANIu-r5
      HandoverFromUTRANCommand-GERANIu-r5-IEs,
      -- UTRAN should not include the IE nonCriticalExtensions when it sets
      -- the IE geranIu-message included in handoverFromUTRANCommand-GERANIu-r5 to
      -- single-GERANIu-Message
      -- The UE behaviour upon receiving a message including this combination of IE values is
      -- not specified
      nonCriticalExtensions SEQUENCE {} OPTIONAL
    },
    later-than-r5 SEQUENCE {
      criticalExtensions SEQUENCE {}
    }
  }
}

HandoverFromUTRANCommand-GERANIu-r5-IEs ::= SEQUENCE {
  -- User equipment IEs
  activationTime ActivationTime OPTIONAL,
  -- Measurement IEs
  frequency-Band Frequency-Band,
  -- Other IEs
  geranIu-Message CHOICE {
    -- In the single-GERANIu-Message case the following rules apply:
    -- 1> the GERAN Iu message directly follows the basic production; the final padding that
    -- results when PER encoding the abstract syntax value is removed prior to appending
    -- the GERAN Iu message.
    -- 2> the RRC message excluding the GERAN Iu part does not contain a length determinant;
    -- there is no explicit parameter indicating the size of the included GERAN Iu
    -- message.
    -- 3> depending on need, final padding (all "0"s) is added to ensure the final result
    -- comprises a full number of octets.
    single-GERANIu-Message SEQUENCE {},
    geranIu-MessageList SEQUENCE {
      geranIu-Messages GERANIu-MessageList
    }
  }
}

HandoverFromUTRANCommand-CDMA2000 ::= CHOICE {
  r3 SEQUENCE {
    handoverFromUTRANCommand-CDMA2000-r3
    HandoverFromUTRANCommand-CDMA2000-r3-IEs,
    laterNonCriticalExtensions SEQUENCE {
      -- Container for additional R99 extensions
    }
  }
}

```

```

        handoverFromUTRANCommand-CDMA2000-r3-add-ext
            BIT STRING OPTIONAL,
        nonCriticalExtensions SEQUENCE {} OPTIONAL
    } OPTIONAL
},
later-than-r3 SEQUENCE {
    rrc-TransactionIdentifier RRC-TransactionIdentifier,
    criticalExtensions SEQUENCE {}
}
}

HandoverFromUTRANCommand-CDMA2000-r3-IEs ::= SEQUENCE {
    -- User equipment IEs
    rrc-TransactionIdentifier RRC-TransactionIdentifier,
    activationTime ActivationTime OPTIONAL,
    -- Radio bearer IEs
    toHandoverRAB-Info RAB-Info OPTIONAL,
    -- Other IEs
    cdma2000-MessageList CDMA2000-MessageList
}

HandoverFromUTRANCommand-EUTRA ::= SEQUENCE {
    rrc-TransactionIdentifier RRC-TransactionIdentifier,
    criticalExtensions CHOICE {
        r8 SEQUENCE {
            handoverFromUTRANCommand-EUTRA-r8 HandoverFromUTRANCommand-EUTRA-r8-IEs,
            handoverFromUTRANCommand-EUTRA-r8-add-ext BIT STRING OPTIONAL,
            nonCriticalExtensions SEQUENCE {} OPTIONAL
        },
        criticalExtensions CHOICE {
            r11 SEQUENCE {
                handoverFromUTRANCommand-EUTRA-r11 HandoverFromUTRANCommand-EUTRA-r11-IEs,
                handoverFromUTRANCommand-EUTRA-r11-add-ext BIT STRING OPTIONAL,
                nonCriticalExtensions SEQUENCE {} OPTIONAL
            },
            criticalExtensions SEQUENCE {}
        }
    }
}

HandoverFromUTRANCommand-EUTRA-r8-IEs ::= SEQUENCE {
    -- User equipment IEs
    activationTime ActivationTime OPTIONAL,
    -- Radio bearer IEs
    toHandoverRAB-Info RAB-InformationList OPTIONAL,
    -- Other IEs
    eutra-Message OCTET STRING
}

HandoverFromUTRANCommand-EUTRA-r11-IEs ::= SEQUENCE {
    -- User equipment IEs
    rsr-vcc-Info RSR-VCC-Info OPTIONAL,
    activationTime ActivationTime OPTIONAL,
    -- Radio bearer IEs
    toHandoverRAB-Info RAB-InformationList OPTIONAL,
    -- Other IEs
    eutra-Message OCTET STRING
}

-- *****
--
-- HANDOVER FROM UTRAN FAILURE
--
-- *****

HandoverFromUTRANFailure ::= SEQUENCE {
    -- User equipment IEs
    rrc-TransactionIdentifier RRC-TransactionIdentifier,
    -- Other IEs
    interRAT-HO-FailureCause InterRAT-HO-FailureCause OPTIONAL,
    -- In case the interRATMessage to be transferred is for GERAN Iu mode, the
    -- message should be placed in the HandoverFromUtranFailure-v590ext-IEs
    -- non-critical extension container.
    -- In case the interRATMessage to be transferred is for E-UTRA, the
    -- message should be placed in the HandoverFromUtranFailure-v860ext-IEs
    -- non-critical extension container.
    interRATMessage CHOICE {

```

```

    gsm                SEQUENCE {
      gsm-MessageList  GSM-MessageList
    },
    cdma2000            SEQUENCE {
      cdma2000-MessageList  CDMA2000-MessageList
    }
  } OPTIONAL,
  laterNonCriticalExtensions SEQUENCE {
    -- Container for additional R99 extensions
    handoverFromUTRANFailure-r3-add-ext  BIT STRING OPTIONAL,
    v590NonCriticalExtensions SEQUENCE {
      handoverFromUTRANFailure-v590ext  HandoverFromUtranFailure-v590ext-IEs,
      v860NonCriticalExtensions SEQUENCE {
        handoverFromUTRANFailure-v860ext  HandoverFromUtranFailure-v860ext-IEs,
        nonCriticalExtensions SEQUENCE {} OPTIONAL
      } OPTIONAL
    } OPTIONAL
  } OPTIONAL
}

HandoverFromUtranFailure-v590ext-IEs ::= SEQUENCE {
  geranIu-MessageList  GERANIu-MessageList  OPTIONAL
}

HandoverFromUtranFailure-v860ext-IEs ::= SEQUENCE {
  eutra-Message  OCTET STRING  OPTIONAL
}

-- *****
--
-- INTER RAT HANDOVER INFO
--
-- *****

InterRATHandoverInfo ::= SEQUENCE {
  -- This structure is defined for historical reasons, backward compatibility with 44.018
  predefinedConfigStatusList  CHOICE {
    absent  NULL,
    present  PredefinedConfigStatusList
  },
  ue-SecurityInformation  CHOICE {
    absent  NULL,
    present  UE-SecurityInformation
  },
  ue-CapabilityContainer  CHOICE {
    absent  NULL,
    present  -- present is an octet aligned string containing IE UE-RadioAccessCapabilityInfo
              OCTET STRING (SIZE (0..63))
  },
  -- Non critical extensions
  v390NonCriticalExtensions  CHOICE {
    absent  NULL,
    present  SEQUENCE {
      interRATHandoverInfo-v390ext  InterRATHandoverInfo-v390ext-IEs,
      v3a0NonCriticalExtensions SEQUENCE {
        interRATHandoverInfo-v3a0ext  InterRATHandoverInfo-v3a0ext-IEs,
        laterNonCriticalExtensions SEQUENCE {
          interRATHandoverInfo-v3d0ext  InterRATHandoverInfo-v3d0ext-IEs,
          -- Container for additional R99 extensions
          interRATHandoverInfo-r3-add-ext  BIT STRING
            (CONTAINING InterRATHandoverInfo-r3-add-ext-IEs)  OPTIONAL,
          v3g0NonCriticalExtensions SEQUENCE {
            interRATHandoverInfo-v3g0ext  InterRATHandoverInfo-v3g0ext-IEs,
            v4b0NonCriticalExtensions SEQUENCE {
              interRATHandoverInfo-v4b0ext  InterRATHandoverInfo-v4b0ext-IEs,
              v4d0NonCriticalExtensions SEQUENCE {
                interRATHandoverInfo-v4d0ext  InterRATHandoverInfo-v4d0ext-IEs,
                -- Reserved for future non critical extension
                v590NonCriticalExtensions SEQUENCE {
                  interRATHandoverInfo-v590ext
                    InterRATHandoverInfo-v590ext-IEs,
                  v690NonCriticalExtensions SEQUENCE {
                    interRATHandoverInfo-v690ext
                      InterRATHandoverInfo-v690ext-IEs,
                    v6b0NonCriticalExtensions
                      InterRATHandoverInfo-NonCriticalExtension-v6b0-IEs  OPTIONAL
                  } OPTIONAL
                }
              }
            }
          }
        }
      }
    }
  } OPTIONAL
}

```



```

        } OPTIONAL
      } OPTIONAL
    } OPTIONAL
  } OPTIONAL
}

InterRATHandoverInfo-v390ext-IEs ::= SEQUENCE {
  -- User equipment IEs
  ue-RadioAccessCapability-v380ext    UE-RadioAccessCapability-v380ext    OPTIONAL,
  dl-PhysChCapabilityFDD-v380ext      DL-PhysChCapabilityFDD-v380ext
}

InterRATHandoverInfo-v3a0ext-IEs ::= SEQUENCE {
  -- User equipment IEs
  ue-RadioAccessCapability-v3a0ext    UE-RadioAccessCapability-v3a0ext    OPTIONAL
}

InterRATHandoverInfo-v3d0ext-IEs ::= SEQUENCE {
  -- User equipment IEs
  uESpecificBehaviourInformationInterRAT UEspecificBehaviourInformationInterRAT OPTIONAL
}

InterRATHandoverInfo-v3g0ext-IEs ::= SEQUENCE {
  -- User equipment IEs
  ue-RadioAccessCapability-v3g0ext    UE-RadioAccessCapability-v3g0ext    OPTIONAL
}

InterRATHandoverInfo-r3-add-ext-IEs ::= SEQUENCE {
  interRATHandoverInfo-v690ext1      InterRATHandoverInfo-v690ext1-IEs,
  v7e0NonCriticalExtensions          SEQUENCE {
    interRATHandoverInfo-v7e0ext      InterRATHandoverInfo-v7e0ext-IEs,
    v7f0NonCriticalExtensions        SEQUENCE {
      interRATHandoverInfo-v7f0ext    InterRATHandoverInfo-v7f0ext-IEs,
      va40NonCriticalExtensions      SEQUENCE {
        interRATHandoverInfo-va40ext  InterRATHandoverInfoBand-va40ext-IEs,
        nonCriticalExtensions        SEQUENCE {} OPTIONAL
      } OPTIONAL
    } OPTIONAL
  } OPTIONAL
}

InterRATHandoverInfo-v4b0ext-IEs ::= SEQUENCE {
  -- User equipment IEs
  accessStratumReleaseIndicator      AccessStratumReleaseIndicator
}

InterRATHandoverInfo-v4d0ext-IEs ::= SEQUENCE {
  -- User equipment IEs
  tdd128-RF-Capability               RadioFrequencyBandTDDList        OPTIONAL
}

InterRATHandoverInfo-v590ext-IEs ::= SEQUENCE {
  -- User equipment IEs
  predefinedConfigStatusListComp     PredefinedConfigStatusListComp     OPTIONAL,
  ue-RadioAccessCapabilityComp       UE-RadioAccessCapabilityComp       OPTIONAL
}

InterRATHandoverInfo-v690ext1-IEs ::= SEQUENCE {
  -- User equipment IEs
  ue-RadioAccessCapability-v650ext    UE-RadioAccessCapability-v650ext    OPTIONAL
}

InterRATHandoverInfo-v690ext-IEs ::= SEQUENCE {
  -- User equipment IEs
  ue-SecurityInformation2            UE-SecurityInformation2            OPTIONAL,
  ue-RadioAccessCapabilityComp-ext    UE-RadioAccessCapabilityComp-ext    OPTIONAL,
  ue-RadioAccessCapabilityComp2       UE-RadioAccessCapabilityComp2
}

InterRATHandoverInfo-NonCriticalExtension-v6b0-IEs ::= SEQUENCE {
  interRATHandoverInfo-v6b0ext      InterRATHandoverInfo-v6b0ext-IEs,
  v6e0NonCriticalExtensions        SEQUENCE {
    interRATHandoverInfo-v6e0ext    InterRATHandoverInfo-v6e0ext-IEs,
    v770NonCriticalExtensions      SEQUENCE {
      interRATHandoverInfo-v770ext  InterRATHandoverInfo-v770ext-IEs,

```

```

v790nonCriticalExtensions SEQUENCE {
  interRATHandoverInfo-v790ext InterRATHandoverInfo-v790ext-IEs,
  v860NonCriticalExtensions SEQUENCE {
    interRATHandoverInfo-v860ext InterRATHandoverInfo-v860ext-IEs,
    v880NonCriticalExtensions SEQUENCE {
      interRATHandoverInfo-v880ext InterRATHandoverInfo-v880ext-IEs,
      v920NonCriticalExtensions SEQUENCE {
        interRATHandoverInfo-v920ext InterRATHandoverInfo-v920ext-IEs,
        v8b0NonCriticalExtensions SEQUENCE {
          interRATHandoverInfo-v8b0ext InterRATHandoverInfo-v8b0ext-IEs,
          v950NonCriticalExtensions SEQUENCE {
            interRATHandoverInfo-v950ext InterRATHandoverInfo-v950ext-IEs,
            va40NonCriticalExtensions SEQUENCE {
              interRATHandoverInfo-va40ext InterRATHandoverInfo-va40ext-IEs,
              va80NonCriticalExtensions SEQUENCE {
                interRATHandoverInfo-va80ext InterRATHandoverInfo-va80ext-IEs,
                vb50NonCriticalExtensions SEQUENCE {
                  interRATHandoverInfo-vb50ext InterRATHandoverInfo-vb50ext-IEs,
                  vb70NonCriticalExtensions SEQUENCE {
                    interRATHandoverInfo-vb70ext InterRATHandoverInfo-vb70ext-IEs,
                    vbc0NonCriticalExtensions SEQUENCE {
                      interRATHandoverInfo-vbc0ext InterRATHandoverInfo-vbc0ext-IEs,
                      vc50NonCriticalExtensions SEQUENCE {
                        interRATHandoverInfo-vc50ext InterRATHandoverInfo-vc50ext-
IEs,
                        vd20NonCriticalExtensions SEQUENCE {
                          interRATHandoverInfo-vd20ext InterRATHandoverInfo-vd20ext-IEs,
                          nonCriticalExtensions SEQUENCE {}
                        } OPTIONAL
                      } OPTIONAL
                    } OPTIONAL
                  } OPTIONAL
                } OPTIONAL
              } OPTIONAL
            } OPTIONAL
          } OPTIONAL
        } OPTIONAL
      } OPTIONAL
    } OPTIONAL
  } OPTIONAL
}

InterRATHandoverInfo-v6b0ext-IEs ::= SEQUENCE {
  -- User equipment IEs
  supportForSIB11bis ENUMERATED { true } OPTIONAL
}

InterRATHandoverInfo-v6e0ext-IEs ::= SEQUENCE {
  -- User equipment IEs
  supportForFDPCH ENUMERATED { true } OPTIONAL
}

InterRATHandoverInfo-v770ext-IEs ::= SEQUENCE {
  ue-RadioAccessCapabilityInfo UE-RadioAccessCapabilityInfo-v770ext OPTIONAL,
  ue-RadioAccessCapabilityComp UE-RadioAccessCapabilityComp-v770ext OPTIONAL,
  ue-RadioAccessCapabilityComp2 UE-RadioAccessCapabilityComp2-v770ext OPTIONAL
}

InterRATHandoverInfo-v790ext-IEs ::= SEQUENCE {
  -- User equipment IEs
  supportForEDPCCHPowerBoosting ENUMERATED { true } OPTIONAL
}

InterRATHandoverInfo-v7e0ext-IEs ::= SEQUENCE {
  -- User equipment IEs

```

```

    ue-RadioAccessCapability          UE-RadioAccessCapability-v7e0ext      OPTIONAL
  }
InterRATHandoverInfo-v7f0ext-IEs ::= SEQUENCE {
  -- User equipment IEs
  ue-RadioAccessCapability          UE-RadioAccessCapability-v7f0ext      OPTIONAL,
  ue-RadioAccessCapabilityComp2     UE-RadioAccessCapabilityComp2-v7f0ext OPTIONAL
}
InterRATHandoverInfo-v860ext-IEs ::= SEQUENCE {
  ue-RadioAccessCapabilityInfo      UE-RadioAccessCapability-v860ext      OPTIONAL,
  ue-RadioAccessCapabilityComp2     UE-RadioAccessCapabilityComp2-v860ext OPTIONAL
}
InterRATHandoverInfo-v880ext-IEs ::= SEQUENCE {
  -- UE radio access capability
  ue-RadioAccessCapabilityInfo      UE-RadioAccessCapability-v880ext      OPTIONAL,
  ue-RadioAccessCapabilityInfo-TDD128 UE-RadioAccessCapabilityComp-TDD128  OPTIONAL
}
InterRATHandoverInfo-v920ext-IEs ::= SEQUENCE {
  ue-RadioAccessCapabilityInfo      UE-RadioAccessCapability-v920ext      OPTIONAL,
  ue-RadioAccessCapabilityComp2     UE-RadioAccessCapabilityComp2-v920ext OPTIONAL
}
InterRATHandoverInfo-v8b0ext-IEs ::= SEQUENCE {
  -- UE radio access capability
  ue-RadioAccessCapabilityInfo      UE-RadioAccessCapabilityInfo-TDD128-v8b0ext OPTIONAL
}
InterRATHandoverInfo-v950ext-IEs ::= SEQUENCE {
  -- User equipment IEs
  pdcp-Capability                  PDCP-Capability-r4-ext              OPTIONAL
}
InterRATHandoverInfo-va40ext-IEs ::= SEQUENCE {
  ue-RadioAccessCapabilityInfo      UE-RadioAccessCapability-va40ext      OPTIONAL,
  ue-RadioAccessCapabilityComp2     UE-RadioAccessCapabilityComp2-va40ext OPTIONAL
}
InterRATHandoverInfoBand-va40ext-IEs ::= SEQUENCE {
  -- User equipment IEs
  ue-RadioAccessCapabBand          UE-RadioAccessCapabBand-va40ext      OPTIONAL,
  rf-CapabilityFDDComp             RF-CapabBandListFDDComp-ext2        OPTIONAL
}
InterRATHandoverInfo-va80ext-IEs ::= SEQUENCE {
  ue-RadioAccessCapabilityInfo-va80ext UE-RadioAccessCapability-va80ext      OPTIONAL
}
InterRATHandoverInfo-vb50ext-IEs ::= SEQUENCE {
  ue-RadioAccessCapabilityInfo-vb50ext UE-RadioAccessCapability-vb50ext      OPTIONAL,
  ue-RadioAccessCapabilityComp2       UE-RadioAccessCapabilityComp2-vb50ext OPTIONAL,
  ue-RadioAccessCapabilityInfo-TDD128 UE-RadioAccessCapabilityInfo-TDD128-vb50ext OPTIONAL
}
InterRATHandoverInfo-vb70ext-IEs ::= SEQUENCE {
  ue-RadioAccessCapabilityInfo-vb70ext UE-RadioAccessCapability-vb70ext      OPTIONAL
}
InterRATHandoverInfo-vbc0ext-IEs ::= SEQUENCE {
  ue-RadioAccessCapabilityInfo-vbc0ext UE-RadioAccessCapability-vbc0ext      OPTIONAL
}
InterRATHandoverInfo-vc50ext-IEs ::= SEQUENCE {
  ue-RadioAccessCapabilityComp2       UE-RadioAccessCapabilityComp2-vc50ext OPTIONAL
}
InterRATHandoverInfo-vd20ext-IEs ::= SEQUENCE {
  -- dummy is not used in this version of the specification
  -- and if received it should be ignored
  ue-RadioAccessCapabilityInfo      UE-RadioAccessCapability-vd20ext      OPTIONAL,
  dummy                             UE-RadioAccessCapabilityComp2-vd20ext OPTIONAL
}
-- *****
--
-- MEASUREMENT CONTROL

```

```

--
-- *****
MeasurementControl ::= CHOICE {
  -- The Rel-4 functionality of UE Positioning OTDOA AssistanceData TDD is only available
  -- in the later-than-r3 branch of this message (i.e. through the use of the IE
  -- ue-Positioning-OTDOA-AssistanceData-r4)
  r3
    SEQUENCE {
      measurementControl-r3          MeasurementControl-r3-IEs,
      v390nonCriticalExtensions      SEQUENCE {
        measurementControl-v390ext    MeasurementControl-v390ext,
        v3a0NonCriticalExtensions     SEQUENCE {
          measurementControl-v3a0ext  MeasurementControl-v3a0ext,
          laterNonCriticalExtensions  SEQUENCE {
            -- Container for additional R99 extensions
            measurementControl-r3-add-ext  BIT STRING OPTIONAL,
            v4b0NonCriticalExtensions     SEQUENCE {
              -- The content of the v4b0 non-critical extension has been removed. If sent
              -- to a UE of AS release 4, the UE behaviour is unspecified. A UE of AS
              -- release 5 onward shall comply with the v4b0 and later extensions in this
              -- branch of the message.
              v590NonCriticalExtensions SEQUENCE {
                measurementControl-v590ext    MeasurementControl-v590ext-IEs,
                v5b0NonCriticalExtensions     SEQUENCE {
                  measurementControl-v5b0ext    MeasurementControl-v5b0ext-IEs,
                  nonCriticalExtensions         SEQUENCE {} OPTIONAL
                } OPTIONAL
              } OPTIONAL
            } OPTIONAL
          } OPTIONAL
        } OPTIONAL
      } OPTIONAL
    },
  later-than-r3
    SEQUENCE {
      -- Least significant part of extended "RRC transaction identifier" (Rel-5 onward)
      rrc-TransactionIdentifier    RRC-TransactionIdentifier,
      criticalExtensions           CHOICE {
        r4
          SEQUENCE {
            measurementControl-r4          MeasurementControl-r4-IEs,
            v4d0NonCriticalExtensions      SEQUENCE {
              -- Container for adding non critical extensions after freezing REL-5
              measurementControl-r4-add-ext  BIT STRING OPTIONAL,
              v590NonCriticalExtensions     SEQUENCE {
                measurementControl-v590ext    MeasurementControl-v590ext-IEs,
                v5b0NonCriticalExtensions     SEQUENCE {
                  measurementControl-v5b0ext    MeasurementControl-v5b0ext-IEs,
                  nonCriticalExtensions         SEQUENCE {} OPTIONAL
                } OPTIONAL
              } OPTIONAL
            } OPTIONAL
          } OPTIONAL
        },
        later-than-r4
          SEQUENCE {
            -- Most significant part of extended "RRC transaction identifier" (MSP):
            -- extended "RRC transaction identifier" =
            -- rrc-TransactionIdentifier-MSP * 4 + rrc-TransactionIdentifier
            rrc-TransactionIdentifier-MSP    RRC-TransactionIdentifier,
            criticalExtensions               CHOICE {
              r6
                SEQUENCE {
                  measurementControl-r6          MeasurementControl-r6-IEs,
                  v6a0NonCriticalExtensions      SEQUENCE {
                    measurementControl-v6a0ext    MeasurementControl-v6a0ext-IEs,
                    nonCriticalExtensions         SEQUENCE {} OPTIONAL
                  } OPTIONAL
                },
              criticalExtensions               CHOICE {
                r7
                  SEQUENCE {
                    measurementControl-r7          MeasurementControl-r7-IEs,
                    -- Container for adding non critical extensions after freezing REL-7
                    measurementControl-r7-add-ext  BIT STRING OPTIONAL,
                    v7b0NonCriticalExtensions     SEQUENCE {
                      measurementControl-v7b0ext    MeasurementControl-v7b0ext-IEs,
                      nonCriticalExtensions         SEQUENCE {} OPTIONAL
                    } OPTIONAL
                  },
                criticalExtensions               CHOICE {
                  r8
                    SEQUENCE {
                      measurementControl-r8          MeasurementControl-r8-IEs,
                      -- Container for adding non critical extensions after freezing REL-9
                    }
                  }
                }
              }
            }
          }
        }
      }
    }
  }
}

```

REL-10

```
measurementControl-r8-add-ext BIT STRING OPTIONAL,
v8a0NonCriticalExtensions SEQUENCE {
  measurementControl-v8a0ext MeasurementControl-v8a0ext-IEs,
  vb50NonCriticalExtensions SEQUENCE {
    measurementControl-vb50ext MeasurementControl-vb50ext-IEs,
    nonCriticalExtensions SEQUENCE {} OPTIONAL
  } OPTIONAL
} OPTIONAL
},
criticalExtensions CHOICE {
  r9 SEQUENCE {
    measurementControl-r9 MeasurementControl-r9-IEs,
    -- Container for adding non critical extensions after freezing

    measurementControl-r9-add-ext BIT STRING OPTIONAL,
    v970NonCriticalExtensions SEQUENCE {
      measurementControl-v970ext
      MeasurementControl-v970ext-IEs,
      vb50NonCriticalExtensions SEQUENCE {
        measurementControl-vb50ext
        MeasurementControl-vb50ext-IEs,
        nonCriticalExtensions SEQUENCE {} OPTIONAL
      } OPTIONAL
    } OPTIONAL
  } OPTIONAL
},
criticalExtensions CHOICE {
  r10 SEQUENCE {
    measurementControl-r10 MeasurementControl-r10-IEs,
    -- Container for adding non critical extensions after
    -- freezing REL-11
    measurementControl-r10-add-ext BIT STRING OPTIONAL,
    vaa0NonCriticalExtensions SEQUENCE {
      measurementControl-vaa0ext
      MeasurementControl-vaa0ext-IEs,
      vab0NonCriticalExtensions SEQUENCE {
        measurementControl-vab0ext
        MeasurementControl-vab0ext-IEs,
        vb50NonCriticalExtensions SEQUENCE {
          measurementControl-vb50ext
          MeasurementControl-vb50ext-IEs,
          nonCriticalExtensions SEQUENCE {} OPTIONAL
        } OPTIONAL
      } OPTIONAL
    } OPTIONAL
  } OPTIONAL
},
criticalExtensions CHOICE {
  r11 SEQUENCE {
    measurementControl-r11
    MeasurementControl-r11-IEs,
    -- Container for adding non critical extensions after
    -- freezing REL-12
    measurementControl-r11-add-ext BIT STRING
    OPTIONAL,
    nonCriticalExtensions SEQUENCE {} OPTIONAL
  },
  criticalExtensions CHOICE {
    r12 SEQUENCE {
      measurementControl-r12
      MeasurementControl-r12-IEs,
      -- Container for adding non critical extensions
      -- after freezing REL-13
      measurementControl-r12-add-ext BIT STRING
      OPTIONAL,
      nonCriticalExtensions SEQUENCE {} OPTIONAL
    },
    criticalExtensions SEQUENCE {}
  }
}
}
}
}
}
}
}
}
}
}
}
```

```

MeasurementControl-r3-IEs ::= SEQUENCE {
  -- User equipment IEs
  rrc-TransactionIdentifier      RRC-TransactionIdentifier,
  -- Measurement IEs
  measurementIdentity            MeasurementIdentity,
  -- TABULAR: The measurement type is included in MeasurementCommand.
  measurementCommand             MeasurementCommand,
  measurementReportingMode       MeasurementReportingMode           OPTIONAL,
  additionalMeasurementList       AdditionalMeasurementID-List       OPTIONAL,
  -- Physical channel IEs
  dpch-CompressedModeStatusInfo  DPCH-CompressedModeStatusInfo     OPTIONAL
}

MeasurementControl-v390ext ::= SEQUENCE {
  ue-Positioning-Measurement-v390ext  UE-Positioning-Measurement-v390ext  OPTIONAL
}

MeasurementControl-v3a0ext ::= SEQUENCE {
  sfn-Offset-Validity             SFN-Offset-Validity             OPTIONAL
}

MeasurementControl-r4-IEs ::= SEQUENCE {
  -- Measurement IEs
  measurementIdentity            MeasurementIdentity,
  -- TABULAR: The measurement type is included in measurementCommand.
  measurementCommand             MeasurementCommand-r4,
  measurementReportingMode       MeasurementReportingMode           OPTIONAL,
  additionalMeasurementList       AdditionalMeasurementID-List       OPTIONAL,
  -- Physical channel IEs
  dpch-CompressedModeStatusInfo  DPCH-CompressedModeStatusInfo     OPTIONAL
}

MeasurementControl-v590ext-IEs ::= SEQUENCE {
  measurementCommand-v590ext      CHOICE {
    -- the choice "intra-frequency" shall be used for the case of intra-frequency measurement,
    -- as well as when intra-frequency events are configured for inter-frequency measurement
    intra-frequency                Intra-FreqEventCriteriaList-v590ext,
    inter-frequency                Inter-FreqEventCriteriaList-v590ext
  }
  OPTIONAL,
  intraFreqReportingCriteria-1b-r5  IntraFreqReportingCriteria-1b-r5  OPTIONAL,
  intraFreqEvent-1d-r5             IntraFreqEvent-1d-r5             OPTIONAL,
  -- Most significant part of extended "RRC transaction identifier" (MSP):
  -- extended "RRC transaction identifier" =
  -- rrc-TransactionIdentifier-MSP-v590ext * 4 + rrc-TransactionIdentifier
  rrc-TransactionIdentifier-MSP-v590ext  RRC-TransactionIdentifier
}

MeasurementControl-v5b0ext-IEs ::= SEQUENCE {
  interRATCellInfoIndication      InterRATCellInfoIndication      OPTIONAL
}

MeasurementControl-r6-IEs ::= SEQUENCE {
  -- Measurement IEs
  measurementIdentity            MeasurementIdentity,
  -- TABULAR: The measurement type is included in measurementCommand.
  measurementCommand             MeasurementCommand-r6,
  measurementReportingMode       MeasurementReportingMode           OPTIONAL,
  additionalMeasurementList       AdditionalMeasurementID-List       OPTIONAL,
  -- Physical channel IEs
  dpch-CompressedModeStatusInfo  DPCH-CompressedModeStatusInfo     OPTIONAL
}

MeasurementControl-v6a0ext-IEs ::= SEQUENCE {
  intraFreqReportingCriteria-1b-r5  IntraFreqReportingCriteria-1b-r5  OPTIONAL
}

MeasurementControl-r7-IEs ::= SEQUENCE {
  -- Measurement IEs
  measurementIdentity            MeasurementIdentity,
  -- TABULAR: The measurement type is included in measurementCommand.
  measurementCommand             MeasurementCommand-r7,
  measurementReportingMode       MeasurementReportingMode           OPTIONAL,
  additionalMeasurementList       AdditionalMeasurementID-List       OPTIONAL,
  -- Physical channel IEs
  dpch-CompressedModeStatusInfo  DPCH-CompressedModeStatusInfo     OPTIONAL
}

```

```

MeasurementControl-v7b0ext-IEs ::= SEQUENCE {
  -- Measurement IEs
  newInterFreqCellList          NewInterFreqCellList-v7b0ext          OPTIONAL
}

MeasurementControl-r8-IEs ::= SEQUENCE {
  -- Measurement IEs
  measurementIdentity            MeasurementIdentity,
  -- TABULAR: The measurement type is included in measurementCommand.
  measurementCommand            MeasurementCommand-r8,
  measurementReportingMode      MeasurementReportingMode              OPTIONAL,
  additionalMeasurementList      AdditionalMeasurementID-List          OPTIONAL,
  -- Physical channel IEs
  dpch-CompressedModeStatusInfo DPCH-CompressedModeStatusInfo        OPTIONAL
}

MeasurementControl-v8a0ext-IEs ::= SEQUENCE {
  -- Measurement IEs
  newIntraFreqCellList          NewIntraFreqCellList-LCR-v8a0ext          OPTIONAL,
  newInterFreqCellList          NewInterFreqCellList-LCR-v8a0ext          OPTIONAL
}

MeasurementControl-r9-IEs ::= SEQUENCE {
  -- Measurement IEs
  -- if the UE supports extended measurements, "measurementIdentity"
  -- shall be ignored if "measurementIdentity" in MeasurementControl-v970ext-IEs
  -- is present, and the value of that element shall be used instead.
  measurementIdentity            MeasurementIdentity,
  -- TABULAR: The measurement type is included in measurementCommand.
  measurementCommand            MeasurementCommand-r9,
  measurementReportingMode      MeasurementReportingMode              OPTIONAL,
  -- if the UE supports extended measurements, "additionalMeasurementList"
  -- shall be ignored if "additionalMeasurementList" in MeasurementControl-v970ext-IEs
  -- is present, and the value of that element shall be used instead.
  additionalMeasurementList      AdditionalMeasurementID-List          OPTIONAL,
  cellDCHMeasOccasionInfo-TDD128 CellDCHMeasOccasionInfo-TDD128-r9    OPTIONAL,
  -- Physical channel IEs
  dpch-CompressedModeStatusInfo DPCH-CompressedModeStatusInfo        OPTIONAL
}

MeasurementControl-v970ext-IEs ::= SEQUENCE {
  -- Measurement IEs
  measurementIdentity            MeasurementIdentity-r9                  OPTIONAL,
  additionalMeasurementList      AdditionalMeasurementID-List-r9        OPTIONAL
}

MeasurementControl-r10-IEs ::= SEQUENCE {
  -- Measurement IEs
  -- if the UE supports extended measurements, "measurementIdentity"
  -- shall be ignored if "measurementIdentity" in MeasurementControl-vab0ext-IEs
  -- is present, and the value of that element shall be used instead.
  measurementIdentity            MeasurementIdentity,
  -- TABULAR: The measurement type is included in measurementCommand.
  measurementCommand            MeasurementCommand-r10,
  measurementReportingMode      MeasurementReportingMode              OPTIONAL,
  -- if the UE supports extended measurements, "additionalMeasurementList"
  -- shall be ignored if "additionalMeasurementList" in MeasurementControl-vab0ext-IEs
  -- is present, and the value of that element shall be used instead.
  additionalMeasurementList      AdditionalMeasurementID-List          OPTIONAL,
  cellDCHMeasOccasionInfo-TDD128 CellDCHMeasOccasionInfo-TDD128-r9    OPTIONAL,
  -- Physical channel IEs
  dpch-CompressedModeStatusInfo DPCH-CompressedModeStatusInfo-r10      OPTIONAL
}

MeasurementControl-vaa0ext-IEs ::= SEQUENCE {
  -- Measurement IEs
  periodicalReportingCriteriaOnSecULFreq
  PeriodicalWithReportingCellStatusOnSecULFreq          OPTIONAL
}

MeasurementControl-vab0ext-IEs ::= MeasurementControl-v970ext-IEs

MeasurementControl-r11-IEs ::= SEQUENCE {
  -- Measurement IEs
  measurementIdentity            MeasurementIdentity-r9,
  -- TABULAR: The measurement type is included in measurementCommand.
  measurementCommand            MeasurementCommand-r11,
  measurementReportingMode      MeasurementReportingMode              OPTIONAL,

```

```

        additionalMeasurementList      AdditionalMeasurementID-List-r9      OPTIONAL,
        cellDCHMeasOccasionInfo-TDD128 CellDCHMeasOccasionInfo-TDD128-r9  OPTIONAL,
    -- Physical channel IES
        dpch-CompressedModeStatusInfo   DPCH-CompressedModeStatusInfo-r10    OPTIONAL
    }

MeasurementControl-vb50ext-IEs ::= SEQUENCE {
    -- Measurement IES
    interRATMeasurement                 InterRATMeasurement-r11              OPTIONAL
}

MeasurementControl-rl2-IEs ::= SEQUENCE {
    -- Measurement IES
    measurementIdentity                 MeasurementIdentity-r9                OPTIONAL,
    -- TABULAR: The measurement type is included in measurementCommand.
    measurementCommand                  MeasurementCommand-r12,
    measurementReportingMode            MeasurementReportingMode              OPTIONAL,
    additionalMeasurementList           AdditionalMeasurementID-List-r9      OPTIONAL,
    cellDCHMeasOccasionInfo-TDD128     CellDCHMeasOccasionInfo-TDD128-r9  OPTIONAL,
    measurementScalingFactor            MeasurementScalingFactor              OPTIONAL,
    -- Physical channel IES
    dpch-CompressedModeStatusInfo       DPCH-CompressedModeStatusInfo-r10    OPTIONAL
}

-- *****
--
-- MEASUREMENT CONTROL FAILURE
--
-- *****

MeasurementControlFailure ::= SEQUENCE {
    -- User equipment IES
    -- Least significant part of extended "RRC transaction identifier" (Rel-5 onward)
    rrc-TransactionIdentifier           RRC-TransactionIdentifier,
    failureCause                        FailureCauseWithProtErr,
    laterNonCriticalExtensions          SEQUENCE {
        -- Container for additional R99 extensions
        measurementControlFailure-r3-add-ext BIT STRING OPTIONAL,
        v590NonCriticalExtensions        SEQUENCE {
            measurementControlFailure-v590ext MeasurementControlFailure-v590ext-IEs,
            vc50NonCriticalExtensions    SEQUENCE {
                measurementControlFailure-vc50ext MeasurementControlFailure-vc50ext-IEs,
                nonCriticalExtensions    SEQUENCE {} OPTIONAL
            } OPTIONAL
        } OPTIONAL
    } OPTIONAL
}

MeasurementControlFailure-v590ext-IEs ::= SEQUENCE {
    -- Most significant part of extended "RRC transaction identifier" (MSP):
    -- extended "RRC transaction identifier" =
    -- rrc-TransactionIdentifier-MSP-v590ext * 4 + rrc-TransactionIdentifier
    -- If the rrc-TransactionIdentifier-MSP-v590ext was not received in the MEASUREMENT CONTROL
    -- message, then the rrc-TransactionIdentifier-MSP-v590ext shall be set to zero
    rrc-TransactionIdentifier-MSP-v590ext RRC-TransactionIdentifier
}

MeasurementControlFailure-vc50ext-IEs ::= SEQUENCE {
    measurementIdentity                 MeasurementIdentity-r9                OPTIONAL
}

-- *****
--
-- MEASUREMENT REPORT
--
-- *****

MeasurementReport ::= SEQUENCE {
    -- Measurement IES
    -- if the UE supports extended measurements, "measurementIdentity"
    -- shall be ignored if "measurementIdentity" in MeasurementReport-v970ext-IEs
    -- is present, and the value of that element shall be used instead.
    measurementIdentity                 MeasurementIdentity,
    measuredResults                     MeasuredResults                      OPTIONAL,
    measuredResultsOnRACH                MeasuredResultsOnRACH                OPTIONAL,
    additionalMeasuredResults            MeasuredResultsList                  OPTIONAL,
    eventResults                         EventResults                          OPTIONAL,
    -- Non-critical extensions

```



```

v390nonCriticalExtensions SEQUENCE {
  measurementReport-v390ext MeasurementReport-v390ext,
  laterNonCriticalExtensions SEQUENCE {
    -- Container for additional R99 extensions
    measurementReport-r3-add-ext BIT STRING OPTIONAL,
    v4b0NonCriticalExtensions SEQUENCE {
      measurementReport-v4b0ext MeasurementReport-v4b0ext-IEs,
      -- Extension mechanism for non-Rel4 information
      v590NonCriticalExtensions SEQUENCE {
        measurementReport-v590ext MeasurementReport-v590ext-IEs,
        v5b0NonCriticalExtensions SEQUENCE {
          measurementReport-v5b0ext MeasurementReport-v5b0ext-IEs,
          v690NonCriticalExtensions SEQUENCE {
            measurementReport-v690ext MeasurementReport-v690ext-IEs,
            v770NonCriticalExtensions SEQUENCE {
              measurementReport-v770ext MeasurementReport-v770ext-IEs,
              v860NonCriticalExtensions SEQUENCE {
                measurementReport-v860ext MeasurementReport-v860ext-IEs,
                v920NonCriticalExtensions SEQUENCE {
                  measurementReport-v920ext MeasurementReport-v920ext-
IEs,
                  v970NonCriticalExtensions SEQUENCE {
                    measurementReport-v970ext-IE
                    MeasurementReport-v970ext-IEs,
                    va40NonCriticalExtensions SEQUENCE {
                      measurementReport-va40ext
                      MeasurementReport-va40ext-IEs,
                      vb50NonCriticalExtensions SEQUENCE {
                        measurementReport-vb50ext
                        MeasurementReport-vb50ext-IEs,
                        vc50NonCriticalExtensions SEQUENCE {
                          measurementReport-vc50ext
                          MeasurementReport-vc50ext-IEs,
                          nonCriticalExtensions
                          SEQUENCE {} OPTIONAL
                        } OPTIONAL
                      } OPTIONAL
                    } OPTIONAL
                  } OPTIONAL
                } OPTIONAL
              } OPTIONAL
            } OPTIONAL
          } OPTIONAL
        } OPTIONAL
      } OPTIONAL
    } OPTIONAL
  } OPTIONAL
}

MeasurementReport-v390ext ::= SEQUENCE {
  measuredResults-v390ext MeasuredResults-v390ext OPTIONAL
}

MeasurementReport-v4b0ext-IEs ::= SEQUENCE {
  interFreqEventResults-LCR InterFreqEventResults-LCR-r4-ext OPTIONAL,
  -- additionalMeasuredResults-LCR shall contain measurement results and additional measurement
  -- results list.
  additionalMeasuredResults-LCR MeasuredResultsList-LCR-r4-ext OPTIONAL,
  -- dummy is not used in this version of the specification. It should not be sent and
  -- if received it should be ignored.
  dummy PrimaryCPICH-Info OPTIONAL
}

MeasurementReport-v590ext-IEs ::= SEQUENCE {
  measuredResults-v590ext MeasuredResults-v590ext OPTIONAL
}

MeasurementReport-v5b0ext-IEs ::= SEQUENCE {
  interRATCellInfoIndication InterRATCellInfoIndication OPTIONAL
}

MeasurementReport-v690ext-IEs ::= SEQUENCE {
  measuredResultsOnRACHinterFreq MeasuredResultsOnRACHinterFreq OPTIONAL
}

MeasurementReport-v770ext-IEs ::= SEQUENCE {
  measuredResults MeasuredResults-v770ext OPTIONAL,

```

```

    additionalMeasuredResults      MeasuredResultsList-v770ext      OPTIONAL,
    eventResults                    EventResults-v770ext                  OPTIONAL,
    ue-Positioning-OTDOA-MeasuredResults
                                   UE-Positioning-OTDOA-MeasuredResultsTDD-ext  OPTIONAL
}

MeasurementReport-v860ext-IEs ::= SEQUENCE {
    activationTime      ActivationTime      OPTIONAL,
    measuredResults     MeasuredResults-v860ext  OPTIONAL,
    additionalMeasuredResults
                        MeasuredResultsList-v860ext  OPTIONAL,
    eventResults        EventResults-v860ext      OPTIONAL,
    eutra-MeasuredResults
                        EUTRA-MeasuredResults      OPTIONAL,
    eutra-EventResults  EUTRA-EventResults      OPTIONAL
}

MeasurementReport-v920ext-IEs ::= SEQUENCE {
    csgProximityIndication      CSGProximityIndication      OPTIONAL,
    measuredResults              MeasuredResults-v920ext            OPTIONAL,
    measuredResultsOnSecUlFreq   MeasuredResultsOnSecUlFreq  OPTIONAL,
    additionalMeasuredResults     MeasuredResultsList-v920ext  OPTIONAL,
    additionalMeasuredResultsOnSecUlFreq
                                   MeasuredResultsListOnSecUlFreq  OPTIONAL,
    eventResultsOnSecUlFreq      EventResultsOnSecUlFreq      OPTIONAL,
    eutra-MeasuredResults         EUTRA-MeasuredResults-v920ext  OPTIONAL
}

MeasurementReport-v970ext-IEs ::= SEQUENCE {
    measurementIdentity      MeasurementIdentityExt      OPTIONAL
}

MeasurementReport-va40ext-IEs ::= SEQUENCE {
    eventResults              EventResults-va40ext      OPTIONAL,
    loggedMeasAvailable       ENUMERATED { true }      OPTIONAL,
    loggedANRRResultsAvailable
                              ENUMERATED { true }      OPTIONAL
}

MeasurementReport-vb50ext-IEs ::= SEQUENCE {
    -- Measurement IEs
    measuredResultsOnRACH      MeasuredResultsOnRACH-EUTRAFreq  OPTIONAL,
    eutra-EventResultsForCELLFACH
                              EUTRA-EventResultsForCELLFACH      OPTIONAL,
    csgProximityIndication     CSGProximityIndication-vb50ext    OPTIONAL,
    eutra-MeasuredResults      EUTRA-MeasuredResults-vb50ext    OPTIONAL,
    eutra-EventResults         EUTRA-EventResults-vb50ext      OPTIONAL
}

MeasurementReport-vc50ext-IEs ::= SEQUENCE {
    -- Measurement IEs
    measuredResultsOnRACH      MeasuredResultsOnRACH-vc50ext    OPTIONAL,
    measuredResults            MeasuredResults-vc50ext              OPTIONAL,
    measuredResultsOnSecUlFreq
                              MeasuredResultsOnSecUlFreq-vc50ext  OPTIONAL,
    additionalMeasuredResults   MeasuredResultsList-vc50ext      OPTIONAL,
    additionalMeasuredResultsOnSecUlFreq
                                   MeasuredResultsListOnSecUlFreq-vc50ext  OPTIONAL,
    eutra-MeasuredResults       EUTRA-MeasuredResults-vc50ext    OPTIONAL,
    eutra-EventResults          EUTRA-EventResults-vc50ext        OPTIONAL,
    eutra-EventResultsForCELLFACH
                              EUTRA-EventResultsForCELLFACH-vc50ext  OPTIONAL
}

-- *****
--
-- PAGING TYPE 1
--
-- *****

PagingType1 ::= SEQUENCE {
    -- User equipment IEs
    pagingRecordList      PagingRecordList      OPTIONAL,
    -- Other IEs
    bcch-ModificationInfo
                        BCCH-ModificationInfo      OPTIONAL,
    laterNonCriticalExtensions
                        SEQUENCE {
        -- Container for additional R99 extensions
        pagingType1-r3-add-ext      BIT STRING      OPTIONAL,
        v590NonCriticalExtensions    SEQUENCE {
            pagingType1-v590ext      PagingType1-v590ext-IEs,
            v860NonCriticalExtensions
                                SEQUENCE {
                pagingType1-v860ext      PagingType1-v860ext-IEs,
                vc50NonCriticalExtensions
                                    SEQUENCE {
                    pagingType1-vc50ext      PagingType1-vc50ext-IEs,

```

```

        nonCriticalExtensions          SEQUENCE {}          OPTIONAL
    } OPTIONAL
} OPTIONAL
} OPTIONAL
}

PagingType1-v590ext-IEs ::= SEQUENCE {
    -- User equipment IEs
    pagingRecord2List                PagingRecord2List-r5          OPTIONAL
}

PagingType1-v860ext-IEs ::= SEQUENCE {
    -- Other IEs
    etws-Information                  ETWS-Information          OPTIONAL
}

PagingType1-vc50ext-IEs ::= SEQUENCE {
    bcch-ModificationInfo-vc50ext    BCCH-ModificationInfo-vc50ext    OPTIONAL
}

-- *****
--
-- PAGING TYPE 2
--
-- *****

PagingType2 ::= SEQUENCE {
    -- User equipment IEs
    rrc-TransactionIdentifier          RRC-TransactionIdentifier,
    pagingCause                        PagingCause,
    -- Core network IEs
    cn-DomainIdentity                 CN-DomainIdentity,
    pagingRecordTypeID                PagingRecordTypeID,
    laterNonCriticalExtensions         SEQUENCE {
        -- Container for additional R99 extensions
        pagingType2-r3-add-ext         BIT STRING          OPTIONAL,
        nonCriticalExtensions          SEQUENCE {}          OPTIONAL
    } OPTIONAL
}

-- *****
--
-- PHYSICAL CHANNEL RECONFIGURATION
--
-- *****

PhysicalChannelReconfiguration ::= CHOICE {
    r3                                  SEQUENCE {
        physicalChannelReconfiguration-r3
        v3a0NonCriticalExtensions       SEQUENCE {
            physicalChannelReconfiguration-v3a0ext    PhysicalChannelReconfiguration-v3a0ext,
            laterNonCriticalExtensions       SEQUENCE {
                -- Container for additional R99 extensions
                physicalChannelReconfiguration-r3-add-ext    BIT STRING          OPTIONAL,
                v4b0NonCriticalExtensitions    SEQUENCE {
                    physicalChannelReconfiguration-v4b0ext
                    PhysicalChannelReconfiguration-v4b0ext-IEs,
                }
                v590NonCriticalExtensitions    SEQUENCE {
                    physicalChannelReconfiguration-v590ext
                    PhysicalChannelReconfiguration-v590ext-IEs,
                }
                v690NonCriticalExtensions     SEQUENCE {
                    physicalChannelReconfiguration-v690ext
                    PhysicalChannelReconfiguration-v690ext-IEs,
                }
                v770NonCriticalExtensions     SEQUENCE {
                    physicalChannelReconfiguration-v770ext
                    PhysicalChannelReconfiguration-v770ext-IEs,
                }
                nonCriticalExtensions         SEQUENCE {}          OPTIONAL
            } OPTIONAL
        } OPTIONAL
    } OPTIONAL
},
    later-than-r3                      SEQUENCE {
        rrc-TransactionIdentifier          RRC-TransactionIdentifier,

```

```

criticalExtensions          CHOICE {
r4                          SEQUENCE {
    physicalChannelReconfiguration-r4
                                PhysicalChannelReconfiguration-r4-IEs,
v4d0NonCriticalExtensions  SEQUENCE {
    -- Container for adding non critical extensions after freezing REL-5
    physicalChannelReconfiguration-r4-add-ext    BIT STRING    OPTIONAL,
v590NonCriticalExtensstions SEQUENCE {
    physicalChannelReconfiguration-v590ext
                                PhysicalChannelReconfiguration-v590ext-IEs,
v690NonCriticalExtensions  SEQUENCE {
    physicalChannelReconfiguration-v690ext
                                PhysicalChannelReconfiguration-v690ext-IEs,
v770NonCriticalExtensions  SEQUENCE {
    physicalChannelReconfiguration-v770ext
                                PhysicalChannelReconfiguration-v770ext-IEs,
    nonCriticalExtensions    SEQUENCE {}    OPTIONAL
    } OPTIONAL
    } OPTIONAL
    } OPTIONAL
},
criticalExtensions          CHOICE {
r5                          SEQUENCE {
    physicalChannelReconfiguration-r5
                                PhysicalChannelReconfiguration-r5-IEs,
    -- Container for adding non critical extensions after freezing REL-6
    physicalChannelReconfiguration-r5-add-ext    BIT STRING    OPTIONAL,
v690NonCriticalExtensions  SEQUENCE {
    physicalChannelReconfiguration-v690ext
                                PhysicalChannelReconfiguration-v690ext-IEs,
v770NonCriticalExtensions  SEQUENCE {
    physicalChannelReconfiguration-v770ext
                                PhysicalChannelReconfiguration-v770ext-IEs,
    nonCriticalExtensions    SEQUENCE {}    OPTIONAL
    } OPTIONAL
    } OPTIONAL
},
criticalExtensions          CHOICE {
r6                          SEQUENCE {
    physicalChannelReconfiguration-r6
                                PhysicalChannelReconfiguration-r6-IEs,
    -- Container for adding non critical extensions after freezing REL-7
    physicalChannelReconfiguration-r6-add-ext    BIT STRING    OPTIONAL,
v6b0NonCriticalExtensions  SEQUENCE {
    physicalChannelReconfiguration-v6b0ext
                                PhysicalChannelReconfiguration-v6b0ext-IEs,
v770NonCriticalExtensions  SEQUENCE {
    physicalChannelReconfiguration-v770ext
                                PhysicalChannelReconfiguration-v770ext-IEs,
    nonCriticalExtensions    SEQUENCE {}    OPTIONAL
    } OPTIONAL
    } OPTIONAL
},
criticalExtensions          CHOICE {
r7                          SEQUENCE {
    physicalChannelReconfiguration-r7
                                PhysicalChannelReconfiguration-r7-IEs,
    -- Container for adding non critical extensions after freezing REL-7
    physicalChannelReconfiguration-r7-add-ext    BIT STRING    OPTIONAL,
v780NonCriticalExtensions  SEQUENCE {
    physicalChannelReconfiguration-v780ext
                                PhysicalChannelReconfiguration-v780ext-IEs,
v7d0NonCriticalExtensions  SEQUENCE {
    physicalChannelReconfiguration-v7d0ext
                                PhysicalChannelReconfiguration-v7d0ext-IEs,
v7f0NonCriticalExtensions  SEQUENCE {
    physicalChannelReconfiguration-v7f0ext
                                PhysicalChannelReconfiguration-v7f0ext-IEs,
v7g0NonCriticalExtensions  SEQUENCE {
    physicalChannelReconfiguration-v7g0ext
                                PhysicalChannelReconfiguration-v7g0ext-IEs,
    nonCriticalExtensions    SEQUENCE {}    OPTIONAL
    } OPTIONAL
    } OPTIONAL
    } OPTIONAL
    } OPTIONAL
},
},

```

```

criticalExtensions          CHOICE {
  r8                        SEQUENCE {
    physicalChannelReconfiguration-r8
      PhysicalChannelReconfiguration-r8-IEs,
    -- Container for adding non critical extensions after freezing REL-9
    physicalChannelReconfiguration-r8-add-ext BIT STRING OPTIONAL,
    v7d0NonCriticalExtensions SEQUENCE {
      physicalChannelReconfiguration-v7d0ext
        PhysicalChannelReconfiguration-v7d0ext-IEs,
    v7f0NonCriticalExtensions SEQUENCE {
      physicalChannelReconfiguration-v7f0ext
        PhysicalChannelReconfiguration-v7f0ext-IEs,
    v890NonCriticalExtensions SEQUENCE {
      physicalChannelReconfiguration-v890ext
        PhysicalChannelReconfiguration-v890ext-IEs,
    v7g0NonCriticalExtensions SEQUENCE {
      physicalChannelReconfiguration-v7g0ext
        PhysicalChannelReconfiguration-v7g0ext-IEs,
    v8a0NonCriticalExtensions SEQUENCE {
      physicalChannelReconfiguration-v8a0ext
        PhysicalChannelReconfiguration-v8a0ext-IEs,
    nonCriticalExtensions SEQUENCE {}
  } OPTIONAL
} OPTIONAL
} OPTIONAL
},
criticalExtensions          CHOICE {
  r9                        SEQUENCE {
    physicalChannelReconfiguration-r9
      PhysicalChannelReconfiguration-r9-IEs,
    -- Container for adding non critical extensions after
    -- freezing REL-10
    physicalChannelReconfiguration-r9-add-ext
      BIT STRING OPTIONAL,
    v950NonCriticalExtensions SEQUENCE {
      physicalChannelReconfiguration-v950ext
        PhysicalChannelReconfiguration-v950ext-IEs,
    nonCriticalExtensions SEQUENCE {} OPTIONAL
  } OPTIONAL
},
criticalExtensions          CHOICE {
  r10                       SEQUENCE {
    physicalChannelReconfiguration-r10
      PhysicalChannelReconfiguration-r10-IEs,
    -- Container for adding non critical extensions after
    -- freezing REL-11
    physicalChannelReconfiguration-r10-add-ext
      BIT STRING OPTIONAL,
    vb50NonCriticalExtensions SEQUENCE {
      physicalChannelReconfiguration-vb50ext
        PhysicalChannelReconfiguration-vb50ext-IEs,
    nonCriticalExtensions SEQUENCE {}
  } OPTIONAL
},
criticalExtensions          CHOICE {
  r11                       SEQUENCE {
    physicalChannelReconfiguration-r11
      PhysicalChannelReconfiguration-r11-IEs,
    -- Container for adding non critical extensions after
    -- freezing REL-12
    physicalChannelReconfiguration-r11-add-ext
      BIT STRING OPTIONAL,
    nonCriticalExtensions SEQUENCE {} OPTIONAL
  },
criticalExtensions          CHOICE {
  r12                       SEQUENCE {
    physicalChannelReconfiguration-r12
      PhysicalChannelReconfiguration-r12-IEs,
    -- Container for adding non critical extensions
    -- after freezing REL-13
    physicalChannelReconfiguration-r12-add-ext
      BIT STRING OPTIONAL,
    nonCriticalExtensions SEQUENCE {} OPTIONAL
  }
}

```



```

    new-DSCH-RNTI          DSCH-RNTI          OPTIONAL,
    rrc-StateIndicator     RRC-StateIndicator,
    utran-DRX-CycleLengthCoeff  UTRAN-DRX-CycleLengthCoefficient  OPTIONAL,
-- Core network IEs
  cn-InformationInfo      CN-InformationInfo      OPTIONAL,
-- UTRAN mobility IEs
  ura-Identity           URA-Identity           OPTIONAL,
-- Radio bearer IEs
  dl-CounterSynchronisationInfo  DL-CounterSynchronisationInfo  OPTIONAL,
-- Physical channel IEs
  frequencyInfo          FrequencyInfo          OPTIONAL,
  maxAllowedUL-TX-Power  MaxAllowedUL-TX-Power  OPTIONAL,
-- Note: the reference to CPCH in the element name below is incorrect. The name is not
-- changed to keep it aligned with R99.
  ul-ChannelRequirement  UL-ChannelRequirementWithCPCH-SetID-r4  OPTIONAL,
  modeSpecificInfo       CHOICE {
    fdd                   SEQUENCE {
      -- dummy is not used in this version of specification, it should
      -- not be sent and if received it should be ignored.
      dummy               DL-PDSCH-Information  OPTIONAL
    },
    tdd                   NULL
  },
  dl-CommonInformation   DL-CommonInformation-r4  OPTIONAL,
  dl-InformationPerRL-List  DL-InformationPerRL-List-r4  OPTIONAL
}

```

```

PhysicalChannelReconfiguration-r5-IEs ::= SEQUENCE {
-- User equipment IEs
  integrityProtectionModeInfo  IntegrityProtectionModeInfo  OPTIONAL,
  cipheringModeInfo           CipheringModeInfo           OPTIONAL,
  activationTime              ActivationTime              OPTIONAL,
  new-U-RNTI                  U-RNTI                  OPTIONAL,
  new-C-RNTI                  C-RNTI                  OPTIONAL,
-- The IE "new-DSCH-RNTI" should not be included in FDD mode, and if received
-- the UE behaviour is unspecified
  new-DSCH-RNTI              DSCH-RNTI              OPTIONAL,
  new-H-RNTI                  H-RNTI                  OPTIONAL,
  rrc-StateIndicator         RRC-StateIndicator,
  utran-DRX-CycleLengthCoeff  UTRAN-DRX-CycleLengthCoefficient  OPTIONAL,
-- Core network IEs
  cn-InformationInfo         CN-InformationInfo         OPTIONAL,
-- UTRAN mobility IEs
  ura-Identity               URA-Identity               OPTIONAL,
-- Radio bearer IEs
  dl-CounterSynchronisationInfo  DL-CounterSynchronisationInfo-r5  OPTIONAL,
-- Physical channel IEs
  frequencyInfo              FrequencyInfo              OPTIONAL,
  maxAllowedUL-TX-Power      MaxAllowedUL-TX-Power      OPTIONAL,
-- Note: the reference to CPCH in the element name below is incorrect. The name is not
-- changed to keep it aligned with R99.
  ul-ChannelRequirement      UL-ChannelRequirementWithCPCH-SetID-r5  OPTIONAL,
  modeSpecificInfo           CHOICE {
    fdd                       SEQUENCE {
      -- dummy is not used in this version of specification, it should
      -- not be sent and if received it should be ignored.
      dummy                   DL-PDSCH-Information  OPTIONAL
    },
    tdd                       NULL
  },
  dl-HSPDSCH-Information     DL-HSPDSCH-Information     OPTIONAL,
  dl-CommonInformation       DL-CommonInformation-r5    OPTIONAL,
  dl-InformationPerRL-List   DL-InformationPerRL-List-r5  OPTIONAL
}

```

```

PhysicalChannelReconfiguration-r6-IEs ::= SEQUENCE {
-- User equipment IEs
  integrityProtectionModeInfo  IntegrityProtectionModeInfo  OPTIONAL,
  cipheringModeInfo           CipheringModeInfo           OPTIONAL,
  activationTime              ActivationTime              OPTIONAL,
  delayRestrictionFlag       DelayRestrictionFlag       OPTIONAL,
  new-U-RNTI                  U-RNTI                  OPTIONAL,
  new-C-RNTI                  C-RNTI                  OPTIONAL,
-- The IE "new-DSCH-RNTI" should not be included in FDD mode,
-- and if received the UE behaviour is unspecified
  new-DSCH-RNTI              DSCH-RNTI              OPTIONAL,
  new-H-RNTI                  H-RNTI                  OPTIONAL,
  newPrimary-E-RNTI          E-RNTI                  OPTIONAL,

```

```

    newSecondary-E-RNTI          E-RNTI          OPTIONAL,
    rrc-StateIndicator           RRC-StateIndicator,
    utran-DRX-CycleLengthCoeff  UTRAN-DRX-CycleLengthCoefficient  OPTIONAL,
-- Core network IEs
  cn-InformationInfo           CN-InformationInfo-r6          OPTIONAL,
-- UTRAN mobility IEs
  ura-Identity                 URA-Identity                 OPTIONAL,
-- Radio bearer IEs
  dl-CounterSynchronisationInfo DL-CounterSynchronisationInfo-r5  OPTIONAL,
-- Physical channel IEs
  frequencyInfo                FrequencyInfo                OPTIONAL,
  maxAllowedUL-TX-Power        MaxAllowedUL-TX-Power        OPTIONAL,
  ul-DPCH-Info                 UL-DPCH-Info-r6             OPTIONAL,
  ul-EDCH-Information           UL-EDCH-Information-r6       OPTIONAL,
  dl-HSPDSCH-Information        DL-HSPDSCH-Information-r6     OPTIONAL,
  dl-CommonInformation          DL-CommonInformation-r6       OPTIONAL,
  dl-InformationPerRL-List      DL-InformationPerRL-List-r6   OPTIONAL,
-- MBMS IEs
  mbms-PL-ServiceRestrictInfo  MBMS-PL-ServiceRestrictInfo-r6  OPTIONAL
}

PhysicalChannelReconfiguration-v690ext-IEs ::= SEQUENCE {
-- User Equipment IEs
  delayRestrictionFlag         DelayRestrictionFlag          OPTIONAL,
-- Core network IEs
  primary-plmn-Identity         PLMN-Identity                 OPTIONAL,
-- Physical channel IEs
  -- The IE harq-Preamble-Mode should not be used in the r3 and r4 versions of the message
  -- If included in the r3 or r4 version of the message, the UE should ignore the IE
  harq-Preamble-Mode           HARQ-Preamble-Mode            OPTIONAL,
  beaconPLEst                   BEACON-PL-Est                 OPTIONAL,
  postVerificationPeriod        ENUMERATED { true }           OPTIONAL,
  dhs-sync                       DHS-Sync                       OPTIONAL,
  timingMaintainedSynchInd      TimingMaintainedSynchInd      OPTIONAL,
-- MBMS IEs
  mbms-PL-ServiceRestrictInfo  MBMS-PL-ServiceRestrictInfo-r6  OPTIONAL
}

PhysicalChannelReconfiguration-v6b0ext-IEs ::= SEQUENCE {
-- Physical channel IEs
  dl-InformationPerRL-List-v6b0ext  DL-InformationPerRL-List-v6b0ext  OPTIONAL
}

PhysicalChannelReconfiguration-r7-IEs ::= SEQUENCE {
-- User equipment IEs
  integrityProtectionModeInfo     IntegrityProtectionModeInfo-r7     OPTIONAL,
  cipheringModeInfo               CipheringModeInfo-r7               OPTIONAL,
  activationTime                   ActivationTime                       OPTIONAL,
  delayRestrictionFlag             DelayRestrictionFlag                 OPTIONAL,
  new-U-RNTI                       U-RNTI                               OPTIONAL,
  new-C-RNTI                       C-RNTI                               OPTIONAL,
  -- The IE "new-DSCH-RNTI" should not be included in FDD mode,
  -- and if received the UE behaviour is unspecified
  new-DSCH-RNTI                   DSCH-RNTI                           OPTIONAL,
  new-H-RNTI                       H-RNTI                               OPTIONAL,
  newPrimary-E-RNTI               E-RNTI                               OPTIONAL,
  newSecondary-E-RNTI             E-RNTI                               OPTIONAL,
  rrc-StateIndicator              RRC-StateIndicator,
  ueMobilityStateIndicator         High-MobilityDetected              OPTIONAL,
  utran-DRX-CycleLengthCoeff       UTRAN-DRX-CycleLengthCoefficient-r7  OPTIONAL,
-- Core network IEs
  cn-InformationInfo           CN-InformationInfo-r6          OPTIONAL,
-- UTRAN mobility IEs
  ura-Identity                 URA-Identity                 OPTIONAL,
  supportForChangeOfUE-Capability BOOLEAN                             OPTIONAL,
  responseToChangeOfUE-Capability ENUMERATED { true }           OPTIONAL,
-- Radio bearer IEs
  dl-CounterSynchronisationInfo DL-CounterSynchronisationInfo-r5  OPTIONAL,
-- Physical channel IEs
  frequencyInfo                FrequencyInfo                OPTIONAL,
  multi-frequencyInfo           Multi-frequencyInfo-LCR-r7       OPTIONAL,
  dtx-drx-TimingInfo            DTX-DRX-TimingInfo-r7           OPTIONAL,
  dtx-drx-Info                  DTX-DRX-Info-r7                OPTIONAL,
  hs-scch-LessInfo              HS-SCCH-LessInfo-r7             OPTIONAL,
  mimoParameters                MIMO-Parameters-r7             OPTIONAL,
  maxAllowedUL-TX-Power        MaxAllowedUL-TX-Power          OPTIONAL,
  ul-DPCH-Info                 UL-DPCH-Info-r7                OPTIONAL,
  ul-EDCH-Information           UL-EDCH-Information-r7          OPTIONAL,

```



```

        dl-HSPDSCH-Information          DL-HSPDSCH-Information-r7          OPTIONAL,
        dl-CommonInformation            DL-CommonInformation-r7          OPTIONAL,
        dl-InformationPerRL-List        DL-InformationPerRL-List-r7     OPTIONAL,
    -- MBMS IEs
        mbms-PL-ServiceRestrictInfo     MBMS-PL-ServiceRestrictInfo-r6  OPTIONAL
    }

PhysicalChannelReconfiguration-v770ext-IEs ::= SEQUENCE {
    -- User equipment IEs
        ueMobilityStateIndicator        High-MobilityDetected           OPTIONAL
    }

PhysicalChannelReconfiguration-v780ext-IEs ::= SEQUENCE {
    -- Transport channel IEs
        harqInfo                        HARQ-Info-r7                   OPTIONAL,
    -- Physical channel IEs
        hs-DSCH-TBSizeTable             HS-DSCH-TBSizeTable           OPTIONAL
    }

PhysicalChannelReconfiguration-v7d0ext-IEs ::= SEQUENCE {
    -- Physical channel IEs
        ul-EDCH-Information             UL-EDCH-Information-ext       OPTIONAL
    }

PhysicalChannelReconfiguration-v7f0ext-IEs ::= SEQUENCE {
    -- Physical channel IEs
        mimoParameters                  MIMO-Parameters-v7f0ext       OPTIONAL
    }

PhysicalChannelReconfiguration-v7g0ext-IEs ::= SEQUENCE {
    -- Physical channel IEs
        mimoParameters                  MIMO-Parameters-v7g0ext       OPTIONAL
    }

PhysicalChannelReconfiguration-r8-IEs ::= SEQUENCE {
    -- User equipment IEs
        integrityProtectionModeInfo     IntegrityProtectionModeInfo-r7  OPTIONAL,
        cipheringModeInfo               CipheringModeInfo-r7           OPTIONAL,
        activationTime                  ActivationTime                   OPTIONAL,
        delayRestrictionFlag             DelayRestrictionFlag           OPTIONAL,
        new-U-RNTI                       U-RNTI                         OPTIONAL,
        new-C-RNTI                       C-RNTI                         OPTIONAL,
        -- The IE "new-DSCH-RNTI" should not be included in FDD mode,
        -- and if received the UE behaviour is unspecified
        new-DSCH-RNTI                   DSCH-RNTI                       OPTIONAL,
        new-H-RNTI                       H-RNTI                         OPTIONAL,
        newPrimary-E-RNTI                E-RNTI                         OPTIONAL,
        newSecondary-E-RNTI              E-RNTI                         OPTIONAL,
        rrc-StateIndicator               RRC-StateIndicator,
        ueMobilityStateIndicator         High-MobilityDetected         OPTIONAL,
        utran-DRX-CycleLengthCoeff      UTRAN-DRX-CycleLengthCoefficient-r7  OPTIONAL,
    -- Core network IEs
        cn-InformationInfo               CN-InformationInfo-r6         OPTIONAL,
    -- UTRAN mobility IEs
        ura-Identity                     URA-Identity                   OPTIONAL,
        supportForChangeOfUE-Capability  BOOLEAN                        OPTIONAL,
        responseToChangeOfUE-Capability  ENUMERATED { true }          OPTIONAL,
    -- Radio bearer IEs
        dl-CounterSynchronisationInfo    DL-CounterSynchronisationInfo-r5  OPTIONAL,
    -- Transport channel IEs
        harqInfo                        HARQ-Info-r7                   OPTIONAL,
    -- Physical channel IEs
        frequencyInfo                   FrequencyInfo                   OPTIONAL,
        multi-frequencyInfo              Multi-frequencyInfo-LCR-r7     OPTIONAL,
        dtx-drx-TimingInfo               DTX-DRX-TimingInfo-r7         OPTIONAL,
        dtx-drx-Info                     DTX-DRX-Info-r7               OPTIONAL,
        hs-scch-LessInfo                 HS-SCCH-LessInfo-r7           OPTIONAL,
        mimoParameters                   MIMO-Parameters-r8            OPTIONAL,
        maxAllowedUL-TX-Power            MaxAllowedUL-TX-Power         OPTIONAL,
        ul-DPCH-Info                     UL-DPCH-Info-r7               OPTIONAL,
        ul-EDCH-Information               UL-EDCH-Information-r8        OPTIONAL,
        dl-HSPDSCH-Information            DL-HSPDSCH-Information-r8     OPTIONAL,
        dl-CommonInformation              DL-CommonInformation-r8       OPTIONAL,
        dl-InformationPerRL-List          DL-InformationPerRL-List-r8   OPTIONAL,
        dl-SecondaryCellInfoFDD           DL-SecondaryCellInfoFDD       OPTIONAL,
        controlChannelDRXInfo-TDD128     ControlChannelDRXInfo-TDD128-r8  OPTIONAL,
        sps-Information-TDD128           SPS-Information-TDD128-r8     OPTIONAL,
    -- MBMS IEs

```

```

    mbms-PL-ServiceRestrictInfo      MBMS-PL-ServiceRestrictInfo-r6      OPTIONAL
  }
PhysicalChannelReconfiguration-v890ext-IEs ::= SEQUENCE {
  -- Physical channel IEs
    dl-SecondaryCellInfoFDD-v890ext    DL-SecondaryCellInfoFDD-v890ext    OPTIONAL,
    dl-HSPDSCH-Information              DL-HSPDSCH-Information-r8-ext      OPTIONAL
  }
PhysicalChannelReconfiguration-v8a0ext-IEs ::= SEQUENCE {
  -- Physical channel IEs
    dl-HSPDSCH-Information              DL-HSPDSCH-Information-r8-ext2     OPTIONAL
  }
PhysicalChannelReconfiguration-r9-IEs ::= SEQUENCE {
  -- User equipment IEs
    integrityProtectionModeInfo        IntegrityProtectionModeInfo-r7      OPTIONAL,
    cipheringModeInfo                  CipheringModeInfo-r7                OPTIONAL,
    activationTime                      ActivationTime                        OPTIONAL,
    delayRestrictionFlag                DelayRestrictionFlag                OPTIONAL,
    new-U-RNTI                          U-RNTI                              OPTIONAL,
    new-C-RNTI                          C-RNTI                              OPTIONAL,
    -- The IE "new-DSCH-RNTI" should not be included in FDD mode,
    -- and if received the UE behaviour is unspecified
    new-DSCH-RNTI                      DSCH-RNTI                           OPTIONAL,
    new-H-RNTI                          H-RNTI                              OPTIONAL,
    newPrimary-E-RNTI                  E-RNTI                              OPTIONAL,
    newSecondary-E-RNTI                E-RNTI                              OPTIONAL,
    rrc-StateIndicator                 RRC-StateIndicator,
    ueMobilityStateIndicator            High-MobilityDetected               OPTIONAL,
    utran-DRX-CycleLengthCoeff          UTRAN-DRX-CycleLengthCoefficient-r7 OPTIONAL,
  -- Core network IEs
    cn-InformationInfo                  CN-InformationInfo-r6               OPTIONAL,
  -- UTRAN mobility IEs
    ura-Identity                        URA-Identity                        OPTIONAL,
    supportForChangeOfUE-Capability     BOOLEAN                             OPTIONAL,
    responseToChangeOfUE-Capability     ENUMERATED { true }                 OPTIONAL,
  -- Radio bearer IEs
    dl-CounterSynchronisationInfo       DL-CounterSynchronisationInfo-r5    OPTIONAL,
  -- Transport channel IEs
    harqInfo                             HARQ-Info-r7                        OPTIONAL,
  -- Physical channel IEs
    frequencyInfo                       FrequencyInfo                         OPTIONAL,
    multi-frequencyInfo                 Multi-frequencyInfo-LCR-r7          OPTIONAL,
    dtx-drx-TimingInfo                  DTX-DRX-TimingInfo-r7              OPTIONAL,
    dtx-drx-Info                         DTX-DRX-Info-r7                    OPTIONAL,
    hs-scch-LessInfo                    HS-SCCH-LessInfo-r7                OPTIONAL,
    mimoParameters                      MIMO-Parameters-r9                 OPTIONAL,
    controlChannelDRXInfo-TDD128         ControlChannelDRXInfo-TDD128-r8     OPTIONAL,
    sps-Information-TDD128               SPS-Information-TDD128-r8          OPTIONAL,
    maxAllowedUL-TX-Power                MaxAllowedUL-TX-Power               OPTIONAL,
    ul-DPCH-Info                         UL-DPCH-Info-r7                     OPTIONAL,
    ul-EDCH-Information                 UL-EDCH-Information-r9              OPTIONAL,
    ul-SecondaryCellInfoFDD              UL-SecondaryCellInfoFDD             OPTIONAL,
    dl-HSPDSCH-Information               DL-HSPDSCH-Information-r9          OPTIONAL,
    dl-CommonInformation                 DL-CommonInformation-r8             OPTIONAL,
    dl-InformationPerRL-List             DL-InformationPerRL-List-r8         OPTIONAL,
    dl-SecondaryCellInfoFDD              DL-SecondaryCellInfoFDD-r9         OPTIONAL,
  -- MBMS IEs
    mbms-PL-ServiceRestrictInfo         MBMS-PL-ServiceRestrictInfo-r6     OPTIONAL,
  -- Measurement IEs for LCR
    cellDCHMeasOccasionInfo-TDD128      CellDCHMeasOccasionInfo-TDD128-r9  OPTIONAL
  }
PhysicalChannelReconfiguration-v950ext-IEs ::= SEQUENCE {
  -- Physical channel IEs
    secondaryCellMimoParameters          SecondaryCellMIMOparametersFDD-v950ext OPTIONAL
  }
PhysicalChannelReconfiguration-r10-IEs ::= SEQUENCE {
  -- User equipment IEs
    integrityProtectionModeInfo        IntegrityProtectionModeInfo-r7      OPTIONAL,
    cipheringModeInfo                  CipheringModeInfo-r7                OPTIONAL,
    activationTime                      ActivationTime                        OPTIONAL,
    delayRestrictionFlag                DelayRestrictionFlag                OPTIONAL,
    new-U-RNTI                          U-RNTI                              OPTIONAL,
    new-C-RNTI                          C-RNTI                              OPTIONAL,
    -- The IE "new-DSCH-RNTI" should not be included in FDD mode,

```

```

-- and if received the UE behaviour is unspecified
new-DSCH-RNTI          DSCH-RNTI          OPTIONAL,
new-H-RNTI             H-RNTI            OPTIONAL,
newPrimary-E-RNTI     E-RNTI            OPTIONAL,
newSecondary-E-RNTI   E-RNTI            OPTIONAL,
rrc-StateIndicator    RRC-StateIndicator,
ueMobilityStateIndicator High-MobilityDetected OPTIONAL,
utran-DRX-CycleLengthCoeff UTRAN-DRX-CycleLengthCoefficient-r7 OPTIONAL,
-- Core network IEs
cn-InformationInfo    CN-InformationInfo-r6          OPTIONAL,
-- UTRAN mobility IEs
ura-Identity         URA-Identity          OPTIONAL,
supportForChangeOfUE-Capability BOOLEAN          OPTIONAL,
responseToChangeOfUE-Capability ENUMERATED { true } OPTIONAL,
-- Radio bearer IEs
dl-CounterSynchronisationInfo DL-CounterSynchronisationInfo-r5 OPTIONAL,
-- Transport channel IEs
harqInfo             HARQ-Info-r7          OPTIONAL,
-- Physical channel IEs
frequencyInfo        FrequencyInfo         OPTIONAL,
multi-frequencyInfo  Multi-frequencyInfo-LCR-r7 OPTIONAL,
dtx-drx-TimingInfo   DTX-DRX-TimingInfo-r7          OPTIONAL,
dtx-drx-Info         DTX-DRX-Info-r7          OPTIONAL,
hs-scch-LessInfo     HS-SCCH-LessInfo-r7        OPTIONAL,
mimoParameters       MIMO-Parameters-r9        OPTIONAL,
controlChannelDRXInfo-TDD128 ControlChannelDRXInfo-TDD128-r8 OPTIONAL,
sps-Information-TDD128 SPS-Information-TDD128-r8          OPTIONAL,
maxAllowedUL-TX-Power MaxAllowedUL-TX-Power          OPTIONAL,
ul-DPCH-Info         UL-DPCH-Info-r7          OPTIONAL,
ul-EDCH-Information UL-EDCH-Information-r9        OPTIONAL,
ul-SecondaryCellInfoFDD UL-SecondaryCellInfoFDD          OPTIONAL,
ul-MulticarrierEDCHInfo-TDD128 UL-MulticarrierEDCHInfo-TDD128 OPTIONAL,
dl-HSPDSCH-Information DL-HSPDSCH-Information-r9        OPTIONAL,
dl-CommonInformation DL-CommonInformation-r10        OPTIONAL,
dl-InformationPerRL-List DL-InformationPerRL-List-r8        OPTIONAL,
dl-SecondaryCellInfoFDD DL-SecondaryCellInfoFDD-r10        OPTIONAL,
additionalDLSecCellInfoListFDD AdditionalDLSecCellInfoListFDD    OPTIONAL,
mu-MIMO-Info-TDD128   MU-MIMO-Info-TDD128          OPTIONAL,
-- MBMS IEs
mbms-PL-ServiceRestrictInfo MBMS-PL-ServiceRestrictInfo-r6 OPTIONAL,
-- Measurement IEs for LCR
cellDCHMeasOccasionInfo-TDD128 CellDCHMeasOccasionInfo-TDD128-r9 OPTIONAL
}

PhysicalChannelReconfiguration-vb50ext-IEs ::= SEQUENCE {
    ulOLTDInfoFDD          UL-OLTD-InfoFDD          OPTIONAL
}

PhysicalChannelReconfiguration-r11-IEs ::= SEQUENCE {
-- User equipment IEs
integrityProtectionModeInfo IntegrityProtectionModeInfo-r7 OPTIONAL,
cipheringModeInfo          CipheringModeInfo-r7          OPTIONAL,
activationTime             ActivationTime                OPTIONAL,
delayRestrictionFlag       DelayRestrictionFlag          OPTIONAL,
new-U-RNTI                 U-RNTI                        OPTIONAL,
new-C-RNTI                 C-RNTI                        OPTIONAL,
-- The IE "new-DSCH-RNTI" should not be included in FDD mode,
-- and if received the UE behaviour is unspecified
new-DSCH-RNTI             DSCH-RNTI          OPTIONAL,
new-H-RNTI                H-RNTI            OPTIONAL,
newPrimary-E-RNTI         E-RNTI            OPTIONAL,
newSecondary-E-RNTI       E-RNTI            OPTIONAL,
rrc-StateIndicator        RRC-StateIndicator,
ueMobilityStateIndicator  High-MobilityDetected OPTIONAL,
utran-DRX-CycleLengthCoeff UTRAN-DRX-CycleLengthCoefficient-r7 OPTIONAL,
-- Core network IEs
cn-InformationInfo        CN-InformationInfo-r6          OPTIONAL,
-- UTRAN mobility IEs
ura-Identity              URA-Identity          OPTIONAL,
supportForChangeOfUE-Capability BOOLEAN          OPTIONAL,
responseToChangeOfUE-Capability ENUMERATED { true } OPTIONAL,
-- Radio bearer IEs
dl-CounterSynchronisationInfo DL-CounterSynchronisationInfo-r5 OPTIONAL,
-- Transport channel IEs
harqInfo                  HARQ-Info-r11          OPTIONAL,
-- Physical channel IEs
frequencyInfo             FrequencyInfo         OPTIONAL,
multi-frequencyInfo       Multi-frequencyInfo-LCR-r7 OPTIONAL,

```

```

    dtx-drx-TimingInfo          DTX-DRX-TimingInfo-r7          OPTIONAL,
    dtx-drx-Info                DTX-DRX-Info-r7                OPTIONAL,
    hs-scch-LessInfo            HS-SCCH-LessInfo-r7            OPTIONAL,
    mimoParameters              MIMO-Parameters-r9            OPTIONAL,
    mimo4x4Parameters           MIMO4x4-Parameters           OPTIONAL,
    controlChannelDRXInfo-TDD128 ControlChannelDRXInfo-TDD128-r8 OPTIONAL,
    sps-Information-TDD128       SPS-Information-TDD128-r8      OPTIONAL,
    maxAllowedUL-TX-Power        MaxAllowedUL-TX-Power         OPTIONAL,
    ul-DPCH-Info                UL-DPCH-Info-r11              OPTIONAL,
    ul-EDCH-Information          UL-EDCH-Information-r11       OPTIONAL,
    ul-SecondaryCellInfoFDD      UL-SecondaryCellInfoFDD       OPTIONAL,
    ul-MulticarrierEDCHInfo-TDD128 UL-MulticarrierEDCHInfo-TDD128 OPTIONAL,
    ul-CLTD-InfoFDD             UL-CLTD-InfoFDD              OPTIONAL,
    ul-OLTD-InfoFDD             UL-OLTD-InfoFDD              OPTIONAL,
    dl-HSPDSCH-Information       DL-HSPDSCH-Information-r11    OPTIONAL,
    dl-CommonInformation         DL-CommonInformation-r11      OPTIONAL,
    dl-InformationPerRL-List     DL-InformationPerRL-List-r11  OPTIONAL,
    dl-SecondaryCellInfoFDD      DL-SecondaryCellInfoFDD-r11  OPTIONAL,
    additionalDLSecCellInfoListFDD AdditionalDLSecCellInfoListFDD-r11 OPTIONAL,
    additionalDLSecCellInfoListFDD2 AdditionalDLSecCellInfoListFDD2 OPTIONAL,
    commonERGCHInfoFDD          CommonERGCHInfoFDD            OPTIONAL,
    mu-MIMO-Info-TDD128         MU-MIMO-Info-TDD128           OPTIONAL,
-- MBMS IEs
    mbms-PL-ServiceRestrictInfo MBMS-PL-ServiceRestrictInfo-r6 OPTIONAL,
-- Measurement IEs for LCR
    cellDCHMeasOccasionInfo-TDD128 CellDCHMeasOccasionInfo-TDD128-r9 OPTIONAL
}

PhysicalChannelReconfiguration-r12-IEs ::= SEQUENCE {
-- User equipment IEs
    integrityProtectionModeInfo IntegrityProtectionModeInfo-r7 OPTIONAL,
    cipheringModeInfo          CipheringModeInfo-r7          OPTIONAL,
    activationTime              ActivationTime                 OPTIONAL,
    delayRestrictionFlag        DelayRestrictionFlag          OPTIONAL,
    new-U-RNTI                  U-RNTI                       OPTIONAL,
    new-C-RNTI                  C-RNTI                       OPTIONAL,
    -- The IE "new-DSCH-RNTI" should not be included in FDD mode,
    -- and if received the UE behaviour is unspecified
    new-DSCH-RNTI              DSCH-RNTI                    OPTIONAL,
    new-H-RNTI                  H-RNTI                       OPTIONAL,
    newPrimary-E-RNTI           E-RNTI                       OPTIONAL,
    newSecondary-E-RNTI         E-RNTI                       OPTIONAL,
    rrc-StateIndicator          RRC-StateIndicator,
    ueMobilityStateIndicator     High-MobilityDetected         OPTIONAL,
    utran-DRX-CycleLengthCoeff  UTRAN-DRX-CycleLengthCoefficient-r7 OPTIONAL,
-- Core network IEs
    cn-InformationInfo          CN-InformationInfo-r6         OPTIONAL,
-- UTRAN mobility IEs
    ura-Identity                URA-Identity                 OPTIONAL,
    supportForChangeOfUE-Capability BOOLEAN                          OPTIONAL,
    responseToChangeOfUE-Capability ENUMERATED { true }              OPTIONAL,
-- Radio bearer IEs
    dl-CounterSynchronisationInfo DL-CounterSynchronisationInfo-r5 OPTIONAL,
-- Transport channel IEs
    harqInfo                    HARQ-Info-r11                 OPTIONAL,
-- Physical channel IEs
    frequencyInfo               FrequencyInfo                 OPTIONAL,
    multi-frequencyInfo          Multi-frequencyInfo-LCR-r7    OPTIONAL,
    dtx-drx-TimingInfo          DTX-DRX-TimingInfo-r7        OPTIONAL,
    dtx-drx-Info                DTX-DRX-Info-r12            OPTIONAL,
    hs-scch-LessInfo            HS-SCCH-LessInfo-r7          OPTIONAL,
    mimoParameters              MIMO-Parameters-r9            OPTIONAL,
    mimo4x4Parameters           MIMO4x4-Parameters           OPTIONAL,
    dch-Enhancements-Info-FDD   DCH-Enhancements-Info-FDD    OPTIONAL,
    controlChannelDRXInfo-TDD128 ControlChannelDRXInfo-TDD128-r8 OPTIONAL,
    sps-Information-TDD128       SPS-Information-TDD128-r8      OPTIONAL,
    maxAllowedUL-TX-Power        MaxAllowedUL-TX-Power         OPTIONAL,
    ul-DPCH-Info                UL-DPCH-Info-r11              OPTIONAL,
    ul-EDCH-Information          UL-EDCH-Information-r11       OPTIONAL,
    ul-SecondaryCellInfoFDD      UL-SecondaryCellInfoFDD-r12    OPTIONAL,
    ul-MulticarrierEDCHInfo-TDD128 UL-MulticarrierEDCHInfo-TDD128 OPTIONAL,
    ul-CLTD-InfoFDD             UL-CLTD-InfoFDD              OPTIONAL,
    ul-OLTD-InfoFDD             UL-OLTD-InfoFDD              OPTIONAL,
    dl-HSPDSCH-Information       DL-HSPDSCH-Information-r12    OPTIONAL,
    dl-CommonInformation         DL-CommonInformation-r12      OPTIONAL,
    dl-InformationPerRL-List     DL-InformationPerRL-List-r12  OPTIONAL,
    dl-SecondaryCellInfoFDD      DL-SecondaryCellInfoFDD-r11    OPTIONAL,
    additionalDLSecCellInfoListFDD AdditionalDLSecCellInfoListFDD-r11 OPTIONAL,

```

```

    additionalDLSecCellInfoListFDD2 AdditionalDLSecCellInfoListFDD2    OPTIONAL,
    commonERGCHInfoFDD              CommonERGCHInfoFDD              OPTIONAL,
    dPCCH2InfoFDD                    DPCCCH2InfoFDD                OPTIONAL,
    mu-MIMO-Info-TDD128              MU-MIMO-Info-TDD128          OPTIONAL,
    nonrectResAllocInd-TDD128        Non-rectResAllocInd-TDD128   OPTIONAL,
    nonrectResSpecTSset-TDD128       Non-rectResSpecTSset-TDD128  OPTIONAL,
-- MBMS IEs
    mbms-PL-ServiceRestrictInfo      MBMS-PL-ServiceRestrictInfo-r6  OPTIONAL,
-- Measurement IEs for LCR
    cellDCHMeasOccasionInfo-TDD128    CellDCHMeasOccasionInfo-TDD128-r9  OPTIONAL
}

-- *****
--
-- PHYSICAL CHANNEL RECONFIGURATION COMPLETE
--
-- *****

PhysicalChannelReconfigurationComplete ::= SEQUENCE {
-- User equipment IEs
    rrc-TransactionIdentifier          RRC-TransactionIdentifier,
    ul-IntegProtActivationInfo          IntegrityProtActivationInfo      OPTIONAL,
-- TABULAR: UL-TimingAdvance is applicable for TDD mode only.
    ul-TimingAdvance                   UL-TimingAdvance                OPTIONAL,
-- Radio bearer IEs
    count-C-ActivationTime              ActivationTime                    OPTIONAL,
-- dummy is not used in this version of the specification and
-- it should be ignored by the receiver.
    dummy                               RB-ActivationTimeInfoList        OPTIONAL,
    ul-CounterSynchronisationInfo        UL-CounterSynchronisationInfo    OPTIONAL,
    laterNonCriticalExtensions            SEQUENCE {
-- Container for additional R99 extensions
        physicalChannelReconfigurationComplete-r3-add-ext    BIT STRING    OPTIONAL,
        v770NonCriticalExtensions                             SEQUENCE {
            physicalChannelReconfigurationComplete-v770ext
            PhysicalChannelReconfigurationComplete-v770ext-IEs,
            nonCriticalExtensions                             SEQUENCE {}    OPTIONAL
        }    OPTIONAL
    }    OPTIONAL
}

PhysicalChannelReconfigurationComplete-v770ext-IEs ::= SEQUENCE {
-- TABULAR: EXT-UL-TimingAdvance is applicable for TDD mode only.
    ext-UL-TimingAdvance                 EXT-UL-TimingAdvance            OPTIONAL,
    deferredMeasurementControlReading      ENUMERATED { true }             OPTIONAL
}

-- *****
--
-- PHYSICAL CHANNEL RECONFIGURATION FAILURE
--
-- *****

PhysicalChannelReconfigurationFailure ::= SEQUENCE {
-- User equipment IEs
    rrc-TransactionIdentifier          RRC-TransactionIdentifier        OPTIONAL,
    failureCause                       FailureCauseWithProtErr,
    laterNonCriticalExtensions            SEQUENCE {
-- Container for additional R99 extensions
        physicalChannelReconfigurationFailure-r3-add-ext    BIT STRING    OPTIONAL,
        nonCriticalExtensions                             SEQUENCE {}    OPTIONAL
    }    OPTIONAL
}

-- *****
--
-- PHYSICAL SHARED CHANNEL ALLOCATION (TDD only)
--
-- *****

PhysicalSharedChannelAllocation ::= CHOICE {
    r3                                   SEQUENCE {
        physicalSharedChannelAllocation-r3
        PhysicalSharedChannelAllocation-r3-IEs,
        laterNonCriticalExtensions        SEQUENCE {
-- Container for additional R99 extensions
            physicalSharedChannelAllocation-r3-add-ext    BIT STRING    OPTIONAL,

```

```

        nonCriticalExtensions          SEQUENCE {} OPTIONAL
    } OPTIONAL
},
later-than-r3                          SEQUENCE {
    dsch-RNTI                          DSCH-RNTI                          OPTIONAL,
    rrc-TransactionIdentifier          RRC-TransactionIdentifier,
    criticalExtensions                 CHOICE {
        r4                             SEQUENCE {
            physicalSharedChannelAllocation-r4
            PhysicalSharedChannelAllocation-r4-IEs,
            v4d0NonCriticalExtensions  SEQUENCE {
                -- Container for adding non critical extensions after freezing REL-5
                physicalSharedChannelAllocation-r4-add-ext BIT STRING OPTIONAL,
                v690NonCriticalExtensions SEQUENCE {
                    physicalSharedChannelAllocation-v690ext
                    PhysicalSharedChannelAllocation-v690ext-IEs,
                    v770NonCriticalExtensions SEQUENCE {
                        physicalSharedChannelAllocation-v770ext
                        PhysicalSharedChannelAllocation-v770ext-IEs,
                        nonCriticalExtensions SEQUENCE {} OPTIONAL
                    } OPTIONAL
                } OPTIONAL
            } OPTIONAL
        } OPTIONAL
    },
    criticalExtensions                 SEQUENCE {}
}
}

PhysicalSharedChannelAllocation-r3-IEs ::= SEQUENCE {
    -- TABULAR: Integrity protection shall not be performed on this message.
    -- User equipment IES
    dsch-RNTI                          DSCH-RNTI                          OPTIONAL,
    rrc-TransactionIdentifier          RRC-TransactionIdentifier,
    -- Physical channel IES
    ul-TimingAdvance                 UL-TimingAdvanceControl            OPTIONAL,
    pusch-CapacityAllocationInfo      PUSCH-CapacityAllocationInfo      OPTIONAL,
    pdsch-CapacityAllocationInfo      PDSCH-CapacityAllocationInfo      OPTIONAL,
    -- TABULAR: If confirmRequest is not present, the default value "No Confirm"
    -- shall be used as specified in 10.2.25.
    confirmRequest                    ENUMERATED {
        confirmPDSCH, confirmPUSCH } OPTIONAL,
    trafficVolumeReportRequest        INTEGER (0..255)                   OPTIONAL,
    iscpTimeslotList                  TimeslotList                       OPTIONAL,
    requestPCCPCHRSCP                 BOOLEAN
}

PhysicalSharedChannelAllocation-r4-IEs ::= SEQUENCE {
    -- TABULAR: Integrity protection shall not be performed on this message.
    -- Physical channel IES
    ul-TimingAdvance                 UL-TimingAdvanceControl-r4        OPTIONAL,
    pusch-CapacityAllocationInfo      PUSCH-CapacityAllocationInfo-r4  OPTIONAL,
    pdsch-CapacityAllocationInfo      PDSCH-CapacityAllocationInfo-r4  OPTIONAL,
    -- TABULAR: If confirmRequest is not present, the default value "No Confirm"
    -- shall be used as specified in 10.2.25.
    confirmRequest                    ENUMERATED {
        confirmPDSCH, confirmPUSCH } OPTIONAL,
    trafficVolumeReportRequest        INTEGER (0..255)                   OPTIONAL,
    iscpTimeslotList                  TimeslotList-r4                   OPTIONAL,
    requestPCCPCHRSCP                 BOOLEAN
}

PhysicalSharedChannelAllocation-v690ext-IEs ::= SEQUENCE {
    -- Physical Channel IES
    beaconPLEst                       BEACON-PL-Est                     OPTIONAL
}

PhysicalSharedChannelAllocation-v770ext-IEs ::= SEQUENCE {
    ul-TimingAdvance                 UL-TimingAdvanceControl-r7        OPTIONAL,
    pusch-CapacityAllocationInfo      PUSCH-CapacityAllocationInfo-r7  OPTIONAL,
    pdsch-CapacityAllocationInfo      PDSCH-CapacityAllocationInfo-r7  OPTIONAL
}

-- *****
--
-- PUSCH CAPACITY REQUEST (TDD only)
--
-- *****

```

```

PUSCHCapacityRequest ::= SEQUENCE {
  -- User equipment IEs
  dsch-RNTI                DSCH-RNTI                OPTIONAL,
  -- Measurement IEs
  trafficVolume            TrafficVolumeMeasuredResultsList  OPTIONAL,
  timeslotListWithISCP    TimeslotListWithISCP    OPTIONAL,
  primaryCCPCH-RSCP       PrimaryCCPCH-RSCP          OPTIONAL,
  allocationConfirmation   CHOICE {
    pdschConfirmation      PDSCH-Identity,
    puschConfirmation      PUSCH-Identity
  } OPTIONAL,
  protocolErrorIndicator   ProtocolErrorIndicatorWithMoreInfo,
  laterNonCriticalExtensions SEQUENCE {
    -- Container for additional R99 extensions
    puschCapacityRequest-r3-add-ext BIT STRING          OPTIONAL,
    v590NonCriticalExtensions SEQUENCE {
      puschCapacityRequest-v590ext PUSCHCapacityRequest-v590ext,
      nonCriticalExtensions        SEQUENCE {} OPTIONAL
    } OPTIONAL
  } OPTIONAL
}

PUSCHCapacityRequest-v590ext ::= SEQUENCE {
  primaryCCPCH-RSCP-delta DeltaRSCP          OPTIONAL
}

-- *****
--
-- RADIO BEARER RECONFIGURATION
--
-- *****

RadioBearerReconfiguration ::= CHOICE {
  r3 SEQUENCE {
    radioBearerReconfiguration-r3 RadioBearerReconfiguration-r3-IEs,
    -- Prefix "v3ao" is used (in one instance) to keep alignment with R99
    v3aoNonCriticalExtensions SEQUENCE {
      radioBearerReconfiguration-v3a0ext RadioBearerReconfiguration-v3a0ext,
      laterNonCriticalExtensions SEQUENCE {
        -- Container for additional R99 extensions
        radioBearerReconfiguration-r3-add-ext BIT STRING          OPTIONAL,
        v4b0NonCriticalExtensions SEQUENCE {
          radioBearerReconfiguration-v4b0ext
            RadioBearerReconfiguration-v4b0ext-IEs,
          v590NonCriticalExtensions SEQUENCE {
            radioBearerReconfiguration-v590ext
              RadioBearerReconfiguration-v590ext-IEs,
            v5d0NonCriticalExtensitions SEQUENCE {
              radioBearerReconfiguration-v5d0ext
                RadioBearerReconfiguration-v5d0ext-IEs,
            v690NonCriticalExtensions SEQUENCE {
              radioBearerReconfiguration-v690ext
                RadioBearerReconfiguration-v690ext-IEs,
            v770NonCriticalExtensions SEQUENCE {
              radioBearerReconfiguration-v770ext
                RadioBearerReconfiguration-v770ext-IEs,
            nonCriticalExtensions SEQUENCE {} OPTIONAL
          } OPTIONAL
        } OPTIONAL
      } OPTIONAL
    } OPTIONAL
  } OPTIONAL
},
  later-than-r3 SEQUENCE {
    rrc-TransactionIdentifier RRC-TransactionIdentifier,
    criticalExtensions CHOICE {
      r4 SEQUENCE {
        radioBearerReconfiguration-r4 RadioBearerReconfiguration-r4-IEs,
        v4d0NonCriticalExtensions SEQUENCE {
          -- Container for adding non critical extensions after freezing REL-5
          radioBearerReconfiguration-r4-add-ext BIT STRING          OPTIONAL,
          v590NonCriticalExtensions SEQUENCE {
            radioBearerReconfiguration-v590ext
              RadioBearerReconfiguration-v590ext-IEs,
            v5d0NonCriticalExtensitions SEQUENCE {

```

```

        radioBearerReconfiguration-v5d0ext
        v690NonCriticalExtensions      RadioBearerReconfiguration-v5d0ext-IEs,
        radioBearerReconfiguration-v690ext
        v770NonCriticalExtensions      SEQUENCE {
        radioBearerReconfiguration-v770ext
        RadioBearerReconfiguration-v770ext-IEs,
        nonCriticalExtensions          SEQUENCE {}      OPTIONAL
    }      OPTIONAL
    }      OPTIONAL
    }      OPTIONAL
    }      OPTIONAL
},
criticalExtensions                    CHOICE {
    r5                                  SEQUENCE {
        radioBearerReconfiguration-r5      RadioBearerReconfiguration-r5-IEs,
        -- Container for adding non critical extensions after freezing REL-6
        radioBearerReconfiguration-r5-add-ext BIT STRING      OPTIONAL,
        v5d0NonCriticalExtensions          SEQUENCE {
            radioBearerReconfiguration-v5d0ext RadioBearerReconfiguration-v5d0ext-IEs,
            v690NonCriticalExtensions        SEQUENCE {
                radioBearerReconfiguration-v690ext
                RadioBearerReconfiguration-v690ext-IEs,
            }      SEQUENCE {
            v770NonCriticalExtensions        SEQUENCE {
                radioBearerReconfiguration-v770ext
                RadioBearerReconfiguration-v770ext-IEs,
            }      SEQUENCE {
            nonCriticalExtensions            SEQUENCE {}      OPTIONAL
        }      OPTIONAL
    }      OPTIONAL
    }      OPTIONAL
},
criticalExtensions                    CHOICE {
    r6                                  SEQUENCE {
        radioBearerReconfiguration-r6      RadioBearerReconfiguration-r6-IEs,
        -- Container for adding non critical extensions after freezing REL-7
        radioBearerReconfiguration-r6-add-ext BIT STRING      OPTIONAL,
        v6b0NonCriticalExtensions          SEQUENCE {
            radioBearerReconfiguration-v6b0ext
            RadioBearerReconfiguration-v6b0ext-IEs,
        }      SEQUENCE {
        v6f0NonCriticalExtensions          SEQUENCE {
            radioBearerRconfiguration-v6f0ext
            RadioBearerReconfiguration-v6f0ext-IEs,
        }      SEQUENCE {
        v770NonCriticalExtensions          SEQUENCE {
            radioBearerReconfiguration-v770ext
            RadioBearerReconfiguration-v770ext-IEs,
        }      SEQUENCE {
        nonCriticalExtensions              SEQUENCE {}      OPTIONAL
    }      OPTIONAL
    }      OPTIONAL
    }      OPTIONAL
},
criticalExtensions                    CHOICE {
    r7                                  SEQUENCE {
        radioBearerReconfiguration-r7      RadioBearerReconfiguration-r7-IEs,
        v780NonCriticalExtensions          SEQUENCE {
            radioBearerReconfiguration-v780ext
            RadioBearerReconfiguration-v780ext-IEs,
        }      SEQUENCE {
        v790NonCriticalExtensions          SEQUENCE {
            radioBearerReconfiguration-v790ext
            RadioBearerReconfiguration-v790ext-IEs,
        }      SEQUENCE {
        v7d0NonCriticalExtensions          SEQUENCE {
            radioBearerReconfiguration-v7d0ext
            RadioBearerReconfiguration-v7d0ext-IEs,
        }      SEQUENCE {
        v7f0NonCriticalExtensions          SEQUENCE {
            radioBearerReconfiguration-v7f0ext
            RadioBearerReconfiguration-v7f0ext-IEs,
        }      SEQUENCE {
        v7g0NonCriticalExtensions          SEQUENCE {
            radioBearerReconfiguration-v7g0ext
            RadioBearerReconfiguration-v7g0ext-IEs,
        }      SEQUENCE {
        nonCriticalExtensions              SEQUENCE {}      OPTIONAL
    }      OPTIONAL
    }      OPTIONAL
    }      OPTIONAL
    }      OPTIONAL
},
criticalExtensions                    CHOICE {

```



```

r8          SEQUENCE {
radioBearerReconfiguration-r8  RadioBearerReconfiguration-r8-IEs,
-- Container for adding non critical extensions after freezing REL-9
radioBearerReconfiguration-r8-add-ext  BIT STRING      OPTIONAL,
v7d0NonCriticalExtensions          SEQUENCE {
  radioBearerReconfiguration-v7d0ext
  RadioBearerReconfiguration-v7d0ext-IEs,
v7f0NonCriticalExtensions          SEQUENCE {
  radioBearerReconfiguration-v7f0ext
  RadioBearerReconfiguration-v7f0ext-IEs,
v890NonCriticalExtensions          SEQUENCE {
  radioBearerReconfiguration-v890ext
  RadioBearerReconfiguration-v890ext-IEs,
v7g0NonCriticalExtensions          SEQUENCE {
  radioBearerReconfiguration-v7g0ext
  RadioBearerReconfiguration-v7g0ext-IEs,
v8a0NonCriticalExtensions          SEQUENCE {
  radioBearerReconfiguration-v8a0ext
  RadioBearerReconfiguration-v8a0ext-IEs,
  nonCriticalExtensions          SEQUENCE {}
} OPTIONAL
} OPTIONAL
} OPTIONAL
} OPTIONAL
},
criticalExtensions          CHOICE {
r9          SEQUENCE {
  radioBearerReconfiguration-r9
  RadioBearerReconfiguration-r9-IEs,
-- Container for adding non critical extensions after
-- freezing REL-10
radioBearerReconfiguration-r9-add-ext  BIT STRING      OPTIONAL,
v950NonCriticalExtensions          SEQUENCE {
  radioBearerReconfiguration-v950ext
  RadioBearerReconfiguration-v950ext-IEs,
v9c0NonCriticalExtensions          SEQUENCE {
  radioBearerReconfiguration-v9c0ext
  RadioBearerReconfiguration-v9c0ext-IEs,
  nonCriticalExtensions          SEQUENCE {}      OPTIONAL
} OPTIONAL
} OPTIONAL
},
criticalExtensions          CHOICE {
r10         SEQUENCE {
  radioBearerReconfiguration-r10
  RadioBearerReconfiguration-r10-IEs,
-- Container for adding non critical extensions after
-- freezing REL-11
radioBearerReconfiguration-r10-add-ext  BIT STRING      OPTIONAL,
v9c0NonCriticalExtensions          SEQUENCE {
  radioBearerReconfiguration-v9c0ext
  RadioBearerReconfiguration-v9c0ext-IEs,
vaa0NonCriticalExtensions          SEQUENCE {
  radioBearerReconfiguration-vaa0ext
  RadioBearerReconfiguration-vaa0ext-IEs,
vb50NonCriticalExtensions          SEQUENCE {
  radioBearerReconfiguration-vb50ext
  RadioBearerReconfiguration-vb50ext-IEs,
  nonCriticalExtensions          SEQUENCE {}      OPTIONAL
} OPTIONAL
} OPTIONAL
},
criticalExtensions          CHOICE {
r11         SEQUENCE {
  radioBearerReconfiguration-r11
  RadioBearerReconfiguration-r11-IEs,
-- Container for adding non critical extensions after
-- freezing REL-12
radioBearerReconfiguration-r11-add-ext  BIT STRING      OPTIONAL,
  nonCriticalExtensions          SEQUENCE {}      OPTIONAL
},
criticalExtensions          CHOICE {

```



```

}

RadioBearerReconfiguration-v3a0ext ::= SEQUENCE {
  -- The IE "new-DSCH-RNTI" should not be included in FDD mode, and if received the UE behaviour
  -- is unspecified
  new-DSCH-RNTI          DSCH-RNTI          OPTIONAL
}

RadioBearerReconfiguration-v4b0ext-IEs ::= SEQUENCE {
  -- Physical channel IEs
  -- dummy is not used in this version of the specification, it should
  -- not be sent and if received it should be ignored.
  dummy                  SSDT-UL          OPTIONAL,
  -- The order of the RLs in IE cell-id-PerRL-List is the same as
  -- in IE DL-InformationPerRL-List included in this message
  cell-id-PerRL-List     CellIdentity-PerRL-List  OPTIONAL
}

RadioBearerReconfiguration-v590ext-IEs ::= SEQUENCE {
  -- Physical channel IEs
  dl-TPC-PowerOffsetPerRL-List  DL-TPC-PowerOffsetPerRL-List  OPTIONAL
}

RadioBearerReconfiguration-v5d0ext-IEs ::= SEQUENCE {
  --Radio Bearer IEs
  pdcp-ROHC-TargetMode          PDCP-ROHC-TargetMode          OPTIONAL
}

RadioBearerReconfiguration-r4-IEs ::= SEQUENCE {
  -- User equipment IEs
  integrityProtectionModeInfo    IntegrityProtectionModeInfo    OPTIONAL,
  cipheringModeInfo              CipheringModeInfo                OPTIONAL,
  activationTime                  ActivationTime                    OPTIONAL,
  new-U-RNTI                      U-RNTI                          OPTIONAL,
  new-C-RNTI                      C-RNTI                          OPTIONAL,
  -- The IE "new-DSCH-RNTI" should not be included in FDD mode, and if received
  -- the UE behaviour is unspecified
  new-DSCH-RNTI                  DSCH-RNTI                        OPTIONAL,
  rrc-StateIndicator              RRC-StateIndicator,            OPTIONAL,
  utran-DRX-CycleLengthCoeff      UTRAN-DRX-CycleLengthCoefficient  OPTIONAL,
  -- Core network IEs
  cn-InformationInfo              CN-InformationInfo              OPTIONAL,
  -- UTRAN mobility IEs
  ura-Identity                    URA-Identity                    OPTIONAL,
  -- Radio bearer IEs
  rab-InformationReconfigList     RAB-InformationReconfigList     OPTIONAL,
  rb-InformationReconfigList-r4   RB-InformationReconfigList-r4   OPTIONAL,
  rb-InformationAffectedList      RB-InformationAffectedList      OPTIONAL,
  -- Transport channel IEs
  ul-CommonTransChInfo            UL-CommonTransChInfo-r4        OPTIONAL,
  ul-deletedTransChInfoList       UL-DeletedTransChInfoList       OPTIONAL,
  ul-AddReconfTransChInfoList     UL-AddReconfTransChInfoList     OPTIONAL,
  -- 'dummy', 'dummy1' and 'dummy2' are not used in this version of the specification,
  -- they should not be sent and if received they should be ignored.
  dummy                           CHOICE {
    fdd                             SEQUENCE {
      dummy1                         CPCH-SetID                       OPTIONAL,
      dummy2                         DRAC-StaticInformationList       OPTIONAL
    },
    tdd                             NULL
  } OPTIONAL,
  dl-CommonTransChInfo            DL-CommonTransChInfo-r4        OPTIONAL,
  dl-DeletedTransChInfoList       DL-DeletedTransChInfoList       OPTIONAL,
  dl-AddReconfTransChInfoList-r4  DL-AddReconfTransChInfoList-r4  OPTIONAL,
  -- Physical channel IEs
  frequencyInfo                   FrequencyInfo                     OPTIONAL,
  maxAllowedUL-TX-Power            MaxAllowedUL-TX-Power           OPTIONAL,
  ul-ChannelRequirement            UL-ChannelRequirement-r4        OPTIONAL,
  modeSpecificPhysChInfo          CHOICE {
    fdd                             SEQUENCE {
      -- dummy is not used in this version of specification, it should
      -- not be sent and if received it should be ignored.
      dummy                          DL-PDSCH-Information             OPTIONAL
    },
    tdd                             NULL
  },
  dl-CommonInformation            DL-CommonInformation-r4         OPTIONAL,
  dl-InformationPerRL-List        DL-InformationPerRL-List-r4     OPTIONAL
}

```

```

}

RadioBearerReconfiguration-r5-IEs ::= SEQUENCE {
  -- User equipment IEs
  integrityProtectionModeInfo      IntegrityProtectionModeInfo      OPTIONAL,
  cipheringModeInfo                CipheringModeInfo                OPTIONAL,
  activationTime                    ActivationTime                    OPTIONAL,
  new-U-RNTI                        U-RNTI                          OPTIONAL,
  new-C-RNTI                        C-RNTI                          OPTIONAL,
  -- The IE "new-DSCH-RNTI" should not be included in FDD mode, and if received
  -- the UE behaviour is unspecified
  new-DSCH-RNTI                    DSCH-RNTI                       OPTIONAL,
  new-H-RNTI                        H-RNTI                          OPTIONAL,
  rrc-StateIndicator                RRC-StateIndicator,
  utran-DRX-CycleLengthCoeff       UTRAN-DRX-CycleLengthCoefficient OPTIONAL,
  -- Core network IEs
  cn-InformationInfo                CN-InformationInfo              OPTIONAL,
  -- UTRAN mobility IEs
  ura-Identity                      URA-Identity                   OPTIONAL,
  -- Specification mode information
  specificationMode                 CHOICE {
    complete                         SEQUENCE {
      -- Radio bearer IEs
      rab-InformationReconfigList    RAB-InformationReconfigList    OPTIONAL,
      rb-InformationReconfigList     RB-InformationReconfigList-r5  OPTIONAL,
      rb-InformationAffectedList     RB-InformationAffectedList-r5  OPTIONAL,
      rb-PDCPContextRelocationList  RB-PDCPContextRelocationList  OPTIONAL,
      -- Transport channel IEs
      ul-CommonTransChInfo          UL-CommonTransChInfo-r4       OPTIONAL,
      ul-deletedTransChInfoList     UL-DeletedTransChInfoList     OPTIONAL,
      ul-AddReconfTransChInfoList   UL-AddReconfTransChInfoList   OPTIONAL,
      -- 'dummy', 'dummy1' and 'dummy2' are not used in this version of the
      -- specification, they should not be sent and if received they should be ignored.
      dummy                          CHOICE {
        fdd                          SEQUENCE {
          dummy1                     CPCH-SetID                    OPTIONAL,
          dummy2                     DRAC-StaticInformationList    OPTIONAL
        },
        tdd                          NULL
      }
      dl-CommonTransChInfo          DL-CommonTransChInfo-r4       OPTIONAL,
      dl-DeletedTransChInfoList     DL-DeletedTransChInfoList-r5  OPTIONAL,
      dl-AddReconfTransChInfoList   DL-AddReconfTransChInfoList-r5 OPTIONAL
    },
    preconfiguration                SEQUENCE {
      -- All IEs that include an FDD/TDD choice are split in two IEs for this message,
      -- one for the FDD only elements and one for the TDD only elements, so that one
      -- FDD/TDD choice in this level is sufficient.
      preConfigMode                 CHOICE {
        predefinedConfigIdentity     PredefinedConfigIdentity,
        defaultConfig                SEQUENCE {
          defaultConfigMode          DefaultConfigMode,
          defaultConfigIdentity      DefaultConfigIdentity-r5
        }
      }
    }
  },
  -- Physical channel IEs
  frequencyInfo                    FrequencyInfo                    OPTIONAL,
  maxAllowedUL-TX-Power             MaxAllowedUL-TX-Power          OPTIONAL,
  ul-ChannelRequirement             UL-ChannelRequirement-r5      OPTIONAL,
  modeSpecificPhysChInfo           CHOICE {
    fdd                             SEQUENCE {
      -- dummy is not used in this version of specification, it should
      -- not be sent and if received it should be ignored.
      dummy                          DL-PDSCH-Information          OPTIONAL
    },
    tdd                             NULL
  },
  dl-HSPDSCH-Information            DL-HSPDSCH-Information         OPTIONAL,
  dl-CommonInformation              DL-CommonInformation-r5        OPTIONAL,
  dl-InformationPerRL-List          DL-InformationPerRL-List-r5    OPTIONAL
}

RadioBearerReconfiguration-r6-IEs ::= SEQUENCE {
  -- User equipment IEs
  integrityProtectionModeInfo      IntegrityProtectionModeInfo      OPTIONAL,
  cipheringModeInfo                CipheringModeInfo                OPTIONAL,

```

```

activationTime          ActivationTime          OPTIONAL,
delayRestrictionFlag   DelayRestrictionFlag   OPTIONAL,
new-U-RNTI             U-RNTI                 OPTIONAL,
new-C-RNTI             C-RNTI                 OPTIONAL,
-- The IE "new-DSCH-RNTI" should not be included in FDD mode,
-- and if received the UE behaviour is unspecified
new-DSCH-RNTI         DSCH-RNTI                 OPTIONAL,
new-H-RNTI             H-RNTI                 OPTIONAL,
newPrimary-E-RNTI     E-RNTI                 OPTIONAL,
newSecondary-E-RNTI   E-RNTI                 OPTIONAL,
rrc-StateIndicator    RRC-StateIndicator,
utran-DRX-CycleLengthCoeff  UTRAN-DRX-CycleLengthCoefficient  OPTIONAL,
-- Core network IEs
cn-InformationInfo    CN-InformationInfo-r6   OPTIONAL,
-- UTRAN mobility IEs
ura-Identity          URA-Identity           OPTIONAL,
-- Specification mode information
specificationMode     CHOICE {
  complete            SEQUENCE {
    -- Radio bearer IEs
    rab-InformationReconfigList  RAB-InformationReconfigList  OPTIONAL,
    rb-InformationReconfigList  RB-InformationReconfigList-r6  OPTIONAL,
    rb-InformationAffectedList  RB-InformationAffectedList-r6  OPTIONAL,
    rb-PDCPContextRelocationList  RB-PDCPContextRelocationList  OPTIONAL,
    pdcp-ROHC-TargetMode       PDCP-ROHC-TargetMode         OPTIONAL,
    -- Transport channel IEs
    ul-CommonTransChInfo       UL-CommonTransChInfo-r4       OPTIONAL,
    ul-deletedTransChInfoList  UL-DeletedTransChInfoList-r6  OPTIONAL,
    ul-AddReconfTransChInfoList  UL-AddReconfTransChInfoList-r6  OPTIONAL,
    dl-CommonTransChInfo       DL-CommonTransChInfo-r4       OPTIONAL,
    dl-DeletedTransChInfoList  DL-DeletedTransChInfoList-r5  OPTIONAL,
    dl-AddReconfTransChInfoList  DL-AddReconfTransChInfoList-r5  OPTIONAL
  },
  preconfiguration      SEQUENCE {
    -- All IEs that include an FDD/TDD choice are split in two IEs for this message,
    -- one for the FDD only elements and one for the TDD only elements, so that one
    -- FDD/TDD choice in this level is sufficient.
    preConfigMode        CHOICE {
      predefinedConfigIdentity  PredefinedConfigIdentity,
      defaultConfig           SEQUENCE {
        defaultConfigMode      DefaultConfigMode,
        defaultConfigIdentity  DefaultConfigIdentity-r6
      }
    }
  }
},
-- Physical channel IEs
frequencyInfo         FrequencyInfo           OPTIONAL,
maxAllowedUL-TX-Power  MaxAllowedUL-TX-Power  OPTIONAL,
ul-DPCH-Info          UL-DPCH-Info-r6         OPTIONAL,
ul-EDCH-Information   UL-EDCH-Information-r6  OPTIONAL,
dl-HSPDSCH-Information  DL-HSPDSCH-Information-r6  OPTIONAL,
dl-CommonInformation  DL-CommonInformation-r6  OPTIONAL,
dl-InformationPerRL-List  DL-InformationPerRL-List-r6  OPTIONAL,
-- MBMS IEs
mbms-PL-ServiceRestrictInfo  MBMS-PL-ServiceRestrictInfo-r6  OPTIONAL
}

RadioBearerReconfiguration-v690ext-IEs ::= SEQUENCE {
-- User Equipment IEs
delayRestrictionFlag   DelayRestrictionFlag   OPTIONAL,
-- Core network IEs
primary-plmn-Identity  PLMN-Identity         OPTIONAL,
-- Physical channel IEs
-- The IE harq-Preamble-Mode should not be used in the r3 and r4 versions of the message
-- If included in the r3 or r4 version of the message, the UE should ignore the IE
harq-Preamble-Mode     HARQ-Preamble-Mode     OPTIONAL,
beaconPLEst            BEACON-PL-Est          OPTIONAL,
postVerificationPeriod  ENUMERATED { true }    OPTIONAL,
dhs-sync               DHS-Sync                OPTIONAL,
timingMaintainedSynchInd  TimingMaintainedSynchInd  OPTIONAL,
-- MBMS IEs
mbms-PL-ServiceRestrictInfo  MBMS-PL-ServiceRestrictInfo-r6  OPTIONAL
}

RadioBearerReconfiguration-v6b0ext-IEs ::= SEQUENCE {
-- Physical channel IEs
dl-InformationPerRL-List-v6b0ext  DL-InformationPerRL-List-v6b0ext  OPTIONAL
}

```

```

}

RadioBearerReconfiguration-v6f0ext-IEs ::= SEQUENCE {
  -- Specification mode information
  specificationMode CHOICE {
    complete SEQUENCE {
      -- Radio bearer IEs
      rab-InformationMBMSPTpList RAB-InformationMBMSPTpList OPTIONAL
    }
  }
}

RadioBearerReconfiguration-r7-IEs ::= SEQUENCE {
  -- User equipment IEs
  integrityProtectionModeInfo IntegrityProtectionModeInfo-r7 OPTIONAL,
  cipheringModeInfo CipheringModeInfo-r7 OPTIONAL,
  activationTime ActivationTime OPTIONAL,
  delayRestrictionFlag DelayRestrictionFlag OPTIONAL,
  new-U-RNTI U-RNTI OPTIONAL,
  new-C-RNTI C-RNTI OPTIONAL,
  -- The IE "new-DSCH-RNTI" should not be included in FDD mode,
  -- and if received the UE behaviour is unspecified
  new-DSCH-RNTI DSCH-RNTI OPTIONAL,
  new-H-RNTI H-RNTI OPTIONAL,
  newPrimary-E-RNTI E-RNTI OPTIONAL,
  newSecondary-E-RNTI E-RNTI OPTIONAL,
  rrc-StateIndicator RRC-StateIndicator,
  ueMobilityStateIndicator High-MobilityDetected OPTIONAL,
  utran-DRX-CycleLengthCoeff UTRAN-DRX-CycleLengthCoefficient-r7 OPTIONAL,
  -- Core network IEs
  cn-InformationInfo CN-InformationInfo-r6 OPTIONAL,
  -- UTRAN mobility IEs
  ura-Identity URA-Identity OPTIONAL,
  supportForChangeOfUE-Capability BOOLEAN OPTIONAL,
  responseToChangeOfUE-Capability ENUMERATED { true } OPTIONAL,
  -- Specification mode information
  specificationMode CHOICE {
    complete SEQUENCE {
      -- Radio bearer IEs
      rab-InformationReconfigList RAB-InformationReconfigList OPTIONAL,
      rab-InformationMBMSPTpList RAB-InformationMBMSPTpList OPTIONAL,
      rb-InformationReconfigList RB-InformationReconfigList-r7 OPTIONAL,
      rb-InformationAffectedList RB-InformationAffectedList-r7 OPTIONAL,
      rb-PDCPContextRelocationList RB-PDCPContextRelocationList OPTIONAL,
      pdcp-ROHC-TargetMode PDCP-ROHC-TargetMode OPTIONAL,
      -- Transport channel IEs
      ul-CommonTransChInfo UL-CommonTransChInfo-r4 OPTIONAL,
      ul-deletedTransChInfoList UL-DeletedTransChInfoList-r6 OPTIONAL,
      ul-AddReconfTransChInfoList UL-AddReconfTransChInfoList-r7 OPTIONAL,
      dl-CommonTransChInfo DL-CommonTransChInfo-r4 OPTIONAL,
      dl-DeletedTransChInfoList DL-DeletedTransChInfoList-r7 OPTIONAL,
      dl-AddReconfTransChInfoList DL-AddReconfTransChInfoList-r7 OPTIONAL
    },
    preconfiguration SEQUENCE {
      -- All IEs that include an FDD/TDD choice are split in two IEs for this message,
      -- one for the FDD only elements and one for the TDD only elements, so that one
      -- FDD/TDD choice in this level is sufficient.
      preConfigMode CHOICE {
        predefinedConfigIdentity PredefinedConfigIdentity,
        defaultConfig SEQUENCE {
          defaultConfigMode DefaultConfigMode,
          defaultConfigIdentity DefaultConfigIdentity-r6
        }
      }
    }
  },
  -- Physical channel IEs
  frequencyInfo FrequencyInfo OPTIONAL,
  multi-frequencyInfo Multi-frequencyInfo-LCR-r7 OPTIONAL,
  dtx-drx-TimingInfo DTX-DRX-TimingInfo-r7 OPTIONAL,
  dtx-drx-Info DTX-DRX-Info-r7 OPTIONAL,
  hs-scch-LessInfo HS-SCCH-LessInfo-r7 OPTIONAL,
  mimoParameters MIMO-Parameters-r7 OPTIONAL,
  maxAllowedUL-TX-Power MaxAllowedUL-TX-Power OPTIONAL,
  ul-DPCH-Info UL-DPCH-Info-r7 OPTIONAL,
  ul-EDCH-Information UL-EDCH-Information-r7 OPTIONAL,
  dl-HSPDSCH-Information DL-HSPDSCH-Information-r7 OPTIONAL,
  dl-CommonInformation DL-CommonInformation-r7 OPTIONAL,

```

```

        dl-InformationPerRL-List      DL-InformationPerRL-List-r7      OPTIONAL,
-- MBMS IEs
        mbms-PL-ServiceRestrictInfo  MBMS-PL-ServiceRestrictInfo-r6  OPTIONAL
    }
RadioBearerReconfiguration-v770ext-IEs ::= SEQUENCE {
-- User equipment IEs
        ueMobilityStateIndicator      High-MobilityDetected          OPTIONAL
    }
RadioBearerReconfiguration-v780ext-IEs ::= SEQUENCE {
-- Physical channel IEs
        hs-DSCH-TBSizeTable           HS-DSCH-TBSizeTable           OPTIONAL
    }
RadioBearerReconfiguration-v790ext-IEs ::= SEQUENCE {
-- Container for adding non critical extensions after freezing REL-8
        radioBearerReconfiguration-r7-add-ext  BIT STRING                    OPTIONAL
    }
RadioBearerReconfiguration-v7d0ext-IEs ::= SEQUENCE {
-- Physical channel IEs
        ul-EDCH-Information            UL-EDCH-Information-ext       OPTIONAL
    }
RadioBearerReconfiguration-v7f0ext-IEs ::= SEQUENCE {
-- Physical channel IEs
        mimoParameters                 MIMO-Parameters-v7f0ext      OPTIONAL
    }
RadioBearerReconfiguration-v7g0ext-IEs ::= SEQUENCE {
-- Physical channel IEs
        mimoParameters                 MIMO-Parameters-v7g0ext      OPTIONAL
    }
RadioBearerReconfiguration-r8-IEs ::= SEQUENCE {
-- User equipment IEs
        integrityProtectionModeInfo      IntegrityProtectionModeInfo-r7  OPTIONAL,
        cipheringModeInfo                CipheringModeInfo-r7           OPTIONAL,
        activationTime                    ActivationTime                   OPTIONAL,
        delayRestrictionFlag              DelayRestrictionFlag           OPTIONAL,
        new-U-RNTI                        U-RNTI                        OPTIONAL,
        new-C-RNTI                        C-RNTI                        OPTIONAL,
-- The IE "new-DSCH-RNTI" should not be included in FDD mode,
-- and if received the UE behaviour is unspecified
        new-DSCH-RNTI                    DSCH-RNTI                      OPTIONAL,
        new-H-RNTI                        H-RNTI                         OPTIONAL,
        newPrimary-E-RNTI                 E-RNTI                         OPTIONAL,
        newSecondary-E-RNTI               E-RNTI                         OPTIONAL,
        rrc-StateIndicator                RRC-StateIndicator,           High-MobilityDetected          OPTIONAL,
        ueMobilityStateIndicator          High-MobilityDetected          OPTIONAL,
        utran-DRX-CycleLengthCoeff        UTRAN-DRX-CycleLengthCoefficient-r7  OPTIONAL,
-- Core network IEs
        cn-InformationInfo                CN-InformationInfo-r6         OPTIONAL,
-- UTRAN mobility IEs
        ura-Identity                      URA-Identity                   OPTIONAL,
        supportForChangeOfUE-Capability    BOOLEAN                        OPTIONAL,
        responseToChangeOfUE-Capability    ENUMERATED { true }           OPTIONAL,
-- Specification mode information
-- dummy is not used in this version of the specification, it should
-- not be sent and if received it should be ignored.
        dummy                             DefaultConfigForCellFACH       OPTIONAL,
        specificationMode                  CHOICE {
            complete                       SEQUENCE {
-- Radio bearer IEs
                rab-InformationReconfigList  RAB-InformationReconfigList-r8  OPTIONAL,
                rab-InformationMBMSPTpList  RAB-InformationMBMSPTpList      OPTIONAL,
                rb-InformationReconfigList  RB-InformationReconfigList-r8   OPTIONAL,
                rb-InformationAffectedList  RB-InformationAffectedList-r8   OPTIONAL,
                rb-PDCPContextRelocationList  RB-PDCPContextRelocationList  OPTIONAL,
                pdcp-ROHC-TargetMode        PDCP-ROHC-TargetMode           OPTIONAL,
-- Transport channel IEs
                ul-CommonTransChInfo        UL-CommonTransChInfo-r4         OPTIONAL,
                ul-deletedTransChInfoList    UL-DeletedTransChInfoList-r6    OPTIONAL,
                ul-AddReconfTransChInfoList  UL-AddReconfTransChInfoList-r8  OPTIONAL,
                dl-CommonTransChInfo        DL-CommonTransChInfo-r4         OPTIONAL,
                dl-DeletedTransChInfoList    DL-DeletedTransChInfoList-r7    OPTIONAL,
                dl-AddReconfTransChInfoList  DL-AddReconfTransChInfoList-r7  OPTIONAL
            }
        }
    }

```

```

    },
    preconfiguration          SEQUENCE {
    -- All IEs that include an FDD/TDD choice are split in two IEs for this message,
    -- one for the FDD only elements and one for the TDD only elements, so that one
    -- FDD/TDD choice in this level is sufficient.
        preConfigMode          CHOICE {
            predefinedConfigIdentity    PredefinedConfigIdentity,
            defaultConfig              SEQUENCE {
                defaultConfigMode      DefaultConfigMode,
                defaultConfigIdentity   DefaultConfigIdentity-r6
            }
        }
    }
},
-- Physical channel IEs
frequencyInfo                FrequencyInfo                OPTIONAL,
multi-frequencyInfo          Multi-frequencyInfo-LCR-r7    OPTIONAL,
dtx-drx-TimingInfo          DTX-DRX-TimingInfo-r7    OPTIONAL,
dtx-drx-Info                 DTX-DRX-Info-r7        OPTIONAL,
hs-scch-LessInfo            HS-SCCH-LessInfo-r7     OPTIONAL,
mimoParameters              MIMO-Parameters-r8     OPTIONAL,
maxAllowedUL-TX-Power       MaxAllowedUL-TX-Power  OPTIONAL,
ul-DPCH-Info                UL-DPCH-Info-r7       OPTIONAL,
ul-EDCH-Information         UL-EDCH-Information-r8 OPTIONAL,
dl-HSPDSCH-Information      DL-HSPDSCH-Information-r8 OPTIONAL,
dl-CommonInformation        DL-CommonInformation-r8 OPTIONAL,
dl-InformationPerRL-List    DL-InformationPerRL-List-r8 OPTIONAL,
dl-SecondaryCellInfoFDD     DL-SecondaryCellInfoFDD OPTIONAL,
controlChannelDRXInfo-TDD128 ControlChannelDRXInfo-TDD128-r8 OPTIONAL,
sps-Information-TDD128      SPS-Information-TDD128-r8 OPTIONAL,
-- MBMS IEs
mbms-PL-ServiceRestrictInfo MBMS-PL-ServiceRestrictInfo-r6 OPTIONAL
}

RadioBearerReconfiguration-v890ext-IEs ::= SEQUENCE {
-- Physical channel IEs
dl-SecondaryCellInfoFDD-v890ext    DL-SecondaryCellInfoFDD-v890ext    OPTIONAL,
dl-HSPDSCH-Information              DL-HSPDSCH-Information-r8-ext      OPTIONAL
}

RadioBearerReconfiguration-v8a0ext-IEs ::= SEQUENCE {
-- Physical channel IEs
dl-HSPDSCH-Information              DL-HSPDSCH-Information-r8-ext2     OPTIONAL
}

RadioBearerReconfiguration-r9-IEs ::= SEQUENCE {
-- User equipment IEs
integrityProtectionModeInfo         IntegrityProtectionModeInfo-r7     OPTIONAL,
cipheringModeInfo                   CipheringModeInfo-r7               OPTIONAL,
activationTime                       ActivationTime                       OPTIONAL,
delayRestrictionFlag                 DelayRestrictionFlag                OPTIONAL,
new-U-RNTI                           U-RNTI                             OPTIONAL,
new-C-RNTI                           C-RNTI                             OPTIONAL,
-- The IE "new-DSCH-RNTI" should not be included in FDD mode,
-- and if received the UE behaviour is unspecified
new-DSCH-RNTI                       DSCH-RNTI                          OPTIONAL,
new-H-RNTI                           H-RNTI                             OPTIONAL,
newPrimary-E-RNTI                   E-RNTI                             OPTIONAL,
newSecondary-E-RNTI                 E-RNTI                             OPTIONAL,
rrc-StateIndicator                  RRC-StateIndicator,
ueMobilityStateIndicator             High-MobilityDetected              OPTIONAL,
utran-DRX-CycleLengthCoeff          UTRAN-DRX-CycleLengthCoefficient-r7 OPTIONAL,
-- Core network IEs
cn-InformationInfo                  CN-InformationInfo-r6              OPTIONAL,
-- UTRAN mobility IEs
ura-Identity                         URA-Identity                       OPTIONAL,
supportForChangeOfUE-Capability      BOOLEAN                            OPTIONAL,
responseToChangeOfUE-Capability      ENUMERATED { true }                OPTIONAL,
-- Specification mode information
-- dummy is not used in this version of the specification, it should
-- not be sent and if received UE behaviour is unspecified.
dummy                                DefaultConfigForCellFACH            OPTIONAL,
specificationMode                    CHOICE {
    complete                          SEQUENCE {
        -- Radio bearer IEs
        rab-InformationReconfigList    RAB-InformationReconfigList-r8    OPTIONAL,
        rab-InformationMBMSptpList     RAB-InformationMBMSptpList        OPTIONAL,
        rb-InformationReconfigList     RB-InformationReconfigList-r8     OPTIONAL,

```



```

        rb-InformationAffectedList          RB-InformationAffectedList-r8          OPTIONAL,
        rb-PDCPContextRelocationList       RB-PDCPContextRelocationList           OPTIONAL,
        pdcp-ROHC-TargetMode                PDCP-ROHC-TargetMode                   OPTIONAL,
    -- Transport channel IEs
        ul-CommonTransChInfo                UL-CommonTransChInfo-r4                OPTIONAL,
        ul-deletedTransChInfoList           UL-DeletedTransChInfoList-r6           OPTIONAL,
        ul-AddReconfTransChInfoList         UL-AddReconfTransChInfoList-r8         OPTIONAL,
        dl-CommonTransChInfo                DL-CommonTransChInfo-r4                OPTIONAL,
        dl-DeletedTransChInfoList           DL-DeletedTransChInfoList-r7           OPTIONAL,
        dl-AddReconfTransChInfoList         DL-AddReconfTransChInfoList-r9         OPTIONAL
    },
    preconfiguration                        SEQUENCE {
    -- All IEs that include an FDD/TDD choice are split in two IEs for this message,
    -- one for the FDD only elements and one for the TDD only elements, so that one
    -- FDD/TDD choice in this level is sufficient.
        preConfigMode                        CHOICE {
            predefinedConfigIdentity         PredefinedConfigIdentity,
            defaultConfig                    SEQUENCE {
                defaultConfigMode           DefaultConfigMode,
                defaultConfigIdentity       DefaultConfigIdentity-r6
            }
        }
    },
-- Physical channel IEs
    frequencyInfo                          FrequencyInfo                            OPTIONAL,
    multi-frequencyInfo                     Multi-frequencyInfo-LCR-r7              OPTIONAL,
    dtx-drx-TimingInfo                      DTX-DRX-TimingInfo-r7                  OPTIONAL,
    dtx-drx-Info                            DTX-DRX-Info-r7                        OPTIONAL,
    hs-scch-LessInfo                        HS-SCCH-LessInfo-r7                    OPTIONAL,
    mimoParameters                          MIMO-Parameters-r9                     OPTIONAL,
    maxAllowedUL-TX-Power                   MaxAllowedUL-TX-Power                   OPTIONAL,
    ul-DPCH-Info                            UL-DPCH-Info-r7                         OPTIONAL,
    ul-EDCH-Information                     UL-EDCH-Information-r9                  OPTIONAL,
    ul-SecondaryCellInfoFDD                 UL-SecondaryCellInfoFDD                 OPTIONAL,
    dl-HSPDSCH-Information                  DL-HSPDSCH-Information-r9               OPTIONAL,
    dl-CommonInformation                    DL-CommonInformation-r8                 OPTIONAL,
    dl-InformationPerRL-List                DL-InformationPerRL-List-r8             OPTIONAL,
    dl-SecondaryCellInfoFDD                 DL-SecondaryCellInfoFDD-r9              OPTIONAL,
    controlChannelDRXInfo-TDD128            ControlChannelDRXInfo-TDD128-r8         OPTIONAL,
    sps-Information-TDD128                  SPS-Information-TDD128-r8              OPTIONAL,
-- MBMS IEs
    mbms-PL-ServiceRestrictInfo             MBMS-PL-ServiceRestrictInfo-r6         OPTIONAL,
-- Measurement IEs for LCR
    cellDCHMeasOccasionInfo-TDD128         CellDCHMeasOccasionInfo-TDD128-r9      OPTIONAL
}

RadioBearerReconfiguration-v950ext-IEs ::= SEQUENCE {
    -- Physical channel IEs
    secondaryCellMimoParameters             SecondaryCellMIMOparametersFDD-v950ext  OPTIONAL
}

RadioBearerReconfiguration-v9c0ext-IEs ::= SEQUENCE {
    -- For 1.28Mcps TDD only
    dl-AddReconfTransChInfoList            DL-AddReconfTransChInfoList-TDD128-v9c0ext  OPTIONAL
}

RadioBearerReconfiguration-r10-IEs ::= SEQUENCE {
    -- User equipment IEs
    integrityProtectionModeInfo             IntegrityProtectionModeInfo-r7           OPTIONAL,
    cipheringModeInfo                       CipheringModeInfo-r7                     OPTIONAL,
    activationTime                           ActivationTime                             OPTIONAL,
    delayRestrictionFlag                     DelayRestrictionFlag                       OPTIONAL,
    new-U-RNTI                               U-RNTI                                    OPTIONAL,
    new-C-RNTI                               C-RNTI                                    OPTIONAL,
    -- The IE "new-DSCH-RNTI" should not be included in FDD mode,
    -- and if received the UE behaviour is unspecified
    new-DSCH-RNTI                           DSCH-RNTI                                OPTIONAL,
    new-H-RNTI                               H-RNTI                                    OPTIONAL,
    newPrimary-E-RNTI                       E-RNTI                                    OPTIONAL,
    newSecondary-E-RNTI                     E-RNTI                                    OPTIONAL,
    rrc-StateIndicator                       RRC-StateIndicator,
    ueMobilityStateIndicator                 High-MobilityDetected                     OPTIONAL,
    utran-DRX-CycleLengthCoeff              UTRAN-DRX-CycleLengthCoefficient-r7      OPTIONAL,
-- Core network IEs
    cn-InformationInfo                       CN-InformationInfo-r6                     OPTIONAL,
-- UTRAN mobility IEs
    ura-Identity                             URA-Identity                             OPTIONAL,

```

```

    supportForChangeOfUE-Capability BOOLEAN OPTIONAL,
    responseToChangeOfUE-Capability ENUMERATED { true } OPTIONAL,
-- Specification mode information
-- dummy is not used in this version of the specification, it should
-- not be sent and if received UE behaviour is unspecified.
dummy DefaultConfigForCellFACH OPTIONAL,
specificationMode CHOICE {
    complete SEQUENCE {
-- Radio bearer IEs
        rab-InformationReconfigList RAB-InformationReconfigList-r8 OPTIONAL,
        rab-InformationMBMSPTpList RAB-InformationMBMSPTpList OPTIONAL,
        rb-InformationReconfigList RB-InformationReconfigList-r8 OPTIONAL,
        rb-InformationAffectedList RB-InformationAffectedList-r8 OPTIONAL,
        rb-PDCPContextRelocationList RB-PDCPContextRelocationList OPTIONAL,
        pdcp-ROHC-TargetMode PDCP-ROHC-TargetMode OPTIONAL,
-- Transport channel IEs
        ul-CommonTransChInfo UL-CommonTransChInfo-r4 OPTIONAL,
        ul-deletedTransChInfoList UL-DeletedTransChInfoList-r6 OPTIONAL,
        ul-AddReconfTransChInfoList UL-AddReconfTransChInfoList-r8 OPTIONAL,
        dl-CommonTransChInfo DL-CommonTransChInfo-r4 OPTIONAL,
        dl-DeletedTransChInfoList DL-DeletedTransChInfoList-r7 OPTIONAL,
        dl-AddReconfTransChInfoList DL-AddReconfTransChInfoList-r9 OPTIONAL
    },
    preconfiguration SEQUENCE {
-- All IEs that include an FDD/TDD choice are split in two IEs for this message,
-- one for the FDD only elements and one for the TDD only elements, so that one
-- FDD/TDD choice in this level is sufficient.
        preConfigMode CHOICE {
            predefinedConfigIdentity PredefinedConfigIdentity,
            defaultConfig SEQUENCE {
                defaultConfigMode DefaultConfigMode,
                defaultConfigIdentity DefaultConfigIdentity-r6
            }
        }
    }
},
-- Physical channel IEs
frequencyInfo FrequencyInfo OPTIONAL,
multi-frequencyInfo Multi-frequencyInfo-LCR-r7 OPTIONAL,
dtx-drx-TimingInfo DTX-DRX-TimingInfo-r7 OPTIONAL,
dtx-drx-Info DTX-DRX-Info-r7 OPTIONAL,
hs-scch-LessInfo HS-SCCH-LessInfo-r7 OPTIONAL,
mimoParameters MIMO-Parameters-r9 OPTIONAL,
maxAllowedUL-TX-Power MaxAllowedUL-TX-Power OPTIONAL,
ul-DPCH-Info UL-DPCH-Info-r7 OPTIONAL,
ul-EDCH-Information UL-EDCH-Information-r9 OPTIONAL,
ul-SecondaryCellInfoFDD UL-SecondaryCellInfoFDD OPTIONAL,
ul-MulticarrierEDCHInfo-TDD128 UL-MulticarrierEDCHInfo-TDD128 OPTIONAL,
dl-HSPDSCH-Information DL-HSPDSCH-Information-r9 OPTIONAL,
dl-CommonInformation DL-CommonInformation-r10 OPTIONAL,
dl-InformationPerRL-List DL-InformationPerRL-List-r8 OPTIONAL,
dl-SecondaryCellInfoFDD DL-SecondaryCellInfoFDD-r10 OPTIONAL,
additionalDLSecCellInfoListFDD AdditionalDLSecCellInfoListFDD OPTIONAL,
controlChannelDRXInfo-TDD128 ControlChannelDRXInfo-TDD128-r8 OPTIONAL,
sps-Information-TDD128 SPS-Information-TDD128-r8 OPTIONAL,
mu-MIMO-Info-TDD128 MU-MIMO-Info-TDD128 OPTIONAL,
-- MBMS IEs
mbms-PL-ServiceRestrictInfo MBMS-PL-ServiceRestrictInfo-r6 OPTIONAL,
-- Measurement IEs for LCR
cellDCHMeasOccasionInfo-TDD128 CellDCHMeasOccasionInfo-TDD128-r9 OPTIONAL
}

RadioBearerReconfiguration-vb50ext-IEs ::= SEQUENCE {
    ulOLTDInfoFDD UL-OLTD-InfoFDD OPTIONAL
}

RadioBearerReconfiguration-r11-IEs ::= SEQUENCE {
-- User equipment IEs
    integrityProtectionModeInfo IntegrityProtectionModeInfo-r7 OPTIONAL,
    cipheringModeInfo CipheringModeInfo-r7 OPTIONAL,
    activationTime ActivationTime OPTIONAL,
    delayRestrictionFlag DelayRestrictionFlag OPTIONAL,
    new-U-RNTI U-RNTI OPTIONAL,
    new-C-RNTI C-RNTI OPTIONAL,
-- The IE "new-DSCH-RNTI" should not be included in FDD mode,
-- and if received the UE behaviour is unspecified
    new-DSCH-RNTI DSCH-RNTI OPTIONAL,
    new-H-RNTI H-RNTI OPTIONAL,

```

```

newPrimary-E-RNTI          E-RNTI          OPTIONAL,
newSecondary-E-RNTI        E-RNTI          OPTIONAL,
rrc-StateIndicator         RRC-StateIndicator,
ueMobilityStateIndicator   High-MobilityDetected   OPTIONAL,
utran-DRX-CycleLengthCoeff UTRAN-DRX-CycleLengthCoefficient-r7 OPTIONAL,
-- Core network IEs
  cn-InformationInfo        CN-InformationInfo-r6   OPTIONAL,
-- UTRAN mobility IEs
  ura-Identity              URA-Identity          OPTIONAL,
  supportForChangeOfUE-Capability BOOLEAN              OPTIONAL,
  responseToChangeOfUE-Capability ENUMERATED { true }     OPTIONAL,
-- Specification mode information
  defaultConfigForCellFACH  DefaultConfigForCellFACH  OPTIONAL,
  specificationMode         CHOICE {
    complete                SEQUENCE {
-- Radio bearer IEs
      rab-InformationReconfigList RAB-InformationReconfigList-r8 OPTIONAL,
      rab-InformationMBMSPTpList RAB-InformationMBMSPTpList  OPTIONAL,
      rb-InformationReconfigList RB-InformationReconfigList-r11 OPTIONAL,
      rb-InformationAffectedList RB-InformationAffectedList-r8  OPTIONAL,
      rb-PDCPContextRelocationList RB-PDCPContextRelocationList  OPTIONAL,
      pdcp-ROHC-TargetMode       PDCP-ROHC-TargetMode         OPTIONAL,
      umRlc-ReEstablishmentRBList RB-IdentityList              OPTIONAL,
-- Transport channel IEs
      ul-CommonTransChInfo        UL-CommonTransChInfo-r4        OPTIONAL,
      ul-deletedTransChInfoList    UL-DeletedTransChInfoList-r6    OPTIONAL,
      ul-AddReconfTransChInfoList  UL-AddReconfTransChInfoList-r8  OPTIONAL,
      dl-CommonTransChInfo        DL-CommonTransChInfo-r4        OPTIONAL,
      dl-DeletedTransChInfoList    DL-DeletedTransChInfoList-r7    OPTIONAL,
      dl-AddReconfTransChInfoList  DL-AddReconfTransChInfoList-r11  OPTIONAL
    },
    preconfiguration            SEQUENCE {
-- All IEs that include an FDD/TDD choice are split in two IEs for this message,
-- one for the FDD only elements and one for the TDD only elements, so that one
-- FDD/TDD choice in this level is sufficient.
      preConfigMode            CHOICE {
        predefinedConfigIdentity  PredefinedConfigIdentity,
        defaultConfig            SEQUENCE {
          defaultConfigMode       DefaultConfigMode,
          defaultConfigIdentity   DefaultConfigIdentity-r6
        }
      }
    }
  },
preconfiguration            SEQUENCE {
-- Physical channel IEs
  frequencyInfo             FrequencyInfo                OPTIONAL,
  multi-frequencyInfo       Multi-frequencyInfo-LCR-r7          OPTIONAL,
  dtx-drx-TimingInfo        DTX-DRX-TimingInfo-r7          OPTIONAL,
  dtx-drx-Info              DTX-DRX-Info-r7                  OPTIONAL,
  hs-scch-LessInfo          HS-SCCH-LessInfo-r7              OPTIONAL,
  mimoParameters            MIMO-Parameters-r9                OPTIONAL,
  mimo4x4Parameters         MIMO4x4-Parameters              OPTIONAL,
  maxAllowedUL-TX-Power     MaxAllowedUL-TX-Power            OPTIONAL,
  ul-DPCH-Info              UL-DPCH-Info-r11                  OPTIONAL,
  ul-EDCH-Information        UL-EDCH-Information-r11          OPTIONAL,
  ul-SecondaryCellInfoFDD    UL-SecondaryCellInfoFDD          OPTIONAL,
  ul-MulticarrierEDCHInfo-TDD128 UL-MulticarrierEDCHInfo-TDD128  OPTIONAL,
  ul-CLTD-InfoFDD           UL-CLTD-InfoFDD              OPTIONAL,
  ul-OLTD-InfoFDD           UL-OLTD-InfoFDD              OPTIONAL,
  dl-HSPDSCH-Information     DL-HSPDSCH-Information-r11        OPTIONAL,
  dl-CommonInformation       DL-CommonInformation-r11        OPTIONAL,
  dl-InformationPerRL-List    DL-InformationPerRL-List-r11      OPTIONAL,
  dl-SecondaryCellInfoFDD     DL-SecondaryCellInfoFDD-r11      OPTIONAL,
  additionalDLSecCellInfoListFDD AdditionalDLSecCellInfoListFDD-r11 OPTIONAL,
  additionalDLSecCellInfoListFDD2 AdditionalDLSecCellInfoListFDD2  OPTIONAL,
  commonERGCHInfoFDD         CommonERGCHInfoFDD              OPTIONAL,
  controlChannelDRXInfo-TDD128 ControlChannelDRXInfo-TDD128-r8  OPTIONAL,
  sps-Information-TDD128      SPS-Information-TDD128-r8        OPTIONAL,
  mu-MIMO-Info-TDD128        MU-MIMO-Info-TDD128            OPTIONAL,
-- MBMS IEs
  mbms-PL-ServiceRestrictInfo MBMS-PL-ServiceRestrictInfo-r6  OPTIONAL,
-- Measurement IEs for LCR
  cellDCHMeasOccasionInfo-TDD128 CellDCHMeasOccasionInfo-TDD128-r9  OPTIONAL
}
},
RadioBearerReconfiguration-r12-IEs ::= SEQUENCE {
-- User equipment IEs
  integrityProtectionModeInfo IntegrityProtectionModeInfo-r7  OPTIONAL,

```

```

    cipheringModeInfo          CipheringModeInfo-r7          OPTIONAL,
    activationTime             ActivationTime              OPTIONAL,
    delayRestrictionFlag      DelayRestrictionFlag  OPTIONAL,
    new-U-RNTI                 U-RNTI              OPTIONAL,
    new-C-RNTI                 C-RNTI              OPTIONAL,
    -- The IE "new-DSCH-RNTI" should not be included in FDD mode,
    -- and if received the UE behaviour is unspecified
    new-DSCH-RNTI             DSCH-RNTI              OPTIONAL,
    new-H-RNTI                 H-RNTI              OPTIONAL,
    newPrimary-E-RNTI         E-RNTI              OPTIONAL,
    newSecondary-E-RNTI       E-RNTI              OPTIONAL,
    rrc-StateIndicator        RRC-StateIndicator,
    ueMobilityStateIndicator  High-MobilityDetected  OPTIONAL,
    utran-DRX-CycleLengthCoeff  UTRAN-DRX-CycleLengthCoefficient-r7  OPTIONAL,
    accessGroupIdentity       AccessGroupIdentity    OPTIONAL,
-- Core network IEs
  cn-InformationInfo         CN-InformationInfo-r6  OPTIONAL,
-- UTRAN mobility IEs
  ura-Identity               URA-Identity          OPTIONAL,
  supportForChangeOfUE-Capability  BOOLEAN              OPTIONAL,
  responseToChangeOfUE-Capability  ENUMERATED { true }  OPTIONAL,
-- Specification mode information
  defaultConfigForCellFACH    DefaultConfigForCellFACH  OPTIONAL,
  specificationMode          CHOICE {
    complete                  SEQUENCE {
-- Radio bearer IEs
      rab-InformationReconfigList  RAB-InformationReconfigList-r8  OPTIONAL,
      rab-InformationMBMSPTpList  RAB-InformationMBMSPTpList      OPTIONAL,
      rb-InformationReconfigList  RB-InformationReconfigList-r11  OPTIONAL,
      rb-InformationAffectedList  RB-InformationAffectedList-r8   OPTIONAL,
      rb-PDCPContextRelocationList  RB-PDCPContextRelocationList  OPTIONAL,
      pdcp-ROHC-TargetMode        PDCP-ROHC-TargetMode          OPTIONAL,
      umRlc-ReEstablishmentRBList  RB-IdentityList               OPTIONAL,
-- Transport channel IEs
      ul-CommonTransChInfo        UL-CommonTransChInfo-r12        OPTIONAL,
      ul-deletedTransChInfoList    UL-DeletedTransChInfoList-r6    OPTIONAL,
      ul-AddReconfTransChInfoList  UL-AddReconfTransChInfoList-r8  OPTIONAL,
      dl-CommonTransChInfo        DL-CommonTransChInfo-r4        OPTIONAL,
      dl-DeletedTransChInfoList    DL-DeletedTransChInfoList-r7   OPTIONAL,
      dl-AddReconfTransChInfoList  DL-AddReconfTransChInfoList-r11  OPTIONAL
    },
    preconfiguration          SEQUENCE {
-- All IEs that include an FDD/TDD choice are split in two IEs for this message,
-- one for the FDD only elements and one for the TDD only elements, so that one
-- FDD/TDD choice in this level is sufficient.
      preConfigMode           CHOICE {
        predefinedConfigIdentity  PredefinedConfigIdentity,
        defaultConfig            SEQUENCE {
          defaultConfigMode      DefaultConfigMode,
          defaultConfigIdentity  DefaultConfigIdentity-r6
        }
      }
    }
  },
-- Physical channel IEs
  frequencyInfo              FrequencyInfo            OPTIONAL,
  multi-frequencyInfo        Multi-frequencyInfo-LCR-r7  OPTIONAL,
  dtx-drx-TimingInfo        DTX-DRX-TimingInfo-r7  OPTIONAL,
  dtx-drx-Info               DTX-DRX-Info-r12      OPTIONAL,
  hs-scch-LessInfo          HS-SCCH-LessInfo-r7    OPTIONAL,
  mimoParameters             MIMO-Parameters-r9     OPTIONAL,
  mimo4x4Parameters         MIMO4x4-Parameters     OPTIONAL,
  dch-Enhancements-Info-FDD  DCH-Enhancements-Info-FDD  OPTIONAL,
  maxAllowedUL-TX-Power      MaxAllowedUL-TX-Power  OPTIONAL,
  ul-DPCH-Info               UL-DPCH-Info-r11      OPTIONAL,
  ul-EDCH-Information        UL-EDCH-Information-r11  OPTIONAL,
  ul-SecondaryCellInfoFDD    UL-SecondaryCellInfoFDD-r12  OPTIONAL,
  ul-MulticarrierEDCHInfo-TDD128  UL-MulticarrierEDCHInfo-TDD128  OPTIONAL,
  ul-CLTD-InfoFDD           UL-CLTD-InfoFDD       OPTIONAL,
  ul-OLTD-InfoFDD           UL-OLTD-InfoFDD       OPTIONAL,
  ul-OtherTTIConfiguration-Info  UL-OtherTTIConfiguration-Information  OPTIONAL,
  filteredUPHReportInfo     FilteredUEPowerHeadroomReportInfo  OPTIONAL,
  dl-HSPDSCH-Information    DL-HSPDSCH-Information-r12  OPTIONAL,
  dl-CommonInformation       DL-CommonInformation-r12  OPTIONAL,
  dl-InformationPerRL-List   DL-InformationPerRL-List-r12  OPTIONAL,
  dl-SecondaryCellInfoFDD    DL-SecondaryCellInfoFDD-r11  OPTIONAL,
  additionalDLSecCellInfoListFDD  AdditionalDLSecCellInfoListFDD-r11  OPTIONAL,
  additionalDLSecCellInfoListFDD2  AdditionalDLSecCellInfoListFDD2  OPTIONAL,

```

```

        commonERGCHInfoFDD          CommonERGCHInfoFDD          OPTIONAL,
        dPCCH2InfoFDD                DPCCH2InfoFDD          OPTIONAL,
        controlChannelDRXInfo-TDD128 ControlChannelDRXInfo-TDD128-r8 OPTIONAL,
        sps-Information-TDD128        SPS-Information-TDD128-r8  OPTIONAL,
        mu-MIMO-Info-TDD128           MU-MIMO-Info-TDD128      OPTIONAL,
        nonrectResAllocInd-TDD128     Non-rectResAllocInd-TDD128 OPTIONAL,
        nonrectResSpecTSset-TDD128    Non-rectResSpecTSset-TDD128 OPTIONAL,
    -- MBMS IEs
        mbms-PL-ServiceRestrictInfo   MBMS-PL-ServiceRestrictInfo-r6 OPTIONAL,
    -- Measurement IEs for LCR
        cellDCHMeasOccasionInfo-TDD128 CellDCHMeasOccasionInfo-TDD128-r9 OPTIONAL
    }

-- *****
--
-- RADIO BEARER RECONFIGURATION COMPLETE
--
-- *****

RadioBearerReconfigurationComplete ::= SEQUENCE {
    -- User equipment IEs
    rrc-TransactionIdentifier          RRC-TransactionIdentifier,
    ul-IntegProtActivationInfo         IntegrityProtActivationInfo    OPTIONAL,
    -- TABULAR: UL-TimingAdvance is applicable for TDD mode only.
    ul-TimingAdvance                   UL-TimingAdvance              OPTIONAL,
    -- Radio bearer IEs
    count-C-ActivationTime              ActivationTime                  OPTIONAL,
    -- dummy is not used in this version of the specification and
    -- it should be ignored by the receiver.
    dummy                               RB-ActivationTimeInfoList     OPTIONAL,
    ul-CounterSynchronisationInfo       UL-CounterSynchronisationInfo OPTIONAL,
    laterNonCriticalExtensions           SEQUENCE {
        -- Container for additional R99 extensions
        radioBearerReconfigurationComplete-r3-add-ext    BIT STRING    OPTIONAL,
        v770NonCriticalExtensions                       SEQUENCE {
            radioBearerReconfigurationComplete-v770ext
                RadioBearerReconfigurationComplete-v770ext-IEs,
            nonCriticalExtensions                       SEQUENCE {} OPTIONAL
        } OPTIONAL
    } OPTIONAL
}

RadioBearerReconfigurationComplete-v770ext-IEs ::= SEQUENCE {
    -- TABULAR: EXT-UL-TimingAdvance is applicable for TDD mode only.
    ext-UL-TimingAdvance                EXT-UL-TimingAdvance          OPTIONAL,
    deferredMeasurementControlReading     ENUMERATED { true }          OPTIONAL
}

-- *****
--
-- RADIO BEARER RECONFIGURATION FAILURE
--
-- *****

RadioBearerReconfigurationFailure ::= SEQUENCE {
    -- User equipment IEs
    rrc-TransactionIdentifier            RRC-TransactionIdentifier,
    failureCause                         FailureCauseWithProtErr,
    -- Radio bearer IEs
    potentiallySuccessfulBearerList      RB-IdentityList               OPTIONAL,
    laterNonCriticalExtensions           SEQUENCE {
        -- Container for additional R99 extensions
        radioBearerReconfigurationFailure-r3-add-ext    BIT STRING    OPTIONAL,
        nonCriticalExtensions                       SEQUENCE {} OPTIONAL
    } OPTIONAL
}

-- *****
--
-- RADIO BEARER RELEASE
--
-- *****

RadioBearerRelease ::= CHOICE {
    r3                                     SEQUENCE {
        radioBearerRelease-r3            RadioBearerRelease-r3-IEs,
        v3a0NonCriticalExtensions         SEQUENCE {
            radioBearerRelease-v3a0ext    RadioBearerRelease-v3a0ext,

```

```

laterNonCriticalExtensions SEQUENCE {
  -- Container for additional R99 extensions
  radioBearerRelease-r3-add-ext BIT STRING OPTIONAL,
  v4b0NonCriticalExtensions SEQUENCE {
    radioBearerRelease-v4b0ext RadioBearerRelease-v4b0ext-IEs,
    v590NonCriticalExtensions SEQUENCE {
      radioBearerRelease-v590ext RadioBearerRelease-v590ext-IEs,
      v690NonCriticalExtensions SEQUENCE {
        radioBearerRelease-v690ext RadioBearerRelease-v690ext-IEs,
        v770NonCriticalExtensions SEQUENCE {
          radioBearerRelease-v770ext RadioBearerRelease-v770ext-IEs,
          nonCriticalExtensions SEQUENCE {} OPTIONAL
        } OPTIONAL
      } OPTIONAL
    } OPTIONAL
  } OPTIONAL
},
later-than-r3 SEQUENCE {
  rrc-TransactionIdentifier RRC-TransactionIdentifier,
  criticalExtensions CHOICE {
    r4 SEQUENCE {
      radioBearerRelease-r4 RadioBearerRelease-r4-IEs,
      v4d0NonCriticalExtensions SEQUENCE {
        -- Container for adding non critical extensions after freezing REL-5
        radioBearerRelease-r4-add-ext BIT STRING OPTIONAL,
        v590NonCriticalExtensions SEQUENCE {
          radioBearerRelease-v590ext RadioBearerRelease-v590ext-IEs,
          v690NonCriticalExtensions SEQUENCE {
            radioBearerRelease-v690ext RadioBearerRelease-v690ext-IEs,
            v770NonCriticalExtensions SEQUENCE {
              radioBearerRelease-v770ext RadioBearerRelease-v770ext-IEs,
              nonCriticalExtensions SEQUENCE {} OPTIONAL
            } OPTIONAL
          } OPTIONAL
        } OPTIONAL
      } OPTIONAL
    } OPTIONAL
  },
  criticalExtensions CHOICE {
    r5 SEQUENCE {
      radioBearerRelease-r5 RadioBearerRelease-r5-IEs,
      -- Container for adding non critical extensions after freezing REL-6
      radioBearerRelease-r5-add-ext BIT STRING OPTIONAL,
      v690NonCriticalExtensions SEQUENCE {
        radioBearerRelease-v690ext RadioBearerRelease-v690ext-IEs,
        v770NonCriticalExtensions SEQUENCE {
          radioBearerRelease-v770ext RadioBearerRelease-v770ext-IEs,
          nonCriticalExtensions SEQUENCE {} OPTIONAL
        } OPTIONAL
      } OPTIONAL
    },
    criticalExtensions CHOICE {
      r6 SEQUENCE {
        radioBearerRelease-r6 RadioBearerRelease-r6-IEs,
        -- Container for adding non critical extensions after freezing REL-7
        radioBearerRelease-r6-add-ext BIT STRING OPTIONAL,
        v6b0NonCriticalExtensions SEQUENCE {
          radioBearerRelease-v6b0ext RadioBearerRelease-v6b0ext-IEs,
          v770NonCriticalExtensions SEQUENCE {
            radioBearerRelease-v770ext RadioBearerRelease-v770ext-IEs,
            nonCriticalExtensions SEQUENCE {} OPTIONAL
          } OPTIONAL
        } OPTIONAL
      },
      criticalExtensions CHOICE {
        r7 SEQUENCE {
          radioBearerRelease-r7 RadioBearerRelease-r7-IEs,
          -- Container for adding non critical extensions after freezing REL-8
          radioBearerRelease-r7-add-ext BIT STRING OPTIONAL,
          v780NonCriticalExtensions SEQUENCE {
            radioBearerRelease-v780ext RadioBearerRelease-v780ext-IEs,
            v7d0NonCriticalExtensions SEQUENCE {
              radioBearerRelease-v7d0ext RadioBearerRelease-v7d0ext-IEs,
              v7f0NonCriticalExtensions SEQUENCE {
                radioBearerRelease-v7f0ext RadioBearerRelease-v7f0ext-IEs,
                v7g0NonCriticalExtensions SEQUENCE {
                  radioBearerRelease-v7g0ext
                }
              }
            }
          }
        }
      }
    }
  }

```

```

        nonCriticalExtensions      RadioBearerRelease-v7g0ext-IEs,
    } OPTIONAL                      SEQUENCE {}      OPTIONAL
    } OPTIONAL
    } OPTIONAL
    } OPTIONAL
},
criticalExtensions                CHOICE {
  r8                               SEQUENCE {
    radioBearerRelease-r8          RadioBearerRelease-r8-IEs,
    -- Container for adding non critical extensions after freezing REL-9
    radioBearerRelease-r8-add-ext  BIT STRING      OPTIONAL,
    v7d0NonCriticalExtensions      SEQUENCE {
      radioBearerRelease-v7d0ext   RadioBearerRelease-v7d0ext-IEs,
      v7f0NonCriticalExtensions    SEQUENCE {
        radioBearerRelease-v7f0ext RadioBearerRelease-v7f0ext-IEs,
        v890NonCriticalExtensions  SEQUENCE {
          radioBearerRelease-v890ext
          RadioBearerRelease-v890ext-IEs,
          v7g0NonCriticalExtensions SEQUENCE {
            radioBearerRelease-v7g0ext
            RadioBearerRelease-v7g0ext-IEs,
            v8a0NonCriticalExtensions SEQUENCE {
              radioBearerRelease-v8a0ext
              RadioBearerRelease-v8a0ext-IEs,
              nonCriticalExtensions SEQUENCE {}      OPTIONAL
            } OPTIONAL
          } OPTIONAL
        } OPTIONAL
      } OPTIONAL
    } OPTIONAL
  } OPTIONAL
},
criticalExtensions                CHOICE {
  r9                               SEQUENCE {
    radioBearerRelease-r9          RadioBearerRelease-r9-IEs,
    -- Container for adding non critical extensions after
    -- freezing REL-10
    radioBearerRelease-r9-add-ext  BIT STRING      OPTIONAL,
    v950NonCriticalExtensions      SEQUENCE {
      radioBearerRelease-v950ext   RadioBearerRelease-v950ext-IEs,
      v970NonCriticalExtensions    SEQUENCE {
        radioBearerRelease-v970ext RadioBearerRelease-v970ext-
        IEs,
        v9c0NonCriticalExtensions SEQUENCE {
          radioBearerRelease-v9c0ext RadioBearerRelease-
          v9c0ext-IEs,
          nonCriticalExtensions    SEQUENCE {}      OPTIONAL
        } OPTIONAL
      } OPTIONAL
    } OPTIONAL
  } OPTIONAL
},
criticalExtensions                CHOICE {
  r10                              SEQUENCE {
    radioBearerRelease-r10         RadioBearerRelease-r10-IEs,
    -- Container for adding non critical extensions after
    -- freezing REL-11
    radioBearerRelease-r10-add-ext BIT STRING      OPTIONAL,
    v9c0NonCriticalExtensions      SEQUENCE {
      radioBearerRelease-v9c0ext   RadioBearerRelease-
      v9c0ext-IEs,
      vb50NonCriticalExtensions    SEQUENCE {
        radioBearerRelease-vb50ext
        RadioBearerRelease-vb50ext-IEs,
        nonCriticalExtensions      SEQUENCE {}      OPTIONAL
      } OPTIONAL
    } OPTIONAL
  } OPTIONAL
},
criticalExtensions                CHOICE {
  r11                              SEQUENCE {
    radioBearerRelease-r11         RadioBearerRelease-r11-IEs,
    -- Container for adding non critical extensions after
    -- freezing REL-12
    radioBearerRelease-r11-add-ext BIT STRING      OPTIONAL,
    nonCriticalExtensions          SEQUENCE {}      OPTIONAL
  } OPTIONAL
},

```

```

    criticalExtensions CHOICE {
      r12 SEQUENCE {
        radioBearerRelease-r12
        RadioBearerRelease-r12-IEs,
        -- Container for adding non critical extensions
        -- after freezing REL-13
        radioBearerRelease-r11-add-ext
        nonCriticalExtensions BIT STRING OPTIONAL,
        SEQUENCE {} OPTIONAL
      },
      criticalExtensions SEQUENCE {}
    }
  }
}
}
}
}
}
}
}
}
}
}

RadioBearerRelease-r3-IEs ::= SEQUENCE {
  -- User equipment IEs
  rrc-TransactionIdentifier RRC-TransactionIdentifier,
  integrityProtectionModeInfo IntegrityProtectionModeInfo OPTIONAL,
  cipheringModeInfo CipheringModeInfo OPTIONAL,
  activationTime ActivationTime OPTIONAL,
  new-U-RNTI U-RNTI OPTIONAL,
  new-C-RNTI C-RNTI OPTIONAL,
  rrc-StateIndicator RRC-StateIndicator,
  utran-DRX-CycleLengthCoeff UTRAN-DRX-CycleLengthCoefficient OPTIONAL,
  -- Core network IEs
  cn-InformationInfo CN-InformationInfo OPTIONAL,
  signallingConnectionRelIndication CN-DomainIdentity OPTIONAL,
  -- UTRAN mobility IEs
  ura-Identity URA-Identity OPTIONAL,
  -- Radio bearer IEs
  rab-InformationReconfigList RAB-InformationReconfigList OPTIONAL,
  rb-InformationReleaseList RB-InformationReleaseList,
  rb-InformationAffectedList RB-InformationAffectedList OPTIONAL,
  dl-CounterSynchronisationInfo DL-CounterSynchronisationInfo OPTIONAL,
  -- Transport channel IEs
  ul-CommonTransChInfo UL-CommonTransChInfo OPTIONAL,
  ul-deletedTransChInfoList UL-DeletedTransChInfoList OPTIONAL,
  ul-AddReconfTransChInfoList UL-AddReconfTransChInfoList OPTIONAL,
  -- 'dummy', 'dummy1' and 'dummy2' are not used in this version of the specification,
  -- they should not be sent and if received they should be ignored.
  dummy CHOICE {
    fdd SEQUENCE {
      dummy1 CPCH-SetID OPTIONAL,
      dummy2 DRAC-StaticInformationList OPTIONAL
    },
    tdd NULL
  }
  dl-CommonTransChInfo DL-CommonTransChInfo OPTIONAL,
  dl-DeletedTransChInfoList DL-DeletedTransChInfoList OPTIONAL,
  dl-AddReconfTransChInfoList DL-AddReconfTransChInfo2List OPTIONAL,
  -- Physical channel IEs
  frequencyInfo FrequencyInfo OPTIONAL,
  maxAllowedUL-TX-Power MaxAllowedUL-TX-Power OPTIONAL,
  ul-ChannelRequirement UL-ChannelRequirement OPTIONAL,
  modeSpecificPhysChInfo CHOICE {
    fdd SEQUENCE {
      -- dummy is not used in this version of specification, it should
      -- not be sent and if received it should be ignored.
      dummy DL-PDSCH-Information OPTIONAL
    },
    tdd NULL
  },
  dl-CommonInformation DL-CommonInformation OPTIONAL,
  dl-InformationPerRL-List DL-InformationPerRL-List OPTIONAL
}

RadioBearerRelease-v3a0ext ::= SEQUENCE {
  -- The IE "new-DSCH-RNTI" should not be included in FDD mode, and if received the UE behaviour
  -- is unspecified

```



```

    new-DSCH-RNTI                DSCH-RNTI                OPTIONAL
}

RadioBearerRelease-v4b0ext-IEs ::= SEQUENCE {
    -- Physical channel IEs
    -- dummy is not used in this version of the specification, it should
    -- not be sent and if received it should be ignored.
    dummy                        SSDT-UL                OPTIONAL,
    -- The order of the RLs in IE cell-id-PerRL-List is the same as
    -- in IE DL-InformationPerRL-List included in this message
    cell-id-PerRL-List          CellIdentity-PerRL-List    OPTIONAL
}

RadioBearerRelease-v590ext-IEs ::= SEQUENCE {
    -- Physical channel IEs
    dl-TPC-PowerOffsetPerRL-List DL-TPC-PowerOffsetPerRL-List    OPTIONAL
}

RadioBearerRelease-r4-IEs ::= SEQUENCE {
    -- User equipment IEs
    integrityProtectionModeInfo IntegrityProtectionModeInfo    OPTIONAL,
    cipheringModeInfo          CipheringModeInfo                OPTIONAL,
    activationTime             ActivationTime                    OPTIONAL,
    new-U-RNTI                 U-RNTI                        OPTIONAL,
    new-C-RNTI                 C-RNTI                        OPTIONAL,
    -- The IE "new-DSCH-RNTI" should not be included in FDD mode, and if received
    -- the UE behaviour is unspecified
    new-DSCH-RNTI             DSCH-RNTI                    OPTIONAL,
    rrc-StateIndicator         RRC-StateIndicator,
    utran-DRX-CycleLengthCoeff UTRAN-DRX-CycleLengthCoefficient    OPTIONAL,
    -- Core network IEs
    cn-InformationInfo         CN-InformationInfo              OPTIONAL,
    signallingConnectionRelIndication CN-DomainIdentity        OPTIONAL,
    -- UTRAN mobility IEs
    ura-Identity               URA-Identity                    OPTIONAL,
    -- Radio bearer IEs
    rab-InformationReconfigList RAB-InformationReconfigList    OPTIONAL,
    rb-InformationReleaseList   RB-InformationReleaseList,
    rb-InformationAffectedList  RB-InformationAffectedList        OPTIONAL,
    dl-CounterSynchronisationInfo DL-CounterSynchronisationInfo    OPTIONAL,
    -- Transport channel IEs
    ul-CommonTransChInfo       UL-CommonTransChInfo-r4        OPTIONAL,
    ul-deletedTransChInfoList   UL-DeletedTransChInfoList    OPTIONAL,
    ul-AddReconfTransChInfoList UL-AddReconfTransChInfoList    OPTIONAL,
    -- 'dummy', 'dummy1' and 'dummy2' are not used in this version of the specification,
    -- they should not be sent and if received they should be ignored.
    dummy                       CHOICE {
        fdd                       SEQUENCE {
            dummy1                 CPCH-SetID                OPTIONAL,
            dummy2                 DRAC-StaticInformationList    OPTIONAL
        },
        tdd                       NULL
    }
    dl-CommonTransChInfo       DL-CommonTransChInfo-r4        OPTIONAL,
    dl-DeletedTransChInfoList   DL-DeletedTransChInfoList    OPTIONAL,
    dl-AddReconfTransChInfoList DL-AddReconfTransChInfoList-r4    OPTIONAL,
    -- Physical channel IEs
    frequencyInfo              FrequencyInfo                OPTIONAL,
    maxAllowedUL-TX-Power       MaxAllowedUL-TX-Power        OPTIONAL,
    ul-ChannelRequirement       UL-ChannelRequirement-r4        OPTIONAL,
    modeSpecificPhysChInfo      CHOICE {
        fdd                       SEQUENCE {
            -- dummy is not used in this version of specification, it should
            -- not be sent and if received it should be ignored.
            dummy                  DL-PDSCH-Information        OPTIONAL
        },
        tdd                       NULL
    },
    dl-CommonInformation        DL-CommonInformation-r4        OPTIONAL,
    dl-InformationPerRL-List     DL-InformationPerRL-List-r4    OPTIONAL
}

RadioBearerRelease-r5-IEs ::= SEQUENCE {
    -- User equipment IEs
    integrityProtectionModeInfo IntegrityProtectionModeInfo    OPTIONAL,
    cipheringModeInfo          CipheringModeInfo                OPTIONAL,
    activationTime             ActivationTime                    OPTIONAL,
    new-U-RNTI                 U-RNTI                        OPTIONAL,

```

```

new-C-RNTI                C-RNTI                OPTIONAL,
-- The IE "new-DSCH-RNTI should not be included in FDD mode,
-- and if received the UE behaviour is unspecified
new-DSCH-RNTI            DSCH-RNTI                OPTIONAL,
new-H-RNTI                H-RNTI                OPTIONAL,
rrc-StateIndicator        RRC-StateIndicator,
utran-DRX-CycleLengthCoeff  UTRAN-DRX-CycleLengthCoefficient  OPTIONAL,
-- Core network IEs
cn-InformationInfo        CN-InformationInfo        OPTIONAL,
signallingConnectionRelIndication  CN-DomainIdentity        OPTIONAL,
-- UTRAN mobility IEs
ura-Identity              URA-Identity              OPTIONAL,
-- Radio bearer IEs
rab-InformationReconfigList  RAB-InformationReconfigList  OPTIONAL,
rb-InformationReleaseList    RB-InformationReleaseList,
rb-InformationAffectedList    RB-InformationAffectedList-r5  OPTIONAL,
dl-CounterSynchronisationInfo  DL-CounterSynchronisationInfo-r5  OPTIONAL,
-- Transport channel IEs
ul-CommonTransChInfo        UL-CommonTransChInfo-r4        OPTIONAL,
ul-deletedTransChInfoList    UL-DeletedTransChInfoList      OPTIONAL,
ul-AddReconfTransChInfoList  UL-AddReconfTransChInfoList    OPTIONAL,
-- 'dummy', 'dummy1' and 'dummy2' are not used in this version of the specification,
-- they should not be sent and if received they should be ignored.
dummy                      CHOICE {
    fdd                      SEQUENCE {
        dummy1                CPCH-SetID                OPTIONAL,
        dummy2                DRAC-StaticInformationList  OPTIONAL
    },
    tdd                      NULL
}
dl-CommonTransChInfo        DL-CommonTransChInfo-r4        OPTIONAL,
dl-DeletedTransChInfoList    DL-DeletedTransChInfoList-r5    OPTIONAL,
dl-AddReconfTransChInfoList  DL-AddReconfTransChInfoList-r5  OPTIONAL,
-- Physical channel IEs
frequencyInfo              FrequencyInfo                OPTIONAL,
maxAllowedUL-TX-Power        MaxAllowedUL-TX-Power        OPTIONAL,
ul-ChannelRequirement        UL-ChannelRequirement-r5      OPTIONAL,
modeSpecificPhysChInfo      CHOICE {
    fdd                      SEQUENCE {
        -- dummy is not used in this version of specification, it should
        -- not be sent and if received it should be ignored.
        dummy                DL-PDSCH-Information        OPTIONAL
    },
    tdd                      NULL
},
dl-HSPDSCH-Information        DL-HSPDSCH-Information        OPTIONAL,
dl-CommonInformation        DL-CommonInformation-r5      OPTIONAL,
dl-InformationPerRL-List      DL-InformationPerRL-List-r5    OPTIONAL
}

RadioBearerRelease-v690ext-IEs ::= SEQUENCE {
-- Core network IEs
primary-plmn-Identity        PLMN-Identity                OPTIONAL,
-- Physical channel IEs
-- The IE harq-Preamble-Mode should not be used in the r3 and r4 versions of the message
-- If included in the r3 or r4 version of the message, the UE should ignore the IE
harq-Preamble-Mode          HARQ-Preamble-Mode            OPTIONAL,
beaconPLEst                 BEACON-PL-Est                OPTIONAL,
postVerificationPeriod        ENUMERATED { true }          OPTIONAL,
dhs-sync                     DHS-Sync                      OPTIONAL,
timingMaintainedSynchInd      TimingMaintainedSynchInd      OPTIONAL,
-- MBMS IEs
mbms-PL-ServiceRestrictInfo  MBMS-PL-ServiceRestrictInfo-r6  OPTIONAL,
mbms-RB-ListReleasedToChangeTransferMode  RB-InformationReleaseList  OPTIONAL
}

RadioBearerRelease-r6-IEs ::= SEQUENCE {
-- User equipment IEs
integrityProtectionModeInfo  IntegrityProtectionModeInfo    OPTIONAL,
cipheringModeInfo            CipheringModeInfo              OPTIONAL,
activationTime                ActivationTime                  OPTIONAL,
new-U-RNTI                    U-RNTI                        OPTIONAL,
new-C-RNTI                    C-RNTI                        OPTIONAL,
-- The IE "new-DSCH-RNTI" should not be included in FDD mode,
-- and if received the UE behaviour is unspecified
new-DSCH-RNTI                DSCH-RNTI                      OPTIONAL,
new-H-RNTI                    H-RNTI                        OPTIONAL,

```

```

    newPrimary-E-RNTI          E-RNTI          OPTIONAL,
    newSecondary-E-RNTI        E-RNTI          OPTIONAL,
    rrc-StateIndicator          RRC-StateIndicator,
    utran-DRX-CycleLengthCoeff UTRAN-DRX-CycleLengthCoefficient OPTIONAL,
-- Core network IEs
    cn-InformationInfo          CN-InformationInfo-r6    OPTIONAL,
    signallingConnectionRelIndication CN-DomainIdentity    OPTIONAL,
-- UTRAN mobility IEs
    ura-Identity                URA-Identity          OPTIONAL,
-- Radio bearer IEs
    rab-InformationReconfigList RAB-InformationReconfigList OPTIONAL,
    rb-InformationReleaseList   RB-InformationReleaseList,
    rb-InformationReconfigList  RB-InformationReconfigList-r6    OPTIONAL,
    rb-InformationAffectedList  RB-InformationAffectedList-r6    OPTIONAL,
    dl-CounterSynchronisationInfo DL-CounterSynchronisationInfo-r5 OPTIONAL,
-- Transport channel IEs
    ul-CommonTransChInfo       UL-CommonTransChInfo-r4    OPTIONAL,
    ul-deletedTransChInfoList  UL-DeletedTransChInfoList-r6   OPTIONAL,
    ul-AddReconfTransChInfoList UL-AddReconfTransChInfoList-r6  OPTIONAL,
    dl-CommonTransChInfo       DL-CommonTransChInfo-r4    OPTIONAL,
    dl-DeletedTransChInfoList  DL-DeletedTransChInfoList-r5   OPTIONAL,
    dl-AddReconfTransChInfoList DL-AddReconfTransChInfoList-r5  OPTIONAL,
-- Physical channel IEs
    frequencyInfo              FrequencyInfo          OPTIONAL,
    maxAllowedUL-TX-Power      MaxAllowedUL-TX-Power    OPTIONAL,
    ul-DPCH-Info               UL-DPCH-Info-r6         OPTIONAL,
    ul-EDCH-Information         UL-EDCH-Information-r6    OPTIONAL,
    dl-HSPDSCH-Information     DL-HSPDSCH-Information-r6  OPTIONAL,
    dl-CommonInformation       DL-CommonInformation-r6   OPTIONAL,
    dl-InformationPerRL-List    DL-InformationPerRL-List-r6  OPTIONAL,
-- MBMS IEs
    mbms-PL-ServiceRestrictInfo MBMS-PL-ServiceRestrictInfo-r6 OPTIONAL,
    mbms-RB-ListReleasedToChangeTransferMode
                                RB-InformationReleaseList    OPTIONAL
}

RadioBearerRelease-v6b0ext-IEs ::= SEQUENCE {
-- Physical channel IEs
    dl-InformationPerRL-List-v6b0ext DL-InformationPerRL-List-v6b0ext OPTIONAL
}

RadioBearerRelease-r7-IEs ::= SEQUENCE {
-- User equipment IEs
    integrityProtectionModeInfo IntegrityProtectionModeInfo-r7 OPTIONAL,
    cipheringModeInfo          CipheringModeInfo-r7        OPTIONAL,
    activationTime              ActivationTime              OPTIONAL,
    new-U-RNTI                  U-RNTI                    OPTIONAL,
    new-C-RNTI                  C-RNTI                    OPTIONAL,
    -- The IE "new-DSCH-RNTI" should not be included in FDD mode,
    -- and if received the UE behaviour is unspecified
    new-DSCH-RNTI              DSCH-RNTI                  OPTIONAL,
    new-H-RNTI                  H-RNTI                    OPTIONAL,
    newPrimary-E-RNTI          E-RNTI                    OPTIONAL,
    newSecondary-E-RNTI        E-RNTI                    OPTIONAL,
    rrc-StateIndicator          RRC-StateIndicator,
    ueMobilityStateIndicator    High-MobilityDetected     OPTIONAL,
    utran-DRX-CycleLengthCoeff UTRAN-DRX-CycleLengthCoefficient-r7 OPTIONAL,
-- Core network IEs
    cn-InformationInfo          CN-InformationInfo-r6    OPTIONAL,
    signallingConnectionRelIndication CN-DomainIdentity    OPTIONAL,
-- UTRAN mobility IEs
    ura-Identity                URA-Identity          OPTIONAL,
    supportForChangeOfUE-Capability BOOLEAN                OPTIONAL,
-- Radio bearer IEs
    rab-InformationReconfigList RAB-InformationReconfigList OPTIONAL,
    rb-InformationReleaseList   RB-InformationReleaseList,
    rb-InformationReconfigList  RB-InformationReconfigList-r7    OPTIONAL,
    rb-InformationAffectedList  RB-InformationAffectedList-r7    OPTIONAL,
    dl-CounterSynchronisationInfo DL-CounterSynchronisationInfo-r5 OPTIONAL,
-- Transport channel IEs
    ul-CommonTransChInfo       UL-CommonTransChInfo-r4    OPTIONAL,
    ul-deletedTransChInfoList  UL-DeletedTransChInfoList-r6   OPTIONAL,
    ul-AddReconfTransChInfoList UL-AddReconfTransChInfoList-r7  OPTIONAL,
    dl-CommonTransChInfo       DL-CommonTransChInfo-r4    OPTIONAL,
    dl-DeletedTransChInfoList  DL-DeletedTransChInfoList-r7   OPTIONAL,
    dl-AddReconfTransChInfoList DL-AddReconfTransChInfoList-r7  OPTIONAL,
-- Physical channel IEs
    frequencyInfo              FrequencyInfo          OPTIONAL,

```

```

multi-frequencyInfo          Multi-frequencyInfo-LCR-r7          OPTIONAL,
dtx-drx-TimingInfo          DTX-DRX-TimingInfo-r7          OPTIONAL,
dtx-drx-Info                DTX-DRX-Info-r7              OPTIONAL,
hs-scch-LessInfo            HS-SCCH-LessInfo-r7          OPTIONAL,
mimoParameters              MIMO-Parameters-r7          OPTIONAL,
maxAllowedUL-TX-Power       MaxAllowedUL-TX-Power        OPTIONAL,
ul-DPCH-Info                UL-DPCH-Info-r7              OPTIONAL,
ul-EDCH-Information         UL-EDCH-Information-r7       OPTIONAL,
dl-HSPDSCH-Information      DL-HSPDSCH-Information-r7    OPTIONAL,
dl-CommonInformation        DL-CommonInformation-r7      OPTIONAL,
dl-InformationPerRL-List    DL-InformationPerRL-List-r7  OPTIONAL,
-- MBMS IEs
  mbms-PL-ServiceRestrictInfo  MBMS-PL-ServiceRestrictInfo-r6  OPTIONAL,
  mbms-RB-ListReleasedToChangeTransferMode
                                RB-InformationReleaseList      OPTIONAL
}

RadioBearerRelease-v770ext-IEs ::= SEQUENCE {
  -- User equipment IEs
  ueMobilityStateIndicator      High-MobilityDetected          OPTIONAL
}

RadioBearerRelease-v780ext-IEs ::= SEQUENCE {
  -- Physical channel IEs
  hs-DSCH-TBSizeTable          HS-DSCH-TBSizeTable           OPTIONAL
}

RadioBearerRelease-v7d0ext-IEs ::= SEQUENCE {
  -- Physical channel IEs
  ul-EDCH-Information          UL-EDCH-Information-ext       OPTIONAL
}

RadioBearerRelease-v7f0ext-IEs ::= SEQUENCE {
  -- Physical channel IEs
  mimoParameters              MIMO-Parameters-v7f0ext       OPTIONAL
}

RadioBearerRelease-v7g0ext-IEs ::= SEQUENCE {
  -- Physical channel IEs
  mimoParameters              MIMO-Parameters-v7g0ext       OPTIONAL
}

RadioBearerRelease-r8-IEs ::= SEQUENCE {
  -- User equipment IEs
  integrityProtectionModeInfo  IntegrityProtectionModeInfo-r7  OPTIONAL,
  cipheringModeInfo           CipheringModeInfo-r7           OPTIONAL,
  activationTime              ActivationTime                   OPTIONAL,
  new-U-RNTI                  U-RNTI                         OPTIONAL,
  new-C-RNTI                  C-RNTI                         OPTIONAL,
  -- The IE "new-DSCH-RNTI" should not be included in FDD mode,
  -- and if received the UE behaviour is unspecified
  new-DSCH-RNTI              DSCH-RNTI                       OPTIONAL,
  new-H-RNTI                  H-RNTI                         OPTIONAL,
  newPrimary-E-RNTI          E-RNTI                         OPTIONAL,
  newSecondary-E-RNTI        E-RNTI                         OPTIONAL,
  rrc-StateIndicator          RRC-StateIndicator,
  ueMobilityStateIndicator      High-MobilityDetected          OPTIONAL,
  utran-DRX-CycleLengthCoeff  UTRAN-DRX-CycleLengthCoefficient-r7  OPTIONAL,
  -- Core network IEs
  cn-InformationInfo          CN-InformationInfo-r6          OPTIONAL,
  signallingConnectionRelIndication  CN-DomainIdentity             OPTIONAL,
  -- UTRAN mobility IEs
  ura-Identity                URA-Identity                   OPTIONAL,
  supportForChangeOfUE-Capability  BOOLEAN                       OPTIONAL,
  -- Radio bearer IEs
  rab-InformationReconfigList  RAB-InformationReconfigList-r8  OPTIONAL,
  rb-InformationReleaseList    RB-InformationReleaseList,
  rb-InformationReconfigList    RB-InformationReconfigList-r8  OPTIONAL,
  rb-InformationAffectedList    RB-InformationAffectedList-r8  OPTIONAL,
  dl-CounterSynchronisationInfo  DL-CounterSynchronisationInfo-r5  OPTIONAL,
  -- Transport channel IEs
  ul-CommonTransChInfo        UL-CommonTransChInfo-r4        OPTIONAL,
  ul-deletedTransChInfoList    UL-DeletedTransChInfoList-r6    OPTIONAL,
  ul-AddReconfTransChInfoList  UL-AddReconfTransChInfoList-r8  OPTIONAL,
  dl-CommonTransChInfo        DL-CommonTransChInfo-r4        OPTIONAL,
  dl-DeletedTransChInfoList    DL-DeletedTransChInfoList-r7    OPTIONAL,
  dl-AddReconfTransChInfoList  DL-AddReconfTransChInfoList-r7  OPTIONAL,
  -- Physical channel IEs

```

```

    frequencyInfo                FrequencyInfo                OPTIONAL,
    multi-frequencyInfo          Multi-frequencyInfo-LCR-r7  OPTIONAL,
    dtx-drx-TimingInfo          DTX-DRX-TimingInfo-r7      OPTIONAL,
    dtx-drx-Info                DTX-DRX-Info-r7           OPTIONAL,
    hs-scch-LessInfo            HS-SCCH-LessInfo-r7       OPTIONAL,
    mimoParameters              MIMO-Parameters-r8        OPTIONAL,
    maxAllowedUL-TX-Power       MaxAllowedUL-TX-Power     OPTIONAL,
    ul-DPCH-Info                UL-DPCH-Info-r7           OPTIONAL,
    ul-EDCH-Information          UL-EDCH-Information-r8    OPTIONAL,
    dl-HSPDSCH-Information       DL-HSPDSCH-Information-r8  OPTIONAL,
    dl-CommonInformation         DL-CommonInformation-r8    OPTIONAL,
    dl-InformationPerRL-List     DL-InformationPerRL-List-r8 OPTIONAL,
    dl-SecondaryCellInfoFDD     DL-SecondaryCellInfoFDD   OPTIONAL,
    controlChannelDRXInfo-TDD128 ControlChannelDRXInfo-TDD128-r8 OPTIONAL,
    sps-Information-TDD128      SPS-Information-TDD128-r8  OPTIONAL,
-- MBMS IEs
    mbms-PL-ServiceRestrictInfo MBMS-PL-ServiceRestrictInfo-r6 OPTIONAL,
    mbms-RB-ListReleasedToChangeTransferMode
                                RB-InformationReleaseList  OPTIONAL
}

RadioBearerRelease-v890ext-IEs ::= SEQUENCE {
-- Physical channel IEs
    dl-SecondaryCellInfoFDD-v890ext DL-SecondaryCellInfoFDD-v890ext OPTIONAL,
    dl-HSPDSCH-Information          DL-HSPDSCH-Information-r8-ext OPTIONAL
}

RadioBearerRelease-v8a0ext-IEs ::= SEQUENCE {
-- Physical channel IEs
    dl-HSPDSCH-Information          DL-HSPDSCH-Information-r8-ext2 OPTIONAL
}

RadioBearerRelease-r9-IEs ::= SEQUENCE {
-- User equipment IEs
    integrityProtectionModeInfo    IntegrityProtectionModeInfo-r7  OPTIONAL,
    cipheringModeInfo              CipheringModeInfo-r7            OPTIONAL,
    activationTime                  ActivationTime                    OPTIONAL,
    new-U-RNTI                      U-RNTI                          OPTIONAL,
    new-C-RNTI                      C-RNTI                          OPTIONAL,
-- The IE "new-DSCH-RNTI" should not be included in FDD mode,
-- and if received the UE behaviour is unspecified
    new-DSCH-RNTI                  DSCH-RNTI                        OPTIONAL,
    new-H-RNTI                      H-RNTI                          OPTIONAL,
    newPrimary-E-RNTI              E-RNTI                          OPTIONAL,
    newSecondary-E-RNTI            E-RNTI                          OPTIONAL,
    rrc-StateIndicator              RRC-StateIndicator,
    ueMobilityStateIndicator        High-MobilityDetected            OPTIONAL,
    utran-DRX-CycleLengthCoeff     UTRAN-DRX-CycleLengthCoefficient-r7 OPTIONAL,
-- Core network IEs
    cn-InformationInfo              CN-InformationInfo-r6           OPTIONAL,
    signallingConnectionRelIndication CN-DomainIdentity              OPTIONAL,
-- UTRAN mobility IEs
    ura-Identity                    URA-Identity                    OPTIONAL,
    supportForChangeOfUE-Capability BOOLEAN                          OPTIONAL,
-- Radio bearer IEs
    rab-InformationReconfigList     RAB-InformationReconfigList-r8  OPTIONAL,
    rb-InformationReleaseList       RB-InformationReleaseList,
    rb-InformationReconfigList     RB-InformationReconfigList-r8   OPTIONAL,
    rb-InformationAffectedList      RB-InformationAffectedList-r8   OPTIONAL,
    dl-CounterSynchronisationInfo  DL-CounterSynchronisationInfo-r5 OPTIONAL,
-- Transport channel IEs
    ul-CommonTransChInfo           UL-CommonTransChInfo-r4        OPTIONAL,
    ul-deletedTransChInfoList       UL-DeletedTransChInfoList-r6   OPTIONAL,
    ul-AddReconfTransChInfoList     UL-AddReconfTransChInfoList-r8  OPTIONAL,
    dl-CommonTransChInfo           DL-CommonTransChInfo-r4        OPTIONAL,
    dl-DeletedTransChInfoList       DL-DeletedTransChInfoList-r7   OPTIONAL,
    dl-AddReconfTransChInfoList     DL-AddReconfTransChInfoList-r9  OPTIONAL,
-- Physical channel IEs
    frequencyInfo                FrequencyInfo                OPTIONAL,
    multi-frequencyInfo          Multi-frequencyInfo-LCR-r7  OPTIONAL,
    dtx-drx-TimingInfo          DTX-DRX-TimingInfo-r7      OPTIONAL,
    dtx-drx-Info                DTX-DRX-Info-r7           OPTIONAL,
    hs-scch-LessInfo            HS-SCCH-LessInfo-r7       OPTIONAL,
    mimoParameters              MIMO-Parameters-r9        OPTIONAL,
    maxAllowedUL-TX-Power       MaxAllowedUL-TX-Power     OPTIONAL,
    ul-DPCH-Info                UL-DPCH-Info-r7           OPTIONAL,
    ul-EDCH-Information          UL-EDCH-Information-r9    OPTIONAL,
    ul-SecondaryCellInfoFDD     UL-SecondaryCellInfoFDD   OPTIONAL,

```

```

dl-HSPDSCH-Information          DL-HSPDSCH-Information-r9          OPTIONAL,
dl-CommonInformation            DL-CommonInformation-r8           OPTIONAL,
dl-InformationPerRL-List        DL-InformationPerRL-List-r8       OPTIONAL,
dl-SecondaryCellInfoFDD        DL-SecondaryCellInfoFDD-r9        OPTIONAL,
controlChannelDRXInfo-TDD128    ControlChannelDRXInfo-TDD128-r8  OPTIONAL,
sps-Information-TDD128          SPS-Information-TDD128-r8        OPTIONAL,
-- MBMS IEs
  mbms-PL-ServiceRestrictInfo    MBMS-PL-ServiceRestrictInfo-r6   OPTIONAL,
  mbms-RB-ListReleasedToChangeTransferMode
                                  RB-InformationReleaseList        OPTIONAL
}

RadioBearerRelease-v950ext-IEs ::= SEQUENCE {
  -- Physical channel IEs
  secondaryCellMimoParameters      SecondaryCellMIMOparametersFDD-v950ext  OPTIONAL
}

RadioBearerRelease-v970ext-IEs ::= SEQUENCE {
  -- Measurement IEs for LCR
  cellDCHMeasOccasionInfo-TDD128  CellDCHMeasOccasionInfo-TDD128-r9  OPTIONAL
}

RadioBearerRelease-v9c0ext-IEs ::= SEQUENCE {
  -- For 1.28Mcps TDD only
  dl-AddReconfTransChInfoList      DL-AddReconfTransChInfoList-TDD128-v9c0ext  OPTIONAL
}

RadioBearerRelease-r10-IEs ::= SEQUENCE {
  -- User equipment IEs
  integrityProtectionModeInfo      IntegrityProtectionModeInfo-r7      OPTIONAL,
  cipheringModeInfo                CipheringModeInfo-r7                 OPTIONAL,
  activationTime                    ActivationTime                         OPTIONAL,
  new-U-RNTI                        U-RNTI                              OPTIONAL,
  new-C-RNTI                        C-RNTI                              OPTIONAL,
  -- The IE "new-DSCH-RNTI" should not be included in FDD mode,
  -- and if received the UE behaviour is unspecified
  new-DSCH-RNTI                    DSCH-RNTI                           OPTIONAL,
  new-H-RNTI                        H-RNTI                              OPTIONAL,
  newPrimary-E-RNTI                 E-RNTI                              OPTIONAL,
  newSecondary-E-RNTI               E-RNTI                              OPTIONAL,
  rrc-StateIndicator                RRC-StateIndicator,
  ueMobilityStateIndicator           High-MobilityDetected                OPTIONAL,
  utran-DRX-CycleLengthCoeff        UTRAN-DRX-CycleLengthCoefficient-r7  OPTIONAL,
  -- Core network IEs
  cn-InformationInfo                CN-InformationInfo-r6                OPTIONAL,
  signallingConnectionRelIndication CN-DomainIdentity                   OPTIONAL,
  -- UTRAN mobility IEs
  ura-Identity                      URA-Identity                         OPTIONAL,
  supportForChangeOfUE-Capability    BOOLEAN                              OPTIONAL,
  -- Radio bearer IEs
  rab-InformationReconfigList        RAB-InformationReconfigList-r8       OPTIONAL,
  rb-InformationReleaseList          RB-InformationReleaseList,
  rb-InformationReconfigList        RB-InformationReconfigList-r8       OPTIONAL,
  rb-InformationAffectedList        RB-InformationAffectedList-r8       OPTIONAL,
  dl-CounterSynchronisationInfo      DL-CounterSynchronisationInfo-r5    OPTIONAL,
  -- Transport channel IEs
  ul-CommonTransChInfo              UL-CommonTransChInfo-r4             OPTIONAL,
  ul-deletedTransChInfoList          UL-DeletedTransChInfoList-r6        OPTIONAL,
  ul-AddReconfTransChInfoList        UL-AddReconfTransChInfoList-r8     OPTIONAL,
  dl-CommonTransChInfo              DL-CommonTransChInfo-r4            OPTIONAL,
  dl-DeletedTransChInfoList          DL-DeletedTransChInfoList-r7       OPTIONAL,
  dl-AddReconfTransChInfoList        DL-AddReconfTransChInfoList-r9     OPTIONAL,
  -- Physical channel IEs
  frequencyInfo                     FrequencyInfo                         OPTIONAL,
  multi-frequencyInfo                Multi-frequencyInfo-LCR-r7          OPTIONAL,
  dtx-drx-TimingInfo                DTX-DRX-TimingInfo-r7              OPTIONAL,
  dtx-drx-Info                      DTX-DRX-Info-r7                    OPTIONAL,
  hs-scch-LessInfo                  HS-SCCH-LessInfo-r7                OPTIONAL,
  mimoParameters                    MIMO-Parameters-r9                 OPTIONAL,
  maxAllowedUL-TX-Power              MaxAllowedUL-TX-Power               OPTIONAL,
  ul-DPCH-Info                      UL-DPCH-Info-r7                    OPTIONAL,
  ul-EDCH-Information                UL-EDCH-Information-r9              OPTIONAL,
  ul-SecondaryCellInfoFDD            UL-SecondaryCellInfoFDD             OPTIONAL,
  ul-MulticarrierEDCHInfo-TDD128     UL-MulticarrierEDCHInfo-TDD128     OPTIONAL,
  dl-HSPDSCH-Information            DL-HSPDSCH-Information-r9          OPTIONAL,
  dl-CommonInformation              DL-CommonInformation-r10            OPTIONAL,
  dl-InformationPerRL-List           DL-InformationPerRL-List-r8         OPTIONAL,
  dl-SecondaryCellInfoFDD            DL-SecondaryCellInfoFDD-r10        OPTIONAL,

```

```

        additionalDLSecCellInfoListFDD AdditionalDLSecCellInfoListFDD OPTIONAL,
        controlChannelDRXInfo-TDD128 ControlChannelDRXInfo-TDD128-r8 OPTIONAL,
        sps-Information-TDD128 SPS-Information-TDD128-r8 OPTIONAL,
        mu-MIMO-Info-TDD128 MU-MIMO-Info-TDD128 OPTIONAL,
    -- MBMS IEs
        mbms-PL-ServiceRestrictInfo MBMS-PL-ServiceRestrictInfo-r6 OPTIONAL,
        mbms-RB-ListReleasedToChangeTransferMode RB-InformationReleaseList OPTIONAL,
    -- Measurement IEs for LCR
        cellDCHMeasOccasionInfo-TDD128 CellDCHMeasOccasionInfo-TDD128-r9 OPTIONAL
    }

RadioBearerRelease-vb50ext-IEs ::= SEQUENCE {
    ulOLTDInfoFDD UL-OLTD-InfoFDD OPTIONAL
}

RadioBearerRelease-r11-IEs ::= SEQUENCE {
    -- User equipment IEs
        integrityProtectionModeInfo IntegrityProtectionModeInfo-r7 OPTIONAL,
        cipheringModeInfo CipheringModeInfo-r7 OPTIONAL,
        activationTime ActivationTime OPTIONAL,
        new-U-RNTI U-RNTI OPTIONAL,
        new-C-RNTI C-RNTI OPTIONAL,
        -- The IE "new-DSCH-RNTI" should not be included in FDD mode,
        -- and if received the UE behaviour is unspecified
        new-DSCH-RNTI DSCH-RNTI OPTIONAL,
        new-H-RNTI H-RNTI OPTIONAL,
        newPrimary-E-RNTI E-RNTI OPTIONAL,
        newSecondary-E-RNTI E-RNTI OPTIONAL,
        rrc-StateIndicator RRC-StateIndicator,
        ueMobilityStateIndicator High-MobilityDetected OPTIONAL,
        utran-DRX-CycleLengthCoeff UTRAN-DRX-CycleLengthCoefficient-r7 OPTIONAL,
    -- Core network IEs
        cn-InformationInfo CN-InformationInfo-r6 OPTIONAL,
        signallingConnectionRelIndication CN-DomainIdentity OPTIONAL,
    -- UTRAN mobility IEs
        ura-Identity URA-Identity OPTIONAL,
        supportForChangeOfUE-Capability BOOLEAN OPTIONAL,
    -- Radio bearer IEs
        rab-InformationReconfigList RAB-InformationReconfigList-r8 OPTIONAL,
        rb-InformationReleaseList RB-InformationReleaseList,
        rb-InformationReconfigList RB-InformationReconfigList-r11 OPTIONAL,
        rb-InformationAffectedList RB-InformationAffectedList-r8 OPTIONAL,
        dl-CounterSynchronisationInfo DL-CounterSynchronisationInfo-r5 OPTIONAL,
    -- Transport channel IEs
        ul-CommonTransChInfo UL-CommonTransChInfo-r4 OPTIONAL,
        ul-deletedTransChInfoList UL-DeletedTransChInfoList-r6 OPTIONAL,
        ul-AddReconfTransChInfoList UL-AddReconfTransChInfoList-r8 OPTIONAL,
        dl-CommonTransChInfo DL-CommonTransChInfo-r4 OPTIONAL,
        dl-DeletedTransChInfoList DL-DeletedTransChInfoList-r7 OPTIONAL,
        dl-AddReconfTransChInfoList DL-AddReconfTransChInfoList-r11 OPTIONAL,
    -- Physical channel IEs
        frequencyInfo FrequencyInfo OPTIONAL,
        multi-frequencyInfo Multi-frequencyInfo-LCR-r7 OPTIONAL,
        dtx-drx-TimingInfo DTX-DRX-TimingInfo-r7 OPTIONAL,
        dtx-drx-Info DTX-DRX-Info-r7 OPTIONAL,
        hs-scch-LessInfo HS-SCCH-LessInfo-r7 OPTIONAL,
        mimoParameters MIMO-Parameters-r9 OPTIONAL,
        mimo4x4Parameters MIMO4x4-Parameters OPTIONAL,
        maxAllowedUL-TX-Power MaxAllowedUL-TX-Power OPTIONAL,
        ul-DPCH-Info UL-DPCH-Info-r11 OPTIONAL,
        ul-EDCH-Information UL-EDCH-Information-r11 OPTIONAL,
        ul-SecondaryCellInfoFDD UL-SecondaryCellInfoFDD OPTIONAL,
        ul-MulticarrierEDCHInfo-TDD128 UL-MulticarrierEDCHInfo-TDD128 OPTIONAL,
        ul-CLTD-InfoFDD UL-CLTD-InfoFDD OPTIONAL,
        ul-OLTD-InfoFDD UL-OLTD-InfoFDD OPTIONAL,
        dl-HSPDSCH-Information DL-HSPDSCH-Information-r11 OPTIONAL,
        dl-CommonInformation DL-CommonInformation-r11 OPTIONAL,
        dl-InformationPerRL-List DL-InformationPerRL-List-r11 OPTIONAL,
        dl-SecondaryCellInfoFDD DL-SecondaryCellInfoFDD-r11 OPTIONAL,
        additionalDLSecCellInfoListFDD AdditionalDLSecCellInfoListFDD-r11 OPTIONAL,
        additionalDLSecCellInfoListFDD2 AdditionalDLSecCellInfoListFDD2 OPTIONAL,
        commonERGCHInfoFDD CommonERGCHInfoFDD OPTIONAL,
        controlChannelDRXInfo-TDD128 ControlChannelDRXInfo-TDD128-r8 OPTIONAL,
        sps-Information-TDD128 SPS-Information-TDD128-r8 OPTIONAL,
        mu-MIMO-Info-TDD128 MU-MIMO-Info-TDD128 OPTIONAL,
    -- MBMS IEs
        mbms-PL-ServiceRestrictInfo MBMS-PL-ServiceRestrictInfo-r6 OPTIONAL,

```

```

    mbms-RB-ListReleasedToChangeTransferMode
    RB-InformationReleaseList OPTIONAL,
-- Measurement IEs for LCR
    cellDCHMeasOccasionInfo-TDD128 CellDCHMeasOccasionInfo-TDD128-r9 OPTIONAL
}

RadioBearerRelease-r12-IEs ::= SEQUENCE {
-- User equipment IEs
    integrityProtectionModeInfo IntegrityProtectionModeInfo-r7 OPTIONAL,
    cipheringModeInfo CipheringModeInfo-r7 OPTIONAL,
    activationTime ActivationTime OPTIONAL,
    new-U-RNTI U-RNTI OPTIONAL,
    new-C-RNTI C-RNTI OPTIONAL,
-- The IE "new-DSCH-RNTI" should not be included in FDD mode,
-- and if received the UE behaviour is unspecified
    new-DSCH-RNTI DSCH-RNTI OPTIONAL,
    new-H-RNTI H-RNTI OPTIONAL,
    newPrimary-E-RNTI E-RNTI OPTIONAL,
    newSecondary-E-RNTI E-RNTI OPTIONAL,
    rrc-StateIndicator RRC-StateIndicator,
    ueMobilityStateIndicator High-MobilityDetected OPTIONAL,
    utran-DRX-CycleLengthCoeff UTRAN-DRX-CycleLengthCoefficient-r7 OPTIONAL,
    accessGroupIdentity AccessGroupIdentity OPTIONAL,
-- Core network IEs
    cn-InformationInfo CN-InformationInfo-r6 OPTIONAL,
    signallingConnectionRelIndication CN-DomainIdentity OPTIONAL,
-- UTRAN mobility IEs
    ura-Identity URA-Identity OPTIONAL,
    supportForChangeOfUE-Capability BOOLEAN OPTIONAL,
-- Radio bearer IEs
    rab-InformationReconfigList RAB-InformationReconfigList-r8 OPTIONAL,
    rb-InformationReleaseList RB-InformationReleaseList,
    rb-InformationReconfigList RB-InformationReconfigList-r11 OPTIONAL,
    rb-InformationAffectedList RB-InformationAffectedList-r8 OPTIONAL,
    dl-CounterSynchronisationInfo DL-CounterSynchronisationInfo-r5 OPTIONAL,
-- Transport channel IEs
    ul-CommonTransChInfo UL-CommonTransChInfo-r12 OPTIONAL,
    ul-deletedTransChInfoList UL-DeletedTransChInfoList-r6 OPTIONAL,
    ul-AddReconfTransChInfoList UL-AddReconfTransChInfoList-r8 OPTIONAL,
    dl-CommonTransChInfo DL-CommonTransChInfo-r4 OPTIONAL,
    dl-DeletedTransChInfoList DL-DeletedTransChInfoList-r7 OPTIONAL,
    dl-AddReconfTransChInfoList DL-AddReconfTransChInfoList-r11 OPTIONAL,
-- Physical channel IEs
    frequencyInfo FrequencyInfo OPTIONAL,
    multi-frequencyInfo Multi-frequencyInfo-LCR-r7 OPTIONAL,
    dtx-drx-TimingInfo DTX-DRX-TimingInfo-r7 OPTIONAL,
    dtx-drx-Info DTX-DRX-Info-r12 OPTIONAL,
    hs-scch-LessInfo HS-SCCH-LessInfo-r7 OPTIONAL,
    mimoParameters MIMO-Parameters-r9 OPTIONAL,
    mimo4x4Parameters MIMO4x4-Parameters OPTIONAL,
    dch-Enhancements-Info-FDD DCH-Enhancements-Info-FDD OPTIONAL,
    maxAllowedUL-TX-Power MaxAllowedUL-TX-Power OPTIONAL,
    ul-DPCH-Info UL-DPCH-Info-r11 OPTIONAL,
    ul-EDCH-Information UL-EDCH-Information-r11 OPTIONAL,
    ul-SecondaryCellInfoFDD UL-SecondaryCellInfoFDD-r12 OPTIONAL,
    ul-MulticarrierEDCHInfo-TDD128 UL-MulticarrierEDCHInfo-TDD128 OPTIONAL,
    ul-CLTD-InfoFDD UL-CLTD-InfoFDD OPTIONAL,
    ul-OLTD-InfoFDD UL-OLTD-InfoFDD OPTIONAL,
    ul-OtherTTIConfiguration-Info UL-OtherTTIConfiguration-Information OPTIONAL,
    filteredUPHReportInfo FilteredUEPowerHeadroomReportInfo OPTIONAL,
    dl-HSPDSCH-Information DL-HSPDSCH-Information-r12 OPTIONAL,
    dl-CommonInformation DL-CommonInformation-r12 OPTIONAL,
    dl-InformationPerRL-List DL-InformationPerRL-List-r12 OPTIONAL,
    dl-SecondaryCellInfoFDD DL-SecondaryCellInfoFDD-r11 OPTIONAL,
    additionalDLSecCellInfoListFDD AdditionalDLSecCellInfoListFDD-r11 OPTIONAL,
    additionalDLSecCellInfoListFDD2 AdditionalDLSecCellInfoListFDD2 OPTIONAL,
    commonERGCHInfoFDD CommonERGCHInfoFDD OPTIONAL,
    controlChannelDRXInfo-TDD128 ControlChannelDRXInfo-TDD128-r8 OPTIONAL,
    sps-Information-TDD128 SPS-Information-TDD128-r8 OPTIONAL,
    mu-MIMO-Info-TDD128 MU-MIMO-Info-TDD128 OPTIONAL,
    non-rectResAllocInd-TDD128 Non-rectResAllocInd-TDD128 OPTIONAL,
    non-rectResSpecTSset-TDD128 Non-rectResSpecTSset-TDD128 OPTIONAL,
-- MBMS IEs
    mbms-PL-ServiceRestrictInfo MBMS-PL-ServiceRestrictInfo-r6 OPTIONAL,
    mbms-RB-ListReleasedToChangeTransferMode RB-InformationReleaseList OPTIONAL,
-- Measurement IEs for LCR
    cellDCHMeasOccasionInfo-TDD128 CellDCHMeasOccasionInfo-TDD128-r9 OPTIONAL
}

```



```

}
-- *****
--
-- RADIO BEARER RELEASE COMPLETE
--
-- *****

RadioBearerReleaseComplete ::= SEQUENCE {
  -- User equipment IEs
  rrc-TransactionIdentifier      RRC-TransactionIdentifier,
  ul-IntegProtActivationInfo     IntegrityProtActivationInfo      OPTIONAL,
  -- TABULAR: UL-TimingAdvance is applicable for TDD mode only.
  ul-TimingAdvance              UL-TimingAdvance                OPTIONAL,
  -- Radio bearer IEs
  count-C-ActivationTime        ActivationTime                OPTIONAL,
  -- dummy is not used in this version of the specification and
  -- it should be ignored by the receiver.
  dummy                         RB-ActivationTimeInfoList     OPTIONAL,
  ul-CounterSynchronisationInfo UL-CounterSynchronisationInfo  OPTIONAL,
  laterNonCriticalExtensions     SEQUENCE {
    -- Container for additional R99 extensions
    radioBearerReleaseComplete-r3-add-ext  BIT STRING      OPTIONAL,
    v770NonCriticalExtensions              SEQUENCE {
      radioBearerReleaseComplete-v770ext
      RadioBearerReleaseComplete-v770ext-IEs,
      nonCriticalExtensions                SEQUENCE {}    OPTIONAL
    } OPTIONAL
  } OPTIONAL
}

RadioBearerReleaseComplete-v770ext-IEs ::= SEQUENCE {
  -- TABULAR: EXT-UL-TimingAdvance is applicable for TDD mode only.
  ext-UL-TimingAdvance          EXT-UL-TimingAdvance    OPTIONAL,
  deferredMeasurementControlReading  ENUMERATED { true }    OPTIONAL
}

-- *****
--
-- RADIO BEARER RELEASE FAILURE
--
-- *****

RadioBearerReleaseFailure ::= SEQUENCE {
  -- User equipment IEs
  rrc-TransactionIdentifier      RRC-TransactionIdentifier,
  failureCause                  FailureCauseWithProtErr,
  -- Radio bearer IEs
  potentiallySuccessfulBearerList  RB-IdentityList          OPTIONAL,
  laterNonCriticalExtensions       SEQUENCE {
    -- Container for additional R99 extensions
    radioBearerReleaseFailure-r3-add-ext  BIT STRING      OPTIONAL,
    nonCriticalExtensions                SEQUENCE {}    OPTIONAL
  } OPTIONAL
}

-- *****
--
-- RADIO BEARER SETUP
--
-- *****

RadioBearerSetup ::= CHOICE {
  r3                             SEQUENCE {
    radioBearerSetup-r3          RadioBearerSetup-r3-IEs,
    v3a0NonCriticalExtensions     SEQUENCE {
      radioBearerSetup-v3a0ext    RadioBearerSetup-v3a0ext,
      laterNonCriticalExtensions  SEQUENCE {
        -- Container for additional R99 extensions
        radioBearerSetup-r3-add-ext  BIT STRING      OPTIONAL,
        v4b0NonCriticalExtensions    SEQUENCE {
          radioBearerSetup-v4b0ext    RadioBearerSetup-v4b0ext-IEs,
          v590NonCriticalExtensions    SEQUENCE {
            radioBearerSetup-v590ext  RadioBearerSetup-v590ext-IEs,
            v5d0NonCriticalExtensions SEQUENCE {
              radioBearerSetup-v5d0ext RadioBearerSetup-v5d0ext-IEs,
              v690NonCriticalExtensions SEQUENCE {
                radioBearerSetup-v690ext  RadioBearerSetup-v690ext-IEs,

```

```

        nonCriticalExtensions          SEQUENCE {} OPTIONAL
    } OPTIONAL
} OPTIONAL
} OPTIONAL
} OPTIONAL
},
later-than-r3          SEQUENCE {
    rrc-TransactionIdentifier          RRC-TransactionIdentifier,
    criticalExtensions                CHOICE {
        r4                          SEQUENCE {
            radioBearerSetup-r4          RadioBearerSetup-r4-IEs,
            v4d0NonCriticalExtensions    SEQUENCE {
                -- Container for adding non critical extensions after freezing REL-5
                radioBearerSetup-r4-add-ext BIT STRING OPTIONAL,
                v590NonCriticalExtensions    SEQUENCE {
                    radioBearerSetup-v590ext RadioBearerSetup-v590ext-IEs,
                    v5d0NonCriticalExtensstions SEQUENCE {
                        radioBearerSetup-v5d0ext RadioBearerSetup-v5d0ext-IEs,
                        v690NonCriticalExtensions SEQUENCE {
                            radioBearerSetup-v690ext RadioBearerSetup-v690ext-IEs,
                            nonCriticalExtensions SEQUENCE {} OPTIONAL
                        } OPTIONAL
                    } OPTIONAL
                } OPTIONAL
            } OPTIONAL
        } OPTIONAL
    },
    criticalExtensions                CHOICE {
        r5                          SEQUENCE {
            radioBearerSetup-r5          RadioBearerSetup-r5-IEs,
            -- Container for adding non critical extensions after freezing REL-6
            radioBearerSetup-r5-add-ext BIT STRING OPTIONAL,
            v5d0NonCriticalExtensstions SEQUENCE {
                radioBearerSetup-v5d0ext RadioBearerSetup-v5d0ext-IEs,
                v690NonCriticalExtensions SEQUENCE {
                    radioBearerSetup-v690ext RadioBearerSetup-v690ext-IEs,
                    nonCriticalExtensions SEQUENCE {} OPTIONAL
                } OPTIONAL
            } OPTIONAL
        } OPTIONAL
    },
    criticalExtensions                CHOICE {
        r6                          SEQUENCE {
            radioBearerSetup-r6          RadioBearerSetup-r6-IEs,
            -- Container for adding non critical extensions after freezing REL-7
            radioBearerSetup-r6-add-ext BIT STRING OPTIONAL,
            v6b0NonCriticalExtensions    SEQUENCE {
                radioBearerSetup-v6b0ext RadioBearerSetup-v6b0ext-IEs,
                nonCriticalExtensions SEQUENCE {} OPTIONAL
            } OPTIONAL
        } OPTIONAL
    },
    criticalExtensions                CHOICE {
        r7                          SEQUENCE {
            radioBearerSetup-r7          RadioBearerSetup-r7-IEs,
            -- Container for adding non critical extensions after freezing REL-8
            radioBearerSetup-r7-add-ext BIT STRING
                (CONTAINING RadioBearerSetup-r7-add-ext-IEs) OPTIONAL,
            v780NonCriticalExtensions    SEQUENCE {
                radioBearerSetup-v780ext RadioBearerSetup-v780ext-IEs,
                v820NonCriticalExtensions SEQUENCE {
                    radioBearerSetup-v820ext RadioBearerSetup-v820ext-IEs,
                    nonCriticalExtensions SEQUENCE {} OPTIONAL
                } OPTIONAL
            } OPTIONAL
        } OPTIONAL
    },
    criticalExtensions                CHOICE {
        r8                          SEQUENCE {
            radioBearerSetup-r8          RadioBearerSetup-r8-IEs,
            -- Container for adding non critical extensions after freezing REL-9
            radioBearerSetup-r8-add-ext BIT STRING OPTIONAL,
            v7d0NonCriticalExtensions    SEQUENCE {
                radioBearerSetup-v7d0ext RadioBearerSetup-v7d0ext-IEs,
                v7f0NonCriticalExtensions SEQUENCE {
                    radioBearerSetup-v7f0ext RadioBearerSetup-v7f0ext-IEs,
                    v890NonCriticalExtensions SEQUENCE {
                        radioBearerSetup-v890ext
                            RadioBearerSetup-v890ext-IEs,
                        v7g0NonCriticalExtensions SEQUENCE {

```



```

    integrityProtectionModeInfo      IntegrityProtectionModeInfo      OPTIONAL,
    cipheringModeInfo                CipheringModeInfo                OPTIONAL,
    activationTime                    ActivationTime                     OPTIONAL,
    new-U-RNTI                        U-RNTI                           OPTIONAL,
    new-C-RNTI                        C-RNTI                           OPTIONAL,
    rrc-StateIndicator                RRC-StateIndicator,
    utran-DRX-CycleLengthCoeff        UTRAN-DRX-CycleLengthCoefficient OPTIONAL,
-- UTRAN mobility IEs
    ura-Identity                       URA-Identity                       OPTIONAL,
-- Core network IEs
    cn-InformationInfo                CN-InformationInfo                OPTIONAL,
-- Radio bearer IEs
    srb-InformationSetupList          SRB-InformationSetupList          OPTIONAL,
    rab-InformationSetupList          RAB-InformationSetupList          OPTIONAL,
    rb-InformationAffectedList        RB-InformationAffectedList        OPTIONAL,
    dl-CounterSynchronisationInfo     DL-CounterSynchronisationInfo     OPTIONAL,
-- Transport channel IEs
    ul-CommonTransChInfo              UL-CommonTransChInfo              OPTIONAL,
    ul-deletedTransChInfoList         UL-DeletedTransChInfoList         OPTIONAL,
    ul-AddReconfTransChInfoList       UL-AddReconfTransChInfoList       OPTIONAL,
    -- 'dummy', 'dummy1' and 'dummy2' are not used in this version of the specification,
    -- they should not be sent and if received they should be ignored.
    dummy                              CHOICE {
        fdd                            SEQUENCE {
            dummy1                      CPCH-SetID                        OPTIONAL,
            dummy2                      DRAC-StaticInformationList        OPTIONAL,
        },
        tdd                            NULL
    }
    dl-CommonTransChInfo              DL-CommonTransChInfo              OPTIONAL,
    dl-DeletedTransChInfoList         DL-DeletedTransChInfoList         OPTIONAL,
    dl-AddReconfTransChInfoList       DL-AddReconfTransChInfoList       OPTIONAL,
-- Physical channel IEs
    frequencyInfo                     FrequencyInfo                       OPTIONAL,
    maxAllowedUL-TX-Power              MaxAllowedUL-TX-Power              OPTIONAL,
    ul-ChannelRequirement              UL-ChannelRequirement              OPTIONAL,
    modeSpecificPhysChInfo            CHOICE {
        fdd                            SEQUENCE {
            -- dummy is not used in this version of specification, it should
            -- not be sent and if received it should be ignored.
            dummy                        DL-PDSCH-Information              OPTIONAL,
        },
        tdd                            NULL
    },
    dl-CommonInformation              DL-CommonInformation              OPTIONAL,
    dl-InformationPerRL-List          DL-InformationPerRL-List          OPTIONAL,
}

RadioBearerSetup-v3a0ext ::= SEQUENCE {
    -- The IE "new-DSCH-RNTI" should not be included in FDD mode, and if received the UE behaviour
    -- is unspecified
    new-DSCH-RNTI                      DSCH-RNTI                          OPTIONAL
}

RadioBearerSetup-v4b0ext-IEs ::= SEQUENCE {
    -- Physical channel IEs
    -- dummy is not used in this version of the specification, it should
    -- not be sent and if received it should be ignored.
    dummy                                SSDT-UL                              OPTIONAL,
    -- The order of the RLs in IE cell-id-PerRL-List is the same as
    -- in IE DL-InformationPerRL-List included in this message
    cell-id-PerRL-List                  CellIdentity-PerRL-List              OPTIONAL
}

RadioBearerSetup-v590ext-IEs ::= SEQUENCE {
    -- Physical channel IEs
    dl-TPC-PowerOffsetPerRL-List        DL-TPC-PowerOffsetPerRL-List        OPTIONAL
}

RadioBearerSetup-v5d0ext-IEs ::= SEQUENCE {
    --Radio Bearer IEs
    pdcp-ROHC-TargetMode                PDCP-ROHC-TargetMode                OPTIONAL
}

RadioBearerSetup-r4-IEs ::= SEQUENCE {
    -- User equipment IEs
    integrityProtectionModeInfo          IntegrityProtectionModeInfo          OPTIONAL,
    cipheringModeInfo                    CipheringModeInfo                    OPTIONAL,
}

```

```

activationTime          ActivationTime          OPTIONAL,
new-U-RNTI              U-RNTI              OPTIONAL,
new-C-RNTI              C-RNTI              OPTIONAL,
-- The IE "new-DSCH-RNTI" should not be included in FDD mode, and if received
-- the UE behaviour is unspecified
new-DSCH-RNTI          DSCH-RNTI              OPTIONAL,
rrc-StateIndicator      RRC-StateIndicator,
utran-DRX-CycleLengthCoeff  UTRAN-DRX-CycleLengthCoefficient  OPTIONAL,
-- UTRAN mobility IEs
ura-Identity            URA-Identity            OPTIONAL,
-- Core network IEs
cn-InformationInfo      CN-InformationInfo      OPTIONAL,
-- Radio bearer IEs
srb-InformationSetupList  SRB-InformationSetupList  OPTIONAL,
rab-InformationSetupList  RAB-InformationSetupList-r4  OPTIONAL,
rb-InformationAffectedList  RB-InformationAffectedList  OPTIONAL,
dl-CounterSynchronisationInfo  DL-CounterSynchronisationInfo  OPTIONAL,
-- Transport channel IEs
ul-CommonTransChInfo      UL-CommonTransChInfo-r4  OPTIONAL,
ul-deletedTransChInfoList  UL-DeletedTransChInfoList  OPTIONAL,
ul-AddReconfTransChInfoList  UL-AddReconfTransChInfoList  OPTIONAL,
-- 'dummy', 'dummy1' and 'dummy2' are not used in this version of the specification,
-- they should not be sent and if received they should be ignored.
dummy                   CHOICE {
    fdd                   SEQUENCE {
        dummy1            CPCH-SetID            OPTIONAL,
        dummy2            DRAC-StaticInformationList  OPTIONAL
    },
    tdd                   NULL
}
dl-CommonTransChInfo      DL-CommonTransChInfo-r4  OPTIONAL,
dl-DeletedTransChInfoList  DL-DeletedTransChInfoList  OPTIONAL,
dl-AddReconfTransChInfoList  DL-AddReconfTransChInfoList-r4  OPTIONAL,
-- Physical channel IEs
frequencyInfo            FrequencyInfo            OPTIONAL,
maxAllowedUL-TX-Power      MaxAllowedUL-TX-Power      OPTIONAL,
ul-ChannelRequirement      UL-ChannelRequirement-r4  OPTIONAL,
modeSpecificPhysChInfo      CHOICE {
    fdd                   SEQUENCE {
        -- dummy is not used in this version of specification, it should
        -- not be sent and if received it should be ignored.
        dummy              DL-PDSCH-Information      OPTIONAL
    },
    tdd                   NULL
},
dl-CommonInformation      DL-CommonInformation-r4  OPTIONAL,
dl-InformationPerRL-List  DL-InformationPerRL-List-r4  OPTIONAL
}

RadioBearerSetup-r5-IEs ::= SEQUENCE {
-- User equipment IEs
integrityProtectionModeInfo  IntegrityProtectionModeInfo  OPTIONAL,
cipheringModeInfo            CipheringModeInfo            OPTIONAL,
activationTime                ActivationTime                OPTIONAL,
new-U-RNTI                    U-RNTI                      OPTIONAL,
new-C-RNTI                    C-RNTI                      OPTIONAL,
-- The IE "new-DSCH-RNTI" should not be included in FDD mode, and if received
-- the UE behaviour is unspecified
new-DSCH-RNTI                DSCH-RNTI                    OPTIONAL,
new-H-RNTI                    H-RNTI                      OPTIONAL,
rrc-StateIndicator            RRC-StateIndicator,
utran-DRX-CycleLengthCoeff    UTRAN-DRX-CycleLengthCoefficient  OPTIONAL,
-- UTRAN mobility IEs
ura-Identity                  URA-Identity                  OPTIONAL,
-- Core network IEs
cn-InformationInfo            CN-InformationInfo            OPTIONAL,
-- Radio bearer IEs
srb-InformationSetupList      SRB-InformationSetupList-r5  OPTIONAL,
rab-InformationSetupList      RAB-InformationSetupList-r5  OPTIONAL,
rb-InformationAffectedList     RB-InformationAffectedList-r5  OPTIONAL,
dl-CounterSynchronisationInfo  DL-CounterSynchronisationInfo-r5  OPTIONAL,
-- Transport channel IEs
ul-CommonTransChInfo          UL-CommonTransChInfo-r4  OPTIONAL,
ul-deletedTransChInfoList      UL-DeletedTransChInfoList  OPTIONAL,
ul-AddReconfTransChInfoList    UL-AddReconfTransChInfoList  OPTIONAL,
-- 'dummy', 'dummy1' and 'dummy2' are not used in this version of the specification,
-- they should not be sent and if received they should be ignored.
dummy                          CHOICE {

```

```

        fdd
            dummy1
            dummy2
        },
        tdd
    }
    dl-CommonTransChInfo          DL-CommonTransChInfo-r4          OPTIONAL,
    dl-DeletedTransChInfoList     DL-DeletedTransChInfoList-r5   OPTIONAL,
    dl-AddReconfTransChInfoList   DL-AddReconfTransChInfoList-r5  OPTIONAL,
-- Physical channel IEs
    frequencyInfo                 FrequencyInfo                 OPTIONAL,
    maxAllowedUL-TX-Power         MaxAllowedUL-TX-Power         OPTIONAL,
    ul-ChannelRequirement         UL-ChannelRequirement-r5     OPTIONAL,
    modeSpecificPhysChInfo        CHOICE {
        fdd
            SEQUENCE {
                -- dummy is not used in this version of specification, it should
                -- not be sent and if received it should be ignored.
                dummy              DL-PDSCH-Information           OPTIONAL
            }
        tdd
            NULL
    },
    dl-HSPDSCH-Information        DL-HSPDSCH-Information        OPTIONAL,
    dl-CommonInformation          DL-CommonInformation-r5       OPTIONAL,
    dl-InformationPerRL-List      DL-InformationPerRL-List-r5   OPTIONAL
}

RadioBearerSetup-v690ext-IEs ::= SEQUENCE {
-- Core network IEs
    primary-plmn-Identity         PLMN-Identity                OPTIONAL,
-- Physical channel IEs
    -- The IE harq-Preamble-Mode should not be used in the r3 and r4 versions of the message
    -- If included in the r3 or r4 version of the message, the UE should ignore the IE
    harq-Preamble-Mode           HARQ-Preamble-Mode            OPTIONAL,
    beaconPLEst                  BEACON-PL-Est                OPTIONAL,
    postVerificationPeriod       ENUMERATED { true }           OPTIONAL,
    dhs-sync                      DHS-Sync                      OPTIONAL,
    timingMaintainedSynchInd     TimingMaintainedSynchInd      OPTIONAL,
-- Radio bearer IEs
    rab-InformationSetupList      RAB-InformationSetupList-r6-ext  OPTIONAL,
-- MBMS IEs
    mbms-PL-ServiceRestrictInfo  MBMS-PL-ServiceRestrictInfo-r6  OPTIONAL
}

RadioBearerSetup-r6-IEs ::= SEQUENCE {
-- User equipment IEs
    integrityProtectionModeInfo   IntegrityProtectionModeInfo    OPTIONAL,
    cipheringModeInfo            CipheringModeInfo              OPTIONAL,
    activationTime               ActivationTime                  OPTIONAL,
    new-U-RNTI                   U-RNTI                        OPTIONAL,
    new-C-RNTI                   C-RNTI                        OPTIONAL,
    -- The IE "new-DSCH-RNTI" should not be included in FDD mode,
    -- and if received the UE behaviour is unspecified
    new-DSCH-RNTI               DSCH-RNTI                     OPTIONAL,
    new-H-RNTI                   H-RNTI                        OPTIONAL,
    newPrimary-E-RNTI            E-RNTI                        OPTIONAL,
    newSecondary-E-RNTI          E-RNTI                        OPTIONAL,
    rrc-StateIndicator           RRC-StateIndicator,          OPTIONAL,
    utran-DRX-CycleLengthCoeff   UTRAN-DRX-CycleLengthCoefficient  OPTIONAL,
-- UTRAN mobility IEs
    ura-Identity                 URA-Identity                  OPTIONAL,
-- Core network IEs
    cn-InformationInfo           CN-InformationInfo-r6         OPTIONAL,
    specificationMode            CHOICE {
        complete
            SEQUENCE {
-- Radio bearer IEs
                srb-InformationSetupList      SRB-InformationSetupList-r6     OPTIONAL,
                rab-InformationSetupList      RAB-InformationSetupList-r6     OPTIONAL,
                rab-InformationReconfigList   RAB-InformationReconfigList     OPTIONAL,
                rb-InformationReconfigList    RB-InformationReconfigList-r6   OPTIONAL,
                rb-InformationAffectedList    RB-InformationAffectedList-r6   OPTIONAL,
                dl-CounterSynchronisationInfo DL-CounterSynchronisationInfo-r5  OPTIONAL,
                pdcp-ROHC-TargetMode        PDCP-ROHC-TargetMode           OPTIONAL,
-- Transport channel IEs
                ul-CommonTransChInfo        UL-CommonTransChInfo-r4        OPTIONAL,
                ul-deletedTransChInfoList    UL-DeletedTransChInfoList-r6    OPTIONAL,
                ul-AddReconfTransChInfoList  UL-AddReconfTransChInfoList-r6  OPTIONAL,
                dl-CommonTransChInfo        DL-CommonTransChInfo-r4        OPTIONAL,
                dl-DeletedTransChInfoList    DL-DeletedTransChInfoList-r5    OPTIONAL
            }
        }
    }
}

```

```

        dl-AddReconfTransChInfoList      DL-AddReconfTransChInfoList-r5      OPTIONAL
    },
    -- dummy is not used in this version of the specification
    -- if it is sent, the UE behaviour is unspecified.
    dummy                                SEQUENCE {
        rab-Info                          RAB-Info-r6,
        defaultConfigMode                  DefaultConfigMode,
        defaultConfigIdentity              DefaultConfigIdentity-r6,
        rb-InformationChangedList          RB-InformationChangedList-r6      OPTIONAL,
        powerOffsetInfoShort               PowerOffsetInfoShort
    }
},
-- Physical channel IEs
frequencyInfo                            FrequencyInfo                        OPTIONAL,
maxAllowedUL-TX-Power                     MaxAllowedUL-TX-Power               OPTIONAL,
ul-DPCH-Info                              UL-DPCH-Info-r6                     OPTIONAL,
ul-EDCH-Information                       UL-EDCH-Information-r6              OPTIONAL,
dl-HSPDSCH-Information                    DL-HSPDSCH-Information-r6           OPTIONAL,
dl-CommonInformation                      DL-CommonInformation-r6             OPTIONAL,
dl-InformationPerRL-List                  DL-InformationPerRL-List-r6         OPTIONAL,
-- MBMS IEs
mbms-PL-ServiceRestrictInfo              MBMS-PL-ServiceRestrictInfo-r6     OPTIONAL
}

RadioBearerSetup-v6b0ext-IEs ::= SEQUENCE {
-- Physical channel IEs
dl-InformationPerRL-List-v6b0ext          DL-InformationPerRL-List-v6b0ext    OPTIONAL,
-- MBMS IEs
-- The order of the RABs in IE rab-InformationSetupListExt is the same as
-- in IE rab-InformationSetupList that is included in this message
rab-InformationSetupListExt              RAB-InformationSetupList-v6b0ext    OPTIONAL
}

RadioBearerSetup-r7-IEs ::= SEQUENCE {
-- User equipment IEs
integrityProtectionModeInfo              IntegrityProtectionModeInfo-r7      OPTIONAL,
cipheringModeInfo                        CipheringModeInfo-r7                 OPTIONAL,
activationTime                            ActivationTime                         OPTIONAL,
new-U-RNTI                                U-RNTI                               OPTIONAL,
new-C-RNTI                                C-RNTI                               OPTIONAL,
-- The IE "new-DSCH-RNTI" should not be included in FDD mode,
-- and if received the UE behaviour is unspecified
new-DSCH-RNTI                            DSCH-RNTI                            OPTIONAL,
new-H-RNTI                                H-RNTI                               OPTIONAL,
newPrimary-E-RNTI                        E-RNTI                               OPTIONAL,
newSecondary-E-RNTI                      E-RNTI                               OPTIONAL,
rrc-StateIndicator                       RRC-StateIndicator,
utran-DRX-CycleLengthCoeff               UTRAN-DRX-CycleLengthCoefficient-r7 OPTIONAL,
-- UTRAN mobility IEs
ura-Identity                              URA-Identity                         OPTIONAL,
supportForChangeOfUE-Capability           BOOLEAN                               OPTIONAL,
-- Core network IEs
cn-InformationInfo                        CN-InformationInfo-r6                OPTIONAL,
specificationMode                         CHOICE {
-- Radio bearer IEs
-- complete
-- Radio bearer IEs
srb-InformationSetupList                  SRB-InformationSetupList-r7         OPTIONAL,
rab-InformationSetupList                  RAB-InformationSetupList-r7         OPTIONAL,
rab-InformationReconfigList               RAB-InformationReconfigList         OPTIONAL,
rb-InformationReconfigList                RB-InformationReconfigList-r7       OPTIONAL,
rb-InformationAffectedList                RB-InformationAffectedList-r7       OPTIONAL,
dl-CounterSynchronisationInfo            DL-CounterSynchronisationInfo-r5    OPTIONAL,
pdcp-ROHC-TargetMode                     PDCP-ROHC-TargetMode                OPTIONAL,
-- Transport channel IEs
ul-CommonTransChInfo                     UL-CommonTransChInfo-r4             OPTIONAL,
ul-deletedTransChInfoList                 UL-DeletedTransChInfoList-r6        OPTIONAL,
ul-AddReconfTransChInfoList              UL-AddReconfTransChInfoList-r7      OPTIONAL,
dl-CommonTransChInfo                     DL-CommonTransChInfo-r4             OPTIONAL,
dl-DeletedTransChInfoList                 DL-DeletedTransChInfoList-r7        OPTIONAL,
dl-AddReconfTransChInfoList              DL-AddReconfTransChInfoList-r7      OPTIONAL
},
-- dummy is not used in this version of the specification
-- if it is sent, the UE behaviour is unspecified.
dummy                                    NULL
},
-- Physical channel IEs
frequencyInfo                            FrequencyInfo                        OPTIONAL,
multi-frequencyInfo                       Multi-frequencyInfo-LCR-r7          OPTIONAL,

```

```

    dtx-drx-TimingInfo          DTX-DRX-TimingInfo-r7          OPTIONAL,
    dtx-drx-Info                DTX-DRX-Info-r7          OPTIONAL,
    hs-scch-LessInfo            HS-SCCH-LessInfo-r7          OPTIONAL,
    mimoParameters              MIMO-Parameters-r7          OPTIONAL,
    maxAllowedUL-TX-Power       MaxAllowedUL-TX-Power        OPTIONAL,
    ul-DPCH-Info                UL-DPCH-Info-r7          OPTIONAL,
    ul-EDCH-Information          UL-EDCH-Information-r7        OPTIONAL,
    dl-HSPDSCH-Information       DL-HSPDSCH-Information-r7      OPTIONAL,
    dl-CommonInformation         DL-CommonInformation-r7       OPTIONAL,
    dl-InformationPerRL-List     DL-InformationPerRL-List-r7   OPTIONAL,
-- MBMS IEs
    mbms-PL-ServiceRestrictInfo MBMS-PL-ServiceRestrictInfo-r6 OPTIONAL
}

RadioBearerSetup-r7-add-ext-IEs ::= SEQUENCE {
    radioBearerSetup-v7d0ext      RadioBearerSetup-v7d0ext-IEs    OPTIONAL,
    v7f0NonCriticalExtensions      SEQUENCE {
        radioBearerSetup-v7f0ext      RadioBearerSetup-v7f0ext-IEs,
        v7g0NonCriticalExtensions      SEQUENCE {
            radioBearerSetup-v7g0ext      RadioBearerSetup-v7g0ext-IEs,
            nonCriticalExtensions        SEQUENCE {} OPTIONAL
        } OPTIONAL
    }
}

RadioBearerSetup-v780ext-IEs ::= SEQUENCE {
-- Physical channel IEs
    hs-DSCH-TBSizeTable          HS-DSCH-TBSizeTable            OPTIONAL
}

RadioBearerSetup-v7d0ext-IEs ::= SEQUENCE {
-- Physical channel IEs
    ul-EDCH-Information          UL-EDCH-Information-ext        OPTIONAL
}

RadioBearerSetup-v7f0ext-IEs ::= SEQUENCE {
-- Physical channel IEs
    mimoParameters              MIMO-Parameters-v7f0ext        OPTIONAL
}

RadioBearerSetup-v7g0ext-IEs ::= SEQUENCE {
-- Physical channel IEs
    mimoParameters              MIMO-Parameters-v7g0ext        OPTIONAL
}

RadioBearerSetup-r8-IEs ::= SEQUENCE {
-- User equipment IEs
    integrityProtectionModeInfo    IntegrityProtectionModeInfo-r7    OPTIONAL,
    cipheringModeInfo              CipheringModeInfo-r7              OPTIONAL,
    sr-vcc-Info                    SR-VCC-Info                      OPTIONAL,
    activationTime                  ActivationTime                     OPTIONAL,
    new-U-RNTI                     U-RNTI                          OPTIONAL,
    new-C-RNTI                     C-RNTI                          OPTIONAL,
-- The IE "new-DSCH-RNTI" should not be included in FDD mode,
-- and if received the UE behaviour is unspecified
    new-DSCH-RNTI                 DSCH-RNTI                       OPTIONAL,
    new-H-RNTI                     H-RNTI                          OPTIONAL,
    newPrimary-E-RNTI              E-RNTI                          OPTIONAL,
    newSecondary-E-RNTI            E-RNTI                          OPTIONAL,
    rrc-StateIndicator             RRC-StateIndicator,
    utran-DRX-CycleLengthCoeff      UTRAN-DRX-CycleLengthCoefficient-r7 OPTIONAL,
-- UTRAN mobility IEs
    ura-Identity                   URA-Identity                    OPTIONAL,
    supportForChangeOfUE-Capability BOOLEAN                            OPTIONAL,
-- Core network IEs
    cn-InformationInfo             CN-InformationInfo-r6            OPTIONAL,
-- Radio bearer IEs
    srb-InformationSetupList        SRB-InformationSetupList-r8      OPTIONAL,
    rab-InformationSetupList        RAB-InformationSetupList-r8      OPTIONAL,
    rab-InformationReconfigList     RAB-InformationReconfigList-r8   OPTIONAL,
    rb-InformationReconfigList      RB-InformationReconfigList-r8    OPTIONAL,
    rb-InformationAffectedList      RB-InformationAffectedList-r8    OPTIONAL,
    dl-CounterSynchronisationInfo    DL-CounterSynchronisationInfo-r5 OPTIONAL,
    pdcp-ROHC-TargetMode           PDCP-ROHC-TargetMode            OPTIONAL,
-- Transport channel IEs
    ul-CommonTransChInfo           UL-CommonTransChInfo-r4          OPTIONAL,
    ul-deletedTransChInfoList       UL-DeletedTransChInfoList-r6     OPTIONAL,
    ul-AddReconfTransChInfoList     UL-AddReconfTransChInfoList-r8   OPTIONAL,

```



```

    dl-CommonTransChInfo          DL-CommonTransChInfo-r4          OPTIONAL,
    dl-DeletedTransChInfoList      DL-DeletedTransChInfoList-r7      OPTIONAL,
    dl-AddReconfTransChInfoList    DL-AddReconfTransChInfoList-r7    OPTIONAL,
-- Physical channel IEs
  frequencyInfo                   FrequencyInfo                   OPTIONAL,
  multi-frequencyInfo             Multi-frequencyInfo-LCR-r7        OPTIONAL,
  dtx-drx-TimingInfo             DTX-DRX-TimingInfo-r7            OPTIONAL,
  dtx-drx-Info                   DTX-DRX-Info-r7                 OPTIONAL,
  hs-scch-LessInfo               HS-SCCH-LessInfo-r7              OPTIONAL,
  mimoParameters                 MIMO-Parameters-r8              OPTIONAL,
  maxAllowedUL-TX-Power           MaxAllowedUL-TX-Power            OPTIONAL,
  ul-DPCH-Info                   UL-DPCH-Info-r7                  OPTIONAL,
  ul-EDCH-Information            UL-EDCH-Information-r8           OPTIONAL,
  dl-HSPDSCH-Information         DL-HSPDSCH-Information-r8        OPTIONAL,
  dl-CommonInformation            DL-CommonInformation-r8          OPTIONAL,
  dl-InformationPerRL-List        DL-InformationPerRL-List-r8      OPTIONAL,
  dl-SecondaryCellInfoFDD         DL-SecondaryCellInfoFDD          OPTIONAL,
  controlChannelDRXInfo-TDD128    ControlChannelDRXInfo-TDD128-r8  OPTIONAL,
  sps-Information-TDD128          SPS-Information-TDD128-r8        OPTIONAL,
-- MBMS IEs
  mbms-PL-ServiceRestrictInfo     MBMS-PL-ServiceRestrictInfo-r6   OPTIONAL
}

RadioBearerSetup-v820ext-IEs ::= SEQUENCE {
-- Radio bearer IEs
  rab-InformationSetupList         RAB-InformationSetupList-v820ext  OPTIONAL
}

RadioBearerSetup-v890ext-IEs ::= SEQUENCE {
-- Physical channel IEs
  dl-SecondaryCellInfoFDD-v890ext DL-SecondaryCellInfoFDD-v890ext    OPTIONAL,
  dl-HSPDSCH-Information          DL-HSPDSCH-Information-r8-ext      OPTIONAL
}

RadioBearerSetup-v8a0ext-IEs ::= SEQUENCE {
-- Physical channel IEs
  dl-HSPDSCH-Information          DL-HSPDSCH-Information-r8-ext2     OPTIONAL
}

RadioBearerSetup-r9-IEs ::= SEQUENCE {
-- User equipment IEs
  integrityProtectionModeInfo     IntegrityProtectionModeInfo-r7     OPTIONAL,
  cipheringModeInfo              CipheringModeInfo-r7               OPTIONAL,
  sr-vcc-Info                    SR-VCC-Info                       OPTIONAL,
  activationTime                 ActivationTime                      OPTIONAL,
  new-U-RNTI                     U-RNTI                            OPTIONAL,
  new-C-RNTI                     C-RNTI                            OPTIONAL,
-- The IE "new-DSCH-RNTI" should not be included in FDD mode,
-- and if received the UE behaviour is unspecified
  new-DSCH-RNTI                 DSCH-RNTI                         OPTIONAL,
  new-H-RNTI                     H-RNTI                            OPTIONAL,
  newPrimary-E-RNTI              E-RNTI                            OPTIONAL,
  newSecondary-E-RNTI            E-RNTI                            OPTIONAL,
  rrc-StateIndicator             RRC-StateIndicator,
  utran-DRX-CycleLengthCoeff     UTRAN-DRX-CycleLengthCoefficient-r7 OPTIONAL,
-- UTRAN mobility IEs
  ura-Identity                   URA-Identity                      OPTIONAL,
  supportForChangeOfUE-Capability BOOLEAN                             OPTIONAL,
-- Core network IEs
  cn-InformationInfo             CN-InformationInfo-r6              OPTIONAL,
-- Radio bearer IEs
  srb-InformationSetupList        SRB-InformationSetupList-r8        OPTIONAL,
  rab-InformationSetupList        RAB-InformationSetupList-r8        OPTIONAL,
  rab-InformationReconfigList     RAB-InformationReconfigList-r8     OPTIONAL,
  rb-InformationReconfigList      RB-InformationReconfigList-r8      OPTIONAL,
  rb-InformationAffectedList      RB-InformationAffectedList-r8      OPTIONAL,
  dl-CounterSynchronisationInfo   DL-CounterSynchronisationInfo-r5   OPTIONAL,
  pdcp-ROHC-TargetMode           PDCP-ROHC-TargetMode              OPTIONAL,
-- Transport channel IEs
  ul-CommonTransChInfo           UL-CommonTransChInfo-r4           OPTIONAL,
  ul-deletedTransChInfoList       UL-DeletedTransChInfoList-r6       OPTIONAL,
  ul-AddReconfTransChInfoList     UL-AddReconfTransChInfoList-r8     OPTIONAL,
  dl-CommonTransChInfo           DL-CommonTransChInfo-r4           OPTIONAL,
  dl-DeletedTransChInfoList       DL-DeletedTransChInfoList-r7       OPTIONAL,
  dl-AddReconfTransChInfoList     DL-AddReconfTransChInfoList-r9     OPTIONAL,
-- Physical channel IEs
  frequencyInfo                   FrequencyInfo                   OPTIONAL,
  multi-frequencyInfo             Multi-frequencyInfo-LCR-r7        OPTIONAL,

```

```

    dtx-drx-TimingInfo          DTX-DRX-TimingInfo-r7          OPTIONAL,
    dtx-drx-Info                DTX-DRX-Info-r7          OPTIONAL,
    hs-scch-LessInfo            HS-SCCH-LessInfo-r7          OPTIONAL,
    mimoParameters              MIMO-Parameters-r9          OPTIONAL,
    maxAllowedUL-TX-Power       MaxAllowedUL-TX-Power        OPTIONAL,
    ul-DPCH-Info                UL-DPCH-Info-r7          OPTIONAL,
    ul-EDCH-Information          UL-EDCH-Information-r9        OPTIONAL,
    ul-SecondaryCellInfoFDD      UL-SecondaryCellInfoFDD      OPTIONAL,
    dl-HSPDSCH-Information       DL-HSPDSCH-Information-r9     OPTIONAL,
    dl-CommonInformation         DL-CommonInformation-r8      OPTIONAL,
    dl-InformationPerRL-List     DL-InformationPerRL-List-r8  OPTIONAL,
    dl-SecondaryCellInfoFDD      DL-SecondaryCellInfoFDD-r9   OPTIONAL,
    controlChannelDRXInfo-TDD128 ControlChannelDRXInfo-TDD128-r8 OPTIONAL,
    sps-Information-TDD128       SPS-Information-TDD128-r8    OPTIONAL,
-- MBMS IEs
    mbms-PL-ServiceRestrictInfo MBMS-PL-ServiceRestrictInfo-r6 OPTIONAL,
-- Measurement IEs for LCR
    cellDCHMeasOccasionInfo-TDD128 CellDCHMeasOccasionInfo-TDD128-r9 OPTIONAL
}

RadioBearerSetup-v950ext-IEs ::= SEQUENCE {
-- Physical channel IEs
    secondaryCellMimoParameters SecondaryCellMIMOparametersFDD-v950ext OPTIONAL
}

RadioBearerSetup-v9c0ext-IEs ::= SEQUENCE {
-- For 1.28Mcps TDD only
    dl-AddReconfTransChInfoList DL-AddReconfTransChInfoList-TDD128-v9c0ext OPTIONAL
}

RadioBearerSetup-r10-IEs ::= SEQUENCE {
-- User equipment IEs
    integrityProtectionModeInfo IntegrityProtectionModeInfo-r7 OPTIONAL,
    cipheringModeInfo          CipheringModeInfo-r7          OPTIONAL,
    sr-vcc-Info                SR-VCC-Info                  OPTIONAL,
    activationTime              ActivationTime                 OPTIONAL,
    new-U-RNTI                  U-RNTI                      OPTIONAL,
    new-C-RNTI                  C-RNTI                      OPTIONAL,
    -- The IE "new-DSCH-RNTI" should not be included in FDD mode,
    -- and if received the UE behaviour is unspecified
    new-DSCH-RNTI              DSCH-RNTI                   OPTIONAL,
    new-H-RNTI                  H-RNTI                      OPTIONAL,
    newPrimary-E-RNTI           E-RNTI                      OPTIONAL,
    newSecondary-E-RNTI         E-RNTI                      OPTIONAL,
    rrc-StateIndicator          RRC-StateIndicator,
    utran-DRX-CycleLengthCoeff UTRAN-DRX-CycleLengthCoefficient-r7 OPTIONAL,
-- UTRAN mobility IEs
    ura-Identity                URA-Identity                 OPTIONAL,
    supportForChangeOfUE-Capability BOOLEAN                       OPTIONAL,
-- Core network IEs
    cn-InformationInfo          CN-InformationInfo-r6        OPTIONAL,
-- Radio bearer IEs
    srb-InformationSetupList     SRB-InformationSetupList-r8   OPTIONAL,
    rab-InformationSetupList     RAB-InformationSetupList-r8   OPTIONAL,
    rab-InformationReconfigList  RAB-InformationReconfigList-r8 OPTIONAL,
    rb-InformationReconfigList   RB-InformationReconfigList-r8 OPTIONAL,
    rb-InformationAffectedList   RB-InformationAffectedList-r8 OPTIONAL,
    dl-CounterSynchronisationInfo DL-CounterSynchronisationInfo-r5 OPTIONAL,
    pdcp-ROHC-TargetMode        PDCP-ROHC-TargetMode        OPTIONAL,
-- Transport channel IEs
    ul-CommonTransChInfo        UL-CommonTransChInfo-r4      OPTIONAL,
    ul-deletedTransChInfoList    UL-DeletedTransChInfoList-r6 OPTIONAL,
    ul-AddReconfTransChInfoList  UL-AddReconfTransChInfoList-r8 OPTIONAL,
    dl-CommonTransChInfo         DL-CommonTransChInfo-r4      OPTIONAL,
    dl-DeletedTransChInfoList    DL-DeletedTransChInfoList-r7 OPTIONAL,
    dl-AddReconfTransChInfoList  DL-AddReconfTransChInfoList-r9 OPTIONAL,
-- Physical channel IEs
    frequencyInfo                FrequencyInfo                 OPTIONAL,
    multi-frequencyInfo          Multi-frequencyInfo-LCR-r7    OPTIONAL,
    dtx-drx-TimingInfo          DTX-DRX-TimingInfo-r7      OPTIONAL,
    dtx-drx-Info                DTX-DRX-Info-r7            OPTIONAL,
    hs-scch-LessInfo            HS-SCCH-LessInfo-r7          OPTIONAL,
    mimoParameters              MIMO-Parameters-r9          OPTIONAL,
    maxAllowedUL-TX-Power       MaxAllowedUL-TX-Power        OPTIONAL,
    ul-DPCH-Info                UL-DPCH-Info-r7            OPTIONAL,
    ul-EDCH-Information          UL-EDCH-Information-r9      OPTIONAL,
    ul-SecondaryCellInfoFDD      UL-SecondaryCellInfoFDD      OPTIONAL,
    ul-MulticarrierEDCHInfo-TDD128 UL-MulticarrierEDCHInfo-TDD128 OPTIONAL,

```

```

dl-HSPDSCH-Information          DL-HSPDSCH-Information-r9          OPTIONAL,
dl-CommonInformation            DL-CommonInformation-r10          OPTIONAL,
dl-InformationPerRL-List        DL-InformationPerRL-List-r8       OPTIONAL,
dl-SecondaryCellInfoFDD         DL-SecondaryCellInfoFDD-r10       OPTIONAL,
additionalDLSecCellInfoListFDD AdditionalDLSecCellInfoListFDD     OPTIONAL,
controlChannelDRXInfo-TDD128    ControlChannelDRXInfo-TDD128-r8  OPTIONAL,
sps-Information-TDD128          SPS-Information-TDD128-r8        OPTIONAL,
mu-MIMO-Info-TDD128            MU-MIMO-Info-TDD128              OPTIONAL,
-- MBMS IEs
  mbms-PL-ServiceRestrictInfo    MBMS-PL-ServiceRestrictInfo-r6   OPTIONAL,
-- Measurement IEs for LCR
  cellDCHMeasOccasionInfo-TDD128 CellDCHMeasOccasionInfo-TDD128-r9  OPTIONAL
}

RadioBearerSetup-vb50ext-IEs ::= SEQUENCE {
  ulOLTDInfoFDD                  UL-OLTD-InfoFDD                  OPTIONAL
}

RadioBearerSetup-r11-IEs ::= SEQUENCE {
  -- User equipment IEs
  integrityProtectionModeInfo    IntegrityProtectionModeInfo-r7   OPTIONAL,
  cipheringModeInfo              CipheringModeInfo-r7              OPTIONAL,
  sr-vcc-Info                     SR-VCC-Info                       OPTIONAL,
  activationTime                  ActivationTime                       OPTIONAL,
  new-U-RNTI                       U-RNTI                             OPTIONAL,
  new-C-RNTI                       C-RNTI                             OPTIONAL,
  -- The IE "new-DSCH-RNTI" should not be included in FDD mode,
  -- and if received the UE behaviour is unspecified
  new-DSCH-RNTI                   DSCH-RNTI                           OPTIONAL,
  new-H-RNTI                       H-RNTI                             OPTIONAL,
  newPrimary-E-RNTI               E-RNTI                             OPTIONAL,
  newSecondary-E-RNTI             E-RNTI                             OPTIONAL,
  rrc-StateIndicator              RRC-StateIndicator,
  utran-DRX-CycleLengthCoeff      UTRAN-DRX-CycleLengthCoefficient-r7 OPTIONAL,
  -- UTRAN mobility IEs
  ura-Identity                     URA-Identity                       OPTIONAL,
  supportForChangeOfUE-Capability BOOLEAN                             OPTIONAL,
  -- Core network IEs
  cn-InformationInfo              CN-InformationInfo-r6             OPTIONAL,
  -- Radio bearer IEs
  srb-InformationSetupList         SRB-InformationSetupList-r11      OPTIONAL,
  rab-InformationSetupList         RAB-InformationSetupList-r11      OPTIONAL,
  rab-InformationReconfigList      RAB-InformationReconfigList-r8    OPTIONAL,
  rb-InformationReconfigList       RB-InformationReconfigList-r11    OPTIONAL,
  rb-InformationAffectedList       RB-InformationAffectedList-r8     OPTIONAL,
  dl-CounterSynchronisationInfo    DL-CounterSynchronisationInfo-r5  OPTIONAL,
  pdcp-ROHC-TargetMode            PDCP-ROHC-TargetMode             OPTIONAL,
  -- Transport channel IEs
  ul-CommonTransChInfo            UL-CommonTransChInfo-r4           OPTIONAL,
  ul-deletedTransChInfoList        UL-DeletedTransChInfoList-r6     OPTIONAL,
  ul-AddReconfTransChInfoList      UL-AddReconfTransChInfoList-r8   OPTIONAL,
  dl-CommonTransChInfo            DL-CommonTransChInfo-r4           OPTIONAL,
  dl-DeletedTransChInfoList        DL-DeletedTransChInfoList-r7     OPTIONAL,
  dl-AddReconfTransChInfoList      DL-AddReconfTransChInfoList-r11  OPTIONAL,
  -- Physical channel IEs
  frequencyInfo                    FrequencyInfo                       OPTIONAL,
  multi-frequencyInfo              Multi-frequencyInfo-LCR-r7        OPTIONAL,
  dtx-drx-TimingInfo              DTX-DRX-TimingInfo-r7            OPTIONAL,
  dtx-drx-Info                     DTX-DRX-Info-r7                  OPTIONAL,
  hs-scch-LessInfo                 HS-SCCH-LessInfo-r7              OPTIONAL,
  mimoParameters                   MIMO-Parameters-r9               OPTIONAL,
  mimo4x4Parameters                MIMO4x4-Parameters               OPTIONAL,
  maxAllowedUL-TX-Power             MaxAllowedUL-TX-Power             OPTIONAL,
  ul-DPCH-Info                     UL-DPCH-Info-r11                 OPTIONAL,
  ul-EDCH-Information              UL-EDCH-Information-r11          OPTIONAL,
  ul-SecondaryCellInfoFDD          UL-SecondaryCellInfoFDD          OPTIONAL,
  ul-MulticarrierEDCHInfo-TDD128    UL-MulticarrierEDCHInfo-TDD128  OPTIONAL,
  ul-CLTD-InfoFDD                  UL-CLTD-InfoFDD                  OPTIONAL,
  ul-OLTD-InfoFDD                  UL-OLTD-InfoFDD                  OPTIONAL,
  dl-HSPDSCH-Information            DL-HSPDSCH-Information-r11       OPTIONAL,
  dl-CommonInformation              DL-CommonInformation-r11         OPTIONAL,
  dl-InformationPerRL-List          DL-InformationPerRL-List-r11     OPTIONAL,
  dl-SecondaryCellInfoFDD          DL-SecondaryCellInfoFDD-r11     OPTIONAL,
  additionalDLSecCellInfoListFDD    AdditionalDLSecCellInfoListFDD-r11 OPTIONAL,
  additionalDLSecCellInfoListFDD2  AdditionalDLSecCellInfoListFDD2  OPTIONAL,
  commonERGCHInfoFDD               CommonERGCHInfoFDD                OPTIONAL,
  controlChannelDRXInfo-TDD128      ControlChannelDRXInfo-TDD128-r8  OPTIONAL,
  sps-Information-TDD128            SPS-Information-TDD128-r8        OPTIONAL,

```

```

    mu-MIMO-Info-TDD128          MU-MIMO-Info-TDD128          OPTIONAL,
-- MBMS IEs
  mbms-PL-ServiceRestrictInfo    MBMS-PL-ServiceRestrictInfo-r6    OPTIONAL,
-- Measurement IEs for LCR
  cellDCHMeasOccasionInfo-TDD128 CellDCHMeasOccasionInfo-TDD128-r9  OPTIONAL
}

RadioBearerSetup-r12-IEs ::= SEQUENCE {
-- User equipment IEs
  integrityProtectionModeInfo      IntegrityProtectionModeInfo-r7     OPTIONAL,
  cipheringModeInfo                CipheringModeInfo-r7               OPTIONAL,
  sr-vcc-Info                      SR-VCC-Info                       OPTIONAL,
  activationTime                   ActivationTime                      OPTIONAL,
  new-U-RNTI                       U-RNTI                            OPTIONAL,
  new-C-RNTI                       C-RNTI                            OPTIONAL,
  -- The IE "new-DSCH-RNTI" should not be included in FDD mode,
  -- and if received the UE behaviour is unspecified
  new-DSCH-RNTI                   DSCH-RNTI                         OPTIONAL,
  new-H-RNTI                       H-RNTI                            OPTIONAL,
  newPrimary-E-RNTI               E-RNTI                            OPTIONAL,
  newSecondary-E-RNTI             E-RNTI                            OPTIONAL,
  rrc-StateIndicator              RRC-StateIndicator,
  utran-DRX-CycleLengthCoeff      UTRAN-DRX-CycleLengthCoefficient-r7 OPTIONAL,
  accessGroupIdentity             AccessGroupIdentity                OPTIONAL,
-- UTRAN mobility IEs
  ura-Identity                     URA-Identity                      OPTIONAL,
  supportForChangeOfUE-Capability  BOOLEAN                           OPTIONAL,
-- Core network IEs
  cn-InformationInfo              CN-InformationInfo-r6              OPTIONAL,
-- Radio bearer IEs
  srb-InformationSetupList        SRB-InformationSetupList-r11       OPTIONAL,
  rab-InformationSetupList        RAB-InformationSetupList-r11       OPTIONAL,
  rab-InformationReconfigList     RAB-InformationReconfigList-r8     OPTIONAL,
  rb-InformationReconfigList      RB-InformationReconfigList-r11     OPTIONAL,
  rb-InformationAffectedList      RB-InformationAffectedList-r8      OPTIONAL,
  dl-CounterSynchronisationInfo   DL-CounterSynchronisationInfo-r5  OPTIONAL,
  pdcp-ROHC-TargetMode           PCP-ROHC-TargetMode               OPTIONAL,
-- Transport channel IEs
  ul-CommonTransChInfo           UL-CommonTransChInfo-r12          OPTIONAL,
  ul-deletedTransChInfoList      UL-DeletedTransChInfoList-r6      OPTIONAL,
  ul-AddReconfTransChInfoList    UL-AddReconfTransChInfoList-r8    OPTIONAL,
  dl-CommonTransChInfo           DL-CommonTransChInfo-r4           OPTIONAL,
  dl-DeletedTransChInfoList      DL-DeletedTransChInfoList-r7      OPTIONAL,
  dl-AddReconfTransChInfoList    DL-AddReconfTransChInfoList-r11   OPTIONAL,
-- Physical channel IEs
  frequencyInfo                  FrequencyInfo                      OPTIONAL,
  multi-frequencyInfo            Multi-frequencyInfo-LCR-r7        OPTIONAL,
  dtx-drx-TimingInfo             DTX-DRX-TimingInfo-r7            OPTIONAL,
  dtx-drx-Info                   DTX-DRX-Info-r12                 OPTIONAL,
  hs-scch-LessInfo               HS-SCCH-LessInfo-r7              OPTIONAL,
  mimoParameters                 MIMO-Parameters-r9               OPTIONAL,
  mimo4x4Parameters              MIMO4x4-Parameters               OPTIONAL,
  dch-Enhancements-Info-FDD      DCH-Enhancements-Info-FDD        OPTIONAL,
  maxAllowedUL-TX-Power          MaxAllowedUL-TX-Power             OPTIONAL,
  ul-DPCH-Info                   UL-DPCH-Info-r11                 OPTIONAL,
  ul-EDCH-Information            UL-EDCH-Information-r11           OPTIONAL,
  ul-SecondaryCellInfoFDD        UL-SecondaryCellInfoFDD-r12       OPTIONAL,
  ul-MulticarrierEDCHInfo-TDD128 UL-MulticarrierEDCHInfo-TDD128    OPTIONAL,
  ul-CLTD-InfoFDD                UL-CLTD-InfoFDD                  OPTIONAL,
  ul-OLTD-InfoFDD                UL-OLTD-InfoFDD                  OPTIONAL,
  ul-OtherTTIConfiguration-Info  UL-OtherTTIConfiguration-Information OPTIONAL,
  filteredUPHReportInfo          FilteredUEPowerHeadroomReportInfo OPTIONAL,
  dl-HSPDSCH-Information         DL-HSPDSCH-Information-r12        OPTIONAL,
  dl-CommonInformation           DL-CommonInformation-r12          OPTIONAL,
  dl-InformationPerRL-List       DL-InformationPerRL-List-r12      OPTIONAL,
  dl-SecondaryCellInfoFDD        DL-SecondaryCellInfoFDD-r11       OPTIONAL,
  additionalDLSecCellInfoListFDD AdditionalDLSecCellInfoListFDD-r11  OPTIONAL,
  additionalDLSecCellInfoListFDD2 AdditionalDLSecCellInfoListFDD2    OPTIONAL,
  commonERGCHInfoFDD            CommonERGCHInfoFDD                OPTIONAL,
  controlChannelDRXInfo-TDD128   ControlChannelDRXInfo-TDD128-r8  OPTIONAL,
  sps-Information-TDD128         SPS-Information-TDD128-r8         OPTIONAL,
  mu-MIMO-Info-TDD128           MU-MIMO-Info-TDD128              OPTIONAL,
  non-rectResAllocInd-TDD128     Non-rectResAllocInd-TDD128       OPTIONAL,
  non-rectResSpectTSset-TDD128   Non-rectResSpectTSset-TDD128     OPTIONAL,
-- MBMS IEs
  mbms-PL-ServiceRestrictInfo    MBMS-PL-ServiceRestrictInfo-r6    OPTIONAL,
-- Measurement IEs for LCR
  cellDCHMeasOccasionInfo-TDD128 CellDCHMeasOccasionInfo-TDD128-r9  OPTIONAL
}

```

```

}
-- *****
--
-- RADIO BEARER SETUP COMPLETE
--
-- *****

RadioBearerSetupComplete ::= SEQUENCE {
  -- User equipment IEs
  rrc-TransactionIdentifier      RRC-TransactionIdentifier,
  ul-IntegProtActivationInfo     IntegrityProtActivationInfo      OPTIONAL,
  -- TABULAR: UL-TimingAdvance is applicable for TDD mode only.
  ul-TimingAdvance              UL-TimingAdvance                OPTIONAL,
  start-Value                   START-Value                    OPTIONAL,
  -- Radio bearer IEs
  count-C-ActivationTime        ActivationTime                 OPTIONAL,
  -- dummy is not used in this version of the specification and
  -- it should be ignored by the receiver.
  dummy                          RB-ActivationTimeInfoList    OPTIONAL,
  ul-CounterSynchronisationInfo UL-CounterSynchronisationInfo  OPTIONAL,
  laterNonCriticalExtensions     SEQUENCE {
    -- Container for additional R99 extensions
    radioBearerSetupComplete-r3-add-ext  BIT STRING          OPTIONAL,
    v770NonCriticalExtensions           SEQUENCE {
      radioBearerSetupComplete-v770ext
    }
    nonCriticalExtensions              SEQUENCE {}          OPTIONAL
  } OPTIONAL
}

RadioBearerSetupComplete-v770ext-IEs ::= SEQUENCE {
  -- TABULAR: EXT-UL-TimingAdvance is applicable for TDD mode only.
  ext-UL-TimingAdvance             EXT-UL-TimingAdvance  OPTIONAL,
  deferredMeasurementControlReading ENUMERATED { true }    OPTIONAL
}

-- *****
--
-- RADIO BEARER SETUP FAILURE
--
-- *****

RadioBearerSetupFailure ::= SEQUENCE {
  -- User equipment IEs
  rrc-TransactionIdentifier      RRC-TransactionIdentifier,
  failureCause                   FailureCauseWithProtErr,
  -- Radio bearer IEs
  potentiallySuccessfulBearerList RB-IdentityList                OPTIONAL,
  laterNonCriticalExtensions     SEQUENCE {
    -- Container for additional R99 extensions
    radioBearerSetupFailure-r3-add-ext  BIT STRING          OPTIONAL,
    nonCriticalExtensions              SEQUENCE {}          OPTIONAL
  } OPTIONAL
}

-- *****
--
-- RRC CONNECTION REJECT
--
-- *****

RRCConnectionReject ::= CHOICE {
  r3                               SEQUENCE {
    rrcConnectionReject-r3          RRCConnectionReject-r3-IEs,
    laterNonCriticalExtensions      SEQUENCE {
      -- Container for additional R99 extensions
      rrcConnectionReject-r3-add-ext  BIT STRING          OPTIONAL,
      v690NonCriticalExtensions      SEQUENCE {
        rrcConnectionReject-v690ext  RRCConnectionReject-v690ext-IEs,
        v6f0NonCriticalExtensions    SEQUENCE {
          rrcConnectionReject-v6f0ext RRCConnectionReject-v6f0ext-IEs,
          v860NonCriticalExtensions  SEQUENCE {
            rrcConnectionReject-v860ext RRCConnectionReject-v860ext-IEs,
            va40NonCriticalExtensions  SEQUENCE {
              rrcConnectionReject-va40ext RRCConnectionReject-va40ext-IEs,
              vb50NonCriticalExtensions  SEQUENCE {

```

```

        rrcConnectionReject-vb50ext      RRCConnectionReject-vb50ext-IEs,
        nonCriticalExtensions             SEQUENCE {}          OPTIONAL
    } OPTIONAL
} OPTIONAL
} OPTIONAL
},
later-than-r3                            SEQUENCE {
    initialUE-Identity                    InitialUE-Identity,
    rrc-TransactionIdentifier              RRC-TransactionIdentifier,
    criticalExtensions                     SEQUENCE {}
}
}
RRCConnectionReject-r3-IEs ::= SEQUENCE {
    -- TABULAR: Integrity protection shall not be performed on this message.
    -- User equipment IEs
    initialUE-Identity                    InitialUE-Identity,
    rrc-TransactionIdentifier              RRC-TransactionIdentifier,
    rejectionCause                        RejectionCause,
    waitTime                              WaitTime,
    redirectionInfo                        RedirectionInfo          OPTIONAL
}
RRCConnectionReject-v690ext-IEs ::= SEQUENCE {
    redirectionInfo-v690ext                GSM-TargetCellInfoList    OPTIONAL
}
RRCConnectionReject-v6f0ext-IEs ::= SEQUENCE {
    countingCompletion                     ENUMERATED { true }      OPTIONAL
}
RRCConnectionReject-v860ext-IEs ::= SEQUENCE {
    redirectionInfo                        RedirectionInfo-v860ext  OPTIONAL
}
RRCConnectionReject-va40ext-IEs ::= SEQUENCE {
    extendedWaitTime                      ExtendedWaitTime          OPTIONAL
}
RRCConnectionReject-vb50ext-IEs ::= SEQUENCE {
    eutra-TargetFreqInfoList              EUTRA-TargetFreqInfoList-vb50ext  OPTIONAL
}
-- *****
--
-- RRC CONNECTION RELEASE
--
-- *****
RRCConnectionRelease ::= CHOICE {
    r3                                     SEQUENCE {
        rrcConnectionRelease-r3            RRCConnectionRelease-r3-IEs,
        laterNonCriticalExtensions          SEQUENCE {
            -- Container for additional R99 extensions
            rrcConnectionRelease-r3-add-ext BIT STRING          OPTIONAL,
            v690NonCriticalExtensions       SEQUENCE {
                rrcConnectionRelease-v690ext RRCConnectionRelease-v690ext-IEs,
                v770NonCriticalExtensions    SEQUENCE {
                    rrcConnectionRelease-v770ext RRCConnectionRelease-v770ext-IEs,
                    v860NonCriticalExtensions  SEQUENCE {
                        rrcConnectionRelease-v860ext RRCConnectionRelease-v860ext-IEs,
                        va40NonCriticalExtensions SEQUENCE {
                            rrcConnectionRelease-va40ext RRCConnectionRelease-va40ext-IEs,
                            nonCriticalExtensions SEQUENCE {}          OPTIONAL
                        } OPTIONAL
                    } OPTIONAL
                } OPTIONAL
            } OPTIONAL
        } OPTIONAL
    } OPTIONAL
},
later-than-r3                            SEQUENCE {
    rrc-TransactionIdentifier              RRC-TransactionIdentifier,
    criticalExtensions                     CHOICE {
        r4                                 SEQUENCE {
            rrcConnectionRelease-r4         RRCConnectionRelease-r4-IEs,

```

```

v4d0NonCriticalExtensions          SEQUENCE {
  -- Container for adding non critical extensions after freezing REL-6
  rrcConnectionRelease-r4-add-ext  BIT STRING      OPTIONAL,
  v690NonCriticalExtensions        SEQUENCE {
    rrcConnectionRelease-v690ext   RRCConnectionRelease-v690ext-IEs,
    v770NonCriticalExtensions      SEQUENCE {
      rrcConnectionRelease-v770ext RRCConnectionRelease-v770ext-IEs,
      v860NonCriticalExtensions    SEQUENCE {
        rrcConnectionRelease-v860ext RRCConnectionRelease-v860ext-IEs,
        va40NonCriticalExtensions   SEQUENCE {
          rrcConnectionRelease-va40ext
                                RRCConnectionRelease-va40ext-IEs,
          vb50NonCriticalExtensions SEQUENCE {
            rrcConnectionRelease-vb50ext
                                RRCConnectionRelease-vb50ext-IEs,
            nonCriticalExtensions  SEQUENCE {}      OPTIONAL
          } OPTIONAL
        } OPTIONAL
      } OPTIONAL
    } OPTIONAL
  } OPTIONAL
},
criticalExtensions                SEQUENCE {}
}
}

RRCConnectionRelease-r3-IEs ::= SEQUENCE {
  -- User equipment IEs
  rrc-TransactionIdentifier      RRC-TransactionIdentifier,
  -- n-308 is conditional on the UE state
  n-308                          N-308                      OPTIONAL,
  releaseCause                   ReleaseCause,
  rplmn-information              Rplmn-Information            OPTIONAL
}

RRCConnectionRelease-r4-IEs ::= SEQUENCE {
  -- User equipment IEs
  -- n-308 is conditional on the UE state.
  n-308                          N-308                      OPTIONAL,
  releaseCause                   ReleaseCause,
  rplmn-information              Rplmn-Information-r4        OPTIONAL
}

RRCConnectionRelease-v690ext-IEs ::= SEQUENCE {
  redirectionInfo-v690ext        RedirectionInfo-r6      OPTIONAL
}

RRCConnectionRelease-v770ext-IEs ::= SEQUENCE {
  -- User equipment IEs
  ueMobilityStateIndicator       High-MobilityDetected    OPTIONAL
}

RRCConnectionRelease-v860ext-IEs ::= SEQUENCE {
  -- Other IEs
  redirectionInfo                RedirectionInfo-v860ext      OPTIONAL
}

RRCConnectionRelease-va40ext-IEs ::= SEQUENCE {
  extendedWaitTime               ExtendedWaitTime          OPTIONAL
}

RRCConnectionRelease-vb50ext-IEs ::= SEQUENCE {
  -- Other IEs
  eutra-TargetFreqInfoList       EUTRA-TargetFreqInfoList-vb50ext  OPTIONAL
}

-- *****
--
-- RRC CONNECTION RELEASE for CCCH
--
-- *****

RRCConnectionRelease-CCCH ::= CHOICE {
  r3                             SEQUENCE {
    rrcConnectionRelease-CCCH-r3  RRCConnectionRelease-CCCH-r3-IEs,
    laterNonCriticalExtensions    SEQUENCE {

```

```
-- Container for additional R99 extensions
rrcConnectionRelease-CCCH-r3-add-ext    BIT STRING    OPTIONAL,
v690NonCriticalExtensions                SEQUENCE {
    rrcConnectionRelease-v690ext        RRCConnectionRelease-CCCH-v690ext-IEs,
    v860NonCriticalExtensions            SEQUENCE {
        rrcConnectionRelease-v860ext    RRCConnectionRelease-CCCH-v860ext-IEs,
        va40NonCriticalExtensions        SEQUENCE {
            rrcConnectionRelease-va40ext RRCConnectionRelease-va40ext-IEs,
            nonCriticalExtensions        SEQUENCE {} OPTIONAL
        } OPTIONAL
    } OPTIONAL
} OPTIONAL
},
later-than-r3                            SEQUENCE {
    u-RNTI                                U-RNTI,
    rrc-TransactionIdentifier              RRC-TransactionIdentifier,
    criticalExtensions                      CHOICE {
        r4                                SEQUENCE {
            rrcConnectionRelease-CCCH-r4 RRCConnectionRelease-CCCH-r4-IEs,
            v4d0NonCriticalExtensions    SEQUENCE {
                -- Container for adding non critical extensions after freezing REL-5
                rrcConnectionRelease-CCCH-r4-add-ext    BIT STRING    OPTIONAL,
                v690NonCriticalExtensions                SEQUENCE {
                    rrcConnectionRelease-v690ext        RRCConnectionRelease-CCCH-v690ext-IEs,
                    v860NonCriticalExtensions            SEQUENCE {
                        rrcConnectionRelease-v860ext    RRCConnectionRelease-CCCH-v860ext-IEs,
                        va40NonCriticalExtensions        SEQUENCE {
                            rrcConnectionRelease-va40ext
                                                                RRCConnectionRelease-va40ext-IEs,
                            nonCriticalExtensions        SEQUENCE {}    OPTIONAL
                        } OPTIONAL
                    } OPTIONAL
                } OPTIONAL
            } OPTIONAL
        }
    } OPTIONAL
},
criticalExtensions                        SEQUENCE {
    -- TABULAR: CHOICE IdentityType (U-RNTI, GroupIdentity) is replaced with the
    -- optional element groupIdentity, since the U-RNTI is mandatory in ASN.1.
    -- In case CHOICE IdentityType is equal to GroupIdentity the value of the U-RNTI
    -- shall be ignored by a UE complying with this version of the message.
    groupIdentity                          SEQUENCE ( SIZE (1 .. maxURNTI-Group) ) OF
                                            GroupReleaseInformation    OPTIONAL,
    criticalExtensions                      CHOICE {
        r5                                SEQUENCE {
            rrcConnectionRelease-CCCH-r5    RRCConnectionRelease-CCCH-r5-IEs,
            -- Container for adding non critical extensions after freezing REL-6
            rrcConnectionRelease-CCCH-r5-add-ext    BIT STRING    OPTIONAL,
            v690NonCriticalExtensions                SEQUENCE {
                rrcConnectionRelease-v690ext        RRCConnectionRelease-CCCH-v690ext-IEs,
                v860NonCriticalExtensions            SEQUENCE {
                    rrcConnectionRelease-v860ext
                                                                RRCConnectionRelease-CCCH-v860ext-IEs,
                    va40NonCriticalExtensions        SEQUENCE {
                        rrcConnectionRelease-va40ext
                                                                RRCConnectionRelease-va40ext-IEs,
                        nonCriticalExtensions        SEQUENCE {}    OPTIONAL
                    } OPTIONAL
                } OPTIONAL
            } OPTIONAL
        }
    } OPTIONAL
},
    criticalExtensions                      SEQUENCE {}
}
}
}
}
RRConnectionRelease-CCCH-r3-IEs ::= SEQUENCE {
    -- User equipment IES
    u-RNTI                                U-RNTI,
    -- The rest of the message is identical to the one sent on DCCH.
    rrcConnectionRelease                    RRConnectionRelease-r3-IEs
}

RRConnectionRelease-CCCH-r4-IEs ::= SEQUENCE {
    -- The rest of the message is identical to the one sent on DCCH.
    rrcConnectionRelease                    RRConnectionRelease-r4-IEs
}
```



```

}

-- The R5 and R4 sequence of IEs are identical in this message
RRCConnectionRelease-CCCH-r5-IEs ::= RRCConnectionRelease-CCCH-r4-IEs

-- The R6 non-critical extension is identical to the one sent on DCCH.
RRCConnectionRelease-CCCH-v690ext-IEs ::= RRCConnectionRelease-v690ext-IEs

-- The R8 non-critical extension is identical to the one sent on DCCH.
RRCConnectionRelease-CCCH-v860ext-IEs ::= RRCConnectionRelease-v860ext-IEs

-- The R10 non-critical extension is identical to the one sent on DCCH.
RRCConnectionRelease-CCCH-va40ext-IEs ::= RRCConnectionRelease-va40ext-IEs

-- *****
--
-- RRC CONNECTION RELEASE COMPLETE
--
-- *****

RRCConnectionReleaseComplete ::= SEQUENCE {
  -- User equipment IEs
  rrc-TransactionIdentifier      RRC-TransactionIdentifier,
  errorIndication                FailureCauseWithProtErr           OPTIONAL,
  laterNonCriticalExtensions     SEQUENCE {
    -- Container for additional R99 extensions
    rrcConnectionReleaseComplete-r3-add-ext  BIT STRING           OPTIONAL,
    nonCriticalExtensions                 SEQUENCE {}           OPTIONAL
  } OPTIONAL
}

-- *****
--
-- RRC CONNECTION REQUEST
--
-- *****

RRCConnectionRequest ::= SEQUENCE {
  -- TABULAR: Integrity protection shall not be performed on this message.
  -- User equipment IEs
  initialUE-Identity              InitialUE-Identity,
  establishmentCause              EstablishmentCause,
  -- protocolErrorIndicator is MD, but for compactness reasons no default value
  -- has been assigned to it.
  protocolErrorIndicator          ProtocolErrorIndicator,
  -- Measurement IEs
  measuredResultsOnRACH           MeasuredResultsOnRACH           OPTIONAL,
  -- Non critical Extensions
  v3d0NonCriticalExtensions       SEQUENCE {
    rrcConnectionRequest-v3d0ext    RRCConnectionRequest-v3d0ext-IEs,
    -- Reserved for future non critical extension
    v4b0NonCriticalExtensions       SEQUENCE {
      rrcConnectionRequest-v4b0ext  RRCConnectionRequest-v4b0ext-IEs,
      v590NonCriticalExtensions     SEQUENCE {
        rrcConnectionRequest-v590ext RRCConnectionRequest-v590ext-IEs,
        v690NonCriticalExtensions   SEQUENCE {
          rrcConnectionRequest-v690ext RRCConnectionRequest-v690ext-IEs,
          -- Reserved for future non critical extension
          v6b0NonCriticalExtensions  SEQUENCE {
            rrcConnectionRequest-v6b0ext RRCConnectionRequest-v6b0ext-IEs,
            v6e0NonCriticalExtensions  SEQUENCE {
              rrcConnectionRequest-v6e0ext RRCConnectionRequest-v6e0ext-IEs,
              v770NonCriticalExtensions  SEQUENCE {
                rrcConnectionRequest-v770ext
                RRCConnectionRequest-v770ext-IEs,
                v7b0NonCriticalExtensions SEQUENCE {
                  rrcConnectionRequest-v7b0ext
                  RRCConnectionRequest-v7b0ext-IEs,
                  v860NonCriticalExtensions SEQUENCE {
                    rrcConnectionRequest-v860ext
                    RRCConnectionRequest-v860ext-IEs,
                    v7e0NonCriticalExtensions SEQUENCE {
                      rrcConnectionRequest-v7e0ext
                      RRCConnectionRequest-v7e0ext-IEs,
                      v7g0NonCriticalExtensions SEQUENCE {
                        rrcConnectionRequest-v7g0ext
                        RRCConnectionRequest-v7g0ext-IEs,
                        v920NonCriticalExtensions SEQUENCE {

```



```

RRCCONNECTIONREQUEST-V7G0EXT-IES ::= SEQUENCE {
  -- Measurement IEs
  measuredResultsOnRACH-v7g0ext      MeasuredResultsOnRACH-v7g0ext      OPTIONAL
}

RRCCONNECTIONREQUEST-V860EXT-IES ::= SEQUENCE {
  -- User equipment IEs
  supportOfCommonEDCH                ENUMERATED { true }                OPTIONAL,
  multiCellSupport                    ENUMERATED { true }                OPTIONAL,
  pre-redirectInfo                    Pre-RedirectInfo                    OPTIONAL,
  supportOfMACiis                     ENUMERATED { true }                OPTIONAL,
  supportOfSPSOperation               ENUMERATED { true }                OPTIONAL
}

RRCCONNECTIONREQUEST-V920EXT-IES ::= SEQUENCE {
  -- User equipment IEs
  supportOfDualCellMIMO               ENUMERATED { true }                OPTIONAL
}

RRCCONNECTIONREQUEST-V940EXT-IES ::= SEQUENCE {
  -- User equipment IEs
  systemInformationContainerStoredIndicator  ENUMERATED { true }                OPTIONAL
}

RRCCONNECTIONREQUEST-V9B0EXT-IES ::= SEQUENCE {
  -- User equipment IEs
  cSPBIndication                     ENUMERATED { true }                OPTIONAL
}

RRCCONNECTIONREQUEST-NonCriticalExts-va40-IES ::= SEQUENCE {
  rrcConnectionRequest-va40ext      RRCCONNECTIONREQUEST-va40ext-IES,
  v9b0NonCriticalExtensions         SEQUENCE {
    rrcConnectionRequest-v9b0ext    RRCCONNECTIONREQUEST-v9b0ext-IES,
    vb50NonCriticalExtensions       SEQUENCE {
      rrcConnectionRequest-vb50ext  RRCCONNECTIONREQUEST-vb50ext-IES,
      vc50NonCriticalExtensions     SEQUENCE {
        rrcConnectionRequest-vc50ext RRCCONNECTIONREQUEST-vc50ext-IES,
        nonCriticalExtensions       SEQUENCE {} OPTIONAL
      } OPTIONAL
    } OPTIONAL
  } OPTIONAL
}

RRCCONNECTIONREQUEST-va40ext-IES ::= SEQUENCE {
  -- User equipment IEs
  -- For 1.28 Mcps TDD, IE "supportOfMoreThanTwoCellsOrMIMO4x4" represent MU-MIMO capability,
  -- higherRate indicates uplink and downlink MU-MIMO, lowerRate indicates uplink MU-MIMO
  supportOfMoreThanTwoCellsOrMIMO4x4  ENUMERATED { higherRate, lowerRate }  OPTIONAL,
  supportOf1stFrequencyBand           ENUMERATED { true }                   OPTIONAL,
  supportOf2ndFrequencyBand           ENUMERATED { true }                   OPTIONAL
}

RRCCONNECTIONREQUEST-VB50EXT-IES ::= SEQUENCE {
  -- Measurement IEs
  measuredResultsOnRACHEUTRAFREQ      MeasuredResultsOnRACH-EUTRAFREQ      OPTIONAL
}

RRCCONNECTIONREQUEST-VC50EXT-IES ::= SEQUENCE {
  -- Measurement IEs
  measuredResultsOnRACH                MeasuredResultsOnRACH-vc50ext        OPTIONAL
}

-- *****
--
-- RRC CONNECTION SETUP
--
-- *****

RRCCONNECTIONSETUP ::= CHOICE {
  r3                                     SEQUENCE {
    rrcConnectionSetup-r3              RRCCONNECTIONSETUP-r3-IES,
    laterNonCriticalExtensions         SEQUENCE {
      -- Container for additional R99 extensions
      rrcConnectionSetup-r3-add-ext    BIT STRING                          OPTIONAL,
      v4b0NonCriticalExtensions       SEQUENCE {
        rrcConnectionSetup-v4b0ext    RRCCONNECTIONSETUP-v4b0ext-IES,
        v590NonCriticalExtensions     SEQUENCE {
          rrcConnectionSetup-v590ext  RRCCONNECTIONSETUP-v590ext-IES,

```

```

        v690NonCriticalExtensions SEQUENCE {
            rrcConnectionSetup-v690ext RRCCConnectionSetup-v690ext-IEs,
            nonCriticalExtensions SEQUENCE {} OPTIONAL
        } OPTIONAL
    } OPTIONAL
},
later-than-r3 SEQUENCE {
    initialUE-Identity InitialUE-Identity,
    rrc-TransactionIdentifier RRC-TransactionIdentifier,
    criticalExtensions CHOICE {
        r4 SEQUENCE {
            rrcConnectionSetup-r4 RRCCConnectionSetup-r4-IEs,
            v4d0NonCriticalExtensions SEQUENCE {
                -- Container for adding non critical extensions after freezing REL-5
                rrcConnectionSetup-r4-add-ext BIT STRING OPTIONAL,
                v590NonCriticalExtensions SEQUENCE {
                    rrcConnectionSetup-v590ext RRCCConnectionSetup-v590ext-IEs,
                    v690NonCriticalExtensions SEQUENCE {
                        rrcConnectionSetup-v690ext RRCCConnectionSetup-v690ext-IEs,
                        nonCriticalExtensions SEQUENCE {} OPTIONAL
                    } OPTIONAL
                } OPTIONAL
            } OPTIONAL
        }
    },
    criticalExtensions CHOICE {
        r5 SEQUENCE {
            rrcConnectionSetup-r5 RRCCConnectionSetup-r5-IEs,
            -- Container for adding non critical extensions after freezing REL-6
            rrcConnectionSetup-r5-add-ext BIT STRING OPTIONAL,
            v690NonCriticalExtensions SEQUENCE {
                rrcConnectionSetup-v690ext RRCCConnectionSetup-v690ext-IEs,
                nonCriticalExtensions SEQUENCE {} OPTIONAL
            } OPTIONAL
        }
    },
    criticalExtensions CHOICE {
        r6 SEQUENCE {
            rrcConnectionSetup-r6 RRCCConnectionSetup-r6-IEs,
            -- Container for adding non critical extensions after freezing REL-7
            rrcConnectionSetup-r6-add-ext BIT STRING OPTIONAL,
            v6b0NonCriticalExtensions SEQUENCE {
                rrcConnectionSetup-v6b0ext RRCCConnectionSetup-v6b0ext-IEs,
                nonCriticalExtensions SEQUENCE {} OPTIONAL
            } OPTIONAL
        }
    },
    criticalExtensions CHOICE {
        r7 SEQUENCE {
            rrcConnectionSetup-r7 RRCCConnectionSetup-r7-IEs,
            -- Container for adding non critical extensions after freezing REL-8
            rrcConnectionSetup-r7-add-ext BIT STRING OPTIONAL,
            v780NonCriticalExtensions SEQUENCE {
                rrcConnectionSetup-v780ext RRCCConnectionSetup-v780ext-IEs,
                v7d0NonCriticalExtensions SEQUENCE {
                    rrcConnectionSetup-v7d0ext RRCCConnectionSetup-v7d0ext-IEs,
                    nonCriticalExtensions SEQUENCE {} OPTIONAL
                } OPTIONAL
            } OPTIONAL
        }
    },
    criticalExtensions CHOICE {
        r8 SEQUENCE {
            rrcConnectionSetup-r8 RRCCConnectionSetup-r8-IEs,
            -- Container for adding non critical extensions after freezing REL-9
            rrcConnectionSetup-r8-add-ext BIT STRING OPTIONAL,
            v7d0NonCriticalExtensions SEQUENCE {
                rrcConnectionSetup-v7d0ext RRCCConnectionSetup-v7d0ext-IEs,
                v890NonCriticalExtensions SEQUENCE {
                    rrcConnectionSetup-v890ext RRCCConnectionSetup-v890ext-IEs,
                    v8a0NonCriticalExtensions SEQUENCE {
                        rrcConnectionSetup-v8a0ext RRCCConnectionSetup-v8a0ext-IEs,
                        nonCriticalExtensions SEQUENCE {} OPTIONAL
                    } OPTIONAL
                } OPTIONAL
            } OPTIONAL
        }
    },
    criticalExtensions CHOICE {

```



```

    ul-CommonTransChInfo          UL-CommonTransChInfo          OPTIONAL,
    -- NOTE: ul-AddReconfTransChInfoList should be optional in later versions of
    -- this message
    ul-AddReconfTransChInfoList    UL-AddReconfTransChInfoList,
    dl-CommonTransChInfo          DL-CommonTransChInfo          OPTIONAL,
    -- NOTE: dl-AddReconfTransChInfoList should be optional in later versions
    -- of this message
    dl-AddReconfTransChInfoList    DL-AddReconfTransChInfoList,
  -- Physical channel IEs
    frequencyInfo                 FrequencyInfo                OPTIONAL,
    maxAllowedUL-TX-Power         MaxAllowedUL-TX-Power    OPTIONAL,
    ul-ChannelRequirement         UL-ChannelRequirement    OPTIONAL,
    dl-CommonInformation          DL-CommonInformation     OPTIONAL,
    dl-InformationPerRL-List      DL-InformationPerRL-List OPTIONAL
  }

RRCConnectionSetup-v4b0ext-IEs ::= SEQUENCE {
  capabilityUpdateRequirement-r4-ext  CapabilityUpdateRequirement-r4-ext  OPTIONAL,
  -- Physical channel IEs
  -- dummy is not used in this version of the specification, it should
  -- not be sent and if received it should be ignored.
  dummy                               SSDT-UL                               OPTIONAL,
  -- The order of the RLs in IE cell-id-PerRL-List is the same as
  -- in IE DL-InformationPerRL-List included in this message
  cell-id-PerRL-List                 CellIdentity-PerRL-List           OPTIONAL
}

RRCConnectionSetup-v590ext-IEs ::= SEQUENCE {
  -- User equipment IEs
  systemSpecificCapUpdateReq         SystemSpecificCapUpdateReq-v590ext  OPTIONAL,
  -- Physical channel IEs
  dl-TPC-PowerOffsetPerRL-List      DL-TPC-PowerOffsetPerRL-List       OPTIONAL
}

RRCConnectionSetup-r4-IEs ::= SEQUENCE {
  -- TABULAR: Integrity protection shall not be performed on this message.
  activationTime                     ActivationTime                       OPTIONAL,
  new-U-RNTI                          U-RNTI,
  new-c-RNTI                          C-RNTI                              OPTIONAL,
  rrc-StateIndicator                 RRC-StateIndicator,
  utran-DRX-CycleLengthCoeff         UTRAN-DRX-CycleLengthCoefficient,
  -- TABULAR: If capabilityUpdateRequirement is not present, the default value
  -- defined in 10.3.3.2 shall be used.
  capabilityUpdateRequirement         CapabilityUpdateRequirement-r4       OPTIONAL,
  -- Radio bearer IEs
  srb-InformationSetupList           SRB-InformationSetupList2,
  -- Transport channel IEs
  ul-CommonTransChInfo              UL-CommonTransChInfo-r4            OPTIONAL,
  ul-AddReconfTransChInfoList        UL-AddReconfTransChInfoList        OPTIONAL,
  dl-CommonTransChInfo              DL-CommonTransChInfo-r4            OPTIONAL,
  dl-AddReconfTransChInfoList        DL-AddReconfTransChInfoList-r4     OPTIONAL,
  -- Physical channel IEs
  frequencyInfo                     FrequencyInfo                        OPTIONAL,
  maxAllowedUL-TX-Power              MaxAllowedUL-TX-Power              OPTIONAL,
  ul-ChannelRequirement              UL-ChannelRequirement-r4           OPTIONAL,
  dl-CommonInformation              DL-CommonInformation-r4            OPTIONAL,
  dl-InformationPerRL-List           DL-InformationPerRL-List-r4        OPTIONAL
}

RRCConnectionSetup-r5-IEs ::= SEQUENCE {
  -- TABULAR: Integrity protection shall not be performed on this message.
  activationTime                     ActivationTime                       OPTIONAL,
  new-U-RNTI                          U-RNTI,
  new-c-RNTI                          C-RNTI                              OPTIONAL,
  rrc-StateIndicator                 RRC-StateIndicator,
  utran-DRX-CycleLengthCoeff         UTRAN-DRX-CycleLengthCoefficient,
  -- TABULAR: If capabilityUpdateRequirement is not present, the default value
  -- defined in 10.3.3.2 shall be used.
  capabilityUpdateRequirement         CapabilityUpdateRequirement-r5       OPTIONAL,
  -- Specification mode information
  specificationMode                  CHOICE {
    complete                          SEQUENCE {
      -- Radio bearer IEs
      srb-InformationSetupList         SRB-InformationSetupList2,
      -- Transport channel IEs
      ul-CommonTransChInfo            UL-CommonTransChInfo-r4            OPTIONAL,
      ul-AddReconfTransChInfoList      UL-AddReconfTransChInfoList        OPTIONAL,
      dl-CommonTransChInfo            DL-CommonTransChInfo-r4            OPTIONAL,

```

```

        dl-AddReconfTransChInfoList      DL-AddReconfTransChInfoList-r4      OPTIONAL
    },
    preconfiguration                      SEQUENCE {
        -- All IEs that include an FDD/TDD choice are split in two IEs for this message,
        -- one for the FDD only elements and one for the TDD only elements, so that one
        -- FDD/TDD choice in this level is sufficient.
        preConfigMode                     CHOICE {
            predefinedConfigIdentity      PredefinedConfigIdentity,
            defaultConfig                  SEQUENCE {
                defaultConfigMode         DefaultConfigMode,
                defaultConfigIdentity     DefaultConfigIdentity-r5
            }
        }
    }
},
-- Physical channel IEs
frequencyInfo                           FrequencyInfo                           OPTIONAL,
maxAllowedUL-TX-Power                    MaxAllowedUL-TX-Power                    OPTIONAL,
ul-ChannelRequirement                    UL-ChannelRequirement-r4                 OPTIONAL,
dl-CommonInformation                     DL-CommonInformation-r4                  OPTIONAL,
dl-InformationPerRL-List                  DL-InformationPerRL-List-r5bis           OPTIONAL
}

RRCConnectionSetup-v690ext-IEs ::= SEQUENCE {
    -- Physical Channel IEs
    beaconPLEst                           BEACON-PL-Est                           OPTIONAL,
    postVerificationPeriod                  ENUMERATED { true }                       OPTIONAL
}

RRCConnectionSetup-r6-IEs ::= SEQUENCE {
    -- TABULAR: Integrity protection shall not be performed on this message.
    activationTime                         ActivationTime                             OPTIONAL,
    new-U-RNTI                             U-RNTI,
    new-c-RNTI                             C-RNTI                                    OPTIONAL,
    new-H-RNTI                             H-RNTI                                    OPTIONAL,
    newPrimary-E-RNTI                      E-RNTI                                    OPTIONAL,
    newSecondary-E-RNTI                    E-RNTI                                    OPTIONAL,
    rrc-StateIndicator                      RRC-StateIndicator,
    utran-DRX-CycleLengthCoeff              UTRAN-DRX-CycleLengthCoefficient,
    -- TABULAR: If capabilityUpdateRequirement is not present, the default value
    -- defined in 10.3.3.2 shall be used.
    capabilityUpdateRequirement            CapabilityUpdateRequirement-r5             OPTIONAL,
    -- Specification mode information
    specificationMode                       CHOICE {
        complete                            SEQUENCE {
            -- Radio bearer IEs
            srb-InformationSetupList        SRB-InformationSetupList2-r6,
            -- Transport channel IEs
            ul-CommonTransChInfo            UL-CommonTransChInfo-r4                  OPTIONAL,
            ul-AddReconfTransChInfoList     UL-AddReconfTransChInfoList-r6          OPTIONAL,
            dl-CommonTransChInfo            DL-CommonTransChInfo-r4                  OPTIONAL,
            dl-AddReconfTransChInfoList     DL-AddReconfTransChInfoList-r5          OPTIONAL
        },
        preconfiguration                    SEQUENCE {
            -- All IEs that include an FDD/TDD choice are split in two IEs for this message,
            -- one for the FDD only elements and one for the TDD only elements, so that one
            -- FDD/TDD choice in this level is sufficient.
            preConfigMode                     CHOICE {
                predefinedConfigIdentity      PredefinedConfigIdentity,
                defaultConfig                  SEQUENCE {
                    defaultConfigMode         DefaultConfigMode,
                    defaultConfigIdentity     DefaultConfigIdentity-r6
                }
            }
        }
    }
},
-- Physical channel IEs
frequencyInfo                           FrequencyInfo                           OPTIONAL,
maxAllowedUL-TX-Power                    MaxAllowedUL-TX-Power                    OPTIONAL,
ul-DPCH-Info                             UL-DPCH-Info-r6                          OPTIONAL,
ul-EDCH-Information                       UL-EDCH-Information-r6                   OPTIONAL,
dl-HSPDSCH-Information                    DL-HSPDSCH-Information-r6                OPTIONAL,
dl-CommonInformation                       DL-CommonInformation-r6                   OPTIONAL,
dl-InformationPerRL-List                    DL-InformationPerRL-List-r6                OPTIONAL
}

RRCConnectionSetup-v6b0ext-IEs ::= SEQUENCE {
    -- Physical channel IEs

```

```

    dl-InformationPerRL-List-v6b0ext    DL-InformationPerRL-List-v6b0ext    OPTIONAL
}

RRCConnectionSetup-r7-IEs ::= SEQUENCE {
  -- TABULAR: Integrity protection shall not be performed on this message.
  activationTime                      ActivationTime                      OPTIONAL,
  new-U-RNTI                          U-RNTI,
  new-c-RNTI                          C-RNTI                      OPTIONAL,
  new-H-RNTI                          H-RNTI                      OPTIONAL,
  newPrimary-E-RNTI                   E-RNTI                      OPTIONAL,
  newSecondary-E-RNTI                 E-RNTI                      OPTIONAL,
  rrc-StateIndicator                  RRC-StateIndicator,
  utran-DRX-CycleLengthCoeff          UTRAN-DRX-CycleLengthCoefficient-r7,
  -- TABULAR: If capabilityUpdateRequirement is not present, the default value
  -- defined in 10.3.3.2 shall be used.
  capabilityUpdateRequirement          CapabilityUpdateRequirement-r7    OPTIONAL,
  supportForChangeOfUE-Capability     BOOLEAN,
  -- Specification mode information
  specificationMode                    CHOICE {
    complete                            SEQUENCE {
      -- Radio bearer IEs
      srb-InformationSetupList          SRB-InformationSetupList2-r7,
      -- Transport channel IEs
      ul-CommonTransChInfo             UL-CommonTransChInfo-r4        OPTIONAL,
      ul-AddReconfTransChInfoList      UL-AddReconfTransChInfoList-r7  OPTIONAL,
      dl-CommonTransChInfo             DL-CommonTransChInfo-r4        OPTIONAL,
      dl-AddReconfTransChInfoList      DL-AddReconfTransChInfoList-r7  OPTIONAL
    },
    preconfiguration                    SEQUENCE {
      -- All IEs that include an FDD/TDD choice are split in two IEs for this message,
      -- one for the FDD only elements and one for the TDD only elements, so that one
      -- FDD/TDD choice in this level is sufficient.
      preConfigMode                     CHOICE {
        predefinedConfigIdentity        PredefinedConfigIdentity,
        defaultConfig                   SEQUENCE {
          defaultConfigMode             DefaultConfigMode,
          defaultConfigIdentity         DefaultConfigIdentity-r6
        }
      }
    }
  },
  -- Physical channel IEs
  frequencyInfo                       FrequencyInfo                  OPTIONAL,
  multi-frequencyInfo                 Multi-frequencyInfo-LCR-r7    OPTIONAL,
  dtx-drx-TimingInfo                 DTX-DRX-TimingInfo-r7       OPTIONAL,
  dtx-drx-Info                        DTX-DRX-Info-r7             OPTIONAL,
  hs-scch-LessInfo                    HS-SCCH-LessInfo-r7         OPTIONAL,
  maxAllowedUL-TX-Power               MaxAllowedUL-TX-Power        OPTIONAL,
  ul-DPCH-Info                        UL-DPCH-Info-r7             OPTIONAL,
  ul-EDCH-Information                 UL-EDCH-Information-r7       OPTIONAL,
  dl-HSPDSCH-Information              DL-HSPDSCH-Information-r7    OPTIONAL,
  dl-CommonInformation                DL-CommonInformation-r7      OPTIONAL,
  dl-InformationPerRL-List            DL-InformationPerRL-List-r7  OPTIONAL
}

RRCConnectionSetup-v780ext-IEs ::= SEQUENCE {
  -- Physical channel IEs
  hs-DSCH-TBSizeTable                 HS-DSCH-TBSizeTable          OPTIONAL
}

RRCConnectionSetup-v7d0ext-IEs ::= SEQUENCE {
  -- Physical channel IEs
  ul-EDCH-Information                 UL-EDCH-Information-ext      OPTIONAL
}

RRCConnectionSetup-r8-IEs ::= SEQUENCE {
  -- TABULAR: Integrity protection shall not be performed on this message.
  activationTime                      ActivationTime                      OPTIONAL,
  new-U-RNTI                          U-RNTI,
  new-c-RNTI                          C-RNTI                      OPTIONAL,
  new-H-RNTI                          H-RNTI                      OPTIONAL,
  newPrimary-E-RNTI                   E-RNTI                      OPTIONAL,
  newSecondary-E-RNTI                 E-RNTI                      OPTIONAL,
  rrc-StateIndicator                  RRC-StateIndicator,
  utran-DRX-CycleLengthCoeff          UTRAN-DRX-CycleLengthCoefficient-r7,
  -- TABULAR: If capabilityUpdateRequirement is not present, the default value
  -- defined in 10.3.3.2 shall be used.
  capabilityUpdateRequirement          CapabilityUpdateRequirement-r8    OPTIONAL,

```



```

    supportForChangeOfUE-Capability BOOLEAN,
-- Specification mode information
-- dummy is not used in this version of the specification, it should
-- not be sent and if received it should be ignored.
dummy                DefaultConfigForCellFACH                OPTIONAL,
specificationMode    CHOICE {
    complete          SEQUENCE {
        -- Radio bearer IEs
        srb-InformationSetupList        SRB-InformationSetupList2-r8,
        -- Transport channel IEs
        ul-CommonTransChInfo           UL-CommonTransChInfo-r4                OPTIONAL,
        ul-AddReconfTransChInfoList    UL-AddReconfTransChInfoList-r8    OPTIONAL,
        dl-CommonTransChInfo           DL-CommonTransChInfo-r4                OPTIONAL,
        dl-AddReconfTransChInfoList    DL-AddReconfTransChInfoList-r7    OPTIONAL
    },
    preconfiguration    SEQUENCE {
        -- All IEs that include an FDD/TDD choice are split in two IEs for this message,
        -- one for the FDD only elements and one for the TDD only elements, so that one
        -- FDD/TDD choice in this level is sufficient.
        preConfigMode    CHOICE {
            predefinedConfigIdentity    PredefinedConfigIdentity,
            defaultConfig              SEQUENCE {
                defaultConfigMode      DefaultConfigMode,
                defaultConfigIdentity  DefaultConfigIdentity-r6
            }
        }
    }
},
-- Physical channel IEs
frequencyInfo          FrequencyInfo                OPTIONAL,
multi-frequencyInfo    Multi-frequencyInfo-LCR-r7    OPTIONAL,
dtx-drx-TimingInfo    DTX-DRX-TimingInfo-r7        OPTIONAL,
dtx-drx-Info          DTX-DRX-Info-r7              OPTIONAL,
hs-scch-LessInfo      HS-SCCH-LessInfo-r7          OPTIONAL,
maxAllowedUL-TX-Power MaxAllowedUL-TX-Power        OPTIONAL,
ul-DPCH-Info          UL-DPCH-Info-r7              OPTIONAL,
ul-EDCH-Information    UL-EDCH-Information-r8        OPTIONAL,
dl-HSPDSCH-Information DL-HSPDSCH-Information-r8    OPTIONAL,
dl-CommonInformation    DL-CommonInformation-r8      OPTIONAL,
dl-InformationPerRL-List DL-InformationPerRL-List-r8        OPTIONAL,
dl-SecondaryCellInfoFDD DL-SecondaryCellInfoFDD                OPTIONAL,
sps-Information-TDD128 SPS-Information-TDD128-r8            OPTIONAL
}

RRCConnectionSetup-v890ext-IEs ::= SEQUENCE {
-- Physical channel IEs
    dl-SecondaryCellInfoFDD-v890ext    DL-SecondaryCellInfoFDD-v890ext    OPTIONAL,
    dl-HSPDSCH-Information              DL-HSPDSCH-Information-r8-ext      OPTIONAL
}

RRCConnectionSetup-v8a0ext-IEs ::= SEQUENCE {
-- Physical channel IEs
    dl-HSPDSCH-Information              DL-HSPDSCH-Information-r8-ext2    OPTIONAL
}

RRCConnectionSetup-r9-IEs ::= SEQUENCE {
-- TABULAR: Integrity protection shall not be performed on this message.
    activationTime                    ActivationTime                OPTIONAL,
    new-U-RNTI                        U-RNTI,
    new-c-RNTI                        C-RNTI                OPTIONAL,
    new-H-RNTI                        H-RNTI                OPTIONAL,
    newPrimary-E-RNTI                E-RNTI                OPTIONAL,
    newSecondary-E-RNTI              E-RNTI                OPTIONAL,
    rrc-StateIndicator                RRC-StateIndicator,
    utran-DRX-CycleLengthCoeff        UTRAN-DRX-CycleLengthCoefficient-r7,
    -- TABULAR: If capabilityUpdateRequirement is not present, the default value
    -- defined in 10.3.3.2 shall be used.
    capabilityUpdateRequirement        CapabilityUpdateRequirement-r8    OPTIONAL,
    supportForChangeOfUE-Capability    BOOLEAN,
-- Specification mode information
-- dummy is not used in this version of the specification, it should
-- not be sent and if received UE behaviour is unspecified.
dummy                DefaultConfigForCellFACH                OPTIONAL,
specificationMode    CHOICE {
    complete          SEQUENCE {
        -- Radio bearer IEs
        srb-InformationSetupList        SRB-InformationSetupList2-r8,
        -- Transport channel IEs

```

```

        ul-CommonTransChInfo          UL-CommonTransChInfo-r4          OPTIONAL,
        ul-AddReconfTransChInfoList    UL-AddReconfTransChInfoList-r8    OPTIONAL,
        dl-CommonTransChInfo           DL-CommonTransChInfo-r4          OPTIONAL,
        dl-AddReconfTransChInfoList    DL-AddReconfTransChInfoList-r9    OPTIONAL
    },
    preconfiguration                    SEQUENCE {
        -- All IEs that include an FDD/TDD choice are split in two IEs for this message,
        -- one for the FDD only elements and one for the TDD only elements, so that one
        -- FDD/TDD choice in this level is sufficient.
        preConfigMode                   CHOICE {
            predefinedConfigIdentity     PredefinedConfigIdentity,
            defaultConfig                SEQUENCE {
                defaultConfigMode       DefaultConfigMode,
                defaultConfigIdentity   DefaultConfigIdentity-r6
            }
        }
    }
},
-- Physical channel IEs
frequencyInfo                          FrequencyInfo                          OPTIONAL,
multi-frequencyInfo                    Multi-frequencyInfo-LCR-r7              OPTIONAL,
dtx-drx-TimingInfo                    DTX-DRX-TimingInfo-r7                 OPTIONAL,
dtx-drx-Info                          DTX-DRX-Info-r7                       OPTIONAL,
hs-scch-LessInfo                      HS-SCCH-LessInfo-r7                   OPTIONAL,
maxAllowedUL-TX-Power                 MaxAllowedUL-TX-Power                 OPTIONAL,
ul-DPCH-Info                          UL-DPCH-Info-r7                      OPTIONAL,
ul-EDCH-Information                   UL-EDCH-Information-r9               OPTIONAL,
dl-HSPDSCH-Information                DL-HSPDSCH-Information-r9            OPTIONAL,
dl-CommonInformation                  DL-CommonInformation-r8              OPTIONAL,
dl-InformationPerRL-List              DL-InformationPerRL-List-r8          OPTIONAL,
dl-SecondaryCellInfoFDD               DL-SecondaryCellInfoFDD-r9           OPTIONAL,
sps-Information-TDD128                SPS-Information-TDD128-r8           OPTIONAL
}

RRCConnectionSetup-v950ext-IEs ::= SEQUENCE {
    -- Physical channel IEs
    secondaryCellMimoParameters        SecondaryCellMIMOparametersFDD-v950ext  OPTIONAL
}

RRCConnectionSetup-rl0-IEs ::= SEQUENCE {
    -- TABULAR: Integrity protection shall not be performed on this message.
    activationTime                     ActivationTime                          OPTIONAL,
    new-U-RNTI                         U-RNTI,
    new-c-RNTI                         C-RNTI,
    new-H-RNTI                         H-RNTI,
    newPrimary-E-RNTI                 E-RNTI,
    newSecondary-E-RNTI               E-RNTI,
    rrc-StateIndicator                RRC-StateIndicator,
    utran-DRX-CycleLengthCoeff        UTRAN-DRX-CycleLengthCoefficient-r7,
    -- TABULAR: If capabilityUpdateRequirement is not present, the default value
    -- defined in 10.3.3.2 shall be used.
    capabilityUpdateRequirement        CapabilityUpdateRequirement-r8         OPTIONAL,
    supportForChangeOfUE-Capability    BOOLEAN,
    -- Specification mode information
    -- dummy is not used in this version of the specification, it should
    -- not be sent and if received UE behaviour is unspecified.
    dummy                              DefaultConfigForCellFACH              OPTIONAL,
    specificationMode                  CHOICE {
        complete                       SEQUENCE {
            -- Radio bearer IEs
            srb-InformationSetupList    SRB-InformationSetupList2-r8,
            -- Transport channel IEs
            ul-CommonTransChInfo       UL-CommonTransChInfo-r4          OPTIONAL,
            ul-AddReconfTransChInfoList UL-AddReconfTransChInfoList-r8    OPTIONAL,
            dl-CommonTransChInfo       DL-CommonTransChInfo-r4          OPTIONAL,
            dl-AddReconfTransChInfoList DL-AddReconfTransChInfoList-r9    OPTIONAL
        },
        preconfiguration                SEQUENCE {
            -- All IEs that include an FDD/TDD choice are split in two IEs for this message,
            -- one for the FDD only elements and one for the TDD only elements, so that one
            -- FDD/TDD choice in this level is sufficient.
            preConfigMode               CHOICE {
                predefinedConfigIdentity PredefinedConfigIdentity,
                defaultConfig            SEQUENCE {
                    defaultConfigMode   DefaultConfigMode,
                    defaultConfigIdentity DefaultConfigIdentity-r6
                }
            }
        }
    }
}

```

```

    },
  },
  -- Physical channel IEs
  frequencyInfo           FrequencyInfo           OPTIONAL,
  multi-frequencyInfo     Multi-frequencyInfo-LCR-r7     OPTIONAL,
  dtx-drx-TimingInfo     DTX-DRX-TimingInfo-r7           OPTIONAL,
  dtx-drx-Info           DTX-DRX-Info-r7             OPTIONAL,
  hs-scch-LessInfo       HS-SCCH-LessInfo-r7           OPTIONAL,
  maxAllowedUL-TX-Power  MaxAllowedUL-TX-Power         OPTIONAL,
  ul-DPCH-Info           UL-DPCH-Info-r7             OPTIONAL,
  ul-EDCH-Information    UL-EDCH-Information-r9         OPTIONAL,
  dl-HSPDSCH-Information DL-HSPDSCH-Information-r9     OPTIONAL,
  dl-CommonInformation   DL-CommonInformation-r10      OPTIONAL,
  dl-InformationPerRL-List DL-InformationPerRL-List-r8   OPTIONAL,
  dl-SecondaryCellInfoFDD DL-SecondaryCellInfoFDD-r10   OPTIONAL,
  additionalDLSecCellInfoListFDD AdditionalDLSecCellInfoListFDD OPTIONAL,
  sps-Information-TDD128 SPS-Information-TDD128-r8     OPTIONAL,
  mu-MIMO-Info-TDD128   MU-MIMO-Info-TDD128         OPTIONAL
}

RRCCConnectionSetup-vaj0ext-IEs ::= SEQUENCE {
  capabilityUpdateRequirement  CapabilityUpdateRequirement-vaj0ext  OPTIONAL
}

RRCCConnectionSetup-r11-IEs ::= SEQUENCE {
  -- TABULAR: Integrity protection shall not be performed on this message.
  activationTime              ActivationTime              OPTIONAL,
  new-U-RNTI                  U-RNTI,
  new-c-RNTI                  C-RNTI                  OPTIONAL,
  new-H-RNTI                  H-RNTI                  OPTIONAL,
  newPrimary-E-RNTI          E-RNTI                  OPTIONAL,
  newSecondary-E-RNTI        E-RNTI                  OPTIONAL,
  rrc-StateIndicator          RRC-StateIndicator,
  utran-DRX-CycleLengthCoeff UTRAN-DRX-CycleLengthCoefficient-r7,
  -- TABULAR: If capabilityUpdateRequirement is not present, the default value
  -- defined in 10.3.3.2 shall be used.
  capabilityUpdateRequirement CapabilityUpdateRequirement-r8  OPTIONAL,
  supportForChangeOfUE-Capability BOOLEAN,
  -- Specification mode information
  defaultConfigForCellFACH    DefaultConfigForCellFACH    OPTIONAL,
  specificationMode           CHOICE {
    complete                   SEQUENCE {
      -- Radio bearer IEs
      srb-InformationSetupList  SRB-InformationSetupList2-r8,
      -- Transport channel IEs
      ul-CommonTransChInfo     UL-CommonTransChInfo-r4     OPTIONAL,
      ul-AddReconfTransChInfoList UL-AddReconfTransChInfoList-r8  OPTIONAL,
      dl-CommonTransChInfo     DL-CommonTransChInfo-r4     OPTIONAL,
      dl-AddReconfTransChInfoList DL-AddReconfTransChInfoList-r11  OPTIONAL
    },
    preconfiguration           SEQUENCE {
      -- All IEs that include an FDD/TDD choice are split in two IEs for this message,
      -- one for the FDD only elements and one for the TDD only elements, so that one
      -- FDD/TDD choice in this level is sufficient.
      preConfigMode            CHOICE {
        predefinedConfigIdentity  PredefinedConfigIdentity,
        defaultConfig            SEQUENCE {
          defaultConfigMode      DefaultConfigMode,
          defaultConfigIdentity  DefaultConfigIdentity-r6
        }
      }
    }
  },
}

-- Physical channel IEs
frequencyInfo           FrequencyInfo           OPTIONAL,
multi-frequencyInfo     Multi-frequencyInfo-LCR-r7     OPTIONAL,
dtx-drx-TimingInfo     DTX-DRX-TimingInfo-r7           OPTIONAL,
dtx-drx-Info           DTX-DRX-Info-r7             OPTIONAL,
hs-scch-LessInfo       HS-SCCH-LessInfo-r7           OPTIONAL,
maxAllowedUL-TX-Power  MaxAllowedUL-TX-Power         OPTIONAL,
ul-DPCH-Info           UL-DPCH-Info-r11           OPTIONAL,
ul-EDCH-Information    UL-EDCH-Information-r11         OPTIONAL,
dl-HSPDSCH-Information DL-HSPDSCH-Information-r11     OPTIONAL,
dl-CommonInformation   DL-CommonInformation-r10      OPTIONAL,
dl-InformationPerRL-List DL-InformationPerRL-List-r8   OPTIONAL,
dl-SecondaryCellInfoFDD DL-SecondaryCellInfoFDD-r11   OPTIONAL,
additionalDLSecCellInfoListFDD AdditionalDLSecCellInfoListFDD-r11  OPTIONAL,
commonERGCHInfoFDD     CommonERGCHInfoFDD           OPTIONAL,

```

```

    sps-Information-TDD128          SPS-Information-TDD128-r8          OPTIONAL,
    mu-MIMO-Info-TDD128           MU-MIMO-Info-TDD128          OPTIONAL
}

RRCConnectionSetup-r12-IEs ::= SEQUENCE {
  -- TABULAR: Integrity protection shall not be performed on this message.
  activationTime                  ActivationTime                OPTIONAL,
  new-U-RNTI                      U-RNTI,
  new-c-RNTI                      C-RNTI                      OPTIONAL,
  new-H-RNTI                      H-RNTI                      OPTIONAL,
  newPrimary-E-RNTI              E-RNTI                      OPTIONAL,
  newSecondary-E-RNTI            E-RNTI                      OPTIONAL,
  rrc-StateIndicator              RRC-StateIndicator,
  utran-DRX-CycleLengthCoeff      UTRAN-DRX-CycleLengthCoefficient-r7,
  -- TABULAR: If capabilityUpdateRequirement is not present, the default value
  -- defined in 10.3.3.2 shall be used.
  capabilityUpdateRequirement     CapabilityUpdateRequirement-r12  OPTIONAL,
  supportForChangeOfUE-Capability BOOLEAN,
  -- Specification mode information
  defaultConfigForCellFACH        DefaultConfigForCellFACH        OPTIONAL,
  specificationMode                CHOICE {
    complete                       SEQUENCE {
      -- Radio bearer IEs
      srb-InformationSetupList      SRB-InformationSetupList2-r8,
      -- Transport channel IEs
      ul-CommonTransChInfo          UL-CommonTransChInfo-r4        OPTIONAL,
      ul-AddReconfTransChInfoList   UL-AddReconfTransChInfoList-r8  OPTIONAL,
      dl-CommonTransChInfo          DL-CommonTransChInfo-r4        OPTIONAL,
      dl-AddReconfTransChInfoList   DL-AddReconfTransChInfoList-r11  OPTIONAL
    },
    preconfiguration                SEQUENCE {
      -- All IEs that include an FDD/TDD choice are split in two IEs for this message,
      -- one for the FDD only elements and one for the TDD only elements, so that one
      -- FDD/TDD choice in this level is sufficient.
      preConfigMode                 CHOICE {
        predefinedConfigIdentity     PredefinedConfigIdentity,
        defaultConfig                SEQUENCE {
          defaultConfigMode          DefaultConfigMode,
          defaultConfigIdentity      DefaultConfigIdentity-r6
        }
      }
    }
  },
  -- Physical channel IEs
  frequencyInfo                   FrequencyInfo                 OPTIONAL,
  multi-frequencyInfo             Multi-frequencyInfo-LCR-r7    OPTIONAL,
  dtx-drx-TimingInfo             DTX-DRX-TimingInfo-r7        OPTIONAL,
  dtx-drx-Info                   DTX-DRX-Info-r12            OPTIONAL,
  hs-scch-LessInfo               HS-SCCH-LessInfo-r7          OPTIONAL,
  maxAllowedUL-TX-Power           MaxAllowedUL-TX-Power        OPTIONAL,
  ul-DPCH-Info                   UL-DPCH-Info-r11            OPTIONAL,
  ul-EDCH-Information             UL-EDCH-Information-r11      OPTIONAL,
  dl-HSPDSCH-Information          DL-HSPDSCH-Information-r12   OPTIONAL,
  dl-CommonInformation            DL-CommonInformation-r10     OPTIONAL,
  dl-InformationPerRL-List        DL-InformationPerRL-List-r8  OPTIONAL,
  dl-SecondaryCellInfoFDD         DL-SecondaryCellInfoFDD-r11  OPTIONAL,
  additionalDLSecCellInfoListFDD  AdditionalDLSecCellInfoListFDD-r11  OPTIONAL,
  commonERGCHInfoFDD             CommonERGCHInfoFDD          OPTIONAL,
  sps-Information-TDD128          SPS-Information-TDD128-r8    OPTIONAL,
  mu-MIMO-Info-TDD128            MU-MIMO-Info-TDD128         OPTIONAL,
  non-rectResAllocInd-TDD128     Non-rectResAllocInd-TDD128  OPTIONAL,
  non-rectResSpectTSset-TDD128   Non-rectResSpectTSset-TDD128  OPTIONAL
}

-- *****
--
-- RRC CONNECTION SETUP COMPLETE
--
-- *****

RRCConnectionSetupComplete ::= SEQUENCE {
  -- TABULAR: Integrity protection shall not be performed on this message.
  -- User equipment IEs
  rrc-TransactionIdentifier        RRC-TransactionIdentifier,
  startList                       STARTList,
  ue-RadioAccessCapability         UE-RadioAccessCapability      OPTIONAL,
  -- Other IEs
  ue-RATSpecificCapability         InterRAT-UE-RadioAccessCapabilityList  OPTIONAL,

```



```

        rrcConnectionSetupComplete-v7f0ext
        va40NonCriticalExtensions
            rrcConnectionSetupCompleteBand-va40ext
                nonCriticalExtensions
                    }
                }
            }
        }
    }
}

RRConnectionSetupComplete-v4b0ext-IEs ::= SEQUENCE {
    -- User equipment IEs
    ue-RadioAccessCapability-v4b0ext          UE-RadioAccessCapability-v4b0ext          OPTIONAL
}

RRConnectionSetupComplete-v590ext-IEs ::= SEQUENCE {
    -- User equipment IEs
    ue-RadioAccessCapability-v590ext          UE-RadioAccessCapability-v590ext          OPTIONAL,
    -- Other IEs
    ue-RATSpecificCapability-v590ext          InterRAT-UE-RadioAccessCapability-v590ext  OPTIONAL
}

RRConnectionSetupComplete-v5c0ext-IEs ::= SEQUENCE {
    -- User equipment IEs
    ue-RadioAccessCapability-v5c0ext          UE-RadioAccessCapability-v5c0ext          OPTIONAL
}

RRConnectionSetupComplete-v650ext-IEs ::= SEQUENCE {
    -- User equipment IEs
    ue-RadioAccessCapability-v650ext          UE-RadioAccessCapability-v650ext
}

RRConnectionSetupComplete-v680ext-IEs ::= SEQUENCE {
    -- User equipment IEs
    ue-RadioAccessCapability-v680ext          UE-RadioAccessCapability-v680ext
}

RRConnectionSetupComplete-v690ext-IEs ::= SEQUENCE {
    -- User equipment IEs
    ueCapabilityContainer                     BIT STRING
                                              (CONTAINING UE-CapabilityContainer-IEs) OPTIONAL
}

RRConnectionSetupComplete-v770ext-IEs ::= SEQUENCE {
    -- Other IEs
    deferredMeasurementControlReading        ENUMERATED { true }                      OPTIONAL
}

RRConnectionSetupComplete-v7e0ext-IEs ::= SEQUENCE {
    -- User equipment IEs
    ue-RadioAccessCapability                  UE-RadioAccessCapability-v7e0ext
}

RRConnectionSetupComplete-v7f0ext-IEs ::= SEQUENCE {
    -- User equipment IEs
    ue-RadioAccessCapability                  UE-RadioAccessCapability-v7f0ext          OPTIONAL
}

RRConnectionSetupComplete-va40ext-IEs ::= SEQUENCE {
    -- Other IEs
    loggedMeasAvailable                       ENUMERATED { true }                      OPTIONAL,
    loggedANRResultsAvailable                 ENUMERATED { true }                      OPTIONAL
}

RRConnectionSetupCompleteBand-va40ext-IEs ::= SEQUENCE {
    -- User equipment IEs
    ue-RadioAccessCapabBand                  UE-RadioAccessCapabBand-va40ext          OPTIONAL
}

RRConnectionSetupComplete-vb50ext-IEs ::= SEQUENCE {
    -- Other IEs
    connEstFailInfoAvailable                  ENUMERATED { true }                      OPTIONAL
}

-- *****
--
-- RRC FAILURE INFO

```

```

--
-- *****
RRC-FailureInfo ::= CHOICE {
    r3
        SEQUENCE {
            rRC-FailureInfo-r3
                laterNonCriticalExtensions
                    SEQUENCE {
                        -- Container for additional R99 extensions
                        rrc-FailureInfo-r3-add-ext
                            BIT STRING
                            OPTIONAL,
                        nonCriticalExtensions
                            SEQUENCE {}
                            OPTIONAL
                    }
                OPTIONAL
            },
            criticalExtensions
                SEQUENCE {}
        }
}

RRC-FailureInfo-r3-IEs ::= SEQUENCE {
    -- Non-RRC IEs
    failureCauseWithProtErr
        FailureCauseWithProtErr
}

-- *****
--
-- RRC STATUS
--
-- *****

RRCStatus ::= SEQUENCE {
    -- Other IEs
    -- TABULAR: Identification of received message is nested in
    -- ProtocolErrorMoreInformation
    protocolErrorInformation
        ProtocolErrorMoreInformation,
    laterNonCriticalExtensions
        SEQUENCE {
            -- Container for additional R99 extensions
            rrcStatus-r3-add-ext
                BIT STRING
                OPTIONAL,
            nonCriticalExtensions
                SEQUENCE {}
                OPTIONAL
        }
        OPTIONAL
}

-- *****
--
-- SECURITY MODE COMMAND
--
-- *****

SecurityModeCommand ::= CHOICE {
    r3
        SEQUENCE {
            securityModeCommand-r3
                SecurityModeCommand-r3-IEs,
            laterNonCriticalExtensions
                SEQUENCE {
                    -- Container for additional R99 extensions
                    securityModeCommand-r3-add-ext
                        BIT STRING
                        OPTIONAL,
                    nonCriticalExtensions
                        SEQUENCE {}
                        OPTIONAL
                }
            }
        OPTIONAL
    },
    later-than-r3
        SEQUENCE {
            rrc-TransactionIdentifier
                RRC-TransactionIdentifier,
            criticalExtensions
                CHOICE {
                    r7
                        SEQUENCE {
                            securityModeCommand-r7
                                SecurityModeCommand-r7-IEs,
                            -- Container for adding non critical extensions after freezing REL-8
                            securityModeCommand-r7-add-ext
                                BIT STRING
                                OPTIONAL,
                            nonCriticalExtensions
                                SEQUENCE {}
                                OPTIONAL
                        }
                    },
            criticalExtensions
                SEQUENCE {}
        }
}

SecurityModeCommand-r3-IEs ::= SEQUENCE {
    -- TABULAR: Integrity protection shall always be performed on this message.
    -- User equipment IEs
    rrc-TransactionIdentifier
        RRC-TransactionIdentifier,
    securityCapability
        SecurityCapability,
    cipheringModeInfo
        CipheringModeInfo
        OPTIONAL,
    integrityProtectionModeInfo
        IntegrityProtectionModeInfo
        OPTIONAL,
    -- Core network IEs
    cn-DomainIdentity
        CN-DomainIdentity,
    -- Other IEs
    ue-SystemSpecificSecurityCap
        InterRAT-UE-SecurityCapList
        OPTIONAL
}

```

```

}

SecurityModeCommand-r7-IEs ::= SEQUENCE {
-- TABULAR: Integrity protection shall always be performed on this message.
-- User equipment IEs
    securityCapability          SecurityCapability,
    cipheringModeInfo           CipheringModeInfo-r7           OPTIONAL,
    integrityProtectionModeInfo IntegrityProtectionModeInfo-r7  OPTIONAL,
-- Core network IEs
    cn-DomainIdentity           CN-DomainIdentity,
-- Other IEs
    ue-SystemSpecificSecurityCap InterRAT-UE-SecurityCapList    OPTIONAL
}

-- *****
--
-- SECURITY MODE COMPLETE
--
-- *****

SecurityModeComplete ::= SEQUENCE {
-- TABULAR: Integrity protection shall always be performed on this message.

-- User equipment IEs
    rrc-TransactionIdentifier    RRC-TransactionIdentifier,
    ul-IntegProtActivationInfo   IntegrityProtActivationInfo    OPTIONAL,
-- Radio bearer IEs
    rb-UL-CiphActivationTimeInfo RB-ActivationTimeInfoList        OPTIONAL,
    laterNonCriticalExtensions   SEQUENCE {
        -- Container for additional R99 extensions
        securityModeComplete-r3-add-ext BIT STRING        OPTIONAL,
        nonCriticalExtensions         SEQUENCE {}          OPTIONAL
    } OPTIONAL
}

-- *****
--
-- SECURITY MODE FAILURE
--
-- *****

SecurityModeFailure ::= SEQUENCE {
-- User equipment IEs
    rrc-TransactionIdentifier    RRC-TransactionIdentifier,
    failureCause                 FailureCauseWithProtErr,
    laterNonCriticalExtensions   SEQUENCE {
        -- Container for additional R99 extensions
        securityModeFailure-r3-add-ext BIT STRING        OPTIONAL,
        nonCriticalExtensions         SEQUENCE {}          OPTIONAL
    } OPTIONAL
}

-- *****
--
-- SIGNALLING CONNECTION RELEASE
--
-- *****

SignallingConnectionRelease ::= CHOICE {
    r3
        SEQUENCE {
            signallingConnectionRelease-r3 SignallingConnectionRelease-r3-IEs,
            laterNonCriticalExtensions     SEQUENCE {
                -- Container for additional R99 extensions
                signallingConnectionRelease-r3-add-ext BIT STRING        OPTIONAL,
                va40NonCriticalExtensions         SEQUENCE {
                    signallingConnectionRelease-va40ext SignallingConnectionRelease-va40ext-IEs,
                    nonCriticalExtensions         SEQUENCE {}          OPTIONAL
                } OPTIONAL
            } OPTIONAL
        },
    later-than-r3
        SEQUENCE {
            rrc-TransactionIdentifier    RRC-TransactionIdentifier,
            criticalExtensions           SEQUENCE {}
        }
}

SignallingConnectionRelease-r3-IEs ::= SEQUENCE {
-- User equipment IEs

```



```

        rrc-TransactionIdentifier      RRC-TransactionIdentifier,
-- Core network IEs
        cn-DomainIdentity              CN-DomainIdentity
    }

SignallingConnectionRelease-va40ext-IEs ::= SEQUENCE {
    extendedWaitTime                   ExtendedWaitTime                OPTIONAL
}

-- *****
--
-- SIGNALLING CONNECTION RELEASE INDICATION
--
-- *****

SignallingConnectionReleaseIndication ::= SEQUENCE {
-- Core network IEs
    cn-DomainIdentity                  CN-DomainIdentity,
    laterNonCriticalExtensions          SEQUENCE {
-- Container for additional R99 extensions
        signallingConnectionReleaseIndication-r3-add-ext      BIT STRING        OPTIONAL,
        v860nonCriticalExtensions                             SEQUENCE {
            signallingConnectionReleaseIndication-v860ext
                SignallingConnectionReleaseIndication-v860ext,
            nonCriticalExtensions                             SEQUENCE {}        OPTIONAL
        } OPTIONAL
    } OPTIONAL
}

SignallingConnectionReleaseIndication-v860ext ::= SEQUENCE {
    signallingConnectionReleaseIndicationCause
        ENUMERATED { uRequestedPSDataSessionEnd, anyOtherCause }
}

-- *****
--
-- SYSTEM INFORMATION for BCH
--
-- *****

SystemInformation-BCH ::= SEQUENCE {
-- Other information elements
    sfn-Prime                          SFN-Prime,
    payload                              CHOICE {
        noSegment                        NULL,
        firstSegment                     FirstSegment,
        subsequentSegment                 SubsequentSegment,
        lastSegmentShort                  LastSegmentShort,
        lastAndFirst                      SEQUENCE {
            lastSegmentShort              LastSegmentShort,
            firstSegment                   FirstSegmentShort
        },
        lastAndComplete                   SEQUENCE {
            lastSegmentShort              LastSegmentShort,
            completeSIB-List               CompleteSIB-List
        },
        lastAndCompleteAndFirst           SEQUENCE {
            lastSegmentShort              LastSegmentShort,
            completeSIB-List               CompleteSIB-List,
            firstSegment                   FirstSegmentShort
        },
        completeSIB-List                  CompleteSIB-List,
        completeAndFirst                   SEQUENCE {
            completeSIB-List               CompleteSIB-List,
            firstSegment                   FirstSegmentShort
        },
        completeSIB                       CompleteSIB,
        lastSegment                        LastSegment,
        spare5                             NULL,
        spare4                             NULL,
        spare3                             NULL,
        spare2                             NULL,
        spare1                             NULL
    }
}

-- *****
--

```

```

-- SYSTEM INFORMATION2 for BCH
--
-- *****

SystemInformation2-BCH ::= SEQUENCE {
    segmentCombination CHOICE {
        combination2 FirstSegment2,
        combination3 SubsequentSegment2,
        combination4 LastSegmentShort2,
        combination5 SEQUENCE {
            lastSegmentShort LastSegmentShort2,
            firstSegmentShort FirstSegmentShort2
        },
        combination6 SEQUENCE {
            lastSegmentShort LastSegmentShort2,
            completeSIB-List CompleteSIB2-List
        },
        combination7 SEQUENCE {
            lastSegmentShort LastSegmentShort2,
            completeSIB-List CompleteSIB2-List,
            firstSegment FirstSegmentShort2
        },
        combination8 CompleteSIB2-List,
        combination9 SEQUENCE {
            completeSIB-List CompleteSIB2-List,
            firstSegment FirstSegmentShort2
        },
        combination10 CompleteSIB2,
        combination11 LastSegment2,
        spare6 NULL,
        spare5 NULL,
        spare4 NULL,
        spare3 NULL,
        spare2 NULL,
        spare1 NULL
    }
}

-- *****
--
-- SYSTEM INFORMATION for FACH
--
-- *****

-- this IE is not used in this version of the specification.
SystemInformation-FACH ::= SEQUENCE {
    -- Other information elements
    payload CHOICE {
        noSegment NULL,
        firstSegment FirstSegment,
        subsequentSegment SubsequentSegment,
        lastSegmentShort LastSegmentShort,
        lastAndFirst SEQUENCE {
            lastSegmentShort LastSegmentShort,
            firstSegment FirstSegmentShort
        },
        lastAndComplete SEQUENCE {
            lastSegmentShort LastSegmentShort,
            completeSIB-List CompleteSIB-List
        },
        lastAndCompleteAndFirst SEQUENCE {
            lastSegmentShort LastSegmentShort,
            completeSIB-List CompleteSIB-List,
            firstSegment FirstSegmentShort
        },
        completeSIB-List CompleteSIB-List,
        completeAndFirst SEQUENCE {
            completeSIB-List CompleteSIB-List,
            firstSegment FirstSegmentShort
        },
        completeSIB CompleteSIB,
        lastSegment LastSegment,
        spare5 NULL,
        spare4 NULL,
        spare3 NULL,
        spare2 NULL,
        spare1 NULL
    }
}

```

```

}
-- *****
--
-- First segment
--
-- *****

FirstSegment ::=
    SEQUENCE {
        -- Other information elements
        sib-Type          SIB-Type,
        seg-Count         SegCount,
        sib-Data-fixed    SIB-Data-fixed
    }

FirstSegment2 ::=
    SEQUENCE {
        -- Other information elements
        sib-Type          SIB-Type2,
        seg-Count         SegCount,
        sib-Data-fixed    SIB-Data2-fixed
    }

-- *****
--
-- First segment (short)
--
-- *****

FirstSegmentShort ::=
    SEQUENCE {
        -- Other information elements
        sib-Type          SIB-Type,
        seg-Count         SegCount,
        sib-Data-variable SIB-Data-variable
    }

FirstSegmentShort2 ::=
    SEQUENCE {
        -- Other information elements
        sib-Type          SIB-Type2,
        seg-Count         SegCount,
        sib-Data-variable SIB-Data2-variable
    }

-- *****
--
-- Subsequent segment
--
-- *****

SubsequentSegment ::=
    SEQUENCE {
        -- Other information elements
        sib-Type          SIB-Type,
        segmentIndex      SegmentIndex,
        sib-Data-fixed    SIB-Data-fixed
    }

SubsequentSegment2 ::=
    SEQUENCE {
        -- Other information elements
        sib-Type          SIB-Type2,
        segmentIndex      SegmentIndex,
        sib-Data-fixed    SIB-Data2-fixed
    }

-- *****
--
-- Last segment
--
-- *****

LastSegment ::=
    SEQUENCE {
        -- Other information elements
        sib-Type          SIB-Type,
        segmentIndex      SegmentIndex,
        -- For sib-Data-fixed, in case the SIB data is less than 222 bits, padding
        -- shall be used. The same padding bits shall be used as defined in clause 12.1
        sib-Data-fixed    SIB-Data-fixed
    }

LastSegment2 ::=
    SEQUENCE {

```

```

-- Other information elements
sib-Type                SIB-Type2,
segmentIndex            SegmentIndex,
-- For sib-Data-fixed, in case the SIB data is less than 232 bits, padding
-- shall be used. The same padding bits shall be used as defined in clause 12.1
sib-Data-fixed          SIB-Data2-fixed
}

LastSegmentShort ::=
-- Other information elements
sib-Type                SIB-Type,
segmentIndex            SegmentIndex,
sib-Data-variable       SIB-Data-variable
}

LastSegmentShort2 ::=
-- Other information elements
sib-Type                SIB-Type2,
segmentIndex            SegmentIndex,
sib-Data-variable       SIB-Data2-variable
}

-- *****
--
-- Complete SIB
--
-- *****

CompleteSIB-List ::=
SEQUENCE (SIZE (1..maxSIBperMsg)) OF
CompleteSIBshort

CompleteSIB2-List ::=
SEQUENCE (SIZE (1..maxSIBperMsg)) OF
CompleteSIBshort2

CompleteSIB ::=
-- Other information elements
sib-Type                SIB-Type,
-- For sib-Data-fixed, in case the SIB data is less than 226 bits, padding
-- shall be used. The same padding bits shall be used as defined in clause 12.1
sib-Data-fixed          BIT STRING (SIZE (226))
}

CompleteSIB2 ::=
-- Other information elements
sib-Type                SIB-Type2,
-- For sib-Data-fixed, in case the SIB data is less than 236 bits, padding
-- shall be used. The same padding bits shall be used as defined in clause 12.1
sib-Data-fixed          BIT STRING (SIZE (236))
}

CompleteSIBshort ::=
-- Other information elements
sib-Type                SIB-Type,
sib-Data-variable       SIB-Data-variable
}

CompleteSIBshort2 ::=
-- Other information elements
sib-Type                SIB-Type2,
sib-Data-variable       SIB-Data2-variable
}

-- *****
--
-- SYSTEM INFORMATION CHANGE INDICATION
--
-- *****

SystemInformationChangeIndication ::= SEQUENCE {
-- Other IEs
bcch-ModificationInfo   BCCH-ModificationInfo,
laterNonCriticalExtensions SEQUENCE {
-- Container for additional R99 extensions
systemInformationChangeIndication-r3-add-ext BIT STRING OPTIONAL,
v860NonCriticalExtensions SEQUENCE {
systemInformationChangeIndication-v860ext
SystemInformationChangeIndication-v860ext-IEs,
vc50NonCriticalExtensions SEQUENCE {

```

```

        systemInformationChangeIndication-vc50ext
        SystemInformationChangeIndication-vc50ext-IEs,
        nonCriticalExtensions SEQUENCE {} OPTIONAL
    } OPTIONAL
} OPTIONAL
}

SystemInformationChangeIndication-v860ext-IEs ::= SEQUENCE {
    -- Other IEs
    etws-Information ETWS-Information OPTIONAL
}

SystemInformationChangeIndication-vc50ext-IEs ::= SEQUENCE {
    bcch-ModificationInfo-vc50ext BCCH-ModificationInfo-vc50ext OPTIONAL
}

-- *****
--
-- TRANSPORT CHANNEL RECONFIGURATION
--
-- *****

TransportChannelReconfiguration ::= CHOICE {
    r3 SEQUENCE {
        transportChannelReconfiguration-r3
        TransportChannelReconfiguration-r3-IEs,
        v3a0NonCriticalExtensions SEQUENCE {
            transportChannelReconfiguration-v3a0ext
            TransportChannelReconfiguration-v3a0ext,
            laterNonCriticalExtensions SEQUENCE {
                -- Container for additional R99 extensions
                transportChannelReconfiguration-r3-add-ext BIT STRING OPTIONAL,
                v4b0NonCriticalExtensions SEQUENCE {
                    transportChannelReconfiguration-v4b0ext
                    TransportChannelReconfiguration-v4b0ext-IEs,
                v590NonCriticalExtensions SEQUENCE {
                    transportChannelReconfiguration-v590ext
                    TransportChannelReconfiguration-v590ext-IEs,
                v690NonCriticalExtensions SEQUENCE {
                    transportChannelReconfiguration-v690ext
                    TransportChannelReconfiguration-v690ext-IEs,
                v770NonCriticalExtensions SEQUENCE {
                    transportChannelReconfiguration-v770ext
                    TransportChannelReconfiguration-v770ext-IEs,
                nonCriticalExtensions SEQUENCE {} OPTIONAL
            } OPTIONAL
        } OPTIONAL
    } OPTIONAL
} OPTIONAL
},
    later-than-r3 SEQUENCE {
        rrc-TransactionIdentifier RRC-TransactionIdentifier,
        criticalExtensions CHOICE {
            r4 SEQUENCE {
                transportChannelReconfiguration-r4
                TransportChannelReconfiguration-r4-IEs,
                v4d0NonCriticalExtensions SEQUENCE {
                    -- Container for adding non critical extensions after freezing REL-5
                    transportChannelReconfiguration-r4-add-ext BIT STRING OPTIONAL,
                    v590NonCriticalExtensions SEQUENCE {
                        transportChannelReconfiguration-v590ext
                        TransportChannelReconfiguration-v590ext-IEs,
                    v690NonCriticalExtensions SEQUENCE {
                        transportChannelReconfiguration-v690ext
                        TransportChannelReconfiguration-v690ext-IEs,
                    v770NonCriticalExtensions SEQUENCE {
                        transportChannelReconfiguration-v770ext
                        TransportChannelReconfiguration-v770ext-IEs,
                    nonCriticalExtensions SEQUENCE {} OPTIONAL
                } OPTIONAL
            } OPTIONAL
        } OPTIONAL
    } OPTIONAL
},
    criticalExtensions CHOICE {

```

```

r5
    SEQUENCE {
    transportChannelReconfiguration-r5
        TransportChannelReconfiguration-r5-IEs,
    -- Container for adding non critical extensions after freezing REL-6
    transportChannelReconfiguration-r5-add-ext        BIT STRING        OPTIONAL,
    v690NonCriticalExtensions        SEQUENCE {
        transportChannelReconfiguration-v690ext
            TransportChannelReconfiguration-v690ext-IEs,
        v770NonCriticalExtensions        SEQUENCE {
            transportChannelReconfiguration-v770ext
                TransportChannelReconfiguration-v770ext-IEs,
            nonCriticalExtensions        SEQUENCE {}        OPTIONAL
        }        OPTIONAL
    }        OPTIONAL
    },
criticalExtensions        CHOICE {
    r6
        SEQUENCE {
        transportChannelReconfiguration-r6
            TransportChannelReconfiguration-r6-IEs,
        -- Container for adding non critical extensions after freezing REL-7
        transportChannelReconfiguration-r6-add-ext        BIT STRING        OPTIONAL,
        v6b0NonCriticalExtensions        SEQUENCE {
            transportChannelReconfiguration-v6b0ext
                TransportChannelReconfiguration-v6b0ext-IEs,
            v770NonCriticalExtensions        SEQUENCE {
                transportChannelReconfiguration-v770ext
                    TransportChannelReconfiguration-v770ext-IEs,
                nonCriticalExtensions        SEQUENCE {}        OPTIONAL
            }        OPTIONAL
        }        OPTIONAL
    }        OPTIONAL
    },
criticalExtensions        CHOICE {
    r7
        SEQUENCE {
        transportChannelReconfiguration-r7
            TransportChannelReconfiguration-r7-IEs,
        -- Container for adding non critical extensions after freezing REL-8
        transportChannelReconfiguration-r7-add-ext        BIT STRING        OPTIONAL,
        v780NonCriticalExtensions        SEQUENCE {
            transportChannelReconfiguration-v780ext
                TransportChannelReconfiguration-v780ext-IEs,
            v7d0NonCriticalExtensions        SEQUENCE {
                transportChannelReconfiguration-v7d0ext
                    TransportChannelReconfiguration-v7d0ext-IEs,
            v7f0NonCriticalExtensions        SEQUENCE {
                transportChannelReconfiguration-v7f0ext
                    TransportChannelReconfiguration-v7f0ext-IEs,
            v7g0NonCriticalExtensions        SEQUENCE {
                transportChannelReconfiguration-v7g0ext
                    TransportChannelReconfiguration-v7g0ext-IEs,
                nonCriticalExtensions        SEQUENCE {}        OPTIONAL
            }        OPTIONAL
        }        OPTIONAL
    }        OPTIONAL
    }        OPTIONAL
    },
criticalExtensions        CHOICE {
    r8
        SEQUENCE {
        transportChannelReconfiguration-r8
            TransportChannelReconfiguration-r8-IEs,
        -- Container for adding non critical extensions after freezing REL-9
        transportChannelReconfiguration-r8-add-ext        BIT STRING        OPTIONAL,
        v7d0NonCriticalExtensions        SEQUENCE {
            transportChannelReconfiguration-v7d0ext
                TransportChannelReconfiguration-v7d0ext-IEs,
            v7f0NonCriticalExtensions        SEQUENCE {
                transportChannelReconfiguration-v7f0ext
                    TransportChannelReconfiguration-v7f0ext-IEs,
            v890NonCriticalExtensions        SEQUENCE {
                transportChannelReconfiguration-v890ext
                    TransportChannelReconfiguration-v890ext-IEs,
            v7g0NonCriticalExtensions        SEQUENCE {
                transportChannelReconfiguration-v7g0ext
                    TransportChannelReconfiguration-v7g0ext-IEs,
            v8a0NonCriticalExtensions        SEQUENCE {
                transportChannelReconfiguration-v8a0ext
                    TransportChannelReconfiguration-v8a0ext-IEs,
                nonCriticalExtensions

```



```

rrc-TransactionIdentifier      RRC-TransactionIdentifier,
integrityProtectionModeInfo   IntegrityProtectionModeInfo   OPTIONAL,
cipheringModeInfo             CipheringModeInfo               OPTIONAL,
activationTime                 ActivationTime                   OPTIONAL,
new-U-RNTI                    U-RNTI                         OPTIONAL,
new-C-RNTI                    C-RNTI                         OPTIONAL,
rrc-StateIndicator            RRC-StateIndicator,
utran-DRX-CycleLengthCoeff    UTRAN-DRX-CycleLengthCoefficient OPTIONAL,
-- Core network IEs
cn-InformationInfo            CN-InformationInfo              OPTIONAL,
-- UTRAN mobility IEs
ura-Identity                  URA-Identity                    OPTIONAL,
-- Radio bearer IEs
dl-CounterSynchronisationInfo DL-CounterSynchronisationInfo  OPTIONAL,
-- Transport channel IEs
ul-CommonTransChInfo         UL-CommonTransChInfo           OPTIONAL,
ul-AddReconfTransChInfoList  UL-AddReconfTransChInfoList   OPTIONAL,
-- 'dummy', 'dummy1' and 'dummy2' are not used in this version of the specification,
-- they should not be sent and if received they should be ignored.
dummy                         CHOICE {
  fdd                          SEQUENCE {
    dummy1                      CPCH-SetID                     OPTIONAL,
    dummy2                      DRAC-StaticInformationList    OPTIONAL
  },
  tdd                          NULL
}
dl-CommonTransChInfo         DL-CommonTransChInfo           OPTIONAL,
dl-AddReconfTransChInfoList  DL-AddReconfTransChInfoList   OPTIONAL,
-- Physical channel IEs
frequencyInfo                 FrequencyInfo                    OPTIONAL,
maxAllowedUL-TX-Power         MaxAllowedUL-TX-Power          OPTIONAL,
ul-ChannelRequirement         UL-ChannelRequirement          OPTIONAL,
modeSpecificPhysChInfo       CHOICE {
  fdd                          SEQUENCE {
    -- dummy is not used in this version of specification, it should
    -- not be sent and if received it should be ignored.
    dummy                       DL-PDSCH-Information           OPTIONAL
  },
  tdd                          NULL
},
dl-CommonInformation         DL-CommonInformation           OPTIONAL,
dl-InformationPerRL-List     DL-InformationPerRL-List      OPTIONAL
}

TransportChannelReconfiguration-v3a0ext ::= SEQUENCE {
  -- The IE "new-DSCH-RNTI" should not be included in FDD mode, and if received
  -- the UE behaviour is unspecified
  new-DSCH-RNTI              DSCH-RNTI                      OPTIONAL
}

TransportChannelReconfiguration-v4b0ext-IEs ::= SEQUENCE {
  -- Physical channel IEs
  -- dummy is not used in this version of the specification, it should
  -- not be sent and if received it should be ignored.
  dummy                      SSdT-UL                          OPTIONAL,
  -- The order of the RLs in IE cell-id-PerRL-List is the same as
  -- in IE DL-InformationPerRL-List included in this message
  cell-id-PerRL-List         CellIdentity-PerRL-List        OPTIONAL
}

TransportChannelReconfiguration-v590ext-IEs ::= SEQUENCE {
  -- Physical channel IEs
  dl-TPC-PowerOffsetPerRL-List DL-TPC-PowerOffsetPerRL-List  OPTIONAL
}

TransportChannelReconfiguration-r4-IEs ::= SEQUENCE {
  -- User equipment IEs
  integrityProtectionModeInfo IntegrityProtectionModeInfo    OPTIONAL,
  cipheringModeInfo          CipheringModeInfo               OPTIONAL,
  activationTime              ActivationTime                     OPTIONAL,
  new-U-RNTI                  U-RNTI                         OPTIONAL,
  new-C-RNTI                  C-RNTI                         OPTIONAL,
  -- The IE "new-DSCH-RNTI" should not be included in FDD mode, and if received
  -- the UE behaviour is unspecified
  new-DSCH-RNTI              DSCH-RNTI                      OPTIONAL,
  rrc-StateIndicator          RRC-StateIndicator,
  utran-DRX-CycleLengthCoeff UTRAN-DRX-CycleLengthCoefficient OPTIONAL,
  -- Core network IEs

```



```

    cn-InformationInfo          CN-InformationInfo          OPTIONAL,
-- UTRAN mobility IEs
    ura-Identity                URA-Identity                OPTIONAL,
-- Radio bearer IEs
    dl-CounterSynchronisationInfo DL-CounterSynchronisationInfo  OPTIONAL,
-- Transport channel IEs
    ul-CommonTransChInfo        UL-CommonTransChInfo-r4          OPTIONAL,
    ul-AddReconfTransChInfoList UL-AddReconfTransChInfoList      OPTIONAL,
-- 'dummy', 'dummy1' and 'dummy2' are not used in this version of the specification,
-- they should not be sent and if received they should be ignored.
    dummy                        CHOICE {
        fdd                      SEQUENCE {
            dummy1                CPCH-SetID          OPTIONAL,
            dummy2                DRAC-StaticInformationList  OPTIONAL
        },
        tdd                      NULL
    }
    dl-CommonTransChInfo        DL-CommonTransChInfo-r4          OPTIONAL,
    dl-AddReconfTransChInfoList DL-AddReconfTransChInfoList-r4    OPTIONAL,
-- Physical channel IEs
    frequencyInfo              FrequencyInfo                    OPTIONAL,
    maxAllowedUL-TX-Power       MaxAllowedUL-TX-Power            OPTIONAL,
    ul-ChannelRequirement       UL-ChannelRequirement-r4         OPTIONAL,
    modeSpecificPhysChInfo      CHOICE {
        fdd                      SEQUENCE {
            -- dummy is not used in this version of specification, it should
            -- not be sent and if received it should be ignored.
            dummy                 DL-PDSCH-Information    OPTIONAL
        },
        tdd                      NULL
    },
    dl-CommonInformation        DL-CommonInformation-r4          OPTIONAL,
    dl-InformationPerRL-List     DL-InformationPerRL-List-r4     OPTIONAL
}

TransportChannelReconfiguration-r5-IEs ::= SEQUENCE {
-- User equipment IEs
    integrityProtectionModeInfo IntegrityProtectionModeInfo      OPTIONAL,
    cipheringModeInfo           CipheringModeInfo                 OPTIONAL,
    activationTime               ActivationTime                     OPTIONAL,
    new-U-RNTI                  U-RNTI                          OPTIONAL,
    new-C-RNTI                  C-RNTI                          OPTIONAL,
-- The IE "new-DSCH-RNTI" should not be included in FDD mode, and if received
-- the UE behaviour is unspecified
    new-DSCH-RNTI              DSCH-RNTI                        OPTIONAL,
    new-H-RNTI                 H-RNTI                          OPTIONAL,
    rrc-StateIndicator         RRC-StateIndicator,
    utran-DRX-CycleLengthCoeff UTRAN-DRX-CycleLengthCoefficient  OPTIONAL,
-- Core network IEs
    cn-InformationInfo          CN-InformationInfo          OPTIONAL,
-- UTRAN mobility IEs
    ura-Identity                URA-Identity                OPTIONAL,
-- Radio bearer IEs
    dl-CounterSynchronisationInfo DL-CounterSynchronisationInfo-r5  OPTIONAL,
-- Transport channel IEs
    ul-CommonTransChInfo        UL-CommonTransChInfo-r4          OPTIONAL,
    ul-AddReconfTransChInfoList UL-AddReconfTransChInfoList      OPTIONAL,
-- 'dummy', 'dummy1' and 'dummy2' are not used in this version of the specification,
-- they should not be sent and if received they should be ignored.
    dummy                        CHOICE {
        fdd                      SEQUENCE {
            dummy1                CPCH-SetID          OPTIONAL,
            dummy2                DRAC-StaticInformationList  OPTIONAL
        },
        tdd                      NULL
    }
    dl-CommonTransChInfo        DL-CommonTransChInfo-r4          OPTIONAL,
    dl-AddReconfTransChInfoList DL-AddReconfTransChInfoList-r5    OPTIONAL,
-- Physical channel IEs
    frequencyInfo              FrequencyInfo                    OPTIONAL,
    maxAllowedUL-TX-Power       MaxAllowedUL-TX-Power            OPTIONAL,
    ul-ChannelRequirement       UL-ChannelRequirement-r5         OPTIONAL,
    modeSpecificPhysChInfo      CHOICE {
        fdd                      SEQUENCE {
            -- dummy is not used in this version of specification, it should
            -- not be sent and if received it should be ignored.
            dummy                 DL-PDSCH-Information    OPTIONAL
        },
        tdd                      NULL
    },
}

```

```

        tdd                NULL
    },
    dl-HSPDSCH-Information DL-HSPDSCH-Information    OPTIONAL,
    dl-CommonInformation  DL-CommonInformation-r5    OPTIONAL,
    dl-InformationPerRL-List DL-InformationPerRL-List-r5    OPTIONAL
}

TransportChannelReconfiguration-v690ext-IEs ::= SEQUENCE {
    -- User Equipment IEs
    delayRestrictionFlag      DelayRestrictionFlag      OPTIONAL,
    -- Core network IEs
    primary-plmn-Identity     PLMN-Identity             OPTIONAL,
    -- Physical channel IEs
    -- The IE harq-Preamble-Mode should not be used in the r3 and r4 versions of the message
    -- If included in the r3 or r4 version of the message, the UE should ignore the IE
    harq-Preamble-Mode       HARQ-Preamble-Mode        OPTIONAL,
    beaconPLEst              BEACON-PL-Est             OPTIONAL,
    postVerificationPeriod   ENUMERATED { true }        OPTIONAL,
    dhs-sync                 DHS-Sync                 OPTIONAL,
    timingMaintainedSynchInd TimingMaintainedSynchInd    OPTIONAL,
    -- MBMS IEs
    mbms-PL-ServiceRestrictInfo MBMS-PL-ServiceRestrictInfo-r6    OPTIONAL
}

TransportChannelReconfiguration-r6-IEs ::= SEQUENCE {
    -- User equipment IEs
    integrityProtectionModeInfo IntegrityProtectionModeInfo    OPTIONAL,
    cipheringModeInfo         CipheringModeInfo             OPTIONAL,
    activationTime            ActivationTime                 OPTIONAL,
    delayRestrictionFlag      DelayRestrictionFlag      OPTIONAL,
    new-U-RNTI                U-RNTI                     OPTIONAL,
    new-C-RNTI                C-RNTI                     OPTIONAL,
    -- The IE "new-DSCH-RNTI" should not be included in FDD mode,
    -- and if received the UE behaviour is unspecified
    new-DSCH-RNTI            DSCH-RNTI                 OPTIONAL,
    new-H-RNTI                H-RNTI                     OPTIONAL,
    newPrimary-E-RNTI        E-RNTI                     OPTIONAL,
    newSecondary-E-RNTI      E-RNTI                     OPTIONAL,
    rrc-StateIndicator       RRC-StateIndicator,
    utran-DRX-CycleLengthCoeff UTRAN-DRX-CycleLengthCoefficient    OPTIONAL,
    -- Core network IEs
    cn-InformationInfo        CN-InformationInfo-r6        OPTIONAL,
    -- UTRAN mobility IEs
    ura-Identity              URA-Identity                 OPTIONAL,
    -- Radio bearer IEs
    dl-CounterSynchronisationInfo DL-CounterSynchronisationInfo-r5    OPTIONAL,
    -- Transport channel IEs
    ul-CommonTransChInfo     UL-CommonTransChInfo-r4        OPTIONAL,
    ul-AddReconfTransChInfoList UL-AddReconfTransChInfoList-r6    OPTIONAL,
    dl-CommonTransChInfo     DL-CommonTransChInfo-r4        OPTIONAL,
    dl-AddReconfTransChInfoList DL-AddReconfTransChInfoList-r5    OPTIONAL,
    -- Physical channel IEs
    frequencyInfo            FrequencyInfo                 OPTIONAL,
    maxAllowedUL-TX-Power     MaxAllowedUL-TX-Power        OPTIONAL,
    ul-DPCH-Info             UL-DPCH-Info-r6             OPTIONAL,
    ul-EDCH-Information       UL-EDCH-Information-r6        OPTIONAL,
    dl-HSPDSCH-Information    DL-HSPDSCH-Information-r6    OPTIONAL,
    dl-CommonInformation      DL-CommonInformation-r6        OPTIONAL,
    dl-InformationPerRL-List   DL-InformationPerRL-List-r6    OPTIONAL,
    -- MBMS IEs
    mbms-PL-ServiceRestrictInfo MBMS-PL-ServiceRestrictInfo-r6    OPTIONAL
}

TransportChannelReconfiguration-v6b0ext-IEs ::= SEQUENCE {
    -- Physical channel IEs
    dl-InformationPerRL-List-v6b0ext DL-InformationPerRL-List-v6b0ext    OPTIONAL
}

TransportChannelReconfiguration-r7-IEs ::= SEQUENCE {
    -- User equipment IEs
    integrityProtectionModeInfo IntegrityProtectionModeInfo-r7    OPTIONAL,
    cipheringModeInfo         CipheringModeInfo-r7            OPTIONAL,
    activationTime            ActivationTime                 OPTIONAL,
    delayRestrictionFlag      DelayRestrictionFlag      OPTIONAL,
    new-U-RNTI                U-RNTI                     OPTIONAL,
    new-C-RNTI                C-RNTI                     OPTIONAL,
    -- The IE "new-DSCH-RNTI" should not be included in FDD mode,
    -- and if received the UE behaviour is unspecified

```

```

    new-DSCH-RNTI          DSCH-RNTI          OPTIONAL,
    new-H-RNTI             H-RNTI           OPTIONAL,
    newPrimary-E-RNTI     E-RNTI         OPTIONAL,
    newSecondary-E-RNTI   E-RNTI         OPTIONAL,
    rrc-StateIndicator    RRC-StateIndicator,
    ueMobilityStateIndicator High-MobilityDetected OPTIONAL,
    utran-DRX-CycleLengthCoeff UTRAN-DRX-CycleLengthCoefficient-r7 OPTIONAL,
-- Core network IEs
  cn-InformationInfo      CN-InformationInfo-r6      OPTIONAL,
-- UTRAN mobility IEs
  ura-Identity           URA-Identity          OPTIONAL,
  supportForChangeOfUE-Capability BOOLEAN          OPTIONAL,
  responseToChangeOfUE-Capability ENUMERATED { true } OPTIONAL,
-- Radio bearer IEs
  dl-CounterSynchronisationInfo DL-CounterSynchronisationInfo-r5 OPTIONAL,
-- Transport channel IEs
  ul-CommonTransChInfo    UL-CommonTransChInfo-r4      OPTIONAL,
  ul-AddReconfTransChInfoList UL-AddReconfTransChInfoList-r7 OPTIONAL,
  dl-CommonTransChInfo    DL-CommonTransChInfo-r4      OPTIONAL,
  dl-AddReconfTransChInfoList DL-AddReconfTransChInfoList-r7 OPTIONAL,
-- Physical channel IEs
  frequencyInfo           FrequencyInfo          OPTIONAL,
  multi-frequencyInfo     Multi-frequencyInfo-LCR-r7      OPTIONAL,
  dtx-drx-TimingInfo      DTX-DRX-TimingInfo-r7          OPTIONAL,
  dtx-drx-Info            DTX-DRX-Info-r7            OPTIONAL,
  hs-scch-LessInfo        HS-SCCH-LessInfo-r7          OPTIONAL,
  mimoParameters          MIMO-Parameters-r7          OPTIONAL,
  maxAllowedUL-TX-Power    MaxAllowedUL-TX-Power          OPTIONAL,
  ul-DPCH-Info            UL-DPCH-Info-r7            OPTIONAL,
  ul-EDCH-Information      UL-EDCH-Information-r7          OPTIONAL,
  dl-HSPDSCH-Information   DL-HSPDSCH-Information-r7          OPTIONAL,
  dl-CommonInformation     DL-CommonInformation-r7          OPTIONAL,
  dl-InformationPerRL-List DL-InformationPerRL-List-r7      OPTIONAL,
-- MBMS IEs
  mbms-PL-ServiceRestrictInfo MBMS-PL-ServiceRestrictInfo-r6 OPTIONAL
}

TransportChannelReconfiguration-v770ext-IEs ::= SEQUENCE {
-- User equipment IEs
  ueMobilityStateIndicator High-MobilityDetected OPTIONAL
}

TransportChannelReconfiguration-v780ext-IEs ::= SEQUENCE {
-- Physical channel IEs
  hs-DSCH-TBSizeTable      HS-DSCH-TBSizeTable      OPTIONAL
}

TransportChannelReconfiguration-v7d0ext-IEs ::= SEQUENCE {
-- Physical channel IEs
  ul-EDCH-Information      UL-EDCH-Information-ext    OPTIONAL
}

TransportChannelReconfiguration-v7f0ext-IEs ::= SEQUENCE {
-- Physical channel IEs
  mimoParameters           MIMO-Parameters-v7f0ext    OPTIONAL
}

TransportChannelReconfiguration-v7g0ext-IEs ::= SEQUENCE {
-- Physical channel IEs
  mimoParameters           MIMO-Parameters-v7g0ext    OPTIONAL
}

TransportChannelReconfiguration-r8-IEs ::= SEQUENCE {
-- User equipment IEs
  integrityProtectionModeInfo IntegrityProtectionModeInfo-r7 OPTIONAL,
  cipheringModeInfo         CipheringModeInfo-r7        OPTIONAL,
  activationTime            ActivationTime              OPTIONAL,
  delayRestrictionFlag      DelayRestrictionFlag        OPTIONAL,
  new-U-RNTI                U-RNTI                    OPTIONAL,
  new-C-RNTI                C-RNTI                    OPTIONAL,
  -- The IE "new-DSCH-RNTI" should not be included in FDD mode,
  -- and if received the UE behaviour is unspecified
  new-DSCH-RNTI            DSCH-RNTI                    OPTIONAL,
  new-H-RNTI                H-RNTI                    OPTIONAL,
  newPrimary-E-RNTI        E-RNTI                    OPTIONAL,
  newSecondary-E-RNTI      E-RNTI                    OPTIONAL,
  rrc-StateIndicator        RRC-StateIndicator,
  ueMobilityStateIndicator High-MobilityDetected    OPTIONAL,
}

```

```

    utran-DRX-CycleLengthCoeff      UTRAN-DRX-CycleLengthCoefficient-r7  OPTIONAL,
-- Core network IEs
  cn-InformationInfo                CN-InformationInfo-r6                 OPTIONAL,
-- UTRAN mobility IEs
  ura-Identity                      URA-Identity                          OPTIONAL,
  supportForChangeOfUE-Capability   BOOLEAN                               OPTIONAL,
  responseToChangeOfUE-Capability   ENUMERATED { true }                  OPTIONAL,
-- Radio bearer IEs
  dl-CounterSynchronisationInfo     DL-CounterSynchronisationInfo-r5     OPTIONAL,
-- Transport channel IEs
  ul-CommonTransChInfo              UL-CommonTransChInfo-r4              OPTIONAL,
  ul-AddReconfTransChInfoList       UL-AddReconfTransChInfoList-r8       OPTIONAL,
  dl-CommonTransChInfo              DL-CommonTransChInfo-r4              OPTIONAL,
  dl-AddReconfTransChInfoList       DL-AddReconfTransChInfoList-r7       OPTIONAL,
-- Physical channel IEs
  frequencyInfo                     FrequencyInfo                          OPTIONAL,
  multi-frequencyInfo               Multi-frequencyInfo-LCR-r7           OPTIONAL,
  dtx-drx-TimingInfo               DTX-DRX-TimingInfo-r7               OPTIONAL,
  dtx-drx-Info                     DTX-DRX-Info-r7                     OPTIONAL,
  hs-scch-LessInfo                 HS-SCCH-LessInfo-r7                 OPTIONAL,
  mimoParameters                   MIMO-Parameters-r8                  OPTIONAL,
  maxAllowedUL-TX-Power             MaxAllowedUL-TX-Power                OPTIONAL,
  ul-DPCH-Info                     UL-DPCH-Info-r7                     OPTIONAL,
  ul-EDCH-Information              UL-EDCH-Information-r8              OPTIONAL,
  dl-HSPDSCH-Information            DL-HSPDSCH-Information-r8           OPTIONAL,
  dl-CommonInformation              DL-CommonInformation-r8             OPTIONAL,
  dl-InformationPerRL-List          DL-InformationPerRL-List-r8         OPTIONAL,
  dl-SecondaryCellInfoFDD           DL-SecondaryCellInfoFDD             OPTIONAL,
  controlChannelDRXInfo-TDD128      ControlChannelDRXInfo-TDD128-r8     OPTIONAL,
  sps-Information-TDD128            SPS-Information-TDD128-r8          OPTIONAL,
-- MBMS IEs
  mbms-PL-ServiceRestrictInfo       MBMS-PL-ServiceRestrictInfo-r6      OPTIONAL
}

TransportChannelReconfiguration-v890ext-IEs ::= SEQUENCE {
-- Physical channel IEs
  dl-SecondaryCellInfoFDD-v890ext    DL-SecondaryCellInfoFDD-v890ext     OPTIONAL,
  dl-HSPDSCH-Information             DL-HSPDSCH-Information-r8-ext       OPTIONAL
}

TransportChannelReconfiguration-v8a0ext-IEs ::= SEQUENCE {
-- Physical channel IEs
  dl-HSPDSCH-Information             DL-HSPDSCH-Information-r8-ext2      OPTIONAL
}

TransportChannelReconfiguration-r9-IEs ::= SEQUENCE {
-- User equipment IEs
  integrityProtectionModeInfo        IntegrityProtectionModeInfo-r7       OPTIONAL,
  cipheringModeInfo                 CipheringModeInfo-r7                 OPTIONAL,
  activationTime                    ActivationTime                         OPTIONAL,
  delayRestrictionFlag               DelayRestrictionFlag                 OPTIONAL,
  new-U-RNTI                         U-RNTI                               OPTIONAL,
  new-C-RNTI                         C-RNTI                               OPTIONAL,
  -- The IE "new-DSCH-RNTI" should not be included in FDD mode,
  -- and if received the UE behaviour is unspecified
  new-DSCH-RNTI                     DSCH-RNTI                            OPTIONAL,
  new-H-RNTI                         H-RNTI                               OPTIONAL,
  newPrimary-E-RNTI                 E-RNTI                               OPTIONAL,
  newSecondary-E-RNTI               E-RNTI                               OPTIONAL,
  rrc-StateIndicator                RRC-StateIndicator,
  ueMobilityStateIndicator           High-MobilityDetected                OPTIONAL,
  utran-DRX-CycleLengthCoeff        UTRAN-DRX-CycleLengthCoefficient-r7  OPTIONAL,
-- Core network IEs
  cn-InformationInfo                CN-InformationInfo-r6                 OPTIONAL,
-- UTRAN mobility IEs
  ura-Identity                      URA-Identity                          OPTIONAL,
  supportForChangeOfUE-Capability   BOOLEAN                               OPTIONAL,
  responseToChangeOfUE-Capability   ENUMERATED { true }                  OPTIONAL,
-- Radio bearer IEs
  dl-CounterSynchronisationInfo     DL-CounterSynchronisationInfo-r5     OPTIONAL,
-- Transport channel IEs
  ul-CommonTransChInfo              UL-CommonTransChInfo-r4              OPTIONAL,
  ul-AddReconfTransChInfoList       UL-AddReconfTransChInfoList-r8       OPTIONAL,
  dl-CommonTransChInfo              DL-CommonTransChInfo-r4              OPTIONAL,
  dl-AddReconfTransChInfoList       DL-AddReconfTransChInfoList-r9       OPTIONAL,
-- Physical channel IEs
  frequencyInfo                     FrequencyInfo                          OPTIONAL,
  multi-frequencyInfo               Multi-frequencyInfo-LCR-r7           OPTIONAL,

```

```

    dtx-drx-TimingInfo          DTX-DRX-TimingInfo-r7          OPTIONAL,
    dtx-drx-Info                DTX-DRX-Info-r7                OPTIONAL,
    hs-scch-LessInfo            HS-SCCH-LessInfo-r7            OPTIONAL,
    mimoParameters              MIMO-Parameters-r9            OPTIONAL,
    maxAllowedUL-TX-Power       MaxAllowedUL-TX-Power        OPTIONAL,
    ul-DPCH-Info                UL-DPCH-Info-r7            OPTIONAL,
    ul-EDCH-Information         UL-EDCH-Information-r9      OPTIONAL,
    ul-SecondaryCellInfoFDD     UL-SecondaryCellInfoFDD      OPTIONAL,
    dl-HSPDSCH-Information      DL-HSPDSCH-Information-r9   OPTIONAL,
    dl-CommonInformation        DL-CommonInformation-r8     OPTIONAL,
    dl-InformationPerRL-List    DL-InformationPerRL-List-r8 OPTIONAL,
    dl-SecondaryCellInfoFDD     DL-SecondaryCellInfoFDD-r9  OPTIONAL,
    controlChannelDRXInfo-TDD128 ControlChannelDRXInfo-TDD128-r8 OPTIONAL,
    sps-Information-TDD128      SPS-Information-TDD128-r8   OPTIONAL,
-- MBMS IEs
    mbms-PL-ServiceRestrictInfo MBMS-PL-ServiceRestrictInfo-r6 OPTIONAL,
-- Measurement IEs for LCR
    cellDCHMeasOccasionInfo-TDD128 CellDCHMeasOccasionInfo-TDD128-r9 OPTIONAL
}

TransportChannelReconfiguration-v950ext-IEs ::= SEQUENCE {
-- Physical channel IEs
    secondaryCellMimoParameters SecondaryCellMIMOparametersFDD-v950ext OPTIONAL
}

TransportChannelReconfiguration-v9c0ext-IEs ::= SEQUENCE {
-- For 1.28Mcps TDD only
    dl-AddReconfTransChInfoList DL-AddReconfTransChInfoList-TDD128-v9c0ext OPTIONAL
}

TransportChannelReconfiguration-r10-IEs ::= SEQUENCE {
-- User equipment IEs
    integrityProtectionModeInfo IntegrityProtectionModeInfo-r7 OPTIONAL,
    cipheringModeInfo          CipheringModeInfo-r7          OPTIONAL,
    activationTime              ActivationTime                 OPTIONAL,
    delayRestrictionFlag        DelayRestrictionFlag          OPTIONAL,
    new-U-RNTI                  U-RNTI                       OPTIONAL,
    new-C-RNTI                  C-RNTI                       OPTIONAL,
-- The IE "new-DSCH-RNTI" should not be included in FDD mode,
-- and if received the UE behaviour is unspecified
    new-DSCH-RNTI              DSCH-RNTI                     OPTIONAL,
    new-H-RNTI                  H-RNTI                       OPTIONAL,
    newPrimary-E-RNTI           E-RNTI                       OPTIONAL,
    newSecondary-E-RNTI         E-RNTI                       OPTIONAL,
    rrc-StateIndicator          RRC-StateIndicator,
    ueMobilityStateIndicator     High-MobilityDetected         OPTIONAL,
    utran-DRX-CycleLengthCoeff  UTRAN-DRX-CycleLengthCoefficient-r7 OPTIONAL,
-- Core network IEs
    cn-InformationInfo          CN-InformationInfo-r6         OPTIONAL,
-- UTRAN mobility IEs
    ura-Identity                URA-Identity                  OPTIONAL,
    supportForChangeOfUE-Capability BOOLEAN                        OPTIONAL,
    responseToChangeOfUE-Capability ENUMERATED { true }          OPTIONAL,
-- Radio bearer IEs
    dl-CounterSynchronisationInfo DL-CounterSynchronisationInfo-r5 OPTIONAL,
-- Transport channel IEs
    ul-CommonTransChInfo        UL-CommonTransChInfo-r4      OPTIONAL,
    ul-AddReconfTransChInfoList UL-AddReconfTransChInfoList-r8 OPTIONAL,
    dl-CommonTransChInfo        DL-CommonTransChInfo-r4      OPTIONAL,
    dl-AddReconfTransChInfoList DL-AddReconfTransChInfoList-r9 OPTIONAL,
-- Physical channel IEs
    frequencyInfo               FrequencyInfo                  OPTIONAL,
    multi-frequencyInfo         Multi-frequencyInfo-LCR-r7    OPTIONAL,
    dtx-drx-TimingInfo          DTX-DRX-TimingInfo-r7        OPTIONAL,
    dtx-drx-Info                DTX-DRX-Info-r7            OPTIONAL,
    hs-scch-LessInfo            HS-SCCH-LessInfo-r7          OPTIONAL,
    mimoParameters              MIMO-Parameters-r9            OPTIONAL,
    maxAllowedUL-TX-Power       MaxAllowedUL-TX-Power        OPTIONAL,
    ul-DPCH-Info                UL-DPCH-Info-r7            OPTIONAL,
    ul-EDCH-Information         UL-EDCH-Information-r9      OPTIONAL,
    ul-SecondaryCellInfoFDD     UL-SecondaryCellInfoFDD      OPTIONAL,
    ul-MulticarrierEDCHInfo-TDD128 UL-MulticarrierEDCHInfo-TDD128 OPTIONAL,
    dl-HSPDSCH-Information      DL-HSPDSCH-Information-r9   OPTIONAL,
    dl-CommonInformation        DL-CommonInformation-r10     OPTIONAL,
    dl-InformationPerRL-List    DL-InformationPerRL-List-r8  OPTIONAL,
    dl-SecondaryCellInfoFDD     DL-SecondaryCellInfoFDD-r10  OPTIONAL,
    additionalDLSecCellInfoListFDD AdditionalDLSecCellInfoListFDD OPTIONAL,
    controlChannelDRXInfo-TDD128 ControlChannelDRXInfo-TDD128-r8 OPTIONAL,

```

```

    sps-Information-TDD128          SPS-Information-TDD128-r8          OPTIONAL,
    mu-MIMO-Info-TDD128            MU-MIMO-Info-TDD128              OPTIONAL,
-- MBMS IEs
    mbms-PL-ServiceRestrictInfo    MBMS-PL-ServiceRestrictInfo-r6    OPTIONAL,
-- Measurement IEs for LCR
    cellDCHMeasOccasionInfo-TDD128 CellDCHMeasOccasionInfo-TDD128-r9  OPTIONAL
}

TransportChannelReconfiguration-vb50ext-IEs ::= SEQUENCE {
    ulOLTDInfoFDD                  UL-OLTD-InfoFDD                  OPTIONAL
}

TransportChannelReconfiguration-r11-IEs ::= SEQUENCE {
-- User equipment IEs
    integrityProtectionModeInfo    IntegrityProtectionModeInfo-r7    OPTIONAL,
    cipheringModeInfo              CipheringModeInfo-r7              OPTIONAL,
    activationTime                  ActivationTime                      OPTIONAL,
    delayRestrictionFlag            DelayRestrictionFlag              OPTIONAL,
    new-U-RNTI                      U-RNTI                            OPTIONAL,
    new-C-RNTI                      C-RNTI                            OPTIONAL,
-- The IE "new-DSCH-RNTI" should not be included in FDD mode,
-- and if received the UE behaviour is unspecified
    new-DSCH-RNTI                  DSCH-RNTI                        OPTIONAL,
    new-H-RNTI                      H-RNTI                            OPTIONAL,
    newPrimary-E-RNTI              E-RNTI                            OPTIONAL,
    newSecondary-E-RNTI            E-RNTI                            OPTIONAL,
    rrc-StateIndicator              RRC-StateIndicator,
    ueMobilityStateIndicator        High-MobilityDetected            OPTIONAL,
    utran-DRX-CycleLengthCoeff      UTRAN-DRX-CycleLengthCoefficient-r7 OPTIONAL,
-- Core network IEs
    cn-InformationInfo              CN-InformationInfo-r6            OPTIONAL,
-- UTRAN mobility IEs
    ura-Identity                    URA-Identity                      OPTIONAL,
    supportForChangeOfUE-Capability BOOLEAN                            OPTIONAL,
    responseToChangeOfUE-Capability ENUMERATED { true }                    OPTIONAL,
-- Radio bearer IEs
    dl-CounterSynchronisationInfo    DL-CounterSynchronisationInfo-r5  OPTIONAL,
-- Transport channel IEs
    ul-CommonTransChInfo             UL-CommonTransChInfo-r4          OPTIONAL,
    ul-AddReconfTransChInfoList      UL-AddReconfTransChInfoList-r8   OPTIONAL,
    dl-CommonTransChInfo             DL-CommonTransChInfo-r4          OPTIONAL,
    dl-AddReconfTransChInfoList      DL-AddReconfTransChInfoList-r11  OPTIONAL,
-- Physical channel IEs
    frequencyInfo                    FrequencyInfo                      OPTIONAL,
    multi-frequencyInfo              Multi-frequencyInfo-LCR-r7        OPTIONAL,
    dtx-drx-TimingInfo              DTX-DRX-TimingInfo-r7            OPTIONAL,
    dtx-drx-Info                     DTX-DRX-Info-r7                  OPTIONAL,
    hs-scch-LessInfo                 HS-SCCH-LessInfo-r7              OPTIONAL,
    mimoParameters                   MIMO-Parameters-r9               OPTIONAL,
    mimo4x4Parameters                MIMO4x4-Parameters               OPTIONAL,
    maxAllowedUL-TX-Power             MaxAllowedUL-TX-Power             OPTIONAL,
    ul-DPCH-Info                      UL-DPCH-Info-r11                 OPTIONAL,
    ul-EDCH-Information               UL-EDCH-Information-r11           OPTIONAL,
    ul-SecondaryCellInfoFDD           UL-SecondaryCellInfoFDD           OPTIONAL,
    ul-MulticarrierEDCHInfo-TDD128    UL-MulticarrierEDCHInfo-TDD128   OPTIONAL,
    ul-CLTD-InfoFDD                  UL-CLTD-InfoFDD                  OPTIONAL,
    ul-OLTD-InfoFDD                  UL-OLTD-InfoFDD                  OPTIONAL,
    dl-HSPDSCH-Information            DL-HSPDSCH-Information-r11        OPTIONAL,
    dl-CommonInformation              DL-CommonInformation-r11          OPTIONAL,
    dl-InformationPerRL-List          DL-InformationPerRL-List-r11      OPTIONAL,
    dl-SecondaryCellInfoFDD           DL-SecondaryCellInfoFDD-r11       OPTIONAL,
    additionalDLSecCellInfoListFDD    AdditionalDLSecCellInfoListFDD-r11 OPTIONAL,
    additionalDLSecCellInfoListFDD2   AdditionalDLSecCellInfoListFDD2   OPTIONAL,
    commonERGCHInfoFDD               CommonERGCHInfoFDD               OPTIONAL,
    controlChannelDRXInfo-TDD128      ControlChannelDRXInfo-TDD128-r8   OPTIONAL,
    sps-Information-TDD128            SPS-Information-TDD128-r8        OPTIONAL,
    mu-MIMO-Info-TDD128              MU-MIMO-Info-TDD128              OPTIONAL,
-- MBMS IEs
    mbms-PL-ServiceRestrictInfo      MBMS-PL-ServiceRestrictInfo-r6    OPTIONAL,
-- Measurement IEs for LCR
    cellDCHMeasOccasionInfo-TDD128    CellDCHMeasOccasionInfo-TDD128-r9  OPTIONAL
}

TransportChannelReconfiguration-r12-IEs ::= SEQUENCE {
-- User equipment IEs
    integrityProtectionModeInfo    IntegrityProtectionModeInfo-r7    OPTIONAL,
    cipheringModeInfo              CipheringModeInfo-r7              OPTIONAL,
    activationTime                  ActivationTime                      OPTIONAL,

```

```

delayRestrictionFlag          DelayRestrictionFlag          OPTIONAL,
new-U-RNTI                    U-RNTI                        OPTIONAL,
new-C-RNTI                    C-RNTI                        OPTIONAL,
-- The IE "new-DSCH-RNTI" should not be included in FDD mode,
-- and if received the UE behaviour is unspecified
new-DSCH-RNTI                DSCH-RNTI                    OPTIONAL,
new-H-RNTI                    H-RNTI                        OPTIONAL,
newPrimary-E-RNTI            E-RNTI                        OPTIONAL,
newSecondary-E-RNTI          E-RNTI                        OPTIONAL,
rrc-StateIndicator            RRC-StateIndicator,
ueMobilityStateIndicator      High-MobilityDetected         OPTIONAL,
utran-DRX-CycleLengthCoeff    UTRAN-DRX-CycleLengthCoefficient-r7 OPTIONAL,
-- Core network IES
cn-InformationInfo            CN-InformationInfo-r6         OPTIONAL,
-- UTRAN mobility IES
ura-Identity                  URA-Identity                  OPTIONAL,
supportForChangeOfUE-Capability BOOLEAN                        OPTIONAL,
responseToChangeOfUE-Capability ENUMERATED { true }         OPTIONAL,
-- Radio bearer IES
dl-CounterSynchronisationInfo DL-CounterSynchronisationInfo-r5 OPTIONAL,
-- Transport channel IES
ul-CommonTransChInfo          UL-CommonTransChInfo-r12     OPTIONAL,
ul-AddReconfTransChInfoList    UL-AddReconfTransChInfoList-r8 OPTIONAL,
dl-CommonTransChInfo          DL-CommonTransChInfo-r4      OPTIONAL,
dl-AddReconfTransChInfoList    DL-AddReconfTransChInfoList-r11 OPTIONAL,
-- Physical channel IES
frequencyInfo                  FrequencyInfo                  OPTIONAL,
multi-frequencyInfo            Multi-frequencyInfo-LCR-r7    OPTIONAL,
dtx-drx-TimingInfo            DTX-DRX-TimingInfo-r7        OPTIONAL,
dtx-drx-Info                  DTX-DRX-Info-r12             OPTIONAL,
hs-scch-LessInfo              HS-SCCH-LessInfo-r7          OPTIONAL,
mimoParameters                MIMO-Parameters-r9           OPTIONAL,
mimo4x4Parameters             MIMO4x4-Parameters           OPTIONAL,
dch-Enhancements-Info-FDD     DCH-Enhancements-Info-FDD    OPTIONAL,
maxAllowedUL-TX-Power          MaxAllowedUL-TX-Power        OPTIONAL,
ul-DPCH-Info                  UL-DPCH-Info-r11             OPTIONAL,
ul-EDCH-Information            UL-EDCH-Information-r11      OPTIONAL,
ul-SecondaryCellInfoFDD       UL-SecondaryCellInfoFDD-r12   OPTIONAL,
ul-MulticarrierEDCHInfo-TDD128 UL-MulticarrierEDCHInfo-TDD128 OPTIONAL,
ul-CLTD-InfoFDD               UL-CLTD-InfoFDD              OPTIONAL,
ul-OLTD-InfoFDD               UL-OLTD-InfoFDD              OPTIONAL,
ul-OtherTTIConfiguration-Info UL-OtherTTIConfiguration-Information OPTIONAL,
filteredUPHrReportInfo         FilteredUEPowerHeadroomReportInfo OPTIONAL,
dl-HSPDSCH-Information         DL-HSPDSCH-Information-r12    OPTIONAL,
dl-CommonInformation           DL-CommonInformation-r12      OPTIONAL,
dl-InformationPerRL-List       DL-InformationPerRL-List-r12  OPTIONAL,
dl-SecondaryCellInfoFDD        DL-SecondaryCellInfoFDD-r11   OPTIONAL,
additionalDLSecCellInfoListFDD AdditionalDLSecCellInfoListFDD-r11 OPTIONAL,
additionalDLSecCellInfoListFDD2 AdditionalDLSecCellInfoListFDD2 OPTIONAL,
commonERGCHInfoFDD            CommonERGCHInfoFDD           OPTIONAL,
dPCCH2InfoFDD                 DPCCH2InfoFDD                OPTIONAL,
controlChannelDRXInfo-TDD128   ControlChannelDRXInfo-TDD128-r8 OPTIONAL,
sps-Information-TDD128         SPS-Information-TDD128-r8     OPTIONAL,
mu-MIMO-Info-TDD128           MU-MIMO-Info-TDD128          OPTIONAL,
non-rectResAllocInd-TDD128     Non-rectResAllocInd-TDD128   OPTIONAL,
non-rectResSpecTSset-TDD128    Non-rectResSpecTSset-TDD128  OPTIONAL,
-- MBMS IES
mbms-PL-ServiceRestrictInfo    MBMS-PL-ServiceRestrictInfo-r6 OPTIONAL,
-- Measurement IES for LCR
cellDCHMeasOccasionInfo-TDD128 CellDCHMeasOccasionInfo-TDD128-r9 OPTIONAL
}

-- *****
--
-- TRANSPORT CHANNEL RECONFIGURATION COMPLETE
--
-- *****

TransportChannelReconfigurationComplete ::= SEQUENCE {
-- User equipment IES
  rrc-TransactionIdentifier      RRC-TransactionIdentifier,
  ul-IntegProtActivationInfo      IntegrityProtActivationInfo   OPTIONAL,
  -- TABULAR: UL-TimingAdvance is applicable for TDD mode only.
  ul-TimingAdvance                UL-TimingAdvance             OPTIONAL,
-- Radio bearer IES
  count-C-ActivationTime          ActivationTime                 OPTIONAL,
  -- dummy is not used in this version of the specification and
  -- it should be ignored by the receiver.

```

```

dummy                RB-ActivationTimeInfoList                OPTIONAL,
ul-CounterSynchronisationInfo  UL-CounterSynchronisationInfo  OPTIONAL,
laterNonCriticalExtensions  SEQUENCE {
  -- Container for additional R99 extensions
  transportChannelReconfigurationComplete-r3-add-ext  BIT STRING  OPTIONAL,
  v770NonCriticalExtensions  SEQUENCE {
    transportChannelReconfigurationComplete-v770ext
    TransportChannelReconfigurationComplete-v770ext-IEs,
    nonCriticalExtensions  SEQUENCE {}  OPTIONAL
  }  OPTIONAL
}
}

TransportChannelReconfigurationComplete-v770ext-IEs ::= SEQUENCE {
  -- TABULAR: EXT-UL-TimingAdvance is applicable for TDD mode only.
  ext-UL-TimingAdvance  EXT-UL-TimingAdvance  OPTIONAL,
  deferredMeasurementControlReading  ENUMERATED { true }  OPTIONAL
}

-- *****
--
-- TRANSPORT CHANNEL RECONFIGURATION FAILURE
--
-- *****

TransportChannelReconfigurationFailure ::= SEQUENCE {
  -- User equipment IEs
  rrc-TransactionIdentifier  RRC-TransactionIdentifier,
  failureCause  FailureCauseWithProtErr,
  laterNonCriticalExtensions  SEQUENCE {
    -- Container for additional R99 extensions
    transportChannelReconfigurationFailure-r3-add-ext  BIT STRING  OPTIONAL,
    nonCriticalExtensions  SEQUENCE {}  OPTIONAL
  }  OPTIONAL
}

-- *****
--
-- TRANSPORT FORMAT COMBINATION CONTROL in AM or UM RLC mode
--
-- *****

TransportFormatCombinationControl ::= SEQUENCE {
  -- rrc-TransactionIdentifier is always included in this version of the specification
  rrc-TransactionIdentifier  RRC-TransactionIdentifier  OPTIONAL,
  modeSpecificInfo  CHOICE {
    fdd  NULL,
    tdd  SEQUENCE {
      tfcs-ID  TFCS-Identity  OPTIONAL
    }
  },
  dpch-TFCS-InUplink  TFC-Subset,
  activationTimeForTFCSsubset  ActivationTime  OPTIONAL,
  tfc-ControlDuration  TFC-ControlDuration  OPTIONAL,
  laterNonCriticalExtensions  SEQUENCE {
    -- Container for additional R99 extensions
    transportFormatCombinationControl-r3-add-ext  BIT STRING  OPTIONAL,
    v820NonCriticalExtensions  SEQUENCE {
      transportformatcombinationcontrol-v820ext
      TransportFormatCombinationControl-v820ext-IEs,
      nonCriticalExtensions  SEQUENCE {}  OPTIONAL
    }  OPTIONAL
  }  OPTIONAL
}

TransportFormatCombinationControl-v820ext-IEs ::= SEQUENCE {
  -- Transport Format Combination Control IEs
  ul-AMR-Rate  UL-AMR-Rate  OPTIONAL
}

-- *****
--
-- TRANSPORT FORMAT COMBINATION CONTROL FAILURE
--
-- *****

TransportFormatCombinationControlFailure ::= SEQUENCE {
  -- User equipment IEs

```



```

rrc-TransactionIdentifier      RRC-TransactionIdentifier,
failureCause                   FailureCauseWithProtErr,
laterNonCriticalExtensions     SEQUENCE {
  -- Container for additional R99 extensions
  transportFormatCombinationControlFailure-r3-add-ext  BIT STRING      OPTIONAL,
  nonCriticalExtensions     SEQUENCE {}      OPTIONAL
}
}

-- *****
--
-- UE CAPABILITY ENQUIRY
--
-- *****

UECapabilityEnquiry ::= CHOICE {
  r3                      SEQUENCE {
    ueCapabilityEnquiry-r3      UECapabilityEnquiry-r3-IEs,
    laterNonCriticalExtensions  SEQUENCE {
      -- Container for additional R99 extensions
      ueCapabilityEnquiry-r3-add-ext  BIT STRING      OPTIONAL,
      v4b0NonCriticalExtensions      SEQUENCE {
        ueCapabilityEnquiry-v4b0ext  UECapabilityEnquiry-v4b0ext-IEs,
        v590NonCriticalExtensions    SEQUENCE {
          ueCapabilityEnquiry-v590ext  UECapabilityEnquiry-v590ext-IEs,
          v770NonCriticalExtensions    SEQUENCE {
            ueCapabilityEnquiry-v770ext  UECapabilityEnquiry-v770ext-IEs,
            v860NonCriticalExtensions    SEQUENCE {
              ueCapabilityEnquiry-v860ext  UECapabilityEnquiry-v860ext-IEs,
              vaj0NonCriticalExtensions    SEQUENCE {
                ueCapabilityEnquiry-vaj0ext  UECapabilityEnquiry-vaj0ext-IEs,
                nonCriticalExtensions      SEQUENCE {}      OPTIONAL
              } OPTIONAL
            } OPTIONAL
          } OPTIONAL
        } OPTIONAL
      } OPTIONAL
    } OPTIONAL
  },
  later-than-r3           SEQUENCE {
    rrc-TransactionIdentifier      RRC-TransactionIdentifier,
    criticalExtensions             SEQUENCE {}
  }
}

UECapabilityEnquiry-r3-IEs ::= SEQUENCE {
  -- User equipment IEs
  rrc-TransactionIdentifier      RRC-TransactionIdentifier,
  capabilityUpdateRequirement    CapabilityUpdateRequirement
}

UECapabilityEnquiry-v4b0ext-IEs ::= SEQUENCE {
  capabilityUpdateRequirement-r4-ext  CapabilityUpdateRequirement-r4-ext
}

UECapabilityEnquiry-v590ext-IEs ::= SEQUENCE {
  systemSpecificCapUpdateReq      SystemSpecificCapUpdateReq-v590ext
}

UECapabilityEnquiry-v770ext-IEs ::= SEQUENCE {
  capabilityUpdateRequirement      CapabilityUpdateRequirement-v770ext      OPTIONAL
}

UECapabilityEnquiry-v860ext-IEs ::= SEQUENCE {
  capabilityUpdateRequirement      CapabilityUpdateRequirement-v860ext      OPTIONAL
}

UECapabilityEnquiry-vaj0ext-IEs ::= SEQUENCE {
  capabilityUpdateRequirement      CapabilityUpdateRequirement-vaj0ext      OPTIONAL
}

-- *****
--
-- UE CAPABILITY INFORMATION
--
-- *****

UECapabilityInformation ::= SEQUENCE {

```



```

        ue-RadioAccessCapability-v3g0ext      UE-RadioAccessCapability-v3g0ext      OPTIONAL,
        ue-RadioAccessCapability-v590ext      UE-RadioAccessCapability-v590ext      OPTIONAL,
-- Other IEs
        ue-RATSpecificCapability-v590ext      InterRAT-UE-RadioAccessCapability-v590ext  OPTIONAL
    }
UECapabilityInformation-v5c0ext ::= SEQUENCE {
-- User equipment IEs
        ue-RadioAccessCapability-v5c0ext      UE-RadioAccessCapability-v5c0ext      OPTIONAL
    }
UECapabilityInformation-v650ext-IEs ::= SEQUENCE {
        ue-RadioAccessCapability-v650ext      UE-RadioAccessCapability-v650ext
    }
UECapabilityInformation-v680ext-IEs ::= SEQUENCE {
-- User equipment IEs
        ue-RadioAccessCapability-v680ext      UE-RadioAccessCapability-v680ext
    }
UECapabilityInformation-v690ext-IEs ::= SEQUENCE {
-- User equipment IEs
        ueCapabilityContainer                BIT STRING
                                           (CONTAINING UE-CapabilityContainer-IEs) OPTIONAL
    }
UECapabilityInformation-v7e0ext-IEs ::= SEQUENCE {
-- User equipment IEs
        ue-RadioAccessCapability            UE-RadioAccessCapability-v7e0ext
    }
UECapabilityInformation-v7f0ext-IEs ::= SEQUENCE {
-- User equipment IEs
        ue-RadioAccessCapability            UE-RadioAccessCapability-v7f0ext      OPTIONAL
    }
UECapabilityInformation-va40ext-IEs ::= SEQUENCE {
-- User equipment IEs
        ue-RadioAccessCapabBand            UE-RadioAccessCapabBand-va40ext      OPTIONAL
    }
-- *****
--
-- UE CAPABILITY INFORMATION CONFIRM
--
-- *****
UECapabilityInformationConfirm ::= CHOICE {
    r3                SEQUENCE {
        ueCapabilityInformationConfirm-r3
        laterNonCriticalExtensions    SEQUENCE {
-- Container for additional R99 extensions
            ueCapabilityInformationConfirm-r3-add-ext    BIT STRING    OPTIONAL,
            v770NonCriticalExtensions    SEQUENCE {
                ueCapabilityInformationConfirm-v770ext    UECapabilityInformationConfirm-v770ext-IEs,
                nonCriticalExtensions    SEQUENCE {}    OPTIONAL
            }    OPTIONAL
        }    OPTIONAL
    },
    later-than-r3        SEQUENCE {
        rrc-TransactionIdentifier        RRC-TransactionIdentifier,
        criticalExtensions                SEQUENCE {}
    }
}
UECapabilityInformationConfirm-r3-IEs ::= SEQUENCE {
-- User equipment IEs
        rrc-TransactionIdentifier        RRC-TransactionIdentifier
    }
UECapabilityInformationConfirm-v770ext-IEs ::= SEQUENCE {
-- User equipment IEs
        acceptanceOfChangeOfCapability    ENUMERATED {
            refused, accepted, acceptedWithReconfigurationToFollow
        }    OPTIONAL
    }
}

```

```

-- *****
--
-- UPLINK DIRECT TRANSFER
--
-- *****

UplinkDirectTransfer ::= SEQUENCE {
  -- Core network IEs
  cn-DomainIdentity          CN-DomainIdentity,
  nas-Message                NAS-Message,
  -- Measurement IEs
  measuredResultsOnRACH      MeasuredResultsOnRACH          OPTIONAL,
  laterNonCriticalExtensions SEQUENCE {
    -- Container for additional R99 extensions
    uplinkDirectTransfer-r3-add-ext BIT STRING          OPTIONAL,
    v690NonCriticalExtensions SEQUENCE {
      uplinkDirectTransfer-v690ext UplinkDirectTransfer-v690ext-IEs,
      v7g0NonCriticalExtensions SEQUENCE {
        uplinkDirectTransfer-v7g0ext UplinkDirectTransfer-v7g0ext-IEs,
        vb50NonCriticalExtensions SEQUENCE {
          uplinkDirectTransfer-vb50ext UplinkDirectTransfer-vb50ext-IEs,
          vc50NonCriticalExtensions SEQUENCE {
            uplinkDirectTransfer-vc50ext UplinkDirectTransfer-vc50ext-IEs,
            nonCriticalExtensions SEQUENCE {}          OPTIONAL
          }
        }
      }
    }
  }
}

UplinkDirectTransfer-v690ext-IEs ::= SEQUENCE {
  -- Measurement IEs
  measuredResultsOnRACHinterFreq MeasuredResultsOnRACHinterFreq          OPTIONAL
}

UplinkDirectTransfer-v7g0ext-IEs ::= SEQUENCE {
  -- Measurement IEs
  measuredResultsOnRACH-v7g0ext MeasuredResultsOnRACH-v7g0ext          OPTIONAL
}

UplinkDirectTransfer-vb50ext-IEs ::= SEQUENCE {
  -- Measurement IEs
  measuredResultsOnRACHEUTRAFreq MeasuredResultsOnRACH-EUTRAFreq          OPTIONAL
}

UplinkDirectTransfer-vc50ext-IEs ::= SEQUENCE {
  -- Measurement IEs
  measuredResultsOnRACH MeasuredResultsOnRACH-vc50ext          OPTIONAL
}

-- *****
--
-- UPLINK PHYSICAL CHANNEL CONTROL
--
-- *****

UplinkPhysicalChannelControl ::= CHOICE {
  r3 SEQUENCE {
    uplinkPhysicalChannelControl-r3 UplinkPhysicalChannelControl-r3-IEs,
    laterNonCriticalExtensions SEQUENCE {
      -- Container for additional R99 extensions
      uplinkPhysicalChannelControl-r3-add-ext BIT STRING          OPTIONAL,
      v4b0NonCriticalExtensions SEQUENCE {
        uplinkPhysicalChannelControl-v4b0ext UplinkPhysicalChannelControl-v4b0ext-IEs,
        -- Extension mechanism for non-release 4 information
        noncriticalExtensions SEQUENCE {}          OPTIONAL
      }
    }
  },
  later-than-r3 SEQUENCE {
    rrc-TransactionIdentifier RRC-TransactionIdentifier,
    criticalExtensions CHOICE {
      r4 SEQUENCE {
        uplinkPhysicalChannelControl-r4 UplinkPhysicalChannelControl-r4-IEs,
        v4d0NonCriticalExtensions SEQUENCE {
          -- Container for adding non critical extensions after freezing REL-5
          uplinkPhysicalChannelControl-r4-add-ext BIT STRING          OPTIONAL,

```

```

        v690NonCriticalExtensions      SEQUENCE {
            uplinkPhysicalChannelControl-v690ext
                UplinkPhysicalChannelControl-v690ext-IEs,
            nonCriticalExtensions        SEQUENCE {} OPTIONAL
        } OPTIONAL
    },
    criticalExtensions                  CHOICE {
        r5                              SEQUENCE {
            uplinkPhysicalChannelControl-r5 UplinkPhysicalChannelControl-r5-IEs,
            -- Container for adding non critical extensions after freezing REL-6
            uplinkPhysicalChannelControl-r5-add-ext    BIT STRING    OPTIONAL,
            v690NonCriticalExtensions      SEQUENCE {
                uplinkPhysicalChannelControl-v690ext
                    UplinkPhysicalChannelControl-v690ext-IEs,
                v6a0NonCriticalExtensions  SEQUENCE{
                    uplinkPhysicalChannelControl-v6a0ext
                        UplinkPhysicalChannelControl-v6a0ext-IEs,
                    nonCriticalExtensions  SEQUENCE {} OPTIONAL
                } OPTIONAL
            } OPTIONAL
        },
        criticalExtensions                CHOICE {
            r7                            SEQUENCE {
                uplinkPhysicalChannelControl-r7 UplinkPhysicalChannelControl-r7-IEs,
                -- Container for adding non critical extensions after freezing REL-8
                uplinkPhysicalChannelControl-r7-add-ext    BIT STRING    OPTIONAL,
                nonCriticalExtensions        SEQUENCE {}    OPTIONAL
            },
            criticalExtensions            SEQUENCE {}
        }
    }
}

UplinkPhysicalChannelControl-r3-IEs ::= SEQUENCE {
    -- User equipment IEs
    rrc-TransactionIdentifier    RRC-TransactionIdentifier,
    -- Physical channel IEs
    ccTrCH-PowerControlInfo      CCTrCH-PowerControlInfo        OPTIONAL,
    timingAdvance                UL-TimingAdvanceControl    OPTIONAL,
    alpha                        Alpha                    OPTIONAL,
    specialBurstScheduling       SpecialBurstScheduling    OPTIONAL,
    prach-ConstantValue          ConstantValueTdd        OPTIONAL,
    pusch-ConstantValue          ConstantValueTdd        OPTIONAL
}

UplinkPhysicalChannelControl-v4b0ext-IEs ::= SEQUENCE {
    -- In case of TDD, openLoopPowerControl-IPDL-TDD is included instead of IE
    -- up-IPDL-Parameters in up-OTDOA-AssistanceData
    openLoopPowerControl-IPDL-TDD    OpenLoopPowerControl-IPDL-TDD-r4    OPTIONAL
}

UplinkPhysicalChannelControl-r4-IEs ::= SEQUENCE {
    -- Physical channel IEs
    ccTrCH-PowerControlInfo      CCTrCH-PowerControlInfo-r4        OPTIONAL,
    specialBurstScheduling       SpecialBurstScheduling            OPTIONAL,
    tddOption                    CHOICE {
        tdd384                    SEQUENCE {
            timingAdvance          UL-TimingAdvanceControl-r4    OPTIONAL,
            alpha                  Alpha                    OPTIONAL,
            prach-ConstantValue     ConstantValueTdd        OPTIONAL,
            pusch-ConstantValue     ConstantValueTdd        OPTIONAL,
            openLoopPowerControl-IPDL-TDD    OpenLoopPowerControl-IPDL-TDD-r4    OPTIONAL
        },
        tdd128                    SEQUENCE {
            ul-SynchronisationParameters    UL-SynchronisationParameters-r4    OPTIONAL
        }
    }
}

UplinkPhysicalChannelControl-r5-IEs ::= SEQUENCE {
    -- Physical channel IEs
    ccTrCH-PowerControlInfo      CCTrCH-PowerControlInfo-r5        OPTIONAL,
    specialBurstScheduling       SpecialBurstScheduling            OPTIONAL,
    tddOption                    CHOICE {
        tdd384                    SEQUENCE {

```

```

        timingAdvance          UL-TimingAdvanceControl-r4  OPTIONAL,
        alpha                  Alpha                      OPTIONAL,
        prach-ConstantValue    ConstantValueTdd    OPTIONAL,
        pusch-ConstantValue    ConstantValueTdd    OPTIONAL,
        openLoopPowerControl-IPDL-TDD  OpenLoopPowerControl-IPDL-TDD-r4  OPTIONAL,
        hs-SICH-PowerControl    HS-SICH-Power-Control-Info-TDD384  OPTIONAL
    },
    tdd128                      SEQUENCE {
        ul-SynchronisationParameters  UL-SynchronisationParameters-r4  OPTIONAL
    }
}

UplinkPhysicalChannelControl-v690ext-IEs ::= SEQUENCE {
    -- Physical Channel IEs
    beaconPLEst                BEACON-PL-Est                OPTIONAL
}

UplinkPhysicalChannelControl-v6a0ext-IEs ::= SEQUENCE {
    -- Physical Channel IEs
    desired-HS-SICH-PowerLevel  INTEGER (-120..-58)  OPTIONAL,
    tpc-Step-Size               ENUMERATED { s1, s2, s3 , spare1 }  OPTIONAL
}

UplinkPhysicalChannelControl-r7-IEs ::= SEQUENCE {
    -- Physical channel IEs
    ccTrCH-PowerControlInfo     CCTrCH-PowerControlInfo-r7        OPTIONAL,
    specialBurstScheduling      SpecialBurstScheduling            OPTIONAL,
    tddOption                   CHOICE {
        tdd384                  SEQUENCE {
            timingAdvance        UL-TimingAdvanceControl-r4  OPTIONAL,
            alpha                Alpha                      OPTIONAL,
            prach-ConstantValue   ConstantValueTdd    OPTIONAL,
            pusch-ConstantValue   ConstantValueTdd    OPTIONAL,
            openLoopPowerControl-IPDL-TDD  OpenLoopPowerControl-IPDL-TDD-r4  OPTIONAL,
            hs-SICH-PowerControl   HS-SICH-Power-Control-Info-TDD384  OPTIONAL
        },
        tdd768                  SEQUENCE {
            timingAdvance        UL-TimingAdvanceControl-r7  OPTIONAL,
            alpha                Alpha                      OPTIONAL,
            prach-ConstantValue   ConstantValueTdd    OPTIONAL,
            pusch-ConstantValue   ConstantValueTdd    OPTIONAL,
            openLoopPowerControl-IPDL-TDD  OpenLoopPowerControl-IPDL-TDD-r4  OPTIONAL,
            hs-SICH-PowerControl   HS-SICH-Power-Control-Info-TDD768  OPTIONAL
        },
        tdd128                  SEQUENCE {
            ul-SynchronisationParameters  UL-SynchronisationParameters-r4  OPTIONAL,
            desired-HS-SICH-PowerLevel     INTEGER (-120..-58)  OPTIONAL,
            tpc-Step-Size                  ENUMERATED { s1, s2, s3 , spare1 }  OPTIONAL
        }
    }
}

-- *****
--
-- URA UPDATE
--
-- *****

URAUUpdate ::= SEQUENCE {
    -- User equipment IEs
    u-RNTI                U-RNTI,
    ura-UpdateCause       URA-UpdateCause,
    protocolErrorIndicator  ProtocolErrorIndicatorWithMoreInfo,
    laterNonCriticalExtensions  SEQUENCE {
        -- Container for additional R99 extensions
        uraUpdate-r3-add-ext  BIT STRING
            (CONTAINING URAUpdate-r3-add-ext-IEs)  OPTIONAL,
        v770NonCriticalExtensions  SEQUENCE {
            uraUpdate-v770ext  UraUpdate-v770ext-IEs,
            v860NonCriticalExtensions  SEQUENCE {
                uraUpdate-v860ext  URAUpdate-v860ext-IEs,
                va40NonCriticalExtensions  SEQUENCE {
                    uraUpdate-va40ext  URAUpdate-va40ext-IEs,
                    nonCriticalExtensions  SEQUENCE {}  OPTIONAL
                }  OPTIONAL
            }  OPTIONAL
        }  OPTIONAL
    }  OPTIONAL
}

```

```

    } OPTIONAL
  }

URAUUpdate-r3-add-ext-IEs ::= SEQUENCE {
  uraUpdate-v7e0ext          URAUpdate-v7e0ext-IEs,
  nonCriticalExtensions      SEQUENCE {} OPTIONAL
}

UraUpdate-v770ext-IEs ::= SEQUENCE {
  -- User equipment IEs
  support-hsdschReception-CellUraPch    ENUMERATED { true }    OPTIONAL,
  support-hsdschReception-CellFach     ENUMERATED { true }    OPTIONAL
}

URAUUpdate-v7e0ext-IEs ::= SEQUENCE {
  -- User equipment IEs
  supportForTwoDRXSchemesInPCH          ENUMERATED { true }    OPTIONAL
}

URAUUpdate-v860ext-IEs ::= SEQUENCE {
  -- User equipment IEs
  supportOfHS-DSCHDRXOperation          ENUMERATED { true }    OPTIONAL,
  supportOfCommonEDCH                   ENUMERATED { true }    OPTIONAL,
  supportOfMACiis                        ENUMERATED { true }    OPTIONAL
}

URAUUpdate-va40ext-IEs ::= SEQUENCE {
  loggedMeasAvailable    ENUMERATED { true } OPTIONAL,
  loggedANRRResultsAvailable    ENUMERATED { true }    OPTIONAL
}

-- *****
--
-- URA UPDATE CONFIRM
--
-- *****

URAUUpdateConfirm ::= CHOICE {
  r3          SEQUENCE {
    uraUpdateConfirm-r3          URAUpdateConfirm-r3-IEs,
    laterNonCriticalExtensions   SEQUENCE {
      -- Container for additional R99 extensions
      uraUpdateConfirm-r3-add-ext    BIT STRING    OPTIONAL,
      v690NonCriticalExtensions      SEQUENCE {
        uraUpdateConfirm-v690ext    URAUpdateConfirm-v690ext-IEs,
        nonCriticalExtensions        SEQUENCE {}    OPTIONAL
      } OPTIONAL
    } OPTIONAL
  },
  later-than-r3          SEQUENCE {
    rrc-TransactionIdentifier      RRC-TransactionIdentifier,
    criticalExtensions             CHOICE {
      r5          SEQUENCE {
        uraUpdateConfirm-r5          URAUpdateConfirm-r5-IEs,
        v690NonCriticalExtensions    SEQUENCE {
          uraUpdateConfirm-v690ext    URAUpdateConfirm-v690ext-IEs,
          nonCriticalExtensions        SEQUENCE {}    OPTIONAL
        } OPTIONAL
      },
      criticalExtensions             CHOICE {
        r7          SEQUENCE {
          uraUpdateConfirm-r7          URAUpdateConfirm-r7-IEs,
          -- Container for adding non critical extensions after freezing REL-8
          uraUpdateConfirm-r7-add-ext    BIT STRING    OPTIONAL,
          v860NonCriticalExtensions      SEQUENCE {
            uraUpdateConfirm-v860ext    URAUpdateConfirm-v860ext-IEs,
            nonCriticalExtensions        SEQUENCE {}    OPTIONAL
          } OPTIONAL
        },
        criticalExtensions             SEQUENCE {}
      }
    }
  }
}

URAUUpdateConfirm-r3-IEs ::= SEQUENCE {
  -- User equipment IEs
  rrc-TransactionIdentifier      RRC-TransactionIdentifier,

```

```

    integrityProtectionModeInfo    IntegrityProtectionModeInfo    OPTIONAL,
    cipheringModeInfo              CipheringModeInfo              OPTIONAL,
    new-U-RNTI                     U-RNTI                        OPTIONAL,
    new-C-RNTI                     C-RNTI                        OPTIONAL,
    rrc-StateIndicator             RRC-StateIndicator,          OPTIONAL,
    utran-DRX-CycleLengthCoeff     UTRAN-DRX-CycleLengthCoefficient OPTIONAL,
-- CN information elements
    cn-InformationInfo             CN-InformationInfo           OPTIONAL,
-- UTRAN mobility IEs
    ura-Identity                   URA-Identity                 OPTIONAL,
-- Radio bearer IEs
    dl-CounterSynchronisationInfo DL-CounterSynchronisationInfo OPTIONAL
}

URAUUpdateConfirm-r5-IEs ::= SEQUENCE {
-- User equipment IEs
    integrityProtectionModeInfo    IntegrityProtectionModeInfo    OPTIONAL,
    cipheringModeInfo              CipheringModeInfo              OPTIONAL,
    new-U-RNTI                     U-RNTI                        OPTIONAL,
    new-C-RNTI                     C-RNTI                        OPTIONAL,
    rrc-StateIndicator             RRC-StateIndicator,          OPTIONAL,
    utran-DRX-CycleLengthCoeff     UTRAN-DRX-CycleLengthCoefficient OPTIONAL,
-- CN information elements
    cn-InformationInfo             CN-InformationInfo           OPTIONAL,
-- UTRAN mobility IEs
    ura-Identity                   URA-Identity                 OPTIONAL,
-- Radio bearer IEs
    dl-CounterSynchronisationInfo DL-CounterSynchronisationInfo-r5 OPTIONAL
}

URAUUpdateConfirm-v690ext-IEs ::= SEQUENCE {
-- Core network IEs
    primary-plmn-Identity          PLMN-Identity                OPTIONAL
}

URAUUpdateConfirm-r7-IEs ::= SEQUENCE {
-- User equipment IEs
    integrityProtectionModeInfo    IntegrityProtectionModeInfo-r7 OPTIONAL,
    cipheringModeInfo              CipheringModeInfo-r7         OPTIONAL,
    new-U-RNTI                     U-RNTI                        OPTIONAL,
    new-C-RNTI                     C-RNTI                        OPTIONAL,
    rrc-StateIndicator             RRC-StateIndicator,          OPTIONAL,
    utran-DRX-CycleLengthCoeff     UTRAN-DRX-CycleLengthCoefficient-r7 OPTIONAL,
-- CN information elements
    cn-InformationInfo             CN-InformationInfo           OPTIONAL,
    primary-plmn-Identity          PLMN-Identity                OPTIONAL,
-- UTRAN mobility IEs
    ura-Identity                   URA-Identity                 OPTIONAL,
    supportForChangeOfUE-Capability BOOLEAN                        OPTIONAL,
-- Radio bearer IEs
    dl-CounterSynchronisationInfo DL-CounterSynchronisationInfo-r5 OPTIONAL
}

URAUUpdateConfirm-v860ext-IEs ::= SEQUENCE {
-- User equipment IEs
    new-H-RNTI                     H-RNTI                        OPTIONAL,
    newPrimary-E-RNTI              E-RNTI                        OPTIONAL,
-- Specification mode information
    -- dummy is not used in this version of the specification, it should
    -- not be sent and if received it should be ignored.
    dummy                           DefaultConfigForCellFACH      OPTIONAL
}

-- *****
--
-- URA UPDATE CONFIRM for CCCH
--
-- *****

URAUUpdateConfirm-CCCH ::= CHOICE {
    r3                               SEQUENCE {
        uraUpdateConfirm-CCCH-r3    URAUpdateConfirm-CCCH-r3-IEs,
        laterNonCriticalExtensions  SEQUENCE {
            -- Container for additional R99 extensions
            uraUpdateConfirm-CCCH-r3-add-ext BIT STRING OPTIONAL,
            v690NonCriticalExtensions SEQUENCE {
                uraUpdateConfirm-v690ext    URAUpdateConfirm-v690ext-IEs,
                v860NonCriticalExtensions  SEQUENCE {

```



```

        uraUpdateConfirm-v860ext      URAUpdateConfirm-v860ext-IEs,
        nonCriticalExtensions          SEQUENCE {}      OPTIONAL
    } OPTIONAL
} OPTIONAL
},
later-than-r3                        SEQUENCE {
    u-RNTI                             U-RNTI,
    rrc-TransactionIdentifier          RRC-TransactionIdentifier,
    criticalExtensions                 SEQUENCE {}
}
}

URAUpdateConfirm-CCCH-r3-IEs ::= SEQUENCE {
    -- User equipment IES
    u-RNTI                             U-RNTI,
    -- The rest of the message is identical to the one sent on DCCH.
    uraUpdateConfirm                   URAUpdateConfirm-r3-IEs
}

-- *****
--
-- UTRAN MOBILITY INFORMATION
--
-- *****

UTRANMobilityInformation ::= CHOICE {
    r3                                SEQUENCE {
        uranMobilityInformation-r3     UTRANMobilityInformation-r3-IEs,
        v3a0NonCriticalExtensions      SEQUENCE {
            uranMobilityInformation-v3a0ext UTRANMobilityInformation-v3a0ext-IEs,
            laterNonCriticalExtensions    SEQUENCE {
                -- Container for additional R99 extensions
                uranMobilityInformation-r3-add-ext BIT STRING      OPTIONAL,
                v690NonCriticalExtensions        SEQUENCE {
                    uranMobilityInformation-v690ext UtranMobilityInformation-v690ext-IEs,
                    v860NonCriticalExtentions    SEQUENCE {
                        uranMobilityInformation-v860ext UTRANMobilityInformation-v860ext1-IEs,
                        nonCriticalExtensions      SEQUENCE {}      OPTIONAL
                    } OPTIONAL
                } OPTIONAL
            } OPTIONAL
        } OPTIONAL
    } OPTIONAL
},
later-than-r3                        SEQUENCE {
    rrc-TransactionIdentifier          RRC-TransactionIdentifier,
    criticalExtensions                CHOICE {
        r5                            SEQUENCE {
            uranMobilityInformation-r5     UTRANMobilityInformation-r5-IEs,
            v690NonCriticalExtensions      SEQUENCE {
                uranMobilityInformation-v690ext UtranMobilityInformation-v690ext-IEs,
                v860NonCriticalExtentions    SEQUENCE {
                    uranMobilityInformation-v860ext UTRANMobilityInformation-v860ext1-IEs,
                    nonCriticalExtensions    SEQUENCE {}      OPTIONAL
                } OPTIONAL
            } OPTIONAL
        } OPTIONAL
    },
    criticalExtensions                CHOICE {
        r7                            SEQUENCE{
            uranMobilityInformation-r7     UTRANMobilityInformation-r7-IEs,
            -- Container for adding non critical extensions after freezing REL-8
            uranMobilityInformation-r7-add-ext BIT STRING      OPTIONAL,
            v860NonCriticalExtensions      SEQUENCE {
                uranMobilityInformation-v860ext UTRANMobilityInformation-v860ext2-IEs,
                vb50NonCriticalExtentions    SEQUENCE {
                    uranMobilityInformation-vb50ext
                    UTRANMobilityInformation-vb50ext-IEs,
                    nonCriticalExtensions    SEQUENCE {}      OPTIONAL
                } OPTIONAL
            } OPTIONAL
        } OPTIONAL
    },
    criticalExtensions                CHOICE {
        r11                            SEQUENCE{
            uranMobilityInformation-r11     UTRANMobilityInformation-r11-IEs,
            -- Container for adding non critical extensions after freezing REL-12
            uranMobilityInformation-r11-add-ext BIT STRING      OPTIONAL,
            nonCriticalExtensions          SEQUENCE {}      OPTIONAL
        }
    },
}

```

```
criticalExtensions CHOICE {
  r12 SEQUENCE {
    utranMobilityInformation-r12 UTRANMobilityInformation-r12-IEs,
    -- Container for adding non critical extensions after freezing REL-13
    utranMobilityInformation-r12-add-ext BIT STRING OPTIONAL,
    nonCriticalExtensions SEQUENCE {} OPTIONAL
  },
  criticalExtensions SEQUENCE {}
}
}
}
}
}
}
}
}
}
}
}

UTRANMobilityInformation-r3-IEs ::= SEQUENCE {
  -- User equipment IEs
  rrc-TransactionIdentifier RRC-TransactionIdentifier,
  integrityProtectionModeInfo IntegrityProtectionModeInfo OPTIONAL,
  cipheringModeInfo CipheringModeInfo OPTIONAL,
  new-U-RNTI U-RNTI OPTIONAL,
  new-C-RNTI C-RNTI OPTIONAL,
  ue-ConnTimersAndConstants UE-ConnTimersAndConstants OPTIONAL,
  -- CN information elements
  cn-InformationInfo CN-InformationInfoFull OPTIONAL,
  -- UTRAN mobility IEs
  ura-Identity URA-Identity OPTIONAL,
  -- Radio bearer IEs
  dl-CounterSynchronisationInfo DL-CounterSynchronisationInfo OPTIONAL,
  -- Extension mechanism for non- release99 information
  nonCriticalExtensions SEQUENCE {} OPTIONAL
}

UTRANMobilityInformation-v3a0ext-IEs ::= SEQUENCE {
  ue-ConnTimersAndConstants-v3a0ext UE-ConnTimersAndConstants-v3a0ext
}

UTRANMobilityInformation-r5-IEs ::= SEQUENCE {
  -- User equipment IEs
  integrityProtectionModeInfo IntegrityProtectionModeInfo OPTIONAL,
  cipheringModeInfo CipheringModeInfo OPTIONAL,
  new-U-RNTI U-RNTI OPTIONAL,
  new-C-RNTI C-RNTI OPTIONAL,
  ue-ConnTimersAndConstants UE-ConnTimersAndConstants-r5 OPTIONAL,
  -- CN information elements
  cn-InformationInfo CN-InformationInfoFull OPTIONAL,
  -- UTRAN mobility IEs
  ura-Identity URA-Identity OPTIONAL,
  -- Radio bearer IEs
  dl-CounterSynchronisationInfo DL-CounterSynchronisationInfo-r5 OPTIONAL
}

UtranMobilityInformation-v690ext-IEs ::= SEQUENCE {
  -- Core network IEs
  primary-plmn-Identity PLMN-Identity OPTIONAL
}

UTRANMobilityInformation-r7-IEs ::= SEQUENCE {
  -- User equipment IEs
  integrityProtectionModeInfo IntegrityProtectionModeInfo-r7 OPTIONAL,
  cipheringModeInfo CipheringModeInfo-r7 OPTIONAL,
  new-U-RNTI U-RNTI OPTIONAL,
  new-C-RNTI C-RNTI OPTIONAL,
  new-H-RNTI H-RNTI OPTIONAL,
  ue-ConnTimersAndConstants UE-ConnTimersAndConstants-r5 OPTIONAL,
  -- CN information elements
  cn-InformationInfo CN-InformationInfoFull OPTIONAL,
  primary-plmn-Identity PLMN-Identity OPTIONAL,
  -- UTRAN mobility IEs
  ura-Identity URA-Identity OPTIONAL,
  supportForChangeOfUE-Capability BOOLEAN OPTIONAL,
  -- Radio bearer IEs
  dl-CounterSynchronisationInfo DL-CounterSynchronisationInfo-r5 OPTIONAL
}

UTRANMobilityInformation-v860ext1-IEs ::= SEQUENCE {
  -- User equipment IEs
```

```

-- UE shall take into account the following ue-ConnTimersAndConstants
-- only when ue-ConnTimersAndConstants IE is present in
-- UTRANMobilityInformation-r3-IEs or UTRANMobilityInformation-r5-IEs.
-- Otherwise, UE shall discard it.
    ue-ConnTimersAndConstants      UE-ConnTimersAndConstants-v860ext
}

UTRANMobilityInformation-v860ext2-IEs ::= SEQUENCE {
-- User equipment IEs
    newPrimary-E-RNTI              E-RNTI                                OPTIONAL,
-- UE shall take into account the following ue-ConnTimersAndConstants
-- only when ue-ConnTimersAndConstants IE is present in
-- UTRANMobilityInformation-r7-IEs. Otherwise, UE shall discard it.
    ue-ConnTimersAndConstants      UE-ConnTimersAndConstants-v860ext,
-- UTRAN Mobility IEs
    dedicatedPriorityInformation    DedicatedPriorityInformation        OPTIONAL
}

UTRANMobilityInformation-vb50ext-IEs ::= SEQUENCE {
-- UTRAN Mobility IEs
    dedicatedPriorityInformation    DedicatedPriorityInformation-r11  OPTIONAL
}

UTRANMobilityInformation-r11-IEs ::= SEQUENCE {
-- User equipment IEs
    integrityProtectionModeInfo    IntegrityProtectionModeInfo-r7    OPTIONAL,
    cipheringModeInfo              CipheringModeInfo-r7              OPTIONAL,
    new-U-RNTI                     U-RNTI                           OPTIONAL,
    new-C-RNTI                     C-RNTI                           OPTIONAL,
    new-H-RNTI                     H-RNTI                           OPTIONAL,
    newPrimary-E-RNTI              E-RNTI                           OPTIONAL,
    ue-ConnTimersAndConstants      UE-ConnTimersAndConstants-r11    OPTIONAL,
-- CN information elements
    cn-InformationInfo             CN-InformationInfoFull           OPTIONAL,
    primary-plmn-Identity          PLMN-Identity                   OPTIONAL,
-- UTRAN mobility IEs
    ura-Identity                   URA-Identity                     OPTIONAL,
    supportForChangeOfUE-Capability BOOLEAN                          OPTIONAL,
    dedicatedPriorityInformation    DedicatedPriorityInformation-r11  OPTIONAL,
-- Radio bearer IEs
    dl-CounterSynchronisationInfo DL-CounterSynchronisationInfo-r5 OPTIONAL
}

UTRANMobilityInformation-r12-IEs ::= SEQUENCE {
-- User equipment IEs
    integrityProtectionModeInfo    IntegrityProtectionModeInfo-r7    OPTIONAL,
    cipheringModeInfo              CipheringModeInfo-r7              OPTIONAL,
    new-U-RNTI                     U-RNTI                           OPTIONAL,
    new-C-RNTI                     C-RNTI                           OPTIONAL,
    new-H-RNTI                     H-RNTI                           OPTIONAL,
    newPrimary-E-RNTI              E-RNTI                           OPTIONAL,
    ue-ConnTimersAndConstants      UE-ConnTimersAndConstants-r11    OPTIONAL,
    measurementReleaseEnhancement MeasurementReleaseEnhancement     OPTIONAL,
-- CN information elements
    cn-InformationInfo             CN-InformationInfoFull           OPTIONAL,
    primary-plmn-Identity          PLMN-Identity                   OPTIONAL,
    domainSpecificAccessRestrictionParametersUpdate
        DomainSpecificAccessRestrictionParam-v670ext  OPTIONAL,
    pagingPermissionWithAccessControlParametersUpdate
        PagingPermissionWithAccessControlParameters    OPTIONAL,
-- UTRAN mobility IEs
    ura-Identity                   URA-Identity                     OPTIONAL,
    supportForChangeOfUE-Capability BOOLEAN                          OPTIONAL,
    dedicatedPriorityInformation    DedicatedPriorityInformation-r11  OPTIONAL,
-- Radio bearer IEs
    dl-CounterSynchronisationInfo DL-CounterSynchronisationInfo-r5 OPTIONAL,
-- WLAN IEs
    dedicatedWLANOffloadInformation DedicatedWLANOffloadInformation    OPTIONAL
}

-- *****
--
-- UTRAN MOBILITY INFORMATION CONFIRM
--
-- *****

UTRANMobilityInformationConfirm ::= SEQUENCE {
-- User equipment IEs

```

```

rrc-TransactionIdentifier      RRC-TransactionIdentifier,
ul-IntegProtActivationInfo     IntegrityProtActivationInfo      OPTIONAL,
-- Radio bearer IEs
count-C-ActivationTime        ActivationTime                        OPTIONAL,
-- dummy is not used in this version of the specification and
-- it should be ignored by the receiver.
dummy                          RB-ActivationTimeInfoList      OPTIONAL,
ul-CounterSynchronisationInfo  UL-CounterSynchronisationInfo   OPTIONAL,
laterNonCriticalExtensions     SEQUENCE {
  -- Container for additional R99 extensions
  utranMobilityInformationConfirm-r3-add-ext      BIT STRING      OPTIONAL,
  v770NonCriticalExtension                       SEQUENCE {
    utranMobilityInformationConfirm-v770ext
    va40NonCriticalExtensions                     SEQUENCE {
      utranMobilityInformationConfirm-va40ext
      nonCriticalExtensions                       SEQUENCE {}      OPTIONAL
    }      OPTIONAL
  }      OPTIONAL
}
}

UTRANMobilityInformationConfirm-v770ext-IEs ::= SEQUENCE {
  deferredMeasurementControlReading              ENUMERATED { true }      OPTIONAL
}

UTRANMobilityInformationConfirm-va40ext-IEs ::= SEQUENCE {
  loggedMeasAvailable                           ENUMERATED { true }      OPTIONAL
}

-- *****
--
-- UTRAN MOBILITY INFORMATION FAILURE
--
-- *****

UTRANMobilityInformationFailure ::= SEQUENCE {
  -- UE information elements
  rrc-TransactionIdentifier      RRC-TransactionIdentifier,
  failureCause                   FailureCauseWithProtErr,
  laterNonCriticalExtensions     SEQUENCE {
    -- Container for additional R99 extensions
    utranMobilityInformationFailure-r3-add-ext      BIT STRING      OPTIONAL,
    nonCriticalExtensions           SEQUENCE {}      OPTIONAL
  }      OPTIONAL
}

-- *****
--
-- MBMS ACCESS INFORMATION
--
-- *****

MBMSAccessInformation ::= SEQUENCE {
  -- Access Information IEs
  mbms-ServiceAccessInfoList     MBMS-ServiceAccessInfoList-r6,
  -- Non critical extensions
  nonCriticalExtensions           SEQUENCE {}      OPTIONAL
}

-- *****
--
-- MBMS COMMON PTM RB INFORMATION
--
-- *****

MBMSCommonPTMRBInformation ::= SEQUENCE {
  -- Common PTM RB Information IEs
  mbms-CommonRBInformationList   MBMS-CommonRBInformationList-r6,
  mbms-TranspChInfoForEachTrCh   MBMS-TranspChInfoForEachTrCh-r6,
  mbms-TranspChInfoForEachCCTrCh MBMS-TranspChInfoForEachCCTrCh-r6      OPTIONAL,
  -- For FDD and TDD 3.84Mcps in a cell operating in MBSFN only mode and for TDD 7.68Mcps the
  -- IE mbms-PhyChInformationList shall be ignored.
  mbms-PhyChInformationList      MBMS-PhyChInformationList-r6,
  -- Non critical extensions
  v770NonCriticalExtensions       SEQUENCE {
    mbmsCommonPTMRBInformation-v770ext
  }
}

```

```

        v780NonCriticalExtensions      MBMSCommonPTMRBInformation-v770ext-IEs,
        mbmsCommonPTMRBInformation-v780ext SEQUENCE {
            v860NonCriticalExtensions  MBMSCommonPTMRBInformation-v780ext-IEs,
            mbmsCommonPTMRBInformation-v860ext SEQUENCE {
                nonCriticalExtensions  MBMSCommonPTMRBInformation-v860ext-IEs,
                SEQUENCE {} OPTIONAL
            } OPTIONAL
        } OPTIONAL
    } OPTIONAL
}

MBMSCommonPTMRBInformation-v770ext-IEs ::= SEQUENCE {
    -- TABULAR: CHOICE mode == "FDD or TDD"
    mbms-PhyChInformationList-r7      MBMS-PhyChInformationList-r7      OPTIONAL
}

MBMSCommonPTMRBInformation-v780ext-IEs ::= SEQUENCE {
    mbsfn-TDDInformation-LCR          MBSFN-TDDInformation-LCR          OPTIONAL
}

MBMSCommonPTMRBInformation-v860ext-IEs ::= SEQUENCE {
    -- TABULAR: CHOICE mode == "3.84 Mcps TDD IMB"
    mbms-PhyChInformationList        MBMS-PhyChInformationList-IMB384  OPTIONAL
}

-- *****
--
-- MBMS CURRENT CELL PTM RB INFORMATION
--
-- *****

MBMSCurrentCellPTMRBInformation ::= SEQUENCE {
    -- Current Cell PTM RB Information IEs
    mbms-CurrentCell-SCCPCHList      MBMS-CurrentCell-SCCPCHList-r6      OPTIONAL,
    mbms-SIBType5-SCCPCHList         MBMS-SIBType5-SCCPCHList-r6        OPTIONAL,
    -- Non critical extensions
    v770NonCriticalExtensions        SEQUENCE {
        mbmsCurrentCellPTMRBInfo-v770ext
        MBMSCurrentCellPTMRBInfo-v770ext-IEs,
        nonCriticalExtensions        SEQUENCE {} OPTIONAL
    } OPTIONAL
}

MBMSCurrentCellPTMRBInfo-v770ext-IEs ::= SEQUENCE {
    mbsfn-TDM-Info-List              MBSFN-TDM-Info-List              OPTIONAL
}

-- *****
--
-- MBMS GENERAL INFORMATION
--
-- *****

MBMSGeneralInformation ::= SEQUENCE {
    -- MBMS General Information IEs
    mbms-PreferredFrequencyInfo      MBMS-PreferredFrequencyList-r6      OPTIONAL,
    mbms-TimersAndCounters           MBMS-TimersAndCounters-r6,
    michConfigurationInfo            MBMS-MICHConfigurationInfo-r6,
    cellGroupIdentity                MBMS-CellGroupIdentity-r6,
    mschDefaultConfigurationInfo     MBMS-MSCH-ConfigurationInfo-r6      OPTIONAL,
    -- Non critical extensions
    v6b0NonCriticalExtensions        SEQUENCE {
        mbmsGeneralInformation-v6b0ext MBMSGeneralInformation-v6b0ext-IEs,
        v770NonCriticalExtensions     SEQUENCE {
            mbmsGeneralInformation-v770ext MBMSGeneralInformation-v770ext-IEs,
            v860NonCriticalExtensions   SEQUENCE {
                mbmsGeneralInformation-v860ext MBMSGeneralInformation-v860ext-IEs,
                v890NoncriticalExtensions SEQUENCE {
                    mbmsGeneralInformation-v890ext MBMSGeneralInformation-v890ext-IEs,
                    nonCriticalExtensions SEQUENCE {} OPTIONAL
                } OPTIONAL
            } OPTIONAL
        } OPTIONAL
    } OPTIONAL
}
}

```

```

MBMSGeneralInformation-v6b0ext-IEs ::= SEQUENCE {
    indicateChangeInSelectedServices    BOOLEAN
}

MBMSGeneralInformation-v770ext-IEs ::= SEQUENCE {
    mbmsMICHConfiguration                MBMS-MICHConfigurationInfo-v770ext    OPTIONAL,
    mbsfnInterFrequencyNeighbourList     MBSFN-InterFrequencyNeighbourList-r7    OPTIONAL
}

MBMSGeneralInformation-v860ext-IEs ::= SEQUENCE {
    mbsfnInterFrequencyNeighbourList     MBSFN-InterFrequencyNeighbourList-v860ext    OPTIONAL
}

MBMSGeneralInformation-v890ext-IEs ::= SEQUENCE {
    mbmsNetworkStandardTimeInformation-LCR
    MBMS-NetworkStandardTimeInformation-LCR-v890ext    OPTIONAL,
    mbmsMICHConfiguration                MBMS-MICHConfigurationInfo-v890ext    OPTIONAL
}

-- *****
--
-- MBMS MODIFICATION REQUEST
--
-- *****

MBMSModificationRequest ::= SEQUENCE {
    -- MBMS Modification Request IES
    mbms-PreferredFreqRequest            MBMS-ServiceIdentity-r6            OPTIONAL,
    rb-InformationReleaseList             RB-InformationReleaseList         OPTIONAL,
    -- Non critical extensions
    v6b0NonCriticalExtensions             SEQUENCE {
        mbmsModificationRequest-v6b0ext MBMSModificationRequest-v6b0ext-IEs,
        v6f0NonCriticalExtensions         SEQUENCE {
            mbmsModificationRequest-v6f0ext MBMSModificationRequest-v6f0ext-IEs,
            nonCriticalExtensions          SEQUENCE {}    OPTIONAL
        }
    }
}

MBMSModificationRequest-v6b0ext-IEs ::= SEQUENCE {
    mbmsSelectedServiceInfo              MBMS-SelectedServiceInfo
}

MBMSModificationRequest-v6f0ext-IEs ::= SEQUENCE {
    mbmsSupportOfServiceChangeForAPtprB  ENUMERATED { true }    OPTIONAL
}

-- *****
--
-- MBMS MODIFIED SERVICES INFORMATION
--
-- *****

MBMSModifiedServicesInformation ::= SEQUENCE {
    -- MBMS Modified Services Information IES
    modifiedServiceList                  MBMS-ModifedServiceList-r6            OPTIONAL,
    mbms-ReacquireMCCH                   ENUMERATED { true }    OPTIONAL,
    mbms-DynamicPersistenceLevel         DynamicPersistenceLevel              OPTIONAL,
    endOfModifiedMCCHInformation         INTEGER (1..16)          OPTIONAL,
    mbmsNumberOfNeighbourCells           MBMS-NumberOfNeighbourCells-r6,
    mbms-AllUnmodifiedPTMServices        ENUMERATED { true }    OPTIONAL,
    mbms-PTMActivationTime               MBMS-PTMActivationTime-r6           OPTIONAL,
    -- Non critical extensions
    v770NonCriticalExtensions             SEQUENCE {
        mbmsModifiedServicesInformation-v770ext
        MBMSModifiedServicesInformation-v770ext-IEs,
        v7c0NonCriticalExtensions         SEQUENCE {
            mbmsModifiedServicesInformation-v7c0ext
            MBMSModifiedServicesInformation-v7c0ext-IEs,
            nonCriticalExtensions          SEQUENCE {}    OPTIONAL
        }
    }
}

MBMSModifiedServicesInformation-v770ext-IEs ::= SEQUENCE {
    modifiedServiceList                  MBMS-ModifiedServiceList-v770ext    OPTIONAL,

```

```

        mib-ValueTag                MIB-ValueTag                OPTIONAL
    }

MBMSModifiedServicesInformation-v7c0ext-IEs ::= SEQUENCE {
    modifiedServiceList              MBMS-ModifiedServiceList-LCR-v7c0ext    OPTIONAL
}

-- *****
--
-- MBMS NEIGHBOURING CELL PTM RB INFORMATION
--
-- *****

MBMSNeighbouringCellPTMRBInformation ::= SEQUENCE {
    -- MBMS Neighbouring Cell PTM RB Information IEs
    neighbouringCellIdentity         IntraFreqCellID,
    neighbouringCellSCCPCHList       MBMS-NeighbouringCellSCCPCHList-r6,
    -- Non critical extensions
    v770NonCriticalExtensions        SEQUENCE {
        mbmsNeighbouringCellPTMRBInformation-v770ext
        MBMSNeighbouringCellPTMRBInformation-v770ext-IEs,
        nonCriticalExtensions         SEQUENCE {}    OPTIONAL
    }
    OPTIONAL
}

MBMSNeighbouringCellPTMRBInformation-v770ext-IEs ::= SEQUENCE {
    -- The "choice_PhyCH" in the tabular is realized by using the following IE due to the
    -- constraint in the ASN.1 implementation.
    neighbouringCellSCCPCHList       MBMS-NeighbouringCellSCCPCHList-v770ext    OPTIONAL
}

-- *****
--
-- MBMS SCHEDULING INFORMATION
--
-- *****

MBMSSchedulingInformation ::= SEQUENCE {
    -- MBMS Scheduling Information IEs
    serviceSchedulingInfoList        MBMS-ServiceSchedulingInfoList-r6,
    -- Non critical extensions
    nonCriticalExtensions             SEQUENCE {}    OPTIONAL
}

-- *****
--
-- MBMS UNMODIFIED SERVICES INFORMATION
--
-- *****

MBMSUnmodifiedServicesInformation ::= SEQUENCE {
    -- MBMS Unmodified Services Information IEs
    unmodifiedServiceList            MBMS-UnmodifiedServiceList-r6    OPTIONAL,
    -- Non critical extensions
    v770NonCriticalExtensions        SEQUENCE {
        mbmsUnmodifiedServicesInformation-v770ext
        MBMSUnmodifiedServicesInformation-v770ext-IEs,
        nonCriticalExtensions         SEQUENCE {}    OPTIONAL
    }
    OPTIONAL
}

MBMSUnmodifiedServicesInformation-v770ext-IEs ::= SEQUENCE {
    unmodifiedServiceList            MBMS-UnmodifiedServiceList-v770ext    OPTIONAL
}

-- *****
--
-- System Information Container
--
-- *****

System-Information-Container ::= SEQUENCE {
    mib                               OCTET STRING (CONTAINING MasterInformationBlock),
    sysInfoTypeSB1                    OCTET STRING (CONTAINING SysInfoTypesB1)    OPTIONAL,
    sysInfoTypeSB2                    OCTET STRING (CONTAINING SysInfoTypesB2)    OPTIONAL,
    sysInfoTypeP1                    OCTET STRING (CONTAINING SysInfoTypeP1),
    sysInfoTypeP3                    OCTET STRING (CONTAINING SysInfoTypeP3),

```

```

sysInfoType5          OCTET STRING (CONTAINING SysInfoType5),
sysInfoType7          OCTET STRING (CONTAINING SysInfoType7),
sysInfoType11         OCTET STRING (CONTAINING SysInfoType11)          OPTIONAL,
sysInfoType11bis     OCTET STRING (CONTAINING SysInfoType11bis)       OPTIONAL,
sysInfoType12         OCTET STRING (CONTAINING SysInfoType12)         OPTIONAL,
vb50NonCriticalExtensions SEQUENCE {
    system-Information-Container-vb50ext System-Information-Container-vb50ext-IEs,
    vc50NonCriticalExtensions SEQUENCE {
        system-Information-Container-vc50ext System-Information-Container-vc50ext-IEs,
        nonCriticalExtensions SEQUENCE {} OPTIONAL
    } OPTIONAL
}
}

System-Information-Container-vb50ext-IEs ::= SEQUENCE {
    sysInfoType22 OCTET STRING (CONTAINING SysInfoType22) OPTIONAL
}

System-Information-Container-vc50ext-IEs ::= SEQUENCE {
    sysInfoType11ter OCTET STRING (CONTAINING SysInfoType11ter) OPTIONAL
}
-- *****
--
-- LOGGING MEASUREMENT CONFIGURATION
--
-- *****

LoggingMeasurementConfiguration ::= SEQUENCE {
    rrc-TransactionIdentifier RRC-TransactionIdentifier,
    criticalExtensions CHOICE {
        r10 SEQUENCE {
            loggingMeasurementConfiguration-r10-IEs LoggingMeasurementConfiguration-r10-IEs,
            -- Container for additional R10 extensions
            loggingMeasurementConfiguration-r10-add-ext BIT STRING OPTIONAL,
            nonCriticalExtensions SEQUENCE {} OPTIONAL
        },
        criticalExtensions CHOICE {
            r11 SEQUENCE {
                loggingMeasurementConfiguration-r11-IEs LoggingMeasurementConfiguration-r11-IEs,
                loggingMeasurementConfiguration-r11-add-ext BIT STRING OPTIONAL,
                nonCriticalExtensions SEQUENCE {} OPTIONAL
            },
            criticalExtensions SEQUENCE {}
        }
    }
}

LoggingMeasurementConfiguration-r10-IEs ::= SEQUENCE {
    loggedMeasurementsConfigurationInfo LoggedMeasurementsConfigurationInfo OPTIONAL,
    loggedANRConfigurationInfo LoggedANRConfigurationInfo OPTIONAL
}

LoggingMeasurementConfiguration-r11-IEs ::= SEQUENCE {
    loggedMeasurementsConfigurationInfo LoggedMeasurementsConfigurationInfo-r11 OPTIONAL,
    loggedANRConfigurationInfo LoggedANRConfigurationInfo OPTIONAL
}
-- *****
--
-- UE INFORMATION RESPONSE
--
-- *****

UEInformationResponse ::= SEQUENCE {
    rrc-TransactionIdentifier RRC-TransactionIdentifier,
    loggedMeasReport LoggedMeasReport OPTIONAL,
    loggedANRRReportInfoList LoggedANRRReportInfoList OPTIONAL,
    vb50NonCriticalExtensions SEQUENCE {
        ueInformationResponse-vb50ext UEInformationResponse-vb50ext-IEs,
        vbb0NonCriticalExtensions SEQUENCE {
            ueInformationResponse-vbb0ext UEInformationResponse-vbb0ext-IEs,
            vc50NonCriticalExtensions SEQUENCE {
                ueInformationResponse-vc50ext UEInformationResponse-vc50ext-IEs,
                nonCriticalExtensions SEQUENCE {} OPTIONAL
            } OPTIONAL
        } OPTIONAL
    } OPTIONAL
}
}

```



```

UEInformationResponse-vb50ext-IEs ::= SEQUENCE {
    loggedMeasReport          LoggedMeasReport-vb50ext    OPTIONAL,
    -- dummy is not used in this version of the specification. It should not be sent and
    -- if received it should be ignored.
    dummy                    ConnectionEstablishmentFailureReport    OPTIONAL,
    loggedANRRReportInfoList  LoggedANRRReportInfoList-vb50ext    OPTIONAL
}

UEInformationResponse-vbb0ext-IEs ::= SEQUENCE {
    connectionEstablishmentFailureReport
    ConnectionEstablishmentFailureReport-r11    OPTIONAL
}

UEInformationResponse-vc50ext-IEs ::= SEQUENCE {
    loggedMeasReport          LoggedMeasReport-vc50ext    OPTIONAL,
    connectionEstablishmentFailureReport
    ConnectionEstablishmentFailureReport-vc50ext    OPTIONAL
}

-- *****
--
-- UE INFORMATION REQUEST
--
-- *****

UEInformationRequest ::= SEQUENCE {
    rrc-TransactionIdentifier    RRC-TransactionIdentifier,
    criticalExtensions            CHOICE {
        r10                      SEQUENCE {
            ueInformationRequest-r10          UEInformationRequest-r10-IEs,
            -- Container for additional R10 extensions
            ueInformationRequest-r10-add-ext    BIT STRING    OPTIONAL,
            nonCriticalExtensions    SEQUENCE {}    OPTIONAL
        },
        criticalExtensions        CHOICE {
            r11                    SEQUENCE {
                ueInformationRequest-r11    UEInformationRequest-r11-IEs,
                -- Container for additional R11 extensions
                ueInformationRequest-r11-add-ext    BIT STRING    OPTIONAL,
                nonCriticalExtensions    SEQUENCE {}    OPTIONAL
            },
            criticalExtensions    SEQUENCE {}
        }
    }
}

UEInformationRequest-r10-IEs ::= SEQUENCE {
    loggedMeasReportRequest    ENUMERATED { true } OPTIONAL,
    loggedANRRReportRequest    ENUMERATED { true } OPTIONAL
}

UEInformationRequest-r11-IEs ::= SEQUENCE {
    loggedMeasReportRequest    ENUMERATED { true } OPTIONAL,
    loggedANRRReportRequest    ENUMERATED { true } OPTIONAL,
    connectionEstablishmentFailureRequest    ENUMERATED { true } OPTIONAL
}

END

```

11.3 Information element definitions

InformationElements DEFINITIONS AUTOMATIC TAGS ::=

BEGIN

IMPORTS

```

    hiPDSCHidentities,
    hiPUSCHidentities,
    hiRM,
    maxAC,
    maxAdditionalMeas,
    maxAddPos,
    maxMultipleFrequencyBandsEUTRA,
    maxMultipleFrequencyBandsFDD,
    maxASC,

```

maxASCmap,
maxASCpersist,
maxCCTrCH,
maxCellMeas,
maxCellMeas-1,
maxCellMeas-ext,
maxCellMeas-ext2,
maxCellMeas-ext-1,
maxCellMeasOnSecULFreq,
maxCellMeasOnSecULFreq-1,
maxCNdomains,
maxCommonHRNTI,
maxCommonQueueID,
maxCPCHsets,
maxDedicatedCSGFreq,
maxDPCH-DLchan,
maxDPDCH-UL,
maxDRACclasses,
maxE-DCHMACdFlow,
maxE-DCHMACdFlow-1,
maxEDCHs,
maxEDCHs-1,
maxEDCHTxPattern-TDD128,
maxEDCHTxPattern-TDD128-1,
maxERNTIgroup,
maxERNTIperGroup,
maxERUCCH,
maxEUTRACellPerFreq,
maxEUTRATargetFreqs,
maxExcludedDetectedSetCells,
maxFACHPCH,
maxFreq,
maxFreqBandsEUTRA,
maxFreqBandsEUTRA-ext,
maxFreqBandsFDD,
maxFreqBandsFDD2,
maxFreqBandsFDD3,
maxFreqBandsFDD-ext,
maxFreqBandsFDD-ext2,
maxFreqBandsFDD-ext3,
maxFreqBandsIndicatorSupport,
maxFreqBandsTDD,
maxFreqBandsTDD-ext,
maxFreqBandsGSM,
maxFreqMeasWithoutCM,
maxGANSS,
maxGANSS-1,
maxGANSSSat,
maxGANSSSat-1,
maxGERAN-SI,
maxHNBNameSize,
maxHProcesses,
maxHSDSCHTBIndex,
maxHSDSCHTBIndex-tdd384,
maxHSSCCHs,
maxHSSCCHs-1,
maxHSSICH-TDD128,
maxHSSICH-TDD128-1,
maxHS-SCCHLessTrBlk,
maxIGPInfo,
maxInterSysMessages,
maxLoCHperRLC,
maxLoggedMeasReport,
maxnumLoggedMeas,
maxMAC-d-PDUsizes,
maxMBMS-CommonCCTrCh,
maxMBMS-CommonPhyCh,
maxMBMS-CommonRB,
maxMBMS-CommonTrCh,
maxMBMS-Freq,
maxMBMS-L1CP,
maxMBMSservCount,
maxMBMSservModif,
maxMBMSservSched,
maxMBMSservSelect,
maxMBMSservUnmodif,
maxMBMSTransmis,
maxMBSFNclusters,

maxMeasCSGRange,
maxMeasEvent,
maxMeasEventOnSecULFreq,
maxMeasIdentity,
maxMeasIntervals,
maxMeasParEvent,
maxNonContiguousMultiCellCombinations,
maxMeasOccasionPattern,
maxMeasOccasionPattern-1,
maxNumAccessGroups,
maxNumCDMA2000Freqs,
maxNumE-AGCH,
maxNumE-HICH,
maxNumEUTRAFreqs,
maxNumEUTRAFreqs-FACH,
maxNumEUTRAFreqs-FACH-ext,
maxNumFDDFreqs,
maxNumGSMCellGroup,
maxNumGSMFreqRanges,
maxGSMTargetCells,
maxNumMDTPLMN,
maxNumTDDFreqs,
maxNumANRLoggedItems,
maxOtherRAT,
maxOtherRAT-16,
maxPagel,
maxPCPCH-Apsig,
maxPCPCH-ApsubCh,
maxPCPCH-CDsig,
maxPCPCH-CDsubCh,
maxPCPCH-SF,
maxPCPCHs,
maxPDCPAlgoType,
maxPDSCH,
maxPDSCH-TFCIgroups,
maxPRACH,
maxPRACH-EUL,
maxPRACH-FPACH,
maxPredefConfig,
maxPrio,
maxPrio-1,
maxPUSCH,
maxQueueIDs,
maxRABsetup,
maxRAT,
maxRB,
maxRBallRABs,
maxRBperTrCh,
maxRBMuxOptions,
maxRBperRAB,
maxReportedEUTRAFreqs,
maxReportedEUTRAFreqs-ext,
maxReportedEUTRACellPerFreq,
maxReportedGSMCells,
maxRLCPDUsPerLogChan,
maxRMPfrequencies,
maxSRBsetup,
maxRL,
maxRL-1,
maxEDCHRL,
maxEDCHRL-1,
maxROHC-PacketSizes-r4,
maxROHC-Profile-r4,
maxRxPatternForHSDSCH-TDD128,
maxRxPatternForHSDSCH-TDD128-1,
maxSat,
maxSatClockModels,
maxSCCPCH,
maxSgnType,
maxSIB,
maxSIB2,
maxSIB-FACH,
maxSirequest,
maxSystemCapability,
maxTDD128Carrier,
maxTDD128Carrier-1,
maxTbsForHSDSCH-TDD128,
maxTbsForHSDSCH-TDD128-1,

```

maxTF,
maxTF-CPCH,
maxTFC,
maxTFCsub,
maxTFCl-2-Combs,
maxTGPS,
maxTrCH,
maxTrCHConcat,
maxTrCHpreconf,
maxTS,
maxTS-1,
maxTS-2,
maxTS-LCR,
maxTS-LCR-1,
maxURA,
maxURNTI-Group,
maxWLANID
FROM Constant-definitions;

-- *****
--
-- CORE NETWORK INFORMATION ELEMENTS (10.3.1)
--
-- *****

Ansi-41-IDNNS ::= BIT STRING (SIZE (14))

CN-DomainIdentity ::= ENUMERATED {
    cs-domain,
    ps-domain }

CN-DomainInformation ::= SEQUENCE {
    cn-DomainIdentity CN-DomainIdentity,
    cn-DomainSpecificNAS-Info NAS-SystemInformationGSM-MAP
}

CN-DomainInformationFull ::= SEQUENCE {
    cn-DomainIdentity CN-DomainIdentity,
    cn-DomainSpecificNAS-Info NAS-SystemInformationGSM-MAP,
    cn-DRX-CycleLengthCoeff CN-DRX-CycleLengthCoefficient
}

CN-DomainInformationList ::= SEQUENCE (SIZE (1..maxCNdomains)) OF
    CN-DomainInformation

CN-DomainInformationListFull ::= SEQUENCE (SIZE (1..maxCNdomains)) OF
    CN-DomainInformationFull

CN-DomainSysInfo ::= SEQUENCE {
    cn-DomainIdentity CN-DomainIdentity,
    cn-Type CHOICE {
        gsm-MAP NAS-SystemInformationGSM-MAP,
        ansi-41 NAS-SystemInformationANSI-41
    },
    cn-DRX-CycleLengthCoeff CN-DRX-CycleLengthCoefficient
}

CN-DomainSysInfoList ::= SEQUENCE (SIZE (1..maxCNdomains)) OF
    CN-DomainSysInfo

CN-InformationInfo ::= SEQUENCE {
    plmn-Identity PLMN-Identity OPTIONAL,
    cn-CommonGSM-MAP-NAS-SysInfo NAS-SystemInformationGSM-MAP OPTIONAL,
    cn-DomainInformationList CN-DomainInformationList OPTIONAL
}

CN-InformationInfo-r6 ::= SEQUENCE {
    plmn-Identity PLMN-Identity OPTIONAL,
    cn-CommonGSM-MAP-NAS-SysInfo NAS-SystemInformationGSM-MAP OPTIONAL,
    cn-DomainInformationList CN-DomainInformationList OPTIONAL,
    primary-plmn-Identity PLMN-Identity OPTIONAL
}

CN-InformationInfoFull ::= SEQUENCE {
    plmn-Identity PLMN-Identity OPTIONAL,
    cn-CommonGSM-MAP-NAS-SysInfo NAS-SystemInformationGSM-MAP OPTIONAL,
    cn-DomainInformationListFull CN-DomainInformationListFull OPTIONAL
}

```

```

Digit ::= INTEGER (0..9)

DomainSpecificEAB-Parameters ::= SEQUENCE {
    cs-DomainSpecificEAB-Parameters EAB-Configuration OPTIONAL,
    ps-DomainSpecificEAB-Parameters EAB-Configuration OPTIONAL,
    commonEAB-Parameters EAB-Configuration OPTIONAL
}

EAB-AccessClassBarredList ::= SEQUENCE (SIZE (10)) OF
    AccessClassBarred

EAB-Configuration ::= SEQUENCE {
    eab-Category ENUMERATED {a,b,c},
    eab-AccessClassBarredList EAB-AccessClassBarredList
}

EAB-Parameters ::= CHOICE {
    eab-ParametersPerPLMN-List EAB-ParametersPerPLMN-List,
    eab-ParametersForAll DomainSpecificEAB-Parameters
}

EAB-ParametersPerPLMN ::= SEQUENCE {
    domainSpecificEAB-Parameters DomainSpecificEAB-Parameters OPTIONAL
}

EAB-ParametersPerPLMN-List ::= SEQUENCE (SIZE (1..6)) OF EAB-ParametersPerPLMN

Ec-NOforANR ::= SEQUENCE {
    ec-N0 INTEGER (-24..0) OPTIONAL
}

Gsm-map-IDNNS ::= SEQUENCE {
    routingbasis CHOICE {
        localPTMSI SEQUENCE {
            routingparameter RoutingParameter
        },
        tMSIofsamePLMN SEQUENCE {
            routingparameter RoutingParameter
        },
        tMSIofdifferentPLMN SEQUENCE {
            routingparameter RoutingParameter
        },
        iMSIresponsetopaging SEQUENCE {
            routingparameter RoutingParameter
        },
        iMSIcauseUEinitiatedEvent SEQUENCE {
            routingparameter RoutingParameter
        },
        iMEI SEQUENCE {
            routingparameter RoutingParameter
        },
        spare2 SEQUENCE {
            routingparameter RoutingParameter
        },
        spare1 SEQUENCE {
            routingparameter RoutingParameter
        }
    },
    -- dummy is not used in this version of the specification and
    -- it should be ignored by the receiver.
    dummy BOOLEAN
}

IMEI ::= SEQUENCE (SIZE (15)) OF
    IMEI-Digit

IMEI-Digit ::= INTEGER (0..15)

IMSI-GSM-MAP ::= SEQUENCE (SIZE (6..21)) OF
    Digit

IntraDomainNasNodeSelector ::= SEQUENCE {
    version CHOICE {
        release99 SEQUENCE {
            cn-Type CHOICE {
                gsm-Map-IDNNS Gsm-map-IDNNS,
                ansi-41-IDNNS Ansi-41-IDNNS
            }
        }
    }
}

```

```

    }
  },
  later
  futurecoding
}
}
}
LAI ::=
  plmn-Identity
  lac
SEQUENCE {
  PLMN-Identity,
  BIT STRING (SIZE (16))
}
LocationRegistrationAccessClassBarredList ::= SEQUENCE (SIZE (15)) OF
  AccessClassBarred
LocationRegistrationParameters ::= CHOICE {
  noRestriction
  restriction
  LocationRegistrationAccessClassBarredList
}
MCC ::=
  SEQUENCE (SIZE (3)) OF
  Digit
MNC ::=
  SEQUENCE (SIZE (2..3)) OF
  Digit
MultiplePLMN-List-r6 ::=
  SEQUENCE {
  mibPLMN-Identity
  multiplePLMNs
  BOOLEAN,
  SEQUENCE (SIZE (1..5)) OF
  PLMN-IdentityWithOptionalMCC-r6
}
NAS-Message ::=
  OCTET STRING (SIZE (1..4095))
NAS-Synchronisation-Indicator ::=
  BIT STRING(SIZE(4))
NAS-SystemInformationGSM-MAP ::=
  OCTET STRING (SIZE (1..8))
P-TMSI-GSM-MAP ::=
  BIT STRING (SIZE (32))
PagingPermissionWithAccessControlForSharedNetwork ::= CHOICE {
  pagingPermissionWithAccessControlList
  pagingPermissionWithAccessControlForAll
  PagingPermissionWithAccessControlParameters
}
PagingPermissionWithAccessControlList ::= SEQUENCE {
  pagingPermissionWithAccessControlParametersForOperator1
  PagingPermissionWithAccessControlParameters OPTIONAL,
  pagingPermissionWithAccessControlParametersForOperator2
  PagingPermissionWithAccessControlParameters OPTIONAL,
  pagingPermissionWithAccessControlParametersForOperator3
  PagingPermissionWithAccessControlParameters OPTIONAL,
  pagingPermissionWithAccessControlParametersForOperator4
  PagingPermissionWithAccessControlParameters OPTIONAL,
  pagingPermissionWithAccessControlParametersForOperator5
  PagingPermissionWithAccessControlParameters OPTIONAL
}
PagingPermissionWithAccessControlParameters ::= SEQUENCE {
  pagingResponseRestrictionIndicator ENUMERATED {all, cS, pS, none},
  locationRegistrationRestrictionIndicator ENUMERATED {all, cS, pS},
  locationRegistration
  LocationRegistrationParameters
}
PagingRecordTypeID ::=
  ENUMERATED {
  imsi-GSM-MAP,
  tmsi-GSM-MAP-P-TMSI,
  imsi-DS-41,
  tmsi-DS-41 }
PLMN-Identity ::=
  mcc
  mnc
SEQUENCE {
  MCC,
  MNC
}
PLMN-IdentityWithOptionalMCC-r6 ::= SEQUENCE {
  mcc
  MCC OPTIONAL,

```

```

    mnc                MNC
  }

PLMN-Type ::=
  gsm-MAP              CHOICE {
    plmn-Identity      SEQUENCE {
                      PLMN-Identity
    },
    ansi-41            SEQUENCE {
    p-REV              P-REV,
    min-P-REV         Min-P-REV,
    sid               SID,
    nid               NID
    },
    gsm-MAP-and-ANSI-41 SEQUENCE {
    plmn-Identity     PLMN-Identity,
    p-REV             P-REV,
    min-P-REV        Min-P-REV,
    sid              SID,
    nid              NID
    },
    spare              NULL
  }

RAB-Identity ::=
  gsm-MAP-RAB-Identity BIT STRING (SIZE (8)),
  ansi-41-RAB-Identity BIT STRING (SIZE (8))
}

RAI ::=
  lai              LAI,
  rac              RoutingAreaCode
}

RoutingAreaCode ::=
  BIT STRING (SIZE (8))

RoutingParameter ::=
  BIT STRING (SIZE (10))

TMSI-GSM-MAP ::=
  BIT STRING (SIZE (32))

-- *****
--
--   UTRAN MOBILITY INFORMATION ELEMENTS (10.3.2)
--
-- *****

AccessClassBarred ::=
  ENUMERATED {
    barred, notBarred }

AccessClassBarredList ::=
  SEQUENCE (SIZE (maxAC)) OF
    AccessClassBarred

AllowedIndicator ::=
  ENUMERATED {
    allowed, notAllowed }

CellAccessRestriction ::=
  SEQUENCE {
    cellBarred          CellBarred,
    cellReservedForOperatorUse ReservedIndicator,
    cellReservationExtension ReservedIndicator,
    -- NOTE: IE accessClassBarredList should not be included if the IE CellAccessRestriction
    -- is included in the IE SysInfoType4
    accessClassBarredList AccessClassBarredList           OPTIONAL
  }

CellAccessRestriction-v870ext ::=
  SEQUENCE {
    cellReservedForCSG  ENUMERATED { true }           OPTIONAL
  }

CellBarred ::=
  CHOICE {
    barred              SEQUENCE {
      intraFreqCellReselectionInd AllowedIndicator,
      t-Barred              T-Barred
    },
    notBarred          NULL
  }

CellIdentity ::=
  BIT STRING (SIZE (28))

CellIdentity-PerRL-List ::=
  SEQUENCE (SIZE (1..maxRL)) OF CellIdentity

```

```

CellIDListItem ::= SEQUENCE {
    cell-Identity      CellIdentity,
    plmn-Identity      PLMN-Identity      OPTIONAL
}

CellSelectReselectInfoSIB-3-4 ::= SEQUENCE {
    mappingInfo        MappingInfo        OPTIONAL,
    cellSelectQualityMeasure CHOICE {
        cpich-Ec-N0      SEQUENCE {
            -- Default value for q-HYST-2-S is q-HYST-1-S
            q-HYST-2-S      Q-Hyst-S      OPTIONAL
        },
        cpich-RSCP        NULL
    },
    modeSpecificInfo   CHOICE {
        fdd               SEQUENCE {
            s-Intrasearch S-SearchQual      OPTIONAL,
            s-Intersearch S-SearchQual      OPTIONAL,
            s-SearchHCS   S-SearchRXLEV     OPTIONAL,
            rat-List      RAT-FDD-InfoList  OPTIONAL,
            q-QualMin     Q-QualMin,
            q-RxlevMin    Q-RxlevMin
        },
        tdd               SEQUENCE {
            s-Intrasearch S-SearchRXLEV     OPTIONAL,
            s-Intersearch S-SearchRXLEV     OPTIONAL,
            s-SearchHCS   S-SearchRXLEV     OPTIONAL,
            rat-List      RAT-TDD-InfoList  OPTIONAL,
            q-RxlevMin    Q-RxlevMin
        }
    },
    q-Hyst-1-S          Q-Hyst-S,
    t-Reselection-S    T-Reselection-S,
    hcs-ServingCellInformation HCS-ServingCellInformation OPTIONAL,
    maxAllowedUL-TX-Power MaxAllowedUL-TX-Power
}

CSG-DedicatedFrequencyInfoList ::= SEQUENCE (SIZE (1..maxDedicatedCSGFreq)) OF
    FrequencyInfo

CSG-Identity ::= BIT STRING (SIZE (27))

CSG-PSCSplitInfo ::= SEQUENCE {
    -- Actual value = IE value * 8
    startPSC          INTEGER (0..63),
    numberOfPSCs      ENUMERATED { psc5, psc10, psc15, psc20,
        psc30, psc40, psc50, psc64, psc80,
        psc120, psc160, psc256, alltheRest,
        spare3, spare2, spare1 },
    -- Actual value = IE value * 8
    pscRange2Offset   INTEGER (1..63)      OPTIONAL
}

DedicatedWLANOffloadInformation ::= SEQUENCE {
    configurationInfo CHOICE {
        continue      NULL,
        newConfiguration SEQUENCE {
            t-330      T-330      OPTIONAL,
            wlanOffloadInformation WLANOffloadInformation
        }
    }
}

DomainSpecificAccessRestrictionForSharedNetwork-v670ext ::= CHOICE {
    domainSpecificAccessRestrictionList DomainSpecificAccessRestrictionList-v670ext,
    domainSpecificAccessRestrictionParametersForAll DomainSpecificAccessRestrictionParam-v670ext
}

DomainSpecificAccessRestrictionList-v670ext ::= SEQUENCE {
    domainSpecificAccessRestrictionParametersForOperator1
        DomainSpecificAccessRestrictionParam-v670ext OPTIONAL,
    domainSpecificAccessRestrictionParametersForOperator2
        DomainSpecificAccessRestrictionParam-v670ext OPTIONAL,
    domainSpecificAccessRestrictionParametersForOperator3
        DomainSpecificAccessRestrictionParam-v670ext OPTIONAL,
    domainSpecificAccessRestrictionParametersForOperator4
}

```



```

        DomainSpecificAccessRestrictionParam-v670ext    OPTIONAL,
    domainSpecificAccessRestrictionParametersForOperator5
        DomainSpecificAccessRestrictionParam-v670ext    OPTIONAL
    }

DomainSpecificAccessRestrictionParam-v670ext ::= SEQUENCE {
    cSDomainSpecificAccessRestriction    DomainSpecificAccessRestriction-v670ext,
    pSDomainSpecificAccessRestriction    DomainSpecificAccessRestriction-v670ext
}

DomainSpecificAccessRestriction-v670ext ::= CHOICE {
    noRestriction        NULL,
    restriction          SEQUENCE {
        domainSpecificAccessClassBarredList    AccessClassBarredList    OPTIONAL
    }
}

MapParameter ::=
    INTEGER (0..127)

Mapping ::=
    SEQUENCE {
        rat                RAT,
        mappingFunctionParameterList    MappingFunctionParameterList
    }

Mapping-LCR-r4 ::=
    SEQUENCE {
        mappingFunctionParameterList    MappingFunctionParameterList
    }

MappingFunctionParameter ::=
    SEQUENCE {
        functionType        MappingFunctionType,
        mapParameter1        MapParameter                                OPTIONAL,
        mapParameter2        MapParameter,
        -- The presence of upperLimit is conditional on the number of repetition
        upperLimit            UpperLimit                                OPTIONAL
    }

MappingFunctionParameterList ::=
    SEQUENCE (SIZE (1..maxMeasIntervals)) OF
        MappingFunctionParameter

MappingFunctionType ::=
    ENUMERATED {
        linear,
        functionType2,
        functionType3,
        functionType4 }

-- In MappingInfo list, mapping for FDD and 3.84Mcps TDD is defined.
-- For 1.28Mcps TDD, Mapping-LCR-r4 is used instead.
MappingInfo ::=
    SEQUENCE (SIZE (1..maxRAT)) OF
        Mapping

OccurrenceSequenceNumberOfPICH ::=
    INTEGER (1..maxSCCPCH)

DedicatedPriorityInformation ::=
    SEQUENCE {
        action                CHOICE {
            clearDedicatedPriorities        NULL,
            configureDedicatedPriorities    SEQUENCE {
                t-322                T-322                OPTIONAL,
                priorityLevelList        PriorityLevelList    OPTIONAL,
                eutraDetection            BOOLEAN
            }
        }
    }

DedicatedPriorityInformation-r11 ::=
    SEQUENCE {
        action                CHOICE {
            clearDedicatedPriorities        NULL,
            configureDedicatedPriorities    SEQUENCE {
                t-322                T-322                OPTIONAL,
                priorityLevelList        PriorityLevelList-r11    OPTIONAL,
                eutraDetection            BOOLEAN
            }
        }
    }

PriorityLevel ::=
    SEQUENCE {
        priority                INTEGER (0..maxPrio-1)                OPTIONAL,
        radioAccessTechnology    CHOICE {
            utraFDD                SEQUENCE (SIZE (1..maxNumFDDFreqs)) OF SEQUENCE {

```

```

        uarfcn                UARFCN
    },
    ultraTDD                  SEQUENCE (SIZE (1..maxNumTDDFreqs)) OF SEQUENCE{
        uarfcn                UARFCN
    },
    eutra                      SEQUENCE (SIZE (1..maxNumEUTRAFreqs)) OF SEQUENCE{
        earfcn                EARFCN
    },
    gsm                        SEQUENCE {
        gsm-CellGroup        GSM-CellGroup
    }
}

PriorityLevel-r11 ::=
    priority                    INTEGER (0..maxPrio-1)                OPTIONAL,
    radioAccessTechnology      CHOICE {
        ultraFDD              SEQUENCE (SIZE (1..maxNumFDDFreqs)) OF SEQUENCE{
            uarfcn            UARFCN
        },
        ultraTDD              SEQUENCE (SIZE (1..maxNumTDDFreqs)) OF SEQUENCE{
            uarfcn            UARFCN
        },
        eutra                  SEQUENCE (SIZE (1..maxNumEUTRAFreqs)) OF
            EARFCNRange,
        gsm                    SEQUENCE {
            gsm-CellGroup    GSM-CellGroup
        }
    }
}

PriorityLevelList ::=
    SEQUENCE (SIZE (1..maxPrio)) OF
        PriorityLevel

PriorityLevelList-r11 ::=
    SEQUENCE (SIZE (1..maxPrio)) OF
        PriorityLevel-r11

-- Actual value Q-Hyst-S = IE value * 2
Q-Hyst-S ::=
    INTEGER (0..20)

Q-Hyst-S-Fine ::= INTEGER (0..40)

RAT ::=
    ENUMERATED {
        ultra-FDD,
        ultra-TDD,
        gsm,
        cdma2000 }

RAT-FDD-Info ::=
    SEQUENCE {
        rat-Identifier        RAT-Identifier,
        s-SearchRAT           S-SearchQual,
        s-HCS-RAT             S-SearchRXLEV                OPTIONAL,
        s-Limit-SearchRAT    S-SearchQual
    }

RAT-FDD-InfoList ::=
    SEQUENCE (SIZE (1..maxOtherRAT)) OF
        RAT-FDD-Info

RAT-Identifier ::=
    ENUMERATED {
        gsm, cdma2000 }

RAT-TDD-Info ::=
    SEQUENCE {
        rat-Identifier        RAT-Identifier,
        s-SearchRAT           S-SearchRXLEV,
        s-HCS-RAT             S-SearchRXLEV                OPTIONAL,
        s-Limit-SearchRAT    S-SearchRXLEV
    }

RAT-TDD-InfoList ::=
    SEQUENCE (SIZE (1..maxOtherRAT)) OF
        RAT-TDD-Info

ReservedIndicator ::=
    ENUMERATED {
        reserved,
        notReserved }

-- Actual value S-SearchQual = IE value * 2
S-SearchQual ::=
    INTEGER (-16..10)

```

```

-- Actual value S-SearchRXLEV = (IE value * 2) + 1
S-SearchRXLEV ::= INTEGER (-53..45)

-- Actual value ScalingFactor = IE value * 0.1
SpeedDependentScalingFactor ::= INTEGER (0..10)

T-Barred ::= ENUMERATED {
    s10, s20, s40, s80,
    s160, s320, s640, s1280 }

T-Reselection-S ::= INTEGER (0..31)

-- Actual value T-Reselection-S-Fine = IE value * 0.2
T-Reselection-S-Fine ::= INTEGER (0..31)

-- Actual value ScalingFactor = IE value * 0.25
TreseselectionScalingFactor ::= INTEGER (4..19)

-- Actual value ScalingFactor2 = IE value * 0.25
TreseselectionScalingFactor2 ::= INTEGER (1..16)

-- For UpperLimit, the used range depends on the RAT used.
UpperLimit ::= INTEGER (1..91)

URA-Identity ::= BIT STRING (SIZE (16))

URA-IdentityList ::= SEQUENCE (SIZE (1..maxURA)) OF
    URA-Identity

-- *****
--
--     USER EQUIPMENT INFORMATION ELEMENTS (10.3.3)
--
-- *****

AccessGroupIdentity ::= INTEGER (0..15)

AccessStratumReleaseIndicator ::= ENUMERATED {
    rel-4, rel-5, rel-6, rel-7, rel-8,
    rel-9, rel-10, rel-11, rel-12,
    spare7, spare6, spare5, spare4, spare3,
    spare2, spare1 }

-- TABULAR : for ActivationTime, value 'now' always appear as default, and is encoded
-- by absence of the field
ActivationTime ::= INTEGER (0..255)

BackoffControlParams ::= SEQUENCE {
    n-AP-RetransMax      N-AP-RetransMax,
    n-AccessFails       N-AccessFails,
    nf-BO-NoAICH        NF-BO-NoAICH,
    ns-BO-Busy          NS-BO-Busy,
    nf-BO-AllBusy       NF-BO-AllBusy,
    nf-BO-Mismatch      NF-BO-Mismatch,
    t-CPCH              T-CPCH
}

BandComb ::= INTEGER (1..256)

C-RNTI ::= BIT STRING (SIZE (16))

CapabilityUpdateRequirement ::= SEQUENCE {
    ue-RadioCapabilityFDDUpdateRequirement BOOLEAN,
    -- ue-RadioCapabilityTDDUpdateRequirement is for 3.84Mcps TDD update requirement
    ue-RadioCapabilityTDDUpdateRequirement BOOLEAN,
    systemSpecificCapUpdateReqList      SystemSpecificCapUpdateReqList      OPTIONAL
}

CapabilityUpdateRequirement-r4-ext ::= SEQUENCE {
    ue-RadioCapabilityUpdateRequirement-TDD128 BOOLEAN
}

CapabilityUpdateRequirement-r4 ::= SEQUENCE {
    ue-RadioCapabilityFDDUpdateRequirement-FDD BOOLEAN,
    ue-RadioCapabilityTDDUpdateRequirement-TDD384 BOOLEAN,
    ue-RadioCapabilityTDDUpdateRequirement-TDD128 BOOLEAN,
    systemSpecificCapUpdateReqList      SystemSpecificCapUpdateReqList      OPTIONAL
}

```

```

CapabilityUpdateRequirement-r5 ::= SEQUENCE {
    ue-RadioCapabilityFDDUpdateRequirement-FDD      BOOLEAN,
    ue-RadioCapabilityTDDUpdateRequirement-TDD384   BOOLEAN,
    ue-RadioCapabilityTDDUpdateRequirement-TDD128   BOOLEAN,
    systemSpecificCapUpdateReqList                 SystemSpecificCapUpdateReqList-r5      OPTIONAL
}

CapabilityUpdateRequirement-v770ext ::= SEQUENCE {
    ue-RadioCapabilityTDDUpdateRequirement-TDD768   BOOLEAN
}

CapabilityUpdateRequirement-r7 ::= SEQUENCE {
    ue-RadioCapabilityFDDUpdateRequirement-FDD      BOOLEAN,
    ue-RadioCapabilityTDDUpdateRequirement-TDD384   BOOLEAN,
    ue-RadioCapabilityTDDUpdateRequirement-TDD768   BOOLEAN,
    ue-RadioCapabilityTDDUpdateRequirement-TDD128   BOOLEAN,
    systemSpecificCapUpdateReqList                 SystemSpecificCapUpdateReqList-r5      OPTIONAL
}

CapabilityUpdateRequirement-v860ext ::= SEQUENCE {
    -- If both IEs are present, the elements in the IE SystemSpecificCapUpdateReqList-r8
    -- shall be appended to the elements in the IE SystemSpecificCapUpdateReqList
    systemSpecificCapUpdateReqList                 SystemSpecificCapUpdateReqList-r8      OPTIONAL
}

CapabilityUpdateRequirement-r8 ::= SEQUENCE {
    ue-RadioCapabilityFDDUpdateRequirement-FDD      BOOLEAN,
    ue-RadioCapabilityTDDUpdateRequirement-TDD384   BOOLEAN,
    ue-RadioCapabilityTDDUpdateRequirement-TDD768   BOOLEAN,
    ue-RadioCapabilityTDDUpdateRequirement-TDD128   BOOLEAN,
    systemSpecificCapUpdateReqList                 SystemSpecificCapUpdateReqList-r8      OPTIONAL
}

CapabilityUpdateRequirement-vaj0ext ::= SEQUENCE {
    eUTRABandSpecificCapUpdateReqList             EUTRABandSpecificCapUpdateReqList
}

CapabilityUpdateRequirement-r12 ::= SEQUENCE {
    ue-RadioCapabilityFDDUpdateRequirement-FDD      BOOLEAN,
    ue-RadioCapabilityTDDUpdateRequirement-TDD384   BOOLEAN,
    ue-RadioCapabilityTDDUpdateRequirement-TDD768   BOOLEAN,
    ue-RadioCapabilityTDDUpdateRequirement-TDD128   BOOLEAN,
    systemSpecificCapUpdateReqList                 SystemSpecificCapUpdateReqList-r8      OPTIONAL,
    eUTRABandSpecificCapUpdateReqList             EUTRABandSpecificCapUpdateReqList      OPTIONAL
}

-- If the IE CellUpdateCause has the value 'cellUpdateCause-ext', the actual value is
-- defined in the IE CellUpdateCause-ext.
CellUpdateCause ::=
    ENUMERATED {
        cellReselection,
        periodicalCellUpdate,
        uplinkDataTransmission,
        utran-pagingResponse,
        re-enteredServiceArea,
        radiolinkFailure,
        rlc-unrecoverableError,
        cellUpdateCause-ext }

-- The IE CellUpdateCause-ext shall be present, if the IE CellUpdateCause has the
-- value 'cellUpdateCause-ext'.
-- dummy is not used in this version of the specification, it should not be sent
-- and if received it should be ignored by the receiver.
CellUpdateCause-ext ::=
    ENUMERATED {
        mbms-Reception,
        mbms-PTP-RB-Request,
        dummy,
        spare1 }

ChipRateCapability ::=
    ENUMERATED {
        mcps3-84, mcps1-28 }

CipheringAlgorithm ::=
    ENUMERATED {
        uea0, uea1 }

CipheringAlgorithm-r7 ::=
    ENUMERATED {

```

```

        uea0, uea1, uea2 }

CipheringModeCommand ::=          CHOICE {
    startRestart                  CipheringAlgorithm,
    dummy                          NULL
}

CipheringModeCommand-r7 ::=      SEQUENCE {
    startRestart                  CipheringAlgorithm-r7
}

CipheringModeInfo ::=            SEQUENCE {
    -- TABULAR: The ciphering algorithm is included in the CipheringModeCommand.
    cipheringModeCommand          CipheringModeCommand,
    activationTimeForDPCH          ActivationTime                      OPTIONAL,
    rb-DL-CiphActivationTimeInfo  RB-ActivationTimeInfoList      OPTIONAL
}

CipheringModeInfo-r7 ::=         SEQUENCE {
    -- TABULAR: The ciphering algorithm is included in the CipheringModeCommand.
    cipheringModeCommand          CipheringModeCommand-r7,
    activationTimeForDPCH          ActivationTime                      OPTIONAL,
    rb-DL-CiphActivationTimeInfo  RB-ActivationTimeInfoList      OPTIONAL
}

CN-DRX-CycleLengthCoefficient ::= INTEGER (6..9)

CN-PagedUE-Identity ::=         CHOICE {
    imsi-GSM-MAP                  IMSI-GSM-MAP,
    tmsi-GSM-MAP                  TMSI-GSM-MAP,
    p-TMSI-GSM-MAP                P-TMSI-GSM-MAP,
    imsi-DS-41                    IMSI-DS-41,
    tmsi-DS-41                    TMSI-DS-41,
    spare3                          NULL,
    spare2                          NULL,
    spare1                          NULL
}

CompressedModeMeasCapability ::= SEQUENCE {
    fdd-Measurements               BOOLEAN,
    -- TABULAR: The IEs tdd-Measurements, gsm-Measurements and multiCarrierMeasurements
    -- are made optional since they are conditional based on another information element.
    -- Their absence corresponds to the case where the condition is not true.
    -- The IE 'tdd-Measurements' applies to either or both TDD 3.84 Mcps and TDD 7.68 Mcps,
    -- depending on the RF capability conditions.
    tdd-Measurements               BOOLEAN                      OPTIONAL,
    gsm-Measurements               GSM-Measurements            OPTIONAL,
    multiCarrierMeasurements       BOOLEAN                      OPTIONAL
}

CompressedModeMeasCapability-LCR-r4 ::= SEQUENCE {
    tdd128-Measurements            BOOLEAN                      OPTIONAL
}

CompressedModeMeasCapability-v860ext ::= SEQUENCE {
    adjacentFrequencyMeasurements  ENUMERATED { true }      OPTIONAL
}

CompressedModeMeasCapability-v920ext ::= SEQUENCE {
    interBandMeasurements          ENUMERATED { true }      OPTIONAL
}

CompressedModeMeasCapability-va40ext ::= SEQUENCE {
    enhancedInterFrequencyMeasurements  ENUMERATED { true }      OPTIONAL,
    freqSpecificCompressedMode          ENUMERATED { true }      OPTIONAL
}

CompressedModeMeasCapabEUTRA ::= SEQUENCE {
    radioFrequencyBandEUTRA         RadioFrequencyBandEUTRA,
    compressedMode                   BOOLEAN
}

CompressedModeMeasCapabEUTRAExt ::= SEQUENCE {
    radioFrequencyBandEUTRA         RadioFrequencyBandEUTRAExt
}

CompressedModeMeasCapabEUTRAExt2 ::= SEQUENCE {
    radioFrequencyBandEUTRA         RadioFrequencyBandEUTRAExt2,

```

```

    compressedMode                BOOLEAN
}

CompressedModeMeasCapabEUTRAList ::= SEQUENCE (SIZE (1..maxFreqBandsEUTRA)) OF
    CompressedModeMeasCapabEUTRA

CompressedModeMeasCapabEUTRAList2 ::= SEQUENCE (SIZE (1..maxFreqBandsEUTRA)) OF
    CompressedModeMeasCapabEUTRAExt

CompressedModeMeasCapabEUTRAList3 ::= SEQUENCE (SIZE (1..maxFreqBandsEUTRA-ext)) OF
    CompressedModeMeasCapabEUTRAExt2

CompressedModeMeasCapabFDDList ::= SEQUENCE (SIZE (1..maxFreqBandsFDD)) OF
    CompressedModeMeasCapabFDD

CompressedModeMeasCapabFDDList2 ::= SEQUENCE (SIZE (1..maxFreqBandsFDD)) OF
    CompressedModeMeasCapabFDD2

CompressedModeMeasCapabFDDList3 ::= SEQUENCE (SIZE (1..maxFreqBandsFDD-ext2)) OF
    CompressedModeMeasCapabFDD3

CompressedModeMeasCapabFDDList-ext ::= SEQUENCE (SIZE (1..maxFreqBandsFDD)) OF
    CompressedModeMeasCapabFDD-ext

CompressedModeMeasCapabFDD ::= SEQUENCE {
    radioFrequencyBandFDD        RadioFrequencyBandFDD    OPTIONAL,
    dl-MeasurementsFDD           BOOLEAN,
    ul-MeasurementsFDD           BOOLEAN
}

CompressedModeMeasCapabFDD2 ::= SEQUENCE {
    -- UE may omit both IEs if this IE indicates the compressed mode capability within the same
    -- frequency band. Otherwise, the UE shall include either one of the following OPTIONAL IEs.
    radioFrequencyBandFDD        RadioFrequencyBandFDD    OPTIONAL,
    radioFrequencyBandFDD2       RadioFrequencyBandFDD2   OPTIONAL,
    dl-MeasurementsFDD           BOOLEAN,
    ul-MeasurementsFDD           BOOLEAN
}

CompressedModeMeasCapabFDD3 ::= SEQUENCE {
    -- UE may omit radioFrequencyBandFDD3 if this IE indicates the compressed mode capability within
    -- the same frequency band. Otherwise, the UE shall include the IE.
    radioFrequencyBandFDD3       RadioFrequencyBandFDD3   OPTIONAL,
    dl-MeasurementsFDD           BOOLEAN,
    ul-MeasurementsFDD           BOOLEAN
}

CompressedModeMeasCapabFDD-ext ::= SEQUENCE {
    radioFrequencyBandFDD2       RadioFrequencyBandFDD2,
    dl-MeasurementsFDD           BOOLEAN,
    ul-MeasurementsFDD           BOOLEAN
}

CompressedModeMeasCapabTDDList ::= SEQUENCE (SIZE (1..maxFreqBandsTDD)) OF
    CompressedModeMeasCapabTDD

CompressedModeMeasCapabTDD ::= SEQUENCE {
    radioFrequencyBandTDD        RadioFrequencyBandTDD,
    dl-MeasurementsTDD           BOOLEAN,
    ul-MeasurementsTDD           BOOLEAN
}

CompressedModeMeasCapabGSMList ::= SEQUENCE (SIZE (1..maxFreqBandsGSM)) OF
    CompressedModeMeasCapabGSM

CompressedModeMeasCapabGSM ::= SEQUENCE {
    radioFrequencyBandGSM        RadioFrequencyBandGSM,
    dl-MeasurementsGSM           BOOLEAN,
    ul-MeasurementsGSM           BOOLEAN
}

CompressedModeMeasCapabMC ::= SEQUENCE {
    dl-MeasurementsMC            BOOLEAN,
    ul-MeasurementsMC            BOOLEAN
}

CPCH-Parameters ::= SEQUENCE {
    initialPriorityDelayList      InitialPriorityDelayList    OPTIONAL,

```

```

backoffControlParams          BackoffControlParams,
-- TABULAR: TPC step size nested inside PowerControlAlgorithm
powerControlAlgorithm         PowerControlAlgorithm,
dl-DPCCH-BER                  DL-DPCCH-BER
}

CSG-ProximityIndicationCapability ::= SEQUENCE {
  supportOfIntraFreqProximityIndication  ENUMERATED { true }           OPTIONAL,
  supportOfInterFreqProximityIndication  ENUMERATED { true }           OPTIONAL,
  supportOfE-UltraProximityIndication    ENUMERATED { true }           OPTIONAL
}

DL-CapabilityWithSimultaneousHS-DSCHConfig ::= ENUMERATED{kbps32, kbps64, kbps128, kbps384}

DL-DPCCH-BER ::=
    INTEGER (0..63)

DL-InformationPerSecondaryRL-List ::=
    SEQUENCE (SIZE (1..maxEDCHRL)) OF
        DL-InformationPerSecondaryRL

DL-InformationPerSecondaryRL-List-r12 ::=
    SEQUENCE (SIZE (1..maxEDCHRL)) OF
        DL-InformationPerSecondaryRL-r12

DL-InformationPerSecondaryRL ::=
    SEQUENCE {
        primaryCPICH-Info          PrimaryCPICH-Info,
        cell-id                    CellIdentity                OPTIONAL,
        dl-FDPCHInfoPerRL-SecULFreq DL-FDPCH-InfoPerRL-r7,
        e-AGCH-Information          E-AGCH-Information      OPTIONAL,
        e-HICH-Information          E-HICH-Information      OPTIONAL,
        e-RGCH-Info                 CHOICE {
            e-RGCH-Information      E-RGCH-Information,
            releaseIndicator         NULL
        } OPTIONAL
    }

DL-InformationPerSecondaryRL-r12 ::=
    SEQUENCE {
        primaryCPICH-Info          PrimaryCPICH-Info,
        cell-id                    CellIdentity                OPTIONAL,
        dl-FDPCHInfoPerRL-SecULFreq DL-FDPCH-InfoPerRL-r7,
        e-AGCH-Information          E-AGCH-Information      OPTIONAL,
        e-HICH-Information          E-HICH-Information      OPTIONAL,
        e-RGCH-Info                 CHOICE {
            e-RGCH-Information      E-RGCH-Information,
            releaseIndicator         NULL
        } OPTIONAL,
        secondary-Serving-E-DCHRL-Indicator  ENUMERATED { true }    OPTIONAL,
        radioLinksWithoutDPCHFDPCCHIndicator  NULL                    OPTIONAL
    }

DL-PhysChCapabilityFDD ::=
    SEQUENCE {
        -- The IE "maxNoDPCH-PDSCH-Codes" only gives information on the maximum number of DPCH Codes.
        maxNoDPCH-PDSCH-Codes      INTEGER (1..8),
        maxNoPhysChBitsReceived     MaxNoPhysChBitsReceived,
        supportForSF-512            BOOLEAN,
        -- dummy and dummy2 are not used in this version of the specification
        -- and if received they should be ignored.
        dummy                       BOOLEAN,
        dummy2                       SimultaneousSCCPCH-DPCH-Reception
    }

DL-PhysChCapabilityFDD-v380ext ::=
    SEQUENCE {
        -- dummy is not used in this version of the specification, it should
        -- not be sent and if received it should be ignored.
        dummy                       SupportOfDedicatedPilotsForChEstimation  OPTIONAL
    }

SupportOfDedicatedPilotsForChEstimation ::=
    ENUMERATED { true }

DL-PhysChCapabilityFDD-v770ext ::=
    SEQUENCE {
        hsdSCH-physical-layer-category-ext  HSDSCH-physical-layer-category-ext  OPTIONAL,
        hsscchlessHsdSCHOperation           ENUMERATED { true }                 OPTIONAL,
        enhancedFdpch                       ENUMERATED { true }                 OPTIONAL,
        hsdSCHReception-CellFach            ENUMERATED { true }                 OPTIONAL,
        hsdSCHReception-CellUraPch         ENUMERATED { true }                 OPTIONAL
    }

DL-PhysChCapabilityFDD-v860ext ::=
    SEQUENCE {
        hsdSCH-physical-layer-category-ext2  HSDSCH-physical-layer-category-ext2  OPTIONAL,
        supportOfTargetCellPreConfig         ENUMERATED { true }                 OPTIONAL,
    }

```

```

    supportOfHsdSCHDrxOperation          ENUMERATED { true }          OPTIONAL
  }

DL-PhysChCapabilityFDD-v920ext ::= SEQUENCE {
  hsdSCH-physical-layer-category-ext3   HSDSCH-physical-layer-category-ext3 OPTIONAL,
  supportOfMimoOnlySingleStream         ENUMERATED { true }          OPTIONAL
}

DL-PhysChCapabilityFDD-va40ext ::= SEQUENCE {
  hsdSCH-physical-layer-category-ext4   HSDSCH-physical-layer-category-ext4 OPTIONAL,
  hsdSCH-physical-layer-category-ext5   HSDSCH-physical-layer-category-ext5 OPTIONAL
}

DL-PhysChCapabilityFDD-vb50ext ::= SEQUENCE {
  hsdSCH-physical-layer-category-ext6   HSDSCH-physical-layer-category-ext6 OPTIONAL,
  hsdSCH-physical-layer-category-ext7   HSDSCH-physical-layer-category-ext7 OPTIONAL,
  hsdSCH-physical-layer-category-ext8   HSDSCH-physical-layer-category-ext8 OPTIONAL,
  supportOf4x4MimoDualStreamRestriction ENUMERATED { true }          OPTIONAL,
  supportOfHS-DSCHSecondDRXOperation   ENUMERATED { true }          OPTIONAL,
  supportOfNodeBTrigHS-DPCCHTransmission ENUMERATED { true }          OPTIONAL
}

DL-PhysChCapabilityFDD-vb80ext ::= SEQUENCE {
  non-ContiguousMulti-CellWithMIMO     ENUMERATED { true }          OPTIONAL
}

DL-PhysChCapabilityFDD-vc50ext ::= SEQUENCE {
  supportforDCHEnhancements             ENUMERATED { basic, full }    OPTIONAL,
  simultaneousSupportforDCHEnhancementsAndCM ENUMERATED { true }      OPTIONAL,
  simultaneousSupportforDCHEnhancementsAndDPCCHDiscontTx ENUMERATED { true }    OPTIONAL,
  drx-enhancements                     ENUMERATED { true }          OPTIONAL,
  hs-dpcchOverheadReduction             ENUMERATED { true }          OPTIONAL,
  supportofEnhancedServingCellChangeForEvent1C ENUMERATED { true }        OPTIONAL,
  supportofDPCCH2                       ENUMERATED { true }          OPTIONAL
}

DL-PhysChCapabilityFDD-vd20ext ::= SEQUENCE {
  supportofPowerControlAlgorithm3       ENUMERATED { true }          OPTIONAL,
  supportofBlindHarqRetransmissionsforHsdpa ENUMERATED { true }        OPTIONAL
}

DL-PhysChCapabilityTDD ::= SEQUENCE {
  maxTS-PerFrame                       MaxTS-PerFrame,
  maxPhysChPerFrame                    MaxPhysChPerFrame,
  minimumSF                             MinimumSF-DL,
  supportOfPDSCH                        BOOLEAN,
  maxPhysChPerTS                        MaxPhysChPerTS
}

DL-PhysChCapabilityTDD-LCR-r4 ::= SEQUENCE {
  maxTS-PerSubFrame                    MaxTS-PerSubFrame-r4,
  maxPhysChPerSubFrame                 MaxPhysChPerSubFrame-r4,
  minimumSF                             MinimumSF-DL,
  supportOfPDSCH                        BOOLEAN,
  maxPhysChPerTS                        MaxPhysChPerTS,
  supportOf8PSK                         BOOLEAN
}

DL-PhysChCapabilityTDD-128-v770ext ::= SEQUENCE {
  multiCarrier-physical-layer-category MultiCarrier-HSDSCH-physical-layer-category OPTIONAL
}

DL-PhysChCapabilityTDD-128-v860ext ::= SEQUENCE {
  hsdSCH-physical-layer-category-extension HSDSCH-physical-layer-category-extension OPTIONAL,
  multiCarrier-physical-layer-category-extension MultiCarrier-HSDSCH-physical-layer-category-extension OPTIONAL,
  supportOfSFModeForHSPDSCHDualStream   ENUMERATED { sf1, sf1sf16 }    OPTIONAL
}

DL-PhysChCapabilityInfoTDD-128-va40ext ::= SEQUENCE {
  multiCarrier-physical-layer-category-extension2 MultiCarrier-HSDSCH-physical-layer-category-extension2 OPTIONAL
}

DL-PhysChCapabilityInfoTDD-128-vc50ext ::= SEQUENCE {
  supportofNon-rectResourceAllocation    ENUMERATED { true }          OPTIONAL
}

```



```

DL-PhysChCapabilityTDD-768 ::= SEQUENCE {
    maxTS-PerFrame
    maxPhysChPerFrame
    minimumSF
    supportOfPDSCH
    tdd768-hspdsch
        supported
        unsupported
    },
    maxPhysChPerTS
}

DL-PhysChCapabilityInfoTDD-768 ::= SEQUENCE {
    maxTS-PerFrame
    maxPhysChPerFrame
    minimumSF
    supportOfPDSCH
    maxPhysChPerTS
}

DL-TransChCapability ::= SEQUENCE {
    maxNoBitsReceived
    maxConvCodeBitsReceived
    turboDecodingSupport
    maxSimultaneousTransChs
    maxSimultaneousCCTrCH-Count
    maxReceivedTransportBlocks
    maxNumberOfTFC
    maxNumberOfTF
}

DRAC-SysInfo ::= SEQUENCE {
    transmissionProbability
    maximumBitRate
}

DRAC-SysInfoList ::= SEQUENCE (SIZE (1..maxDRACclasses)) OF
    DRAC-SysInfo

DSCH-RNTI ::= BIT STRING (SIZE (16))

DelayRestrictionFlag ::= ENUMERATED { true }

E-RNTI ::= BIT STRING (SIZE (16))

ESN-DS-41 ::= BIT STRING (SIZE (32))

EstablishmentCause ::= ENUMERATED {
    originatingConversationalCall,
    originatingStreamingCall,
    originatingInteractiveCall,
    originatingBackgroundCall,
    originatingSubscribedTrafficCall,
    terminatingConversationalCall,
    terminatingStreamingCall,
    terminatingInteractiveCall,
    terminatingBackgroundCall,
    emergencyCall,
    interRAT-CellReselection,
    interRAT-CellChangeOrder,
    registration,
    detach,
    originatingHighPrioritySignalling,
    originatingLowPrioritySignalling,
    callRe-establishment,
    terminatingHighPrioritySignalling,
    terminatingLowPrioritySignalling,
    terminatingCauseUnknown,
    mbms-Reception,
    mbms-PTP-RB-Request,
    delayTolerantAccess,
    spare9,
    spare8,
    spare7,
    spare6,
    spare5,
    spare4,
}

```

```

        spare3,
        spare2,
        spare1 }

ExtendedWaitTime ::= INTEGER (1..1800)

EUTRABandSpecificCapUpdateReqList ::= SEQUENCE (SIZE (1..16)) OF RadioFrequencyBandEUTRAExt2

FailureCauseWithProtErr ::= CHOICE {
    configurationUnsupported          NULL,
    physicalChannelFailure           NULL,
    incompatibleSimultaneousReconfiguration
                                     NULL,
    compressedModeRuntimeError       TGPSI,
    protocolError                    ProtocolErrorInformation,
    cellUpdateOccurred              NULL,
    invalidConfiguration            NULL,
    configurationIncomplete          NULL,
    unsupportedMeasurement           NULL,
    mbmsSessionAlreadyReceivedCorrectly NULL,
    lowerPriorityMBMSService         NULL,
    spare5                           NULL,
    spare4                           NULL,
    spare3                           NULL,
    spare2                           NULL,
    spare1                           NULL
}

FailureCauseWithProtErrTrId ::= SEQUENCE {
    rrc-TransactionIdentifier        RRC-TransactionIdentifier,
    failureCause                    FailureCauseWithProtErr
}

FrequencyBandsIndicatorSupport ::= SEQUENCE {
    modeSpecificInfo                CHOICE {
        fdd                          SEQUENCE {
            frequencyBandsSupportFDD  FrequencyBandsRedirectionFDD
        },
        tdd                          SEQUENCE {
            frequencyBandsSupportTDD128 FrequencyBandsIndicatorTDD128
        }
    }
}

FrequencyBandsIndicatorTDD128 ::= SEQUENCE (SIZE (1..maxFreqBandsIndicatorSupport)) OF
    FrequencyBandsIndicatorSupportTDD128

FrequencyBandsIndicatorSupportTDD128 ::= SEQUENCE {
    frequencyBandsIndicatorTDD      RadioFrequencyBandTDD-r10
}

FrequencyBandsRedirectionFDD ::= SEQUENCE (SIZE (1..maxFreqBandsIndicatorSupport)) OF
    FrequencyBandsIndicatorFDD

FrequencyBandsIndicatorFDD ::= CHOICE {
    frequencyBandsIndicator1        RadioFrequencyBandFDD,
    frequencyBandsIndicator2        RadioFrequencyBandFDD2,
    frequencyBandsIndicator3        RadioFrequencyBandFDD3
}

GANSS-Mode ::= ENUMERATED {
    networkBased,
    uEBased,
    both,
    none }

GroupIdentityWithReleaseInformation ::= SEQUENCE {
    rrc-ConnectionReleaseInformation RRC-ConnectionReleaseInformation,
    groupReleaseInformation          GroupReleaseInformation
}

GroupReleaseInformation ::= SEQUENCE {
    uRNTI-Group                     U-RNTI-Group
}

GSM-Measurements ::= SEQUENCE {
    gsm900                          BOOLEAN,
    dcs1800                          BOOLEAN,
}

```

```

    gsm1900                                BOOLEAN
}

H-RNTI ::=                                BIT STRING (SIZE (16))

High-MobilityDetected ::=                 ENUMERATED { high-MobilityDetected }

HSDSCH-physical-layer-category ::=        INTEGER (1..64)

HSDSCH-physical-layer-category-ext ::=    INTEGER (1..20)

HSDSCH-physical-layer-category-ext2 ::=   INTEGER (21..24)

HSDSCH-physical-layer-category-ext3 ::=   INTEGER (25..28)

HSDSCH-physical-layer-category-ext4 ::=   INTEGER (29..30)

HSDSCH-physical-layer-category-ext5 ::=   INTEGER (31..32)

HSDSCH-physical-layer-category-ext6 ::=   INTEGER (33..34)

HSDSCH-physical-layer-category-ext7 ::=   INTEGER (35..36)

HSDSCH-physical-layer-category-ext8 ::=   INTEGER (37..38)

HSDSCH-physical-layer-category-extension ::= INTEGER (1..64)

MultiCarrier-HSDSCH-physical-layer-category ::= INTEGER (1..64)

MultiCarrier-HSDSCH-physical-layer-category-extension ::= INTEGER (1..36)

MultiCarrier-HSDSCH-physical-layer-category-extension2 ::= INTEGER (37..64)

MultiflowCapabBandCombination ::=         SEQUENCE {
    numberOfCellsBandA                    INTEGER(1..6),
    numberOfFrequenciesBandA              INTEGER(1..3),
    numberOfCellsBandB                    INTEGER(1..6),
    numberOfFrequenciesBandB              INTEGER(1..3)
}

MultiflowCapabBandCombList ::= SEQUENCE (SIZE (1..16)) OF MultiflowCapabBandCombination

MultiflowCapability ::=                   SEQUENCE {
    mimoInDifferentBands                   MultiflowMIMOCapability           OPTIONAL,
    longerHARQProcessing                    ENUMERATED { true }              OPTIONAL
}

MultiflowPerBandCapability ::=             SEQUENCE {
    numberOfCells                           INTEGER(2..8),
    numberOfFrequencies                       INTEGER(1..4),
    mimo                                     MultiflowMIMOCapability           OPTIONAL,
    nonContiguousCapability                 MultiflowNonContiguousCapability  OPTIONAL
}

MultiflowMIMOCapability ::=               ENUMERATED { single-stream, dual-stream }

MultiflowNonContiguousCapability ::=       SEQUENCE {
    gapSize                                 ENUMERATED { fiveMHz, tenMHz, anyGapSize,
                                                    spare5, spare4, spare3, spare2, spare1 }
}

UESpecificBehaviourInformationIdle ::=     BIT STRING (SIZE (4))

UESpecificBehaviourInformationInterRAT ::= BIT STRING (SIZE (8))

IdleIntervalMeasCapabEUTRA ::=            SEQUENCE {
    radioFrequencyBandEUTRA                RadioFrequencyBandEUTRA,
    idleInterval                             BOOLEAN
}

IdleIntervalMeasCapabEUTRAExtension ::=    SEQUENCE {
    radioFrequencyBandEUTRA                 RadioFrequencyBandEUTRAExt
}

IdleIntervalMeasCapabEUTRAList ::=         SEQUENCE (SIZE (1..maxFreqBandsEUTRA)) OF
    IdleIntervalMeasCapabEUTRA

IdleIntervalMeasCapabEUTRAExtensionList ::= SEQUENCE (SIZE (1..maxFreqBandsEUTRA)) OF

```

```

IdleIntervalMeasCapabEUTRAExtension

IMSI-and-ESN-DS-41 ::= SEQUENCE {
    imsi-DS-41          IMSI-DS-41,
    esn-DS-41          ESN-DS-41
}

IMSI-DS-41 ::= OCTET STRING (SIZE (5..7))

InitialPriorityDelayList ::= SEQUENCE (SIZE (1..maxASC)) OF
    NS-IP

InitialUE-Identity ::= CHOICE {
    imsi                IMSI-GSM-MAP,
    tmsi-and-LAI        TMSI-and-LAI-GSM-MAP,
    p-TMSI-and-RAI     P-TMSI-and-RAI-GSM-MAP,
    imei                IMEI,
    esn-DS-41          ESN-DS-41,
    imsi-DS-41          IMSI-DS-41,
    imsi-and-ESN-DS-41 IMSI-and-ESN-DS-41,
    tmsi-DS-41          TMSI-DS-41
}

IntegrityCheckInfo ::= SEQUENCE {
    messageAuthenticationCode MessageAuthenticationCode,
    rrc-MessageSequenceNumber RRC-MessageSequenceNumber
}

IntegrityProtActivationInfo ::= SEQUENCE {
    rrc-MessageSequenceNumberList RRC-MessageSequenceNumberList
}

IntegrityProtectionAlgorithm ::= ENUMERATED {
    uial }

IntegrityProtectionAlgorithm-r7 ::= ENUMERATED {
    uial, uia2 }

IntegrityProtectionModeCommand ::= CHOICE {
    startIntegrityProtection SEQUENCE {
        integrityProtInitNumber IntegrityProtInitNumber
    },
    modify                    SEQUENCE {
        dl-IntegrityProtActivationInfo IntegrityProtActivationInfo
    }
}

IntegrityProtectionModeInfo ::= SEQUENCE {
    -- TABULAR: DL integrity protection activation info and Integrity
    -- protection intialisation number have been nested inside
    -- IntegrityProtectionModeCommand.
    integrityProtectionModeCommand IntegrityProtectionModeCommand,
    integrityProtectionAlgorithm   IntegrityProtectionAlgorithm   OPTIONAL
}

IntegrityProtectionModeInfo-r7 ::= SEQUENCE {
    -- TABULAR: DL integrity protection activation info and Integrity
    -- protection intialisation number have been nested inside
    -- IntegrityProtectionModeCommand.
    integrityProtectionModeCommand IntegrityProtectionModeCommand,
    integrityProtectionAlgorithm   IntegrityProtectionAlgorithm-r7 OPTIONAL
}

IntegrityProtInitNumber ::= BIT STRING (SIZE (32))

-- dummy is not used in this version of the specification, it should
-- not be sent and if received it should be ignored.
MaxHcContextSpace ::= ENUMERATED {
    dummy, by1024, by2048, by4096,
    by8192 }

MaxHcContextSpace-r5-ext ::= ENUMERATED {
    by16384, by32768, by65536, by131072 }

MaxROHC-ContextSessions-r4 ::= ENUMERATED {
    s2, s4, s8, s12, s16, s24, s32, s48,
    s64, s128, s256, s512, s1024, s16384 }

```

```

MaximumAM-EntityNumberRLC-Cap ::= ENUMERATED {
    dummy, am4, am5, am6,
    am8, am16, am30 }

-- Actual value MaximumBitRate = IE value * 16
MaximumBitRate ::= INTEGER (0..32)

MaximumRLC-WindowSize ::= ENUMERATED { mws2047, mws4095 }

MaxNoDPDCH-BitsTransmitted ::= ENUMERATED {
    b600, b1200, b2400, b4800,
    b9600, b19200, b28800, b38400,
    b48000, b57600 }

MaxNoBits ::= ENUMERATED {
    b640, b1280, b2560, b3840, b5120,
    b6400, b7680, b8960, b10240,
    b20480, b40960, b81920, b163840 }

MaxNoPhysChBitsReceived ::= ENUMERATED {
    dummy, b1200, b2400, b3600,
    b4800, b7200, b9600, b14400,
    b19200, b28800, b38400, b48000,
    b57600, b67200, b76800 }

MaxNoSCCPCH-RL ::= ENUMERATED {
    r11 }

MaxNumberOfTF ::= ENUMERATED {
    tf32, tf64, tf128, tf256,
    tf512, tf1024 }

MaxNumberOfTFC-DL ::= ENUMERATED {
    tfc16, tfc32, tfc48, tfc64, tfc96,
    tfc128, tfc256, tfc512, tfc1024 }

MaxNumberOfTFC-UL ::= ENUMERATED {
    dummy1, dummy2, tfc16, tfc32, tfc48, tfc64,
    tfc96, tfc128, tfc256, tfc512, tfc1024 }

-- the values 1 to 4 for MaxPhysChPerFrame are not used in this version of the protocol
MaxPhysChPerFrame ::= INTEGER (1..224)

MaxPhysChPerFrame-768 ::= INTEGER (1..448)

MaxPhysChPerSubFrame-r4 ::= INTEGER (1..96)

MaxPhysChPerTimeslot ::= ENUMERATED {
    ts1, ts2 }

MaxPhysChPerTimeslot-LCR-r7 ::= INTEGER (1..4)

-- the values 1 to 4 for MaxPhysChPerTS are not used in this version of the protocol
MaxPhysChPerTS ::= INTEGER (1..16)

MaxPhysChPerTS-768 ::= INTEGER (1..32)

MaxSimultaneousCCTrCH-Count ::= INTEGER (1..8)

MaxSimultaneousTransChsDL ::= ENUMERATED {
    e4, e8, e16, e32 }

MaxSimultaneousTransChsUL ::= ENUMERATED {
    dummy, e4, e8, e16, e32 }

MaxTransportBlocksDL ::= ENUMERATED {
    tb4, tb8, tb16, tb32, tb48,
    tb64, tb96, tb128, tb256, tb512 }

MaxTransportBlocksUL ::= ENUMERATED {
    dummy, tb4, tb8, tb16, tb32, tb48,
    tb64, tb96, tb128, tb256, tb512 }

MaxTS-PerFrame ::= INTEGER (1..14)

MaxTS-PerSubFrame-r4 ::= INTEGER (1..6)

```

```

-- TABULAR: MeasurementCapability contains dependencies to UE-MultiModeRAT-Capability,
-- the conditional fields have been left mandatory for now.
MeasurementCapability ::= SEQUENCE {
    downlinkCompressedMode          CompressedModeMeasCapability,
    uplinkCompressedMode            CompressedModeMeasCapability
}

MeasurementCapabilityExt ::= SEQUENCE{
    compressedModeMeasCapabFDDList    CompressedModeMeasCapabFDDList,
    compressedModeMeasCapabTDDList    CompressedModeMeasCapabTDDList  OPTIONAL,
    compressedModeMeasCapabGSMLList   CompressedModeMeasCapabGSMLList  OPTIONAL,
    compressedModeMeasCapabMC         CompressedModeMeasCapabMC        OPTIONAL
}

MeasurementCapabilityExt2 ::= SEQUENCE{
    compressedModeMeasCapabFDDList2    CompressedModeMeasCapabFDDList2,
    compressedModeMeasCapabTDDList     CompressedModeMeasCapabTDDList  OPTIONAL,
    compressedModeMeasCapabGSMLList    CompressedModeMeasCapabGSMLList  OPTIONAL,
    compressedModeMeasCapabMC          CompressedModeMeasCapabMC        OPTIONAL
}

MeasurementCapabilityExt3 ::= SEQUENCE {
    compressedModeMeasCapabEUTRAList    CompressedModeMeasCapabEUTRAList  OPTIONAL
}

MeasurementCapabilityExt4 ::= SEQUENCE{
    compressedModeMeasCapabFDDList2     CompressedModeMeasCapabFDDList2    OPTIONAL,
    compressedModeMeasCapabFDDList3     CompressedModeMeasCapabFDDList3    OPTIONAL,
    compressedModeMeasCapabTDDList      CompressedModeMeasCapabTDDList     OPTIONAL,
    compressedModeMeasCapabGSMLList     CompressedModeMeasCapabGSMLList    OPTIONAL,
    compressedModeMeasCapabMC           CompressedModeMeasCapabMC          OPTIONAL,
    compressedModeMeasCapabEUTRAList    CompressedModeMeasCapabEUTRAList    OPTIONAL
}

MeasurementCapabilityExt5 ::= SEQUENCE {
    compressedModeMeasCapabEUTRAList2    CompressedModeMeasCapabEUTRAList2  OPTIONAL
}

MeasurementCapabilityExt6 ::= SEQUENCE{
    compressedModeMeasCapabEUTRAList3    CompressedModeMeasCapabEUTRAList3  OPTIONAL
}

MeasurementCapability-r4-ext ::= SEQUENCE {
    downlinkCompressedMode-LCR          CompressedModeMeasCapability-LCR-r4,
    uplinkCompressedMode-LCR            CompressedModeMeasCapability-LCR-r4
}

MeasurementCapability-v860ext ::= SEQUENCE {
    downlinkCompressedMode              CompressedModeMeasCapability-v860ext
}

MeasurementCapability-v920ext ::= SEQUENCE {
    downlinkCompressedMode              CompressedModeMeasCapability-v920ext
}

MeasurementCapability-va40ext ::= SEQUENCE {
    interFrequencyDetectedSetMeasurements  ENUMERATED { true }          OPTIONAL,
    downlinkCompressedMode                  CompressedModeMeasCapability-va40ext
}

MeasurementCapability-vb50ext ::= SEQUENCE {
    interFrequencyMeasOnConfigCarriersWithoutCompMode  ENUMERATED { true }          OPTIONAL,
    cellsExcludedFromDetectedSetMeasurements           ENUMERATED { true }          OPTIONAL
}

MeasurementCapabilityTDD ::= SEQUENCE {
    idleIntervalMeasCapabEUTRAList         IdleIntervalMeasCapabEUTRAList  OPTIONAL
}

MeasurementCapabilityTDD-vb50ext ::= SEQUENCE {
    idleIntervalMeasCapabEUTRAList         IdleIntervalMeasCapabEUTRAExtensionList  OPTIONAL
}

MeasurementCapability-vb70ext ::= SEQUENCE {
    widebandRSRQFDDMeasurements           ENUMERATED { true }          OPTIONAL,
    widebandRSRQTDDMeasurements           ENUMERATED { true }          OPTIONAL
}

```

```

MeasurementCapability-vc50ext ::= SEQUENCE {
    event2gReportingOnaConfiguredSecDLFrequency    ENUMERATED { true }    OPTIONAL,
    extendedRsrqLowerValueRange                   ENUMERATED { true }    OPTIONAL,
    rsrqOnAllSymbols                               ENUMERATED { true }    OPTIONAL,
    increasedUECarrierMonitoringUTRA              ENUMERATED { true }    OPTIONAL,
    increasedUECarrierMonitoringE-UTRA           ENUMERATED { true }    OPTIONAL,
    enhancedUPHReporting                           ENUMERATED { true }    OPTIONAL
}

MessageAuthenticationCode ::=          BIT STRING (SIZE (32))

MinimumSF-DL ::=                        ENUMERATED {
    sf1, sf16 }

MinimumSF-DL-768 ::=                    ENUMERATED {
    sf1, sf32 }

MinimumSF-UL ::=                        ENUMERATED {
    sf1, sf2, sf4, sf8, dummy }

NonContiguousMultiCellCombinationList ::= SEQUENCE (SIZE
(1..maxNonContiguousMultiCellCombinations)) OF
    NonContiguousMultiCell

NonContiguousMultiCell ::= SEQUENCE {
    aggregatedCells          ENUMERATED { nc-2c, nc-3c, nc-4c },
    gapSize                  ENUMERATED { fiveMHz, tenMHz, anyGapSize,
    spare5, spare4, spare3, spare2, spare1 },
    nonContiguousMultiCellCombination22    ENUMERATED { true }    OPTIONAL,
    nonContiguousMultiCellCombination31-13    ENUMERATED { true }    OPTIONAL
}

MultiModeCapability ::=                  ENUMERATED {
    tdd, fdd, fdd-tdd }

MultiRAT-Capability ::=                  SEQUENCE {
    supportOfGSM              BOOLEAN,
    supportOfMulticarrier     BOOLEAN
}

MultiModeRAT-Capability-v590ext ::= SEQUENCE {
    supportOfUTRAN-ToGERAN-NACC    BOOLEAN
}

MultiModeRAT-Capability-v680ext ::= SEQUENCE {
    supportOfHandoverToGAN        ENUMERATED { doesSupportHandoverToGAN }    OPTIONAL
}

MultiModeRAT-Capability-v770ext ::= SEQUENCE {
    supportOfPSHandoverToGAN      ENUMERATED { doesSupportPSHandoverToGAN }    OPTIONAL
}

MultiModeRAT-Capability-v860ext ::= SEQUENCE {
    supportOfEUTRAFDD            ENUMERATED { doesSupportEUTRAFDD }    OPTIONAL,
    supportOfInterRATHOTOEUTRAFDD    ENUMERATED { doesSupportInterRATHOTOEUTRAFDD }    OPTIONAL,
    supportOfEUTRATDD            ENUMERATED { doesSupportEUTRATDD }    OPTIONAL,
    supportOfInterRATHOTOEUTRATDD    ENUMERATED { doesSupportInterRATHOTOEUTRATDD }    OPTIONAL,
    eutraFeatureGroupIndicators     BIT STRING (SIZE (4))    OPTIONAL
}

MultiModeRAT-Capability-vae0ext ::=      SEQUENCE {
    eutraSupportOfMFBI           ENUMERATED { true }    OPTIONAL
}

MultiModeRAT-Capability-vb50ext ::= SEQUENCE {
    supportOfEUTRAFDDMeasurementReportingInCELLFACH    ENUMERATED {
    doesSupportOfEUTRAFDDMeasurementReportingInCELLFACH }    OPTIONAL,
    supportOfEUTRATDDMeasurementReportingInCELLFACH    ENUMERATED {
    doesSupportOfEUTRATDDMeasurementReportingInCELLFACH }    OPTIONAL
}

MultiModeRAT-Capability-vc50ext ::= SEQUENCE {
    supportOfRAN-AssistedWLAN-Interworking-RAN-Rules    ENUMERATED { true }    OPTIONAL,
    supportOfRAN-AssistedWLAN-Interworking-ANDSF-Policies    ENUMERATED { true }    OPTIONAL
}

MultiModeRAT-Capability-vd20ext ::= SEQUENCE {
    supportOfExtendedEUTRAFrequencyPriority    ENUMERATED { true }    OPTIONAL
}

```

```

}

N-300 ::= INTEGER (0..7)
N-301 ::= INTEGER (0..7)
N-302 ::= INTEGER (0..7)
N-304 ::= INTEGER (0..7)
N-308 ::= INTEGER (1..8)
N-310 ::= INTEGER (0..7)
N-312 ::= ENUMERATED {
    s1, s50, s100, s200, s400,
    s600, s800, s1000 }
N-312ext ::= ENUMERATED {
    s2, s4, s10, s20 }
N-312-r5 ::= ENUMERATED {
    s1, s2, s4, s10, s20,
    s50, s100, s200, s400,
    s600, s800, s1000 }
N-313 ::= ENUMERATED {
    s1, s2, s4, s10, s20,
    s50, s100, s200 }
N-315 ::= ENUMERATED {
    s1, s50, s100, s200, s400,
    s600, s800, s1000 }
N-315ext ::= ENUMERATED {
    s2, s4, s10, s20 }
N-315-r5 ::= ENUMERATED {
    s1, s2, s4, s10, s20,
    s50, s100, s200, s400,
    s600, s800, s1000 }

N-AccessFails ::= INTEGER (1..64)
N-AP-RetransMax ::= INTEGER (1..64)

NeighCellSI-AcquisitionCapability ::= SEQUENCE {
    supportOfIntraFreqSIACquisitionForHO    ENUMERATED { true }           OPTIONAL,
    supportOfInterFreqSIACquisitionForHO    ENUMERATED { true }           OPTIONAL,
    supportOfE-UtraSIACquisitionForHO       ENUMERATED { true }           OPTIONAL
}

NetworkAssistedGANSS-Supported-List ::= SEQUENCE (SIZE (1..maxGANSS)) OF SEQUENCE {
    gANSS-Id                                ENUMERATED {
        sbas, modernizedGPS, qzss, glonass, bds,
        spare3, spare2, spare1 }           OPTIONAL,
    gANSS-Mode                              GANSS-Mode,
    gANSS-SignalId                          GANSS-Signal-Id                OPTIONAL,
    supportForUE-GANSS-TimingOfCellFrames   BOOLEAN,
    supportForUE-GANSS-CarrierPhaseMeasurement BOOLEAN                OPTIONAL
}

-- Each element in the NetworkAssistedGANSS-Supported-List-v860ext provides extension information
-- to the corresponding element (position) in the NetworkAssistedGANSS-Supported-List
NetworkAssistedGANSS-Supported-List-v860ext ::= SEQUENCE (SIZE (1..maxGANSS)) OF SEQUENCE {
    sbas-Ids                                BIT STRING (SIZE (8))           OPTIONAL,
    gANSS-SignalIds                        BIT STRING (SIZE (8))           OPTIONAL,
    non-native-AD-choices-supported        ENUMERATED { true }             OPTIONAL
}

NetworkAssistedGPS-Supported ::= ENUMERATED {
    networkBased,
    ue-Based,
    bothNetworkAndUE-Based,
    noNetworkAssistedGPS }

```



```

NF-BO-AllBusy ::= INTEGER (0..31)
NF-BO-NoAICH ::= INTEGER (0..31)
NF-BO-Mismatch ::= INTEGER (0..127)
NS-BO-Busy ::= INTEGER (0..63)
NS-IP ::= INTEGER (0..28)
P-TMSI-and-RAI-GSM-MAP ::= SEQUENCE {
    p-TMSI P-TMSI-GSM-MAP,
    rai RAI
}
PagingCause ::= ENUMERATED {
    terminatingConversationalCall,
    terminatingStreamingCall,
    terminatingInteractiveCall,
    terminatingBackgroundCall,
    terminatingHighPrioritySignalling,
    terminatingLowPrioritySignalling,
    terminatingCauseUnknown,
    spare
}
PagingRecord ::= CHOICE {
    cn-Identity SEQUENCE {
        pagingCause PagingCause,
        cn-DomainIdentity CN-DomainIdentity,
        cn-pagedUE-Identity CN-PagedUE-Identity
    },
    utran-Identity SEQUENCE {
        u-RNTI U-RNTI,
        cn-OriginatedPage-connectedMode-UE SEQUENCE {
            pagingCause PagingCause,
            cn-DomainIdentity CN-DomainIdentity,
            pagingRecordTypeID PagingRecordTypeID
        }
    }
} OPTIONAL
PagingRecord2-r5 ::= CHOICE {
    utran-SingleUE-Identity SEQUENCE {
        u-RNTI U-RNTI,
        cn-OriginatedPage-connectedMode-UE SEQUENCE {
            pagingCause PagingCause,
            cn-DomainIdentity CN-DomainIdentity,
            pagingRecordTypeID PagingRecordTypeID
        }
    } OPTIONAL,
    rrc-ConnectionReleaseInformation RRC-ConnectionReleaseInformation
},
    utran-GroupIdentity SEQUENCE ( SIZE (1..maxURNTI-Group) ) OF
        GroupIdentityWithReleaseInformation
}
PagingRecordList ::= SEQUENCE (SIZE (1..maxPage1)) OF
    PagingRecord
PagingRecord2List-r5 ::= SEQUENCE (SIZE (1..maxPage1)) OF
    PagingRecord2-r5
PDCP-Capability ::= SEQUENCE {
    losslessSRNS-RelocationSupport BOOLEAN,
    -- If present, the "maxHcContextSpace" in the IE "PDCP-Capability-r5-ext" overrides the
    -- "supported" value in this IE. The value in this IE may be used by a pre-REL-5 UTRAN.
    supportForRfc2507 CHOICE {
        notSupported NULL,
        supported MaxHcContextSpace
    }
}
PDCP-Capability-r4-ext ::= SEQUENCE {
    supportForRfc3095 CHOICE {
        notSupported NULL,
        supported SEQUENCE {
            maxROHC-ContextSessions MaxROHC-ContextSessions-r4 DEFAULT s16,
            reverseCompressionDepth INTEGER (0..65535) DEFAULT 0
        }
    }
}

```

```

    }
  }
}

PDCP-Capability-r5-ext ::= SEQUENCE {
    supportForRfc3095ContextRelocation    BOOLEAN,
    maxHcContextSpace                     MaxHcContextSpace-r5-ext    OPTIONAL
}

PDCP-Capability-r5-ext2 ::= SEQUENCE {
    losslessDLRLC-PDUSizeChange          ENUMERATED { true }          OPTIONAL
}

PDCP-Capability-v770ext ::= SEQUENCE {
    supportForCSVoiceoverHSPA            ENUMERATED { true }          OPTIONAL
}

PhysicalChannelCapability ::= SEQUENCE {
    fddPhysChCapability                  SEQUENCE {
        downlinkPhysChCapability          DL-PhysChCapabilityFDD,
        uplinkPhysChCapability            UL-PhysChCapabilityFDD
    }
    -- tddPhysChCapability describes the 3.84Mcps TDD physical channel capability
    tddPhysChCapability                  SEQUENCE {
        downlinkPhysChCapability          DL-PhysChCapabilityTDD,
        uplinkPhysChCapability            UL-PhysChCapabilityTDD
    }
    OPTIONAL
}

PhysicalChannelCapability-v770ext ::= SEQUENCE {
    fddPhysChCapability                  SEQUENCE {
        downlinkPhysChCapability          DL-PhysChCapabilityFDD-v770ext,
        uplinkPhysChCapability            UL-PhysChCapabilityFDD-v770ext
    }
    OPTIONAL,
    tddPhysChCapability-384              SEQUENCE {
        -- No TDD384 DL physical channel capability extension
        uplinkPhysChCapability            UL-PhysChCapabilityTDD-384-v770ext
    }
    OPTIONAL,
    tddPhysChCapability-768              SEQUENCE {
        downlinkPhysChCapability          DL-PhysChCapabilityTDD-768,
        uplinkPhysChCapability            UL-PhysChCapabilityTDD-768
    }
    OPTIONAL,
    tddPhysChCapability-128              SEQUENCE {
        downlinkPhysChCapability          DL-PhysChCapabilityTDD-128-v770ext,
        uplinkPhysChCapability            UL-PhysChCapabilityTDD-128-v770ext
    }
    OPTIONAL
}

PhysicalChannelCapability-v860ext ::= SEQUENCE {
    fddPhysChCapability                  SEQUENCE {
        downlinkPhysChCapability          DL-PhysChCapabilityFDD-v860ext
    }
    OPTIONAL,
    tddPhysChCapability-128              SEQUENCE {
        downlinkPhysChCapability          DL-PhysChCapabilityTDD-128-v860ext
    }
    OPTIONAL
}

PhysicalChannelCapability-v920ext ::= SEQUENCE {
    fddPhysChCapability                  SEQUENCE {
        downlinkPhysChCapability          DL-PhysChCapabilityFDD-v920ext,
        uplinkPhysChCapability            UL-PhysChCapabilityFDD-v920ext
    }
    OPTIONAL
}

PhysicalChannelCapability-va40ext ::= SEQUENCE {
    fddPhysChCapability                  SEQUENCE {
        downlinkPhysChCapability          DL-PhysChCapabilityFDD-va40ext
    }
    OPTIONAL,
    tddPhysChCapability-128              SEQUENCE {
        downlinkPhysChCapability          DL-PhysChCapabilityInfoTDD-128-va40ext,
        uplinkPhysChCapability            UL-PhysChCapabilityInfoTDD-128-va40ext
    }
    OPTIONAL
}

PhysicalChannelCapability-vb50ext ::= SEQUENCE {
    fddPhysChCapability                  SEQUENCE {
        downlinkPhysChCapability          DL-PhysChCapabilityFDD-vb50ext,
        uplinkPhysChCapability            UL-PhysChCapabilityFDD-vb50ext
    }
}

```

```

    }
    OPTIONAL
  }
}

PhysicalChannelCapability-vb80ext ::= SEQUENCE {
  fddPhysChCapability          SEQUENCE {
    downlinkPhysChCapability    DL-PhysChCapabilityFDD-vb80ext
  }
  OPTIONAL
}

PhysicalChannelCapability-vc50ext ::= SEQUENCE {
  fddPhysChCapability          SEQUENCE {
    downlinkPhysChCapability    DL-PhysChCapabilityFDD-vc50ext          OPTIONAL,
    uplinkPhysChCapability      UL-PhysChCapabilityFDD-vc50ext          OPTIONAL
  }
  OPTIONAL,
  tddPhysChCapability          SEQUENCE {
    downlinkPhysChCapability    DL-PhysChCapabilityInfoTDD-128-vc50ext
  }
  OPTIONAL
}

PhysicalChannelCapability-vd20ext ::= SEQUENCE {
  fddPhysChCapability          SEQUENCE {
    downlinkPhysChCapability    DL-PhysChCapabilityFDD-vd20ext  OPTIONAL,
    uplinkPhysChCapability      UL-PhysChCapabilityFDD-vd20ext  OPTIONAL
  }
  OPTIONAL
}

PhysicalChannelCapabilityInfo-v770ext ::= SEQUENCE {
  tddPhysChCapability-768      SEQUENCE {
    downlinkPhysChCapability    DL-PhysChCapabilityInfoTDD-768,
    uplinkPhysChCapability      UL-PhysChCapabilityTDD
  }
  OPTIONAL,
  tddPhysChCapability-128      SEQUENCE {
    uplinkPhysChCapability      UL-PhysChCapabilityInfoTDD-128-v770ext
  }
  OPTIONAL
}

-- PhysicalChannelCapability-LCR-r4 describes the 1.28Mcps TDD physical channel capability
PhysicalChannelCapability-LCR-r4 ::= SEQUENCE {
  tdd128-PhysChCapability      SEQUENCE {
    downlinkPhysChCapability    DL-PhysChCapabilityTDD-LCR-r4,
    uplinkPhysChCapability      UL-PhysChCapabilityTDD-LCR-r4
  }
  OPTIONAL
}

-- PhysicalChannelCapability-hspdsch-r5 describes the HS-PDSCH physical channel capability
PhysicalChannelCapability-hspdsch-r5 ::= SEQUENCE {
  fdd-hspdsch                  CHOICE {
    supported                    SEQUENCE {
      -- hsdSCH-physical-layer-category values shall be restricted to the range [1..12]
      -- even if the UE physical capability category is above 12.
      hsdSCH-physical-layer-category  HSDSCH-physical-layer-category,
      -- dummy and dummy2 are not used in this version of the specification
      -- and if received they should be ignored.
      dummy                          BOOLEAN,
      dummy2                          BOOLEAN
    },
    unsupported                    NULL
  },
  tdd384-hspdsch                CHOICE {
    supported                    HSDSCH-physical-layer-category,
    unsupported                    NULL
  },
  tdd128-hspdsch                CHOICE {
    supported                    HSDSCH-physical-layer-category,
    unsupported                    NULL
  }
}

PNBSCH-Allocation-r4 ::= SEQUENCE {
  numberOfRepetitionsPerSFNPeriod  ENUMERATED {
    c2, c3, c4, c5, c6, c7, c8, c9, c10,
    c12, c14, c16, c18, c20, c24, c28, c32,
    c36, c40, c48, c56, c64, c72, c80 }
}

Pre-RedirectionInfo ::= SEQUENCE {
  supportEUTRA-FDD              BOOLEAN,

```

```

    supportEUTRA-TDD                BOOLEAN
}

ProtocolErrorCause ::=                ENUMERATED {
    asn1-ViolationOrEncodingError,
    messageTypeNonexistent,
    messageNotCompatibleWithReceiverState,
    ie-ValueNotComprehended,
    informationElementMissing,
    messageExtensionNotComprehended,
    spare2, spare1 }

ProtocolErrorIndicator ::=            ENUMERATED {
    noError, errorOccurred }

ProtocolErrorIndicatorWithMoreInfo ::= CHOICE {
    noError                            NULL,
    errorOccurred                       SEQUENCE {
        rrc-TransactionIdentifier      RRC-TransactionIdentifier,
        protocolErrorInformation        ProtocolErrorInformation
    }
}

ProtocolErrorMoreInformation ::=      SEQUENCE {
    diagnosticsType                    CHOICE {
        type1                           CHOICE {
            asn1-ViolationOrEncodingError    NULL,
            messageTypeNonexistent           NULL,
            messageNotCompatibleWithReceiverState
            ie-ValueNotComprehended          IdentificationOfReceivedMessage,
            conditionalInformationElementError IdentificationOfReceivedMessage,
            messageExtensionNotComprehended  IdentificationOfReceivedMessage,
            spare1                           NULL,
            spare2                           NULL
        },
        spare                            NULL
    }
}

RadioFrequencyBandEUTRA ::=          INTEGER (1..64)

RadioFrequencyBandEUTRAExt ::=       INTEGER (65..256)

RadioFrequencyBandEUTRAExt2 ::=      INTEGER (1..256)

RadioFrequencyBandFDD ::=            ENUMERATED {
    -- fdd2100, fdd1900, fdd1800 correspond to Band I, Band II and Band III respectively
    fdd2100,
    fdd1900,
    fdd1800,
    bandVI,
    bandIV,
    bandV,
    bandVII,
    extension-indicator }

RadioFrequencyBandFDD2 ::=           ENUMERATED {
    bandVIII,
    bandIX,
    bandX,
    bandXI,
    bandXII,
    bandXIII,
    bandXIV,
    bandXV,
    bandXVI,
    bandXVII,
    bandXVIII,
    bandXIX,
    bandXX,
    bandXXI,
    bandXXII,
    extension-indicator }

RadioFrequencyBandFDD3 ::=           ENUMERATED {spare64, spare63, bandXXV, bandXXVI, spare60,
    spare59, spare58, spare57, spare56, bandXXXII, spare54, spare53, spare52, spare51, spare50, spare49,

```

spare48, spare47, spare46, spare45, spare44, spare43, spare42, spare41, spare40, spare39, spare38, spare37, spare36, spare35, spare34, spare33, spare32, spare31, spare30, spare29, spare28, spare27, spare26, spare25, spare24, spare23, spare22, spare21, spare20, spare19, spare18, spare17, spare16, spare15, spare14, spare13, spare12, spare11, spare10, spare9, spare8, spare7, spare6, spare5, spare4, spare3, spare2, extension-indicator }

```

RadioFrequencyBandTDDList ::=          ENUMERATED {
                                         a, b, c, ab, ac, bc, abc, spare }

RadioFrequencyBandTDDList-r7 ::=       ENUMERATED {
                                         a, b, c, d, ab, ac, ad, bc, bd, cd, abc, abd, acd, bcd,
                                         abcd, notabcd }

RadioFrequencyBandTDDext ::=           ENUMERATED {
                                         e, f, g, h, i, j, k, l, m, n, o, p, spare4, spare3,
                                         spare2, spare1 }

RadioFrequencyBandTDDextList ::=       SEQUENCE (SIZE (1..maxFreqBandsTDD-ext)) OF
                                         RadioFrequencyBandTDDext

RadioFrequencyBandTDD ::=              ENUMERATED {
                                         a, b, c, d }

RadioFrequencyBandTDD-r10 ::=          ENUMERATED {
                                         a, b, c, d, e, f, spare2, spare1 }

RadioFrequencyBandGSM ::=              ENUMERATED {
                                         gsm450,
                                         gsm480,
                                         gsm850,
                                         gsm900P,
                                         gsm900E,
                                         gsm1800,
                                         gsm1900,
                                         spare9, spare8, spare7, spare6, spare5,
                                         spare4, spare3, spare2, spare1}

Rb-timer-indicator ::=                 SEQUENCE {
                                         t314-expired
                                         BOOLEAN,
                                         t315-expired
                                         BOOLEAN }

Re-EstablishmentTimer ::=              ENUMERATED {
                                         useT314, useT315
}

RedirectionInfo ::=                    CHOICE {
                                         frequencyInfo,
                                         interRATInfo
}

RedirectionInfo-r6 ::=                  CHOICE {
                                         frequencyInfo,
                                         interRATInfo-r6
}

RedirectionInfo-v860ext ::=             CHOICE {
                                         -- CHOICE frequencyInfo is provided in IE RedirectionInfo or IE RedirectionInfo-r6
                                         frequencyInfo
                                         NULL,
                                         interRATInfo
                                         InterRATInfo-v860ext
}

RejectionCause ::=                     ENUMERATED {
                                         congestion,
                                         unspecified }

ReleaseCause ::=                        ENUMERATED {
                                         normalEvent,
                                         unspecified,
                                         pre-emptiveRelease,
                                         congestion,
                                         re-establishmentReject,
                                         directedsignallingconnectionre-establishment,
                                         userInactivity,
                                         spare }

RF-Capability ::=                       SEQUENCE {
                                         fddRF-Capability
                                         SEQUENCE {
                                         ue-PowerClass
                                         UE-PowerClass,

```

```

        txRxFrequencySeparation      TxRxFrequencySeparation
    }                                OPTIONAL,
    tddRF-Capability                  SEQUENCE {
        ue-PowerClass                 UE-PowerClass,
        radioFrequencyTDDBandList    RadioFrequencyBandTDDList,
        chipRateCapability            ChipRateCapability
    }                                OPTIONAL
}

RF-Capability-r4-ext ::=            SEQUENCE {
    tddRF-Capability                  SEQUENCE {
        ue-PowerClass                 UE-PowerClass,
        radioFrequencyBandTDDList    RadioFrequencyBandTDDList,
        chipRateCapability            ChipRateCapability
    }                                OPTIONAL
}

RF-Capability-v770ext ::=          SEQUENCE {
    -- If TDD384 and/or TDD128 RF capability is indicated in IEs 'RF-Capability' or
    -- 'RF-Capability-r4-ext', the corresponding IE 'RadioFrequencyBandTDDList-r7' shall
    -- be included in this IE.
    tdd384RF-Capability               RadioFrequencyBandTDDList-r7          OPTIONAL,
    tdd768RF-Capability               SEQUENCE {
        ue-PowerClass                 UE-PowerClass,
        radioFrequencyBandTDDList    RadioFrequencyBandTDDList-r7
    }                                OPTIONAL,
    -- The element 'chipRateCapability' = 'mcps7-68'
    tdd128RF-Capability               RadioFrequencyBandTDDList-r7          OPTIONAL
}

RF-Capability-v860ext ::=          SEQUENCE {
    tdd128RF-Capability               RadioFrequencyBandTDDList-r7          OPTIONAL,
    tdd384RF-Capability               RadioFrequencyBandTDDList-r7          OPTIONAL,
    tdd768RF-Capability               RadioFrequencyBandTDDList-r7          OPTIONAL
}

RF-Capability-vaa0ext ::=          SEQUENCE {
    supportOfMFBI                     ENUMERATED { true }                OPTIONAL
}

RLC-Capability ::=                 SEQUENCE {
    -- If present, the "totalRLC-AM-BufferSize" in the IE "RLC-Capability-r5-ext" overrides the
    -- corresponding value in this IE. The value in this IE may be used by a pre-REL-5 UTRAN.
    totalRLC-AM-BufferSize            TotalRLC-AM-BufferSize,
    maximumRLC-WindowSize              MaximumRLC-WindowSize,
    maximumAM-EntityNumber             MaximumAM-EntityNumberRLC-Cap
}

RLC-Capability-r5-ext ::=          SEQUENCE {
    totalRLC-AM-BufferSize            TotalRLC-AM-BufferSize-r5-ext          OPTIONAL
}

RLC-Capability-v770ext ::=          SEQUENCE {
    supportOfTwoLogicalChannel         BOOLEAN
}

RLC-Capability-v920ext ::=          SEQUENCE {
    totalRLC-AM-BufferSize            TotalRLC-AM-BufferSize-v920ext          OPTIONAL
}

RLC-Capability-va40ext ::=          SEQUENCE {
    totalRLC-AM-BufferSize            TotalRLC-AM-BufferSize-va40ext          OPTIONAL
}

RLC-Capability-vb50ext ::=          SEQUENCE {
    totalRLC-AM-BufferSize            TotalRLC-AM-BufferSize-vb50ext          OPTIONAL
}

RRC-ConnectionReleaseInformation ::= CHOICE {
    noRelease                          NULL,
    release                             SEQUENCE {
        releaseCause                  ReleaseCause
    }
}

RRC-MessageSequenceNumber ::=      INTEGER (0..15)

```

```

RRC-MessageSequenceNumberList ::= SEQUENCE (SIZE (4..5)) OF
    RRC-MessageSequenceNumber

RRC-StateIndicator ::= ENUMERATED {
    cell-DCH, cell-FACH, cell-PCH, ura-PCH }

RRC-TransactionIdentifier ::= INTEGER (0..3)

RSR-VCC-Info ::= SEQUENCE {
    nonce BIT STRING (SIZE (128)) OPTIONAL,
    ims-Information OCTET STRING (SIZE (1.. 32))
}

S-RNTI ::= BIT STRING (SIZE (20))

S-RNTI-2 ::= BIT STRING (SIZE (10))

SecurityCapability ::= SEQUENCE {
    cipheringAlgorithmCap BIT STRING {
        -- For each bit value "0" means false/ not supported
        spare15(0),
        spare14(1),
        spare13(2),
        spare12(3),
        spare11(4),
        spare10(5),
        spare9(6),
        spare8(7),
        spare7(8),
        spare6(9),
        spare5(10),
        spare4(11),
        spare3(12),
        uea2(13),
        uea1(14),
        uea0(15)
    } (SIZE (16)),
    integrityProtectionAlgorithmCap BIT STRING {
        -- For each bit value "0" means false/ not supported
        spare15(0),
        spare14(1),
        spare13(2),
        spare12(3),
        spare11(4),
        spare10(5),
        spare9(6),
        spare8(7),
        spare7(8),
        spare6(9),
        spare5(10),
        spare4(11),
        spare3(12),
        uia2(13),
        uia1(14),
        spare0(15)
    } (SIZE (16))
}

SecondaryServingEDCHCell-Info ::= SEQUENCE {
    primary-E-RNTI E-RNTI OPTIONAL,
    secondary-E-RNTI E-RNTI OPTIONAL
}

SecondaryEDCH-Info-Common ::= SEQUENCE {
    frequencyInfo FrequencyInfo,
    scramblingCodeType ScramblingCodeType,
    scramblingCodeNumber UL-ScramblingCode,
    ms2-SchedTransmGrantHARQAlloc BIT STRING (SIZE (8)) OPTIONAL,
    servingGrant SEQUENCE {
        primary-Secondary-GrantSelector ENUMERATED { primary, secondary }
    } OPTIONAL,
    minReduced-E-DPDCH-GainFactor MinReduced-E-DPDCH-GainFactor OPTIONAL,
    e-DCH-minimumSet-E-TFCI E-DCH-MinimumSet-E-TFCI OPTIONAL,
    dpccchPowerOffset-SecondaryULFrequency INTEGER(0..7),
    pc-Preamble PC-Preamble
}

SecondaryEDCH-Info-Common-r12 ::= SEQUENCE {

```

```

frequencyInfo                FrequencyInfo,
scramblingCodeType           ScramblingCodeType,
scramblingCodeNumber         UL-ScramblingCode,
ms2-SchedTransmGranthARQAlloc BIT STRING (SIZE (8))           OPTIONAL,
servicingGrant                SEQUENCE {
  primary-Secondary-GrantSelector  ENUMERATED { primary, secondary }
}
minReduced-E-DPDCH-GainFactor MinReduced-E-DPDCH-GainFactor  OPTIONAL,
e-DCH-minimumSet-E-TFCI      E-DCH-MinimumSet-E-TFCI          OPTIONAL,
minimumTEBS-threshold        MinimumTEBS-threshold            OPTIONAL,
implicitGrantHandling         ENUMERATED { true }              OPTIONAL,
dpcchPowerOffset-SecondaryULFrequency INTEGER(0..7),
pc-Preamble                   PC-Preamble,
ue-DPCCHPowerResetAfterDTXOnSecUplink UE-DPCCHPowerResetAfterDTXOnSecUplink  OPTIONAL
}

Servicing-HSDSCH-CellInformation ::= SEQUENCE {
  deltaACK                    DeltaACK                OPTIONAL,
  deltaNACK                    DeltaNACK                OPTIONAL,
  harq-Preamble-Mode          HARQ-Preamble-Mode,
  primaryCPICH-Info           PrimaryCPICH-Info        OPTIONAL,
  dl-hspdsch-Information      DL-HSPDSCH-Information  OPTIONAL,
  harqInfo                     HARQ-Info              OPTIONAL,
  mac-hsResetIndicator        ENUMERATED { true }     OPTIONAL
}

Servicing-HSDSCH-CellInformation-r7 ::= SEQUENCE {
  deltaACK                    DeltaACK                OPTIONAL,
  deltaNACK                    DeltaNACK                OPTIONAL,
  harq-Preamble-Mode          HARQ-Preamble-Mode,
  primaryCPICH-Info           PrimaryCPICH-Info        OPTIONAL,
  dl-hspdsch-Information-r7   DL-HSPDSCH-Information-r7  OPTIONAL,
  harqInfo-r7                 HARQ-Info-r7            OPTIONAL,
  mac-hsResetIndicator        ENUMERATED { true }     OPTIONAL
}

Servicing-HSDSCH-CellInformation-r8 ::= SEQUENCE {
  deltaACK                    DeltaACK                OPTIONAL,
  deltaNACK                    DeltaNACK                OPTIONAL,
  harq-Preamble-Mode          HARQ-Preamble-Mode,
  primaryCPICH-Info           PrimaryCPICH-Info        OPTIONAL,
  dl-hspdsch-Information-r8   DL-HSPDSCH-Information-r8  OPTIONAL,
  harqInfo-r7                 HARQ-Info-r7            OPTIONAL,
  mac-hsResetIndicator        ENUMERATED { true }     OPTIONAL
}

Servicing-HSDSCH-CellInformation-r9 ::= SEQUENCE {
  deltaACK                    DeltaACK                OPTIONAL,
  deltaNACK                    DeltaNACK                OPTIONAL,
  harq-Preamble-Mode          HARQ-Preamble-Mode,
  primaryCPICH-Info           PrimaryCPICH-Info        OPTIONAL,
  dl-hspdsch-Information-r9   DL-HSPDSCH-Information-r9  OPTIONAL,
  harqInfo-r7                 HARQ-Info-r7            OPTIONAL,
  mac-hsResetIndicator        ENUMERATED { true }     OPTIONAL
}

Servicing-HSDSCH-CellInformation-r11 ::= SEQUENCE {
  deltaACK                    DeltaACK-r11            OPTIONAL,
  deltaNACK                    DeltaNACK-r11            OPTIONAL,
  harq-Preamble-Mode          HARQ-Preamble-Mode,
  primaryCPICH-Info           PrimaryCPICH-Info        OPTIONAL,
  dl-hspdsch-Information-r11  DL-HSPDSCH-Information-r11  OPTIONAL,
  harqInfo-r11                HARQ-Info-r11            OPTIONAL,
  mac-hsResetIndicator        ENUMERATED { true }     OPTIONAL,
  mac-hsResetIndicator-assisting ENUMERATED { true }     OPTIONAL
}

Servicing-HSDSCH-CellInformation-r12 ::= SEQUENCE {
  deltaACK                    DeltaACK-r11            OPTIONAL,
  deltaNACK                    DeltaNACK-r11            OPTIONAL,
  harq-Preamble-Mode          HARQ-Preamble-Mode,
  primaryCPICH-Info           PrimaryCPICH-Info        OPTIONAL,
  dl-hspdsch-Information-r12  DL-HSPDSCH-Information-r12  OPTIONAL,
  harqInfo-r11                HARQ-Info-r11            OPTIONAL,
  mac-hsResetIndicator        ENUMERATED { true }     OPTIONAL,
  mac-hsResetIndicator-assisting ENUMERATED { true }     OPTIONAL
}

```



```

SimultaneousSCCPCH-DPCH-Reception ::= CHOICE {
    notSupported          NULL,
    supported             SEQUENCE {
        maxNoSCCPCH-RL   MaxNoSCCPCH-RL,
        -- simultaneousSCCPCH-DPCH-DPDCH-Reception is applicable only if
        -- the IE Support of PDSCH = TRUE
        -- Note: the reference to DPDCH in the element name below is incorrect (see tabular). The
        -- name is not changed, to keep it aligned with R99.
        simultaneousSCCPCH-DPCH-DPDCH-Reception    BOOLEAN
    }
}

SRNC-Identity ::=          BIT STRING (SIZE (12))

SR-VCC-Info ::=          SEQUENCE {
    nonce                  BIT STRING (SIZE (128))          OPTIONAL
}

SR-VCC-SecurityRABInfo-v860ext ::= SEQUENCE {
    sr-vcc-Info            SR-VCC-Info,
    rab-InfoReplace       RAB-InfoReplace
}

START-Value ::=          BIT STRING (SIZE (20))

STARTList ::=            SEQUENCE (SIZE (1..maxCNdomains)) OF
                          STARTSingle

STARTSingle ::=          SEQUENCE {
    cn-DomainIdentity     CN-DomainIdentity,
    start-Value           START-Value
}

SystemSpecificCapUpdateReq ::= ENUMERATED {
    gsm }

SystemSpecificCapUpdateReq-v590ext ::= ENUMERATED {
    geranIu }

SystemSpecificCapUpdateReq-r5 ::= ENUMERATED {
    gsm, geranIu }

SystemSpecificCapUpdateReq-r8 ::= ENUMERATED {
    gsm, geranIu, eutra, spare5,
    spare4, spare3, spare2, spare1 }

SystemSpecificCapUpdateReqList ::= SEQUENCE (SIZE (1..maxSystemCapability)) OF
    SystemSpecificCapUpdateReq

SystemSpecificCapUpdateReqList-r5 ::= SEQUENCE (SIZE (1..maxSystemCapability)) OF
    SystemSpecificCapUpdateReq-r5

SystemSpecificCapUpdateReqList-r8 ::= SEQUENCE (SIZE (1..maxSystemCapability)) OF
    SystemSpecificCapUpdateReq-r8

T-300 ::=                ENUMERATED {
    ms100, ms200, ms400, ms600, ms800,
    ms1000, ms1200, ms1400, ms1600,
    ms1800, ms2000, ms3000, ms4000,
    ms6000, ms8000 }

T-301 ::=                ENUMERATED {
    ms100, ms200, ms400, ms600, ms800,
    ms1000, ms1200, ms1400, ms1600,
    ms1800, ms2000, ms3000, ms4000,
    ms6000, ms8000, spare }

T-302 ::=                ENUMERATED {
    ms100, ms200, ms400, ms600, ms800,
    ms1000, ms1200, ms1400, ms1600,
    ms1800, ms2000, ms3000, ms4000,
    ms6000, ms8000, spare }

T-304 ::=                ENUMERATED {
    ms100, ms200, ms400,
    ms1000, ms2000, spare3, spare2, spare1 }

T-305 ::=                ENUMERATED {

```

```

        noUpdate, m5, m10, m30,
        m60, m120, m360, m720 }

T-307 ::=
    ENUMERATED {
        s5, s10, s15, s20,
        s30, s40, s50, spare }

T-308 ::=
    ENUMERATED {
        ms40, ms80, ms160, ms320 }

T-309 ::=
    INTEGER (1..8)

T-310 ::=
    ENUMERATED {
        ms40, ms80, ms120, ms160,
        ms200, ms240, ms280, ms320 }

T-311 ::=
    ENUMERATED {
        ms250, ms500, ms750, ms1000,
        ms1250, ms1500, ms1750, ms2000 }

-- The value 0 for T-312 is not used in this version of the specification
T-312 ::=
    INTEGER (0..15)

T-313 ::=
    INTEGER (0..15)

T-314 ::=
    ENUMERATED {
        s0, s2, s4, s6, s8,
        s12, s16, s20 }

T-315 ::=
    ENUMERATED {
        s0, s10, s30, s60, s180,
        s600, s1200, s1800 }

T-316 ::=
    ENUMERATED {
        s0, s10, s20, s30, s40,
        s50, s-inf, spare }

-- All the values are changed to "infinity" in Rel-5
T-317 ::=
    ENUMERATED {
        infinity0, infinity1, infinity2, infinity3, infinity4,
        infinity5, infinity6, infinity7}

T-318 ::=
    ENUMERATED {
        ms250, ms500, ms750, ms1000, ms1250, ms1500,
        ms1750, ms2000, ms3000, ms4000, ms6000, ms8000,
        ms10000, ms12000, ms16000 }

T-319 ::=
    ENUMERATED {
        ms80, ms160, ms320, ms640, ms1280, ms2560, ms5120 }

T-321 ::=
    ENUMERATED {
        ms100, ms200, ms400, ms800 }

T-322 ::=
    ENUMERATED { m5, m10, m20, m30, m60,
        m120, m180, spare1 }

T-323 ::=
    ENUMERATED { s0, s5, s10, s20, s30, s60, s90, s120 }

T-328 ::=
    ENUMERATED { ms20, ms40, ms60, ms80 }

T-329 ::=
    ENUMERATED { s05p, s1, s2, s4 }
T-330 ::=
    ENUMERATED { m5, m10, m20, m30,
        m60, m120, m180, spare1 }

T-CPCH ::=
    ENUMERATED {
        ct0, ct1 }

TMSI-and-LAI-GSM-MAP ::=
    SEQUENCE {
        tmsi
        lai
    }

TMSI-DS-41 ::=
    OCTET STRING (SIZE (2..17))

TotalRLC-AM-BufferSize ::=
    ENUMERATED {
        dummy, kb10, kb50, kb100,
        kb150, kb500, kb1000, spare }

```

```

TotalRLC-AM-BufferSize-r5-ext ::= ENUMERATED {
    kb200, kb300, kb400, kb750 }

TotalRLC-AM-BufferSize-v920ext ::= ENUMERATED {
    kb1150, kb1250 }

TotalRLC-AM-BufferSize-va40ext ::= ENUMERATED {
    kb1500, kb1800, kb2300, kb2550 }

TotalRLC-AM-BufferSize-vb50ext ::= ENUMERATED {
    kb3400, kb3500, kb4400, kb4500, kb5000, spare3, spare2,
    spare1 }

-- Actual value TransmissionProbability = IE value * 0.125
TransmissionProbability ::= INTEGER (1..8)

TransportChannelCapability ::= SEQUENCE {
    dl-TransChCapability    DL-TransChCapability,
    ul-TransChCapability    UL-TransChCapability
}

TurboSupport ::= CHOICE {
    notSupported           NULL,
    supported              MaxNoBits
}

-- Values defined as spare shall not be sent in this version of the protocol. If a spare value is
-- received, it should be interpreted as 'default-RxTX-separation'.
TxRxFrequencySeparation ::= ENUMERATED {
    default-TxRx-separation, spare2, spare1 }

U-RNTI ::= SEQUENCE {
    srnc-Identity          SRNC-Identity,
    s-RNTI                 S-RNTI
}

U-RNTI-Group ::= CHOICE {
-- TABULAR: not following the tabular strictly, but this will most likely save bits
    all                    NULL,
    u-RNTI-BitMaskIndex-b1 BIT STRING (SIZE (31)),
    u-RNTI-BitMaskIndex-b2 BIT STRING (SIZE (30)),
    u-RNTI-BitMaskIndex-b3 BIT STRING (SIZE (29)),
    u-RNTI-BitMaskIndex-b4 BIT STRING (SIZE (28)),
    u-RNTI-BitMaskIndex-b5 BIT STRING (SIZE (27)),
    u-RNTI-BitMaskIndex-b6 BIT STRING (SIZE (26)),
    u-RNTI-BitMaskIndex-b7 BIT STRING (SIZE (25)),
    u-RNTI-BitMaskIndex-b8 BIT STRING (SIZE (24)),
    u-RNTI-BitMaskIndex-b9 BIT STRING (SIZE (23)),
    u-RNTI-BitMaskIndex-b10 BIT STRING (SIZE (22)),
    u-RNTI-BitMaskIndex-b11 BIT STRING (SIZE (21)),
    u-RNTI-BitMaskIndex-b12 BIT STRING (SIZE (20)),
    u-RNTI-BitMaskIndex-b13 BIT STRING (SIZE (19)),
    u-RNTI-BitMaskIndex-b14 BIT STRING (SIZE (18)),
    u-RNTI-BitMaskIndex-b15 BIT STRING (SIZE (17)),
    u-RNTI-BitMaskIndex-b16 BIT STRING (SIZE (16)),
    u-RNTI-BitMaskIndex-b17 BIT STRING (SIZE (15)),
    u-RNTI-BitMaskIndex-b18 BIT STRING (SIZE (14)),
    u-RNTI-BitMaskIndex-b19 BIT STRING (SIZE (13)),
    u-RNTI-BitMaskIndex-b20 BIT STRING (SIZE (12)),
    u-RNTI-BitMaskIndex-b21 BIT STRING (SIZE (11)),
    u-RNTI-BitMaskIndex-b22 BIT STRING (SIZE (10)),
    u-RNTI-BitMaskIndex-b23 BIT STRING (SIZE (9)),
    u-RNTI-BitMaskIndex-b24 BIT STRING (SIZE (8)),
    u-RNTI-BitMaskIndex-b25 BIT STRING (SIZE (7)),
    u-RNTI-BitMaskIndex-b26 BIT STRING (SIZE (6)),
    u-RNTI-BitMaskIndex-b27 BIT STRING (SIZE (5)),
    u-RNTI-BitMaskIndex-b28 BIT STRING (SIZE (4)),
    u-RNTI-BitMaskIndex-b29 BIT STRING (SIZE (3)),
    u-RNTI-BitMaskIndex-b30 BIT STRING (SIZE (2)),
    u-RNTI-BitMaskIndex-b31 BIT STRING (SIZE (1))
}

U-RNTI-Short ::= SEQUENCE {
    srnc-Identity          SRNC-Identity,
    s-RNTI-2              S-RNTI-2
}

UE-AddPos-Supported-List ::= SEQUENCE (SIZE (1..maxAddPos)) OF UE-AddPos-element

```

```
UE-AddPos-element ::= SEQUENCE {
    addPos-ID                        ENUMERATED {barometricPressure, wlan, bt, mbs,
                                                spare4, spare3, spare2, spare1 },
    addPos-Mode                      ENUMERATED {standalone, ue-assisted,
                                                both, spare1 }
}

UE-BasedNetworkPerformanceMeasurementsParameters ::= SEQUENCE {
    supportOfLoggedMeasurementsIdlePCH ENUMERATED { true } OPTIONAL
}

UE-CapabilityContainer-IEs ::= SEQUENCE {
-- Container for transparent transfer of capability information not related to
-- features for which early implementation is desired
    ue-RadioAccessCapability-v690ext    UE-RadioAccessCapability-v690ext,
    ue-RATSpecificCapability-v690ext    InterRAT-UE-RadioAccessCapability-v690ext  OPTIONAL,
    v6b0NonCriticalExtensions           SEQUENCE {
        ue-RadioAccessCapability-v6b0ext    UE-RadioAccessCapability-v6b0ext-IEs,
        v6e0NonCriticalExtensions          SEQUENCE {
            ue-RadioAccessCapability-v6e0ext    UE-RadioAccessCapability-v6e0ext-IEs,
            v770NonCriticalExtensions          SEQUENCE {
                ue-RadioAccessCapability-v770ext    UE-RadioAccessCapability-v770ext-IEs,
                v790NonCriticalExtensions          SEQUENCE {
                    ue-RadioAccessCapability-v790ext    UE-RadioAccessCapability-v790ext-IEs,
                    v860NonCriticalExtensions          SEQUENCE {
                        ue-RadioAccessCapability-v860ext    UE-RadioAccessCapability-v860ext-IEs,
                        ue-RATSpecificCapability-v860ext    InterRAT-UE-RadioAccessCapability-v860ext  OPTIONAL,
                        v880NonCriticalExtensions          SEQUENCE {
                            ue-RadioAccessCapability-v880ext    UE-RadioAccessCapability-v880ext-IEs,
                            v890NonCriticalExtensions          SEQUENCE {
                                ue-RadioAccessCapability-v890ext    UE-RadioAccessCapability-v890ext-IEs,
                                v920NonCriticalExtensions          SEQUENCE {
                                    ue-RadioAccessCapability-v920ext    UE-RadioAccessCapability-v920ext-IEs,
                                    v970NonCriticalExtensions          SEQUENCE {
                                        ue-RadioAccessCapability-v970ext    UE-RadioAccessCapability-v970ext-IEs,
                                        va40NonCriticalExtensions          SEQUENCE {
                                            ue-RadioAccessCapability-va40ext    UE-RadioAccessCapability-va40ext-IEs,
                                            va60NonCriticalExtensions          SEQUENCE {
                                                ue-RadioAccessCapability-va60ext    UE-RadioAccessCapability-va60ext-IEs,
                                                va80NonCriticalExtensions          SEQUENCE {
                                                    ue-RadioAccessCapability-va80ext    UE-RadioAccessCapability-va80ext-IEs,
                                                    laterNonCriticalExtensions
                                                    UE-RadioAccessCapability-
LaterNonCriticalExtensions          OPTIONAL
                                                }
                                            }
                                        }
                                    }
                                }
                            }
                        }
                    }
                }
            }
        }
    }
}

UE-RadioAccessCapability-v6b0ext-IEs ::= SEQUENCE {
-- User equipment IEs
    supportForSIB11bis                ENUMERATED { true } OPTIONAL
}

UE-RadioAccessCapability-v6e0ext-IEs ::= SEQUENCE {
-- User equipment IEs
    supportForFDPCH                    ENUMERATED { true } OPTIONAL
}
```

```

}

UE-RadioAccessCapability-v770ext-IEs ::= SEQUENCE {
  -- User equipment IEs
  pdcp-Capability          PDCP-Capability-v770ext          OPTIONAL,
  rlc-Capability           RLC-Capability-v770ext,          OPTIONAL,
  rf-Capability            RF-Capability-v770ext            OPTIONAL,
  physicalChannelCapability PhysicalChannelCapability-v770ext,
  multiModeRAT-Capability MultiModeRAT-Capability-v770ext,
  ue-PositioningCapability UE-PositioningCapability-v770ext,
  mac-ehsSupport           ENUMERATED { true }              OPTIONAL,
  ue-specificCapabilityInformation UE-SpecificCapabilityInformation-LCRTDD OPTIONAL
}

UE-RadioAccessCapability-v790ext-IEs ::= SEQUENCE {
  -- User equipment IEs
  supportForEDPCCHPowerBoosting    ENUMERATED { true }    OPTIONAL
}

UE-RadioAccessCapability-v860ext-IEs ::= SEQUENCE {
  -- UE radio access capability
  rf-Capability          RF-Capability-v860ext          OPTIONAL,
  physicalChannelCapability PhysicalChannelCapability-v860ext,
  multiModeRAT-Capability MultiModeRAT-Capability-v860ext,
  ue-PositioningCapability UE-PositioningCapability-v860ext,
  measurementCapability MeasurementCapability-v860ext    OPTIONAL,
  measurementCapabilityTDD MeasurementCapabilityTDD    OPTIONAL,
  supportOfCommonEDCH    ENUMERATED { true }            OPTIONAL,
  supportOfMACiis        ENUMERATED { true }            OPTIONAL,
  supportOfSPSOperation  ENUMERATED { true }            OPTIONAL,
  supportOfControlChannelDRXOperation ENUMERATED { true }    OPTIONAL,
  supportOfCSG           ENUMERATED { true }            OPTIONAL,
  -- UE radio access capability extension
  ue-RadioAccessCapabBandFDDList3 UE-RadioAccessCapabBandFDDList3 OPTIONAL
}

UE-RadioAccessCapability-v880ext-IEs ::= SEQUENCE {
  -- UE radio access capability
  supportForPriorityReselectionInUTRAN    ENUMERATED { true }    OPTIONAL
}

UE-RadioAccessCapability-v890ext-IEs ::= SEQUENCE {
  -- UE radio access capability
  supportCellSpecificTxDiversityinDC-Operation    ENUMERATED { true }    OPTIONAL
}

UE-RadioAccessCapability-v920ext-IEs ::= SEQUENCE {
  -- UE physical channel capability,
  ue-RadioAccessCapabBandCombList    UE-RadioAccessCapabBandCombList    OPTIONAL,
  physicalChannelCapability           PhysicalChannelCapability-v920ext,
  rlc-Capability                      RLC-Capability-v920ext,
  supportOfenhancedTS0               ENUMERATED { true }            OPTIONAL,
  measurementCapability               MeasurementCapability-v920ext    OPTIONAL,
  -- UE radio access capability
  csgProximityIndicationCapability    CSG-ProximityIndicationCapability    OPTIONAL,
  neighCellSI-AcquisitionCapability   NeighCellSI-AcquisitionCapability   OPTIONAL
}

UE-RadioAccessCapability-v970ext-IEs ::= SEQUENCE {
  -- UE physical channel capability
  ue-ExtendedMeasurementSupport    ENUMERATED { true }    OPTIONAL
}

UE-RadioAccessCapability-v9c0ext-IEs ::= SEQUENCE {
  -- UE voice over IMS related capability
  voiceOverUTRA-PS-HS-Support    ENUMERATED { true }    OPTIONAL,
  srvcc-SupportFromUTRA-to-UTRA  ENUMERATED { true }    OPTIONAL,
  srvcc-SupportFromUTRA-to-GERAN  ENUMERATED { true }    OPTIONAL,
  -- UE radio access capability
  ue-supportMac-ehsWindowSizeExtension    ENUMERATED { true }    OPTIONAL
}

UE-RadioAccessCapability-LaterNonCriticalExtensions ::= SEQUENCE {
  v9c0NonCriticalExtensions    SEQUENCE {
    ue-RadioAccessCapability-v9c0ext    UE-RadioAccessCapability-v9c0ext-IEs,
    vaa0NonCriticalExtensions    SEQUENCE {
      ue-RadioAccessCapability-vaa0ext    UE-RadioAccessCapability-vaa0ext-IEs,
      vb50NonCriticalExtensions    SEQUENCE {

```

```

        ue-RadioAccessCapability-vb50ext          UE-RadioAccessCapability-vb50ext-IEs,
        vb70NonCriticalExtensions          SEQUENCE {
            ue-RadioAccessCapability-vb70ext          UE-RadioAccessCapability-vb70ext-IEs,
            vae0NonCriticalExtensions          SEQUENCE {
                ue-RadioAccessCapability-vae0ext          UE-RadioAccessCapability-vae0ext-IEs,
                vb80NonCriticalExtensions          SEQUENCE {
                    ue-RadioAccessCapability-vb80ext          UE-RadioAccessCapability-vb80ext-
IEs,
                    vc50NonCriticalExtensions          SEQUENCE {
                        ue-RadioAccessCapability-vc50ext
                        UE-RadioAccessCapability-vc50ext-IEs,
                        vd20NonCriticalExtensions          SEQUENCE {
                            ue-RadioAccessCapability-vd20ext
                            UE-RadioAccessCapability-vd20ext-IEs,
                            nonCriticalExtensions          SEQUENCE {} OPTIONAL
                        } OPTIONAL
                    } OPTIONAL
                } OPTIONAL
            } OPTIONAL
        } OPTIONAL
    } OPTIONAL
}

UE-RadioAccessCapability-va40ext-IEs ::= SEQUENCE {
    -- UE physical channel capability
    ue-RadioAccessCapabBandCombList-va40ext          UE-RadioAccessCapabBandCombList-va40ext          OPTIONAL,
    physicalChannelCapability          PhysicalChannelCapability-va40ext,
    rlc-Capability          RLC-Capability-va40ext,
    measurementCapability          MeasurementCapability-va40ext          OPTIONAL,
    supportOfMUMIMO          ENUMERATED { uplink, uplink-and-downlink } OPTIONAL,
    supportForDualCellMimoInDifferentBands          ENUMERATED { true } OPTIONAL,
    ue-BasedNetworkPerformanceMeasurementsParameters          UE-BasedNetworkPerformanceMeasurementsParameters          OPTIONAL,
    supportOfUTRANANR          ENUMERATED { true } OPTIONAL,
    -- UE radio access capability extension
    ue-RadioAccessCapabBandFDDList4          UE-RadioAccessCapabBandFDDList4          OPTIONAL
}

UE-RadioAccessCapability-va60ext-IEs ::= SEQUENCE {
    ue-RadioAccessCapabBandFDDList4          UE-RadioAccessCapabBandFDDList4-va60ext          OPTIONAL
}

UE-RadioAccessCapability-va80ext-IEs ::= SEQUENCE {
    ue-RadioAccessCapabBandFDDList4          UE-RadioAccessCapabBandFDDList4-va80ext          OPTIONAL
}

UE-RadioAccessCapability-vaa0ext-IEs ::= SEQUENCE {
    supportOfUMRLCRe-establish-via-reconfig          ENUMERATED { true } OPTIONAL,
    rf-capability          RF-Capability-vaa0ext          OPTIONAL
}

UE-RadioAccessCapability-vae0ext-IEs ::= SEQUENCE {
    -- UE radio access capability
    multiModeRAT-Capability          MultiModeRAT-Capability-vae0ext          OPTIONAL
}

UE-RadioAccessCapability-vb50ext-IEs ::= SEQUENCE {
    multiModeRAT-Capability          MultiModeRAT-Capability-vb50ext,
    supportOfCommonERGCHBasedInterferenceControl          ENUMERATED { true } OPTIONAL,
    supportOfFallbackToR99PRACH          ENUMERATED { true } OPTIONAL,
    supportOfConcurrentDeployment          ENUMERATED { true } OPTIONAL,
    supportOfTTIalignmentAndPerHARQProcess          ENUMERATED { true } OPTIONAL,
    -- UE physical channel capability
    ue-RadioAccessCapabBandCombList-vb50ext          UE-RadioAccessCapabBandCombList-vb50ext          OPTIONAL,
    multiflowCapabBandCombList          MultiflowCapabBandCombList          OPTIONAL,
    physicalChannelCapability          PhysicalChannelCapability-vb50ext,
    rlc-Capability          RLC-Capability-vb50ext,
    multiflowCapability          MultiflowCapability          OPTIONAL,
    -- UE radio access capability extension
    ue-RadioAccessCapabBandFDDList6          UE-RadioAccessCapabBandFDDList6          OPTIONAL,
    -- Measurement capability
    measurementCapability          MeasurementCapability-vb50ext          OPTIONAL,
    measurementCapabilityTDD          MeasurementCapabilityTDD-vb50ext          OPTIONAL,
    -- UE voice over IMS related capability
    rsrvcc-SupportFromUTRA-CS-to-EUTRA-FDD          ENUMERATED { true } OPTIONAL,

```

```

    rsvcc-SupportFromUTRA-CS-to-EUTRA-TDD    ENUMERATED { true }          OPTIONAL,
    supportOfHSDPCCHPowerOffsetExtension      ENUMERATED { true }          OPTIONAL,
    supportOfSTTDOnDLControlChannelsWhenMultiflowOperationIsActive  ENUMERATED { true }
  }
}

UE-RadioAccessCapability-vb70ext-IEs ::= SEQUENCE {
    measurementCapability                      MeasurementCapability-vb70ext    OPTIONAL,
    ue-RadioAccessCapabBandFDDList7          UE-RadioAccessCapabBandFDDList7  OPTIONAL
}

UE-RadioAccessCapability-vb80ext-IEs ::= SEQUENCE {
    -- UE physical channel capability
    physicalChannelCapability                  PhysicalChannelCapability-vb80ext
}

UE-RadioAccessCapability-vc50ext-IEs ::= SEQUENCE {
    --the capability is for FDD only
    measurementCapability                      MeasurementCapability-vc50ext    OPTIONAL,
    supportOfDsacAndPpacInCellDch            ENUMERATED { true }            OPTIONAL,
    supportOfMultiflowWithFTPICHFromAssisting  ENUMERATED { true }            OPTIONAL,
    multiModeRAT-Capability                   MultiModeRAT-Capability-vc50ext  OPTIONAL,
    -- UE physical channel capability
    physicalChannelCapability                  PhysicalChannelCapability-vc50ext  OPTIONAL
}

UE-RadioAccessCapability-vd20ext-IEs ::= SEQUENCE {
    -- dummy is not used in this version of the specification
    -- and if received it should be ignored

    ue-RadioAccessCapabBandCombList          UE-RadioAccessCapabBandCombList-vd20ext  OPTIONAL,
    dummy1                                    MultiModeRAT-Capability-vd20ext          OPTIONAL,
    -- UE physical channel capability
    dummy2                                    PhysicalChannelCapability-vd20ext         OPTIONAL,
    -- UE positioning capability
    dummy3                                    UE-PositioningCapability-vd20ext         OPTIONAL,
    -- the capability is for FDD only
    dummy4                                    ENUMERATED { true }                    OPTIONAL,
    dummy5                                    ENUMERATED { true }                    OPTIONAL,
    dummy6                                    ENUMERATED { true }                    OPTIONAL,
    dummy7                                    ENUMERATED { true }                    OPTIONAL
}

UE-ConnTimersAndConstants ::= SEQUENCE {
    -- Optional is used also for parameters for which the default value is the last one read in SIB1
    -- t-301 and n-301 should not be used by the UE in this version of the specification
    t-301                                    T-301                                  DEFAULT ms2000,
    n-301                                    N-301                                  DEFAULT 2,
    t-302                                    T-302                                  DEFAULT ms4000,
    n-302                                    N-302                                  DEFAULT 3,
    t-304                                    T-304                                  DEFAULT ms2000,
    n-304                                    N-304                                  DEFAULT 2,
    t-305                                    T-305                                  DEFAULT m30,
    t-307                                    T-307                                  DEFAULT s30,
    t-308                                    T-308                                  DEFAULT ms160,
    t-309                                    T-309                                  DEFAULT 5,
    t-310                                    T-310                                  DEFAULT ms160,
    n-310                                    N-310                                  DEFAULT 4,
    t-311                                    T-311                                  DEFAULT ms2000,
    t-312                                    T-312                                  DEFAULT 1,
    -- n-312 shall be ignored if n-312 in UE-ConnTimersAndConstants-v3a0ext is present, and the
    -- value of that element shall be used instead.
    n-312                                    N-312                                  DEFAULT s1,
    t-313                                    T-313                                  DEFAULT 3,
    n-313                                    N-313                                  DEFAULT s20,
    t-314                                    T-314                                  DEFAULT s12,
    t-315                                    T-315                                  DEFAULT s180,
    -- n-315 shall be ignored if n-315 in UE-ConnTimersAndConstants-v3a0ext is present, and the
    -- value of that element shall be used instead.
    n-315                                    N-315                                  DEFAULT s1,
    t-316                                    T-316                                  DEFAULT s30,
    t-317                                    T-317                                  DEFAULT infinity4
}

UE-ConnTimersAndConstants-v3a0ext ::= SEQUENCE {
    n-312                                    N-312ext                                OPTIONAL,

```

```

    n-315                N-315ext                OPTIONAL
  }

UE-ConnTimersAndConstants-r5 ::= SEQUENCE {
-- Optional is used also for parameters for which the default value is the last one read in SIB1
-- t-301 and n-301 should not be used by the UE in this version of the specification
  t-301                T-301                DEFAULT ms2000,
  n-301                N-301                DEFAULT 2,
  t-302                T-302                DEFAULT ms4000,
  n-302                N-302                DEFAULT 3,
  t-304                T-304                DEFAULT ms2000,
  n-304                N-304                DEFAULT 2,
  t-305                T-305                DEFAULT m30,
  t-307                T-307                DEFAULT s30,
  t-308                T-308                DEFAULT ms160,
  t-309                T-309                DEFAULT 5,
  t-310                T-310                DEFAULT ms160,
  n-310                N-310                DEFAULT 4,
  t-311                T-311                DEFAULT ms2000,
  t-312                T-312                DEFAULT 1,
  n-312                N-312-r5             DEFAULT s1,
  t-313                T-313                DEFAULT 3,
  n-313                N-313                DEFAULT s20,
  t-314                T-314                DEFAULT s12,
  t-315                T-315                DEFAULT s180,
  n-315                N-315-r5             DEFAULT s1,
  t-316                T-316                DEFAULT s30,
  t-317                T-317                DEFAULT infinity4
}

UE-ConnTimersAndConstants-v860ext ::= SEQUENCE {
  t-323                T-323                OPTIONAL
}

UE-ConnTimersAndConstants-r11 ::= SEQUENCE {
-- Optional is used also for parameters for which the default value is the last one read in SIB1
-- t-301 and n-301 should not be used by the UE in this version of the specification
  t-301                T-301                DEFAULT ms2000,
  n-301                N-301                DEFAULT 2,
  t-302                T-302                DEFAULT ms4000,
  n-302                N-302                DEFAULT 3,
  t-304                T-304                DEFAULT ms2000,
  n-304                N-304                DEFAULT 2,
  t-305                T-305                DEFAULT m30,
  t-307                T-307                DEFAULT s30,
  t-308                T-308                DEFAULT ms160,
  t-309                T-309                DEFAULT 5,
  t-310                T-310                DEFAULT ms160,
  n-310                N-310                DEFAULT 4,
  t-311                T-311                DEFAULT ms2000,
  t-312                T-312                DEFAULT 1,
  n-312                N-312-r5             DEFAULT s1,
  t-313                T-313                DEFAULT 3,
  n-313                N-313                DEFAULT s20,
  t-314                T-314                DEFAULT s12,
  t-315                T-315                DEFAULT s180,
  n-315                N-315-r5             DEFAULT s1,
  t-316                T-316                DEFAULT s30,
  t-317                T-317                DEFAULT infinity4,
  t-323                T-323                OPTIONAL
}

UE-GANSSPositioning-Capability ::= SEQUENCE {
  networkAssistedGANSS-supportedList NetworkAssistedGANSS-Supported-List OPTIONAL
}

UE-GANSSPositioning-Capability-v860ext-IEs ::= SEQUENCE {
  networkAssistedGANSS-supportedList NetworkAssistedGANSS-Supported-List-v860ext OPTIONAL
}

UE-IdleTimersAndConstants ::= SEQUENCE {
  t-300                T-300,
  n-300                N-300,
  t-312                T-312,
  -- n-312 shall be ignored if n-312 in UE-IdleTimersAndConstants-v3a0ext is present, and the
  -- value of that element shall be used instead.
  n-312                N-312
}

```



```

UE-HSPA-Identities-r6 ::= SEQUENCE {
    new-H-RNTI                H-RNTI                OPTIONAL,
    newPrimary-E-RNTI         E-RNTI                OPTIONAL,
    newSecondary-E-RNTI       E-RNTI                OPTIONAL
}

UE-IdleTimersAndConstants-v3a0ext ::= SEQUENCE {
    n-312                      N-312ext              OPTIONAL
}

UE-MultiModeRAT-Capability ::= SEQUENCE {
    multiRAT-CapabilityList    MultiRAT-Capability,
    multiModeCapability        MultiModeCapability
}

UE-PowerClass ::= INTEGER (1..4)

UE-PowerClassExt ::= ENUMERATED {class1, class2, class3, class4,
    spare4, spare3, spare2, spare1 }

UE-RadioAccessCapability ::= SEQUENCE {
    -- UE-RadioAccessCapability is compatible with R99, although accessStratumReleaseIndicator
    -- is removed from this IE, since its encoding did not result in bits. The
    -- accessStratumReleaseIndicator is provided in the relevant REL-4 extension IEs.
    pdcp-Capability            PDCP-Capability,
    rlc-Capability              RLC-Capability,
    transportChannelCapability TransportChannelCapability,
    rf-Capability               RF-Capability,
    physicalChannelCapability   PhysicalChannelCapability,
    ue-MultiModeRAT-Capability UE-MultiModeRAT-Capability,
    securityCapability          SecurityCapability,
    ue-positioning-Capability   UE-Positioning-Capability,
    measurementCapability       MeasurementCapability    OPTIONAL
}

UE-RadioAccessCapabilityInfo ::= SEQUENCE {
    ue-RadioAccessCapability    UE-RadioAccessCapability,
    ue-RadioAccessCapability-v370ext UE-RadioAccessCapability-v370ext
}

UE-RadioAccessCapability-v370ext ::= SEQUENCE {
    ue-RadioAccessCapabBandFDDList UE-RadioAccessCapabBandFDDList
}

UE-RadioAccessCapability-v380ext ::= SEQUENCE {
    ue-PositioningCapabilityExt-v380 UE-PositioningCapabilityExt-v380
}

UE-RadioAccessCapability-v3a0ext ::= SEQUENCE {
    ue-PositioningCapabilityExt-v3a0 UE-PositioningCapabilityExt-v3a0
}

UE-RadioAccessCapability-v3g0ext ::= SEQUENCE {
    ue-PositioningCapabilityExt-v3g0 UE-PositioningCapabilityExt-v3g0
}

UE-RadioAccessCapability-v650ext ::= SEQUENCE {
    ue-RadioAccessCapabBandFDDList2 UE-RadioAccessCapabBandFDDList2,
    -- This IE shall be included if the UE also supports Band I-VII
    ue-RadioAccessCapabBandFDDList-ext UE-RadioAccessCapabBandFDDList-ext    OPTIONAL
}

UE-RadioAccessCapability-v690ext ::= SEQUENCE {
    physicalchannelcapability-edch PhysicalChannelCapability-edch-r6,
    -- TABULAR: deviceType is MD in tabular description
    -- Default value is 'doesBenefitFromBatteryConsumptionOptimisation'
    deviceType          ENUMERATED { doesNotBenefitFromBatteryConsumptionOptimisation }    OPTIONAL
}

UE-RadioAccessCapability-v7e0ext ::= SEQUENCE {
    -- User equipment IEs
    supportForTwoDRXschemesInPCH          ENUMERATED { true }          OPTIONAL,
    supportEDPDCHPowerInterpolation       ENUMERATED { true }          OPTIONAL
}

UE-RadioAccessCapability-v7f0ext ::= SEQUENCE {
    supportofTxDivOnNonMIMOChannel        ENUMERATED { true }          OPTIONAL,

```

```

-- IE physicalChannelCapability-LCR and ue-RadioAccessCapabilityComp-TDD128 shall only be
-- included in InterRATHandoverInfo for 1.28 Mcps TDD, otherwise these IEs are not needed here.
physicalChannelCapability-LCR          PhysicalChannelCapability-LCR-r4          OPTIONAL,
ue-RadioAccessCapabilityComp-TDD128   UE-RadioAccessCapabilityComp-TDD128-v7f0ext OPTIONAL
}

UE-RadioAccessCapabilityInfo-v770ext ::= SEQUENCE {
  rf-Capability                RF-Capability-v770ext                OPTIONAL,
  physicalChannelCapability     PhysicalChannelCapabilityInfo-v770ext,
  ganssSupportIndication       ENUMERATED { true }                  OPTIONAL,
  mac-ehsSupport               ENUMERATED { true }                  OPTIONAL,
  ue-SpecificCapabilityInformation UE-SpecificCapabilityInformation-LCRTDD OPTIONAL
}

UE-RadioAccessCapabilityInfo-TDD128-v8b0ext ::= SEQUENCE {
  -- INTER RAT HANDOVER INFO
  measurementCapabilityTDD      MeasurementCapabilityTDD      OPTIONAL,
  hSDSCH-physical-layer-category-extension HSDSCH-physical-layer-category-extension OPTIONAL
}

UE-RadioAccessCapabilityInfo-TDD128-vb50ext ::= SEQUENCE {
  -- INTER RAT HANDOVER INFO
  measurementCapabilityTDD      MeasurementCapabilityTDD-vb50ext OPTIONAL
}

UE-RadioAccessCapability-v860ext ::= SEQUENCE {
  ue-RadioAccessCapabBandFDDList3 UE-RadioAccessCapabBandFDDList3
}

UE-RadioAccessCapability-v880ext ::= SEQUENCE {
  -- INTER RAT HANDOVER INFO
  supportForPriorityReselectionInUTRAN ENUMERATED { true }          OPTIONAL
}

UE-RadioAccessCapability-v890ext ::= SEQUENCE {
  -- UE radio access capability
  supportCellSpecificTxDiversityinDC-Operation ENUMERATED { true }    OPTIONAL
}

UE-RadioAccessCapability-v920ext ::= SEQUENCE {
  supportOfenhancedTS0         ENUMERATED { true }          OPTIONAL
}

UE-RadioAccessCapability-va40ext ::= SEQUENCE {
  ue-RadioAccessCapabBandFDDList4 UE-RadioAccessCapabBandFDDList4
}

UE-RadioAccessCapability-va60ext ::= SEQUENCE {
  ue-RadioAccessCapabBandFDDList4 UE-RadioAccessCapabBandFDDList4-va60ext OPTIONAL
}

UE-RadioAccessCapability-va80ext ::= SEQUENCE {
  ue-RadioAccessCapabBandFDDList4-va60ext UE-RadioAccessCapabBandFDDList4-va60ext OPTIONAL,
  ue-RadioAccessCapabBandFDDList4-va80ext UE-RadioAccessCapabBandFDDList4-va80ext OPTIONAL
}

UE-RadioAccessCapability-vb50ext ::= SEQUENCE {
  ue-RadioAccessCapabBandFDDList6 UE-RadioAccessCapabBandFDDList6    OPTIONAL
}

UE-RadioAccessCapability-vb70ext ::= SEQUENCE {
  ue-RadioAccessCapabBandFDDList7 UE-RadioAccessCapabBandFDDList7    OPTIONAL
}

UE-RadioAccessCapability-vc0ext ::= SEQUENCE {
  interRATsupportMultiCellConfiguration ENUMERATED { true }          OPTIONAL,
  ue-RadioAccessCapabBandCombList       UE-RadioAccessCapabBandCombList OPTIONAL,
  ue-RadioAccessCapabBandCombList-va40ext UE-RadioAccessCapabBandCombList-va40ext OPTIONAL
}

UE-RadioAccessCapability-vc20ext ::= SEQUENCE {
  ue-RadioAccessCapabBandCombList UE-RadioAccessCapabBandCombList-vc20ext OPTIONAL
}

UE-RadioAccessCapabBand-va40ext ::= SEQUENCE {

```

```

    ue-RadioAccessCapabBandFDDList5          UE-RadioAccessCapabBandFDDList5,
    -- This IE shall be included if the UE also supports Band I - Band XXII
    ue-RadioAccessCapabBandFDDList-ext2      UE-RadioAccessCapabBandFDDList-ext2    OPTIONAL
}

UE-RadioAccessCapabBandFDDList2 ::= SEQUENCE (SIZE (1..maxFreqBandsFDD)) OF
    UE-RadioAccessCapabBandFDD2

UE-RadioAccessCapabBandFDDList3 ::= SEQUENCE (SIZE (1..maxFreqBandsFDD)) OF
    UE-RadioAccessCapabBandFDD3

UE-RadioAccessCapabBandFDDList4 ::= SEQUENCE (SIZE (1..maxFreqBandsFDD)) OF
    UE-RadioAccessCapabBandFDD4

UE-RadioAccessCapabBandFDDList4-va60ext ::= SEQUENCE (SIZE (1..maxFreqBandsFDD)) OF
    UE-RadioAccessCapabBandFDD4-va60ext

UE-RadioAccessCapabBandFDDList4-va80ext ::= SEQUENCE (SIZE (1..maxFreqBandsFDD-ext3)) OF
    UE-RadioAccessCapabBandFDD4-va80ext

UE-RadioAccessCapabBandFDDList5 ::= SEQUENCE (SIZE (1..maxFreqBandsFDD-ext2)) OF
    UE-RadioAccessCapabBandFDD5

UE-RadioAccessCapabBandFDDList6 ::= SEQUENCE (SIZE (1..maxFreqBandsFDD3)) OF
    UE-RadioAccessCapabBandFDD6

UE-RadioAccessCapabBandFDDList7 ::= SEQUENCE (SIZE (1..maxFreqBandsFDD3)) OF
    UE-RadioAccessCapabBandFDD7

UE-RadioAccessCapabBandFDD2 ::= SEQUENCE {
    radioFrequencyBandFDD2          RadioFrequencyBandFDD2,
    fddRF-Capability                SEQUENCE {
        ue-PowerClass              UE-PowerClassExt,
        txRxFrequencySeparation    TxRxFrequencySeparation
    } OPTIONAL,
    measurementCapability2          MeasurementCapabilityExt2
}

UE-RadioAccessCapabBandFDD3 ::= SEQUENCE {
    -- UE may omit both IEs if this IE indicates the same EUTRA compressed
    -- mode capability for all supported UTRA bands
    -- Otherwise, the UE shall include either one of the following OPTIONAL IEs.
    radioFrequencyBandFDD          RadioFrequencyBandFDD    OPTIONAL,
    radioFrequencyBandFDD2        RadioFrequencyBandFDD2    OPTIONAL,
    measurementCapability3        MeasurementCapabilityExt3
}

UE-RadioAccessCapabBandFDD4 ::= SEQUENCE {
    -- UE may omit all the radioFrequencyBand IEs if this IE indicates the same
    -- capability for all supported UTRA bands
    -- Otherwise, the UE shall include either one of the following OPTIONAL IEs.
    radioFrequencyBandFDD          RadioFrequencyBandFDD    OPTIONAL,
    radioFrequencyBandFDD2        RadioFrequencyBandFDD2    OPTIONAL,
    radioFrequencyBandFDD3        RadioFrequencyBandFDD3    OPTIONAL,
    additionalSecondaryCells      ENUMERATED { a1, a2 }    OPTIONAL,
    nonContiguousMultiCellCombinationList NonContiguousMultiCellCombinationList    OPTIONAL
}

UE-RadioAccessCapabBandFDD4-va60ext ::= SEQUENCE {
    supportofULOLTD                ENUMERATED { true }    OPTIONAL
}

UE-RadioAccessCapabBandFDD4-va80ext ::= SEQUENCE {
    -- UE may omit all the radioFrequencyBand IEs if this IE indicates the same
    -- capability for all supported UTRA bands
    -- Otherwise, the UE shall include either one of the following OPTIONAL IEs.
    radioFrequencyBandFDD          RadioFrequencyBandFDD    OPTIONAL,
    radioFrequencyBandFDD2        RadioFrequencyBandFDD2    OPTIONAL,
    radioFrequencyBandFDD3        RadioFrequencyBandFDD3    OPTIONAL,
    additionalSecondaryCells      ENUMERATED { a1, a2 }    OPTIONAL,
    nonContiguousMultiCellCombinationList NonContiguousMultiCellCombinationList
    OPTIONAL,
    supportofULOLTD                ENUMERATED { true }    OPTIONAL
}

UE-RadioAccessCapabBandFDD5 ::= SEQUENCE {
    radioFrequencyBandFDD3        RadioFrequencyBandFDD3,
    fddRF-Capability              SEQUENCE {

```

```

        ue-PowerClass                UE-PowerClassExt,
        txRxFrequencySeparation      TxRxFrequencySeparation
    } OPTIONAL,
    measurementCapability4            MeasurementCapabilityExt4
}

UE-RadioAccessCapabBandFDD6 ::= SEQUENCE {
    -- UE may omit all the radioFrequencyBand IEs if this IE indicates the same
    -- capability for all supported UTRA bands
    -- Otherwise, the UE shall include either one of the following OPTIONAL IEs.
    radioFrequencyBandFDD             RadioFrequencyBandFDD     OPTIONAL,
    radioFrequencyBandFDD2            RadioFrequencyBandFDD2    OPTIONAL,
    radioFrequencyBandFDD3            RadioFrequencyBandFDD3    OPTIONAL,
    additionalSecondaryCells2         ENUMERATED { a3, a4, a5, a6 }    OPTIONAL,
    supportOfULCLTD                   ENUMERATED { true }          OPTIONAL,
    multiflowCapability                MultiflowPerBandCapability  OPTIONAL,
    mimo4x4CapabilityBand              ENUMERATED { true }          OPTIONAL,
    supportOfULMIMO                   ENUMERATED { true }          OPTIONAL,
    measurementCapability5             MeasurementCapabilityExt5,
    freqSpecificCompressedModeForNonContiguous ENUMERATED { true }    OPTIONAL
}

UE-RadioAccessCapabBandFDD7 ::= SEQUENCE {
    -- UE may omit all the radioFrequencyBand IEs if this IE indicates the same
    -- capability for all supported UTRA bands
    -- Otherwise, the UE shall include either one of the following OPTIONAL IEs.
    radioFrequencyBandFDD             RadioFrequencyBandFDD     OPTIONAL,
    radioFrequencyBandFDD2            RadioFrequencyBandFDD2    OPTIONAL,
    radioFrequencyBandFDD3            RadioFrequencyBandFDD3    OPTIONAL,
    measurementCapability6             MeasurementCapabilityExt6
}

UE-PositioningCapabilityExt-v380 ::= SEQUENCE {
    rx-tx-TimeDifferenceType2Capable  BOOLEAN
}

UE-PositioningCapabilityExt-v3a0 ::= SEQUENCE {
    validity-CellPCH-UraPCH          ENUMERATED { true }
}

UE-PositioningCapabilityExt-v3g0 ::= SEQUENCE {
    sfn-sfnType2Capability            ENUMERATED { true }
}

UE-PositioningCapability-v770ext ::= SEQUENCE {
    ue-GANSSPositioning-Capability    UE-GANSSPositioning-Capability    OPTIONAL
}

UE-PositioningCapability-v860ext ::= SEQUENCE {
    ue-GANSSPositioning-Capability-v860ext
    UE-GANSSPositioning-Capability-v860ext-IEs    OPTIONAL
}

UE-PositioningCapability-vd20ext ::= SEQUENCE {
    ue-Positioning-AddPos-Capability  UE-AddPos-Supported-List    OPTIONAL
}

UE-RadioAccessCapabBandCombList ::= SEQUENCE (SIZE (1..16)) OF BandComb

UE-RadioAccessCapabBandFDDList ::= SEQUENCE (SIZE (1..maxFreqBandsFDD)) OF
    UE-RadioAccessCapabBandFDD

UE-RadioAccessCapabBandFDDList-ext ::= SEQUENCE (SIZE (1..maxFreqBandsFDD)) OF
    UE-RadioAccessCapabBandFDD-ext

UE-RadioAccessCapabBandFDDList-ext2 ::= SEQUENCE (SIZE (1..maxFreqBandsFDD2)) OF
    UE-RadioAccessCapabBandFDD-ext2

UE-RadioAccessCapabBandFDD ::= SEQUENCE {
    radioFrequencyBandFDD             RadioFrequencyBandFDD,
    fddRF-Capability                  SEQUENCE {
        ue-PowerClass                UE-PowerClassExt,
        txRxFrequencySeparation      TxRxFrequencySeparation
    } OPTIONAL,
    measurementCapability              MeasurementCapabilityExt
}

```

```

UE-RadioAccessCapabBandFDD-ext ::= SEQUENCE {
    radioFrequencyBandFDD          RadioFrequencyBandFDD,
    compressedModeMeasCapabFDDList-ext  CompressedModeMeasCapabFDDList-ext
}

UE-RadioAccessCapabBandFDD-ext2 ::= SEQUENCE {
    radioFrequencyBandFDD          RadioFrequencyBandFDD          OPTIONAL,
    radioFrequencyBandFDD2         RadioFrequencyBandFDD2         OPTIONAL,
    compressedModeMeasCapabFDDList3  CompressedModeMeasCapabFDDList3
}

UE-RadioAccessCapability-v4b0ext ::= SEQUENCE {
    pdcp-Capability-r4-ext          PDCP-Capability-r4-ext,
    tdd-CapabilityExt               SEQUENCE {
        rf-Capability                RF-Capability-r4-ext,
        physicalChannelCapability-LCR  PhysicalChannelCapability-LCR-r4,
        measurementCapability-r4-ext  MeasurementCapability-r4-ext
    }
    -- IE " AccessStratumReleaseIndicator" is not needed in RRC CONNECTION SETUP COMPLETE
    accessStratumReleaseIndicator  AccessStratumReleaseIndicator  OPTIONAL
}

UE-RadioAccessCapabilityComp ::= SEQUENCE {
    totalAM-RLCMemoryExceeds10kB    BOOLEAN,
    rf-CapabilityComp                RF-CapabilityComp
}

UE-RadioAccessCapabilityComp-ext ::= SEQUENCE {
    rf-CapabilityFDDComp             RF-CapabBandListFDDComp-ext
}

UE-RadioAccessCapabilityComp-TDD128-v7f0ext ::= SEQUENCE {
    hSDSCH-physical-layer-category  HSDSCH-physical-layer-category          OPTIONAL,
    multiCarrier-physical-layer-category  MultiCarrier-HSDSCH-physical-layer-category  OPTIONAL,
    tdd-edch-PhysicalLayerCategory        INTEGER (1..6)                          OPTIONAL,
    dl-CapabilityWithSimultaneousHS-DSCHConfig  DL-CapabilityWithSimultaneousHS-DSCHConfig  OPTIONAL,
    supportForCSVoiceoverHSPA             ENUMERATED { true }                       OPTIONAL,
    totalRLC-AM-BufferSize                TotalRLC-AM-BufferSize-r5-ext             OPTIONAL
}

UE-RadioAccessCapabilityComp-v770ext ::= SEQUENCE {
    rf-CapabilityComp                RF-CapabilityComp-v770ext,
    securityCapabilityIndication      ENUMERATED { true }                       OPTIONAL,
    ganssSupportIndication             ENUMERATED { true }                       OPTIONAL,
    mac-ehsSupport                    ENUMERATED { true }                       OPTIONAL
}

UE-RadioAccessCapabilityComp2 ::= SEQUENCE {
    fddPhysicalChannelCapab-hspdsch-edch  SEQUENCE {
        dl-CapabilityWithSimultaneousHS-DSCHConfig  DL-CapabilityWithSimultaneousHS-DSCHConfig  OPTIONAL,
        physicalChannelCapabComp-hspdsch-r6         HSDSCH-physical-layer-category,
        physicalChannelCapability-edch-r6           PhysicalChannelCapability-edch-r6
    }
    OPTIONAL
}

UE-RadioAccessCapabilityComp2-v770ext ::= SEQUENCE {
    hsdSCH-physical-layer-category-ext  HSDSCH-physical-layer-category-ext  OPTIONAL,
    edch-PhysicalLayerCategory-extension  INTEGER (7)                          OPTIONAL,
    hsscHlessHsdSCHOperation             ENUMERATED { true }                   OPTIONAL,
    enhancedFdpch                        ENUMERATED { true }                   OPTIONAL,
    hsdSCHReception-CellFach             ENUMERATED { true }                   OPTIONAL,
    hsdSCHReception-CellUraPch          ENUMERATED { true }                   OPTIONAL,
    discontinuousDpcchTransmission       ENUMERATED { true }                   OPTIONAL,
    slotFormat4                          ENUMERATED { true }                   OPTIONAL,
    pdcp-Capability                      PDCP-Capability-v770ext             OPTIONAL
}

UE-RadioAccessCapabilityComp2-v7f0ext ::= SEQUENCE {
    supportOfTxDivOnNonMIMOChannel       ENUMERATED { true }                   OPTIONAL
}

UE-RadioAccessCapabilityComp2-v860ext ::= SEQUENCE {
    hsdSCH-physical-layer-category-ext2  HSDSCH-physical-layer-category-ext2  OPTIONAL,
    supportOfMACiis                      ENUMERATED { true }                   OPTIONAL
}

```

```

}

UE-RadioAccessCapabilityComp2-v920ext ::= SEQUENCE {
    hsdSCH-physical-layer-category-ext3    HSDSCH-physical-layer-category-ext3    OPTIONAL,
    edch-PhysicalLayerCategory-extension2  INTEGER (8..9)                        OPTIONAL
}

UE-RadioAccessCapabilityComp2-va40ext ::= SEQUENCE {
    hsdSCH-physical-layer-category-ext4    HSDSCH-physical-layer-category-ext4    OPTIONAL,
    hsdSCH-physical-layer-category-ext5    HSDSCH-physical-layer-category-ext5    OPTIONAL
}

UE-RadioAccessCapabilityComp2-vb50ext ::= SEQUENCE {
    hsdSCH-physical-layer-category-ext6    HSDSCH-physical-layer-category-ext6    OPTIONAL,
    hsdSCH-physical-layer-category-ext7    HSDSCH-physical-layer-category-ext7    OPTIONAL,
    hsdSCH-physical-layer-category-ext8    HSDSCH-physical-layer-category-ext8    OPTIONAL,
    edch-PhysicalLayerCategory-extension3  INTEGER (10..12)                       OPTIONAL,
    supportOfHSDPCCHPowerOffsetExtension  ENUMERATED { true }                   OPTIONAL
}

UE-RadioAccessCapabilityComp2-vc50ext ::= SEQUENCE {
    supportOfDsacAndPpacInCellDch         ENUMERATED { true }                   OPTIONAL,
    supportForDCHEnhancements             ENUMERATED { basic, full }           OPTIONAL,
    simultaneousSupportForDCHEnhancementsAndCM  ENUMERATED { true }                 OPTIONAL,
    simultaneousSupportForDCHEnhancementsAndDPCCCHDiscntTx  ENUMERATED { true }                 OPTIONAL
}

UE-RadioAccessCapabilityComp2-vd20ext ::= SEQUENCE {
    supportOfDualCellEDCHwithDPDCH        ENUMERATED { true }                   OPTIONAL
}

UE-RadioAccessCapabilityComp-TDD128 ::= SEQUENCE {
    tdd128RF-Capability                   RadioFrequencyBandTDDextList         OPTIONAL,
    supportOfSFModeForHSPDSCHDualStream   ENUMERATED { sf1, sf1sf16 }          OPTIONAL,
    supportOfCommonEDCH                   ENUMERATED { true }                  OPTIONAL,
    supportOfMACiis                       ENUMERATED { true }                  OPTIONAL,
    supportOfSPSOperation                  ENUMERATED { true }                  OPTIONAL,
    supportOfControlChannelDRXOperation    ENUMERATED { true }                  OPTIONAL
}

RF-CapabilityComp ::= SEQUENCE {
    fdd                                     CHOICE {
        notSupported                       NULL,
        supported                           RF-CapabBandListFDDComp
    },
    tdd384-RF-Capability                   CHOICE {
        notSupported                       NULL,
        supported                           RadioFrequencyBandTDDList
    },
    tdd128-RF-Capability                   CHOICE {
        notSupported                       NULL,
        supported                           RadioFrequencyBandTDDList
    }
}

RF-CapabilityComp-v770ext ::= SEQUENCE {
    -- If support of TDD384 and/or TDD128 RF capability is indicated in IEs 'RF-CapabilityComp',
    -- the corresponding IE 'RadioFrequencyBandTDDList-r7' shall be included in this IE.
    tdd384-RF-Capability                   RadioFrequencyBandTDDList-r7         OPTIONAL,
    tdd768-RF-Capability                   CHOICE {
        notSupported                       NULL,
        supported                           RadioFrequencyBandTDDList-r7
    },
    tdd128-RF-Capability                   RadioFrequencyBandTDDList-r7         OPTIONAL
}

-- NOTE: This IE defines the supported TX/RX frequency separation for the respective supported
-- frequency band. Values defined as spare shall not be sent in this version of the protocol.
-- If a spare value is received, it should be interpreted as 'default-RxTX-sparation'.
RF-CapabBandFDDComp ::= ENUMERATED { notSupported,
    default-TxRx-separation, spare2, spare1 }

RF-CapabBandListFDDComp ::= SEQUENCE (SIZE (1..maxFreqBandsFDD)) OF
    -- The first entry corresponds with the first value of IE RadioFrequencyBandFDD,
    -- fdd2100, and so on. No more than seven entries should be included in this IE. The
    -- 8'th entry, if present, shall be ignored.
    -- An extension of this IE may be provided using the IE 'RF-CapabBandListFDDComp-ext'.
    RF-CapabBandFDDComp

```

```

RF-CapabBandListFDDComp-ext ::= SEQUENCE (SIZE (1..maxFreqBandsFDD-ext)) OF
-- The first entry corresponds with the first value of IE RadioFrequencyBandFDD2,
-- bandVIII, and so on.
RF-CapabBandFDDComp

RF-CapabBandListFDDComp-ext2 ::= SEQUENCE (SIZE (1..maxFreqBandsFDD-ext2)) OF
-- The first entry corresponds with the first value of IE RadioFrequencyBandFDD3,
-- 23 (Band XXIII), and so on.
RF-CapabBandFDDComp

UE-RadioAccessCapabBandCombList-va40ext ::= SEQUENCE (SIZE (1..16)) OF SupportedCarrierCombination

UE-RadioAccessCapabBandCombList-vb50ext ::= SEQUENCE (SIZE (1..16)) OF
SupportedCarrierCombination-ext

UE-RadioAccessCapabBandCombList-vd20ext ::= SEQUENCE (SIZE (1..16)) OF
SupportDualBandDualCellEdch

SupportedCarrierCombination ::= SEQUENCE {
carrierCombination12    BOOLEAN,
carrierCombination21    BOOLEAN,
carrierCombination13    BOOLEAN,
carrierCombination31    BOOLEAN,
carrierCombination22    BOOLEAN
}

SupportedCarrierCombination-ext ::= SEQUENCE {
carrierCombination14    BOOLEAN,
carrierCombination41    BOOLEAN,
carrierCombination15    BOOLEAN,
carrierCombination51    BOOLEAN,
carrierCombination16    BOOLEAN,
carrierCombination61    BOOLEAN,
carrierCombination17    BOOLEAN,
carrierCombination71    BOOLEAN,
carrierCombination23    BOOLEAN,
carrierCombination32    BOOLEAN,
carrierCombination24    BOOLEAN,
carrierCombination42    BOOLEAN,
carrierCombination25    BOOLEAN,
carrierCombination52    BOOLEAN,
carrierCombination26    BOOLEAN,
carrierCombination62    BOOLEAN,
carrierCombination33    BOOLEAN,
carrierCombination34    BOOLEAN,
carrierCombination43    BOOLEAN,
carrierCombination44    BOOLEAN,
carrierCombination35    BOOLEAN,
carrierCombination53    BOOLEAN
}

SupportDualBandDualCellEdch ::= SEQUENCE {
dualBandDualCellEdchIndication    ENUMERATED { true }    OPTIONAL
}

UE-RadioAccessCapability-v590ext ::= SEQUENCE {
dl-CapabilityWithSimultaneousHS-DSCHConfig
DL-CapabilityWithSimultaneousHS-DSCHConfig    OPTIONAL,
pdcp-Capability-r5-ext            PDCP-Capability-r5-ext,
rlc-Capability-r5-ext             RLC-Capability-r5-ext,
physicalChannelCapability         PhysicalChannelCapability-hspdsch-r5,
multiModerAT-Capability-v590ext   MultiModerAT-Capability-v590ext
}

UE-RadioAccessCapability-v5c0ext ::= SEQUENCE {
pdcp-Capability-r5-ext2           PDCP-Capability-r5-ext2
}

UE-RadioAccessCapability-v680ext ::= SEQUENCE {
multiModerAT-Capability-v680ext   MultiModerAT-Capability-v680ext
}

UL-OLTD-InfoFDD ::= SEQUENCE {
ulOLTDActivation                 ENUMERATED {true}
}

```

```

UL-PhysChCapabilityFDD ::= SEQUENCE {
    maxNoDPDCH-BitsTransmitted MaxNoDPDCH-BitsTransmitted,
    -- dummy is not used in this version of the specification and
    -- it should be ignored by the receiver.
    dummy BOOLEAN
}

UL-PhysChCapabilityFDD-r6 ::= SEQUENCE {
    maxNoDPDCH-BitsTransmitted MaxNoDPDCH-BitsTransmitted,
    physicalchannelcapability-edch PhysicalChannelCapability-edch-r6
}

UL-PhysChCapabilityFDD-v770ext ::= SEQUENCE {
    edch-PhysicalLayerCategory-extension INTEGER (7) OPTIONAL,
    discontinuousDpccchTransmission ENUMERATED { true } OPTIONAL,
    slotFormat4 ENUMERATED { true } OPTIONAL
}

UL-PhysChCapabilityFDD-v920ext ::= SEQUENCE {
    edch-PhysicalLayerCategory-extension2 INTEGER (8..9) OPTIONAL
}

UL-PhysChCapabilityFDD-vb50ext ::= SEQUENCE {
    edch-PhysicalLayerCategory-extension3 INTEGER (10..12) OPTIONAL
}

UL-PhysChCapabilityFDD-vc50ext ::= SEQUENCE {
    supportofCellReselectionIndicationReporting ENUMERATED { true } OPTIONAL,
    supportofRadioLinkswithoutDPCHFDPCH ENUMERATED { true } OPTIONAL,
    supportofServingE-DCHCellDecoupling ENUMERATED { true } OPTIONAL,
    accessGroupsAccessControl ENUMERATED { true } OPTIONAL,
    enhancedTTISwitching ENUMERATED { true } OPTIONAL,
    implicitGrantHandling ENUMERATED { true } OPTIONAL,
    dtx-enhancements ENUMERATED { true } OPTIONAL
}

UL-PhysChCapabilityFDD-vd20ext ::= SEQUENCE {
    supportOfDualCelledCHwithDPDCH ENUMERATED { true } OPTIONAL
}

UL-PhysChCapabilityTDD ::= SEQUENCE {
    maxTS-PerFrame MaxTS-PerFrame,
    maxPhysChPerTimeslot MaxPhysChPerTimeslot,
    minimumSF MinimumSF-UL,
    supportOfPUSCH BOOLEAN
}

UL-PhysChCapabilityTDD-384-v770ext ::= SEQUENCE {
    tdd384-edch CHOICE {
        supported SEQUENCE {
            tdd-edch-PhysicalLayerCategory INTEGER (1..16)
        },
        unsupported NULL
    }
}

UL-PhysChCapabilityTDD-LCR-r4 ::= SEQUENCE {
    maxTS-PerSubFrame MaxTS-PerSubFrame-r4,
    maxPhysChPerTimeslot MaxPhysChPerTimeslot,
    minimumSF MinimumSF-UL,
    supportOfPUSCH BOOLEAN,
    supportOf8PSK BOOLEAN
}

UL-PhysChCapabilityTDD-128-v770ext ::= SEQUENCE {
    maxPhysChPerTimeslot MaxPhysChPerTimeslot-LCR-r7,
    tdd128-edch CHOICE {
        supported SEQUENCE {
            tdd-edch-PhysicalLayerCategory INTEGER (1..6)
        },
        unsupported NULL
    }
}

UL-PhysChCapabilityInfoTDD-128-v770ext ::= SEQUENCE {
    maxPhysChPerTimeslot MaxPhysChPerTimeslot-LCR-r7
}

```



```

UL-PhysChCapabilityInfoTDD-128-va40ext ::= SEQUENCE {
    multiCarrier-EdchPhysicalLayerCategory-128 INTEGER (1..8) OPTIONAL,
    maxNumberCarrierForMCHSUPA-TDD ENUMERATED {nf-2, nf-3, nf-6, spare} OPTIONAL
}

UL-PhysChCapabilityTDD-768 ::= SEQUENCE {
    maxTS-PerFrame MaxTS-PerFrame,
    maxPhysChPerTimeslot MaxPhysChPerTimeslot,
    minimumSF MinimumSF-UL,
    supportOfPUSCH BOOLEAN,
    tdd384-edch CHOICE {
        supported SEQUENCE {
            tdd-edch-PhysicalLayerCategory INTEGER (1..16)
        },
        unsupported NULL
    }
}

UL-OtherTTIConfiguration-Information ::= SEQUENCE {
    configurationInfo CHOICE {
        continue NULL,
        newConfiguration SEQUENCE {
            ul-EDCH-Information UL-EDCH-Information-r11,
            ul-AddReconfTransChInfoList UL-AddReconfTransChInfoList-r8,
            dtx-drx-TimingInfo DTX-DRX-TimingInfo-r7 OPTIONAL,
            dtx-drx-Info DTX-DRX-Info-r12 OPTIONAL
        }
    },
    activationDelay ActivationDelay OPTIONAL
}

UL-SecondaryCellInfoFDD ::= CHOICE {
    continue NULL,
    newConfiguration SEQUENCE {
        secondaryServingEDCHCell-Info SecondaryServingEDCHCell-Info OPTIONAL,
        secondaryEDCH-Info-Common SecondaryEDCH-Info-Common OPTIONAL,
        dl-InformationPerSecondaryRL-List DL-InformationPerSecondaryRL-List OPTIONAL
    }
}

UL-SecondaryCellInfoFDD-r12 ::= CHOICE {
    continue NULL,
    newConfiguration SEQUENCE {
        secondaryServingEDCHCell-Info SecondaryServingEDCHCell-Info OPTIONAL,
        secondaryEDCH-Info-Common SecondaryEDCH-Info-Common-r12 OPTIONAL,
        dl-InformationPerSecondaryRL-List DL-InformationPerSecondaryRL-List-r12 OPTIONAL
    }
}

PhysicalChannelCapability-edch-r6 ::= SEQUENCE {
    fdd-edch CHOICE {
        supported SEQUENCE {
            edch-PhysicalLayerCategory INTEGER (1..16)
        },
        unsupported NULL
    }
}

UL-TransChCapability ::= SEQUENCE {
    maxNoBitsTransmitted MaxNoBits,
    maxConvCodeBitsTransmitted MaxNoBits,
    turboEncodingSupport TurboSupport,
    maxSimultaneousTransChs MaxSimultaneousTransChsUL,
    modeSpecificInfo CHOICE {
        fdd NULL,
        tdd SEQUENCE {
            maxSimultaneousCCTrCH-Count MaxSimultaneousCCTrCH-Count
        }
    },
    maxTransmittedBlocks MaxTransportBlocksUL,
    maxNumberOfTFC MaxNumberOfTFC-UL,
    maxNumberOfTF MaxNumberOfTF
}

UE-Positioning-Capability ::= SEQUENCE {
    standaloneLocMethodsSupported BOOLEAN,
    ue-BasedOTDOA-Supported BOOLEAN,

```

```

    networkAssistedGPS-Supported
    supportForUE-GPS-TimingOfCellFrames
    supportForIPDL
}

NetworkAssistedGPS-Supported,
BOOLEAN,
BOOLEAN

UE-SecurityInformation ::= SEQUENCE {
    start-CS          START-Value
}

UE-SecurityInformation2 ::= SEQUENCE {
    start-PS          START-Value
}

UE-SpecificCapabilityInformation-LCRTDD ::= ENUMERATED {
    nF,
    nFMc-TriRx-UniTx,
    nFMc-TriRx-TriTx,
    nFMc-HexRx-UniTx,
    nFMc-HexRx-TriTx,
    nFMc-HexRx-HexTx,
    nFMc-TwoRx-UniTx-Discontiguous,
    nFMc-TwoRx-TwoTx-Discontiguous,
    nFMc-TwoRx-UniTx-Contiguous,
    nFMc-TwoRx-TwoTx-Contiguous,
    spare6,
    spare5,
    spare4,
    spare3,
    spare2,
    spare1 }

URA-UpdateCause ::= ENUMERATED {
    changeOfURA,
    periodicURAUpdate,
    dummy,
    spare1 }

UTRAN-DRX-CycleLengthCoefficient ::= INTEGER (3..9)

UTRAN-DRX-CycleLengthCoefficient-r7 ::= SEQUENCE {
    drx-CycleLengthCoefficient      INTEGER (3..9),
    drx-CycleLengthCoefficient2     INTEGER (3..9)           OPTIONAL,
    timeForDRXCycle2               T-319                  OPTIONAL
}

WaitTime ::= INTEGER (0..15)

-- *****
--
-- RADIO BEARER INFORMATION ELEMENTS (10.3.4)
--
-- *****

AlgorithmSpecificInfo ::= CHOICE {
    rfc2507-Info          RFC2507-Info
}

AlgorithmSpecificInfo-r4 ::= CHOICE {
    rfc2507-Info          RFC2507-Info,
    rfc3095-Info          RFC3095-Info-r4
}

CID-InclusionInfo-r4 ::= ENUMERATED {
    pdcp-Header,
    rfc3095-PacketFormat }

CommonRBMappingInfo ::= SEQUENCE {
    logicalChannelIdentity LogicalChannelIdentity,
    mac-ehs-QueueId        MAC-ehs-QueueId
}

-- Upper limit of COUNT-C is 2^32 - 1
COUNT-C ::= INTEGER (0..4294967295)

-- Upper limit of COUNT-C-MSB is 2^25 - 1
COUNT-C-MSB ::= INTEGER (0..33554431)

CS-HSPA-Information ::= SEQUENCE {

```

```

    ul-AMR-Rate                UL-AMR-Rate                OPTIONAL,
    maxCS-Delay                MaxCS-Delay
}

DefaultConfigForCellFACH ::= SEQUENCE {
    defaultConfigMode          DefaultConfigMode,
    defaultConfigIdForCellFACH DefaultConfigIdForCellFACH
}

DefaultConfigIdentity ::= INTEGER (0..10)

DefaultConfigIdentity-r4 ::= INTEGER (0..12)

DefaultConfigIdentity-r5 ::= INTEGER (0..13)

-- DefaultConfigIdentity-r6 values 25..31 are spare and shall not be used in this version of
-- the protocol
DefaultConfigIdentity-r6 ::= INTEGER (0..31)

-- DefaultConfigIdForCellFACH values 1..15 are spare and shall not be used in this version of
-- the protocol
DefaultConfigIdForCellFACH ::= INTEGER (0..15)

DefaultConfigMode ::= ENUMERATED {
    fdd,
    tdd }

DDI ::= INTEGER (0..62)

DL-AM-RLC-Mode ::= SEQUENCE {
    inSequenceDelivery        BOOLEAN,
    receivingWindowSize       ReceivingWindowSize,
    dl-RLC-StatusInfo        DL-RLC-StatusInfo
}

DL-AM-RLC-Mode-r5 ::= SEQUENCE {
    dl-RLC-PDU-size          OctetModeRLC-SizeInfoType1,
    inSequenceDelivery        BOOLEAN,
    receivingWindowSize       ReceivingWindowSize,
    dl-RLC-StatusInfo        DL-RLC-StatusInfo
}

DL-AM-RLC-Mode-r7 ::= SEQUENCE {
    dl-RLC-PDU-size          CHOICE {
        fixedSize            OctetModeRLC-SizeInfoType1,
        flexibleSize         ENUMERATED { size7, size15 }
    },
    inSequenceDelivery        BOOLEAN,
    receivingWindowSize       ReceivingWindowSize,
    dl-RLC-StatusInfo        DL-RLC-StatusInfo
}

DL-AM-RLC-Mode-r11 ::= SEQUENCE {
    dl-RLC-PDU-size          CHOICE {
        fixedSize            OctetModeRLC-SizeInfoType1,
        flexibleSize         ENUMERATED { size7, size15 }
    },
    inSequenceDelivery        BOOLEAN,
    receivingWindowSize       ReceivingWindowSize,
    dl-RLC-StatusInfo        DL-RLC-StatusInfo-r11
}

DL-CounterSynchronisationInfo ::= SEQUENCE {
    rB-WithPDCP-InfoList    RB-WithPDCP-InfoList    OPTIONAL
}

DL-CounterSynchronisationInfo-r5 ::= SEQUENCE {
    rb-WithPDCP-InfoList    RB-WithPDCP-InfoList    OPTIONAL,
    rb-PDCPContextRelocationList RB-PDCPContextRelocationList OPTIONAL
}

DL-LogicalChannelMapping ::= SEQUENCE {
    -- TABULAR: DL-TransportChannelType contains TransportChannelIdentity as well.
    dl-TransportChannelType DL-TransportChannelType,
    logicalChannelIdentity  LogicalChannelIdentity    OPTIONAL
}

DL-LogicalChannelMapping-r5 ::= SEQUENCE {

```

```

-- TABULAR: DL-TransportChannelType contains TransportChannelIdentity as well.
dl-TransportChannelType          DL-TransportChannelType-r5,
logicalChannelIdentity            LogicalChannelIdentity            OPTIONAL
}

DL-LogicalChannelMapping-r7 ::= SEQUENCE {
-- TABULAR: DL-TransportChannelType contains TransportChannelIdentity as well.
dl-TransportChannelType          DL-TransportChannelType-r7,
logicalChannelIdentity            LogicalChannelIdentity            OPTIONAL
}

DL-LogicalChannelMappingList ::= SEQUENCE (SIZE (1..maxLoCHperRLC)) OF
DL-LogicalChannelMapping

DL-LogicalChannelMappingList-r5 ::= SEQUENCE (SIZE (1..maxLoCHperRLC)) OF
DL-LogicalChannelMapping-r5

DL-LogicalChannelMappingList-r7 ::= SEQUENCE (SIZE (1..maxLoCHperRLC)) OF
DL-LogicalChannelMapping-r7

DL-Reception-Window-Size-r6 ::= ENUMERATED { size32, size48, size64, size80, size96, size112 }

DL-RFC3095-r4 ::= SEQUENCE {
-- dummy is not used in this version of the specification and shall be ignored by the receiver.
dummy                            CID-InclusionInfo-r4,
max-CID                          INTEGER (1..16383)                DEFAULT 15,
reverseDecompressionDepth        INTEGER (0..65535)                DEFAULT 0
}

DL-RLC-Mode ::= CHOICE {
dl-AM-RLC-Mode                   DL-AM-RLC-Mode,
dl-UM-RLC-Mode                   NULL,
dl-TM-RLC-Mode                   DL-TM-RLC-Mode
}

DL-RLC-Mode-r5 ::= CHOICE {
dl-AM-RLC-Mode                   DL-AM-RLC-Mode-r5,
dl-UM-RLC-Mode                   DL-UM-RLC-Mode-r5,
dl-TM-RLC-Mode                   DL-TM-RLC-Mode
}

DL-RLC-Mode-r6 ::= CHOICE {
dl-AM-RLC-Mode                   DL-AM-RLC-Mode-r5,
dl-UM-RLC-Mode                   DL-UM-RLC-Mode-r6,
dl-TM-RLC-Mode                   DL-TM-RLC-Mode
}

DL-RLC-Mode-r7 ::= CHOICE {
dl-AM-RLC-Mode                   DL-AM-RLC-Mode-r7,
dl-UM-RLC-Mode                   DL-UM-RLC-Mode-r6,
dl-TM-RLC-Mode                   DL-TM-RLC-Mode
}

DL-RLC-Mode-r11 ::= CHOICE {
dl-AM-RLC-Mode                   DL-AM-RLC-Mode-r11,
dl-UM-RLC-Mode                   DL-UM-RLC-Mode-r6,
dl-TM-RLC-Mode                   DL-TM-RLC-Mode
}

DL-RLC-StatusInfo ::= SEQUENCE {
timerStatusProhibit              TimerStatusProhibit            OPTIONAL,
-- dummy is not used in this version of the specification, it should not be sent
-- and if received they should be ignored.
dummy                            TimerEPC                        OPTIONAL,
missingPDU-Indicator              BOOLEAN,
timerStatusPeriodic              TimerStatusPeriodic            OPTIONAL
}

DL-RLC-StatusInfo-r11 ::= SEQUENCE {
timerStatusProhibit              TimerStatusProhibit            OPTIONAL,
missingPDU-Indicator              BOOLEAN,
timerStatusPeriodic              TimerStatusPeriodic            OPTIONAL,
timerReordering                  TimerReordering                OPTIONAL
}

DL-TM-RLC-Mode ::= SEQUENCE {
segmentationIndication            BOOLEAN
}

```

```

DL-TransportChannelType ::=          CHOICE {
    dch                               TransportChannelIdentity,
    fach                              NULL,
    -- The choice "dsch" should not be used in FDD mode, and if received
    -- the UE behaviour is unspecified.
    dsch                              TransportChannelIdentity,
    -- The choice "dch-and-dsch" should not be used in FDD mode, and if received the UE
    -- behaviour is unspecified
    dch-and-dsch                      TransportChannelIdentityDCHandDSCH
}

DL-TransportChannelType-r5 ::=       CHOICE {
    dch                               TransportChannelIdentity,
    fach                              NULL,
    -- The choice "dsch" should not be used in FDD mode, and if received
    -- the UE behaviour is unspecified.
    dsch                              TransportChannelIdentity,
    -- The choice "dch-and-dsch" should not be used in FDD mode, and if received the UE
    -- behaviour is unspecified
    dch-and-dsch                      TransportChannelIdentityDCHandDSCH,
    hsdSCH                            MAC-d-FlowIdentity,
    dch-and-hsdSCH                    MAC-d-FlowIdentityDCHandHSDSCH
}

DL-TransportChannelType-r7 ::=       CHOICE {
    dch                               TransportChannelIdentity,
    fach                              NULL,
    -- The choice "dsch" should not be used in FDD mode, and if received
    -- the UE behaviour is unspecified.
    dsch                              TransportChannelIdentity,
    -- The choice "dch-and-dsch" should not be used in FDD mode, and if received the UE
    -- behaviour is unspecified
    dch-and-dsch                      TransportChannelIdentityDCHandDSCH,
    hsdSCH                            CHOICE {
        mac-hs                        MAC-d-FlowIdentity,
        mac-ehs                       MAC-ehs-QueueId
    },
    dch-and-hsdSCH                    CHOICE {
        mac-hs                        MAC-d-FlowIdentityDCHandHSDSCH,
        mac-ehs                       MAC-ehs-QueueIdDCHandHSDSCH
    }
}

DL-UM-RLC-LI-size ::=               ENUMERATED {
    size7, size15 }

DL-UM-RLC-Mode-r5 ::=               SEQUENCE {
    dl-UM-RLC-LI-size                 DL-UM-RLC-LI-size
}

DL-UM-RLC-Mode-r6 ::=               SEQUENCE {
    dl-UM-RLC-LI-size                 DL-UM-RLC-LI-size,
    dl-Reception-Window-Size          DL-Reception-Window-Size-r6          OPTIONAL
}

ExpectReordering ::=                ENUMERATED {
    reorderingNotExpected,
    reorderingExpected }

ExplicitDiscard ::=                 SEQUENCE {
    timerMRW                           TimerMRW,
    timerDiscard                        TimerDiscard,
    maxMRW                              MaxMRW
}

HeaderCompressionInfo ::=           SEQUENCE {
    algorithmSpecificInfo               AlgorithmSpecificInfo
}

HeaderCompressionInfoList ::=       SEQUENCE (SIZE (1..maxPDCPALgoType)) OF
    HeaderCompressionInfo

HeaderCompressionInfo-r4 ::=         SEQUENCE {
    algorithmSpecificInfo-r4            AlgorithmSpecificInfo-r4
}

HeaderCompressionInfoList-r4 ::=     SEQUENCE (SIZE (1..maxPDCPALgoType)) OF

```

```

HeaderCompressionInfo-r4

LogicalChannelIdentity ::=          INTEGER (1..15)

LosslessSRNS-RelocSupport ::=      CHOICE {
    supported                       MaxPDCP-SN-WindowSize,
    notSupported                     NULL
}

MAC-d-HFN-initial-value ::=        BIT STRING (SIZE (24))

MAC-LogicalChannelPriority ::=      INTEGER (1..8)

-- Actual value MaxCS-Delay = (IE value * 10) + 20
MaxCS-Delay ::=                    INTEGER (0..18)

MaxDAT ::=                          ENUMERATED {
    dat1, dat2, dat3, dat4, dat5, dat6,
    dat7, dat8, dat9, dat10, dat15, dat20,
    dat25, dat30, dat35, dat40 }

MaxDAT-Retransmissions ::=         SEQUENCE {
    maxDAT                           MaxDAT,
    timerMRW                         TimerMRW,
    maxMRW                           MaxMRW
}

MaxMRW ::=                          ENUMERATED {
    mm1, mm4, mm6, mm8, mm12, mm16,
    mm24, mm32 }

MaxPDCP-SN-WindowSize ::=          ENUMERATED {
    sn255, sn65535 }

MaxRST ::=                          ENUMERATED {
    rst1, rst4, rst6, rst8, rst12,
    rst16, rst24, rst32 }

NoExplicitDiscard ::=              ENUMERATED {
    dt10, dt20, dt30, dt40, dt50,
    dt60, dt70, dt80, dt90, dt100 }

PDCP-Info ::=                      SEQUENCE {
    losslessSRNS-RelocSupport         LosslessSRNS-RelocSupport           OPTIONAL,
    -- TABULAR: pdcP-PDU-Header is MD in the tabular format and it can be encoded
    -- in one bit, so the OPTIONAL is removed for compactness.
    pdcP-PDU-Header                   PDCP-PDU-Header,
    headerCompressionInfoList         HeaderCompressionInfoList         OPTIONAL
}

PDCP-Info-r4 ::=                   SEQUENCE {
    losslessSRNS-RelocSupport         LosslessSRNS-RelocSupport           OPTIONAL,
    -- TABULAR: pdcP-PDU-Header is MD in the tabular format and it can be encoded
    -- in one bit, so the OPTIONAL is removed for compactness.
    pdcP-PDU-Header                   PDCP-PDU-Header,
    headerCompressionInfoList         HeaderCompressionInfoList-r4       OPTIONAL
}

PDCP-InfoReconfig ::=              SEQUENCE {
    pdcP-Info                         PDCP-Info,
    -- dummy is not used in this version of the specification and
    -- it should be ignored.
    dummy                              INTEGER (0..65535)
}

PDCP-InfoReconfig-r4 ::=           SEQUENCE {
    pdcP-Info                         PDCP-Info-r4
}

PDCP-PDU-Header ::=                ENUMERATED {
    present, absent }

PDCP-ROHC-TargetMode ::=           ENUMERATED { o-Mode, r-Mode }

PDCP-SN-Info ::=                   INTEGER (0..65535)

Poll-PDU ::=                        ENUMERATED {
    pdu1, pdu2, pdu4, pdu8, pdu16,

```

```

        pdu32, pdu64, pdu128 }

Poll-SDU ::=
    ENUMERATED {
        sdu1, sdu4, sdu16, sdu64 }

PollingInfo ::=
    SEQUENCE {
        timerPollProhibit      TimerPollProhibit      OPTIONAL,
        timerPoll              TimerPoll              OPTIONAL,
        poll-PDU              Poll-PDU              OPTIONAL,
        poll-SDU              Poll-SDU              OPTIONAL,
        lastTransmissionPDU-Poll  BOOLEAN,
        lastRetransmissionPDU-Poll  BOOLEAN,
        pollWindow            PollWindow            OPTIONAL,
        timerPollPeriodic      TimerPollPeriodic      OPTIONAL
    }

PollWindow ::=
    ENUMERATED {
        pw50, pw60, pw70, pw80, pw85,
        pw90, pw95, pw99 }

PredefinedConfigIdentity ::=
    INTEGER (0..15)

PredefinedConfigValueTag ::=
    INTEGER (0..15)

PredefinedRB-Configuration ::=
    SEQUENCE {
        re-EstablishmentTimer      Re-EstablishmentTimer,
        srb-InformationList         SRB-InformationSetupList,
        rb-InformationList         RB-InformationSetupList
    }

PreDefRadioConfiguration ::=
    SEQUENCE {
        -- Radio bearer IEs
        predefinedRB-Configuration      PredefinedRB-Configuration,
        -- Transport channel IEs
        preDefTransChConfiguration      PreDefTransChConfiguration,
        -- Physical channel IEs
        preDefPhyChConfiguration        PreDefPhyChConfiguration
    }

PreDefRadioConfiguration-v770ext ::= SEQUENCE {
    -- Physical channel IEs
    preDefPhyChConfiguration      PreDefPhyChConfiguration-v770ext
}

PreDefRadioConfiguration-v920ext ::= SEQUENCE {
    -- Transport channel IEs
    mac-ehsWindowSize             MAC-hs-WindowSize-r9
}

PredefinedConfigStatusList ::=
    SEQUENCE (SIZE (maxPredefConfig)) OF
    PredefinedConfigStatusInfo

PredefinedConfigStatusInfo ::=
    CHOICE {
        storedWithValueTagSameAsPrevious      NULL,
        other                                  CHOICE {
            notStored                          NULL,
            storedWithDifferentValueTag        PredefinedConfigValueTag
        }
    }

PredefinedConfigStatusListComp ::= SEQUENCE {
    setsWithDifferentValueTag      PredefinedConfigSetsWithDifferentValueTag,
    otherEntries                   PredefinedConfigStatusListVarSz      OPTIONAL
}

PredefinedConfigSetsWithDifferentValueTag ::= SEQUENCE (SIZE (1..2)) OF
    PredefinedConfigSetWithDifferentValueTag

PredefinedConfigSetWithDifferentValueTag ::= SEQUENCE {
    startPosition                  INTEGER (0..10)      DEFAULT 0,
    -- numberOfEntries             INTEGER (6..16),
    -- numberOfEntries is covered by the size of the list in IE PredefinedConfigValueTagList
    valueTagList                  PredefinedConfigValueTagList
}

PredefinedConfigValueTagList ::=
    SEQUENCE (SIZE (1..maxPredefConfig)) OF
    PredefinedConfigValueTag

```

```

PredefinedConfigStatusListVarSz ::= SEQUENCE (SIZE (1..maxPredefConfig)) OF
                                      PredefinedConfigStatusInfo

RAB-Info ::= SEQUENCE {
  rab-Identity          RAB-Identity,
  cn-DomainIdentity    CN-DomainIdentity,
  nas-Synchronisation-Indicator NAS-Synchronisation-Indicator OPTIONAL,
  re-EstablishmentTimer Re-EstablishmentTimer
}

RAB-Info-r6-ext ::= SEQUENCE {
  mbms-SessionIdentity MBMS-SessionIdentity OPTIONAL
}

RAB-Info-v6b0ext ::= SEQUENCE {
  mbms-ServiceIdentity OCTET STRING (SIZE (3))
}

RAB-Info-r6 ::= SEQUENCE {
  rab-Identity          RAB-Identity,
  mbms-SessionIdentity MBMS-SessionIdentity OPTIONAL,
  cn-DomainIdentity    CN-DomainIdentity,
  nas-Synchronisation-Indicator NAS-Synchronisation-Indicator OPTIONAL,
  re-EstablishmentTimer Re-EstablishmentTimer
}

RAB-Info-r7 ::= SEQUENCE {
  rab-Identity          RAB-Identity,
  mbms-SessionIdentity MBMS-SessionIdentity OPTIONAL,
  mbms-ServiceIdentity OCTET STRING (SIZE (3)) OPTIONAL,
  cn-DomainIdentity    CN-DomainIdentity,
  nas-Synchronisation-Indicator NAS-Synchronisation-Indicator OPTIONAL,
  re-EstablishmentTimer Re-EstablishmentTimer
}

RAB-InfoReplace ::= SEQUENCE {
  rab-Identity          RAB-Identity,
  cn-DomainIdentity    CN-DomainIdentity
}

RAB-InformationList ::= SEQUENCE (SIZE (1..maxRABsetup)) OF
  RAB-Info

RAB-InformationList-r6 ::= SEQUENCE (SIZE (1..maxRABsetup)) OF
  RAB-Info-r6

RAB-InformationReconfigList ::= SEQUENCE (SIZE (1.. maxRABsetup)) OF
  RAB-InformationReconfig

RAB-InformationReconfigList-r8 ::= SEQUENCE (SIZE (1..maxRABsetup)) OF
  RAB-InformationReconfig-r8

RAB-InformationReconfig ::= SEQUENCE {
  rab-Identity          RAB-Identity,
  cn-DomainIdentity    CN-DomainIdentity,
  nas-Synchronisation-Indicator NAS-Synchronisation-Indicator
}

RAB-InformationReconfig-r8 ::= SEQUENCE {
  rab-Identity          RAB-Identity,
  cn-DomainIdentity    CN-DomainIdentity,
  nas-Synchronisation-Indicator NAS-Synchronisation-Indicator,
  cs-HSPA-Information  CS-HSPA-Information OPTIONAL
}

RAB-Info-Post ::= SEQUENCE {
  rab-Identity          RAB-Identity,
  cn-DomainIdentity    CN-DomainIdentity,
  nas-Synchronisation-Indicator NAS-Synchronisation-Indicator OPTIONAL
}

RAB-InformationMBMSPTp ::= SEQUENCE {
  rb-Identity          RB-Identity,
  mbms-ServiceIdentity OCTET STRING (SIZE (3)),
  mbms-SessionIdentity MBMS-SessionIdentity OPTIONAL
}

```



```

RAB-InformationMBMSptpList ::= SEQUENCE (SIZE (1..maxMBMSservSelect)) OF
                                RAB-InformationMBMSptp

RAB-InformationSetup ::= SEQUENCE {
    rab-Info RAB-Info,
    rb-InformationSetupList RB-InformationSetupList
}

RAB-InformationSetup-r4 ::= SEQUENCE {
    rab-Info RAB-Info,
    rb-InformationSetupList RB-InformationSetupList-r4
}

RAB-InformationSetup-r5 ::= SEQUENCE {
    rab-Info RAB-Info,
    rb-InformationSetupList RB-InformationSetupList-r5
}

RAB-InformationSetup-r6-ext ::= SEQUENCE {
    rab-Info-r6-ext RAB-Info-r6-ext
}

RAB-InformationSetup-r6 ::= SEQUENCE {
    rab-Info RAB-Info-r6,
    rb-InformationSetupList RB-InformationSetupList-r6
}

RAB-InformationSetup-v6b0ext ::= SEQUENCE {
    rab-Info-v6b0ext RAB-Info-v6b0ext OPTIONAL
}

RAB-InformationSetup-r7 ::= SEQUENCE {
    rab-Info RAB-Info-r7,
    rb-InformationSetupList RB-InformationSetupList-r7
}

RAB-InformationSetup-r8 ::= SEQUENCE {
    rab-Info RAB-Info-r7,
    cs-HSPA-Information CS-HSPA-Information OPTIONAL,
    rab-InfoReplace RAB-InfoReplace OPTIONAL,
    rb-InformationSetupList RB-InformationSetupList-r8
}

RAB-InformationSetup-v820ext ::= SEQUENCE {
    cs-HSPA-Information CS-HSPA-Information OPTIONAL
}

RAB-InformationSetup-r11 ::= SEQUENCE {
    rab-Info RAB-Info-r7,
    cs-HSPA-Information CS-HSPA-Information OPTIONAL,
    rab-InfoReplace RAB-InfoReplace OPTIONAL,
    rb-InformationSetupList RB-InformationSetupList-r11
}

RAB-InformationSetupList ::= SEQUENCE (SIZE (1..maxRABsetup)) OF
                                RAB-InformationSetup

RAB-InformationSetupList-r4 ::= SEQUENCE (SIZE (1..maxRABsetup)) OF
                                RAB-InformationSetup-r4

RAB-InformationSetupList-r5 ::= SEQUENCE (SIZE (1..maxRABsetup)) OF
                                RAB-InformationSetup-r5

RAB-InformationSetupList-r6 ::= SEQUENCE (SIZE (1..maxRABsetup)) OF
                                RAB-InformationSetup-r6

-- The IE 'RAB-InformationSetupList-r6-ext' provides elements of extension information, which
-- are added to the corresponding elements of the IE 'RAB-InformationSetupList/-r4/-r5'.
RAB-InformationSetupList-r6-ext ::= SEQUENCE (SIZE (1..maxRABsetup)) OF
                                RAB-InformationSetup-r6-ext

RAB-InformationSetupList-v6b0ext ::= SEQUENCE (SIZE (1..maxRABsetup)) OF
                                RAB-InformationSetup-v6b0ext

RAB-InformationSetupList-r7 ::= SEQUENCE (SIZE (1..maxRABsetup)) OF
                                RAB-InformationSetup-r7

RAB-InformationSetupList-r8 ::= SEQUENCE (SIZE (1..maxRABsetup)) OF

```

```

RAB-InformationSetup-r8
RAB-InformationSetupList-v820ext ::= SEQUENCE (SIZE (1..maxRABsetup)) OF
RAB-InformationSetup-v820ext
RAB-InformationSetupList-r11 ::= SEQUENCE (SIZE (1..maxRABsetup)) OF
RAB-InformationSetup-r11
RB-ActivationTimeInfo ::= SEQUENCE {
rb-Identity RB-Identity,
rlc-SequenceNumber RLC-SequenceNumber
}
RB-ActivationTimeInfoList ::= SEQUENCE (SIZE (1..maxRB)) OF
RB-ActivationTimeInfo
RB-COUNT-C-Information ::= SEQUENCE {
rb-Identity RB-Identity,
count-C-UL COUNT-C,
count-C-DL COUNT-C
}
RB-COUNT-C-InformationList ::= SEQUENCE (SIZE (1..maxRBallRABs)) OF
RB-COUNT-C-Information
RB-COUNT-C-MSB-Information ::= SEQUENCE {
rb-Identity RB-Identity,
count-C-MSB-UL COUNT-C-MSB,
count-C-MSB-DL COUNT-C-MSB
}
RB-COUNT-C-MSB-InformationList ::= SEQUENCE (SIZE (1..maxRBallRABs)) OF
RB-COUNT-C-MSB-Information
RB-Identity ::= INTEGER (1..32)
RB-IdentityList ::= SEQUENCE (SIZE (1..maxRB)) OF
RB-Identity
RB-InformationAffected ::= SEQUENCE {
rb-Identity RB-Identity,
rb-MappingInfo RB-MappingInfo
}
RB-InformationAffected-r5 ::= SEQUENCE {
rb-Identity RB-Identity,
rb-MappingInfo RB-MappingInfo-r5
}
RB-InformationAffected-r6 ::= SEQUENCE {
rb-Identity RB-Identity,
rb-MappingInfo RB-MappingInfo-r6
}
RB-InformationAffected-r7 ::= SEQUENCE {
rb-Identity RB-Identity,
rb-MappingInfo RB-MappingInfo-r7
}
RB-InformationAffected-r8 ::= SEQUENCE {
rb-Identity RB-Identity,
rb-MappingInfo RB-MappingInfo-r8
}
RB-InformationAffectedList ::= SEQUENCE (SIZE (1..maxRB)) OF
RB-InformationAffected
RB-InformationAffectedList-r5 ::= SEQUENCE (SIZE (1..maxRB)) OF
RB-InformationAffected-r5
RB-InformationAffectedList-r6 ::= SEQUENCE (SIZE (1..maxRB)) OF
RB-InformationAffected-r6
RB-InformationAffectedList-r7 ::= SEQUENCE (SIZE (1..maxRB)) OF
RB-InformationAffected-r7
RB-InformationAffectedList-r8 ::= SEQUENCE (SIZE (1..maxRB)) OF
RB-InformationAffected-r8

```

```

RB-InformationChanged-r6 ::=          SEQUENCE {
  rb-Identity                        RB-Identity,
  rb-Change                          CHOICE {
    release                          NULL,
    re-mapToDefaultRb                RB-Identity
  }
}

RB-InformationChangedList-r6 ::=      SEQUENCE (SIZE (1..maxRB)) OF
                                      RB-InformationChanged-r6

RB-InformationReconfig ::=           SEQUENCE {
  rb-Identity                        RB-Identity,
  pdcp-Info                          PDCP-InfoReconfig                OPTIONAL,
  pdcp-SN-Info                       PDCP-SN-Info                    OPTIONAL,
  rlc-Info                           RLC-Info                        OPTIONAL,
  rb-MappingInfo                     RB-MappingInfo                 OPTIONAL,
  rb-StopContinue                    RB-StopContinue                 OPTIONAL
}

RB-InformationReconfig-r4 ::=        SEQUENCE {
  rb-Identity                        RB-Identity,
  pdcp-Info                          PDCP-InfoReconfig-r4            OPTIONAL,
  pdcp-SN-Info                       PDCP-SN-Info                    OPTIONAL,
  rlc-Info                           RLC-Info                        OPTIONAL,
  rb-MappingInfo                     RB-MappingInfo                 OPTIONAL,
  rb-StopContinue                    RB-StopContinue                 OPTIONAL
}

RB-InformationReconfig-r5 ::=        SEQUENCE {
  rb-Identity                        RB-Identity,
  pdcp-Info                          PDCP-InfoReconfig-r4            OPTIONAL,
  pdcp-SN-Info                       PDCP-SN-Info                    OPTIONAL,
  rlc-Info                           RLC-Info-r5                     OPTIONAL,
  rb-MappingInfo                     RB-MappingInfo-r5              OPTIONAL,
  rb-StopContinue                    RB-StopContinue                 OPTIONAL
}

RB-InformationReconfig-r6 ::=        SEQUENCE {
  rb-Identity                        RB-Identity,
  pdcp-Info                          PDCP-InfoReconfig-r4            OPTIONAL,
  pdcp-SN-Info                       PDCP-SN-Info                    OPTIONAL,
  rlc-Info                           RLC-Info-r6                     OPTIONAL,
  rb-MappingInfo                     RB-MappingInfo-r6              OPTIONAL,
  rb-StopContinue                    RB-StopContinue                 OPTIONAL
}

RB-InformationReconfig-r7 ::=        SEQUENCE {
  rb-Identity                        RB-Identity,
  pdcp-Info                          PDCP-InfoReconfig-r4            OPTIONAL,
  pdcp-SN-Info                       PDCP-SN-Info                    OPTIONAL,
  rlc-Info                           RLC-Info-r7                     OPTIONAL,
  rb-MappingInfo                     RB-MappingInfo-r7              OPTIONAL,
  rb-StopContinue                    RB-StopContinue                 OPTIONAL
}

RB-InformationReconfig-r8 ::=        SEQUENCE {
  rb-Identity                        RB-Identity,
  pdcp-Info                          PDCP-InfoReconfig-r4            OPTIONAL,
  pdcp-SN-Info                       PDCP-SN-Info                    OPTIONAL,
  rlc-Info                           RLC-Info-r7                     OPTIONAL,
  rb-MappingInfo                     RB-MappingInfo-r8              OPTIONAL,
  rb-StopContinue                    RB-StopContinue                 OPTIONAL
}

RB-InformationReconfig-r11 ::=       SEQUENCE {
  rb-Identity                        RB-Identity,
  pdcp-Info                          PDCP-InfoReconfig-r4            OPTIONAL,
  pdcp-SN-Info                       PDCP-SN-Info                    OPTIONAL,
  rlc-Info                           RLC-Info-r11                    OPTIONAL,
  rb-MappingInfo                     RB-MappingInfo-r8              OPTIONAL,
  rb-StopContinue                    RB-StopContinue                 OPTIONAL
}

RB-InformationReconfigList ::=       SEQUENCE (SIZE (1..maxRB)) OF
                                      RB-InformationReconfig

```

```

RB-InformationReconfigList-r4 ::= SEQUENCE (SIZE (1..maxRB)) OF
    RB-InformationReconfig-r4

RB-InformationReconfigList-r5 ::= SEQUENCE (SIZE (1..maxRB)) OF
    RB-InformationReconfig-r5

RB-InformationReconfigList-r6 ::= SEQUENCE (SIZE (1..maxRB)) OF
    RB-InformationReconfig-r6

RB-InformationReconfigList-r7 ::= SEQUENCE (SIZE (1..maxRB)) OF
    RB-InformationReconfig-r7

RB-InformationReconfigList-r8 ::= SEQUENCE (SIZE (1..maxRB)) OF
    RB-InformationReconfig-r8

RB-InformationReconfigList-r11 ::= SEQUENCE (SIZE (1..maxRB)) OF
    RB-InformationReconfig-r11

RB-InformationReleaseList ::= SEQUENCE (SIZE (1..maxRB)) OF
    RB-Identity

RB-InformationSetup ::= SEQUENCE {
    rb-Identity
    pdcp-Info
    rlc-InfoChoice
    rb-MappingInfo
}

RB-InformationSetup-r4 ::= SEQUENCE {
    rb-Identity
    pdcp-Info
    rlc-InfoChoice
    rb-MappingInfo
}

RB-InformationSetup-r5 ::= SEQUENCE {
    rb-Identity
    pdcp-Info
    rlc-InfoChoice
    rb-MappingInfo
}

RB-InformationSetup-r6 ::= SEQUENCE {
    rb-Identity
    pdcp-Info
    rlc-InfoChoice
    rb-MappingInfo
}

RB-InformationSetup-r7 ::= SEQUENCE {
    rb-Identity
    pdcp-Info
    rlc-InfoChoice
    rb-MappingInfo
}

RB-InformationSetup-r8 ::= SEQUENCE {
    rb-Identity
    pdcp-Info
    rlc-InfoChoice
    rb-MappingInfo
}

RB-InformationSetup-r11 ::= SEQUENCE {
    rb-Identity
    pdcp-Info
    rlc-InfoChoice
    rb-MappingInfo
}

RB-InformationSetupList ::= SEQUENCE (SIZE (1..maxRBperRAB)) OF
    RB-InformationSetup

RB-InformationSetupList-r4 ::= SEQUENCE (SIZE (1..maxRBperRAB)) OF
    RB-InformationSetup-r4

RB-InformationSetupList-r5 ::= SEQUENCE (SIZE (1..maxRBperRAB)) OF
    RB-InformationSetup-r5

```

```

RB-InformationSetupList-r6 ::= SEQUENCE (SIZE (1..maxRBperRAB)) OF
                               RB-InformationSetup-r6

RB-InformationSetupList-r7 ::= SEQUENCE (SIZE (1..maxRBperRAB)) OF
                               RB-InformationSetup-r7

RB-InformationSetupList-r8 ::= SEQUENCE (SIZE (1..maxRBperRAB)) OF
                               RB-InformationSetup-r8

RB-InformationSetupList-r11 ::= SEQUENCE (SIZE (1..maxRBperRAB)) OF
                                RB-InformationSetup-r11

RB-MappingInfo ::= SEQUENCE (SIZE (1..maxRBMuxOptions)) OF
                   RB-MappingOption

RB-MappingInfo-r5 ::= SEQUENCE (SIZE (1..maxRBMuxOptions)) OF
                      RB-MappingOption-r5

RB-MappingInfo-r6 ::= SEQUENCE (SIZE (1..maxRBMuxOptions)) OF
                      RB-MappingOption-r6

RB-MappingInfo-r7 ::= SEQUENCE (SIZE (1..maxRBMuxOptions)) OF
                      RB-MappingOption-r7

RB-MappingInfo-r8 ::= SEQUENCE (SIZE (1..maxRBMuxOptions)) OF
                      RB-MappingOption-r8

RB-MappingOption ::= SEQUENCE {
    ul-LogicalChannelMappings          UL-LogicalChannelMappings          OPTIONAL,
    dl-LogicalChannelMappingList      DL-LogicalChannelMappingList      OPTIONAL
}

RB-MappingOption-r5 ::= SEQUENCE {
    ul-LogicalChannelMappings          UL-LogicalChannelMappings          OPTIONAL,
    dl-LogicalChannelMappingList-r5    DL-LogicalChannelMappingList-r5    OPTIONAL
}

RB-MappingOption-r6 ::= SEQUENCE {
    ul-LogicalChannelMappings-r6      UL-LogicalChannelMappings-r6      OPTIONAL,
    dl-LogicalChannelMappingList-r5    DL-LogicalChannelMappingList-r5    OPTIONAL
}

RB-MappingOption-r7 ::= SEQUENCE {
    ul-LogicalChannelMappings-r6      UL-LogicalChannelMappings-r6      OPTIONAL,
    dl-LogicalChannelMappingList-r7    DL-LogicalChannelMappingList-r7    OPTIONAL
}

RB-MappingOption-r8 ::= SEQUENCE {
    ul-LogicalChannelMappings-r8      UL-LogicalChannelMappings-r8      OPTIONAL,
    dl-LogicalChannelMappingList-r7    DL-LogicalChannelMappingList-r7    OPTIONAL
}

RB-PDCPContextRelocation ::= SEQUENCE {
    rb-Identity                        RB-Identity,
    dl-RFC3095-Context-Relocation      BOOLEAN,
    ul-RFC3095-Context-Relocation      BOOLEAN
}

RB-PDCPContextRelocationList ::= SEQUENCE (SIZE (1..maxRBallRABs)) OF
                                  RB-PDCPContextRelocation

RB-StopContinue ::= ENUMERATED {
    stopRB, continueRB }

RB-WithPDCP-Info ::= SEQUENCE {
    rb-Identity                        RB-Identity,
    pdcp-SN-Info                       PDCP-SN-Info
}

RB-WithPDCP-InfoList ::= SEQUENCE (SIZE (1..maxRBallRABs)) OF
                          RB-WithPDCP-Info

ReceivingWindowSize ::= ENUMERATED {
    rw1, rw8, rw16, rw32, rw64, rw128, rw256,
    rw512, rw768, rw1024, rw1536, rw2047,
    rw2560, rw3072, rw3584, rw4095 }

```

```

RFC2507-Info ::=
    f-MAX-PERIOD                INTEGER (1..65535)                DEFAULT 256,
    f-MAX-TIME                   INTEGER (1..255)                DEFAULT 5,
    max-HEADER                   INTEGER (60..65535)            DEFAULT 168,
    tcp-SPACE                    INTEGER (3..255)                DEFAULT 15,
    non-TCP-SPACE                INTEGER (3..65535)            DEFAULT 15,
    -- TABULAR: expectReordering has only two possible values, so using Optional or Default
    -- would be wasteful
    expectReordering             ExpectReordering
}

RFC3095-Info-r4 ::=
    rohcProfileList             ROHC-ProfileList-r4,
    ul-RFC3095                  UL-RFC3095-r4                    OPTIONAL,
    dl-RFC3095                  DL-RFC3095-r4                    OPTIONAL
}

RLC-Info ::=
    ul-RLC-Mode                 UL-RLC-Mode                     OPTIONAL,
    dl-RLC-Mode                 DL-RLC-Mode                     OPTIONAL
}

RLC-Info-r5 ::=
    ul-RLC-Mode                 UL-RLC-Mode                     OPTIONAL,
    dl-RLC-Mode                 DL-RLC-Mode-r5                  OPTIONAL,
    rlc-OneSidedReEst           BOOLEAN
}

RLC-Info-r6 ::=
    ul-RLC-Mode                 UL-RLC-Mode                     OPTIONAL,
    dl-RLC-Mode                 DL-RLC-Mode-r6                  OPTIONAL,
    rlc-OneSidedReEst           BOOLEAN,
    altE-bitInterpretation      ENUMERATED { true }            OPTIONAL
}

RLC-Info-r7 ::=
    ul-RLC-Mode                 UL-RLC-Mode                     OPTIONAL,
    dl-RLC-Mode                 DL-RLC-Mode-r7                  OPTIONAL,
    rlc-OneSidedReEst           BOOLEAN,
    altE-bitInterpretation      ENUMERATED { true }            OPTIONAL,
    useSpecialValueOfHEField    ENUMERATED { true }            OPTIONAL
}

RLC-Info-r11 ::=
    ul-RLC-Mode                 UL-RLC-Mode                     OPTIONAL,
    dl-RLC-Mode                 DL-RLC-Mode-r11                 OPTIONAL,
    rlc-OneSidedReEst           BOOLEAN,
    altE-bitInterpretation      ENUMERATED { true }            OPTIONAL,
    useSpecialValueOfHEField    ENUMERATED { true }            OPTIONAL
}

RLC-Info-MCCH-r6 ::=
    dl-UM-RLC-LI-size           DL-UM-RLC-LI-size,
    dl-UM-RLC-OutOSeqDelivery-Info UM-RLC-OutOSeqDelivery-Info-r6  OPTIONAL
}

RLC-Info-MSCH-r6 ::=
    dl-UM-RLC-LI-size           DL-UM-RLC-LI-size
}

RLC-Info-MTCH-r6 ::=
    dl-UM-RLC-LI-size           DL-UM-RLC-LI-size,
    dl-UM-RLC-DuplAvoid-Reord-Info UM-RLC-DuplAvoid-Reord-Info-r6  OPTIONAL
}

RLC-InfoChoice ::=
    rlc-Info                     RLC-Info,
    same-as-RB                    RB-Identity
}

RLC-InfoChoice-r5 ::=
    rlc-Info                     RLC-Info-r5,
    same-as-RB                    RB-Identity
}

RLC-InfoChoice-r6 ::=
    rlc-Info                     RLC-Info-r6,
    same-as-RB                    RB-Identity
}

```

```

}
RLC-InfoChoice-r7 ::= CHOICE {
    rlc-Info          RLC-Info-r7,
    same-as-RB       RB-Identity
}
RLC-InfoChoice-r11 ::= CHOICE {
    rlc-Info          RLC-Info-r11,
    same-as-RB       RB-Identity
}
RLC-PDU-Size ::= OctetModeRLC-SizeInfoType1
RLC-PDU-SizeConstraint ::= SEQUENCE {
    lengthIndicatorSize    ENUMERATED { size7, size15 }    OPTIONAL,
    -- the actual values are (IE value * 8) + 16
    minRLC-PDU-Size       INTEGER (0..1503),
    largestRLC-PDU-Size   INTEGER (0..1503)
}
RLC-PDU-SizeList ::= SEQUENCE (SIZE (1..maxRLCPDUsizePerLogChan)) OF
    RLC-PDU-Size
RLC-SequenceNumber ::= INTEGER (0..4095)
RLC-SizeInfo ::= SEQUENCE {
    rlc-SizeIndex         INTEGER (1..maxTF)
}
RLC-SizeExplicitList ::= SEQUENCE (SIZE (1..maxTF)) OF
    RLC-SizeInfo
ROHC-Profile-r4 ::= INTEGER (1..3)
ROHC-ProfileList-r4 ::= SEQUENCE (SIZE (1..maxROHC-Profile-r4)) OF
    ROHC-Profile-r4
ROHC-PacketSize-r4 ::= INTEGER (2..1500)
ROHC-PacketSizeList-r4 ::= SEQUENCE (SIZE (1..maxROHC-PacketSizes-r4)) OF
    ROHC-PacketSize-r4
SRB-InformationSetup ::= SEQUENCE {
    -- The default value for rb-Identity is the smallest value not used yet.
    rb-Identity          RB-Identity                      OPTIONAL,
    rlc-InfoChoice       RLC-InfoChoice,
    rb-MappingInfo       RB-MappingInfo
}
SRB-InformationSetup-r5 ::= SEQUENCE {
    -- The default value for rb-Identity is the smallest value not used yet.
    rb-Identity          RB-Identity                      OPTIONAL,
    rlc-InfoChoice       RLC-InfoChoice-r5,
    rb-MappingInfo       RB-MappingInfo-r5
}
SRB-InformationSetup-r6 ::= SEQUENCE {
    -- The default value for rb-Identity is the smallest value not used yet.
    rb-Identity          RB-Identity                      OPTIONAL,
    rlc-InfoChoice       RLC-InfoChoice-r6,
    rb-MappingInfo       RB-MappingInfo-r6
}
SRB-InformationSetup-r7 ::= SEQUENCE {
    -- The default value for rb-Identity is the smallest value not used yet.
    rb-Identity          RB-Identity                      OPTIONAL,
    rlc-InfoChoice       RLC-InfoChoice-r7,
    rb-MappingInfo       RB-MappingInfo-r7
}
SRB-InformationSetup-r8 ::= SEQUENCE {
    -- The default value for rb-Identity is the smallest value not used yet.
    rb-Identity          RB-Identity                      OPTIONAL,
    rlc-InfoChoice       RLC-InfoChoice-r7,
    rb-MappingInfo       RB-MappingInfo-r8
}

```

```

SRB-InformationSetup-r11 ::=          SEQUENCE {
  -- The default value for rb-Identity is the smallest value not used yet.
  rb-Identity                        RB-Identity                               OPTIONAL,
  rlc-InfoChoice                     RLC-InfoChoice-r11,
  rb-MappingInfo                     RB-MappingInfo-r8
}

SRB-InformationSetupList ::=          SEQUENCE (SIZE (1..maxSRBsetup)) OF
  SRB-InformationSetup

SRB-InformationSetupList-r5 ::=       SEQUENCE (SIZE (1..maxSRBsetup)) OF
  SRB-InformationSetup-r5

SRB-InformationSetupList-r6 ::=       SEQUENCE (SIZE (1..maxSRBsetup)) OF
  SRB-InformationSetup-r6

SRB-InformationSetupList-r7 ::=       SEQUENCE (SIZE (1..maxSRBsetup)) OF
  SRB-InformationSetup-r7

SRB-InformationSetupList-r8 ::=       SEQUENCE (SIZE (1..maxSRBsetup)) OF
  SRB-InformationSetup-r8

SRB-InformationSetupList-r11 ::=      SEQUENCE (SIZE (1..maxSRBsetup)) OF
  SRB-InformationSetup-r11

SRB-InformationSetupList2 ::=         SEQUENCE (SIZE (3..4)) OF
  SRB-InformationSetup

SRB-InformationSetupList2-r6 ::=      SEQUENCE (SIZE (3..4)) OF
  SRB-InformationSetup-r6

SRB-InformationSetupList2-r7 ::=      SEQUENCE (SIZE (3..4)) OF
  SRB-InformationSetup-r7

SRB-InformationSetupList2-r8 ::=      SEQUENCE (SIZE (3..4)) OF
  SRB-InformationSetup-r8

TimerDAR-r6 ::=                       ENUMERATED {
  ms40, ms80, ms120, ms160, ms240, ms320, ms480, ms640,
  ms960, ms1280, ms1920, ms2560, ms3840, ms5120 }

TimerDiscard ::=                      ENUMERATED {
  td0-1, td0-25, td0-5, td0-75,
  td1, td1-25, td1-5, td1-75,
  td2, td2-5, td3, td3-5, td4,
  td4-5, td5, td7-5 }

TimerEPC ::=                          ENUMERATED {
  te50, te60, te70, te80, te90,
  te100, te120, te140, te160, te180,
  te200, te300, te400, te500, te700,
  te900 }

TimerMRW ::=                          ENUMERATED {
  te50, te60, te70, te80, te90, te100,
  te120, te140, te160, te180, te200,
  te300, te400, te500, te700, te900 }

TimerOSD-r6 ::=                       ENUMERATED {
  ms40, ms80, ms120, ms160, ms240, ms320, ms480, ms640,
  ms960, ms1280, ms1920, ms2560, ms3840, ms5120 }

TimerPoll ::=                         ENUMERATED {
  tp10, tp20, tp30, tp40, tp50,
  tp60, tp70, tp80, tp90, tp100,
  tp110, tp120, tp130, tp140, tp150,
  tp160, tp170, tp180, tp190, tp200,
  tp210, tp220, tp230, tp240, tp250,
  tp260, tp270, tp280, tp290, tp300,
  tp310, tp320, tp330, tp340, tp350,
  tp360, tp370, tp380, tp390, tp400,
  tp410, tp420, tp430, tp440, tp450,
  tp460, tp470, tp480, tp490, tp500,
  tp510, tp520, tp530, tp540, tp550,
  tp600, tp650, tp700, tp750, tp800,
  tp850, tp900, tp950, tp1000 }

TimerPollPeriodic ::=                ENUMERATED {

```



```

tper100, tper200, tper300, tper400,
tper500, tper750, tper1000, tper2000 }

TimerPollProhibit ::=          ENUMERATED {
    tpp10, tpp20, tpp30, tpp40, tpp50,
    tpp60, tpp70, tpp80, tpp90, tpp100,
    tpp110, tpp120, tpp130, tpp140, tpp150,
    tpp160, tpp170, tpp180, tpp190, tpp200,
    tpp210, tpp220, tpp230, tpp240, tpp250,
    tpp260, tpp270, tpp280, tpp290, tpp300,
    tpp310, tpp320, tpp330, tpp340, tpp350,
    tpp360, tpp370, tpp380, tpp390, tpp400,
    tpp410, tpp420, tpp430, tpp440, tpp450,
    tpp460, tpp470, tpp480, tpp490, tpp500,
    tpp510, tpp520, tpp530, tpp540, tpp550,
    tpp600, tpp650, tpp700, tpp750, tpp800,
    tpp850, tpp900, tpp950, tpp1000 }

TimerReordering ::=           ENUMERATED {
    tr50, tr100, tr150, tr200, tr400, tr600, tr800, tr1000 }

TimerRST ::=                  ENUMERATED {
    tr50, tr100, tr150, tr200, tr250, tr300,
    tr350, tr400, tr450, tr500, tr550,
    tr600, tr700, tr800, tr900, tr1000 }

TimerStatusPeriodic ::=      ENUMERATED {
    tsp100, tsp200, tsp300, tsp400, tsp500,
    tsp750, tsp1000, tsp2000 }

TimerStatusProhibit ::=      ENUMERATED {
    tsp10, tsp20, tsp30, tsp40, tsp50,
    tsp60, tsp70, tsp80, tsp90, tsp100,
    tsp110, tsp120, tsp130, tsp140, tsp150,
    tsp160, tsp170, tsp180, tsp190, tsp200,
    tsp210, tsp220, tsp230, tsp240, tsp250,
    tsp260, tsp270, tsp280, tsp290, tsp300,
    tsp310, tsp320, tsp330, tsp340, tsp350,
    tsp360, tsp370, tsp380, tsp390, tsp400,
    tsp410, tsp420, tsp430, tsp440, tsp450,
    tsp460, tsp470, tsp480, tsp490, tsp500,
    tsp510, tsp520, tsp530, tsp540, tsp550,
    tsp600, tsp650, tsp700, tsp750, tsp800,
    tsp850, tsp900, tsp950, tsp1000 }

TransmissionRLC-Discard ::=   CHOICE {
    timerBasedExplicit          ExplicitDiscard,
    timerBasedNoExplicit        NoExplicitDiscard,
    maxDAT-Retransmissions      MaxDAT-Retransmissions,
    noDiscard                    MaxDAT
}

TransmissionWindowSize ::=    ENUMERATED {
    tw1, tw8, tw16, tw32, tw64, tw128, tw256,
    tw512, tw768, tw1024, tw1536, tw2047,
    tw2560, tw3072, tw3584, tw4095 }

-- Actual bit rate per each value is defined in [62] and [63]
UL-AMR-Rate ::=              ENUMERATED {
    t0, t1, t2, t3, t4, t5, t6, t7, t8, spare7, spare6, spare5,
    spare4, spare3, spare2, spare1 }

UL-AM-RLC-Mode ::=           SEQUENCE {
    transmissionRLC-Discard      TransmissionRLC-Discard,
    transmissionWindowSize       TransmissionWindowSize,
    timerRST                      TimerRST,
    max-RST                       MaxRST,
    pollingInfo                    PollingInfo                                OPTIONAL
}

UL-CounterSynchronisationInfo ::= SEQUENCE {
    rB-WithPDCP-InfoList         RB-WithPDCP-InfoList    OPTIONAL,
    startList                     STARTList
}

UL-LogicalChannelMapping ::= SEQUENCE {
    -- TABULAR: UL-TransportChannelType contains TransportChannelIdentity as well.
    ul-TransportChannelType       UL-TransportChannelType,

```

```

    logicalChannelIdentity      LogicalChannelIdentity      OPTIONAL,
    rlc-SizeList                CHOICE {
        allSizes                NULL,
        configured              NULL,
        explicitList            RLC-SizeExplicitList
    },
    mac-LogicalChannelPriority    MAC-LogicalChannelPriority
}

UL-LogicalChannelMapping-r6 ::= SEQUENCE {
    ul-TrCH-Type                CHOICE {
        dch-rach-usch           SEQUENCE {
            -- TABULAR: UL-TransportChannelType contains TransportChannelIdentity as well.
            ul-TransportChannelType  UL-TransportChannelType,
            logicalChannelIdentity    LogicalChannelIdentity      OPTIONAL,
            rlc-SizeList             CHOICE {
                allSizes            NULL,
                configured          NULL,
                explicitList        RLC-SizeExplicitList
            }
        },
        e-dch                   SEQUENCE {
            logicalChannelIdentity    LogicalChannelIdentity,
            e-DCH-MAC-d-FlowIdentity  E-DCH-MAC-d-FlowIdentity,
            ddi                      DDI,
            rlc-PDU-SizeList         RLC-PDU-SizeList,
            includeInSchedulingInfo   BOOLEAN
        }
    },
    mac-LogicalChannelPriority    MAC-LogicalChannelPriority
}

UL-LogicalChannelMapping-r8 ::= SEQUENCE {
    ul-TrCH-Type                CHOICE {
        dch-rach-usch           SEQUENCE {
            -- TABULAR: UL-TransportChannelType contains TransportChannelIdentity as well.
            ul-TransportChannelType  UL-TransportChannelType,
            logicalChannelIdentity    LogicalChannelIdentity      OPTIONAL,
            rlc-SizeList             CHOICE {
                allSizes            NULL,
                configured          NULL,
                explicitList        RLC-SizeExplicitList
            }
        },
        e-dch                   SEQUENCE {
            logicalChannelIdentity    LogicalChannelIdentity,
            e-DCH-MAC-d-FlowIdentity  E-DCH-MAC-d-FlowIdentity,
            rlc-PDU-Size             CHOICE {
                fixedSize           SEQUENCE {
                    ddi            DDI,
                    rlc-PDU-SizeList  RLC-PDU-SizeList
                },
                flexibleSize        RLC-PDU-SizeConstraint
            },
            includeInSchedulingInfo   BOOLEAN
        }
    },
    mac-LogicalChannelPriority    MAC-LogicalChannelPriority
}

UL-LogicalChannelMappingList ::= SEQUENCE {
    -- rlc-LogicalChannelMappingIndicator shall be set to TRUE in this version
    -- of the specification
    rlc-LogicalChannelMappingIndicator  BOOLEAN,
    ul-LogicalChannelMapping            SEQUENCE (SIZE (maxLoCHperRLC)) OF
                                        UL-LogicalChannelMapping
}

UL-LogicalChannelMappingList-r6 ::= SEQUENCE {
    -- rlc-LogicalChannelMappingIndicator shall be set to TRUE in this version
    -- of the specification
    rlc-LogicalChannelMappingIndicator  BOOLEAN,
    ul-LogicalChannelMapping            SEQUENCE (SIZE (maxLoCHperRLC)) OF
                                        UL-LogicalChannelMapping-r6
}

UL-LogicalChannelMappingList-r8 ::= SEQUENCE {
    -- rlc-LogicalChannelMappingIndicator shall be set to TRUE in this version

```

```

-- of the specification
rlc-LogicalChannelMappingIndicator  BOOLEAN,
ul-LogicalChannelMapping            SEQUENCE (SIZE (maxLoCHperRLC)) OF
                                     UL-LogicalChannelMapping-r8
}

UL-LogicalChannelMappings ::=      CHOICE {
  oneLogicalChannel                UL-LogicalChannelMapping,
  twoLogicalChannels                UL-LogicalChannelMappingList
}

UL-LogicalChannelMappings-r6 ::=   CHOICE {
  oneLogicalChannel                UL-LogicalChannelMapping-r6,
  twoLogicalChannels                UL-LogicalChannelMappingList-r6
}

UL-LogicalChannelMappings-r8 ::=   CHOICE {
  oneLogicalChannel                UL-LogicalChannelMapping-r8,
  twoLogicalChannels                UL-LogicalChannelMappingList-r8
}

UL-RFC3095-r4 ::=                  SEQUENCE {
  -- dummy1 is not used in this version of the specification and shall be ignored by the receiver.
  dummy1                            CID-InclusionInfo-r4,
  max-CID                            INTEGER (1..16383)                DEFAULT 15,
  -- dummy is not used in this version of the specification and
  -- it should be ignored by the receiver.
  dummy                              ROHC-PacketSizeList-r4
}

UL-RLC-Mode ::=                    CHOICE {
  ul-AM-RLC-Mode                    UL-AM-RLC-Mode,
  ul-UM-RLC-Mode                    UL-UM-RLC-Mode,
  ul-TM-RLC-Mode                    UL-TM-RLC-Mode,
  spare                              NULL
}

UL-TM-RLC-Mode ::=                 SEQUENCE {
  transmissionRLC-Discard            TransmissionRLC-Discard        OPTIONAL,
  segmentationIndication            BOOLEAN
}

UL-UM-RLC-Mode ::=                 SEQUENCE {
  transmissionRLC-Discard            TransmissionRLC-Discard        OPTIONAL
}

UL-TransportChannelType ::=        CHOICE {
  dch                                TransportChannelIdentity,
  rach                                NULL,
  -- dummy is not used in this version of the specification and
  -- if received the UE behaviour is not specified.
  dummy                              NULL,
  usch                                TransportChannelIdentity
}

UM-RLC-DuplAvoid-Reord-Info-r6 ::= SEQUENCE {
  timer-DAR                          TimerDAR-r6,
  widowSize-DAR                      WindowSizeDAR-r6
}

UM-RLC-OutOSeqDelivery-Info-r6 ::= SEQUENCE {
  timer-OSD                          TimerOSD-r6                    OPTIONAL,
  widowSize-OSD                      WindowSizeOSD-r6
}

WindowSizeDAR-r6 ::=                ENUMERATED {
  ws4, ws8, ws16, ws32, ws40, ws48,
  ws56, ws64 }

WindowSizeOSD-r6 ::=                ENUMERATED {
  ws8, ws16, ws32, ws40, ws48,
  ws56, ws64 }

-- *****
--
--   TRANSPORT CHANNEL INFORMATION ELEMENTS (10.3.5)
--
-- *****

```

```

AddOrReconfMAC-dFlow ::=          SEQUENCE {
    mac-hs-AddReconfQueue-List      MAC-hs-AddReconfQueue-List      OPTIONAL,
    mac-hs-DelQueue-List             MAC-hs-DelQueue-List             OPTIONAL
}

AddOrReconfMAC-ehs-ReordQ ::=     SEQUENCE {
    mac-ehs-AddReconfQueue-List      MAC-ehs-AddReconfReordQ-List     OPTIONAL,
    -- dummy is not used in this version of the specification, it should
    -- not be sent and if received it should be ignored.
    dummy                             MAC-ehs-DelReordQ-List          OPTIONAL
}

AddOrReconfMAC-ehs-ReordQ-r9 ::=  SEQUENCE {
    mac-ehs-AddReconfQueue-List      MAC-ehs-AddReconfReordQ-List-r9 OPTIONAL
}

AddOrReconfMAC-ehs-ReordQ-TDD128-v9c0ext ::= SEQUENCE {
    mac-ehs-AddReconfQueue-List      MAC-ehs-AddReconfReordQ-List-TDD128-v9c0ext OPTIONAL
}

AddOrReconfMAC-ehs-ReordQ-r11 ::= SEQUENCE {
    mac-ehs-AddReconfQueue-List      MAC-ehs-AddReconfReordQ-List-r11 OPTIONAL
}

AllowedTFC-List ::=               SEQUENCE (SIZE (1..maxTFC)) OF
    TFC-Value

AllowedTFI-List ::=               SEQUENCE (SIZE (1..maxTF)) OF
    INTEGER (0..31)

BitModeRLC-SizeInfo ::=          CHOICE {
    sizeType1                         INTEGER (0..127),
    -- Actual value sizeType2 = (part1 * 8) + 128 + part2
    sizeType2                         SEQUENCE {
        part1                         INTEGER (0..15),
        part2                         INTEGER (1..7)
    },
    -- Actual value sizeType3 = (part1 * 16) + 256 + part2
    sizeType3                         SEQUENCE {
        part1                         INTEGER (0..47),
        part2                         INTEGER (1..15)
    },
    -- Actual value sizeType4 = (part1 * 64) + 1024 + part2
    sizeType4                         SEQUENCE {
        part1                         INTEGER (0..62),
        part2                         INTEGER (1..63)
    }
}

-- Actual value BLER-QualityValue = IE value * 0.1
BLER-QualityValue ::=             INTEGER (-63..0)

ChannelCodingType ::=             CHOICE {
    -- noCoding is only used for TDD in this version of the specification,
    -- otherwise it should be ignored
    noCoding                          NULL,
    convolutional                      CodingRate,
    turbo                              NULL
}

CodingRate ::=                     ENUMERATED {
    half,
    third
}

Common-E-DCH-MAC-d-Flow ::=       SEQUENCE {
    mac-d-FlowIdentity                E-DCH-MAC-d-FlowIdentity,
    mac-d-FlowPowerOffset             E-DCH-MAC-d-FlowPowerOffset,
    mac-d-FlowMaxRetrans               E-DCH-MAC-d-FlowMaxRetrans,
    mac-d-FlowMultiplexingList        E-DCH-MAC-d-FlowMultiplexingList OPTIONAL,
    e-dch-mac-d-flow-retransmission-timer E-DCH-MAC-d-FlowRetransTimer OPTIONAL
}

Common-E-DCH-MAC-d-FlowList ::=   SEQUENCE (SIZE (1..maxE-DCHMACdFlow)) OF
    Common-E-DCH-MAC-d-Flow

Common-E-DCH-MAC-d-Flow-Info-ConcurrentTTI ::= SEQUENCE {
    mac-d-FlowIdentity                E-DCH-MAC-d-FlowIdentity,

```

```

    mac-d-FlowPowerOffset          E-DCH-MAC-d-FlowPowerOffset OPTIONAL,
    mac-d-FlowMaxRetrans           E-DCH-MAC-d-FlowMaxRetrans  OPTIONAL
}

Common-E-DCH-MAC-d-Flow-Info-List-ConcurrentTTI ::= SEQUENCE (SIZE (1..maxE-DCHMACdFlow)) OF
    Common-E-DCH-MAC-d-Flow-Info-ConcurrentTTI

CommonDynamicTF-Info ::= SEQUENCE {
    rlc-Size                       CHOICE {
        fdd                       SEQUENCE {
            octetModeRLC-SizeInfoType2  OctetModeRLC-SizeInfoType2
        },
        tdd                       SEQUENCE {
            commonTDD-Choice           CHOICE {
                bitModeRLC-SizeInfo   BitModeRLC-SizeInfo,
                octetModeRLC-SizeInfoType1  OctetModeRLC-SizeInfoType1
            }
        }
    },
    numberOfTbSizeList             SEQUENCE (SIZE (1..maxTF)) OF
        NumberOfTransportBlocks,
    logicalChannelList             LogicalChannelList
}

CommonDynamicTF-Info-DynamicTTI ::= SEQUENCE {
    commonTDD-Choice              CHOICE {
        bitModeRLC-SizeInfo       BitModeRLC-SizeInfo,
        octetModeRLC-SizeInfoType1  OctetModeRLC-SizeInfoType1
    },
    numberOfTbSizeAndTTIList      NumberOfTbSizeAndTTIList,
    logicalChannelList            LogicalChannelList
}

CommonDynamicTF-InfoList ::= SEQUENCE (SIZE (1..maxTF)) OF
    CommonDynamicTF-Info

CommonDynamicTF-InfoList-DynamicTTI ::= SEQUENCE (SIZE (1..maxTF)) OF
    CommonDynamicTF-Info-DynamicTTI

CommonTransChTFS ::= SEQUENCE {
    tti                           CHOICE {
        tti10                     CommonDynamicTF-InfoList,
        tti20                     CommonDynamicTF-InfoList,
        tti40                     CommonDynamicTF-InfoList,
        tti80                     CommonDynamicTF-InfoList,
        dynamic                   CommonDynamicTF-InfoList-DynamicTTI
    },
    semistaticTF-Information       SemistaticTF-Information
}

CommonTransChTFS-LCR ::= SEQUENCE {
    tti                           CHOICE {
        tti5                     CommonDynamicTF-InfoList,
        tti10                   CommonDynamicTF-InfoList,
        tti20                   CommonDynamicTF-InfoList,
        tti40                   CommonDynamicTF-InfoList,
        tti80                   CommonDynamicTF-InfoList,
        dynamic                 CommonDynamicTF-InfoList-DynamicTTI
    },
    semistaticTF-Information       SemistaticTF-Information
}

Common-MAC-ehs-ReorderingQueue ::= SEQUENCE {
    mac-ehs-QueueId              MAC-ehs-QueueId,
    t1-ReleaseTimer              T1-ReleaseTimer,
    reorderingResetTimer         Treset-ResetTimer OPTIONAL,
    mac-ehsWindowSize            MAC-hs-WindowSize
}

Common-MAC-ehs-ReorderingQueueList ::= SEQUENCE (SIZE (1..maxCommonQueueID)) OF
    Common-MAC-ehs-ReorderingQueue

Concurrent-Deployment-2ms-10ms-TTI ::= SEQUENCE {
    tti-selection                CHOICE {
        fixed                     SEQUENCE {
            fixed-TTI-Selection    ENUMERATED { tti2, tti10 }
        },
        threshold-based            SEQUENCE {

```

```

        common-E-DCH-TTI-Selection-Thresh          INTEGER (0..15)
    },
    concurrent-TTI-Partition-Index                INTEGER (0..maxEDCHs-1),
    commonEDCHSystemInfoParamConcurrentTTI        CommonEDCHSystemInfoParamConcurrentTTI OPTIONAL
}

CPCH-SetID ::=                                 INTEGER (1..maxCPCHsets)

CRC-Size ::=                                 ENUMERATED {
    crc0, crc8, crc12, crc16, crc24 }

DedicatedDynamicTF-Info ::= SEQUENCE {
    rlc-Size                                 CHOICE {
        bitMode                             BitModeRLC-SizeInfo,
        octetModeType1                      OctetModeRLC-SizeInfoType1
    },
    numberOfTbSizeList                      SEQUENCE (SIZE (1..maxTF)) OF
        NumberOfTransportBlocks,
    logicalChannelList                      LogicalChannelList
}

DedicatedDynamicTF-Info-DynamicTTI ::= SEQUENCE {
    rlc-Size                                 CHOICE {
        bitMode                             BitModeRLC-SizeInfo,
        octetModeType1                      OctetModeRLC-SizeInfoType1
    },
    numberOfTbSizeAndTTIList                NumberOfTbSizeAndTTIList,
    logicalChannelList                      LogicalChannelList
}

DedicatedDynamicTF-InfoList ::= SEQUENCE (SIZE (1..maxTF)) OF
    DedicatedDynamicTF-Info

DedicatedDynamicTF-InfoList-DynamicTTI ::= SEQUENCE (SIZE (1..maxTF)) OF
    DedicatedDynamicTF-Info-DynamicTTI

DedicatedTransChTFS ::= SEQUENCE {
    tti                                     CHOICE {
        tti10                               DedicatedDynamicTF-InfoList,
        tti20                               DedicatedDynamicTF-InfoList,
        tti40                               DedicatedDynamicTF-InfoList,
        tti80                               DedicatedDynamicTF-InfoList,
        dynamic                             DedicatedDynamicTF-InfoList-DynamicTTI
    },
    semistaticTF-Information                SemistaticTF-Information
}

-- The maximum allowed size of DL-AddReconfTransChInfo2List sequence is 16
DL-AddReconfTransChInfo2List ::= SEQUENCE (SIZE (1..maxTrCHpreconf)) OF
    DL-AddReconfTransChInformation2

-- The maximum allowed size of DL-AddReconfTransChInfoList sequence is 16
DL-AddReconfTransChInfoList ::= SEQUENCE (SIZE (1..maxTrCHpreconf)) OF
    DL-AddReconfTransChInformation

-- The maximum allowed size of DL-AddReconfTransChInfoList-r4 sequence is 16
DL-AddReconfTransChInfoList-r4 ::= SEQUENCE (SIZE (1..maxTrCHpreconf)) OF
    DL-AddReconfTransChInformation-r4

-- The maximum allowed size of DL-AddReconfTransChInfoList-r5 sequence is 16
DL-AddReconfTransChInfoList-r5 ::= SEQUENCE (SIZE (1..maxTrCHpreconf)) OF
    DL-AddReconfTransChInformation-r5

-- The maximum allowed size of DL-AddReconfTransChInfoList-r7 sequence is 16
DL-AddReconfTransChInfoList-r7 ::= SEQUENCE (SIZE (1..maxTrCHpreconf)) OF
    DL-AddReconfTransChInformation-r7

DL-AddReconfTransChInfoList-r9 ::= SEQUENCE (SIZE (1..maxTrCHpreconf)) OF
    DL-AddReconfTransChInformation-r9

DL-AddReconfTransChInfoList-TDD128-v9c0ext ::= SEQUENCE (SIZE (1..maxTrCHpreconf)) OF
    DL-AddReconfTransChInformation-TDD128-v9c0ext

DL-AddReconfTransChInfoList-r11 ::= SEQUENCE (SIZE (1..maxTrCHpreconf)) OF
    DL-AddReconfTransChInformation-r11

-- ASN.1 for IE "Added or Reconfigured DL TrCH information"

```

```

-- in case of messages other than: Radio Bearer Release message and
-- Radio Bearer Reconfiguration message
DL-AddReconfTransChInformation ::= SEQUENCE {
    dl-TransportChannelType          DL-TrCH-Type,
    dl-transportChannelIdentity      TransportChannelIdentity,
    tfs-SignallingMode              CHOICE {
        explicit-config             TransportFormatSet,
        sameAsULTrCH                UL-TransportChannelIdentity
    },
    dch-QualityTarget                QualityTarget                OPTIONAL,
    -- dummy is not used in this version of the specification, it should
    -- not be sent and if received it should be ignored.
    dummy                            TM-SignallingInfo            OPTIONAL
}

DL-AddReconfTransChInformation-r4 ::= SEQUENCE {
    dl-TransportChannelType          DL-TrCH-Type,
    dl-transportChannelIdentity      TransportChannelIdentity,
    tfs-SignallingMode              CHOICE {
        explicit-config             TransportFormatSet,
        sameAsULTrCH                UL-TransportChannelIdentity
    },
    dch-QualityTarget                QualityTarget                OPTIONAL
}

DL-AddReconfTransChInformation-r5 ::= SEQUENCE {
    dl-TransportChannelType          DL-TrCH-TypeId1-r5,
    tfs-SignallingMode              CHOICE {
        explicit-config             TransportFormatSet,
        sameAsULTrCH                UL-TransportChannelIdentity,
        hsdSCH                      HSDSCH-Info
    },
    dch-QualityTarget                QualityTarget                OPTIONAL
}

DL-AddReconfTransChInformation-r7 ::= SEQUENCE {
    dl-TransportChannelType          DL-TrCH-TypeId1-r5,
    tfs-SignallingMode              CHOICE {
        explicit-config             TransportFormatSet,
        sameAsULTrCH                UL-TransportChannelIdentity,
        hsdSCH                      HSDSCH-Info-r7
    },
    dch-QualityTarget                QualityTarget                OPTIONAL
}

DL-AddReconfTransChInformation-r9 ::= SEQUENCE {
    dl-TransportChannelType          DL-TrCH-TypeId1-r5,
    tfs-SignallingMode              CHOICE {
        explicit-config             TransportFormatSet,
        sameAsULTrCH                UL-TransportChannelIdentity,
        hsdSCH                      HSDSCH-Info-r9
    },
    dch-QualityTarget                QualityTarget                OPTIONAL
}

DL-AddReconfTransChInformation-TDD128-v9c0ext ::= SEQUENCE {
    hsdSCH                          HSDSCH-Info-TDD128-v9c0ext    OPTIONAL
}

DL-AddReconfTransChInformation-r11 ::= SEQUENCE {
    dl-TransportChannelType          DL-TrCH-TypeId1-r5,
    tfs-SignallingMode              CHOICE {
        explicit-config             TransportFormatSet,
        sameAsULTrCH                UL-TransportChannelIdentity,
        hsdSCH                      HSDSCH-Info-r11
    },
    dch-QualityTarget                QualityTarget                OPTIONAL
}

-- ASN.1 for IE "Added or Reconfigured DL TrCH information"
-- in case of Radio Bearer Release message and
-- Radio Bearer Reconfiguration message
DL-AddReconfTransChInformation2 ::= SEQUENCE {
    dl-TransportChannelType          DL-TrCH-Type,
    transportChannelIdentity        TransportChannelIdentity,
    tfs-SignallingMode              CHOICE {
        explicit-config             TransportFormatSet,
        sameAsULTrCH                UL-TransportChannelIdentity
    }
}

```

```

    },
    qualityTarget                QualityTarget                OPTIONAL
  }

DL-CommonTransChInfo ::=          SEQUENCE {
  sccpch-TFCS                    TFCS                    OPTIONAL,
  -- modeSpecificInfo should be optional. A new version of this IE should be defined
  -- to be used in later versions of messages using this IE
  modeSpecificInfo                CHOICE {
    fdd                            SEQUENCE {
      dl-Parameters                CHOICE {
        dl-DCH-TFCS                TFCS,
        sameAsUL                    NULL
      }
    }
    tdd                            SEQUENCE {
      individualDL-CCTrCH-InfoList IndividualDL-CCTrCH-InfoList
    }
  }
}

DL-CommonTransChInfo-r4 ::=        SEQUENCE {
  sccpch-TFCS                    TFCS                    OPTIONAL,
  modeSpecificInfo                CHOICE {
    fdd                            SEQUENCE {
      dl-Parameters                CHOICE {
        dl-DCH-TFCS                SEQUENCE {
          tfcs                      TFCS                    OPTIONAL
        },
        sameAsUL                    NULL
      }
    }
    tdd                            SEQUENCE {
      individualDL-CCTrCH-InfoList IndividualDL-CCTrCH-InfoList
    }
  }
} OPTIONAL

DL-DeletedTransChInfoList ::=      SEQUENCE (SIZE (1..maxTrCH)) OF
  DL-TransportChannelIdentity

DL-DeletedTransChInfoList-r5 ::=   SEQUENCE (SIZE (1..maxTrCH)) OF
  DL-TransportChannelIdentity-r5

DL-DeletedTransChInfoList-r7 ::=   SEQUENCE (SIZE (1..maxTrCH)) OF
  DL-TransportChannelIdentity-r7

DL-TransportChannelIdentity ::=     SEQUENCE {
  dl-TransportChannelType          DL-TrCH-Type,
  dl-TransportChannelIdentity      TransportChannelIdentity
}

DL-TransportChannelIdentity-r5 ::=  SEQUENCE {
  dl-TransportChannelType          DL-TrCH-TypeId2-r5
}

DL-TransportChannelIdentity-r7 ::=  SEQUENCE {
  dl-TransportChannelType          DL-TrCH-TypeId2-r7
}

-- The choice "dsch" should not be used in FDD mode, and if received the UE behaviour is unspecified
DL-TrCH-Type ::=                   ENUMERATED {dch, dsch}

DL-TrCH-TypeId1-r5 ::=             CHOICE {
  dch                              TransportChannelIdentity,
  -- The choice "dsch" should not be used in FDD mode, and if received
  -- the UE behaviour is unspecified.
  dsch                              TransportChannelIdentity,
  hsdSCH                            NULL
}

DL-TrCH-TypeId2-r5 ::=             CHOICE {
  dch                              TransportChannelIdentity,
  -- The choice "dsch" should not be used in FDD mode, and if received
  -- the UE behaviour is unspecified.
  dsch                              TransportChannelIdentity,
}

```



```

    hsdSCH                MAC-d-FlowIdentity
  }

DL-TrCH-TypeId2-r7 ::=          CHOICE {
  dch                    TransportChannelIdentity,
  -- The choice "dsch" should not be used in FDD mode, and if received
  -- the UE behaviour is unspecified.
  dsch                  TransportChannelIdentity,
  hsdSCH                CHOICE {
    mac-hs              MAC-d-FlowIdentity,
    mac-ehs            MAC-ehs-QueueId
  }
}

DRAC-ClassIdentity ::=          INTEGER (1..maxDRACClasses)

DRAC-StaticInformation ::=      SEQUENCE {
  transmissionTimeValidity  TransmissionTimeValidity,
  timeDurationBeforeRetry   TimeDurationBeforeRetry,
  drac-ClassIdentity        DRAC-ClassIdentity
}

DRAC-StaticInformationList ::=  SEQUENCE (SIZE (1..maxTrCH)) OF
  DRAC-StaticInformation

E-DCH-AddReconf-MAC-d-Flow ::= SEQUENCE {
  mac-d-FlowIdentity        E-DCH-MAC-d-FlowIdentity,
  mac-d-FlowPowerOffset     E-DCH-MAC-d-FlowPowerOffset           OPTIONAL,
  mac-d-FlowMaxRetrans      E-DCH-MAC-d-FlowMaxRetrans           OPTIONAL,
  mac-d-FlowMultiplexingList E-DCH-MAC-d-FlowMultiplexingList   OPTIONAL,
  transmissionGrantType     CHOICE {
    non-ScheduledTransGrantInfo SEQUENCE {
      maxMAC-e-PDUContents      INTEGER (1..19982),
      ms2-NonSchedTransmGrantHARQAlloc BIT STRING (SIZE (8))           OPTIONAL
    },
    scheduledTransmissionGrantInfo NULL
  } OPTIONAL
}

E-DCH-AddReconf-MAC-d-Flow-r7 ::= SEQUENCE {
  mac-d-FlowIdentity        E-DCH-MAC-d-FlowIdentity,
  mac-d-FlowPowerOffset     E-DCH-MAC-d-FlowPowerOffset           OPTIONAL,
  mac-d-FlowMaxRetrans      E-DCH-MAC-d-FlowMaxRetrans           OPTIONAL,
  mac-d-FlowRetransTimer    E-DCH-MAC-d-FlowRetransTimer         OPTIONAL,
  mac-d-FlowMultiplexingList E-DCH-MAC-d-FlowMultiplexingList   OPTIONAL,
  transmissionGrantType     CHOICE {
    non-ScheduledTransGrantInfo SEQUENCE {
      modeSpecificInfo          CHOICE {
        fdd                    SEQUENCE {
          maxMAC-e-PDUContents      INTEGER (1..19982),
          ms2-NonSchedTransmGrantHARQAlloc BIT STRING (SIZE (8))           OPTIONAL
        },
        tdd                    NULL
      }
    },
    scheduledTransmissionGrantInfo NULL
  } OPTIONAL
}

E-DCH-AddReconf-MAC-d-FlowList ::= SEQUENCE (SIZE (1..maxE-DCHMACdFlow)) OF
  E-DCH-AddReconf-MAC-d-Flow

E-DCH-AddReconf-MAC-d-FlowList-r7 ::= SEQUENCE (SIZE (1..maxE-DCHMACdFlow)) OF
  E-DCH-AddReconf-MAC-d-Flow-r7

E-DCH-MAC-d-FlowIdentity ::=    INTEGER (0..maxE-DCHMACdFlow-1)

E-DCH-MAC-d-FlowMaxRetrans ::=  INTEGER (0..15)

E-DCH-MAC-d-FlowMultiplexingList ::= BIT STRING (SIZE (maxE-DCHMACdFlow))

E-DCH-MAC-d-FlowPowerOffset ::=  INTEGER (0..6)

E-DCH-MAC-d-FlowRetransTimer ::= ENUMERATED {
  ms10, ms15, ms20, ms25, ms30, ms35, ms40, ms45, ms50,
  ms55, ms60, ms65, ms70, ms75, ms80, ms85, ms90, ms95,
  ms100, ms110, ms120, ms140, ms160, ms200, ms240, ms280,
  ms320, ms400, ms480, ms560 }

```

```

E-DCH-TTI ::= ENUMERATED { tti2, tti10 }

ExplicitTFCS-Configuration ::= CHOICE {
  complete          TFCS-ReconfAdd,
  addition          TFCS-ReconfAdd,
  removal          TFCS-RemovalList,
  replacement      SEQUENCE {
    tfcsRemoval    TFCS-RemovalList,
    tfcsAdd        TFCS-ReconfAdd
  }
}

ExplicitTFCS-Configuration-r12 ::= CHOICE {
  complete          TFCS-ReconfAdd-r12,
  addition          TFCS-ReconfAdd-r12,
  removal          TFCS-RemovalList,
  replacement      SEQUENCE {
    tfcsRemoval    TFCS-RemovalList,
    tfcsAdd        TFCS-ReconfAdd-r12
  }
}

GainFactor ::= INTEGER (0..15)

GainFactorInformation ::= CHOICE {
  signalledGainFactors    SignalledGainFactors,
  computedGainFactors     ReferenceTFC-ID
}

GainFactorInformation-10msMode ::= CHOICE {
  signalledGainFactors    SEQUENCE {
    gainFactorBetaC      GainFactor,
    gainFactorBetaD      GainFactor,
    referenceTFC-ID      ReferenceTFC-ID OPTIONAL
  },
  computedGainFactors     ReferenceTFC-ID
}

HSDSCH-Info ::= SEQUENCE {
  harqInfo                HARQ-Info OPTIONAL,
  addOrReconfMAC-dFlow    AddOrReconfMAC-dFlow OPTIONAL
}

HSDSCH-Info-r7 ::= SEQUENCE {
  harqInfo                HARQ-Info-r7 OPTIONAL,
  dl-MAC-HeaderType      CHOICE {
    mac-hs                AddOrReconfMAC-dFlow,
    mac-ehs                AddOrReconfMAC-ehs-ReordQ
  } OPTIONAL
}

HSDSCH-Info-r9 ::= SEQUENCE {
  harqInfo                HARQ-Info-r7 OPTIONAL,
  dl-MAC-HeaderType      CHOICE {
    mac-hs                AddOrReconfMAC-dFlow,
    mac-ehs                AddOrReconfMAC-ehs-ReordQ-r9
  } OPTIONAL
}

HSDSCH-Info-TDD128-v9c0ext ::= SEQUENCE {
  mac-ehs                AddOrReconfMAC-ehs-ReordQ-TDD128-v9c0ext OPTIONAL
}

HSDSCH-Info-r11 ::= SEQUENCE {
  harqInfo                HARQ-Info-r11 OPTIONAL,
  dl-MAC-HeaderType      CHOICE {
    mac-hs                AddOrReconfMAC-dFlow,
    mac-ehs                AddOrReconfMAC-ehs-ReordQ-r11
  } OPTIONAL
}

HARQ-Info ::= SEQUENCE {
  numberOfProcesses      INTEGER (1..8),
  memoryPartitioning     CHOICE {
    implicit              NULL,
    explicit              SEQUENCE (SIZE (1..maxHProcesses)) OF

```

```

    }
    }
}

HARQ-Info-r7 ::=
    numberOfProcesses          SEQUENCE {
                                ENUMERATED { n1, n2, n3, n4, n5, n6, n7, n8,
                                              n12, n14, n16 },
                                CHOICE {
                                    implicit      NULL,
                                    explicit      SEQUENCE {
                                                    SEQUENCE (SIZE (1..maxHProcesses)) OF
                                                    HARQMemorySize,
                                                    SEQUENCE (SIZE (1..maxHProcesses)) OF
                                                    HARQMemorySize OPTIONAL
                                                }
                                }
    }
}

HARQ-Info-r11 ::=
    numberOfProcesses          SEQUENCE {
                                ENUMERATED { n1, n2, n3, n4, n5, n6, n7, n8,
                                              n12, n14, n16, n24, n28, n32 },
                                CHOICE {
                                    implicit      NULL,
                                    explicit      SEQUENCE {
                                                    SEQUENCE (SIZE (1..maxHProcesses)) OF
                                                    HARQMemorySize,
                                                    SEQUENCE (SIZE (1..maxHProcesses)) OF
                                                    HARQMemorySize OPTIONAL,
                                                    SEQUENCE (SIZE (1..maxHProcesses)) OF
                                                    HARQMemorySize OPTIONAL,
                                                    SEQUENCE (SIZE (1..maxHProcesses)) OF
                                                    HARQMemorySize OPTIONAL
                                                }
                                }
    }
}

HARQMemorySize ::=
    ENUMERATED {
        hms800, hms1600, hms2400, hms3200, hms4000,
        hms4800, hms5600, hms6400, hms7200, hms8000,
        hms8800, hms9600, hms10400, hms11200, hms12000,
        hms12800, hms13600, hms14400, hms15200, hms16000,
        hms17600, hms19200, hms20800, hms22400, hms24000,
        hms25600, hms27200, hms28800, hms30400, hms32000,
        hms36000, hms40000, hms44000, hms48000, hms52000,
        hms56000, hms60000, hms64000, hms68000, hms72000,
        hms76000, hms80000, hms88000, hms96000, hms104000,
        hms112000, hms120000, hms128000, hms136000, hms144000,
        hms152000, hms160000, hms176000, hms192000, hms208000,
        hms224000, hms240000, hms256000, hms272000, hms288000,
        hms304000 }

IndividualDL-CCTrCH-Info ::=
    dl-TFCS-Identity          SEQUENCE {
                                TFCS-Identity,
                                tfcs-SignallingMode CHOICE {
                                    explicit-config TFCS,
                                    sameAsUL         TFCS-Identity
                                }
    }
}

IndividualDL-CCTrCH-InfoList ::= SEQUENCE (SIZE (1..maxCCTrCH)) OF
    IndividualDL-CCTrCH-Info

IndividualUL-CCTrCH-Info ::= SEQUENCE {
    ul-TFCS-Identity          TFCS-Identity,
    ul-TFCS                   TFCS,
    tfc-Subset                 TFC-Subset
}

IndividualUL-CCTrCH-InfoList ::= SEQUENCE (SIZE (1..maxCCTrCH)) OF
    IndividualUL-CCTrCH-Info

LogicalChannelByRB ::=
    rb-Identity              SEQUENCE {
                                RB-Identity,
                                logChOfRb      INTEGER (0..1)
    }
    OPTIONAL

LogicalChannelList ::=
    allSizes                 CHOICE {
                                NULL,

```

```

        configured                NULL,
        explicitList              SEQUENCE (SIZE (1..15)) OF
                                  LogicalChannelByRB
    }

MAC-d-FlowIdentityDCHandHSDSCH ::= SEQUENCE {
    dch-transport-ch-id          TransportChannelIdentity,
    hsdSCH-mac-d-flow-id        MAC-d-FlowIdentity
}

MAC-d-FlowIdentity ::=          INTEGER (0..7)

MAC-d-PDU-SizeInfo-List ::=    SEQUENCE (SIZE(1.. maxMAC-d-PDU-sizes)) OF
                                  MAC-d-PDUsizeInfo

--MAC-d-Pdu sizes need to be defined
MAC-d-PDUsizeInfo ::=          SEQUENCE {
    mac-d-PDU-Size              INTEGER (1..5000),
    mac-d-PDU-Index             INTEGER(0..7)
}

MAC-hs-AddReconfQueue-List ::= SEQUENCE (SIZE(1..maxQueueIDs)) OF
                                  MAC-hs-AddReconfQueue

MAC-hs-AddReconfQueue ::=      SEQUENCE {
    mac-hsQueueId               INTEGER(0..7),
    mac-dFlowId                 MAC-d-FlowIdentity,
    reorderingReleaseTimer      T1-ReleaseTimer,
    mac-hsWindowSize            MAC-hs-WindowSize,
    mac-d-PDU-SizeInfo-List     MAC-d-PDU-SizeInfo-List           OPTIONAL
}

MAC-hs-DelQueue-List ::=       SEQUENCE (SIZE(1..maxQueueIDs)) OF
                                  MAC-hs-DelQueue

MAC-hs-DelQueue ::=            SEQUENCE {
    mac-hsQueueId               INTEGER(0..7)
}

MAC-ehs-AddReconfReordQ-List ::= SEQUENCE (SIZE(1..maxQueueIDs)) OF
                                  MAC-ehs-AddReconfReordQ

MAC-ehs-AddReconfReordQ-List-r9 ::= SEQUENCE (SIZE(1..maxQueueIDs)) OF
                                  MAC-ehs-AddReconfReordQ-r9

MAC-ehs-AddReconfReordQ-List-TDD128-v9c0ext ::= SEQUENCE (SIZE(1..maxQueueIDs)) OF
                                  MAC-ehs-AddReconfReordQ-TDD128-v9c0ext

MAC-ehs-AddReconfReordQ-List-r11 ::= SEQUENCE (SIZE(1..maxQueueIDs)) OF
                                  MAC-ehs-AddReconfReordQ-r11

MAC-ehs-AddReconfReordQ ::=    SEQUENCE {
    mac-ehs-QueueId             MAC-ehs-QueueId,
    reorderingReleaseTimer      T1-ReleaseTimer,
    reorderingResetTimer        Treset-ResetTimer           OPTIONAL,
    mac-ehsWindowSize           MAC-hs-WindowSize
}

MAC-ehs-AddReconfReordQ-r9 ::= SEQUENCE {
    mac-ehs-QueueId             MAC-ehs-QueueId,
    reorderingReleaseTimer      T1-ReleaseTimer,
    reorderingResetTimer        Treset-ResetTimer           OPTIONAL,
    mac-ehsWindowSize           MAC-hs-WindowSize-r9
}

MAC-ehs-AddReconfReordQ-TDD128-v9c0ext ::= SEQUENCE {
    mac-ehsWindowSize-extension MAC-ehs-WindowSize-TDD128-v9c0ext   OPTIONAL
}

MAC-ehs-AddReconfReordQ-r11 ::= SEQUENCE {
    mac-ehs-QueueId             MAC-ehs-QueueId,
    reorderingReleaseTimer      T1-ReleaseTimer,
    reorderingResetTimer        Treset-ResetTimer           OPTIONAL,
    mac-ehsWindowSize           MAC-hs-WindowSize-r11,
    -- For 1.28Mcps TDD only
    mac-ehsWindowSize-extension MAC-ehs-WindowSize-TDD128-v9c0ext   OPTIONAL
}

```

```

MAC-ehs-DelReordQ-List ::= SEQUENCE (SIZE(1..maxQueueIDs)) OF
                            MAC-ehs-DelReordQ

MAC-ehs-DelReordQ ::= SEQUENCE {
    mac-ehs-QueueId          MAC-ehs-QueueId
}

MAC-ehs-QueueIdDCHandHSDSCH ::= SEQUENCE {
    dch-transport-ch-id      TransportChannelIdentity,
    hsdSCH-mac-ehs-QueueId   MAC-ehs-QueueId
}

MAC-ehs-QueueId ::= INTEGER (0..7)

MAC-hs-WindowSize ::= ENUMERATED {
    mws4, mws6, mws8, mws12, mws16, mws24, mws32 }

MAC-hs-WindowSize-r9 ::= ENUMERATED {
    mws4, mws6, mws8, mws12, mws16, mws24, mws32,
    mw64, mw128 }

MAC-ehs-WindowSize-TDD128-v9c0ext ::= ENUMERATED {
    mws96, mws160, mws192, mws256 }

MAC-hs-WindowSize-r11 ::= ENUMERATED {
    mws4, mws6, mws8, mws12, mws16, mws24, mws32,
    mws64, mws128, mws256, spare6, spare5, spare4,
    spare3, spare2, spare1 }

NumberOfTbSizeAndTTIList ::= SEQUENCE (SIZE (1..maxTF)) OF SEQUENCE {
    numberOfTransportBlocks      NumberOfTransportBlocks,
    transmissionTimeInterval     TransmissionTimeInterval
}

MessType ::= ENUMERATED {
    transportFormatCombinationControl }

MinimumTEBS-threshold ::= ENUMERATED {
    pl2, pl4, pl8, pl16, pl32,
    pl64, pl128, pl256, pl512, pl1024,
    pl2k, pl4k, pl8k, pl16k, pl32k,
    pl64k, pl128k, pl256k, pl512k, pl1024k,
    spare12, spare11, spare10, spare9, spare8,
    spare7, spare6, spare5, spare4, spare3,
    spare2, spare1 }

Non-allowedTFC-List ::= SEQUENCE (SIZE (1..maxTFC)) OF
    TFC-Value

NumberOfTransportBlocks ::= CHOICE {
    zero          NULL,
    one           NULL,
    small         INTEGER (2..17),
    large        INTEGER (18..512)
}

OctetModeRLC-SizeInfoType1 ::= CHOICE {
    -- Actual size = (8 * sizeType1) + 16
    sizeType1     INTEGER (0..31),
    sizeType2     SEQUENCE {
        -- Actual size = (32 * part1) + 272 + (part2 * 8)
        part1      INTEGER (0..23),
        part2      INTEGER (1..3)
    },
    sizeType3     SEQUENCE {
        -- Actual size = (64 * part1) + 1040 + (part2 * 8)
        part1      INTEGER (0..61),
        part2      INTEGER (1..7)
    }
} OPTIONAL

OctetModeRLC-SizeInfoType2 ::= CHOICE {
    -- Actual size = (sizeType1 * 8) + 48
    sizeType1     INTEGER (0..31),
    -- Actual size = (sizeType2 * 16) + 312
    sizeType2     INTEGER (0..63),
    -- Actual size = (sizeType3 * 64) + 1384
    sizeType3     INTEGER (0..56)
}

```

```

}

PowerOffsetInfoShort ::=
    referenceTFC
    modeSpecificInfo
        fdd
            gainFactorBetaC
        },
        tdd
            NULL
    },
    gainFactorBetaD
}

PowerOffsetInformation ::=
    gainFactorInformation
    -- PowerOffsetPp-m is always absent in TDD
    powerOffsetPp-m
}

PowerOffsetInformation-10msMode ::=
    gainFactorInformation
}

PowerOffsetPp-m ::=
    INTEGER (-5..10)

PreDefTransChConfiguration ::=
    ul-CommonTransChInfo
    ul-AddReconfTrChInfoList
    dl-CommonTransChInfo
    dl-TrChInfoList
}

QualityTarget ::=
    bler-QualityValue
}

RateMatchingAttribute ::=
    INTEGER (1..hiRM)

ReferenceTFC-ID ::=
    INTEGER (0..3)

RestrictedTrChInfo ::=
    ul-TransportChannelType
    restrictedTrChIdentity
    allowedTFI-List
}

RestrictedTrChInfoList ::=
    SEQUENCE (SIZE (1..maxTrCH)) OF
        RestrictedTrChInfo

SemistaticTF-Information ::=
    -- TABULAR: Transmission time interval has been included in the IE CommonTransChTFS.
    channelCodingType
    rateMatchingAttribute
    crc-Size
}

SignalledGainFactors ::=
    modeSpecificInfo
        fdd
            gainFactorBetaC
        },
        tdd
            NULL
    },
    gainFactorBetaD
    referenceTFC-ID
}

SplitTFCSI-Signalling ::=
    splitType
    tfci-Field2-Length
    tfci-Field1-Information
    tfci-Field2-Information
}

SplitType ::=
    ENUMERATED {
        hardSplit, logicalSplit }

```

```

T1-ReleaseTimer ::=
    ENUMERATED {
        rt10, rt20, rt30, rt40, rt50,
        rt60, rt70, rt80, rt90, rt100,
        rt120, rt140, rt160, rt200, rt300,
        rt400 }

TFC-Subset ::=
    minimumAllowedTFC-Number
    allowedTFC-List
    non-allowedTFC-List
    restrictedTrChInfoList
    fullTFCS
    CHOICE {
        TFC-Value,
        AllowedTFC-List,
        Non-allowedTFC-List,
        RestrictedTrChInfoList,
        NULL
    }

TFC-SubsetList ::=
    modeSpecificInfo
        fdd
        tdd
            tfcs-ID
        },
    tfc-Subset
    SEQUENCE (SIZE (1.. maxTFCsub)) OF SEQUENCE {
        CHOICE {
            NULL,
            SEQUENCE {
                TFC-Identity
            }
        }
        TFC-Subset
    }

TFC-Value ::=
    INTEGER (0..1023)

TFCI-Field2-Information ::=
    tfci-Range
    explicit-config
    CHOICE {
        TFCI-RangeList,
        ExplicitTFCS-Configuration
    }

TFCI-Range ::=
    maxTFCIField2Value
    tfcs-InfoForDSCH
    SEQUENCE {
        INTEGER (1..1023),
        TFC-InfoForDSCH
    }

TFCI-RangeList ::=
    SEQUENCE (SIZE (1..maxPDSCH-TFCIgroups)) OF
    TFCI-Range

TFCS ::=
    normalTFCI-Signalling
    -- dummy is not used in this version of specification, it should
    -- not be sent and if received the UE behaviour is not specified.
    dummy
    CHOICE {
        ExplicitTFCS-Configuration,
        SplitTFCI-Signalling
    }

TFCS-r12 ::=
    normalTFCI-Signalling
    CHOICE {
        ExplicitTFCS-Configuration-r12
    }

TFCS-Identity ::=
    tfcs-ID
    sharedChannelIndicator
    SEQUENCE {
        TFC-IdentityPlain
        BOOLEAN
    }
    DEFAULT 1,

TFCS-IdentityPlain ::=
    INTEGER (1..8)

TFCS-InfoForDSCH ::=
    ctfc2bit
    ctfc4bit
    ctfc6bit
    ctfc8bit
    ctfc12bit
    ctfc16bit
    ctfc24bit
    CHOICE {
        INTEGER (0..3),
        INTEGER (0..15),
        INTEGER (0..63),
        INTEGER (0..255),
        INTEGER (0..4095),
        INTEGER (0..65535),
        INTEGER (0..16777215)
    }

TFCS-ReconfAdd ::=
    ctfcSize
        ctfc2Bit
            ctfc2
            powerOffsetInformation
        },
    ctfc4Bit
        ctfc4
        powerOffsetInformation
    },
    ctfc6Bit
    SEQUENCE{
        CHOICE{
            SEQUENCE (SIZE (1..maxTFC)) OF SEQUENCE {
                INTEGER (0..3),
                PowerOffsetInformation
            }
            OPTIONAL
        },
        SEQUENCE (SIZE (1..maxTFC)) OF SEQUENCE {
            INTEGER (0..15),
            PowerOffsetInformation
        }
        OPTIONAL
    },
        SEQUENCE (SIZE (1..maxTFC)) OF SEQUENCE {

```

```

        ctfc6
        powerOffsetInformation
    },
    ctfc8Bit
    ctfc8
    powerOffsetInformation
},
ctfc12Bit
ctfc12
powerOffsetInformation
},
ctfc16Bit
ctfc16
powerOffsetInformation
},
ctfc24Bit
ctfc24
powerOffsetInformation
}
}
}

TFCS-ReconfAdd-r12 ::=
    ctfcSize
        ctfc2Bit
        ctfc2
        powerOffsetInformation
        powerOffsetInformation-10msMode
    },
    ctfc4Bit
    ctfc4
    powerOffsetInformation
    powerOffsetInformation-10msMode
    },
    ctfc6Bit
    ctfc6
    powerOffsetInformation
    powerOffsetInformation-10msMode
    },
    ctfc8Bit
    ctfc8
    powerOffsetInformation
    powerOffsetInformation-10msMode
    },
    ctfc12Bit
    ctfc12
    powerOffsetInformation
    powerOffsetInformation-10msMode
    },
    ctfc16Bit
    ctfc16
    powerOffsetInformation
    powerOffsetInformation-10msMode
    },
    ctfc24Bit
    ctfc24
    powerOffsetInformation
    powerOffsetInformation-10msMode
    }
}

TFCS-Removal ::=
    tfci
}

TFCS-RemovalList ::=
    SEQUENCE (SIZE (1..maxTFC)) OF
    TFCS-Removal

TimeDurationBeforeRetry ::=
    INTEGER (1..256)

TM-SignallingInfo ::=
    messType
    tm-SignallingMode
    mode1
    mode2
    -- in ul-controlledTrChList, TrCH-Type is always DCH
    ul-controlledTrChList

```



```

    }
  }
}

TransmissionTimeInterval ::=      ENUMERATED {
    tti10, tti20, tti40, tti80 }

TransmissionTimeValidity ::=     INTEGER (1..256)

TransportChannelConcatInfo ::=   SEQUENCE (SIZE (1..maxTrCHConcat)) OF
    TransportChannelIdentity

TransportChannelIdentity ::=     INTEGER (1..32)

TransportChannelIdentityDCHandDSCH ::= SEQUENCE {
    dch-transport-ch-id          TransportChannelIdentity,
    dsch-transport-ch-id        TransportChannelIdentity
}

TransportFormatSet ::=           CHOICE {
    dedicatedTransChTFS         DedicatedTransChTFS,
    commonTransChTFS            CommonTransChTFS
}

TransportFormatSet-LCR ::=       CHOICE {
    dedicatedTransChTFS         DedicatedTransChTFS,
    commonTransChTFS-LCR       CommonTransChTFS-LCR
}

Treset-ResetTimer ::=           ENUMERATED {
    rt1, rt2, rt3, rt4 }

-- The maximum allowed size of UL-AddReconfTransChInfoList sequence is 16
UL-AddReconfTransChInfoList ::= SEQUENCE (SIZE (1..maxTrCHpreconf)) OF
    UL-AddReconfTransChInformation

-- The maximum allowed size of UL-AddReconfTransChInfoList-r6 sequence is 32
UL-AddReconfTransChInfoList-r6 ::= SEQUENCE (SIZE (1..maxTrCH)) OF
    UL-AddReconfTransChInformation-r6

-- The maximum allowed size of UL-AddReconfTransChInfoList-r7 sequence is 32
UL-AddReconfTransChInfoList-r7 ::= SEQUENCE (SIZE (1..maxTrCH)) OF
    UL-AddReconfTransChInformation-r7

-- The maximum allowed size of UL-AddReconfTransChInfoList-r8 sequence is 32
UL-AddReconfTransChInfoList-r8 ::= SEQUENCE (SIZE (1..maxTrCH)) OF
    UL-AddReconfTransChInformation-r8

UL-AddReconfTransChInformation ::= SEQUENCE {
    ul-TransportChannelType      UL-TrCH-Type,
    transportChannelIdentity     TransportChannelIdentity,
    transportFormatSet           TransportFormatSet
}

UL-AddReconfTransChInformation-r6 ::= CHOICE {
    dch-usch                     SEQUENCE {
        ul-TransportChannelType      UL-TrCH-Type,
        transportChannelIdentity     TransportChannelIdentity,
        transportFormatSet           TransportFormatSet
    },
    e-dch                         SEQUENCE {
        tti                          E-DCH-TTI,
        harq-Info                    ENUMERATED { rv0, rvtable },
        addReconf-MAC-d-FlowList     E-DCH-AddReconf-MAC-d-FlowList OPTIONAL
    }
}

UL-AddReconfTransChInformation-r7 ::= CHOICE {
    dch-usch                     SEQUENCE {
        ul-TransportChannelType      UL-TrCH-Type,
        transportChannelIdentity     TransportChannelIdentity,
        transportFormatSet           TransportFormatSet
    },
    e-dch                         SEQUENCE {
        modeSpecific                 CHOICE {
            fdd                      SEQUENCE {
                tti                  E-DCH-TTI
            }
        }
    }
}

```

```

        },
        tdd                NULL
    },
    harq-Info              ENUMERATED { rv0, rvtable },
    addReconf-MAC-d-FlowList E-DCH-AddReconf-MAC-d-FlowList-r7 OPTIONAL
}
}

UL-AddReconfTransChInformation-r8 ::= CHOICE {
    dch-usch              SEQUENCE {
        ul-TransportChannelType    UL-TrCH-Type,
        transportChannelIdentity    TransportChannelIdentity,
        transportFormatSet          TransportFormatSet
    },
    e-dch                SEQUENCE {
        ul-MAC-HeaderType          ENUMERATED { mac-iis } OPTIONAL,
        modeSpecific              CHOICE {
            fdd                    SEQUENCE {
                tti                E-DCH-TTI
            },
            tdd                    NULL
        },
        harq-Info                ENUMERATED { rv0, rvtable },
        addReconf-MAC-d-FlowList E-DCH-AddReconf-MAC-d-FlowList-r7 OPTIONAL
    }
}

UL-CommonTransChInfo ::= SEQUENCE {
    -- TABULAR: tfc-subset is applicable to FDD only, TDD specifies tfc-subset in individual
    -- CCH Info.
    tfc-Subset              TFC-Subset                OPTIONAL,
    prach-TFCS              TFCS                      OPTIONAL,
    modeSpecificInfo        CHOICE {
        fdd                  SEQUENCE {
            ul-TFCS
        },
        tdd                  SEQUENCE {
            individualUL-CCH-InfoList    IndividualUL-CCH-InfoList OPTIONAL
        }
    }
}

UL-CommonTransChInfo-r4 ::= SEQUENCE {
    -- TABULAR: tfc-subset is applicable to FDD only, TDD specifies tfc-subset in individual
    -- CCH Info.
    tfc-Subset              TFC-Subset                OPTIONAL,
    prach-TFCS              TFCS                      OPTIONAL,
    modeSpecificInfo        CHOICE {
        fdd                  SEQUENCE {
            ul-TFCS
        },
        tdd                  SEQUENCE {
            individualUL-CCH-InfoList    IndividualUL-CCH-InfoList OPTIONAL
        }
    }
}
tfc-SubsetList            TFC-SubsetList            OPTIONAL,
}

UL-CommonTransChInfo-r12 ::= SEQUENCE {
    -- TABULAR: tfc-subset is applicable to FDD only, TDD specifies tfc-subset in individual
    -- CCH Info.
    tfc-Subset              TFC-Subset                OPTIONAL,
    prach-TFCS              TFCS                      OPTIONAL,
    modeSpecificInfo        CHOICE {
        fdd                  SEQUENCE {
            ul-TFCS
        },
        tdd                  SEQUENCE {
            individualUL-CCH-InfoList    IndividualUL-CCH-InfoList OPTIONAL
        }
    }
}
tfc-SubsetList            TFC-SubsetList            OPTIONAL,
}

-- In UL-ControlledTrChList, TrCH-Type is always DCH
UL-ControlledTrChList ::= SEQUENCE (SIZE (1..maxTrCH)) OF

```

```

        TransportChannelIdentity
UL-DeletedTransChInfoList ::= SEQUENCE (SIZE (1..maxTrCH)) OF
        UL-TransportChannelIdentity
UL-DeletedTransChInfoList-r6 ::= SEQUENCE (SIZE (1..maxTrCH)) OF
        UL-TransportChannelIdentity-r6
UL-TransportChannelIdentity ::= SEQUENCE {
        ul-TransportChannelType      UL-TrCH-Type,
        ul-TransportChannelIdentity TransportChannelIdentity
}
UL-TransportChannelIdentity-r6 ::= CHOICE {
        dch-usch SEQUENCE {
                ul-TransportChannelType      UL-TrCH-Type,
                ul-TransportChannelIdentity TransportChannelIdentity
        },
        e-dch      E-DCH-MAC-d-FlowIdentity
}
UL-TrCH-Type ::= ENUMERATED {dch, usch}
USCH-TransportChannelsInfo ::= SEQUENCE (SIZE (1..maxTrCH)) OF
        SEQUENCE {
                usch-TransportChannelIdentity TransportChannelIdentity,
                usch-TFS                      TransportFormatSet
        }
-- *****
--
--     PHYSICAL CHANNEL INFORMATION ELEMENTS (10.3.6)
--
-- *****
ACK-NACK-repetitionFactor ::= INTEGER(1..4)
ActivationDelay ::= ENUMERATED {
        radio-frames-0,
        radio-frames-1,
        radio-frames-2,
        radio-frames-3,
        radio-frames-4,
        radio-frames-5,
        spare2,
        spare1 }
AC-To-ASC-Mapping ::= INTEGER (0..7)
AC-To-ASC-MappingTable ::= SEQUENCE (SIZE (maxASCmap)) OF
        AC-To-ASC-Mapping
AccessServiceClass-FDD ::= SEQUENCE {
        availableSignatureStartIndex      INTEGER (0..15),
        availableSignatureEndIndex        INTEGER (0..15),
        assignedSubChannelNumber          BIT STRING {
                b3(0),
                b2(1),
                b1(2),
                b0(3)
        } (SIZE(4))
}
AccessServiceClass-TDD ::= SEQUENCE {
        channelisationCodeIndices        BIT STRING {
                chCodeIndex7(0),
                chCodeIndex6(1),
                chCodeIndex5(2),
                chCodeIndex4(3),
                chCodeIndex3(4),
                chCodeIndex2(5),
                chCodeIndex1(6),
                chCodeIndex0(7)
        } (SIZE(8)) OPTIONAL,
        subchannelSize                    CHOICE {
                size1 NULL,
                size2 SEQUENCE {

```

```

        -- subch0 means bitstring '01' in the tabular, subch1 means bitsring '10'
        subchannels      ENUMERATED { subch0, subch1 } OPTIONAL
    },
    size4
        subchannels      SEQUENCE {
                            BIT STRING {
                                subCh3(0),
                                subCh2(1),
                                subCh1(2),
                                subCh0(3)
                            } (SIZE(4)) OPTIONAL
                        },
    size8
        subchannels      SEQUENCE {
                            BIT STRING {
                                subCh7(0),
                                subCh6(1),
                                subCh5(2),
                                subCh4(3),
                                subCh3(4),
                                subCh2(5),
                                subCh1(6),
                                subCh0(7)
                            } (SIZE(8)) OPTIONAL
                        }
    }
}

AccessServiceClass-TDD-r7 ::=
    channelisationCodeIndices SEQUENCE {
        BIT STRING {
            chCodeIndex15(0),
            chCodeIndex14(1),
            chCodeIndex13(2),
            chCodeIndex12(3),
            chCodeIndex11(4),
            chCodeIndex10(5),
            chCodeIndex9(6),
            chCodeIndex8(7),
            chCodeIndex7(8),
            chCodeIndex6(9),
            chCodeIndex5(10),
            chCodeIndex4(11),
            chCodeIndex3(12),
            chCodeIndex2(13),
            chCodeIndex1(14),
            chCodeIndex0(15)
        } (SIZE(16)) OPTIONAL,
        subchannelSize CHOICE {
            size1 NULL,
            size2 SEQUENCE {
                -- subch0 means bitstring '01' in the tabular, subch1 means bitsring '10'
                subchannels      ENUMERATED { subch0, subch1 } OPTIONAL
            },
            size4 SEQUENCE {
                BIT STRING {
                    subCh3(0),
                    subCh2(1),
                    subCh1(2),
                    subCh0(3)
                } (SIZE(4)) OPTIONAL
            },
            size8 SEQUENCE {
                BIT STRING {
                    subCh7(0),
                    subCh6(1),
                    subCh5(2),
                    subCh4(3),
                    subCh3(4),
                    subCh2(5),
                    subCh1(6),
                    subCh0(7)
                } (SIZE(8)) OPTIONAL
            },
            size16 SEQUENCE {
                BIT STRING {
                    subCh15(0),
                    subCh14(1),
                    subCh13(2),
                    subCh12(3),
                    subCh11(4),

```



```

AdditionalDLSecCellInfoListFDD2 ::= SEQUENCE (SIZE (4)) OF
    AdditionalDLSecCellInfoFDD-r11

AdditionalDLSecCellInfoHandoverToUtranListFDD ::= SEQUENCE (SIZE (2)) OF
    AdditionalDLSecCellInfoFDD-HandoverToUtran

-- AdditionalDLSecCellInfoFDD is introduced to avoid a SEQUENCE of SEQUENCE, a convention in RAN2.
AdditionalDLSecCellInfoFDD ::= SEQUENCE {
    dl-SecondaryCellInfoFDD          DL-SecondaryCellInfoFDD-r10          OPTIONAL
}

AdditionalDLSecCellInfoFDD-r11 ::= SEQUENCE {
    dl-SecondaryCellInfoFDD          DL-SecondaryCellInfoFDD-r11          OPTIONAL
}

AdditionalDLSecCellInfoFDD-HandoverToUtran ::= SEQUENCE {
    dl-SecondaryCellInfoFDD          DL-SecondaryCellInfoFDD-HandoverToUtran
    OPTIONAL
}

AICH-Info ::=
    channelisationCode256          SEQUENCE {
        channelisationCode256,
        sttd-Indicator              BOOLEAN,
        aich-TransmissionTiming     AICH-TransmissionTiming
    }

AICH-Info-Compressed ::=
    channelisationCode256          SEQUENCE {
        ChannelisationCode256
    }

AICH-PowerOffset ::=
    INTEGER (-22..5)

AICH-TransmissionTiming ::=
    ENUMERATED {
        e0, e1
    }

AllocationPeriodInfo ::=
    allocationActivationTime        SEQUENCE {
        INTEGER (0..255),
        allocationDuration          INTEGER (1..256)
    }

-- Actual value Alpha = IE value * 0.125
Alpha ::=
    INTEGER (0..8)

Antenna3And4 ::= SEQUENCE {
    antenna3And4-S-CPICH           Antenna3And4-S-CPICH          OPTIONAL,
    antenna3And4-D-CPICH           Antenna3And4-D-CPICH          OPTIONAL
}

Antenna3And4-S-CPICH ::= SEQUENCE {
    antenna3-S-CPICH               Antenna3-S-CPICH          OPTIONAL,
    antenna4-S-CPICH               Antenna4-S-CPICH          OPTIONAL,
    s-cpich-PowerOffset-Mimo       S-CPICH-PowerOffset-4x4MIMO OPTIONAL
}

Antenna3And4-D-CPICH ::= SEQUENCE {
    antenna3-D-CPICH               Antenna3-D-CPICH          OPTIONAL,
    antenna4-D-CPICH               Antenna4-D-CPICH          OPTIONAL,
    d-cpich-PowerOffset-Mimo       D-CPICH-PowerOffset-4x4MIMO OPTIONAL,
    initialD-CPICHStatus           ENUMERATED { activated }          OPTIONAL
}

Antenna3-D-CPICH ::= SEQUENCE {
    channelisationCode             ChannelisationCode256
}

Antenna4-D-CPICH ::= SEQUENCE {
    channelisationCode             ChannelisationCode256
}

Antenna3-S-CPICH ::= SEQUENCE {
    channelisationCode             ChannelisationCode256
}

Antenna4-S-CPICH ::= SEQUENCE {
    channelisationCode             ChannelisationCode256
}

AP-AICH-ChannelisationCode ::=
    INTEGER (0..255)

```

```

AP-PreambleScramblingCode ::=          INTEGER (0..79)

AP-Signature ::=                        INTEGER (0..15)

AP-Signature-VCAM ::=                   SEQUENCE {
    ap-Signature                         AP-Signature,
    availableAP-SubchannelList           AvailableAP-SubchannelList OPTIONAL
}

AP-Subchannel ::=                       INTEGER (0..11)

ASCSetting-FDD ::=                      SEQUENCE {
    -- TABULAR: accessServiceClass-FDD is MD in tabular description
    -- Default value is previous ASC
    -- If this is the first ASC, the default value is all available signature and sub-channels
    accessServiceClass-FDD               AccessServiceClass-FDD OPTIONAL
}

ASCSetting-TDD ::=                      SEQUENCE {
    -- TABULAR: accessServiceClass-TDD is MD in tabular description
    -- Default value is previous ASC
    -- If this is the first ASC, the default value is all available channelisation codes and
    -- all available sub-channels with subchannelSize=size1.
    accessServiceClass-TDD               AccessServiceClass-TDD OPTIONAL
}

ASCSetting-TDD-r7 ::=                   SEQUENCE {
    -- TABULAR: accessServiceClass-TDD is MD in tabular description
    -- Default value is previous ASC
    -- If this is the first ASC, the default value is all available channelisation codes and
    -- all available sub-channels with subchannelSize=size1.
    accessServiceClass-TDD               AccessServiceClass-TDD-r7 OPTIONAL
}

ASCSetting-TDD-LCR-r4 ::=               SEQUENCE {
    -- TABULAR: accessServiceClass-TDD-LCR is MD in tabular description
    -- Default value is previous ASC
    -- If this is the first ASC, the default value is all available SYNC_UL codes and
    -- all available sub-channels with subchannelSize=size1.
    accessServiceClass-TDD-LCR           AccessServiceClass-TDD-LCR-r4 OPTIONAL
}

AvailableAP-Signature-VCAMList ::=      SEQUENCE (SIZE (1..maxPCPCH-APsig)) OF
                                         AP-Signature-VCAM

AvailableAP-SignatureList ::=           SEQUENCE (SIZE (1..maxPCPCH-APsig)) OF
                                         AP-Signature

AvailableAP-SubchannelList ::=          SEQUENCE (SIZE (1..maxPCPCH-APsubCh)) OF
                                         AP-Subchannel

AvailableMinimumSF-ListVCAM ::=         SEQUENCE (SIZE (1..maxPCPCH-SF)) OF
                                         AvailableMinimumSF-VCAM

AvailableMinimumSF-VCAM ::=             SEQUENCE {
    minimumSpreadingFactor               MinimumSpreadingFactor,
    nf-Max                               NF-Max,
    maxAvailablePCPCH-Number             MaxAvailablePCPCH-Number,
    availableAP-Signature-VCAMList       AvailableAP-Signature-VCAMList
}

AvailableSignatures ::=                 BIT STRING {
    signature15(0),
    signature14(1),
    signature13(2),
    signature12(3),
    signature11(4),
    signature10(5),
    signature9(6),
    signature8(7),
    signature7(8),
    signature6(9),
    signature5(10),
    signature4(11),
    signature3(12),
    signature2(13),
    signature1(14),

```

```

signature0(15)
} (SIZE(16))

AvailableSubChannelNumbers ::= BIT STRING {
    subCh11(0),
    subCh10(1),
    subCh9(2),
    subCh8(3),
    subCh7(4),
    subCh6(5),
    subCh5(6),
    subCh4(7),
    subCh3(8),
    subCh2(9),
    subCh1(10),
    subCh0(11)
} (SIZE(12))

BEACON-PL-Est ::= ENUMERATED { true }

BurstType ::= ENUMERATED {
    type1, type2 }

-- Actual value Bler-Target = IE value * 0.05
Bler-Target ::= INTEGER (-63..0)

CCTrCH-PowerControlInfo ::= SEQUENCE {
    tfcs-Identity          TFCS-Identity          OPTIONAL,
    ul-DPCH-PowerControlInfo  UL-DPCH-PowerControlInfo
}

CCTrCH-PowerControlInfo-r4 ::= SEQUENCE {
    tfcs-Identity          TFCS-Identity          OPTIONAL,
    ul-DPCH-PowerControlInfo-r4  UL-DPCH-PowerControlInfo-r4
}

CCTrCH-PowerControlInfo-r5 ::= SEQUENCE {
    tfcs-Identity          TFCS-Identity          OPTIONAL,
    ul-DPCH-PowerControlInfo-r5  UL-DPCH-PowerControlInfo-r5
}

CCTrCH-PowerControlInfo-r7 ::= SEQUENCE {
    tfcs-Identity          TFCS-Identity          OPTIONAL,
    ul-DPCH-PowerControlInfo-r7  UL-DPCH-PowerControlInfo-r7
}

CD-AccessSlotSubchannel ::= INTEGER (0..11)

CD-AccessSlotSubchannelList ::= SEQUENCE (SIZE (1..maxPCPCH-CDsubCh)) OF
    CD-AccessSlotSubchannel

CD-CA-ICH-ChannelisationCode ::= INTEGER (0..255)

CD-PreambleScramblingCode ::= INTEGER (0..79)

CD-SignatureCode ::= INTEGER (0..15)

CD-SignatureCodeList ::= SEQUENCE (SIZE (1..maxPCPCH-CDsig)) OF
    CD-SignatureCode

CellAndChannelIdentity ::= SEQUENCE {
    -- burstType may be set to either value and should be ignored by the receiver for 1.28 Mcps TDD.
    burstType          BurstType,
    midambleShift      MidambleShiftLong,
    timeslot           TimeslotNumber,
    cellParametersID   CellParametersID
}

CellParametersID ::= INTEGER (0..127)

Cfntargetsfnframeoffset ::= INTEGER(0..255)

ChannelAssignmentActive ::= CHOICE {
    notActive          NULL,
    isActive          AvailableMinimumSF-ListVCAM
}

ChannelisationCode256 ::= INTEGER (0..255)

```



```

ChannelReqParamsForUCSM ::= SEQUENCE {
    availableAP-SignatureList AvailableAP-SignatureList,
    availableAP-SubchannelList AvailableAP-SubchannelList OPTIONAL
}

ClosedLoopTimingAdjMode ::= ENUMERATED {
    slot1, slot2 }

CodeNumberDSCH ::= INTEGER (0..255)

CodeRange ::= SEQUENCE {
    pdsch-CodeMapList PDSCH-CodeMapList
}

CodeResourceInformation-TDD128 ::= SEQUENCE {
    start-code HS-ChannelisationCode-LCR,
    stop-code HS-ChannelisationCode-LCR
}

CodeWordSet ::= ENUMERATED {
    longCWS,
    mediumCWS,
    shortCWS,
    ssdtOff }

Common-E-DCH-ResourceInfoList ::= SEQUENCE {
    s-offset INTEGER (0..9) OPTIONAL,
    f-dpch-ChannelisationCodeNumber INTEGER (0..255) OPTIONAL,
    e-RGCH-Information E-RGCH-Information-CommonEdch OPTIONAL,
    e-hich-Info E-HICH-Information-CommonEdch,
    ul-DPCH-CodeInfoForCommonEDCH UL-DPCH-CodeInfoForCommonEDCH
}

Common-E-DCH-ResourceInfoListExt ::= SEQUENCE {
    twoMsHarqConfiguration TwoMsHarqConfiguration
}

Common-E-RNTI-Info ::= SEQUENCE (SIZE (1..maxERUCCH)) OF
    SEQUENCE {
        starting-E-RNTI E-RNTI,
        number-of-group INTEGER (1..maxERNTIgroup),
        number-of-ENRTI-per-group INTEGER (1..maxERNTIperGroup)
    }

CommonEDCHResourceConfigInfoListExt ::= SEQUENCE {
    scheduledTransmissionConfiguration ScheduledTransmissionConfiguration OPTIONAL,
    cOffset INTEGER (0..29) OPTIONAL
}

-- For FDD, the network should not include the IE CommonEDCHSystemInfo.
-- Instead, the IE commonEDCHSystemInfoFDD should be used.
-- If included, the UE behavior is unspecified.
CommonEDCHSystemInfo ::= SEQUENCE {
    ul-InterferenceForCommonEDCH UL-Interference OPTIONAL,
    common-E-DCH-MAC-d-FlowList Common-E-DCH-MAC-d-FlowList,
    modeSpecificInfo CHOICE {
        dummy SEQUENCE {},
        tdd CHOICE {
            tdd768 NULL,
            tdd384 NULL,
            tdd128 SEQUENCE {
                e-RUCCH-Info E-RUCCH-Info-TDD128,
                e-PUCH-Info E-PUCH-Info-TDD128,
                e-hich-Information E-HICH-Information-TDD128,
                e-agch-Information E-AGCH-Information-TDD128,
                harq-Info ENUMERATED { rv0, rvtable },
                ccch-transmission-Info SEQUENCE {
                    common-e-rnti-Info Common-E-RNTI-Info,
                    harq-MaximumNumberOfRetransmissions INTEGER (0..7),
                    harq-retransmission-timer ENUMERATED {
                        ms10, ms15, ms20, ms25,
                        ms30, ms35, ms40, ms45,
                        ms50, ms55, ms60, ms65,
                        ms70, ms75, ms80, ms85,
                        ms90, ms95, ms100, ms110,
                        ms120, ms140, ms160 },
                    harq-power-offset INTEGER (0..6)
                }
            }
        }
    }
}

```

```

}
}
}
}
}
}

CommonEDCHSystemInfoFDD ::= SEQUENCE {
    ul-InterferenceForCommonEDCH          UL-Interference          OPTIONAL,
    common-E-DCH-MAC-d-FlowList           Common-E-DCH-MAC-d-FlowList,
    prach-PreambleForEnhancedUplink       PRACH-PreambleForEnhancedUplink,
    initialServingGrantValue              INTEGER (0..37),
    e-dch-TTI                             E-DCH-TTI,
    e-agch-Information                     E-AGCH-Information,
    harq-Info                              ENUMERATED { rv0, rvtable },
    ul-DPCHpowerControlInfoForCommonEDCH UL-DPCHpowerControlInfoForCommonEDCH,
    e-dpcch-Info                          E-DPCCH-Info-r7,
    e-dpdch-Info                          E-DPDCH-Info-r8,
    -- Actual value dl-FDPCH-TPCcommandErrorRate = IE value * 0.01
    dl-FDPCH-TPCcommandErrorRate          INTEGER (1..10),
    additional-E-DCH-TransmitBackoff       INTEGER (0..15),
    max-CCCH-ResourceAllocation            ENUMERATED {
        tti8, tti12, tti16, tti20, tti24, tti32,
        tti40, tti80 },
    max-PeriodForCollisionResolution       INTEGER (8..24),
    e-dch-TransmitContinuationOffset       ENUMERATED {
        tti0, tti4, tti8, tti16, tti24, tti40,
        tti80,infinity },
    ack-nack-support-on-HS-DPCCH          BOOLEAN,
    measurement-Feedback-Info              Measurement-Feedback-Info-r7          OPTIONAL,
    common-E-DCH-ResourceInfoList          SEQUENCE (SIZE (1..maxEDCHs)) OF
        Common-E-DCH-ResourceInfoList
}

CommonEDCHSystemInfoParamConcurrentTTI ::= SEQUENCE {
    common-E-DCH-MAC-d-Flow-Info-List-ConcurrentTTI
        Common-E-DCH-MAC-d-Flow-Info-List-ConcurrentTTI OPTIONAL,
    initialServingGrantValue              INTEGER (0..37) OPTIONAL,
    e-agch-Information                     E-AGCH-Information          OPTIONAL,
    ul-DPCHpowerControlInfoConcurrentTTI UL-DPCHpowerControlInfoConcurrentTTI          OPTIONAL,
    e-DPCCH-DPCCH-PowerOffset              E-DPCCH-DPCCH-PowerOffset          OPTIONAL,
    e-dpdch-Info                          E-DPDCH-Info-r8,
    additional-E-DCH-TransmitBackoff       INTEGER (0..15) OPTIONAL,
    max-CCCH-ResourceAllocation            ENUMERATED {
        tti8, tti12, tti16, tti20, tti24, tti32,
        tti40, tti80 } OPTIONAL,
    max-PeriodForCollisionResolution       INTEGER (8..24) OPTIONAL,
    e-dch-TransmitContinuationOffset       ENUMERATED {
        tti0, tti4, tti8, tti16, tti24, tti40,
        tti80,infinity } OPTIONAL,
    measurement-Feedback-Info-ConcurrentTTI Measurement-Feedback-Info-ConcurrentTTI
        OPTIONAL
}

CommonERGCHChannelConfig ::= SEQUENCE {
    channelisationCode                     INTEGER (0..127)          OPTIONAL,
    signatureSequence                       INTEGER (0..39)          OPTIONAL
}

CommonERGCHInfoFDD ::= SEQUENCE {
    configurationInfo                       CHOICE {
        continue                            NULL,
        newConfiguration                    SEQUENCE {
            eRGCHNeighbourCellList          BIT STRING (SIZE (maxCellMeas)),
            commonERGCHChannelConfigList    SEQUENCE (SIZE (1.. maxCellMeas)) OF
                CommonERGCHChannelConfig,
            minimumServingGrantValue        INTEGER (0..37)          OPTIONAL,
            reportingRange                   ReportingRange,
            filterCoefficient                FilterCoefficient          DEFAULT fc0
        }
    }
}

CommonTimeslotInfo ::= SEQUENCE {
    -- TABULAR: secondInterleavingMode is MD, but since it can be encoded in a single
    -- bit it is not defined as OPTIONAL.
    secondInterleavingMode                  SecondInterleavingMode,

```

```

    tfci-Coding                TFCI-Coding                OPTIONAL,
    puncturingLimit            PuncturingLimit,
    repetitionPeriodAndLength  RepetitionPeriodAndLength  OPTIONAL
}

CommonTimeslotInfoMBMS ::=          SEQUENCE {
    -- TABULAR: secondInterleavingMode is MD, but since it can be encoded in a single
    -- bit it is not defined as OPTIONAL.
    secondInterleavingMode        SecondInterleavingMode,
    tfci-Coding                    TFCI-Coding                OPTIONAL,
    puncturingLimit                PuncturingLimit
}

CommonTimeslotInfoSCCPCH ::=        SEQUENCE {
    -- TABULAR: secondInterleavingMode is MD, but since it can be encoded in a single
    -- bit it is not defined as OPTIONAL.
    secondInterleavingMode        SecondInterleavingMode,
    tfci-Coding                    TFCI-Coding                OPTIONAL,
    puncturingLimit                PuncturingLimit,
    repetitionPeriodLengthAndOffset RepetitionPeriodLengthAndOffset  OPTIONAL
}

ConstantValue ::=                  INTEGER (-35..-10)

ConstantValueTdd ::=                INTEGER (-35..10)

ControlChannelDRXCycle-TDD128 ::=  ENUMERATED {
    sub-frames-1, sub-frames-2, sub-frames-4, sub-frames-8,
    sub-frames-16, sub-frames-32, sub-frames-64, spare1 }

ControlChannelDRXInfo-TDD128-r8 ::= SEQUENCE {
    controlChannelDrxOperation      CHOICE {
        continue                    SEQUENCE {
            enablingDelay            EnablingDelay-TDD128            OPTIONAL
        },
        newOperation                SEQUENCE {
            hs-SCCH-Drx-Info         HS-SCCH-DRX-Info-TDD128,
            e-AGCH-Drx-Info         E-AGCH-DRX-Info-TDD128  OPTIONAL,
            enablingDelay            EnablingDelay-TDD128
        }
    }
}

CPCH-PersistenceLevels ::=         SEQUENCE {
    cpch-SetID                     CPCH-SetID,
    dynamicPersistenceLevelTF-List  DynamicPersistenceLevelTF-List
}

CPCH-PersistenceLevelsList ::=     SEQUENCE (SIZE (1..maxCPCHsets)) OF
    CPCH-PersistenceLevels

CPCH-SetInfo ::=                   SEQUENCE {
    cpch-SetID                     CPCH-SetID,
    transportFormatSet              TransportFormatSet,
    tfcs                             TFCS,
    ap-PreambleScramblingCode       AP-PreambleScramblingCode,
    ap-AICH-ChannelisationCode      AP-AICH-ChannelisationCode,
    cd-PreambleScramblingCode       CD-PreambleScramblingCode,
    cd-CA-ICH-ChannelisationCode    CD-CA-ICH-ChannelisationCode,
    cd-AccessSlotSubchannelList     CD-AccessSlotSubchannelList  OPTIONAL,
    cd-SignatureCodeList            CD-SignatureCodeList        OPTIONAL,
    deltaPp-m                       DeltaPp-m,
    ul-DPCCH-SlotFormat             UL-DPCCH-SlotFormat,
    n-StartMessage                  N-StartMessage,
    n-EOT                            N-EOT,
    -- TABULAR: VCAM info has been nested inside ChannelAssignmentActive,
    -- which in turn is mandatory since it's only a binary choice.
    channelAssignmentActive         ChannelAssignmentActive,
    cpch-StatusIndicationMode       CPCH-StatusIndicationMode,
    pcpch-ChannelInfoList           PCPCH-ChannelInfoList
}

CPCH-SetInfoList ::=               SEQUENCE (SIZE (1..maxCPCHsets)) OF
    CPCH-SetInfo

CPCH-StatusIndicationMode ::=     ENUMERATED {
    pa-mode,
    pamsf-mode }

```

```

CQI-CycleSwitchTimer ::=          ENUMERATED {
    sub-frames-4,
    sub-frames-8,
    sub-frames-16,
    sub-frames-32,
    sub-frames-64,
    sub-frames-128,
    sub-frames-256,
    sub-frames-512,
    sub-frames-Infinity,
    spare7,
    spare6,
    spare5,
    spare4,
    spare3,
    spare2,
    spare1 }

CQI-DTX-Timer ::=                ENUMERATED {
    sub-frames-0,
    sub-frames-1,
    sub-frames-2,
    sub-frames-4,
    sub-frames-8,
    sub-frames-16,
    sub-frames-32,
    sub-frames-64,
    sub-frames-128,
    sub-frames-256,
    sub-frames-512,
    sub-frames-Infinity,
    spare4,
    spare3,
    spare2,
    spare1 }

CQI-RepetitionFactor ::=        INTEGER(1..4)

CSICH-PowerOffset ::=           INTEGER (-10..5)

D-CPICH-PowerOffset-4x4MIMO ::=  INTEGER (-12..0)

DCH-Enhancements-Info-FDD ::=  SEQUENCE {
    configurationInfo            CHOICE {
        continue                 NULL,
        newConfiguration         SEQUENCE {
            ulTransmissionMode   CHOICE {
                tenMSOnly        NULL,
                twentyMSOnly     NULL,
                tenORTwentyMS    SEQUENCE {
                    ul-TransModeSwitchingParam  UL-TransModeSwitchingParam
                }
            },
            dlFETMode             CHOICE {
                basic              NULL,
                full               SEQUENCE {
                    early-dch-QualityTarget  QualityTarget,
                    early-dch-TargetSlot    INTEGER (11..28),
                    trChConcatInfo         TransportChannelConcatInfo
                }
            }
        }
    }
}

-- DefaultDPCH-OffsetValueFDD and DefaultDPCH-OffsetValueTDD corresponds to
-- IE "Default DPCH Offset Value" depending on the mode.
-- Actual value DefaultDPCH-OffsetValueFDD = IE value * 512

DefaultDPCH-OffsetValueFDD ::=  INTEGER (0..599)

DefaultDPCH-OffsetValueTDD ::=  INTEGER (0..7)

DeltaPp-m ::=                   INTEGER (-10..10)

DeltaCQI ::=                     INTEGER (0..8)

```

```

DeltaCQI-r11 ::= INTEGER (0..10)
DeltaNACK ::= INTEGER (0..8)
DeltaNACK-r11 ::= INTEGER (0..10)
DeltaACK ::= INTEGER (0..8)
DeltaACK-r11 ::= INTEGER (0..10)
-- Actual value DeltaSIR = IE value * 0.1
DeltaSIR ::= INTEGER (0..30)
DesignatedNonServingHS-DSCHCellInfo ::= SEQUENCE {
    primaryCPICH-Info PrimaryCPICH-Info
}
DHS-Sync ::= INTEGER (-20..10)
DL-CCTrCh ::= SEQUENCE {
    tfcs-ID TFCS-IdentityPlain DEFAULT 1,
    timeInfo TimeInfo,
    commonTimeslotInfo CommonTimeslotInfo OPTIONAL,
    dl-CCTrCH-TimeslotsCodes DownlinkTimeslotsCodes OPTIONAL,
    ul-CCTrChTPCList UL-CCTrChTPCList OPTIONAL
}
DL-CCTrCh-r4 ::= SEQUENCE {
    tfcs-ID TFCS-IdentityPlain DEFAULT 1,
    timeInfo TimeInfo,
    commonTimeslotInfo CommonTimeslotInfo OPTIONAL,
    tddOption CHOICE {
        tdd384 SEQUENCE {
            dl-CCTrCH-TimeslotsCodes DownlinkTimeslotsCodes OPTIONAL
        },
        tdd128 SEQUENCE {
            dl-CCTrCH-TimeslotsCodes DownlinkTimeslotsCodes-LCR-r4 OPTIONAL
        }
    },
    ul-CCTrChTPCList UL-CCTrChTPCList OPTIONAL
}
DL-CCTrCh-r7 ::= SEQUENCE {
    tfcs-ID TFCS-IdentityPlain DEFAULT 1,
    timeInfo TimeInfo,
    commonTimeslotInfo CommonTimeslotInfo OPTIONAL,
    tddOption CHOICE {
        tdd384 SEQUENCE {
            dl-CCTrCH-TimeslotsCodes DownlinkTimeslotsCodes-r7 OPTIONAL
        },
        tdd768 SEQUENCE {
            dl-CCTrCH-TimeslotsCodes DownlinkTimeslotsCodes-VHCR OPTIONAL
        },
        tdd128 SEQUENCE {
            dl-CCTrCH-TimeslotsCodes DownlinkTimeslotsCodes-LCR-r4 OPTIONAL
        }
    },
    ul-CCTrChTPCList UL-CCTrChTPCList OPTIONAL
}
DL-CCTrChList ::= SEQUENCE (SIZE (1..maxCCTrCH)) OF
    DL-CCTrCh
DL-CCTrChList-r7 ::= SEQUENCE (SIZE (1..maxCCTrCH)) OF
    DL-CCTrCh-r7
DL-CCTrChList-r4 ::= SEQUENCE (SIZE (1..maxCCTrCH)) OF
    DL-CCTrCh-r4
DL-CCTrChListToRemove ::= SEQUENCE (SIZE (1..maxCCTrCH)) OF
    TFCS-IdentityPlain
DL-ChannelisationCode ::= SEQUENCE {
    secondaryScramblingCode SecondaryScramblingCode OPTIONAL,
    sf-AndCodeNumber SF512-AndCodeNumber,
    scramblingCodeChange ScramblingCodeChange OPTIONAL
}

```

```

DL-ChannelisationCodeList ::=          SEQUENCE (SIZE (1..maxDPCH-DLchan)) OF
                                         DL-ChannelisationCode

DL-CommonInformation ::=              SEQUENCE {
  dl-DPCH-InfoCommon                  DL-DPCH-InfoCommon          OPTIONAL,
  modeSpecificInfo                     CHOICE {
    fdd                                 SEQUENCE {
      defaultDPCH-OffsetValue          DefaultDPCH-OffsetValueFDD  OPTIONAL,
      dpch-CompressedModeInfo          DPCH-CompressedModeInfo    OPTIONAL,
      tx-DiversityMode                 TX-DiversityMode           OPTIONAL,
      -- dummy is not used in this version of the specification, it should
      -- not be sent and if received it should be ignored.
      dummy                             SSDT-Information          OPTIONAL
    },
    tdd                                 SEQUENCE {
      defaultDPCH-OffsetValue          DefaultDPCH-OffsetValueTDD  OPTIONAL
    }
  }
}

DL-CommonInformation-r4 ::=          SEQUENCE {
  dl-DPCH-InfoCommon                  DL-DPCH-InfoCommon-r4      OPTIONAL,
  modeSpecificInfo                     CHOICE {
    fdd                                 SEQUENCE {
      defaultDPCH-OffsetValue          DefaultDPCH-OffsetValueFDD  OPTIONAL,
      dpch-CompressedModeInfo          DPCH-CompressedModeInfo    OPTIONAL,
      tx-DiversityMode                 TX-DiversityMode           OPTIONAL,
      -- dummy is not used in this version of the specification, it should
      -- not be sent and if received it should be ignored.
      dummy                             SSDT-Information-r4        OPTIONAL
    },
    tdd                                 SEQUENCE {
      tddOption                         CHOICE {
        tdd384                          NULL,
        tdd128                          SEQUENCE {
          tstd-Indicator                 BOOLEAN
        }
      },
      defaultDPCH-OffsetValue          DefaultDPCH-OffsetValueTDD  OPTIONAL
    }
  }
}

DL-CommonInformation-r5 ::=          SEQUENCE {
  dl-DPCH-InfoCommon                  DL-DPCH-InfoCommon-r4      OPTIONAL,
  modeSpecificInfo                     CHOICE {
    fdd                                 SEQUENCE {
      defaultDPCH-OffsetValue          DefaultDPCH-OffsetValueFDD  OPTIONAL,
      dpch-CompressedModeInfo          DPCH-CompressedModeInfo    OPTIONAL,
      tx-DiversityMode                 TX-DiversityMode           OPTIONAL,
      -- dummy is not used in this version of the specification, it should
      -- not be sent and if received it should be ignored.
      dummy                             SSDT-Information-r4        OPTIONAL
    },
    tdd                                 SEQUENCE {
      tddOption                         CHOICE {
        tdd384                          NULL,
        tdd128                          SEQUENCE {
          tstd-Indicator                 BOOLEAN
        }
      },
      defaultDPCH-OffsetValue          DefaultDPCH-OffsetValueTDD  OPTIONAL
    }
  },
  mac-hsResetIndicator                ENUMERATED { true }        OPTIONAL
}

DL-CommonInformation-r6 ::=          SEQUENCE {
  dl-dpchInfoCommon                   CHOICE {
    dl-DPCH-InfoCommon                 DL-DPCH-InfoCommon-r6,
    dl-FDPCH-InfoCommon                 DL-FDPCH-InfoCommon-r6
  }
  modeSpecificInfo                     CHOICE {
    fdd                                 SEQUENCE {
      defaultDPCH-OffsetValue          DefaultDPCH-OffsetValueFDD  OPTIONAL,
      dpch-CompressedModeInfo          DPCH-CompressedModeInfo    OPTIONAL,
      tx-DiversityMode                 TX-DiversityMode           OPTIONAL
    }
  }
}

```

```

    },
    tdd
        tddOption
            tdd384
            tdd128
            tstd-Indicator
        }
    },
    defaultDPCH-OffsetValue
        DefaultDPCH-OffsetValueTDD OPTIONAL
}

},
mac-hsResetIndicator
postVerificationPeriod
    ENUMERATED { true }
    ENUMERATED { true }
    OPTIONAL,
    OPTIONAL
}

DL-CommonInformation-r7 ::=
    dl-dpchInfoCommon
        dl-DPCH-InfoCommon
        dl-FDPCH-InfoCommon
    }
    modeSpecificInfo
        fdd
            defaultDPCH-OffsetValue
            dpch-CompressedModeInfo
            tx-DiversityMode
        },
        tdd
            tddOption
                tdd384
                tdd768
                tdd128
                tstd-Indicator
            }
        },
        defaultDPCH-OffsetValue
            DefaultDPCH-OffsetValueTDD OPTIONAL
    }
},
mac-hsResetIndicator
postVerificationPeriod
    ENUMERATED { true }
    ENUMERATED { true }
    OPTIONAL,
    OPTIONAL
}

DL-CommonInformation-r8 ::=
    dl-dpchInfoCommon
        dl-DPCH-InfoCommon
        dl-FDPCH-InfoCommon
    }
    modeSpecificInfo
        fdd
            defaultDPCH-OffsetValue
            dpch-CompressedModeInfo
            tx-DiversityMode
        },
        tdd
            tddOption
                tdd384
                tdd768
                tdd128
                tstd-Indicator
            }
        },
        defaultDPCH-OffsetValue
            DefaultDPCH-OffsetValueTDD OPTIONAL
    }
},
mac-hsResetIndicator
postVerificationPeriod
    ENUMERATED { true }
    ENUMERATED { true }
    OPTIONAL,
    OPTIONAL
}

DL-CommonInformation-r10 ::=
    dl-dpchInfoCommon
        dl-DPCH-InfoCommon
        dl-FDPCH-InfoCommon
    }
    modeSpecificInfo
        fdd
            defaultDPCH-OffsetValue
            dpch-CompressedModeInfo
            tx-DiversityMode
        },

```

```

    tdd
        tddOption
            tdd384
            tdd768
            tdd128
            tstd-Indicator
        },
        defaultDPCH-OffsetValue
    },
    mac-hsResetIndicator
    postVerificationPeriod
}

DL-CommonInformation-r11 ::=
    dl-dpchInfoCommon
        dl-DPCH-InfoCommon
        dl-FDPCH-InfoCommon
    },
    modeSpecificInfo
        fdd
            defaultDPCH-OffsetValue
            dpch-CompressedModeInfo
            tx-DiversityMode
        },
        tdd
            tddOption
                tdd384
                tdd768
                tdd128
                tstd-Indicator
            },
            defaultDPCH-OffsetValue
        },
        mac-hsResetIndicator
        postVerificationPeriod
        mac-hsResetIndicator-assisting
    }

DL-CommonInformation-r12 ::=
    dl-dpchInfoCommon
        dl-DPCH-InfoCommon
        dl-FDPCH-InfoCommon
    },
    modeSpecificInfo
        fdd
            defaultDPCH-OffsetValue
            dpch-CompressedModeInfo
            tx-DiversityMode
        },
        tdd
            tddOption
                tdd384
                tdd768
                tdd128
                tstd-Indicator
            },
            defaultDPCH-OffsetValue
        },
        mac-hsResetIndicator
        postVerificationPeriod
        mac-hsResetIndicator-assisting
    }

DL-CommonInformationPost ::=
    dl-DPCH-InfoCommon
}

DL-CommonInformationPredef ::=
    dl-DPCH-InfoCommon
}

DL-CompressedModeMethod ::=

```

SEQUENCE {
CHOICE {
NULL,
NULL,
SEQUENCE {
BOOLEAN

DefaultDPCH-OffsetValueTDD OPTIONAL

ENUMERATED { true } OPTIONAL,
ENUMERATED { true } OPTIONAL

SEQUENCE {
CHOICE {
DL-DPCH-InfoCommon-r6,
DL-FDPCH-InfoCommon-r6

OPTIONAL,
CHOICE {
SEQUENCE {
DefaultDPCH-OffsetValueFDD OPTIONAL,
DPCH-CompressedModeInfo-r10 OPTIONAL,
TX-DiversityMode OPTIONAL

SEQUENCE {
CHOICE {
NULL,
NULL,
SEQUENCE {
BOOLEAN

DefaultDPCH-OffsetValueTDD OPTIONAL

ENUMERATED { true } OPTIONAL,
ENUMERATED { true } OPTIONAL,
ENUMERATED { true } OPTIONAL

SEQUENCE {
CHOICE {
DL-DPCH-InfoCommon-r12,
DL-FDPCH-InfoCommon-r6

OPTIONAL,
CHOICE {
SEQUENCE {
DefaultDPCH-OffsetValueFDD OPTIONAL,
DPCH-CompressedModeInfo-r10 OPTIONAL,
TX-DiversityMode OPTIONAL

SEQUENCE {
CHOICE {
NULL,
NULL,
SEQUENCE {
BOOLEAN

DefaultDPCH-OffsetValueTDD OPTIONAL

ENUMERATED { true } OPTIONAL,
ENUMERATED { true } OPTIONAL,
ENUMERATED { true } OPTIONAL

SEQUENCE {
DL-DPCH-InfoCommonPost

SEQUENCE {
DL-DPCH-InfoCommonPredef OPTIONAL

ENUMERATED {

```

-- dummy is not used in this version of the specification, it should
-- not be sent and if received the UE behaviour is not specified.
    dummy, sf-2,
    higherLayerScheduling }

DL-DPCH-InfoCommon ::=
    SEQUENCE {
        cfnHandling
            CHOICE {
                maintain
                    NULL,
                initialise
                    SEQUENCE {
                        -- IE dummy is not used in this version of the specification
                        -- The IE should not be sent and if received it should be ignored
                        dummy
                            Cfntargetsfnsframeoffset
                                OPTIONAL
                    }
            },
        modeSpecificInfo
            CHOICE {
                fdd
                    SEQUENCE {
                        dl-DPCH-PowerControlInfo
                            DL-DPCH-PowerControlInfo
                                OPTIONAL,
                        powerOffsetPilot-pdpdch
                            PowerOffsetPilot-pdpdch,
                        dl-rate-matching-restriction
                            Dl-rate-matching-restriction
                                OPTIONAL,
                        -- TABULAR: The number of pilot bits is nested inside the spreading factor.
                        spreadingFactorAndPilot
                            SF512-AndPilot,
                        positionFixedOrFlexible
                            PositionFixedOrFlexible,
                        tfci-Existence
                            BOOLEAN
                    },
                tdd
                    SEQUENCE {
                        dl-DPCH-PowerControlInfo
                            DL-DPCH-PowerControlInfo
                                OPTIONAL
                    }
            }
    }

DL-DPCH-InfoCommon-r4 ::=
    SEQUENCE {
        cfnHandling
            CHOICE {
                maintain
                    NULL,
                initialise
                    SEQUENCE {
                        -- IE dummy is not used in this version of the specification
                        -- The IE should not be sent and if received it should be ignored
                        dummy
                            Cfntargetsfnsframeoffset
                                OPTIONAL
                    }
            },
        modeSpecificInfo
            CHOICE {
                fdd
                    SEQUENCE {
                        dl-DPCH-PowerControlInfo
                            DL-DPCH-PowerControlInfo
                                OPTIONAL,
                        powerOffsetPilot-pdpdch
                            PowerOffsetPilot-pdpdch,
                        dl-rate-matching-restriction
                            Dl-rate-matching-restriction
                                OPTIONAL,
                        -- TABULAR: The number of pilot bits is nested inside the spreading factor.
                        spreadingFactorAndPilot
                            SF512-AndPilot,
                        positionFixedOrFlexible
                            PositionFixedOrFlexible,
                        tfci-Existence
                            BOOLEAN
                    },
                tdd
                    SEQUENCE {
                        dl-DPCH-PowerControlInfo
                            DL-DPCH-PowerControlInfo
                                OPTIONAL
                    }
            }
    },
    -- The IE mac-d-HFN-initial-value should be absent in the RRCConnectionSetup-r4-IEs or
    -- RRCConnectionSetup-r5-IEs or HandoverToUTRANCommand-r4-IEs or HandoverToUTRANCommand-r5-IEs and
    -- if the IE is included, the general error handling for conditional IEs applies.
    mac-d-HFN-initial-value
        MAC-d-HFN-initial-value
            OPTIONAL
}

DL-DPCH-InfoCommon-r6 ::=
    SEQUENCE {
        cfnHandling
            CHOICE {
                maintain
                    SEQUENCE {
                        timingMaintainedSynchInd
                            TimingMaintainedSynchInd
                                OPTIONAL
                    },
                initialise
                    NULL
            },
        modeSpecificInfo
            CHOICE {
                fdd
                    SEQUENCE {
                        dl-DPCH-PowerControlInfo
                            DL-DPCH-PowerControlInfo
                                OPTIONAL,
                        powerOffsetPilot-pdpdch
                            PowerOffsetPilot-pdpdch,
                        dl-rate-matching-restriction
                            Dl-rate-matching-restriction
                                OPTIONAL,
                        -- TABULAR: The number of pilot bits is nested inside the spreading factor.
                        spreadingFactorAndPilot
                            SF512-AndPilot,
                        positionFixedOrFlexible
                            PositionFixedOrFlexible,
                        tfci-Existence
                            BOOLEAN
                    },
                tdd
                    SEQUENCE {

```

```

        dl-DPCH-PowerControlInfo          DL-DPCH-PowerControlInfo          OPTIONAL
    }
},
-- The IE mac-d-HFN-initial-value should be absent in the RRCConnectionSetup and the
-- HandoverToUTRANCommand messages. If the IE is included, the general error handling
-- for conditional IEs applies.
mac-d-HFN-initial-value                  MAC-d-HFN-initial-value          OPTIONAL
}

DL-DPCH-InfoCommon-r12 ::=              SEQUENCE {
    cfnHandling                           CHOICE {
        maintain                           SEQUENCE {
            timingmaintainedsynchind      TimingMaintainedSynchInd          OPTIONAL
        },
        initialise                          NULL
    },
    modeSpecificInfo                       CHOICE {
        fdd                                 SEQUENCE {
            dl-DPCH-PowerControlInfo      DL-DPCH-PowerControlInfo          OPTIONAL,
            powerOffsetPilot-pdpdch        PowerOffsetPilot-pdpdch,
            dl-rate-matching-restriction    Dl-rate-matching-restriction      OPTIONAL,
            -- TABULAR: The number of pilot bits is nested inside the spreading factor.
            spreadingFactorAndPilot         SF512-AndPilot-r12,
            positionFixedOrFlexible         PositionFixedOrFlexible,
            tfci-Existence                  BOOLEAN
        },
        tdd                                 SEQUENCE {
            dl-DPCH-PowerControlInfo      DL-DPCH-PowerControlInfo          OPTIONAL
        }
    },
-- The IE mac-d-HFN-initial-value should be absent in the RRCConnectionSetup and the
-- HandoverToUTRANCommand messages. If the IE is included, the general error handling
-- for conditional IEs applies.
mac-d-HFN-initial-value                  MAC-d-HFN-initial-value          OPTIONAL
}

DL-DPCH-InfoCommonPost ::=              SEQUENCE {
    dl-DPCH-PowerControlInfo              DL-DPCH-PowerControlInfo          OPTIONAL
}

DL-DPCH-InfoCommonPredef ::=            SEQUENCE {
    modeSpecificInfo                       CHOICE {
        fdd                                 SEQUENCE {
            -- TABULAR: The number of pilot bits is nested inside the spreading factor.
            spreadingFactorAndPilot         SF512-AndPilot,
            positionFixedOrFlexible         PositionFixedOrFlexible,
            tfci-Existence                  BOOLEAN
        },
        tdd                                 SEQUENCE {
            commonTimeslotInfo             CommonTimeslotInfo
        }
    }
}

DL-DPCH-InfoPerRL ::=                   CHOICE {
    fdd                                     SEQUENCE {
        pCPICH-UsageForChannelEst          PCPICH-UsageForChannelEst,
        dpch-FrameOffset                   DPCH-FrameOffset,
        secondaryCPICH-Info                 SecondaryCPICH-Info                OPTIONAL,
        dl-ChannelisationCodeList          DL-ChannelisationCodeList,
        tpc-CombinationIndex               TPC-CombinationIndex,
        -- dummy is not used in this version of the specification, it should
        -- not be sent and if received it should be ignored.
        dummy                               SSdT-CellIdentity                 OPTIONAL,
        closedLoopTimingAdjMode            ClosedLoopTimingAdjMode           OPTIONAL
    },
    tdd                                     SEQUENCE {
        dl-CCTrChListToEstablish           DL-CCTrChList                     OPTIONAL,
        dl-CCTrChListToRemove              DL-CCTrChListToRemove            OPTIONAL
    }
}

DL-DPCH-InfoPerRL-r4 ::=                CHOICE {
    fdd                                     SEQUENCE {
        pCPICH-UsageForChannelEst          PCPICH-UsageForChannelEst,
        dpch-FrameOffset                   DPCH-FrameOffset,
        secondaryCPICH-Info                 SecondaryCPICH-Info                OPTIONAL,
        dl-ChannelisationCodeList          DL-ChannelisationCodeList,

```

```

        tpc-CombinationIndex          TPC-CombinationIndex,
        -- dummy is not used in this version of the specification, it should
        -- not be sent and if received it should be ignored.
        dummy                          SSDT-CellIdentity          OPTIONAL,
        closedLoopTimingAdjMode        ClosedLoopTimingAdjMode    OPTIONAL
    },
    tdd                                SEQUENCE {
        dl-CCTrChListToEstablish        DL-CCTrChList-r4          OPTIONAL,
        dl-CCTrChListToRemove          DL-CCTrChListToRemove    OPTIONAL
    }
}

DL-DPCH-InfoPerRL-r5 ::=
    fdd                                CHOICE {
        SEQUENCE {
            pCPICH-UsageForChannelEst   PCPICH-UsageForChannelEst,
            dpch-FrameOffset             DPCH-FrameOffset,
            secondaryCPICH-Info          SecondaryCPICH-Info      OPTIONAL,
            dl-ChannelisationCodeList    DL-ChannelisationCodeList,
            tpc-CombinationIndex         TPC-CombinationIndex,
            powerOffsetTPC-pdpdch        PowerOffsetTPC-pdpdch   OPTIONAL,
            -- dummy is not used in this version of the specification, it should
            -- not be sent and if received it should be ignored.
            dummy                          SSDT-CellIdentity          OPTIONAL,
            closedLoopTimingAdjMode        ClosedLoopTimingAdjMode    OPTIONAL
        },
        tdd                                SEQUENCE {
            dl-CCTrChListToEstablish        DL-CCTrChList-r4          OPTIONAL,
            dl-CCTrChListToRemove          DL-CCTrChListToRemove    OPTIONAL
        }
    }

DL-DPCH-InfoPerRL-r6 ::=
    fdd                                CHOICE {
        SEQUENCE {
            pCPICH-UsageForChannelEst   PCPICH-UsageForChannelEst,
            dpch-FrameOffset             DPCH-FrameOffset,
            secondaryCPICH-Info          SecondaryCPICH-Info      OPTIONAL,
            dl-ChannelisationCodeList    DL-ChannelisationCodeList,
            tpc-CombinationIndex         TPC-CombinationIndex,
            powerOffsetTPC-pdpdch        PowerOffsetTPC-pdpdch   OPTIONAL,
            closedLoopTimingAdjMode        ClosedLoopTimingAdjMode    OPTIONAL
        },
        tdd                                SEQUENCE {
            dl-CCTrChListToEstablish        DL-CCTrChList-r4          OPTIONAL,
            dl-CCTrChListToRemove          DL-CCTrChListToRemove    OPTIONAL
        }
    }

DL-DPCH-InfoPerRL-r7 ::=
    fdd                                CHOICE {
        SEQUENCE {
            pCPICH-UsageForChannelEst   PCPICH-UsageForChannelEst,
            dpch-FrameOffset             DPCH-FrameOffset,
            secondaryCPICH-Info          SecondaryCPICH-Info      OPTIONAL,
            dl-ChannelisationCodeList    DL-ChannelisationCodeList,
            tpc-CombinationIndex         TPC-CombinationIndex,
            powerOffsetTPC-pdpdch        PowerOffsetTPC-pdpdch   OPTIONAL,
            closedLoopTimingAdjMode        ClosedLoopTimingAdjMode    OPTIONAL
        },
        tdd                                SEQUENCE {
            dl-CCTrChListToEstablish        DL-CCTrChList-r7          OPTIONAL,
            dl-CCTrChListToRemove          DL-CCTrChListToRemove    OPTIONAL
        }
    }

DL-DPCH-InfoPerRL-r12 ::=
    fdd                                CHOICE {
        SEQUENCE {
            pCPICH-UsageForChannelEst   PCPICH-UsageForChannelEst,
            dpch-FrameOffset             DPCH-FrameOffset,
            secondaryCPICH-Info          SecondaryCPICH-Info      OPTIONAL,
            dl-ChannelisationCodeList    DL-ChannelisationCodeList,
            tpc-CombinationIndex         TPC-CombinationIndex,
            powerOffsetTPC-pdpdch        PowerOffsetTPC-pdpdch   OPTIONAL,
            powerOffsetPO-SRB            PowerOffsetPO-SRB        OPTIONAL,
            closedLoopTimingAdjMode        ClosedLoopTimingAdjMode    OPTIONAL
        },
        tdd                                SEQUENCE {
            dl-CCTrChListToEstablish        DL-CCTrChList-r7          OPTIONAL,
            dl-CCTrChListToRemove          DL-CCTrChListToRemove    OPTIONAL
        }
    }

```

```

}

DL-DPCH-InfoPerRL-ASU ::=
    CHOICE {
        fdd
            PCPICH-UsageForChannelEst
            dpch-FrameOffset
            secondaryCPICH-Info
            dl-ChannelisationCodeList
            tpc-CombinationIndex
            powerOffsetTPC-pdpdch
            powerOffsetPO-SRB
            closedLoopTimingAdjMode
        },
        tdd
            dl-CCTrChListToEstablish
            dl-CCTrChListToRemove
    }

DL-FDPCH-InfoPerRL-r6 ::=
    SEQUENCE {
        pCPICH-UsageForChannelEst
        fdpch-FrameOffset
        secondaryCPICH-Info
        secondaryScramblingCode
        dl-ChannelisationCode
        tpc-CombinationIndex
    }

DL-FDPCH-InfoPerRL-r7 ::=
    SEQUENCE {
        pCPICH-UsageForChannelEst
        fdpch-FrameOffset
        fdpch-SlotFormat
        secondaryCPICH-Info
        secondaryScramblingCode
        dl-ChannelisationCode
        tpc-CombinationIndex
        sttdIndication
    }

DL-DPCH-InfoPerRL-PostFDD ::=
    SEQUENCE {
        pCPICH-UsageForChannelEst
        dl-ChannelisationCode
        tpc-CombinationIndex
    }

DL-DPCH-InfoPerRL-PostTDD ::=
    SEQUENCE {
        dl-DPCH-TimeslotsCodes
    }

DL-DPCH-InfoPerRL-PostTDD-LCR-r4 ::=
    SEQUENCE {
        dl-CCTrCH-TimeslotsCodes
    }

DL-DPCH-PowerControlInfo ::=
    SEQUENCE {
        modeSpecificInfo
        CHOICE {
            fdd
                dpc-Mode
            },
        tdd
            tpc-StepSizeTDD
    }

DL-FDPCH-InfoCommon-r6 ::=
    SEQUENCE {
        cfnHandling
        CHOICE {
            maintain
                SEQUENCE {
                    timingmaintainedsynchind
                }
            },
        initialise
        DL-DPCH-PowerControlInfo
        -- Actual value dl-FDPCH-TPCcommandErrorRate = IE value * 0.01
        -- dl-FDPCH-TPCcommandErrorRate values 11..16 are spare and shall not be used in this version of
        -- the protocol.
        -- In addition, this IE shall always be included otherwise the UE behaviour is unspecified.
        dl-FDPCH-TPCcommandErrorRate
    }

```

```

}
DL-FrameType ::=
    ENUMERATED {
        dl-FrameTypeA, dl-FrameTypeB }

DL-HSPDSCH-Information ::=
    SEQUENCE {
        hs-scch-Info          HS-SCCH-Info          OPTIONAL,
        measurement-feedback-Info Measurement-Feedback-Info OPTIONAL,
        modeSpecificInfo      CHOICE {
            tdd
                CHOICE {
                    tdd384
                        SEQUENCE {
                            dl-HSPDSCH-TS-Configuration DL-HSPDSCH-TS-Configuration OPTIONAL
                        },
                    tdd128
                        SEQUENCE {
                            hs-PDSCH-Midamble-Configuration-tdd128
                            HS-PDSCH-Midamble-Configuration-TDD128 OPTIONAL
                        }
                }
            },
        fdd                    NULL
    }
}

DL-HSPDSCH-Information-r6 ::= SEQUENCE {
    hs-scch-Info          HS-SCCH-Info-r6          OPTIONAL,
    measurement-feedback-Info Measurement-Feedback-Info OPTIONAL,
    modeSpecificInfo      CHOICE {
        tdd
            CHOICE {
                tdd384
                    SEQUENCE {
                        dl-HSPDSCH-TS-Configuration DL-HSPDSCH-TS-Configuration OPTIONAL
                    },
                tdd128
                    SEQUENCE {
                        hs-PDSCH-Midamble-Configuration-tdd128
                        HS-PDSCH-Midamble-Configuration-TDD128 OPTIONAL
                    }
            }
        },
    fdd                    NULL
}

DL-HSPDSCH-Information-r7 ::= SEQUENCE {
    hs-scch-Info          HS-SCCH-Info-r7          OPTIONAL,
    measurement-feedback-Info Measurement-Feedback-Info-r7 OPTIONAL,
    modeSpecificInfo      CHOICE {
        tdd
            CHOICE {
                tdd384
                    SEQUENCE {
                        dl-HSPDSCH-TS-Configuration DL-HSPDSCH-TS-Configuration OPTIONAL
                    },
                tdd768
                    SEQUENCE {
                        dl-HSPDSCH-TS-Configuration DL-HSPDSCH-TS-Configuration-VHCR OPTIONAL
                    },
                tdd128
                    SEQUENCE {
                        hs-PDSCH-Midamble-Configuration-tdd128
                        HS-PDSCH-Midamble-Configuration-TDD128 OPTIONAL,
                        dl-MultiCarrier-Information DL-MultiCarrier-Information OPTIONAL
                    }
            }
        },
    fdd                    SEQUENCE {
        dl-64QAM-Configured ENUMERATED { true } OPTIONAL
    }
}

DL-HSPDSCH-Information-r8 ::= SEQUENCE {
    hs-scch-Info          HS-SCCH-Info-r7          OPTIONAL,
    measurement-feedback-Info Measurement-Feedback-Info-r7 OPTIONAL,
    modeSpecificInfo      CHOICE {
        tdd
            CHOICE {
                tdd384
                    SEQUENCE {
                        dl-HSPDSCH-TS-Configuration DL-HSPDSCH-TS-Configuration OPTIONAL
                    },
                tdd768
                    SEQUENCE {
                        dl-HSPDSCH-TS-Configuration DL-HSPDSCH-TS-Configuration-VHCR OPTIONAL
                    },
                tdd128
                    SEQUENCE {
                        hs-PDSCH-Midamble-Configuration-tdd128
                        HS-PDSCH-Midamble-Configuration-TDD128 OPTIONAL,
                        dl-MultiCarrier-Information DL-MultiCarrier-Information OPTIONAL
                    }
            }
    }
}

```

```

    },
    fdd
        dl-64QAM-Configured      SEQUENCE {
        hs-DSCH-TBSizeTable      ENUMERATED { true }
                                HS-DSCH-TBSizeTable
                                OPTIONAL,
                                OPTIONAL
        }
    }
}

DL-HSPDSCH-Information-r8-ext ::= SEQUENCE {
    modeSpecificInfo            CHOICE {
        tdd
            tdd384              CHOICE {
            tdd768              NULL,
            tdd128              NULL,
                                SEQUENCE {
                outofSyncWindow OutofSyncWindow
                                OPTIONAL
            }
        },
        fdd
            NULL
    }
}

DL-HSPDSCH-Information-r8-ext2 ::= SEQUENCE {
    hs-scch-Info                HS-SCCH-Info-r8-ext
                                OPTIONAL
}

DL-HSPDSCH-Information-r9 ::= SEQUENCE {
    hs-scch-Info                HS-SCCH-Info-r9
                                OPTIONAL,
    measurement-feedback-Info  Measurement-Feedback-Info-r7
                                OPTIONAL,
    modeSpecificInfo            CHOICE {
        tdd
            CHOICE {
                tdd384          SEQUENCE {
                    dl-HSPDSCH-TS-Configuration DL-HSPDSCH-TS-Configuration OPTIONAL
                },
                tdd768          SEQUENCE {
                    dl-HSPDSCH-TS-Configuration DL-HSPDSCH-TS-Configuration-VHCR  OPTIONAL
                },
                tdd128          SEQUENCE {
                    hs-PDSCH-Midamble-Configuration-tdd128
                    HS-PDSCH-Midamble-Configuration-TDD128
                    dl-MultiCarrier-Information DL-MultiCarrier-Information
                    ts0-Indicator              ENUMERATED { true }
                    outofSyncWindow          OutofSyncWindow
                    OPTIONAL,
                    OPTIONAL,
                    OPTIONAL,
                    OPTIONAL
                }
            }
        },
        fdd
            dl-64QAM-Configured      SEQUENCE {
            hs-DSCH-TBSizeTable      ENUMERATED { true }
                                HS-DSCH-TBSizeTable
                                OPTIONAL,
                                OPTIONAL
        }
    }
}

DL-HSPDSCH-Information-r11 ::= SEQUENCE {
    hs-scch-Info                HS-SCCH-Info-r9
                                OPTIONAL,
    measurement-feedback-Info  Measurement-Feedback-Info-r11
                                OPTIONAL,
    modeSpecificInfo            CHOICE {
        tdd
            CHOICE {
                tdd384          SEQUENCE {
                    dl-HSPDSCH-TS-Configuration DL-HSPDSCH-TS-Configuration OPTIONAL
                },
                tdd768          SEQUENCE {
                    dl-HSPDSCH-TS-Configuration DL-HSPDSCH-TS-Configuration-VHCR  OPTIONAL
                },
                tdd128          SEQUENCE {
                    hs-PDSCH-Midamble-Configuration-tdd128
                    HS-PDSCH-Midamble-Configuration-TDD128
                    dl-MultiCarrier-Information DL-MultiCarrier-Information
                    ts0-Indicator              ENUMERATED { true }
                    outofSyncWindow          OutofSyncWindow
                    OPTIONAL,
                    OPTIONAL,
                    OPTIONAL,
                    OPTIONAL
                }
            }
        },
        fdd
            dl-64QAM-Configured      SEQUENCE {
            hs-DSCH-TBSizeTable      ENUMERATED { true }
                                HS-DSCH-TBSizeTable
                                OPTIONAL,
                                OPTIONAL
        }
    }
}

DL-HSPDSCH-Information-r12 ::= SEQUENCE {

```

```

hs-scch-Info          HS-SCCH-Info-r9          OPTIONAL,
measurement-feedback-Info Measurement-Feedback-Info-r12  OPTIONAL,
modeSpecificInfo     CHOICE {
  tdd                 CHOICE {
    tdd384            SEQUENCE {
      dl-HSPDSCH-TS-Configuration  DL-HSPDSCH-TS-Configuration  OPTIONAL
    },
    tdd768            SEQUENCE {
      dl-HSPDSCH-TS-Configuration  DL-HSPDSCH-TS-Configuration-VHCR  OPTIONAL
    },
    tdd128            SEQUENCE {
      hs-PDSCH-Midamble-Configuration-tdd128
      HS-PDSCH-Midamble-Configuration-TDD128  OPTIONAL,
      dl-MultiCarrier-Information  DL-MultiCarrier-Information  OPTIONAL,
      ts0-Indicator              ENUMERATED { true }  OPTIONAL,
      outofSyncWindow            OutofSyncWindow  OPTIONAL,
      ts0ChannelizationCodes     DL-TS-ChannelisationCodesShort  OPTIONAL
    }
  },
  fdd                 SEQUENCE {
    dl-64QAM-Configured          ENUMERATED { true }  OPTIONAL,
    hs-DSCH-TBSizeTable          HS-DSCH-TBSizeTable  OPTIONAL
  }
}
}

OutOfSyncWindow ::= ENUMERATED {
  ms40, ms80, ms160, ms320,
  ms640, spare3, spare2, spare1 }

DL-HSPDSCH-MultiCarrier-Information ::= SEQUENCE (SIZE (1..maxTDD128Carrier)) OF
  SEQUENCE {
    uarfcn-Carrier          UARFCN,
    harqInfo                HARQ-Info  OPTIONAL,
    hs-PDSCH-Midamble-Configuration  HS-PDSCH-Midamble-Configuration-TDD128  OPTIONAL,
    hs-SCCH-TDD128-MultiCarrier  SEQUENCE (SIZE (1..maxHSSCCHs)) OF
      HS-SCCH-TDD128-MultiCarrier  OPTIONAL
  }

-- The IE 'DL-HSPDSCH-TS-Configuration' applies to tdd-384 REL-5 onward
DL-HSPDSCH-TS-Configuration ::= SEQUENCE (SIZE (1..maxTS-1)) OF
  SEQUENCE {
    timeslot                TimeslotNumber,
    midambleShiftAndBurstType  MidambleShiftAndBurstType-DL
  }

-- The IE 'DL-HSPDSCH-TS-Configuration-VHCR' applies to tdd-768 REL-7 onward
DL-HSPDSCH-TS-Configuration-VHCR ::= SEQUENCE (SIZE (1..maxTS-1)) OF
  SEQUENCE {
    timeslot                TimeslotNumber,
    midambleShiftAndBurstType  MidambleShiftAndBurstType-DL-VHCR
  }

DL-InformationPerRL ::= SEQUENCE {
  modeSpecificInfo        CHOICE {
    fdd                   SEQUENCE {
      primaryCPICH-Info    PrimaryCPICH-Info,
      -- dummy1 and dummy 2 are not used in this version of specification, they should
      -- not be sent and if received they should be ignored.
      dummy1                PDSCH-SHO-DCH-Info  OPTIONAL,
      dummy2                PDSCH-CodeMapping  OPTIONAL
    },
    tdd                   PrimaryCCPCH-Info
  },
  dl-DPCH-InfoPerRL      DL-DPCH-InfoPerRL  OPTIONAL,
  -- dummy is not used in this version of the specification, it should
  -- not be sent and if received it should be ignored.
  dummy                  SCCPCH-InfoForFACH  OPTIONAL
}

DL-InformationPerRL-r4 ::= SEQUENCE {
  modeSpecificInfo        CHOICE {
    fdd                   SEQUENCE {
      primaryCPICH-Info    PrimaryCPICH-Info,
      -- dummy1 and dummy 2 are not used in this version of specification, they should
      -- not be sent and if received they should be ignored.
      dummy1                PDSCH-SHO-DCH-Info  OPTIONAL,
      dummy2                PDSCH-CodeMapping  OPTIONAL
    }
  }
}

```

```

    },
    tdd
        PrimaryCCPCH-Info-r4
    },
    dl-DPCH-InfoPerRL
        DL-DPCH-InfoPerRL-r4
        OPTIONAL,
    -- dummy is not used in this version of the specification, it should
    -- not be sent and if received it should be ignored.
    dummy
        SCCPCH-InfoForFACH-r4
        OPTIONAL,
    cell-id
        CellIdentity
        OPTIONAL
}

DL-InformationPerRL-r5 ::= SEQUENCE {
    modeSpecificInfo
        CHOICE {
            fdd
                SEQUENCE {
                    primaryCPICH-Info
                        PrimaryCPICH-Info,
                    -- dummy1 and dummy 2 are not used in this version of specification, they should
                    -- not be sent and if received they should be ignored.
                    dummy1
                        PDSCH-SHO-DCH-Info
                        OPTIONAL,
                    dummy2
                        PDSCH-CodeMapping
                        OPTIONAL,
                    servingHSDSCH-RL-indicator
                        BOOLEAN
                },
            tdd
                PrimaryCCPCH-Info-r4
        },
    dl-DPCH-InfoPerRL
        DL-DPCH-InfoPerRL-r5
        OPTIONAL,
    -- dummy is not used in this version of the specification, it should
    -- not be sent and if received it should be ignored.
    dummy
        SCCPCH-InfoForFACH-r4
        OPTIONAL,
    cell-id
        CellIdentity
        OPTIONAL
}

DL-InformationPerRL-r5bis ::= SEQUENCE {
    modeSpecificInfo
        CHOICE {
            fdd
                SEQUENCE {
                    primaryCPICH-Info
                        PrimaryCPICH-Info,
                    -- dummy1 and dummy 2 are not used in this version of specification, they should
                    -- not be sent and if received they should be ignored.
                    dummy1
                        PDSCH-SHO-DCH-Info
                        OPTIONAL,
                    dummy2
                        PDSCH-CodeMapping
                        OPTIONAL
                },
            tdd
                PrimaryCCPCH-Info-r4
        },
    dl-DPCH-InfoPerRL
        DL-DPCH-InfoPerRL-r5
        OPTIONAL,
    -- dummy is not used in this version of the specification, it should
    -- not be sent and if received it should be ignored.
    dummy
        SCCPCH-InfoForFACH-r4
        OPTIONAL,
    cell-id
        CellIdentity
        OPTIONAL
}

DL-InformationPerRL-r6 ::= SEQUENCE {
    modeSpecificInfo
        CHOICE {
            fdd
                SEQUENCE {
                    primaryCPICH-Info
                        PrimaryCPICH-Info,
                    servingHSDSCH-RL-indicator
                        BOOLEAN,
                    servingEDCH-RL-indicator
                        BOOLEAN
                },
            tdd
                PrimaryCCPCH-Info-r4
        },
    dl-dpchsInfo
        CHOICE {
            dl-DPCH-InfoPerRL
                DL-DPCH-InfoPerRL-r6,
            dl-FDPCH-InfoPerRL
                DL-FDPCH-InfoPerRL-r6
        }
        OPTIONAL,
    e-AGCH-Information
        E-AGCH-Information
        OPTIONAL,
    e-HICH-Info
        CHOICE {
            e-HICH-Information
                E-HICH-Information,
            releaseIndicator
                NULL
        }
        OPTIONAL,
    e-RGCH-Info
        CHOICE {
            e-RGCH-Information
                E-RGCH-Information,
            releaseIndicator
                NULL
        }
        OPTIONAL,
    cell-id
        CellIdentity
        OPTIONAL
}

DL-InformationPerRL-v6b0ext ::= SEQUENCE {
    sttdIndication
        STTDIndication
        OPTIONAL
}

DL-InformationPerRL-r7 ::= SEQUENCE {
    modeSpecificInfo
        CHOICE {

```



```

    fdd
      primaryCPICH-Info
      servingHSDSCH-RL-indicator
      servingEDCH-RL-indicator
    },
    tdd
      PrimaryCCPCH-Info-r4
  },
  dl-dpchInfo
    dl-DPCH-InfoPerRL
    dl-FDPCH-InfoPerRL
  }
  e-AGCH-Information
  modeSpecificInfo2
    fdd
      e-HICH-Info
      e-HICH-Information
      releaseIndicator
    } OPTIONAL,
    e-RGCH-Info
      e-RGCH-Information
      releaseIndicator
    } OPTIONAL
  },
  tdd
    tdd384-tdd768
      e-HICH-Info
    },
    tdd128
      e-HICH-Info
    }
  },
  cell-id
    CellIdentity
  } OPTIONAL
}

DL-InformationPerRL-r8 ::=
  modeSpecificInfo
    fdd
      primaryCPICH-Info
      servingHSDSCH-RL-indicator
      servingEDCH-RL-indicator
    },
    tdd
      PrimaryCCPCH-Info-r4
  },
  dl-dpchInfo
    dl-DPCH-InfoPerRL
    dl-FDPCH-InfoPerRL
  }
  e-AGCH-Information
  modeSpecificInfo2
    fdd
      e-HICH-Info
      e-HICH-Information
      releaseIndicator
    } OPTIONAL,
    e-RGCH-Info
      e-RGCH-Information
      releaseIndicator
    } OPTIONAL
  },
  tdd
    tdd384-tdd768
      e-HICH-Info
    },
    tdd128
      e-HICH-Info
    }
  },
  cell-id
    CellIdentity
  } OPTIONAL
}

DL-InformationPerRL-r11 ::=
  modeSpecificInfo
    fdd
      primaryCPICH-Info
      servingHSDSCH-RL-indicator
      servingEDCH-RL-indicator
    }
  }

```

```

    },
    tdd
        PrimaryCCPCH-Info-r4
    },
    dl-dpchsInfo CHOICE {
        dl-DPCH-InfoPerRL DL-DPCH-InfoPerRL-r7,
        dl-FDPCH-InfoPerRL DL-FDPCH-InfoPerRL-r7
    } OPTIONAL,
    e-AGCH-Information E-AGCH-Information-r8 OPTIONAL,
    e-ROCH-Information E-ROCH-Information OPTIONAL,
    modeSpecificInfo2 CHOICE {
        fdd SEQUENCE {
            e-HICH-Info CHOICE {
                e-HICH-Information E-HICH-Information-r11,
                releaseIndicator NULL,
                secondaryReleaseIndicator NULL
            } OPTIONAL,
            e-RGCH-Info CHOICE {
                e-RGCH-Information E-RGCH-Information,
                releaseIndicator NULL
            } OPTIONAL,
            f-TPICH-Info CHOICE {
                f-TPICH-Information F-TPICH-Information,
                releaseIndicator NULL
            } OPTIONAL
        }
    },
    tdd CHOICE {
        tdd384-tdd768 SEQUENCE {
            e-HICH-Info E-HICH-Information-TDD384-768 OPTIONAL
        },
        tdd128 SEQUENCE {
            e-HICH-Info E-HICH-Information-TDD128 OPTIONAL
        }
    }
},
cell-id CellIdentity OPTIONAL
}

DL-InformationPerRL-r12 ::= SEQUENCE {
    modeSpecificInfo CHOICE {
        fdd SEQUENCE {
            primaryCPICH-Info PrimaryCPICH-Info,
            servingHSDSCH-RL-indicator BOOLEAN,
            servingEDCH-RL-indicator BOOLEAN
        },
        tdd PrimaryCCPCH-Info-r4
    },
    dl-dpchsInfo CHOICE {
        dl-DPCH-InfoPerRL DL-DPCH-InfoPerRL-r12,
        dl-FDPCH-InfoPerRL DL-FDPCH-InfoPerRL-r7,
        radioLinksWithoutDPCHFDPCHInfo RadioLinksWithoutDPCHFDPCHInfo
    } OPTIONAL,
    e-AGCH-Information E-AGCH-Information-r8 OPTIONAL,
    e-ROCH-Information E-ROCH-Information OPTIONAL,
    modeSpecificInfo2 CHOICE {
        fdd SEQUENCE {
            e-HICH-Info CHOICE {
                e-HICH-Information E-HICH-Information-r11,
                releaseIndicator NULL,
                secondaryReleaseIndicator NULL
            } OPTIONAL,
            e-RGCH-Info CHOICE {
                e-RGCH-Information E-RGCH-Information,
                releaseIndicator NULL
            } OPTIONAL,
            f-TPICH-Info CHOICE {
                f-TPICH-Information F-TPICH-Information,
                releaseIndicator NULL
            } OPTIONAL
        }
    },
    tdd CHOICE {
        tdd384-tdd768 SEQUENCE {
            e-HICH-Info E-HICH-Information-TDD384-768 OPTIONAL
        },
        tdd128 SEQUENCE {
            e-HICH-Info E-HICH-Information-TDD128 OPTIONAL
        }
    }
},
}

```

```

    cell-id                CellIdentity                OPTIONAL
}

DL-InformationPerRL-List ::= SEQUENCE (SIZE (1..maxRL)) OF
    DL-InformationPerRL

DL-InformationPerRL-List-r4 ::= SEQUENCE (SIZE (1..maxRL)) OF
    DL-InformationPerRL-r4

DL-InformationPerRL-List-r5 ::= SEQUENCE (SIZE (1..maxRL)) OF
    DL-InformationPerRL-r5

DL-InformationPerRL-List-r6 ::= SEQUENCE (SIZE (1..maxRL)) OF
    DL-InformationPerRL-r6

DL-InformationPerRL-List-v6b0ext ::= SEQUENCE (SIZE (1..maxRL)) OF
    DL-InformationPerRL-v6b0ext

DL-InformationPerRL-List-r5bis ::= SEQUENCE (SIZE (1..maxRL)) OF
    DL-InformationPerRL-r5bis

DL-InformationPerRL-List-r7 ::= SEQUENCE (SIZE (1..maxRL)) OF
    DL-InformationPerRL-r7

DL-InformationPerRL-List-r8 ::= SEQUENCE (SIZE (1..maxRL)) OF
    DL-InformationPerRL-r8

DL-InformationPerRL-List-r11 ::= SEQUENCE (SIZE (1..maxRL)) OF
    DL-InformationPerRL-r11

DL-InformationPerRL-List-r12 ::= SEQUENCE (SIZE (1..maxRL)) OF
    DL-InformationPerRL-r12

DL-InformationPerRL-ListPostFDD ::= SEQUENCE (SIZE (1..maxRL)) OF
    DL-InformationPerRL-PostFDD

DL-InformationPerRL-PostFDD ::= SEQUENCE {
    primaryCPICH-Info          PrimaryCPICH-Info,
    dl-DPCH-InfoPerRL         DL-DPCH-InfoPerRL-PostFDD
}

DL-InformationPerRL-PostTDD ::= SEQUENCE {
    primaryCCPCH-Info          PrimaryCCPCH-InfoPost,
    dl-DPCH-InfoPerRL         DL-DPCH-InfoPerRL-PostTDD
}

DL-InformationPerRL-PostTDD-LCR-r4 ::= SEQUENCE {
    primaryCCPCH-Info          PrimaryCCPCH-InfoPostTDD-LCR-r4,
    dl-DPCH-InfoPerRL         DL-DPCH-InfoPerRL-PostTDD-LCR-r4
}

--for 1.28Mcps TDD Multi-Carrier
DL-MultiCarrier-Information ::= SEQUENCE {
    tsn-Length                 ENUMERATED { tsn-6bits, tsn-9bits }    OPTIONAL,
    multiCarrierNumber         INTEGER (1..maxTDD128Carrier)        OPTIONAL,
    dl-HSPDSCH-MultiCarrier-Information DL-HSPDSCH-MultiCarrier-Information    OPTIONAL
}

DL-PDSCH-Information ::= SEQUENCE {
    -- dummy1 and dummy 2 are not used in this version of specification, it should
    -- not be sent and if received it should be ignored.
    dummy1                     PDSCH-SHO-DCH-Info                 OPTIONAL,
    dummy2                     PDSCH-CodeMapping                 OPTIONAL
}

Dl-rate-matching-restriction ::= SEQUENCE {
    restrictedTrCH-InfoList     RestrictedTrCH-InfoList                OPTIONAL
}

DL-SecondaryCellInfoFDD ::= CHOICE {
    continue                   NULL,
    newConfiguration          SEQUENCE {
        new-H-RNTI             H-RNTI,
        dl-64QAM-Configured    ENUMERATED { true }                OPTIONAL,
        hs-DSCH-TBSizeTable    HS-DSCH-TBSizeTable                OPTIONAL,
        primaryCPICH-Info      PrimaryCPICH-Info,
        dl-ScramblingCode      SecondaryScramblingCode            OPTIONAL,
        hS-SCCHChannelisationCodeInfo SEQUENCE (SIZE (1..maxHSSCCHs)) OF
    }
}

```

```

        measurementPowerOffset
        uarfcn-DL
    }
}

DL-SecondaryCellInfoFDD-v890ext ::= SEQUENCE {
    differentTxModeFromServingHS-DSCHCell    ENUMERATED { different }    OPTIONAL
}

DL-SecondaryCellInfoFDD-r9 ::= SEQUENCE {
    configurationInfo    CHOICE {
        continue    NULL,
        newConfiguration    SEQUENCE {
            new-H-RNTI    H-RNTI,
            dl-64QAM-Configured    ENUMERATED { true }    OPTIONAL,
            hs-DSCH-TBSizeTable    HS-DSCH-TBSizeTable    OPTIONAL,
            primaryCPICH-Info    PrimaryCPICH-Info,
            dl-ScramblingCode    SecondaryScramblingCode    OPTIONAL,
            hs-SCCHChannelisationCodeInfo    SEQUENCE (SIZE (1..maxHSSCCHs)) OF
                HS-SCCH-Codes,
            measurementPowerOffset    MeasurementPowerOffset,
            uarfcn-DL    UARFCN,
            differentTxModeFromServingHS-DSCHCell    ENUMERATED { different }    OPTIONAL
        }
    },
    secondaryCellMIMOparameters    SecondaryCellMIMOparametersFDD    OPTIONAL
}

DL-SecondaryCellInfoFDD-r10 ::= SEQUENCE {
    configurationInfo    CHOICE {
        continue    NULL,
        newConfiguration    SEQUENCE {
            new-H-RNTI    H-RNTI,
            dl-64QAM-Configured    ENUMERATED { true }    OPTIONAL,
            hs-DSCH-TBSizeTable    HS-DSCH-TBSizeTable    OPTIONAL,
            primaryCPICH-Info    PrimaryCPICH-Info,
            dl-ScramblingCode    SecondaryScramblingCode    OPTIONAL,
            hs-SCCHChannelisationCodeInfo    SEQUENCE (SIZE (1..maxHSSCCHs)) OF
                HS-SCCH-Codes,
            measurementPowerOffset    MeasurementPowerOffset,
            uarfcn-DL    UARFCN,
            differentTxModeFromServingHS-DSCHCell    ENUMERATED { different }    OPTIONAL
        }
    },
    secondaryCellMIMOparameters    SecondaryCellMIMOparametersFDD-r10    OPTIONAL
}

DL-SecondaryCellInfoFDD-r11 ::= SEQUENCE {
    configurationInfo    CHOICE {
        continue    NULL,
        newConfiguration    SEQUENCE {
            new-H-RNTI    H-RNTI,
            dl-64QAM-Configured    ENUMERATED { true }    OPTIONAL,
            hs-DSCH-TBSizeTable    HS-DSCH-TBSizeTable    OPTIONAL,
            primaryCPICH-Info    PrimaryCPICH-Info,
            dl-ScramblingCode    SecondaryScramblingCode    OPTIONAL,
            hs-SCCHChannelisationCodeInfo    SEQUENCE (SIZE (1..maxHSSCCHs)) OF
                HS-SCCH-Codes,
            measurementPowerOffset    MeasurementPowerOffset,
            measurementPowerOffset1    MeasurementPowerOffset    OPTIONAL,
            uarfcn-DL    UARFCN,
            differentTxModeFromServingHS-DSCHCell    ENUMERATED { different }    OPTIONAL,
            multiflowConfigurationInfo    MultiflowConfigurationInfo    OPTIONAL
        }
    },
    secondaryCellMIMOparameters    SecondaryCellMIMOparametersFDD-r10    OPTIONAL,
    secondaryCell4x4MIMOparameters    SecondaryCell4x4MIMOparametersFDD    OPTIONAL
}

DL-SecondaryCellInfoFDD-HandoverToUtran ::= SEQUENCE {
    configurationInfo    CHOICE {
        continue    NULL,
        newConfiguration    SEQUENCE {
            new-H-RNTI    H-RNTI,
            primaryCPICH-Info    PrimaryCPICH-Info,
            dl-ScramblingCode    SecondaryScramblingCode    OPTIONAL,
            hs-SCCHChannelisationCodeInfo    SEQUENCE (SIZE (1..maxHSSCCHs)) OF

```

```

        measurementPowerOffset      HS-SCCH-Codes,
        uarfcn-DL                    MeasurementPowerOffset,
        differentTxModeFromServingHS-DSCHCell UARFCN,
        ENUMERATED { different }    OPTIONAL
    }
}

DL-TPC-PowerOffsetPerRL ::= SEQUENCE {
    powerOffsetTPC-pdpdch          PowerOffsetTPC-pdpdch          OPTIONAL
}

-- NOTE: The radio links in the following list have a one-to-one mapping with the
-- radio links in the message.
DL-TPC-PowerOffsetPerRL-List ::= SEQUENCE (SIZE (1..maxRL)) OF
    DL-TPC-PowerOffsetPerRL

DL-TS-ChannelisationCode ::= ENUMERATED {
    cc16-1, cc16-2, cc16-3, cc16-4,
    cc16-5, cc16-6, cc16-7, cc16-8,
    cc16-9, cc16-10, cc16-11, cc16-12,
    cc16-13, cc16-14, cc16-15, cc16-16 }

DL-TS-ChannelisationCode-VHCR ::= ENUMERATED {
    cc32-1, cc32-2, cc32-3, cc32-4,
    cc132-5, cc32-6, cc32-7, cc32-8,
    cc32-9, cc32-10, cc32-11, cc32-12,
    cc32-13, cc32-14, cc32-15, cc32-16,
    cc32-17, cc32-18, cc32-19, cc32-20,
    cc32-21, cc32-22, cc32-23, cc32-24,
    cc32-25, cc32-26, cc32-27, cc32-28,
    cc32-29, cc32-30, cc32-31, cc32-32 }

DL-TS-ChannelisationCodesShort ::= SEQUENCE {
    codesRepresentation          CHOICE {
        consecutive              SEQUENCE {
            firstChannelisationCode DL-TS-ChannelisationCode,
            lastChannelisationCode  DL-TS-ChannelisationCode
        },
        bitmap                   BIT STRING {
            chCode16-SF16(0),
            chCode15-SF16(1),
            chCode14-SF16(2),
            chCode13-SF16(3),
            chCode12-SF16(4),
            chCode11-SF16(5),
            chCode10-SF16(6),
            chCode9-SF16(7),
            chCode8-SF16(8),
            chCode7-SF16(9),
            chCode6-SF16(10),
            chCode5-SF16(11),
            chCode4-SF16(12),
            chCode3-SF16(13),
            chCode2-SF16(14),
            chCode1-SF16(15)
        } (SIZE (16))
    }
}

DL-TS-ChannelisationCodesShort-VHCR ::= SEQUENCE {
    codesRepresentation          CHOICE {
        consecutive              SEQUENCE {
            firstChannelisationCode DL-TS-ChannelisationCode-VHCR,
            lastChannelisationCode  DL-TS-ChannelisationCode-VHCR
        },
        bitmap                   BIT STRING {
            chCode32-SF32(0),
            chCode31-SF32(1),
            chCode30-SF32(2),
            chCode29-SF32(3),
            chCode28-SF32(4),
            chCode27-SF32(5),
            chCode26-SF32(6),
            chCode25-SF32(7),
            chCode24-SF32(8),
            chCode23-SF32(9),
            chCode22-SF32(10),

```

```

        chCode21-SF32(11),
        chCode20-SF32(12),
        chCode19-SF32(13),
        chCode18-SF32(14),
        chCode17-SF32(15),
        chCode16-SF32(16),
        chCode15-SF32(17),
        chCode14-SF32(18),
        chCode13-SF32(19),
        chCode12-SF32(20),
        chCode11-SF32(21),
        chCode10-SF32(22),
        chCode9-SF32(23),
        chCode8-SF32(24),
        chCode7-SF32(25),
        chCode6-SF32(26),
        chCode5-SF32(27),
        chCode4-SF32(28),
        chCode3-SF32(29),
        chCode2-SF32(30),
        chCode1-SF32(31)
    } (SIZE (32))
}
}

DL-ChannelCodes-MBSFN-IMB384 ::= SEQUENCE {
    firstChannelisationCode    INTEGER (1..15),
    lastChannelisationCode     INTEGER (1..15)                OPTIONAL
}

DLUL-HSPA-Information-r8 ::= SEQUENCE {
    ul-EDCH-Information        UL-EDCH-Information-r8,
    dl-CommonInformation       DL-CommonInformation-r8,
    dl-InformationPerRL-List   DL-InformationPerRL-List-r7,
    dl-HSPDSCH-Information     DL-HSPDSCH-Information-r8
}

DLUL-HSPA-Information-r9 ::= SEQUENCE {
    ul-EDCH-Information        UL-EDCH-Information-r9,
    dl-CommonInformation       DL-CommonInformation-r8,
    dl-InformationPerRL-List   DL-InformationPerRL-List-r7,
    dl-HSPDSCH-Information     DL-HSPDSCH-Information-r9
}

DLUL-HSPA-Information-r10 ::= SEQUENCE {
    ul-EDCH-Information        UL-EDCH-Information-r9,
    dl-CommonInformation       DL-CommonInformation-r10,
    dl-InformationPerRL-List   DL-InformationPerRL-List-r7,
    dl-HSPDSCH-Information     DL-HSPDSCH-Information-r9
}

DownlinkAdditionalTimeslots ::= SEQUENCE {
    parameters                 CHOICE {
        sameAsLast             SEQUENCE {
            timeslotNumber     TimeslotNumber
        },
        newParameters           SEQUENCE {
            individualTimeslotInfo IndividualTimeslotInfo,
            dl-TS-ChannelisationCodesShort DL-TS-ChannelisationCodesShort
        }
    }
}

DownlinkAdditionalTimeslots-VHCR ::= SEQUENCE {
    parameters                 CHOICE {
        sameAsLast             SEQUENCE {
            timeslotNumber     TimeslotNumber
        },
        newParameters           SEQUENCE {
            individualTimeslotInfo IndividualTimeslotInfo-VHCR,
            dl-TS-ChannelisationCodesShort DL-TS-ChannelisationCodesShort-VHCR
        }
    }
}

DownlinkAdditionalTimeslots-LCR-r4 ::= SEQUENCE {
    parameters                 CHOICE {
        sameAsLast             SEQUENCE {

```

```

        timeslotNumber          TimeslotNumber-LCR-r4
    },
    newParameters                SEQUENCE {
        individualTimeslotInfo   IndividualTimeslotInfo-LCR-r4,
        dl-TS-ChannelisationCodesShort DL-TS-ChannelisationCodesShort
    }
}

DownlinkAdditionalTimeslots-r7 ::= SEQUENCE {
    parameters                   CHOICE {
        sameAsLast               SEQUENCE {
            timeslotNumber       TimeslotNumber
        },
        newParameters            SEQUENCE {
            individualTimeslotInfo IndividualTimeslotInfo-r7,
            dl-TS-ChannelisationCodesShort DL-TS-ChannelisationCodesShort
        }
    }
}

DownlinkTimeslotsCodes ::= SEQUENCE {
    firstIndividualTimeslotInfo IndividualTimeslotInfo,
    dl-TS-ChannelisationCodesShort DL-TS-ChannelisationCodesShort,
    moreTimeslots               CHOICE {
        noMore                   NULL,
        additionalTimeslots      CHOICE {
            consecutive           INTEGER (1..maxTS-1),
            timeslotList         SEQUENCE (SIZE (1..maxTS-1)) OF
                DownlinkAdditionalTimeslots
        }
    }
}

DownlinkTimeslotsCodes-VHCR ::= SEQUENCE {
    firstIndividualTimeslotInfo IndividualTimeslotInfo-VHCR,
    dl-TS-ChannelisationCodesShort DL-TS-ChannelisationCodesShort-VHCR,
    moreTimeslots               CHOICE {
        noMore                   NULL,
        additionalTimeslots      CHOICE {
            consecutive           INTEGER (1..maxTS-1),
            timeslotList         SEQUENCE (SIZE (1..maxTS-1)) OF
                DownlinkAdditionalTimeslots-VHCR
        }
    }
}

DownlinkTimeslotsCodes-LCR-r4 ::= SEQUENCE {
    firstIndividualTimeslotInfo IndividualTimeslotInfo-LCR-r4,
    dl-TS-ChannelisationCodesShort DL-TS-ChannelisationCodesShort,
    moreTimeslots               CHOICE {
        noMore                   NULL,
        additionalTimeslots      CHOICE {
            consecutive           INTEGER (1..maxTS-LCR-1),
            timeslotList         SEQUENCE (SIZE (1..maxTS-LCR-1)) OF
                DownlinkAdditionalTimeslots-LCR-r4
        }
    }
}

DownlinkTimeslotsCodes-r7 ::= SEQUENCE {
    firstIndividualTimeslotInfo IndividualTimeslotInfo-r7,
    dl-TS-ChannelisationCodesShort DL-TS-ChannelisationCodesShort,
    moreTimeslots               CHOICE {
        noMore                   NULL,
        additionalTimeslots      CHOICE {
            consecutive           INTEGER (1..maxTS-1),
            timeslotList         SEQUENCE (SIZE (1..maxTS-1)) OF
                DownlinkAdditionalTimeslots-r7
        }
    }
}

DPC-Mode ::= ENUMERATED {
    singleTPC,
    tpcTripletInSoft }

DPCCH2Info ::= SEQUENCE {
    dpcch2TxPowerOffset          Dpcch2TxPowerOffset
}

```

```

}

DPCCH2InfoFDD ::= SEQUENCE {
    configurationInfo CHOICE {
        continue NULL,
        newConfiguration SEQUENCE {
            dpcch2Info DPCCH2Info OPTIONAL,
            f-dpchInfo F-DPCHInfo OPTIONAL,
            extended-E-DPCCH-DPCCHPO Extended-E-DPCCH-DPCCH-PowerOffset OPTIONAL,
            designatedNonServingHS-DSCHCellInfo DesignatedNonServingHS-DSCHCellInfo OPTIONAL
        }
    }
}

Dpcch2TxPowerOffset ::= INTEGER (0..20)

-- Actual value DPCCH-PowerOffset = IE value * 2
DPCCH-PowerOffset ::= INTEGER (-82..-3)

-- Actual value DPCCH-PowerOffset2 = 2 + (IE value * 4)
DPCCH-PowerOffset2 ::= INTEGER (-28..-13)

DPCH-CompressedModeInfo ::= SEQUENCE {
    tgp-SequenceList TGP-SequenceList
}

DPCH-CompressedModeInfo-r8 ::= SEQUENCE {
    tgp-SequenceList TGP-SequenceList-r8
}

DPCH-CompressedModeInfo-r10 ::= SEQUENCE {
    tgp-SequenceList TGP-SequenceList-r10
}

DPCH-CompressedModeStatusInfo ::= SEQUENCE {
    tgps-Reconfiguration-CFN TGPS-Reconfiguration-CFN,
    tgp-SequenceShortList SEQUENCE (SIZE (1..maxTGPS)) OF
        TGP-SequenceShort
}

DPCH-CompressedModeStatusInfo-r10 ::= SEQUENCE {
    tgps-Reconfiguration-CFN TGPS-Reconfiguration-CFN,
    tgp-SequenceShortList SEQUENCE (SIZE (1..maxTGPS)) OF
        TGP-SequenceShort-r10
}

-- Actual value DPCH-FrameOffset = IE value * 256
DPCH-FrameOffset ::= INTEGER (0..149)

FDPCH-SlotFormat ::= INTEGER (0..9)

UE-DRX-Cycle-InactivityThreshold ::= ENUMERATED {
    sub-frames-0,
    sub-frames-1,
    sub-frames-2,
    sub-frames-4,
    sub-frames-8,
    sub-frames-16,
    sub-frames-32,
    sub-frames-64,
    sub-frames-128,
    sub-frames-256,
    sub-frames-512,
    spare5,
    spare4,
    spare3,
    spare2,
    spare1 }

DRX-Info ::= SEQUENCE {
    ue-drx-Cycle UE-DRX-Cycle,
    ue-drx-Cycle-InactivityThreshold UE-DRX-Cycle-InactivityThreshold,
    ue-GrantMonitoring-InactivityThreshold UE-GrantMonitoring-InactivityThreshold,
    ue-drx-GrantMonitoring BOOLEAN
}

DRX-Info-r12 ::= SEQUENCE {

```



```

    ue-drx-Cycle                UE-DRX-Cycle,
    ue-drx-Cycle2              UE-DRX-Cycle2                OPTIONAL,
    ue-drx-Cycle-InactivityThreshold UE-DRX-Cycle-InactivityThreshold,
    ue-drx-Cycle2-InactivityThreshold UE-DRX-Cycle-InactivityThreshold OPTIONAL,
    ue-GrantMonitoring-InactivityThreshold
                                UE-GrantMonitoring-InactivityThreshold,
    ue-drx-GrantMonitoring      BOOLEAN
}

DSCH-Mapping ::=                SEQUENCE {
    maxTFCI-Field2Value        MaxTFCI-Field2Value,
    spreadingFactor            SF-PDSCH,
    codeNumber                 CodeNumberDSCH,
    multiCodeInfo              MultiCodeInfo
}

DSCH-MappingList ::=           SEQUENCE (SIZE (1..maxPDSCH-TFCIgroups)) OF
                                DSCH-Mapping

DSCH-RadioLinkIdentifier ::=  INTEGER (0..511)

DSCH-TransportChannelsInfo ::= SEQUENCE (SIZE (1..maxTrCH)) OF
                                SEQUENCE {
    dsch-transport-channel-identity TransportChannelIdentity,
    dsch-TFS                     TransportFormatSet
}

DTX-DRX-Info-r7 ::=           SEQUENCE {
    dtx-Info                    DTX-Info                OPTIONAL,
    drx-Info                    DRX-Info                OPTIONAL,
    uplink-DPCCHSlotFormatInformation Uplink-DPCCH-Slot-Format-Information
}

DTX-DRX-Info-r12 ::=          SEQUENCE {
    dtx-Info                    DTX-Info                OPTIONAL,
    dtx-Info-SecondaryUplinkFrequency DTX-Info-SecondaryUplinkFrequency OPTIONAL,
    drx-Info                    DRX-Info-r12            OPTIONAL,
    uplink-DPCCHSlotFormatInformation Uplink-DPCCH-Slot-Format-Information
}

DTX-E-DCH-TTI-10ms ::=        SEQUENCE {
    ue-dtx-Cycle1-10ms         UE-DTX-Cycle1-10ms,
    ue-dtx-Cycle2-10ms         UE-DTX-Cycle2-10ms,
    mac-dtx-Cycle-10ms         MAC-DTX-Cycle-10ms
}

DTX-E-DCH-TTI-2ms ::=         SEQUENCE {
    ue-dtx-Cycle1-2ms          UE-DTX-Cycle1-2ms,
    ue-dtx-Cycle2-2ms          UE-DTX-Cycle2-2ms,
    mac-dtx-Cycle-2ms          MAC-DTX-Cycle-2ms
}

DTX-Info ::=                   SEQUENCE {
    e-dch-TTI-Length           CHOICE {
        dtx-e-dch-TTI-10ms     DTX-E-DCH-TTI-10ms,
        dtx-e-dch-TTI-2ms      DTX-E-DCH-TTI-2ms
    },
    ue-dtx-cycle2InactivityThreshold UE-DTX-Cycle2InactivityThreshold,
    ue-dtx-cycle2DefaultSG        INTEGER (0..38)                OPTIONAL,
    -- if ue-dtx-long-preamble-length is not present, the value is '2 slots'
    ue-dtx-long-preamble-length   UE-DTX-long-preamble-length    OPTIONAL,
    mac-InactivityThreshold        MAC-InactivityThreshold,
    cqi-dtx-Timer                 CQI-DTX-Timer,
    ue-dpcch-Burst1               UE-DPCCH-Burst,
    ue-dpcch-Burst2               UE-DPCCH-Burst
}

DTX-Info-SecondaryUplinkFrequency ::= SEQUENCE {
    e-dch-TTI-Length           CHOICE {
        dtx-e-dch-TTI-10ms     NULL,
        dtx-e-dch-TTI-2ms      SEQUENCE {
            ue-dtx-Cycle1-2ms-Secondary UE-DTX-Cycle1-2ms                OPTIONAL,
            ue-dtx-Cycle2-2ms-Secondary UE-DTX-Cycle2-2ms-Secondary
        }
    },
    ue-dtx-cycle2InactivityThreshold-Secondary UE-DTX-Cycle2InactivityThreshold OPTIONAL,
    -- if ue-dtx-long-preamble-length is not present, the value is '2 slots'
    ue-dtx-long-preamble-length-Secondary   UE-DTX-long-preamble-length    OPTIONAL,
    ue-dpcch-Burst1-Secondary               UE-DPCCH-Burst                OPTIONAL,
}

```

```

    ue-dpcch-Burst2-Secondary                UE-DPCCH-Burst                OPTIONAL
}

DurationTimeInfo ::=                       INTEGER (1..4096)

DynamicPersistenceLevel ::=                 INTEGER (1..8)

DynamicPersistenceLevelList ::=             SEQUENCE (SIZE (1..maxPRACH)) OF
                                             DynamicPersistenceLevel

DynamicPersistenceLevelTF-List ::=          SEQUENCE (SIZE (1..maxTF-CPCH)) OF
                                             DynamicPersistenceLevel

DynamicTFInformationCCCH ::=                SEQUENCE {
    octetModeRLC-SizeInfoType2             OctetModeRLC-SizeInfoType2
}

E-AGCH-ChannelisationCode ::=              INTEGER (0..255)

E-AGCH-DRX-Info-TDD128 ::=                 SEQUENCE {
    e-AGCH-DRX-InfoType                     CHOICE {
        sameAsHS-SCCH                        NULL,
        e-AGCH-DRX-Parameters                SEQUENCE {
            e-AGCH-DRX-Cycle                  ControlChannelDRXCycle-TDD128,
            e-AGCH-InactivityMonitorThreshold E-AGCH-InactivityMonitorThreshold-TDD128
        },
        e-AGCH-DRX-Offset                     INTEGER (0..63)
    }
}

E-AGCH-InactivityMonitorThreshold-TDD128 ::= ENUMERATED {
    radio-frames-0, radio-frames-1, radio-frames-2,
    radio-frames-4, radio-frames-8, radio-frames-16,
    radio-frames-32, radio-frames-64, radio-frames-128,
    radio-frames-256, radio-frames-512,
    spare5, spare4, spare3, spare2, infinity }

E-AGCH-Individual ::=                     SEQUENCE {
    tS-number                                INTEGER (0..14),
    channelisation-code                       DL-TS-ChannelisationCode,
    midambleShiftAndBurstType                MidambleShiftAndBurstType-EDCH
}

E-AGCH-Individual-VHCR ::=                 SEQUENCE {
    tS-number                                INTEGER (0..14),
    channelisation-code                       DL-TS-ChannelisationCode-VHCR,
    midambleShiftAndBurstType                MidambleShiftAndBurstType-EDCH
}

E-AGCH-Individual-LCR ::=                  SEQUENCE {
    timeslotNumber                           TimeslotNumber-LCR-r4,
    firstChannelisationCode                   HS-ChannelisationCode-LCR,
    secondChannelisationCode                  HS-ChannelisationCode-LCR,
    midambleAllocationMode                    CHOICE {
        defaultMidamble                       NULL,
        commonMidamble                         NULL,
        ueSpecificMidamble                     INTEGER (0..15)
    },
    -- Actual value midambleConfiguration = IE value * 2
    midambleConfiguration                    INTEGER (1..8)
}

E-AGCH-Information ::=                     SEQUENCE {
    e-AGCH-ChannelisationCode                 E-AGCH-ChannelisationCode
}

E-AGCH-Information-r7 ::=                  SEQUENCE {
    modeSpecific                               CHOICE {
        fdd                                     SEQUENCE {
            e-AGCH-ChannelisationCode           E-AGCH-ChannelisationCode
        },
        tdd                                     CHOICE {
            tdd384                               SEQUENCE {
                long-Term-Grant-Indicator        BOOLEAN OPTIONAL,
                length-of-TTRI-field             INTEGER (1..12),
                e-AGCH-Set-Config                E-AGCH-Set-Config,
                e-AGCH-BLER-Target                Bler-Target
            }
        }
    }
}

```

```

    },
    tdd768
        long-Term-Grant-Indicator
        length-of-TTRI-field
        e-AGCH-Set-Config
        e-AGCH-BLER-Target
    },
    tdd128
        rdi-Indicator
        tpc-StepSize
        e-AGCH-Set-Config
        e-AGCH-BLER-Target
    }
}
}
}

E-AGCH-Information-r8 ::= SEQUENCE {
    modeSpecific CHOICE {
        fdd SEQUENCE {
            e-AGCH-ChannelisationCode E-AGCH-ChannelisationCode
        },
        tdd CHOICE {
            tdd384 SEQUENCE {
                long-Term-Grant-Indicator BOOLEAN OPTIONAL,
                length-of-TTRI-field INTEGER (1..12),
                e-AGCH-Set-Config E-AGCH-Set-Config,
                e-AGCH-BLER-Target Bler-Target
            },
            tdd768 SEQUENCE {
                long-Term-Grant-Indicator BOOLEAN OPTIONAL,
                length-of-TTRI-field INTEGER (1..12),
                e-AGCH-Set-Config E-AGCH-Set-Config-VHCR,
                e-AGCH-BLER-Target Bler-Target
            },
            tdd128 SEQUENCE {
                rdi-Indicator BOOLEAN,
                tpc-StepSize TPC-StepSizeTDD,
                e-AGCH-Set-Config E-AGCH-Set-Config-LCR,
                e-AGCH-BLER-Target Bler-Target,
                e-AGCH-InactivityMonitorThreshold E-AGCH-InactivityMonitorThreshold-TDD128 OPTIONAL
            }
        }
    }
}

E-AGCH-Information-TDD128 ::= SEQUENCE {
    rdi-Indicator BOOLEAN,
    tpc-StepSize TPC-StepSizeTDD,
    e-AGCH-Set-Config E-AGCH-Set-Config-LCR,
    e-AGCH-BLER-Target Bler-Target
}

E-AGCH-Set-Config ::= SEQUENCE (SIZE (1..maxNumE-AGCH)) OF
    E-AGCH-Individual

E-AGCH-Set-Config-VHCR ::= SEQUENCE (SIZE (1..maxNumE-AGCH)) OF
    E-AGCH-Individual-VHCR

E-AGCH-Set-Config-LCR ::= SEQUENCE (SIZE (1..maxNumE-AGCH)) OF
    E-AGCH-Individual-LCR

E-ROCH-ChannelisationCode ::= INTEGER (0..255)

E-ROCH-Information ::= SEQUENCE {
    e-ROCH-ChannelisationCode E-ROCH-ChannelisationCode,
    e-roch-e-rnti E-RNTI
}

E-DCH-MinimumSet-E-TFCI ::= INTEGER (0..127)

E-DCH-ReconfigurationInfo ::= SEQUENCE {
    e-DCH-RL-InfoNewServingCell E-DCH-RL-InfoNewServingCell OPTIONAL,
    e-DCH-RL-InfoOtherCellList SEQUENCE (SIZE (1..maxEDCHRL)) OF
        E-DCH-RL-InfoOtherCell OPTIONAL
}

```

```

E-DCH-ReconfigurationInfo-r7 ::= SEQUENCE {
    e-DCH-RL-InfoNewServingCell      E-DCH-RL-InfoNewServingCell-r7      OPTIONAL,
    e-DCH-RL-InfoOtherCellList       SEQUENCE (SIZE (1..maxEDCHRL)) OF    E-DCH-RL-InfoOtherCell              OPTIONAL
}

E-DCH-ReconfigurationInfo-r11 ::= SEQUENCE {
    e-DCH-RL-InfoNewServingCell      E-DCH-RL-InfoNewServingCell-r11     OPTIONAL,
    e-DCH-RL-InfoOtherCellList       SEQUENCE (SIZE (1..maxEDCHRL)) OF    E-DCH-RL-InfoOtherCell-r11         OPTIONAL
}

E-DCH-ReconfigurationInfo-SecULFrequency ::= SEQUENCE {
    e-DCH-RL-InfoNewSecServingCell    E-DCH-RL-InfoNewSecServingCell      OPTIONAL,
    e-DCH-RL-InfoOtherCellList-SecULFreq SEQUENCE (SIZE (1..maxEDCHRL)) OF    E-DCH-RL-InfoOtherCell-SecULFreq   OPTIONAL
}

E-DCH-RL-InfoNewServingCell ::= SEQUENCE {
    primaryCPICH-Info                 PrimaryCPICH-Info,
    e-AGCH-Information                E-AGCH-Information,
    servingGrant                      SEQUENCE {
        value                          INTEGER (0..38)                      OPTIONAL,
        primary-Secondary-GrantSelector ENUMERATED { primary, secondary }
    } OPTIONAL,
    e-DPCCH-DPCCH-PowerOffset         E-DPCCH-DPCCH-PowerOffset           OPTIONAL,
    reference-E-TFCIs                 E-DPDCH-Reference-E-TFCIList        OPTIONAL,
    powerOffsetForSchedInfo           INTEGER (0..6)                      OPTIONAL,
    threeIndexStepThreshold           INTEGER (0..37)                    OPTIONAL,
    twoIndexStepThreshold             INTEGER (0..37)                    OPTIONAL,
    e-HICH-Information                E-HICH-Information                 OPTIONAL,
    e-RGCH-Info                       CHOICE {
        e-RGCH-Information             E-RGCH-Information,
        releaseIndicator               NULL
    } OPTIONAL
}

E-DCH-RL-InfoNewServingCell-r7 ::= SEQUENCE {
    primaryCPICH-Info                 PrimaryCPICH-Info,
    e-AGCH-Information                E-AGCH-Information,
    servingGrant                      SEQUENCE {
        value                          INTEGER (0..38)                      OPTIONAL,
        primary-Secondary-GrantSelector ENUMERATED { primary, secondary }
    } OPTIONAL,
    e-DPCCH-DPCCH-PowerOffset         E-DPCCH-DPCCH-PowerOffset           OPTIONAL,
    reference-E-TFCIs                 E-DPDCH-Reference-E-TFCIList-r7     OPTIONAL,
    powerOffsetForSchedInfo           INTEGER (0..6)                      OPTIONAL,
    threeIndexStepThreshold           INTEGER (0..37)                    OPTIONAL,
    twoIndexStepThreshold             INTEGER (0..37)                    OPTIONAL,
    e-HICH-Information                E-HICH-Information                 OPTIONAL,
    e-RGCH-Info                       CHOICE {
        e-RGCH-Information             E-RGCH-Information,
        releaseIndicator               NULL
    } OPTIONAL
}

E-DCH-RL-InfoNewServingCell-r11 ::= SEQUENCE {
    primaryCPICH-Info                 PrimaryCPICH-Info,
    e-AGCH-Information                E-AGCH-Information,
    e-ROCH-Information                E-ROCH-Information                 OPTIONAL,
    servingGrant                      SEQUENCE {
        value                          INTEGER (0..38)                      OPTIONAL,
        primary-Secondary-GrantSelector ENUMERATED { primary, secondary }
    } OPTIONAL,
    e-DPCCH-DPCCH-PowerOffset         E-DPCCH-DPCCH-PowerOffset           OPTIONAL,
    reference-E-TFCIs                 E-DPDCH-Reference-E-TFCIList-r7     OPTIONAL,
    powerOffsetForSchedInfo           INTEGER (0..6)                      OPTIONAL,
    threeIndexStepThreshold           INTEGER (0..37)                    OPTIONAL,
    twoIndexStepThreshold             INTEGER (0..37)                    OPTIONAL,
    e-HICH-Information                E-HICH-Information-r11              OPTIONAL,
    e-RGCH-Info                       CHOICE {
        e-RGCH-Information             E-RGCH-Information,
        releaseIndicator               NULL
    } OPTIONAL
}

E-DCH-RL-InfoNewSecServingCell ::= SEQUENCE {
    e-AGCH-Information                E-AGCH-Information,
}

```

```

e-HICH-Information          E-HICH-Information          OPTIONAL,
e-RGCH-Info                CHOICE {
  e-RGCH-Information        E-RGCH-Information,
  releaseIndicator          NULL
} OPTIONAL
}

E-DCH-RL-InfoOtherCell ::= SEQUENCE {
  primaryCPICH-Info        PrimaryCPICH-Info,
  e-HICH-Info              CHOICE {
    e-HICH-Information      E-HICH-Information,
    releaseIndicator        NULL
  } OPTIONAL,
  e-RGCH-Info              CHOICE {
    e-RGCH-Information      E-RGCH-Information,
    releaseIndicator        NULL
  } OPTIONAL
}

E-DCH-RL-InfoOtherCell-r11 ::= SEQUENCE {
  primaryCPICH-Info        PrimaryCPICH-Info,
  e-HICH-Info              CHOICE {
    e-HICH-Information-r11 E-HICH-Information-r11,
    releaseIndicator        NULL,
    secondaryReleaseIndicator NULL
  } OPTIONAL,
  e-RGCH-Info              CHOICE {
    e-RGCH-Information      E-RGCH-Information,
    releaseIndicator        NULL
  } OPTIONAL
}

E-DCH-RL-InfoOtherCell-SecULFreq ::= SEQUENCE {
  primaryCPICH-Info        PrimaryCPICH-Info,
  e-HICH-Information        E-HICH-Information          OPTIONAL,
  e-RGCH-Info              CHOICE {
    e-RGCH-Information      E-RGCH-Information,
    releaseIndicator        NULL
  } OPTIONAL
}

E-DCH-RL-InfoSameServingCell ::= SEQUENCE {
  e-DPCCH-DPCCH-PowerOffset E-DPCCH-DPCCH-PowerOffset          OPTIONAL,
  reference-E-TFCIs         E-DPDCH-Reference-E-TFCIList-r7  OPTIONAL
}

E-DCH-SPS-Information-TDD128 ::= SEQUENCE {
  e-dch-SPS-Operation        CHOICE {
    continue                 NULL,
    newOperation             E-DCH-SPS-NewOperation-TDD128
  }
}

E-DCH-SPS-NewOperation-TDD128 ::= SEQUENCE {
  e-hich-Info                E-HICH-Information-For-SPS-TDD128,
  e-dch-TxPattern            E-DCH-TxPatternList-TDD128          OPTIONAL,
  initialSPSInfoForEDCH      SEQUENCE {
    n-E-UCCH                 INTEGER (1..8),
    codeResourceInfo          UL-TS-ChannelisationCode,
    timeslotResourceRelatedInfo BIT STRING (SIZE (5)),
    powerResourceRelatedInfo INTEGER (1..32),
    activationTime            ActivationTime,
    subframeNum               INTEGER (0..1),
    initialTxPatternIndex     INTEGER (0..maxEDCHTxPattern-TDD128-1)
  } OPTIONAL
}

E-DCH-TxPatternList-TDD128 ::= SEQUENCE (SIZE (1..maxEDCHTxPattern-TDD128)) OF
  SEQUENCE {
    repetitionPeriodAndLength RepetitionPeriodAndLengthForSPS
  }

E-DPCCH-Info ::= SEQUENCE {
  e-DPCCH-DPCCH-PowerOffset E-DPCCH-DPCCH-PowerOffset,
  happyBit-DelayCondition   HappyBit-DelayCondition
}

E-DPCCH-Info-r7 ::= SEQUENCE {

```

```

    e-DPCCH-DPCCH-PowerOffset          E-DPCCH-DPCCH-PowerOffset,
    happyBit-DelayCondition             HappyBit-DelayCondition,
    e-TFC-Boost-Info                    E-TFC-Boost-Info-r7          OPTIONAL,
    e-DPDCH-PowerInterpolation          E-DPDCH-PowerInterpolation  OPTIONAL
}

E-DPCCH-DPCCH-PowerOffset ::=          INTEGER (0..8)

Extended-E-DPCCH-DPCCH-PowerOffset ::= INTEGER (9..15)

E-DPDCH-Info ::=                       SEQUENCE {
    e-TFCI-TableIndex                  E-TFCI-TableIndex,
    e-DCH-MinimumSet-E-TFCI            E-DCH-MinimumSet-E-TFCI      OPTIONAL,
    reference-E-TFCIs                   E-DPDCH-Reference-E-TFCIList,
    maxChannelisationCodes              E-DPDCH-MaxChannelisationCodes,
    pl-NonMax                           E-DPDCH-PL-NonMax,
    schedulingInfoConfiguration         E-DPDCH-SchedulingInfoConfiguration,
    threeIndexStepThreshold             INTEGER (0..37)              OPTIONAL,
    twoIndexStepThreshold               INTEGER (0..37)              OPTIONAL
}

E-DPDCH-Info-r7 ::=                    SEQUENCE {
    e-TFCI-TableIndex                  E-TFCI-TableIndex,
    e-DCH-MinimumSet-E-TFCI            E-DCH-MinimumSet-E-TFCI      OPTIONAL,
    reference-E-TFCIs                   E-DPDCH-Reference-E-TFCIList-r7,
    maxChannelisationCodes              E-DPDCH-MaxChannelisationCodes,
    pl-NonMax                           E-DPDCH-PL-NonMax,
    schedulingInfoConfiguration         E-DPDCH-SchedulingInfoConfiguration,
    threeIndexStepThreshold             INTEGER (0..37)              OPTIONAL,
    twoIndexStepThreshold               INTEGER (0..37)              OPTIONAL
}

E-DPDCH-Info-r8 ::=                    SEQUENCE {
    e-TFCI-TableIndex                  E-TFCI-TableIndex,
    e-DCH-MinimumSet-E-TFCI            E-DCH-MinimumSet-E-TFCI      OPTIONAL,
    reference-E-TFCIs                   E-DPDCH-Reference-E-TFCIList-r7,
    minReduced-E-DPDCH-GainFactor       MinReduced-E-DPDCH-GainFactor  OPTIONAL,
    maxChannelisationCodes              E-DPDCH-MaxChannelisationCodes,
    pl-NonMax                           E-DPDCH-PL-NonMax,
    schedulingInfoConfiguration         E-DPDCH-SchedulingInfoConfiguration,
    threeIndexStepThreshold             INTEGER (0..37)              OPTIONAL,
    twoIndexStepThreshold               INTEGER (0..37)              OPTIONAL
}

E-DPDCH-PeriodicityOfSchedInfo ::=    ENUMERATED {
    everyEDCHTTI, ms4, ms10, ms20, ms50, ms100, ms200, ms500,
    ms1000 }

-- The actual value of E-DPDCH-PL-NonMax is: IE value * 0.04
E-DPDCH-PL-NonMax ::=                  INTEGER (11..25)

E-DPDCH-PowerInterpolation ::=         BOOLEAN

E-DPDCH-Reference-E-TFCI ::=           SEQUENCE {
    reference-E-TFCI                    INTEGER (0..127),
    reference-E-TFCI-PO                  INTEGER (0..29)
}

E-DPDCH-Reference-E-TFCI-r7 ::=        SEQUENCE {
    reference-E-TFCI                    INTEGER (0..127),
    reference-E-TFCI-PO-r7              INTEGER (0..31)
}

E-DPDCH-Reference-E-TFCIList ::=       SEQUENCE (SIZE (1..8)) OF E-DPDCH-Reference-E-TFCI

E-DPDCH-Reference-E-TFCIList-r7 ::=    SEQUENCE (SIZE (1..8)) OF E-DPDCH-Reference-E-TFCI-r7

E-DPDCH-SchedulingInfoConfiguration ::= SEQUENCE {
    periodicityOfSchedInfo-NoGrant      E-DPDCH-PeriodicityOfSchedInfo  OPTIONAL,
    periodicityOfSchedInfo-Grant        E-DPDCH-PeriodicityOfSchedInfo  OPTIONAL,
    powerOffsetForSchedInfo             INTEGER (0..6)
}

E-DPDCH-SchedulingTransmConfiguration ::= SEQUENCE {
    ms2-SchedTransmGranthARQAlloc       BIT STRING (SIZE (8))            OPTIONAL,
    servingGrant                         SEQUENCE {
        value                            INTEGER (0..38),
        primary-Secondary-GrantSelector  ENUMERATED { primary, secondary }
    }
}

```

```

    }
  }
  OPTIONAL
}

E-DPDCH-MaxChannelisationCodes ::= ENUMERATED {
    sf256, sf128, sf64, sf32, sf16, sf8, sf4, sf4x2,
    sf2x2, sf4x2-and-sf2x2 }

E-HICH-ChannelisationCode ::= INTEGER (0..127)

E-HICH-Information ::= SEQUENCE {
    channelisationCode      E-HICH-ChannelisationCode,
    signatureSequence       E-HICH-RGCH-SignatureSequence
}

E-HICH-Information-r11 ::= SEQUENCE {
    channelisationCode      E-HICH-ChannelisationCode,
    signatureSequence       E-HICH-RGCH-SignatureSequence,
    secondarySignatureSequence E-HICH-RGCH-SignatureSequence
}
OPTIONAL

E-HICH-Information-CommonEdch ::= SEQUENCE {
    channelisationCode      E-HICH-ChannelisationCode
    signatureSequence       E-HICH-RGCH-SignatureSequence
}
OPTIONAL,
OPTIONAL

E-HICH-Information-TDD384-768 ::= SEQUENCE {
    n-E-HICH                INTEGER (4..44),
    tS-Number                INTEGER (0..14),
    modeSpecificInfo         CHOICE {
        tdd384                DL-TS-ChannelisationCode,
        tdd768                DL-TS-ChannelisationCode-VHCR
    },
    burst-Type               ENUMERATED { type1, type2 },
    midamble-Allocation-Mode ENUMERATED { default, common }
}

E-HICH-Information-LCR ::= SEQUENCE {
    ei                      INTEGER (0..3),
    timeslotNumber          TimeslotNumber-LCR-r4,
    channelisation-Code     HS-ChannelisationCode-LCR,
    midambleAllocationMode  CHOICE {
        defaultMidamble       NULL,
        ueSpecificMidamble    INTEGER (0..15)
    },
    -- Actual value midambleConfiguration = IE value * 2
    midambleConfiguration  INTEGER (1..8)
}

E-HICH-Information-TDD128 ::= SEQUENCE {
    n-E-HICH                INTEGER (4..15),
    e-HICH-InfoList         E-HICH-Information-LCR-List
}

E-HICH-Information-LCR-List ::= SEQUENCE (SIZE (1..maxNumE-HICH)) OF
    E-HICH-Information-LCR

E-HICH-RGCH-SignatureSequence ::= INTEGER (0..39)

E-HICH-Information-For-SPS-TDD128 ::= SEQUENCE {
    configurationmode       CHOICE {
        implicit             SEQUENCE {
            ei                INTEGER (0..3)
        }
        explicit             SEQUENCE {
            timeslotNumber    TimeslotNumber-LCR-r4,
            channelisation-Code HS-ChannelisationCode-LCR,
            midambleAllocationMode CHOICE {
                defaultMidamble    NULL,
                ueSpecificMidamble  INTEGER (0..15)
            }
        },
        -- Actual value midambleConfiguration = IE value * 2
        midambleConfiguration  INTEGER (1..8)
    },
    signatureSequenceGroupIndex  INTEGER (0..19)
}

```

```

E-PUCH-Info ::=
    e-TFCS-Info
    modeSpecificInfo
        tdd348-tdd768
            noSlotsForTFClAndTPC
            e-PUCH-ContantValue
            e-PUCH-TS-ConfigurationList
            e-PUCH-CodeHopping
            e-PUCH-TPC-Step-Size
            minimum-Allowed-Code-Rate
            maximum-Allowed-Code-Rate
        },
        tdd128
            snpl-ReportType
            prxdes-base
            beaconPLEst
            tpc-StepSize
            pebase-PowerControlGAP
            ul-SynchronisationParameters
            e-PUCH-TS-ConfigurationList

            minimum-Allowed-Code-Rate
            maximum-Allowed-Code-Rate
            maximumNumOfRetransSchedInfo
            retransTimerForSchedInfo

    },
    -- For 3.84/7.68 TDD only, should be ignored for 1.28Mcps TDD mode
    powerOffsetForSchedInfo
}

E-PUCH-Info-TDD128 ::=
    e-TFCS-Info
    snpl-ReportType
    prxdes-base
    beaconPLEst
    tpc-StepSize
    pebase-PowerControlGAP
    ul-SynchronisationParameters
    e-PUCH-TS-ConfigurationList

    minimum-Allowed-Code-Rate
    maximum-Allowed-Code-Rate
    maximumNumOfRetransSchedInfo
    retransTimerForSchedInfo

    -- dummy is not used in this version of the specification, it should
    -- not be sent and if received it should be ignored.
    dummy
}

E-PUCH-Info-MulticarrierEDCH-TDD128 ::=
    e-PUCH-TS-ConfigurationList
}

E-PUCH-TS-Slots ::=
    ts-Number
    midambleShiftAndBurstType
}

E-PUCH-TS-Slots-LCR ::=
    -- Note: For 1.28Mcps TDD operation, valid value for timeslotNumber is INTEGER (1..5)
    timeslotNumber
    midambleAllocationMode
        defaultMidamble
        ueSpecificMidamble
    },
    -- Actual value midambleConfiguration = IE value * 2
    midambleConfiguration
}

```



```

E-RGCH-CombinationIndex ::=          INTEGER (0..5)

E-RGCH-Information ::=                SEQUENCE {
  signatureSequence                   E-HICH-RGCH-SignatureSequence,
  rg-CombinationIndex                 E-RGCH-CombinationIndex
}

E-RGCH-Information-CommonEdch ::=    SEQUENCE {
  signatureSequence                   E-HICH-RGCH-SignatureSequence          OPTIONAL
}

E-RUCCH-AccessServiceClass ::=       PRACH-Partitioning-LCR-r4

E-RUCCH-Info ::=                     SEQUENCE {
  modeSpecificInfo                   CHOICE {
    tdd384-tdd768                     SEQUENCE {
      e-RUCCH-ConstantValue            INTEGER (-35..10),
      e-RUCCH-PersistenceScalingFactor PersistenceScalingFactor,
      t-RUCCH                           ENUMERATED {ms40, ms80, ms120, ms160, ms200,
                                                ms240, ms280, ms320}          OPTIONAL,
      e-RUCCH-TS-Number                 INTEGER (0..14)                    OPTIONAL,
      e-RUCCH-Midamble                   ENUMERATED {direct, direct-Inverted}  OPTIONAL,
      t-adv                               ENUMERATED { sec1, sec2, sec4, sec8, sec16,
                                                sec32, sec128, infinity }          OPTIONAL,
      t-SCHED                            ENUMERATED { zero, ms40, ms80, ms160, ms250,
                                                sec1, sec2, sec4 }          OPTIONAL,
      modeSpecificInfo                   CHOICE {
        tdd384                           CHOICE {
          sF16                            SEQUENCE (SIZE (1..8)) OF SF16Codes,
          sF8                              SEQUENCE (SIZE (1..8)) OF SF8Codes
        },
        tdd768                            CHOICE {
          sF32                            SEQUENCE (SIZE (1..16)) OF SF32Codes,
          sF816                           SEQUENCE (SIZE (1..16)) OF SF16Codes2
        }
      }
    },
    tdd128                             SEQUENCE {
      t-RUCCH                            ENUMERATED { ms20, ms40, ms60, ms80, ms120,
                                                ms160, ms200, ms240, ms280, ms320,
                                                ms400, ms500, ms600, ms800, ms1000,
                                                ms2000 }          OPTIONAL,
      n-RUCCH                            INTEGER (0..7)                    OPTIONAL,
      t-WAIT                              ENUMERATED { everyEDCHTTI, ms40, ms80, ms160,
                                                ms320, ms640, ms1000, ms2000 }  OPTIONAL,
      t-SI                               ENUMERATED { everyEDCHTTI, ms20, ms40, ms60, ms80,
                                                ms160, ms200 }          OPTIONAL,
      extendedEstimationWindow           INTEGER (2..5)                    OPTIONAL,
      e-RUCCH-AccessServiceClass         E-RUCCH-AccessServiceClass        OPTIONAL,
      e-RUCCH-PersistenceScalingFactor    PersistenceScalingFactorList       OPTIONAL,
      sync-UL-InfoForE-RUCCH             SYNC-UL-InfoForE-RUCCH            OPTIONAL,
      prach-information                   PRACH-Information-LCR-List        OPTIONAL
    }
  },
  tdd128                             SEQUENCE {
    t-RUCCH                            ENUMERATED { ms20, ms40, ms60, ms80, ms120,
                                                ms160, ms200, ms240, ms280, ms320,
                                                ms400, ms500, ms600, ms800, ms1000,
                                                ms2000 }          OPTIONAL,
    n-RUCCH                            INTEGER (0..7)                    OPTIONAL,
    t-WAIT                              ENUMERATED { everyEDCHTTI, ms40, ms80, ms160,
                                                ms320, ms640, ms1000, ms2000 }  OPTIONAL,
    t-SI                               ENUMERATED { everyEDCHTTI, ms20, ms40, ms60, ms80,
                                                ms160, ms200 }          OPTIONAL,
    extendedEstimationWindow           INTEGER (2..5)                    OPTIONAL,
    e-RUCCH-AccessServiceClass         E-RUCCH-AccessServiceClass        OPTIONAL,
    e-RUCCH-PersistenceScalingFactor    PersistenceScalingFactorList       OPTIONAL,
    sync-UL-InfoForE-RUCCH             SYNC-UL-InfoForE-RUCCH            OPTIONAL,
    prach-information                   PRACH-Information-LCR-List        OPTIONAL
  }
}

E-RUCCH-Info-TDD128 ::=              SEQUENCE {
  t-RUCCH                            ENUMERATED { ms20, ms40, ms60, ms80, ms120,
                                                ms160, ms200, ms240, ms280, ms320,
                                                ms400, ms500, ms600, ms800, ms1000,
                                                ms2000 }          OPTIONAL,
  n-RUCCH                            INTEGER (0..7)                    OPTIONAL,
  t-WAIT                              ENUMERATED { everyEDCHTTI, ms40, ms80, ms160,
                                                ms320, ms640, ms1000, ms2000 }  OPTIONAL,
  t-SI                               ENUMERATED { everyEDCHTTI, ms20, ms40, ms60, ms80,
                                                ms160, ms200 }          OPTIONAL,
  extendedEstimationWindow           INTEGER (2..5)                    OPTIONAL,
  e-RUCCH-AccessServiceClass         E-RUCCH-AccessServiceClass        OPTIONAL,
  e-RUCCH-PersistenceScalingFactor    PersistenceScalingFactorList       OPTIONAL,
  sync-UL-InfoForE-RUCCH             SYNC-UL-InfoForE-RUCCH            OPTIONAL,
  prach-information                   PRACH-Information-LCR-List        OPTIONAL
}

E-TFC-Boost-Info-r7 ::=              SEQUENCE {
  e-TFCI-Boost                        INTEGER (0..127),
  delta-T2TP                           INTEGER (0..6)                    OPTIONAL
}

```

```

E-TFCI-TableIndex ::=                INTEGER (0..1)

E-TFCS-Info ::=                      SEQUENCE {
    reference-Beta-QPSK-List          SEQUENCE (SIZE (1..8)) OF Reference-Beta-QPSK,
    reference-Beta-16QAM-List        SEQUENCE (SIZE (1..8)) OF Reference-Beta-16QAM
}

EARFCN ::=                           INTEGER (0..65535)

EARFCNExtension ::=                  INTEGER (65536..262143)

EARFCNExtension2 ::=                 INTEGER (0..262143)

EARFCNRange ::= SEQUENCE {
-- If the IE earfcn is set to a value of 65535, then the EARFCN
-- value for that instance shall be read from the IE earfcnExt.
    earfcn                          EARFCN,
    earfcnExt                        EARFCNExtension                OPTIONAL
}

EnablingDelay ::=                    ENUMERATED {
    radio-frames-0,
    radio-frames-1,
    radio-frames-2,
    radio-frames-4,
    radio-frames-8,
    radio-frames-16,
    radio-frames-32,
    radio-frames-64,
    radio-frames-128,
    spare7,
    spare6,
    spare5,
    spare4,
    spare3,
    spare2,
    spare1 }

EnablingDelay-TDD128 ::=             ENUMERATED {
    radio-frames-0, radio-frames-1, radio-frames-2,
    radio-frames-4, radio-frames-8, radio-frames-16,
    radio-frames-32, radio-frames-64, radio-frames-128,
    spare7, spare6, spare5, spare4, spare3, spare2,
    infinity }

EXT-UL-TimingAdvance ::=            SEQUENCE {
    modeSpecificInfo                 CHOICE {
        tdd384                       SEQUENCE {
            ex-ul-TimingAdvance       INTEGER (0..255)
        },
        tdd768                       SEQUENCE {
            ex-ul-TimingAdvance       INTEGER (0..511)
        }
    }
}

F-DPCHInfo ::=                      SEQUENCE {
    fdpch-SlotFormat                 INTEGER (0..9)                OPTIONAL,
    codeNumber                       INTEGER (0..255)                OPTIONAL,
    -- Actual value dl-FDPCH-TPCcommandErrorRate = IE value * 0.01
    dl-FDPCH-TPCcommandErrorRate     INTEGER (1..10)                OPTIONAL
}

FACH-PCH-Information ::=            SEQUENCE {
    transportFormatSet               TransportFormatSet,
    transportChannelIdentity         TransportChannelIdentity,
    ctch-Indicator                   BOOLEAN
}

FACH-PCH-InformationList ::=        SEQUENCE (SIZE (1..maxFACHPCH)) OF
    FACH-PCH-Information

Fallback-R99-PRACH-info-IEs ::=    SEQUENCE {
    cCCH-Fallback                    BOOLEAN,
    dCCH-Fallback                    BOOLEAN
}

```

```

Feedback-cycle ::=
    ENUMERATED {
        fc0, fc2, fc4, fc8, fc10, fc20, fc40, fc80, fc160}

Feedback-cycle2 ::=
    ENUMERATED {
        fc0, fc8, fc10, fc16,
        fc20, fc32, fc40, fc64,
        fc80, fc160, spare6, spare5,
        spare4, spare3, spare2, spare1}

Feedback-cycle-r7 ::=
    ENUMERATED {
        fc0, fc2, fc4, fc8, fc10, fc20, fc40, fc80, fc160,
        fc16, fc32, fc64, spare4, spare3, spare2, spare1 }

FPACH-Info-r4 ::=
    timeslot
    channelisationCode
    midambleShiftAndBurstType
    wi
    SEQUENCE {
        TimeslotNumber-LCR-r4,
        TDD-FPACH-CCode16-r4,
        MidambleShiftAndBurstType-LCR-r4,
        Wi-LCR
    }

F-TPICH-InfoNewServingCell ::= SEQUENCE {
    f-tpich-Information
    F-TPICH-Information
}

F-TPICH-InfoOtherCell ::= SEQUENCE {
    primaryCPICH-Info
    f-tpich-Info
    f-tpich-Information
    releaseIndicator
    PrimaryCPICH-Info,
    CHOICE {
        F-TPICH-Information,
        NULL
    }
}

F-TPICH-Information ::= SEQUENCE {
    ftpich-SlotFormat
    ftpich-CodeNumber
    ftpich-FrameOffset
    FTPICH-SlotFormat,
    INTEGER (0..255),
    FTPICH-FrameOffset
}

F-TPICH-ReconfigurationInfo ::= SEQUENCE {
    f-tpich-InfoNewServingCell
    f-tpich-InfoOtherCellList
    F-TPICH-InfoNewServingCell
    SEQUENCE (SIZE (1..maxRL)) OF
        F-TPICH-InfoOtherCell
    OPTIONAL,
    OPTIONAL
}

-- Actual value FTPICH-FrameOffset = IE value * 256
FTPICH-FrameOffset ::=
    INTEGER (0..149)

FTPICH-SlotFormat ::=
    INTEGER (0..9)

FreqIndexListForEnhancedMeas ::= SEQUENCE (SIZE (1..maxFreqMeasWithoutCM)) OF
    FrequencyIndexForEnhancedMeas

FreqIndexListForEnhancedMeas-r12 ::= SEQUENCE (SIZE (1..maxFreqMeasWithoutCM)) OF
    FrequencyIndexForEnhancedMeas-r12

FrequencyInfo ::=
    modeSpecificInfo
    fdd
    tdd
    CHOICE {
        FrequencyInfoFDD,
        FrequencyInfoTDD
    }
}

FrequencyInfoFDD ::=
    uarfcn-UL
    uarfcn-DL
    SEQUENCE {
        UARFCN
        UARFCN
    }
    OPTIONAL,

FrequencyInfoTDD ::=
    uarfcn-Nt
    SEQUENCE {
        UARFCN
    }

FrequencyIndexForEnhancedMeas ::=
    INTEGER (0..maxCellMeas-1)

FrequencyIndexForEnhancedMeas-r12 ::=
    INTEGER (0..maxCellMeas-ext-1)

HappyBit-DelayCondition ::=
    ENUMERATED {
        ms2, ms10, ms20, ms50, ms100, ms200, ms500, ms1000 }

HARQ-Preamble-Mode ::=
    INTEGER (0..1)

```

```

HS-ChannelisationCode-PCR ::= ENUMERATED {
    cc16-1, cc16-2, cc16-3, cc16-4,
    cc16-5, cc16-6, cc16-7, cc16-8,
    cc16-9, cc16-10, cc16-11, cc16-12,
    cc16-13, cc16-14, cc16-15, cc16-16 }

HS-ChannelisationCodeSetInfo-PCR ::= SEQUENCE {
    startCode HS-ChannelisationCode-PCR,
    stopCode HS-ChannelisationCode-PCR
}

HS-DSCH-CommonSystemInformation ::= SEQUENCE {
    ccch-MappingInfo CommonRBMappingInfo,
    srb1-MappingInfo CommonRBMappingInfo OPTIONAL,
    common-MAC-ehs-ReorderingQueueList Common-MAC-ehs-ReorderingQueueList,
    hs-scch-SystemInfo HS-SCCH-SystemInfo,
    harq-SystemInfo HARQ-Info,
    common-H-RNTI-information SEQUENCE (SIZE (1..maxCommonHRNTI)) OF
        H-RNTI,
    bcchSpecific-H-RNTI H-RNTI
}

HS-DSCH-CommonSystemInformation-TDD128 ::= SEQUENCE {
    ccch-MappingInfo CommonRBMappingInfo,
    srb1-MappingInfo CommonRBMappingInfo OPTIONAL,
    common-MAC-ehs-ReorderingQueueList Common-MAC-ehs-ReorderingQueueList,
    hs-scch-SystemInfo-tdd128 HS-SCCH-SystemInfo-TDD128,
    harq-SystemInfo HARQ-Info,
    hs-pdsch-MidambleConfiguration HS-PDSCH-Midamble-Configuration-TDD128,
    common-H-RNTI-information SEQUENCE (SIZE (1..maxCommonHRNTI)) OF H-RNTI,
    bcchSpecific-H-RNTI H-RNTI
}

HS-DSCH-DrxBurstFach ::= ENUMERATED {
    f1, f2, f4, f8, f16, spare3, spare2, spare1 }

HS-DSCH-DrxCycleFach-info ::= SEQUENCE {
    t-321 T-321,
    hs-dsch-DrxCycleFach HS-DSCH-DrxCycleFach,
    hs-dsch-DrxBurstFach HS-DSCH-DrxBurstFach,
    drxInterruption-hs-dsch BOOLEAN
}

HS-DSCH-DrxCycleFach-info-TDD128 ::= SEQUENCE {
    t-321 T-321,
    hs-dsch-DrxCycleFach HS-DSCH-DrxCycleFach,
    hs-dsch-DrxBurstFach HS-DSCH-DrxBurstFach
}

HS-DSCH-DrxCycleFach-SecondDrx-info ::= SEQUENCE {
    hs-dsch-SecondDrx-CycleFach HS-DSCH-SecondDrx-CycleFach,
    drx-level CHOICE {
        one-level-DRX SEQUENCE {
            hs-dsch-Second-Rx-BurstFach HS-DSCH-Second-Rx-BurstFach OPTIONAL,
            t329 T-329 OPTIONAL
        },
        two-level-DRX SEQUENCE {
            t328 T-328 OPTIONAL,
            hs-dsch-First-Rx-BurstFach HS-DSCH-First-Rx-BurstFach OPTIONAL,
            hs-dsch-First-Drx-CycleFach HS-DSCH-First-Drx-CycleFach OPTIONAL,
            hs-dsch-Second-Rx-BurstFach HS-DSCH-Second-Rx-BurstFach OPTIONAL,
            t329 T-329 OPTIONAL
        }
    }
}

HS-DSCH-DrxCycleFach ::= ENUMERATED {
    f4, f8, f16, f32 }

HS-DSCH-First-Drx-CycleFach ::= ENUMERATED {
    f2, f4, f8, f16, f32, f64 }

HS-DSCH-First-Rx-BurstFach ::= ENUMERATED {
    f0p4, f0p8 }

HS-DSCH-PagingSystemInformation ::= SEQUENCE {
    dlScramblingCode SecondaryScramblingCode OPTIONAL,

```

```

    pich-ForHSDPASupportedPagingList      SEQUENCE (SIZE (1..maxSCCPCH)) OF
                                           PICH-ForHSDPASupportedPaging,
    numberOfPcchTransmissions              INTEGER (1..5),
    transportBlockSizeList                  SEQUENCE (SIZE (1..2)) OF
                                           TransportBlockSizeIndex
}

HS-DSCH-PagingSystemInformation-TDD128 ::= SEQUENCE {
    pich-ForHdschList                      SEQUENCE (SIZE (1..maxSCCPCH)) OF
                                           PICH-ForHSDPASupportedPaging-TDD128,
    dtch-DCCH-reception-window-size        INTEGER (1..16),
    pcch-InformationList                    PCCH-InformationList                OPTIONAL
}

HS-DSCH-RxPatternList-TDD128 ::= SEQUENCE (SIZE (1..maxRxPatternForHSDSCH-TDD128)) OF
    SEQUENCE {
        repetitionPeriodAndLength          RepetitionPeriodAndLengthForSPS
    }

HS-DSCH-Second-Rx-BurstFach ::= ENUMERATED {
    f1, f2 }

HS-DSCH-SecondDrx-CycleFach ::= ENUMERATED {
    f4, f8, f16, f32, f64, f128, f256, f512 }

HS-DSCH-TBSizeTable ::= ENUMERATED { octetAligned }

HS-DSCH-TbsList-TDD128 ::= SEQUENCE (SIZE (1..maxTbsForHSDSCH-TDD128)) OF
    SEQUENCE {
        hs-dsch-TBSizeIndex                INTEGER (1..63)
    }

HS-DSCH-SPS-Information-TDD128 ::= SEQUENCE {
    hs-dsch-SPS-Operation                  CHOICE {
        continue                            NULL,
        newOperation                        HS-DSCH-SPS-NewOperation-TDD128
    }
}

HS-DSCH-SPS-NewOperation-TDD128 ::= SEQUENCE {
    hs-dsch-TbsList                       HS-DSCH-TbsList-TDD128                OPTIONAL,
    hs-dsch-RxPatternList                  HS-DSCH-RxPatternList-TDD128            OPTIONAL,
    hARQInfoForSPS                         SEQUENCE {
        numberOfProcesses                   INTEGER (1..8),
        memorySize                          HARQMemorySize
    }
    OPTIONAL,
    hs-sich-List                           HS-SICH-List-TDD128,
    initialSPSInfoForHSDSCH                 SEQUENCE {
        timeslotInfo                       BIT STRING (SIZE (5)),
        codeResourceInfo                   HS-ChannelisationCodeSetInfo-LCR,
        activationTime                      ActivationTime,
        sfNum                               INTEGER (0..1),
        initialRxPatternIndex              INTEGER (0..maxRxPatternForHSDSCH-TDD128-1),
        initialTfsIndex                    INTEGER (0..maxTbsForHSDSCH-TDD128-1),
        modulation                          ENUMERATED { modQPSK, mod16QAM },
        hs-sich-Index                       INTEGER (0..maxHSSICH-TDD128-1)
    }
    OPTIONAL
}

HS-DPCCHOverheadReduction ::= SEQUENCE {
    hs-dpcch-ReductionType                 ENUMERATED { reductionType1, reductionType2}    OPTIONAL,
    feedback-cycle2                        Feedback-cycle2,
    cqi-CycleSwitchTimer                   CQI-CycleSwitchTimer
}

HS-PDSCH-Midamble-Configuration-TDD128 ::= SEQUENCE {
    midambleAllocationMode                 CHOICE {
        defaultMidamble                     NULL,
        commonMidamble                      NULL,
        ueSpecificMidamble                  INTEGER (0..15)
    },
    -- Actual value midambleConfiguration = IE value * 2
    midambleConfiguration                  INTEGER (1..8)
}

HS-SCCH-Info ::= SEQUENCE {
    modeSpecificInfo                       SEQUENCE {
        fdd                                  CHOICE {
            SEQUENCE {

```

```

        hs-SCCHChannelisationCodeInfo SEQUENCE (SIZE (1..maxHSSCCHs)) OF
            HS-SCCH-Codes,
        dl-ScramblingCode SecondaryScramblingCode OPTIONAL
    },
    tdd CHOICE {
        tdd384 SEQUENCE {
            nack-ack-power-offset INTEGER (-7..8),
            hs-SICH-PowerControl-Info HS-SICH-Power-Control-Info-TDD384,
            hs-SCCH-SetConfiguration SEQUENCE (SIZE (1..maxHSSCCHs)) OF
                HS-SCCH-TDD384
        },
        tdd128 SEQUENCE (SIZE (1..maxHSSCCHs)) OF
            HS-SCCH-TDD128
    }
}

HS-SCCH-Info-r6 ::= SEQUENCE {
    modeSpecificInfo CHOICE {
        fdd SEQUENCE {
            hs-SCCHChannelisationCodeInfo SEQUENCE (SIZE (1..maxHSSCCHs)) OF
                HS-SCCH-Codes,
            dl-ScramblingCode SecondaryScramblingCode OPTIONAL
        },
        tdd CHOICE {
            tdd384 SEQUENCE {
                nack-ack-power-offset INTEGER (-7..8),
                hs-SICH-PowerControl-Info HS-SICH-Power-Control-Info-TDD384,
                dhs-sync DHS-Sync OPTIONAL,
                bler-target Bler-Target,
                hs-SCCH-SetConfiguration SEQUENCE (SIZE (1..maxHSSCCHs)) OF
                    HS-SCCH-TDD384-r6
            },
            tdd128 SEQUENCE {
                nack-ack-power-offset INTEGER (-7..8),
                power-level-HSSICH INTEGER (-120..-58),
                tpc-step-size ENUMERATED { s1, s2, s3 , spare1 },
                bler-target Bler-Target,
                hs-SCCH-SetConfiguration SEQUENCE (SIZE (1..maxHSSCCHs)) OF
                    HS-SCCH-TDD128-r6
            }
        }
    }
}

HS-SCCH-Info-r7 ::= SEQUENCE {
    modeSpecificInfo CHOICE {
        fdd SEQUENCE {
            hs-SCCHChannelisationCodeInfo SEQUENCE (SIZE (1..maxHSSCCHs)) OF
                HS-SCCH-Codes,
            dl-ScramblingCode SecondaryScramblingCode OPTIONAL
        },
        tdd CHOICE {
            tdd384 SEQUENCE {
                nack-ack-power-offset INTEGER (-7..8),
                hs-SICH-PowerControl-Info HS-SICH-Power-Control-Info-TDD384,
                dhs-sync DHS-Sync OPTIONAL,
                bler-target Bler-Target,
                hs-SCCH-SetConfiguration SEQUENCE (SIZE (1..maxHSSCCHs)) OF
                    HS-SCCH-TDD384-r6
            },
            tdd768 SEQUENCE {
                nack-ack-power-offset INTEGER (-7..8),
                hs-SICH-PowerControl-Info HS-SICH-Power-Control-Info-TDD768,
                dhs-sync DHS-Sync OPTIONAL,
                bler-target Bler-Target,
                hs-SCCH-SetConfiguration SEQUENCE (SIZE (1..maxHSSCCHs)) OF
                    HS-SCCH-TDD768
            },
            tdd128 SEQUENCE {
                nack-ack-power-offset INTEGER (-7..8),
                power-level-HSSICH INTEGER (-120..-58),
                tpc-step-size ENUMERATED { s1, s2, s3 , spare1 },
                bler-target Bler-Target,
                powerControlGAP PowerControlGAP OPTIONAL,
                pathlossCompensationSwitch BOOLEAN OPTIONAL,
                hs-SCCH-SetConfiguration SEQUENCE (SIZE (1..maxHSSCCHs)) OF
                    HS-SCCH-TDD128-r6
            }
        }
    }
}

```

```

    }
  }
}

HS-SCCH-Info-r8-ext ::=
  modeSpecificInfo
  fdd
  tdd
    tdd384
    tdd768
    tdd128
      hS-SCCH-tpc-step-size
    }
  }
}

HS-SCCH-Info-r9 ::=
  modeSpecificInfo
  fdd
    hS-SCCHChannelisationCodeInfo
    dl-ScramblingCode
  },
  tdd
    tdd384
      nack-ack-power-offset
      hS-SICH-PowerControl-Info
      dhs-sync
      bler-target
      hS-SCCH-SetConfiguration
    },
    tdd768
      nack-ack-power-offset
      hS-SICH-PowerControl-Info
      dhs-sync
      bler-target
      hS-SCCH-SetConfiguration
    },
    tdd128
      nack-ack-power-offset
      power-level-HSSICH
      tpc-step-size
      bler-target
      hS-SCCH-tpc-step-size
      powerControlGAP
      pathlossCompensationSwitch
      hS-SCCH-SetConfiguration
    }
  }
}

HS-SCCH-DRX-InactivityThreshold-TDD128 ::= ENUMERATED {
  sub-frames-1, sub-frames-2, sub-frames-4,
  sub-frames-8, sub-frames-16, sub-frames-32,
  sub-frames-64, sub-frames-128, sub-frames-256,
  sub-frames-512,
  spare6, spare5, spare4, spare3, spare2,
  infinity }

HS-SCCH-DRX-Info-TDD128 ::=
  hS-SCCH-DRX-Cycle
  hS-SCCH-DRX-InactivityThreshold
  hS-SCCH-DRX-Offset
}

HS-SCCH-Codes ::=
  INTEGER (0..127)

HS-SCCH-Less-NewOperation ::=
  hs-pdsch-CodeIndex
  hs-scch-LessTFS
}

SEQUENCE {
  CHOICE {
    NULL,
    CHOICE {
      NULL,
      NULL,
      SEQUENCE {
        ENUMERATED { s1, s2, s3, spare1 } OPTIONAL
      }
    }
  }
}

SEQUENCE {
  CHOICE {
    SEQUENCE {
      SEQUENCE (SIZE (1..maxHSSCCHs)) OF
        HS-SCCH-Codes,
      SecondaryScramblingCode OPTIONAL
    },
    CHOICE {
      SEQUENCE {
        INTEGER (-7..8),
        HS-SICH-Power-Control-Info-TDD384,
        DHS-Sync OPTIONAL,
        Bler-Target,
        SEQUENCE (SIZE (1..maxHSSCCHs)) OF
          HS-SCCH-TDD384-r6
      },
      SEQUENCE {
        INTEGER (-7..8),
        HS-SICH-Power-Control-Info-TDD768,
        DHS-Sync OPTIONAL,
        Bler-Target,
        SEQUENCE (SIZE (1..maxHSSCCHs)) OF
          HS-SCCH-TDD768
      },
      SEQUENCE {
        INTEGER (-7..8),
        INTEGER (-120..-58),
        ENUMERATED { s1, s2, s3, spare1 },
        Bler-Target,
        ENUMERATED { s1, s2, s3, spare1 } OPTIONAL,
        PowerControlGAP OPTIONAL,
        BOOLEAN OPTIONAL,
        SEQUENCE (SIZE (1..maxHSSCCHs)) OF
          HS-SCCH-TDD128-r6
      }
    }
  }
}

SEQUENCE {
  ControlChannelDRXCycle-TDD128,
  HS-SCCH-DRX-InactivityThreshold-TDD128 OPTIONAL,
  INTEGER (0..63)
}

INTEGER (0..127)

SEQUENCE {
  INTEGER (1..15),
  HS-SCCH-LessTFSList
}

```

```

HS-SCCH-LessInfo-r7 ::= SEQUENCE {
    hs-scchLessOperation CHOICE {
        continue NULL,
        newOperation HS-SCCH-Less-NewOperation
    }
}

HS-SCCH-LessTFList ::= SEQUENCE (SIZE (1..maxHS-SCCHLessTrBlk)) OF
    SEQUENCE {
        hs-scch-LessTFSI INTEGER (1..90),
        hs-scch-LessSecondCodeSupport BOOLEAN
    }
}

HS-SCCH-SystemInfo ::= SEQUENCE {
    dl-ScramblingCode SecondaryScramblingCode OPTIONAL,
    hs-SCCHChannelisationCodeInfo SEQUENCE (SIZE (1..maxHSSCCHs)) OF
        HS-SCCH-Codes
}

HS-SCCH-SystemInfo-TDD128 ::= SEQUENCE {
    hs-SCCH-SetConfiguration SEQUENCE (SIZE (1..maxHSSCCHs)) OF
        HS-SCCH-TDD128-r6,
    power-level-HSSICH INTEGER (-120..-58),
    nack-ack-power-offset INTEGER (-7..8),
    tpc-step-size ENUMERATED { s1, s2, s3 , spare1 },
    bler-target Bler-Target,
    power-control-gap INTEGER (1..255) OPTIONAL,
    pathloss-compensation-switch BOOLEAN OPTIONAL
}

HS-SCCH-TDD128 ::= SEQUENCE {
    timeslotNumber TimeslotNumber-LCR-r4,
    firstChannelisationCode HS-ChannelisationCode-LCR,
    secondChannelisationCode HS-ChannelisationCode-LCR,
    midambleAllocationMode CHOICE {
        defaultMidamble NULL,
        commonMidamble NULL,
        ueSpecificMidamble INTEGER(0..15)
    },
    -- Actual value midambleConfiguration = IE value * 2
    midambleConfiguration INTEGER (1..8),
    bler-target Bler-Target,
    hs-sich-configuration HS-SICH-Configuration-TDD128
}

HS-SCCH-TDD128-r6 ::= SEQUENCE {
    timeslotNumber TimeslotNumber-LCR-r4,
    firstChannelisationCode HS-ChannelisationCode-LCR,
    secondChannelisationCode HS-ChannelisationCode-LCR,
    midambleAllocationMode CHOICE {
        defaultMidamble NULL,
        commonMidamble NULL,
        ueSpecificMidamble INTEGER(0..15)
    },
    -- Actual value midambleConfiguration = IE value * 2
    midambleConfiguration INTEGER (1..8),
    hs-sich-configuration HS-SICH-Configuration-TDD128-r6
}

--for TDD128 Multi-Carrier
HS-SCCH-TDD128-MultiCarrier ::= SEQUENCE {
    uarfcn-HS-SCCH-Rx UARFCN,
    timeslotNumber TimeslotNumber-LCR-r4,
    firstChannelisationCode HS-ChannelisationCode-LCR,
    secondChannelisationCode HS-ChannelisationCode-LCR,
    midambleAllocationMode CHOICE {
        defaultMidamble NULL,
        commonMidamble NULL,
        ueSpecificMidamble INTEGER(0..15)
    },
    -- Actual value midambleConfiguration = IE value * 2
    midambleConfiguration INTEGER (1..8),
    bler-target Bler-Target,
    hs-sich-configuration HS-SICH-Configuration-TDD128
}

HS-SICH-Configuration-TDD128 ::= SEQUENCE {
    timeslotNumber TimeslotNumber-LCR-r4,

```



```

channelisationCode          HS-ChannelisationCode-LCR,
midambleAllocationMode     CHOICE {
  defaultMidamble          NULL,
  ueSpecificMidamble       SEQUENCE {
    midambleShift          MidambleShiftLong
  }
},
-- Actual value midambleConfiguration = IE value * 2
midambleConfiguration      INTEGER (1..8),
nack-ack-power-offset      INTEGER (-7..8),
power-level-HSSICH         INTEGER (-120..-58),
tpc-step-size              ENUMERATED { s1, s2, s3 , spare1}
}

HS-SICH-Configuration-TDD128-r6 ::= SEQUENCE {
  timeslotNumber            TimeslotNumber-LCR-r4,
  channelisationCode        HS-ChannelisationCode-LCR,
  midambleAllocationMode    CHOICE {
    defaultMidamble        NULL,
    ueSpecificMidamble     SEQUENCE {
      midambleShift        MidambleShiftLong
    }
  },
  -- Actual value midambleConfiguration = IE value * 2
  midambleConfiguration    INTEGER (1..8)
}

HS-SICH-List-TDD128 ::= SEQUENCE (SIZE (1..maxHSSICH-TDD128)) OF
  CHOICE {
    implicit SEQUENCE {
      hS-SCCH-Index INTEGER (0..maxHSSCCHs-1)
    },
    explicit SEQUENCE {
      hS-SICH-Info HS-SICH-Configuration-TDD128-r6
    }
  }

--The order of the list corresponds to the order of HS-SCCHs in HS-SCCH info
HS-SICH-ReferenceSignalInfoList ::= SEQUENCE ( SIZE (1.. maxHSSCCHs)) OF
  SEQUENCE {
    -- Actual value midambleConfiguration = IE value * 2
    midambleConfiguration INTEGER (1..8),
    midambleShift          INTEGER (0..15),
    timeslot                INTEGER (1..5)
  }

HS-SCCH-TDD384 ::= SEQUENCE {
  timeslotNumber            TimeslotNumber,
  channelisationCode        DL-TS-ChannelisationCode,
  midambleAllocationMode    CHOICE {
    defaultMidamble        NULL,
    commonMidamble         NULL,
    ueSpecificMidamble     SEQUENCE {
      midambleShift        MidambleShiftLong
    }
  },
  midambleconfiguration     MidambleConfigurationBurstTypeland3,
  bler-target               Bler-Target,
  hs-sich-configuration     HS-SICH-Configuration-TDD384
}

HS-SCCH-TDD384-r6 ::= SEQUENCE {
  timeslotNumber            TimeslotNumber,
  channelisationCode        DL-TS-ChannelisationCode,
  midambleAllocationMode    CHOICE {
    defaultMidamble        NULL,
    commonMidamble         NULL,
    ueSpecificMidamble     SEQUENCE {
      midambleShift        MidambleShiftLong
    }
  },
  midambleconfiguration     MidambleConfigurationBurstTypeland3,
  hs-sich-configuration     HS-SICH-Configuration-TDD384
}

HS-SCCH-TDD768 ::= SEQUENCE {
  timeslotNumber            TimeslotNumber,
  channelisationCode        DL-TS-ChannelisationCode-VHCR,

```

```

midambleAllocationMode          CHOICE {
    defaultMidamble              NULL,
    commonMidamble               NULL,
    ueSpecificMidamble           SEQUENCE {
        midambleShift            MidambleShiftLong
    }
},
midambleconfiguration           MidambleConfigurationBurstTypeland3,
hs-sich-configuration           HS-SICH-Configuration-TDD768
}

HS-SICH-Configuration-TDD384 ::= SEQUENCE {
    timeslotNumber               TimeslotNumber,
    channelisationCode           DL-TS-ChannelisationCode,
    midambleAllocationMode       CHOICE {
        defaultMidamble          NULL,
        ueSpecificMidamble       SEQUENCE {
            midambleShift        MidambleShiftLong
        }
    },
    midambleconfiguration        MidambleConfigurationBurstTypeland3
}

HS-SICH-Configuration-TDD768 ::= SEQUENCE {
    timeslotNumber               TimeslotNumber,
    channelisationCode           DL-TS-ChannelisationCode-VHCR,
    midambleAllocationMode       CHOICE {
        defaultMidamble          NULL,
        ueSpecificMidamble       SEQUENCE {
            midambleShift        MidambleShiftLong
        }
    },
    midambleconfiguration        MidambleConfigurationBurstTypeland3
}

HS-SICH-Power-Control-Info-TDD384 ::= SEQUENCE {
    -- Actual value ul-target-SIR = IE value * 0.5
    ul-target-SIR                INTEGER (-22..40),
    -- Note: IE 'ConstantValue' is used (instead of IE 'ConstantValueTDD') to keep
    -- compatibility with REL-5
    hs-sich-ConstantValue        ConstantValue
}

HS-SICH-Power-Control-Info-TDD768 ::= SEQUENCE {
    -- Actual value ul-target-SIR = IE value * 0.5
    ul-target-SIR                INTEGER (-22..40),
    -- Note: IE 'ConstantValue' is used (instead of IE 'ConstantValueTDD') to keep
    -- compatibility with REL-5
    hs-sich-ConstantValue        ConstantValue
}

IndividualTimeslotInfo ::= SEQUENCE {
    timeslotNumber               TimeslotNumber,
    tfci-Existence               BOOLEAN,
    midambleShiftAndBurstType    MidambleShiftAndBurstType
}

IndividualTimeslotInfo-VHCR ::= SEQUENCE {
    timeslotNumber               TimeslotNumber,
    tfci-Existence               BOOLEAN,
    midambleShiftAndBurstType-VHCR MidambleShiftAndBurstType-VHCR
}

IndividualTimeslotInfo-LCR-r4 ::= SEQUENCE {
    timeslotNumber               TimeslotNumber-LCR-r4,
    tfci-Existence               BOOLEAN,
    midambleShiftAndBurstType    MidambleShiftAndBurstType-LCR-r4,
    modulation                   ENUMERATED { mod-QPSK, mod-8PSK },
    ss-TPC-Symbols               ENUMERATED { zero, one, sixteenOverSF },
    additionalSS-TPC-Symbols     INTEGER(1..15) OPTIONAL
}

IndividualTimeslotInfo-LCR-r4-ext ::= SEQUENCE {
    -- timeslotNumber and tfci-Existence is taken from IndividualTimeslotInfo.
    -- midambleShiftAndBurstType in IndividualTimeslotInfo shall be ignored.
    midambleShiftAndBurstType    MidambleShiftAndBurstType-LCR-r4,
    modulation                   ENUMERATED { mod-QPSK, mod-8PSK },
    ss-TPC-Symbols               ENUMERATED { zero, one, sixteenOverSF }
}

```

```

}

IndividualTimeslotInfo-r7 ::= SEQUENCE {
    timeslotNumber          TimeslotNumber,
    tfci-Existence         BOOLEAN,
    midambleShiftAndBurstType MidambleShiftAndBurstType-r7
}

IndividualTS-Interference ::= SEQUENCE {
    timeslot                TimeslotNumber,
    ul-TimeslotInterference TDD-UL-Interference
}

IndividualTS-InterferenceList ::= SEQUENCE (SIZE (1..maxTS)) OF
    IndividualTS-Interference

ITP ::= ENUMERATED {
    mode0, model }

NidentifyAbort ::= INTEGER (1..128)

MAC-DTX-Cycle-10ms ::= ENUMERATED {
    sub-frames-5,
    sub-frames-10,
    sub-frames-20,
    spare1 }

MAC-DTX-Cycle-2ms ::= ENUMERATED {
    sub-frames-1,
    sub-frames-4,
    sub-frames-5,
    sub-frames-8,
    sub-frames-10,
    sub-frames-16,
    sub-frames-20,
    spare1 }

MAC-InactivityThreshold ::= ENUMERATED {
    e-dch-tti-1,
    e-dch-tti-2,
    e-dch-tti-4,
    e-dch-tti-8,
    e-dch-tti-16,
    e-dch-tti-32,
    e-dch-tti-64,
    e-dch-tti-128,
    e-dch-tti-256,
    e-dch-tti-512,
    e-dch-tti-Infinity,
    spare5,
    spare4,
    spare3,
    spare2,
    spare1 }

MaxAllowedUL-TX-Power ::= INTEGER (-50..33)

MaxAvailablePCPCH-Number ::= INTEGER (1..64)
MaxPowerIncrease-r4 ::= INTEGER (0..3)

MaxTFCI-Field2Value ::= INTEGER (1..1023)

Measurement-Feedback-Info ::= SEQUENCE {
    modeSpecificInfo CHOICE {
        fdd SEQUENCE {
            measurementPowerOffset MeasurementPowerOffset,
            feedback-cycle Feedback-cycle,
            cqi-RepetitionFactor CQI-RepetitionFactor,
            deltaCQI DeltaCQI
        },
        tdd NULL
    }
}

Measurement-Feedback-Info-r7 ::= SEQUENCE {
    modeSpecificInfo CHOICE {
        fdd SEQUENCE {
            measurementPowerOffset MeasurementPowerOffset,

```

```

        feedback-cycle          Feedback-cycle-r7,
        cqi-RepetitionFactor    CQI-RepetitionFactor,
        deltaCQI                DeltaCQI
    },
    tdd                          NULL
}
}

Measurement-Feedback-Info-r11 ::= SEQUENCE {
    modeSpecificInfo            CHOICE {
        fdd                      SEQUENCE {
            measurementPowerOffset MeasurementPowerOffset,
            feedback-cycle        Feedback-cycle-r7,
            cqi-RepetitionFactor  CQI-RepetitionFactor,
            cqi-RepetitionFactor-Assisting CQI-RepetitionFactor OPTIONAL,
            deltaCQI              DeltaCQI-r11
        },
        tdd                          NULL
    }
}

Measurement-Feedback-Info-r12 ::= SEQUENCE {
    modeSpecificInfo            CHOICE {
        fdd                      SEQUENCE {
            measurementPowerOffset MeasurementPowerOffset,
            feedback-cycle        Feedback-cycle-r7,
            hs-DPCCHOverheadReduction HS-DPCCHOverheadReduction OPTIONAL,
            cqi-RepetitionFactor  CQI-RepetitionFactor,
            cqi-RepetitionFactor-Assisting CQI-RepetitionFactor OPTIONAL,
            deltaCQI              DeltaCQI-r11
        },
        tdd                          NULL
    }
}

Measurement-Feedback-Info-ConcurrentTTI ::= SEQUENCE {
    feedback-cycle          Feedback-cycle-r7          OPTIONAL,
    cqi-RepetitionFactor    CQI-RepetitionFactor      OPTIONAL,
    deltaCQI                DeltaCQI                  OPTIONAL
}

MidambleConfigurationBurstTypeLand3 ::= ENUMERATED {ms4, ms8, ms16}

MidambleConfigurationBurstType1 ::= ENUMERATED {ms4, ms8, ms16}

MidambleConfigurationBurstType2 ::= ENUMERATED {ms3, ms6}

MidambleConfigurationBurstType2-VHCR ::= ENUMERATED {ms4, ms8}

MidambleShiftAndBurstType ::= SEQUENCE {
    burstType                CHOICE {
        type1                SEQUENCE {
            midambleConfigurationBurstTypeLand3 MidambleConfigurationBurstTypeLand3,
            midambleAllocationMode              CHOICE {
                defaultMidamble          NULL,
                commonMidamble           NULL,
                ueSpecificMidamble       SEQUENCE {
                    midambleShift        MidambleShiftLong
                }
            }
        },
        type2                SEQUENCE {
            midambleConfigurationBurstType2    MidambleConfigurationBurstType2,
            midambleAllocationMode              CHOICE {
                defaultMidamble          NULL,
                commonMidamble           NULL,
                ueSpecificMidamble       SEQUENCE {
                    midambleShift        MidambleShiftShort
                }
            }
        },
        type3                SEQUENCE {
            midambleConfigurationBurstTypeLand3 MidambleConfigurationBurstTypeLand3,
            midambleAllocationMode              CHOICE {
                defaultMidamble          NULL,
                ueSpecificMidamble       SEQUENCE {
                    midambleShift        MidambleShiftLong
                }
            }
        }
    }
}

```

```

    }
  }
}

MidambleShiftAndBurstType-VHCR ::= SEQUENCE {
  burstType
  type1
    SEQUENCE {
      midambleConfigurationBurstType1and3 MidambleConfigurationBurstType1and3,
      midambleAllocationMode
        CHOICE {
          defaultMidamble
            NULL,
          commonMidamble
            NULL,
          ueSpecificMidamble
            SEQUENCE {
              midambleShift
                MidambleShiftLong
            }
        }
    },
  type2
    SEQUENCE {
      midambleConfigurationBurstType2 MidambleConfigurationBurstType2-VHCR,
      midambleAllocationMode
        CHOICE {
          defaultMidamble
            NULL,
          commonMidamble
            NULL,
          ueSpecificMidamble
            SEQUENCE {
              midambleShift
                MidambleShiftShort-VHCR
            }
        }
    },
  type3
    SEQUENCE {
      midambleConfigurationBurstType1and3 MidambleConfigurationBurstType1and3,
      midambleAllocationMode
        CHOICE {
          defaultMidamble
            NULL,
          ueSpecificMidamble
            SEQUENCE {
              midambleShift
                MidambleShiftLong
            }
        }
    },
  -- mbsfnBurstType4 is only used DL
  mbsfnBurstType4
    NULL
}

MidambleShiftAndBurstType-r7 ::= SEQUENCE {
  burstType
  type1
    SEQUENCE {
      midambleConfigurationBurstType1and3 MidambleConfigurationBurstType1and3,
      midambleAllocationMode
        CHOICE {
          defaultMidamble
            NULL,
          commonMidamble
            NULL,
          ueSpecificMidamble
            SEQUENCE {
              midambleShift
                MidambleShiftLong
            }
        }
    },
  type2
    SEQUENCE {
      midambleConfigurationBurstType2 MidambleConfigurationBurstType2,
      midambleAllocationMode
        CHOICE {
          defaultMidamble
            NULL,
          commonMidamble
            NULL,
          ueSpecificMidamble
            SEQUENCE {
              midambleShift
                MidambleShiftShort
            }
        }
    },
  type3
    SEQUENCE {
      midambleConfigurationBurstType1and3 MidambleConfigurationBurstType1and3,
      midambleAllocationMode
        CHOICE {
          defaultMidamble
            NULL,
          ueSpecificMidamble
            SEQUENCE {
              midambleShift
                MidambleShiftLong
            }
        }
    },
  -- mbsfnBurstType4 is only used DL
  mbsfnBurstType4
    NULL
}

MidambleShiftAndBurstType-DL ::= SEQUENCE {

```

```

burstType
  type1
    CHOICE {
      SEQUENCE {
        midambleConfigurationBurstType1and3 MidambleConfigurationBurstType1and3,
        midambleAllocationMode
          CHOICE {
            defaultMidamble NULL,
            commonMidamble NULL,
            ueSpecificMidamble
              SEQUENCE {
                midambleShift MidambleShiftLong
              }
          }
      }
    },
  type2
    SEQUENCE {
      midambleConfigurationBurstType2 MidambleConfigurationBurstType2,
      midambleAllocationMode
        CHOICE {
          defaultMidamble NULL,
          commonMidamble NULL,
          ueSpecificMidamble
            SEQUENCE {
              midambleShift MidambleShiftShort
            }
        }
    }
}

MidambleShiftAndBurstType-DL-VHCR ::= SEQUENCE {
  burstType
    CHOICE {
      type1
        SEQUENCE {
          midambleConfigurationBurstType1and3 MidambleConfigurationBurstType1and3,
          midambleAllocationMode
            CHOICE {
              defaultMidamble NULL,
              commonMidamble NULL,
              ueSpecificMidamble
                SEQUENCE {
                  midambleShift MidambleShiftLong
                }
            }
        }
      },
      type2
        SEQUENCE {
          midambleConfigurationBurstType2 MidambleConfigurationBurstType2-VHCR,
          midambleAllocationMode
            CHOICE {
              defaultMidamble NULL,
              commonMidamble NULL,
              ueSpecificMidamble
                SEQUENCE {
                  midambleShift MidambleShiftShort-VHCR
                }
            }
        }
    }
}

MidambleShiftAndBurstType-LCR-r4 ::= SEQUENCE {
  midambleAllocationMode
    CHOICE {
      defaultMidamble NULL,
      commonMidamble NULL,
      ueSpecificMidamble
        SEQUENCE {
          midambleShift INTEGER (0..15)
        }
    }
  },
  -- Actual value midambleConfiguration = IE value * 2
  midambleConfiguration
    INTEGER (1..8)
}

MidambleShiftAndBurstType-EDCH ::= SEQUENCE {
  burstType
    CHOICE {
      type1
        SEQUENCE {
          midambleConfigurationBurstType1 MidambleConfigurationBurstType1,
          midambleAllocationMode
            CHOICE {
              defaultMidamble NULL,
              commonMidamble NULL,
              ueSpecificMidamble
                SEQUENCE {
                  midambleShift MidambleShiftLong
                }
            }
        }
      },
      type2
        SEQUENCE {
          midambleConfigurationBurstType2 MidambleConfigurationBurstType2,
          midambleAllocationMode
            CHOICE {
              defaultMidamble NULL,
              commonMidamble NULL,
            }
        }
    }
}

```

```

        ueSpecificMidamble
        midambleShift
    }
}
}
}
}

MidambleShiftLong ::=
    INTEGER (0..15)

MidambleShiftShort ::=
    INTEGER (0..5)

MidambleShiftShort-VHCR ::=
    INTEGER (0..7)

MIMO-N-M-Ratio ::=
    ENUMERATED {
        mnm1-2, mnm2-3, mnm3-4, mnm4-5, mnm5-6,
        mnm6-7, mnm7-8, mnm8-9, mnm9-10, mnm1-1 }

MIMO-Operation ::=
    ENUMERATED {
        start, continue }

MIMO-Parameters-r7 ::=
    SEQUENCE {
        mimoOperation          MIMO-Operation,
        mimoN-M-Ratio          MIMO-N-M-Ratio          OPTIONAL,
        mimoPilotConfiguration MIMO-PilotConfiguration OPTIONAL
    }

MIMO4x4-Parameters ::=
    SEQUENCE {
        configurationInfo      CHOICE {
            continue          NULL,
            newConfiguration SEQUENCE {
                mimo4x4N-M-Ratio          MIMO-N-M-Ratio          OPTIONAL,
                mimo4x4PilotConfiguration MIMO4x4-PilotConfiguration OPTIONAL,
                precodingWeightSetRestriction BIT STRING (SIZE (64))    OPTIONAL
            }
        }
    }

MIMO-Parameters-v7f0ext ::= MIMO-PilotConfiguration-v7f0ext

MIMO-Parameters-v7g0ext ::= SEQUENCE {
    precodingWeightSetRestriction    ENUMERATED { true }    OPTIONAL
}

MIMO-Parameters-r8 ::=
    SEQUENCE {
        mimoOperation          MIMO-Operation,
        modeSpecificInfo      CHOICE {
            fdd                SEQUENCE {
                mimoN-M-Ratio          MIMO-N-M-Ratio          OPTIONAL,
                mimoPilotConfiguration MIMO-PilotConfiguration OPTIONAL
            },
            tdd                CHOICE {
                tdd128           SEQUENCE {
                    mimoSFModeForHSPDSDualStream    ENUMERATED {sf1, sflsf16},
                    hs-sich-ReferenceSignalInfoList HS-SICH-ReferenceSignalInfoList OPTIONAL
                },
                tdd384-tdd768    NULL
            }
        }
    }

MIMO-Parameters-r9 ::=
    SEQUENCE {
        mimoOperation          MIMO-Operation,
        modeSpecificInfo      CHOICE {
            fdd                SEQUENCE {
                mimoN-M-Ratio          MIMO-N-M-Ratio          OPTIONAL,
                mimoPilotConfiguration MIMO-PilotConfiguration-r9    OPTIONAL,
                precodingWeightSetRestriction    ENUMERATED { true }    OPTIONAL
            },
            tdd                CHOICE {
                tdd128           SEQUENCE {
                    mimoSFModeForHSPDSDualStream    ENUMERATED {sf1, sflsf16},
                    hs-sich-ReferenceSignalInfoList HS-SICH-ReferenceSignalInfoList OPTIONAL
                },
                tdd384-tdd768    NULL
            }
        }
    }
}

```

```

}
MIMO-PilotConfiguration ::= SEQUENCE {
    secondCPICH-Pattern CHOICE {
        normalPattern NULL,
        diversityPattern SEQUENCE {
            channelisationCode ChannelisationCode256
        }
    }
}
MIMO-PilotConfiguration-v7f0ext ::= SEQUENCE {
    s-cpich-PowerOffset-Mimo S-CPICH-PowerOffset-MIMO OPTIONAL
}
MIMO-PilotConfiguration-r9 ::= SEQUENCE {
    secondCPICH-Pattern CHOICE {
        normalPattern NULL,
        diversityPattern SEQUENCE {
            channelisationCode ChannelisationCode256,
            s-cpich-PowerOffset-Mimo S-CPICH-PowerOffset-MIMO OPTIONAL
        }
    }
}
MIMO4x4-PilotConfiguration ::= SEQUENCE {
    antenna2 MIMO-PilotConfiguration-r9 OPTIONAL,
    antenna3And4 Antenna3And4 OPTIONAL
}
MinimumSpreadingFactor ::= ENUMERATED {
    sf4, sf8, sf16, sf32,
    sf64, sf128, sf256 }
MinReduced-E-DPDCH-GainFactor ::= ENUMERATED {
    m8-15, m11-15, m15-15, m21-15, m30-15,
    m42-15, m60-15, m84-15 }
MultiCodeInfo ::= INTEGER (1..16)
-- These IEs are applied for 1.28 Mcps TDD only
Multi-frequencyInfo-LCR-r7 ::= SEQUENCE {
    -- If the secondary frequency is present, it indicates working frequency
    secondFrequencyInfo FrequencyInfoTDD OPTIONAL,
    fPachFrequencyInfo FrequencyInfoTDD OPTIONAL,
    --If a cell UpPCH uses other uplink service timeslot, it indicates the UpPCH position
    upPCHpositionInfo UpPCHposition-LCR OPTIONAL
}
MultiflowCellType ::= ENUMERATED { intra-nodeB, inter-nodeB }
MultiflowConfigurationInfo ::= SEQUENCE {
    cellType MultiflowCellType,
    timeReferenceCell ENUMERATED { true } OPTIONAL
}
MU-MIMO-Info-TDD128 ::= CHOICE {
    continue NULL,
    newConfiguration SEQUENCE {
        mu-MIMO-Operation MU-MIMO-Operation,
        standaloneMidambleInfo StandaloneMidambleInfo-TDD128 OPTIONAL
    }
}
MU-MIMO-Operation ::= ENUMERATED {
    uL, dL, uLandDL, spare }
N-EOT ::= INTEGER (0..7)
N-GAP ::= ENUMERATED {
    f2, f4, f8 }
N-PCH ::= INTEGER (1..8)
N-StartMessage ::= INTEGER (1..8)
NB01 ::= INTEGER (0..50)

```



```

NewTiming ::= SEQUENCE {
    enablingDelay          EnablingDelay,
    ue-dtx-drx-Offset     UE-DTX-DRX-Offset
}

NF-Max ::= INTEGER (1..64)

NodeB-Trigger-HS-DPCCH-Transmission ::= SEQUENCE {
    hs-dpcch-TransmitContinuationOffset  ENUMERATED {
        ms10, ms20, ms30, ms40, ms80, ms160,
        ms320, ms800} OPTIONAL
}

Non-ScheduledTransGrantInfoTDD ::= CHOICE {
    tdd384-768 SEQUENCE {
        timeslotResourceRelatedInfo  BIT STRING (SIZE (13)),
        powerResourceRelatedInfo     INTEGER (1..32),
        activationTime                ActivationTime,
        repetitionPeriodAndLength     RepetitionPeriodAndLength OPTIONAL,
        codeResourceInfo              UL-TS-ChannelisationCode
    },
    tdd128 SEQUENCE {
        n-E-UCCH                      INTEGER (1..8) OPTIONAL,
        n-E-HICH                      INTEGER (4..15) OPTIONAL,
        timeslotResourceRelatedInfo  BIT STRING (SIZE (5)),
        powerResourceRelatedInfo     INTEGER (1..32),
        activationTime                ActivationTime,
        sfnNum                       INTEGER (0..1),
        repetitionPeriodAndLength     RepetitionPeriodAndLength OPTIONAL,
        codeResourceInfo              UL-TS-ChannelisationCode,
        e-HICH-Info SEQUENCE {
            timeslotNumber            TimeslotNumber-LCR-r4,
            channelisation-Code       HS-ChannelisationCode-LCR,
            midambleAllocationMode    CHOICE {
                defaultMidamble      NULL,
                ueSpecificMidamble    INTEGER (0..15)
            }
        },
        -- Actual value midambleConfiguration = IE value * 2
        midambleConfiguration        INTEGER (1..8),
        signatureSequenceGroupIndex  INTEGER (0..19)
    }
}

Non-ScheduledTransGrantInfoTDD-ext ::= CHOICE {
    tdd384-768 NULL,
    tdd128 SEQUENCE {
        t-SI-nst ENUMERATED {
            everyEDCHTTI, ms20, ms40, ms60, ms80, ms160,
            ms200} OPTIONAL
    }
}

Non-ScheduledTransGrantInfoTDD-r9 ::= CHOICE {
    tdd384-768 SEQUENCE {
        timeslotResourceRelatedInfo  BIT STRING (SIZE (13)),
        powerResourceRelatedInfo     INTEGER (1..32),
        activationTime                ActivationTime,
        repetitionPeriodAndLength     RepetitionPeriodAndLength OPTIONAL,
        codeResourceInfo              UL-TS-ChannelisationCode
    },
    tdd128 SEQUENCE {
        n-E-UCCH                      INTEGER (1..8) OPTIONAL,
        n-E-HICH                      INTEGER (4..15) OPTIONAL,
        timeslotResourceRelatedInfo  BIT STRING (SIZE (5)),
        powerResourceRelatedInfo     INTEGER (1..32),
        activationTime                ActivationTime,
        sfnNum                       INTEGER (0..1),
        repetitionPeriodAndLength     RepetitionPeriodAndLength OPTIONAL,
        codeResourceInfo              UL-TS-ChannelisationCode,
        e-HICH-Info SEQUENCE {
            timeslotNumber            TimeslotNumber-LCR-r4,
            channelisation-Code       HS-ChannelisationCode-LCR,
            midambleAllocationMode    CHOICE {
                defaultMidamble      NULL,
                ueSpecificMidamble    INTEGER (0..15)
            }
        },
        -- Actual value midambleConfiguration = IE value * 2
    }
}

```

```

        midambleConfiguration          INTEGER (1..8),
        signatureSequenceGroupIndex    INTEGER (0..19)
    },
    t-SI-nst                            ENUMERATED {
        everyEDCHTTI, ms20, ms40, ms60, ms80, ms160,
        ms200 }                          OPTIONAL
}

Non-rectResAllocInd-TDD128 ::=          ENUMERATED { true }

Non-rectResSpecTSset-TDD128 ::=         BIT STRING (SIZE (7))

NumberOfDPDCH ::=                       INTEGER (1..maxDPDCH-UL)

NumberOfFBI-Bits ::=                    INTEGER (1..2)

NumberOfTPC-Bits ::=                    ENUMERATED { tpc4 }

OpenLoopPowerControl-TDD ::=            SEQUENCE {
    primaryCCPCH-TX-Power                PrimaryCCPCH-TX-Power,
    -- alpha, prach-ConstantValue, dpch-ConstantValue and pusch-ConstantValue
    -- shall be ignored in 1.28Mcps TDD mode.
    alpha                                Alpha                                OPTIONAL,
    prach-ConstantValue                  ConstantValueTdd,
    dpch-ConstantValue                   ConstantValueTdd,
    pusch-ConstantValue                  ConstantValueTdd                    OPTIONAL
}

OpenLoopPowerControl-IPDL-TDD-r4 ::=    SEQUENCE {
    ipdl-alpha                            Alpha,
    maxPowerIncrease                      MaxPowerIncrease-r4
}

PagingIndicatorLength ::=               ENUMERATED {
    pi4, pi8, pi16 }

PC-Preamble ::=                         INTEGER (0..7)

PCCH-InformationList ::=                SEQUENCE {
    paging-associatedHspdschInfo          SEQUENCE (SIZE (1.. maxSCCPCH)) OF
        SEQUENCE {
            hs-pdsch-MidambleConfiguration HS-PDSCH-Midamble-Configuration-TDD128,
            timeslotResourceRelatedInfo    BIT STRING (SIZE (6)),
            codeResourceInformation         CodeResourceInformation-TDD128
        },
    paging-sub-Channel-size               INTEGER (1..3),
    transportBlockSizeList                SEQUENCE (SIZE (1..2)) OF TransportBlockSizeIndex
}

PCP-Length ::=                          ENUMERATED {
    as0, as8 }

PCPCH-ChannelInfo ::=                  SEQUENCE {
    pcpch-UL-ScramblingCode               INTEGER (0..79),
    pcpch-DL-ChannelisationCode           INTEGER (0..511),
    pcpch-DL-ScramblingCode               SecondaryScramblingCode            OPTIONAL,
    pcp-Length                             PCP-Length,
    ucsM-Info                              UCSM-Info                            OPTIONAL
}

PCPCH-ChannelInfoList ::=              SEQUENCE (SIZE (1..maxPCPCHs)) OF
    PCPCH-ChannelInfo

PCPICH-UsageForChannelEst ::=           ENUMERATED {
    maybeUsed,
    shallNotBeUsed }

PDSCH-CapacityAllocationInfo ::=        SEQUENCE {
    -- pdsch-PowerControlInfo is conditional on new-configuration branch below, if this
    -- selected the IE is OPTIONAL otherwise it should not be sent
    pdsch-PowerControlInfo                 PDSCH-PowerControlInfo                OPTIONAL,
    pdsch-AllocationPeriodInfo             AllocationPeriodInfo,
    configuration                           CHOICE {
        old-Configuration                   SEQUENCE {
            tfcs-ID                         TFCS-IdentityPlain                    DEFAULT 1,
            pdsch-Identity                  PDSCH-Identity
        },

```

```

        new-Configuration
        pdsch-Info
        pdsch-Identity
    }
}

PDSCH-CapacityAllocationInfo-r4 ::= SEQUENCE {
    pdsch-AllocationPeriodInfo    AllocationPeriodInfo,
    configuration                   CHOICE {
        old-Configuration          SEQUENCE {
            tfcs-ID                TFCS-IdentityPlain           DEFAULT 1,
            pdsch-Identity          PDSCH-Identity
        },
        new-Configuration          SEQUENCE {
            pdsch-Info              PDSCH-Info-r4,
            pdsch-Identity          PDSCH-Identity           OPTIONAL,
            pdsch-PowerControlInfo  PDSCH-PowerControlInfo   OPTIONAL
        }
    }
}

PDSCH-CapacityAllocationInfo-r7 ::= SEQUENCE {
    pdsch-AllocationPeriodInfo    AllocationPeriodInfo,
    configuration                   CHOICE {
        old-Configuration          SEQUENCE {
            tfcs-ID                TFCS-IdentityPlain           DEFAULT 1,
            pdsch-Identity          PDSCH-Identity
        },
        new-Configuration          SEQUENCE {
            pdsch-Info              PDSCH-Info-r7,
            pdsch-Identity          PDSCH-Identity           OPTIONAL,
            pdsch-PowerControlInfo  PDSCH-PowerControlInfo   OPTIONAL
        }
    }
}

PDSCH-CodeInfo ::=
    spreadingFactor
    codeNumber
    multiCodeInfo
}

PDSCH-CodeInfoList ::=
    SEQUENCE (SIZE (1..maxTFCI-2-Combs)) OF
        PDSCH-CodeInfo

PDSCH-CodeMap ::=
    SEQUENCE {
        spreadingFactor
        multiCodeInfo
        codeNumberStart
        codeNumberStop
    }

PDSCH-CodeMapList ::=
    SEQUENCE (SIZE (1..maxPDSCH-TFCIgroups)) OF
        PDSCH-CodeMap

PDSCH-CodeMapping ::=
    dl-ScramblingCode
    signallingMethod
    codeRange
    tfci-Range
    explicit-config
    replace
}

PDSCH-Identity ::=
    INTEGER (1..hiPDSCHidentities)

PDSCH-Info ::=
    tfcs-ID
    commonTimeslotInfo
    pdsch-TimeslotsCodes
}

PDSCH-Info-r4 ::=
    tfcs-ID
    commonTimeslotInfo
    tddOption
}
SEQUENCE {
    PDSCH-Info,
    PDSCH-Identity
    OPTIONAL

    AllocationPeriodInfo,
    CHOICE {
        SEQUENCE {
            TFCS-IdentityPlain           DEFAULT 1,
            PDSCH-Identity
        },
        SEQUENCE {
            PDSCH-Info-r4,
            PDSCH-Identity           OPTIONAL,
            PDSCH-PowerControlInfo   OPTIONAL
        }
    }

    AllocationPeriodInfo,
    CHOICE {
        SEQUENCE {
            TFCS-IdentityPlain           DEFAULT 1,
            PDSCH-Identity
        },
        SEQUENCE {
            PDSCH-Info-r7,
            PDSCH-Identity           OPTIONAL,
            PDSCH-PowerControlInfo   OPTIONAL
        }
    }

    SEQUENCE {
        SecondaryScramblingCode           OPTIONAL,
        CHOICE {
            CodeRange,
            DSCH-MappingList,
            PDSCH-CodeInfoList,
            ReplacedPDSCH-CodeInfoList
        }
    }

    INTEGER (1..hiPDSCHidentities)

    SEQUENCE {
        TFCS-IdentityPlain           DEFAULT 1,
        CommonTimeslotInfo           OPTIONAL,
        DownlinkTimeslotsCodes       OPTIONAL
    }

    SEQUENCE {
        TFCS-IdentityPlain           DEFAULT 1,
        CommonTimeslotInfo           OPTIONAL,
        CHOICE {

```

```

    tdd384
      pdsch-TimeslotsCodes
    },
    tdd128
      pdsch-TimeslotsCodes
  }
}

PDSCH-Info-r7 ::=
  tfcs-ID
  commonTimeslotInfo
  tddOption
    tdd384
      pdsch-TimeslotsCodes
    },
    tdd768
      pdsch-TimeslotsCodes
    },
    tdd128
      pdsch-TimeslotsCodes
  }
}

PDSCH-Info-LCR-r4 ::=
  tfcs-ID
  commonTimeslotInfo
  pdsch-TimeslotsCodes
}

PDSCH-PowerControlInfo ::=
  tpc-StepSizeTDD
  ul-CCTrChTPCList
}

PDSCH-SHO-DCH-Info ::=
  dsch-RadioLinkIdentifier
  rl-IdentifierList
}

PDSCH-SysInfo ::=
  pdsch-Identity
  pdsch-Info
  dsch-TFS
  dsch-TFCS
}

PDSCH-SysInfo-VHCR-r7 ::=
  pdsch-Identity
  pdsch-Info
  dsch-TransportChannelsInfo
  dsch-TFCS
}

PDSCH-SysInfo-HCR-r5 ::=
  pdsch-Identity
  pdsch-Info
  dsch-TransportChannelsInfo
  dsch-TFCS
}

PDSCH-SysInfo-LCR-r4 ::=
  pdsch-Identity
  pdsch-Info
  dsch-TFS
  dsch-TFCS
}

PDSCH-SysInfoList ::=
  SEQUENCE (SIZE (1..maxPDSCH)) OF
    PDSCH-SysInfo

PDSCH-SysInfoList-VHCR-r7 ::=
  SEQUENCE (SIZE (1..maxPDSCH)) OF PDSCH-SysInfo-VHCR-r7

PDSCH-SysInfoList-HCR-r5 ::=
  SEQUENCE (SIZE (1..maxPDSCH)) OF PDSCH-SysInfo-HCR-r5

PDSCH-SysInfoList-LCR-r4 ::=
  SEQUENCE (SIZE (1..maxPDSCH)) OF
    PDSCH-SysInfo-LCR-r4

```

```

PDSCH-SysInfoList-SFN ::= SEQUENCE (SIZE (1..maxPDSCH)) OF
    SEQUENCE {
        pdsch-SysInfo PDSCH-SysInfo,
        sfn-TimeInfo SFN-TimeInfo OPTIONAL
    }

PDSCH-SysInfoList-SFN-HCR-r5 ::= SEQUENCE (SIZE (1..maxPDSCH)) OF
    SEQUENCE {
        pdsch-SysInfo PDSCH-SysInfo-HCR-r5,
        sfn-TimeInfo SFN-TimeInfo OPTIONAL
    }

PDSCH-SysInfoList-SFN-LCR-r4 ::= SEQUENCE (SIZE (1..maxPDSCH)) OF
    SEQUENCE {
        pdsch-SysInfo PDSCH-SysInfo-LCR-r4,
        sfn-TimeInfo SFN-TimeInfo OPTIONAL
    }

PersistenceScalingFactor ::= ENUMERATED {
    psf0-9, psf0-8, psf0-7, psf0-6,
    psf0-5, psf0-4, psf0-3, psf0-2 }

PersistenceScalingFactorList ::= SEQUENCE (SIZE (1..maxASCpersist)) OF
    PersistenceScalingFactor

PI-CountPerFrame ::= ENUMERATED {
    e18, e36, e72, e144 }

PichChannelisationCodeList-LCR-r4 ::= SEQUENCE (SIZE (1..2)) OF
    DL-TS-ChannelisationCode

PICH-ForHSDPASupportedPaging ::= SEQUENCE {
    hsdpa-AssociatedPichInfo PICH-Info,
    hs-pdschChannelisationCode INTEGER(1..15)
}

PICH-ForHSDPASupportedPaging-TDD128 ::= CHOICE {
    implicit SEQUENCE {
        occurrenceSequenceNumberOfPICH OccurrenceSequenceNumberOfPICH OPTIONAL
    },
    explicit PICH-Info-LCR-r4
}

PICH-Info ::= CHOICE {
    fdd SEQUENCE {
        channelisationCode256 ChannelisationCode256,
        pi-CountPerFrame PI-CountPerFrame,
        sttd-Indicator BOOLEAN
    },
    tdd SEQUENCE {
        channelisationCode TDD-PICH-CCode OPTIONAL,
        timeslot TimeslotNumber OPTIONAL,
        midambleShiftAndBurstType MidambleShiftAndBurstType,
        repetitionPeriodLengthOffset RepPerLengthOffset-PICH OPTIONAL,
        pagingIndicatorLength PagingIndicatorLength DEFAULT pi4,
        n-GAP N-GAP DEFAULT f4,
        n-PCH N-PCH DEFAULT 2
    }
}

PICH-Info-HCR-VHCR-r7 ::= SEQUENCE {
    channelisationCode CHOICE {
        tdd384 TDD-PICH-CCode,
        tdd768 TDD768-PICH-CCode
    } OPTIONAL,
    timeslot TimeslotNumber OPTIONAL,
    midambleShiftAndBurstType MidambleShiftAndBurstType,
    repetitionPeriodLengthOffset RepPerLengthOffset-PICH OPTIONAL,
    pagingIndicatorLength PagingIndicatorLength DEFAULT pi4,
    n-GAP N-GAP DEFAULT f4,
    n-PCH N-PCH DEFAULT 2
}

PICH-Info-LCR-r4 ::= SEQUENCE {
    timeslot TimeslotNumber-LCR-r4 OPTIONAL,
    pichChannelisationCodeList-LCR-r4 PichChannelisationCodeList-LCR-r4,
    midambleShiftAndBurstType MidambleShiftAndBurstType-LCR-r4,

```

```

    repetitionPeriodLengthOffset      RepPerLengthOffset-PICH      OPTIONAL,
    pagingIndicatorLength              PagingIndicatorLength        DEFAULT pi4,
    n-GAP                              N-GAP                       DEFAULT f4,
    n-PCH                              N-PCH                       DEFAULT 2
}

PICH-PowerOffset ::=                INTEGER (-10..5)

PilotBits128 ::=                    ENUMERATED {
    pb4, pb8 }

PilotBits128-r12 ::=                ENUMERATED {
    pb0, pb4, pb8 }

PilotBits256 ::=                    ENUMERATED {
    pb2, pb4, pb8 }

PilotBits256-r12 ::=                ENUMERATED {
    pb0, pb2, pb4, pb8 }

-- Actual measurement power offset value = IE value * 0.5
MeasurementPowerOffset ::=          INTEGER (-12..26)

PLCCH-Info ::=                      SEQUENCE {
    plcchSequenceNumber              INTEGER(1..14),
    timeslotNumber                    TimeslotNumber-LCR-r4,
    channelisationCode                DL-TS-ChannelisationCode,
    tpcCommandTargetRate              TPC-CommandTargetRate
}

PositionFixedOrFlexible ::=          ENUMERATED {
    fixed,
    flexible }

PowerControlAlgorithm ::=            CHOICE {
    algorithm1                        TPC-StepSizeFDD,
    algorithm2                        NULL
}

PowerControlGAP ::=                 INTEGER (0..255)

PowerOffsetPilot-pdpdch ::=          INTEGER (0..24)

PowerOffsetPO-SRB ::=                INTEGER (0..24)

PowerOffsetTPC-pdpdch ::=            INTEGER (0..24)

PowerRampStep ::=                    INTEGER (1..8)

PRACH-ChanCodes-LCR-r4 ::=           SEQUENCE (SIZE (1..4)) OF
    TDD-PRACH-CCode-LCR-r4

PRACH-ChanCodes-List-LCR ::=         SEQUENCE (SIZE (1..2)) OF
    TDD-PRACH-CCode-LCR-r4

PRACH-Definition-LCR-r4 ::=          SEQUENCE {
    timeslot                          TimeslotNumber-PRACH-LCR-r4,
    prach-ChanCodes-LCR                PRACH-ChanCodes-LCR-r4,
    midambleShiftAndBurstType          MidambleShiftAndBurstType-LCR-r4,
    fpach-Info                          FPACH-Info-r4
}

PRACH-Information-LCR ::=             SEQUENCE {
    timeslot                          TimeslotNumber-PRACH-LCR-r4,
    prach-ChanCodes-list-LCR            PRACH-ChanCodes-List-LCR,
    midambleShiftAndBurstType          MidambleShiftAndBurstType-LCR-r4,
    fpach-Info                          FPACH-Info-r4
}
OPTIONAL

PRACH-Information-LCR-List ::=        SEQUENCE (SIZE (1..maxPRACH-FPACH)) OF
    PRACH-Information-LCR

PRACH-Midamble ::=                   ENUMERATED {
    direct,
    direct-Inverted }

PRACH-Partitioning ::=               CHOICE {
    fdd                                SEQUENCE (SIZE (1..maxASC)) OF

```

```

-- TABULAR: If only "NumASC+1" (with, NumASC+1 < maxASC) ASCSetting-FDD are listed,
-- the remaining (NumASC+2 through maxASC) ASCs are unspecified.
        ASCSetting-FDD,
tdd
        SEQUENCE (SIZE (1..maxASC)) OF
-- TABULAR: If only "NumASC+1" (with, NumASC+1 < maxASC) ASCSetting-TDD are listed,
-- the remaining (NumASC+2 through maxASC) ASCs are unspecified.
        ASCSetting-TDD
}

PRACH-Partitioning-r7 ::= CHOICE {
    fdd
        SEQUENCE (SIZE (1..maxASC)) OF
-- TABULAR: If only "NumASC+1" (with, NumASC+1 < maxASC) ASCSetting-FDD are listed,
-- the remaining (NumASC+2 through maxASC) ASCs are unspecified.
        ASCSetting-FDD,
    tdd
        SEQUENCE (SIZE (1..maxASC)) OF
-- TABULAR: If only "NumASC+1" (with, NumASC+1 < maxASC) ASCSetting-TDD are listed,
-- the remaining (NumASC+2 through maxASC) ASCs are unspecified.
        ASCSetting-TDD-r7
}

PRACH-Partitioning-LCR-r4 ::= SEQUENCE (SIZE (1..maxASC)) OF
-- TABULAR: If only "NumASC+1" (with, NumASC+1 < maxASC) ASCSetting-TDD-LCR-r4 are listed,
-- the remaining (NumASC+2 through maxASC) ASCs are unspecified.
        ASCSetting-TDD-LCR-r4

PRACH-PowerOffset ::= SEQUENCE {
    powerRampStep
        PowerRampStep,
    preambleRetransMax
        PreambleRetransMax
}

PRACH-PreambleForEnhancedUplink ::= SEQUENCE {
    availableSignatures
        AvailableSignatures OPTIONAL,
    e-ai-Indication
        BOOLEAN,
    preambleScramblingCodeWordNumber
        PreambleScramblingCodeWordNumber OPTIONAL,
    availableSubChannelNumbers
        AvailableSubChannelNumbers OPTIONAL,
    prach-Partitioning
        PRACH-Partitioning-r7 OPTIONAL,
    persistenceScalingFactorList
        PersistenceScalingFactorList OPTIONAL,
    ac-To-ASC-MappingTable
        AC-To-ASC-MappingTable OPTIONAL,
    primaryCPICH-TX-Power
        PrimaryCPICH-TX-Power OPTIONAL,
    constantValue
        ConstantValue OPTIONAL,
    prach-PowerOffset
        PRACH-PowerOffset OPTIONAL,
    rach-TransmissionParameters
        RACH-TransmissionParameters OPTIONAL,
    aich-Info
        AICH-Info OPTIONAL,
    powerOffsetPp-e
        INTEGER (-5..10)
}

PRACH-PreambleForEnhancedUplinkExt ::= SEQUENCE {
    availableSignatures
        AvailableSignatures,
    preambleScramblingCodeWordNumber
        PreambleScramblingCodeWordNumber,
    aich-Info
        AICH-Info-Compressed OPTIONAL
}

PRACH-PreambleForEnhancedUplinkExtList ::= SEQUENCE (SIZE (1..maxPRACH-EUL)) OF
        PRACH-PreambleForEnhancedUplinkExtWithWeight

PRACH-PreambleForEnhancedUplinkExtWithWeight ::= SEQUENCE {
    prach-PreambleForEnhancedUplinkExt
        PRACH-PreambleForEnhancedUplinkExt,
-- Actual value weight = IE value * 0.2
    weight
        INTEGER (1..5) OPTIONAL
}

PRACH-RACH-Info ::= SEQUENCE {
    modeSpecificInfo
        CHOICE {
            fdd
                SEQUENCE {
                    availableSignatures
                        AvailableSignatures,
                    availableSF
                        SF-PRACH,
                    preambleScramblingCodeWordNumber
                        PreambleScramblingCodeWordNumber,
                    puncturingLimit
                        PuncturingLimit,
                    availableSubChannelNumbers
                        AvailableSubChannelNumbers
                },
            tdd
                SEQUENCE {
                    timeslot
                        TimeslotNumber,
                    channelisationCodeList
                        TDD-PRACH-CCodeList,
                    prach-Midamble
                        PRACH-Midamble
                }
        }
}

```

```

}
}
PRACH-RACH-Info-VHCR-r7 ::= SEQUENCE {
    timeslot                TimeslotNumber,
    channelisationCodeList  TDD768-PRACH-CCodeList,
    prach-Midamble          PRACH-Midamble
}
PRACH-RACH-Info-LCR-v770ext ::= SEQUENCE {
    e-RUCCH-Sync-UL-Codes-Bitmap Sync-UL-Codes-Bitmap
}
PRACH-RACH-Info-LCR-r4 ::= SEQUENCE {
    sync-UL-Info            SYNC-UL-Info-r4,
    prach-DefinitionList    SEQUENCE (SIZE (1..maxPRACH-FPACH)) OF
                            PRACH-Definition-LCR-r4
}
PRACH-SystemInformation ::= SEQUENCE {
    prach-RACH-Info        PRACH-RACH-Info,
    transportChannelIdentity TransportChannelIdentity,
    rach-TransportFormatSet TransportFormatSet OPTIONAL,
    rach-TFCS              TFCS OPTIONAL,
    prach-Partitioning     PRACH-Partitioning OPTIONAL,
    persistenceScalingFactorList PersistenceScalingFactorList OPTIONAL,
    ac-To-ASC-MappingTable AC-To-ASC-MappingTable OPTIONAL,
    modeSpecificInfo       CHOICE {
        fdd                 SEQUENCE {
            primaryCPICH-TX-Power PrimaryCPICH-TX-Power OPTIONAL,
            constantValue         ConstantValue OPTIONAL,
            prach-PowerOffset      PRACH-PowerOffset OPTIONAL,
            rach-TransmissionParameters RACH-TransmissionParameters OPTIONAL,
            aich-Info             AICH-Info OPTIONAL
        },
        tdd                 NULL
    }
}
PRACH-SystemInformation-VHCR-r7 ::= SEQUENCE {
    prach-RACH-Info        PRACH-RACH-Info-VHCR-r7,
    prach-Partitioning     PRACH-Partitioning-r7 OPTIONAL
}
PRACH-SystemInformation-LCR-r4 ::= SEQUENCE {
    prach-RACH-Info-LCR    PRACH-RACH-Info-LCR-r4,
    rach-TransportFormatSet-LCR TransportFormatSet-LCR OPTIONAL,
    prach-Partitioning-LCR PRACH-Partitioning-LCR-r4 OPTIONAL
}
PRACH-SystemInformation-LCR-v770ext ::= SEQUENCE {
    prach-RACH-Info-LCR    PRACH-RACH-Info-LCR-v770ext
}
PRACH-SystemInformationList ::= SEQUENCE (SIZE (1..maxPRACH)) OF
    PRACH-SystemInformation
PRACH-SystemInformationList-VHCR-r7 ::= SEQUENCE (SIZE (1..maxPRACH)) OF
    PRACH-SystemInformation-VHCR-r7
PRACH-SystemInformationList-LCR-r4 ::= SEQUENCE (SIZE (1..maxPRACH)) OF
    PRACH-SystemInformation-LCR-r4
PRACH-SystemInformationList-LCR-v770ext ::= SEQUENCE (SIZE (1..maxPRACH)) OF
    PRACH-SystemInformation-LCR-v770ext
PreambleRetransMax ::= INTEGER (1..64)
PreambleScramblingCodeWordNumber ::= INTEGER (0..15)
PreDefPhyChConfiguration ::= SEQUENCE {
    ul-DPCH-InfoPredef     UL-DPCH-InfoPredef,
    dl-CommonInformationPredef DL-CommonInformationPredef OPTIONAL
}
PreDefPhyChConfiguration-v770ext ::= SEQUENCE {
    ul-DPCH-InfoPredef     UL-DPCH-InfoPredef-v770ext
}

```



```

PrimaryCCPCH-Info ::=
    CHOICE {
        fdd
            tx-DiversityIndicator
            BOOLEAN
        },
        tdd
            -- syncCase should be ignored for 1.28Mcps TDD mode
            syncCase
                CHOICE {
                    syncCase1
                        SEQUENCE {
                            timeslot
                                TimeslotNumber
                        },
                    syncCase2
                        SEQUENCE {
                            timeslotSync2
                                TimeslotSync2
                        }
                }
            cellParametersID
                CellParametersID
            sctd-Indicator
                BOOLEAN
    }
    OPTIONAL,
    OPTIONAL,
}

PrimaryCCPCH-Info-r4 ::=
    CHOICE {
        fdd
            tx-DiversityIndicator
            BOOLEAN
        },
        tdd
            tddOption
                CHOICE {
                    tdd384-tdd768
                        syncCase
                            CHOICE {
                                syncCase1
                                    SEQUENCE {
                                        timeslot
                                            TimeslotNumber
                                    },
                                syncCase2
                                    SEQUENCE {
                                        timeslotSync2
                                            TimeslotSync2
                                    }
                            }
                    tdd128
                        SEQUENCE {
                            tstd-Indicator
                                BOOLEAN
                        }
                }
            cellParametersID
                CellParametersID
            sctd-Indicator
                BOOLEAN
    }
    OPTIONAL,
    OPTIONAL,
}

PrimaryCCPCH-Info-LCR-r4 ::=
    SEQUENCE {
        tstd-Indicator
            BOOLEAN,
        cellParametersID
            CellParametersID
        sctd-Indicator
            BOOLEAN
    }
    OPTIONAL,
}

-- For 1.28Mcps TDD, the following IE includes elements for the PCCPCH Info additional to those
-- in PrimaryCCPCH-Info
PrimaryCCPCH-Info-LCR-r4-ext ::=
    SEQUENCE {
        tstd-Indicator
            BOOLEAN
    }
}

PrimaryCCPCH-InfoPost ::=
    SEQUENCE {
        syncCase
            CHOICE {
                syncCase1
                    SEQUENCE {
                        timeslot
                            TimeslotNumber
                    },
                syncCase2
                    SEQUENCE {
                        timeslotSync2
                            TimeslotSync2
                    }
            }
        cellParametersID
            CellParametersID,
        sctd-Indicator
            BOOLEAN
    }
}

PrimaryCCPCH-InfoPostTDD-LCR-r4 ::= SEQUENCE {
    tstd-Indicator
        BOOLEAN,
    cellParametersID
        CellParametersID,
    sctd-Indicator
        BOOLEAN
}
}

PrimaryCCPCH-TX-Power ::=
    INTEGER (6..43)

```

```

PrimaryCPICH-Info ::= SEQUENCE {
    primaryScramblingCode PrimaryScramblingCode
}

PrimaryCPICH-TX-Power ::= INTEGER (-10..50)

PrimaryScramblingCode ::= INTEGER (0..511)

PuncturingLimit ::= ENUMERATED {
    p10-40, p10-44, p10-48, p10-52, p10-56,
    p10-60, p10-64, p10-68, p10-72, p10-76,
    p10-80, p10-84, p10-88, p10-92, p10-96, p11 }

PUSCH-CapacityAllocationInfo ::= SEQUENCE {
    pusch-Allocation CHOICE {
        pusch-AllocationPending NULL,
        pusch-AllocationAssignment SEQUENCE {
            pusch-AllocationPeriodInfo AllocationPeriodInfo,
            pusch-PowerControlInfo UL-TargetSIR OPTIONAL,
            configuration CHOICE {
                old-Configuration SEQUENCE {
                    tfcs-ID TFCS-IdentityPlain DEFAULT 1,
                    pusch-Identity PUSCH-Identity
                },
                new-Configuration SEQUENCE {
                    pusch-Info PUSCH-Info,
                    pusch-Identity PUSCH-Identity OPTIONAL
                }
            }
        }
    }
}

PUSCH-CapacityAllocationInfo-r4 ::= SEQUENCE {
    pusch-Allocation CHOICE {
        pusch-AllocationPending NULL,
        pusch-AllocationAssignment SEQUENCE {
            pusch-AllocationPeriodInfo AllocationPeriodInfo,
            pusch-PowerControlInfo PUSCH-PowerControlInfo-r4 OPTIONAL,
            configuration CHOICE {
                old-Configuration SEQUENCE {
                    tfcs-ID TFCS-IdentityPlain DEFAULT 1,
                    pusch-Identity PUSCH-Identity
                },
                new-Configuration SEQUENCE {
                    pusch-Info PUSCH-Info-r4,
                    pusch-Identity PUSCH-Identity OPTIONAL
                }
            }
        }
    }
}

PUSCH-CapacityAllocationInfo-r7 ::= SEQUENCE {
    pusch-Allocation CHOICE {
        pusch-AllocationPending NULL,
        pusch-AllocationAssignment SEQUENCE {
            pusch-AllocationPeriodInfo AllocationPeriodInfo,
            pusch-PowerControlInfo PUSCH-PowerControlInfo-r7 OPTIONAL,
            configuration CHOICE {
                old-Configuration SEQUENCE {
                    tfcs-ID TFCS-IdentityPlain DEFAULT 1,
                    pusch-Identity PUSCH-Identity
                },
                new-Configuration SEQUENCE {
                    pusch-Info PUSCH-Info-VHCR,
                    pusch-Identity PUSCH-Identity OPTIONAL
                }
            }
        }
    }
}

PUSCH-Identity ::= INTEGER (1..hiPUSCHidentities)

PUSCH-Info ::= SEQUENCE {
    tfcs-ID TFCS-IdentityPlain DEFAULT 1,
    commonTimeslotInfo CommonTimeslotInfo OPTIONAL,
}

```

```

    pusch-TimeslotsCodes          UplinkTimeslotsCodes          OPTIONAL
  }

PUSCH-Info-r4 ::=                SEQUENCE {
  tfcs-ID                        TFCS-IdentityPlain          DEFAULT 1,
  commonTimeslotInfo             CommonTimeslotInfo        OPTIONAL,
  tddOption                      CHOICE {
    tdd384                       SEQUENCE {
      pusch-TimeslotsCodes        UplinkTimeslotsCodes    OPTIONAL
    },
    tdd128                       SEQUENCE {
      pusch-TimeslotsCodes        UplinkTimeslotsCodes-LCR-r4  OPTIONAL
    }
  }
}

PUSCH-Info-VHCR ::=             SEQUENCE {
  tfcs-ID                        TFCS-IdentityPlain          DEFAULT 1,
  commonTimeslotInfo             CommonTimeslotInfo        OPTIONAL,
  pusch-TimeslotsCodes-VHCR      UplinkTimeslotsCodes-VHCR  OPTIONAL
}

PUSCH-Info-LCR-r4 ::=           SEQUENCE {
  tfcs-ID                        TFCS-IdentityPlain          DEFAULT 1,

  commonTimeslotInfo             CommonTimeslotInfo        OPTIONAL,
  pusch-TimeslotsCodes           UplinkTimeslotsCodes-LCR-r4  OPTIONAL
}

PUSCH-PowerControlInfo-r4 ::=   SEQUENCE {
  -- The IE ul-TargetSIR corresponds to PRX-PUSCHdes for 1.28Mcps TDD
  -- Actual value PRX-PUSCHdes = (value of IE "ul-TargetSIR" - 120)
  ul-TargetSIR                   UL-TargetSIR,
  tddOption                      CHOICE {
    tdd384                       NULL,
    tdd128                       SEQUENCE {
      tpc-StepSize                TPC-StepSizeTDD          OPTIONAL
    }
  }
}

PUSCH-PowerControlInfo-r7 ::=   SEQUENCE {
  -- The IE ul-TargetSIR corresponds to PRX-PUSCHdes for 1.28Mcps TDD
  -- Actual value PRX-PUSCHdes = (value of IE "ul-TargetSIR" - 120)
  ul-TargetSIR                   UL-TargetSIR,
  tddOption                      CHOICE {
    tdd384                       NULL,
    tdd768                       NULL,
    tdd128                       SEQUENCE {
      tpc-StepSize                TPC-StepSizeTDD          OPTIONAL
    }
  }
}

PUSCH-SysInfo ::=               SEQUENCE {
  pusch-Identity                 PUSCH-Identity,
  pusch-Info                     PUSCH-Info,
  usch-TFS                       TransportFormatSet        OPTIONAL,
  usch-TFCS                      TFCS                      OPTIONAL
}

PUSCH-SysInfo-VHCR ::=          SEQUENCE {
  pusch-Identity                 PUSCH-Identity,
  pusch-Info-VHCR                PUSCH-Info-VHCR,
  usch-TransportChannelsInfo      USCH-TransportChannelsInfo  OPTIONAL,
  usch-TFCS                      TFCS                      OPTIONAL
}

PUSCH-SysInfo-HCR-r5 ::=        SEQUENCE {
  pusch-Identity                 PUSCH-Identity,
  pusch-Info                     PUSCH-Info,
  usch-TransportChannelsInfo      USCH-TransportChannelsInfo  OPTIONAL,
  usch-TFCS                      TFCS                      OPTIONAL
}

PUSCH-SysInfo-LCR-r4 ::=        SEQUENCE {
  pusch-Identity                 PUSCH-Identity,
  pusch-Info                     PUSCH-Info-LCR-r4,

```

```

    usch-TFS                TransportFormatSet                OPTIONAL,
    usch-TFCS                TFCS                            OPTIONAL
}

PUSCH-SysInfoList ::= SEQUENCE (SIZE (1..maxPUSCH)) OF
    PUSCH-SysInfo

PUSCH-SysInfoList-HCR-r5 ::= SEQUENCE (SIZE (1..maxPUSCH)) OF PUSCH-SysInfo-HCR-r5

PUSCH-SysInfoList-LCR-r4 ::= SEQUENCE (SIZE (1..maxPUSCH)) OF
    PUSCH-SysInfo-LCR-r4

PUSCH-SysInfoList-SFN ::= SEQUENCE (SIZE (1..maxPUSCH)) OF
    SEQUENCE {
        pusch-SysInfo                PUSCH-SysInfo,
        sfm-TimeInfo                  SFN-TimeInfo                OPTIONAL
    }

PUSCH-SysInfoList-SFN-HCR-r5 ::= SEQUENCE (SIZE (1..maxPUSCH)) OF
    SEQUENCE {
        pusch-SysInfo                PUSCH-SysInfo-HCR-r5,
        sfm-TimeInfo                  SFN-TimeInfo                OPTIONAL
    }

PUSCH-SysInfoList-SFN-LCR-r4 ::= SEQUENCE (SIZE (1..maxPUSCH)) OF
    SEQUENCE {
        pusch-SysInfo                PUSCH-SysInfo-LCR-r4,
        sfm-TimeInfo                  SFN-TimeInfo                OPTIONAL
    }

PUSCH-SysInfoList-SFN-VHCR ::= SEQUENCE (SIZE (1..maxPUSCH)) OF
    SEQUENCE {
        pusch-SysInfo-VHCR           PUSCH-SysInfo-VHCR,
        sfm-TimeInfo                  SFN-TimeInfo                OPTIONAL
    }

RACH-TransmissionParameters ::= SEQUENCE {
    mmax                INTEGER (1..32),
    nb01Min             NB01,
    nb01Max             NB01
}

RadioLinkswithoutDPCHFDPCInfo ::= SEQUENCE {
    frameOffset        DPCH-FrameOffset
}

ReducedScramblingCodeNumber ::= INTEGER (0..8191)

Reference-Beta-QPSK ::= SEQUENCE {
    reference-Code-Rate    INTEGER (0..10),
    reference-Beta         INTEGER (-15..16)
}

Reference-Beta-16QAM ::= SEQUENCE {
    reference-Code-Rate    INTEGER (0..10),
    reference-Beta         INTEGER (-15..16)
}

RepetitionPeriodAndLength ::= CHOICE {
    repetitionPeriod1        NULL,
    -- repetitionPeriod2 could just as well be NULL also.
    repetitionPeriod2        INTEGER (1..1),
    repetitionPeriod4        INTEGER (1..3),
    repetitionPeriod8        INTEGER (1..7),
    repetitionPeriod16       INTEGER (1..15),
    repetitionPeriod32       INTEGER (1..31),
    repetitionPeriod64       INTEGER (1..63)
}

RepetitionPeriodLengthAndOffset ::= CHOICE {
    repetitionPeriod1        NULL,
    repetitionPeriod2        SEQUENCE {
        length                NULL,
        offset                INTEGER (0..1)
    },
    repetitionPeriod4        SEQUENCE {
        length                INTEGER (1..3),
        offset                INTEGER (0..3)
    }
}

```

```

    },
    repetitionPeriod8          SEQUENCE {
        length                 INTEGER (1..7),
        offset                  INTEGER (0..7)
    },
    repetitionPeriod16         SEQUENCE {
        length                 INTEGER (1..15),
        offset                  INTEGER (0..15)
    },
    repetitionPeriod32         SEQUENCE {
        length                 INTEGER (1..31),
        offset                  INTEGER (0..31)
    },
    repetitionPeriod64         SEQUENCE {
        length                 INTEGER (1..63),
        offset                  INTEGER (0..63)
    }
}

RepetitionPeriodAndLengthForSPS ::= CHOICE {
    repetitionPeriod1          NULL,
    -- repetitionPeriod2 could just as well be NULL also.
    repetitionPeriod2          INTEGER (1..1),
    repetitionPeriod4          INTEGER (1..3),
    repetitionPeriod8          INTEGER (1..7),
    repetitionPeriod16         INTEGER (1..15),
    repetitionPeriod32         INTEGER (1..31)
}

ReplacedPDSCH-CodeInfo ::= SEQUENCE {
    tfci-Field2                MaxTFCI-Field2Value,
    spreadingFactor            SF-PDSCH,
    codeNumber                  CodeNumberDSCH,
    multiCodeInfo              MultiCodeInfo
}

ReplacedPDSCH-CodeInfoList ::= SEQUENCE (SIZE (1..maxTFCI-2-Combs)) OF
    ReplacedPDSCH-CodeInfo

RepPerLengthOffset-PICH ::= CHOICE {
    rpp4-2                     INTEGER (0..3),
    rpp8-2                     INTEGER (0..7),
    rpp8-4                     INTEGER (0..7),
    rpp16-2                    INTEGER (0..15),
    rpp16-4                    INTEGER (0..15),
    rpp32-2                    INTEGER (0..31),
    rpp32-4                    INTEGER (0..31),
    rpp64-2                    INTEGER (0..63),
    rpp64-4                    INTEGER (0..63)
}

RepPerLengthOffset-MICH ::= CHOICE {
    rpp4-2                     INTEGER (0..3),
    rpp8-2                     INTEGER (0..7),
    rpp8-4                     INTEGER (0..7),
    rpp16-2                    INTEGER (0..15),
    rpp16-4                    INTEGER (0..15),
    rpp32-2                    INTEGER (0..31),
    rpp32-4                    INTEGER (0..31),
    rpp64-2                    INTEGER (0..63),
    rpp64-4                    INTEGER (0..63)
}

RestrictedTrCH ::= SEQUENCE {
    dl-restrictedTrCh-Type     DL-TrCH-Type,
    restrictedDL-TrCH-Identity TransportChannelIdentity,
    allowedTFIList             AllowedTFI-List
}

RestrictedTrCH-InfoList ::= SEQUENCE (SIZE(1..maxTrCH)) OF
    RestrictedTrCH

RL-AdditionInformation ::= SEQUENCE {
    primaryCPICH-Info          PrimaryCPICH-Info,
    dl-DPCH-InfoPerRL          DL-DPCH-InfoPerRL,
    -- dummy and dummy2 are not used in this version of specification
    -- and the IEs should be ignored.
    dummy                       BOOLEAN,

```

dummy2	SCCPCH-InfoForFACH	OPTIONAL
}		
RL-AdditionInformation-r6 ::=	SEQUENCE {	
primaryCPICH-Info	PrimaryCPICH-Info,	
cell-Id	CellIdentity	OPTIONAL,
dl-dpchInfo	CHOICE {	
dl-DPCH-InfoPerRL	DL-DPCH-InfoPerRL-r5,	
dl-FDPCH-InfoPerRL	DL-FDPCH-InfoPerRL-r6	
},		
e-HICH-Information	E-HICH-Information	OPTIONAL,
e-RGCH-Information	E-RGCH-Information	OPTIONAL
}		
RL-AdditionInformation-r7 ::=	SEQUENCE {	
primaryCPICH-Info	PrimaryCPICH-Info,	
cell-Id	CellIdentity	OPTIONAL,
dl-dpchInfo	CHOICE {	
dl-DPCH-InfoPerRL	DL-DPCH-InfoPerRL-r5,	
dl-FDPCH-InfoPerRL	DL-FDPCH-InfoPerRL-r7	
},		
e-HICH-Information	E-HICH-Information	OPTIONAL,
e-RGCH-Information	E-RGCH-Information	OPTIONAL
}		
RL-AdditionInformation-r8 ::=	SEQUENCE {	
primaryCPICH-Info	PrimaryCPICH-Info,	
cell-Id	CellIdentity	OPTIONAL,
dl-dpchInfo	CHOICE {	
dl-DPCH-InfoPerRL	DL-DPCH-InfoPerRL-r5,	
dl-FDPCH-InfoPerRL	DL-FDPCH-InfoPerRL-r7	
},		
e-HICH-Information	E-HICH-Information	OPTIONAL,
e-RGCH-Information	E-RGCH-Information	OPTIONAL,
targetCellPreconfigInfo	TargetCellPreconfigInfo	OPTIONAL
}		
RL-AdditionInformation-r9 ::=	SEQUENCE {	
primaryCPICH-Info	PrimaryCPICH-Info,	
cell-Id	CellIdentity	OPTIONAL,
dl-dpchInfo	CHOICE {	
dl-DPCH-InfoPerRL	DL-DPCH-InfoPerRL-r5,	
dl-FDPCH-InfoPerRL	DL-FDPCH-InfoPerRL-r7	
},		
e-HICH-Information	E-HICH-Information	OPTIONAL,
e-RGCH-Information	E-RGCH-Information	OPTIONAL,
targetCellPreconfigInfo	TargetCellPreconfigInfo-r9	OPTIONAL
}		
RL-AdditionInformation-r10 ::=	SEQUENCE {	
primaryCPICH-Info	PrimaryCPICH-Info,	
cell-Id	CellIdentity	OPTIONAL,
dl-dpchInfo	CHOICE {	
dl-DPCH-InfoPerRL	DL-DPCH-InfoPerRL-r5,	
dl-FDPCH-InfoPerRL	DL-FDPCH-InfoPerRL-r7	
},		
e-HICH-Information	E-HICH-Information	OPTIONAL,
e-RGCH-Information	E-RGCH-Information	OPTIONAL,
targetCellPreconfigInfo	TargetCellPreconfigInfo-r10	OPTIONAL
}		
RL-AdditionInformation-vb50ext ::=	SEQUENCE {	
targetCellPreconfigInfo	TargetCellPreconfigInfo-vb50ext	OPTIONAL
}		
RL-AdditionInformation-r11 ::=	SEQUENCE {	
primaryCPICH-Info	PrimaryCPICH-Info,	
cell-Id	CellIdentity	OPTIONAL,
dl-dpchInfo	CHOICE {	
dl-DPCH-InfoPerRL	DL-DPCH-InfoPerRL-r5,	
dl-FDPCH-InfoPerRL	DL-FDPCH-InfoPerRL-r7	
},		
e-HICH-Information	E-HICH-Information-r11	OPTIONAL,
e-RGCH-Information	E-RGCH-Information	OPTIONAL,
f-TPICH-Information	F-TPICH-Information	OPTIONAL,
targetCellPreconfigInfo	TargetCellPreconfigInfo-r11	OPTIONAL
}		

```

RL-AdditionInformation-r12 ::= SEQUENCE {
    primaryCPICH-Info      PrimaryCPICH-Info,
    cell-Id                CellIdentity                               OPTIONAL,
    dl-dpchInfo            CHOICE {
        dl-DPCH-InfoPerRL  DL-DPCH-InfoPerRL-ASU,
        dl-FDPCH-InfoPerRL DL-FDPCH-InfoPerRL-r7,
        radioLinkswithoutDPCHFDPCHInfo RadioLinkswithoutDPCHFDPCHInfo
    },
    e-HICH-Information     E-HICH-Information-r11          OPTIONAL,
    e-RGCH-Information     E-RGCH-Information              OPTIONAL,
    f-TPICH-Information    F-TPICH-Information            OPTIONAL,
    targetCellPreconfigInfo TargetCellPreconfigInfo-r12  OPTIONAL
}

RL-AdditionInformation-v6b0ext ::= SEQUENCE {
    sttdIndication        STTDIndication                               OPTIONAL
}

RL-AdditionInformation-v890ext ::= SEQUENCE {
    targetCellPreconfigInfo TargetCellPreconfigInfo-v890ext  OPTIONAL
}

RL-AdditionInformation-v950ext ::= SEQUENCE {
    targetCellPreconfigInfo TargetCellPreconfigInfo-v950ext  OPTIONAL
}

RL-AdditionInformationList ::= SEQUENCE (SIZE (1..maxRL-1)) OF
    RL-AdditionInformation

RL-AdditionInformationList-r6 ::= SEQUENCE (SIZE (1..maxRL-1)) OF
    RL-AdditionInformation-r6

RL-AdditionInformationList-r7 ::= SEQUENCE (SIZE (1..maxRL-1)) OF
    RL-AdditionInformation-r7

RL-AdditionInformation-list-v6b0ext ::= SEQUENCE (SIZE (1..maxRL)) OF
    RL-AdditionInformation-v6b0ext

RL-AdditionInformationList-r8 ::= SEQUENCE (SIZE(1..maxRL-1)) OF
    RL-AdditionInformation-r8

RL-AdditionInformationList-v890ext ::= SEQUENCE (SIZE (1..maxRL-1)) OF
    RL-AdditionInformation-v890ext

RL-AdditionInformationList-r9 ::= SEQUENCE (SIZE(1..maxRL-1)) OF
    RL-AdditionInformation-r9

RL-AdditionInformationList-v950ext ::= SEQUENCE (SIZE(1..maxRL-1)) OF
    RL-AdditionInformation-v950ext

RL-AdditionInformationList-r10 ::= SEQUENCE (SIZE(1..maxRL-1)) OF
    RL-AdditionInformation-r10

RL-AdditionInformationList-vb50ext ::= SEQUENCE (SIZE(1..maxRL-1)) OF
    RL-AdditionInformation-vb50ext

RL-AdditionInformationList-r11 ::= SEQUENCE (SIZE(1..maxRL-1)) OF
    RL-AdditionInformation-r11

RL-AdditionInformationList-r12 ::= SEQUENCE (SIZE(1..maxRL-1)) OF
    RL-AdditionInformation-r12

RL-AdditionInformationList-SecULFreq ::= SEQUENCE (SIZE(1..maxEDCHRL-1)) OF
    RL-AdditionInformation-SecULFreq

RL-AdditionInformationList-SecULFreq-r12 ::= SEQUENCE (SIZE(1..maxEDCHRL-1)) OF
    RL-AdditionInformation-SecULFreq-r12

RL-AdditionInformation-SecULFreq ::= SEQUENCE {
    primaryCPICH-Info      PrimaryCPICH-Info,
    cell-id                CellIdentity                               OPTIONAL,
    dl-FDPCH-InfoPerRL    DL-FDPCH-InfoPerRL-r7,
    e-HICH-Information     E-HICH-Information,
    e-RGCH-Information     E-RGCH-Information              OPTIONAL
}

RL-AdditionInformation-SecULFreq-r12 ::= SEQUENCE {
    primaryCPICH-Info      PrimaryCPICH-Info,

```

```

cell-id                CellIdentity                OPTIONAL,
dl-FDPCH-InfoPerRL    DL-FDPCH-InfoPerRL-r7,
e-HICH-Information    E-HICH-Information,
e-RGCH-Information    E-RGCH-Information                OPTIONAL,
radioLinkswithoutDPCHFDPCHIndicator    NULL                                OPTIONAL
}

RL-IdentififierList ::= SEQUENCE (SIZE (1..maxRL)) OF
                        PrimaryCPICH-Info

RL-RemovalInformationList ::= SEQUENCE (SIZE (1..maxRL)) OF
                              PrimaryCPICH-Info

RL-RemovalInformationList-SecULFreq ::= SEQUENCE (SIZE(1..maxEDCHRL)) OF
                                        PrimaryCPICH-Info

RPP ::= ENUMERATED {
         mode0, model }

S-Field ::= ENUMERATED {
             e1bit, e2bits }

SCCPCH-ChannelisationCode ::= ENUMERATED {
                                cc16-1, cc16-2, cc16-3, cc16-4,
                                cc16-5, cc16-6, cc16-7, cc16-8,
                                cc16-9, cc16-10, cc16-11, cc16-12,
                                cc16-13, cc16-14, cc16-15, cc16-16 }

SCCPCH-ChannelisationCode-VHCR ::= ENUMERATED {
                                     cc32-1, cc32-2, cc32-3, cc32-4,
                                     cc32-5, cc32-6, cc32-7, cc32-8,
                                     cc32-9, cc32-10, cc32-11, cc32-12,
                                     cc32-13, cc32-14, cc32-15, cc32-16,
                                     cc32-17, cc32-18, cc32-19, cc32-20,
                                     cc32-21, cc32-22, cc32-23, cc32-24,
                                     cc32-25, cc32-26, cc32-27, cc32-28,
                                     cc32-29, cc32-30, cc32-31, cc32-32 }

SCCPCH-ChannelisationCodeList ::= SEQUENCE (SIZE (1..16)) OF
                                   SCCPCH-ChannelisationCode

SCCPCH-ChannelisationCodeList-VHCR ::= SEQUENCE (SIZE (1..32)) OF
                                        SCCPCH-ChannelisationCode-VHCR

SCCPCH-InfoForFACH ::= SEQUENCE {
  secondaryCCPCH-Info    SecondaryCCPCH-Info,
  tfcs                  TFCS,
  modeSpecificInfo      CHOICE {
    fdd                 SEQUENCE {
      fach-PCH-InformationList    FACH-PCH-InformationList,
      sib-ReferenceListFACH      SIB-ReferenceListFACH
    },
    tdd                 SEQUENCE {
      fach-PCH-InformationList    FACH-PCH-InformationList
    }
  }
}

SCCPCH-InfoForFACH-r4 ::= SEQUENCE {
  secondaryCCPCH-Info    SecondaryCCPCH-Info-r4,
  tfcs                  TFCS,
  fach-PCH-InformationList    FACH-PCH-InformationList,
  modeSpecificInfo      CHOICE {
    fdd                 SEQUENCE {
      sib-ReferenceListFACH      SIB-ReferenceListFACH
    },
    tdd                 NULL
  }
}

SCCPCH-SystemInformation ::= SEQUENCE {
  secondaryCCPCH-Info    SecondaryCCPCH-Info,
  tfcs                  TFCS                                OPTIONAL,
  fach-PCH-InformationList    FACH-PCH-InformationList    OPTIONAL,
  pich-Info             PICH-Info                            OPTIONAL
}

SCCPCH-SystemInformation-LCR-r4-ext ::= SEQUENCE {

```



```

secondaryCCPCH-LCR-Extensions SecondaryCCPCH-Info-LCR-r4-ext,
-- pich-Info in the SCCPCH-SystemInformation IE shall be absent,
-- and instead the following used.
pich-Info PICH-Info-LCR-r4 OPTIONAL
}

SCCPCH-SystemInformation-HCR-VHCR-r7 ::= SEQUENCE {
    secondaryCCPCH-Info SecondaryCCPCH-Info-HCR-VHCR-r7,
    tfcs TFCS OPTIONAL,
    fach-PCH-InformationList FACH-PCH-InformationList OPTIONAL,
    pich-Info PICH-Info-HCR-VHCR-r7 OPTIONAL
}

SCCPCH-SystemInformationList ::= SEQUENCE (SIZE (1..maxSCCPCH)) OF
    SCCPCH-SystemInformation

SCCPCH-SystemInformationList-HCR-VHCR-r7 ::= SEQUENCE (SIZE (1..maxSCCPCH)) OF
    SCCPCH-SystemInformation-HCR-VHCR-r7

-- SCCPCH-SystemInformationList-LCR-r4-ext includes elements additional to those in
-- SCCPCH-SystemInformationList for the 1.28Mcps TDD. The order of the IEs
-- indicates which SCCPCH-SystemInformation-LCR-r4-ext IE extends which
-- SCCPCH-SystemInformation IE.
SCCPCH-SystemInformationList-LCR-r4-ext ::= SEQUENCE (SIZE (1..maxSCCPCH)) OF
    SCCPCH-SystemInformation-LCR-r4-ext

-- The SCCPCH-SystemInformation-MBMS-r6 is used for an S-CCPCH dedicated for MBMS purposes.
SCCPCH-SystemInformation-MBMS-r6 ::= SEQUENCE {
    secondaryCCPCHInfo-MBMS SecondaryCCPCHInfo-MBMS-r6,
    transportFormatCombinationSet TFCS,
    fachCarryingMCCH SEQUENCE {
        mcch-transportFormatSet TransportFormatSet,
        mcch-ConfigurationInfo MBMS-MCCH-ConfigurationInfo-r6
    },
    fachCarryingMTCH-List MBMS-FACHCarryingMTCH-List OPTIONAL,
    -- If schedulingInformation is provided
    fachCarryingMSCH SEQUENCE {
        msch-transportFormatSet TransportFormatSet,
        -- dummy is not used in this version of the specification, it should
        -- not be sent and if received it should be ignored.
        dummy MBMS-MSCH-ConfigurationInfo-r6
    }
    OPTIONAL
}

-- The SCCPCH-SystemInformation-MBMS-r7 is used for an S-CCPCH dedicated for MBMS purposes.
SCCPCH-SystemInformation-MBMS-r7 ::= SEQUENCE {
    secondaryCCPCHInfo-MBMS SecondaryCCPCHInfo-MBMS-r7,
    transportFormatCombinationSet TFCS,
    fachCarryingMCCH SEQUENCE {
        mcch-transportFormatSet TransportFormatSet,
        mcch-ConfigurationInfo MBMS-MCCH-ConfigurationInfo-r6
    },
    fachCarryingMTCH-List MBMS-FACHCarryingMTCH-List OPTIONAL,
    -- If schedulingInformation is provided
    fachCarryingMSCH SEQUENCE {
        msch-transportFormatSet TransportFormatSet
    }
    OPTIONAL
}

S-CPICH-PowerOffset-MIMO ::= INTEGER (-6..0)

S-CPICH-PowerOffset-4x4MIMO ::= INTEGER (-12..0)

ScheduledTransmissionConfiguration ::= SEQUENCE {
    common-E-DCH-ResourceInfoListExt SEQUENCE (SIZE (1..maxEDCHs)) OF
        Common-E-DCH-ResourceInfoListExt
}

ScramblingCodeChange ::= ENUMERATED {
    codeChange, noCodeChange }

ScramblingCodeType ::= ENUMERATED {
    shortSC,
    longSC }

SecondaryCCPCH-Info ::= SEQUENCE {
    modeSpecificInfo CHOICE {
        fdd SEQUENCE {

```

```

-- dummy1 is not used in this version of the specification and should be ignored.
dummy1          PCPICH-UsageForChannelEst,
-- dummy2 is not used in this version of the specification. It should not
-- be sent and if received it should be ignored.
dummy2          SecondaryCPICH-Info          OPTIONAL,
secondaryScramblingCode SecondaryScramblingCode OPTIONAL,
sttG-Indicator  BOOLEAN,
sf-AndCodeNumber SF256-AndCodeNumber,
pilotSymbolExistence BOOLEAN,
tfci-Existence  BOOLEAN,
positionFixedOrFlexible PositionFixedOrFlexible,
timingOffset     TimingOffset                DEFAULT 0
},
tdd              SEQUENCE {
-- TABULAR: the offset is included in CommonTimeslotInfoSCCPCH
commonTimeslotInfo CommonTimeslotInfoSCCPCH,
individualTimeslotInfo IndividualTimeslotInfo,
channelisationCode  SCCPCH-ChannelisationCodeList
}
}
}

SecondaryCCPCH-Info-r4 ::= SEQUENCE {
modeSpecificInfo CHOICE {
fdd              SEQUENCE {
secondaryScramblingCode SecondaryScramblingCode OPTIONAL,
sttG-Indicator        BOOLEAN,
sf-AndCodeNumber      SF256-AndCodeNumber,
pilotSymbolExistence BOOLEAN,
tfci-Existence        BOOLEAN,
positionFixedOrFlexible PositionFixedOrFlexible,
timingOffset          TimingOffset                DEFAULT 0
},
tdd              SEQUENCE {
-- TABULAR: the offset is included in CommonTimeslotInfoSCCPCH
commonTimeslotInfo CommonTimeslotInfoSCCPCH,
tddOption          CHOICE {
tdd384            SEQUENCE {
individualTimeslotInfo IndividualTimeslotInfo
},
tdd128            SEQUENCE {
individualTimeslotInfo IndividualTimeslotInfo-LCR-r4
}
},
channelisationCode SCCPCH-ChannelisationCodeList
}
}
}

SecondaryCCPCH-Info-HCR-VHCR-r7 ::= SEQUENCE {
modeSpecificInfo CHOICE {
tdd384          SEQUENCE {
individualTimeslotInfo IndividualTimeslotInfo-r7,
channelisationCode  SCCPCH-ChannelisationCodeList
},
tdd768          SEQUENCE {
individualTimeslotInfo IndividualTimeslotInfo-VHCR,
channelisationCode  SCCPCH-ChannelisationCodeList-VHCR
}
}
}

SecondaryCCPCH-Info-LCR-r4-ext ::= SEQUENCE {
individualTimeslotLCR-Ext IndividualTimeslotInfo-LCR-r4-ext
}

SecondaryCCPCHFrameType2Info ::= SEQUENCE {
subFrameNumber INTEGER (0..4),
dl-ChannelisationCodes DL-ChannelCodes-MBSFN-IMB384,
modulation CHOICE {
modQPSK NULL,
mod16QAM SEQUENCE {
cpich-SecCCPCH-PowerOffset INTEGER (-11..4)
}
}
}

SecondaryCCPCHInfo-MBMS-r6 ::= SEQUENCE {

```

```

modeSpecificInfo CHOICE {
  fdd SEQUENCE {
    secondaryScramblingCode SecondaryScramblingCode OPTIONAL,
    sttd-Indicator BOOLEAN,
    sf-AndCodeNumber SF256-AndCodeNumber,
    timingOffset TimingOffset DEFAULT 0
  },
  tdd384 SEQUENCE {
    commonTimeslotInfoMBMS CommonTimeslotInfoMBMS,
    downlinkTimeslotsCodes DownlinkTimeslotsCodes
  },
  tdd128 SEQUENCE {
    commonTimeslotInfoMBMS CommonTimeslotInfoMBMS,
    downlinkTimeslotsCodes DownlinkTimeslotsCodes-LCR-r4
  }
}
}

SecondaryCCPCHInfo-MBMS-r7 ::= SEQUENCE {
  modeSpecificInfo CHOICE {
    -- The CHOICE fdd is used for both "fdd" and "3.84 Mcps TDD MBSFN IMB"
    fdd SEQUENCE {
      -- The IE secondaryScramblingCode is not applicable for "3.84 Mcps TDD MBSFN IMB"
      secondaryScramblingCode SecondaryScramblingCode OPTIONAL,
      -- The IE sttd-Indicator is not applicable for cells operating in MBSFN mode,
      -- the UE behaviour is unspecified
      sttd-Indicator BOOLEAN,
      sf-AndCodeNumber SF256-AndCodeNumber,
      -- The IE timingOffset is not applicable for "3.84 Mcps TDD MBSFN IMB"
      timingOffset TimingOffset DEFAULT 0,
      modulation CHOICE {
        modQPSK NULL,
        -- The CHOICE mod16QAM is not applicable for MCCH in "3.84 Mcps TDD MBSFN IMB"
        mod16QAM INTEGER (-11..4)
      } OPTIONAL
    },
    tdd384 SEQUENCE {
      commonTimeslotInfoMBMS CommonTimeslotInfoMBMS,
      downlinkTimeslotsCodes DownlinkTimeslotsCodes-r7,
      modulation ENUMERATED { modQPSK, mod16QAM }
    },
    tdd768 SEQUENCE {
      commonTimeslotInfoMBMS CommonTimeslotInfoMBMS,
      downlinkTimeslotsCodes DownlinkTimeslotsCodes-VHCR,
      modulation ENUMERATED { modQPSK, mod16QAM }
    },
    tdd128 SEQUENCE {
      commonTimeslotInfoMBMS CommonTimeslotInfoMBMS,
      downlinkTimeslotsCodes DownlinkTimeslotsCodes-LCR-r4,
      mbsfnSpecialTimeSlot TimeSlotLCR-ext OPTIONAL,
      modulation ENUMERATED { modQPSK, mod16QAM }
    }
  }
}

SecondaryCCPCHInfoDiff-MBMS ::= SEQUENCE {
  secondaryScramblingCode SecondaryScramblingCode OPTIONAL,
  sttd-Indicator BOOLEAN,
  sf-AndCodeNumber SF256-AndCodeNumber OPTIONAL,
  timingOffset TimingOffset OPTIONAL
}

SecondaryCPICH-Info ::= SEQUENCE {
  secondaryDL-ScramblingCode SecondaryScramblingCode OPTIONAL,
  channelisationCode ChannelisationCode256
}

SecondaryScramblingCode ::= INTEGER (1..15)

SecondaryCellMIMOparametersFDD ::= CHOICE {
  continue NULL,
  newConfiguration SEQUENCE {
    mimoN-M-Ratio MIMO-N-M-Ratio OPTIONAL,
    mimoPilotConfiguration MIMO-PilotConfiguration-r9 OPTIONAL
  }
}

SecondaryCellMIMOparametersFDD-v950ext ::= SEQUENCE {

```

```

    precodingWeightSetRestriction      ENUMERATED { true }      OPTIONAL
  }

SecondaryCellMIMOparametersFDD-r10 ::= CHOICE {
  continue                            NULL,
  newConfiguration                    SEQUENCE {
    mimoN-M-Ratio                     MIMO-N-M-Ratio          OPTIONAL,
    mimoPilotConfiguration            MIMO-PilotConfiguration-r9  OPTIONAL,
    precodingWeightSetRestriction     ENUMERATED { true }      OPTIONAL
  }
}

SecondaryCell4x4MIMOparametersFDD ::= SEQUENCE {
  configurationInfo                   CHOICE {
    continue                            NULL,
    newConfiguration                    SEQUENCE {
      mimoN-M-Ratio                     MIMO-N-M-Ratio          OPTIONAL,
      mimoPilotConfiguration            MIMO4x4-PilotConfiguration  OPTIONAL,
      precodingWeightSetRestriction     BIT STRING (SIZE (64))    OPTIONAL
    }
  }
}

SecondInterleavingMode ::= ENUMERATED {
  frameRelated, timeslotRelated }

ServingCellChangeMACreset ::= BOOLEAN

ServingCellChangeMsgType ::= ENUMERATED {
  radioBearerSetup,
  radioBearerReconfiguration,
  transportChannelReconfiguration,
  physicalChannelReconfiguration }

ServingCellChangeParameters ::= SEQUENCE {
  servingCellChangeMACreset          ServingCellChangeMACreset,
  servingCellChangeMsgType           ServingCellChangeMsgType,
  servingCellChangeTrId              ServingCellChangeTrId
}

ServingCellChangeParameters-r12 ::= SEQUENCE {
  servingCellChangeMACreset          ServingCellChangeMACreset,
  servingCellChangeMsgType           ServingCellChangeMsgType,
  servingCellChangeTrId              ServingCellChangeTrId,
  enhancedServingCellChangeforEvent1cSupportIndicator  ENUMERATED { true } OPTIONAL
}

ServingCellChangeTrId ::= INTEGER (0..3)

SF8Codes ::= ENUMERATED {
  cc8-1, cc8-2, cc8-3, cc8-4, cc8-5, cc8-6, cc8-7, cc8-8}

SF16Codes ::= ENUMERATED {
  cc16-1, cc16-2, cc16-3, cc16-4, cc16-5, cc16-6, cc16-7,
  cc16-8}

SF16Codes2 ::= ENUMERATED {
  cc16-1, cc16-2, cc16-3, cc16-4, cc16-5, cc16-6, cc16-7,
  cc16-8, cc16-9, cc16-10, cc16-11, cc16-12, cc16-13, cc16-14,
  cc16-15, cc16-16}

SF32Codes ::= ENUMERATED {
  cc32-1, cc32-2, cc32-3, cc32-4, cc32-5, cc32-6, cc32-7,
  cc32-8, cc32-9, cc32-10, cc32-11, cc32-12, cc32-13, cc32-14,
  cc32-15, cc32-16}

-- SF256-AndCodeNumber encodes both "Spreading factor" and "Code Number"
SF256-AndCodeNumber ::= CHOICE {
  sf4                                INTEGER (0..3),
  sf8                                INTEGER (0..7),
  sf16                               INTEGER (0..15),
  sf32                               INTEGER (0..31),
  sf64                               INTEGER (0..63),
  sf128                              INTEGER (0..127),
  sf256                              INTEGER (0..255)
}

-- SF512-AndCodeNumber encodes both "Spreading factor" and "Code Number"
SF512-AndCodeNumber ::= CHOICE {

```

```

sf4                INTEGER (0..3),
sf8                INTEGER (0..7),
sf16               INTEGER (0..15),
sf32               INTEGER (0..31),
sf64               INTEGER (0..63),
sf128              INTEGER (0..127),
sf256              INTEGER (0..255),
sf512              INTEGER (0..511)
}

-- SF512-AndPilot encodes both "Spreading factor" and "Number of bits for Pilot bits"
SF512-AndPilot ::= CHOICE {
  sfd4              NULL,
  sfd8              NULL,
  sfd16             NULL,
  sfd32             NULL,
  sfd64             NULL,
  sfd128            PilotBits128,
  sfd256            PilotBits256,
  sfd512            NULL
}

SF512-AndPilot-r12 ::= CHOICE {
  sfd4              NULL,
  sfd8              NULL,
  sfd16             NULL,
  sfd32             NULL,
  sfd64             NULL,
  sfd128            PilotBits128-r12,
  sfd256            PilotBits256-r12,
  sfd512            NULL
}

SF-PDSCH ::= ENUMERATED {
  sfp4, sfp8, sfp16, sfp32,
  sfp64, sfp128, sfp256 }

SF-PRACH ::= ENUMERATED {
  sfpr32, sfpr64, sfpr128, sfpr256 }

SFN-TimeInfo ::= SEQUENCE {
  activationTimeSFN INTEGER (0..4095),
  physChDuration    DurationTimeInfo
}

-- actual scheduling value = 2(signalled value +1) and is the periodicity of sending
-- special burst frames
SpecialBurstScheduling ::= INTEGER (0..7)

SpreadingFactor ::= ENUMERATED {
  sf4, sf8, sf16, sf32,
  sf64, sf128, sf256 }

SPS-Information-TDD128-r8 ::= SEQUENCE {
  e-dch-SPS-Info    E-DCH-SPS-Information-TDD128      OPTIONAL,
  hs-dsch-SPS-Info  HS-DSCH-SPS-Information-TDD128    OPTIONAL
}

SRB-delay ::= INTEGER (0..7)

SSDT-CellIdentity ::= ENUMERATED {
  ssdt-id-a, ssdt-id-b, ssdt-id-c,
  ssdt-id-d, ssdt-id-e, ssdt-id-f,
  ssdt-id-g, ssdt-id-h }

SSDT-Information ::= SEQUENCE {
  s-Field           S-Field,
  codeWordSet       CodeWordSet
}

SSDT-Information-r4 ::= SEQUENCE {
  s-Field           S-Field,
  codeWordSet       CodeWordSet,
  ssdt-UL-r4        SSDT-UL                          OPTIONAL
}

SSDT-UL ::= ENUMERATED {
  ul, ul-AndDL }

```

```

StandaloneMidambleInfo-TDD128 ::= SEQUENCE {
    -- Actual value midambleConfiguration = IE value * 2
    midambleConfiguration      INTEGER (1..8),
    midambleShift               INTEGER (0..15),
    timeSlotInformation         BIT STRING (SIZE (5)),
    activationTime              ActivationTime,
    subframeNum                 INTEGER (0..1),
    repetitionPeriod            ENUMERATED {
        v1, v2, v4, v8,
        v16, v32, v64, spare},
    referenceBeta               INTEGER (-15..16) OPTIONAL
}

STTDIndication ::= ENUMERATED { true }

SynchronisationParameters-r4 ::= SEQUENCE {
    sync-UL-CodesBitmap        BIT STRING {
        code7(0),
        code6(1),
        code5(2),
        code4(3),
        code3(4),
        code2(5),
        code1(6),
        code0(7)
    } (SIZE (8)),
    fpach-Info                 FPACH-Info-r4,
    -- Actual value prxUpPCHdes = IE value - 120
    prxUpPCHdes                INTEGER (0..62),
    sync-UL-Procedure          SYNC-UL-Procedure-r4 OPTIONAL
}

Sync-UL-Codes-Bitmap ::= BIT STRING {
    code7(0),
    code6(1),
    code5(2),
    code4(3),
    code3(4),
    code2(5),
    code1(6),
    code0(7)
} (SIZE (8))

SYNC-UL-Procedure-r4 ::= SEQUENCE {
    max-SYNC-UL-Transmissions  ENUMERATED { tr1, tr2, tr4, tr8 },
    powerRampStep              INTEGER (0..3)
}

SYNC-UL-Info-r4 ::= SEQUENCE {
    sync-UL-CodesBitmap        Sync-UL-Codes-Bitmap,
    -- Actual value prxUpPCHdes = IE value - 120
    prxUpPCHdes                INTEGER (0..62),
    powerRampStep              INTEGER (0..3),
    max-SYNC-UL-Transmissions  ENUMERATED { tr1, tr2, tr4, tr8 },
    mmax                       INTEGER(1..32)
}

SYNC-UL-InfoForE-RUCCH ::= SEQUENCE {
    prxUpPCHdes                INTEGER (0..62) OPTIONAL,
    powerRampStep              INTEGER (0..3) OPTIONAL,
    max-SYNC-UL-Transmissions  ENUMERATED { tr1, tr2, tr4, tr8 } OPTIONAL,
    e-RUCCH-Sync-UL-Codes-Bitmap Sync-UL-Codes-Bitmap,
    mmax                       INTEGER(1..32)
}

TargetCellPreconfigInfo ::= SEQUENCE {
    activationTimeOffset        ActivationTimeOffset OPTIONAL,
    new-H-RNTI                  H-RNTI,
    newPrimary-E-RNTI           E-RNTI OPTIONAL,
    newSecondary-E-RNTI         E-RNTI OPTIONAL,
    serving-HSDSCH-CellInformation Serving-HSDSCH-CellInformation-r8,
    e-dch-ReconfigurationInfo   E-DCH-ReconfigurationInfo-r7,
    dtx-drx-TimingInfo          DTX-DRX-TimingInfo-r7 OPTIONAL,
    dtx-drx-Info                DTX-DRX-Info-r7 OPTIONAL,
    hs-scch-LessInfo            HS-SCCH-LessInfo-r7 OPTIONAL,
    mimoParameters              MIMO-Parameters-r8 OPTIONAL,
    dl-SecondaryCellInfoFDD      DL-SecondaryCellInfoFDD OPTIONAL
}

```

```

}

TargetCellPreconfigInfo-v890ext ::=      MIMO-Parameters-v7f0ext

TargetCellPreconfigInfo-r9 ::=          SEQUENCE {
  activationTimeOffset      ActivationTimeOffset      OPTIONAL,
  new-H-RNTI                H-RNTI,
  newPrimary-E-RNTI        E-RNTI          OPTIONAL,
  newSecondary-E-RNTI      E-RNTI          OPTIONAL,
  serving-HSDSCH-CellInformation  Serving-HSDSCH-CellInformation-r9,
  e-dch-ReconfigurationInfo E-DCH-ReconfigurationInfo-r7,
  dtx-drx-TimingInfo       DTX-DRX-TimingInfo-r7      OPTIONAL,
  dtx-drx-Info             DTX-DRX-Info-r7            OPTIONAL,
  hs-scch-LessInfo         HS-SCCH-LessInfo-r7        OPTIONAL,
  mimoParameters           MIMO-Parameters-r9         OPTIONAL,
  dl-SecondaryCellInfoFDD  DL-SecondaryCellInfoFDD-r9      OPTIONAL,
  ul-SecondaryCellInfoFDD  UL-SecondaryCellInfoFDD      OPTIONAL,
  e-dch-ReconfigurationInfo-SecULFrequency  E-DCH-ReconfigurationInfo-SecULFrequency  OPTIONAL
}

TargetCellPreconfigInfo-v950ext ::=      SecondaryCellMIMOparametersFDD-v950ext

TargetCellPreconfigInfo-r10 ::=         SEQUENCE {
  activationTimeOffset      ActivationTimeOffset      OPTIONAL,
  new-H-RNTI                H-RNTI,
  newPrimary-E-RNTI        E-RNTI          OPTIONAL,
  newSecondary-E-RNTI      E-RNTI          OPTIONAL,
  serving-HSDSCH-CellInformation  Serving-HSDSCH-CellInformation-r9,
  e-dch-ReconfigurationInfo E-DCH-ReconfigurationInfo-r7,
  dtx-drx-TimingInfo       DTX-DRX-TimingInfo-r7      OPTIONAL,
  dtx-drx-Info             DTX-DRX-Info-r7            OPTIONAL,
  hs-scch-LessInfo         HS-SCCH-LessInfo-r7        OPTIONAL,
  mimoParameters           MIMO-Parameters-r9         OPTIONAL,
  dl-SecondaryCellInfoFDD  DL-SecondaryCellInfoFDD-r10  OPTIONAL,
  additionalDLSecCellInfoListFDD  AdditionalDLSecCellInfoListFDD  OPTIONAL,
  ul-SecondaryCellInfoFDD  UL-SecondaryCellInfoFDD      OPTIONAL,
  e-dch-ReconfigurationInfo-SecULFrequency  E-DCH-ReconfigurationInfo-SecULFrequency  OPTIONAL
}

TargetCellPreconfigInfo-vb50ext ::=     SEQUENCE {
  ulOLTDInfoFDD            UL-OLTD-InfoFDD          OPTIONAL
}

TargetCellPreconfigInfo-r11 ::=         SEQUENCE {
  activationTimeOffset      ActivationTimeOffset      OPTIONAL,
  new-H-RNTI                H-RNTI,
  newPrimary-E-RNTI        E-RNTI          OPTIONAL,
  newSecondary-E-RNTI      E-RNTI          OPTIONAL,
  serving-HSDSCH-CellInformation  Serving-HSDSCH-CellInformation-r11,
  e-dch-ReconfigurationInfo E-DCH-ReconfigurationInfo-r11,
  dtx-drx-TimingInfo       DTX-DRX-TimingInfo-r7      OPTIONAL,
  dtx-drx-Info             DTX-DRX-Info-r7            OPTIONAL,
  hs-scch-LessInfo         HS-SCCH-LessInfo-r7        OPTIONAL,
  mimoParameters           MIMO-Parameters-r9         OPTIONAL,
  mimo4x4Parameters        MIMO4x4-Parameters        OPTIONAL,
  dl-SecondaryCellInfoFDD  DL-SecondaryCellInfoFDD-r11  OPTIONAL,
  additionalDLSecCellInfoListFDD  AdditionalDLSecCellInfoListFDD-r11  OPTIONAL,
  additionalDLSecCellInfoListFDD2  AdditionalDLSecCellInfoListFDD2  OPTIONAL,
  ul-SecondaryCellInfoFDD  UL-SecondaryCellInfoFDD      OPTIONAL,
  e-dch-ReconfigurationInfo-SecULFrequency  E-DCH-ReconfigurationInfo-SecULFrequency  OPTIONAL,
  ul-CLTD-InfoFDD          UL-CLTD-InfoFDD          OPTIONAL,
  f-tpich-ReconfigurationInfo  F-TPICH-ReconfigurationInfo  OPTIONAL,
  ul-OLTD-InfoFDD          UL-OLTD-InfoFDD          OPTIONAL,
  ul-16QAM-Config          UL-16QAM-Config          OPTIONAL,
  ul-64QAM-Config          UL-64QAM-Config          OPTIONAL,
  ul-MIMO-Info             UL-MIMO-InfoFDD          OPTIONAL
}

TargetCellPreconfigInfo-r12 ::=         SEQUENCE {
  activationTimeOffset      ActivationTimeOffset      OPTIONAL,
  new-H-RNTI                H-RNTI,
  newPrimary-E-RNTI        E-RNTI          OPTIONAL,
  newSecondary-E-RNTI      E-RNTI          OPTIONAL,
  serving-HSDSCH-CellInformation  Serving-HSDSCH-CellInformation-r12,
  e-dch-ReconfigurationInfo  E-DCH-ReconfigurationInfo-r11,

```

dtx-drx-TimingInfo	DTX-DRX-TimingInfo-r7	OPTIONAL,
dtx-drx-Info	DTX-DRX-Info-r12	OPTIONAL,
hs-scch-LessInfo	HS-SCCH-LessInfo-r7	OPTIONAL,
mimoParameters	MIMO-Parameters-r9	OPTIONAL,
mimo4x4Parameters	MIMO4x4-Parameters	OPTIONAL,
dl-SecondaryCellInfoFDD	DL-SecondaryCellInfoFDD-r11	OPTIONAL,
additionalDLSecCellInfoListFDD	AdditionalDLSecCellInfoListFDD-r11	OPTIONAL,
additionalDLSecCellInfoListFDD2	AdditionalDLSecCellInfoListFDD2	OPTIONAL,
ul-SecondaryCellInfoFDD	UL-SecondaryCellInfoFDD-r12	OPTIONAL,
e-dch-ReconfigurationInfo-SecULFrequency	E-DCH-ReconfigurationInfo-SecULFrequency	OPTIONAL,
ul-CLTD-InfoFDD	UL-CLTD-InfoFDD	OPTIONAL,
f-tpich-ReconfigurationInfo	F-TPICH-ReconfigurationInfo	OPTIONAL,
uL-OLTD-InfoFDD	UL-OLTD-InfoFDD	OPTIONAL,
ul-16QAM-Config	UL-16QAM-Config	OPTIONAL,
ul-64QAM-Config	UL-64QAM-Config	OPTIONAL,
ul-MIMO-Info	UL-MIMO-InfoFDD	OPTIONAL,
dPCCH2InfoFDD	DPCCH2InfoFDD	OPTIONAL
}		
TDD-FPACH-CCode16-r4 ::=	ENUMERATED {	
	cc16-1, cc16-2, cc16-3, cc16-4,	
	cc16-5, cc16-6, cc16-7, cc16-8,	
	cc16-9, cc16-10, cc16-11, cc16-12,	
	cc16-13, cc16-14, cc16-15, cc16-16 }	
TDD-UL-Interference ::=	INTEGER (-110..-52)	
TDD-PICH-CCode ::=	ENUMERATED {	
	cc16-1, cc16-2, cc16-3, cc16-4,	
	cc16-5, cc16-6, cc16-7, cc16-8,	
	cc16-9, cc16-10, cc16-11, cc16-12,	
	cc16-13, cc16-14, cc16-15, cc16-16 }	
TDD768-PICH-CCode ::=	ENUMERATED {	
	cc32-1, cc32-2, cc32-3, cc32-4,	
	cc32-5, cc32-6, cc32-7, cc32-8,	
	cc32-9, cc32-10, cc32-11, cc32-12,	
	cc32-13, cc32-14, cc32-15, cc32-16,	
	cc32-17, cc32-18, cc32-19, cc32-20,	
	cc32-21, cc32-22, cc32-23, cc32-24,	
	cc32-25, cc32-26, cc32-27, cc32-28,	
	cc32-29, cc32-30, cc32-31, cc32-32 }	
TDD-MBSFNInformation ::=	SEQUENCE (SIZE (1..maxTS)) OF	
	TDD-MBSFNslotInfo	
TDD-MBSFNslotInfo ::=	SEQUENCE {	
timeSlotNumber	TimeslotNumber,	
cellParametersID	CellParametersID	
}		
TDD-PRACH-CCode8 ::=	ENUMERATED {	
	cc8-1, cc8-2, cc8-3, cc8-4,	
	cc8-5, cc8-6, cc8-7, cc8-8 }	
TDD-PRACH-CCode16 ::=	ENUMERATED {	
	cc16-1, cc16-2, cc16-3, cc16-4,	
	cc16-5, cc16-6, cc16-7, cc16-8,	
	cc16-9, cc16-10, cc16-11, cc16-12,	
	cc16-13, cc16-14, cc16-15, cc16-16 }	
TDD-PRACH-CCode-LCR-r4 ::=	ENUMERATED {	
	cc4-1, cc4-2, cc4-3, cc4-4,	
	cc8-1, cc8-2, cc8-3, cc8-4,	
	cc8-5, cc8-6, cc8-7, cc8-8,	
	cc16-1, cc16-2, cc16-3, cc16-4,	
	cc16-5, cc16-6, cc16-7, cc16-8,	
	cc16-9, cc16-10, cc16-11, cc16-12,	
	cc16-13, cc16-14, cc16-15, cc16-16 }	
TDD-PRACH-CCodeList ::=	CHOICE {	
sf8	SEQUENCE (SIZE (1..8)) OF	
	TDD-PRACH-CCode8,	
-- Channelisation codes cc16-9, cc16-10, cc16-11, cc16-12, cc16-13, cc16-14,		
-- cc16-15 and cc16-16 shall not be used		
sf16	SEQUENCE (SIZE (1..8)) OF	
	TDD-PRACH-CCode16	

```

}

TDD768-PRACH-CCode16 ::=          ENUMERATED {
                                     cc16-1, cc16-2, cc16-3, cc16-4,
                                     cc16-5, cc16-6, cc16-7, cc16-8,
                                     cc16-9, cc16-10, cc16-11, cc16-12,
                                     cc16-13, cc16-14, cc16-15, cc16-16 }

TDD768-PRACH-CCode32 ::=          ENUMERATED {
                                     cc32-1, cc32-2, cc32-3, cc32-4,
                                     cc32-5, cc32-6, cc32-7, cc32-8,
                                     cc32-9, cc32-10, cc32-11, cc32-12,
                                     cc32-13, cc32-14, cc32-15, cc32-16 }

TDD768-PRACH-CCodeList ::=        CHOICE {
    sf32                             SEQUENCE (SIZE (1..16)) OF
                                     TDD768-PRACH-CCode32,
-- Channelisation codes cc32-17, cc32-18, cc32-19, cc32-20, cc32-21, cc32-22,
-- cc32-23, cc32-24, cc32-25, cc32-26, cc32-27, cc32-28, cc32-29, cc32-30, cc32-31
-- and cc32-32 shall not be used
    sf16                             SEQUENCE (SIZE (1..16)) OF
                                     TDD768-PRACH-CCode16
}

TFC-ControlDuration ::=           ENUMERATED {
                                     tfc-cd1, tfc-cd2, tfc-cd4, tfc-cd8,
                                     tfc-cd16, tfc-cd24, tfc-cd32,
                                     tfc-cd48, tfc-cd64, tfc-cd128,
                                     tfc-cd192, tfc-cd256, tfc-cd512 }

TFCI-Coding ::=                   ENUMERATED {
                                     tfci-bits-4, tfci-bits-8,
                                     tfci-bits-16, tfci-bits-32 }

TGCFN ::=                         INTEGER (0..255)

-- In TGD, value 270 represents "undefined" in the tabular description.
TGD ::=                           INTEGER (15..270)

TGL ::=                           INTEGER (1..14)

TGMP ::=                           ENUMERATED {
                                     tdd-Measurement, fdd-Measurement,
                                     gsm-CarrierRSSIMeasurement,
                                     gsm-initialBSICIdentification, gsmBSICReconfirmation,
                                     multi-carrier }

TGMP-r8 ::=                       ENUMERATED {
                                     tdd-Measurement, fdd-Measurement,
                                     gsm-CarrierRSSIMeasurement,
                                     gsm-initialBSICIdentification, gsmBSICReconfirmation,
                                     multi-carrier, e-UTRA, spare }

TGP-Sequence ::=                  SEQUENCE {
    tgpsi                             TGPSI,
    tgps-Status                         CHOICE {
        activate                         SEQUENCE {
            tgcfn
        },
        deactivate                       NULL
    },
    tgps-ConfigurationParams            TGPS-ConfigurationParams            OPTIONAL
}

TGP-Sequence-r8 ::=               SEQUENCE {
    tgpsi                             TGPSI,
    tgps-Status                         CHOICE {
        activate                         SEQUENCE {
            tgcfn
        },
        deactivate                       NULL
    },
    tgps-ConfigurationParams            TGPS-ConfigurationParams-r8        OPTIONAL
}

TGP-Sequence-r10 ::=              SEQUENCE {
    tgpsi                             TGPSI,
    tgps-Status                         CHOICE {

```

```

        activate          SEQUENCE {
            tgcfm          TGCFM
        },
        deactivate        NULL
    },
    tgps-ConfigurationParams    TGPS-ConfigurationParams-r10    OPTIONAL
}

TGPS-Reconfiguration-CFN ::=    INTEGER (0..255)

TGP-SequenceList ::=          SEQUENCE (SIZE (1..maxTGPS)) OF
                                TGP-Sequence

TGP-SequenceList-r8 ::=      SEQUENCE (SIZE (1..maxTGPS)) OF
                                TGP-Sequence-r8

TGP-SequenceList-r10 ::=     SEQUENCE (SIZE (1..maxTGPS)) OF
                                TGP-Sequence-r10

TGP-SequenceShort ::=        SEQUENCE {
    tgpsi                    TGPSI,
    tgps-Status              CHOICE {
        activate              SEQUENCE {
            tgcfm            TGCFM
        },
        deactivate            NULL
    }
}

TGP-SequenceShort-r10 ::=    SEQUENCE {
    tgpsi                    TGPSI,
    tgps-Status              CHOICE {
        activate              SEQUENCE {
            tgcfm            TGCFM
        },
        deactivate            NULL
    },
    freqSpecificCompressedMode    ENUMERATED { true }    OPTIONAL
}

TGPL ::=                    INTEGER (1..144)

-- TABULAR: In TGPRC, value 0 represents "infinity" in the tabular description.
TGPRC ::=                    INTEGER (0..511)

TGPS-ConfigurationParams ::= SEQUENCE {
    tgmp                    TGMP,
    tgprc                    TGPRC,
    tgsn                    TGSN,
    tg11                    TGL,
    tg12                    TGL    OPTIONAL,
    tgd                    TGD,
    tgpl1                    TGPL,
    -- dummy is not used in this version of the specification, it should
    -- not be sent and if received it shall be ignored.
    dummy                    TGPL    OPTIONAL,
    rpp                    RPP,
    itp                    ITP,
    -- TABULAR: Compressed mode method is nested inside UL-DL-Mode
    ul-DL-Mode                UL-DL-Mode,
    dl-FrameType                DL-FrameType,
    deltaSIR1                    DeltaSIR,
    deltaSIRAfter1                DeltaSIR,
    deltaSIR2                    DeltaSIR    OPTIONAL,
    deltaSIRAfter2                DeltaSIR    OPTIONAL,
    nIdentifyAbort                NIdentifyAbort    OPTIONAL,
    treconfirmAbort                TreconfirmAbort    OPTIONAL
}

TGPS-ConfigurationParams-r8 ::= SEQUENCE {
    tgmp                    TGMP-r8,
    tgprc                    TGPRC,
    tgsn                    TGSN,
    tg11                    TGL,
    tg12                    TGL    OPTIONAL,
    tgd                    TGD,
    tgpl1                    TGPL,
    rpp                    RPP,

```

```

itp                                ITP,
-- TABULAR: Compressed mode method is nested inside UL-DL-Mode
ul-DL-Mode                          UL-DL-Mode,
dl-FrameType                        DL-FrameType,
deltaSIR1                           DeltaSIR,
deltaSIRAfter1                      DeltaSIR,
deltaSIR2                           DeltaSIR                                OPTIONAL,
deltaSIRAfter2                      DeltaSIR                                OPTIONAL,
nidentifyAbort                      NidentifyAbort                        OPTIONAL,
treconfirmAbort                    TreconfirmAbort                        OPTIONAL
}

TGPS-ConfigurationParams-r10 ::= SEQUENCE {
  tgmpr                             TGMP-r8,
  freqSpecificCompressedMode        ENUMERATED { true }                    OPTIONAL,
  tgprc                             TGPRC,
  tgsn                              TGSN,
  tgl1                              TGL,
  tgl2                              TGL                                OPTIONAL,
  tgd                               TGD,
  tgpl1                             TGPL,
  rpp                               RPP,
  itp                               ITP,
  -- TABULAR: Compressed mode method is nested inside UL-DL-Mode
  ul-DL-Mode                          UL-DL-Mode,
  dl-FrameType                        DL-FrameType,
  deltaSIR1                           DeltaSIR,
  deltaSIRAfter1                      DeltaSIR,
  deltaSIR2                           DeltaSIR                                OPTIONAL,
  deltaSIRAfter2                      DeltaSIR                                OPTIONAL,
  nidentifyAbort                      NidentifyAbort                        OPTIONAL,
  treconfirmAbort                    TreconfirmAbort                        OPTIONAL
}

TGPSI ::= INTEGER (1..maxTGPS)

TGSN ::= INTEGER (0..14)

TimeInfo ::= SEQUENCE {
  activationTime                    ActivationTime                        OPTIONAL,
  durationTimeInfo                  DurationTimeInfo                      OPTIONAL
}

TimeSlotLCR-ext ::= ENUMERATED {
  ts7, spare3, spare2, spare1 }

TimeslotList ::= SEQUENCE (SIZE (1..maxTS)) OF
  TimeslotNumber

TimeslotList-r4 ::= CHOICE {
  -- the choice for 7.68 Mcps TDD is as for 3.84 Mcps TDD --
  tdd384                            SEQUENCE (SIZE (1..maxTS)) OF
    TimeslotNumber,
  tdd128                            SEQUENCE (SIZE (1..maxTS-LCR)) OF
    TimeslotNumber-LCR-r4
}

-- If TimeslotNumber is included for a 1.28Mcps TDD description, it shall take values from 0..6
TimeslotNumber ::= INTEGER (0..14)

TimeslotNumber-LCR-r4 ::= INTEGER (0..6)

TimeslotNumber-PRACH-LCR-r4 ::= INTEGER (1..6)

TimeslotSync2 ::= INTEGER (0..6)

DTX-DRX-TimingInfo-r7 ::= SEQUENCE {
  timing                            CHOICE {
    continue                         NULL,
    newTiming                        NewTiming
  }
}

-- Actual value TimingOffset = IE value * 256
TimingOffset ::= INTEGER (0..149)

TimingMaintainedSynchInd ::= ENUMERATED { false }

```

```

TPC-CombinationIndex ::=          INTEGER (0..5)

TPC-CommandTargetRate ::=        INTEGER (0..10)

-- Actual value TPC-StepSizeFDD = IE value + 1
TPC-StepSizeFDD ::=              INTEGER (0..1)

TPC-StepSizeTDD ::=              INTEGER (1..3)

TransportBlockSizeIndex ::=      INTEGER (1..32)

-- Actual value TreconfirmAbort = IE value * 0.5 seconds
TreconfirmAbort ::=              INTEGER (1..20)

TwoMsHarqConfiguration ::=       SEQUENCE {
    harqProcessAllocation         BIT STRING (SIZE (8))           OPTIONAL
}

TX-DiversityMode ::=             ENUMERATED {
    noDiversity,
    sttd,
    closedLoopModel,
    -- dummy is not used in this version of the specification, it should
    -- not be sent and if received it should be ignored.
    dummy }

UARFCN ::=                       INTEGER (0..16383)

UCSM-Info ::=                    SEQUENCE {
    minimumSpreadingFactor        MinimumSpreadingFactor,
    nf-Max                        NF-Max,
    channelReqParamsForUCSM      ChannelReqParamsForUCSM
}

UE-DPCCH-Burst ::=              ENUMERATED {
    sub-frames-1,
    sub-frames-2,
    sub-frames-5,
    spare1 }

UE-DPCCHPowerResetAfterDTXOnSecUplink ::= SEQUENCE {
    filterCoefficient             INTEGER (0..5),
    -- Actual value range powerOffset = (-4..10) * 2
    powerOffset                   INTEGER (-8..20),
    inactivityThresholdForResetPower ENUMERATED {
        ms10, ms20, ms30, ms40,
        ms50, ms60, ms80, ms120}           OPTIONAL
}

UE-DRX-Cycle ::=                ENUMERATED {
    sub-frames-4,
    sub-frames-5,
    sub-frames-8,
    sub-frames-10,
    sub-frames-16,
    sub-frames-20,
    spare2,
    spare1 }

UE-DRX-Cycle2 ::=               ENUMERATED {
    sub-frames-4,
    sub-frames-5,
    sub-frames-8,
    sub-frames-10,
    sub-frames-16,
    sub-frames-20,
    sub-frames-32,
    sub-frames-40,
    sub-frames-64,
    sub-frames-80,
    spare6,
    spare5,
    spare4,
    spare3,
    spare2,
    spare1 }

UE-DTX-Cycle1-10ms ::=          ENUMERATED {

```

```
sub-frames-1,
sub-frames-5,
sub-frames-10,
sub-frames-20 }

UE-DTX-Cycle1-2ms ::=
ENUMERATED {
sub-frames-1,
sub-frames-4,
sub-frames-5,
sub-frames-8,
sub-frames-10,
sub-frames-16,
sub-frames-20,
spare1 }

UE-DTX-Cycle2-10ms ::=
ENUMERATED {
sub-frames-5,
sub-frames-10,
sub-frames-20,
sub-frames-40,
sub-frames-80,
sub-frames-160,
spare2,
spare1 }

UE-DTX-Cycle2-2ms ::=
ENUMERATED {
sub-frames-4,
sub-frames-5,
sub-frames-8,
sub-frames-10,
sub-frames-16,
sub-frames-20,
sub-frames-32,
sub-frames-40,
sub-frames-64,
sub-frames-80,
sub-frames-128,
sub-frames-160,
spare4,
spare3,
spare2,
spare1 }

UE-DTX-Cycle2-2ms-Secondary ::=
ENUMERATED {
sub-frames-4,
sub-frames-5,
sub-frames-8,
sub-frames-10,
sub-frames-16,
sub-frames-20,
sub-frames-32,
sub-frames-40,
sub-frames-64,
sub-frames-80,
sub-frames-128,
sub-frames-160,
sub-frames-256,
sub-frames-320,
sub-frames-512,
sub-frames-640,
sub-frames-1024,
sub-frames-1280,
spare14,
spare13,
spare12,
spare11,
spare10,
spare9,
spare8,
spare7,
spare6,
spare5,
spare4,
spare3,
spare2,
spare1 }

UE-DTX-Cycle2InactivityThreshold ::=
ENUMERATED {
```

```

        e-dch-tti-1,
        e-dch-tti-4,
        e-dch-tti-8,
        e-dch-tti-16,
        e-dch-tti-32,
        e-dch-tti-64,
        e-dch-tti-128,
        e-dch-tti-256,
        spare8,
        spare7,
        spare6,
        spare5,
        spare4,
        spare3,
        spare2,
        spare1 }

UE-DTX-long-preamble-length ::=      ENUMERATED {
        slots-4,
        slots-15 }

UE-DTX-DRX-Offset ::=                INTEGER (0..159)

UE-GrantMonitoring-InactivityThreshold ::=  ENUMERATED {
        e-dch-tti-0,
        e-dch-tti-1,
        e-dch-tti-2,
        e-dch-tti-4,
        e-dch-tti-8,
        e-dch-tti-16,
        e-dch-tti-32,
        e-dch-tti-64,
        e-dch-tti-128,
        e-dch-tti-256,
        spare6,
        spare5,
        spare4,
        spare3,
        spare2,
        spare1 }

UL-16QAM-Config ::=      SEQUENCE {
        ul-16QAM-Settings          UL-16QAM-Settings          OPTIONAL,
        e-TFCI-TableIndex          E-TFCI-TableIndex          OPTIONAL,
        mac-es-e-resetIndicator    ENUMERATED { true }      OPTIONAL
    }

UL-16QAM-Settings ::=      SEQUENCE {
        beta-Ed-Gain-E-AGCH-Table-Selection INTEGER (0..1)
    }

UL-64QAM-Config ::=      SEQUENCE {
        ul-64QAM-Settings          UL-64QAM-Settings          OPTIONAL,
        mac-is-i-resetIndicator    ENUMERATED { true }      OPTIONAL
    }

UL-64QAM-Settings ::=      SEQUENCE {
        beta-Ed-Gain-E-AGCH-Table-Selection INTEGER (0..1)
    }

UL-CCTrCH ::=              SEQUENCE {
        tfcs-ID                    TFCS-IdentityPlain        DEFAULT 1,
        ul-TargetSIR               UL-TargetSIR,
        timeInfo                    TimeInfo,
        commonTimeslotInfo          CommonTimeslotInfo        OPTIONAL,
        ul-CCTrCH-TimeslotsCodes    UplinkTimeslotsCodes        OPTIONAL
    }

UL-CCTrCH-r4 ::=          SEQUENCE {
        tfcs-ID                    TFCS-IdentityPlain        DEFAULT 1,
        -- The IE ul-TargetSIR corresponds to PRX-DPCHdes for 1.28Mcps TDD
        -- Actual value PRX-DPCHdes = (value of IE "ul-TargetSIR" - 120)
        ul-TargetSIR               UL-TargetSIR,
        timeInfo                    TimeInfo,
        commonTimeslotInfo          CommonTimeslotInfo        OPTIONAL,
        tddOption                   CHOICE {
            tdd384                  SEQUENCE {
                ul-CCTrCH-TimeslotsCodes    UplinkTimeslotsCodes        OPTIONAL
            }
        }
    }

```

```

    },
    tdd128
        ul-CCTrCH-TimeslotsCodes
        SEQUENCE {
            UplinkTimeslotsCodes-LCR-r4 OPTIONAL
        }
    }
}

UL-CCTrCH-r7 ::=
    SEQUENCE {
        tfcs-ID
            TFCS-IdentityPlain
            DEFAULT 1,
        -- The IE ul-TargetSIR corresponds to PRX-DPCHdes for 1.28Mcps TDD
        -- Actual value PRX-DPCHdes = (value of IE "ul-TargetSIR" - 120)
        ul-TargetSIR
            UL-TargetSIR,
        timeInfo
            TimeInfo,
        commonTimeslotInfo
            CommonTimeslotInfo
            OPTIONAL,
        tddOption
            CHOICE {
                tdd384
                    SEQUENCE {
                        ul-CCTrCH-TimeslotsCodes
                            UplinkTimeslotsCodes
                            OPTIONAL
                    },
                tdd768
                    SEQUENCE {
                        ul-CCTrCH-TimeslotsCodes
                            UplinkTimeslotsCodes-VHCR
                            OPTIONAL
                    },
                tdd128
                    SEQUENCE {
                        ul-CCTrCH-TimeslotsCodes
                            UplinkTimeslotsCodes-LCR-r7
                            OPTIONAL
                    }
            }
    }

UL-CCTrCHList ::=
    SEQUENCE (SIZE (1..maxCCTrCH)) OF
        UL-CCTrCH

UL-CCTrCHList-r4 ::=
    SEQUENCE (SIZE (1..maxCCTrCH)) OF
        UL-CCTrCH-r4

UL-CCTrCHList-r7 ::=
    SEQUENCE (SIZE (1..maxCCTrCH)) OF
        UL-CCTrCH-r7

UL-CCTrCHListToRemove ::=
    SEQUENCE (SIZE (1..maxCCTrCH)) OF
        TFCS-IdentityPlain

UL-CCTrChTPCLList ::=
    SEQUENCE (SIZE (0..maxCCTrCH)) OF
        TFCS-Identity

UL-ChannelRequirement ::=
    CHOICE {
        ul-DPCH-Info
            UL-DPCH-Info,
        -- dummy is not used in this version of the specification, it should
        -- not be sent and if received the UE behaviour is not specified.
        dummy
            CPCH-SetInfo
    }

UL-ChannelRequirement-r4 ::=
    CHOICE {
        ul-DPCH-Info
            UL-DPCH-Info-r4,
        -- dummy is not used in this version of the specification, it should
        -- not be sent and if received the UE behaviour is not specified.
        dummy
            CPCH-SetInfo
    }

UL-ChannelRequirement-r5 ::=
    CHOICE {
        ul-DPCH-Info
            UL-DPCH-Info-r5,
        -- dummy is not used in this version of the specification, it should
        -- not be sent and if received the UE behaviour is not specified.
        dummy
            CPCH-SetInfo
    }

-- Note: the reference to CPCH in the element name below is incorrect. The name is not
-- changed to keep it aligned with R99.
UL-ChannelRequirementWithCPCH-SetID ::= CHOICE {
    ul-DPCH-Info
        UL-DPCH-Info,
    -- dummy1 and dummy 2 are not used in this version of the specification, they should
    -- not be sent and if received the UE behaviour is not specified.
    dummy1
        CPCH-SetInfo,
    dummy2
        CPCH-SetID
}

-- Note: the reference to CPCH in the element name below is incorrect. The name is not
-- changed to keep it aligned with R99.
UL-ChannelRequirementWithCPCH-SetID-r4 ::= CHOICE {
    ul-DPCH-Info
        UL-DPCH-Info-r4,
    -- dummy1 and dummy2 are not used in this version of the specification, they

```

```

-- should not be sent and if received the UE behaviour is not specified.
dummy1          CPCH-SetInfo,
dummy2          CPCH-SetID
}

-- Note: the reference to CPCH in the element name below is incorrect. The name is not
-- changed to keep it aligned with R99.
UL-ChannelRequirementWithCPCH-SetID-r5 ::= CHOICE {
  ul-DPCH-Info          UL-DPCH-Info-r5,
  -- dummy1 and dummy2 are not used in this version of the specification, they should
  -- not be sent and if received the UE behaviour is not specified.
  dummy1          CPCH-SetInfo,
  dummy2          CPCH-SetID
}

UL-CLTD-InfoFDD ::= SEQUENCE {
  configurationInfo          CHOICE {
    continue          NULL,
    newConfiguration    SEQUENCE {
      s-dpccch-Info    S-DPCCCH-Information,
      initial-CLTD-ActivationState  ENUMERATED { first-state, second-state } OPTIONAL,
      primaryCPICH-Info  PrimaryCPICH-Info          OPTIONAL
    }
  }
}

UL-CompressedModeMethod ::= ENUMERATED {
  sf-2,
  higherLayerScheduling }

UL-DL-Mode ::= CHOICE {
  ul          UL-CompressedModeMethod,
  dl          DL-CompressedModeMethod,
  ul-and-dl   SEQUENCE {
    ul          UL-CompressedModeMethod,
    dl          DL-CompressedModeMethod
  }
}

UL-DPCCCH-SlotFormat ::= ENUMERATED {
  slf0, slf1, slf2 }

UL-DPCH-CodeInfoForCommonEDCH ::= SEQUENCE {
  ul-DPCCHscramblingCodeType  ScramblingCodeType,
  ul-DPCCHscramblingCode      UL-ScramblingCode          OPTIONAL
}

UL-DPCH-Info ::= SEQUENCE {
  ul-DPCH-PowerControlInfo    UL-DPCH-PowerControlInfo          OPTIONAL,
  modeSpecificInfo            CHOICE {
    fdd          SEQUENCE {
      scramblingCodeType  ScramblingCodeType,
      scramblingCode      UL-ScramblingCode,
      numberOfDPDCH        NumberOfDPDCH          DEFAULT 1,
      spreadingFactor      SpreadingFactor,
      tfci-Existence      BOOLEAN,
      -- numberOfFBI-Bits is conditional based on history
      numberOfFBI-Bits    NumberOfFBI-Bits          OPTIONAL,
      puncturingLimit     PuncturingLimit
    },
    tdd          SEQUENCE {
      ul-TimingAdvance    UL-TimingAdvanceControl          OPTIONAL,
      ul-CCTrCHList       UL-CCTrCHList          OPTIONAL,
      ul-CCTrCHListToRemove  UL-CCTrCHListToRemove          OPTIONAL
    }
  }
}

UL-DPCH-Info-r4 ::= SEQUENCE {
  ul-DPCH-PowerControlInfo    UL-DPCH-PowerControlInfo-r4          OPTIONAL,
  modeSpecificInfo            CHOICE {
    fdd          SEQUENCE {
      scramblingCodeType  ScramblingCodeType,
      scramblingCode      UL-ScramblingCode,
      numberOfDPDCH        NumberOfDPDCH          DEFAULT 1,
      spreadingFactor      SpreadingFactor,
      tfci-Existence      BOOLEAN,
      -- numberOfFBI-Bits is conditional based on history
    }
  }
}

```



```

        numberOfFBI-Bits      NumberOfFBI-Bits      OPTIONAL,
        puncturingLimit      PuncturingLimit
    },
    tdd                      SEQUENCE {
        ul-TimingAdvance      UL-TimingAdvanceControl-r4  OPTIONAL,
        ul-CCTrCHList         UL-CCTrCHList-r4          OPTIONAL,
        ul-CCTrCHListToRemove UL-CCTrCHListToRemove    OPTIONAL
    }
}
}

UL-DPCH-Info-r5 ::=      SEQUENCE {
    ul-DPCH-PowerControlInfo  UL-DPCH-PowerControlInfo-r5  OPTIONAL,
    modeSpecificInfo          CHOICE {
        fdd                   SEQUENCE {
            scramblingCodeType  ScramblingCodeType,
            scramblingCode      UL-ScramblingCode,
            numberOfDPDCH       NumberOfDPDCH                DEFAULT 1,
            spreadingFactor     SpreadingFactor,
            tfci-Existence      BOOLEAN,
            -- numberOfFBI-Bits is conditional based on history
            numberOfFBI-Bits    NumberOfFBI-Bits                OPTIONAL,
            puncturingLimit     PuncturingLimit
        },
        tdd                   SEQUENCE {
            ul-TimingAdvance      UL-TimingAdvanceControl-r4  OPTIONAL,
            ul-CCTrCHList         UL-CCTrCHList-r4          OPTIONAL,
            ul-CCTrCHListToRemove UL-CCTrCHListToRemove    OPTIONAL
        }
    }
}

UL-DPCH-Info-r6 ::=      SEQUENCE {
    ul-DPCH-PowerControlInfo  UL-DPCH-PowerControlInfo-r6  OPTIONAL,
    modeSpecificInfo          CHOICE {
        fdd                   SEQUENCE {
            scramblingCodeType  ScramblingCodeType,
            scramblingCode      UL-ScramblingCode,
            dpdchPresence       CHOICE {
                present        SEQUENCE {
                    numberOfDPDCH  NumberOfDPDCH                DEFAULT 1,
                    spreadingFactor SpreadingFactor,
                    tfci-Existence BOOLEAN,
                    -- numberOfFBI-Bits is conditional based on history
                    numberOfFBI-Bits NumberOfFBI-Bits                OPTIONAL,
                    puncturingLimit PuncturingLimit
                },
                notPresent      SEQUENCE {
                    tfci-Existence  BOOLEAN,
                    -- numberOfFBI-Bits is conditional based on history
                    numberOfFBI-Bits NumberOfFBI-Bits                OPTIONAL
                }
            }
        },
        tdd                   SEQUENCE {
            ul-TimingAdvance      UL-TimingAdvanceControl-r4  OPTIONAL,
            ul-CCTrCHList         UL-CCTrCHList-r4          OPTIONAL,
            ul-CCTrCHListToRemove UL-CCTrCHListToRemove    OPTIONAL
        }
    }
}

UL-DPCH-Info-r7 ::=      SEQUENCE {
    ul-DPCH-PowerControlInfo  UL-DPCH-PowerControlInfo-r7  OPTIONAL,
    modeSpecificInfo          CHOICE {
        fdd                   SEQUENCE {
            scramblingCodeType  ScramblingCodeType,
            scramblingCode      UL-ScramblingCode,
            dpdchPresence       CHOICE {
                present        SEQUENCE {
                    numberOfDPDCH  NumberOfDPDCH                DEFAULT 1,
                    spreadingFactor SpreadingFactor,
                    tfci-Existence BOOLEAN,
                    -- numberOfFBI-Bits is conditional based on history
                    numberOfFBI-Bits NumberOfFBI-Bits                OPTIONAL,
                    numberOfTPC-Bits NumberOfTPC-Bits                OPTIONAL,
                    puncturingLimit PuncturingLimit
                },
            }
        }
    }
}

```

```

        notPresent
            tfci-Existence
            -- numberOfFBI-Bits is conditional based on history
            numberOfFBI-Bits
            numberOfTPC-Bits
        }
    },
    tdd
        ul-TimingAdvance
        ul-CCTrCHList
        ul-CCTrCHListToRemove
    }
}

UL-DPCH-Info-r11 ::=
    ul-DPCH-PowerControlInfo
    modeSpecificInfo
        fdd
            scramblingCodeType
            scramblingCode
            dpdchPresence
                present
                    numberOfDPDCH
                    spreadingFactor
                    tfci-Existence
                    -- numberOfFBI-Bits is conditional based on history
                    numberOfFBI-Bits
                    numberOfTPC-Bits
                    puncturingLimit
                },
                notPresent
                    tfci-Existence
                    -- numberOfFBI-Bits is conditional based on history
                    numberOfFBI-Bits
                    numberOfTPC-Bits
            }
        },
        tdd
            ul-TimingAdvance
            ul-CCTrCHList
            ul-CCTrCHListToRemove
        }
    }

UL-DPCH-InfoPostFDD ::=
    ul-DPCH-PowerControlInfo
    scramblingCodeType
    reducedScramblingCodeNumber
    spreadingFactor

UL-DPCH-InfoPostTDD ::=
    ul-DPCH-PowerControlInfo
    ul-TimingAdvance
    ul-CCTrCH-TimeslotsCodes

UL-DPCH-InfoPostTDD-LCR-r4 ::=
    ul-DPCH-PowerControlInfo
    ul-TimingAdvance
    ul-CCTrCH-TimeslotsCodes

UL-DPCH-InfoPredef ::=
    ul-DPCH-PowerControlInfo
    modeSpecificInfo
        fdd
            tfci-Existence
            puncturingLimit
        },
        tdd
            commonTimeslotInfo
    }

```

```

    }
  }
}

UL-DPCH-InfoPredef-v770ext ::= SEQUENCE {
  modeSpecificInfo CHOICE {
    fdd SEQUENCE {
      numberOfTPC-Bits NumberOfTPC-Bits OPTIONAL
    },
    tdd NULL }
  }
}

UL-DPCH-PowerControlInfo ::= CHOICE {
  fdd SEQUENCE {
    dpcch-PowerOffset DPCCH-PowerOffset,
    pc-Preamble PC-Preamble,
    srb-delay SRB-delay,
    -- TABULAR: TPC step size nested inside PowerControlAlgorithm
    powerControlAlgorithm PowerControlAlgorithm
  },
  tdd SEQUENCE {
    ul-TargetSIR UL-TargetSIR OPTIONAL,
    ul-OL-PC-Signalling CHOICE {
      broadcast-UL-OL-PC-info NULL,
      individuallySignalled SEQUENCE {
        individualTS-InterferenceList IndividualTS-InterferenceList,
        dpch-ConstantValue ConstantValueTdd,
        primaryCCPCH-TX-Power PrimaryCCPCH-TX-Power
      }
    }
  } OPTIONAL
}

UL-DPCH-PowerControlInfo-r4 ::= CHOICE {
  fdd SEQUENCE {
    dpcch-PowerOffset DPCCH-PowerOffset,
    pc-Preamble PC-Preamble,
    srb-delay SRB-delay,
    -- TABULAR: TPC step size nested inside PowerControlAlgorithm
    powerControlAlgorithm PowerControlAlgorithm
  },
  tdd SEQUENCE {
    -- The IE ul-TargetSIR corresponds to PRX-DPCHdes for 1.28Mcps TDD
    -- Actual value PRX-DPCHdes = (value of IE "ul-TargetSIR" - 120)
    ul-TargetSIR UL-TargetSIR OPTIONAL,
    ul-OL-PC-Signalling CHOICE {
      broadcast-UL-OL-PC-info NULL,
      individuallySignalled SEQUENCE {
        tddOption CHOICE {
          tdd384 SEQUENCE {
            individualTS-InterferenceList IndividualTS-InterferenceList,
            dpch-ConstantValue ConstantValue
          },
          tdd128 SEQUENCE {
            tpc-StepSize TPC-StepSizeTDD
          }
        }
      },
      primaryCCPCH-TX-Power PrimaryCCPCH-TX-Power
    }
  }
}

UL-DPCH-PowerControlInfo-r5 ::= CHOICE {
  fdd SEQUENCE {
    dpcch-PowerOffset DPCCH-PowerOffset,
    pc-Preamble PC-Preamble,
    srb-delay SRB-delay,
    -- TABULAR: TPC step size nested inside PowerControlAlgorithm
    powerControlAlgorithm PowerControlAlgorithm,
    deltaACK DeltaACK OPTIONAL,
    deltaNACK DeltaNACK OPTIONAL,
    ack-NACK-repetition-factor ACK-NACK-repetitionFactor OPTIONAL
  },
  tdd SEQUENCE {
    -- The IE ul-TargetSIR corresponds to PRX-DPCHdes for 1.28Mcps TDD
    -- Actual value PRX-DPCHdes = (value of IE "ul-TargetSIR" - 120)
    ul-TargetSIR UL-TargetSIR OPTIONAL,
    ul-OL-PC-Signalling CHOICE {

```

```

        broadcast-UL-OL-PC-info          NULL,
        individuallySignalled           SEQUENCE {
            tddOption                   CHOICE {
                tdd384                  SEQUENCE {
                    individualTS-InterferenceList  IndividualTS-InterferenceList,
                    dpch-ConstantValue            ConstantValue
                },
                tdd128                   SEQUENCE {
                    tpc-StepSize            TPC-StepSizeTDD
                }
            },
        },
        primaryCCPCH-TX-Power            PrimaryCCPCH-TX-Power
    },
}
}
}
}
}

UL-DPCH-PowerControlInfo-r6 ::= CHOICE {
    fdd SEQUENCE {
        dpch-PowerOffset      DPCCH-PowerOffset,
        pc-Preamble           PC-Preamble,
        srb-delay             SRB-delay,
        -- TABULAR: TPC step size nested inside PowerControlAlgorithm
        powerControlAlgorithm PowerControlAlgorithm,
        deltaACK              DeltaACK OPTIONAL,
        deltaNACK             DeltaNACK OPTIONAL,
        ack-NACK-repetition-factor  ACK-NACK-repetitionFactor OPTIONAL,
        harq-Preamble-Mode    HARQ-Preamble-Mode
    },
    tdd SEQUENCE {
        -- The IE ul-TargetSIR corresponds to PRX-DPCHdes for 1.28Mcps TDD
        -- Actual value PRX-DPCHdes = (value of IE "ul-TargetSIR" - 120)
        ul-TargetSIR          UL-TargetSIR OPTIONAL,
        ul-OL-PC-Signalling   CHOICE {
            broadcast-UL-OL-PC-info          NULL,
            individuallySignalled           SEQUENCE {
                tddOption                   CHOICE {
                    tdd384                  SEQUENCE {
                        individualTS-InterferenceList  IndividualTS-InterferenceList,
                        dpch-ConstantValue            ConstantValue
                    },
                    tdd128                   SEQUENCE {
                        beaconPLEst          BEACON-PL-Est OPTIONAL,
                        tpc-StepSize        TPC-StepSizeTDD
                    }
                },
            },
        },
        primaryCCPCH-TX-Power            PrimaryCCPCH-TX-Power
    }
}
}
}
}

UL-DPCH-PowerControlInfo-r7 ::= CHOICE {
    fdd SEQUENCE {
        dpch-PowerOffset      DPCCH-PowerOffset,
        pc-Preamble           PC-Preamble,
        srb-delay             SRB-delay,
        -- TABULAR: TPC step size nested inside PowerControlAlgorithm
        powerControlAlgorithm PowerControlAlgorithm,
        deltaACK              DeltaACK OPTIONAL,
        deltaNACK             DeltaNACK OPTIONAL,
        ack-NACK-repetition-factor  ACK-NACK-repetitionFactor OPTIONAL,
        harq-Preamble-Mode    HARQ-Preamble-Mode
    },
    tdd SEQUENCE {
        -- The IE ul-TargetSIR corresponds to PRX-DPCHdes for 1.28Mcps TDD
        -- Actual value PRX-DPCHdes = (value of IE "ul-TargetSIR" - 120)
        ul-TargetSIR          UL-TargetSIR OPTIONAL,
        ul-OL-PC-Signalling   CHOICE {
            broadcast-UL-OL-PC-info          NULL,
            individuallySignalled           SEQUENCE {
                tddOption                   CHOICE {
                    tdd384                  SEQUENCE {
                        individualTS-InterferenceList  IndividualTS-InterferenceList,
                        dpch-ConstantValue            ConstantValue
                    },
                    tdd768                   SEQUENCE {
                        individualTS-InterferenceList  IndividualTS-InterferenceList,
                    }
                }
            }
        }
    }
}
}
}
}
}

```

```

                dpch-ConstantValue          ConstantValue
            },
            tdd128                            SEQUENCE {
                beaconPLEst                  BEACON-PL-Est      OPTIONAL,
                tpc-StepSize                TPC-StepSizeTDD
            },
        },
        primaryCCPCH-TX-Power                PrimaryCCPCH-TX-Power
    },
}
}

UL-DPCH-PowerControlInfo-r11 ::= CHOICE {
    fdd
        dpcch-PowerOffset                    DPCCH-PowerOffset,
        pc-Preamble                          PC-Preamble,
        sRB-delay                             SRB-delay,
        -- TABULAR: TPC step size nested inside PowerControlAlgorithm
        powerControlAlgorithm                PowerControlAlgorithm,
        deltaACK                              DeltaACK-r11      OPTIONAL,
        deltaNACK                              DeltaNACK-r11    OPTIONAL,
        ack-NACK-repetition-factor            ACK-NACK-repetitionFactor  OPTIONAL,
        ack-NACK-repetition-factor-assisting  ACK-NACK-repetitionFactor  OPTIONAL,
        harq-Preamble-Mode                    HARQ-Preamble-Mode
    },
    tdd
        SEQUENCE {
            -- The IE ul-TargetSIR corresponds to PRX-DPCHdes for 1.28Mcps TDD
            -- Actual value PRX-DPCHdes = (value of IE "ul-TargetSIR" - 120)
            ul-TargetSIR                      UL-TargetSIR      OPTIONAL,
            ul-OL-PC-Signalling                CHOICE {
                broadcast-UL-OL-PC-info        NULL,
                individuallySignalled          SEQUENCE {
                    tddOption                  CHOICE {
                        tdd384                  SEQUENCE {
                            individualTS-InterferenceList IndividualTS-InterferenceList,
                            dpch-ConstantValue ConstantValue
                        },
                        tdd768                  SEQUENCE {
                            individualTS-InterferenceList IndividualTS-InterferenceList,
                            dpch-ConstantValue ConstantValue
                        },
                        tdd128                  SEQUENCE {
                            beaconPLEst        BEACON-PL-Est      OPTIONAL,
                            tpc-StepSize      TPC-StepSizeTDD
                        }
                    },
                },
            primaryCCPCH-TX-Power                PrimaryCCPCH-TX-Power
        }
    }
}

UL-DPCHpowerControlInfoConcurrentTTI ::= SEQUENCE {
    deltaACK                                DeltaACK          OPTIONAL,
    deltaNACK                                DeltaNACK          OPTIONAL,
    ack-NACK-repetition-factor               ACK-NACK-repetitionFactor  OPTIONAL
}

UL-DPCHpowerControlInfoForCommonEDCH ::= SEQUENCE {
    -- TABULAR: TPC step size nested inside PowerControlAlgorithm
    powerControlAlgorithm                   PowerControlAlgorithm,
    deltaACK                                  DeltaACK          OPTIONAL,
    deltaNACK                                  DeltaNACK          OPTIONAL,
    ack-NACK-repetition-factor                ACK-NACK-repetitionFactor  OPTIONAL
}

UL-DPCH-PowerControlInfoPostFDD ::= SEQUENCE {
    -- DPCCH-PowerOffset2 has a smaller range to save bits
    dpcch-PowerOffset2                       DPCCH-PowerOffset2,
    pc-Preamble                               PC-Preamble,
    sRB-delay                                 SRB-delay
}

UL-DPCH-PowerControlInfoPostTDD ::= SEQUENCE {
    ul-TargetSIR                             UL-TargetSIR,
    ul-TimeslotInterference                   TDD-UL-Interference
}

```

```

UL-DPCH-PowerControlInfoPostTDD-LCR-r4 ::= SEQUENCE {
  -- The IE ul-TargetSIR corresponds to PRX-DPCHdes for 1.28Mcps TDD
  -- Actual value PRX-DPCHdes = (value of IE "ul-TargetSIR" - 120)
  ul-TargetSIR          UL-TargetSIR
}

UL-DPCH-PowerControlInfoPredef ::= CHOICE {
  fdd SEQUENCE {
    -- TABULAR: TPC step size nested inside PowerControlAlgorithm
    powerControlAlgorithm PowerControlAlgorithm
  },
  tdd SEQUENCE {
    -- dpch-ConstantValue shall be ignored if in 1.28Mcps TDD mode.
    dpch-ConstantValue ConstantValueTdd
  }
}

UL-EDCH-Information-ext ::= CHOICE {
  fdd NULL,
  tdd SEQUENCE {
    non-ScheduledTransGrantInfo Non-ScheduledTransGrantInfoTDD-ext OPTIONAL
  }
}

UL-EDCH-Information-r6 ::= SEQUENCE {
  mac-es-e-resetIndicator ENUMERATED { true } OPTIONAL,
  e-DPCCH-Info E-DPCCH-Info OPTIONAL,
  e-DPDCH-Info E-DPDCH-Info OPTIONAL,
  schedulingTransmConfiguration E-DPDCH-SchedulingTransmConfiguration OPTIONAL
}

UL-EDCH-Information-r7 ::= SEQUENCE {
  mac-es-e-resetIndicator ENUMERATED { true } OPTIONAL,
  modeSpecificInfo CHOICE {
    fdd SEQUENCE {
      e-DPCCH-Info E-DPCCH-Info-r7 OPTIONAL,
      e-DPDCH-Info E-DPDCH-Info-r7 OPTIONAL,
      schedulingTransmConfiguration E-DPDCH-SchedulingTransmConfiguration OPTIONAL,
      ul-16QAM-Settings UL-16QAM-Settings OPTIONAL
    },
    tdd SEQUENCE {
      e-RUCCH-Info E-RUCCH-Info OPTIONAL,
      e-PUCH-Info E-PUCH-Info OPTIONAL,
      non-ScheduledTransGrantInfo Non-ScheduledTransGrantInfoTDD OPTIONAL
    }
  }
}

UL-EDCH-Information-r8 ::= SEQUENCE {
  mac-es-e-resetIndicator ENUMERATED { true } OPTIONAL,
  modeSpecificInfo CHOICE {
    fdd SEQUENCE {
      e-DPCCH-Info E-DPCCH-Info-r7 OPTIONAL,
      e-DPDCH-Info E-DPDCH-Info-r8 OPTIONAL,
      schedulingTransmConfiguration E-DPDCH-SchedulingTransmConfiguration OPTIONAL,
      ul-16QAM-Settings UL-16QAM-Settings OPTIONAL
    },
    tdd SEQUENCE {
      e-RUCCH-Info E-RUCCH-Info OPTIONAL,
      e-PUCH-Info E-PUCH-Info OPTIONAL,
      non-ScheduledTransGrantInfo Non-ScheduledTransGrantInfoTDD OPTIONAL
    }
  }
}

UL-EDCH-Information-r9 ::= SEQUENCE {
  mac-es-e-resetIndicator ENUMERATED { true } OPTIONAL,
  modeSpecificInfo CHOICE {
    fdd SEQUENCE {
      e-DPCCH-Info E-DPCCH-Info-r7 OPTIONAL,
      e-DPDCH-Info E-DPDCH-Info-r8 OPTIONAL,
      schedulingTransmConfiguration E-DPDCH-SchedulingTransmConfiguration OPTIONAL,
      ul-16QAM-Settings UL-16QAM-Settings OPTIONAL
    },
    tdd SEQUENCE {
      e-RUCCH-Info E-RUCCH-Info OPTIONAL
    }
  }
}

```

```

        e-PUCH-Info          E-PUCH-Info          OPTIONAL,
        non-ScheduledTransGrantInfo Non-ScheduledTransGrantInfoTDD-r9  OPTIONAL
    }
}

UL-EDCH-Information-r11 ::= SEQUENCE {
    mac-es-e-resetIndicator    ENUMERATED { true }          OPTIONAL,
    modeSpecificInfo          CHOICE {
        fdd                    SEQUENCE {
            e-DPCCH-Info      E-DPCCH-Info-r7          OPTIONAL,
            e-DPDCH-Info      E-DPDCH-Info-r8          OPTIONAL,
            ul-MIMO-Info      UL-MIMO-InfoFDD          OPTIONAL,
            schedulingTransmConfiguration E-DPDCH-SchedulingTransmConfiguration OPTIONAL,
            ul-16QAM-Settings UL-16QAM-Settings          OPTIONAL,
            ul-64QAM-Settings UL-64QAM-Settings          OPTIONAL
        },
        tdd                    SEQUENCE {
            e-RUCCH-Info      E-RUCCH-Info          OPTIONAL,
            e-PUCH-Info      E-PUCH-Info          OPTIONAL,
            non-ScheduledTransGrantInfo Non-ScheduledTransGrantInfoTDD-r9  OPTIONAL
        }
    }
}

UL-MIMO-InfoFDD ::= SEQUENCE {
    configurationInfo          CHOICE {
        continue              NULL,
        newConfiguration      SEQUENCE {
            s-e-dpcch-power-offset    INTEGER(0..17),
            rank2-minimum-E-TFCI      E-DCH-MinimumSet-E-TFCI,
            inter-stream-compensation  INTEGER(0..15)          OPTIONAL
        }
    }
}

UL-MulticarrierEDCH-InfolistItem-TDD128 ::= SEQUENCE {
    uarfcn                    UARFCN,
    prxdes-base              INTEGER (-112..-50),
    e-PUCH-info              E-PUCH-Info-MulticarrierEDCH-TDD128  OPTIONAL,
    e-AGCH-info              E-AGCH-Information-TDD128          OPTIONAL,
    e-HICH-info              E-HICH-Information-TDD128          OPTIONAL
}

UL-MulticarrierEDCH-Infolist-TDD128 ::= SEQUENCE (SIZE (1..maxTDD128Carrier-1)) OF
    UL-MulticarrierEDCH-InfolistItem-TDD128

UL-MulticarrierEDCH-Deletelist-TDD128 ::= SEQUENCE (SIZE (1..maxTDD128Carrier-1)) OF
    UARFCN

UL-MulticarrierEDCHInfo-TDD128 ::= SEQUENCE {
    configuration-info        CHOICE {
        continue              NULL,
        newConfiguration      UL-MulticarrierEDCH-NewConfigurationInfo-TDD128
    }
}

UL-MulticarrierEDCH-NewConfigurationInfo-TDD128 ::= SEQUENCE {
    tsn-Length                ENUMERATED { tsn-14bits }          OPTIONAL,
    ul-MulticarrierEDCH-Infolist UL-MulticarrierEDCH-Infolist-TDD128  OPTIONAL,
    ul-MulticarrierEDCH-Deletelist UL-MulticarrierEDCH-Deletelist-TDD128  OPTIONAL
}

UL-Interference ::= INTEGER (-110..-70)

UL-ScramblingCode ::= INTEGER (0..16777215)

UL-SynchronisationParameters-r4 ::= SEQUENCE {
    stepSize                  INTEGER (1..8),
    frequency                 INTEGER (1..8)
}

-- Actual value UL-TargetSIR = (IE value * 0.5) - 11
UL-TargetSIR ::= INTEGER (0..62)

UL-TimingAdvance ::= INTEGER (0..63)

```

```

UL-TimingAdvanceControl ::= CHOICE {
    disabled
    enabled SEQUENCE {
        ul-TimingAdvance UL-TimingAdvance OPTIONAL,
        activationTime ActivationTime OPTIONAL
    }
}

UL-TimingAdvanceControl-r4 ::= CHOICE {
    disabled
    enabled SEQUENCE {
        tddOption CHOICE {
            tdd384 SEQUENCE {
                ul-TimingAdvance UL-TimingAdvance OPTIONAL,
                activationTime ActivationTime OPTIONAL
            },
            tdd128 SEQUENCE {
                ul-SynchronisationParameters UL-SynchronisationParameters-r4 OPTIONAL,
                synchronisationParameters SynchronisationParameters-r4 OPTIONAL
            }
        }
    }
}

UL-TimingAdvanceControl-r7 ::= CHOICE {
    disabled
    enabled SEQUENCE {
        tddOption CHOICE {
            tdd384 SEQUENCE {
                ul-TimingAdvance UL-TimingAdvance OPTIONAL,
                ext-UL-TimingAdvance EXT-UL-TimingAdvance OPTIONAL,
                activationTime ActivationTime OPTIONAL
            },
            tdd768 SEQUENCE {
                ext-UL-TimingAdvance EXT-UL-TimingAdvance OPTIONAL,
                activationTime ActivationTime OPTIONAL
            },
            tdd128 SEQUENCE {
                ul-SynchronisationParameters UL-SynchronisationParameters-r4 OPTIONAL,
                synchronisationParameters SynchronisationParameters-r4 OPTIONAL
            }
        }
    }
}

UL-TimingAdvanceControl-LCR-r4 ::= CHOICE {
    disabled
    enabled SEQUENCE {
        ul-SynchronisationParameters UL-SynchronisationParameters-r4 OPTIONAL,
        synchronisationParameters SynchronisationParameters-r4 OPTIONAL
    }
}

UL-TransModeSwitchingParam ::= SEQUENCE {
    k INTEGER (1..32),
    l INTEGER (1..32),
    m INTEGER (1..32)
}

UL-TS-ChannelisationCode ::= ENUMERATED {
    cc1-1, cc2-1, cc2-2,
    cc4-1, cc4-2, cc4-3, cc4-4,
    cc8-1, cc8-2, cc8-3, cc8-4,
    cc8-5, cc8-6, cc8-7, cc8-8,
    cc16-1, cc16-2, cc16-3, cc16-4,
    cc16-5, cc16-6, cc16-7, cc16-8,
    cc16-9, cc16-10, cc16-11, cc16-12,
    cc16-13, cc16-14, cc16-15, cc16-16 }

UL-TS-ChannelisationCodeList ::= SEQUENCE (SIZE (1..2)) OF
    UL-TS-ChannelisationCode

UL-TS-ChannelisationCodeList-r7 ::= SEQUENCE (SIZE (1..2)) OF
    SEQUENCE {
        ul-TS-Channelisation-Code UL-TS-ChannelisationCode,
        plcch-info PLCCH-Info OPTIONAL
    }
}

```



```

UL-TS-ChannelisationCode-VHCR ::= ENUMERATED {
    cc1-1, cc2-1, cc2-2,
    cc4-1, cc4-2, cc4-3, cc4-4,
    cc8-1, cc8-2, cc8-3, cc8-4,
    cc8-5, cc8-6, cc8-7, cc8-8,
    cc16-1, cc16-2, cc16-3, cc16-4,
    cc16-5, cc16-6, cc16-7, cc16-8,
    cc16-9, cc16-10, cc16-11, cc16-12,
    cc16-13, cc16-14, cc16-15, cc16-16,
    cc32-1, cc32-2, cc32-3, cc32-4,
    cc32-5, cc32-6, cc32-7, cc32-8,
    cc32-9, cc32-10, cc32-11, cc32-12,
    cc32-13, cc32-14, cc32-15, cc32-16,
    cc32-17, cc32-18, cc32-19, cc32-20,
    cc32-21, cc32-22, cc32-23, cc32-24,
    cc32-25, cc32-26, cc32-27, cc32-28,
    cc32-29, cc32-30, cc32-31, cc32-32 }

UL-TS-ChannelisationCodeList-VHCR ::= SEQUENCE (SIZE (1..2)) OF
    UL-TS-ChannelisationCode-VHCR

Uplink-DPCCH-Slot-Format-Information ::= ENUMERATED {
    slot-format-1,
    -- dummy is not used in this version of
    -- specification, it should not be sent and if
    -- received it should be ignored.
    dummy,
    slot-format-4,
    spare1 }

UplinkAdditionalTimeslots ::= SEQUENCE {
    parameters CHOICE {
        sameAsLast SEQUENCE {
            timeslotNumber TimeslotNumber
        },
        newParameters SEQUENCE {
            individualTimeslotInfo IndividualTimeslotInfo,
            ul-TS-ChannelisationCodeList UL-TS-ChannelisationCodeList
        }
    }
}

UplinkAdditionalTimeslots-LCR-r4 ::= SEQUENCE {
    parameters CHOICE {
        sameAsLast SEQUENCE {
            timeslotNumber TimeslotNumber
        },
        newParameters SEQUENCE {
            individualTimeslotInfo IndividualTimeslotInfo-LCR-r4,
            ul-TS-ChannelisationCodeList UL-TS-ChannelisationCodeList
        }
    }
}

UplinkAdditionalTimeslots-LCR-r7 ::= SEQUENCE {
    parameters CHOICE {
        sameAsLast SEQUENCE {
            timeslotNumber TimeslotNumber
            -- plcch-info assigned as previously defined slot
        },
        newParameters SEQUENCE {
            individualTimeslotInfo IndividualTimeslotInfo-LCR-r4,
            ul-TS-ChannelisationCodeList UL-TS-ChannelisationCodeList-r7
        }
    }
}

UplinkAdditionalTimeslots-VHCR ::= SEQUENCE {
    parameters CHOICE {
        sameAsLast SEQUENCE {
            timeslotNumber TimeslotNumber
        },
        newParameters SEQUENCE {
            individualTimeslotInfo IndividualTimeslotInfo-VHCR,
            ul-TS-ChannelisationCodeList UL-TS-ChannelisationCodeList
        }
    }
}

```

```

UplinkTimeslotsCodes ::=          SEQUENCE {
  dynamicSFusage                   BOOLEAN,
  firstIndividualTimeslotInfo      IndividualTimeslotInfo,
  ul-TS-ChannelisationCodeList    UL-TS-ChannelisationCodeList,
  moreTimeslots                    CHOICE {
    noMore                          NULL,
    additionalTimeslots             CHOICE {
      consecutive                   SEQUENCE {
        numAdditionalTimeslots      INTEGER (1..maxTS-1)
      },
      timeslotList                  SEQUENCE (SIZE (1..maxTS-1)) OF
        UplinkAdditionalTimeslots
    }
  }
}

UplinkTimeslotsCodes-VHCR ::=     SEQUENCE {
  dynamicSFusage                   BOOLEAN,
  firstIndividualTimeslotInfo      IndividualTimeslotInfo-VHCR,
  ul-TS-ChannelisationCodeList    UL-TS-ChannelisationCodeList-VHCR,
  moreTimeslots                    CHOICE {
    noMore                          NULL,
    additionalTimeslots             CHOICE {
      consecutive                   SEQUENCE {
        numAdditionalTimeslots      INTEGER (1..maxTS-1)
      },
      timeslotList                  SEQUENCE (SIZE (1..maxTS-1)) OF
        UplinkAdditionalTimeslots-VHCR
    }
  }
}

UplinkTimeslotsCodes-LCR-r4 ::=   SEQUENCE {
  dynamicSFusage                   BOOLEAN,
  firstIndividualTimeslotInfo      IndividualTimeslotInfo-LCR-r4,
  ul-TS-ChannelisationCodeList    UL-TS-ChannelisationCodeList,
  moreTimeslots                    CHOICE {
    noMore                          NULL,
    additionalTimeslots             CHOICE {
      consecutive                   SEQUENCE {
        numAdditionalTimeslots      INTEGER (1..maxTS-LCR-1)
      },
      timeslotList                  SEQUENCE (SIZE (1..maxTS-LCR-1)) OF
        UplinkAdditionalTimeslots-LCR-r4
    }
  }
}

UplinkTimeslotsCodes-LCR-r7 ::=   SEQUENCE {
  dynamicSFusage                   BOOLEAN,
  firstIndividualTimeslotInfo      IndividualTimeslotInfo-LCR-r4,
  ul-TS-ChannelisationCodeList    UL-TS-ChannelisationCodeList-r7,
  moreTimeslots                    CHOICE {
    noMore                          NULL,
    additionalTimeslots             CHOICE {
      consecutive                   SEQUENCE {
        -- the choice of 'consecutive' is not needed because there is only 1 option.
        numAdditionalTimeslots      INTEGER (1..maxTS-LCR-1)
      },
      timeslotList                  SEQUENCE (SIZE (1..maxTS-LCR-1)) OF
        UplinkAdditionalTimeslots-LCR-r7
    }
  }
}

UpPCHposition-LCR ::=             INTEGER (0..127)

Wi-LCR ::=                        INTEGER (1..4)

-- *****
--
--   MEASUREMENT INFORMATION ELEMENTS (10.3.7)
--
-- *****

AcquisitionSatInfo ::=           SEQUENCE {
  satID                            SatID,

```

```

-- Actual value dopplerOthOrder = IE value * 2.5
dopplerOthOrder          INTEGER (-2048..2047),
extraDopplerInfo        ExtraDopplerInfo          OPTIONAL,
codePhase                INTEGER (0..1022),
integerCodePhase        INTEGER (0..19),
gps-BitNumber            INTEGER (0..3),
codePhaseSearchWindow   CodePhaseSearchWindow,
azimuthAndElevation     AzimuthAndElevation       OPTIONAL
}

AcquisitionSatInfo-va40ext ::= SEQUENCE {
    azimuthAndElevation     AzimuthAndElevation-va40ext  OPTIONAL
}

AcquisitionSatInfo-r10 ::= SEQUENCE {
    satID                   SatID,
    -- Actual value dopplerOthOrder = IE value * 2.5
    dopplerOthOrder          INTEGER (-2048..2047),
    extraDopplerInfo        ExtraDopplerInfo          OPTIONAL,
    codePhase                INTEGER (0..1022),
    integerCodePhase        INTEGER (0..19),
    gps-BitNumber            INTEGER (0..3),
    codePhaseSearchWindow   CodePhaseSearchWindow,
    azimuthAndElevation     AzimuthAndElevation-r10     OPTIONAL
}

AcquisitionSatInfo-vc50ext ::= SEQUENCE {
    extraDopplerInfoExtension ExtraDopplerInfoExtension  OPTIONAL
}

AcquisitionSatInfo-r12 ::= SEQUENCE {
    satID                   SatID,
    -- Actual value dopplerOthOrder = IE value * 2.5
    dopplerOthOrder          INTEGER (-2048..2047),
    extraDopplerInfo        ExtraDopplerInfo          OPTIONAL,
    -- If the extraDopplerInfoExtension is present, the extraDopplerInfo should not be present
    extraDopplerInfoExtension ExtraDopplerInfoExtension  OPTIONAL,
    codePhase                INTEGER (0..1022),
    integerCodePhase        INTEGER (0..19),
    gps-BitNumber            INTEGER (0..3),
    codePhaseSearchWindow   CodePhaseSearchWindow,
    azimuthAndElevation     AzimuthAndElevation-r10     OPTIONAL
}

AcquisitionSatInfoList ::= SEQUENCE (SIZE (1..maxSat)) OF
    AcquisitionSatInfo

AcquisitionSatInfoList-va40ext ::= SEQUENCE (SIZE (1..maxSat)) OF
    AcquisitionSatInfo-va40ext

AcquisitionSatInfoList-r10 ::= SEQUENCE (SIZE (1..maxSat)) OF
    AcquisitionSatInfo-r10

AcquisitionSatInfoList-vc50ext ::= SEQUENCE (SIZE (1..maxSat)) OF
    AcquisitionSatInfo-vc50ext

AcquisitionSatInfoList-r12 ::= SEQUENCE (SIZE (1..maxSat)) OF
    AcquisitionSatInfo-r12

AdditionalMeasurementID-List ::= SEQUENCE (SIZE (1..maxAdditionalMeas)) OF
    MeasurementIdentity

AdditionalMeasurementID-List-r9 ::= SEQUENCE (SIZE (1..maxAdditionalMeas)) OF
    MeasurementIdentity-r9

AlmanacSatInfo ::= SEQUENCE {
    dataID                  INTEGER (0..3),
    satID                   SatID,
    e                       BIT STRING (SIZE (16)),
    t-oa                    BIT STRING (SIZE (8)),
    deltaI                  BIT STRING (SIZE (16)),
    omegaDot                BIT STRING (SIZE (16)),
    satHealth               BIT STRING (SIZE (8)),
    a-Sqrt                  BIT STRING (SIZE (24)),
    omega0                  BIT STRING (SIZE (24)),
    m0                      BIT STRING (SIZE (24)),
    omega                   BIT STRING (SIZE (24)),
    af0                     BIT STRING (SIZE (11)),
    af1                     BIT STRING (SIZE (11))
}

```

```

}
AlmanacSatInfoList ::=                               SEQUENCE (SIZE (1..maxSat)) OF
                                                       AlmanacSatInfo

ALM-BDSKeplerianSet ::=                             SEQUENCE {
  sat-info-BDSkpList                                GANSS-SAT-Info-Almanac-BDSkpList
}

ALM-ECEFSbasAlmanacSet ::=                          SEQUENCE {
  sat-info-SBAscecefList                            GANSS-SAT-Info-Almanac-SBAscecefList
}

ALM-GlonassAlmanacSet ::=                           SEQUENCE {
  sat-info-GLOkpList                                GANSS-SAT-Info-Almanac-GLOkpList
}

ALM-keplerianParameters ::=                         SEQUENCE {
  -- time of week by 600s steps
  t-oa                                               INTEGER (0..1023),
  iod-a                                              INTEGER (0..15),
  sat-info-kpList                                    GANSS-SAT-Info-Almanac-KpList
}

ALM-MidiAlmanacSet ::=                              SEQUENCE {
  -- time of week by 4096s steps
  t-oa                                               INTEGER (0..147),
  sat-info-MIDIkpList                               GANSS-SAT-Info-Almanac-MIDIkpList
}

ALM-NAVKeplerianSet ::=                             SEQUENCE {
  -- time of week by 4096s steps
  t-oa                                               INTEGER (0..147),
  sat-info-NAVkpList                                GANSS-SAT-Info-Almanac-NAVkpList
}

ALM-ReducedKeplerianSet ::=                        SEQUENCE {
  -- time of week by 4096s steps
  t-oa                                               INTEGER (0..147),
  sat-info-REDkpList                               GANSS-SAT-Info-Almanac-REDkpList
}

AuxInfoGANSS-ID1 ::=                                SEQUENCE (SIZE (1..maxGANSSSat)) OF AuxInfoGANSS-ID1-element

AuxInfoGANSS-ID1-element ::=                       SEQUENCE {
  svID                                               INTEGER(0..63),
  signalsAvailable                                  BIT STRING (SIZE(8))
}

AuxInfoGANSS-ID3 ::=                                SEQUENCE (SIZE (1.. maxGANSSSat)) OF AuxInfoGANSS-ID3-element

AuxInfoGANSS-ID3-element ::=                      SEQUENCE {
  svID                                               INTEGER (0..63),
  signalsAvailable                                  BIT STRING (SIZE (8)),
  channelNumber                                     INTEGER (-7..13)
}

AverageRLC-BufferPayload ::=                       ENUMERATED {
  pla0, pla4, pla8, pla16, pla32,
  pla64, pla128, pla256, pla512,
  pla1024, pla2k, pla4k, pla8k, pla16k,
  pla32k, pla64k, pla128k, pla256k,
  pla512k, pla1024k, spare12, spare11,
  spare10, spare9, spare8, spare7, spare6,
  spare5, spare4, spare3, spare2, spare1 }

AzimuthAndElevation ::=                            SEQUENCE {
  -- Actual value azimuth = IE value * 11.25 + IE value of azimuthLSB * 0.703125 degrees
  azimuth                                            INTEGER (0..31),
  -- Actual value elevation = IE value * 11.25 + IE value of elevationLSB * 0.703125 degrees
  elevation                                          INTEGER (0..7)
}

AzimuthAndElevation-va40ext ::=                     SEQUENCE {
  azimuthLSB                                         INTEGER (0..15),
  elevationLSB                                       INTEGER (0..15)
}

```

```

AzimuthAndElevation-r10 ::= SEQUENCE {
    -- Actual value azimuth = IE value * 11.25 + IE value of azimuthLSB * 0.703125 degrees
    azimuth                INTEGER (0..31),
    -- Actual value elevation = IE value * 11.25 + IE value of elevationLSB * 0.703125 degrees
    elevation              INTEGER (0..7),
    azimuthLSB             INTEGER (0..15),
    elevationLSB           INTEGER (0..15)
}

BadSatList ::=
    SEQUENCE (SIZE (1..maxSat)) OF
        INTEGER (0..63)

Frequency-Band ::=
    ENUMERATED {
        dcs1800BandUsed, pcs1900BandUsed }

BCCH-ARFCN ::=
    INTEGER (0..1023)

BDSclockModel ::=
    SEQUENCE {
        bdsAODC            BIT STRING (SIZE (5)),
        bdsToc             BIT STRING (SIZE (17)),
        bdsa0              BIT STRING (SIZE (24)),
        bdsa1              BIT STRING (SIZE (22)),
        bdsa2              BIT STRING (SIZE (11)),
        bdsTgd1           BIT STRING (SIZE (10))
    }

BDS-IGPInfoList ::= SEQUENCE (SIZE (1..maxIGPInfo)) OF SEQUENCE {
    bds-IGPNumber        INTEGER (1..320),
    bds-VerticalDelay    BIT STRING (SIZE (9)),
    bds-GIVEI            BIT STRING (SIZE (4))
}

DBDS-InfoList ::= SEQUENCE (SIZE (1..maxSgnType)) OF DBDS-Info

DBDS-Info ::= SEQUENCE {
    bds-SignalID        GANSS-Signal-Id    OPTIONAL,
    dbds-SignalInfoList DBDS-SignalInfoList
}

DBDS-SignalInfoList ::= SEQUENCE (SIZE (1..maxGANSSSat)) OF
    DBDS-SignalInfo

DBDS-SignalInfo ::= SEQUENCE {
    svID                INTEGER(0..63),
    bds-UDREI           INTEGER (0..15),
    bds-RURAI           INTEGER (0..15),
    bds-ECC-DeltaT     BIT STRING (SIZE (13))
}

BLER-MeasurementResults ::=
    SEQUENCE {
        transportChannelIdentity    TransportChannelIdentity,
        dl-TransportChannelBLER     DL-TransportChannelBLER           OPTIONAL
    }

BLER-MeasurementResultsList ::=
    SEQUENCE (SIZE (1..maxTrCH)) OF
        BLER-MeasurementResults

BLER-TransChIdList ::=
    SEQUENCE (SIZE (1..maxTrCH)) OF
        TransportChannelIdentity

BSIC-VerificationRequired ::=
    ENUMERATED {
        required, notRequired }

BSICReported ::=
    CHOICE {
        -- Value maxCellMeas is not allowed for verifiedBSIC
        verifiedBSIC        INTEGER (0..maxCellMeas),
        nonVerifiedBSIC    BCCH-ARFCN
    }

BurstModeParameters ::=
    SEQUENCE {
        burstStart          INTEGER (0..15),
        burstLength         INTEGER (10..25),
        burstFreq           INTEGER (1..16)
    }

CellDCH-ReportCriteria ::=
    CHOICE {
        intraFreqReportingCriteria    IntraFreqReportingCriteria,
        periodicalReportingCriteria    PeriodicalReportingCriteria
    }

```

```

}

CellDCH-ReportCriteria-LCR-r4 ::= CHOICE {
    intraFreqReportingCriteria    IntraFreqReportingCriteria-LCR-r4,
    periodicalReportingCriteria    PeriodicalReportingCriteria
}

CellDCHMeasOccasionPattern-LCR ::= SEQUENCE {
    patternIdentifier              INTEGER(0..maxMeasOccasionPattern-1),
    statusFlag                    ENUMERATED {
        activate, deactivate},
    measurementPurpose            BIT STRING (SIZE (5))                OPTIONAL,
    measurementOccasionPatternParameter MeasurementOccasionPatternParameter OPTIONAL
}

CellDCHMeasOccasionInfo-TDD128-r9 ::= SEQUENCE {
    cellDCHMeasOccasionSequenceList SEQUENCE (SIZE (1..maxMeasOccasionPattern)) OF
    CellDCHMeasOccasionPattern-LCR
}

-- Actual value CellIndividualOffset = IE value * 0.5
CellIndividualOffset ::= INTEGER (-20..20)

CellInfo ::= SEQUENCE {
    cellIndividualOffset          CellIndividualOffset          DEFAULT 0,
    referenceTimeDifferenceToCell ReferenceTimeDifferenceToCell OPTIONAL,
    modeSpecificInfo             CHOICE {
        fdd                      SEQUENCE {
            primaryCPICH-Info    PrimaryCPICH-Info          OPTIONAL,
            primaryCPICH-TX-Power PrimaryCPICH-TX-Power    OPTIONAL,
            readSFN-Indicator     BOOLEAN,
            tx-DiversityIndicator BOOLEAN
        },
        tdd                      SEQUENCE {
            primaryCCPCH-Info    PrimaryCCPCH-Info,
            primaryCCPCH-TX-Power PrimaryCCPCH-TX-Power    OPTIONAL,
            timeslotInfoList     TimeslotInfoList        OPTIONAL,
            readSFN-Indicator     BOOLEAN
        }
    }
}

CellInfo-r4 ::= SEQUENCE {
    cellIndividualOffset          CellIndividualOffset          DEFAULT 0,
    referenceTimeDifferenceToCell ReferenceTimeDifferenceToCell OPTIONAL,
    modeSpecificInfo             CHOICE {
        fdd                      SEQUENCE {
            primaryCPICH-Info    PrimaryCPICH-Info          OPTIONAL,
            primaryCPICH-TX-Power PrimaryCPICH-TX-Power    OPTIONAL,
            readSFN-Indicator     BOOLEAN,
            tx-DiversityIndicator BOOLEAN
        },
        tdd                      SEQUENCE {
            primaryCCPCH-Info    PrimaryCCPCH-Info-r4,
            primaryCCPCH-TX-Power PrimaryCCPCH-TX-Power    OPTIONAL,
            timeslotInfoList-r4  TimeslotInfoList-r4      OPTIONAL,
            readSFN-Indicator     BOOLEAN
        }
    }
}

CellInfo-LCR-r8-ext ::= SEQUENCE {
    cellSelectionReselectionInfo CellSelectReselectInfoMC-RSCP OPTIONAL
}

CellInfo-r9 ::= SEQUENCE {
    cellIndividualOffset          CellIndividualOffset          DEFAULT 0,
    referenceTimeDifferenceToCell ReferenceTimeDifferenceToCell OPTIONAL,
    modeSpecificInfo             CHOICE {
        fdd                      SEQUENCE {
            primaryCPICH-Info    PrimaryCPICH-Info          OPTIONAL,
            primaryCPICH-TX-Power PrimaryCPICH-TX-Power    OPTIONAL,
            readSFN-Indicator     BOOLEAN,
            tx-DiversityIndicator BOOLEAN
        },
        tdd                      SEQUENCE {
            primaryCCPCH-Info    PrimaryCCPCH-Info-r4,

```

```

        primaryCCPCH-TX-Power      PrimaryCCPCH-TX-Power      OPTIONAL,
        timeslotInfoList          TimeslotInfoList-r4      OPTIONAL,
        readSFN-Indicator          BOOLEAN
    },
},
-- For 1.28 Mcps TDD, cellSelectionReselectionInfo is optional present when sent
-- in Measurement Control.For FDD, this IE is not needed.
cellSelectionReselectionInfo      CellSelectReselectInfoMC-RSCP      OPTIONAL
}

CellInfoListToBeExcluded ::=      SEQUENCE (SIZE (1..maxExcludedDetectedSetCells )) OF
                                    PrimaryCPICH-Info

CellInfoSI-RSCP ::=                SEQUENCE {
    cellIndividualOffset            CellIndividualOffset            DEFAULT 0,
    referenceTimeDifferenceToCell    ReferenceTimeDifferenceToCell    OPTIONAL,
    modeSpecificInfo                CHOICE {
        fdd                        SEQUENCE {
            primaryCPICH-Info      PrimaryCPICH-Info              OPTIONAL,
            primaryCPICH-TX-Power   PrimaryCPICH-TX-Power          OPTIONAL,
            readSFN-Indicator       BOOLEAN,
            tx-DiversityIndicator   BOOLEAN
        },
        tdd                        SEQUENCE {
            primaryCCPCH-Info       PrimaryCCPCH-Info,
            primaryCCPCH-TX-Power   PrimaryCCPCH-TX-Power          OPTIONAL,
            timeslotInfoList        TimeslotInfoList               OPTIONAL,
            readSFN-Indicator       BOOLEAN
        }
    },
    cellSelectionReselectionInfo      CellSelectReselectInfoSIB-11-12-RSCP      OPTIONAL
}

CellInfoSI-RSCP-LCR-r4 ::=         SEQUENCE {
    cellIndividualOffset            CellIndividualOffset            DEFAULT 0,
    referenceTimeDifferenceToCell    ReferenceTimeDifferenceToCell    OPTIONAL,
    primaryCCPCH-Info              PrimaryCCPCH-Info-LCR-r4,
    primaryCCPCH-TX-Power           PrimaryCCPCH-TX-Power           OPTIONAL,
    timeslotInfoList                TimeslotInfoList-LCR-r4        OPTIONAL,
    readSFN-Indicator               BOOLEAN,
    cellSelectionReselectionInfo      CellSelectReselectInfoSIB-11-12-RSCP      OPTIONAL
}

CellInfoSI-ECN0 ::=               SEQUENCE {
    cellIndividualOffset            CellIndividualOffset            DEFAULT 0,
    referenceTimeDifferenceToCell    ReferenceTimeDifferenceToCell    OPTIONAL,
    modeSpecificInfo                CHOICE {
        fdd                        SEQUENCE {
            primaryCPICH-Info      PrimaryCPICH-Info              OPTIONAL,
            primaryCPICH-TX-Power   PrimaryCPICH-TX-Power          OPTIONAL,
            readSFN-Indicator       BOOLEAN,
            tx-DiversityIndicator   BOOLEAN
        },
        tdd                        SEQUENCE {
            primaryCCPCH-Info       PrimaryCCPCH-Info,
            primaryCCPCH-TX-Power   PrimaryCCPCH-TX-Power          OPTIONAL,
            timeslotInfoList        TimeslotInfoList               OPTIONAL,
            readSFN-Indicator       BOOLEAN
        }
    },
    cellSelectionReselectionInfo      CellSelectReselectInfoSIB-11-12-ECN0      OPTIONAL
}

CellInfoSI-ECN0-LCR-r4 ::=         SEQUENCE {
    cellIndividualOffset            CellIndividualOffset            DEFAULT 0,
    referenceTimeDifferenceToCell    ReferenceTimeDifferenceToCell    OPTIONAL,
    primaryCCPCH-Info              PrimaryCCPCH-Info-LCR-r4,
    primaryCCPCH-TX-Power           PrimaryCCPCH-TX-Power           OPTIONAL,
    timeslotInfoList                TimeslotInfoList-LCR-r4        OPTIONAL,
    readSFN-Indicator               BOOLEAN,
    cellSelectionReselectionInfo      CellSelectReselectInfoSIB-11-12-ECN0      OPTIONAL
}

CellInfoSI-HCS-RSCP ::=            SEQUENCE {
    cellIndividualOffset            CellIndividualOffset            DEFAULT 0,
    referenceTimeDifferenceToCell    ReferenceTimeDifferenceToCell    OPTIONAL,
    modeSpecificInfo                CHOICE {
        fdd                        SEQUENCE {

```

```

        primaryCPICH-Info          PrimaryCPICH-Info          OPTIONAL,
        primaryCPICH-TX-Power      PrimaryCPICH-TX-Power     OPTIONAL,
        readSFN-Indicator          BOOLEAN,
        tx-DiversityIndicator      BOOLEAN
    },
    tdd
        primaryCCPCH-Info          PrimaryCCPCH-Info,
        primaryCCPCH-TX-Power      PrimaryCCPCH-TX-Power     OPTIONAL,
        timeslotInfoList          TimeslotInfoList         OPTIONAL,
        readSFN-Indicator          BOOLEAN
    }
},
cellSelectionReselectionInfo      CellSelectReselectInfoSIB-11-12-HCS-RSCP  OPTIONAL
}

CellInfoSI-HCS-RSCP-LCR-r4 ::= SEQUENCE {
    cellIndividualOffset          CellIndividualOffset      DEFAULT 0,
    referenceTimeDifferenceToCell ReferenceTimeDifferenceToCell OPTIONAL,
    primaryCCPCH-Info            PrimaryCCPCH-Info-LCR-r4,
    primaryCCPCH-TX-Power        PrimaryCCPCH-TX-Power     OPTIONAL,
    timeslotInfoList             TimeslotInfoList-LCR-r4  OPTIONAL,
    readSFN-Indicator            BOOLEAN,
    cellSelectionReselectionInfo CellSelectReselectInfoSIB-11-12-HCS-RSCP  OPTIONAL
}

CellInfoSI-HCS-ECN0 ::= SEQUENCE {
    cellIndividualOffset          CellIndividualOffset      DEFAULT 0,
    referenceTimeDifferenceToCell ReferenceTimeDifferenceToCell OPTIONAL,
    modeSpecificInfo             CHOICE {
        fdd
            primaryCPICH-Info          PrimaryCPICH-Info          OPTIONAL,
            primaryCPICH-TX-Power      PrimaryCPICH-TX-Power     OPTIONAL,
            readSFN-Indicator          BOOLEAN,
            tx-DiversityIndicator      BOOLEAN
        },
        tdd
            primaryCCPCH-Info          PrimaryCCPCH-Info,
            primaryCCPCH-TX-Power      PrimaryCCPCH-TX-Power     OPTIONAL,
            timeslotInfoList          TimeslotInfoList         OPTIONAL,
            readSFN-Indicator          BOOLEAN
        }
    },
    cellSelectionReselectionInfo      CellSelectReselectInfoSIB-11-12-HCS-ECN0  OPTIONAL
}

CellInfoSI-HCS-ECN0-LCR-r4 ::= SEQUENCE {
    cellIndividualOffset          CellIndividualOffset      DEFAULT 0,
    referenceTimeDifferenceToCell ReferenceTimeDifferenceToCell OPTIONAL,
    primaryCCPCH-Info            PrimaryCCPCH-Info-LCR-r4,
    primaryCCPCH-TX-Power        PrimaryCCPCH-TX-Power     OPTIONAL,
    timeslotInfoList             TimeslotInfoList-LCR-r4  OPTIONAL,
    readSFN-Indicator            BOOLEAN,
    cellSelectionReselectionInfo CellSelectReselectInfoSIB-11-12-HCS-ECN0  OPTIONAL
}

CellMeasuredResults ::= SEQUENCE {
    cellIdentity                  CellIdentity              OPTIONAL,
    -- dummy is not used in this version of the specification, it should
    -- not be sent and if received it should be ignored.
    dummy                         SFN-SFN-ObsTimeDifference          OPTIONAL,
    cellSynchronisationInfo       CellSynchronisationInfo    OPTIONAL,
    modeSpecificInfo              CHOICE {
        fdd
            primaryCPICH-Info          PrimaryCPICH-Info,
            cpich-Ec-N0                CPICH-Ec-N0              OPTIONAL,
            cpich-RSCP                  CPICH-RSCP                OPTIONAL,
            pathloss                    Pathloss                  OPTIONAL
        },
        tdd
            cellParametersID           CellParametersID,
            proposedTGSN               TGSN                      OPTIONAL,
            primaryCCPCH-RSCP          PrimaryCCPCH-RSCP         OPTIONAL,
            pathloss                    Pathloss                  OPTIONAL,
            timeslotISCP-List          TimeslotISCP-List        OPTIONAL
        }
    }
}

```



```

-- The IE is created in order to add missing DeltaRSCPPerCell IE from Rel-5.
CellMeasuredResults-r9 ::= SEQUENCE {
  cellIdentity CellIdentity OPTIONAL,
  cellSynchronisationInfo CellSynchronisationInfo OPTIONAL,
  modeSpecificInfo CHOICE {
    fdd SEQUENCE {
      primaryCPICH-Info PrimaryCPICH-Info,
      cpich-Ec-N0 CPICH-Ec-N0 OPTIONAL,
      cpich-RSCP CPICH-RSCP OPTIONAL,
      deltaRSCPPerCell DeltaRSCPPerCell OPTIONAL,
      pathloss Pathloss OPTIONAL
    },
    tdd SEQUENCE {
      cellParametersID CellParametersID,
      proposedTGSN TGSN OPTIONAL,
      primaryCCPCH-RSCP PrimaryCCPCH-RSCP OPTIONAL,
      pathloss Pathloss OPTIONAL,
      timeslotISCP-List TimeslotISCP-List OPTIONAL
    }
  }
}

CellMeasuredResults-v920ext ::= SEQUENCE {
  csgIdentity CSG-Identity OPTIONAL,
  csgMemberIndication ENUMERATED { member } OPTIONAL
}

CellMeasuredResults-vc50ext ::= SEQUENCE {
  csg-MemberPLMNList CSG-MemberPLMNList OPTIONAL
}

CellMeasurementEventResults ::= CHOICE {
  fdd SEQUENCE (SIZE (1..maxCellMeas)) OF
    PrimaryCPICH-Info,
  tdd SEQUENCE (SIZE (1..maxCellMeas)) OF
    PrimaryCCPCH-Info
}

CellMeasurementEventResultsOnSecULFreq ::= CHOICE {
  fdd SEQUENCE (SIZE (1.. maxCellMeasOnSecULFreq)) OF
    PrimaryCPICH-Info,
  spare NULL
}

CellMeasurementEventResults-LCR-r4 ::= SEQUENCE (SIZE (1..maxCellMeas)) OF
  PrimaryCCPCH-Info-LCR-r4

CellReportingQuantities ::= SEQUENCE {
  -- dummy is not used in this version of the specification
  -- and if received it should be ignored.
  dummy SFN-SFN-OTD-Type,
  cellIdentity-reportingIndicator BOOLEAN,
  cellSynchronisationInfoReportingIndicator BOOLEAN,
  modeSpecificInfo CHOICE {
    fdd SEQUENCE {
      cpich-Ec-N0-reportingIndicator BOOLEAN,
      cpich-RSCP-reportingIndicator BOOLEAN,
      pathloss-reportingIndicator BOOLEAN
    },
    tdd SEQUENCE {
      timeslotISCP-reportingIndicator BOOLEAN,
      proposedTGSN-ReportingRequired BOOLEAN,
      primaryCCPCH-RSCP-reportingIndicator BOOLEAN,
      pathloss-reportingIndicator BOOLEAN
    }
  }
}

CellSelectReselectInfoMC-RSCP ::= SEQUENCE {
  q-OffsetS-N Q-OffsetS-N DEFAULT 0,
  maxAllowedUL-TX-Power MaxAllowedUL-TX-Power OPTIONAL,
  hcs-NeighbouringCellInformation-RSCP HCS-NeighbouringCellInformation-RSCP OPTIONAL,
  modeSpecificInfo CHOICE {
    fdd SEQUENCE {
      q-QualMin Q-QualMin OPTIONAL,
      q-RxlevMin Q-RxlevMin OPTIONAL
    },
  }
}

```

```

        tdd                SEQUENCE {
            q-RxlevMin      Q-RxlevMin                OPTIONAL
        },
        gsm                SEQUENCE {
            q-RxlevMin      Q-RxlevMin                OPTIONAL
        }
    }
}

CellSelectReselectInfoSIB-11-12 ::= SEQUENCE {
    q-Offset1S-N           Q-OffsetS-N                DEFAULT 0,
    q-Offset2S-N           Q-OffsetS-N                OPTIONAL,
    maxAllowedUL-TX-Power  MaxAllowedUL-TX-Power      OPTIONAL,
    hcs-NeighbouringCellInformation-RSCP  HCS-NeighbouringCellInformation-RSCP  OPTIONAL,
    modeSpecificInfo      CHOICE {
        fdd                SEQUENCE {
            q-QualMin      Q-QualMin                OPTIONAL,
            q-RxlevMin     Q-RxlevMin                OPTIONAL
        },
        tdd                SEQUENCE {
            q-RxlevMin     Q-RxlevMin                OPTIONAL
        },
        gsm                SEQUENCE {
            q-RxlevMin     Q-RxlevMin                OPTIONAL
        }
    }
}

CellSelectReselectInfoSIB-11-12-RSCP ::= SEQUENCE {
    q-OffsetS-N           Q-OffsetS-N                DEFAULT 0,
    maxAllowedUL-TX-Power  MaxAllowedUL-TX-Power      OPTIONAL,
    modeSpecificInfo      CHOICE {
        fdd                SEQUENCE {
            q-QualMin      Q-QualMin                OPTIONAL,
            q-RxlevMin     Q-RxlevMin                OPTIONAL
        },
        tdd                SEQUENCE {
            q-RxlevMin     Q-RxlevMin                OPTIONAL
        },
        gsm                SEQUENCE {
            q-RxlevMin     Q-RxlevMin                OPTIONAL
        }
    }
}

CellSelectReselectInfoSIB-11-12-ECNO ::= SEQUENCE {
    q-Offset1S-N           Q-OffsetS-N                DEFAULT 0,
    q-Offset2S-N           Q-OffsetS-N                DEFAULT 0,
    maxAllowedUL-TX-Power  MaxAllowedUL-TX-Power      OPTIONAL,
    modeSpecificInfo      CHOICE {
        fdd                SEQUENCE {
            q-QualMin      Q-QualMin                OPTIONAL,
            q-RxlevMin     Q-RxlevMin                OPTIONAL
        },
        tdd                SEQUENCE {
            q-RxlevMin     Q-RxlevMin                OPTIONAL
        },
        gsm                SEQUENCE {
            q-RxlevMin     Q-RxlevMin                OPTIONAL
        }
    }
}

CellSelectReselectInfoSIB-11-12-HCS-RSCP ::= SEQUENCE {
    q-OffsetS-N           Q-OffsetS-N                DEFAULT 0,
    maxAllowedUL-TX-Power  MaxAllowedUL-TX-Power      OPTIONAL,
    hcs-NeighbouringCellInformation-RSCP  HCS-NeighbouringCellInformation-RSCP  OPTIONAL,
    modeSpecificInfo      CHOICE {
        fdd                SEQUENCE {
            q-QualMin      Q-QualMin                OPTIONAL,
            q-RxlevMin     Q-RxlevMin                OPTIONAL
        },
        tdd                SEQUENCE {
            q-RxlevMin     Q-RxlevMin                OPTIONAL
        },
        gsm                SEQUENCE {

```

```

    }
    }
}

CellSelectReselectInfoSIB-11-12-HCS-ECN0 ::= SEQUENCE {
    q-Offset1S-N          Q-OffsetS-N          DEFAULT 0,
    q-Offset2S-N          Q-OffsetS-N          DEFAULT 0,
    maxAllowedUL-TX-Power MaxAllowedUL-TX-Power OPTIONAL,
    hcs-NeighbouringCellInformation-ECN0
        HCS-NeighbouringCellInformation-ECN0 OPTIONAL,
    modeSpecificInfo
        CHOICE {
            fdd
                SEQUENCE {
                    q-QualMin          Q-QualMin          OPTIONAL,
                    q-RxlevMin         Q-RxlevMin         OPTIONAL
                },
            tdd
                SEQUENCE {
                    q-RxlevMin         Q-RxlevMin         OPTIONAL
                },
            gsm
                SEQUENCE {
                    q-RxlevMin         Q-RxlevMin         OPTIONAL
                }
        }
}

CellSelectReselectInfo-v590ext ::= SEQUENCE {
    deltaQrxlevmin        DeltaQrxlevmin        OPTIONAL,
    deltaQhcs             DeltaRSCP             OPTIONAL
}

CellSelectReselectInfoPCHFACH-v5b0ext ::= SEQUENCE {
    q-Hyst-1-S-PCH        Q-Hyst-S-Fine          OPTIONAL,
    q-Hyst-1-S-FACH       Q-Hyst-S-Fine          OPTIONAL,
    q-Hyst-2-S-PCH        Q-Hyst-S-Fine          OPTIONAL,
    q-Hyst-2-S-FACH       Q-Hyst-S-Fine          OPTIONAL,
    t-Reselection-S-PCH   T-Reselection-S        OPTIONAL,
    t-Reselection-S-FACH T-Reselection-S-Fine    OPTIONAL
}

CellSelectReselectInfoTreselectionScaling-v5c0ext ::= SEQUENCE {
    -- For speed detection, the same HCS parameters are utilised
    non-HCS-t-CR-Max      T-CRMax              OPTIONAL,
    speedDependentScalingFactor
        SpeedDependentScalingFactor OPTIONAL,
    interFrequencyTreselectionScalingFactor
        TreselectionScalingFactor   OPTIONAL,
    interRATTreselectionScalingFactor
        TreselectionScalingFactor   OPTIONAL
}

CellsForInterFreqMeasList ::= SEQUENCE (SIZE (1..maxCellMeas)) OF
    InterFreqCellID

CellsForInterFreqMeasList-r12 ::= SEQUENCE (SIZE (1..maxCellMeas-ext)) OF
    InterFreqCellID-r12

CellsForInterRATMeasList ::= SEQUENCE (SIZE (1..maxCellMeas)) OF
    InterRATCellID

CellsForIntraFreqMeasList ::= SEQUENCE (SIZE (1..maxCellMeas)) OF
    IntraFreqCellID

CellsForIntraFreqMeasListOnSecULFreq ::= SEQUENCE (SIZE (1..maxCellMeasOnSecULFreq)) OF
    IntraFreqCellIDOnSecULFreq

CellSynchronisationInfo ::= SEQUENCE {
    modeSpecificInfo
        CHOICE {
            fdd
                SEQUENCE {
                    countC-SFN-Frame-difference
                        CountC-SFN-Frame-difference OPTIONAL,
                    tm
                        INTEGER(0..38399)
                },
            tdd
                SEQUENCE {
                    countC-SFN-Frame-difference
                        CountC-SFN-Frame-difference OPTIONAL
                }
        }
}

CellToReport ::= SEQUENCE {
    bsicReported
        BSICReported
}

```

```

CellToReportList ::= SEQUENCE (SIZE (1..maxCellMeas)) OF
    CellToReport

CNAVclockModel ::= SEQUENCE {
    cnavToc BIT STRING (SIZE (11)),
    cnavTop BIT STRING (SIZE (11)),
    cnavURA0 BIT STRING (SIZE (5)),
    cnavURA1 BIT STRING (SIZE (3)),
    cnavURA2 BIT STRING (SIZE (3)),
    cnavAf2 BIT STRING (SIZE (10)),
    cnavAf1 BIT STRING (SIZE (20)),
    cnavAf0 BIT STRING (SIZE (26)),
    cnavTgd BIT STRING (SIZE (13)),
    cnavISCl1cp BIT STRING (SIZE (13)) OPTIONAL,
    cnavISCl1cd BIT STRING (SIZE (13)) OPTIONAL,
    cnavISCl1ca BIT STRING (SIZE (13)) OPTIONAL,
    cnavISCl2c BIT STRING (SIZE (13)) OPTIONAL,
    cnavISCl5i5 BIT STRING (SIZE (13)) OPTIONAL,
    cnavISCl5q5 BIT STRING (SIZE (13)) OPTIONAL
}

CodePhaseSearchWindow ::= ENUMERATED {
    w1023, w1, w2, w3, w4, w6, w8,
    w12, w16, w24, w32, w48, w64,
    w96, w128, w192 }

CountC-SFN-Frame-difference ::= SEQUENCE {
    -- Actual value countC-SFN-High = IE value * 256
    countC-SFN-High INTEGER(0..15),
    off INTEGER(0..255)
}

-- SPARE: CPICH-Ec-No, Max = 49
-- Values above Max are spare
CPICH-Ec-N0 ::= INTEGER (0..63)

-- SPARE: CPICH- RSCP, Max = 91
-- Values above Max are spare
CPICH-RSCP ::= INTEGER (0..127)

CPICH-Ec-N0-RSCP ::= SEQUENCE {
    cpich-Ec-N0 CPICH-Ec-N0,
    cpich-RSCP CPICH-RSCP
}

CSG-MemberPLMNList ::= SEQUENCE(SIZE (1..6)) OF
    PLMN-Identity

CSGCellInfo ::= SEQUENCE {
    modeSpecificInfo CHOICE {
        fdd SEQUENCE {
            startPSC PrimaryCPICH-Info,
            numberOfPSCs INTEGER (1..512)
        },
        tdd NULL
    }
}

CSGCellInfoList ::= SEQUENCE (SIZE (1..maxMeasCSGRange)) OF
    CSGCellInfo

CSGInterFreqCellInfo ::= SEQUENCE {
    frequencyInfo FrequencyInfo,
    cSGInterFreqCellInfoListperFreq CSGCellInfoList
}

CSGInterFreqCellInfoList ::= SEQUENCE (SIZE (1..maxFreq)) OF
    CSGInterFreqCellInfo

CSGIntraFreqCellInfoList ::= CSGCellInfoList

CSGProximityDetection ::= SEQUENCE {
    uTRACSGProximityDetec ENUMERATED { enable } OPTIONAL,
    e-UTRACSGProximityDetec ENUMERATED { enable } OPTIONAL
}

CSGProximityIndication ::= SEQUENCE {
    cSGproximityInd ENUMERATED {entering, leaving },

```

```

radioAccessTechnology          CHOICE {
  uTRA                          SEQUENCE {
    CSGFrequencyInfoUTRA      FrequencyInfo
  },
  e-UTRA                        SEQUENCE {
    CSGFrequencyInfoEUTRA    EARFCN
  }
}

CSGProximityIndication-vb50ext ::= SEQUENCE {
  CSGFrequencyInfoEUTRA      EARFCNExtension          OPTIONAL
}

DataBitAssistance ::= SEQUENCE {
  ganss-signal-id            GANSS-Signal-Id,
  data-bits                  BIT STRING (SIZE (1..1024))
}

DataBitAssistanceList ::= SEQUENCE (SIZE (1..maxGANSSSat)) OF
  DataBitAssistanceSat

DataBitAssistanceSat ::= SEQUENCE {
  satID                      INTEGER(0..63),
  dataBitAssistanceSgnList   DataBitAssistanceSgnList
}

DataBitAssistanceSgnList ::= SEQUENCE (SIZE (1..maxSgnType)) OF
  DataBitAssistance

DeltaPRC ::= INTEGER (-127..127)

--Actual value DeltaQrxlevmin = IE value * 2
DeltaQrxlevmin ::= INTEGER (-2..-1)

DeltaRSCP ::= INTEGER (-5..-1)

DeltaRSCPPerCell ::= SEQUENCE {
  deltaRSCP                  DeltaRSCP          OPTIONAL
}

-- Actual value DeltaRRC = IE value * 0.032
DeltaRRC ::= INTEGER (-7..7)

DeltaUT1 ::= SEQUENCE {
  b1                          BIT STRING (SIZE (11)),
  b2                          BIT STRING (SIZE (10))
}

DGANSSInfo ::= SEQUENCE {
  ganssSignalId              GANSS-Signal-Id          OPTIONAL,
  ganssStatusHealth         GANSS-Status-Health,
  dgansssignalInformationList DGANSSSignalInformationList OPTIONAL
}

DGANSSInfo-r9 ::= SEQUENCE {
  ganssSignalId              GANSS-Signal-Id          OPTIONAL,
  ganssStatusHealth         GANSS-Status-Health,
  dgansssignalInformationList DGANSSSignalInformationList-r9 OPTIONAL
}

DGANSSInfo-v920ext ::= SEQUENCE {
  dgansssignalInformationList DGANSSSignalInformationList-v920ext OPTIONAL
}

DGANSSInfoList ::= SEQUENCE (SIZE (1..maxSgnType)) OF
  DGANSSInfo

DGANSSInfoList-r9 ::= SEQUENCE (SIZE (1..maxSgnType)) OF
  DGANSSInfo-r9

DGANSSInfoList-v920ext ::= SEQUENCE (SIZE (1..maxSgnType)) OF
  DGANSSInfo-v920ext

DGANSSSignalInformation ::= SEQUENCE {
  satId                      INTEGER (0..63),
  iode-dganss               BIT STRING (SIZE (10)),
  udre                       UDRE,

```

```

    ganss-prc                INTEGER (-2047..2047),      -- scale factor 0.32
    ganss-rrc                INTEGER (-127..127)       -- scale factor 0.032
}

DGANSSSignalInformation-r9 ::= SEQUENCE {
    satId                    INTEGER (0..63),
    iode-dganss              BIT STRING (SIZE (10)),
    udre                     UDRE,
    ganss-prc                INTEGER (-2047..2047),    -- scale factor 0.32
    ganss-rrc                INTEGER (-127..127),      -- scale factor 0.032
    udreGrowthRate           UDREGrowthRate           OPTIONAL,
    udreValidityTime         UDREValidityTime         OPTIONAL
}

DGANSSSignalInformation-v920ext ::= SEQUENCE {
    udreGrowthRate           UDREGrowthRate           OPTIONAL,
    udreValidityTime         UDREValidityTime         OPTIONAL
}

DGANSSSignalInformationList ::= SEQUENCE (SIZE (1..maxGANSSSat)) OF
    DGANSSSignalInformation

DGANSSSignalInformationList-r9 ::= SEQUENCE (SIZE (1..maxGANSSSat)) OF
    DGANSSSignalInformation-r9

DGANSSSignalInformationList-v920ext ::= SEQUENCE (SIZE (1..maxGANSSSat)) OF
    DGANSSSignalInformation-v920ext

DGANSS-Sig-Id-Req ::= BIT STRING (SIZE (8))

DGPS-CorrectionSatInfo ::= SEQUENCE {
    satID                    SatID,
    iode                     IOE,
    udre                     UDRE,
    prc                      PRC,
    rrc                      RRC,
    -- dummy1 and dummy2 are not used in this version of the specification and should be ignored.
    dummy1                   DeltaPRC,
    dummy2                   DeltaRRC,
    -- dummy3 and dummy4 are not used in this version of the specification. They should not
    -- be sent and if received they should be ignored.
    dummy3                   DeltaPRC                 OPTIONAL,
    dummy4                   DeltaRRC                 OPTIONAL
}

DGPS-CorrectionSatInfo-r9 ::= SEQUENCE {
    satID                    SatID,
    iode                     IOE,
    udre                     UDRE,
    prc                      PRC,
    rrc                      RRC,
    udreGrowthRate           UDREGrowthRate           OPTIONAL,
    udreValidityTime         UDREValidityTime         OPTIONAL
}

DGPS-CorrectionSatInfo-v920ext ::= SEQUENCE {
    udreGrowthRate           UDREGrowthRate           OPTIONAL,
    udreValidityTime         UDREValidityTime         OPTIONAL
}

DGPS-CorrectionSatInfoList ::= SEQUENCE (SIZE (1..maxSat)) OF
    DGPS-CorrectionSatInfo

DGPS-CorrectionSatInfoList-r9 ::= SEQUENCE (SIZE (1..maxSat)) OF
    DGPS-CorrectionSatInfo-r9

DGPS-CorrectionSatInfoList-v920ext ::= SEQUENCE (SIZE (1..maxSat)) OF
    DGPS-CorrectionSatInfo-v920ext

DiffCorrectionStatus ::= ENUMERATED {
    udre-1-0, udre-0-75, udre-0-5, udre-0-3,
    udre-0-2, udre-0-1, noData, invalidData }

DL-TransportChannelBLER ::= INTEGER (0..63)

DopplerUncertainty ::= ENUMERATED {
    hz12-5, hz25, hz50, hz100, hz200,

```

```

        spare3, spare2, spare1 }

DopplerUncertaintyExt ::=          ENUMERATED {
        hz300, hz400, hz500, hz600, noInformation,
        spare3, spare2, spare1 }

EllipsoidPoint ::=                SEQUENCE {
    latitudeSign          ENUMERATED { north, south },
    latitude              INTEGER (0..8388607),
    longitude            INTEGER (-8388608..8388607)
}

EllipsoidPointAltitude ::=        SEQUENCE {
    latitudeSign          ENUMERATED { north, south },
    latitude              INTEGER (0..8388607),
    longitude            INTEGER (-8388608..8388607),
    altitudeDirection    ENUMERATED {height, depth},
    altitude              INTEGER (0..32767)
}

EllipsoidPointAltitudeEllipsoide ::= SEQUENCE {
    latitudeSign          ENUMERATED { north, south },
    latitude              INTEGER (0..8388607),
    longitude            INTEGER (-8388608..8388607),
    altitudeDirection    ENUMERATED {height, depth},
    altitude              INTEGER (0..32767),
    uncertaintySemiMajor INTEGER (0..127),
    uncertaintySemiMinor INTEGER (0..127),
    -- Actual value orientationMajorAxis = IE value * 2
    orientationMajorAxis INTEGER (0..89),
    uncertaintyAltitude  INTEGER (0..127),
    confidence            INTEGER (0..100)
}

EllipsoidPointUncertCircle ::=    SEQUENCE {
    latitudeSign          ENUMERATED { north, south },
    latitude              INTEGER (0..8388607),
    longitude            INTEGER (-8388608..8388607),
    uncertaintyCode       INTEGER (0..127)
}

EllipsoidPointUncertEllipse ::=   SEQUENCE {
    latitudeSign          ENUMERATED { north, south },
    latitude              INTEGER (0..8388607),
    longitude            INTEGER (-8388608..8388607),
    uncertaintySemiMajor INTEGER (0..127),
    uncertaintySemiMinor INTEGER (0..127),
    -- Actual value orientationMajorAxis = IE value * 2
    orientationMajorAxis INTEGER (0..89),
    confidence            INTEGER (0..100)
}

EnvironmentCharacterisation ::=   ENUMERATED {
    possibleHeavyMultipathNLOS,
    lightMultipathLOS,
    notDefined,
    spare }

EUTRA-CSGMemberPLMNList ::= SEQUENCE(SIZE (1..5)) OF
    PLMN-Identity

Eutra-EventResult ::=            SEQUENCE {
    earfcn                EARFCN,
    reportedCells         SEQUENCE (SIZE (1..maxReportedEUTRACellPerFreq)) OF
        EUTRA-PhysicalCellIdentity
}

EUTRA-EventResult-vb50ext ::=    SEQUENCE {
    earfcn                EARFCNExtension OPTIONAL
}

EUTRA-EventResult-vc50ext ::=    SEQUENCE {
    earfcn                EARFCNExtension2,

```

```

    reportedCells                SEQUENCE (SIZE (1..maxReportedEUTRACellPerFreq)) OF
    }                             EUTRA-PhysicalCellIdentity

Eutra-EventResultList ::=        SEQUENCE (SIZE (1..maxReportedEUTRAFreqs)) OF
    Eutra-EventResult

EUTRA-EventResultList-vb50ext ::= SEQUENCE (SIZE (1..maxReportedEUTRAFreqs)) OF
    EUTRA-EventResult-vb50ext

EUTRA-EventResultList-vc50ext ::= SEQUENCE (SIZE (1..maxReportedEUTRAFreqs-ext)) OF
    EUTRA-EventResult-vc50ext

EUTRA-EventResults ::=          SEQUENCE {
    eventID                      EventIDInterRAT,
    eutra-EventResultsList       Eutra-EventResultList
}

EUTRA-EventResults-vb50ext ::=  SEQUENCE {
    eutra-EventResultsList       EUTRA-EventResultList-vb50ext
}

EUTRA-EventResults-vc50ext ::=  SEQUENCE {
    eutra-EventResultsList       EUTRA-EventResultList-vc50ext
}

EUTRA-EventResultsForCELLFACH ::= SEQUENCE {
    eutraFrequencyIndicator       BIT STRING (SIZE (maxNumEUTRAFreqs-FACH))
}

EUTRA-EventResultsForCELLFACH-vc50ext ::= SEQUENCE {
    eutraFrequencyIndicator       BIT STRING (SIZE (maxNumEUTRAFreqs-FACH))
}

EUTRA-FrequencyAndPriorityInfo ::= SEQUENCE {
    earfcn                      EARFCN,
    measurementBandwidth        EUTRA-MeasurementBandwidth           OPTIONAL,
    priority                    INTEGER (0..maxPrio-1),
    -- Actual value = IE value * 2
    qRxLevMinEUTRA              INTEGER (-70..-22),
    -- Actual value = IE value * 2
    threshXhigh                 INTEGER (0..31),
    -- Actual value = IE value * 2
    threshXlow                  INTEGER (0..31),
    eutra-blackListedCellList   EUTRA-BlacklistedCellPerFreqList   OPTIONAL,
    eutraDetection               BOOLEAN
}

EUTRA-FrequencyAndPriorityInfo-v920ext ::= SEQUENCE {
    qqualMinEUTRA               INTEGER (-34..-3)           OPTIONAL,
    threshXhigh2                 INTEGER (0..31)           OPTIONAL,
    threshXlow2                  INTEGER (0..31)           OPTIONAL
}

EUTRA-FrequencyAndPriorityInfo-vb50ext ::= SEQUENCE {
    qqualMinEUTRA-WB             INTEGER (-34..-3)           OPTIONAL
}

EUTRA-FrequencyAndPriorityInfo-vc50ext ::= SEQUENCE {
    qqualMinRSRQ-OnAllSymbols    INTEGER (-34..-3)           OPTIONAL,
    reducedMeasurementPerformance ENUMERATED {true}         OPTIONAL
}

EUTRA-FrequencyAndPriorityInfoExtension-vb50ext ::= SEQUENCE {
    earfcn                      EARFCNExtension,
    measurementBandwidth        EUTRA-MeasurementBandwidth           OPTIONAL,
    priority                    INTEGER (0..maxPrio-1),
    -- Actual value = IE value * 2
    qRxLevMinEUTRA              INTEGER (-70..-22),
    -- Actual value = IE value * 2
    threshXhigh                 INTEGER (0..31),
    -- Actual value = IE value * 2
    threshXlow                  INTEGER (0..31),
    qqualMinEUTRA               INTEGER (-34..-3)           OPTIONAL,
    threshXhigh2                 INTEGER (0..31)           OPTIONAL,
    threshXlow2                  INTEGER (0..31)           OPTIONAL,
    eutra-blackListedCellList   EUTRA-BlacklistedCellPerFreqList   OPTIONAL,
    eutraDetection               BOOLEAN
}

```



```

}

EUTRA-FrequencyAndPriorityInfoExtension-vb80ext ::= SEQUENCE {
    qqualMinEUTRA-WB          INTEGER (-34..-3)          OPTIONAL
}

EUTRA-FrequencyAndPriorityInfoExtension-vc50ext ::= SEQUENCE {
    qqualMinRSRQ-OnAllSymbols    INTEGER (-34..-3)          OPTIONAL,
    reducedMeasurementPerformance ENUMERATED {true}          OPTIONAL
}

EUTRA-FrequencyAndPriorityInfoExtensionList ::= SEQUENCE (SIZE (1..maxNumEUTRAFreqs)) OF
    EUTRA-FrequencyAndPriorityInfoExtension-vb50ext

EUTRA-FrequencyAndPriorityInfoExtensionList-vb80ext ::= SEQUENCE (SIZE (1..maxNumEUTRAFreqs)) OF
    EUTRA-FrequencyAndPriorityInfoExtension-vb80ext

EUTRA-FrequencyAndPriorityInfoExtensionList-vc50ext ::= SEQUENCE (SIZE (1..maxNumEUTRAFreqs)) OF
    EUTRA-FrequencyAndPriorityInfoExtension-vc50ext

EUTRA-FrequencyAndPriorityInfoList ::= SEQUENCE (SIZE (1..maxNumEUTRAFreqs)) OF
    EUTRA-FrequencyAndPriorityInfo

EUTRA-FrequencyAndPriorityInfoList-v920ext ::= SEQUENCE (SIZE (1..maxNumEUTRAFreqs)) OF
    EUTRA-FrequencyAndPriorityInfo-v920ext

EUTRA-FrequencyAndPriorityInfoList-vb50ext ::= SEQUENCE (SIZE (1..maxNumEUTRAFreqs)) OF
    EUTRA-FrequencyAndPriorityInfo-vb50ext

EUTRA-FrequencyAndPriorityInfoList-vc50ext ::= SEQUENCE (SIZE (1..maxNumEUTRAFreqs)) OF
    EUTRA-FrequencyAndPriorityInfo-vc50ext

EUTRA-FrequencyList ::=
    SEQUENCE {
        eutraFrequencyRemoval    EUTRA-FrequencyRemoval,
        eutraNewFrequencies      EUTRA-FrequencyInfoList          OPTIONAL
    }

EUTRA-FrequencyList-r9 ::=
    SEQUENCE {
        eutraFrequencyRemoval    EUTRA-FrequencyRemoval,
        eutraNewFrequencies      EUTRA-FrequencyInfoList          OPTIONAL,
        eutraSIAcquisition       EUTRA-SIAcquisition              OPTIONAL
    }

EUTRA-FrequencyList-r11 ::=
    SEQUENCE {
        eutraFrequencyRemoval    EUTRA-FrequencyRemoval-r11,
        eutraNewFrequencies      EUTRA-FrequencyInfoList-r11      OPTIONAL,
        eutraSIAcquisition       EUTRA-SIAcquisition-r11          OPTIONAL
    }

EUTRA-FrequencyList-r12 ::=
    SEQUENCE {
        eutraFrequencyRemoval    EUTRA-FrequencyRemoval-r11,
        eutraNewFrequencies      EUTRA-FrequencyInfoList-r12      OPTIONAL,
        eutraSIAcquisition       EUTRA-SIAcquisition-r11          OPTIONAL,
        rsrqMeasOnAllSymbols      BOOLEAN                          OPTIONAL
    }

EUTRA-SIAcquisition ::=
    SEQUENCE {
        earfcn                    EARFCN,
        physicalCellIdentity      EUTRA-PhysicalCellIdentity
    }

EUTRA-SIAcquisition-r11 ::=
    SEQUENCE {
        -- If the IE earfcn is set to a value of 65535, then the EARFCN
        -- value for that instance shall be read from the IE earfcnExt.
        earfcn                    EARFCN,
        earfcnExt                  EARFCNExtension                  OPTIONAL,
        physicalCellIdentity      EUTRA-PhysicalCellIdentity
    }

EUTRA-MeasuredCells ::=
    SEQUENCE {
        physicalCellIdentity      EUTRA-PhysicalCellIdentity,
        rSRP                      INTEGER (0..97)                  OPTIONAL,
        rSRQ                      INTEGER (0..33)                  OPTIONAL
    }

Eutra-MeasuredResult ::=
    SEQUENCE {
        earfcn                    EARFCN,
        measuredEUTRACells       SEQUENCE (SIZE (1..maxReportedEUTRACellPerFreq)) OF
    }

```

```

        EUTRA-MeasuredCells
    }

    EUTRA-MeasuredResult-vb50ext ::= SEQUENCE {
        earfcn                                EARFCNExtension                                OPTIONAL
    }

    Eutra-MeasuredResultList ::= SEQUENCE (SIZE (1..maxReportedEUTRAFreqs)) OF
        Eutra-MeasuredResult

    EUTRA-MeasuredResultList-vb50ext ::= SEQUENCE (SIZE (1..maxReportedEUTRAFreqs)) OF
        EUTRA-MeasuredResult-vb50ext

    EUTRA-MeasuredResults ::= SEQUENCE {
        eutraMeasuredResultList              Eutra-MeasuredResultList
    }

    EUTRA-MeasuredResults-vb50ext ::= SEQUENCE {
        eutraMeasuredResultList              EUTRA-MeasuredResultList-vb50ext
    }

    EUTRA-MeasuredCells-v920ext ::= SEQUENCE {
        eutraSIacquisitionResults            EUTRA-SIacquisitionResults
    }

    EUTRA-MeasuredCells-vc50ext ::= SEQUENCE {
        physicalCellIdentity                  EUTRA-PhysicalCellIdentity OPTIONAL,
        rSRP                                  INTEGER (0..97)              OPTIONAL,
        rSRQ                                  INTEGER (0..33)             OPTIONAL,
        eutraSIacquisitionResults            EUTRA-SIacquisitionResults-vc50ext,
        rsrqExtension                         INTEGER (-30..46)          OPTIONAL
    }

    Eutra-MeasuredResult-v920ext ::= SEQUENCE {
        measuredEUTRACells-v920ext           SEQUENCE (SIZE (1..maxReportedEUTRACellPerFreq)) OF
        EUTRA-MeasuredCells-v920ext
    }

    Eutra-MeasuredResult-vc50ext ::= SEQUENCE {
        earfcn                                EARFCNExtension2                OPTIONAL,
        measuredEUTRACells-vc50ext           SEQUENCE (SIZE (1..maxReportedEUTRACellPerFreq)) OF
        EUTRA-MeasuredCells-vc50ext
    }

    Eutra-MeasuredResultList-v920ext ::= SEQUENCE (SIZE (1..maxReportedEUTRAFreqs)) OF
        Eutra-MeasuredResult-v920ext

    Eutra-MeasuredResultList-vc50ext ::= SEQUENCE (SIZE (1..maxReportedEUTRAFreqs)) OF
        Eutra-MeasuredResult-vc50ext

    EUTRA-MeasuredResults-v920ext ::= SEQUENCE {
        eutraMeasuredResultList-v920ext      Eutra-MeasuredResultList-v920ext
    }

    EUTRA-MeasuredResults-vc50ext ::= SEQUENCE {
        eutraMeasuredResultList-vc50ext      Eutra-MeasuredResultList-vc50ext
    }

    EUTRA-SIacquisitionResults ::= SEQUENCE {
        cgiInfo                               SEQUENCE {
            plmn-Identity                     PLMN-Identity,
            cellIdentity                       BIT STRING (SIZE (28)),
            trackingAreaCode                   BIT STRING (SIZE (16))
        },
        csgIdentity                           CSG-Identity                                OPTIONAL,
        csgMemberIndication                   ENUMERATED { member }                       OPTIONAL
    }

    EUTRA-SIacquisitionResults-vc50ext ::= SEQUENCE {
        cgiInfo                               CGI-Info                                    OPTIONAL,
        csgIdentity                           CSG-Identity                                OPTIONAL,
        csgMemberIndication                   ENUMERATED { member }                       OPTIONAL,
        csgMemberPLMN                         EUTRA-CSGMemberPLMNList                    OPTIONAL,
        primaryPLMNSuitable                   ENUMERATED { true }                          OPTIONAL
    }

    CGI-Info ::= SEQUENCE {
        plmn-Identity                         PLMN-Identity,
    }

```

```

        cellIdentity                BIT STRING (SIZE (28)),
        trackingAreaCode            BIT STRING (SIZE (16))
    }

EUTRA-FrequencyRemoval ::= CHOICE {
    removeAllFrequencies           NULL,
    removeSomeFrequencies         SEQUENCE (SIZE (1..maxNumEUTRAFreqs)) OF
        EARFCN,
    removeNoFrequencies           NULL
}

EUTRA-FrequencyRemoval-r11 ::= CHOICE {
    removeAllFrequencies           NULL,
    removeSomeFrequencies         FrequenciesToRemove,
    removeNoFrequencies           NULL
}

EUTRA-FrequencyInfoList ::= SEQUENCE (SIZE (1..maxNumEUTRAFreqs)) OF
    EUTRA-FrequencyInfo

EUTRA-FrequencyInfoList-r11 ::= SEQUENCE (SIZE (1..maxNumEUTRAFreqs)) OF
    EUTRA-FrequencyInfo-r11

EUTRA-FrequencyInfoList-r12 ::= SEQUENCE (SIZE (1..maxNumEUTRAFreqs)) OF
    EUTRA-FrequencyInfo-r12

EUTRA-FrequencyInfo ::= SEQUENCE {
    earfcn                         EARFCN,
    measurementBandwidth           EUTRA-MeasurementBandwidth           OPTIONAL,
    eutra-blackListedCellList     EUTRA-BlacklistedCellPerFreqList     OPTIONAL
}

EUTRA-FrequencyInfo-r11 ::= SEQUENCE {
-- If the IE earfcn is set to a value of 65535, then the EARFCN
-- value for that instance shall be read from the IE earfcnExt.
    earfcn                         EARFCN,
    earfcnExt                       EARFCNExtension           OPTIONAL,
    measurementBandwidth           EUTRA-MeasurementBandwidth           OPTIONAL,
    eutra-blackListedCellList     EUTRA-BlacklistedCellPerFreqList     OPTIONAL,
    widebandRSRQMeasurements       ENUMERATED {true}           OPTIONAL
}

EUTRA-FrequencyInfo-r12 ::= SEQUENCE {
    earfcn                         EARFCNExtension2,
    reducedMeasurementPerformance   ENUMERATED {true}           OPTIONAL,
    measurementBandwidth           EUTRA-MeasurementBandwidth           OPTIONAL,
    eutra-blackListedCellList     EUTRA-BlacklistedCellPerFreqList     OPTIONAL,
    widebandRSRQMeasurements       ENUMERATED {true}           OPTIONAL
}

EUTRA-FrequencyRACHReportingInfo ::= SEQUENCE {
    eutra-FrequencyListIndicator    BIT STRING (SIZE (maxNumEUTRAFreqs)),
    eutra-FrequencyRepQuantityRACH  ENUMERATED { rsrp, rsrq },
    eutra-FrequencyRACHReportingThreshold  INTEGER (0..97),
    rachReportingPriority            ENUMERATED {
        intraEUTRAInter, interIntraEUTRA,
        interEUTRAIntra, eUTRAIntraInter,
        eUTRAInterIntra, spare3,
        spare2, spare1
    } OPTIONAL
}

EUTRA-FrequencyRACHReportingInfo-vc50ext ::= SEQUENCE {
    eutra-FrequencyListIndicator    BIT STRING (SIZE (maxNumEUTRAFreqs)),
    eutra-FrequencyRACHReportingThresholdExtension  INTEGER (-30..-1)           OPTIONAL
}

EUTRA-MeasurementBandwidth ::= ENUMERATED { mbw6, mbw15, mbw25, mbw50, mbw75, mbw100 }

EUTRA-MeasurementForCELLFACH ::= SEQUENCE {
    eutraFrequenciesForMeasurement SEQUENCE (SIZE (1..maxNumEUTRAFreqs-FACH)) OF
        EARFCNRange,
    reportCriteria                  ENUMERATED { event-triggeredreporting,
        periodicalReporting },
    measurementQuantity             ENUMERATED { rsrp, rsrq },
    reportingThreshold              INTEGER (0..97)
}

EUTRA-MeasurementForCELLFACH-r12 ::= SEQUENCE {
    eutraFrequenciesForMeasurement SEQUENCE (SIZE (1..maxNumEUTRAFreqs-FACH-ext)) OF

```

```

        reportCriteria                EARFCNRange,
                                     ENUMERATED { event-triggeredreporting,
                                                  periodicalReporting },
        measurementQuantity            ENUMERATED { rsrp, rsrq },
        reportingThreshold              INTEGER (-30..97)
    }
FrequenciesToRemove ::= SEQUENCE (SIZE (1..maxNumEUTRAFreqs)) OF
    EARFCNRange

Event1a ::= SEQUENCE {
    triggeringCondition                TriggeringCondition2,
    reportingRange                    ReportingRange,
    forbiddenAffectCellList           ForbiddenAffectCellList OPTIONAL,
    w                                  W,
    reportDeactivationThreshold        ReportDeactivationThreshold,
    reportingAmount                    ReportingAmount,
    reportingInterval                  ReportingInterval
}

Event1a-r4 ::= SEQUENCE {
    triggeringCondition                TriggeringCondition2,
    reportingRange                    ReportingRange,
    forbiddenAffectCellList           ForbiddenAffectCellList-r4 OPTIONAL,
    w                                  W,
    reportDeactivationThreshold        ReportDeactivationThreshold,
    reportingAmount                    ReportingAmount,
    reportingInterval                  ReportingInterval
}

Event1a-OnSecULFreq-r9 ::= SEQUENCE {
    triggeringCondition                TriggeringCondition2,
    reportingRange                    ReportingRange,
    forbiddenAffectCellListOnSecULFreq ForbiddenAffectCellListOnSecULFreq OPTIONAL,
    w                                  W,
    reportDeactivationThreshold        ReportDeactivationThreshold,
    reportingAmount                    ReportingAmount,
    reportingInterval                  ReportingInterval
}

Event1a-LCR-r4 ::= SEQUENCE {
    triggeringCondition                TriggeringCondition2,
    reportingRange                    ReportingRange,
    forbiddenAffectCellList           ForbiddenAffectCellList-LCR-r4 OPTIONAL,
    w                                  W,
    reportDeactivationThreshold        ReportDeactivationThreshold,
    reportingAmount                    ReportingAmount,
    reportingInterval                  ReportingInterval
}

Event1b ::= SEQUENCE {
    triggeringCondition                TriggeringCondition1,
    reportingRange                    ReportingRange,
    forbiddenAffectCellList           ForbiddenAffectCellList OPTIONAL,
    w                                  W
}

Event1b-r4 ::= SEQUENCE {
    triggeringCondition                TriggeringCondition1,
    reportingRange                    ReportingRange,
    forbiddenAffectCellList           ForbiddenAffectCellList-r4 OPTIONAL,
    w                                  W
}

Event1b-r7 ::= SEQUENCE {
    triggeringCondition                TriggeringCondition1,
    reportingRange                    ReportingRange,
    forbiddenAffectCellList           ForbiddenAffectCellList-r4 OPTIONAL,
    w                                  W,
    periodicReportingInfo-1b          PeriodicReportingInfo-1b OPTIONAL
}

Event1b-OnSecULFreq-r9 ::= SEQUENCE {
    triggeringCondition                TriggeringCondition1,
    reportingRange                    ReportingRange,
    forbiddenAffectCellListOnSecULFreq ForbiddenAffectCellListOnSecULFreq OPTIONAL,
    w                                  W,
    periodicReportingInfo-1b          PeriodicReportingInfo-1b OPTIONAL
}

```

```

Event1b-LCR-r4 ::=
    triggeringCondition
    reportingRange
    forbiddenAffectCellList
    w
}
SEQUENCE {
    TriggeringCondition1,
    ReportingRange,
    ForbiddenAffectCellList-LCR-r4
    W
    OPTIONAL,
}

Event1c ::=
    replacementActivationThreshold
    reportingAmount
    reportingInterval
}
SEQUENCE {
    ReplacementActivationThreshold,
    ReportingAmount,
    ReportingInterval
}

Event1d ::=
    triggeringCondition
    useCIO
}
SEQUENCE {
    TriggeringCondition2
    BOOLEAN
    OPTIONAL,
    OPTIONAL
}

Event1e ::=
    triggeringCondition
    thresholdUsedFrequency
}
SEQUENCE {
    TriggeringCondition2,
    ThresholdUsedFrequency
}

Event1e-r6 ::=
    triggeringCondition
    thresholdUsedFrequency
}
SEQUENCE {
    TriggeringCondition2,
    ThresholdUsedFrequency-r6
}

Event1f ::=
    triggeringCondition
    thresholdUsedFrequency
}
SEQUENCE {
    TriggeringCondition1,
    ThresholdUsedFrequency
}

Event1f-r6 ::=
    triggeringCondition
    thresholdUsedFrequency
}
SEQUENCE {
    TriggeringCondition1,
    ThresholdUsedFrequency-r6
}

Event1j-r6 ::=
    replacementActivationThreshold
    reportingAmount
    reportingInterval
}
SEQUENCE {
    ReplacementActivationThreshold,
    ReportingAmount,
    ReportingInterval
}

Event2a ::=
    -- dummy is not used in this version of the specification and should be ignored
    dummy
    usedFreqW
    hysteresis
    timeToTrigger
    reportingCellStatus
    nonUsedFreqParameterList
}
SEQUENCE {
    Threshold,
    W,
    HysteresisInterFreq,
    TimeToTrigger,
    ReportingCellStatus
    NonUsedFreqParameterList
    OPTIONAL,
    OPTIONAL
}

Event2a-r6 ::=
    usedFreqW
    hysteresis
    timeToTrigger
    reportingCellStatus
    nonUsedFreqParameterList
}
SEQUENCE {
    W,
    HysteresisInterFreq,
    TimeToTrigger,
    ReportingCellStatus
    NonUsedFreqWList-r6
    OPTIONAL,
    OPTIONAL
}

Event2a-r10 ::=
    usedFreqW
    hysteresis
    timeToTrigger
    reportingCellStatus
    nonUsedFreqParameterList
}
SEQUENCE {
    W,
    HysteresisInterFreq,
    TimeToTrigger,
    ReportingCellStatus-r10
    NonUsedFreq2aParameterList-r10
    OPTIONAL,
    OPTIONAL
}

Event2a-r11 ::=
    usedFreqW
    hysteresis
    timeToTrigger
    reportingCellStatus
    nonUsedFreqParameterList
}
SEQUENCE {
    W,
    HysteresisInterFreq,
    TimeToTrigger,
    ReportingCellStatus-r10
    NonUsedFreq2aParameterList-r11
    OPTIONAL,
    OPTIONAL
}

```

```

Event2b ::=
    usedFreqThreshold          SEQUENCE {
                                Threshold,
                                usedFreqW          W,
                                hysteresis         HysteresisInterFreq,
                                timeToTrigger      TimeToTrigger,
                                reportingCellStatus ReportingCellStatus          OPTIONAL,
                                nonUsedFreqParameterList NonUsedFreqParameterList  OPTIONAL
    }

Event2b-r6 ::=
    usedFreqThreshold          SEQUENCE {
                                Threshold-r6,
                                usedFreqW          W,
                                hysteresis         HysteresisInterFreq,
                                timeToTrigger      TimeToTrigger,
                                reportingCellStatus ReportingCellStatus          OPTIONAL,
                                nonUsedFreqParameterList NonUsedFreqParameterList-r6  OPTIONAL
    }

Event2b-r10 ::=
    usedFreqThreshold          SEQUENCE {
                                Threshold-r6,
                                usedFreqW          W,
                                hysteresis         HysteresisInterFreq,
                                timeToTrigger      TimeToTrigger,
                                reportingCellStatus ReportingCellStatus-r10        OPTIONAL,
                                nonUsedFreqParameterList NonUsedFreqParameterList-r10  OPTIONAL
    }

Event2b-r11 ::=
    usedFreqThreshold          SEQUENCE {
                                Threshold-r6,
                                usedFreqW          W,
                                hysteresis         HysteresisInterFreq,
                                timeToTrigger      TimeToTrigger,
                                reportingCellStatus ReportingCellStatus-r10        OPTIONAL,
                                nonUsedFreqParameterList NonUsedFreqParameterList-r11  OPTIONAL
    }

Event2c ::=
    hysteresis                 SEQUENCE {
                                HysteresisInterFreq,
                                timeToTrigger      TimeToTrigger,
                                reportingCellStatus ReportingCellStatus          OPTIONAL,
                                nonUsedFreqParameterList NonUsedFreqParameterList  OPTIONAL
    }

Event2c-r6 ::=
    hysteresis                 SEQUENCE {
                                HysteresisInterFreq,
                                timeToTrigger      TimeToTrigger,
                                reportingCellStatus ReportingCellStatus          OPTIONAL,
                                nonUsedFreqParameterList NonUsedFreqParameterList-r6  OPTIONAL
    }

Event2c-r10 ::=
    hysteresis                 SEQUENCE {
                                HysteresisInterFreq,
                                timeToTrigger      TimeToTrigger,
                                reportingCellStatus ReportingCellStatus-r10        OPTIONAL,
                                nonUsedFreqParameterList NonUsedFreqParameterList-r10  OPTIONAL
    }

Event2c-r11 ::=
    hysteresis                 SEQUENCE {
                                HysteresisInterFreq,
                                timeToTrigger      TimeToTrigger,
                                reportingCellStatus ReportingCellStatus-r10        OPTIONAL,
                                nonUsedFreqParameterList NonUsedFreqParameterList-r11  OPTIONAL
    }

Event2d ::=
    usedFreqThreshold          SEQUENCE {
                                Threshold,
                                usedFreqW          W,
                                hysteresis         HysteresisInterFreq,
                                timeToTrigger      TimeToTrigger,
                                reportingCellStatus ReportingCellStatus          OPTIONAL
    }

Event2d-r6 ::=
    usedFreqThreshold          SEQUENCE {
                                Threshold-r6,
                                usedFreqW          W,
                                hysteresis         HysteresisInterFreq,
                                timeToTrigger      TimeToTrigger,

```

```

    reportingCellStatus          ReportingCellStatus          OPTIONAL
  }

Event2d-r10 ::=                SEQUENCE {
    usedFreqThreshold           Threshold-r6,
    usedFreqW                   W,
    hysteresis                  HysteresisInterFreq,
    timeToTrigger               TimeToTrigger,
    reportingCellStatus         ReportingCellStatus-r10          OPTIONAL
  }

Event2e ::=                    SEQUENCE {
    hysteresis                  HysteresisInterFreq,
    timeToTrigger               TimeToTrigger,
    reportingCellStatus         ReportingCellStatus          OPTIONAL,
    nonUsedFreqParameterList   NonUsedFreqParameterList    OPTIONAL
  }

Event2e-r6 ::=                SEQUENCE {
    hysteresis                  HysteresisInterFreq,
    timeToTrigger               TimeToTrigger,
    reportingCellStatus         ReportingCellStatus          OPTIONAL,
    nonUsedFreqParameterList   NonUsedFreqParameterList-r6  OPTIONAL
  }

Event2e-r10 ::=               SEQUENCE {
    hysteresis                  HysteresisInterFreq,
    timeToTrigger               TimeToTrigger,
    reportingCellStatus         ReportingCellStatus-r10      OPTIONAL,
    nonUsedFreqParameterList   NonUsedFreqParameterList-r10  OPTIONAL
  }

Event2e-r11 ::=               SEQUENCE {
    hysteresis                  HysteresisInterFreq,
    timeToTrigger               TimeToTrigger,
    reportingCellStatus         ReportingCellStatus-r10      OPTIONAL,
    nonUsedFreqParameterList   NonUsedFreqParameterList-r11  OPTIONAL
  }

Event2f ::=                    SEQUENCE {
    usedFreqThreshold           Threshold,
    usedFreqW                   W,
    hysteresis                  HysteresisInterFreq,
    timeToTrigger               TimeToTrigger,
    reportingCellStatus         ReportingCellStatus          OPTIONAL
  }

Event2f-r6 ::=                SEQUENCE {
    usedFreqThreshold           Threshold-r6,
    usedFreqW                   W,
    hysteresis                  HysteresisInterFreq,
    timeToTrigger               TimeToTrigger,
    reportingCellStatus         ReportingCellStatus          OPTIONAL
  }

Event2f-r10 ::=               SEQUENCE {
    usedFreqThreshold           Threshold-r6,
    usedFreqW                   W,
    hysteresis                  HysteresisInterFreq,
    timeToTrigger               TimeToTrigger,
    reportingCellStatus         ReportingCellStatus-r10      OPTIONAL
  }

Event2g ::=                    SEQUENCE {
    hysteresis                  HysteresisInterFreq,
    timeToTrigger               TimeToTrigger,
    reportingCellStatus         ReportingCellStatus-r10      OPTIONAL,
    useCIO                      ENUMERATED {true}          OPTIONAL
  }

Event3a ::=                    SEQUENCE {
    thresholdOwnSystem          Threshold,
    w                            W,
    thresholdOtherSystem        Threshold,
    hysteresis                  Hysteresis,
    timeToTrigger               TimeToTrigger,
    reportingCellStatus         ReportingCellStatus          OPTIONAL
  }

```

```

}

Event3b ::=
    thresholdOtherSystem
    hysteresis
    timeToTrigger
    reportingCellStatus
SEQUENCE {
    Threshold,
    Hysteresis,
    TimeToTrigger,
    ReportingCellStatus
OPTIONAL
}

Event3c ::=
    thresholdOtherSystem
    hysteresis
    timeToTrigger
    reportingCellStatus
SEQUENCE {
    Threshold,
    Hysteresis,
    TimeToTrigger,
    ReportingCellStatus
OPTIONAL
}

Event3d ::=
    hysteresis
    timeToTrigger
    reportingCellStatus
SEQUENCE {
    Hysteresis,
    TimeToTrigger,
    ReportingCellStatus
OPTIONAL
}

Event3a-r12 ::=
    thresholdOwnSystem
    w
    thresholdOtherSystem
    hysteresis
    timeToTrigger
    reportingCellStatus
SEQUENCE {
    Threshold,
    W,
    Threshold-r12,
    Hysteresis,
    TimeToTrigger,
    ReportingCellStatus
OPTIONAL
}

Event3b-r12 ::=
    thresholdOtherSystem
    hysteresis
    timeToTrigger
    reportingCellStatus
SEQUENCE {
    Threshold-r12,
    Hysteresis,
    TimeToTrigger,
    ReportingCellStatus
OPTIONAL
}

Event3c-r12 ::=
    thresholdOtherSystem
    hysteresis
    timeToTrigger
    reportingCellStatus
SEQUENCE {
    Threshold-r12,
    Hysteresis,
    TimeToTrigger,
    ReportingCellStatus
OPTIONAL
}

EventIDInterFreq ::=
ENUMERATED {
    e2a, e2b, e2c, e2d, e2e, e2f, e2g, spare1 }

EventIDInterRAT ::=
ENUMERATED {
    e3a, e3b, e3c, e3d }

EventIDIntraFreq ::=
ENUMERATED {
    e1a, e1b, e1c, e1d, e1e,
    e1f, e1g, e1h, e1i, e1j,
    spare6, spare5, spare4, spare3, spare2,
    spare1 }

EventResults ::=
    intraFreqEventResults
    interFreqEventResults
    interRATEEventResults
    trafficVolumeEventResults
    qualityEventResults
    ue-InternalEventResults
    ue-positioning-MeasurementEventResults
    spare
CHOICE {
    IntraFreqEventResults,
    InterFreqEventResults,
    InterRATEEventResults,
    TrafficVolumeEventResults,
    QualityEventResults,
    UE-InternalEventResults,
    UE-Positioning-MeasurementEventResults,
    NULL
}

EventResults-v770ext ::=
    ue-positioning-MeasurementEventResults
CHOICE {
    UE-Positioning-MeasurementEventResults-v770ext
}

EventResults-v860ext ::=
    ue-positioning-MeasurementEventResults
CHOICE {
    UE-Positioning-MeasurementEventResults-v860ext
}

```



```

EventResults-va40ext ::= CHOICE {
    interFreqEventResults      InterFreqEventResults-va40ext
}

EventResultsOnSecUlFreq ::= SEQUENCE {
    intraFreqEventResults      IntraFreqEventResultsOnSecUlFreq
}

ExtraDoppler ::= SEQUENCE {
    -- Doppler 1st order term, -0.2..+0.1 m/s2
    -- ( = -42..+21 with 1/210 m/s2 resolution)
    dopplerFirstOrder          INTEGER (-42.. 21),
    dopplerUncertainty          ENUMERATED { dopU40, dopU20, dopU10, dopU5, dopU2-5,
                                           spare3, spare2, spare1 }
}

ExtraDopplerExtension ::= SEQUENCE {
    -- Doppler 1st order term, -0.2..+0.1 m/s2
    -- ( = -42..+21 with 1/210 m/s2 resolution)
    dopplerFirstOrder          INTEGER (-42.. 21),
    dopplerUncertaintyExt      ENUMERATED { dopU60, dopU80, dopU100, dopU120,
                                           noInformation, spare3, spare2, spare1 }
}

ExtraDopplerInfo ::= SEQUENCE {
    -- Actual value doppler1stOrder = IE value * 0.023
    doppler1stOrder            INTEGER (-42..21),
    dopplerUncertainty          DopplerUncertainty
}

ExtraDopplerInfoExtension ::= SEQUENCE {
    -- Actual value doppler1stOrder = IE value * 0.023
    doppler1stOrder            INTEGER (-42..21),
    dopplerUncertaintyExt      DopplerUncertaintyExt
}

FACH-MeasurementOccasionInfo ::= SEQUENCE {
    fACH-meas-occasion-coeff    INTEGER (1..12)                OPTIONAL,
    inter-freq-FDD-meas-ind     BOOLEAN,
    -- inter-freq-TDD-meas-ind is for 3.84Mcps TDD and 7.68 Mcps TDD. For 1.28Mcps TDD, the IE in
    -- FACH-MeasurementOccasionInfo-LCR-r4-ext is used.
    inter-freq-TDD-meas-ind     BOOLEAN,
    inter-RAT-meas-ind          SEQUENCE (SIZE (1..maxOtherRAT)) OF
                                RAT-Type                        OPTIONAL
}

FACH-MeasurementOccasionInfo-LCR-r4-ext ::= SEQUENCE {
    inter-freq-TDD128-meas-ind  BOOLEAN
}

FilterCoefficient ::= ENUMERATED {
    fc0, fc1, fc2, fc3, fc4, fc5,
    fc6, fc7, fc8, fc9, fc11, fc13,
    fc15, fc17, fc19, spare1 }

FilteredUEPowerHeadroomReportInfo ::= SEQUENCE {
    timeToTrigger               TimeToTrigger,
    hysteresis1                  Hysteresis                    OPTIONAL,
    hysteresis2                  Hysteresis                    OPTIONAL,
    uePowerHeadroomThreshold1    UE-PowerHeadroomThreshold    OPTIONAL,
    uePowerHeadroomThreshold2    UE-PowerHeadroomThreshold    OPTIONAL,
    filterCoefficient            FilterCoefficient              OPTIONAL
}

-- Actual value FineSFN-SFN = IE value * 0.0625
FineSFN-SFN ::= INTEGER (0..15)

ForbiddenAffectCell ::= CHOICE {
    fdd                          PrimaryCPICH-Info,
    tdd                          PrimaryCCPCH-Info
}

ForbiddenAffectCell-r4 ::= CHOICE {
    fdd                          PrimaryCPICH-Info,
    tdd                          PrimaryCCPCH-Info-r4
}

```

```

ForbiddenAffectCell-LCR-r4 ::= SEQUENCE {
    tdd PrimaryCCPCH-Info-LCR-r4
}

ForbiddenAffectCellList ::= SEQUENCE (SIZE (1..maxCellMeas)) OF
    ForbiddenAffectCell

ForbiddenAffectCellList-r4 ::= SEQUENCE (SIZE (1..maxCellMeas)) OF
    ForbiddenAffectCell-r4

ForbiddenAffectCellList-LCR-r4 ::= SEQUENCE (SIZE (1..maxCellMeas)) OF
    ForbiddenAffectCell-LCR-r4

ForbiddenAffectCellListOnSecULFreq ::= SEQUENCE (SIZE (1..maxCellMeasOnSecULFreq)) OF
    ForbiddenAffectCellOnSecULFreq

ForbiddenAffectCellOnSecULFreq ::= SEQUENCE {
    primaryCPICH PrimaryCPICH-Info
}

FreqQualityEstimateQuantity-FDD ::= ENUMERATED {
    cpich-Ec-N0,
    cpich-RSCP }

FreqQualityEstimateQuantity-TDD ::= ENUMERATED {
    primaryCCPCH-RSCP }

GanssDataBits ::= SEQUENCE {
    ganssTod INTEGER (0..86399),
    dataBitAssistance ReqDataBitAssistance
}

GANSSDecipheringKeys ::= SEQUENCE {
    currentDecipheringKey BIT STRING (SIZE (56)),
    nextDecipheringKey BIT STRING (SIZE (56))
}

GANSSGenericData ::= SEQUENCE {
    ganssId INTEGER (0..7) OPTIONAL,
    ganssTimeModelsList GANSSTimeModelsList OPTIONAL,
    uePositioningDGANSSCorrections UE-Positioning-DGANSSCorrections OPTIONAL,
    uePositioningGANSSNavigationModel UE-Positioning-GANSS-NavigationModel OPTIONAL,
    uePositioningGANSSRealTimeIntegrity UE-Positioning-GANSS-RealTimeIntegrity OPTIONAL,
    uePositioningGANSSDataBitAssistance UE-Positioning-GANSS-Data-Bit-Assistance OPTIONAL,
    uePositioningGANSSReferenceMeasurementInfo UE-Positioning-GANSS-ReferenceMeasurementInfo OPTIONAL,
    uePositioningGANSSAlmanac UE-Positioning-GANSS-Almanac OPTIONAL,
    uePositioningGANSSUTCModel UE-Positioning-GANSS-UTCModel OPTIONAL
}

GANSSGenericData-v860ext ::= SEQUENCE {
    uePositioningGANSSsbasID UE-Positioning-GANSS-SBAS-ID OPTIONAL,
    uePositioningGANSSAddNavigationModels UE-Positioning-GANSS-AddNavigationModels OPTIONAL,
    uePositioningGANSSAlmanac UE-Positioning-GANSS-Almanac-v860ext OPTIONAL,
    uePositioningGANSSAddUTCModels UE-Positioning-GANSS-AddUTCModels OPTIONAL,
    uePositioningGANSSAuxiliaryInfo UE-Positioning-GANSS-AuxiliaryInfo OPTIONAL
}

GANSSGenericData-r8 ::= SEQUENCE {
    ganssId INTEGER (0..7) OPTIONAL,
    uePositioningGANSSsbasID UE-Positioning-GANSS-SBAS-ID OPTIONAL,
    ganssTimeModelsList GANSSTimeModelsList OPTIONAL,
    uePositioningDGANSSCorrections UE-Positioning-DGANSSCorrections OPTIONAL,
    uePositioningGANSSNavigationModel UE-Positioning-GANSS-NavigationModel OPTIONAL,
    uePositioningGANSSAddNavigationModels UE-Positioning-GANSS-AddNavigationModels OPTIONAL,
    uePositioningGANSSRealTimeIntegrity UE-Positioning-GANSS-RealTimeIntegrity OPTIONAL,
    uePositioningGANSSDataBitAssistance UE-Positioning-GANSS-Data-Bit-Assistance OPTIONAL,
    uePositioningGANSSReferenceMeasurementInfo UE-Positioning-GANSS-ReferenceMeasurementInfo OPTIONAL,
    uePositioningGANSSAlmanac UE-Positioning-GANSS-Almanac-r8 OPTIONAL,
    uePositioningGANSSUTCModel UE-Positioning-GANSS-UTCModel OPTIONAL,
    uePositioningGANSSAddUTCModels UE-Positioning-GANSS-AddUTCModels OPTIONAL,
    uePositioningGANSSAuxiliaryInfo UE-Positioning-GANSS-AuxiliaryInfo OPTIONAL
}

GANSSGenericData-r9 ::= SEQUENCE {

```

```

ganssId INTEGER (0..7) OPTIONAL,
uePositiningGANSSsbasID UE-Positioning-GANSS-SBAS-ID OPTIONAL,
ganssTimeModelsList GANSSTimeModelsList OPTIONAL,
uePositioningDGANSSCorrections UE-Positioning-DGANSSCorrections-r9 OPTIONAL,
uePositioningGANSSNavigationModel UE-Positioning-GANSS-NavigationModel OPTIONAL,
uePositioningGANSSAddNavigationModels UE-Positioning-GANSS-AddNavigationModels OPTIONAL,
uePositioningGANSSRealTimeIntegrity UE-Positioning-GANSS-RealTimeIntegrity OPTIONAL,
uePositioningGANSSDataBitAssistance UE-Positioning-GANSS-Data-Bit-Assistance OPTIONAL,
uePositioningGANSSReferenceMeasurementInfo UE-Positioning-GANSS-ReferenceMeasurementInfo OPTIONAL,
uePositioningGANSSAlmanac UE-Positioning-GANSS-Almanac-r8 OPTIONAL,
uePositioningGANSSUTCModel UE-Positioning-GANSS-UTCModel OPTIONAL,
uePositioningGANSSAddUTCModels UE-Positioning-GANSS-AddUTCModels OPTIONAL,
uePositioningGANSSAuxiliaryInfo UE-Positioning-GANSS-AuxiliaryInfo OPTIONAL
}

GANSSGenericData-v920ext ::= SEQUENCE {
  uePositioningDGANSSCorrections UE-Positioning-DGANSSCorrections-v920ext OPTIONAL
}

GANSSGenericData-va40ext ::= SEQUENCE {
  ganssTimeModelsList GANSSTimeModelsList-va40ext OPTIONAL,
  uePositioningGANSSReferenceMeasurementInfo UE-Positioning-GANSS-ReferenceMeasurementInfo-va40ext OPTIONAL,
  uePositioningGANSSAlmanac UE-Positioning-GANSS-Almanac-va40ext OPTIONAL
}

GANSSGenericData-vc50ext ::= SEQUENCE {
  uePositioningDBDSCorrections UE-Positioning-DBDSCorrections OPTIONAL,
  uePositioningBDSIonoGridModel UE-Positioning-BDS-IonoGridModel OPTIONAL,
  ue-positioning-GANSS-AddNavigationModels UE-Positioning-GANSS-AddNavigationModels-vc50ext OPTIONAL,
  uePositioningGANSSReferenceMeasurementInfo UE-Positioning-GANSS-ReferenceMeasurementInfo-vc50ext OPTIONAL,
  ue-Positioning-GANSS-Almanac UE-Positioning-GANSS-Almanac-vc50ext OPTIONAL,
  ue-Positioning-GANSS-AddUTCModels UE-Positioning-GANSS-AddUTCModels-vc50ext OPTIONAL
}

GANSSGenericData-r10 ::= SEQUENCE {
  ganssId INTEGER (0..7) OPTIONAL,
  uePositiningGANSSsbasID UE-Positioning-GANSS-SBAS-ID OPTIONAL,
  ganssTimeModelsList GANSSTimeModelsList-r10 OPTIONAL,
  uePositioningDGANSSCorrections UE-Positioning-DGANSSCorrections-r9 OPTIONAL,
  uePositioningGANSSNavigationModel UE-Positioning-GANSS-NavigationModel OPTIONAL,
  uePositioningGANSSAddNavigationModels UE-Positioning-GANSS-AddNavigationModels OPTIONAL,
  uePositioningGANSSRealTimeIntegrity UE-Positioning-GANSS-RealTimeIntegrity OPTIONAL,
  uePositioningGANSSDataBitAssistance UE-Positioning-GANSS-Data-Bit-Assistance OPTIONAL,
  uePositioningGANSSReferenceMeasurementInfo UE-Positioning-GANSS-ReferenceMeasurementInfo-r10 OPTIONAL,
  uePositioningGANSSAlmanac UE-Positioning-GANSS-Almanac-r10 OPTIONAL,
  uePositioningGANSSUTCModel UE-Positioning-GANSS-UTCModel OPTIONAL,
  uePositioningGANSSAddUTCModels UE-Positioning-GANSS-AddUTCModels OPTIONAL,
  uePositioningGANSSAuxiliaryInfo UE-Positioning-GANSS-AuxiliaryInfo OPTIONAL
}

GANSSGenericData-r12 ::= SEQUENCE {
  ganssId INTEGER (0..7) OPTIONAL,
  uePositiningGANSSsbasID UE-Positioning-GANSS-SBAS-ID OPTIONAL,
  ganssTimeModelsList GANSSTimeModelsList-r10 OPTIONAL,
  uePositioningDGANSSCorrections UE-Positioning-DGANSSCorrections-r9 OPTIONAL,
  uePositioningDBDSCorrections UE-Positioning-DBDSCorrections OPTIONAL,
  uePositioningBDSIonoGridModel UE-Positioning-BDS-IonoGridModel OPTIONAL,
  uePositioningGANSSNavigationModel UE-Positioning-GANSS-NavigationModel OPTIONAL,
  uePositioningGANSSAddNavigationModels UE-Positioning-GANSS-AddNavigationModels-r12 OPTIONAL,
  uePositioningGANSSRealTimeIntegrity UE-Positioning-GANSS-RealTimeIntegrity OPTIONAL,
  uePositioningGANSSDataBitAssistance UE-Positioning-GANSS-Data-Bit-Assistance OPTIONAL,
  uePositioningGANSSReferenceMeasurementInfo UE-Positioning-GANSS-ReferenceMeasurementInfo-r12 OPTIONAL,
  uePositioningGANSSAlmanac UE-Positioning-GANSS-Almanac-r12 OPTIONAL,
  uePositioningGANSSUTCModel UE-Positioning-GANSS-UTCModel OPTIONAL
}

```

```

    uePositioningGANSSAddUTCModels          UE-Positioning-GANSS-AddUTCModels-r12      OPTIONAL,
    uePositioningGANSSAuxiliaryInfo         UE-Positioning-GANSS-AuxiliaryInfo           OPTIONAL,
}

GANSSGenericDataList ::= SEQUENCE (SIZE (1..maxGANSS)) OF
    GANSSGenericData

GANSSGenericDataList-v860ext ::= SEQUENCE (SIZE (1..maxGANSS)) OF
    GANSSGenericData-v860ext

GANSSGenericDataList-r8 ::= SEQUENCE (SIZE (1..maxGANSS)) OF
    GANSSGenericData-r8

GANSSGenericDataList-r9 ::= SEQUENCE (SIZE (1..maxGANSS)) OF
    GANSSGenericData-r9

GANSSGenericDataList-v920ext ::= SEQUENCE (SIZE (1..maxGANSS)) OF
    GANSSGenericData-v920ext

GANSSGenericDataList-va40ext ::= SEQUENCE (SIZE (1..maxGANSS)) OF
    GANSSGenericData-va40ext

GANSSGenericDataList-vc50ext ::= SEQUENCE (SIZE (1..maxGANSS)) OF
    GANSSGenericData-vc50ext

GANSSGenericDataList-r10 ::= SEQUENCE (SIZE (1..maxGANSS)) OF
    GANSSGenericData-r10

GANSSGenericDataList-r12 ::= SEQUENCE (SIZE (1..maxGANSS)) OF
    GANSSGenericData-r12

GANSSGenericMeasurementInfo ::= SEQUENCE (SIZE (1..maxGANSS)) OF SEQUENCE {
    ganssId                INTEGER (0..7)                OPTIONAL,
    ganssMeasurementSignalList GANSSMeasurementSignalList
}

GANSSGenericMeasurementInfo-v860ext ::= SEQUENCE (SIZE (1..maxGANSS)) OF SEQUENCE {
    ganssMeasurementSignalList GANSSMeasurementSignalList-v860ext
}

GANSSMeasurementParameters ::= SEQUENCE (SIZE (1..maxGANSSSat)) OF SEQUENCE {
    satId                INTEGER (0..63),
    cSurNzero            INTEGER (0..63),
    multipathIndicator   ENUMERATED { nm, low, medium, high },
    carrierQualityIndication BIT STRING (SIZE (2))        OPTIONAL,
    ganssCodePhase       INTEGER (0..2097151),
    ganssIntegerCodePhase INTEGER (0..63)                OPTIONAL,
    codePhaseRmsError    INTEGER (0..63),
    doppler              INTEGER (-32768..32767),
    adr                  INTEGER (0..33554431)            OPTIONAL
}

GANSSMeasurementParameters-v860ext ::= SEQUENCE (SIZE (1..maxGANSSSat)) OF SEQUENCE {
    ganssIntegerCodePhaseExt INTEGER (64..127)            OPTIONAL
}

GANSSMeasurementSignalList ::= SEQUENCE (SIZE (1..maxSgnType)) OF SEQUENCE {
    ganssSignalId        GANSS-Signal-Id                OPTIONAL,
    ganssCodePhaseAmbiguity INTEGER (0..31)                OPTIONAL,
    ganssMeasurementParameters GANSSMeasurementParameters
}

GANSSMeasurementSignalList-v860ext ::= SEQUENCE (SIZE (1..maxSgnType)) OF SEQUENCE {
    ganssCodePhaseAmbiguityExt INTEGER (32..127)            OPTIONAL,
    ganssMeasurementParameters GANSSMeasurementParameters-v860ext
}

GanssNavigationModelAdditionalData ::= SEQUENCE {
    ganssWeek            INTEGER (0..4095),
    ganssToe             INTEGER (0..167),
    t-toeLimit          INTEGER (0..10),
    satellitesListRelatedDataList SatellitesListRelatedDataList    OPTIONAL
}

GANSSReferenceTimeOnly ::= SEQUENCE {
    gANSS-tod           INTEGER (0..3599999),
    gANSS-timeId        INTEGER (0..7)                OPTIONAL,
    gANSS-tod-uncertainty INTEGER (0..127)            OPTIONAL
}

```

```

}

GanssReqGenericData ::= SEQUENCE {
    ganssId INTEGER (0..7) OPTIONAL,
    ganssRealTimeIntegrity BOOLEAN,
    ganssDifferentialCorrection DGANSS-Sig-Id-Req OPTIONAL,
    ganssAlmanac BOOLEAN,
    ganssNavigationModel BOOLEAN,
    ganssTimeModelGNSS-GNSS BIT STRING (SIZE (8)) OPTIONAL,
    ganssReferenceMeasurementInfo BOOLEAN,
    ganssDataBits GanssDataBits OPTIONAL,
    ganssUTCModel BOOLEAN,
    ganssNavigationModelAdditionalData GanssNavigationModelAdditionalData OPTIONAL
}

GanssReqGenericData-v860ext ::= SEQUENCE {
    sbasId UE-Positioning-GANSS-SBAS-ID OPTIONAL,
    ganssAddNavigationModel ENUMERATED { true } OPTIONAL,
    ganssAddUTCModel ENUMERATED { true } OPTIONAL,
    ganssAuxInfo ENUMERATED { true } OPTIONAL,
    ganssAddADchoices SEQUENCE {
        orbitModelID INTEGER (0..7) OPTIONAL,
        clockModelID INTEGER (0..7) OPTIONAL,
        utcModelID INTEGER (0..7) OPTIONAL,
        almanacModelID INTEGER (0..7) OPTIONAL
    } OPTIONAL
}

GanssReqGenericData-vc50ext ::= SEQUENCE {
    bdsIonoGridModelReq ENUMERATED { true } OPTIONAL,
    bdsCorrectionsReq DGANSS-Sig-Id-Req OPTIONAL
}

GanssRequestedGenericAssistanceDataList ::= SEQUENCE (SIZE (1..maxGANSS)) OF
    GanssReqGenericData

GanssRequestedGenericAssistanceDataList-v860ext ::= SEQUENCE (SIZE (1..maxGANSS)) OF
    GanssReqGenericData-v860ext

GanssRequestedGenericAssistanceDataList-vc50ext ::= SEQUENCE (SIZE (1..maxGANSS)) OF
    GanssReqGenericData-vc50ext

GANSSSatelliteInformation ::= SEQUENCE {
    ganssSatId INTEGER (0..63),
    dopplerZeroOrder INTEGER (-2048..2047), -- scale factor 0.5m/s
    extraDoppler ExtraDoppler OPTIONAL,
    codePhase INTEGER (0..1023),
    integerCodePhase INTEGER (0..127),
    codePhaseSearchWindow BIT STRING (SIZE (5)),
    azimuthandElevation AzimuthAndElevation OPTIONAL
}

GANSSSatelliteInformation-va40ext ::= SEQUENCE {
    azimuthandElevation AzimuthAndElevation-va40ext OPTIONAL
}

GANSSSatelliteInformation-r10 ::= SEQUENCE {
    ganssSatId INTEGER (0..63),
    dopplerZeroOrder INTEGER (-2048..2047), -- scale factor 0.5m/s
    extraDoppler ExtraDoppler OPTIONAL,
    codePhase INTEGER (0..1023),
    integerCodePhase INTEGER (0..127),
    codePhaseSearchWindow BIT STRING (SIZE (5)),
    azimuthandElevation AzimuthAndElevation-r10 OPTIONAL
}

GANSSSatelliteInformation-vc50ext ::= SEQUENCE {
    extraDopplerExtension ExtraDopplerExtension OPTIONAL
}

GANSSSatelliteInformation-r12 ::= SEQUENCE {
    ganssSatId INTEGER (0..63),
    dopplerZeroOrder INTEGER (-2048..2047), -- scale factor 0.5m/s
    extraDoppler ExtraDoppler OPTIONAL,
    -- If the extraDopplerExtension is present, the extraDoppler should not be present
    extraDopplerExtension ExtraDopplerExtension OPTIONAL,
    codePhase INTEGER (0..1023),
    integerCodePhase INTEGER (0..127),

```

```

    codePhaseSearchWindow          BIT STRING (SIZE (5)),
    azimuthandElevation            AzimuthAndElevation-r10          OPTIONAL
}

GANSSSatelliteInformationList ::= SEQUENCE (SIZE (1..maxGANSSSat)) OF
    GANSSSatelliteInformation

GANSSSatelliteInformationList-va40ext ::= SEQUENCE (SIZE (1..maxGANSSSat)) OF
    GANSSSatelliteInformation-va40ext

GANSSSatelliteInformationList-r10 ::= SEQUENCE (SIZE (1..maxGANSSSat)) OF
    GANSSSatelliteInformation-r10

GANSSSatelliteInformationList-vc50ext ::= SEQUENCE (SIZE (1..maxGANSSSat)) OF
    GANSSSatelliteInformation-vc50ext

GANSSSatelliteInformationList-r12 ::= SEQUENCE (SIZE (1..maxGANSSSat)) OF
    GANSSSatelliteInformation-r12

GANSSTimeModelsList ::= SEQUENCE (SIZE (1..maxGANSS-1)) OF
    UE-Positioning-GANSS-TimeModel

GANSSTimeModelsList-va40ext ::= SEQUENCE (SIZE (1..maxGANSS-1)) OF
    UE-Positioning-GANSS-TimeModel-va40ext

GANSSTimeModelsList-r10 ::= SEQUENCE (SIZE (1..maxGANSS-1)) OF
    UE-Positioning-GANSS-TimeModel-r10

GANSS-SAT-Info-Almanac-BDSkp ::= SEQUENCE {
    svID          INTEGER(0..63),
    bdsAlmToa     BIT STRING (SIZE (8)),
    bdsAlmSqrtA   BIT STRING (SIZE (24)),
    bdsAlmE       BIT STRING (SIZE (17)),
    bdsAlmW       BIT STRING (SIZE (24)),
    bdsAlmM0      BIT STRING (SIZE (24)),
    bdsAlmOmega0  BIT STRING (SIZE (24)),
    bdsAlmOmegaDot BIT STRING (SIZE (17)),
    bdsAlmDeltaI  BIT STRING (SIZE (16)),
    bdsAlmA0      BIT STRING (SIZE (11)),
    bdsAlmA1      BIT STRING (SIZE (11)),
    bdsSvHealth   BIT STRING (SIZE(9))    OPTIONAL
}

GANSS-SAT-Info-Almanac-GLOkp ::= SEQUENCE {
    gloAlmNA      BIT STRING (SIZE (11)),
    gloAlmNA      BIT STRING (SIZE (5)),
    gloAlmHA      BIT STRING (SIZE (5)),
    gloAlmLambdaA BIT STRING (SIZE (21)),
    gloAlmTlambdaA BIT STRING (SIZE (21)),
    gloAlmDeltaIA BIT STRING (SIZE (18)),
    gloAlmDeltaTA BIT STRING (SIZE (22)),
    gloAlmDeltaTdotA BIT STRING (SIZE (7)),
    gloAlmEpsilonA BIT STRING (SIZE (15)),
    gloAlmOmegaA  BIT STRING (SIZE (16)),
    gloAlmTauA    BIT STRING (SIZE (10)),
    gloAlmCA      BIT STRING (SIZE (1)),
    gloAlmMA      BIT STRING (SIZE (2))    OPTIONAL
}

GANSS-SAT-Info-Almanac-Kp ::= SEQUENCE {
    svId          INTEGER(0..63),
    ganss-alm-e   BIT STRING (SIZE (11)),
    ganss-delta-I-alm BIT STRING (SIZE (11)),
    ganss-omegadot-alm BIT STRING (SIZE (11)),
    ganss-svstatusINAV-alm BIT STRING (SIZE (4)),
    ganss-svstatusFNAV-alm BIT STRING (SIZE (2))    OPTIONAL,
    ganss-delta-a-sqrt-alm BIT STRING (SIZE (13)),
    ganss-omegazerow-alm BIT STRING (SIZE (16)),
    ganss-m-zero-alm BIT STRING (SIZE (16)),
    ganss-omega-alm BIT STRING (SIZE (16)),
    ganss-af-zero-alm BIT STRING (SIZE (16)),
    ganss-af-one-alm BIT STRING (SIZE (13))
}

GANSS-SAT-Info-Almanac-MIDIkp ::= SEQUENCE {
    svID          INTEGER(0..63),
    midiAlmE      BIT STRING (SIZE (11)),
    midiAlmDeltaI BIT STRING (SIZE (11)),

```

```

    midiAlmOmegaDot          BIT STRING (SIZE (11)),
    midiAlmSqrtA             BIT STRING (SIZE (17)),
    midiAlmOmega0           BIT STRING (SIZE (16)),
    midiAlmOmega            BIT STRING (SIZE (16)),
    midiAlmMo               BIT STRING (SIZE (16)),
    midiAlmaf0              BIT STRING (SIZE (11)),
    midiAlmaf1              BIT STRING (SIZE (10)),
    midiAlmL1Health         BIT STRING (SIZE (1)),
    midiAlmL2Health         BIT STRING (SIZE (1)),
    midiAlmL5Health         BIT STRING (SIZE (1))
}

GANSS-SAT-Info-Almanac-NAVkp ::= SEQUENCE {
    svID                    INTEGER(0..63),
    navAlmE                 BIT STRING (SIZE (16)),
    navAlmDeltaI            BIT STRING (SIZE (16)),
    navAlmOMEGADOT         BIT STRING (SIZE (16)),
    navAlmSVHealth         BIT STRING (SIZE (8)),
    navAlmSqrtA             BIT STRING (SIZE (24)),
    navAlmOMEGAo           BIT STRING (SIZE (24)),
    navAlmOmega             BIT STRING (SIZE (24)),
    navAlmMo                BIT STRING (SIZE (24)),
    navAlmaf0               BIT STRING (SIZE (11)),
    navAlmaf1               BIT STRING (SIZE (11))
}

GANSS-SAT-Info-Almanac-REDkp ::= SEQUENCE {
    svID                    INTEGER(0..63),
    redAlmDeltaA            BIT STRING (SIZE (8)),
    redAlmOmega0           BIT STRING (SIZE (7)),
    redAlmPhi0             BIT STRING (SIZE (7)),
    redAlmL1Health         BIT STRING (SIZE (1)),
    redAlmL2Health         BIT STRING (SIZE (1)),
    redAlmL5Health         BIT STRING (SIZE (1))
}

GANSS-SAT-Info-Almanac-SBAscefc ::= SEQUENCE {
    sbasAlmDataID          BIT STRING (SIZE (2)),
    svID                    INTEGER (0..63),
    sbasAlmHealth          BIT STRING (SIZE (8)),
    sbasAlmXg              BIT STRING (SIZE (15)),
    sbasAlmYg              BIT STRING (SIZE (15)),
    sbasAlmZg              BIT STRING (SIZE (9)),
    sbasAlmXgdot           BIT STRING (SIZE (3)),
    sbasAlmYgDot           BIT STRING (SIZE (3)),
    sbasAlmZgDot           BIT STRING (SIZE (4)),
    sbasAlmTo              BIT STRING (SIZE (11))
}

GANSS-SAT-Info-Almanac-BDSkpList ::= SEQUENCE (SIZE (1..maxGANSSSat)) OF
    GANSS-SAT-Info-Almanac-BDSkp

GANSS-SAT-Info-Almanac-GLOkpList ::= SEQUENCE (SIZE (1..maxGANSSSat)) OF
    GANSS-SAT-Info-Almanac-GLOkp

GANSS-SAT-Info-Almanac-KpList ::= SEQUENCE (SIZE (1..maxGANSSSat)) OF
    GANSS-SAT-Info-Almanac-Kp

GANSS-SAT-Info-Almanac-MIDIkpList ::= SEQUENCE (SIZE (1..maxGANSSSat)) OF
    GANSS-SAT-Info-Almanac-MIDIkp

GANSS-SAT-Info-Almanac-NAVkpList ::= SEQUENCE (SIZE (1..maxGANSSSat)) OF
    GANSS-SAT-Info-Almanac-NAVkp

GANSS-SAT-Info-Almanac-REDkpList ::= SEQUENCE (SIZE (1..maxGANSSSat)) OF
    GANSS-SAT-Info-Almanac-REDkp

GANSS-SAT-Info-Almanac-SBAscefcList ::= SEQUENCE (SIZE (1..maxGANSSSat)) OF
    GANSS-SAT-Info-Almanac-SBAscefc

Ganss-Sat-Info-AddNav ::= SEQUENCE {
    satId                   INTEGER (0..63),
    svHealth                BIT STRING (SIZE (6)),
    iod                     BIT STRING (SIZE (11)),
    ganssClockModel         UE-Positioning-GANSS-AddClockModels,
    ganssOrbitModel         UE-Positioning-GANSS-AddOrbitModels
}

```

```

Ganss-Sat-Info-AddNav-r12 ::= SEQUENCE {
    satId          INTEGER (0..63),
    svHealth       BIT STRING (SIZE (6)),
    iod            BIT STRING (SIZE (11)),
    ganssClockModel UE-Positioning-GANSS-AddClockModels-r12,
    ganssOrbitModel UE-Positioning-GANSS-AddOrbitModels-r12
}

Ganss-Sat-Info-AddNav-vc50ext ::= SEQUENCE {
    ganssClockModel UE-Positioning-GANSS-AddClockModels-vc50ext,
    ganssOrbitModel UE-Positioning-GANSS-AddOrbitModels-vc50ext
}

Ganss-Sat-Info-Nav ::= SEQUENCE {
    satId          INTEGER (0..63),
    svHealth       BIT STRING (SIZE (9)),
    iod            BIT STRING (SIZE (10)),
    ganssClockModel UE-Positioning-GANSS-ClockModel,
    ganssOrbitModel UE-Positioning-GANSS-OrbitModel
}

Ganss-Sat-Info-AddNavList ::= SEQUENCE (SIZE (1..maxGANSSSat)) OF
    Ganss-Sat-Info-AddNav

Ganss-Sat-Info-AddNavList-r12 ::= SEQUENCE (SIZE (1..maxGANSSSat)) OF
    Ganss-Sat-Info-AddNav-r12

Ganss-Sat-Info-AddNavList-vc50ext ::= SEQUENCE (SIZE (1..maxGANSSSat)) OF
    Ganss-Sat-Info-AddNav-vc50ext

Ganss-Sat-Info-NavList ::= SEQUENCE (SIZE (1..maxGANSSSat)) OF
    Ganss-Sat-Info-Nav

GANSS-Signal-Id ::= INTEGER (0..7)

GANSS-Status-Health ::= ENUMERATED {
    udre-scale-1dot0,
    udre-scale-0dot75,
    udre-scale-0dot5,
    udre-scale-0dot3,
    udre-scale-0dot2,
    udre-scale-0dot1,
    no-data,
    invalid-data }

GANSS-Storm-Flag ::= SEQUENCE {
    storm-flag-one      BOOLEAN,
    storm-flag-two      BOOLEAN,
    storm-flag-three    BOOLEAN,
    storm-flag-four     BOOLEAN,
    storm-flag-five     BOOLEAN
}

GLONASSclockModel ::= SEQUENCE {
    gloTau      BIT STRING (SIZE (22)),
    gloGamma    BIT STRING (SIZE (11)),
    gloDeltaTau BIT STRING (SIZE (5))
} OPTIONAL

GPS-MeasurementParam ::= SEQUENCE {
    satelliteID      INTEGER (0..63),
    c-N0             INTEGER (0..63),
    doppler          INTEGER (-32768..32768),
    wholeGPS-Chips   INTEGER (0..1022),
    fractionalGPS-Chips INTEGER (0..1023),
    multipathIndicator MultipathIndicator,
    pseudorangeRMS-Error INTEGER (0..63)
}

GPS-MeasurementParamList ::= SEQUENCE (SIZE (1..maxSat)) OF
    GPS-MeasurementParam

GSM-CarrierRSSI ::= BIT STRING (SIZE (6))

GSM-CellGroup ::= SEQUENCE {
    startingARFCN      BCCH-ARFCN,
    bandIndicator      ENUMERATED { dcs1800, pcs1900 },
    followingARFCNs    CHOICE {

```



```

    explicitListOfARFCNs          SEQUENCE (SIZE (0..31)) OF BCCH-ARFCN,
    equallySpacedARFCNs          SEQUENCE {
        arfcn-Spacing              INTEGER (1..8),
        numberOfFollowingARFCNs    INTEGER (0..31)
    },
    variableBitMapOfARFCNs        OCTET STRING (SIZE (1..16)),
    continuousRangeOfARFCNs       SEQUENCE {
        endingARFCN                BCCH-ARFCN
    }
}

GSM-MeasuredResults ::=          SEQUENCE {
    gsm-CarrierRSSI                GSM-CarrierRSSI                OPTIONAL,
    -- dummy is not used in this version of the specification, it should
    -- not be sent and if received it should be ignored.
    dummy                          INTEGER (46..173)              OPTIONAL,
    bsicReported                   BSICReported,
    -- dummy2 is not used in this version of the specification, it should
    -- not be sent and if received it should be ignored.
    dummy2                         ObservedTimeDifferenceToGSM    OPTIONAL
}

GSM-MeasuredResultsList ::=      SEQUENCE (SIZE (1..maxReportedGSMCells)) OF
    GSM-MeasuredResults

GPS-TOW-1msec ::=                INTEGER (0..604799999)

GPS-TOW-1sec ::=                 INTEGER (0..604799)

GPS-TOW-Assist ::=               SEQUENCE {
    satID                          SatID,
    tlm-Message                    BIT STRING (SIZE (14)),
    tlm-Reserved                   BIT STRING (SIZE (2)),
    alert                          BOOLEAN,
    antiSpoof                      BOOLEAN
}

GPS-TOW-AssistList ::=           SEQUENCE (SIZE (1..maxSat)) OF
    GPS-TOW-Assist

GSM-CellID ::=                   SEQUENCE {
    gsm-CellID                     INTEGER (0..maxCellMeas-1)
}

GSM-PriorityInfo ::=             SEQUENCE {
    gsmCellGroup                   GSM-CellGroup,
    priority                       INTEGER (0..maxPrio-1),
    -- Actual value = IE value * 2 + 1
    qRxLevMinGSM                   INTEGER (-58..-13),
    -- Actual value = IE value * 2
    threshXhigh                    INTEGER (0..31),
    -- Actual value = IE value * 2
    threshXlow                     INTEGER (0..31)
}

GSM-PriorityInfoList ::=         SEQUENCE (SIZE (1..maxNumGSMCellGroup)) OF
    GSM-PriorityInfo

GSMCellGroupingList ::=          SEQUENCE (SIZE (1..maxCellMeas)) OF
    GSM-CellID

HCS-CellReselectInformation-RSCP ::= SEQUENCE {
    -- TABULAR: The default value for penaltyTime is "notUsed"
    -- Temporary offset is nested inside PenaltyTime-RSCP
    penaltyTime                    PenaltyTime-RSCP
}

HCS-CellReselectInformation-ECNO ::= SEQUENCE {
    -- TABULAR: The default value for penaltyTime is "notUsed"
    -- Temporary offset is nested inside PenaltyTime-ECNO
    penaltyTime                    PenaltyTime-ECNO
}

HCS-NeighbouringCellInformation-RSCP ::= SEQUENCE {
    hcs-PRIO                       HCS-PRIO                       DEFAULT 0,
    q-HCS                          Q-HCS                          DEFAULT 0,
    hcs-CellReselectInformation     HCS-CellReselectInformation
}

```

```

}

HCS-NeighbouringCellInformation-ECNO ::= SEQUENCE {
    hcs-PRIO                HCS-PRIO                DEFAULT 0,
    q-HCS                   Q-HCS                   DEFAULT 0,
    hcs-CellReselectInformation HCS-CellReselectInformation-ECNO
}

HCS-PRIO ::=
    INTEGER (0..7)

HCS-ServingCellInformation ::= SEQUENCE {
    hcs-PRIO                HCS-PRIO                DEFAULT 0,
    q-HCS                   Q-HCS                   DEFAULT 0,
    t-CR-Max                T-CR-Max                OPTIONAL
}

HorizontalVelocity ::= SEQUENCE {
    bearing                 INTEGER (0..359),
    horizontalSpeed         INTEGER (0..2047)
}

HorizontalWithVerticalVelocity ::= SEQUENCE {
    verticalSpeedDirection  ENUMERATED { upward, downward },
    bearing                 INTEGER (0..359),
    horizontalSpeed         INTEGER (0..2047),
    verticalSpeed           INTEGER (0..255)
}

HorizontalVelocityWithUncertainty ::= SEQUENCE {
    bearing                 INTEGER (0..359),
    horizontalSpeed         INTEGER (0..2047),
    horizontalSpeedUncertainty INTEGER (0..255)
}

HorizontalWithVerticalVelocityAndUncertainty ::= SEQUENCE {
    verticalSpeedDirection  ENUMERATED { upward, downward },
    bearing                 INTEGER (0..359),
    horizontalSpeed         INTEGER (0..2047),
    verticalSpeed           INTEGER (0..255),
    horizontalUncertaintySpeed INTEGER (0..255),
    verticalUncertaintySpeed INTEGER (0..255)
}

-- Actual value Hysteresis = IE value * 0.5
Hysteresis ::=
    INTEGER (0..15)

-- Actual value HysteresisInterFreq = IE value * 0.5
HysteresisInterFreq ::=
    INTEGER (0..29)

IdleIntervalInfo ::= SEQUENCE {
    k                       INTEGER (2..3)          OPTIONAL,
    offset                  INTEGER (0..7)          OPTIONAL
}

InterFreqCell ::= SEQUENCE {
    frequencyInfo           FrequencyInfo,
    nonFreqRelatedEventResults CellMeasurementEventResults
}

InterFreqCell-LCR-r4 ::= SEQUENCE {
    frequencyInfo           FrequencyInfo,
    nonFreqRelatedEventResults CellMeasurementEventResults-LCR-r4
}

InterFreqCellID ::=
    INTEGER (0..maxCellMeas-1)

InterFreqCellID-r12 ::=
    INTEGER (0..maxCellMeas-ext-1)

InterFreqCellInfoList ::= SEQUENCE {
    removedInterFreqCellList RemovedInterFreqCellList  OPTIONAL,
    newInterFreqCellList     NewInterFreqCellList      OPTIONAL,
    cellsForInterFreqMeasList CellsForInterFreqMeasList  OPTIONAL
}

InterFreqCellInfoList-r4 ::= SEQUENCE {
    removedInterFreqCellList RemovedInterFreqCellList  OPTIONAL,
    newInterFreqCellList     NewInterFreqCellList-r4      OPTIONAL,
    cellsForInterFreqMeasList CellsForInterFreqMeasList  OPTIONAL
}

```

```

}

InterFreqCellInfoList-r8 ::= SEQUENCE {
    removedInterFreqCellList    RemovedInterFreqCellList    OPTIONAL,
    newInterFreqCellList        NewInterFreqCellList-r8    OPTIONAL,
    cellsForInterFreqMeasList    CellsForInterFreqMeasList    OPTIONAL
}

InterFreqCellInfoList-r9 ::= SEQUENCE {
    removedInterFreqCellList    RemovedInterFreqCellList    OPTIONAL,
    newInterFreqCellList        NewInterFreqCellList-r9    OPTIONAL,
    cellsForInterFreqMeasList    CellsForInterFreqMeasList    OPTIONAL,
    csgInterFreqCellInfoList    CSGInterFreqCellInfoList    OPTIONAL,
    interFreqSIACquisition      InterFreqSIACquisition      OPTIONAL
}

InterFreqCellInfoList-r10 ::= SEQUENCE {
    removedInterFreqCellList    RemovedInterFreqCellList    OPTIONAL,
    newInterFreqCellList        NewInterFreqCellList-r10    OPTIONAL,
    cellsForInterFreqMeasList    CellsForInterFreqMeasList    OPTIONAL,
    csgInterFreqCellInfoList    CSGInterFreqCellInfoList    OPTIONAL,
    interFreqSIACquisition      InterFreqSIACquisition      OPTIONAL
}

InterFreqCellInfoList-r12 ::= SEQUENCE {
    removedInterFreqCellList-r12    RemovedInterFreqCellList-r12    OPTIONAL,
    newInterFreqCellList-r12        NewInterFreqCellList-r12    OPTIONAL,
    cellsForInterFreqMeasList-r12    CellsForInterFreqMeasList-r12    OPTIONAL,
    csgInterFreqCellInfoList        CSGInterFreqCellInfoList        OPTIONAL,
    interFreqSIACquisition          InterFreqSIACquisition          OPTIONAL,
    rmp-Frequency-List              RMP-Frequency-List              OPTIONAL
}

InterFreqSIACquisition ::= SEQUENCE {
    frequencyInfo                FrequencyInfo,
    modeSpecificInfo             CHOICE {
        fdd                       SEQUENCE {
            primaryScramblingCode    PrimaryCPICH-Info
        },
        tdd                       NULL
    }
}

InterFreqCellInfoSI-List-RSCP ::= SEQUENCE {
    removedInterFreqCellList    RemovedInterFreqCellList    OPTIONAL,
    newInterFreqCellList        NewInterFreqCellSI-List-RSCP    OPTIONAL
}

InterFreqCellInfoSI-List-ECN0 ::= SEQUENCE {
    removedInterFreqCellList    RemovedInterFreqCellList    OPTIONAL,
    newInterFreqCellList        NewInterFreqCellSI-List-ECN0    OPTIONAL
}

InterFreqCellInfoSI-List-HCS-RSCP ::= SEQUENCE {
    removedInterFreqCellList    RemovedInterFreqCellList    OPTIONAL,
    newInterFreqCellList        NewInterFreqCellSI-List-HCS-RSCP    OPTIONAL
}

InterFreqCellInfoSI-List-HCS-ECN0 ::= SEQUENCE {
    removedInterFreqCellList    RemovedInterFreqCellList    OPTIONAL,
    newInterFreqCellList        NewInterFreqCellSI-List-HCS-ECN0    OPTIONAL
}

InterFreqCellInfoSI-List-RSCP-LCR ::= SEQUENCE {
    removedInterFreqCellList    RemovedInterFreqCellList    OPTIONAL,
    newInterFreqCellList        NewInterFreqCellSI-List-RSCP-LCR-r4    OPTIONAL
}

InterFreqCellInfoSI-List-ECN0-LCR ::= SEQUENCE {
    removedInterFreqCellList    RemovedInterFreqCellList    OPTIONAL,
    newInterFreqCellList        NewInterFreqCellSI-List-ECN0-LCR-r4    OPTIONAL
}

InterFreqCellInfoSI-List-HCS-RSCP-LCR ::= SEQUENCE {
    removedInterFreqCellList    RemovedInterFreqCellList    OPTIONAL,
    newInterFreqCellList        NewInterFreqCellSI-List-HCS-RSCP-LCR-r4    OPTIONAL
}

InterFreqCellInfoSI-List-HCS-ECN0-LCR ::= SEQUENCE {

```

```

    removedInterFreqCellList          RemovedInterFreqCellList          OPTIONAL,
    newInterFreqCellList               NewInterFreqCellSI-List-HCS-ECN0-LCR-r4 OPTIONAL
}

InterFreqCellList ::=
    SEQUENCE (SIZE (1..maxFreq)) OF
        InterFreqCell

InterFreqCellList-LCR-r4-ext ::=
    SEQUENCE (SIZE (1..maxFreq)) OF
        InterFreqCell-LCR-r4

InterFreqCellMeasuredResultsList ::= SEQUENCE (SIZE (1..maxCellMeas)) OF
        CellMeasuredResults

InterFreqCellMeasuredResultsList-v920ext ::= SEQUENCE (SIZE (1..maxCellMeas)) OF
        CellMeasuredResults-v920ext

InterFreqCellMeasuredResultsList-vc50ext ::= SEQUENCE (SIZE (1..maxCellMeas)) OF
        CellMeasuredResults-vc50ext

InterFreqEvent ::=
    CHOICE {
        event2a          Event2a,
        event2b          Event2b,
        event2c          Event2c,
        event2d          Event2d,
        event2e          Event2e,
        event2f          Event2f
    }

InterFreqEvent-r6 ::=
    CHOICE {
        event2a          Event2a-r6,
        event2b          Event2b-r6,
        event2c          Event2c-r6,
        event2d          Event2d-r6,
        event2e          Event2e-r6,
        event2f          Event2f-r6
    }

InterFreqEvent-r10 ::=
    CHOICE {
        event2a          Event2a-r10,
        event2b          Event2b-r10,
        event2c          Event2c-r10,
        event2d          Event2d-r10,
        event2e          Event2e-r10,
        event2f          Event2f-r10
    }

InterFreqEvent-r11 ::=
    CHOICE {
        event2a          Event2a-r11,
        event2b          Event2b-r11,
        event2c          Event2c-r11,
        event2d          Event2d-r10,
        event2e          Event2e-r11,
        event2f          Event2f-r10
    }

InterFreqEvent-r12 ::=
    CHOICE {
        event2a          Event2a-r11,
        event2b          Event2b-r11,
        event2c          Event2c-r11,
        event2d          Event2d-r10,
        event2e          Event2e-r11,
        event2f          Event2f-r10,
        event2g          Event2g
    }

InterFreqEventList ::=
    SEQUENCE (SIZE (1..maxMeasEvent)) OF
        InterFreqEvent

InterFreqEventList-r6 ::=
    SEQUENCE (SIZE (1..maxMeasEvent)) OF
        InterFreqEvent-r6

InterFreqEventList-r10 ::=
    SEQUENCE (SIZE (1..maxMeasEvent)) OF
        InterFreqEvent-r10

InterFreqEventList-r11 ::=
    SEQUENCE (SIZE (1..maxMeasEvent)) OF
        InterFreqEvent-r11

```

```

InterFreqEventList-r12 ::=          SEQUENCE (SIZE (1..maxMeasEvent)) OF
                                     InterFreqEvent-r12

--Following IE shall be used regardless of CPICH RSCP(FDD) or Primary CCPCH RSCP(TDD)
--The order of the list corresponds to the order of the cells in InterFrequencyMeasuredResultsList
--The IE is only used for measured results and not for additional measured results.
InterFrequencyMeasuredResultsList-v590ext ::= SEQUENCE (SIZE (1..maxCellMeas)) OF
                                               DeltaRSCPPerCell

Inter-FreqEventCriteria-v590ext ::= SEQUENCE {
    thresholdUsedFrequency-delta          DeltaRSCP,
    thresholdNonUsedFrequency-deltaList   ThresholdNonUsedFrequency-deltaList   OPTIONAL
}

--The order of the list corresponds to the order of the events in Inter-FreqEventList
Inter-FreqEventCriteriaList-v590ext ::= SEQUENCE (SIZE (1..maxMeasEvent)) OF
                                         Inter-FreqEventCriteria-v590ext

--The order of the list corresponds to the order of relevant events in Intra-FreqEventCriteriaList
--i.e. the first element of the list corresponds to the first occurrence of event 1e, 1f, 1h, 1i,
--the second element of the list corresponds to the second occurrence of event 1e, 1f, 1h, 1i
Intra-FreqEventCriteriaList-v590ext ::= SEQUENCE (SIZE (1..maxMeasEvent)) OF
                                         DeltaRSCP

--Following IE shall be used regardless of CPICH RSCP(FDD) or Primary CCPCH RSCP(TDD)
--The order of the list corresponds to the order of the cells in IntraFrequencyMeasuredResultsList
--The IE is only used for measured results and not for additional measured results.
IntraFrequencyMeasuredResultsList-v590ext ::= SEQUENCE (SIZE (1..maxCellMeas)) OF
                                               DeltaRSCPPerCell

InterFreqEventResults ::=          SEQUENCE {
    eventID                               EventIDInterFreq,
    interFreqCellList                     InterFreqCellList           OPTIONAL
}

InterFreqEventResults-va40ext ::= SEQUENCE {
    detectedSetTrigger                     ENUMERATED {true}           OPTIONAL
}

InterFreqEventResults-LCR-r4-ext ::= SEQUENCE {
    eventID                               EventIDInterFreq,
    interFreqCellList                     InterFreqCellList-LCR-r4-ext   OPTIONAL
}

InterFreqMeasQuantity ::=          SEQUENCE {
    reportingCriteria                     CHOICE {
        intraFreqReportingCriteria        SEQUENCE {
            intraFreqMeasQuantity         IntraFreqMeasQuantity
        },
        interFreqReportingCriteria         SEQUENCE {
            filterCoefficient              FilterCoefficient           DEFAULT fc0,
            modeSpecificInfo               CHOICE {
                fdd                        SEQUENCE {
                    freqQualityEstimateQuantity-FDD   FreqQualityEstimateQuantity-FDD
                },
                tdd                        SEQUENCE {
                    freqQualityEstimateQuantity-TDD   FreqQualityEstimateQuantity-TDD
                }
            }
        }
    }
}

InterFreqMeasuredResults ::=        SEQUENCE {
    frequencyInfo                          FrequencyInfo                 OPTIONAL,
    ultra-CarrierRSSI                      UTRA-CarrierRSSI             OPTIONAL,
    interFreqCellMeasuredResultsList       InterFreqCellMeasuredResultsList OPTIONAL
}

InterFreqMeasuredResults-v920ext ::= SEQUENCE {
    interFreqCellMeasuredResultsList       InterFreqCellMeasuredResultsList-v920ext   OPTIONAL
}

InterFreqMeasuredResults-vc50ext ::= SEQUENCE {
    interFreqCellMeasuredResultsList       InterFreqCellMeasuredResultsList-vc50ext   OPTIONAL
}

InterFreqMeasuredResultsList ::=    SEQUENCE (SIZE (1..maxFreq)) OF

```

```

InterFreqMeasuredResults

InterFreqMeasuredResultsList-v920ext ::= SEQUENCE (SIZE (1..maxFreq)) OF
InterFreqMeasuredResults-v920ext

InterFreqMeasuredResultsList-vc50ext ::= SEQUENCE (SIZE (1..maxFreq)) OF
InterFreqMeasuredResults-vc50ext

InterFreqMeasurementSysInfo-RSCP ::= SEQUENCE {
interFreqCellInfoSI-List InterFreqCellInfoSI-List-RSCP OPTIONAL
}

InterFreqMeasurementSysInfo-ECN0 ::= SEQUENCE {
interFreqCellInfoSI-List InterFreqCellInfoSI-List-ECN0 OPTIONAL
}

InterFreqMeasurementSysInfo-HCS-RSCP ::= SEQUENCE {
interFreqCellInfoSI-List InterFreqCellInfoSI-List-HCS-RSCP OPTIONAL
}

InterFreqMeasurementSysInfo-HCS-ECN0 ::= SEQUENCE {
interFreqCellInfoSI-List InterFreqCellInfoSI-List-HCS-ECN0 OPTIONAL
}

InterFreqMeasurementSysInfo-RSCP-LCR-r4 ::= SEQUENCE {
interFreqCellInfoSI-List InterFreqCellInfoSI-List-RSCP-LCR OPTIONAL
}

InterFreqMeasurementSysInfo-ECN0-LCR-r4 ::= SEQUENCE {
interFreqCellInfoSI-List InterFreqCellInfoSI-List-ECN0-LCR OPTIONAL
}

InterFreqMeasurementSysInfo-HCS-RSCP-LCR-r4 ::= SEQUENCE {
interFreqCellInfoSI-List InterFreqCellInfoSI-List-HCS-RSCP-LCR OPTIONAL
}

InterFreqMeasurementSysInfo-HCS-ECN0-LCR-r4 ::= SEQUENCE {
interFreqCellInfoSI-List InterFreqCellInfoSI-List-HCS-ECN0-LCR OPTIONAL
}

InterFreqRACHRepCellsList ::= SEQUENCE (SIZE (1..maxFreq)) OF
InterFreqCellID

InterFreqRACHRepCellsList-r12 ::= SEQUENCE (SIZE (1..maxFreq)) OF
InterFreqCellID-r12

Dummy-InterFreqRACHReportingInfo ::= SEQUENCE {
modeSpecificInfo CHOICE {
fdd SEQUENCE {
interFreqRepQuantityRACH-FDD InterFreqRepQuantityRACH-FDD
},
tdd SEQUENCE {
interFreqRepQuantityRACH-TDDList InterFreqRepQuantityRACH-TDDList
},
interFreqRACHReportingThreshold Threshold,
maxReportedCellsOnRACHinterFreq MaxReportedCellsOnRACHinterFreq
}
}

InterFreqRACHReportingInfo ::= SEQUENCE {
modeSpecificInfo CHOICE {
fdd SEQUENCE {
interFreqRepQuantityRACH-FDD InterFreqRepQuantityRACH-FDD
},
tdd SEQUENCE {
interFreqRepQuantityRACH-TDDList InterFreqRepQuantityRACH-TDDList
}
},
interFreqRACHReportingThreshold Threshold,
maxReportedCellsOnRACHinterFreq MaxReportedCellsOnRACHinterFreq
}

InterFreqBlacklistedCellsList-r12 ::= SEQUENCE (SIZE (1..maxFreq)) OF
InterFreqBlacklistedCells-r12

InterFreqBlacklistedCells-r12 ::= SEQUENCE {
frequencyInfo FrequencyInfo,
excludedCellInfoList CellInfoListToBeExcluded
}

```

```

}

InterFreqReportCriteria ::=
  intraFreqReportingCriteria
  interFreqReportingCriteria
  periodicalReportingCriteria
  noReporting
}

InterFreqReportCriteria-r4 ::=
  intraFreqReportingCriteria
  interFreqReportingCriteria
  periodicalReportingCriteria
  noReporting
}

InterFreqReportCriteria-r6 ::=
  intraFreqReportingCriteria
  interFreqReportingCriteria
  periodicalReportingCriteria
  noReporting
}

InterFreqReportCriteria-r7 ::=
  intraFreqReportingCriteria
  interFreqReportingCriteria
  periodicalReportingCriteria
  noReporting
}

InterFreqReportCriteria-r9 ::=
  intraFreqReportingCriteria
  interFreqReportingCriteria
  periodicalReportingCriteria
  noReporting
}

InterFreqReportCriteria-r10 ::=
  intraFreqReportingCriteria
  interFreqReportingCriteria
  periodicalReportingCriteria
  noReporting
}

InterFreqReportCriteria-r11 ::=
  intraFreqReportingCriteria
  interFreqReportingCriteria
  periodicalReportingCriteria
  noReporting
}

InterFreqReportCriteria-r12 ::=
  intraFreqReportingCriteria
  interFreqReportingCriteria
  periodicalReportingCriteria
  noReporting
}

InterFreqReportingCriteria ::=
  interFreqEventList
}

InterFreqReportingCriteria-r6 ::=
  interFreqEventList
}

InterFreqReportingCriteria-r10 ::=
  interFreqEventList
}

InterFreqReportingCriteria-r11 ::=
  interFreqEventList
}

InterFreqReportingCriteria-r12 ::=
  interFreqEventList
  interFreqBlacklistedCellsList
}

```

CHOICE {
 IntraFreqReportingCriteria,
 InterFreqReportingCriteria,
 PeriodicalWithReportingCellStatus,
 ReportingCellStatusOpt

CHOICE {
 IntraFreqReportingCriteria-r4,
 InterFreqReportingCriteria,
 PeriodicalWithReportingCellStatus,
 ReportingCellStatusOpt

CHOICE {
 IntraFreqReportingCriteria-r6,
 InterFreqReportingCriteria-r6,
 PeriodicalWithReportingCellStatus,
 ReportingCellStatusOpt

CHOICE {
 IntraFreqReportingCriteria-r7,
 InterFreqReportingCriteria-r6,
 PeriodicalWithReportingCellStatus,
 ReportingCellStatusOpt

CHOICE {
 IntraFreqReportingCriteria-r9,
 InterFreqReportingCriteria-r6,
 PeriodicalWithReportingCellStatus,
 ReportingCellStatusOpt

CHOICE {
 IntraFreqReportingCriteria-r9,
 InterFreqReportingCriteria-r10,
 PeriodicalWithReportingCellStatus-r10,
 ReportingCellStatusOpt-r10

CHOICE {
 IntraFreqReportingCriteria-r11,
 InterFreqReportingCriteria-r11,
 PeriodicalWithReportingCellStatus-r10,
 ReportingCellStatusOpt-r10

CHOICE {
 IntraFreqReportingCriteria-r11,
 InterFreqReportingCriteria-r12,
 PeriodicalWithReportingCellStatus-r10,
 ReportingCellStatusOpt-r10

SEQUENCE {
 InterFreqEventList OPTIONAL

SEQUENCE {
 InterFreqEventList-r6 OPTIONAL

SEQUENCE {
 InterFreqEventList-r10 OPTIONAL

SEQUENCE {
 InterFreqEventList-r11 OPTIONAL

SEQUENCE {
 InterFreqEventList-r12 OPTIONAL,
 InterFreqBlacklistedCellsList-r12 OPTIONAL

```

}

InterFreqReportingQuantity ::= SEQUENCE {
    ultra-Carrier-RSSI          BOOLEAN,
    frequencyQualityEstimate    BOOLEAN,
    nonFreqRelatedQuantities    CellReportingQuantities
}

InterFreqRepQuantityRACH-FDD ::= ENUMERATED {
    cpich-EcN0, cpich-RSCP }

-- dummy is not used in this version of the specification, it should
-- not be sent and if received the UE behaviour is not specified.
InterFreqRepQuantityRACH-TDD ::= ENUMERATED {
    dummy,
    primaryCCPCH-RSCP }

InterFreqRepQuantityRACH-TDDList ::= SEQUENCE (SIZE (1..2)) OF
    InterFreqRepQuantityRACH-TDD

InterFrequencyMeasurement ::= SEQUENCE {
    interFreqCellInfoList      InterFreqCellInfoList,
    interFreqMeasQuantity      InterFreqMeasQuantity          OPTIONAL,
    interFreqReportingQuantity InterFreqReportingQuantity      OPTIONAL,
    measurementValidity        MeasurementValidity            OPTIONAL,
    interFreqSetUpdate         UE-AutonomousUpdateMode        OPTIONAL,
    reportCriteria              InterFreqReportCriteria
}

InterFrequencyMeasurement-r4 ::= SEQUENCE {
    interFreqCellInfoList-r4   InterFreqCellInfoList-r4,
    interFreqMeasQuantity-r4   InterFreqMeasQuantity-r4      OPTIONAL,
    interFreqReportingQuantity InterFreqReportingQuantity      OPTIONAL,
    measurementValidity-r4     MeasurementValidity-r4        OPTIONAL,
    interFreqSetUpdate-r4      UE-AutonomousUpdateMode-r4    OPTIONAL,
    reportCriteria-r4          InterFreqReportCriteria-r4
}

InterFrequencyMeasurement-r6 ::= SEQUENCE {
    interFreqCellInfoList-r6   InterFreqCellInfoList-r6,
    interFreqMeasQuantity-r6   InterFreqMeasQuantity-r6      OPTIONAL,
    interFreqReportingQuantity InterFreqReportingQuantity      OPTIONAL,
    measurementValidity-r6     MeasurementValidity-r6        OPTIONAL,
    interFreqSetUpdate-r6      UE-AutonomousUpdateMode-r6    OPTIONAL,
    reportCriteria-r6          InterFreqReportCriteria-r6
}

InterFrequencyMeasurement-r7 ::= SEQUENCE {
    interFreqCellInfoList-r7   InterFreqCellInfoList-r7,
    interFreqMeasQuantity-r7   InterFreqMeasQuantity-r7      OPTIONAL,
    interFreqReportingQuantity InterFreqReportingQuantity      OPTIONAL,
    measurementValidity-r7     MeasurementValidity-r7        OPTIONAL,
    interFreqSetUpdate-r7      UE-AutonomousUpdateMode-r7    OPTIONAL,
    reportCriteria-r7          InterFreqReportCriteria-r7
}

InterFrequencyMeasurement-r8 ::= SEQUENCE {
    interFreqCellInfoList-r8   InterFreqCellInfoList-r8,
    interFreqMeasQuantity-r8   InterFreqMeasQuantity-r8      OPTIONAL,
    interFreqReportingQuantity InterFreqReportingQuantity      OPTIONAL,
    measurementValidity-r8     MeasurementValidity-r8        OPTIONAL,
    interFreqSetUpdate-r8      UE-AutonomousUpdateMode-r8    OPTIONAL,
    adjacentFrequencyIndex     INTEGER (0..31)                 OPTIONAL,
    reportCriteria-r8          InterFreqReportCriteria-r8
}

InterFrequencyMeasurement-r9 ::= SEQUENCE {
    interFreqCellInfoList-r9   InterFreqCellInfoList-r9,
    interFreqMeasQuantity-r9   InterFreqMeasQuantity-r9      OPTIONAL,
    interFreqReportingQuantity InterFreqReportingQuantity      OPTIONAL,
    measurementValidity-r9     MeasurementValidity-r9        OPTIONAL,
    interFreqSetUpdate-r9      UE-AutonomousUpdateMode-r9    OPTIONAL,
    adjacentFrequencyIndex     INTEGER (0..31)                 OPTIONAL,
    interBandFrequencyIndex    INTEGER (0..31)                 OPTIONAL,
    reportCriteria-r9          InterFreqReportCriteria-r9
}

```



```

InterFrequencyMeasurement-r10 ::= SEQUENCE {
    interFreqCellInfoList      InterFreqCellInfoList-r10,
    interFreqMeasQuantity      InterFreqMeasQuantity              OPTIONAL,
    interFreqReportingQuantity  InterFreqReportingQuantity      OPTIONAL,
    measurementValidity         MeasurementValidity              OPTIONAL,
    interFreqSetUpdate          UE-AutonomousUpdateMode          OPTIONAL,
    adjacentFrequencyIndex      INTEGER (0..31)              OPTIONAL,
    interBandFrequencyIndex     INTEGER (0..31)              OPTIONAL,
    freqIndexListForEnhancedMeas FreqIndexListForEnhancedMeas OPTIONAL,
    reportCriteria              InterFreqReportCriteria-r10
}

InterFrequencyMeasurement-r11 ::= SEQUENCE {
    interFreqCellInfoList      InterFreqCellInfoList-r10,
    interFreqMeasQuantity      InterFreqMeasQuantity              OPTIONAL,
    interFreqReportingQuantity  InterFreqReportingQuantity      OPTIONAL,
    measurementValidity         MeasurementValidity              OPTIONAL,
    interFreqSetUpdate          UE-AutonomousUpdateMode          OPTIONAL,
    adjacentFrequencyIndex      INTEGER (0..31)              OPTIONAL,
    interBandFrequencyIndex     INTEGER (0..31)              OPTIONAL,
    freqIndexListForEnhancedMeas FreqIndexListForEnhancedMeas OPTIONAL,
    reportCriteria              InterFreqReportCriteria-r11
}

InterFrequencyMeasurement-r12 ::= SEQUENCE {
    interFreqCellInfoList      InterFreqCellInfoList-r12,
    interFreqMeasQuantity      InterFreqMeasQuantity              OPTIONAL,
    interFreqReportingQuantity  InterFreqReportingQuantity      OPTIONAL,
    measurementValidity         MeasurementValidity              OPTIONAL,
    interFreqSetUpdate          UE-AutonomousUpdateMode          OPTIONAL,
    adjacentFrequencyIndex      INTEGER (0..79)              OPTIONAL,
    interBandFrequencyIndex     INTEGER (0..79)              OPTIONAL,
    freqIndexListForEnhancedMeas FreqIndexListForEnhancedMeas-r12 OPTIONAL,
    reportCriteria              InterFreqReportCriteria-r12
}

InterRAT-TargetCellDescription ::= SEQUENCE {
    technologySpecificInfo      CHOICE {
        gsm                     SEQUENCE {
            bsic                 BSIC,
            frequency-band       Frequency-Band,
            bcch-ARFCN           BCCH-ARFCN,
            ncMode                NC-Mode              OPTIONAL
        },
        is-2000                  NULL,
        spare2                    NULL,
        spare1                    NULL
    }
}

InterRATCellID ::= INTEGER (0..maxCellMeas-1)

InterRATCellInfoIndication ::= INTEGER (0..3)

InterRATCellInfoList ::= SEQUENCE {
    removedInterRATCellList     RemovedInterRATCellList,
    -- NOTE: Future revisions of dedicated messages including IE newInterRATCellList
    -- should use a corrected version of this IE
    newInterRATCellList         NewInterRATCellList,
    cellsForInterRATMeasList     CellsForInterRATMeasList      OPTIONAL
}

InterRATCellInfoList-B ::= SEQUENCE {
    removedInterRATCellList     RemovedInterRATCellList,
    -- NOTE: IE newInterRATCellList should be optional. However, system information
    -- does not support message versions. Hence, this can not be corrected
    newInterRATCellList         NewInterRATCellList-B
}

InterRATCellInfoList-r4 ::= SEQUENCE {
    removedInterRATCellList     RemovedInterRATCellList,
    newInterRATCellList         NewInterRATCellList              OPTIONAL,
    cellsForInterRATMeasList     CellsForInterRATMeasList      OPTIONAL
}

InterRATCellInfoList-r6 ::= SEQUENCE {
    removedInterRATCellList     RemovedInterRATCellList,
}

```

```

newInterRATCellList                NewInterRATCellList                OPTIONAL,
cellsForInterRATMeasList           CellsForInterRATMeasList           OPTIONAL,
interRATCellInfoIndication-r6     InterRATCellInfoIndication         OPTIONAL
}

InterRATCellIndividualOffset ::=      INTEGER (-50..50)

InterRATEvent ::=                    CHOICE {
  event3a                            Event3a,
  event3b                            Event3b,
  event3c                            Event3c,
  event3d                            Event3d
}

InterRATEvent-r12 ::=                CHOICE {
  event3a                            Event3a-r12,
  event3b                            Event3b-r12,
  event3c                            Event3c-r12,
  event3d                            Event3d
}

InterRATEventList ::=                SEQUENCE (SIZE (1..maxMeasEvent)) OF
  InterRATEvent

InterRATEventList-r12 ::=            SEQUENCE (SIZE (1..maxMeasEvent)) OF
  InterRATEvent-r12

InterRATEventResults ::=             SEQUENCE {
  eventID                            EventIDInterRAT,
  cellToReportList                   CellToReportList
}

InterRATInfo ::=                     ENUMERATED {
  gsm
}

InterRATInfo-r6 ::=                  SEQUENCE {
  rat                                InterRATInfo,
  gsm-TargetCellInfoList             GSM-TargetCellInfoList            OPTIONAL
}

InterRATInfo-v860ext ::=             CHOICE {
  -- CHOICE gsm is provided in IE InterRATInfo or IE InterRATInfo-r6
  gsm                                NULL,
  eutra                              SEQUENCE {
    eutra-TargetFreqInfoList         EUTRA-TargetFreqInfoList
  }
}

InterRATMeasQuantity ::=             SEQUENCE {
  measQuantityUTRAN-QualityEstimate  IntraFreqMeasQuantity            OPTIONAL,
  ratSpecificInfo                    CHOICE {
    gsm                               SEQUENCE {
      measurementQuantity             MeasurementQuantityGSM,
      filterCoefficient               FilterCoefficient                DEFAULT fc0,
      bsic-VerificationRequired       BSIC-VerificationRequired
    },
    is-2000                           SEQUENCE {
      tadd-EcIo                       INTEGER (0..63),
      tcomp-EcIo                      INTEGER (0..15),
      softSlope                        INTEGER (0..63)                    OPTIONAL,
      addIntercept                     INTEGER (0..63)                    OPTIONAL
    }
  }
}

InterRATMeasQuantity-r8 ::=          SEQUENCE {
  measQuantityUTRAN-QualityEstimate  IntraFreqMeasQuantity            OPTIONAL,
  ratSpecificInfo                    CHOICE {
    gsm                               SEQUENCE {
      measurementQuantity             MeasurementQuantityGSM,
      filterCoefficient               FilterCoefficient                DEFAULT fc0,
      bsic-VerificationRequired       BSIC-VerificationRequired
    },
    is-2000                           SEQUENCE {
      tadd-EcIo                       INTEGER (0..63),
      tcomp-EcIo                      INTEGER (0..15),
      softSlope                        INTEGER (0..63)                    OPTIONAL,
      addIntercept                     INTEGER (0..63)                    OPTIONAL
    }
  }
}

```

```

    },
    e-UTRA
        measurementQuantity
        filterCoefficient
    }
}

InterRATMeasuredResults ::= CHOICE {
    gsm          GSM-MeasuredResultsList,
    spare       NULL
}

InterRATMeasuredResultsList ::= SEQUENCE (SIZE (1..maxOtherRAT-16)) OF
    InterRATMeasuredResults

InterRATMeasurement ::= SEQUENCE {
    interRATCellInfoList          InterRATCellInfoList          OPTIONAL,
    interRATMeasQuantity          InterRATMeasQuantity          OPTIONAL,
    interRATReportingQuantity     InterRATReportingQuantity     OPTIONAL,
    reportCriteria                InterRATReportCriteria
}

InterRATMeasurement-r4 ::= SEQUENCE {
    interRATCellInfoList-r4      InterRATCellInfoList-r4      OPTIONAL,
    interRATMeasQuantity         InterRATMeasQuantity         OPTIONAL,
    interRATReportingQuantity-r4 InterRATReportingQuantity-r4 OPTIONAL,
    reportCriteria               InterRATReportCriteria
}

InterRATMeasurement-r6 ::= SEQUENCE {
    interRATCellInfoList-r6      InterRATCellInfoList-r6      OPTIONAL,
    interRATMeasQuantity         InterRATMeasQuantity         OPTIONAL,
    interRATReportingQuantity-r6 InterRATReportingQuantity-r6 OPTIONAL,
    reportCriteria               InterRATReportCriteria
}

InterRATMeasurement-r8 ::= SEQUENCE {
    interRATMeasurementObjects   CHOICE {
        interRATCellInfoList-r6,
        eutra-FrequencyList
    } OPTIONAL,
    interRATMeasQuantity-r8      InterRATMeasQuantity-r8      OPTIONAL,
    interRATReportingQuantity-r8 InterRATReportingQuantity-r8 OPTIONAL,
    reportCriteria               InterRATReportCriteria,
    idleIntervalInfo            IdleIntervalInfo            OPTIONAL
}

InterRATMeasurement-r9 ::= SEQUENCE {
    interRATMeasurementObjects   CHOICE {
        interRATCellInfoList-r6,
        eutra-FrequencyList-r9
    } OPTIONAL,
    interRATMeasQuantity-r8      InterRATMeasQuantity-r8      OPTIONAL,
    interRATReportingQuantity-r8 InterRATReportingQuantity-r8 OPTIONAL,
    reportCriteria               InterRATReportCriteria,
    idleIntervalInfo            IdleIntervalInfo            OPTIONAL
}

InterRATMeasurement-r11 ::= SEQUENCE {
    interRATMeasurementObjects   CHOICE {
        interRATCellInfoList-r6,
        eutra-FrequencyList-r11
    } OPTIONAL,
    interRATMeasQuantity-r8      InterRATMeasQuantity-r8      OPTIONAL,
    interRATReportingQuantity-r8 InterRATReportingQuantity-r8 OPTIONAL,
    reportCriteria               InterRATReportCriteria,
    idleIntervalInfo            IdleIntervalInfo            OPTIONAL
}

InterRATMeasurement-r12 ::= SEQUENCE {
    interRATMeasurementObjects   CHOICE {
        interRATCellInfoList-r6,
        eutra-FrequencyList-r12
    } OPTIONAL,
    interRATMeasQuantity-r8      InterRATMeasQuantity-r8      OPTIONAL,
    interRATReportingQuantity-r8 InterRATReportingQuantity-r8 OPTIONAL,
    reportCriteria               InterRATReportCriteria-r12,
}

```

```

    idleIntervalInfo                               IdleIntervalInfo                               OPTIONAL
}

InterRATMeasurementSysInfo ::= SEQUENCE {
    interRATCellInfoList                          InterRATCellInfoList                          OPTIONAL
}

InterRATMeasurementSysInfo-B ::= SEQUENCE {
    interRATCellInfoList                          InterRATCellInfoList-B                       OPTIONAL
}

InterRATReportCriteria ::= CHOICE {
    interRATReportingCriteria                      InterRATReportingCriteria,
    periodicalReportingCriteria                   PeriodicalWithReportingCellStatus,
    noReporting                                   ReportingCellStatusOpt
}

InterRATReportCriteria-r12 ::= CHOICE {
    interRATReportingCriteria                     InterRATReportingCriteria-r12,
    periodicalReportingCriteria                   PeriodicalWithReportingCellStatus,
    noReporting                                   ReportingCellStatusOpt
}

InterRATReportingCriteria ::= SEQUENCE {
    interRATEventList                             InterRATEventList                            OPTIONAL
}

InterRATReportingCriteria-r12 ::= SEQUENCE {
    interRATEventList                             InterRATEventList-r12                       OPTIONAL
}

InterRATReportingQuantity ::= SEQUENCE {
    utran-EstimatedQuality                        BOOLEAN,
    ratSpecificInfo                              CHOICE {
        gsm                                       SEQUENCE {
            -- dummy and dummy2 are not used in this version of the specification
            -- and when received they should be ignored.
            dummy                                  BOOLEAN,
            dummy2                                 BOOLEAN,
            gsm-Carrier-RSSI                       BOOLEAN
        }
    }
}

InterRATReportingQuantity-r8 ::= SEQUENCE {
    utran-EstimatedQuality                        BOOLEAN,
    ratSpecificInfo                              CHOICE {
        gsm                                       SEQUENCE {
            gsm-Carrier-RSSI                       BOOLEAN
        },
        eutra                                       SEQUENCE {
            reportingQuantity                       ENUMERATED { measurementQuantity,
                                                    both }
        }
    }
}

IntraFreqCellID ::= INTEGER (0..maxCellMeas-1)

IntraFreqCellIDOnSecULFreq ::= INTEGER (0..maxCellMeasOnSecULFreq-1)

IntraFreqCellInfoList ::= SEQUENCE {
    removedIntraFreqCellList                     RemovedIntraFreqCellList                     OPTIONAL,
    newIntraFreqCellList                         NewIntraFreqCellList                         OPTIONAL,
    cellsForIntraFreqMeasList                    CellsForIntraFreqMeasList                    OPTIONAL
}

IntraFreqCellInfoList-r4 ::= SEQUENCE {
    removedIntraFreqCellList                     RemovedIntraFreqCellList                     OPTIONAL,
    newIntraFreqCellList                         NewIntraFreqCellList-r4                     OPTIONAL,
    cellsForIntraFreqMeasList                    CellsForIntraFreqMeasList                    OPTIONAL
}

IntraFreqCellInfoListInfoOnSecULFreq ::= SEQUENCE {
    removedIntraFreqCellList                     RemovedIntraFreqCellListOnSecULFreq          OPTIONAL,
    newIntraFreqCellList                         NewIntraFreqCellListOnSecULFreq             OPTIONAL,
    cellsForIntraFreqMeasList                    CellsForIntraFreqMeasListOnSecULFreq        OPTIONAL
}

```

```

}

IntraFreqCellInfoListOnSecULFreq ::= SEQUENCE {
    intraFreqCellInfoListOnSecULFreq
}

IntraFreqCellInfoList-r9 ::= SEQUENCE {
    removedIntraFreqCellList          RemovedIntraFreqCellList          OPTIONAL,
    newIntraFreqCellList                NewIntraFreqCellList-r9          OPTIONAL,
    cellsForIntraFreqMeasList           CellsForIntraFreqMeasList        OPTIONAL,
    csgIntraFreqCellInfoList           CSGIntraFreqCellInfoList         OPTIONAL,
    intraFreqSIAcquisition              IntraFreqSIAcquisition          OPTIONAL
}

IntraFreqCellInfoList-r10 ::= SEQUENCE {
    removedIntraFreqCellList          RemovedIntraFreqCellList          OPTIONAL,
    newIntraFreqCellList                NewIntraFreqCellList-r10        OPTIONAL,
    cellsForIntraFreqMeasList           CellsForIntraFreqMeasList        OPTIONAL,
    csgIntraFreqCellInfoList           CSGIntraFreqCellInfoList         OPTIONAL,
    intraFreqSIAcquisition              IntraFreqSIAcquisition          OPTIONAL
}

IntraFreqSIAcquisitionInfo ::= SEQUENCE (SIZE (1..maxSIRequest)) OF
    PrimaryCPICH-Info

IntraFreqSIAcquisition ::= SEQUENCE {
    modeSpecificInfo                  CHOICE {
        fdd                            SEQUENCE {
            intraFreqSIAcquisitionInfo  IntraFreqSIAcquisitionInfo      OPTIONAL
        },
        tdd                            NULL
    }
}

IntraFreqCellInfoSI-List-RSCP ::= SEQUENCE {
    removedIntraFreqCellList          RemovedIntraFreqCellList          OPTIONAL,
    newIntraFreqCellList                NewIntraFreqCellSI-List-RSCP
}

IntraFreqCellInfoSI-List-ECNO ::= SEQUENCE {
    removedIntraFreqCellList          RemovedIntraFreqCellList          OPTIONAL,
    newIntraFreqCellList                NewIntraFreqCellSI-List-ECNO
}

IntraFreqCellInfoSI-List-HCS-RSCP ::= SEQUENCE {
    removedIntraFreqCellList          RemovedIntraFreqCellList          OPTIONAL,
    newIntraFreqCellList                NewIntraFreqCellSI-List-HCS-RSCP
}

IntraFreqCellInfoSI-List-HCS-ECNO ::= SEQUENCE {
    removedIntraFreqCellList          RemovedIntraFreqCellList          OPTIONAL,
    newIntraFreqCellList                NewIntraFreqCellSI-List-HCS-ECNO
}

IntraFreqCellInfoSI-List-RSCP-LCR-r4 ::= SEQUENCE {
    removedIntraFreqCellList          RemovedIntraFreqCellList          OPTIONAL,
    newIntraFreqCellList                NewIntraFreqCellSI-List-RSCP-LCR-r4
}

IntraFreqCellInfoSI-List-ECNO-LCR-r4 ::= SEQUENCE {
    removedIntraFreqCellList          RemovedIntraFreqCellList          OPTIONAL,
    newIntraFreqCellList                NewIntraFreqCellSI-List-ECNO-LCR-r4
}

IntraFreqCellInfoSI-List-HCS-RSCP-LCR-r4 ::= SEQUENCE {
    removedIntraFreqCellList          RemovedIntraFreqCellList          OPTIONAL,
    newIntraFreqCellList                NewIntraFreqCellSI-List-HCS-RSCP-LCR-r4
}

IntraFreqCellInfoSI-List-HCS-ECNO-LCR-r4 ::= SEQUENCE {
    removedIntraFreqCellList          RemovedIntraFreqCellList          OPTIONAL,
    newIntraFreqCellList                NewIntraFreqCellSI-List-HCS-ECNO-LCR-r4
}

IntraFreqEvent ::= CHOICE {
    e1a                                Event1a,
    e1b                                Event1b,
}

```

```

    e1c                Event1c,
    e1d                NULL,
    e1e                Event1e,
    e1f                Event1f,
    e1g                NULL,
    e1h                ThresholdUsedFrequency,
    e1i                ThresholdUsedFrequency
}

IntraFreqEvent-r4 ::= CHOICE {
    e1a                Event1a-r4,
    e1b                Event1b-r4,
    e1c                Event1c,
    e1d                NULL,
    e1e                Event1e,
    e1f                Event1f,
    e1g                NULL,
    e1h                ThresholdUsedFrequency,
    e1i                ThresholdUsedFrequency
}

IntraFreqEvent-LCR-r4 ::= CHOICE {
    e1a                Event1a-LCR-r4,
    e1b                Event1b-LCR-r4,
    e1c                Event1c,
    e1d                NULL,
    e1e                Event1e,
    e1f                Event1f,
    e1g                NULL,
    e1h                ThresholdUsedFrequency,
    e1i                ThresholdUsedFrequency
}

IntraFreqEvent-r6 ::= CHOICE {
    e1a                Event1a-r4,
    e1b                Event1b-r4,
    e1c                Event1c,
    e1d                Event1d,
    e1e                Event1e-r6,
    e1f                Event1f-r6,
    e1g                NULL,
    e1h                ThresholdUsedFrequency-r6,
    e1i                ThresholdUsedFrequency-r6,
    e1j                Event1j-r6
}

IntraFreqEvent-r7 ::= CHOICE {
    e1a                Event1a-r4,
    e1b                Event1b-r7,
    e1c                Event1c,
    e1d                Event1d,
    e1e                Event1e-r6,
    e1f                Event1f-r6,
    e1g                NULL,
    e1h                ThresholdUsedFrequency-r6,
    e1i                ThresholdUsedFrequency-r6,
    e1j                Event1j-r6
}

IntraFreqEventOnSecULFreq ::= CHOICE {
    e1a                Event1a-OnSecULFreq-r9,
    e1b                Event1b-OnSecULFreq-r9,
    e1c                Event1c,
    e1e                Event1e-r6,
    e1f                Event1f-r6
}

IntraFreqEvent-ld-r5 ::= SEQUENCE {
    triggeringCondition TriggeringCondition2 OPTIONAL,
    useCIO              BOOLEAN           OPTIONAL
}

IntraFreqEventCriteria ::= SEQUENCE {
    event                IntraFreqEvent,
    hysteresis           Hysteresis,
    timeToTrigger        TimeToTrigger,
    reportingCellStatus ReportingCellStatus OPTIONAL
}

```

```

IntraFreqEventCriteria-r4 ::= SEQUENCE {
    event                IntraFreqEvent-r4,
    hysteresis           Hysteresis,
    timeToTrigger       TimeToTrigger,
    reportingCellStatus ReportingCellStatus
} OPTIONAL

IntraFreqEventCriteria-LCR-r4 ::= SEQUENCE {
    event                IntraFreqEvent-LCR-r4,
    hysteresis           Hysteresis,
    timeToTrigger       TimeToTrigger,
    reportingCellStatus ReportingCellStatus
} OPTIONAL

IntraFreqEventCriteria-r6 ::= SEQUENCE {
    event                IntraFreqEvent-r6,
    hysteresis           Hysteresis,
    timeToTrigger       TimeToTrigger,
    reportingCellStatus ReportingCellStatus
} OPTIONAL

IntraFreqEventCriteria-r7 ::= SEQUENCE {
    event                IntraFreqEvent-r7,
    hysteresis           Hysteresis,
    timeToTrigger       TimeToTrigger,
    reportingCellStatus ReportingCellStatus
} OPTIONAL

IntraFreqEventCriteriaOnSecULFreq ::= SEQUENCE {
    event                IntraFreqEventOnSecULFreq,
    hysteresis           Hysteresis,
    timeToTrigger       TimeToTrigger,
    reportingCellStatus ReportingCellStatus
} OPTIONAL

IntraFreqEventCriteriaList ::= SEQUENCE (SIZE (1..maxMeasEvent)) OF
    IntraFreqEventCriteria

IntraFreqEventCriteriaList-r4 ::= SEQUENCE (SIZE (1..maxMeasEvent)) OF
    IntraFreqEventCriteria-r4

IntraFreqEventCriteriaList-LCR-r4 ::= SEQUENCE (SIZE (1..maxMeasEvent)) OF
    IntraFreqEventCriteria-LCR-r4

IntraFreqEventCriteriaList-r6 ::= SEQUENCE (SIZE (1..maxMeasEvent)) OF
    IntraFreqEventCriteria-r6

IntraFreqEventCriteriaList-r7 ::= SEQUENCE (SIZE (1..maxMeasEvent)) OF
    IntraFreqEventCriteria-r7

IntraFreqEventCriteriaListOnSecULFreq ::= SEQUENCE{
    frequencyInfo       FrequencyInfo,
    intraFreqEventCriteria SEQUENCE (SIZE (1..maxMeasEventOnSecULFreq)) OF
        IntraFreqEventCriteriaOnSecULFreq
}

IntraFreqEventResults ::= SEQUENCE {
    eventID              EventIDIntraFreq,
    cellMeasurementEventResults CellMeasurementEventResults
}

IntraFreqEventResultsOnSecULFreq ::= SEQUENCE {
    eventID              EventIDIntraFreq,
    cellMeasurementEventResultsOnSecULFreq CellMeasurementEventResultsOnSecULFreq
}

IntraFreqMeasQuantity ::= SEQUENCE {
    filterCoefficient   FilterCoefficient
    modeSpecificInfo    CHOICE {
        fdd              SEQUENCE {
            intraFreqMeasQuantity-FDD IntraFreqMeasQuantity-FDD
        },
        tdd              SEQUENCE {
            intraFreqMeasQuantity-TDDList IntraFreqMeasQuantity-TDDList
        }
    }
    }
}

```

```

-- If IntraFreqMeasQuantity-FDD is used in InterRATMeasQuantity, then only
-- cpich-Ec-N0 and cpich-RSCP are allowed.
-- dummy is not used in this version of the specification, it should
-- not be sent and if received the UE behaviour is not specified.
IntraFreqMeasQuantity-FDD ::= ENUMERATED {
    cpich-Ec-N0,
    cpich-RSCP,
    pathloss,
    dummy }

IntraFreqMeasQuantity-FDD-sib3 ::= ENUMERATED {
    cpich-Ec-N0, cpich-RSCP }

-- dummy is not used in this version of the specification, it should
-- not be sent and if received the UE behaviour is not specified.
IntraFreqMeasQuantity-TDD ::= ENUMERATED {
    primaryCCPCH-RSCP,
    pathloss,
    timeslotISCP,
    dummy }

IntraFreqMeasQuantity-TDDList ::= SEQUENCE (SIZE (1..4)) OF
    IntraFreqMeasQuantity-TDD

IntraFreqMeasQuantity-TDD-sib3List ::= SEQUENCE (SIZE (1..2)) OF
    ENUMERATED { primaryCCPCH-RSCP, timeslotISCP }

IntraFreqMeasuredResultsList ::= SEQUENCE (SIZE (1..maxCellMeas)) OF
    CellMeasuredResults

IntraFreqMeasuredResultsList-v920ext ::= SEQUENCE (SIZE (1..maxCellMeas)) OF
    CellMeasuredResults-v920ext

IntraFreqMeasuredResultsList-vc50ext ::= SEQUENCE (SIZE (1..maxCellMeas)) OF
    CellMeasuredResults-vc50ext

IntraFreqMeasurementSysInfo-RSCP ::= SEQUENCE {
    intraFreqMeasurementID MeasurementIdentity DEFAULT 1,
    intraFreqCellInfoSI-List IntraFreqCellInfoSI-List-RSCP OPTIONAL,
    intraFreqMeasQuantity IntraFreqMeasQuantity OPTIONAL,
    intraFreqReportingQuantityForRACH IntraFreqReportingQuantityForRACH OPTIONAL,
    maxReportedCellsOnRACH MaxReportedCellsOnRACH OPTIONAL,
    reportingInfoForCellDCH ReportingInfoForCellDCH OPTIONAL
}

IntraFreqMeasurementSysInfo-ECNO ::= SEQUENCE {
    intraFreqMeasurementID MeasurementIdentity DEFAULT 1,
    intraFreqCellInfoSI-List IntraFreqCellInfoSI-List-ECNO OPTIONAL,
    intraFreqMeasQuantity IntraFreqMeasQuantity OPTIONAL,
    intraFreqReportingQuantityForRACH IntraFreqReportingQuantityForRACH OPTIONAL,
    maxReportedCellsOnRACH MaxReportedCellsOnRACH OPTIONAL,
    reportingInfoForCellDCH ReportingInfoForCellDCH OPTIONAL
}

IntraFreqMeasurementSysInfo-HCS-RSCP ::= SEQUENCE {
    intraFreqMeasurementID MeasurementIdentity DEFAULT 1,
    intraFreqCellInfoSI-List IntraFreqCellInfoSI-List-HCS-RSCP OPTIONAL,
    intraFreqMeasQuantity IntraFreqMeasQuantity OPTIONAL,
    intraFreqReportingQuantityForRACH IntraFreqReportingQuantityForRACH OPTIONAL,
    maxReportedCellsOnRACH MaxReportedCellsOnRACH OPTIONAL,
    reportingInfoForCellDCH ReportingInfoForCellDCH OPTIONAL
}

IntraFreqMeasurementSysInfo-HCS-ECNO ::= SEQUENCE {
    intraFreqMeasurementID MeasurementIdentity DEFAULT 1,
    intraFreqCellInfoSI-List IntraFreqCellInfoSI-List-HCS-ECNO OPTIONAL,
    intraFreqMeasQuantity IntraFreqMeasQuantity OPTIONAL,
    intraFreqReportingQuantityForRACH IntraFreqReportingQuantityForRACH OPTIONAL,
    maxReportedCellsOnRACH MaxReportedCellsOnRACH OPTIONAL,
    reportingInfoForCellDCH ReportingInfoForCellDCH OPTIONAL
}

IntraFreqMeasurementSysInfo-RSCP-LCR-r4 ::= SEQUENCE {
    intraFreqMeasurementID MeasurementIdentity DEFAULT 1,
    intraFreqCellInfoSI-List IntraFreqCellInfoSI-List-RSCP-LCR-r4 OPTIONAL,
    intraFreqMeasQuantity IntraFreqMeasQuantity OPTIONAL,
    intraFreqReportingQuantityForRACH IntraFreqReportingQuantityForRACH OPTIONAL,
}

```



```

maxReportedCellsOnRACH           MaxReportedCellsOnRACH           OPTIONAL,
reportingInfoForCellDCH          ReportingInfoForCellDCH-LCR-r4     OPTIONAL
}

IntraFreqMeasurementSysInfo-ECN0-LCR-r4 ::= SEQUENCE {
  intraFreqMeasurementID          MeasurementIdentity                DEFAULT 1,
  intraFreqCellInfoSI-List        IntraFreqCellInfoSI-List-ECN0-LCR-r4  OPTIONAL,
  intraFreqMeasQuantity           IntraFreqMeasQuantity             OPTIONAL,
  intraFreqReportingQuantityForRACH IntraFreqReportingQuantityForRACH  OPTIONAL,
  maxReportedCellsOnRACH          MaxReportedCellsOnRACH            OPTIONAL,
  reportingInfoForCellDCH         ReportingInfoForCellDCH-LCR-r4      OPTIONAL
}

IntraFreqMeasurementSysInfo-HCS-RSCP-LCR-r4 ::= SEQUENCE {
  intraFreqMeasurementID          MeasurementIdentity                DEFAULT 1,
  intraFreqCellInfoSI-List        IntraFreqCellInfoSI-List-HCS-RSCP-LCR-r4  OPTIONAL,
  intraFreqMeasQuantity           IntraFreqMeasQuantity             OPTIONAL,
  intraFreqReportingQuantityForRACH IntraFreqReportingQuantityForRACH  OPTIONAL,
  maxReportedCellsOnRACH          MaxReportedCellsOnRACH            OPTIONAL,
  reportingInfoForCellDCH         ReportingInfoForCellDCH-LCR-r4      OPTIONAL
}

IntraFreqMeasurementSysInfo-HCS-ECN0-LCR-r4 ::= SEQUENCE {
  intraFreqMeasurementID          MeasurementIdentity                DEFAULT 1,
  intraFreqCellInfoSI-List        IntraFreqCellInfoSI-List-HCS-ECN0-LCR-r4  OPTIONAL,
  intraFreqMeasQuantity           IntraFreqMeasQuantity             OPTIONAL,
  intraFreqReportingQuantityForRACH IntraFreqReportingQuantityForRACH  OPTIONAL,
  maxReportedCellsOnRACH          MaxReportedCellsOnRACH            OPTIONAL,
  reportingInfoForCellDCH         ReportingInfoForCellDCH-LCR-r4      OPTIONAL
}

IntraFreqReportCriteria ::= CHOICE {
  intraFreqReportingCriteria      IntraFreqReportingCriteria,
  periodicalReportingCriteria     PeriodicalWithReportingCellStatus,
  noReporting                     ReportingCellStatusOpt
}

IntraFreqReportCriteria-r4 ::= CHOICE {
  intraFreqReportingCriteria-r4   IntraFreqReportingCriteria-r4,
  periodicalReportingCriteria     PeriodicalWithReportingCellStatus,
  noReporting                     ReportingCellStatusOpt
}

IntraFreqReportCriteria-r6 ::= CHOICE {
  intraFreqReportingCriteria-r6   IntraFreqReportingCriteria-r6,
  periodicalReportingCriteria     PeriodicalWithReportingCellStatus,
  noReporting                     ReportingCellStatusOpt
}

IntraFreqReportCriteria-r7 ::= CHOICE {
  intraFreqReportingCriteria-r7   IntraFreqReportingCriteria-r7,
  periodicalReportingCriteria     PeriodicalWithReportingCellStatus,
  noReporting                     ReportingCellStatusOpt
}

IntraFreqReportCriteria-r9 ::= CHOICE {
  intraFreqReportingCriteria-r9   IntraFreqReportingCriteria-r9,
  periodicalReportingCriteria     PeriodicalWithReportingCellStatus,
  noReporting                     ReportingCellStatusOpt
}

IntraFreqReportCriteria-r11 ::= CHOICE {
  intraFreqReportingCriteria-r11  IntraFreqReportingCriteria-r11,
  periodicalReportingCriteria     PeriodicalWithReportingCellStatus,
  noReporting                     ReportingCellStatusOpt
}

IntraFreqReportingCriteria ::= SEQUENCE {
  eventCriteriaList              IntraFreqEventCriteriaList        OPTIONAL
}

IntraFreqReportingCriteria-r4 ::= SEQUENCE {
  eventCriteriaList              IntraFreqEventCriteriaList-r4     OPTIONAL
}

IntraFreqReportingCriteria-LCR-r4 ::= SEQUENCE {
  eventCriteriaList              IntraFreqEventCriteriaList-LCR-r4  OPTIONAL
}

```

```

IntraFreqReportingCriteria-r6 ::= SEQUENCE {
    eventCriteriaList          IntraFreqEventCriteriaList-r6    OPTIONAL
}

IntraFreqReportingCriteria-r7 ::= SEQUENCE {
    eventCriteriaList          IntraFreqEventCriteriaList-r7    OPTIONAL
}

IntraFreqReportingCriteria-r9 ::= SEQUENCE {
    eventCriteriaList          IntraFreqEventCriteriaList-r7    OPTIONAL,
    eventCriteriaListOnSecULFreq IntraFreqEventCriteriaListOnSecULFreq OPTIONAL
}

IntraFreqReportingCriteria-r11 ::= SEQUENCE {
    eventCriteriaList          IntraFreqEventCriteriaList-r7    OPTIONAL,
    eventCriteriaListOnSecULFreq IntraFreqEventCriteriaListOnSecULFreq OPTIONAL,
    excludedCellInfoList      CellInfoListToBeExcluded        OPTIONAL
}

IntraFreqReportingCriteria-lb-r5 ::= SEQUENCE {
    periodicReportingInfo-lb   PeriodicReportingInfo-lb
}

IntraFreqReportingQuantity ::= SEQUENCE {
    activeSetReportingQuantities CellReportingQuantities,
    monitoredSetReportingQuantities CellReportingQuantities,
    detectedSetReportingQuantities CellReportingQuantities        OPTIONAL
}

IntraFreqReportingQuantityForRACH ::= SEQUENCE {
    sfn-SFN-OTD-Type          SFN-SFN-OTD-Type,
    modeSpecificInfo          CHOICE {
        fdd                    SEQUENCE {
            intraFreqRepQuantityRACH-FDD IntraFreqRepQuantityRACH-FDD
        },
        tdd                    SEQUENCE {
            intraFreqRepQuantityRACH-TDDList IntraFreqRepQuantityRACH-TDDList
        }
    }
}

IntraFreqReportingQuantityForRACH-vc50ext ::= SEQUENCE {
    intraFreqRepQuantityRACH-FDD ENUMERATED {
        cpich-EcN0-RSCP, spare1
    }
}

IntraFreqRepQuantityRACH-FDD ::= ENUMERATED {
    cpich-EcN0, cpich-RSCP,
    pathloss, noReport
}

IntraFreqRepQuantityRACH-TDD ::= ENUMERATED {
    timeslotISCP,
    primaryCCPCH-RSCP,
    noReport
}

IntraFreqRepQuantityRACH-TDDList ::= SEQUENCE (SIZE (1..2)) OF
    IntraFreqRepQuantityRACH-TDD

IntraFrequencyMeasurement ::= SEQUENCE {
    intraFreqCellInfoList      IntraFreqCellInfoList          OPTIONAL,
    intraFreqMeasQuantity      IntraFreqMeasQuantity          OPTIONAL,
    intraFreqReportingQuantity IntraFreqReportingQuantity    OPTIONAL,
    measurementValidity        MeasurementValidity          OPTIONAL,
    reportCriteria             IntraFreqReportCriteria        OPTIONAL
}

IntraFrequencyMeasurement-r4 ::= SEQUENCE {
    intraFreqCellInfoList-r4   IntraFreqCellInfoList-r4    OPTIONAL,
    intraFreqMeasQuantity-r4   IntraFreqMeasQuantity-r4   OPTIONAL,
    intraFreqReportingQuantity IntraFreqReportingQuantity    OPTIONAL,
    measurementValidity-r4     MeasurementValidity-r4     OPTIONAL,
    reportCriteria-r4          IntraFreqReportCriteria-r4    OPTIONAL
}

IntraFrequencyMeasurement-r6 ::= SEQUENCE {
    intraFreqCellInfoList-r6   IntraFreqCellInfoList-r6    OPTIONAL,
    intraFreqMeasQuantity-r6   IntraFreqMeasQuantity-r6   OPTIONAL,
}

```

```

    intraFreqReportingQuantity      IntraFreqReportingQuantity      OPTIONAL,
    measurementValidity             MeasurementValidity             OPTIONAL,
    -- reportCriteria is optional in later versions of this message
    reportCriteria                  IntraFreqReportCriteria-r6
}

IntraFrequencyMeasurement-r7 ::= SEQUENCE {
    intraFreqCellInfoList           IntraFreqCellInfoList-r4      OPTIONAL,
    intraFreqMeasQuantity           IntraFreqMeasQuantity         OPTIONAL,
    intraFreqReportingQuantity      IntraFreqReportingQuantity    OPTIONAL,
    measurementValidity             MeasurementValidity            OPTIONAL,
    reportCriteria                  IntraFreqReportCriteria-r7    OPTIONAL
}

IntraFrequencyMeasurement-r9 ::= SEQUENCE {
    intraFreqCellInfoList           IntraFreqCellInfoList-r9      OPTIONAL,
    intraFreqCellInfoListOnSecULFreq IntraFreqCellInfoListOnSecULFreq OPTIONAL,
    intraFreqMeasQuantity           IntraFreqMeasQuantity         OPTIONAL,
    intraFreqReportingQuantity      IntraFreqReportingQuantity    OPTIONAL,
    measurementValidity             MeasurementValidity            OPTIONAL,
    reportCriteria                  IntraFreqReportCriteria-r9    OPTIONAL
}

IntraFrequencyMeasurement-r10 ::= SEQUENCE {
    intraFreqCellInfoList           IntraFreqCellInfoList-r10     OPTIONAL,
    intraFreqCellInfoListOnSecULFreq IntraFreqCellInfoListOnSecULFreq OPTIONAL,
    intraFreqMeasQuantity           IntraFreqMeasQuantity         OPTIONAL,
    intraFreqReportingQuantity      IntraFreqReportingQuantity    OPTIONAL,
    measurementValidity             MeasurementValidity            OPTIONAL,
    reportCriteria                  IntraFreqReportCriteria-r9    OPTIONAL
}

IntraFrequencyMeasurement-r11 ::= SEQUENCE {
    intraFreqCellInfoList           IntraFreqCellInfoList-r10     OPTIONAL,
    intraFreqCellInfoListOnSecULFreq IntraFreqCellInfoListOnSecULFreq OPTIONAL,
    intraFreqMeasQuantity           IntraFreqMeasQuantity         OPTIONAL,
    intraFreqReportingQuantity      IntraFreqReportingQuantity    OPTIONAL,
    measurementValidity             MeasurementValidity            OPTIONAL,
    reportCriteria                  IntraFreqReportCriteria-r11   OPTIONAL,
    periodicalReportingCriteriaOnSecULFreq
    PeriodicalWithReportingCellStatusOnSecULFreq OPTIONAL
}

IntraFrequencyMeasuredResultsListOnSecULFreq ::= SEQUENCE (SIZE (1..maxCellMeasOnSecULFreq)) OF
    CellMeasuredResults-r9

IntraFrequencyMeasuredResultsListOnSecULFreq-vc50ext ::= SEQUENCE (SIZE (1..maxCellMeasOnSecULFreq))
    OF CellMeasuredResults-vc50ext

IntraUTRAANR ::= SEQUENCE {
    loggingAbsoluteThreshold        LoggingAbsoluteThreshold,
    loggingRelativeThreshold        LoggingRelativeThreshold      OPTIONAL
}

IODE ::= INTEGER (0..255)

IP-Length ::= ENUMERATED {
    ip15, ip110 }

IP-PCCPCH-r4 ::= BOOLEAN

IP-Spacing ::= ENUMERATED {
    e5, e7, e10, e15, e20,
    e30, e40, e50 }

IP-Spacing-TDD ::= ENUMERATED {
    e30, e40, e50, e70, e100}

IS-2000SpecificMeasInfo ::= ENUMERATED {
    frequency, timeslot, colourcode,
    outputpower, pn-Offset }

LoggedANRConfigurationInfo ::= SEQUENCE {
    loggingDuration                 ENUMERATED { min10, min30, hr1, spare2, spare1 },
    intraUTRAANR                   IntraUTRAANR                 OPTIONAL,
    interRATANRforEUTRAIndicator    ENUMERATED { true }          OPTIONAL,
    interRATANRforGSMIndicator      ENUMERATED { true }          OPTIONAL
}

```

```

LoggedANRRReportInfoList ::= SEQUENCE (SIZE (1..maxNumANRRLoggedItems)) OF
    LoggedANRRReportInfo

LoggedANRRReportInfoList-vb50ext ::= SEQUENCE (SIZE (1..maxNumANRRLoggedItems)) OF
    LoggedANRRReportInfo-vb50ext

LoggedANRRReportInfo ::= SEQUENCE {
    plmn-Identity          PLMN-Identity,
    servingCell            CellIdentity,
    loggedCellInfo         LoggedCellInfo
}

LoggedANRRReportInfo-vb50ext ::= SEQUENCE {
    loggedCellInfo         LoggedCellInfo-vb50ext
}

LoggedCellInfo ::= CHOICE {
    loggedUTRACellInfo     LoggedUTRACellInfo,
    loggedEUTRACellInfo    LoggedEUTRACellInfo,
    loggedGSMCellInfo      LoggedGSMCellInfo
}

LoggedCellInfo-vb50ext ::= CHOICE {
    loggedEUTRACellInfo    LoggedEUTRACellInfo-vb50ext
}

LoggedConnectionEstablishmentFailureInfo-FDD ::= SEQUENCE {
    loggedConnectionEstablishmentFailureAccessInfo-FDD
        LoggedConnectionEstablishmentFailureAccessInfo-FDD,
    loggedMeasFailedCellMeas          LoggedMeasServingCellMeas-FDD,
    loggedMeasIntrafreqNeighbourList   LoggedMeasIntrafreqNeighbourList-FDD    OPTIONAL,
    loggedMeasInterfreqList            LoggedMeasInterfreqList-FDD        OPTIONAL,
    loggedMeasInterRATNeighbourMeas     LoggedMeasInterRATNeighbourMeas-vb50ext  OPTIONAL,
    loggedConnectionEstablishmentFailureLocationInfo
        LoggedConnectionEstablishmentFailureLocationInfo    OPTIONAL
}

LoggedConnectionEstablishmentFailureInfo-FDD-vc50ext ::= SEQUENCE {
    loggedMeasInterRATNeighbourMeas     LoggedMeasInterRATNeighbourMeas-vc50ext    OPTIONAL
}

LoggedConnectionEstablishmentFailureInfo-FDD-r11 ::= SEQUENCE {
    loggedConnectionEstablishmentFailureAccessInfo-FDD
        LoggedConnectionEstablishmentFailureAccessInfo-FDD,
    loggedMeasFailedCellMeas          LoggedMeasServingCellMeas-FDD,
    loggedMeasIntrafreqNeighbourList   LoggedMeasIntrafreqNeighbourList-FDD    OPTIONAL,
    loggedMeasInterfreqList            LoggedMeasInterfreqList-FDD        OPTIONAL,
    loggedMeasInterRATNeighbourMeas     LoggedMeasInterRATNeighbourMeas-r11    OPTIONAL,
    loggedConnectionEstablishmentFailureLocationInfo
        LoggedConnectionEstablishmentFailureLocationInfo    OPTIONAL
}

LoggedConnectionEstablishmentFailureInfo-TDD128 ::= SEQUENCE {
    loggedConnectionEstablishmentFailureAccessInfo-TDD
        LoggedConnectionEstablishmentFailureAccessInfo-TDD,
    loggedMeasFailedCellMeas          LoggedMeasServingCellMeas-TDD128,
    loggedMeasIntrafreqNeighbourList   LoggedMeasIntrafreqNeighbourMeasList-TDD128  OPTIONAL,
    loggedMeasInterfreqList            LoggedMeasInterfreqList-TDD128    OPTIONAL,
    loggedMeasInterRATNeighbourMeas     LoggedMeasInterRATNeighbourMeas-vb50ext  OPTIONAL,
    loggedConnectionEstablishmentFailureLocationInfo
        LoggedConnectionEstablishmentFailureLocationInfo    OPTIONAL
}

LoggedConnectionEstablishmentFailureInfo-TDD128-r11 ::= SEQUENCE {
    loggedConnectionEstablishmentFailureAccessInfo-TDD
        LoggedConnectionEstablishmentFailureAccessInfo-TDD,
    loggedMeasFailedCellMeas          LoggedMeasServingCellMeas-TDD128,
    loggedMeasIntrafreqNeighbourList   LoggedMeasIntrafreqNeighbourMeasList-TDD128  OPTIONAL,
    loggedMeasInterfreqList            LoggedMeasInterfreqList-TDD128    OPTIONAL,
    loggedMeasInterRATNeighbourMeas     LoggedMeasInterRATNeighbourMeas-r11    OPTIONAL,
    loggedConnectionEstablishmentFailureLocationInfo
        LoggedConnectionEstablishmentFailureLocationInfo    OPTIONAL
}

LoggedConnectionEstablishmentFailureInfo-TDD128-vc50ext ::= SEQUENCE {
    loggedMeasInterRATNeighbourMeas     LoggedMeasInterRATNeighbourMeas-vc50ext    OPTIONAL
}

```

```

LoggedConnectionEstablishmentFailureAccessInfo-FDD ::= SEQUENCE {
    numberOfRRCMsgTransmitted      INTEGER (0..8)
}

LoggedConnectionEstablishmentFailureAccessInfo-TDD ::= SEQUENCE {
    numberOfRRCMsgTransmitted      INTEGER (0..8),
    fpachReceived                  BOOLEAN,
    e-RUCCHFailure                  BOOLEAN      OPTIONAL
}

LoggedConnectionEstablishmentFailureLocationInfo ::= SEQUENCE {
    location      CHOICE {
        ellipsoidPoint                EllipsoidPoint,
        ellipsoidPointUncertCircle     EllipsoidPointUncertCircle,
        ellipsoidPointUncertEllipse    EllipsoidPointUncertEllipse,
        ellipsoidPointAltitude         EllipsoidPointAltitude,
        ellipsoidPointAltitudeEllipse  EllipsoidPointAltitudeEllipsoide
    },
    horizontalVelocity                HorizontalVelocity      OPTIONAL
}

ConnectionEstablishmentFailureReport ::= SEQUENCE {
    timeSinceFailure                  INTEGER (0..172800),
    modeSpecificInfo                  CHOICE {
        fdd                            SEQUENCE {
            loggedConnectionEstablishmentFailureInfo
            LoggedConnectionEstablishmentFailureInfo-FDD
        },
        tdd                            SEQUENCE {
            loggedConnectionEstablishmentFailureInfo
            LoggedConnectionEstablishmentFailureInfo-TDD128
        }
    }
}

ConnectionEstablishmentFailureReport-r11 ::= SEQUENCE {
    timeSinceFailure                  INTEGER (0..172800),
    modeSpecificInfo                  CHOICE {
        fdd                            SEQUENCE {
            loggedConnectionEstablishmentFailureInfo
            LoggedConnectionEstablishmentFailureInfo-FDD-r11
        },
        tdd                            SEQUENCE {
            loggedConnectionEstablishmentFailureInfo
            LoggedConnectionEstablishmentFailureInfo-TDD128-r11
        }
    }
}

ConnectionEstablishmentFailureReport-vc50ext ::= SEQUENCE {
    modeSpecificInfo                  CHOICE {
        fdd                            SEQUENCE {
            loggedConnectionEstablishmentFailureInfo
            LoggedConnectionEstablishmentFailureInfo-FDD-vc50ext
        },
        tdd                            SEQUENCE {
            loggedConnectionEstablishmentFailureInfo
            LoggedConnectionEstablishmentFailureInfo-TDD128-vc50ext
        }
    }
}

LoggedEUTRACellInfo ::= SEQUENCE {
    plmn-Identity                    PLMN-Identity,
    trackingAreaCode                  BIT STRING (SIZE (16)),
    eutraCellIdentity                 BIT STRING (SIZE (28)),
    earfcn                             EARFCN,
    physicalCellIdentity              EUTRA-PhysicalCellIdentity
}

LoggedEUTRACellInfo-vb50ext ::= SEQUENCE {
    earfcn                             EARFCNExtension      OPTIONAL
}

LoggedGSMCellInfo ::= SEQUENCE {

```

```

    plmn-Identity          PLMN-Identity,
    lac                   BIT STRING (SIZE (16)),
    gsmCellIdentity       BIT STRING (SIZE (16)),
    bcch-ARFCN           BCCH-ARFCN,
    bandIndicator         Frequency-Band,
    bsic                  BSIC
}

LoggedMeasurementsConfigurationInfo ::= SEQUENCE {
    absoluteTimeInfo      BIT STRING (SIZE(48)),
    loggingDuration       ENUMERATED {min10, min20, min40, hr1, hr1min30,hr2,spare2,spare1},
    loggingInterval       ENUMERATED {li128,li256,li512,li1024,li2048,li3072,li4096,li6144},
    traceReference        TraceReference,
    traceRecordingSession TraceRecordingSession,
    tce-Id                TCE-Id,
    areaConfiguration     CHOICE {
        cellIDList SEQUENCE (SIZE (1..32)) OF
            CellIdentity,
        locationAreaList SEQUENCE (SIZE (1..8)) OF
            LAI,
        routingAreaList SEQUENCE (SIZE (1..8)) OF
            RAI
    } OPTIONAL
}

LoggedMeasurementsConfigurationInfo-r11 ::= SEQUENCE {
    absoluteTimeInfo      BIT STRING (SIZE(48)),
    loggingDuration       ENUMERATED {min10, min20, min40, hr1, hr1min30,hr2,spare2,spare1},
    loggingInterval       ENUMERATED {li128,li256,li512,li1024,li2048,li3072,li4096,li6144},
    traceReference        TraceReference,
    traceRecordingSession TraceRecordingSession,
    tce-Id                TCE-Id,
    plmnList              PlmnList OPTIONAL,
    areaConfiguration     CHOICE {
        cellIDList SEQUENCE (SIZE (1..32)) OF CellIDListItem,
        locationAreaList SEQUENCE (SIZE (1..8)) OF
            LAI,
        routingAreaList SEQUENCE (SIZE (1..8)) OF
            RAI
    } OPTIONAL
}

LoggedMeasInterfreqList-FDD ::= SEQUENCE (SIZE (1..maxNumFDDFreqs)) OF
    LoggedMeasInterfreqInfo-FDD

LoggedMeasInterfreqInfo-FDD ::= SEQUENCE {
    frequencyInfo         FrequencyInfo,
    loggedMeasInterfreqNeighbourList SEQUENCE (SIZE (1..maxnumLoggedMeas)) OF
        LoggedMeasNeighbourInfo-FDD
}

LoggedMeasInterfreqInfo-TDD128 ::= SEQUENCE {
    frequencyInfo         FrequencyInfo,
    loggedMeasInterfreqNeighbourList LoggedMeasInterfreqNeighbourList-TDD128
}

LoggedMeasInterRATNeighbourMeas ::= SEQUENCE {
    loggedMeasEUTRAFreqList LoggedMeasEUTRAFreqList OPTIONAL,
    loggedMeasGSMNeighbourCellsList LoggedMeasGSMNeighbourCellsList OPTIONAL
}

LoggedMeasInterRATNeighbourMeas-vb50ext ::= SEQUENCE {
    loggedMeasEUTRAFreqList LoggedMeasEUTRAFreqList-vb50ext
}

LoggedMeasInterRATNeighbourMeas-vc50ext ::= SEQUENCE {
    loggedMeasEUTRAFreqList LoggedMeasEUTRAFreqList-vc50ext OPTIONAL
}

LoggedMeasInterRATNeighbourMeas-r11 ::= SEQUENCE {
    loggedMeasEUTRAFreqList LoggedMeasEUTRAFreqList-r11 OPTIONAL,
    loggedMeasGSMNeighbourCellsList LoggedMeasGSMNeighbourCellsList OPTIONAL
}

LoggedMeasIntrafreqNeighbourList-FDD ::= SEQUENCE (SIZE (1..maxnumLoggedMeas)) OF
    LoggedMeasNeighbourInfo-FDD

LoggedMeasNeighbourInfo-FDD ::= SEQUENCE {

```

```

    primaryCPICH-Info    PrimaryCPICH-Info,
    cpich-RSCP           CPICH-RSCP,
    cpich-Ec-N0          CPICH-Ec-N0
}

LoggedMeasIntrafreqNeighbourMeasList-TDD128 ::= SEQUENCE (SIZE (1..maxnumLoggedMeas)) OF
    LoggedMeasNeighbourMeas-TDD128

LoggedMeasNeighbourMeas-TDD128 ::= SEQUENCE {
    cellParametersID      CellParametersID,
    primaryCCPCH-RSCP     PrimaryCCPCH-RSCP
}

LoggedMeasGSMNeighbourCellsList ::= SEQUENCE (SIZE (1..maxnumLoggedMeas)) OF
    LoggedMeasGSMNeighbourCellsinfo

LoggedMeasGSMNeighbourCellsinfo ::= SEQUENCE {
    bsic                  BSIC,
    frequency-band       Frequency-Band,
    bcch-ARFCN           BCCH-ARFCN,
    gsm-CarrierRSSI     GSM-CarrierRSSI
}

LoggedMeasEUTRAFreqList ::= SEQUENCE (SIZE (1..maxNumEUTRAFreqs)) OF
    LoggedMeasEUTRAFreqInfo

LoggedMeasEUTRAFreqList-vb50ext ::= SEQUENCE (SIZE (1..maxNumEUTRAFreqs)) OF
    LoggedMeasEUTRAFreqInfo-vb50ext

LoggedMeasEUTRAFreqList-r11 ::= SEQUENCE (SIZE (1..maxNumEUTRAFreqs)) OF
    LoggedMeasEUTRAFreqInfo-r11

LoggedMeasEUTRAFreqList-vc50ext ::= SEQUENCE (SIZE (1..maxNumEUTRAFreqs)) OF
    LoggedMeasEUTRAFreqInfo-vc50ext

LoggedMeasEUTRAFreqInfo ::= SEQUENCE {
    earfcn                EARFCN,
    loggedMeasEUTRAFreqNeighbourInfoList SEQUENCE (SIZE (1.. maxnumLoggedMeas)) OF
        LoggedMeasEUTRAFreqNeighbourInfo
}

LoggedMeasEUTRAFreqInfo-vb50ext ::= SEQUENCE {
    earfcn                EARFCNExtension OPTIONAL
}

LoggedMeasEUTRAFreqInfo-r11 ::= SEQUENCE {
    earfcn                EARFCNRange,
    loggedMeasEUTRAFreqNeighbourInfoList SEQUENCE (SIZE (1.. maxnumLoggedMeas)) OF
        LoggedMeasEUTRAFreqNeighbourInfo
}

LoggedMeasEUTRAFreqInfo-vc50ext ::= SEQUENCE {
    rSRQType              RsrqType OPTIONAL,
    loggedMeasEUTRAFreqNeighbourInfoList SEQUENCE (SIZE (1.. maxnumLoggedMeas)) OF
        LoggedMeasEUTRAFreqNeighbourInfo-vc50ext
}

LoggedMeasEUTRAFreqNeighbourInfo ::= SEQUENCE {
    physicalCellIdentity EUTRA-PhysicalCellIdentity,
    rSRP                  INTEGER (0..97) ,
    rSRQ                  INTEGER (0..33)
}

LoggedMeasEUTRAFreqNeighbourInfo-vc50ext ::= SEQUENCE {
    rSRQExtension         INTEGER (-30..46) OPTIONAL
}

LoggedMeasInfo-FDD ::= SEQUENCE {
    relativeTimeStamp     INTEGER (0..7200),
    loggedMeasServingCellMeas LoggedMeasServingCellMeas-FDD,
    loggedMeasIntrafreqNeighbourList LoggedMeasIntrafreqNeighbourList-FDD OPTIONAL,
    loggedMeasInterfreqList LoggedMeasInterfreqList-FDD OPTIONAL,
    loggedMeasInterRATNeighbourMeas LoggedMeasInterRATNeighbourMeas OPTIONAL,
    loggedMeasLocationInfo LoggedMeasLocationInfo OPTIONAL
}

LoggedMeasInfo-FDD-vb50ext ::= SEQUENCE {
    loggedMeasServingCellMeas LoggedMeasServingCellMeas-FDD-vb50ext OPTIONAL,

```

```

    loggedMeasLocationInfo                LoggedMeasLocationInfo-vb50ext        OPTIONAL,
    loggedMeasInterRATNeighbourMeas       LoggedMeasInterRATNeighbourMeas-vb50ext OPTIONAL
}

LoggedMeasInfo-FDD-vc50ext ::=          SEQUENCE {
    loggedMeasInterRATNeighbourMeas       LoggedMeasInterRATNeighbourMeas-vc50ext OPTIONAL
}

LoggedMeasInfo-TDD128 ::=              SEQUENCE {
    relativeTimeStamp                     INTEGER (0..7200),
    loggedMeasServingCellMeas             LoggedMeasServingCellMeas-TDD128,
    loggedMeasIntrafreqNeighbourList       LoggedMeasIntrafreqNeighbourMeasList-TDD128 OPTIONAL,
    loggedMeasInterfreqList               LoggedMeasInterfreqList-TDD128        OPTIONAL,
    loggedMeasInterRATNeighbourMeas       LoggedMeasInterRATNeighbourMeas      OPTIONAL,
    loggedMeasLocationInfo                LoggedMeasLocationInfo                OPTIONAL
}

LoggedMeasInfo-TDD128-vb50ext ::=      SEQUENCE {
    loggedMeasServingCellMeas             LoggedMeasServingCellMeas-TDD128-vb50ext OPTIONAL,
    loggedMeasLocationInfo                LoggedMeasLocationInfo-vb50ext        OPTIONAL,
    loggedMeasInterRATNeighbourMeas       LoggedMeasInterRATNeighbourMeas-vb50ext OPTIONAL
}

LoggedMeasInfo-TDD128-vc50ext ::=      SEQUENCE {
    loggedMeasInterRATNeighbourMeas       LoggedMeasInterRATNeighbourMeas-vc50ext OPTIONAL
}

LoggedMeasInfoList-FDD ::=             SEQUENCE (SIZE (1.. maxLoggedMeasReport)) OF LoggedMeasInfo-FDD

LoggedMeasInfoList-FDD-vb50ext ::=      SEQUENCE (SIZE (1..maxLoggedMeasReport)) OF LoggedMeasInfo-FDD-
vb50ext

LoggedMeasInfoList-FDD-vc50ext ::=      SEQUENCE (SIZE (1..maxLoggedMeasReport)) OF LoggedMeasInfo-FDD-
vc50ext

LoggedMeasInfoList-TDD128 ::=          SEQUENCE (SIZE (1.. maxLoggedMeasReport)) OF LoggedMeasInfo-TDD128

LoggedMeasInfoList-TDD128-vb50ext ::=  SEQUENCE (SIZE (1..maxLoggedMeasReport)) OF LoggedMeasInfo-TDD128-
vb50ext

LoggedMeasInfoList-TDD128-vc50ext ::=  SEQUENCE (SIZE (1..maxLoggedMeasReport)) OF LoggedMeasInfo-TDD128-
vc50ext

LoggedMeasInfoList ::=                 SEQUENCE {
    modeSpecificInfo                      CHOICE {
        fdd                                SEQUENCE {
            loggedMeasInfoList             LoggedMeasInfoList-FDD
        },
        tdd                                SEQUENCE {
            loggedMeasInfoList             LoggedMeasInfoList-TDD128
        }
    }
}

LoggedMeasInfoList-vb50ext ::=          SEQUENCE {
    modeSpecificInfo                      CHOICE {
        fdd                                SEQUENCE {
            loggedMeasInfoList             LoggedMeasInfoList-FDD-vb50ext
        },
        tdd                                SEQUENCE {
            loggedMeasInfoList             LoggedMeasInfoList-TDD128-vb50ext
        }
    }
}

LoggedMeasInfoList-vc50ext ::=          SEQUENCE {
    modeSpecificInfo                      CHOICE {
        fdd                                SEQUENCE {
            loggedMeasInfoList             LoggedMeasInfoList-FDD-vc50ext
        },
        tdd                                SEQUENCE {
            loggedMeasInfoList             LoggedMeasInfoList-TDD128-vc50ext
        }
    }
}

LoggedMeasInterfreqList-TDD128 ::=     SEQUENCE (SIZE (1..maxNumTDDFreqs)) OF
LoggedMeasInterfreqInfo-TDD128

```



```

LoggedMeasInterfreqNeighbourList-TDD128 ::= SEQUENCE (SIZE (1..maxnumLoggedMeas)) OF
  LoggedMeasNeighbourMeas-TDD128

LoggedMeasLocationInfo ::= CHOICE {
  ellipsoidPoint          EllipsoidPoint,
  ellipsoidPointAltitude EllipsoidPointAltitude
}

LoggedMeasLocationInfo-vb50ext ::= CHOICE {
  ellipsoidPointUncertCircle      EllipsoidPointUncertCircle,
  ellipsoidPointUncertEllipse     EllipsoidPointUncertEllipse,
  ellipsoidPointAltitudeEllipse   EllipsoidPointAltitudeEllipsoide
}

LoggedMeasReport ::=
  SEQUENCE {
    absoluteTimeInfo          BIT STRING (SIZE(48)),
    traceReference            TraceReference,
    traceRecordingSession     TraceRecordingSession,
    tce-Id                    TCE-Id,
    loggedMeasInfoList        LoggedMeasInfoList      OPTIONAL,
    loggedMeasAvailable       ENUMERATED { true }     OPTIONAL
  }

LoggedMeasReport-vb50ext ::=
  SEQUENCE {
    loggedMeasInfoList        LoggedMeasInfoList-vb50ext      OPTIONAL
  }

LoggedMeasReport-vc50ext ::=
  SEQUENCE {
    loggedMeasInfoList        LoggedMeasInfoList-vc50ext      OPTIONAL
  }

LoggedMeasServingCellMeas-FDD ::=
  SEQUENCE {
    cellIdentity              CellIdentity,
    cpich-RSCP                CPICH-RSCP,
    cpich-Ec-N0               CPICH-Ec-N0
  }

LoggedMeasServingCellMeas-FDD-vb50ext ::=
  SEQUENCE {
    plmnIdentity              PLMN-Identity      OPTIONAL
  }

LoggedMeasServingCellMeas-TDD128 ::=
  SEQUENCE {
    cellIdentity              CellIdentity,
    primaryCCPCH-RSCP        PrimaryCCPCH-RSCP
  }

LoggedMeasServingCellMeas-TDD128-vb50ext ::=
  SEQUENCE {
    plmnIdentity              PLMN-Identity      OPTIONAL
  }

LoggedUTRACellInfo ::= SEQUENCE {
  plmn-Identity              PLMN-Identity,
  cellIdentity              CellIdentity,
  uarfcn                    UARFCN,
  cellParametersID          CellParametersID      OPTIONAL,
  primaryScramblingCode     PrimaryScramblingCode  OPTIONAL
}

LoggingAbsoluteThreshold ::= CHOICE {
  rscpforANR                RSCPforANR,
  ec-N0forANR               Ec-N0forANR
}

-- it applies to RSCP by step of 2 and Ec/N0 by step of 1
-- Actual value LoggingRelativeThreshold = IE value * 2 (RSCP)
-- Actual value LoggingRelativeThreshold = IE value      (Ec/N0)
LoggingRelativeThreshold ::=
  INTEGER (-4..16)

KeplerianParameters ::=
  SEQUENCE {
    toe-nav                  BIT STRING (SIZE (14)),
    ganss-omega-nav         BIT STRING (SIZE (32)),
    delta-n-nav             BIT STRING (SIZE (16)),
    m-zero-nav              BIT STRING (SIZE (32)),
    omegadot-nav           BIT STRING (SIZE (24)),
    ganss-e-nav             BIT STRING (SIZE (32)),
    idot-nav                BIT STRING (SIZE (14)),
    a-sqrt-nav              BIT STRING (SIZE (32)),
  }

```

```

i-zero-nav          BIT STRING (SIZE (32)),
omega-zero-nav     BIT STRING (SIZE (32)),
c-rs-nav           BIT STRING (SIZE (16)),
c-is-nav           BIT STRING (SIZE (16)),
c-us-nav           BIT STRING (SIZE (16)),
c-rc-nav           BIT STRING (SIZE (16)),
c-ic-nav           BIT STRING (SIZE (16)),
c-uc-nav           BIT STRING (SIZE (16))
}

MaxNumberOfReportingCellsType1 ::= ENUMERATED {
    e1, e2, e3, e4, e5, e6}

MaxNumberOfReportingCellsType2 ::= ENUMERATED {
    e1, e2, e3, e4, e5, e6, e7, e8, e9, e10, e11, e12}

MaxNumberOfReportingCellsType3 ::= ENUMERATED {
    viactCellsPlus1,
    viactCellsPlus2,
    viactCellsPlus3,
    viactCellsPlus4,
    viactCellsPlus5,
    viactCellsPlus6 }

MaxReportedCellsOnRACH ::= ENUMERATED {
    noReport,
    currentCell,
    currentAnd-1-BestNeighbour,
    currentAnd-2-BestNeighbour,
    currentAnd-3-BestNeighbour,
    currentAnd-4-BestNeighbour,
    currentAnd-5-BestNeighbour,
    currentAnd-6-BestNeighbour }

MaxReportedCellsOnRACHinterFreq ::= INTEGER (1..8)

MeasuredResults ::= CHOICE {
    intraFreqMeasuredResultsList      IntraFreqMeasuredResultsList,
    interFreqMeasuredResultsList      InterFreqMeasuredResultsList,
    interRATMeasuredResultsList       InterRATMeasuredResultsList,
    trafficVolumeMeasuredResultsList  TrafficVolumeMeasuredResultsList,
    qualityMeasuredResults             QualityMeasuredResults,
    ue-InternalMeasuredResults        UE-InternalMeasuredResults,
    ue-positioning-MeasuredResults    UE-Positioning-MeasuredResults,
    spare                             NULL
}

MeasuredResultsOnSecULFreq ::= SEQUENCE {
    intraFreqMeasuredResultsList      IntraFrequencyMeasuredResultsListOnSecULFreq
}

MeasuredResultsOnSecULFreq-vc50ext ::= SEQUENCE {
    intraFreqMeasuredResultsList      IntraFrequencyMeasuredResultsListOnSecULFreq-vc50ext
}

MeasuredResults-v390ext ::= SEQUENCE {
    ue-positioning-MeasuredResults-v390ext    UE-Positioning-MeasuredResults-v390ext
}

MeasuredResults-v590ext ::= CHOICE {
    intraFrequencyMeasuredResultsList-v590ext    IntraFrequencyMeasuredResultsList-v590ext,
    interFrequencyMeasuredResultsList-v590ext    InterFrequencyMeasuredResultsList-v590ext
}

MeasuredResults-v770ext ::= CHOICE {
    ueInternalMeasuredResults-v770ext            UE-InternalMeasuredResults-v770ext,
    ue-positioning-MeasuredResults-v770ext      UE-Positioning-MeasuredResults-v770ext
}

MeasuredResults-v860ext ::= CHOICE {
    ue-positioning-MeasuredResults-v860ext      UE-Positioning-MeasuredResults-v860ext
}

MeasuredResultsList-v920ext ::= SEQUENCE (SIZE (1..maxAdditionalMeas)) OF
    MeasuredResults-v920ext

MeasuredResultsList-vc50ext ::= SEQUENCE (SIZE (1..maxAdditionalMeas)) OF

```

```

MeasuredResults-vc50ext
MeasuredResultsListOnSecULFreq ::= SEQUENCE (SIZE (1..maxAdditionalMeas)) OF
MeasuredResultsOnSecULFreq
MeasuredResultsListOnSecULFreq-vc50ext ::= SEQUENCE (SIZE (1..maxAdditionalMeas)) OF
MeasuredResultsOnSecULFreq-vc50ext
MeasuredResults-v920ext ::= CHOICE {
    intraFreqMeasuredResultsList      IntraFreqMeasuredResultsList-v920ext,
    interFreqMeasuredResultsList      InterFreqMeasuredResultsList-v920ext
}
MeasuredResults-vc50ext ::= CHOICE {
    intraFreqMeasuredResultsList      IntraFreqMeasuredResultsList-vc50ext,
    interFreqMeasuredResultsList      InterFreqMeasuredResultsList-vc50ext,
    ue-positioning-MeasuredResults    UE-Positioning-MeasuredResults-vc50ext
}
MeasuredResults-LCR-r4 ::= CHOICE {
    intraFreqMeasuredResultsList      IntraFreqMeasuredResultsList,
    interFreqMeasuredResultsList      InterFreqMeasuredResultsList,
    interRATMeasuredResultsList       InterRATMeasuredResultsList,
    trafficVolumeMeasuredResultsList  TrafficVolumeMeasuredResultsList,
    qualityMeasuredResults             QualityMeasuredResults,
    ue-InternalMeasuredResults         UE-InternalMeasuredResults-LCR-r4,
    ue-positioning-MeasuredResults     UE-Positioning-MeasuredResults,
    spare                              NULL
}
MeasuredResultsList ::= SEQUENCE (SIZE (1..maxAdditionalMeas)) OF
MeasuredResults
MeasuredResultsList-LCR-r4-ext ::= SEQUENCE (SIZE (1..maxAdditionalMeas)) OF
MeasuredResults-LCR-r4
MeasuredResultsList-v770ext ::= SEQUENCE (SIZE (1..maxAdditionalMeas)) OF SEQUENCE {
    -- The 'measuredResults' element shall be present, if 'v770' extended measurement results
    -- associated with the corresponding element in the IE 'MeasuredResultList' shall be
    -- provided, otherwise it is not needed
    measuredResults      MeasuredResults-v770ext      OPTIONAL
}
MeasuredResultsList-v860ext ::= SEQUENCE (SIZE (1..maxAdditionalMeas)) OF SEQUENCE {
    -- The 'measuredResults' element shall be present, if 'v860' extended measurement results
    -- associated with the corresponding element in the IE 'MeasuredResultList' shall be
    -- provided, otherwise it is not needed
    measuredResults      MeasuredResults-v860ext      OPTIONAL
}
MeasuredResultsOnRACH ::= SEQUENCE {
    currentCell          SEQUENCE {
        modeSpecificInfo CHOICE {
            fdd           SEQUENCE {
                measurementQuantity CHOICE {
                    cpich-Ec-N0      CPICH-Ec-N0,
                    cpich-RSCP       CPICH-RSCP,
                    pathloss         Pathloss,
                    cpich-Ec-N0-RSCP CPICH-Ec-N0-RSCP
                }
            },
            tdd           SEQUENCE {
                -- For 3.84 Mcps, 7.68 Mcps and 1.28 Mcps TDD
                timeslotISCP      TimeslotISCP-List      OPTIONAL,
                primaryCCPCH-RSCP PrimaryCCPCH-RSCP      OPTIONAL
            }
        },
        monitoredCells      MonitoredCellRACH-List      OPTIONAL
    }
}
MeasuredResultsOnRACH-v7g0ext ::= SEQUENCE {
    currentCell-DeltaRSCP      DeltaRSCPPerCell      OPTIONAL,
    monitoredCellRACH-List-v7g0ext MonitoredCellRACH-List-v7g0ext      OPTIONAL
}
--The order of the list corresponds to the order of the cells in MonitoredCellRACH-List
MonitoredCellRACH-List-v7g0ext ::= SEQUENCE (SIZE (1..8)) OF

```

DeltaRSCPPerCell

```

--TDD choice is removed, compared to tabular, in order to optimise FDD format
MeasuredResultsOnRACHFDD-r11 ::= SEQUENCE {
    currentCell SEQUENCE {
        measurementQuantity CHOICE {
            cpich-Ec-NO CPICH-Ec-NO,
            cpich-RSCP CPICH-RSCP,
            pathloss Pathloss,
            cpich-Ec-NO-RSCP CPICH-Ec-NO-RSCP
        }
    },
    measuredResultsUsedFreq MonitoredCellRACH-ListFDD-r11 OPTIONAL,
    measuredResultsNonUsedFreq MeasuredResultsOnRACHinterFreq OPTIONAL,
    measuredResultsEUTRAFreq MeasuredResultsOnRACH-EUTRAFreq OPTIONAL
}

MeasuredResultsOnRACHinterFreq ::= SEQUENCE {
    interFreqCellIndication-SIB11 INTEGER (0..1),
    interFreqCellIndication-SIB12 INTEGER (0..1),
    interFreqRACHRepCellsList InterFreqRACHRepCellsList
}

MeasuredResultsOnRACHinterFreq-vc50ext ::= SEQUENCE {
    interFreqRACHRepCellsList InterFreqRACHRepCellsList-r12
}

MeasuredResultsOnRACH-vc50ext ::= SEQUENCE {
    measuredResultsNonUsedFreq MeasuredResultsOnRACHinterFreq-vc50ext OPTIONAL,
    measuredResultsEUTRAFreq MeasuredResultsOnRACH-EUTRAFreq-vc50ext OPTIONAL
}

MeasuredResultsOnRACH-EUTRAFreq ::= SEQUENCE {
    eutraFrequencyIndication-SIB19 INTEGER (0..1),
    eutraFrequencyIndicator BIT STRING (SIZE (maxNumEUTRAFreqs-FACH))
}

MeasuredResultsOnRACH-EUTRAFreq-vc50ext ::= SEQUENCE {
    eutraFrequencyIndicator BIT STRING (SIZE (maxNumEUTRAFreqs-FACH))
}

MeasurementCommand ::= CHOICE {
    setup MeasurementType,
    modify SEQUENCE {
        measurementType MeasurementType OPTIONAL
    },
    release NULL
}

MeasurementCommand-r4 ::= CHOICE {
    setup MeasurementType-r4,
    modify SEQUENCE {
        measurementType MeasurementType-r4 OPTIONAL
    },
    release NULL
}

MeasurementCommand-r6 ::= CHOICE {
    setup MeasurementType-r6,
    modify SEQUENCE {
        measurementType MeasurementType-r6 OPTIONAL
    },
    release NULL
}

MeasurementCommand-r7 ::= CHOICE {
    setup MeasurementType-r7,
    modify SEQUENCE {
        measurementType MeasurementType-r7 OPTIONAL
    },
    release NULL
}

MeasurementCommand-r8 ::= CHOICE {
    setup MeasurementType-r8,
    modify SEQUENCE {
        measurementType MeasurementType-r8 OPTIONAL
    },
}

```

```

    release                NULL
  }

MeasurementCommand-r9 ::= CHOICE {
  setup                    MeasurementType-r9,
  modify                   SEQUENCE {
    measurementType        MeasurementType-r9          OPTIONAL
  },
  release                  NULL
}

MeasurementCommand-r10 ::= CHOICE {
  setup                    MeasurementType-r10,
  modify                   SEQUENCE {
    measurementType        MeasurementType-r10        OPTIONAL
  },
  release                  NULL
}

MeasurementCommand-r11 ::= CHOICE {
  setup                    MeasurementType-r11,
  modify                   SEQUENCE {
    measurementType        MeasurementType-r11        OPTIONAL
  },
  release                  NULL
}

MeasurementCommand-r12 ::= CHOICE {
  setup                    MeasurementType-r12,
  modify                   SEQUENCE {
    measurementType        MeasurementType-r12        OPTIONAL
  },
  release                  NULL,
  releaseAll               NULL,
  releaseSome              MeasurementsToRelease
}

MeasurementControlSysInfo ::= SEQUENCE {
  -- CHOICE cellSelectQualityMeasure represents PCCPCH-RSCP in TDD mode.
  use-of-HCS                CHOICE {
    hcs-not-used            SEQUENCE {
      cellSelectQualityMeasure CHOICE {
        cpich-RSCP          SEQUENCE {
          intraFreqMeasurementSysInfo IntraFreqMeasurementSysInfo-RSCP  OPTIONAL,
          interFreqMeasurementSysInfo InterFreqMeasurementSysInfo-RSCP  OPTIONAL
        },
        cpich-Ec-N0        SEQUENCE {
          intraFreqMeasurementSysInfo IntraFreqMeasurementSysInfo-ECN0  OPTIONAL,
          interFreqMeasurementSysInfo InterFreqMeasurementSysInfo-ECN0  OPTIONAL
        }
      },
      interRATMeasurementSysInfo InterRATMeasurementSysInfo-B          OPTIONAL
    },
    hcs-used                SEQUENCE {
      cellSelectQualityMeasure CHOICE {
        cpich-RSCP          SEQUENCE {
          intraFreqMeasurementSysInfo IntraFreqMeasurementSysInfo-HCS-RSCP  OPTIONAL,
          interFreqMeasurementSysInfo InterFreqMeasurementSysInfo-HCS-RSCP  OPTIONAL
        },
        cpich-Ec-N0        SEQUENCE {
          intraFreqMeasurementSysInfo IntraFreqMeasurementSysInfo-HCS-ECN0  OPTIONAL,
          interFreqMeasurementSysInfo InterFreqMeasurementSysInfo-HCS-ECN0  OPTIONAL
        }
      },
      interRATMeasurementSysInfo InterRATMeasurementSysInfo          OPTIONAL
    }
  },
  trafficVolumeMeasSysInfo TrafficVolumeMeasSysInfo          OPTIONAL,
  -- dummy is not used in this version of specification and it shall be ignored by the UE.
  dummy                    UE-InternalMeasurementSysInfo      OPTIONAL
}

MeasurementControlSysInfo-vc50ext ::= SEQUENCE {
  intraFreqReportingQuantityForRACH IntraFreqReportingQuantityForRACH-vc50ext  OPTIONAL,
  rmp-Frequency-List                RMP-Frequency-List                    OPTIONAL
}

MeasurementControlSysInfoExtension ::= SEQUENCE {

```

```

-- CHOICE cellSelectQualityMeasure represents PCCPCH-RSCP in TDD mode.
use-of-HCS CHOICE {
  hcs-not-used SEQUENCE {
    cellSelectQualityMeasure CHOICE {
      cpich-RSCP SEQUENCE {
        newIntraFreqCellList NewIntraFreqCellSI-List-RSCP OPTIONAL,
        newInterFreqCellList NewInterFreqCellSI-List-RSCP OPTIONAL
      },
      cpich-Ec-N0 SEQUENCE {
        newIntraFreqCellList NewIntraFreqCellSI-List-ECN0 OPTIONAL,
        newInterFreqCellList NewInterFreqCellSI-List-ECN0 OPTIONAL
      }
    },
    newInterRATCellList NewInterRATCellList OPTIONAL
  },
  hcs-used SEQUENCE {
    cellSelectQualityMeasure CHOICE {
      cpich-RSCP SEQUENCE {
        newIntraFreqCellList NewIntraFreqCellSI-List-HCS-RSCP OPTIONAL,
        newInterFreqCellList NewInterFreqCellSI-List-HCS-RSCP OPTIONAL
      },
      cpich-Ec-N0 SEQUENCE {
        newIntraFreqCellList NewIntraFreqCellSI-List-HCS-ECN0 OPTIONAL,
        newInterFreqCellList NewInterFreqCellSI-List-HCS-ECN0 OPTIONAL
      }
    },
    newInterRATCellList NewInterRATCellList OPTIONAL
  }
}

MeasurementControlSysInfoExtensionAddon-r5 ::= SEQUENCE {
  --The order of the list corresponds to the order of cell in newIntraFrequencyCellInfoList
  newIntraFrequencyCellInfoListAddon-r5 SEQUENCE (SIZE (1..maxCellMeas)) OF
    CellSelectReselectInfo-v590ext OPTIONAL,
  --The order of the list corresponds to the order of cell in newInterFrequencyCellInfoList
  newInterFrequencyCellInfoListAddon-r5 SEQUENCE (SIZE (1..maxCellMeas)) OF
    CellSelectReselectInfo-v590ext OPTIONAL,
  --The order of the list corresponds to the order of cell in newInterRATCellInfoList
  newInterRATCellInfoListAddon-r5 SEQUENCE (SIZE (1..maxCellMeas)) OF
    CellSelectReselectInfo-v590ext OPTIONAL
}

MeasureControlSysInfoInterFreqExt ::= SEQUENCE {
  -- CHOICE cellSelectQualityMeasure represents PCCPCH-RSCP in TDD mode.
  use-of-HCS CHOICE {
    hcs-not-used SEQUENCE {
      cellSelectQualityMeasure CHOICE {
        cpich-RSCP SEQUENCE {
          newInterFreqCellList NewInterFreqCellSI-List-RSCP-ext OPTIONAL
        },
        cpich-Ec-N0 SEQUENCE {
          newInterFreqCellList NewInterFreqCellSI-List-ECN0-ext OPTIONAL
        }
      }
    },
    hcs-used SEQUENCE {
      cellSelectQualityMeasure CHOICE {
        cpich-RSCP SEQUENCE {
          newInterFreqCellList NewInterFreqCellSI-List-HCS-RSCP-ext OPTIONAL
        },
        cpich-Ec-N0 SEQUENCE {
          newInterFreqCellList NewInterFreqCellSI-List-HCS-ECN0-ext OPTIONAL
        }
      }
    }
  },
  rmp-Frequency-List RMP-Frequency-List OPTIONAL
}

MeasurementControlSysInfoExtension-ICR-r4 ::= SEQUENCE {
  -- CHOICE cellSelectQualityMeasure represents PCCPCH-RSCP in TDD mode.
  use-of-HCS CHOICE {
    hcs-not-used SEQUENCE {
      cellSelectQualityMeasure CHOICE {
        cpich-RSCP SEQUENCE {
          newIntraFreqCellList NewIntraFreqCellSI-List-RSCP-ICR-r4 OPTIONAL,
          newInterFreqCellList NewInterFreqCellSI-List-RSCP-ICR-r4 OPTIONAL
        }
      }
    }
  }
}

```

```

    },
    cpich-Ec-N0          SEQUENCE {
        newIntraFreqCellList    NewIntraFreqCellSI-List-ECN0-LCR-r4 OPTIONAL,
        newInterFreqCellList    NewInterFreqCellSI-List-ECN0-LCR-r4 OPTIONAL
    },
    },
    newInterRATCellList    NewInterRATCellList          OPTIONAL
},
hcs-used                  SEQUENCE {
    cellSelectQualityMeasure CHOICE {
        cpich-RSCP          SEQUENCE {
            newIntraFreqCellList    NewIntraFreqCellSI-List-HCS-RSCP-LCR-r4 OPTIONAL,
            newInterFreqCellList    NewInterFreqCellSI-List-HCS-RSCP-LCR-r4 OPTIONAL
        },
        cpich-Ec-N0          SEQUENCE {
            newIntraFreqCellList    NewIntraFreqCellSI-List-HCS-ECN0-LCR-r4 OPTIONAL,
            newInterFreqCellList    NewInterFreqCellSI-List-HCS-ECN0-LCR-r4 OPTIONAL
        }
    },
    newInterRATCellList    NewInterRATCellList          OPTIONAL
}
}
}

MeasurementControlSysInfo-LCR-r4-ext ::= SEQUENCE {
    -- CHOICE use-of-HCS shall have the same value as the use-of-HCS
    -- in MeasurementControlSysInfo
    -- CHOICE cellSelectQualityMeasure represents PCCPCH-RSCP in TDD mode.
    use-of-HCS          CHOICE {
        hcs-not-used    SEQUENCE {
            -- CHOICE cellSelectQualityMeasure shall have the same value as the
            -- cellSelectQualityMeasure in MeasurementControlSysInfo
            cellSelectQualityMeasure CHOICE {
                cpich-RSCP          SEQUENCE {
                    intraFreqMeasurementSysInfo IntraFreqMeasurementSysInfo-RSCP-LCR-r4 OPTIONAL,
                    interFreqMeasurementSysInfo InterFreqMeasurementSysInfo-RSCP-LCR-r4 OPTIONAL
                },
                cpich-Ec-N0          SEQUENCE {
                    intraFreqMeasurementSysInfo IntraFreqMeasurementSysInfo-ECN0-LCR-r4 OPTIONAL,
                    interFreqMeasurementSysInfo InterFreqMeasurementSysInfo-ECN0-LCR-r4 OPTIONAL
                }
            }
        },
        hcs-used          SEQUENCE {
            -- CHOICE cellSelectQualityMeasure shall have the same value as the
            -- cellSelectQualityMeasure in MeasurementControlSysInfo
            cellSelectQualityMeasure CHOICE {
                cpich-RSCP          SEQUENCE {
                    intraFreqMeasurementSysInfo IntraFreqMeasurementSysInfo-HCS-RSCP-LCR-r4 OPTIONAL,
                    interFreqMeasurementSysInfo InterFreqMeasurementSysInfo-HCS-RSCP-LCR-r4 OPTIONAL
                },
                cpich-Ec-N0          SEQUENCE {
                    intraFreqMeasurementSysInfo IntraFreqMeasurementSysInfo-HCS-ECN0-LCR-r4 OPTIONAL,
                    interFreqMeasurementSysInfo InterFreqMeasurementSysInfo-HCS-ECN0-LCR-r4 OPTIONAL
                }
            }
        }
    }
}

MeasurementIdentity ::= INTEGER (1..16)

MeasurementIdentityExt ::= INTEGER (17..32)

MeasurementIdentity-r9 ::= INTEGER (1..32)

MeasurementOccasionPatternParameter ::= SEQUENCE {
    measurement-Occasion-Coeff    INTEGER (1..9),
    measurement-Occasion-Offset    INTEGER (0..511),
    measurement-Occasion-Length    INTEGER (1..512),
    timeslotBitmap                BIT STRING (SIZE (7)) OPTIONAL
}

MeasurementReleaseEnhancement ::= CHOICE {
    releaseAllMeasurements    NULL,
    releaseSomeMeasurements    MeasurementsToRelease
}

```

```

MeasurementsToRelease ::= SEQUENCE (SIZE (1..maxMeasIdentity)) OF
    MeasurementIdentity-r9

MeasurementQuantityGSM ::=          ENUMERATED {
    gsm-CarrierRSSI,
    dummy }

MeasurementQuantityEUTRA ::=        ENUMERATED {
    rsrp,
    rsrq }

MeasurementReportingMode ::=        SEQUENCE {
    measurementReportTransferMode    TransferMode,
    periodicalOrEventTrigger         PeriodicalOrEventTrigger
}

MeasurementType ::=                  CHOICE {
    intraFrequencyMeasurement        IntraFrequencyMeasurement,
    interFrequencyMeasurement        InterFrequencyMeasurement,
    interRATMeasurement              InterRATMeasurement,
    ue-positioning-Measurement        UE-Positioning-Measurement,
    trafficVolumeMeasurement         TrafficVolumeMeasurement,
    qualityMeasurement                QualityMeasurement,
    ue-InternalMeasurement            UE-InternalMeasurement
}

MeasurementType-r4 ::=               CHOICE {
    intraFrequencyMeasurement-r4     IntraFrequencyMeasurement-r4,
    interFrequencyMeasurement-r4     InterFrequencyMeasurement-r4,
    interRATMeasurement-r4           InterRATMeasurement-r4,
    up-Measurement                    UE-Positioning-Measurement-r4,
    trafficVolumeMeasurement          TrafficVolumeMeasurement,
    qualityMeasurement                QualityMeasurement,
    ue-InternalMeasurement            UE-InternalMeasurement-r4
}

MeasurementType-r6 ::=               CHOICE {
    intraFrequencyMeasurement-r6     IntraFrequencyMeasurement-r6,
    interFrequencyMeasurement-r6     InterFrequencyMeasurement-r6,
    interRATMeasurement-r6           InterRATMeasurement-r6,
    up-Measurement                    UE-Positioning-Measurement-r4,
    trafficVolumeMeasurement          TrafficVolumeMeasurement,
    qualityMeasurement                QualityMeasurement,
    ue-InternalMeasurement            UE-InternalMeasurement-r4
}

MeasurementType-r7 ::=               CHOICE {
    intraFrequencyMeasurement-r7     IntraFrequencyMeasurement-r7,
    interFrequencyMeasurement-r7     InterFrequencyMeasurement-r7,
    interRATMeasurement-r6           InterRATMeasurement-r6,
    up-Measurement                    UE-Positioning-Measurement-r7,
    trafficVolumeMeasurement          TrafficVolumeMeasurement,
    qualityMeasurement                QualityMeasurement,
    ue-InternalMeasurement            UE-InternalMeasurement-r4
}

MeasurementType-r8 ::=               CHOICE {
    intraFrequencyMeasurement-r7     IntraFrequencyMeasurement-r7,
    interFrequencyMeasurement-r8     InterFrequencyMeasurement-r8,
    interRATMeasurement-r8           InterRATMeasurement-r8,
    up-Measurement                    UE-Positioning-Measurement-r8,
    trafficVolumeMeasurement          TrafficVolumeMeasurement,
    qualityMeasurement                QualityMeasurement,
    ue-InternalMeasurement            UE-InternalMeasurement-r4
}

MeasurementType-r9 ::=               CHOICE {
    intraFrequencyMeasurement-r9     IntraFrequencyMeasurement-r9,
    interFrequencyMeasurement-r9     InterFrequencyMeasurement-r9,
    interRATMeasurement-r9           InterRATMeasurement-r9,
    up-Measurement                    UE-Positioning-Measurement-r9,
    trafficVolumeMeasurement          TrafficVolumeMeasurement,
    qualityMeasurement                QualityMeasurement,
    ue-InternalMeasurement            UE-InternalMeasurement-r4,
    csgProximityDetection             CSGProximityDetection
}

MeasurementType-r10 ::=              CHOICE {

```



```

    intraFrequencyMeasurement      IntraFrequencyMeasurement-r10,
    interFrequencyMeasurement      InterFrequencyMeasurement-r10,
    interRATMeasurement            InterRATMeasurement-r9,
    up-Measurement                  UE-Positioning-Measurement-r10,
    trafficVolumeMeasurement        TrafficVolumeMeasurement,
    qualityMeasurement              QualityMeasurement,
    ue-InternalMeasurement          UE-InternalMeasurement-r4,
    csgProximityDetection           CSGProximityDetection
}

MeasurementType-r11 ::=          CHOICE {
    intraFrequencyMeasurement      IntraFrequencyMeasurement-r11,
    interFrequencyMeasurement      InterFrequencyMeasurement-r11,
    interRATMeasurement            InterRATMeasurement-r11,
    up-Measurement                  UE-Positioning-Measurement-r10,
    trafficVolumeMeasurement        TrafficVolumeMeasurement,
    qualityMeasurement              QualityMeasurement,
    ue-InternalMeasurement          UE-InternalMeasurement-r4,
    csgProximityDetection           CSGProximityDetection,
    eutraMeasurementForCELLFACH     EUTRA-MeasurementForCELLFACH
}

MeasurementType-r12 ::=          CHOICE {
    intraFrequencyMeasurement      IntraFrequencyMeasurement-r11,
    interFrequencyMeasurement      InterFrequencyMeasurement-r12,
    interRATMeasurement            InterRATMeasurement-r12,
    up-Measurement                  UE-Positioning-Measurement-r12,
    trafficVolumeMeasurement        TrafficVolumeMeasurement,
    qualityMeasurement              QualityMeasurement,
    ue-InternalMeasurement          UE-InternalMeasurement-r4,
    csgProximityDetection           CSGProximityDetection,
    eutraMeasurementForCELLFACH     EUTRA-MeasurementForCELLFACH-r12
}

MeasurementValidity ::=          SEQUENCE {
    ue-State                        ENUMERATED {
                                     cell-DCH, all-But-Cell-DCH, all-States }
}

MonitoredCellRACH-List ::=      SEQUENCE (SIZE (1..8)) OF
    MonitoredCellRACH-Result

MonitoredCellRACH-Result ::=    SEQUENCE {
    sfn-SFN-ObsTimeDifference      SFN-SFN-ObsTimeDifference          OPTIONAL,
    modeSpecificInfo               CHOICE {
        fdd                         SEQUENCE {
            primaryCPICH-Info        PrimaryCPICH-Info,
            measurementQuantity      CHOICE {
                cpich-Ec-NO          CPICH-Ec-NO,
                cpich-RSCP           CPICH-RSCP,
                pathloss              Pathloss,
                spare                 NULL
            }
        },
        tdd                         SEQUENCE {
            cellParametersID         CellParametersID,
            primaryCCPCH-RSCP        PrimaryCCPCH-RSCP
        }
    }
}

MonitoredCellRACH-ListFDD-r11 ::= SEQUENCE (SIZE (1..8)) OF
    MonitoredCellRACH-ResultFDD-r11

--TDD choice is removed, compared to tabular, in order to optimise FDD format
MonitoredCellRACH-ResultFDD-r11 ::= SEQUENCE {
    sfn-SFN-ObsTimeDifference      SFN-SFN-ObsTimeDifference          OPTIONAL,
    primaryCPICH-Info              PrimaryCPICH-Info,
    measurementQuantity            CHOICE {
        cpich-Ec-NO                 CPICH-Ec-NO,
        cpich-RSCP                   CPICH-RSCP,
        pathloss                       Pathloss,
        spare                          NULL
    }
}

MultipathIndicator ::=          ENUMERATED {
    nm,
}

```

```

    low,
    medium,
    high }

```

```

MultipleEUTRAFrequencyBandIndicatorList ::= SEQUENCE (SIZE (1.. maxMultipleFrequencyBandsEUTRA)) OF
    RadioFrequencyBandEUTRA

MultipleEUTRAFrequencyBandIndicatorExtensionList ::= SEQUENCE (SIZE (1..
maxMultipleFrequencyBandsEUTRA))
    OF RadioFrequencyBandEUTRAExt

MultipleEUTRAFrequencyBandInfo ::= SEQUENCE {
    multipleEUTRAFrequencyBandIndicatorlist MultipleEUTRAFrequencyBandIndicatorList OPTIONAL
}

MultipleEUTRAFrequencyBandExtensionInfo ::= SEQUENCE {
    multipleEUTRAFrequencyBandIndicatorlist MultipleEUTRAFrequencyBandIndicatorExtensionList
    OPTIONAL
}

MultipleEUTRAFrequencyInfoList ::= SEQUENCE (SIZE (1.. maxNumEUTRAFreqs)) OF
    MultipleEUTRAFrequencyBandInfo

MultipleEUTRAFrequencyInfoExtensionList ::= SEQUENCE (SIZE (1.. maxNumEUTRAFreqs)) OF
    MultipleEUTRAFrequencyBandExtensionInfo

MultipleFrequencyBandIndicatorListFDD ::= SEQUENCE (SIZE (1..maxMultipleFrequencyBandsFDD)) OF
    FrequencyBandsIndicatorFDD

MultipleFrequencyBandInfo ::= SEQUENCE {
    multipleFrequencyBandIndicatorListFDD MultipleFrequencyBandIndicatorListFDD OPTIONAL
}

MultipleFrequencyInfoListFDD ::= SEQUENCE (SIZE (1.. maxNumFDDFreqs)) OF
    MultipleFrequencyBandInfo

N-CR-T-CRMaxHyst ::= SEQUENCE {
    n-CR INTEGER (1..16) DEFAULT 8,
    t-CRMaxHyst T-CRMaxHyst
}

NAVclockModel ::= SEQUENCE {
    navToc BIT STRING (SIZE (16)),
    navaf2 BIT STRING (SIZE (8)),
    navaf1 BIT STRING (SIZE (16)),
    navaf0 BIT STRING (SIZE (22)),
    navTgd BIT STRING (SIZE (8))
}

NavigationModelSatInfo ::= SEQUENCE {
    satID SatID,
    satelliteStatus SatelliteStatus,
    ephemerisParameter EphemerisParameter OPTIONAL
}

NavigationModelSatInfoList ::= SEQUENCE (SIZE (1..maxSat)) OF
    NavigationModelSatInfo

NavModel-BDSKeplerianSet ::= SEQUENCE {
    bdsAODE BIT STRING (SIZE (5)),
    bdsURAI BIT STRING (SIZE (4)),
    bdsToe BIT STRING (SIZE (17)),
    bdsAPowerHalf BIT STRING (SIZE (32)),
    bdsE BIT STRING (SIZE (32)),
    bdsW BIT STRING (SIZE (32)),
    bdsDeltaN BIT STRING (SIZE (16)),
    bdsM0 BIT STRING (SIZE (32)),
    bdsOmega0 BIT STRING (SIZE (32)),
    bdsOmegaDot BIT STRING (SIZE (24)),
    bdsI0 BIT STRING (SIZE (32)),
    bdsIDot BIT STRING (SIZE (14)),
    bdsCuc BIT STRING (SIZE (18)),
    bdsCus BIT STRING (SIZE (18)),
    bdsCrc BIT STRING (SIZE (18)),
    bdsCrs BIT STRING (SIZE (18)),
    bdsCic BIT STRING (SIZE (18)),
    bdsCis BIT STRING (SIZE (18))
}

```

```

NavModel-CNAVKeplerianSet ::= SEQUENCE {
    cnavTop BIT STRING (SIZE (11)),
    cnavURAindex BIT STRING (SIZE (5)),
    cnavDeltaA BIT STRING (SIZE (26)),
    cnavAdot BIT STRING (SIZE (25)),
    cnavDeltaNo BIT STRING (SIZE (17)),
    cnavDeltaNoDot BIT STRING (SIZE (23)),
    cnavMo BIT STRING (SIZE (33)),
    cnavE BIT STRING (SIZE (33)),
    cnavOmega BIT STRING (SIZE (33)),
    cnavOMEGA0 BIT STRING (SIZE (33)),
    cnavDeltaOmegaDot BIT STRING (SIZE (17)),
    cnavIo BIT STRING (SIZE (33)),
    cnavIoDot BIT STRING (SIZE (15)),
    cnavCis BIT STRING (SIZE (16)),
    cnavCic BIT STRING (SIZE (16)),
    cnavCrs BIT STRING (SIZE (24)),
    cnavCrc BIT STRING (SIZE (24)),
    cnavCus BIT STRING (SIZE (21)),
    cnavCuc BIT STRING (SIZE (21))
}

NavModel-GLONASsecef ::= SEQUENCE {
    gloEn BIT STRING (SIZE (5)),
    gloP1 BIT STRING (SIZE (2)),
    gloP2 BIT STRING (SIZE (1)),
    gloM BIT STRING (SIZE (2)) OPTIONAL,
    gloX BIT STRING (SIZE (27)),
    gloXdot BIT STRING (SIZE (24)),
    gloXdotdot BIT STRING (SIZE (5)),
    gloY BIT STRING (SIZE (27)),
    gloYdot BIT STRING (SIZE (24)),
    gloYdotdot BIT STRING (SIZE (5)),
    gloZ BIT STRING (SIZE (27)),
    gloZdot BIT STRING (SIZE (24)),
    gloZdotdot BIT STRING (SIZE (5))
}

NavModel-NAVKeplerianSet ::= SEQUENCE {
    navURA BIT STRING (SIZE (4)),
    navFitFlag BIT STRING (SIZE (1)),
    navToe BIT STRING (SIZE (16)),
    navOmega BIT STRING (SIZE (32)),
    navDeltaN BIT STRING (SIZE (16)),
    navM0 BIT STRING (SIZE (32)),
    navOmegaADot BIT STRING (SIZE (24)),
    navE BIT STRING (SIZE (32)),
    navIDot BIT STRING (SIZE (14)),
    navAPowerHalf BIT STRING (SIZE (32)),
    navI0 BIT STRING (SIZE (32)),
    navOmegaA0 BIT STRING (SIZE (32)),
    navCrs BIT STRING (SIZE (16)),
    navCis BIT STRING (SIZE (16)),
    navCus BIT STRING (SIZE (16)),
    navCrc BIT STRING (SIZE (16)),
    navCic BIT STRING (SIZE (16)),
    navCuc BIT STRING (SIZE (16))
}

NavModel-SBASsecef ::= SEQUENCE {
    sbasTo BIT STRING (SIZE (13)) OPTIONAL,
    sbasAccuracy BIT STRING (SIZE (4)),
    sbasXg BIT STRING (SIZE (30)),
    sbasYg BIT STRING (SIZE (30)),
    sbasZg BIT STRING (SIZE (25)),
    sbasXgDot BIT STRING (SIZE (17)),
    sbasYgDot BIT STRING (SIZE (17)),
    sbasZgDot BIT STRING (SIZE (18)),
    sbasXgDotDot BIT STRING (SIZE (10)),
    sbasYgDotDot BIT STRING (SIZE (10)),
    sbasZgDotDot BIT STRING (SIZE (10))
}

EphemerisParameter ::= SEQUENCE {
    codeOnL2 BIT STRING (SIZE (2)),
    uraIndex BIT STRING (SIZE (4)),
    satHealth BIT STRING (SIZE (6)),
}

```

```

iodc BIT STRING (SIZE (10)),
l2Pflag BIT STRING (SIZE (1)),
sflRevd SubFrame1Reserved,
t-GD BIT STRING (SIZE (8)),
t-oc BIT STRING (SIZE (16)),
af2 BIT STRING (SIZE (8)),
af1 BIT STRING (SIZE (16)),
af0 BIT STRING (SIZE (22)),
c-rs BIT STRING (SIZE (16)),
delta-n BIT STRING (SIZE (16)),
m0 BIT STRING (SIZE (32)),
c-uc BIT STRING (SIZE (16)),
e BIT STRING (SIZE (32)),
c-us BIT STRING (SIZE (16)),
a-Sqrt BIT STRING (SIZE (32)),
t-oe BIT STRING (SIZE (16)),
fitInterval BIT STRING (SIZE (1)),
aodo BIT STRING (SIZE (5)),
c-ic BIT STRING (SIZE (16)),
omega0 BIT STRING (SIZE (32)),
c-is BIT STRING (SIZE (16)),
i0 BIT STRING (SIZE (32)),
c-rc BIT STRING (SIZE (16)),
omega BIT STRING (SIZE (32)),
omegaDot BIT STRING (SIZE (24)),
iDot BIT STRING (SIZE (14))
}
NC-Mode ::= BIT STRING (SIZE (3))

Neighbour ::= SEQUENCE {
  modeSpecificInfo CHOICE {
    fdd SEQUENCE {
      neighbourIdentity PrimaryCPICH-Info OPTIONAL,
      ue-RX-TX-TimeDifferenceType2Info UE-RX-TX-TimeDifferenceType2Info OPTIONAL
    },
    tdd SEQUENCE {
      neighbourAndChannelIdentity CellAndChannelIdentity OPTIONAL
    }
  },
  neighbourQuality NeighbourQuality,
  sfn-SFN-ObsTimeDifference2 SFN-SFN-ObsTimeDifference2
}

Neighbour-v390ext ::= SEQUENCE {
  modeSpecificInfo CHOICE {
    fdd SEQUENCE {
      frequencyInfo FrequencyInfo
    },
    tdd NULL
  }
}

NeighbourList ::= SEQUENCE (SIZE (1..maxCellMeas)) OF Neighbour

Neighbour-TDD-r7 ::= SEQUENCE {
  uarfcn UARFCN OPTIONAL
}

-- The order of the cells in IE NeighbourList-TDD-r7 shall be the
-- same as the order in IE NeighbourList
NeighbourList-TDD-r7 ::= SEQUENCE (SIZE (1..maxCellMeas)) OF Neighbour-TDD-r7

-- The order of the cells in IE NeighbourList-v390ext shall be the
-- same as the order in IE NeighbourList
NeighbourList-v390ext ::= SEQUENCE (SIZE (1..maxCellMeas)) OF Neighbour-v390ext

NeighbourQuality ::= SEQUENCE {
  ue-Positioning-OTDOA-Quality UE-Positioning-OTDOA-Quality
}

NewInterFreqCell ::= SEQUENCE {
  interFreqCellID InterFreqCellID OPTIONAL,
  frequencyInfo FrequencyInfo OPTIONAL,
  cellInfo CellInfo
}

NewInterFreqCell-r4 ::= SEQUENCE {

```

```

    interFreqCellID          InterFreqCellID          OPTIONAL,
    frequencyInfo            FrequencyInfo            OPTIONAL,
    cellInfo                 CellInfo-r4
}

NewInterFreqCell-v7b0ext ::= SEQUENCE {
    intraSecondaryFreqIndicator    BOOLEAN
}

NewInterFreqCell-LCR-v8a0ext ::= SEQUENCE {
    cellInfo-LCR-r8                CellInfo-LCR-r8-ext    OPTIONAL
}

NewInterFreqCell-r8 ::= SEQUENCE {
    interFreqCellID              InterFreqCellID          OPTIONAL,
    frequencyInfo                FrequencyInfo            OPTIONAL,
    cellInfo                     CellInfo-r4,
    modeSpecificInfo             CHOICE {
        noInfo                   NULL,
        tdd128                   SEQUENCE {
            intraSecondaryFreqIndicator    BOOLEAN
        }
    }
}

NewInterFreqCell-r9 ::= SEQUENCE {
    interFreqCellID              InterFreqCellID          OPTIONAL,
    frequencyInfo                FrequencyInfo            OPTIONAL,
    cellInfo                     CellInfo-r9,
    modeSpecificInfo             CHOICE {
        noInfo                   NULL,
        tdd128                   SEQUENCE {
            intraSecondaryFreqIndicator    BOOLEAN
        }
    }
}

NewInterFreqCell-r10 ::= SEQUENCE {
    interFreqCellID              InterFreqCellID          OPTIONAL,
    frequencyInfo                FrequencyInfo            OPTIONAL,
    cellInfo                     CellInfo-r9,
    modeSpecificInfo             CHOICE {
        noInfo                   NULL,
        tdd128                   SEQUENCE {
            intraSecondaryFreqIndicator    BOOLEAN,
            sNPLMonitorSetIndicator-TDD128    BIT STRING (SIZE (5))    OPTIONAL
        }
    }
}

NewInterFreqCell-r12 ::= SEQUENCE {
    interFreqCellID              InterFreqCellID-r12      OPTIONAL,
    frequencyInfo                FrequencyInfo            OPTIONAL,
    cellInfo                     CellInfo-r9,
    modeSpecificInfo             CHOICE {
        noInfo                   NULL,
        tdd128                   SEQUENCE {
            intraSecondaryFreqIndicator    BOOLEAN,
            sNPLMonitorSetIndicator-TDD128    BIT STRING (SIZE (5))    OPTIONAL
        }
    }
}

NewInterFreqCellList ::= SEQUENCE (SIZE (1..maxCellMeas)) OF
    NewInterFreqCell

NewInterFreqCellList-r4 ::= SEQUENCE (SIZE (1..maxCellMeas)) OF
    NewInterFreqCell-r4

NewInterFreqCellList-r12 ::= SEQUENCE (SIZE (1..maxCellMeas-ext)) OF
    NewInterFreqCell-r12

-- The order of the list corresponds to the order of cells in newInterFreqCellList
NewInterFreqCellList-v7b0ext ::= SEQUENCE (SIZE (1..maxCellMeas)) OF
    NewInterFreqCell-v7b0ext

-- The order of the list corresponds to the order of cells in newInterFreqCellList
NewInterFreqCellList-LCR-v8a0ext ::= SEQUENCE (SIZE (1..maxCellMeas)) OF

```

```

NewInterFreqCell-LCR-v8a0ext

NewInterFreqCellList-r8 ::= SEQUENCE (SIZE (1..maxCellMeas)) OF
                             NewInterFreqCell-r8

NewInterFreqCellList-r9 ::= SEQUENCE (SIZE (1..maxCellMeas)) OF
                             NewInterFreqCell-r9

NewInterFreqCellList-r10 ::= SEQUENCE (SIZE (1..maxCellMeas)) OF
                              NewInterFreqCell-r10

NewInterFreqCellSI-RSCP ::= SEQUENCE {
    interFreqCellID          OPTIONAL,
    frequencyInfo            OPTIONAL,
    cellInfo                 CellInfoSI-RSCP
}

NewInterFreqCellSI-RSCP-ext ::= SEQUENCE {
    interFreqCellID-r12     OPTIONAL,
    frequencyInfo           OPTIONAL,
    cellInfo                CellInfoSI-RSCP
}

NewInterFreqCellSI-ECN0 ::= SEQUENCE {
    interFreqCellID          OPTIONAL,
    frequencyInfo            OPTIONAL,
    cellInfo                 CellInfoSI-ECN0
}

NewInterFreqCellSI-ECN0-ext ::= SEQUENCE {
    interFreqCellID-r12     OPTIONAL,
    frequencyInfo           OPTIONAL,
    cellInfo                CellInfoSI-ECN0
}

NewInterFreqCellSI-HCS-RSCP ::= SEQUENCE {
    interFreqCellID          OPTIONAL,
    frequencyInfo            OPTIONAL,
    cellInfo                 CellInfoSI-HCS-RSCP
}

NewInterFreqCellSI-HCS-RSCP-ext ::= SEQUENCE {
    interFreqCellID-r12     OPTIONAL,
    frequencyInfo           OPTIONAL,
    cellInfo                CellInfoSI-HCS-RSCP
}

NewInterFreqCellSI-HCS-ECN0 ::= SEQUENCE {
    interFreqCellID          OPTIONAL,
    frequencyInfo            OPTIONAL,
    cellInfo                 CellInfoSI-HCS-ECN0
}

NewInterFreqCellSI-HCS-ECN0-ext ::= SEQUENCE {
    interFreqCellID-r12     OPTIONAL,
    frequencyInfo           OPTIONAL,
    cellInfo                CellInfoSI-HCS-ECN0
}

NewInterFreqCellSI-RSCP-LCR-r4 ::= SEQUENCE {
    interFreqCellID          OPTIONAL,
    frequencyInfo            OPTIONAL,
    cellInfo                 CellInfoSI-RSCP-LCR-r4
}

NewInterFreqCellSI-ECN0-LCR-r4 ::= SEQUENCE {
    interFreqCellID          OPTIONAL,
    frequencyInfo            OPTIONAL,
    cellInfo                 CellInfoSI-ECN0-LCR-r4
}

NewInterFreqCellSI-HCS-RSCP-LCR-r4 ::= SEQUENCE {
    interFreqCellID          OPTIONAL,
    frequencyInfo            OPTIONAL,
    cellInfo                 CellInfoSI-HCS-RSCP-LCR-r4
}

NewInterFreqCellSI-HCS-ECN0-LCR-r4 ::= SEQUENCE {

```

```

interFreqCellID          InterFreqCellID          OPTIONAL,
frequencyInfo            FrequencyInfo            OPTIONAL,
cellInfo                  CellInfoSI-HCS-ECNO-LCR-r4
}

NewInterFreqCellSI-List-ECNO ::=
    SEQUENCE (SIZE (1..maxCellMeas)) OF
    NewInterFreqCellSI-ECNO

NewInterFreqCellSI-List-ECNO-ext ::=
    SEQUENCE (SIZE (1..maxCellMeas-ext2)) OF
    NewInterFreqCellSI-ECNO-ext

NewInterFreqCellSI-List-HCS-RSCP ::=
    SEQUENCE (SIZE (1..maxCellMeas)) OF
    NewInterFreqCellSI-HCS-RSCP

NewInterFreqCellSI-List-HCS-RSCP-ext ::=
    SEQUENCE (SIZE (1..maxCellMeas-ext2)) OF
    NewInterFreqCellSI-HCS-RSCP-ext

NewInterFreqCellSI-List-HCS-ECNO ::=
    SEQUENCE (SIZE (1..maxCellMeas)) OF
    NewInterFreqCellSI-HCS-ECNO

NewInterFreqCellSI-List-HCS-ECNO-ext ::=
    SEQUENCE (SIZE (1..maxCellMeas-ext2)) OF
    NewInterFreqCellSI-HCS-ECNO-ext

NewInterFreqCellSI-List-RSCP ::=
    SEQUENCE (SIZE (1..maxCellMeas)) OF
    NewInterFreqCellSI-RSCP

NewInterFreqCellSI-List-RSCP-ext ::=
    SEQUENCE (SIZE (1..maxCellMeas-ext2)) OF
    NewInterFreqCellSI-RSCP-ext

NewInterFreqCellSI-List-ECNO-LCR-r4 ::=
    SEQUENCE (SIZE (1..maxCellMeas)) OF
    NewInterFreqCellSI-ECNO-LCR-r4

NewInterFreqCellSI-List-HCS-RSCP-LCR-r4 ::= SEQUENCE (SIZE (1..maxCellMeas)) OF
    NewInterFreqCellSI-HCS-RSCP-LCR-r4

NewInterFreqCellSI-List-HCS-ECNO-LCR-r4 ::= SEQUENCE (SIZE (1..maxCellMeas)) OF
    NewInterFreqCellSI-HCS-ECNO-LCR-r4

NewInterFreqCellSI-List-RSCP-LCR-r4 ::= SEQUENCE (SIZE (1..maxCellMeas)) OF
    NewInterFreqCellSI-RSCP-LCR-r4

NewInterRATCell ::=
    SEQUENCE {
        interRATCellID          InterRATCellID          OPTIONAL,
        technologySpecificInfo   CHOICE {
            gsm                  SEQUENCE {
                cellSelectionReselectionInfo CellSelectReselectInfoSIB-11-12 OPTIONAL,
                interRATCellIndividualOffset InterRATCellIndividualOffset,
                bsic              BSIC,
                frequency-band    Frequency-Band,
                bcch-ARFCN       BCCH-ARFCN,
                -- dummy is not used in this version of the specification, it should
                -- not be sent and if received it should be ignored.
                dummy             NULL                OPTIONAL
            },
            is-2000              SEQUENCE {
                is-2000SpecificMeasInfo    IS-2000SpecificMeasInfo
            },
            -- ASN.1 inconsistency: NewInterRATCellList should be optional within
            -- InterRATCellInfoList. The UE shall consider IE NewInterRATCell with
            -- technologySpecificInfo set to "absent" as valid and handle the
            -- message as if the IE NewInterRATCell was absent
            absent                NULL,
            spare1                NULL
        }
    }

NewInterRATCell-B ::=
    SEQUENCE {
        interRATCellID          InterRATCellID          OPTIONAL,
        technologySpecificInfo   CHOICE {
            gsm                  SEQUENCE {
                cellSelectionReselectionInfo CellSelectReselectInfoSIB-11-12 OPTIONAL,
                interRATCellIndividualOffset InterRATCellIndividualOffset,
                bsic              BSIC,
                frequency-band    Frequency-Band,
                bcch-ARFCN       BCCH-ARFCN,
                -- dummy is not used in this version of the specification, it should
                -- not be sent and if received it should be ignored.
                dummy             NULL                OPTIONAL
            }
        }
    }

```

```

    },
    is-2000                               SEQUENCE {
        is-2000SpecificMeasInfo           IS-2000SpecificMeasInfo
    },
    -- ASN.1 inconsistency: NewInterRATCellList-B should be optional within
    -- InterRATCellInfoList-B. The UE shall consider IE NewInterRATCell-B with
    -- technologySpecificInfo set to "absent" as valid and handle the
    -- message as if the IE NewInterRATCell-B was absent
    absent                                NULL,
    spare1                                 NULL
}
}

NewInterRATCellList ::=                SEQUENCE (SIZE (1..maxCellMeas)) OF
                                        NewInterRATCell

NewInterRATCellList-B ::=              SEQUENCE (SIZE (1..maxCellMeas)) OF
                                        NewInterRATCell-B

NewIntraFreqCell ::=                   SEQUENCE {
    intraFreqCellID                     IntraFreqCellID                OPTIONAL,
    cellInfo                             CellInfo
}

NewIntraFreqCell-r4 ::=                SEQUENCE {
    intraFreqCellID                     IntraFreqCellID                OPTIONAL,
    cellInfo                             CellInfo-r4
}
NewIntraFreqCell-r9 ::=                SEQUENCE {
    intraFreqCellID                     IntraFreqCellID                OPTIONAL,
    cellInfo                             CellInfo-r9
}

NewIntraFreqCell-r10 ::=               SEQUENCE {
    intraFreqCellID                     IntraFreqCellID                OPTIONAL,
    cellInfo                             CellInfo-r9,
    modeSpecificInfo                    CHOICE {
        noInfo                          NULL,
        tdd128                           SEQUENCE {
            sNPLMonitorSetIndicator-TDD128  BIT STRING (SIZE (5))    OPTIONAL
        }
    }
}

NewIntraFreqCellOnSecULFreq ::=        SEQUENCE {
    intraFreqCellIDOnSecULFreq          IntraFreqCellIDOnSecULFreq    OPTIONAL,
    cellInfo                             CellInfo-r4
}

NewIntraFreqCellList ::=                SEQUENCE (SIZE (1..maxCellMeas)) OF
                                        NewIntraFreqCell

NewIntraFreqCellList-r4 ::=            SEQUENCE (SIZE (1..maxCellMeas)) OF
                                        NewIntraFreqCell-r4

NewIntraFreqCellList-r9 ::=            SEQUENCE (SIZE (1..maxCellMeas)) OF
                                        NewIntraFreqCell-r9

NewIntraFreqCellList-r10 ::=           SEQUENCE (SIZE (1..maxCellMeas)) OF
                                        NewIntraFreqCell-r10

NewIntraFreqCell-LCR-v8a0ext ::=        SEQUENCE {
    cellInfo-LCR-r8                     CellInfo-LCR-r8-ext            OPTIONAL
}

-- The order of the list corresponds to the order of cells in newIntraFreqCellList
NewIntraFreqCellList-LCR-v8a0ext ::=    SEQUENCE (SIZE (1..maxCellMeas)) OF
                                        NewIntraFreqCell-LCR-v8a0ext

NewIntraFreqCellListOnSecULFreq ::=    SEQUENCE (SIZE (1..maxCellMeasOnSecULFreq)) OF
                                        NewIntraFreqCellOnSecULFreq

NewIntraFreqCellSI-RSCP ::=            SEQUENCE {
    intraFreqCellID                     IntraFreqCellID                OPTIONAL,
    cellInfo                             CellInfoSI-RSCP
}

NewIntraFreqCellSI-ECNO ::=            SEQUENCE {

```



```

    intraFreqCellID          IntraFreqCellID          OPTIONAL,
    cellInfo                  CellInfoSI-ECN0
}
NewIntraFreqCellSI-HCS-RSCP ::= SEQUENCE {
    intraFreqCellID          IntraFreqCellID          OPTIONAL,
    cellInfo                  CellInfoSI-HCS-RSCP
}
NewIntraFreqCellSI-HCS-ECN0 ::= SEQUENCE {
    intraFreqCellID          IntraFreqCellID          OPTIONAL,
    cellInfo                  CellInfoSI-HCS-ECN0
}
NewIntraFreqCellSI-RSCP-LCR-r4 ::= SEQUENCE {
    intraFreqCellID          IntraFreqCellID          OPTIONAL,
    cellInfo                  CellInfoSI-RSCP-LCR-r4
}
NewIntraFreqCellSI-ECN0-LCR-r4 ::= SEQUENCE {
    intraFreqCellID          IntraFreqCellID          OPTIONAL,
    cellInfo                  CellInfoSI-ECN0-LCR-r4
}
NewIntraFreqCellSI-HCS-RSCP-LCR-r4 ::= SEQUENCE {
    intraFreqCellID          IntraFreqCellID          OPTIONAL,
    cellInfo                  CellInfoSI-HCS-RSCP-LCR-r4
}
NewIntraFreqCellSI-HCS-ECN0-LCR-r4 ::= SEQUENCE {
    intraFreqCellID          IntraFreqCellID          OPTIONAL,
    cellInfo                  CellInfoSI-HCS-ECN0-LCR-r4
}
NewIntraFreqCellSI-List-RSCP ::= SEQUENCE (SIZE (1..maxCellMeas)) OF
    NewIntraFreqCellSI-RSCP
NewIntraFreqCellSI-List-ECN0 ::= SEQUENCE (SIZE (1..maxCellMeas)) OF
    NewIntraFreqCellSI-ECN0
NewIntraFreqCellSI-List-HCS-RSCP ::= SEQUENCE (SIZE (1..maxCellMeas)) OF
    NewIntraFreqCellSI-HCS-RSCP
NewIntraFreqCellSI-List-HCS-ECN0 ::= SEQUENCE (SIZE (1..maxCellMeas)) OF
    NewIntraFreqCellSI-HCS-ECN0
NewIntraFreqCellSI-List-RSCP-LCR-r4 ::= SEQUENCE (SIZE (1..maxCellMeas)) OF
    NewIntraFreqCellSI-RSCP-LCR-r4
NewIntraFreqCellSI-List-ECN0-LCR-r4 ::= SEQUENCE (SIZE (1..maxCellMeas)) OF
    NewIntraFreqCellSI-ECN0-LCR-r4
NewIntraFreqCellSI-List-HCS-RSCP-LCR-r4 ::= SEQUENCE (SIZE (1..maxCellMeas)) OF
    NewIntraFreqCellSI-HCS-RSCP-LCR-r4
NewIntraFreqCellSI-List-HCS-ECN0-LCR-r4 ::= SEQUENCE (SIZE (1..maxCellMeas)) OF
    NewIntraFreqCellSI-HCS-ECN0-LCR-r4

-- IE "nonUsedFreqThreshold" is not needed in case of event 2a
-- In case of event 2a UTRAN should include value 0 within IE "nonUsedFreqThreshold"
-- In case of event 2a, the UE shall be ignore IE "nonUsedFreqThreshold"
-- In later versions of the message including this IE, a special version of
-- IE "NonUsedFreqParameterList" may be defined for event 2a, namely a
-- version not including IE "nonUsedFreqThreshold"
NonUsedFreqParameter ::= SEQUENCE {
    nonUsedFreqThreshold      Threshold,
    nonUsedFreqW              W
}
NonUsedFreqParameter-r6 ::= SEQUENCE {
    nonUsedFreqThreshold      Threshold-r6,
    nonUsedFreqW              W
}
NonUsedFreqParameter-r10 ::= SEQUENCE {
    nonUsedFreqThreshold      Threshold-r6,
    nonUsedFreqW              W,
    nonUsedFreqTriggeringConditionDetectedCells ENUMERATED { true } OPTIONAL
}

```

```

NonUsedFreqParameter-r11 ::= SEQUENCE {
    nonUsedFreqThreshold          Threshold-r6,
    nonUsedFreqW                  W,
    nonUsedFreqTriggeringConditionDetectedCells ENUMERATED { true } OPTIONAL,
    -- dummy is not used in this version of the specification and
    -- it should be ignored by the receiver.
    dummy                          CellInfoListToBeExcluded          OPTIONAL
}

NonUsedFreq2aParameter-r10 ::= SEQUENCE {
    nonUsedFreqW                  W,
    nonUsedFreqTriggeringConditionDetectedCells ENUMERATED { true } OPTIONAL
}

NonUsedFreq2aParameter-r11 ::= SEQUENCE {
    nonUsedFreqW                  W,
    nonUsedFreqTriggeringConditionDetectedCells ENUMERATED { true } OPTIONAL,
    -- dummy is not used in this version of the specification and
    -- it should be ignored by the receiver.
    dummy                          CellInfoListToBeExcluded          OPTIONAL
}

NonUsedFreqParameterList ::= SEQUENCE (SIZE (1..maxFreq)) OF
    NonUsedFreqParameter

NonUsedFreqParameterList-r6 ::= SEQUENCE (SIZE (1..maxFreq)) OF
    NonUsedFreqParameter-r6

NonUsedFreqParameterList-r10 ::= SEQUENCE (SIZE (1..maxFreq)) OF
    NonUsedFreqParameter-r10

NonUsedFreqParameterList-r11 ::= SEQUENCE (SIZE (1..maxFreq)) OF
    NonUsedFreqParameter-r11

NonUsedFreq2aParameterList-r10 ::= SEQUENCE (SIZE (1..maxFreq)) OF
    NonUsedFreq2aParameter-r10

NonUsedFreq2aParameterList-r11 ::= SEQUENCE (SIZE (1..maxFreq)) OF
    NonUsedFreq2aParameter-r11

NonUsedFreqWList-r6 ::= SEQUENCE (SIZE (1..maxFreq)) OF W

ObservedTimeDifferenceToGSM ::= INTEGER (0..4095)

OTDOA-SearchWindowSize ::= ENUMERATED {
    c20, c40, c80, c160, c320,
    c640, c1280, moreThan1280 }

-- SPARE: Pathloss, Max = 158
-- Values above Max are spare
Pathloss ::= INTEGER (46..173)

PenaltyTime-RSCP ::= CHOICE {
    notUsed          NULL,
    pt10             TemporaryOffset1,
    pt20             TemporaryOffset1,
    pt30             TemporaryOffset1,
    pt40             TemporaryOffset1,
    pt50             TemporaryOffset1,
    pt60             TemporaryOffset1
}

PenaltyTime-ECNO ::= CHOICE {
    notUsed          NULL,
    pt10             TemporaryOffsetList,
    pt20             TemporaryOffsetList,
    pt30             TemporaryOffsetList,
    pt40             TemporaryOffsetList,
    pt50             TemporaryOffsetList,
    pt60             TemporaryOffsetList
}

PendingTimeAfterTrigger ::= ENUMERATED {
    ptat0-25, ptat0-5, ptat1,
    ptat2, ptat4, ptat8, ptat16 }

PeriodicalOrEventTrigger ::= ENUMERATED {
    periodical,

```

```

        eventTrigger }

PeriodicalReportingCriteria ::= SEQUENCE {
    reportingAmount          ReportingAmount          DEFAULT ra-Infinity,
    reportingInterval        ReportingIntervalLong
}

PeriodicReportingInfo-1b ::= SEQUENCE {
    reportingAmount          ReportingAmount,
    reportingInterval        ReportingInterval
}

PeriodicalWithReportingCellStatus ::= SEQUENCE {
    periodicalReportingCriteria PeriodicalReportingCriteria,
    reportingCellStatus        ReportingCellStatus          OPTIONAL
}

PeriodicalWithReportingCellStatus-r10 ::= SEQUENCE {
    periodicalReportingCriteria PeriodicalReportingCriteria,
    reportingCellStatus-r10     ReportingCellStatus-r10          OPTIONAL
}

PeriodicalWithReportingCellStatusOnSecULFreq ::= SEQUENCE {
    frequencyInfo            FrequencyInfo,
    periodicalWithReportingCellStatus PeriodicalWithReportingCellStatus-r10
}

PLMNIdentitiesOfNeighbourCells ::= SEQUENCE {
    plmnsOfIntraFreqCellsList PLMNsOfIntraFreqCellsList          OPTIONAL,
    plmnsOfInterFreqCellsList PLMNsOfInterFreqCellsList          OPTIONAL,
    plmnsOfInterRATCellsList  PLMNsOfInterRATCellsList          OPTIONAL
}

PLMNIdentitiesOfNeighbourCells-v860ext ::= SEQUENCE {
    multipleplmnsOfIntraFreqCellsList MultiplePLMNsOfIntraFreqCellsList  OPTIONAL,
    multipleplmnsOfInterFreqCellsList MultiplePLMNsOfInterFreqCellsList  OPTIONAL
}

PLMNIdentitiesOfNeighbourCells-vc50ext ::= SEQUENCE {
    plmnsOfInterFreqCellsList  PLMNsOfInterFreqCellsList-vc50ext          OPTIONAL,
    multipleplmnsOfInterFreqCellsList MultiplePLMNsOfInterFreqCellsList-vc50ext  OPTIONAL
}

PlmnList ::= SEQUENCE (SIZE (1..maxNumMDTPLMN)) OF PLMN-Identity

PLMNsOfInterFreqCellsList ::= SEQUENCE (SIZE (1..maxCellMeas)) OF
    SEQUENCE {
        plmn-Identity          PLMN-Identity          OPTIONAL
    }

PLMNsOfInterFreqCellsList-vc50ext ::= SEQUENCE (SIZE (1..maxCellMeas-ext)) OF
    InterFreqCellPLMN

InterFreqCellPLMN ::= SEQUENCE {
    plmn-Identity          PLMN-Identity          OPTIONAL
}

MultiplePLMNsOfInterFreqCellsList ::= SEQUENCE (SIZE (1..maxCellMeas)) OF
    SEQUENCE {
        multiplePLMN-list      SEQUENCE (SIZE (1..6)) OF
            PLMN-IdentityWithOptionalMCC-r6          OPTIONAL
    }

MultiplePLMNsOfInterFreqCellsList-vc50ext ::= SEQUENCE (SIZE (1..maxCellMeas-ext)) OF
    MultiplePLMNInfo

MultiplePLMNInfo ::= SEQUENCE {
    multiplePLMN-list          MultiplePLMN-List          OPTIONAL
}

MultiplePLMN-List ::= SEQUENCE (SIZE (1..6)) OF PLMN-IdentityWithOptionalMCC-r6

PLMNsOfIntraFreqCellsList ::= SEQUENCE (SIZE (1..maxCellMeas)) OF
    SEQUENCE {
        plmn-Identity          PLMN-Identity          OPTIONAL
    }

MultiplePLMNsOfIntraFreqCellsList ::= SEQUENCE (SIZE (1..maxCellMeas)) OF

```

```

multiplePLMN-list          SEQUENCE {
                             SEQUENCE (SIZE (1..6)) OF
                             PLMN-IdentityWithOptionalMCC-r6    OPTIONAL
}

PLMNsOfInterRATCellsList ::= SEQUENCE (SIZE (1..maxCellMeas)) OF
                               SEQUENCE {
                                 plmn-Identity          PLMN-Identity          OPTIONAL
                               }

PositionEstimate ::= CHOICE {
  ellipsoidPoint          EllipsoidPoint,
  ellipsoidPointUncertCircle EllipsoidPointUncertCircle,
  ellipsoidPointUncertEllipse EllipsoidPointUncertEllipse,
  ellipsoidPointAltitude EllipsoidPointAltitude,
  ellipsoidPointAltitudeEllipse EllipsoidPointAltitudeEllipsoide
}

PositioningMethod ::= ENUMERATED {
  otdoa,
  gps,
  otdoaOrGPS, cellID }

-- Actual value PRC = IE value * 0.32
PRC ::= INTEGER (-2047..2047)

-- SPARE: PrimaryCCPCH-RSCP, Max = 91
-- Values above Max are spare
PrimaryCCPCH-RSCP ::= INTEGER (0..127)

Q-HCS ::= INTEGER (0..99)

Q-OffsetS-N ::= INTEGER (-50..50)

Q-QualMin ::= INTEGER (-24..0)

Q-QualMin-Offset ::= INTEGER (1..16)

-- Actual value Q-RxlevMin = (IE value * 2) + 1
Q-RxlevMin ::= INTEGER (-58..-13)

-- Actual value Q-RxlevMin-Offset = (IE value * 2)
Q-RxlevMin-Offset ::= INTEGER (1..8)

QualityEventResults ::= SEQUENCE (SIZE (1..maxTrCH)) OF
  TransportChannelIdentity

QualityMeasuredResults ::= SEQUENCE {
  blerMeasurementResultsList BLER-MeasurementResultsList    OPTIONAL,
  modeSpecificInfo          CHOICE {
    fdd                      NULL,
    tdd                      SEQUENCE {
      sir-MeasurementResults SIR-MeasurementList    OPTIONAL
    }
  }
}

QualityMeasurement ::= SEQUENCE {
  qualityReportingQuantity QualityReportingQuantity    OPTIONAL,
  reportCriteria          QualityReportCriteria
}

QualityReportCriteria ::= CHOICE {
  qualityReportingCriteria QualityReportingCriteria,
  periodicalReportingCriteria PeriodicalReportingCriteria,
  noReporting              NULL
}

QualityReportingCriteria ::= SEQUENCE (SIZE (1..maxTrCH)) OF
  QualityReportingCriteriaSingle

QualityReportingCriteriaSingle ::= SEQUENCE {
  transportChannelIdentity TransportChannelIdentity,
  totalCRC                INTEGER (1..512),
  badCRC                  INTEGER (1..512),
  pendingAfterTrigger     INTEGER (1..512)
}

```

```

QualityReportingQuantity ::=          SEQUENCE {
  dl-TransChBLER                     BOOLEAN,
  bler-dl-TransChIdList              BLER-TransChIdList          OPTIONAL,
  modeSpecificInfo                   CHOICE {
    fdd                               NULL,
    tdd                               SEQUENCE {
      sir-TFCS-List                  SIR-TFCS-List          OPTIONAL
    }
  }
}

RAT-Type ::=                          ENUMERATED {
  gsm, is2000 }

ReferenceCellPosition ::=             CHOICE {
  ellipsoidPoint                     EllipsoidPoint,
  ellipsoidPointWithAltitude         EllipsoidPointAltitude
}

-- ReferenceLocation, as defined in 23.032
ReferenceLocation ::=                SEQUENCE {
  ellipsoidPointAltitudeEllipsoide   EllipsoidPointAltitudeEllipsoide
}

ReferenceLocationGANSS ::=           SEQUENCE {
  ellipsoidPointAltitudeEllipsoide   EllipsoidPointAltitudeEllipsoide
}

ReferenceTimeDifferenceToCell ::=    CHOICE {
  -- Actual value accuracy40 = IE value * 40
  accuracy40                         INTEGER (0..960),
  -- Actual value accuracy256 = IE value * 256
  accuracy256                        INTEGER (0..150),
  -- Actual value accuracy2560 = IE value * 2560
  accuracy2560                       INTEGER (0..15)
}

RemovedInterFreqCellList ::=        CHOICE {
  removeAllInterFreqCells            NULL,
  removeSomeInterFreqCells          SEQUENCE (SIZE (1..maxCellMeas)) OF
  InterFreqCellID,
  removeNoInterFreqCells            NULL
}

RemovedInterFreqCellList-r12 ::=    CHOICE {
  removeAllInterFreqCells            NULL,
  removeSomeInterFreqCells          SEQUENCE (SIZE (1..maxCellMeas-ext)) OF
  InterFreqCellID-r12,
  removeNoInterFreqCells            NULL
}

RemovedInterRATCellList ::=         CHOICE {
  removeAllInterRATCells             NULL,
  removeSomeInterRATCells           SEQUENCE (SIZE (1..maxCellMeas)) OF
  InterRATCellID,
  removeNoInterRATCells             NULL
}

RemovedIntraFreqCellList ::=        CHOICE {
  removeAllIntraFreqCells            NULL,
  removeSomeIntraFreqCells          SEQUENCE (SIZE (1..maxCellMeas)) OF
  IntraFreqCellID,
  removeNoIntraFreqCells            NULL
}

RemovedIntraFreqCellListOnSecULFreq ::= CHOICE {
  removeAllIntraFreqCells            NULL,
  removeSomeIntraFreqCells          SEQUENCE (SIZE (1..maxCellMeasOnSecULFreq)) OF
  IntraFreqCellIDOnSecULFreq,
  removeNoIntraFreqCells            NULL
}

ReplacementActivationThreshold ::=  ENUMERATED {
  notApplicable, t1, t2,
  t3, t4, t5, t6, t7 }

ReportDeactivationThreshold ::=     ENUMERATED {
  notApplicable, t1, t2,

```

```

        t3, t4, t5, t6, t7 }

ReportingAmount ::=          ENUMERATED {
        ra1, ra2, ra4, ra8, ra16, ra32,
        ra64, ra-Infinity }

ReportingCellStatus ::=     CHOICE{
        withinActiveSet      MaxNumberOfReportingCellsType1,
        withinMonitoredSetUsedFreq  MaxNumberOfReportingCellsType1,
        withinActiveAndOrMonitoredUsedFreq  MaxNumberOfReportingCellsType1,
        withinDetectedSetUsedFreq  MaxNumberOfReportingCellsType1,
        withinMonitoredAndOrDetectedUsedFreq
        MaxNumberOfReportingCellsType1,
        allActiveplusMonitoredSet      MaxNumberOfReportingCellsType3,
        allActivePlusDetectedSet      MaxNumberOfReportingCellsType3,
        allActivePlusMonitoredAndOrDetectedSet
        MaxNumberOfReportingCellsType3,
        withinVirtualActSet      MaxNumberOfReportingCellsType1,
        withinMonitoredSetNonUsedFreq  MaxNumberOfReportingCellsType1,
        withinMonitoredAndOrVirtualActiveSetNonUsedFreq
        MaxNumberOfReportingCellsType1,
        allVirtualActSetplusMonitoredSetNonUsedFreq
        MaxNumberOfReportingCellsType3,
        withinActSetOrVirtualActSet-InterRATcells
        MaxNumberOfReportingCellsType2,
        withinActSetAndOrMonitoredUsedFreqOrVirtualActSetAndOrMonitoredNonUsedFreq
        MaxNumberOfReportingCellsType2
}

ReportingCellStatus-r10 ::= CHOICE{
        withinActiveSet      MaxNumberOfReportingCellsType1,
        withinMonitoredSetUsedFreq  MaxNumberOfReportingCellsType1,
        withinActiveAndOrMonitoredUsedFreq  MaxNumberOfReportingCellsType1,
        withinDetectedSetUsedFreq  MaxNumberOfReportingCellsType1,
        withinMonitoredAndOrDetectedUsedFreq
        MaxNumberOfReportingCellsType1,
        allActiveplusMonitoredSet      MaxNumberOfReportingCellsType3,
        allActivePlusDetectedSet      MaxNumberOfReportingCellsType3,
        allActivePlusMonitoredAndOrDetectedSet
        MaxNumberOfReportingCellsType3,
        withinVirtualActSet      MaxNumberOfReportingCellsType1,
        withinMonitoredSetNonUsedFreq  MaxNumberOfReportingCellsType1,
        withinMonitoredAndOrVirtualActiveSetNonUsedFreq
        MaxNumberOfReportingCellsType1,
        allVirtualActSetplusMonitoredSetNonUsedFreq
        MaxNumberOfReportingCellsType3,
        withinActSetOrVirtualActSet-InterRATcells
        MaxNumberOfReportingCellsType2,
        withinActSetAndOrMonitoredUsedFreqOrVirtualActSetAndOrMonitoredNonUsedFreq
        MaxNumberOfReportingCellsType2,
        allVirtualActSetplusMonitoredSetplusDetectedSetNonUsedFreq
        MaxNumberOfReportingCellsType3
}

ReportingCellStatusOpt ::= SEQUENCE {
        reportingCellStatus      ReportingCellStatus      OPTIONAL
}

ReportingCellStatusOpt-r10 ::= SEQUENCE {
        reportingCellStatus      ReportingCellStatus-r10      OPTIONAL
}

ReportingInfoForCellDCH ::= SEQUENCE {
        intraFreqReportingQuantity      IntraFreqReportingQuantity,
        measurementReportingMode      MeasurementReportingMode,
        reportCriteria      CellDCH-ReportCriteria
}

ReportingInfoForCellDCH-LCR-r4 ::= SEQUENCE {
        intraFreqReportingQuantity      IntraFreqReportingQuantity,
        measurementReportingMode      MeasurementReportingMode,
        reportCriteria      CellDCH-ReportCriteria-LCR-r4
}

ReportingInterval ::=      ENUMERATED {
        noPeriodicalreporting, ri0-25,
        ri0-5, ri1, ri2, ri4, ri8, ri16 }

```

```

ReportingIntervalLong ::=          ENUMERATED {
    ril0, ril0-25, ril0-5, ril1,
    ril2, ril3, ril4, ril6, ril8,
    ril12, ril16, ril20, ril24,
    ril28, ril32, ril64 }
-- When the value "ril0" is used, the UE behaviour is not
-- defined.

-- Actual value ReportingRange = IE value * 0.5
ReportingRange ::=                INTEGER (0..29)

ReqDataBitAssistance ::=         SEQUENCE {
    ganssSignalID                 DGANSS-Sig-Id-Req,
    ganssDataBitInterval          INTEGER(0..15),
    ganssSatelliteInfo            SEQUENCE (SIZE (1..maxGANSSSat)) OF INTEGER(0..63) OPTIONAL
}

RL-AdditionInfoList ::=         SEQUENCE (SIZE (1..maxRL)) OF
    PrimaryCPICH-Info

RL-InformationLists ::=         SEQUENCE {
    rl-AdditionInfoList           RL-AdditionInfoList           OPTIONAL,
    rl-RemovalInformationList     RL-RemovalInformationList     OPTIONAL
}

RLC-BuffersPayload ::=         ENUMERATED {
    pl0, pl4, pl8, pl16, pl32,
    pl64, pl128, pl256, pl512, pl1024,
    pl2k, pl4k, pl8k, pl16k, pl32k,
    pl64k, pl128k, pl256k, pl512k, pl1024k,
    spare12, spare11, spare10, spare9, spare8,
    spare7, spare6, spare5, spare4, spare3,
    spare2, spare1 }

RMP-Frequency-List ::=         SEQUENCE (SIZE (1..maxRMPfrequencies)) OF
    BOOLEAN

-- Actual value RRC = IE value * 0.032
RRC ::=                          INTEGER (-127..127)

RSCPforANR ::= SEQUENCE {
    rSCP                          INTEGER (-120..-25)           OPTIONAL
}

RsrqType ::= SEQUENCE{
    allSymbols                    BOOLEAN,
    wideBand                      BOOLEAN
}

SatData ::= SEQUENCE{
    satID                        SatID,
    iode                         IODe
}

SatDataList ::= SEQUENCE (SIZE (0..maxSat)) OF
    SatData

SatellitesListRelatedData ::= SEQUENCE {
    satId                        INTEGER (0..63),
    iod                          INTEGER (0..1023)
}

SatellitesListRelatedDataList ::= SEQUENCE (SIZE (1..maxGANSSSat)) OF
    SatellitesListRelatedData

SatelliteStatus ::=            ENUMERATED {
    ns-NN-U,
    es-SN,
    es-NN-U,
    rev2,
    rev }

Satellite-clock-model ::=     SEQUENCE {
    t-oc                         BIT STRING (SIZE (14)),
    af2                          BIT STRING (SIZE (6)),
    af1                          BIT STRING (SIZE (21)),

```

```

af0                BIT STRING (SIZE (31)),
tgd                BIT STRING (SIZE (10))           OPTIONAL,
sisa               BIT STRING (SIZE (8)),
model-id           INTEGER (0..1)                   OPTIONAL
}

Satellite-clock-modelList ::= SEQUENCE (SIZE (1..maxSatClockModels)) OF Satellite-clock-model

-- Identifies the satellite and is equal to (SV ID No - 1) where SV ID No is defined in [12].
SatID ::= INTEGER (0..63)

SBASclockModel ::= SEQUENCE {
  sbasTo          BIT STRING (SIZE (13)),
  sbasAgfo        BIT STRING (SIZE (12)),
  sbasAgf1        BIT STRING (SIZE (8))
}

S-DPCCH-Information ::= SEQUENCE {
  s-DPCCH-DPCCH-PowerOffset          S-DPCCH-DPCCH-PowerOffset
}

S-DPCCH-DPCCH-PowerOffset ::= INTEGER (0..6)

SFN-Offset-Validity ::= ENUMERATED { false }

SFN-SFN-Drift ::= ENUMERATED {
  sfnsfndrift0, sfnsfndrift1, sfnsfndrift2,
  sfnsfndrift3, sfnsfndrift4, sfnsfndrift5,
  sfnsfndrift8, sfnsfndrift10, sfnsfndrift15,
  sfnsfndrift25, sfnsfndrift35, sfnsfndrift50,
  sfnsfndrift65, sfnsfndrift80, sfnsfndrift100,
  sfnsfndrift-1, sfnsfndrift-2, sfnsfndrift-3,
  sfnsfndrift-4, sfnsfndrift-5, sfnsfndrift-8,
  sfnsfndrift-10, sfnsfndrift-15, sfnsfndrift-25,
  sfnsfndrift-35, sfnsfndrift-50, sfnsfndrift-65,
  sfnsfndrift-80, sfnsfndrift-100}

SFN-SFN-ObsTimeDifference ::= CHOICE {
  type1          SFN-SFN-ObsTimeDifference1,
  type2          SFN-SFN-ObsTimeDifference2
}

-- SPARE: SFN-SFN-ObsTimeDifference1, Max = 9830399
-- For 1.28Mcps TDD, Max value of SFN-SFN-ObsTimeDifference1 is 3276799.
-- Values above Max are spare
SFN-SFN-ObsTimeDifference1 ::= INTEGER (0..16777215)

-- SPARE: SFN-SFN-ObsTimeDifference2, Max = 40961
-- For 1.28Mcps TDD, Max value of SFN-SFN-ObsTimeDifference2 is 27649.
-- Values above Max are spare
SFN-SFN-ObsTimeDifference2 ::= INTEGER (0..65535)

SFN-SFN-OTD-Type ::= ENUMERATED {
  noReport,
  type1,
  type2 }

SFN-SFN-RelTimeDifference1 ::= SEQUENCE {
  sfn-Offset          INTEGER (0 .. 4095),
  sfn-sfn-Reltimedifference INTEGER (0.. 38399)
}

SFN-TOW-Uncertainty ::= ENUMERATED {
  lessThan10,
  moreThan10 }

SIR ::= INTEGER (0..63)

SIR-MeasurementList ::= SEQUENCE (SIZE (1..maxCCTrCH)) OF
  SIR-MeasurementResults

SIR-MeasurementResults ::= SEQUENCE {
  tfcs-ID            TFCS-IdentityPlain,
  sir-TimeslotList   SIR-TimeslotList
}

```



```

SIR-TFCS ::=                                TFCS-IdentityPlain

SIR-TFCS-List ::=                           SEQUENCE (SIZE (1..maxCCTrCH)) OF
                                             SIR-TFCS

SIR-TimeslotList ::=                        SEQUENCE (SIZE (1..maxTS)) OF
                                             SIR

-- SubFrame1Reserved, reserved bits in subframe 1 of the GPS navigation message
SubFrame1Reserved ::=                      SEQUENCE {
    reserved1                               BIT STRING (SIZE (23)),
    reserved2                               BIT STRING (SIZE (24)),
    reserved3                               BIT STRING (SIZE (24)),
    reserved4                               BIT STRING (SIZE (16))
}

T-ADVinfo ::=                               SEQUENCE {
    t-ADV                                    INTEGER(0..2047),
    sfn                                      INTEGER(0..4095)
}

T-ADVinfo-ext ::=                          SEQUENCE {
    t-ADV                                    INTEGER (0..8191),
    sfn                                      INTEGER (0..4095)
}

T-CRMax ::=                                CHOICE {
    notUsed                                  NULL,
    t30                                      N-CR-T-CRMaxHyst,
    t60                                      N-CR-T-CRMaxHyst,
    t120                                    N-CR-T-CRMaxHyst,
    t180                                    N-CR-T-CRMaxHyst,
    t240                                    N-CR-T-CRMaxHyst
}

T-CRMaxHyst ::=                            ENUMERATED {
    notUsed, t10, t20, t30,
    t40, t50, t60, t70 }

TCE-Id ::=                                 SEQUENCE {
    tce-Id                                   OCTET STRING (SIZE (1))
}

TemporaryOffset1 ::=                       ENUMERATED {
    to3, to6, to9, to12, to15,
    to18, to21, infinite }

TemporaryOffset2 ::=                       ENUMERATED {
    to2, to3, to4, to6, to8,
    to10, to12, infinite }

TemporaryOffsetList ::=                    SEQUENCE {
    temporaryOffset1                         TemporaryOffset1,
    temporaryOffset2                         TemporaryOffset2
}

Threshold ::=                              INTEGER (-115..0)

Threshold-r12 ::=                          INTEGER (-115..6)

Threshold-r6 ::=                            INTEGER (-120..0)

-- The order of the list corresponds to the order of frequency defined in Inter-FreqEventCriteria
ThresholdNonUsedFrequency-deltaList ::= SEQUENCE (SIZE (1..maxFreq)) OF
                                         DeltaRSCPPerCell

ThresholdPositionChange ::=                ENUMERATED {
    pc10, pc20, pc30, pc40, pc50,
    pc100, pc200, pc300, pc500,
    pc1000, pc2000, pc5000, pc10000,
    pc20000, pc50000, pc100000 }

ThresholdSFN-GANSS-TOW ::=                 ENUMERATED {
    us1, us2, us3, us5, us10,
    us20, us50, us100 }

```

```

ThresholdSFN-GPS-TOW ::=          ENUMERATED {
                                    ms1, ms2, ms3, ms5, ms10,
                                    ms20, ms50, ms100 }

ThresholdSFN-GPS-TOW-us ::=       ENUMERATED {
                                    us1, us2, us3, us5, us10,
                                    us20, us50, us100 }

ThresholdSFN-SFN-Change ::=       ENUMERATED {
                                    c0-25, c0-5, c1, c2, c3, c4, c5,
                                    c10, c20, c50, c100, c200, c500,
                                    c1000, c2000, c5000 }

ThresholdUsedFrequency ::=        INTEGER (-115..165)

ThresholdUsedFrequency-r6 ::=     INTEGER (-120..165)

-- Actual value TimeInterval = IE value * 20.
TimeInterval ::=                 INTEGER (1..13)

TimeslotInfo ::=                 SEQUENCE {
    timeslotNumber
    burstType
}

TimeslotInfo-LCR-r4 ::=          SEQUENCE {
    timeslotNumber
    TimeslotNumber-LCR-r4
}

TimeslotInfoList ::=            SEQUENCE (SIZE (1..maxTS)) OF
    TimeslotInfo

TimeslotInfoList-LCR-r4 ::=     SEQUENCE (SIZE (1..maxTS-LCR)) OF
    TimeslotInfo-LCR-r4

TimeslotInfoList-r4 ::=         CHOICE {
    -- the choice for 7.68 Mcps TDD is the same as for 3.84 Mcps TDD --
    tdd384
        SEQUENCE (SIZE (1..maxTS)) OF
            TimeslotInfo,
    tdd128
        SEQUENCE (SIZE (1..maxTS-LCR)) OF
            TimeslotInfo-LCR-r4
}

-- SPARE: TimeslotISCP, Max = 91
-- Values above Max are spare
TimeslotISCP ::=                INTEGER (0..127)

-- TimeslotISCP-List shall not include more than 6 elements in 1.28Mcps TDD mode.
TimeslotISCP-List ::=          SEQUENCE (SIZE (1..maxTS)) OF
    TimeslotISCP

TimeslotListWithISCP ::=       SEQUENCE (SIZE (1..maxTS)) OF
    TimeslotWithISCP

TimeslotWithISCP ::=           SEQUENCE {
    timeslot
    TimeslotNumber,
    timeslotISCP
    TimeslotISCP
}

TimeToTrigger ::=              ENUMERATED {
    ttt0, ttt10, ttt20, ttt40, ttt60,
    ttt80, ttt100, ttt120, ttt160,
    ttt200, ttt240, ttt320, ttt640,
    ttt1280, ttt2560, ttt5000 }

TraceReference ::=             SEQUENCE {
    plmn-Identity
    traceId
}

TraceRecordingSession ::=      SEQUENCE {
    traceRecordingSession
}

TrafficVolumeEventParam ::=    SEQUENCE {
    eventID
    TrafficVolumeEventType,

```

```

reportingThreshold          TrafficVolumeThreshold,
timeToTrigger              TimeToTrigger              OPTIONAL,
pendingTimeAfterTrigger    PendingTimeAfterTrigger    OPTIONAL,
tx-InterruptionAfterTrigger TX-InterruptionAfterTrigger OPTIONAL
}

TrafficVolumeEventResults ::= SEQUENCE {
    ul-transportChannelCausingEvent  UL-TrCH-Identity,
    trafficVolumeEventIdentity       TrafficVolumeEventType
}

TrafficVolumeEventType ::= ENUMERATED {
    e4a,
    e4b }

TrafficVolumeMeasQuantity ::= CHOICE {
    rlc-BufferPayload          NULL,
    averageRLC-BufferPayload   TimeInterval,
    varianceOfRLC-BufferPayload TimeInterval
}

TrafficVolumeMeasSysInfo ::= SEQUENCE {
    trafficVolumeMeasurementID      MeasurementIdentity          DEFAULT 4,
    trafficVolumeMeasurementObjectList TrafficVolumeMeasurementObjectList OPTIONAL,
    trafficVolumeMeasQuantity       TrafficVolumeMeasQuantity    OPTIONAL,
    trafficVolumeReportingQuantity   TrafficVolumeReportingQuantity OPTIONAL,
    -- dummy is not used in this version of specification, it should
    -- not be sent and if received it should be ignored.
    dummy                           TrafficVolumeReportingCriteria OPTIONAL,
    measurementValidity              MeasurementValidity           OPTIONAL,
    measurementReportingMode         MeasurementReportingMode,
    reportCriteriaSysInf             TrafficVolumeReportCriteriaSysInfo
}

TrafficVolumeMeasuredResults ::= SEQUENCE {
    rb-Identity                 RB-Identity,
    rlc-BuffersPayload          RLC-BuffersPayload          OPTIONAL,
    averageRLC-BufferPayload     AverageRLC-BufferPayload     OPTIONAL,
    varianceOfRLC-BufferPayload  VarianceOfRLC-BufferPayload  OPTIONAL
}

TrafficVolumeMeasuredResultsList ::= SEQUENCE (SIZE (1..maxRB)) OF
    TrafficVolumeMeasuredResults

TrafficVolumeMeasurement ::= SEQUENCE {
    trafficVolumeMeasurementObjectList TrafficVolumeMeasurementObjectList OPTIONAL,
    trafficVolumeMeasQuantity       TrafficVolumeMeasQuantity    OPTIONAL,
    trafficVolumeReportingQuantity   TrafficVolumeReportingQuantity OPTIONAL,
    measurementValidity              MeasurementValidity           OPTIONAL,
    reportCriteria                   TrafficVolumeReportCriteria
}

TrafficVolumeMeasurementObjectList ::= SEQUENCE (SIZE (1..maxTrCH)) OF
    UL-TrCH-Identity

TrafficVolumeReportCriteria ::= CHOICE {
    trafficVolumeReportingCriteria TrafficVolumeReportingCriteria,
    periodicalReportingCriteria   PeriodicalReportingCriteria,
    noReporting                    NULL
}

TrafficVolumeReportCriteriaSysInfo ::= CHOICE {
    trafficVolumeReportingCriteria TrafficVolumeReportingCriteria,
    periodicalReportingCriteria   PeriodicalReportingCriteria
}

TrafficVolumeReportingCriteria ::= SEQUENCE {
    -- NOTE: transChCriteriaList should be mandatory in later versions of this message
    transChCriteriaList           TransChCriteriaList          OPTIONAL
}

TrafficVolumeReportingQuantity ::= SEQUENCE {
    rlc-RB-BufferPayload          BOOLEAN,
    rlc-RB-BufferPayloadAverage   BOOLEAN,
    rlc-RB-BufferPayloadVariance  BOOLEAN
}

```

```

TrafficVolumeThreshold ::=          ENUMERATED {
                                     th8, th16, th32, th64, th128,
                                     th256, th512, th1024, th2k, th3k,
                                     th4k, th6k, th8k, th12k, th16k,
                                     th24k, th32k, th48k, th64k, th96k,
                                     th128k, th192k, th256k, th384k,
                                     th512k, th768k }

TransChCriteria ::=                 SEQUENCE {
    ul-transportChannelID           UL-TrCH-Identity                OPTIONAL,
    eventSpecificParameters         SEQUENCE (SIZE (1..maxMeasParEvent)) OF
                                     TrafficVolumeEventParam          OPTIONAL
}

TransChCriteriaList ::=            SEQUENCE (SIZE (1..maxTrCH)) OF
    TransChCriteria

TransferMode ::=                   ENUMERATED {
    acknowledgedModeRLC,
    unacknowledgedModeRLC }

TransmittedPowerThreshold ::=      INTEGER (-50..33)

TriggeringCondition1 ::=           ENUMERATED {
    activeSetCellsOnly,
    monitoredSetCellsOnly,
    activeSetAndMonitoredSetCells }

TriggeringCondition2 ::=           ENUMERATED {
    activeSetCellsOnly,
    monitoredSetCellsOnly,
    activeSetAndMonitoredSetCells,
    detectedSetCellsOnly,
    detectedSetAndMonitoredSetCells }

Tutran-Ganss-DriftRate ::=         ENUMERATED {
    ugdr0, ugdr1, ugdr2, ugdr5, ugdr10, ugdr15, ugdr25,
    ugdr50, ugdr-1, ugdr-2, ugdr-5, ugdr-10, ugdr-15,
    ugdr-25, ugdr-50, spare }

TX-InterruptionAfterTrigger ::=    ENUMERATED {
    txiat0-25, txiat0-5, txiat1,
    txiat2, txiat4, txiat8, txiat16 }

UDRE ::=                           ENUMERATED {
    lessThan1,
    between1-and-4,
    between4-and-8,
    over8 }

UDREGrowthRate ::=                ENUMERATED {
    growth-1-5,
    growth-2,
    growth-4,
    growth-6,
    growth-8,
    growth-10,
    growth-12,
    growth-16 }

UDREValidityTime ::=              ENUMERATED {
    val-20sec,
    val-40sec,
    val-80sec,
    val-160sec,
    val-320sec,
    val-640sec,
    val-1280sec,
    val-2560sec }

UE-6AB-Event ::=                  SEQUENCE {
    timeToTrigger                   TimeToTrigger,
    transmittedPowerThreshold       TransmittedPowerThreshold
}

UE-6FG-Event ::=                  SEQUENCE {
    timeToTrigger                   TimeToTrigger,
    -- in 1.28 Mcps TDD ue-RX-TX-TimeDifferenceThreshold corresponds to TADV Threshold
}

```

```

    ue-RX-TX-TimeDifferenceThreshold    UE-RX-TX-TimeDifferenceThreshold
}

-- dummy and dummy2 are not used in this version of the specification, they should
-- not be sent and if received the UE behaviour is not specified.
UE-AutonomousUpdateMode ::=          CHOICE {
    dummy                               NULL,
    onWithNoReporting                   NULL,
    dummy2                               RL-InformationLists
}

UE-InternalEventParam ::=             CHOICE {
    event6a                             UE-6AB-Event,
    event6b                             UE-6AB-Event,
    event6c                             TimeToTrigger,
    event6d                             TimeToTrigger,
    event6e                             TimeToTrigger,
    event6f                             UE-6FG-Event,
    event6g                             UE-6FG-Event
}

UE-InternalEventParamList ::=         SEQUENCE (SIZE (1..maxMeasEvent)) OF
    UE-InternalEventParam

UE-InternalEventResults ::=           CHOICE {
    event6a                             NULL,
    event6b                             NULL,
    event6c                             NULL,
    event6d                             NULL,
    event6e                             NULL,
    event6f                             PrimaryCPICH-Info,
    event6g                             PrimaryCPICH-Info,
    spare                               NULL
}

UE-InternalMeasQuantity ::=           SEQUENCE {
    measurementQuantity                 UE-MeasurementQuantity,
    filterCoefficient                   FilterCoefficient                DEFAULT fc0
}

UE-InternalMeasuredResults ::=         SEQUENCE {
    modeSpecificInfo                   CHOICE {
        fdd                             SEQUENCE {
            ue-TransmittedPowerFDD      UE-TransmittedPower            OPTIONAL,
            ue-RX-TX-ReportEntryList    UE-RX-TX-ReportEntryList       OPTIONAL
        },
        tdd                             SEQUENCE {
            ue-TransmittedPowerTDD-List  UE-TransmittedPowerTDD-List   OPTIONAL,
            appliedTA                     UL-TimingAdvance                OPTIONAL
        }
    }
}

UE-InternalMeasuredResults-LCR-r4 ::= SEQUENCE {
    ue-TransmittedPowerTDD-List        UE-TransmittedPowerTDD-List   OPTIONAL,
    -- If TA value is not greater than 2047, then use this IE to report.
    t-ADVinfo                           T-ADVinfo                       OPTIONAL
}

UE-InternalMeasuredResults-v770ext ::= SEQUENCE {
    modeSpecificInfo                   CHOICE {
        tdd384-768                       SEQUENCE {
            appliedTA                     EXT-UL-TimingAdvance           OPTIONAL
        },
        tdd128                             SEQUENCE {
            -- If TA value is greater than 2047, then use this IE to report
            t-ADVinfo                     T-ADVinfo-ext                   OPTIONAL
        }
    }
}

UE-InternalMeasurement ::=            SEQUENCE {
    ue-InternalMeasQuantity             UE-InternalMeasQuantity        OPTIONAL,
    ue-InternalReportingQuantity        UE-InternalReportingQuantity   OPTIONAL,
    reportCriteria                       UE-InternalReportCriteria
}

UE-InternalMeasurement-r4 ::=         SEQUENCE {

```

```

    ue-InternalMeasQuantity          UE-InternalMeasQuantity          OPTIONAL,
    ue-InternalReportingQuantity     UE-InternalReportingQuantity-r4   OPTIONAL,
    reportCriteria                   UE-InternalReportCriteria
}

UE-InternalMeasurementSysInfo ::= SEQUENCE {
    ue-InternalMeasurementID         MeasurementIdentity          DEFAULT 5,
    ue-InternalMeasQuantity         UE-InternalMeasQuantity
}

UE-InternalReportCriteria ::= CHOICE {
    ue-InternalReportingCriteria     UE-InternalReportingCriteria,
    periodicalReportingCriteria     PeriodicalReportingCriteria,
    noReporting                       NULL
}

UE-InternalReportingCriteria ::= SEQUENCE {
    ue-InternalEventParamList       UE-InternalEventParamList    OPTIONAL
}

UE-InternalReportingQuantity ::= SEQUENCE {
    ue-TransmittedPower              BOOLEAN,
    modeSpecificInfo                 CHOICE {
        fdd                          SEQUENCE {
            ue-RX-TX-TimeDifference   BOOLEAN
        },
        tdd                          SEQUENCE {
            appliedTA                 BOOLEAN
        }
    }
}

UE-InternalReportingQuantity-r4 ::= SEQUENCE {
    ue-TransmittedPower              BOOLEAN,
    modeSpecificInfo                 CHOICE {
        fdd                          SEQUENCE {
            ue-RX-TX-TimeDifference   BOOLEAN
        },
        tdd                          SEQUENCE {
            tddOption                 CHOICE {
                -- appliedTA applies to both 3.84 Mcps TDD and to 7.68 Mcps TDD.
                -- Therefore, no additional choice of TDD mode is necessary
                tdd384                 SEQUENCE {
                    appliedTA          BOOLEAN
                },
                tdd128                 SEQUENCE {
                    t-ADVinfo          BOOLEAN
                }
            }
        }
    }
}

-- TABULAR: UE-MeasurementQuantity, for 3.84 Mcps TDD only the first two values
-- ue-TransmittedPower and ultra-Carrier-RSSI are used.
-- For 1.28 Mcps TDD ue-RX-TX-TimeDifference corresponds to T-ADV in the tabular
UE-MeasurementQuantity ::= ENUMERATED {
    ue-TransmittedPower,
    ultra-Carrier-RSSI,
    ue-RX-TX-TimeDifference }

UE-PowerHeadroomThreshold ::= INTEGER (-50..33)

UE-RX-TX-ReportEntry ::= SEQUENCE {
    primaryCPICH-Info             PrimaryCPICH-Info,
    ue-RX-TX-TimeDifferenceType1  UE-RX-TX-TimeDifferenceType1
}

UE-RX-TX-ReportEntryList ::= SEQUENCE (SIZE (1..maxRL)) OF
    UE-RX-TX-ReportEntry

-- SPARE: UE-RX-TX-TimeDifferenceType1, Max = 1280
-- Values above Max are spare
UE-RX-TX-TimeDifferenceType1 ::= INTEGER (768..1791)

UE-RX-TX-TimeDifferenceType2 ::= INTEGER (0..8191)

```

```

UE-RX-TX-TimeDifferenceType2Info ::= SEQUENCE {
    ue-RX-TX-TimeDifferenceType2
    neighbourQuality
}

-- In 1.28 Mcps TDD, actual value for
-- T-ADV Threshold = (UE-RX-TX-TimeDifferenceThreshold - 768) * 0.125
UE-RX-TX-TimeDifferenceThreshold ::= INTEGER (768..1280)

UE-TransmittedPower ::= INTEGER (0..104)

UE-TransmittedPowerTDD-List ::= SEQUENCE (SIZE (1..maxTS)) OF
    UE-TransmittedPower

UL-TrCH-Identity ::= CHOICE{
    dch
    -- Note: the reference to CPCH in the element name below is incorrect. The name is not changed
    -- to keep it aligned with R99.
    rachorcpch
    usch
}

UE-Positioning-Accuracy ::= BIT STRING (SIZE (7))

UE-Positioning-DBDSCorrections ::= SEQUENCE {
    bds-RefTime INTEGER (0..119),
    bds-DBDS-InfoList DBDS-InfoList
}

UE-Positioning-CipherParameters ::= SEQUENCE {
    cipheringKeyFlag BIT STRING (SIZE (1)),
    cipheringSerialNumber INTEGER (0..65535)
}

UE-Positioning-DGANSSCorrections ::= SEQUENCE {
    dganssreferencetime INTEGER (0..119), -- scale factor 30s
    dganssInfoList DGANSSInfoList
}

UE-Positioning-DGANSSCorrections-r9 ::= SEQUENCE {
    dganssreferencetime INTEGER (0..119), -- scale factor 30s
    dganssInfoList DGANSSInfoList-r9
}

UE-Positioning-DGANSSCorrections-v920ext ::= SEQUENCE {
    dganssInfoList DGANSSInfoList-v920ext
}

UE-Positioning-Error ::= SEQUENCE {
    errorReason UE-Positioning-ErrorCause,
    ue-positioning-GPS-additionalAssistanceDataRequest
    UE-Positioning-GPS-AdditionalAssistanceDataRequest OPTIONAL
}

UE-Positioning-Error-r7 ::= SEQUENCE {
    errorReason UE-Positioning-ErrorCause-r7,
    ue-positioning-GPS-additionalAssistanceDataRequest
    UE-Positioning-GPS-AdditionalAssistanceDataRequest OPTIONAL,
    ue-positioning-GANSS-additionalAssistanceDataRequest
    UE-Positioning-GANSS-AdditionalAssistanceDataRequest OPTIONAL
}

UE-Positioning-Error-v860ext ::= SEQUENCE {
    ue-positioning-GANSS-additionalAssistanceDataRequest
    UE-Positioning-GANSS-AdditionalAssistanceDataRequest-v860ext OPTIONAL
}

UE-Positioning-Error-vc50ext ::= SEQUENCE {
    ue-positioning-GANSS-additionalAssistanceDataRequest
    UE-Positioning-GANSS-AdditionalAssistanceDataRequest-vc50ext OPTIONAL
}

UE-Positioning-ErrorCause ::= ENUMERATED {
    notEnoughOTDOA-Cells,
    notEnoughGPS-Satellites,
    assistanceDataMissing,
    notAccomplishedGPS-TimingOfCellFrames,
    undefinedError,
}

```

```

        requestDeniedByUser,
        notProcessedAndTimeout,
        referenceCellNotServingCell }

UE-Positioning-ErrorCause-r7 ::= ENUMERATED {
    notEnoughOTDOA-Cells,
    notEnoughGPS-Satellites,
    assistanceDataMissing,
    notAccomplishedGPS-TimingOfCellFrames,
    undefinedError,
    requestDeniedByUser,
    notProcessedAndTimeout,
    referenceCellNotServingCell,
    notEnoughGANSS-Satellites,
    notAccomplishedGANSS-TimingOfCellFrames,
    spare6, spare5, spare4, spare3, spare2, spare1 }

UE-Positioning-EventParam ::= SEQUENCE {
    reportingAmount          ReportingAmount,
    reportFirstFix           BOOLEAN,
    measurementInterval      UE-Positioning-MeasurementInterval,
    eventSpecificInfo        UE-Positioning-EventSpecificInfo
}

UE-Positioning-EventParam-r7 ::= SEQUENCE {
    reportingAmount          ReportingAmount,
    reportFirstFix           BOOLEAN,
    measurementInterval      UE-Positioning-MeasurementInterval,
    eventSpecificInfo        UE-Positioning-EventSpecificInfo-r7
}

UE-Positioning-EventParamList ::= SEQUENCE (SIZE (1..maxMeasEvent)) OF
    UE-Positioning-EventParam

UE-Positioning-EventParamList-r7 ::= SEQUENCE (SIZE (1..maxMeasEvent)) OF
    UE-Positioning-EventParam-r7

UE-Positioning-EventSpecificInfo ::= CHOICE {
    e7a                      ThresholdPositionChange,
    e7b                      ThresholdSFN-SFN-Change,
    e7c                      ThresholdSFN-GPS-TOW
}

UE-Positioning-EventSpecificInfo-r7 ::= CHOICE {
    e7a                      ThresholdPositionChange,
    e7b                      ThresholdSFN-SFN-Change,
    e7c                      ThresholdSFN-GPS-TOW-us,
    e7d                      ThresholdSFN-GANSS-TOW
}

-- This IE, if included, shall contain exactly one of the optional elements
UE-Positioning-GANSS-AddUTCModels ::= SEQUENCE {
    utcModel1                UTCmodelSet1          OPTIONAL,
    utcModel2                UTCmodelSet2          OPTIONAL,
    utcModel3                UTCmodelSet3          OPTIONAL
}

-- This IE, if included, shall contain exactly one of the optional elements
UE-Positioning-GANSS-AddUTCModels-r12 ::= SEQUENCE {
    utcModel1                UTCmodelSet1          OPTIONAL,
    utcModel2                UTCmodelSet2          OPTIONAL,
    utcModel3                UTCmodelSet3          OPTIONAL,
    utcModel4                UTCmodelSet4          OPTIONAL
}

UE-Positioning-GANSS-AddUTCModels-vc50ext ::= SEQUENCE {
    utcModel4                UTCmodelSet4          OPTIONAL
}

UE-Positioning-GANSS-Almanac ::= SEQUENCE {
    ganss-wk-number          INTEGER (0..255),
    alm-keplerianParameters  ALM-keplerianParameters OPTIONAL
}

-- This IE, if included, shall contain exactly one of the optional elements
UE-Positioning-GANSS-Almanac-v860ext ::= SEQUENCE {
    alm-keplerianNAValmanac  ALM-NAVKeplerianSet    OPTIONAL,
    alm-keplerianReducedAlmanac  ALM-ReducedKeplerianSet  OPTIONAL,

```



```

    alm-keplerianMidiAlmanac      ALM-MidiAlmanacSet      OPTIONAL,
    alm-keplerianGLONASS         ALM-GlonassAlmanacSet   OPTIONAL,
    alm-ecefSBASAlmanac          ALM-ECEFsbasAlmanacSet  OPTIONAL
  }

UE-Positioning-GANSS-Almanac-r8 ::= SEQUENCE{
  ganss-wk-number                INTEGER (0..255),
  alm-keplerianParameters        ALM-keplerianParameters  OPTIONAL,
  alm-keplerianNAVALmanac        ALM-NAVKeplerianSet      OPTIONAL,
  alm-keplerianReducedAlmanac    ALM-ReducedKeplerianSet  OPTIONAL,
  alm-keplerianMidiAlmanac       ALM-MidiAlmanacSet       OPTIONAL,
  alm-keplerianGLONASS           ALM-GlonassAlmanacSet   OPTIONAL,
  alm-ecefSBASAlmanac            ALM-ECEFsbasAlmanacSet  OPTIONAL
}

UE-Positioning-GANSS-Almanac-va40ext ::= SEQUENCE {
  complete-Almanac-Provided      BOOLEAN                    OPTIONAL
}

UE-Positioning-GANSS-Almanac-r10 ::= SEQUENCE{
  ganss-wk-number                INTEGER (0..255),
  complete-Almanac-Provided      BOOLEAN                    OPTIONAL,
  alm-keplerianParameters        ALM-keplerianParameters  OPTIONAL,
  alm-keplerianNAVALmanac        ALM-NAVKeplerianSet      OPTIONAL,
  alm-keplerianReducedAlmanac    ALM-ReducedKeplerianSet  OPTIONAL,
  alm-keplerianMidiAlmanac       ALM-MidiAlmanacSet       OPTIONAL,
  alm-keplerianGLONASS           ALM-GlonassAlmanacSet   OPTIONAL,
  alm-ecefSBASAlmanac            ALM-ECEFsbasAlmanacSet  OPTIONAL
}

UE-Positioning-GANSS-Almanac-r12 ::= SEQUENCE{
  ganss-wk-number                INTEGER (0..255),
  complete-Almanac-Provided      BOOLEAN                    OPTIONAL,
  alm-keplerianParameters        ALM-keplerianParameters  OPTIONAL,
  alm-keplerianNAVALmanac        ALM-NAVKeplerianSet      OPTIONAL,
  alm-keplerianReducedAlmanac    ALM-ReducedKeplerianSet  OPTIONAL,
  alm-keplerianMidiAlmanac       ALM-MidiAlmanacSet       OPTIONAL,
  alm-keplerianGLONASS           ALM-GlonassAlmanacSet   OPTIONAL,
  alm-ecefSBASAlmanac            ALM-ECEFsbasAlmanacSet  OPTIONAL,
  alm-keplerianBDSAlmanac        ALM-BDSKeplerianSet      OPTIONAL
}

UE-Positioning-GANSS-Almanac-vc50ext ::= SEQUENCE {
  alm-keplerianBDSAlmanac        ALM-BDSKeplerianSet      OPTIONAL
}

UE-Positioning-GANSS-AdditionalAssistanceDataRequest ::= SEQUENCE {
  ganssReferenceTime             BOOLEAN,
  ganssreferenceLocation         BOOLEAN,
  ganssIonosphericModel          BOOLEAN,
  ganssRequestedGenericAssistanceDataList GanssRequestedGenericAssistanceDataList
}

UE-Positioning-GANSS-AdditionalAssistanceDataRequest-v860ext ::= SEQUENCE {
  ganssAddIonoModelReq           BIT STRING (SIZE (2))      OPTIONAL,
  ganssEOPreq                    ENUMERATED { true }        OPTIONAL,
  ganssRequestedGenericAssistanceDataList GanssRequestedGenericAssistanceDataList-v860ext
}

UE-Positioning-GANSS-AdditionalAssistanceDataRequest-vc50ext ::= SEQUENCE {
  ganssRequestedGenericAssistanceDataList GanssRequestedGenericAssistanceDataList-vc50ext
}

UE-Positioning-GANSS-AddIonoModel ::= SEQUENCE {
  dataID                         BIT STRING (SIZE (2)),
  alpha-beta-parameters          UE-Positioning-GPS-IonosphericModel
}

UE-Positioning-GANSS-AddNavigationModels ::= SEQUENCE {
  non-broadcastIndication        ENUMERATED { true }        OPTIONAL,
  ganssSatInfoNavList            Ganss-Sat-Info-AddNavList
}

UE-Positioning-GANSS-AddNavigationModels-r12 ::= SEQUENCE {
  non-broadcastIndication        ENUMERATED { true }        OPTIONAL,
  ganssSatInfoNavList            Ganss-Sat-Info-AddNavList-r12
}

```

```

}
UE-Positioning-GANSS-AddNavigationModels-vc50ext ::= SEQUENCE {
    ganssSatInfoNavList          Ganss-Sat-Info-AddNavList-vc50ext
}
UE-Positioning-GANSS-AssistanceData ::= SEQUENCE {
    ue-positioning-GANSS-ReferenceTime    UE-Positioning-GANSS-ReferenceTime    OPTIONAL,
    uePositioningGanssReferencePosition    ReferenceLocationGANSS                    OPTIONAL,
    uePositioningGanssIonosphericModel     UE-Positioning-GANSS-IonosphericModel   OPTIONAL,
    ganssGenericDataList                  GANSSGenericDataList                    OPTIONAL
}
UE-Positioning-GANSS-AssistanceData-v860ext ::= SEQUENCE {
    uePositioningGanssAddIonoModel         UE-Positioning-GANSS-AddIonoModel        OPTIONAL,
    uePositioningGanssEarthOrientationPara UE-Positioning-GANSS-EarthOrientPara     OPTIONAL,
    ganssGenericDataList                  GANSSGenericDataList-v860ext            OPTIONAL
}
UE-Positioning-GANSS-AssistanceData-r8 ::= SEQUENCE {
    ue-positioning-GANSS-ReferenceTime    UE-Positioning-GANSS-ReferenceTime    OPTIONAL,
    uePositioningGanssReferencePosition    ReferenceLocationGANSS                    OPTIONAL,
    uePositioningGanssIonosphericModel     UE-Positioning-GANSS-IonosphericModel   OPTIONAL,
    uePositioningGanssAddIonoModel         UE-Positioning-GANSS-AddIonoModel        OPTIONAL,
    uePositioningGanssEarthOrientationPara UE-Positioning-GANSS-EarthOrientPara     OPTIONAL,
    ganssGenericDataList                  GANSSGenericDataList-r8                OPTIONAL
}
UE-Positioning-GANSS-AssistanceData-r9 ::= SEQUENCE {
    ue-positioning-GANSS-ReferenceTime    UE-Positioning-GANSS-ReferenceTime    OPTIONAL,
    uePositioningGanssReferencePosition    ReferenceLocationGANSS                    OPTIONAL,
    uePositioningGanssIonosphericModel     UE-Positioning-GANSS-IonosphericModel   OPTIONAL,
    uePositioningGanssAddIonoModel         UE-Positioning-GANSS-AddIonoModel        OPTIONAL,
    uePositioningGanssEarthOrientationPara UE-Positioning-GANSS-EarthOrientPara     OPTIONAL,
    ganssGenericDataList                  GANSSGenericDataList-r9                OPTIONAL
}
UE-Positioning-GANSS-AssistanceData-v920ext ::= SEQUENCE {
    ganssGenericDataList                  GANSSGenericDataList-v920ext            OPTIONAL
}
UE-Positioning-GANSS-AssistanceData-va40ext ::= SEQUENCE {
    ue-positioning-GANSS-ReferenceTime    UE-Positioning-GANSS-ReferenceTime-va40ext  OPTIONAL,
    ganssGenericDataList                  GANSSGenericDataList-va40ext            OPTIONAL
}
UE-Positioning-GANSS-AssistanceData-vc50ext ::= SEQUENCE {
    ganssGenericDataList                  GANSSGenericDataList-vc50ext            OPTIONAL
}
UE-Positioning-GANSS-AssistanceData-r10 ::= SEQUENCE {
    ue-positioning-GANSS-ReferenceTime    UE-Positioning-GANSS-ReferenceTime-r10    OPTIONAL,
    uePositioningGanssReferencePosition    ReferenceLocationGANSS                    OPTIONAL,
    uePositioningGanssIonosphericModel     UE-Positioning-GANSS-IonosphericModel   OPTIONAL,
    uePositioningGanssAddIonoModel         UE-Positioning-GANSS-AddIonoModel        OPTIONAL,
    uePositioningGanssEarthOrientationPara UE-Positioning-GANSS-EarthOrientPara     OPTIONAL,
    ganssGenericDataList                  GANSSGenericDataList-r10                OPTIONAL
}
UE-Positioning-GANSS-AssistanceData-r12 ::= SEQUENCE {
    ue-positioning-GANSS-ReferenceTime    UE-Positioning-GANSS-ReferenceTime-r10    OPTIONAL,
    uePositioningGanssReferencePosition    ReferenceLocationGANSS                    OPTIONAL,
    uePositioningGanssIonosphericModel     UE-Positioning-GANSS-IonosphericModel   OPTIONAL,
    uePositioningGanssAddIonoModel         UE-Positioning-GANSS-AddIonoModel        OPTIONAL,
    uePositioningGanssEarthOrientationPara UE-Positioning-GANSS-EarthOrientPara     OPTIONAL,
    ganssGenericDataList                  GANSSGenericDataList-r12                OPTIONAL
}
UE-Positioning-GANSS-AuxiliaryInfo ::= CHOICE {
    -- This choice may only be present if GANSS ID indicates Modernized GPS
    ganssID1    AuxInfoGANSS-ID1,
    -- This choice may only be present if GANSS ID indicates GLONASS
    ganssID3    AuxInfoGANSS-ID3
}

```

```

UE-Positioning-GANSS-ClockModel ::= SEQUENCE {
    satellite-clock-modelList      Satellite-clock-modelList
}

-- This IE, if included, shall contain exactly one of the optional elements
UE-Positioning-GANSS-AddClockModels ::= SEQUENCE {
    navClockModel                  NAVclockModel                OPTIONAL,
    cnavClockModel                 CNAVclockModel           OPTIONAL,
    glonassClockModel              GLONASSclockModel        OPTIONAL,
    sbasClockModel                 SBASclockModel           OPTIONAL
}

-- This IE, if included, shall contain exactly one of the optional elements
UE-Positioning-GANSS-AddClockModels-r12 ::= SEQUENCE {
    navClockModel                  NAVclockModel                OPTIONAL,
    cnavClockModel                 CNAVclockModel           OPTIONAL,
    glonassClockModel              GLONASSclockModel        OPTIONAL,
    sbasClockModel                 SBASclockModel           OPTIONAL,
    bdsClockModel                  BDSclockModel              OPTIONAL
}

UE-Positioning-GANSS-AddClockModels-vc50ext ::= SEQUENCE {
    bdsClockModel                  BDSclockModel              OPTIONAL
}

-- This IE, if included, shall contain exactly one of the optional elements
UE-Positioning-GANSS-AddOrbitModels ::= SEQUENCE {
    navKeplerianSet                NavModel-NAVKeplerianSet    OPTIONAL,
    cnavKeplerianSet               NavModel-CNAVKeplerianSet   OPTIONAL,
    glonassECEF                    NavModel-GLONASSecef        OPTIONAL,
    sbasECEF                       NavModel-SBASecef           OPTIONAL
}

UE-Positioning-GANSS-AddOrbitModels-r12 ::= SEQUENCE {
    navKeplerianSet                NavModel-NAVKeplerianSet    OPTIONAL,
    cnavKeplerianSet               NavModel-CNAVKeplerianSet   OPTIONAL,
    glonassECEF                    NavModel-GLONASSecef        OPTIONAL,
    sbasECEF                       NavModel-SBASecef           OPTIONAL,
    bdsKeplerianSet                NavModel-BDSKeplerianSet    OPTIONAL
}

UE-Positioning-GANSS-AddOrbitModels-vc50ext ::= SEQUENCE {
    bdsKeplerianSet                NavModel-BDSKeplerianSet    OPTIONAL
}

UE-Positioning-GANSS-Data ::= SEQUENCE {
    ganssDataCipherringInfo         UE-Positioning-CipherParameters    OPTIONAL,
    ganssDecipherringKeys           GANSSDecipherringKeys              OPTIONAL,
    uePositioningGanssReferenceTime UE-Positioning-GANSS-ReferenceTime  OPTIONAL,
    uePositioningGanssReferencePosition ReferenceLocationGANSS              OPTIONAL,
    uePositioningGanssIonosphericModel UE-Positioning-GANSS-IonosphericModel  OPTIONAL,
    ganssGenericDataList            GANSSGenericDataList              OPTIONAL
}

UE-Positioning-GANSS-Data-Bit-Assistance ::= SEQUENCE {
    ganss-tod                       INTEGER (0..59),
    dataBitAssistanceList           DataBitAssistanceList
}

UE-Positioning-GANSS-EarthOrientPara ::= SEQUENCE {
    teop                             BIT STRING (SIZE (16)),
    pmX                              BIT STRING (SIZE (21)),
    pmXdot                           BIT STRING (SIZE (15)),
    pmY                              BIT STRING (SIZE (21)),
    pmYdot                           BIT STRING (SIZE (15)),
    deltaUT1                         BIT STRING (SIZE (31)),
    deltaUT1dot                      BIT STRING (SIZE (19))
}

UE-Positioning-GANSS-IonosphericModel ::= SEQUENCE {
    alpha-zero-ionos                BIT STRING (SIZE (11)),
    alpha-one-ionos                 BIT STRING (SIZE (11)),
    alpha-two-ionos                 BIT STRING (SIZE (14)),
    gANSS-storm-flags               GANSS-Storm-Flag                  OPTIONAL
}

UE-Positioning-BDS-IonoGridModel ::= SEQUENCE {
-- Actual value bds-RefTime = ((30..3600) / 30) - 1.

```

```

    bds-RefTime                INTEGER (0..119),
    bds-IGPInfoList            BDS-IGPInfoList
}

UE-Positioning-GANSS-MeasuredResults ::= SEQUENCE {
    referenceTime              CHOICE {
        utran-GANSSReferenceTimeResult    UTRAN-GANSSReferenceTime,
        ganssReferenceTimeOnly            GANSSReferenceTimeOnly
    },
    ganssGenericMeasurementInfo    GANSSGenericMeasurementInfo
}

UE-Positioning-GANSS-MeasuredResults-v860ext ::= SEQUENCE {
    ganssGenericMeasurementInfo    GANSSGenericMeasurementInfo-v860ext
}

UE-Positioning-GANSS-NavigationModel ::= SEQUENCE {
    non-broadcastIndication        ENUMERATED { true }                OPTIONAL,
    ganssSatInfoNavList            Ganss-Sat-Info-NavList
}

UE-Positioning-GANSS-OrbitModel ::= SEQUENCE {
    keplerianParameters            KeplerianParameters                OPTIONAL
}

UE-Positioning-GANSS-RealTimeIntegrity ::= SEQUENCE (SIZE (1..maxGANSSSat)) OF SEQUENCE {
    bad-ganss-satId                INTEGER (0..63),
    bad-ganss-signalId              BIT STRING (SIZE (8))                OPTIONAL
}

UE-Positioning-GANSS-ReferenceMeasurementInfo ::= SEQUENCE {
    ganssSignalId                  GANSS-Signal-Id                OPTIONAL,
    satelliteInformationList        GANSSSatelliteInformationList
}

UE-Positioning-GANSS-ReferenceMeasurementInfo-va40ext ::= SEQUENCE {
    satelliteInformationList        GANSSSatelliteInformationList-va40ext
}

UE-Positioning-GANSS-ReferenceMeasurementInfo-r10 ::= SEQUENCE {
    ganssSignalId                  GANSS-Signal-Id                OPTIONAL,
    satelliteInformationList        GANSSSatelliteInformationList-r10
}

UE-Positioning-GANSS-ReferenceMeasurementInfo-vc50ext ::= SEQUENCE {
    confidence                      INTEGER (0..100)                OPTIONAL,
    satelliteInformationList        GANSSSatelliteInformationList-vc50ext
}

UE-Positioning-GANSS-ReferenceMeasurementInfo-r12 ::= SEQUENCE {
    ganssSignalId                  GANSS-Signal-Id                OPTIONAL,
    confidence                      INTEGER (0..100)                OPTIONAL,
    satelliteInformationList        GANSSSatelliteInformationList-r12
}

UE-Positioning-GANSS-ReferenceTime ::= SEQUENCE {
    ganssDay                        INTEGER (0..8191)                OPTIONAL,
    ganssTod                        INTEGER (0..86399),
    ganssTodUncertainty              INTEGER (0..127)                OPTIONAL,
    ganssTimeId                    INTEGER (0..7)                OPTIONAL,
    utran-ganssreferenceTime        SEQUENCE {
        timingOfCellFrames          INTEGER (0..3999999),
        mode                        CHOICE {
            fdd                      SEQUENCE {
                primary-CPICH-Info    PrimaryCPICH-Info
            },
            tdd                      SEQUENCE {
                cellParameters        CellParametersID
            }
        },
        referenceSfn                INTEGER (0..4095)
    } OPTIONAL,
    tutran-ganss-driftRate          Tutran-Ganss-DriftRate                OPTIONAL
}

UE-Positioning-GANSS-ReferenceTime-va40ext ::= SEQUENCE {
    ganss-Day-Cycle-Number          INTEGER (0..7)                OPTIONAL
}

```

```

UE-Positioning-GANSS-ReferenceTime-r10 ::= SEQUENCE {
    ganssDay                INTEGER (0..8191)                OPTIONAL,
    ganss-Day-Cycle-Number  INTEGER (0..7)                OPTIONAL,
    ganssTod                INTEGER (0..86399),
    ganssTodUncertainty     INTEGER (0..127)                OPTIONAL,
    ganssTimeId             INTEGER (0..7)                OPTIONAL,
    utran-ganssreferenceTime SEQUENCE {
        timingOfCellFrames  INTEGER (0..3999999),
        mode                 CHOICE {
            fdd              SEQUENCE {
                primary-CPICH-Info  PrimaryCPICH-Info
            },
            tdd              SEQUENCE {
                cellParameters      CellParametersID
            }
        },
        referenceSfn        INTEGER (0..4095)
    }
    OPTIONAL,
    tutran-ganss-driftRate  Tutran-Ganss-DriftRate        OPTIONAL
}

UE-Positioning-GANSS-SBAS-ID ::= ENUMERATED {
    waas,
    egnos,
    msas,
    gagan,
    spare4,
    spare3,
    spare2,
    spare1 }

UE-Positioning-GANSS-TimeModel ::= SEQUENCE {
    ganss-timeModelreferenceTime  INTEGER (0..37799),                -- scale factor 16s
    ganss-t-a0                    INTEGER (-2147483648..2147483647),        -- scale factor 2-35
    -- 'ganss-t-a1' scale factor 2-51
    ganss-t-a1                    INTEGER (-8388608..8388607)                OPTIONAL,
    -- 'ganss-t-a2' scale factor 2-68
    ganss-t-a2                    INTEGER (-64..63)                OPTIONAL,
    gnss-to-id                    ENUMERATED { gps, galileo, qzss,
        glonass, spare4, spare3, spare2, spare1 },
    ganss-wk-number               INTEGER (0..8191)                OPTIONAL
}

UE-Positioning-GANSS-TimeModel-va40ext ::= SEQUENCE {
    deltaT                        INTEGER (-128..127)                OPTIONAL
}

UE-Positioning-GANSS-TimeModel-r10 ::= SEQUENCE {
    ganss-timeModelreferenceTime  INTEGER (0..37799),                -- scale factor 16s
    ganss-t-a0                    INTEGER (-2147483648..2147483647),        -- scale factor 2-35
    -- 'ganss-t-a1' scale factor 2-51
    ganss-t-a1                    INTEGER (-8388608..8388607)                OPTIONAL,
    -- 'ganss-t-a2' scale factor 2-68
    ganss-t-a2                    INTEGER (-64..63)                OPTIONAL,
    gnss-to-id                    ENUMERATED { gps, galileo, qzss,
        glonass, bds, spare3, spare2, spare1 },
    ganss-wk-number               INTEGER (0..8191)                OPTIONAL,
    deltaT                        INTEGER (-128..127)                OPTIONAL
}

UE-Positioning-GANSS-TimeModels ::= SEQUENCE (SIZE (1..maxGANSS-1)) OF
    UE-Positioning-GANSS-TimeModel

UE-Positioning-GANSS-TimeModels-va40ext ::= SEQUENCE (SIZE (1..maxGANSS-1)) OF
    UE-Positioning-GANSS-TimeModel-va40ext

UE-Positioning-GANSS-UTCModel ::= SEQUENCE {
    a-one-utc                    BIT STRING (SIZE (24)),
    a-zero-utc                   BIT STRING (SIZE (32)),
    t-ot-utc                     BIT STRING (SIZE (8)),
    delta-t-ls-utc              BIT STRING (SIZE (8)),
    w-n-t-utc                   BIT STRING (SIZE (8)),
    w-n-lsf-utc                 BIT STRING (SIZE (8)),
}

```

```

    dn-utc                BIT STRING (SIZE (8)),
    delta-t-lsf-utc       BIT STRING (SIZE (8))
}

UE-Positioning-GPS-AcquisitionAssistance ::= SEQUENCE {
    gps-ReferenceTime      GPS-TOW-1msec,
    utran-GPSReferenceTime UTRAN-GPSReferenceTime          OPTIONAL,
    satelliteInformationList AcquisitionSatInfoList
}

UE-Positioning-GPS-AcquisitionAssistance-v770ext ::= SEQUENCE {
    ue-Positioning-GPS-ReferenceTimeUncertainty
                                                UE-Positioning-GPS-ReferenceTimeUncertainty  OPTIONAL
}

UE-Positioning-GPS-AcquisitionAssistance-r7 ::= SEQUENCE {
    gps-ReferenceTime      GPS-TOW-1msec,
    utran-GPSReferenceTime UTRAN-GPSReferenceTime          OPTIONAL,
    ue-Positioning-GPS-ReferenceTimeUncertainty
                                                UE-Positioning-GPS-ReferenceTimeUncertainty  OPTIONAL,
    satelliteInformationList AcquisitionSatInfoList
}

UE-Positioning-GPS-AcquisitionAssistance-va40ext ::= SEQUENCE {
    satelliteInformationList AcquisitionSatInfoList-va40ext
}

UE-Positioning-GPS-AcquisitionAssistance-r10 ::= SEQUENCE {
    gps-ReferenceTime      GPS-TOW-1msec,
    utran-GPSReferenceTime UTRAN-GPSReferenceTime          OPTIONAL,
    ue-Positioning-GPS-ReferenceTimeUncertainty
                                                UE-Positioning-GPS-ReferenceTimeUncertainty  OPTIONAL,
    satelliteInformationList AcquisitionSatInfoList-r10
}

UE-Positioning-GPS-AcquisitionAssistance-vc50ext ::= SEQUENCE {
    confidence              INTEGER (0..100)                OPTIONAL,
    satelliteInformationList AcquisitionSatInfoList-vc50ext
}

UE-Positioning-GPS-AcquisitionAssistance-r12 ::= SEQUENCE {
    gps-ReferenceTime      GPS-TOW-1msec,
    utran-GPSReferenceTime UTRAN-GPSReferenceTime          OPTIONAL,
    ue-Positioning-GPS-ReferenceTimeUncertainty
                                                UE-Positioning-GPS-ReferenceTimeUncertainty  OPTIONAL,
    confidence              INTEGER (0..100)                OPTIONAL,
    satelliteInformationList AcquisitionSatInfoList-r12
}

UE-Positioning-GPS-AdditionalAssistanceDataRequest ::= SEQUENCE {
    almanacRequest          BOOLEAN,
    utcModelRequest         BOOLEAN,
    ionosphericModelRequest BOOLEAN,
    navigationModelRequest BOOLEAN,
    dgpsCorrectionsRequest BOOLEAN,
    referenceLocationRequest BOOLEAN,
    referenceTimeRequest    BOOLEAN,
    aquisitionAssistanceRequest BOOLEAN,
    realTimeIntegrityRequest BOOLEAN,
    navModelAddDataRequest UE-Positioning-GPS-NavModelAddDataReq  OPTIONAL
}

UE-Positioning-GPS-Almanac ::= SEQUENCE {
    wn-a                    BIT STRING (SIZE (8)),
    almanacSatInfoList      AlmanacSatInfoList,
    sv-GlobalHealth         BIT STRING (SIZE (364))          OPTIONAL
}

UE-Positioning-GPS-Almanac-va40ext ::= SEQUENCE {
    complete-Almanac-Provided BOOLEAN          OPTIONAL
}

UE-Positioning-GPS-Almanac-r10 ::= SEQUENCE {
    wn-a                    BIT STRING (SIZE (8)),
    complete-Almanac-Provided BOOLEAN          OPTIONAL,
    almanacSatInfoList      AlmanacSatInfoList,

```

```

    sv-GlobalHealth          BIT STRING (SIZE (364))          OPTIONAL
  }

UE-Positioning-GPS-AssistanceData ::= SEQUENCE {
    ue-positioning-GPS-ReferenceTime      UE-Positioning-GPS-ReferenceTime      OPTIONAL,
    ue-positioning-GPS-ReferenceLocation  ReferenceLocation                      OPTIONAL,
    ue-positioning-GPS-DGPS-Corrections  UE-Positioning-GPS-DGPS-Corrections  OPTIONAL,
    ue-positioning-GPS-NavigationModel    UE-Positioning-GPS-NavigationModel    OPTIONAL,
    ue-positioning-GPS-IonosphericModel   UE-Positioning-GPS-IonosphericModel   OPTIONAL,
    ue-positioning-GPS-UTC-Model          UE-Positioning-GPS-UTC-Model          OPTIONAL,
    ue-positioning-GPS-Almanac            UE-Positioning-GPS-Almanac            OPTIONAL,
    ue-positioning-GPS-AcquisitionAssistance
                                         UE-Positioning-GPS-AcquisitionAssistance  OPTIONAL,
    ue-positioning-GPS-Real-timeIntegrity  BadSatList                            OPTIONAL,
    -- dummy is not used in this version of the specification, it should
    -- not be sent and if received it should be ignored.
    dummy          UE-Positioning-GPS-ReferenceCellInfo          OPTIONAL
  }

UE-Positioning-GPS-AssistanceData-v770ext ::= SEQUENCE {
    ue-positioning-GPS-ReferenceTime      UE-Positioning-GPS-ReferenceTime-v770ext  OPTIONAL,
    ue-positioning-GPS-AcquisitionAssistance
                                         UE-Positioning-GPS-AcquisitionAssistance-v770ext  OPTIONAL
  }

UE-Positioning-GPS-AssistanceData-r7 ::= SEQUENCE {
    ue-positioning-GPS-ReferenceTime      UE-Positioning-GPS-ReferenceTime-r7      OPTIONAL,
    ue-positioning-GPS-ReferenceLocation  ReferenceLocation                        OPTIONAL,
    ue-positioning-GPS-DGPS-Corrections  UE-Positioning-GPS-DGPS-Corrections      OPTIONAL,
    ue-positioning-GPS-NavigationModel    UE-Positioning-GPS-NavigationModel        OPTIONAL,
    ue-positioning-GPS-IonosphericModel   UE-Positioning-GPS-IonosphericModel       OPTIONAL,
    ue-positioning-GPS-UTC-Model          UE-Positioning-GPS-UTC-Model              OPTIONAL,
    ue-positioning-GPS-Almanac            UE-Positioning-GPS-Almanac                OPTIONAL,
    ue-positioning-GPS-AcquisitionAssistance
                                         UE-Positioning-GPS-AcquisitionAssistance-r7  OPTIONAL,
    ue-positioning-GPS-Real-timeIntegrity  BadSatList                                OPTIONAL
  }

UE-Positioning-GPS-AssistanceData-r9 ::= SEQUENCE {
    ue-positioning-GPS-ReferenceTime      UE-Positioning-GPS-ReferenceTime-r9      OPTIONAL,
    ue-positioning-GPS-ReferenceLocation  ReferenceLocation                        OPTIONAL,
    ue-positioning-GPS-DGPS-Corrections  UE-Positioning-GPS-DGPS-Corrections-r9   OPTIONAL,
    ue-positioning-GPS-NavigationModel    UE-Positioning-GPS-NavigationModel        OPTIONAL,
    ue-positioning-GPS-IonosphericModel   UE-Positioning-GPS-IonosphericModel       OPTIONAL,
    ue-positioning-GPS-UTC-Model          UE-Positioning-GPS-UTC-Model              OPTIONAL,
    ue-positioning-GPS-Almanac            UE-Positioning-GPS-Almanac                OPTIONAL,
    ue-positioning-GPS-AcquisitionAssistance
                                         UE-Positioning-GPS-AcquisitionAssistance-r9  OPTIONAL,
    ue-positioning-GPS-Real-timeIntegrity  BadSatList                                OPTIONAL
  }

UE-Positioning-GPS-AssistanceData-v920ext ::= SEQUENCE {
    ue-positioning-GPS-DGPS-Corrections  UE-Positioning-GPS-DGPS-Corrections-v920ext  OPTIONAL
  }

UE-Positioning-GPS-AssistanceData-va40ext ::= SEQUENCE {
    ue-positioning-GPS-ReferenceTime      UE-Positioning-GPS-ReferenceTime-va40ext  OPTIONAL,
    ue-positioning-GPS-Almanac            UE-Positioning-GPS-Almanac-va40ext        OPTIONAL,
    ue-positioning-GPS-AcquisitionAssistance
                                         UE-Positioning-GPS-AcquisitionAssistance-va40ext  OPTIONAL
  }

UE-Positioning-GPS-AssistanceData-r10 ::= SEQUENCE {
    ue-positioning-GPS-ReferenceTime      UE-Positioning-GPS-ReferenceTime-r10      OPTIONAL,
    ue-positioning-GPS-ReferenceLocation  ReferenceLocation                        OPTIONAL,
    ue-positioning-GPS-DGPS-Corrections  UE-Positioning-GPS-DGPS-Corrections-r9   OPTIONAL,
    ue-positioning-GPS-NavigationModel    UE-Positioning-GPS-NavigationModel        OPTIONAL,
    ue-positioning-GPS-IonosphericModel   UE-Positioning-GPS-IonosphericModel       OPTIONAL,
    ue-positioning-GPS-UTC-Model          UE-Positioning-GPS-UTC-Model              OPTIONAL,
    ue-positioning-GPS-Almanac            UE-Positioning-GPS-Almanac-r10            OPTIONAL,
    ue-positioning-GPS-AcquisitionAssistance
                                         UE-Positioning-GPS-AcquisitionAssistance-r10  OPTIONAL,
    ue-positioning-GPS-Real-timeIntegrity  BadSatList                                OPTIONAL
  }

UE-Positioning-GPS-AssistanceData-vc50ext ::= SEQUENCE {

```

```

    ue-positioning-GPS-AcquisitionAssistance
        UE-Positioning-GPS-AcquisitionAssistance-vc50ext
        OPTIONAL
    }

UE-Positioning-GPS-AssistanceData-r12 ::= SEQUENCE {
    ue-positioning-GPS-ReferenceTime      UE-Positioning-GPS-ReferenceTime-r10    OPTIONAL,
    ue-positioning-GPS-ReferenceLocation   ReferenceLocation                        OPTIONAL,
    ue-positioning-GPS-DGPS-Corrections   UE-Positioning-GPS-DGPS-Corrections-r9  OPTIONAL,
    ue-positioning-GPS-NavigationModel    UE-Positioning-GPS-NavigationModel      OPTIONAL,
    ue-positioning-GPS-IonosphericModel    UE-Positioning-GPS-IonosphericModel     OPTIONAL,
    ue-positioning-GPS-UTC-Model           UE-Positioning-GPS-UTC-Model            OPTIONAL,
    ue-positioning-GPS-Almanac             UE-Positioning-GPS-Almanac-r10          OPTIONAL,
    ue-positioning-GPS-AcquisitionAssistance
        UE-Positioning-GPS-AcquisitionAssistance-r12
        OPTIONAL,
    ue-positioning-GPS-Real-timeIntegrity  BadSatList                               OPTIONAL
}

UE-Positioning-GPS-DGPS-Corrections ::= SEQUENCE {
    gps-TOW                GPS-TOW-lsec,
    statusHealth           DiffCorrectionStatus,
    dgps-CorrectionSatInfoList  DGPS-CorrectionSatInfoList
}

UE-Positioning-GPS-DGPS-Corrections-r9 ::= SEQUENCE {
    gps-TOW                GPS-TOW-lsec,
    statusHealth           DiffCorrectionStatus,
    dgps-CorrectionSatInfoList  DGPS-CorrectionSatInfoList-r9
}

UE-Positioning-GPS-DGPS-Corrections-v920ext ::= SEQUENCE {
    dgps-CorrectionSatInfoList  DGPS-CorrectionSatInfoList-v920ext
}

UE-Positioning-GPS-IonosphericModel ::= SEQUENCE {
    alpha0                 BIT STRING (SIZE (8)),
    alpha1                 BIT STRING (SIZE (8)),
    alpha2                 BIT STRING (SIZE (8)),
    alpha3                 BIT STRING (SIZE (8)),
    beta0                  BIT STRING (SIZE (8)),
    beta1                  BIT STRING (SIZE (8)),
    beta2                  BIT STRING (SIZE (8)),
    beta3                  BIT STRING (SIZE (8))
}

UE-Positioning-GPS-MeasurementResults ::= SEQUENCE {
    referenceTime          CHOICE {
        utran-GPSReferenceTimeResult  UTRAN-GPSReferenceTimeResult,
        gps-ReferenceTimeOnly         GPS-TOW-lmsec
    },
    gps-MeasurementParamList  GPS-MeasurementParamList
}

UE-Positioning-GPS-MeasurementResults-v770ext ::= SEQUENCE {
    ue-Positioning-GPS-ReferenceTimeUncertainty
        UE-Positioning-GPS-ReferenceTimeUncertainty    OPTIONAL
}

UE-Positioning-GPS-NavigationModel ::= SEQUENCE {
    navigationModelSatInfoList  NavigationModelSatInfoList
}

UE-Positioning-GPS-NavModelAddDataReq ::= SEQUENCE {
    gps-Week                INTEGER (0..1023),
    -- SPARE: gps-Toe, Max = 167
    -- Values above Max are spare
    gps-Toe                 INTEGER (0..255),
    -- SPARE: tToeLimit, Max = 10
    -- Values above Max are spare
    tToeLimit               INTEGER (0..15),
    satDataList             SatDataList
}

UE-Positioning-GPS-ReferenceCellInfo ::= SEQUENCE {
    modeSpecificInfo        CHOICE {
        fdd                  SEQUENCE {
            referenceIdentity  PrimaryCPICH-Info
        }
    }
}

```



```

    },
    tdd
      referenceIdentity
    }
  }
}

UE-Positioning-GPS-ReferenceTime ::= SEQUENCE {
  gps-Week          INTEGER (0..1023),
  gps-tow-lmsec     GPS-TOW-lmsec,
  utran-GPSReferenceTime  UTRAN-GPSReferenceTime          OPTIONAL,
  sfn-tow-Uncertainty  SFN-TOW-Uncertainty          OPTIONAL,
  utran-GPS-DriftRate  UTRAN-GPS-DriftRate          OPTIONAL,
  gps-TOW-AssistList   GPS-TOW-AssistList          OPTIONAL
}

UE-Positioning-GPS-ReferenceTime-v770ext ::= SEQUENCE {
  ue-Positioning-GPS-ReferenceTimeUncertainty  UE-Positioning-GPS-ReferenceTimeUncertainty  OPTIONAL
}

UE-Positioning-GPS-ReferenceTime-r7 ::= SEQUENCE {
  gps-Week          INTEGER (0..1023),
  gps-tow-lmsec     GPS-TOW-lmsec,
  utran-GPSReferenceTime  UTRAN-GPSReferenceTime          OPTIONAL,
  ue-Positioning-GPS-ReferenceTimeUncertainty  UE-Positioning-GPS-ReferenceTimeUncertainty  OPTIONAL,
  sfn-tow-Uncertainty  SFN-TOW-Uncertainty          OPTIONAL,
  utran-GPS-DriftRate  UTRAN-GPS-DriftRate          OPTIONAL,
  gps-TOW-AssistList   GPS-TOW-AssistList          OPTIONAL
}

UE-Positioning-GPS-ReferenceTime-va40ext ::= SEQUENCE {
  gps-Week-Cycle-Number  INTEGER (0..7)          OPTIONAL
}

UE-Positioning-GPS-ReferenceTime-r10 ::= SEQUENCE {
  gps-Week          INTEGER (0..1023),
  gps-Week-Cycle-Number  INTEGER (0..7)          OPTIONAL,
  gps-tow-lmsec     GPS-TOW-lmsec,
  utran-GPSReferenceTime  UTRAN-GPSReferenceTime          OPTIONAL,
  ue-Positioning-GPS-ReferenceTimeUncertainty  UE-Positioning-GPS-ReferenceTimeUncertainty  OPTIONAL,
  sfn-tow-Uncertainty  SFN-TOW-Uncertainty          OPTIONAL,
  utran-GPS-DriftRate  UTRAN-GPS-DriftRate          OPTIONAL,
  gps-TOW-AssistList   GPS-TOW-AssistList          OPTIONAL
}

UE-Positioning-GPS-ReferenceTimeUncertainty ::= INTEGER (0..127)

UE-Positioning-GPS-UTC-Model ::=
  SEQUENCE {
    al          BIT STRING (SIZE (24)),
    a0          BIT STRING (SIZE (32)),
    t-ot        BIT STRING (SIZE (8)),
    wn-t        BIT STRING (SIZE (8)),
    delta-t-LS  BIT STRING (SIZE (8)),
    wn-lsf      BIT STRING (SIZE (8)),
    dn          BIT STRING (SIZE (8)),
    delta-t-LSF BIT STRING (SIZE (8))
  }

UE-Positioning-IPDL-Parameters ::=
  SEQUENCE {
    ip-Spacing  IP-Spacing,
    ip-Length   IP-Length,
    ip-Offset   INTEGER (0..9),
    seed        INTEGER (0..63),
    burstModeParameters  BurstModeParameters          OPTIONAL
  }

UE-Positioning-IPDL-Parameters-r4 ::=
  SEQUENCE {
    modeSpecificInfo  CHOICE {
      fdd              SEQUENCE {
        ip-Spacing    IP-Spacing,
        ip-Length     IP-Length,
        ip-Offset     INTEGER (0..9),
        seed          INTEGER (0..63)
      },

```

```

        tdd
            ip-Spacing-TDD
            ip-slot
            ip-Start
            ip-PCCPCG
        },
    },
    burstModeParameters
}

UE-Positioning-IPDL-Parameters-TDD-r4-ext ::= SEQUENCE {
    ip-Spacing
    ip-slot
    ip-Start
    ip-PCCPCG
    burstModeParameters
}

UE-Positioning-MeasuredResults ::= SEQUENCE {
    ue-positioning-OTDOA-Measurement
    -- Extended 'ue-positioning-PositionEstimateInfo' information may be provided using IE
    -- 'UE-Positioning-PositionEstimateInfo-v770ext' in IE 'UE-Positioning-MeasuredResults-v770ext'.
    ue-positioning-PositionEstimateInfo
    ue-positioning-GPS-Measurement
    -- The 'ue-positioning-Error' information may be provided using IE 'UE-Positioning-Error-r7' in
    -- IE 'UE-Positioning-MeasuredResults-v770ext'.
    -- If IE 'UE-Positioning-Error-r7' is present, the corresponding IE 'UE-Positioning-Error' shall
    -- be excluded.
    ue-positioning-Error
}

UE-Positioning-MeasuredResults-v770ext ::= SEQUENCE {
    ue-positioning-PositionEstimateInfo
    ue-positioning-GPS-Measurement

    ue-positioning-Error
    ue-positioning-Ganss-MeasuredResults
}

UE-Positioning-MeasuredResults-v390ext ::= SEQUENCE {
    ue-Positioning-OTDOA-Measurement-v390ext
}

UE-Positioning-MeasuredResults-v860ext ::= SEQUENCE {
    ue-positioning-Error
    ue-positioning-Ganss-MeasurementResults
}

UE-Positioning-MeasuredResults-vc50ext ::= SEQUENCE {
    ue-positioning-Error
}

UE-Positioning-Measurement ::= SEQUENCE {
    ue-positioning-ReportingQuantity
    reportCriteria
    ue-positioning-OTDOA-AssistanceData
    ue-positioning-GPS-AssistanceData
}

UE-Positioning-Measurement-v390ext ::= SEQUENCE {
    ue-positioning-ReportingQuantity-v390ext

    measurementValidity
    ue-positioning-OTDOA-AssistanceData-UEB
}

UE-Positioning-Measurement-r4 ::= SEQUENCE {
    ue-positioning-ReportingQuantity
    measurementValidity
    reportCriteria
    ue-positioning-OTDOA-AssistanceData
    ue-positioning-GPS-AssistanceData
}

UE-Positioning-Measurement-r7 ::= SEQUENCE {
    ue-positioning-ReportingQuantity
    measurementValidity
    reportCriteria
}

```

```

    ue-positioning-OTDOA-AssistanceData    UE-Positioning-OTDOA-AssistanceData-r7  OPTIONAL,
    ue-positioning-GPS-AssistanceData      UE-Positioning-GPS-AssistanceData-r7    OPTIONAL,
    ue-positioning-GANSS-AssistanceData    UE-Positioning-GANSS-AssistanceData     OPTIONAL
  }

UE-Positioning-Measurement-r8 ::= SEQUENCE {
    ue-positioning-ReportingQuantity      UE-Positioning-ReportingQuantity-r8,
    measurementValidity                   MeasurementValidity                       OPTIONAL,
    reportCriteria                         UE-Positioning-ReportCriteria-r7,
    ue-positioning-OTDOA-AssistanceData   UE-Positioning-OTDOA-AssistanceData-r7  OPTIONAL,
    ue-positioning-GPS-AssistanceData     UE-Positioning-GPS-AssistanceData-r7    OPTIONAL,
    ue-positioning-GANSS-AssistanceData   UE-Positioning-GANSS-AssistanceData-r8  OPTIONAL
  }

UE-Positioning-Measurement-r9 ::= SEQUENCE {
    ue-positioning-ReportingQuantity      UE-Positioning-ReportingQuantity-r8,
    measurementValidity                   MeasurementValidity                       OPTIONAL,
    reportCriteria                         UE-Positioning-ReportCriteria-r7,
    ue-positioning-OTDOA-AssistanceData   UE-Positioning-OTDOA-AssistanceData-r7  OPTIONAL,
    ue-positioning-GPS-AssistanceData     UE-Positioning-GPS-AssistanceData-r9    OPTIONAL,
    ue-positioning-GANSS-AssistanceData   UE-Positioning-GANSS-AssistanceData-r9  OPTIONAL
  }

UE-Positioning-Measurement-r10 ::= SEQUENCE {
    ue-positioning-ReportingQuantity      UE-Positioning-ReportingQuantity-r8,
    measurementValidity                   MeasurementValidity                       OPTIONAL,
    reportCriteria                         UE-Positioning-ReportCriteria-r7,
    ue-positioning-OTDOA-AssistanceData   UE-Positioning-OTDOA-AssistanceData-r7  OPTIONAL,
    ue-positioning-GPS-AssistanceData     UE-Positioning-GPS-AssistanceData-r10   OPTIONAL,
    ue-positioning-GANSS-AssistanceData   UE-Positioning-GANSS-AssistanceData-r10 OPTIONAL
  }

UE-Positioning-Measurement-r12 ::= SEQUENCE {
    ue-positioning-ReportingQuantity      UE-Positioning-ReportingQuantity-r8,
    measurementValidity                   MeasurementValidity                       OPTIONAL,
    reportCriteria                         UE-Positioning-ReportCriteria-r7,
    ue-positioning-OTDOA-AssistanceData   UE-Positioning-OTDOA-AssistanceData-r7  OPTIONAL,
    ue-positioning-GPS-AssistanceData     UE-Positioning-GPS-AssistanceData-r12   OPTIONAL,
    ue-positioning-GANSS-AssistanceData   UE-Positioning-GANSS-AssistanceData-r12 OPTIONAL
  }

UE-Positioning-MeasurementEventResults ::= CHOICE {
    -- In case of 'event7a' reporting, if IE 'UE-Positioning-PositionEstimateInfo' is not needed,
    -- CHOICE shall be set to 'additionalOrReplacedPosMeasEvent' and the 'event7a' shall be included
    -- in IE 'UE-Positioning-MeasurementEventResults-v770ext'.
    event7a                               UE-Positioning-PositionEstimateInfo,
    event7b                               UE-Positioning-OTDOA-Measurement,
    event7c                               UE-Positioning-GPS-MeasurementResults,
    -- If CHOICE is set to 'additionalOrReplacedPosMeasEvent',
    -- IE 'UE-Positioning-MeasurementEventResults-v770ext' shall be present.
    additionalOrReplacedPosMeasEvent     NULL
  }

UE-Positioning-MeasurementEventResults-v770ext ::= CHOICE {
    event7a                               UE-Positioning-PositionEstimateInfo-v770ext,
    event7c                               UE-Positioning-GPS-MeasurementResults-v770ext,
    event7d                               UE-Positioning-GANSS-MeasuredResults,
    spare                                 NULL
  }

UE-Positioning-MeasurementEventResults-v860ext ::= CHOICE {
    event7d                               UE-Positioning-GANSS-MeasuredResults-v860ext
  }

UE-Positioning-MeasurementInterval ::= ENUMERATED {
    e5, e15, e60, e300,
    e900, e1800, e3600, e7200 }

UE-Positioning-MethodType ::= ENUMERATED {
    ue-Assisted,
    ue-Based,
    ue-BasedPreferred,
    ue-AssistedPreferred }

UE-Positioning-OTDOA-AssistanceData ::= SEQUENCE {
    ue-positioning-OTDOA-ReferenceCellInfo UE-Positioning-OTDOA-ReferenceCellInfo  OPTIONAL,
    ue-positioning-OTDOA-NeighbourCellList

```

```

    UE-Positioning-OTDOA-NeighbourCellList          OPTIONAL
  }
UE-Positioning-OTDOA-AssistanceData-r4 ::= SEQUENCE {
  ue-positioning-OTDOA-ReferenceCellInfo
  UE-Positioning-OTDOA-ReferenceCellInfo-r4        OPTIONAL,
  ue-positioning-OTDOA-NeighbourCellList
  UE-Positioning-OTDOA-NeighbourCellList-r4        OPTIONAL
}
UE-Positioning-OTDOA-AssistanceData-r4ext ::= SEQUENCE {
  -- In case of TDD these IPDL parameters shall be used for the reference cell instead of
  -- IPDL Parameters in IE UE-Positioning-OTDOA-ReferenceCellInfo
  ue-Positioning-IPDL-Parameters-TDD-r4-ext
  UE-Positioning-IPDL-Parameters-TDD-r4-ext        OPTIONAL,
  -- These IPDL parameters shall be used for the neighbour cells in case of TDD instead of
  -- IPDL Parameters in IE UE-Positioning-OTDOA-NeighbourCellInfoList. The cells shall be
  -- listed in the same order as in IE UE-Positioning-OTDOA-NeighbourCellInfoList
  ue-Positioning-IPDL-Parameters-TDDList-r4-ext
  UE-Positioning-IPDL-Parameters-TDDList-r4-ext    OPTIONAL
}
UE-Positioning-OTDOA-AssistanceData-UEB ::= SEQUENCE {
  ue-positioning-OTDOA-ReferenceCellInfo-UEB
  UE-Positioning-OTDOA-ReferenceCellInfo-UEB      OPTIONAL,
  ue-positioning-OTDOA-NeighbourCellList-UEB
  UE-Positioning-OTDOA-NeighbourCellList-UEB      OPTIONAL
}
UE-Positioning-OTDOA-AssistanceData-UEB-ext ::= SEQUENCE {
  ue-positioning-OTDOA-ReferenceCellInfo-UEB-ext
  UE-Positioning-OTDOA-ReferenceCellInfo-UEB-ext  OPTIONAL,
  ue-positioning-OTDOA-NeighbourCellList-UEB-ext
  UE-Positioning-OTDOA-NeighbourCellList-UEB-ext  OPTIONAL
}
UE-Positioning-OTDOA-AssistanceData-r7 ::= SEQUENCE {
  ue-positioning-OTDOA-ReferenceCellInfo           UE-Positioning-OTDOA-ReferenceCellInfo-r7  OPTIONAL,
  ue-positioning-OTDOA-NeighbourCellList           UE-Positioning-OTDOA-NeighbourCellList-r7  OPTIONAL
}
UE-Positioning-IPDL-Parameters-TDDList-r4-ext ::= SEQUENCE (SIZE (1..maxCellMeas)) OF
  UE-Positioning-IPDL-Parameters-TDD-r4-ext
UE-Positioning-OTDOA-MeasuredResultsTDD-ext ::= SEQUENCE {
  neighbourList                                     NeighbourList-TDD-r7          OPTIONAL
}
UE-Positioning-OTDOA-Measurement ::= SEQUENCE {
  sfn                                               INTEGER (0..4095),
  modeSpecificInfo                                CHOICE {
    fdd                                             SEQUENCE {
      referenceCellIdentity                        PrimaryCPICH-Info,
      ue-RX-TX-TimeDifferenceType2Info            UE-RX-TX-TimeDifferenceType2Info
    },
    tdd                                             SEQUENCE {
      referenceCellIdentity                        CellParametersID
    }
  },
  neighbourList                                     NeighbourList                  OPTIONAL
}
UE-Positioning-OTDOA-Measurement-v390ext ::= SEQUENCE {
  neighbourList-v390ext                             NeighbourList-v390ext
}
UE-Positioning-OTDOA-NeighbourCellInfo ::= SEQUENCE {
  modeSpecificInfo                                CHOICE {
    fdd                                             SEQUENCE {
      primaryCPICH-Info                           PrimaryCPICH-Info
    },
    tdd                                             SEQUENCE {
      cellAndChannelIdentity                       CellAndChannelIdentity
    }
  },
  frequencyInfo                                    FrequencyInfo                   OPTIONAL,
  ue-positioning-IPDL-Parameters                  UE-Positioning-IPDL-Parameters OPTIONAL,
  sfn-SFN-RelTimeDifference                       SFN-SFN-RelTimeDifference,

```

```

sfn-SFN-Drift                SFN-SFN-Drift                OPTIONAL,
searchWindowSize              OTDOA-SearchWindowSize,
positioningMode               CHOICE {
    ueBased                    SEQUENCE {},
    ueAssisted                 SEQUENCE {}
}
}

UE-Positioning-OTDOA-NeighbourCellInfo-r4 ::= SEQUENCE {
    modeSpecificInfo          CHOICE {
        fdd                    SEQUENCE {
            primaryCPICH-Info    PrimaryCPICH-Info
        },
        tdd                    SEQUENCE {
            cellAndChannelIdentity CellAndChannelIdentity
        }
    },
    frequencyInfo              FrequencyInfo                OPTIONAL,
    ue-positioning-IPDL-Parameters UE-Positioning-IPDL-Parameters-r4  OPTIONAL,
    sfn-SFN-RelTimeDifference    SFN-SFN-RelTimeDifference1,
    sfn-Offset-Validity          SFN-Offset-Validity                OPTIONAL,
    sfn-SFN-Drift                SFN-SFN-Drift                    OPTIONAL,
    searchWindowSize              OTDOA-SearchWindowSize,
    positioningMode              CHOICE {
        ueBased                    SEQUENCE {
            relativeNorth          INTEGER (-20000..20000)    OPTIONAL,
            relativeEast           INTEGER (-20000..20000)    OPTIONAL,
            relativeAltitude       INTEGER (-4000..4000)      OPTIONAL,
            fineSFN-SFN            FineSFN-SFN              OPTIONAL,
            -- actual value roundTripTime = (IE value * 0.0625) + 876
            roundTripTime          INTEGER (0..32766)        OPTIONAL
        },
        ueAssisted                 SEQUENCE {}
    }
}

UE-Positioning-OTDOA-NeighbourCellInfo-UEB ::= SEQUENCE {
    modeSpecificInfo          CHOICE {
        fdd                    SEQUENCE {
            primaryCPICH-Info    PrimaryCPICH-Info
        },
        tdd                    SEQUENCE {
            cellAndChannelIdentity CellAndChannelIdentity
        }
    },
    frequencyInfo              FrequencyInfo                OPTIONAL,
    ue-positioning-IPDL-Parameters UE-Positioning-IPDL-Parameters  OPTIONAL,
    sfn-SFN-RelTimeDifference    SFN-SFN-RelTimeDifference1,
    sfn-SFN-Drift                SFN-SFN-Drift                    OPTIONAL,
    searchWindowSize              OTDOA-SearchWindowSize,
    relativeNorth                INTEGER (-20000..20000)    OPTIONAL,
    relativeEast                 INTEGER (-20000..20000)    OPTIONAL,
    relativeAltitude             INTEGER (-4000..4000)      OPTIONAL,
    fineSFN-SFN                 FineSFN-SFN              OPTIONAL,
    -- actual value roundTripTime = (IE value * 0.0625) + 876
    roundTripTime                INTEGER (0..32766)        OPTIONAL
}

UE-Positioning-OTDOA-NeighbourCellInfo-UEB-ext ::= SEQUENCE {
    -- actual value roundTripTimeExtension = (IE value * 0.0625)
    roundTripTimeExtension      INTEGER (0..70274)          OPTIONAL
}

UE-Positioning-OTDOA-NeighbourCellInfo-r7 ::= SEQUENCE {
    modeSpecificInfo          CHOICE {
        fdd                    SEQUENCE {
            primaryCPICH-Info    PrimaryCPICH-Info
        },
        tdd                    SEQUENCE {
            cellAndChannelIdentity CellAndChannelIdentity
        }
    },
    frequencyInfo              FrequencyInfo                OPTIONAL,
    ue-positioning-IPDL-Parameters UE-Positioning-IPDL-Parameters-r4  OPTIONAL,
    sfn-SFN-RelTimeDifference    SFN-SFN-RelTimeDifference1,
    sfn-Offset-Validity          SFN-Offset-Validity                OPTIONAL,
    sfn-SFN-Drift                SFN-SFN-Drift                    OPTIONAL,
    searchWindowSize              OTDOA-SearchWindowSize,

```

```

    positioningMode CHOICE {
        ueBased SEQUENCE {
            relativeNorth INTEGER (-20000..20000) OPTIONAL,
            relativeEast  INTEGER (-20000..20000) OPTIONAL,
            relativeAltitude INTEGER (-4000..4000) OPTIONAL,
            fineSFN-SFN FineSFN-SFN OPTIONAL,
            -- actual value roundTripTime = (IE value * 0.0625) + 876
            roundTripTime INTEGER (0.. 32766) OPTIONAL,
            -- actual value roundTripTimeExtension = (IE value * 0.0625)
            roundTripTimeExtension INTEGER (0..70274) OPTIONAL
        },
        ueAssisted SEQUENCE {}
    }
}

UE-Positioning-OTDOA-NeighbourCellList ::= SEQUENCE (SIZE (1..maxCellMeas)) OF
    UE-Positioning-OTDOA-NeighbourCellInfo

UE-Positioning-OTDOA-NeighbourCellList-r4 ::= SEQUENCE (SIZE (1..maxCellMeas)) OF
    UE-Positioning-OTDOA-NeighbourCellInfo-r4

UE-Positioning-OTDOA-NeighbourCellList-UEB ::= SEQUENCE (SIZE (1..maxCellMeas)) OF
    UE-Positioning-OTDOA-NeighbourCellInfo-UEB

-- The order of the list corresponds to the order of UE-Positioning-OTDOA-NeighbourCellInfo-UEB
-- in UE-Positioning-OTDOA-NeighbourCellList-UEB
UE-Positioning-OTDOA-NeighbourCellList-UEB-ext ::= SEQUENCE (SIZE (1..maxCellMeas)) OF
    UE-Positioning-OTDOA-NeighbourCellInfo-UEB-ext

UE-Positioning-OTDOA-NeighbourCellList-r7 ::= SEQUENCE (SIZE (1..maxCellMeas)) OF
    UE-Positioning-OTDOA-NeighbourCellInfo-r7

UE-Positioning-OTDOA-Quality ::= SEQUENCE {
    stdResolution BIT STRING (SIZE (2)),
    numberOfOTDOA-Measurements BIT STRING (SIZE (3)),
    stdOfOTDOA-Measurements BIT STRING (SIZE (5))
}

UE-Positioning-OTDOA-ReferenceCellInfo ::= SEQUENCE {
    sfn INTEGER (0..4095) OPTIONAL,
    modeSpecificInfo CHOICE {
        fdd SEQUENCE {
            primaryCPICH-Info PrimaryCPICH-Info
        },
        tdd SEQUENCE {
            cellAndChannelIdentity CellAndChannelIdentity
        }
    },
    frequencyInfo FrequencyInfo OPTIONAL,
    positioningMode CHOICE {
        ueBased SEQUENCE {},
        ueAssisted SEQUENCE {}
    },
    ue-positioning-IPDL-Parameters UE-Positioning-IPDL-Parameters OPTIONAL
}

UE-Positioning-OTDOA-ReferenceCellInfo-r4 ::= SEQUENCE {
    sfn INTEGER (0..4095) OPTIONAL,
    modeSpecificInfo CHOICE {
        fdd SEQUENCE {
            primaryCPICH-Info PrimaryCPICH-Info
        },
        tdd SEQUENCE {
            cellAndChannelIdentity CellAndChannelIdentity
        }
    },
    frequencyInfo FrequencyInfo OPTIONAL,
    positioningMode CHOICE {
        ueBased SEQUENCE {
            cellPosition ReferenceCellPosition OPTIONAL,
            -- actual value roundTripTime = (IE value * 0.0625) + 876
            roundTripTime INTEGER (0..32766) OPTIONAL
        },
        ueAssisted SEQUENCE {}
    },
    ue-positioning-IPDL-Parameters UE-Positioning-IPDL-Parameters-r4 OPTIONAL
}

```

```

UE-Positioning-OTDOA-ReferenceCellInfo-UEB ::= SEQUENCE {
    sfn INTEGER (0..4095) OPTIONAL,
    modeSpecificInfo CHOICE {
        fdd SEQUENCE {
            primaryCPICH-Info PrimaryCPICH-Info
        },
        tdd SEQUENCE {
            cellAndChannelIdentity CellAndChannelIdentity
        }
    },
    frequencyInfo FrequencyInfo OPTIONAL,
    cellPosition ReferenceCellPosition OPTIONAL,
    -- actual value roundTripTime = (IE value * 0.0625) + 876
    roundTripTime INTEGER (0..32766) OPTIONAL,
    ue-positioning-IPDL-Parameters UE-Positioning-IPDL-Parameters OPTIONAL
}

UE-Positioning-OTDOA-ReferenceCellInfo-UEB-ext ::= SEQUENCE {
    -- actual value roundTripTimeExtension = (IE value * 0.0625)
    roundTripTimeExtension INTEGER (0..70274) OPTIONAL
}

UE-Positioning-OTDOA-ReferenceCellInfo-r7 ::= SEQUENCE {
    sfn INTEGER (0..4095) OPTIONAL,
    modeSpecificInfo CHOICE {
        fdd SEQUENCE {
            primaryCPICH-Info PrimaryCPICH-Info
        },
        tdd SEQUENCE {
            cellAndChannelIdentity CellAndChannelIdentity
        }
    },
    frequencyInfo FrequencyInfo OPTIONAL,
    positioningMode CHOICE {
        ueBased SEQUENCE {
            cellPosition ReferenceCellPosition OPTIONAL,
            -- actual value roundTripTime = (IE value * 0.0625) + 876
            roundTripTime INTEGER (0..32766) OPTIONAL,
            -- actual value roundTripTimeExtension = (IE value * 0.0625)
            roundTripTimeExtension INTEGER (0..70274) OPTIONAL
        },
        ueAssisted SEQUENCE {}
    },
    ue-positioning-IPDL-Parameters UE-Positioning-IPDL-Parameters-r4 OPTIONAL
}

UE-Positioning-PositionEstimateInfo ::= SEQUENCE {
    referenceTime CHOICE {
        utran-GPSReferenceTimeResult UTRAN-GPSReferenceTimeResult,
        gps-ReferenceTimeOnly GPS-TOW-1msec,
        cell-Timing SEQUENCE {
            sfn INTEGER (0..4095),
            modeSpecificInfo CHOICE {
                fdd SEQUENCE {
                    primaryCPICH-Info PrimaryCPICH-Info
                },
                tdd SEQUENCE {
                    cellAndChannelIdentity CellAndChannelIdentity
                }
            }
        }
    },
    positionEstimate PositionEstimate
}

UE-Positioning-PositionEstimateInfo-v770ext ::= SEQUENCE {
    referenceTimeOptions CHOICE {
        -- If 'earlier-than-r7', IE 'UE-Positioning-PositionEstimateInfo' shall be included.
        earlier-than-r7 NULL,
        -- If 'r7', the corresponding IE 'UE-Positioning-PositionEstimateInfo' shall be excluded.
        r7 SEQUENCE {
            referenceTime CHOICE {
                utran-GANSSReferenceTimeResult UTRAN-GANSSReferenceTime,
                ganssReferenceTimeOnly GANSSReferenceTimeOnly
            },
            positionEstimate PositionEstimate
        }
    },
}

```

```

    positionData                BIT STRING (SIZE (16)),
    velocityEstimate            VelocityEstimate                OPTIONAL,
    ue-Positioning-GPS-ReferenceTimeUncertainty
                                UE-Positioning-GPS-ReferenceTimeUncertainty OPTIONAL
}

UE-Positioning-ReportCriteria ::= CHOICE {
    ue-positioning-ReportingCriteria    UE-Positioning-EventParamList,
    periodicalReportingCriteria        PeriodicalReportingCriteria,
    noReporting                        NULL
}

UE-Positioning-ReportCriteria-r7 ::= CHOICE {
    ue-positioning-ReportingCriteria    UE-Positioning-EventParamList-r7,
    periodicalReportingCriteria        PeriodicalReportingCriteria,
    noReporting                        NULL
}

UE-Positioning-ReportingQuantity ::= SEQUENCE {
    methodType                    UE-Positioning-MethodType,
    positioningMethod              PositioningMethod,
    -- dummy1 is not used in this version of specification and it should
    -- be ignored.
    dummy1                        UE-Positioning-ResponseTime,
    horizontal-Accuracy            UE-Positioning-Accuracy                OPTIONAL,
    gps-TimingOfCellWanted        BOOLEAN,
    -- dummy2 is not used in this version of specification and it should
    -- be ignored.
    dummy2                        BOOLEAN,
    additionalAssistanceDataRequest BOOLEAN,
    environmentCharacterisation    EnvironmentCharacterisation    OPTIONAL
}

UE-Positioning-ReportingQuantity-v390ext ::= SEQUENCE {
    vertical-Accuracy              UE-Positioning-Accuracy
}

UE-Positioning-ReportingQuantity-r4 ::= SEQUENCE {
    methodType                    UE-Positioning-MethodType,
    positioningMethod              PositioningMethod,
    horizontalAccuracy             UE-Positioning-Accuracy                OPTIONAL,
    verticalAccuracy               UE-Positioning-Accuracy                OPTIONAL,
    gps-TimingOfCellWanted        BOOLEAN,
    additionalAssistanceDataReq    BOOLEAN,
    environmentCharacterisation    EnvironmentCharacterisation    OPTIONAL
}

UE-Positioning-ReportingQuantity-r7 ::= SEQUENCE {
    methodType                    UE-Positioning-MethodType,
    positioningMethod              PositioningMethod,
    horizontalAccuracy             UE-Positioning-Accuracy                OPTIONAL,
    verticalAccuracy               UE-Positioning-Accuracy                OPTIONAL,
    gps-TimingOfCellWanted        BOOLEAN,
    additionalAssistanceDataReq    BOOLEAN,
    environmentCharacterisation    EnvironmentCharacterisation    OPTIONAL,
    velocityRequested              ENUMERATED { true }                OPTIONAL,
    gANSSPositioningMethods        BIT STRING (SIZE (16))                OPTIONAL,
    gANSSTimingOfCellWanted        BIT STRING (SIZE (8))                OPTIONAL,
    gANSSCarrierPhaseMeasurementRequested
                                    BIT STRING (SIZE (8))                OPTIONAL
}

UE-Positioning-ReportingQuantity-r8 ::= SEQUENCE {
    methodType                    UE-Positioning-MethodType,
    positioningMethod              PositioningMethod,
    horizontalAccuracy             UE-Positioning-Accuracy                OPTIONAL,
    verticalAccuracy               UE-Positioning-Accuracy                OPTIONAL,
    gps-TimingOfCellWanted        BOOLEAN,
    additionalAssistanceDataReq    BOOLEAN,
    environmentCharacterisation    EnvironmentCharacterisation    OPTIONAL,
    velocityRequested              ENUMERATED { true }                OPTIONAL,
    gANSSPositioningMethods        BIT STRING (SIZE (16))                OPTIONAL,
    gANSSTimingOfCellWanted        BIT STRING (SIZE (8))                OPTIONAL,
    gANSSCarrierPhaseMeasurementRequested
                                    BIT STRING (SIZE (8))                OPTIONAL,
    gANSSMultiFreqMeasurementRequested
                                    BIT STRING (SIZE (8))                OPTIONAL
}

```



```

UE-Positioning-ResponseTime ::=
    ENUMERATED {
        s1, s2, s4, s8, s16,
        s32, s64, s128 }

UTCmodelSet1 ::=
    SEQUENCE {
        utcA0          BIT STRING (SIZE (16)),
        utcA1          BIT STRING (SIZE (13)),
        utcA2          BIT STRING (SIZE (7)),
        utcDeltaTls   BIT STRING (SIZE (8)),
        utcTot        BIT STRING (SIZE (16)),
        utcWNot       BIT STRING (SIZE (13)),
        utcWNlsf      BIT STRING (SIZE (8)),
        utcDN         BIT STRING (SIZE (4)),
        utcDeltaTlsf  BIT STRING (SIZE (8))
    }

UTCmodelSet2 ::=
    SEQUENCE {
        nA            BIT STRING (SIZE (11)),
        tauC          BIT STRING (SIZE (32)),
        deltaUT1     DeltaUT1          OPTIONAL,
        kp            BIT STRING (SIZE (2))    OPTIONAL
    }

UTCmodelSet3 ::=
    SEQUENCE {
        utcAlwnt      BIT STRING (SIZE (24)),
        utcA0wnt      BIT STRING (SIZE (32)),
        utcTot        BIT STRING (SIZE (8)),
        utcWNt        BIT STRING (SIZE (8)),
        utcDeltaTls   BIT STRING (SIZE (8)),
        utcWNlsf      BIT STRING (SIZE (8)),
        utcDN         BIT STRING (SIZE (8)),
        utcDeltaTlsf  BIT STRING (SIZE (8)),
        utcStandardID BIT STRING (SIZE (3))
    }

UTCmodelSet4 ::=
    SEQUENCE {
        utcA0          BIT STRING (SIZE (32)),
        utcA1          BIT STRING (SIZE (24)),
        utcDeltaTls   BIT STRING (SIZE (8)),
        utcWNlsf      BIT STRING (SIZE (8)),
        utcDN         BIT STRING (SIZE (8)),
        utcDeltaTlsf  BIT STRING (SIZE (8))
    }

-- SPARE: UTRA-CarrierRSSI, Max = 76
-- Values above Max are spare
UTRA-CarrierRSSI ::=
    INTEGER (0..127)

UTRAN-GANSSReferenceTime ::=
    SEQUENCE {
        ue-GANSSTimingOfCellFrames
            SEQUENCE {
                -- Actual value [ns] = (ms-Part * 4294967296 + ls-Part) * 250
                -- Actual values [ns] > 8639999999750 are reserved and are considered a protocol error
                ms-Part    INTEGER (0..80),
                ls-Part    INTEGER (0..4294967295)
            },
        gANSS-TimeId      INTEGER (0..7)          OPTIONAL,
        gANSS-TimeUncertainty INTEGER (0..127)      OPTIONAL,
        mode              CHOICE {
            fdd
                SEQUENCE {
                    primary-CPICH-Info    PrimaryCPICH-Info
                },
            tdd
                SEQUENCE {
                    cellParameters        CellParametersID
                }
        },
        referenceSfn     INTEGER (0..4095)
    }

UTRAN-FDD-FrequencyList ::=
    SEQUENCE (SIZE(1..maxNumFDDFreqs)) OF
        UTRAN-FDD-Frequency

UTRAN-FDD-Frequency ::=
    SEQUENCE {
        uarfcn          UARFCN,
        priority        INTEGER (0..maxPrio-1),
        -- Actual value = IE value * 2
        threshXhigh     INTEGER (0..31),
        -- Actual value = IE value * 2
        threshXlow      INTEGER (0..31),
    }

```

```

    qQualMinFDD                INTEGER (-24..0)                OPTIONAL,
    -- Actual value = IE value * 2 + 1
    qRxLevMinFDD                INTEGER (-60..-13)              OPTIONAL
}

UTRAN-TDD-FrequencyList ::=          SEQUENCE (SIZE(1..maxNumTDDFreqs)) OF
                                       UTRAN-TDD-Frequency

UTRAN-TDD-Frequency ::=              SEQUENCE {
    uarfcn                       UARFCN,
    priority                       INTEGER (0..maxPrio-1),
    -- Actual value = IE value * 2
    threshXhigh                    INTEGER (0..31),
    -- Actual value = IE value * 2
    threshXlow                      INTEGER (0..31),
    -- Actual value = IE value * 2 + 1
    qRxLevMinTDD                   INTEGER (-60..-13)           OPTIONAL
}

UTRAN-GPS-DriftRate ::=              ENUMERATED {
    utran-GPSDrift0, utran-GPSDrift1, utran-GPSDrift2,
    utran-GPSDrift5, utran-GPSDrift10, utran-GPSDrift15,
    utran-GPSDrift25, utran-GPSDrift50, utran-GPSDrift-1,
    utran-GPSDrift-2, utran-GPSDrift-5, utran-GPSDrift-10,
    utran-GPSDrift-15, utran-GPSDrift-25, utran-GPSDrift-50}

UTRAN-GPSReferenceTime ::=           SEQUENCE {
    -- For utran-GPSTimingOfCell values above 2322431999999 are not
    -- used in this version of the specification
    -- Actual value utran-GPSTimingOfCell = (ms-part * 4294967296) + ls-part
    utran-GPSTimingOfCell          SEQUENCE {
        ms-part                      INTEGER (0..1023),
        ls-part                       INTEGER (0..4294967295)
    },
    modeSpecificInfo               CHOICE {
        fdd                           SEQUENCE {
            referenceIdentity          PrimaryCPICH-Info
        },
        tdd                           SEQUENCE {
            referenceIdentity          CellParametersID
        }
    } OPTIONAL,
    sfn                             INTEGER (0..4095)
}

UTRAN-GPSReferenceTimeResult ::=     SEQUENCE {
    -- For ue-GPSTimingOfCell values above 37158911999999 are not
    -- used in this version of the specification
    -- Actual value ue-GPSTimingOfCell = (ms-part * 4294967296) + ls-part
    ue-GPSTimingOfCell             SEQUENCE {
        ms-part                       INTEGER (0.. 16383),
        ls-part                       INTEGER (0..4294967295)
    },
    modeSpecificInfo               CHOICE {
        fdd                           SEQUENCE {
            referenceIdentity          PrimaryCPICH-Info
        },
        tdd                           SEQUENCE {
            referenceIdentity          CellParametersID
        }
    },
    sfn                             INTEGER (0..4095)
}

UTRA-PriorityInfoList ::=            SEQUENCE {
    utra-ServingCell               SEQUENCE {
        priority                       INTEGER (0..maxPrio-1),
        -- Actual value = IE value * 2
        s-PrioritySearch1              INTEGER (0..31),
        -- Actual value = IE value, default value is 0
        s-PrioritySearch2              INTEGER (0..7)                OPTIONAL,
        -- Actual value = IE value * 2
        threshServingLow               INTEGER (0..31)
    },
    utran-FDD-FrequencyList          UTRAN-FDD-FrequencyList        OPTIONAL,
    utran-TDD-FrequencyList          UTRAN-TDD-FrequencyList        OPTIONAL
}

```

```

UTRA-PriorityInfoList-v920ext ::= SEQUENCE {
    threshServingLow2          INTEGER (0..31)          OPTIONAL
}

VarianceOfRLC-BufferPayload ::= ENUMERATED {
    plv0, plv4, plv8, plv16, plv32, plv64,
    plv128, plv256, plv512, plv1024,
    plv2k, plv4k, plv8k, plv16k, spare2, spare1 }

VelocityEstimate ::= CHOICE {
    horizontalVelocity          HorizontalVelocity,
    horizontalWithVerticalVelocity HorizontalWithVerticalVelocity,
    horizontalVelocityWithUncertainty HorizontalVelocityWithUncertainty,
    horizontalWithVerticalVelocityAndUncertainty HorizontalWithVerticalVelocityAndUncertainty
}

-- Actual value W = IE value * 0.1
W ::= INTEGER (0..20)

-- *****
--
-- OTHER INFORMATION ELEMENTS (10.3.8)
--
-- *****

BCC ::= INTEGER (0..7)

BCCH-ModificationInfo ::= SEQUENCE {
    mib-ValueTag          MIB-ValueTag,
    bcch-ModificationTime BCCH-ModificationTime          OPTIONAL
}

BCCH-ModificationInfo-vc50ext ::= SEQUENCE {
    mib-ValueTagExt      MIB-ValueTagExt          OPTIONAL,
    sb3-ValueTag         CellValueTag2           OPTIONAL
}

-- Actual value BCCH-ModificationTime = IE value * 8
BCCH-ModificationTime ::= INTEGER (0..511)

BSIC ::= SEQUENCE {
    ncc          NCC,
    bcc          BCC
}

CBS-DRX-Level1Information ::= SEQUENCE {
    ctch-AllocationPeriod INTEGER (1..256),
    cbs-FrameOffset      INTEGER (0..255)
}

CBS-DRX-Level1Information-extension-r6 ::= ENUMERATED {p8, p16, p32, p64, p128, p256}

CDMA2000-Message ::= SEQUENCE {
    msg-Type          BIT STRING (SIZE (8)),
    payload          BIT STRING (SIZE (1..512))
}

CDMA2000-MessageList ::= SEQUENCE (SIZE (1..maxInterSysMessages)) OF
    CDMA2000-Message

CDMA2000-UMTS-Frequency-List ::= SEQUENCE (SIZE (1..maxNumCDMA2000Freqs)) OF
    FrequencyInfoCDMA2000

CellValueTag ::= INTEGER (1..4)

CellValueTag2 ::= INTEGER (1..16)

CellValueTagExt ::= INTEGER (0..3)

CellValueTag3 ::= SEQUENCE {
    cellValueTag          CellValueTag,
    cellValueTagExt      CellValueTagExt          OPTIONAL
}

DataTransmFrequency ::= SEQUENCE {
    dataTransmFreqGranularity ENUMERATED { ms100, ms250, ms500, ms1000,
        ms2000, ms5000, ms10000, ms60000 },
    numberOfDataTransmOcc   INTEGER (1..610)
}

```

```

}

DataVolumeHistory ::=
    dataVolumeMonitoringWindow
    dataTransmFrequency
    dataVolumePerRB
SEQUENCE {
    INTEGER (1..120),
    DataTransmFrequency
    DataVolumePerRB-List
OPTIONAL,
OPTIONAL
}

DataVolumePerRB ::=
    rb-Identity
    dataVolume
SEQUENCE {
    RB-Identity,
    INTEGER (0..4294967295)
}

DataVolumePerRB-List ::=
    SEQUENCE (SIZE (1..maxRB)) OF DataVolumePerRB

DeferredMeasurementControlReadingSupport ::= SEQUENCE {
    -- If modeSpecificInfo is not present, deferred SIB11, SIB11bis and SIB12 reading
    -- with default measurement quantities applies
    modeSpecificInfo
        CHOICE {
            fdd
                SEQUENCE {
                    intraFreqMeasQuantity-FDD
                    IntraFreqMeasQuantity-FDD-sib3
                },
            tdd
                SEQUENCE {
                    intraFreqMeasQuantity-TDDList
                    IntraFreqMeasQuantity-TDD-sib3List
                }
        }
    OPTIONAL
}

ETWS-Information ::=
    warningType
    messageIdentifier
    serialNumber
SEQUENCE {
    OCTET STRING (SIZE (1..2)),
    OCTET STRING (SIZE (2)),
    OCTET STRING (SIZE (2))
}

-- This IE is not used in the specification.
ETWS-WarningSecurityInfo ::=
    OCTET STRING

EUTRA-BlacklistedCell ::=
    physicalCellIdentity
SEQUENCE {
    EUTRA-PhysicalCellIdentity
}

EUTRA-BlacklistedCellPerFreqList ::= SEQUENCE (SIZE (1..maxEUTRACellPerFreq)) OF
    EUTRA-BlacklistedCell

EUTRA-PhysicalCellIdentity ::=
    INTEGER (0..503)

EUTRA-RadioAccessCapability ::=
    ue-EUTRA-Capability
SEQUENCE {
    OCTET STRING
}

EUTRA-TargetFreqInfoList ::=
    SEQUENCE (SIZE (1..maxEUTRATargetFreqs)) OF
    EUTRA-TargetFreqInfo

EUTRA-TargetFreqInfoList-vb50ext ::=
    SEQUENCE (SIZE (1..maxEUTRATargetFreqs)) OF
    EUTRA-TargetFreqInfo-vb50ext

EUTRA-TargetFreqInfo ::=
    dlEUTRACarrierFreq
    eutraBlacklistedCellPerFreqList
SEQUENCE {
    EARFCN,
    EUTRA-BlacklistedCellPerFreqList
OPTIONAL
}

EUTRA-TargetFreqInfo-vb50ext ::=
    earfcn
SEQUENCE {
    EARFCNExtension
OPTIONAL
}

--Actual value = 2^(IE value)
ExpirationTimeFactor ::=
    INTEGER (1..8)

ExpirationTimeFactor2 ::=
    INTEGER (0..15)

ExtGANSS-SchedulingInfo ::=
    extensionGANSS-SIBType
    schedulingInfo
    valueTagInfo
SEQUENCE {
    SIB-TypeExtGANSS,
    SchedulingInformation,
    ValueTagInfo
}

-- For each extended GANSS SIB type the value tag information is added at the end

```

```

ExtGANSS-SIBTypeInfoSchedulingInfoList ::= SEQUENCE (SIZE (1..maxGANSS)) OF
    ExtGANSS-SIBTypeInfoSchedulingInfo

ExtGANSS-SIBTypeInfoSchedulingInfo ::= SEQUENCE {
    ganssID                INTEGER (0..7)                OPTIONAL,
    sbasID                 UE-Positioning-GANSS-SBAS-ID    OPTIONAL,
    ganssScheduling        SEQUENCE (SIZE (1..maxSIB)) OF
                            ExtGANSS-SchedulingInfo
}

-- For each extended SIB type the value tag information is added at the end
ExtSIBTypeInfoSchedulingInfo-List ::= SEQUENCE (SIZE (1..maxSIB)) OF
    ExtSIBTypeInfoSchedulingInfo

ExtSIBTypeInfoSchedulingInfo ::= SEQUENCE {
    extensionSIB-Type      SIB-TypeExt,
    schedulingInfo         SchedulingInformation,
    valueTagInfo           ValueTagInfo
}

-- For each extended SIB type the value tag information is added at the end
ExtSIBTypeInfoSchedulingInfo-List2 ::= SEQUENCE (SIZE (1..maxSIB)) OF
    ExtSIBTypeInfoSchedulingInfo2

ExtSIBTypeInfoSchedulingInfo-List3 ::= SEQUENCE (SIZE (1..maxSIB)) OF
    ExtSIBTypeInfoSchedulingInfo3

ExtSIBTypeInfoSchedulingInfo2 ::= SEQUENCE {
    extensionSIB-Type2     SIB-TypeExt2,
    schedulingInfo         SchedulingInformation,
    valueTagInfo           ValueTagInfo
}

ExtSIBTypeInfoSchedulingInfo3 ::= SEQUENCE {
    extensionSIB-Type3     SIB-TypeExt3,
    schedulingInfo         SchedulingInformation2,
    valueTagInfo           ValueTagInfoExtValueTag
}

FDD-UMTS-Frequency-List ::= SEQUENCE (SIZE (1..maxNumFDDFreqs)) OF
    -- NOTE1: The IE "UARFCN (Nlow)" corresponds to
    -- "uarfcn-DL" in FrequencyInfoFDD.
    -- NOTE2: The IE "UARFCN (Nupper)" corresponds to
    -- "uarfcn-UL" in FrequencyInfoFDD.
    FrequencyInfoFDD

FrequencyInfoCDMA2000 ::= SEQUENCE {
    band-Class             BIT STRING (SIZE (5)),
    cdma-Freq              BIT STRING (SIZE(11))
}

GERAN-SystemInfoBlock ::= OCTET STRING (SIZE (1..23))

GERAN-SystemInformation ::= SEQUENCE (SIZE (1..maxGERAN-SI)) OF GERAN-SystemInfoBlock

GSM-BA-Range ::= SEQUENCE {
    gsmLowRangeUARFCN     UARFCN,
    gsmUpRangeUARFCN      UARFCN
}

GSM-BA-Range-List ::= SEQUENCE (SIZE (1..maxNumGSMFreqRanges)) OF
    GSM-BA-Range

-- This IE is formatted as 'TLV' and is coded in the same way as the Mobile Station Classmark 2
-- information element in [5]. The first octet is the Mobile station classmark 2 IEI and its value
-- shall be set to 33H. The second octet is the Length of mobile station classmark 2 and its value
-- shall be set to 3. The octet 3 contains the first octet of the value part of the Mobile Station
-- Classmark 2 information element, the octet 4 contains the second octet of the value part of the
-- Mobile Station Classmark 2 information element and so on. For each of these octets, the first/
-- leftmost/ most significant bit of the octet contains b8 of the corresponding octet of the Mobile
-- Station Classmark 2.
GSM-Classmark2 ::= OCTET STRING (SIZE (5))

-- This IE is formatted as 'V' and is coded in the same way as the value part in the Mobile station
-- classmark 3 information element in [5]
-- The value part is specified by means of CSN.1, which encoding results in a bit string, to which
-- final padding may be appended up to the next octet boundary [5]. The first/ leftmost bit of the

```

```

-- CSN.1 bit string is placed in the first/ leftmost/ most significant bit of the first
-- octet. This continues until the last bit of the CSN.1 bit string, which is placed in the last/
-- rightmost/ least significant bit of the last octet.
GSM-Classmark3 ::= OCTET STRING (SIZE (1..32))

GSM-MessageList ::= SEQUENCE (SIZE (1..maxInterSysMessages)) OF
    BIT STRING (SIZE (1..512))

GSM-MS-RadioAccessCapability ::= OCTET STRING (SIZE (1..64))

GsmSecurityCapability ::= BIT STRING {
    -- For each bit value "0" means false/ not supported
    a5-7(0),
    a5-6(1),
    a5-5(2),
    a5-4(3),
    a5-3(4),
    a5-2(5),
    a5-1(6)
} (SIZE (7))

GSM-TargetCellInfoList ::= SEQUENCE (SIZE (1..maxGSMTargetCells)) OF
    GSM-TargetCellInfo

GSM-TargetCellInfo ::= SEQUENCE {
    bccch-ARFCN BCCH-ARFCN,
    frequency-band Frequency-Band,
    bsic BSIC OPTIONAL
}

HNBNName ::= OCTET STRING (SIZE(1..maxHNBNNameSize))

IdentificationOfReceivedMessage ::= SEQUENCE {
    rrc-TransactionIdentifier RRC-TransactionIdentifier,
    receivedMessageType ReceivedMessageType
}

InterRAT-ChangeFailureCause ::= CHOICE {
    configurationUnacceptable NULL,
    physicalChannelFailure NULL,
    protocolError ProtocolErrorInformation,
    unspecified NULL,
    spare4 NULL,
    spare3 NULL,
    spare2 NULL,
    spare1 NULL
}

GERANIu-MessageList ::= SEQUENCE (SIZE (1..maxInterSysMessages)) OF
    BIT STRING (SIZE (1..32768))

GERANIu-RadioAccessCapability ::= BIT STRING (SIZE (1..170))

InterRAT-UE-RadioAccessCapability ::= CHOICE {
    gsm SEQUENCE {
        gsm-Classmark2 GSM-Classmark2,
        gsm-Classmark3 GSM-Classmark3
    },
    cdma2000 SEQUENCE {
        cdma2000-MessageList CDMA2000-MessageList
    }
}

InterRAT-UE-RadioAccessCapabilityList ::= SEQUENCE (SIZE(1..maxInterSysMessages)) OF
    InterRAT-UE-RadioAccessCapability

InterRAT-UE-RadioAccessCapability-v590ext ::= SEQUENCE {
    geranIu-RadioAccessCapability GERANIu-RadioAccessCapability
}

InterRAT-UE-RadioAccessCapability-v690ext ::= SEQUENCE {
    supportOfInter-RAT-PS-Handover ENUMERATED { doesSupporInter-RAT-PS-Handover } OPTIONAL,
    gsm-MS-RadioAccessCapability GSM-MS-RadioAccessCapability
}

InterRAT-UE-RadioAccessCapability-v860ext ::= SEQUENCE {
    eutra-RadioAccessCapability EUTRA-RadioAccessCapability OPTIONAL
}

```

```

}

InterRAT-UE-SecurityCapability ::= CHOICE {
    gsm                               SEQUENCE {
        gsmSecurityCapability         GsmSecurityCapability
    }
}

InterRAT-UE-SecurityCapList ::= SEQUENCE (SIZE(1..maxInterSysMessages)) OF
    InterRAT-UE-SecurityCapability

InterRAT-HO-FailureCause ::= CHOICE {
    configurationUnacceptable         NULL,
    physicalChannelFailure           NULL,
    protocolError                    ProtocolErrorInformation,
    interRAT-ProtocolError           NULL,
    unspecified                       NULL,
    spare11                          NULL,
    spare10                          NULL,
    spare9                           NULL,
    spare8                           NULL,
    spare7                           NULL,
    spare6                           NULL,
    spare5                           NULL,
    spare4                           NULL,
    spare3                           NULL,
    spare2                           NULL,
    spare1                           NULL
}

MasterInformationBlock ::= SEQUENCE {
    mib-ValueTag                     MIB-ValueTag,
    -- TABULAR: The PLMN identity and ANSI-41 core network information
    -- are included in PLMN-Type.
    plmn-Type                         PLMN-Type,
    sibSb-ReferenceList              SIBSb-ReferenceList,
    -- Extension mechanism for non- release99 information
    v690NonCriticalExtensions        SEQUENCE {
        masterInformationBlock-v690ext MasterInformationBlock-v690ext,
        v6b0NonCriticalExtensions     SEQUENCE {
            masterInformationBlock-v6b0ext MasterInformationBlock-v6b0ext-IEs,
            v860NonCriticalExtensions     SEQUENCE {
                masterInformationBlock-v860ext MasterInformationBlock-v860ext-IEs,
                vc50NonCriticalExtensions   SEQUENCE {
                    masterInformationBlock-vc50ext MasterInformationBlock-vc50ext-IEs,
                    nonCriticalExtensions   SEQUENCE {}
                }
            }
        }
    } OPTIONAL
}

MasterInformationBlock-v690ext ::= SEQUENCE {
    multiplePLMN-List                MultiplePLMN-List-r6          OPTIONAL
}

MasterInformationBlock-v6b0ext-IEs ::= SEQUENCE {
    extSIBTypeInfoSchedulingInfo-List ExtSIBTypeInfoSchedulingInfo-List OPTIONAL
}

MasterInformationBlock-v860ext-IEs ::= SEQUENCE {
    extSIBTypeInfoSchedulingInfo-List ExtSIBTypeInfoSchedulingInfo-List2 OPTIONAL,
    extGANSS-SIBTypeInfoSchedulingInfoList ExtGANSS-SIBTypeInfoSchedulingInfoList OPTIONAL,
    csg-Indicator                    ENUMERATED { true }          OPTIONAL
}

MasterInformationBlock-vc50ext-IEs ::= SEQUENCE {
    mib-ValueTagExt                  MIB-ValueTagExt          OPTIONAL,
    sibSb-ReferenceList              SIBSb-ReferenceList2   OPTIONAL,
    extSIBTypeInfoSchedulingInfo-List ExtSIBTypeInfoSchedulingInfo-List3 OPTIONAL,
    sb3-Information                  SB3-Information        OPTIONAL
}

SB3-Information ::= SEQUENCE {
    sb3-SegCount                     SegCount                DEFAULT 1,
    sb3-Sib-Rep                      SIB-Rep,

```

```

    second-BCH-Channelizationcode    BCH-Channelizationcode
}
MIB-ValueTag ::=                    INTEGER (1..8)
MIB-ValueTagExt ::=                 INTEGER (0..1)
NCC ::=                              INTEGER (0..7)
PLMN-ValueTag ::=                   INTEGER (1..256)

PredefinedConfigIdentityAndValueTag ::= SEQUENCE {
    predefinedConfigIdentity          PredefinedConfigIdentity,
    predefinedConfigValueTag         PredefinedConfigValueTag
}

ProtocolErrorInformation ::=         SEQUENCE {
    diagnosticsType                  CHOICE {
        type1                        SEQUENCE {
            protocolErrorCause       ProtocolErrorCause
        },
        spare                          NULL
    }
}

ReceivedMessageType ::=              ENUMERATED {
    activeSetUpdate,
    cellChangeOrderFromUTRAN,
    cellUpdateConfirm,
    counterCheck,
    downlinkDirectTransfer,
    interRATHandoverCommand,
    measurementControl,
    pagingType2,
    physicalChannelReconfiguration,
    physicalSharedChannelAllocation,
    radioBearerReconfiguration,
    radioBearerRelease,
    radioBearerSetup,
    rrcConnectionRelease,
    rrcConnectionReject,
    rrcConnectionSetup,
    securityModeCommand,
    signallingConnectionRelease,
    transportChannelReconfiguration,
    transportFormatCombinationControl,
    ueCapabilityEnquiry,
    ueCapabilityInformationConfirm,
    uplinkPhysicalChannelControl,
    uraUpdateConfirm,
    utranMobilityInformation,
    assistanceDataDelivery,
    spare6, spare5, spare4, spare3, spare2,
    spare1
}

Rplmn-Information ::=               SEQUENCE {
    gsm-BA-Range-List                GSM-BA-Range-List                OPTIONAL,
    fdd-UMTS-Frequency-List          FDD-UMTS-Frequency-List          OPTIONAL,
    tdd-UMTS-Frequency-List          TDD-UMTS-Frequency-List          OPTIONAL,
    cdma2000-UMTS-Frequency-List     CDMA2000-UMTS-Frequency-List     OPTIONAL
}

Rplmn-Information-r4 ::=            SEQUENCE {
    gsm-BA-Range-List                GSM-BA-Range-List                OPTIONAL,
    fdd-UMTS-Frequency-List          FDD-UMTS-Frequency-List          OPTIONAL,
    -- the option is the same for 7.68 Mcps TDD as for 3.84 Mcps TDD
    -- i.e. TDD-UMTS-Frequency-List applies
    tdd384-UMTS-Frequency-List       TDD-UMTS-Frequency-List          OPTIONAL,
    tdd128-UMTS-Frequency-List       TDD-UMTS-Frequency-List          OPTIONAL,
    cdma2000-UMTS-Frequency-List     CDMA2000-UMTS-Frequency-List     OPTIONAL
}

SIB-Rep ::=                         ENUMERATED {
    frame-8,
    frame-16,
    frame-32,
}

```



```

        frame-64
    }
    BCH-Channelizationcode ::= INTEGER (2..33)
    SchedulingInformation ::= SEQUENCE {
        scheduling SEQUENCE {
            segCount SegCount DEFAULT 1,
            sib-Pos CHOICE {
                -- The element name indicates the repetition period and the value
                -- (multiplied by two) indicates the position of the first segment.
                rep4 INTEGER (0..1),
                rep8 INTEGER (0..3),
                rep16 INTEGER (0..7),
                rep32 INTEGER (0..15),
                rep64 INTEGER (0..31),
                rep128 INTEGER (0..63),
                rep256 INTEGER (0..127),
                rep512 INTEGER (0..255),
                rep1024 INTEGER (0..511),
                rep2048 INTEGER (0..1023),
                rep4096 INTEGER (0..2047)
            },
            sib-PosOffsetInfo SibOFF-List OPTIONAL
        }
    }
    SchedulingInformation2 ::= CHOICE {
        scheduling SEQUENCE {
            segCount SegCount OPTIONAL,
            sib-Pos CHOICE {
                -- The element name indicates the repetition period and the value
                -- (multiplied by two) indicates the position of the first segment.
                rep4 INTEGER (0..1),
                rep8 INTEGER (0..3),
                rep16 INTEGER (0..7),
                rep32 INTEGER (0..15),
                rep64 INTEGER (0..31),
                rep128 INTEGER (0..63),
                rep256 INTEGER (0..127),
                rep512 INTEGER (0..255),
                rep1024 INTEGER (0..511),
                rep2048 INTEGER (0..1023),
                rep4096 INTEGER (0..2047)
            },
            sib-PosOffsetInfo SibOFF-List2 OPTIONAL
        }
    }
    SchedulingInformationSIB ::= SEQUENCE {
        sib-Type SIB-TypeAndTag,
        scheduling SchedulingInformation
    }
    SchedulingInformationSIB2 ::= SEQUENCE {
        sib-Type SIB-TypeAndTag2,
        scheduling SchedulingInformation2
    }
    SchedulingInformationSIBSb ::= SEQUENCE {
        sibSb-Type SIBSb-TypeAndTag,
        scheduling SchedulingInformation
    }
    SchedulingInformationSIBSb2 ::= SEQUENCE {
        sibSb-Type SIBSb-TypeAndTagExtValueTag
    }
    SegCount ::= INTEGER (1..16)
    SegmentIndex ::= INTEGER (1..15)
    -- Actual value SFN-Prime = 2 * IE value
    SFN-Prime ::= INTEGER (0..2047)
    SIB-Data-fixed ::= BIT STRING (SIZE (222))

```

```

SIB-Data2-fixed ::=          BIT STRING (SIZE (232))
SIB-Data-variable ::=       BIT STRING (SIZE (1..214))
SIB-Data2-variable ::=      BIT STRING (SIZE (1..224))
SIBOccurIdentity ::=        INTEGER (0..15)
SIBOccurrenceIdentityAndValueTag ::= SEQUENCE {
    sibOccurIdentity          SIBOccurIdentity,
    sibOccurValueTag         SIBOccurValueTag
}
SIBOccurValueTag ::=        INTEGER (0..15)
SIB-ReferenceList ::=       SEQUENCE (SIZE (1..maxSIB)) OF
    SchedulingInformationSIB
SIB-ReferenceList2 ::=      SEQUENCE (SIZE (1..maxSIB2)) OF
    SchedulingInformationSIB2
SIBSb-ReferenceList ::=     SEQUENCE (SIZE (1..maxSIB)) OF
    SchedulingInformationSIBSb
SIBSb-ReferenceList2 ::=    SEQUENCE (SIZE (1..maxSIB)) OF
    SchedulingInformationSIBSb2
SIB-ReferenceListFACH ::=   SEQUENCE (SIZE (1..maxSIB-FACH)) OF
    SchedulingInformationSIB
SIB-Type ::=                ENUMERATED {
    masterInformationBlock,
    systemInformationBlockType1,
    systemInformationBlockType2,
    systemInformationBlockType3,
    systemInformationBlockType4,
    systemInformationBlockType5,
    systemInformationBlockType6,
    systemInformationBlockType7,
    -- dummy, dummy2 and dummy3 are not used in this version of the specification,
    -- they should not be sent. If they are received they should be ignored
    dummy,
    dummy2,
    dummy3,
    systemInformationBlockType11,
    systemInformationBlockType12,
    systemInformationBlockType13,
    systemInformationBlockType13-1,
    systemInformationBlockType13-2,
    systemInformationBlockType13-3,
    systemInformationBlockType13-4,
    systemInformationBlockType14,
    systemInformationBlockType15,
    systemInformationBlockType15-1,
    systemInformationBlockType15-2,
    systemInformationBlockType15-3,
    systemInformationBlockType16,
    systemInformationBlockType17,
    systemInformationBlockType15-4,
    systemInformationBlockType18,
    schedulingBlock1,
    schedulingBlock2,
    systemInformationBlockType15-5,
    systemInformationBlockType5bis,
    extensionType }
SIB-Type2 ::=              ENUMERATED {
    schedulingBlock3,
    systemInformationBlockType1,
    systemInformationBlockType2,
    systemInformationBlockType3,
    systemInformationBlockType4,
    systemInformationBlockType5,
    systemInformationBlockType5bis,
    systemInformationBlockType6,
    systemInformationBlockType7,
    systemInformationBlockType11,
    systemInformationBlockType11bis,

```

```

systemInformationBlockType12,
systemInformationBlockType13,
systemInformationBlockType13-1,
systemInformationBlockType13-2,
systemInformationBlockType13-3,
systemInformationBlockType13-4,
systemInformationBlockType14,
systemInformationBlockType15,
systemInformationBlockType15bis,
systemInformationBlockType15-1,
systemInformationBlockType15-1bis,
systemInformationBlockType15-1ter,
systemInformationBlockType15-2,
systemInformationBlockType15-2bis,
systemInformationBlockType15-2ter,
systemInformationBlockType15-3,
systemInformationBlockType15-3bis,
systemInformationBlockType15-4,
systemInformationBlockType15-5,
systemInformationBlockType15-6,
systemInformationBlockType15-7,
systemInformationBlockType15-8,
systemInformationBlockType16,
systemInformationBlockType17,
systemInformationBlockType18,
systemInformationBlockType19,
systemInformationBlockType20,
systemInformationBlockType21,
systemInformationBlockType22,
systemInformationBlockType23,
systemInformationBlockType24,
systemInformationBlockType11ter,
spare21, spare20, spare19, spare18,
spare17, spare16, spare15, spare14, spare13, spare12,
spare11, spare10, spare9, spare8, spare7, spare6,
spare5, spare4, spare3, spare2, spare1 }

```

```

SIB-TypeAndTag ::=
    sysInfoType1
    sysInfoType2
    sysInfoType3
    sysInfoType4
    sysInfoType5
    sysInfoType6
    sysInfoType7
    -- dummy, dummy2 and dummy3 are not used in this version of the specification,
    -- they should not be sent. If they are received the UE behaviour is not specified.
    dummy
    dummy2
    dummy3
    sysInfoType11
    sysInfoType12
    sysInfoType13
    sysInfoType13-1
    sysInfoType13-2
    sysInfoType13-3
    sysInfoType13-4
    sysInfoType14
    sysInfoType15
    sysInfoType16
    sysInfoType17
    sysInfoType15-1
    sysInfoType15-2
    sysInfoType15-3
    sysInfoType15-4
    sysInfoType18
    sysInfoType15-5
    sysInfoType5bis
    spare4
    spare3
    spare2
    spare1
}

```

```

CHOICE {
    PLMN-ValueTag,
    CellValueTag,
    CellValueTag,
    CellValueTag,
    CellValueTag,
    CellValueTag,
    NULL,
    CellValueTag,
    NULL,
    NULL,
    CellValueTag,
    CellValueTag,
    CellValueTag,
    CellValueTag,
    CellValueTag,
    CellValueTag,
    CellValueTag,
    CellValueTag,
    CellValueTag,
    CellValueTag,
    CellValueTag,
    PredefinedConfigIdentityAndValueTag,
    NULL,
    CellValueTag,
    SIBOccurrenceIdentityAndValueTag,
    SIBOccurrenceIdentityAndValueTag,
    CellValueTag,
    CellValueTag,
    CellValueTag,
    CellValueTag,
    NULL,
    NULL,
    NULL,
    NULL
}

```

```

SIB-TypeAndTag2 ::=
    sysInfoType1
    sysInfoType2
    sysInfoType3
}

```

```

CHOICE {
    PLMN-ValueTag,
    CellValueTag,
    CellValueTag3,
}

```

```

sysInfoType4          CellValueTag,
sysInfoType5          CellValueTag3,
sysInfoType5bis       CellValueTag3,
sysInfoType6          CellValueTag,
sysInfoType7          NULL,
sysInfoType11         CellValueTag,
sysInfoType11bis      CellValueTag,
sysInfoType12         CellValueTag,
sysInfoType13         CellValueTag,
sysInfoType13-1       CellValueTag,
sysInfoType13-2       CellValueTag,
sysInfoType13-3       CellValueTag,
sysInfoType13-4       CellValueTag,
sysInfoType14         NULL,
sysInfoType15         CellValueTag,
sysInfoType15bis      CellValueTag,
sysInfoType15-1       CellValueTag,
sysInfoType15-1bis    CellValueTag,
sysInfoType15-1ter    CellValueTag,
sysInfoType15-2       SIBOccurrenceIdentityAndValueTag,
sysInfoType15-2bis    SIBOccurrenceIdentityAndValueTag,
sysInfoType15-2ter    SIBOccurrenceIdentityAndValueTag,
sysInfoType15-3       SIBOccurrenceIdentityAndValueTag,
sysInfoType15-3bis    SIBOccurrenceIdentityAndValueTag,
sysInfoType15-4       CellValueTag,
sysInfoType15-5       CellValueTag,
sysInfoType15-6       CellValueTag,
sysInfoType15-7       CellValueTag,
sysInfoType15-8       CellValueTag,
sysInfoType16         PredefinedConfigIdentityAndValueTag,
sysInfoType17         NULL,
sysInfoType18         CellValueTag,
sysInfoType19         CellValueTag,
sysInfoType20         CellValueTag,
sysInfoType21         CellValueTag3,
sysInfoType22         CellValueTag3,
sysInfoType23         CellValueTag,
sysInfoType24         NULL,
sysInfoType11ter      CellValueTag3,
spare22               NULL,
spare21               NULL,
spare20               NULL,
spare19               NULL,
spare18               NULL,
spare17               NULL,
spare16               NULL,
spare15               NULL,
spare14               NULL,
spare13               NULL,
spare12               NULL,
spare11               NULL,
spare10               NULL,
spare9                NULL,
spare8                NULL,
spare7                NULL,
spare6                NULL,
spare5                NULL,
spare4                NULL,
spare3                NULL,
spare2                NULL,
spare1                NULL
}

SIBSb-TypeAndTag ::= CHOICE {
  sysInfoType1        PLMN-ValueTag,
  sysInfoType2        CellValueTag,
  sysInfoType3        CellValueTag,
  sysInfoType4        CellValueTag,
  sysInfoType5        CellValueTag,
  sysInfoType6        CellValueTag,
  sysInfoType7        NULL,
  -- dummy, dummy2 and dummy3 are not used in this version of the specification,
  -- they should not be sent. If they are received the UE behaviour is not specified.
  dummy               CellValueTag,
  dummy2              NULL,
  dummy3              NULL,
  sysInfoType11       CellValueTag,
  sysInfoType12       CellValueTag,

```

```

sysInfoType13          CellValueTag,
sysInfoType13-1       CellValueTag,
sysInfoType13-2       CellValueTag,
sysInfoType13-3       CellValueTag,
sysInfoType13-4       CellValueTag,
sysInfoType14         NULL,
sysInfoType15         CellValueTag,
sysInfoType16         PredefinedConfigIdentityAndValueTag,
sysInfoType17         NULL,
sysInfoTypeSB1        CellValueTag,
sysInfoTypeSB2        CellValueTag,
sysInfoType15-1       CellValueTag,
sysInfoType15-2       SIBOccurrenceIdentityAndValueTag,
sysInfoType15-3       SIBOccurrenceIdentityAndValueTag,
sysInfoType15-4       CellValueTag,
sysInfoType18         CellValueTag,
sysInfoType15-5       CellValueTag,
sysInfoType5bis       CellValueTag,
spare2                NULL,
spare1                NULL
}

```

```

SIBSb-TypeAndTagExtValueTag ::= CHOICE {
  sysInfoType3          CellValueTagExt,
  sysInfoType5          CellValueTagExt,
  sysInfoType5bis       CellValueTagExt,
  sysInfoType21         CellValueTagExt,
  sysInfoType22         CellValueTagExt,
  spare3                NULL,
  spare2                NULL,
  spare1                NULL
}

```

```

SIB-TypeExt ::= CHOICE {
  systemInfoType11bis  NULL,
  systemInfoType15bis  NULL,
  systemInfoType15-1bis NULL,
  systemInfoType15-2bis NULL,
  systemInfoType15-3bis NULL,
  systemInfoType15-6   NULL,
  systemInfoType15-7   NULL,
  systemInfoType15-8   NULL
}

```

```

SIB-TypeExt2 ::= CHOICE {
  systemInfoType19      NULL,
  systemInfoType15-2ter NULL,
  systemInfoType20      NULL,
  systemInfoType21      NULL,
  systemInfoType22      NULL,
  systemInfoType15-1ter NULL,
  systemInfoType23      NULL,
  systemInfoType24      NULL
}

```

```

SIB-TypeExt3 ::= CHOICE {
  systemInfoType11ter  NULL,
  spare7               NULL,
  spare6               NULL,
  spare5               NULL,
  spare4               NULL,
  spare3               NULL,
  spare2               NULL,
  spare1               NULL
}

```

```

SIB-TypeExtGANSS ::= CHOICE {
  systemInfoType15-1bis NULL,
  systemInfoType15-2bis NULL,
  systemInfoType15-2ter NULL,
  systemInfoType15-3bis NULL,
  systemInfoType15-6   NULL,
  systemInfoType15-7   NULL,
  systemInfoType15-8   NULL,
  spare9               NULL,
  spare8               NULL,
  spare7               NULL,
}

```

```

    spare6                NULL,
    spare5                NULL,
    spare4                NULL,
    spare3                NULL,
    spare2                NULL,
    spare1                NULL
}

SibOFF ::=
    ENUMERATED {
        so2, so4, so6, so8, so10,
        so12, so14, so16, so18,
        so20, so22, so24, so26,
        so28, so30, so32 }

SibOFF-vc50ext ::=
    SEQUENCE {
        sibOFF                OPTIONAL
    }

SibOFF-List ::=
    SEQUENCE (SIZE (1..15)) OF
        SibOFF

SibOFF-List2 ::=
    SEQUENCE (SIZE (1..15)) OF
        SibOFF-vc50ext

SysInfoType1 ::=
    SEQUENCE {
        -- Core network IEs
        cn-CommonGSM-MAP-NAS-SysInfo    NAS-SystemInformationGSM-MAP,
        cn-DomainSysInfoList            CN-DomainSysInfoList,
        -- User equipment IEs
        ue-ConnTimersAndConstants        UE-ConnTimersAndConstants        OPTIONAL,
        ue-IdleTimersAndConstants        UE-IdleTimersAndConstants        OPTIONAL,
        -- Extension mechanism for non- release99 information
        v3a0NonCriticalExtensions        SEQUENCE {
            sysInfoType1-v3a0ext        SysInfoType1-v3a0ext-IEs,
            v860NonCriticalExtensions    SEQUENCE {
                sysInfoType1-v860ext    SysInfoType1-v860ext-IEs,
                nonCriticalExtensions    SEQUENCE {} OPTIONAL
            } OPTIONAL
        } OPTIONAL
    }

SysInfoType1-v3a0ext-IEs ::= SEQUENCE {
    ue-ConnTimersAndConstants-v3a0ext    UE-ConnTimersAndConstants-v3a0ext,
    ue-IdleTimersAndConstants-v3a0ext    UE-IdleTimersAndConstants-v3a0ext
}

SysInfoType1-v860ext-IEs ::= SEQUENCE {
    ue-ConnTimersAndConstants            UE-ConnTimersAndConstants-v860ext
}

SysInfoType2 ::=
    SEQUENCE {
        -- UTRAN mobility IEs
        ura-IdentityList                URA-IdentityList,
        -- Extension mechanism for non- release99 information
        nonCriticalExtensions            SEQUENCE {}                OPTIONAL
    }

SysInfoType3 ::=
    SEQUENCE {
        sib4indicator                    BOOLEAN,
        -- UTRAN mobility IEs
        cellIdentity                      CellIdentity,
        cellSelectReselectInfo            CellSelectReselectInfoSIB-3-4,
        cellAccessRestriction            CellAccessRestriction,
        -- Extension mechanism for non- release99 information
        v4b0NonCriticalExtensions        SEQUENCE {
            sysInfoType3-v4b0ext        SysInfoType3-v4b0ext-IEs,
            v590NonCriticalExtension    SEQUENCE {
                sysInfoType3-v590ext    SysInfoType3-v590ext,
                v5c0NoncriticalExtension SEQUENCE {
                    sysInfoType3-v5c0ext SysInfoType3-v5c0ext-IEs,
                    v670NonCriticalExtension SEQUENCE {
                        sysInfoType3-v670ext SysInfoType3-v670ext,
                        v770NonCriticalExtension SEQUENCE {
                            sysInfoType3-v770ext SysInfoType3-v770ext-IEs,
                            v830NonCriticalExtension SEQUENCE {
                                sysInfoType3-v830ext SysInfoType3-v830ext-IEs,
                                v860NonCriticalExtension SEQUENCE {
                                    sysInfoType3-v860ext SysInfoType3-v860ext-IEs,
            }
        }
        }
        }
        }
        }
    }

```

```

    v870NonCriticalExtension          SEQUENCE {
      sysInfoType3-v870ext
      v900NonCriticalExtension        SEQUENCE {
        sysInfoType3-v920ext
        vc50NonCriticalExtension      SEQUENCE {
          sysInfoType3-vc50ext
          SysInfoType3-vc50ext-
IES,
          nonCriticalExtensions      SEQUENCE {} OPTIONAL
        }
      }
    }
  }
}
OPTIONAL
OPTIONAL
OPTIONAL
OPTIONAL
OPTIONAL
OPTIONAL
OPTIONAL
OPTIONAL
OPTIONAL
OPTIONAL
}
SysInfoType3-v4b0ext-IEs ::= SEQUENCE {
  mapping-LCR                        Mapping-LCR-r4                OPTIONAL
}
SysInfoType3-v590ext ::= SEQUENCE {
  cellSelectReselectInfo-v590ext    CellSelectReselectInfo-v590ext  OPTIONAL
}
SysInfoType3-v5c0ext-IEs ::= SEQUENCE {
  cellSelectReselectInfoTreselectionScaling-v5c0ext
  CellSelectReselectInfoTreselectionScaling-v5c0ext  OPTIONAL
}
SysInfoType3-v670ext ::= SEQUENCE {
  domainSpecificAccessRestrictionParametersForPLMNOfMIB
  DomainSpecificAccessRestrictionParam-v670ext      OPTIONAL,
  domainSpecificAccessRestrictionForSharedNetwork
  DomainSpecificAccessRestrictionForSharedNetwork-v670ext  OPTIONAL
}
SysInfoType3-v770ext-IEs ::= SEQUENCE {
  deferredMeasurementControlReadingSupport
  DeferredMeasurementControlReadingSupport          OPTIONAL,
  q-QualMin-Offset                                Q-QualMin-Offset              OPTIONAL,
  q-RxlevMin-Offset                              Q-RxlevMin-Offset             OPTIONAL,
  mbsfnOnlyService                               MBSFNOnlyService              OPTIONAL
}
SysInfoType3-v830ext-IEs ::= SEQUENCE {
  pagingPermissionWithAccessControlParametersForPLMNOfMIB
  PagingPermissionWithAccessControlParameters      OPTIONAL,
  pagingPermissionWithAccessControlParametersForSharedNetwork
  PagingPermissionWithAccessControlForSharedNetwork  OPTIONAL
}
SysInfoType3-v860ext-IEs ::= SEQUENCE {
  csgIdentity                                    CSG-Identity                  OPTIONAL,
  csg-PSCsplitInfo                              CSG-PSCsplitInfo              OPTIONAL
}
SysInfoType3-v870ext-IEs ::= SEQUENCE {
  cellAccessRestriction                        CellAccessRestriction-v870ext  OPTIONAL
}
SysInfoType3-v920ext-IEs ::= SEQUENCE {
  imsEmergencySupportIndicator                ENUMERATED { supported }      OPTIONAL
}
SysInfoType3-vc50ext-IEs ::= SEQUENCE {
  txFailParams                                TxFailParams                  OPTIONAL
}
SysInfoType4 ::= SEQUENCE {
  -- UTRAN mobility IEs
  cellIdentity                                CellIdentity,
  cellSelectReselectInfo                      CellSelectReselectInfoSIB-3-4,
  cellAccessRestriction                       CellAccessRestriction,
  -- Extension mechanism for non- release99 information

```

```

v4b0NonCriticalExtensions SEQUENCE {
  sysInfoType4-v4b0ext SysInfoType4-v4b0ext-IEs,
  v590NonCriticalExtension SEQUENCE {
    sysInfoType4-v590ext SysInfoType4-v590ext,
    v5b0NonCriticalExtension SEQUENCE {
      sysInfoType4-v5b0ext SysInfoType4-v5b0ext-IEs,
      v5c0NonCriticalExtension SEQUENCE {
        sysInfoType4-v5c0ext SysInfoType4-v5c0ext-IEs,
        nonCriticalExtensions SEQUENCE {} OPTIONAL
      } OPTIONAL
    } OPTIONAL
  } OPTIONAL
}

SysInfoType4-v4b0ext-IEs ::= SEQUENCE {
  mapping-LCR Mapping-LCR-r4 OPTIONAL
}

SysInfoType4-v590ext ::= SEQUENCE {
  cellSelectReselectInfo-v590ext CellSelectReselectInfo-v590ext OPTIONAL
}

SysInfoType4-v5b0ext-IEs ::= SEQUENCE {
  cellSelectReselectInfoPCHFACH-v5b0ext CellSelectReselectInfoPCHFACH-v5b0ext OPTIONAL
}

SysInfoType4-v5c0ext-IEs ::= SEQUENCE {
  cellSelectReselectInfoTreselectionScaling-v5c0ext CellSelectReselectInfoTreselectionScaling-v5c0ext OPTIONAL
}

SysInfoType5 ::= SEQUENCE {
  sib6indicator BOOLEAN,
  -- Physical channel IEs
  pich-PowerOffset PICH-PowerOffset,
  modeSpecificInfo CHOICE {
    fdd SEQUENCE {
      aich-PowerOffset AICH-PowerOffset
    },
    tdd SEQUENCE {
      -- If PDSCH/PUSCH is configured for 1.28Mcps or 7.68Mcps TDD, the following IEs should be absent
      -- and the info included in the respective tdd128SpecificInfo or tdd768SpecificInfo instead.
      -- If PDSCH/PUSCH is configured for 3.84Mcps TDD in R5, HCR-r5-SpecificInfo should also be
      -- included.
      pusch-SysInfoList-SFN PUSCH-SysInfoList-SFN OPTIONAL,
      pdsch-SysInfoList-SFN PDSCH-SysInfoList-SFN OPTIONAL,
      openLoopPowerControl-TDD OpenLoopPowerControl-TDD
    }
  },
  primaryCCPCH-Info PrimaryCCPCH-Info OPTIONAL,
  prach-SystemInformationList PRACH-SystemInformationList,
  sCCPCH-SystemInformationList SCCPCH-SystemInformationList,
  -- cbs-DRX-Level1Information is conditional on any of the CTCH indicator IEs in
  -- sCCPCH-SystemInformationList
  cbs-DRX-Level1Information CBS-DRX-Level1Information OPTIONAL,
  -- Extension mechanism for non- release99 information
  v4b0NonCriticalExtensions SEQUENCE {
    sysInfoType5-v4b0ext SysInfoType5-v4b0ext-IEs OPTIONAL,
    -- Extension mechanism for non- rel-4 information
    v590NonCriticalExtensions SEQUENCE {
      sysInfoType5-v590ext SysInfoType5-v590ext-IEs OPTIONAL,
      v650NonCriticalExtensions SEQUENCE {
        sysInfoType5-v650ext SysInfoType5-v650ext-IEs OPTIONAL,
        v680NonCriticalExtensions SEQUENCE {
          sysInfoType5-v680ext SysInfoType5-v680ext-IEs OPTIONAL,
          v690NonCriticalExtensions SEQUENCE {
            sysInfoType5-v690ext SysInfoType5-v690ext-IEs,
            v770NonCriticalExtensions SEQUENCE {
              sysInfoType5-v770ext SysInfoType5-v770ext-IEs,
              v860NonCriticalExtensions SEQUENCE {
                sysInfoType5-v860ext SysInfoType5-v860ext-IEs,
                v890NonCriticalExtensions SEQUENCE {
                  sysInfoType5-v890ext SysInfoType5-v890ext-IEs,
                  v8b0NonCriticalExtensions SEQUENCE {
                    sysInfoType5-v8b0ext SysInfoType5-v8b0ext-IEs,

```



```

SysInfoType5-v770ext-IEs ::= SEQUENCE {
  modeSpecificInfo CHOICE {
    fdd SEQUENCE {
      hs-dsch-CommonSystemInformation HS-DSCH-CommonSystemInformation,
      hs-dsch-PagingSystemInformation HS-DSCH-PagingSystemInformation OPTIONAL
    },
    tdd768 SEQUENCE {
      pusch-SysInfoList-SFN PUSCH-SysInfoList-SFN-VHCR OPTIONAL,
      pdsch-SysInfoList-SFN PDSCH-SysInfoList-VHCR-r7 OPTIONAL,
      -- If SysInfoType5 is sent to configure a 7.68Mcps TDD cell, the 'prach-RACH-Info' in
      -- IE PRACH-SystemInformationList shall be ignored, 'prach-Partitioning' shall be absent
      -- and the corresponding IE in the following IE PRACH-SystemInformationList-VHCR-r7
      -- shall be used instead.
      prach-SystemInformationList PRACH-SystemInformationList-VHCR-r7 OPTIONAL
    },
    tdd128 SEQUENCE {
      prach-SystemInformationList PRACH-SystemInformationList-LCR-v770ext OPTIONAL
    }
  } OPTIONAL,
  -- If SysInfoType5 is sent to configure a 7.68 Mcps TDD cell (in any mode) or a 3.84 Mcps TDD
  -- cell operating in MBSFN mode, IE SCCPCH-SystemInformationList-HCR-VHCR-r7 is used, otherwise
  -- IE SCCPCH-SystemInformationList-r6 is used.
  sccpch-SystemInformationList SCCPCH-SystemInformationList-HCR-VHCR-r7 OPTIONAL,
  sccpch-SystemInformation-MBMS CHOICE {
    -- If choice is 'mcchOnSCCPCHusedForNonMBMS', IE MBMS-MCCH-ConfigurationInfo-r6 is used.
    -- If choice is 'mcchOnSCCPCHusedOnlyForMBMS', IE MBMS-MCCH-ConfigurationInfo-r7 is used
    -- to configure a 7.68Mcps TDD cell or a cell operating in MBSFN mode, otherwise IE
    -- SCCPCH-SystemInformation-MBMS-r6 is used.
    mcchOnSCCPCHusedOnlyForMBMS SCCPCH-SystemInformation-MBMS-r7
  } OPTIONAL,
  tDD-MBSFNInformation TDD-MBSFNInformation OPTIONAL
}

SysInfoType5-v860ext-IEs ::= SEQUENCE {
  -- The field 'dummy' shall be marked absent in SysInfoType5 and SysInfoType5bis. A failure to
  -- comply with this requirement may prevent the UE to receive any service in the cell. The UE
  -- may treat the cell as barred.
  dummy SEQUENCE {} OPTIONAL,
  modeSpecificInfo CHOICE {
    fdd SEQUENCE {
      hs-dsch-DrxCellfach-info HS-DSCH-DrxCellfach-info OPTIONAL
    },
    tdd128 SEQUENCE {
      hs-dsch-CommonSysInfo SEQUENCE {
        hs-dsch-CommonSystemInformation HS-DSCH-CommonSystemInformation-TDD128,
        hs-dsch-PagingSystemInformation HS-DSCH-PagingSystemInformation-TDD128 OPTIONAL
      } OPTIONAL,
      hs-dsch-DrxCellfach-info HS-DSCH-DrxCellfach-info-TDD128 OPTIONAL
    }
  }
}

SysInfoType5-v890ext-IEs ::= SEQUENCE {
  secondFrequencyInfo FrequencyInfoTDD OPTIONAL,
  commonEDCHSystemInfo CommonEDCHSystemInfo OPTIONAL
}

SysInfoType5-v8b0ext-IEs ::= SEQUENCE {
  tresetUsageIndicator ENUMERATED { true } OPTIONAL,
  upPCHpositionInfo UpPCHposition-LCR OPTIONAL
}

SysInfoType5-v8d0ext-IEs ::= SEQUENCE {
  commonEDCHSystemInfoFDD CommonEDCHSystemInfoFDD OPTIONAL
}

SysInfoType5-va40ext-IEs ::= SEQUENCE {
  frequencyBandsIndicatorSupport FrequencyBandsIndicatorSupport OPTIONAL,
  frequencyBandIndicator3 RadioFrequencyBandFDD3 OPTIONAL
}

SysInfoType5-va80ext-IEs ::= SEQUENCE {
  multipleFrequencyBandIndicatorListFDD MultipleFrequencyBandIndicatorListFDD OPTIONAL
}

SysInfoType5-NonCriticalExtensions-vb50-IEs ::= SEQUENCE {
  sysInfoType5-vb50ext SysInfoType5-vb50ext-IEs,
  nonCriticalExtensions SEQUENCE {} OPTIONAL
}

```

```

}

SysInfoType5-vb50ext-IEs ::= SEQUENCE {
    sib22indicator          BOOLEAN,
    cellUpdateMessageOptimisedEncoding  ENUMERATED { true }    OPTIONAL
}

-- SysInfoType5bis uses the same structure as SysInfoType5
SysInfoType5bis ::= SysInfoType5

SysInfoType6 ::=
    SEQUENCE {
        -- Physical channel IEs
        pich-PowerOffset          PICH-PowerOffset,
        modeSpecificInfo          CHOICE {
            fdd                    SEQUENCE {
                aich-PowerOffset          AICH-PowerOffset,
                -- dummy is not used in this version of specification, it should
                -- not be sent and if received it should be ignored.
                dummy                  CSICH-PowerOffset          OPTIONAL
            },
            tdd                    SEQUENCE {
                -- If PDSCH/PUSCH is configured for 1.28Mcps TDD, pusch-SysInfoList-SFN,
                -- pdsch-SysInfoList-SFN and openLoopPowerControl-TDD should be absent
                -- and the info included in the tdd128SpecificInfo instead.
                -- If PDSCH/PUSCH is configured for 7.68Mcps TDD, pusch-SysInfoList-SFN
                -- and pdsch-SysInfoList-SFN should be absent and the info included in the
                -- tdd768SpecificInfo instead.
                -- If PDSCH/PUSCH is configured for 3.84Mcps TDD in R5, HCR-r5-SpecificInfo should
                -- also be included.
                pusch-SysInfoList-SFN          PUSCH-SysInfoList-SFN          OPTIONAL,
                pdsch-SysInfoList-SFN          PDSCH-SysInfoList-SFN          OPTIONAL,
                openLoopPowerControl-TDD          OpenLoopPowerControl-TDD
            }
        },
        primaryCCPCH-Info          PrimaryCCPCH-Info          OPTIONAL,
        prach-SystemInformationList  PRACH-SystemInformationList  OPTIONAL,
        sCCPCH-SystemInformationList  SCCPCH-SystemInformationList  OPTIONAL,
        cbs-DRX-Level1Information  CBS-DRX-Level1Information  OPTIONAL,
        -- Conditional on any of the CTCH indicator IEs in
        -- sCCPCH-SystemInformationList
        -- Extension mechanism for non- release99 information
        v4b0NonCriticalExtensions  SEQUENCE {
            sysInfoType6-v4b0ext          SysInfoType6-v4b0ext-IEs          OPTIONAL,
            -- Extension mechanism for non- rel-4 information
            v590NonCriticalExtensions  SEQUENCE {
                sysInfoType6-v590ext          SysInfoType6-v590ext-IEs          OPTIONAL,
                v650nonCriticalExtensions  SEQUENCE {
                    sysInfoType6-v650ext          SysInfoType6-v650ext-IEs          OPTIONAL,
                    v690nonCriticalExtensions  SEQUENCE {
                        sysInfoType6-v690ext          SysInfoType6-v690ext-IEs,
                        v770NonCriticalExtensions  SEQUENCE {
                            sysInfoType6-v770ext          SysInfoType6-v770ext-IEs,
                            va40NonCriticalExtensions  SEQUENCE {
                                sysInfoType6-va40ext          SysInfoType6-va40ext-IEs,
                                va80NonCriticalExtensions  SEQUENCE {
                                    sysInfoType6-va80ext          SysInfoType6-va80ext-IEs,
                                    nonCriticalExtensions  SEQUENCE {} OPTIONAL
                                } OPTIONAL
                            } OPTIONAL
                        } OPTIONAL
                    } OPTIONAL
                } OPTIONAL
            } OPTIONAL
        } OPTIONAL
    } OPTIONAL
}

SysInfoType6-v4b0ext-IEs ::= SEQUENCE {
    -- openLoopPowerControl-IPDL-TDD is present only if IPDLs are applied for TDD
    openLoopPowerControl-IPDL-TDD  OpenLoopPowerControl-IPDL-TDD-r4  OPTIONAL,
    -- If SysInfoType6 is sent to describe a 1.28Mcps TDD cell, the IE PRACH-RACH-Info included
    -- in PRACH-SystemInformationList shall be ignored, the IE PRACH-Partitioning and the
    -- IE rach-TransportFormatSet shall be absent and the corresponding IEs in the following
    -- PRACH-SystemInformationList-LCR-r4 shall be used
    prach-SystemInformationList-LCR-r4  PRACH-SystemInformationList-LCR-r4  OPTIONAL,
    tdd128SpecificInfo          SEQUENCE {
        pusch-SysInfoList-SFN          PUSCH-SysInfoList-SFN-LCR-r4  OPTIONAL,
        pdsch-SysInfoList-SFN          PDSCH-SysInfoList-SFN-LCR-r4  OPTIONAL,
        pCCPCH-LCR-Extensions          PrimaryCCPCH-Info-LCR-r4-ext  OPTIONAL,

```

```

        sccpCH-LCR-ExtensionsList      SCCPCH-SystemInformationList-LCR-r4-ext OPTIONAL
    }
    frequencyBandIndicator             RadioFrequencyBandFDD             OPTIONAL
}

SysInfoType6-v590ext-IEs ::= SEQUENCE {
    hcr-r5-SpecificInfo                SEQUENCE {
        pusch-SysInfoList-SFN          PUSCH-SysInfoList-SFN-HCR-r5    OPTIONAL,
        pdsch-SysInfoList-SFN          PDSCH-SysInfoList-SFN-HCR-r5    OPTIONAL
    }
}

SysInfoType6-v650ext-IEs ::= SEQUENCE {
    frequencyBandIndicator2            RadioFrequencyBandFDD2
}

SysInfoType6-v690ext-IEs ::= SEQUENCE {
    additionalPRACH-TF-and-TFCS-CCCH-List AdditionalPRACH-TF-and-TFCS-CCCH-List OPTIONAL
}

SysInfoType6-v770ext-IEs ::= SEQUENCE {
    tdd768SpecificInfo                 SEQUENCE {
        pusch-SysInfoList-SFN          PUSCH-SysInfoList-SFN-VHCR      OPTIONAL,
        pdsch-SysInfoList-SFN          PDSCH-SysInfoList-VHCR-r7      OPTIONAL,
        -- If SysInfoType6 is sent to configure a 7.68Mcps TDD cell, the 'prach-RACH-Info' in
        -- IE PRACH-SystemInformationList shall be ignored, 'prach-Partitioning' shall be absent
        -- and the corresponding IE in the following IE PRACH-SystemInformationList-VHCR-r7
        -- shall be used instead.
        prach-SystemInformationList     PRACH-SystemInformationList-VHCR-r7 OPTIONAL
    },
    -- If SysInfoType6 is sent to configure a 7.68 Mcps TDD cell,
    -- IE SCCPCH-SystemInformationList-HCR-VHCR-r7 is used, otherwise
    -- IE SCCPCH-SystemInformationList-r6 is used.
    sccpch-SystemInformationList        SCCPCH-SystemInformationList-HCR-VHCR-r7 OPTIONAL
}

SysInfoType6-va40ext-IEs ::= SEQUENCE {
    frequencyBandIndicator3            RadioFrequencyBandFDD3          OPTIONAL
}

SysInfoType6-va80ext-IEs ::= SEQUENCE {
    multipleFrequencyBandIndicatorListFDD MultipleFrequencyBandIndicatorListFDD OPTIONAL
}

SysInfoType7 ::= SEQUENCE {
    -- Physical channel IEs
    modeSpecificInfo                   CHOICE {
        fdd                             SEQUENCE {
            ul-Interference              UL-Interference
        },
        tdd                             NULL
    },
    prach-Information-SIB5-List         DynamicPersistenceLevelList,
    prach-Information-SIB6-List         DynamicPersistenceLevelList    OPTIONAL,
    expirationTimeFactor                ExpirationTimeFactor            OPTIONAL,
    -- Extension mechanism for non- release99 information
    nonCriticalExtensions                SEQUENCE { }                    OPTIONAL
}

-- This IE is not used in this version of the specification.
-- It was kept only for backwards compatibility reasons
SysInfoType8 ::= SEQUENCE {
    -- User equipment IEs
    -- dummy1, dummy2, dummy3 are not used in this version of the specification and
    -- they should be ignored by the receiver.
    dummy1                              CPCH-Parameters,
    -- Physical channel IEs
    dummy2                              CPCH-SetInfoList,
    dummy3                              CSICH-PowerOffset,
    -- Extension mechanism for non- release99 information
    nonCriticalExtensions                SEQUENCE { }                    OPTIONAL
}

-- This IE is not used in this version of the specification.
-- It was kept only for backwards compatibility reasons
SysInfoType9 ::= SEQUENCE {
    -- Physical channel IEs
    -- dummy is not used in this version of the specification and

```

```

    -- it should be ignored by the receiver.
    dummy                                CPGH-PersistenceLevelsList,
    -- Extension mechanism for non- release99 information
    nonCriticalExtensions                SEQUENCE {}                                OPTIONAL
}

-- This IE is not used in this version of the specification.
-- It was kept only for backwards compatibility reasons
SysInfoType10 ::= SEQUENCE {
    -- User equipment IEs
    -- dummy is not used in this version of the specification, it should
    -- not be sent and if received it should be ignored.
    dummy                                DRAC-SysInfoList,
    -- Extension mechanism for non- release99 information
    nonCriticalExtensions                SEQUENCE {}                                OPTIONAL
}

SysInfoType11 ::= SEQUENCE {
    sib12indicator                       BOOLEAN,
    -- Measurement IEs
    fach-MeasurementOccasionInfo        FACH-MeasurementOccasionInfo        OPTIONAL,
    measurementControlSysInfo           MeasurementControlSysInfo,
    -- Extension mechanism for non- release99 information
    v4b0NonCriticalExtensions           SEQUENCE {
        sysInfoType11-v4b0ext           SysInfoType11-v4b0ext-IEs        OPTIONAL,
        v590NonCriticalExtension        SEQUENCE {
            sysInfoType11-v590ext       SysInfoType11-v590ext-IEs,
            v690NonCriticalExtensions   SEQUENCE {
                sysInfoType11-v690ext   SysInfoType11-v690ext-IEs,
                v6b0NonCriticalExtensions SEQUENCE {
                    sysInfoType11-v6b0ext SysInfoType11-v6b0ext-IEs,
                    v770NonCriticalExtensions SEQUENCE {
                        sysInfoType11-v770ext SysInfoType11-v770ext-IEs,
                        v7b0NonCriticalExtensions SEQUENCE {
                            sysInfoType11-v7b0ext SysInfoType11-v7b0ext-IEs,
                            v860NonCriticalExtensions SEQUENCE {
                                sysInfoType11-v860ext SysInfoType11-v860ext-IEs,
                                va80NonCriticalExtensions SEQUENCE {
                                    sysInfoType11-va80ext SysInfoType11-va80ext-IEs,
                                    vc50NonCriticalExtensions SEQUENCE {
                                        sysInfoType11-vc50ext SysInfoType11-vc50ext-
IEs,
                                        nonCriticalExtensions SEQUENCE {}        OPTIONAL
                                    }
                                }
                            }
                        }
                    }
                }
            }
        }
    }
    OPTIONAL
}

SysInfoType11-v4b0ext-IEs ::= SEQUENCE {
    fach-MeasurementOccasionInfo-LCR-Ext FACH-MeasurementOccasionInfo-LCR-r4-ext OPTIONAL,
    measurementControlSysInfo-LCR        MeasurementControlSysInfo-LCR-r4-ext
}

SysInfoType11-v590ext-IEs ::= SEQUENCE {
    --The order of the list corresponds to the order of cell in newIntraFrequencyCellInfoList
    newIntraFrequencyCellInfoList-v590ext SEQUENCE (SIZE (1..maxCellMeas)) OF
        CellSelectReselectInfo-v590ext OPTIONAL,
    --The order of the list corresponds to the order of cell in newInterFrequencyCellInfoList
    newInterFrequencyCellInfoList-v590ext SEQUENCE (SIZE (1..maxCellMeas)) OF
        CellSelectReselectInfo-v590ext OPTIONAL,
    --The order of the list corresponds to the order of cell in newInterRATCellInfoList
    newInterRATCellInfoList-v590ext SEQUENCE (SIZE (1..maxCellMeas)) OF
        CellSelectReselectInfo-v590ext OPTIONAL,
    intraFreqEventCriteriaList-v590ext Intra-FreqEventCriteriaList-v590ext OPTIONAL,
    intraFreqReportingCriteria-1b-r5 IntraFreqReportingCriteria-1b-r5 OPTIONAL,
    intraFreqEvent-1d-r5 IntraFreqEvent-1d-r5 OPTIONAL
}

SysInfoType11-v690ext-IEs ::= SEQUENCE {
    -- dummy is not used in this version of the specification. If received, the UE behaviour
    -- is not specified.
    dummy                                Dummy-InterFreqRACHReportingInfo    OPTIONAL
}

```

```

}

SysInfoType11-v6b0ext-IEs ::= SEQUENCE {
  -- Measurement IEs
  interFreqRACHReportingInfo      InterFreqRACHReportingInfo      OPTIONAL
}

SysInfoType11-v770ext-IEs ::= SEQUENCE {
  -- Measurement IEs
  mbsfnFrequencyList              MBSFNFrequencyList              OPTIONAL
}

SysInfoType11-v7b0ext-IEs ::= SEQUENCE {
  -- Measurement IEs
  newInterFreqCellList            NewInterFreqCellList-v7b0ext      OPTIONAL
}

SysInfoType11-v860ext-IEs ::= SEQUENCE {
  -- Measurement IEs
  mbsfnFrequencyList              MBSFNFrequencyList-v860ext      OPTIONAL
}

SysInfoType11-va80ext-IEs ::= SEQUENCE {
  -- Measurement IEs
  multipleFrequencyInfoListFDD     MultipleFrequencyInfoListFDD     OPTIONAL
}

SysInfoType11-vc50ext-IEs ::= SEQUENCE {
  measurementControlSysInfo        MeasurementControlSysInfo-vc50ext  OPTIONAL,
  -- Measurement IEs
  measurementScalingFactor         MeasurementScalingFactor           OPTIONAL
}

MeasurementScalingFactor ::= ENUMERATED {
  sf-utra-cf1, sf-utra-cf2}

SysInfoType11bis ::= SEQUENCE {
  -- Measurement IEs
  measurementControlSysInfo        MeasurementControlSysInfoExtension  OPTIONAL,
  measurementControlSysInfo-LCR    MeasurementControlSysInfoExtension-LCR-r4  OPTIONAL,
  measurementControlSysInfoExtensionAddOn-r5
  MeasurementControlSysInfoExtensionAddOn-r5  OPTIONAL,
  -- Extension mechanism for non-release99 information
  v7b0NonCriticalExtensions        SEQUENCE {
    sysInfoType11bis-v7b0ext        SysInfoType11bis-v7b0ext-IEs,
    v860NonCriticalExtensions        SEQUENCE {
      sysInfoType11bis-v860ext        SysInfoType11bis-v860ext-IEs,
      va80NonCriticalExtensions        SEQUENCE {
        sysInfoType11bis-va80ext        SysInfoType11bis-va80ext-IEs,
        vc50NonCriticalExtensions        SEQUENCE {
          sysInfoType11bis-vc50ext        SysInfoType11bis-vc50ext-IEs,
          nonCriticalExtensions        SEQUENCE {} OPTIONAL
        } OPTIONAL
      } OPTIONAL
    } OPTIONAL
  } OPTIONAL
}

SysInfoType11bis-v7b0ext-IEs ::= SEQUENCE {
  -- Measurement IEs
  newInterFreqCellList            NewInterFreqCellList-v7b0ext      OPTIONAL
}

SysInfoType11bis-v860ext-IEs ::= SEQUENCE {
  -- UTRAN mobility IEs
  csg-PSCSPsplitInfo              CSG-PSCSPsplitInfo                OPTIONAL,
  csg-DedicatedFrequencyInfoList  CSG-DedicatedFrequencyInfoList    OPTIONAL
}

SysInfoType11bis-va80ext-IEs ::= SEQUENCE {
  -- Measurement IEs
  multipleFrequencyInfoListFDD     MultipleFrequencyInfoListFDD     OPTIONAL
}

SysInfoType11bis-vc50ext-IEs ::= SEQUENCE {
  measurementControlSysInfo        MeasurementControlSysInfo-vc50ext  OPTIONAL
}

```

```

SysInfoType11ter ::=
  -- Measurement IEs
  measureControlSysInfoInterFreqExt  MeasureControlSysInfoInterFreqExt  OPTIONAL,
  multipleFrequencyInfoListFDD        MultipleFrequencyInfoListFDD    OPTIONAL,
  nonCriticalExtensions                SEQUENCE {}                      OPTIONAL
}

SysInfoType12 ::=
  -- Measurement IEs
  fach-MeasurementOccasionInfo        FACH-MeasurementOccasionInfo    OPTIONAL,
  measurementControlSysInfo           MeasurementControlSysInfo,
  -- Extension mechanism for non- release99 information
  v4b0NonCriticalExtensions            SEQUENCE {
    sysInfoType12-v4b0ext              SysInfoType12-v4b0ext-IEs      OPTIONAL,
    v590NonCriticalExtension            SEQUENCE {
      sysInfoType12-v590ext            SysInfoType12-v590ext-IEs,
      v690NonCriticalExtensions        SEQUENCE {
        sysInfoType12-v690ext          SysInfoType12-v690ext-IEs,
        v6b0NonCriticalExtensions      SEQUENCE {
          sysInfoType12-v6b0ext        SysInfoType12-v6b0ext-IEs,
          v7b0NonCriticalExtensions    SEQUENCE {
            sysInfoType12-v7b0ext      SysInfoType12-v7b0ext-IEs,
            va80NonCriticalExtensions  SEQUENCE {
              sysInfoType12-va80ext    SysInfoType12-va80ext-IEs,
              vc50NonCriticalExtensions SEQUENCE {
                sysInfoType12-vc50ext  SysInfoType12-vc50ext-IEs,
                nonCriticalExtensions SEQUENCE {}                      OPTIONAL
              }
            }
          }
        }
      }
    }
  }
  OPTIONAL
}
  OPTIONAL
}
  OPTIONAL
}
  OPTIONAL
}
  OPTIONAL
}
  OPTIONAL
}
}

SysInfoType12-v4b0ext-IEs ::= SEQUENCE {
  fach-MeasurementOccasionInfo-LCR-Ext  FACH-MeasurementOccasionInfo-LCR-r4-ext  OPTIONAL,
  measurementControlSysInfo-LCR         MeasurementControlSysInfo-LCR-r4-ext
}

SysInfoType12-v590ext-IEs ::= SEQUENCE {
  --The order of the list corresponds to the order of cell in newIntraFrequencyCellInfoList
  newIntraFrequencyCellInfoList-v590ext SEQUENCE (SIZE (1..maxCellMeas)) OF
  CellSelectReselectInfo-v590ext        OPTIONAL,
  --The order of the list corresponds to the order of cell in newInterFrequencyCellInfoList
  newInterFrequencyCellInfoList-v590ext SEQUENCE (SIZE (1..maxCellMeas)) OF
  CellSelectReselectInfo-v590ext        OPTIONAL,
  --The order of the list corresponds to the order of cell in newInterRATCellInfoList
  newInterRATCellInfoList-v590ext       SEQUENCE (SIZE (1..maxCellMeas)) OF
  CellSelectReselectInfo-v590ext        OPTIONAL,
  intraFreqEventCriteriaList-v590ext    Intra-FreqEventCriteriaList-v590ext      OPTIONAL,
  intraFreqReportingCriteria-1b-r5      IntraFreqReportingCriteria-1b-r5        OPTIONAL,
  intraFreqEvent-1d-r5                  IntraFreqEvent-1d-r5                    OPTIONAL
}

SysInfoType12-v690ext-IEs ::= SEQUENCE {
  -- dummy is not used in this version of the specification. If received, the UE behaviour
  -- is not specified.
  dummy                                  Dummy-InterFreqRACHReportingInfo        OPTIONAL
}

SysInfoType12-v6b0ext-IEs ::= SEQUENCE {
  -- Measurement IEs
  interFreqRACHReportingInfo             InterFreqRACHReportingInfo              OPTIONAL
}

SysInfoType12-v7b0ext-IEs ::= SEQUENCE {
  -- Measurement IEs
  newInterFreqCellList                  NewInterFreqCellList-v7b0ext            OPTIONAL
}

SysInfoType12-va80ext-IEs ::= SEQUENCE {
  -- Measurement IEs
  multipleFrequencyInfoListFDD          MultipleFrequencyInfoListFDD            OPTIONAL
}

```

```

SysInfoType12-vc50ext-IEs ::= SEQUENCE {
    measurementControlSysInfo          MeasurementControlSysInfo-vc50ext  OPTIONAL
}

SysInfoType13 ::=
    -- Core network IEs
    cn-DomainSysInfoList              CN-DomainSysInfoList,
    -- User equipment IEs
    ue-IdleTimersAndConstants         UE-IdleTimersAndConstants          OPTIONAL,
    capabilityUpdateRequirement       CapabilityUpdateRequirement        OPTIONAL,
    -- Extension mechanism for non- release99 information
    v3a0NonCriticalExtensions         SEQUENCE {
        sysInfoType13-v3a0ext         SysInfoType13-v3a0ext-IEs,
        v4b0NonCriticalExtensions     SEQUENCE {
            sysInfoType13-v4b0ext     SysInfoType13-v4b0ext-IEs,
            -- Extension mechanism for non- release99 information
            v770NonCriticalExtensions SEQUENCE {
                sysInfoType13-v770ext SysInfoType13-v770ext-IEs,
                nonCriticalExtensions SEQUENCE {}
            }
        }
    }
    OPTIONAL
}

SysInfoType13-v3a0ext-IEs ::= SEQUENCE {
    ue-IdleTimersAndConstants-v3a0ext UE-IdleTimersAndConstants-v3a0ext
}

SysInfoType13-v4b0ext-IEs ::= SEQUENCE {
    capabilityUpdateRequirement-r4Ext CapabilityUpdateRequirement-r4-ext  OPTIONAL
}

SysInfoType13-v770ext-IEs ::= SEQUENCE {
    capabilityUpdateRequirement       CapabilityUpdateRequirement-v770ext  OPTIONAL
}

SysInfoType13-1 ::=
    -- ANSI-41 IEs
    ansi-41-RAND-Information          ANSI-41-RAND-Information,
    -- Extension mechanism for non- release99 information
    nonCriticalExtensions             SEQUENCE {}
    OPTIONAL
}

SysInfoType13-2 ::=
    -- ANSI-41 IEs
    ansi-41-UserZoneID-Information    ANSI-41-UserZoneID-Information,
    -- Extension mechanism for non- release99 information
    nonCriticalExtensions             SEQUENCE {}
    OPTIONAL
}

SysInfoType13-3 ::=
    -- ANSI-41 IEs
    ansi-41-PrivateNeighbourListInfo ANSI-41-PrivateNeighbourListInfo,
    -- Extension mechanism for non- release99 information
    nonCriticalExtensions             SEQUENCE {}
    OPTIONAL
}

SysInfoType13-4 ::=
    -- ANSI-41 IEs
    ansi-41-GlobalServiceRedirectInfo ANSI-41-GlobalServiceRedirectInfo,
    -- Extension mechanism for non- release99 information
    nonCriticalExtensions             SEQUENCE {}
    OPTIONAL
}

SysInfoType14 ::=
    -- Physical channel IEs
    individualTS-InterferenceList     IndividualTS-InterferenceList,
    expirationTimeFactor              ExpirationTimeFactor          OPTIONAL,
    -- Extension mechanism for non- release99 information
    nonCriticalExtensions             SEQUENCE {}
    OPTIONAL
}

SysInfoType15 ::=
    -- Measurement IEs
    ue-positioning-GPS-CipherParameters UE-Positioning-CipherParameters  OPTIONAL,
    ue-positioning-GPS-ReferenceLocation ReferenceLocation,
    ue-positioning-GPS-ReferenceTime  UE-Positioning-GPS-ReferenceTime,

```



```

    ue-positioning-GPS-Real-timeIntegrity      BadSatList      OPTIONAL,
-- Extension mechanism for non- release99 information
v4b0NonCriticalExtensions      SEQUENCE {
    sysInfoType15-v4b0ext      SysInfoType15-v4b0ext-IEs,
-- Extension mechanism for non- release4 information
v770NonCriticalExtensions      SEQUENCE {
    sysInfoType15-v770ext      SysInfoType15-v770ext-IEs,
        va40NonCriticalExtensions      SEQUENCE {
            sysInfoType15-va40ext      SysInfoType15-va40ext-IEs,
            nonCriticalExtensions      SEQUENCE {}          OPTIONAL
        }          OPTIONAL
    }          OPTIONAL
}          OPTIONAL
}

SysInfoType15-v4b0ext-IEs ::= SEQUENCE {
    up-IPDL-Parameters-TDD      UE-Positioning-IPDL-Parameters-TDD-r4-ext      OPTIONAL
}

SysInfoType15-v770ext-IEs ::= SEQUENCE {
-- Measurement IEs
    ue-Positioning-GPS-ReferenceTime      UE-Positioning-GPS-ReferenceTime-v770ext
}

SysInfoType15-va40ext-IEs ::= SEQUENCE {
-- Measurement IEs
    ue-Positioning-GPS-ReferenceTime      UE-Positioning-GPS-ReferenceTime-va40ext
}

SysInfoType15bis ::= SEQUENCE {
-- Measurement IEs
    ue-positioning-GANSS-ReferencePosition      ReferenceLocationGANSS,
    ue-positioning-GANSS-ReferenceTime      UE-Positioning-GANSS-ReferenceTime,
    ue-positioning-GANSS-IonosphericModel      UE-Positioning-GANSS-IonosphericModel      OPTIONAL,
-- Extension mechanism for non-release99 information
v860NonCriticalExtensions      SEQUENCE {
    sysInfoType15bis-v860ext      SysInfoType15bis-v860ext-IEs,
        va40NonCriticalExtensions      SEQUENCE {
            sysInfoType15bis-va40ext      SysInfoType15bis-va40ext-IEs,
            nonCriticalExtensions      SEQUENCE {}          OPTIONAL
        }          OPTIONAL
    }          OPTIONAL
}

SysInfoType15bis-v860ext-IEs ::= SEQUENCE {
-- Measurement IEs
    ue-Positioning-GANSS-AddIonoModel      UE-Positioning-GANSS-AddIonoModel      OPTIONAL,
    ue-Positioning-GANSS-EarthOrientationPara      UE-Positioning-GANSS-EarthOrientPara      OPTIONAL
}

SysInfoType15bis-va40ext-IEs ::= SEQUENCE {
-- Measurement IEs
    ue-positioning-GANSS-ReferenceTime      UE-Positioning-GANSS-ReferenceTime-va40ext
}

SysInfoType15-1 ::= SEQUENCE {
-- DGPS corrections
    ue-positioning-GPS-DGPS-Corrections      UE-Positioning-GPS-DGPS-Corrections,
-- Extension mechanism for non- release99 information
v920NonCriticalExtensions      SEQUENCE {
    sysInfoType15-1-v920ext      SysInfoType15-1-v920ext-IEs,
        nonCriticalExtensions      SEQUENCE {}          OPTIONAL
    }          OPTIONAL
}

SysInfoType15-1-v920ext-IEs ::= SEQUENCE {
-- Measurement IEs
    ue-positioning-GPS-DGPS-Corrections      UE-Positioning-GPS-DGPS-Corrections-v920ext
}

SysInfoType15-1bis ::= SEQUENCE {
-- Measurement IEs
    ue-positioning-GANSS-DGANSS-Corrections      UE-Positioning-DGANSSCorrections,
-- Extension mechanism for non-release99 information
v920NonCriticalExtensions      SEQUENCE {
    sysInfoType15-1bis-v920ext      SysInfoType15-1bis-v920ext-IEs,
        nonCriticalExtensions      SEQUENCE {}          OPTIONAL
    }          OPTIONAL
}

```

```

    } OPTIONAL
}

SysInfoType15-1bis-v920ext-IEs ::= SEQUENCE {
  -- Measurement IEs
  ue-positioning-GANSS-DGANSS-Corrections      UE-Positioning-DGANSSCorrections-v920ext
}

SysInfoType15-1ter ::= SEQUENCE {
  -- Measurement IEs
  uePositioning-BDSCorrections                UE-Positioning-DBDSCorrections          OPTIONAL,
  uePositioningBDSIonoGridModel              UE-Positioning-BDS-IonoGridModel        OPTIONAL,
  -- Extension mechanism for non-release12 information
  nonCriticalExtensions                       SEQUENCE {}                               OPTIONAL
}

SysInfoType15-2 ::= SEQUENCE {
  -- Ephemeris and clock corrections
  transmissionTOW                             GPS-TOW-1sec,
  satID                                        SatID,
  ephemerisParameter                         EphemerisParameter,
  -- Extension mechanism for non- release99 information
  nonCriticalExtensions                       SEQUENCE {}                               OPTIONAL
}

SysInfoType15-2bis ::= SEQUENCE {
  -- Measurement IEs
  ue-positioning-GANSS-navigationModel        UE-Positioning-GANSS-NavigationModel,
  -- Extension mechanism for non-release99 information
  nonCriticalExtensions                       SEQUENCE {}                               OPTIONAL
}

SysInfoType15-2ter ::= SEQUENCE {
  -- Measurement IEs
  ue-positioning-GANSS-AddNavigationModels    UE-Positioning-GANSS-AddNavigationModels,
  -- Extension mechanism for non-release99 information
  vc50NonCriticalExtensions                   SEQUENCE {
    sysInfoType15-2ter-vc50ext                SysInfoType15-2ter-vc50ext-IEs,
    nonCriticalExtensions                     SEQUENCE {}                               OPTIONAL
  } OPTIONAL
}

SysInfoType15-2ter-vc50ext-IEs ::= SEQUENCE {
  -- Measurement IEs
  ue-positioning-GANSS-AddNavigationModels    UE-Positioning-GANSS-AddNavigationModels-vc50ext
  OPTIONAL
}

SysInfoType15-3 ::= SEQUENCE {
  -- Almanac and other data
  transmissionTOW                             GPS-TOW-1sec,
  ue-positioning-GPS-Almanac                  UE-Positioning-GPS-Almanac                OPTIONAL,
  ue-positioning-GPS-IonosphericModel        UE-Positioning-GPS-IonosphericModel      OPTIONAL,
  ue-positioning-GPS-UTC-Model               UE-Positioning-GPS-UTC-Model              OPTIONAL,
  satMask                                    BIT STRING (SIZE (1..32))
  lsbtOW                                     BIT STRING (SIZE (8))                    OPTIONAL,
  -- Extension mechanism for non- release99 information
  va40NonCriticalExtensions                   SEQUENCE {
    sysInfoType15-3-va40ext                    SysInfoType15-3-va40ext-IEs,
    nonCriticalExtensions                       SEQUENCE {}                               OPTIONAL
  } OPTIONAL
}

SysInfoType15-3-va40ext-IEs ::= SEQUENCE {
  -- Measurement IEs
  ue-positioning-GPS-Almanac                  UE-Positioning-GPS-Almanac-va40ext        OPTIONAL
}

SysInfoType15-3bis ::= SEQUENCE {
  -- Measurement IEs
  ue-positioning-GANSS-Almanac                UE-Positioning-GANSS-Almanac              OPTIONAL,
  ue-positioning-GANSS-TimeModels            UE-Positioning-GANSS-TimeModels           OPTIONAL,
  ue-positioning-GANSS-UTC-Model             UE-Positioning-GANSS-UTCModel             OPTIONAL,
  -- Extension mechanism for non-release99 information
  v860NonCriticalExtensions                   SEQUENCE {
    sysInfoType15-3bis-v860ext                 SysInfoType15-3bis-v860ext-IEs,
    va40NonCriticalExtensions                   SEQUENCE {
      sysInfoType15-3bis-va40ext               SysInfoType15-3bis-va40ext-IEs,
    }
  }
}

```

```

        vc50NonCriticalExtensions SEQUENCE {
            sysInfoType15-3bis-vc50ext SysInfoType15-3bis-vc50ext-IEs,
            nonCriticalExtensions SEQUENCE {} OPTIONAL
        } OPTIONAL
    } OPTIONAL
}

SysInfoType15-3bis-v860ext-IEs ::= SEQUENCE {
    -- Measurement IEs
    ue-Positioning-GANSS-Almanac UE-Positioning-GANSS-Almanac-v860ext OPTIONAL,
    ue-Positioning-GANSS-AddUTCModels UE-Positioning-GANSS-AddUTCModels OPTIONAL,
    ue-Positioning-GANSS-AuxiliaryInfo UE-Positioning-GANSS-AuxiliaryInfo OPTIONAL
}

SysInfoType15-3bis-va40ext-IEs ::= SEQUENCE {
    -- Measurement IEs
    ue-Positioning-GANSS-Almanac UE-Positioning-GANSS-Almanac-va40ext OPTIONAL,
    ue-positioning-GANSS-TimeModels UE-Positioning-GANSS-TimeModels-va40ext OPTIONAL
}

SysInfoType15-3bis-vc50ext-IEs ::= SEQUENCE {
    -- Measurement IEs
    ue-Positioning-GANSS-Almanac UE-Positioning-GANSS-Almanac-vc50ext OPTIONAL,
    ue-Positioning-GANSS-AddUTCModels UE-Positioning-GANSS-AddUTCModels-vc50ext OPTIONAL
}

SysInfoType15-4 ::= SEQUENCE {
    -- Measurement IEs
    ue-positioning-OTDOA-CipherParameters UE-Positioning-CipherParameters OPTIONAL,
    ue-positioning-OTDOA-AssistanceData UE-Positioning-OTDOA-AssistanceData,
    v3a0NonCriticalExtensions SEQUENCE {
        sysInfoType15-4-v3a0ext SysInfoType15-4-v3a0ext,
        -- Extension mechanism for non- release99 information
        v4b0NonCriticalExtensions SEQUENCE {
            sysInfoType15-4-v4b0ext SysInfoType15-4-v4b0ext,
            nonCriticalExtensions SEQUENCE {} OPTIONAL
        } OPTIONAL
    } OPTIONAL
}

SysInfoType15-4-v3a0ext ::= SEQUENCE {
    sfn-Offset-Validity SFN-Offset-Validity OPTIONAL
}

SysInfoType15-4-v4b0ext ::= SEQUENCE {
    ue-Positioning-OTDOA-AssistanceData-r4ext UE-Positioning-OTDOA-AssistanceData-r4ext OPTIONAL
}

SysInfoType15-5 ::= SEQUENCE {
    -- Measurement IEs
    ue-positioning-OTDOA-AssistanceData-UEB UE-Positioning-OTDOA-AssistanceData-UEB,
    v3a0NonCriticalExtensions SEQUENCE {
        sysInfoType15-5-v3a0ext SysInfoType15-5-v3a0ext,
        -- Extension mechanism for non- release99 information
        v770NonCriticalExtensions SEQUENCE {
            sysInfoType15-5-v770ext SysInfoType15-5-v770ext-IEs,
            nonCriticalExtensions SEQUENCE {} OPTIONAL
        } OPTIONAL
    } OPTIONAL
}

SysInfoType15-5-v3a0ext ::= SEQUENCE {
    sfn-Offset-Validity SFN-Offset-Validity OPTIONAL
}

SysInfoType15-5-v770ext-IEs ::= SEQUENCE {
    ue-Positioning-OTDOA-AssistanceData-UEB-ext
        UE-Positioning-OTDOA-AssistanceData-UEB-ext OPTIONAL
}

SysInfoType15-6 ::= SEQUENCE {
    -- Measurement IEs
    ue-positioning-GANSS-TOD INTEGER (0..86399),
    ue-positioning-GANSS-ReferenceMeasurementInformation
        UE-Positioning-GANSS-ReferenceMeasurementInfo,
    -- Extension mechanism for non-release99 information
    va40NonCriticalExtensions SEQUENCE {

```

```

        sysInfoType15-6-va40ext          SysInfoType15-6-va40ext-IEs,
        vc50NonCriticalExtensions        SEQUENCE {
        sysInfoType15-6-vc50ext          SysInfoType15-6-vc50ext-IEs,
        nonCriticalExtensions            SEQUENCE {}                OPTIONAL
    } OPTIONAL
}

SysInfoType15-6-va40ext-IEs ::= SEQUENCE {
    ue-positioning-GANSS-ReferenceMeasurementInformation
    UE-Positioning-GANSS-ReferenceMeasurementInfo-va40ext
}

SysInfoType15-6-vc50ext-IEs ::= SEQUENCE {
    ue-positioning-GANSS-ReferenceMeasurementInformation
    UE-Positioning-GANSS-ReferenceMeasurementInfo-vc50ext
}

SysInfoType15-7 ::= SEQUENCE {
    -- Measurement IEs
    ue-positioning-GANSS-DataBitAssistance UE-Positioning-GANSS-Data-Bit-Assistance,
    -- Extension mechanism for non-release99 information
    nonCriticalExtensions SEQUENCE {}                OPTIONAL
}

SysInfoType15-8 ::= SEQUENCE {
    -- Measurement IEs
    ue-positioning-GANSS-DataCipheringInfo UE-Positioning-CipherParameters OPTIONAL,
    ue-positioning-GANSS-realTimeIntegrity UE-Positioning-GANSS-RealTimeIntegrity OPTIONAL,
    -- Extension mechanism for non-release99 information
    nonCriticalExtensions SEQUENCE {}                OPTIONAL
}

SysInfoType16 ::= SEQUENCE {
    -- Radio bearer IEs
    preDefinedRadioConfiguration PreDefRadioConfiguration,
    -- Extension mechanism for non- release99 information
    v770NonCriticalExtensions SEQUENCE {
        sysInfoType16-v770ext          SysInfoType16-v770ext-IEs,
        v920NonCriticalExtensions      SEQUENCE {
            sysInfoType16-v920ext      SysInfoType16-v920ext-IEs,
            nonCriticalExtensions      SEQUENCE {}                OPTIONAL
        } OPTIONAL
    } OPTIONAL
}

SysInfoType16-v770ext-IEs ::= SEQUENCE {
    preDefinedRadioConfiguration PreDefRadioConfiguration-v770ext
}

SysInfoType16-v920ext-IEs ::= SEQUENCE {
    preDefinedRadioConfiguration PreDefRadioConfiguration-v920ext
}

SysInfoType17 ::= SEQUENCE {
    -- Physical channel IEs
    -- If PDSCH/PUSCH is configured for 1.28Mcps or 7.68Mcps TDD, pusch-SysInfoList and
    -- pdsch-SysInfoList should be absent and the info included in the respective
    -- tdd128SpecificInfo or tdd768SpecificInfo instead.
    -- If PDSCH/PUSCH is configured for 3.84Mcps TDD in R5, HCR-r5-SpecificInfo should also be
    -- included.
    pusch-SysInfoList          PUSCH-SysInfoList          OPTIONAL,
    pdsch-SysInfoList          PDSCH-SysInfoList          OPTIONAL,
    -- Extension mechanism for non- release99 information
    v4b0NonCriticalExtensions SEQUENCE {
        sysInfoType17-v4b0ext          SysInfoType17-v4b0ext-IEs,
        v590NonCriticalExtensions      SEQUENCE {
            sysInfoType17-v590ext      SysInfoType17-v590ext-IEs          OPTIONAL,
            v770NonCriticalExtensions SEQUENCE {
                sysInfoType17-v770ext  SysInfoType17-v770ext-IEs,
                nonCriticalExtensions SEQUENCE {}                OPTIONAL
            } OPTIONAL
        } OPTIONAL
    } OPTIONAL
}

SysInfoType17-v4b0ext-IEs ::= SEQUENCE {
    tdd128SpecificInfo SEQUENCE {

```

```

        pusch-SysInfoList          PUSCH-SysInfoList-LCR-r4          OPTIONAL,
        pdsch-SysInfoList          PDSCH-SysInfoList-LCR-r4          OPTIONAL
    }
}

SysInfoType17-v590ext-IEs ::= SEQUENCE {
    hcr-r5-SpecificInfo            SEQUENCE {
        pusch-SysInfoList          PUSCH-SysInfoList-HCR-r5    OPTIONAL,
        pdsch-SysInfoList          PDSCH-SysInfoList-HCR-r5    OPTIONAL
    }
}

SysInfoType17-v770ext-IEs ::= SEQUENCE {
    tdd768SpecificInfo            SEQUENCE {
        pusch-SysInfoList-SFN      PUSCH-SysInfoList-SFN-VHCR    OPTIONAL,
        pdsch-SysInfoList-SFN      PDSCH-SysInfoList-VHCR-r7    OPTIONAL
    }
}

SysInfoType18 ::= SEQUENCE {
    idleModePLMNIdentities         PLMNIdentitiesOfNeighbourCells    OPTIONAL,
    connectedModePLMNIdentities    PLMNIdentitiesOfNeighbourCells    OPTIONAL,
    -- Extension mechanism for non- release99 information
    v6b0NonCriticalExtensions      SEQUENCE {
        sysInfoType18-v6b0ext      SysInfoType18-v6b0ext,
        v860NonCriticalExtensions  SEQUENCE {
            sysInfoType18-v860ext  SysInfoType18-v860ext,
            vc50NonCriticalExtensions SEQUENCE {
                sysInfoType18-vc50ext SysInfoType18-vc50ext,
                nonCriticalExtensions SEQUENCE {} OPTIONAL
            } OPTIONAL
        } OPTIONAL
    } OPTIONAL
}

SysInfoType18-v6b0ext ::= SEQUENCE {
    idleModePLMNIdentitiesSIB11bis PLMNIdentitiesOfNeighbourCells    OPTIONAL,
    connectedModePLMNIdentitiesSIB11bis PLMNIdentitiesOfNeighbourCells    OPTIONAL
}

SysInfoType18-v860ext ::= SEQUENCE {
    idleModePLMNIdentities         PLMNIdentitiesOfNeighbourCells-v860ext    OPTIONAL,
    connectedModePLMNIdentities    PLMNIdentitiesOfNeighbourCells-v860ext    OPTIONAL
}

SysInfoType18-vc50ext ::= SEQUENCE {
    idleModePLMNIdentitiesSIB11ter PLMNIdentitiesOfNeighbourCells-vc50ext    OPTIONAL,
    connectedModePLMNIdentitiesSIB11ter PLMNIdentitiesOfNeighbourCells-vc50ext    OPTIONAL
}

SysInfoType19 ::= SEQUENCE {
    -- Measurement IEs
    ultra-PriorityInfoList         UTRA-PriorityInfoList,
    gsm-PriorityInfoList           GSM-PriorityInfoList          OPTIONAL,
    ultra-FrequencyAndPriorityInfoList EUTRA-FrequencyAndPriorityInfoList    OPTIONAL,
    -- Extension mechanism for non-release8 information
    v920NonCriticalExtensions      SEQUENCE {
        sysInfoType19-v920ext      SysInfoType19-v920ext,
        va80NonCriticalExtensions  SEQUENCE {
            sysInfoType19-va80ext  SysInfoType19-va80ext,
            vb30NonCriticalExtensions SEQUENCE {
                sysInfoType19-vb30ext SysInfoType19-vb30ext,
                vb50NonCriticalExtensions SEQUENCE {
                    sysInfoType19-vb50ext SysInfoType19-vb50ext,
                    vb80NonCriticalExtensions SEQUENCE {
                        sysInfoType19-vb80ext SysInfoType19-vb80ext,
                        vc50NonCriticalExtensions SEQUENCE {
                            sysInfoType19-vc50ext SysInfoType19-vc50ext,
                            nonCriticalExtensions SEQUENCE {} OPTIONAL
                        } OPTIONAL
                    } OPTIONAL
                } OPTIONAL
            } OPTIONAL
        } OPTIONAL
    } OPTIONAL
}

SysInfoType19-v920ext ::= SEQUENCE {

```

```

    ultra-PriorityInfoList-v920ext          UTRA-PriorityInfoList-v920ext,
    eutra-FrequencyAndPriorityInfoList-v920ext EUTRA-FrequencyAndPriorityInfoList-v920ext
}

SysInfoType19-va80ext ::= SEQUENCE {
    multipleEutraFrequencyInfoList          MultipleEUTRAFrequencyInfoList          OPTIONAL
}

SysInfoType19-vb30ext ::= SEQUENCE {
    cell-fach-meas-ind                      ENUMERATED { high-priority-layers, all-layers } OPTIONAL
}

SysInfoType19-vb50ext ::= SEQUENCE {
    gsmTresselectionScalingFactor           TresselectionScalingFactor2           OPTIONAL,
    eutraTresselectionScalingFactor         TresselectionScalingFactor2           OPTIONAL,
    numberOfApplicableEARFCN               INTEGER (0..7)                       OPTIONAL,
    eutra-FrequencyAndPriorityInfoList-vb50ext EUTRA-FrequencyAndPriorityInfoList-vb50ext
    OPTIONAL,
    eutra-FrequencyAndPriorityInfoExtensionList EUTRA-FrequencyAndPriorityInfoExtensionList
    OPTIONAL,
    multipleEutraFrequencyInfoExtensionList MultipleEUTRAFrequencyInfoExtensionList
    OPTIONAL,
    -- Measurement IEs
    eutra-FrequencyRACHReportingInfo       EUTRA-FrequencyRACHReportingInfo       OPTIONAL
}

SysInfoType19-vb80ext ::= SEQUENCE {
    eutra-FrequencyAndPriorityInfoExtensionList-vb80ext EUTRA-
    FrequencyAndPriorityInfoExtensionList-vb80ext          OPTIONAL
}

SysInfoType19-vc50ext ::= SEQUENCE {
    eutra-FrequencyRACHReportingInfo-vc50ext EUTRA-FrequencyRACHReportingInfo-vc50ext
    OPTIONAL,
    eutra-FrequencyAndPriorityInfoList-vc50ext EUTRA-FrequencyAndPriorityInfoList-vc50ext
    OPTIONAL,
    eutra-FrequencyAndPriorityInfoExtensionList-vc50ext EUTRA-FrequencyAndPriorityInfoExtensionList-vc50ext
    OPTIONAL
}

SysInfoType20 ::= SEQUENCE {
    hNBName                                HNBName                                OPTIONAL,
    nonCriticalExtensions                   SEQUENCE {}                             OPTIONAL
}

SysInfoType21 ::= SEQUENCE {
    eab-Parameters                          EAB-Parameters                          OPTIONAL,
    nonCriticalExtensions                   SEQUENCE {}                             OPTIONAL
}

SysInfoType22 ::= SEQUENCE {
    -- In the Tabular there are separate definitions for prach-PreambleForEnhancedUplinkListType1Ext
    -- and prach-PreambleForEnhancedUplinkListType2Ext/prach-PreambleForEnhancedUplinkListType3Ext even
    -- though the contents are the same. The only difference is in how the IE "Weight" is used in
    -- calculating the weight for each signalled PRACH Control Parameters.
    -- To simplify the ASN.1, a single definition is used here for all three cases.
    prach-PreambleForEnhancedUplinkListType1Ext
        PRACH-PreambleForEnhancedUplinkExtList OPTIONAL,
    prach-PreambleForEnhancedUplinkListType2Ext
        PRACH-PreambleForEnhancedUplinkExtList OPTIONAL,
    prach-PreambleForEnhancedUplinkListType3Ext
        PRACH-PreambleForEnhancedUplinkExtList OPTIONAL,
    concurrent-Deployment-2ms-10ms-TTI      Concurrent-Deployment-2ms-10ms-TTI      OPTIONAL,
    nodeB-Trigger-HS-DPCCH-Transmission    NodeB-Trigger-HS-DPCCH-Transmission    OPTIONAL,
    fallback-R99-PRACH-info                 Fallback-R99-PRACH-info-IEs           OPTIONAL,
    commonEDCHResourceConfigInfoListExt    CommonEDCHResourceConfigInfoListExt    OPTIONAL,
    hs-dsch-DrxCellfach-SecondDrx-info     HS-DSCH-DrxCellfach-SecondDrx-info    OPTIONAL,
    -- Extension mechanism for non- release11 information
    vc50NonCriticalExtensions               SEQUENCE {
        sysInfoType22-vc50ext              SysInfoType22-vc50ext-IEs,
        nonCriticalExtensions              SEQUENCE {} OPTIONAL
    }
    OPTIONAL
}

SysInfoType22-vc50ext-IEs ::= SEQUENCE {
    cell-Reselection-indication-reporting    ENUMERATED { true }                   OPTIONAL
}

```

```

SysInfoType23 ::=
    wlanRepresentation          CHOICE {
        wlanOffloadInformationPerPLMN-List      WLANOffloadInformationPerPLMN-List,
        wlanOffloadInformationForAll            WLANOffloadInformation
    },
    nonCriticalExtensions        SEQUENCE {} OPTIONAL
}

SysInfoType24 ::=
    dtchTransmissionBlocked      BIT STRING (SIZE (maxNumAccessGroups)) OPTIONAL,
    expirationTimeFactor          ExpirationTimeFactor2                OPTIONAL,
    nonCriticalExtensions        SEQUENCE {} OPTIONAL
}

SysInfoTypeSB1 ::=
    -- Other IEs
    sib-ReferenceList            SIB-ReferenceList,
    -- Extension mechanism for non- release99 information
    v6b0NonCriticalExtensions    SEQUENCE {
        sysInfoTypeSB1-v6b0ext    SysInfoTypeSB1-v6b0ext,
        v860NonCriticalExtensions SEQUENCE {
            sysInfoTypeSB1-v860ext SysInfoTypeSB1-v860ext,
            vc50NonCriticalExtensions SEQUENCE {
                sysInfoTypeSB1-vc50ext SysInfoTypeSB1-vc50ext,
                nonCriticalExtensions SEQUENCE {} OPTIONAL
            } OPTIONAL
        } OPTIONAL
    } OPTIONAL
}

SysInfoTypeSB1-v6b0ext ::=
    extSIBTypeInfoSchedulingInfo-List ExtSIBTypeInfoSchedulingInfo-List OPTIONAL
}

SysInfoTypeSB1-v860ext ::=
    extSIBTypeInfoSchedulingInfo-List ExtSIBTypeInfoSchedulingInfo-List2 OPTIONAL,
    extGANSS-SIBTypeInfoSchedulingInfoList ExtGANSS-SIBTypeInfoSchedulingInfoList OPTIONAL
}

SysInfoTypeSB1-vc50ext ::=
    sib-ReferenceList            SIBSb-ReferenceList2                OPTIONAL,
    extSIBTypeInfoSchedulingInfo-List ExtSIBTypeInfoSchedulingInfo-List3 OPTIONAL
}

SysInfoTypeSB2 ::=
    -- Other IEs
    sib-ReferenceList            SIB-ReferenceList,
    -- Extension mechanism for non- release99 information
    v6b0NonCriticalExtensions    SEQUENCE {
        sysInfoTypeSB2-v6b0ext    SysInfoTypeSB2-v6b0ext,
        v860NonCriticalExtensions SEQUENCE {
            sysInfoTypeSB2-v860ext SysInfoTypeSB2-v860ext,
            vc50NonCriticalExtensions SEQUENCE {
                sysInfoTypeSB2-vc50ext SysInfoTypeSB2-vc50ext,
                nonCriticalExtensions SEQUENCE {} OPTIONAL
            } OPTIONAL
        } OPTIONAL
    } OPTIONAL
}

SysInfoTypeSB2-v6b0ext ::=
    extSIBTypeInfoSchedulingInfo-List ExtSIBTypeInfoSchedulingInfo-List OPTIONAL
}

SysInfoTypeSB2-v860ext ::=
    extSIBTypeInfoSchedulingInfo-List ExtSIBTypeInfoSchedulingInfo-List2 OPTIONAL,
    extGANSS-SIBTypeInfoSchedulingInfoList ExtGANSS-SIBTypeInfoSchedulingInfoList OPTIONAL
}

SysInfoTypeSB2-vc50ext ::=
    sib-ReferenceList            SIBSb-ReferenceList2                OPTIONAL,
    extSIBTypeInfoSchedulingInfo-List ExtSIBTypeInfoSchedulingInfo-List3 OPTIONAL
}

SysInfoTypeSB3 ::=
    SEQUENCE {

```

```

-- Other IEs
  sb3-ValueTag                CellValueTag2,
  sib-ReferenceList            SIB-ReferenceList2,
-- Extension mechanism for non- release99 information
  nonCriticalExtensions        SEQUENCE {}                                OPTIONAL
}

TDD-UMTS-Frequency-List ::=          SEQUENCE (SIZE (1..maxNumTDDFreqs)) OF
                                       FrequencyInfoTDD

TxFailParams ::=                      SEQUENCE {
  modeSpecificInfo              CHOICE {
    fdd                          SEQUENCE {
      connEstFailCount            ENUMERATED {n1, n2, n3, n4},
      offsetValidity              ENUMERATED {s30, s60, s120, s240,
                                             s300, s420, s600, s900},
      connEstFailTempQoffset      INTEGER (0..15)                OPTIONAL
    },
    tdd                          NULL
  }
}

UE-HistoryInformation ::=             SEQUENCE {
  ue-InactivityPeriod            INTEGER (1..120),
  ue-MobilityStateIndicator      High-MobilityDetected            OPTIONAL,
  ul-dataVolumeHistory           DataVolumeHistory                OPTIONAL,
  dl-dataVolumeHistory           DataVolumeHistory                OPTIONAL
}

-- For systemInformationBlockType1bis the Value Tag Info "CellValueTag" is used
ValueTagInfo ::= CHOICE {
  none                            NULL,
  cellValueTag                    CellValueTag,
  plmn-ValueTag                   PLMN-ValueTag,
  sibOccurrenceIdentityAndValueTag SIBOccurrenceIdentityAndValueTag
}

ValueTagInfoExtValueTag ::= CHOICE {
  cellValueTag                    CellValueTag2
}

-- *****
--
--   ANSI-41 INFORMATION ELEMENTS (10.3.9)
--
-- *****

ANSI-41-GlobalServiceRedirectInfo ::= ANSI-41-NAS-Parameter
ANSI-41-PrivateNeighbourListInfo ::= ANSI-41-NAS-Parameter
ANSI-41-RAND-Information ::=         ANSI-41-NAS-Parameter
ANSI-41-UserZoneID-Information ::=   ANSI-41-NAS-Parameter
ANSI-41-NAS-Parameter ::=           BIT STRING (SIZE (1..2048))

Min-P-REV ::=                        BIT STRING (SIZE (8))

NAS-SystemInformationANSI-41 ::=     ANSI-41-NAS-Parameter
NID ::=                              BIT STRING (SIZE (16))

P-REV ::=                            BIT STRING (SIZE (8))

SID ::=                              BIT STRING (SIZE (15))

-- *****
--
--   MBMS INFORMATION ELEMENTS (10.3.9a)
--
-- *****

MBMS-AccessProbabilityFactor ::=     ENUMERATED {
  apf0, apf32, apf64, apf96, apf128, apf160, apf192,
  apf224, apf256, apf288, apf320, apf352, apf384, apf416,
  apf448, apf480, apf512, apf544, apf576, apf608, apf640,
  apf672, apf704, apf736, apf768, apf800, apf832, apf864,
  apf896, apf928, apf960, apf1000 }

MBMS-CellGroupIdentity-r6 ::=        BIT STRING (SIZE (12))

MBMS-CommonCCTrChIdentity ::=       INTEGER (1..32)

```



```

MBMS-CommonPhyChIdentity ::=          INTEGER (1..32)

MBMS-CommonRBIdentity ::=             INTEGER (1..32)

MBMS-CommonRBInformation-r6 ::=       SEQUENCE {
    commonRBIdentity                MBMS-CommonRBIdentity,
    pdcp-Info                        PDCP-Info-r4,
    rlc-Info                          RLC-Info-MTCH-r6
}

MBMS-CommonRBInformationList-r6 ::= SEQUENCE (SIZE (1..maxMBMS-CommonRB)) OF
    MBMS-CommonRBInformation-r6

MBMS-CommonTrChIdentity ::=           INTEGER (1..32)

MBMS-ConnectedModeCountingScope ::= SEQUENCE {
    countingForUraPCH                BOOLEAN,
    countingForCellPCH                BOOLEAN,
    countingForCellFACH                BOOLEAN
}

MBMS-CurrentCell-SCCPCH-r6 ::=        SEQUENCE {
    sccpchIdentity                    MBMS-SCCPCHIdentity                OPTIONAL,
    secondaryCCPCH-Info                MBMS-CommonPhyChIdentity,
    softComb-TimingOffset                MBMS-SoftComb-TimingOffset        OPTIONAL,
    -- If the IE transpCh-InfoCommonForAllTrCh is absent, the default TFCS as specified
    -- in 14.10.1 applies
    transpCh-InfoCommonForAllTrCh        MBMS-CommonCCTrChIdentity        OPTIONAL,
    transpCHInformation                MBMS-TrCHInformation-CurrList
}

MBMS-CurrentCell-SCCPCHList-r6 ::= SEQUENCE (SIZE (1..maxSCCPCH)) OF
    MBMS-CurrentCell-SCCPCH-r6

MBMS-FACHCarryingMTCH-List ::=        SEQUENCE (SIZE (1..maxFACHPCH)) OF
    TransportFormatSet

MBMS-JoinedInformation-r6 ::=         SEQUENCE {
    p-TMSI                             P-TMSI-GSM-MAP                OPTIONAL
}

MBMS-L1CombiningSchedule-32 ::=       SEQUENCE {
    -- Actual L1 combining schedule values (offset, start, duration) = IE value * 4
    cycleOffset                        INTEGER (0..7)                OPTIONAL,
    mtch-L1CombiningPeriodList          SEQUENCE (SIZE (1..maxMBMS-L1CP)) OF SEQUENCE {
        periodStart                    INTEGER (0..7),
        periodDuration                  INTEGER (1..8)
    }
}

MBMS-L1CombiningSchedule-64 ::=       SEQUENCE {
    -- Actual L1 combining schedule values (offset, start, duration) = IE value * 4
    cycleOffset                        INTEGER (0..15)               OPTIONAL,
    mtch-L1CombiningPeriodList          SEQUENCE (SIZE (1..maxMBMS-L1CP)) OF SEQUENCE {
        periodStart                    INTEGER (0..15),
        periodDuration                  INTEGER (1..16)
    }
}

MBMS-L1CombiningSchedule-128 ::=      SEQUENCE {
    -- Actual L1 combining schedule values (offset, start, duration) = IE value * 4
    cycleOffset                        INTEGER (0..31)                OPTIONAL,
    mtch-L1CombiningPeriodList          SEQUENCE (SIZE (1..maxMBMS-L1CP)) OF SEQUENCE {
        periodStart                    INTEGER (0..31),
        periodDuration                  INTEGER (1..32)
    }
}

MBMS-L1CombiningSchedule-256 ::=      SEQUENCE {
    -- Actual L1 combining schedule values (offset, start, duration) = IE value * 4
    cycleOffset                        INTEGER (0..63)                OPTIONAL,
    mtch-L1CombiningPeriodList          SEQUENCE (SIZE (1..maxMBMS-L1CP)) OF SEQUENCE {
        periodStart                    INTEGER (0..63),
        periodDuration                  INTEGER (1..64)
    }
}

```

```

MBMS-L1CombiningSchedule-512 ::= SEQUENCE {
  -- Actual L1 combining schedule values (offset, start, duration) = IE value * 4
  cycleOffset          INTEGER (0..127)          OPTIONAL,
  mtch-L1CombiningPeriodList SEQUENCE (SIZE (1..maxMBMS-L1CP)) OF SEQUENCE {
    periodStart        INTEGER (0..127),
    periodDuration     INTEGER (1..128)
  }
}

MBMS-L1CombiningSchedule-1024 ::= SEQUENCE {
  -- Actual L1 combining schedule values (offset, start, duration) = IE value * 4
  cycleOffset          INTEGER (0..255)          OPTIONAL,
  mtch-L1CombiningPeriodList SEQUENCE (SIZE (1..maxMBMS-L1CP)) OF SEQUENCE {
    periodStart        INTEGER (0..255),
    periodDuration     INTEGER (1..256)
  }
}

MBMS-L1CombiningSchedule ::= CHOICE {
  cycleLength-32      MBMS-L1CombiningSchedule-32,
  cycleLength-64      MBMS-L1CombiningSchedule-64,
  cycleLength-128     MBMS-L1CombiningSchedule-128,
  cycleLength-256     MBMS-L1CombiningSchedule-256,
  cycleLength-512     MBMS-L1CombiningSchedule-512,
  cycleLength-1024    MBMS-L1CombiningSchedule-1024
}

MBMS-L1CombiningTransmTimeDiff ::= INTEGER (0..3)

MBMS-L23Configuration ::= CHOICE {
  sameAsCurrent       SEQUENCE {
    currentCell-SCCPCH MBMS-SCCPCHIdentity,
    msch-ConfigurationInfo MBMS-MSCH-ConfigurationInfo-r6          OPTIONAL
  },
  different            SEQUENCE {
    -- If the IE transpCh-InfoCommonForAllTrCh is absent, the default TFCS as specified
    -- in 14.10.1 applies
    transpCh-InfoCommonForAllTrCh MBMS-CommonCCTrChIdentity          OPTIONAL,
    transpCHInformation            MBMS-TrCHInformation-NeighbList
  }
}

MBMS-LogicalChIdentity ::= INTEGER (1..15)

MBMS-MCCH-ConfigurationInfo-r6 ::= SEQUENCE {
  accessInfoPeriodCoefficient  INTEGER (0..3),
  repetitionPeriodCoefficient  INTEGER (0..3),
  modificationPeriodCoefficient INTEGER (7..10),
  rlc-Info                    RLC-Info-MCCH-r6,
  tctf-Presence               MBMS-TCTF-Presence          OPTIONAL
}

MBMS-MICHConfigurationInfo-r6 ::= SEQUENCE {
  michPowerOffset      MBMS-MICHPowerOffset,
  mode                 CHOICE {
    fdd                 SEQUENCE {
      channelisationCode256 ChannelisationCode256,
      ni-CountPerFrame      MBMS-NI-CountPerFrame,
      sttd-Indicator        BOOLEAN
    },
    -- The CHOICE tdd384 is used for both tdd384 and tdd768. If IE
    -- 'MBMS-MICHConfigurationInfo-v770ext' is not present, tdd384 applies.
    tdd384              SEQUENCE {
      timeslot          TimeslotNumber,
      midambleShiftAndBurstType MidambleShiftAndBurstType,
      channelisationCode DL-TS-ChannelisationCode,
      repetitionPeriodLengthOffset RepPerLengthOffset-MICH          OPTIONAL,
      mbmsNotificationIndLength MBMS-MICHNotificationIndLength DEFAULT mn4
    },
    tdd128              SEQUENCE {
      timeslot          TimeslotNumber-LCR-r4,
      midambleShiftAndBurstType MidambleShiftAndBurstType-LCR-r4,
      channelisationCodeList SEQUENCE (SIZE (1..2)) OF
        DL-TS-ChannelisationCode,
      repetitionPeriodLengthOffset RepPerLengthOffset-MICH          OPTIONAL,
      mbmsNotificationIndLength MBMS-MICHNotificationIndLength DEFAULT mn4
    }
  }
}

```

```

}

MBMS-MICHConfigurationInfo-v770ext ::= SEQUENCE {
    mode CHOICE {
        -- For tdd384, IE 'MidambleShiftAndBurstType-r7' replaces IE 'MidambleShiftAndBurstType'
        -- in IE 'MBMS-MICHConfigurationInfo-r6'. IE 'MidambleShiftAndBurstType' shall be ignored.
        tdd384 SEQUENCE {
            midambleShiftAndBurstType MidambleShiftAndBurstType-r7
        },
        -- For tdd768, the CHOICE tdd384 in IE 'MBMS-MICHConfigurationInfo-r6' applies, except
        -- that IE 'MidambleShiftAndBurstType-VHCR' replaces IE 'MidambleShiftAndBurstType'. IE
        -- 'MidambleShiftAndBurstType' shall be ignored.
        tdd768 SEQUENCE {
            midambleShiftAndBurstType MidambleShiftAndBurstType-VHCR
        },
        tdd128 SEQUENCE {
            mbsfnSpecialTimeSlot TimeSlotLCR-ext OPTIONAL
        }
    }
}

MBMS-MICHConfigurationInfo-v890ext ::= SEQUENCE {
    mode CHOICE {
        imb384 SEQUENCE {
            channelisationCode256 ChannelisationCode256,
            ni-CountPerFrame MBMS-NI-CountPerFrame-IMB384
        }
    }
}

MBMS-MICHNotificationIndLength ::= ENUMERATED { mn4, mn8, mn16 }

MBMS-MICHPowerOffset ::= INTEGER (-10..5)

MBMS-ModifedService-r6 ::= SEQUENCE {
    mbms-TransmissionIdentity MBMS-TransmissionIdentity,
    mbms-RequiredUEAction MBMS-RequiredUEAction-Mod,
    mbms-PreferredFrequency CHOICE {
        mcch MBMS-PFLIndex,
        dcch MBMS-PFLInfo
    } OPTIONAL,
    --dummy is not used. If received it shall be ignored.
    dummy ENUMERATED { true } OPTIONAL,
    continueMCCHReading BOOLEAN
}

MBMS-ModifedServiceList-r6 ::= SEQUENCE (SIZE (1..maxMBMSservModif)) OF
    MBMS-ModifedService-r6

MBMS-ModifedService-v770ext ::= SEQUENCE {
    mbsfnClusterFrequency MBSFN-ClusterFrequency-r7 OPTIONAL
}

MBMS-ModifedService-LCR-v7c0ext ::= SEQUENCE {
    rbReleaseCause MBMS-PTM-RBReleaseCause-LCR-r7 OPTIONAL
}

-- IE 'MBMS-ModifedServiceList-v770ext' contains a list of extension data
-- associated with the MBMS transmission identities at the corresponding
-- positions in IE 'MBMS-ModifedServiceList-r6'
MBMS-ModifedServiceList-v770ext ::= SEQUENCE (SIZE (1..maxMBMSservModif)) OF
    MBMS-ModifedService-v770ext

-- IE 'MBMS-ModifedServiceList-LCR-v7c0ext' contains a list of extension data
-- associated with the MBMS transmission identities at the corresponding
-- positions in IE 'MBMS-ModifedServiceList-r6'
MBMS-ModifedServiceList-LCR-v7c0ext ::= SEQUENCE (SIZE (1..maxMBMSservModif)) OF
    MBMS-ModifedService-LCR-v7c0ext

MBMS-MSCH-ConfigurationInfo-r6 ::= SEQUENCE {
    mschSchedulingInfo MBMS-MSCHSchedulingInfo OPTIONAL,
    rlc-Info RLC-Info-MSCH-r6 OPTIONAL,
    tctf-Presence MBMS-TCTF-Presence OPTIONAL
}

MBMS-MSCHSchedulingInfo ::= CHOICE {
    schedulingPeriod-32-Offset INTEGER (0..31),
    schedulingPeriod-64-Offset INTEGER (0..63),
}

```

```

schedulingPeriod-128-Offset      INTEGER (0..127),
schedulingPeriod-256-Offset      INTEGER (0..255),
schedulingPeriod-512-Offset      INTEGER (0..511),
schedulingPeriod-1024-Offset     INTEGER (0..1023)
}

MBMS-NeighbouringCellSCCPCH-r6 ::= SEQUENCE {
  secondaryCCPCH-Info             MBMS-CommonPhyChIdentity,
  secondaryCCPCHPwrOffsetDiff    MBMS-SCCPCHPwrOffsetDiff      OPTIONAL,
  layer1Combining                 CHOICE {
    fdd                            SEQUENCE {
      softComb-TimingOffset        MBMS-SoftComb-TimingOffset,
      mbms-L1CombiningTransmTimeDiff MBMS-L1CombiningTransmTimeDiff,
      mbms-L1CombiningSchedule     MBMS-L1CombiningSchedule  OPTIONAL
    },
    tdd                            NULL
  } OPTIONAL,
  mbms-L23Configuration           MBMS-L23Configuration
}

MBMS-NeighbouringCellSCCPCH-v770ext ::= SEQUENCE {
  secondaryCCPCH-Info             MBMS-CommonPhyChIdentity      OPTIONAL,
  secondaryCCPCH-InfoDiff         SecondaryCCPCHInfoDiff-MBMS,
  secondaryCCPCHPwrOffsetDiff     MBMS-SCCPCHPwrOffsetDiff    OPTIONAL,
  layer1Combining                 CHOICE {
    fdd                            SEQUENCE {
      softComb-TimingOffset        MBMS-SoftComb-TimingOffset,
      mbms-L1CombiningTransmTimeDiff MBMS-L1CombiningTransmTimeDiff,
      mbms-L1CombiningSchedule     MBMS-L1CombiningSchedule  OPTIONAL
    },
    tdd                            NULL
  } OPTIONAL,
  mbms-L23Configuration           MBMS-L23Configuration
}

MBMS-NeighbouringCellSCCPCHList-r6 ::= SEQUENCE (SIZE (1..maxSCCPCH)) OF
  MBMS-NeighbouringCellSCCPCH-r6

-- IE "MBMS-NeighbouringCellSCCPCHList-v770ext" may be received as an extension of the IE
-- "MBMS-NeighbouringCellSCCPCHList-r6". When both lists are received in the same message
-- and the total number of list elements is greater than constant value 'maxSCCPCH', the
-- UE behaviour is unspecified.
MBMS-NeighbouringCellSCCPCHList-v770ext ::= SEQUENCE (SIZE (1..maxSCCPCH)) OF
  MBMS-NeighbouringCellSCCPCH-v770ext

MBMS-NetworkStandardTimeInformation-LCR-v890ext ::= SEQUENCE {
  networkStandardTime             BIT STRING (SIZE (40)),
  correlativeSFN                  INTEGER (0..4095)      OPTIONAL
}

MBMS-NI-CountPerFrame ::=          ENUMERATED { ni18, ni36, ni72, ni144 }

MBMS-NI-CountPerFrame-IMB384 ::=   ENUMERATED { ni16, ni32, ni64, ni128 }

MBMS-NumberOfNeighbourCells-r6 ::= INTEGER (0..32)

MBMS-PFLIndex ::=                  INTEGER (1..maxMBMS-Freq)

MBMS-PFLInfo ::=                   FrequencyInfo

MBMS-PhyChInformation-IMB384 ::=   SEQUENCE {
  mbms-CommonPhyChIdentity        MBMS-CommonPhyChIdentity,
  secondaryCCPCHInfo-MBMS         SecondaryCCPCHFrameType2Info
}

MBMS-PhyChInformationList-IMB384 ::= SEQUENCE (SIZE (1..maxMBMS-CommonPhyCh)) OF
  MBMS-PhyChInformation-IMB384

MBMS-PhyChInformation-r6 ::=      SEQUENCE {
  mbms-CommonPhyChIdentity        MBMS-CommonPhyChIdentity,
  secondaryCCPCHInfo-MBMS         SecondaryCCPCHInfo-MBMS-r6
}

MBMS-PhyChInformation-r7 ::=      SEQUENCE {
  mbms-CommonPhyChIdentity        MBMS-CommonPhyChIdentity,
  secondaryCCPCHInfo-MBMS         SecondaryCCPCHInfo-MBMS-r7
}

```

```

MBMS-PhyChInformationList-r6 ::= SEQUENCE (SIZE (1..maxMBMS-CommonPhyCh)) OF
    MBMS-PhyChInformation-r6

MBMS-PhyChInformationList-r7 ::= SEQUENCE (SIZE (1..maxMBMS-CommonPhyCh)) OF
    MBMS-PhyChInformation-r7

MBMS-PL-ServiceRestrictInfo-r6 ::= ENUMERATED { true }

MBMS-PreferredFrequencyInfo-r6 ::= SEQUENCE {
    mbmsPreferredFrequency          INTEGER (1..maxMBMS-Freq)          OPTIONAL,
    layerConvergenceInformation     CHOICE {
        mbms-Qoffset              MBMS-Qoffset,
        mbms-HCSoffset             INTEGER (0..7)
    },
    mbms-PL-ServiceRestrictInfo     MBMS-PL-ServiceRestrictInfo-r6    OPTIONAL
}

MBMS-PreferredFrequencyList-r6 ::= SEQUENCE (SIZE (1..maxMBMS-Freq)) OF
    MBMS-PreferredFrequencyInfo-r6

MBMS-PTMActivationTime-r6 ::= INTEGER (0..2047)

MBMS-PTM-RBInformation-C ::= SEQUENCE {
    rbInformation                   MBMS-CommonRBIdentity,
    shortTransmissionID             MBMS-ShortTransmissionID,
    logicalChIdentity               MBMS-LogicalChIdentity
}

MBMS-PTM-RBInformation-CList ::= SEQUENCE (SIZE (1..maxRBperTrCh)) OF
    MBMS-PTM-RBInformation-C

MBMS-PTM-RBInformation-N ::= SEQUENCE {
    shortTransmissionID             MBMS-ShortTransmissionID,
    logicalChIdentity               MBMS-LogicalChIdentity,
    layer1-CombiningStatus          BOOLEAN
}

MBMS-PTM-RBInformation-NList ::= SEQUENCE (SIZE (1..maxRBperTrCh)) OF
    MBMS-PTM-RBInformation-N

MBMS-PTM-RBReleaseCause-LCR-r7 ::= ENUMERATED {
    normalRelease, outOfMBMSServiceCoverageInRAN,
    networkAbnormalRelease,
    spare5, spare4, spare3, spare2, spare1 }

MBMS-Qoffset ::= ENUMERATED { q4, q8, q12, q16, q20, q30, q40, qInfinity }

MBMS-RequiredUEAction-Mod ::= ENUMERATED {
    none,
    acquireCountingInfo,
    acquireCountingInfoPTM-RBsUnmodified,
    acquirePTM-RBInfo,
    requestPTPRB,
    releasePTM-RB }

MBMS-RequiredUEAction-UMod ::= ENUMERATED {
    none,
    acquirePTM-RBInfo,
    requestPTPRB }

MBMS-SCCPCHIdentity ::= INTEGER (1..maxSCCPCH)

MBMS-SCCPCHPwrOffsetDiff ::= ENUMERATED { mcpo-minus6, mcpo-minus3, mcpo-plus3, mcpo-plus6 }

MBMS-SelectedServiceInfo ::= SEQUENCE {
    status                           CHOICE {
        none                          NULL,
        some                           MBMS-SelectedServicesListFull
    }
}

MBMS-SelectedServicesListFull ::= SEQUENCE (SIZE (1..maxMBMSServSelect)) OF
    MBMS-ServiceIdentity-r6

MBMS-SelectedServicesListShort ::= SEQUENCE (SIZE (1..maxMBMSServSelect)) OF
    MBMS-ShortTransmissionID

MBMS-SelectedServicesShort ::= SEQUENCE {
    mbms-SelectedServicesList        MBMS-SelectedServicesListShort,

```

```

    modificationPeriodIdentity          INTEGER (0..1)
  }

MBMS-ServiceAccessInfo-r6 ::=      SEQUENCE {
    shortTransmissionID                MBMS-ShortTransmissionID,
    accessprobabilityFactor-Idle        MBMS-AccessProbabilityFactor,
    accessprobabilityFactor-Connected   MBMS-AccessProbabilityFactor          OPTIONAL,
    mbms-ConnectedModeCountingScope     MBMS-ConnectedModeCountingScope
  }

MBMS-ServiceAccessInfoList-r6 ::= SEQUENCE (SIZE (1..maxMBMSservCount)) OF
    MBMS-ServiceAccessInfo-r6

MBMS-ServiceIdentity-r6 ::=        SEQUENCE {
    serviceIdentity                     OCTET STRING (SIZE (3)),
    plmn-Identity                       CHOICE {
        -- The 'sameAsMIB-PLMN-Id' choice refers to the 'PLMN Identity' (R99) in MIB.
        sameAsMIB-PLMN-Id               NULL,
        other                            CHOICE {
            -- The 'sameAsMIB-MultiPLMN-Id' choice refers to one of the (1..5) PLMN Identities
            -- provided in the 'Multiple PLMN List' (REL-6) in MIB.
            sameAsMIB-MultiPLMN-Id      INTEGER (1..5),
            explicitPLMN-Id             PLMN-Identity
        }
    }
  }

MBMS-ServiceSchedulingInfo-r6 ::= SEQUENCE {
    mbms-TransmissionIdentity           MBMS-TransmissionIdentity,
    mbms-ServiceTransmInfoList         MBMS-ServiceTransmInfoList          OPTIONAL,
    nextSchedulingperiod                INTEGER (0..31)
  }

MBMS-ServiceSchedulingInfoList-r6 ::= SEQUENCE (SIZE (1..maxMBMSservSched)) OF
    MBMS-ServiceSchedulingInfo-r6

MBMS-ServiceTransmInfo ::=         SEQUENCE {
    -- Actual values (start, duration) = IE values * 4
    start                               INTEGER (0..255),
    duration                             INTEGER (1..256)
  }

MBMS-ServiceTransmInfoList ::=     SEQUENCE (SIZE (1..maxMBMSTransmis)) OF
    MBMS-ServiceTransmInfo

MBMS-SessionIdentity ::=           OCTET STRING (SIZE (1))

MBMS-ShortTransmissionID ::=       INTEGER (1..maxMBMSservUnmodif)

MBMS-SIBType5-SCCPCH-r6 ::=        SEQUENCE {
    sccpchIdentity                     MBMS-SCCPCHIdentity,
    transpCHInformation                 MBMS-TrCHInformation-SIB5List
  }

MBMS-SIBType5-SCCPCHList-r6 ::=    SEQUENCE (SIZE (1..maxSCCPCH)) OF
    MBMS-SIBType5-SCCPCH-r6

MBMS-SoftComb-TimingOffset ::=     ENUMERATED { ms0, ms10, ms20, ms40 }

MBMS-TCTF-Presence ::=             ENUMERATED { false }

MBMS-TimersAndCounters-r6 ::=      SEQUENCE {
    t-318                               T-318                                DEFAULT ms1000
  }

MBMS-TransmissionIdentity ::=      SEQUENCE {
    mbms-ServiceIdentity               MBMS-ServiceIdentity-r6,
    mbms-SessionIdentity               MBMS-SessionIdentity          OPTIONAL
  }

MBMS-TranspChInfoForCCTrCh-r6 ::= SEQUENCE {
    commonCCTrChIdentity               MBMS-CommonCCTrChIdentity,
    transportFormatCombinationSet      TFCS
  }

MBMS-TranspChInfoForEachCCTrCh-r6 ::= SEQUENCE (SIZE (1..maxMBMS-CommonCCTrCh)) OF
    MBMS-TranspChInfoForCCTrCh-r6

```

```

MBMS-TranspChInfoForEachTrCh-r6 ::= SEQUENCE (SIZE (1..maxMBMS-CommonTrCh)) OF
    MBMS-TranspChInfoForTrCh-r6

MBMS-TranspChInfoForTrCh-r6 ::= SEQUENCE {
    commonTrChIdentity      MBMS-CommonTrChIdentity,
    transportFormatSet     TransportFormatSet
}

MBMS-TrCHInformation-Curr ::= SEQUENCE {
    transpCh-Info          MBMS-CommonTrChIdentity,
    rbInformation          MBMS-PTM-RBInformation-CList      OPTIONAL,
    msch-ConfigurationInfo MBMS-MSCH-ConfigurationInfo-r6   OPTIONAL
}

MBMS-TrCHInformation-CurrList ::= SEQUENCE (SIZE (1..maxFACHPCH)) OF
    MBMS-TrCHInformation-Curr

MBMS-TrCHInformation-Neighb ::= SEQUENCE {
    transpCh-Info          MBMS-CommonTrChIdentity,
    transpCh-CombiningStatus BOOLEAN,
    rbInformation          MBMS-PTM-RBInformation-NList      OPTIONAL,
    msch-ConfigurationInfo MBMS-MSCH-ConfigurationInfo-r6   OPTIONAL
}

MBMS-TrCHInformation-NeighbList ::= SEQUENCE (SIZE (1..maxFACHPCH)) OF
    MBMS-TrCHInformation-Neighb

MBMS-TrCHInformation-SIB5 ::= SEQUENCE {
    transpCh-Identity      INTEGER (1..maxFACHPCH),
    rbInformation          MBMS-PTM-RBInformation-CList      OPTIONAL,
    msch-ConfigurationInfo MBMS-MSCH-ConfigurationInfo-r6   OPTIONAL
}

MBMS-TrCHInformation-SIB5List ::= SEQUENCE (SIZE (1..maxFACHPCH)) OF
    MBMS-TrCHInformation-SIB5

MBMS-UnmodifiedService-r6 ::= SEQUENCE {
    mbms-TransmissionIdentity MBMS-TransmissionIdentity,
    mbms-RequiredUEAction     MBMS-RequiredUEAction-UMod,
    mbms-PreferredFrequency   MBMS-PFLIndex                  OPTIONAL
}

MBMS-UnmodifiedServiceList-r6 ::= SEQUENCE (SIZE (1..maxMBMSservUnmodif)) OF
    MBMS-UnmodifiedService-r6

MBMS-UnmodifiedService-v770ext ::= SEQUENCE {
    mbsfnClusterFrequency    MBSFN-ClusterFrequency-r7      OPTIONAL
}

-- IE 'MBMS-UnmodifiedServiceList-v770ext' contains a list of extension data
-- associated with the MBMS transmission identities at the corresponding
-- positions in IE 'MBMS-UnmodifiedServiceList-r6'
MBMS-UnmodifiedServiceList-v770ext ::= SEQUENCE (SIZE (1..maxMBMSservUnmodif)) OF
    MBMS-UnmodifiedService-v770ext

MBSFN-ClusterFrequency-r7 ::= INTEGER (1..maxMBSFNClusters)

MBSFNFrequency ::= SEQUENCE {
    frequencyInfo          FrequencyInfo,
    -- IE "cellParameterID" is used only for MBSFN clusters operating in 1.28 Mcps TDD mode.
    cellParametersID      CellParametersID                  OPTIONAL
}

MBSFNFrequency-v860ext ::= SEQUENCE {
    imb-Indication         ENUMERATED { true }              OPTIONAL
}

MBSFNFrequencyList ::= SEQUENCE (SIZE (0..maxMBSFNClusters)) OF
    MBSFNFrequency

-- List of extensions to the corresponding elements of IE "MBSFNFrequencyList"
MBSFNFrequencyList-v860ext ::= SEQUENCE (SIZE (0..maxMBSFNClusters)) OF
    MBSFNFrequency-v860ext

MBSFNOnlyService ::= ENUMERATED {true}

MBSFNservicesNotNotified-r7 ::= SEQUENCE {

```

```

notificationOfAllMBSFNServicesInTheBand
    ENUMERATED { true }
    OPTIONAL
}

MBSFNInterFrequencyNeighbour-r7 ::= SEQUENCE {
    mbsfnFrequency          FrequencyInfo,
    mbsfnServicesNotification CHOICE {
        mbsfnServicesNotified          NULL,
        mbsfnServicesNotNotified-r7    MBSFNservicesNotNotified-r7
    }
}

MBSFNInterFrequencyNeighbour-v860ext ::= SEQUENCE {
    imb-Indication          ENUMERATED { true }
    OPTIONAL
}

MBSFN-InterFrequencyNeighbourList-r7 ::= SEQUENCE (SIZE (1..maxMBSFNclusters)) OF
    MBSFNInterFrequencyNeighbour-r7

-- List of extensions to the corresponding elements of IE "MBSFN-InterFrequencyNeighbourList-r7"
MBSFN-InterFrequencyNeighbourList-v860ext ::= SEQUENCE (SIZE (1..maxMBSFNclusters)) OF
    MBSFNInterFrequencyNeighbour-v860ext

MBSFN-TDDInformation ::=
    SEQUENCE (SIZE (1..maxTS)) OF
        MBSFN-TDDTimeSlotInfo

MBSFN-TDDInformation-LCR ::=
    SEQUENCE (SIZE (1..maxMBSFNclusters)) OF
        MBSFN-TDDTimeSlotInfo-LCR

MBSFN-TDDTimeSlotInfo ::=
    SEQUENCE {
        timeSlotNumber      TimeslotNumber-LCR-r4,
        cellParametersID    CellParametersID
    }

MBSFN-TDDTimeSlotInfo-LCR ::=
    SEQUENCE {
        frequencyIndex      INTEGER (1..maxMBSFNclusters),
        timeSlotList         MBSFN-TDDInformation
    }

MBSFN-TDM-Info ::=
    SEQUENCE {
        shortTransmissionID  MBMS-ShortTransmissionID,
        tDMPeriod            INTEGER (2..9),
        tDMOffset            INTEGER (0..8),
        tDMLength            INTEGER (1..8)
    }

MBSFN-TDM-Info-List ::=
    SEQUENCE (SIZE (1..maxMBMSservUnmodif)) OF
        MBSFN-TDM-Info

-- *****
--
--     WLAN Offload INFORMATION ELEMENTS (10.3.9b)
--
-- *****

WLANOffloadConfig ::= SEQUENCE {
    threshServingRSCP          WLANThreshServingRSCP          OPTIONAL,
    threshServingECNO          WLANThreshServingECNO          OPTIONAL,
    threshChannelUtilization   WLANThreshChannelUtilization  OPTIONAL,
    threshBackhaulBandwidth    WLANThreshBackhaulBandwidth  OPTIONAL,
    threshBeaconRSSI           WLANThreshBeaconRSSI          OPTIONAL,
    offloadPreferenceIndicator  BIT STRING (SIZE (16))         OPTIONAL,
    t-SteeringWLAN             T-Reselection-S                OPTIONAL
}

WLANThreshServingRSCP ::= SEQUENCE {
    -- Actual value = IE value * 2 + 1
    threshServingLow          INTEGER (-60..-13),
    -- Actual value = IE value * 2 + 1
    threshServingHigh         INTEGER (-60..-13)
}

WLANThreshServingECNO ::= SEQUENCE {
    threshServingLow2         INTEGER (-24..0),
    threshServingHigh2        INTEGER (-24..0)
}

WLANThreshChannelUtilization ::= SEQUENCE {

```



```

    threshChannelUtilizationLow      INTEGER (0..255),
    threshChannelUtilizationHigh     INTEGER (0..255)
}

WLANThreshBackhaulBandwidth ::= SEQUENCE {
    threshBackhaulDLBandwidthLow     WLANThreshBackhaulRate,
    threshBackhaulDLBandwidthHigh    WLANThreshBackhaulRate,
    threshBackhaulULBandwidthLow     WLANThreshBackhaulRate,
    threshBackhaulULBandwidthHigh    WLANThreshBackhaulRate
}

WLANThreshBeaconRSSI ::= SEQUENCE {
    -- Actual value = IE value - 128
    threshBeaconRSSILow              INTEGER (0..255),
    -- Actual value = IE value - 128
    threshBeaconRSSIHigh             INTEGER (0..255)
}

WLANIdentifierList ::= SEQUENCE (SIZE (1..maxWLANID)) OF
    WLANIdentifier

WLANIdentifier ::= SEQUENCE {
    ssid          OCTET STRING (SIZE (1..32))    OPTIONAL,
    bssid         OCTET STRING (SIZE (6))        OPTIONAL,
    hessid        OCTET STRING (SIZE (6))        OPTIONAL
}

WLANOffloadInformationPerPLMN-List ::= SEQUENCE (SIZE (1..6)) OF WLANOffloadInformation

WLANOffloadInformation ::= SEQUENCE {
    wlanOffloadConfig      WLANOffloadConfig      OPTIONAL,
    wlanIdentifierList     WLANIdentifierList      OPTIONAL
}

WLANThreshBackhaulRate ::= ENUMERATED { r0, r4, r8, r16, r32, r64, r128, r256,
    r512, r1024, r2048, r4096, r8192, r16384, r32768,
    r65536, r131072, r262144, r524288, r1048576,
    r2097152, r4194304, r8388608, r16777216,
    r33554432, r67108864, r134217728, r268435456,
    r536870912, r1073741824, r2147483648, r4294967296
}

END

```

11.4 Constant definitions

Constant-definitions DEFINITIONS AUTOMATIC TAGS ::=

BEGIN

```

hipDSCHidentities      INTEGER ::= 64
hipUSCHidentities      INTEGER ::= 64
hiRM                    INTEGER ::= 256
maxAC                   INTEGER ::= 16
maxAdditionalMeas       INTEGER ::= 4
maxAddPos               INTEGER ::= 8
maxASC                  INTEGER ::= 8
maxASCmap               INTEGER ::= 7
maxASCpersist          INTEGER ::= 6
maxCCTrCH               INTEGER ::= 8
maxCellMeas             INTEGER ::= 32
maxCellMeas-ext         INTEGER ::= 80
maxCellMeas-ext2        INTEGER ::= 48
maxCellMeasOnSecULFreq INTEGER ::= 32
maxCellMeas-1           INTEGER ::= 31
maxCellMeas-ext-1      INTEGER ::= 79
maxCellMeasOnSecULFreq-1 INTEGER ::= 31
maxCNdomains            INTEGER ::= 4
maxCommonHRNTI          INTEGER ::= 4
maxCommonQueueID        INTEGER ::= 2
maxCPCHsets             INTEGER ::= 16
maxDedicatedCSGFreq     INTEGER ::= 4
maxDPCH-DLchan          INTEGER ::= 8
maxDPDCH-UL             INTEGER ::= 6
maxDRACclasses          INTEGER ::= 8
maxExcludedDetectedSetCells INTEGER ::= 64
maxE-DCHMACdFlow        INTEGER ::= 8

```

```

maxE-DCHMACdFlow-1          INTEGER ::= 7
maxMultipleFrequencyBandsFDD  INTEGER ::= 8
maxMultipleFrequencyBandsEUTRA  INTEGER ::= 8
maxEUTRACellPerFreq          INTEGER ::= 16
maxEUTRATargetFreqs          INTEGER ::= 8
maxEDCHRL                    INTEGER ::= 4
maxEDCHRL-1                   INTEGER ::= 3
maxEDCHs                       INTEGER ::= 32
maxEDCHs-1                     INTEGER ::= 31
maxEDCHTxPattern-TDD128       INTEGER ::= 4 -- maxEDCHTxPattern-TDD128 should be 3
maxEDCHTxPattern-TDD128-1     INTEGER ::= 3 -- maxEDCHTxPattern-TDD128-1 should be 2
maxERNTIgroup                  INTEGER ::= 32
maxERNTIperGroup              INTEGER ::= 2
maxERUCCH                      INTEGER ::= 256
maxFACHPCH                     INTEGER ::= 8
maxFreq                         INTEGER ::= 8
maxFreqBandsEUTRA              INTEGER ::= 16
maxFreqBandsEUTRA-ext          INTEGER ::= 48
maxFreqBandsFDD                INTEGER ::= 8
maxFreqBandsFDD2               INTEGER ::= 22
maxFreqBandsFDD3               INTEGER ::= 86
maxFreqBandsFDD-ext            INTEGER ::= 15 -- maxFreqBandsFDD-ext ::= 22 - (maxFreqBandsFDD - 1)
maxFreqBandsFDD-ext2           INTEGER ::= 64 -- maxFreqBandsFDD-ext2 ::= 86 - maxFreqBandsFDD2
maxFreqBandsFDD-ext3           INTEGER ::= 78 -- maxFreqBandsFDD-ext3 ::= 86 - maxFreqBandsFDD
maxFreqBandsIndicatorSupport   INTEGER ::= 2
maxFreqBandsTDD                INTEGER ::= 4
maxFreqBandsTDD-ext            INTEGER ::= 16
maxFreqBandsGSM                INTEGER ::= 16
maxFreqMeasWithoutCM           INTEGER ::= 2
maxGANSS                       INTEGER ::= 8
maxGANSS-1                     INTEGER ::= 7
maxGANSSSat                    INTEGER ::= 64
maxGANSSSat-1                  INTEGER ::= 63
maxGERAN-SI                     INTEGER ::= 8
maxGSMTTargetCells             INTEGER ::= 32
maxHNBNameSize                 INTEGER ::= 48
maxHProcesses                   INTEGER ::= 8
maxHS-SCCHLessTrBlk            INTEGER ::= 4
maxHSDSCHTBIndex               INTEGER ::= 64
maxHSDSCHTBIndex-tdd384        INTEGER ::= 512
maxHSSCCHs                     INTEGER ::= 4
maxHSSCCHs-1                   INTEGER ::= 3
maxHSSICH-TDD128               INTEGER ::= 4
maxHSSICH-TDD128-1             INTEGER ::= 3
maxIGPInfo                      INTEGER ::= 320
maxInterSysMessages            INTEGER ::= 4
maxLoCHperRLC                  INTEGER ::= 2
maxLoggedMeasReport            INTEGER ::= 128
maxMAC-d-PDU sizes             INTEGER ::= 8
maxMBMS-CommonCCTrCh           INTEGER ::= 32
maxMBMS-CommonPhyCh            INTEGER ::= 32
maxMBMS-CommonRB               INTEGER ::= 32
maxMBMS-CommonTrCh             INTEGER ::= 32
maxMBMS-Freq                   INTEGER ::= 4
maxMBMS-L1CP                   INTEGER ::= 4
maxMBMSservCount               INTEGER ::= 8
maxMBMSservModif               INTEGER ::= 32
maxMBMSservSched               INTEGER ::= 16
maxMBMSservSelect              INTEGER ::= 8
maxMBMSservUnmodif             INTEGER ::= 64
maxMBMSTransmis                INTEGER ::= 4
maxMBSFNClusters               INTEGER ::= 16
maxMeasCSGRange                INTEGER ::= 4
maxMeasEvent                   INTEGER ::= 8
maxMeasEventOnSecULFreq        INTEGER ::= 8
maxMeasIdentity                 INTEGER ::= 32
maxMeasIntervals                INTEGER ::= 3
maxMeasOccasionPattern         INTEGER ::= 5
maxMeasOccasionPattern-1       INTEGER ::= 4
maxMeasParEvent                 INTEGER ::= 2
maxNonContiguousMultiCellCombinations  INTEGER ::= 3
maxNumAccessGroups              INTEGER ::= 16
maxNumCDMA2000Freqs            INTEGER ::= 8
maxNumE-AGCH                   INTEGER ::= 4
maxNumE-HICH                    INTEGER ::= 4
maxNumEUTRAFreqs               INTEGER ::= 8
maxNumEUTRAFreqs-FACH           INTEGER ::= 4
maxNumEUTRAFreqs-FACH-ext      INTEGER ::= 8

```

```

maxNumGSMCellGroup          INTEGER ::= 16
maxNumGSMFreqRanges         INTEGER ::= 32
maxNumFDDFreqs              INTEGER ::= 8
maxNumANRLoggedItems        INTEGER ::= 4
maxnumLoggedMeas            INTEGER ::= 8
maxNumMDTPLMN               INTEGER ::= 15
maxNumTDDFreqs              INTEGER ::= 8
maxNoOfMeas                 INTEGER ::= 16
maxOtherRAT                 INTEGER ::= 15
maxOtherRAT-16              INTEGER ::= 16
maxPage1                    INTEGER ::= 8
maxPCPCH-APsig              INTEGER ::= 16
maxPCPCH-APsubCh            INTEGER ::= 12
maxPCPCH-CDsig              INTEGER ::= 16
maxPCPCH-CDsubCh            INTEGER ::= 12
maxPCPCH-SF                  INTEGER ::= 7
maxPCPCHs                   INTEGER ::= 64
maxPDCPAlgoType             INTEGER ::= 8
maxPDSCH                    INTEGER ::= 8
maxPDSCH-TFCIgroups         INTEGER ::= 256
maxPRACH                     INTEGER ::= 16
maxPRACH-EUL                INTEGER ::= 4
maxPRACH-FPACH              INTEGER ::= 8
maxPredefConfig             INTEGER ::= 16
maxPrio                      INTEGER ::= 8
maxPrio-1                    INTEGER ::= 7
maxPUSCH                     INTEGER ::= 8
maxQueueIDs                  INTEGER ::= 8
maxRABsetup                  INTEGER ::= 16
maxRAT                       INTEGER ::= 16
maxRB                        INTEGER ::= 32
maxRBallRABs                 INTEGER ::= 27
maxRBMuxOptions              INTEGER ::= 8
maxRBperRAB                  INTEGER ::= 8
maxRBperTrCh                 INTEGER ::= 16
maxReportedEUTRACellPerFreq INTEGER ::= 4
maxReportedEUTRAFreqs        INTEGER ::= 4
maxReportedEUTRAFreqs-ext    INTEGER ::= 8
maxReportedGSMCells          INTEGER ::= 8
maxRL                         INTEGER ::= 8
maxRL-1                       INTEGER ::= 7
maxRLCPDUsizesPerLogChan     INTEGER ::= 32
maxRMPfrequencies            INTEGER ::= 8
maxRFC3095-CID               INTEGER ::= 16384
maxROHC-PacketSizes-r4       INTEGER ::= 16
maxROHC-Profile-r4           INTEGER ::= 8
maxRxPatternForHSDSCH-TDD128 INTEGER ::= 4 -- maxRxPatternForHSDSCH-TDD128 should be 3
maxRxPatternForHSDSCH-TDD128-1 INTEGER ::= 3 -- maxRxPatternForHSDSCH-TDD128-1 should be 2
maxSat                        INTEGER ::= 16
maxSatClockModels            INTEGER ::= 4
maxSCCPCH                    INTEGER ::= 16
maxSgnType                   INTEGER ::= 8
maxSIB                        INTEGER ::= 32
maxSIB2                       INTEGER ::= 64
maxSIB-FACH                   INTEGER ::= 8
maxSIBperMsg                  INTEGER ::= 16
maxSirequest                  INTEGER ::= 4
maxSRBsetup                   INTEGER ::= 8
maxSystemCapability           INTEGER ::= 16
maxTDD128Carrier              INTEGER ::= 6
maxTDD128Carrier-1            INTEGER ::= 5
maxTbsForHSDSCH-TDD128        INTEGER ::= 4
maxTbsForHSDSCH-TDD128-1     INTEGER ::= 3
maxTF                          INTEGER ::= 32
maxTF-CPCH                    INTEGER ::= 16
maxTFC                        INTEGER ::= 1024
maxTFCsub                      INTEGER ::= 1024
maxTFCI-2-Combs               INTEGER ::= 512
maxTGPS                       INTEGER ::= 6
maxTrCH                        INTEGER ::= 32
maxTrCHConcat                 INTEGER ::= 3
-- maxTrCHpreconf should be 16 but has been set to 32 for compatibility
maxTrCHpreconf                INTEGER ::= 32
maxTS                          INTEGER ::= 14
maxTS-1                       INTEGER ::= 13
maxTS-2                       INTEGER ::= 12
maxTS-LCR                      INTEGER ::= 6
maxTS-LCR-1                    INTEGER ::= 5

```

```

maxURA                INTEGER ::= 8
maxURNNTI-Group       INTEGER ::= 8
maxWLANID              INTEGER ::= 16

```

```
END
```

11.5 RRC information between network nodes

```
Internode-definitions DEFINITIONS AUTOMATIC TAGS ::=
```

```
BEGIN
```

```
IMPORTS
```

```

    HandoverToUTRANCommand,
    MeasurementReport,
    PhysicalChannelReconfiguration,
    RadioBearerReconfiguration,
    RadioBearerRelease,
    RadioBearerSetup,
    RRCConnectionSetupComplete-r3-add-ext-IEs,
    RRC-FailureInfo,
    TransportChannelReconfiguration,
    UECapabilityInformation-r3-add-ext-IEs
FROM PDU-definitions

```

```

-- Core Network IEs :
    CN-DomainIdentity,
    CN-DomainInformationList,
    CN-DomainInformationListFull,
    CN-DRX-CycleLengthCoefficient,
    NAS-SystemInformationGSM-MAP,
-- UTRAN Mobility IEs :
    CellIdentity,
    URA-Identity,
-- User Equipment IEs :
    AccessStratumReleaseIndicator,
    C-RNTI,
    ChipRateCapability,
    DL-CapabilityWithSimultaneousHS-DSCHConfig,
    DL-PhysChCapabilityFDD-v380ext,
    DL-PhysChCapabilityTDD,
    DL-PhysChCapabilityTDD-LCR-r4,
    GSM-Measurements,
    HSDSCH-physical-layer-category,
    FailureCauseWithProtErr,
    MaxHcContextSpace,
    MaximumAM-EntityNumberRLC-Cap,
    MaximumRLC-WindowSize,
    MaxNoPhysChBitsReceived,
    MaxNoDPDCH-BitsTransmitted,
    MaxPhysChPerFrame,
    MaxPhysChPerSubFrame-r4,
    MaxPhysChPerTS,
    MaxROHC-ContextSessions-r4,
    MaxTS-PerFrame,
    MaxTS-PerSubFrame-r4,
    MinimumSF-DL,
    MultiModeCapability,
    MultiRAT-Capability,
    NetworkAssistedGPS-Supported,
    PhysicalChannelCapability-edch-r6,
    RadioFrequencyBandTDDList,
    RLC-Capability,
    RRC-MessageSequenceNumber,
    SecurityCapability,
    SimultaneousSCCPCH-DPCH-Reception,
    STARTList,
    STARTSingle,
    START-Value,
    SupportOfDedicatedPilotsForChEstimation,
    T-305,
    TransportChannelCapability,
    TxRxFrequencySeparation,
    U-RNTI,
    UE-CapabilityContainer-IEs,
    UE-GANSSPositioning-Capability,

```

```

UE-MultiModeRAT-Capability,
UE-PowerClassExt,
UE-RadioAccessCapabBandFDDList,
UE-RadioAccessCapabBandFDDList2,
UE-RadioAccessCapabBandFDDList-ext,
UE-RadioAccessCapability,
UE-RadioAccessCapability-v370ext,
UE-RadioAccessCapability-v380ext,
UE-RadioAccessCapability-v3a0ext,
UE-RadioAccessCapability-v3g0ext,
UE-RadioAccessCapability-v4b0ext,
UE-RadioAccessCapability-v590ext,
UE-RadioAccessCapability-v5c0ext,
UE-RadioAccessCapability-v7e0ext,
UE-RadioAccessCapability-v7f0ext,
UL-PhysChCapabilityFDD,
UL-PhysChCapabilityFDD-r6,
UL-PhysChCapabilityTDD,
UL-PhysChCapabilityTDD-LCR-r4,
-- Radio Bearer IEs :
PDCP-ROHC-TargetMode,
PredefinedConfigStatusList,
PredefinedConfigValueTag,
RAB-InformationSetupList,
RAB-InformationSetupList-r4,
RAB-InformationSetupList-r5,
RAB-InformationSetupList-r6-ext,
RAB-InformationSetupList-r6,
RAB-InformationSetupList-v6b0ext,
RAB-InformationSetupList-r7,
RAB-InformationSetupList-r8,
RAB-InformationSetupList-v820ext,
RAB-InformationSetupList-r11,
RB-Identity,
SRB-InformationSetupList,
SRB-InformationSetupList-r5,
SRB-InformationSetupList-r6,
SRB-InformationSetupList-r7,
SRB-InformationSetupList-r8,
SRB-InformationSetupList-r11,
-- Transport Channel IEs :
CPCH-SetID,
DL-CommonTransChInfo,
DL-CommonTransChInfo-r4,
DL-AddReconfTransChInfoList,
DL-AddReconfTransChInfoList-r4,
DL-AddReconfTransChInfoList-r5,
DL-AddReconfTransChInfoList-r7,
DL-AddReconfTransChInfoList-r9,
DL-AddReconfTransChInfoList-TDD128-v9c0ext,
DL-AddReconfTransChInfoList-r11,
DRAC-StaticInformationList,
UL-CommonTransChInfo,
UL-CommonTransChInfo-r4,
UL-CommonTransChInfo-r12,
UL-AddReconfTransChInfoList,
UL-AddReconfTransChInfoList-r6,
UL-AddReconfTransChInfoList-r7,
UL-AddReconfTransChInfoList-r8,
-- Physical Channel IEs :
DCH-Enhancements-Info-FDD,
DL-CommonInformation-r12,
DL-InformationPerRL-List-r12,
DTX-DRX-Info-r12,
FrequencyInfo,
PrimaryCPICH-Info,
TPC-CombinationIndex,
ScramblingCodeChange,
Serving-HSDSCH-CellInformation-r12,
TGCFN,
TGPSI,
TGPS-ConfigurationParams,
TGPS-ConfigurationParams-r8,
UL-SecondaryCellInfoFDD-r12,
-- Measurement IEs :
Event1j-r6,
Hysteresis,
Inter-FreqEventCriteriaList-v590ext,

```

```

    Intra-FreqEventCriteriaList-v590ext,
    IntraFreqEvent-ld-r5,
    IntraFreqReportingCriteria-lb-r5,
    InterRATCellInfoIndication,
    MeasuredResultsOnRACHinterFreq,
    MeasurementIdentity,
    MeasurementIdentity-r9,
    MeasurementReportingMode,
    MeasurementType,
    MeasurementType-r4,
    MeasurementType-r6,
    MeasurementType-r7,
    MeasurementType-r8,
    MeasurementType-r9,
    MeasurementType-r10,
    MeasurementType-r11,
    MeasurementType-r12,
    AdditionalMeasurementID-List,
    AdditionalMeasurementID-List-r9,
    PositionEstimate,
    ReportingCellStatus,
    ThresholdSFN-GPS-TOW-us,
    TimeToTrigger,
-- MBMS IEs :
    MBMS-JoinedInformation-r6,
    MBMS-SelectedServiceInfo,
-- Other IEs :
    GERANIu-RadioAccessCapability,
    GSM-MS-RadioAccessCapability,
    InterRAT-UE-RadioAccessCapabilityList,
    InterRAT-UE-RadioAccessCapability-v590ext,
    InterRAT-UE-RadioAccessCapability-v690ext,
    InterRAT-UE-RadioAccessCapability-v860ext,
    UE-HistoryInformation,
    UESpecificBehaviourInformationIdle,
    UESpecificBehaviourInformationInterRAT

FROM InformationElements

    maxCNDomains,
    maxEDCHRL,
    maxGANS,
    maxNoOfMeas,
    maxRB,
    maxRBallRABs,
    maxRFC3095-CID,
    maxSRBsetup,
    maxRL,
    maxTGPS
FROM Constant-definitions;

-- Part 1: Class definitions similar to what has been defined in 11.1 for RRC messages
-- Information that is transferred in the same direction and across the same path is grouped
-- *****
--
-- RRC information, to target RNC
--
-- *****
-- RRC Information to target RNC sent either from source RNC or from another RAT

ToTargetRNC-Container ::= CHOICE {
    interRATHandoverInfo          InterRATHandoverInfoWithInterRATCapabilities-r3,
    srcRelocation                 SRNC-RelocationInfo-r3,
    rfc3095-ContextInfo           RFC3095-ContextInfo-r5,
    extension                     NULL
}

-- *****
--
-- RRC information, target RNC to source RNC
--
-- *****

TargetRNC-ToSourceRNC-Container ::= CHOICE {
    radioBearerSetup              RadioBearerSetup,

```

```

radioBearerReconfiguration      RadioBearerReconfiguration,
radioBearerRelease              RadioBearerRelease,
transportChannelReconfiguration TransportChannelReconfiguration,
physicalChannelReconfiguration PhysicalChannelReconfiguration,
rrc-FailureInfo                 RRC-FailureInfo,
-- IE dl-DCCHmessage consists of an octet string that includes the IE DL-DCCH-Message
dl-DCCHmessage                  OCTET STRING,
extension                        NULL
}

-- Part 2: Container definitions, similar to the PDU definitions in 11.2 for RRC messages
-- In alphabetical order

-- *****
--
-- Handover to UTRAN information
--
-- *****

InterRATHandoverInfoWithInterRATCapabilities-r3 ::= CHOICE {
  r3                               SEQUENCE {
    -- IE InterRATHandoverInfoWithInterRATCapabilities-r3-IEs also
    -- includes non critical extensions
    interRATHandoverInfo-r3        InterRATHandoverInfoWithInterRATCapabilities-r3-IEs,
    v390NonCriticalExtensions       SEQUENCE {
      interRATHandoverInfoWithInterRATCapabilities-v390ext
      InterRATHandoverInfoWithInterRATCapabilities-v390ext-IEs,
      -- Reserved for future non critical extension
      v690NonCriticalExtensions     SEQUENCE {
        interRATHandoverInfoWithInterRATCapabilities-v690ext
        InterRATHandoverInfoWithInterRATCapabilities-v690ext-IEs,
        v860NonCriticalExtensions   SEQUENCE {
          interRATHandoverInfoWithInterRATCapabilities-v860ext
          InterRATHandoverInfoWithInterRATCapabilities-v860ext-IEs,
          v920NonCriticalExtensions SEQUENCE {
            interRATHandoverInfoWithInterRATCapabilities-v920ext
            InterRATHandoverInfoWithInterRATCapabilities-v920ext-IEs,
            nonCriticalExtensions   SEQUENCE {} OPTIONAL
          }
        } OPTIONAL
      } OPTIONAL
    } OPTIONAL
  },
  criticalExtensions               SEQUENCE {}
}

InterRATHandoverInfoWithInterRATCapabilities-r3-IEs ::= SEQUENCE {
  -- The order of the IEs may not reflect the tabular format
  -- but has been chosen to simplify the handling of the information in the BSC
  -- Other IEs
  ue-RATSpecificCapability         InterRAT-UE-RadioAccessCapabilityList OPTIONAL,
  -- interRATHandoverInfo, Octet string is used to obtain 8 bit length field prior to
  -- actual information. This makes it possible for BSS to transparently handle information
  -- received via GSM air interface even when it includes non critical extensions.
  -- The octet string shall include the InterRATHandoverInfo information
  -- The BSS can re-use the 44.018 length field received from the MS
  interRATHandoverInfo             OCTET STRING (SIZE (0..255))
}

InterRATHandoverInfoWithInterRATCapabilities-v390ext-IEs ::= SEQUENCE {
  -- User equipment IEs
  failureCauseWithProtErr          FailureCauseWithProtErr          OPTIONAL
}

InterRATHandoverInfoWithInterRATCapabilities-v690ext-IEs ::= SEQUENCE {
  -- Other IEs
  ue-RATSpecificCapability-v690ext InterRAT-UE-RadioAccessCapability-v690ext OPTIONAL
}

InterRATHandoverInfoWithInterRATCapabilities-v860ext-IEs ::= SEQUENCE {
  -- Other IEs
  ue-RATSpecificCapability          InterRAT-UE-RadioAccessCapability-v860ext OPTIONAL
}

InterRATHandoverInfoWithInterRATCapabilities-v920ext-IEs ::= SEQUENCE {
  -- Other IEs
  ue-Inactivity-Period              INTEGER (1..120)          OPTIONAL
}

```

```

}
-- *****
--
-- RFC3095 context, source RNC to target RNC
--
-- *****

RFC3095-ContextInfo-r5 ::= CHOICE {
  r5 SEQUENCE {
    RFC3095-ContextInfoList-r5 RFC3095-ContextInfoList-r5,
    -- Reserved for future non critical extension
    nonCriticalExtensions SEQUENCE {} OPTIONAL
  },
  criticalExtensions SEQUENCE {}
}

RFC3095-ContextInfoList-r5 ::= SEQUENCE (SIZE (1..maxRBallRABs)) OF
  RFC3095-ContextInfo

-- *****
--
-- SRNC Relocation information
--
-- *****

SRNC-RelocationInfo-r3 ::= CHOICE {
  r3 SEQUENCE {
    SRNC-RelocationInfo-r3 SRNC-RelocationInfo-r3-IEs,
    v380NonCriticalExtensions SEQUENCE {
      SRNC-RelocationInfo-v380ext SRNC-RelocationInfo-v380ext-IEs,
      -- Reserved for future non critical extension
      v390NonCriticalExtensions SEQUENCE {
        SRNC-RelocationInfo-v390ext SRNC-RelocationInfo-v390ext-IEs,
        v3a0NonCriticalExtensions SEQUENCE {
          SRNC-RelocationInfo-v3a0ext SRNC-RelocationInfo-v3a0ext-IEs,
          v3b0NonCriticalExtensions SEQUENCE {
            SRNC-RelocationInfo-v3b0ext SRNC-RelocationInfo-v3b0ext-IEs,
            v3c0NonCriticalExtensions SEQUENCE {
              SRNC-RelocationInfo-v3c0ext SRNC-RelocationInfo-v3c0ext-IEs,
              laterNonCriticalExtensions SEQUENCE {
                SRNC-RelocationInfo-v3d0ext SRNC-RelocationInfo-v3d0ext-IEs,
                -- Container for additional R99 extensions
                SRNC-RelocationInfo-r3-add-ext BIT STRING
                (CONTAINING SRNC-RelocationInfo-v3h0ext-IEs) OPTIONAL,
                v3g0NonCriticalExtensions SEQUENCE {
                  SRNC-RelocationInfo-v3g0ext SRNC-RelocationInfo-v3g0ext-IEs,
                  v4b0NonCriticalExtensions SEQUENCE {
                    SRNC-RelocationInfo-v4b0ext SRNC-RelocationInfo-v4b0ext-IEs,
                    v590NonCriticalExtensions SEQUENCE {
                      SRNC-RelocationInfo-v590ext
                      SRNC-RelocationInfo-v590ext-IEs,
                      v5a0NonCriticalExtensions SEQUENCE {
                        SRNC-RelocationInfo-v5a0ext
                        SRNC-RelocationInfo-v5a0ext-IEs,
                        v5b0NonCriticalExtensions SEQUENCE {
                          SRNC-RelocationInfo-v5b0ext
                          SRNC-RelocationInfo-v5b0ext-IEs,
                          v5c0NonCriticalExtensions SEQUENCE {
                            SRNC-RelocationInfo-v5c0ext
                            SRNC-RelocationInfo-v5c0ext-IEs,
                            v690NonCriticalExtensions SEQUENCE {
                              SRNC-RelocationInfo-v690ext
                              SRNC-RelocationInfo-v690ext-IEs,
                              v6b0NonCriticalExtensions SEQUENCE {
                                SRNC-RelocationInfo-v6b0ext
                                SRNC-RelocationInfo-v6b0ext-IEs,
                                v770NonCriticalExtensions SEQUENCE {
                                  SRNC-RelocationInfo-v770ext
                                  SRNC-RelocationInfo-v770ext-IEs,
                                  v7e0NonCriticalExtensions SEQUENCE {
                                    SRNC-RelocationInfo-v7e0ext
                                    SRNC-RelocationInfo-v7e0ext-IEs,
                                    v7f0NonCriticalExtensions SEQUENCE {
                                      SRNC-RelocationInfo-v7f0ext
                                      SRNC-RelocationInfo-v7f0ext-IEs,
                                      nonCriticalExtensions

```



```

SEQUENCE {} OPTIONAL
} OPTIONAL
} OPTIONAL
} OPTIONAL
} OPTIONAL
} OPTIONAL
} OPTIONAL
} OPTIONAL
} OPTIONAL
} OPTIONAL
} OPTIONAL
} OPTIONAL
} OPTIONAL
} OPTIONAL
} OPTIONAL
} OPTIONAL
},
later-than-r3
r4 CHOICE {
SEQUENCE {
SRNC-RelocationInfo-r4 SRNC-RelocationInfo-r4-IEs,
v4d0NonCriticalExtensions SEQUENCE {
SRNC-RelocationInfo-v4d0ext SRNC-RelocationInfo-v4d0ext-IEs,
-- Container for adding non critical extensions after freezing REL-5
SRNC-RelocationInfo-r4-add-ext BIT STRING OPTIONAL,
v590NonCriticalExtensions SEQUENCE {
SRNC-RelocationInfo-v590ext SRNC-RelocationInfo-v590ext-IEs,
v5a0NonCriticalExtensions SEQUENCE {
SRNC-RelocationInfo-v5a0ext SRNC-RelocationInfo-v5a0ext-IEs,
v5b0NonCriticalExtensions SEQUENCE {
SRNC-RelocationInfo-v5b0ext SRNC-RelocationInfo-v5b0ext-IEs,
v5c0NonCriticalExtensions SEQUENCE {
SRNC-RelocationInfo-v5c0ext SRNC-RelocationInfo-v5c0ext-IEs,
v690NonCriticalExtensions SEQUENCE {
SRNC-RelocationInfo-v690ext SRNC-RelocationInfo-v690ext-IEs,
v6b0NonCriticalExtensions SEQUENCE {
SRNC-RelocationInfo-v6b0ext
SRNC-RelocationInfo-v6b0ext-IEs,
v770NonCriticalExtensions SEQUENCE {
SRNC-RelocationInfo-v770ext
SRNC-RelocationInfo-v770ext-IEs,
v7e0NonCriticalExtensions SEQUENCE {
SRNC-RelocationInfo-v7e0ext
SRNC-RelocationInfo-v7e0ext-IEs,
v7f0NonCriticalExtensions SEQUENCE {
SRNC-RelocationInfo-v7f0ext
SRNC-RelocationInfo-v7f0ext-IEs,
nonCriticalExtensions SEQUENCE {} OPTIONAL
} OPTIONAL
} OPTIONAL
} OPTIONAL
} OPTIONAL
} OPTIONAL
} OPTIONAL
} OPTIONAL
} OPTIONAL
},
criticalExtensions CHOICE {
r5 SEQUENCE {
SRNC-RelocationInfo-r5 SRNC-RelocationInfo-r5-IEs,
SRNC-RelocationInfo-r5-add-ext BIT STRING OPTIONAL,
v5a0NonCriticalExtensions SEQUENCE {
SRNC-RelocationInfo-v5a0ext SRNC-RelocationInfo-v5a0ext-IEs,
v5b0NonCriticalExtensions SEQUENCE {
SRNC-RelInfo-v5b0ext SRNC-RelocationInfo-v5b0ext-IEs,
v5c0NonCriticalExtensions SEQUENCE {
SRNC-RelocationInfo-v5c0ext SRNC-RelocationInfo-v5c0ext-IEs,
v690NonCriticalExtensions SEQUENCE {
SRNC-RelocationInfo-v690ext SRNC-RelocationInfo-v690ext-IEs,
v6b0NonCriticalExtensions SEQUENCE {
SRNC-RelocationInfo-v6b0ext SRNC-RelocationInfo-v6b0ext-IEs,
v770NonCriticalExtensions SEQUENCE {
SRNC-RelocationInfo-v770ext
SRNC-RelocationInfo-v770ext-IEs,
v7e0NonCriticalExtensions SEQUENCE {

```

```

        SRNC-RelocationInfo-v7e0ext
        SRNC-RelocationInfo-v7e0ext-IEs,
    v7f0NonCriticalExtensions SEQUENCE {
        SRNC-RelocationInfo-v7f0ext
        SRNC-RelocationInfo-v7f0ext-IEs,
        nonCriticalExtensions SEQUENCE {} OPTIONAL
    } OPTIONAL
} OPTIONAL
} OPTIONAL
} OPTIONAL
} OPTIONAL
} OPTIONAL
},
criticalExtensions CHOICE {
    r6 SEQUENCE {
        SRNC-RelocationInfo-r6 SRNC-RelocationInfo-r6-IEs,
        SRNC-RelocationInfo-r6-add-ext BIT STRING
        (CONTAINING SRNC-RelocationInfo-r6-add-ext-IEs) OPTIONAL,
        v6b0NonCriticalExtensions SEQUENCE {
            SRNC-RelocationInfo-v6b0ext SRNC-RelocationInfo-v6b0ext-IEs,
            v770NonCriticalExtensions SEQUENCE {
                SRNC-RelocationInfo-v770ext SRNC-RelocationInfo-v770ext-IEs,
                v820NonCriticalExtensions SEQUENCE {
                    srnc-RelocationInfo-v820ext SRNC-RelocationInfo-v820ext-IEs,
                    v860NonCriticalExtensions SEQUENCE {
                        SRNC-RelocationInfo-v860ext SRNC-RelocationInfo-v860ext-IEs,
                        nonCriticalExtensions SEQUENCE {} OPTIONAL
                    } OPTIONAL
                } OPTIONAL
            } OPTIONAL
        } OPTIONAL
    } OPTIONAL
},
criticalExtensions CHOICE {
    r7 SEQUENCE {
        SRNC-RelocationInfo-r7 SRNC-RelocationInfo-r7-IEs,
        SRNC-RelocationInfo-r7-add-ext BIT STRING
        (CONTAINING SRNC-RelocationInfo-r7-add-ext-IEs) OPTIONAL,
        v820NonCriticalExtensions SEQUENCE {
            srnc-RelocationInfo-v820ext SRNC-RelocationInfo-v820ext-IEs,
            v860NonCriticalExtensions SEQUENCE {
                SRNC-RelocationInfo-v860ext SRNC-RelocationInfo-v860ext-IEs,
                nonCriticalExtensions SEQUENCE {} OPTIONAL
            } OPTIONAL
        } OPTIONAL
    } OPTIONAL
},
criticalExtensions CHOICE {
    r8 SEQUENCE {
        SRNC-RelocationInfo-r8 SRNC-RelocationInfo-r8-IEs,
        SRNC-RelocationInfo-r8-add-ext BIT STRING OPTIONAL,
        v7e0NonCriticalExtensions SEQUENCE {
            SRNC-RelocationInfo-v7e0ext SRNC-RelocationInfo-v7e0ext-IEs,
            v7f0NonCriticalExtensions SEQUENCE {
                SRNC-RelocationInfo-v7f0ext
                SRNC-RelocationInfo-v7f0ext-IEs,
                v8d0NonCriticalExtensions SEQUENCE {
                    SRNC-RelocationInfo-v8d0ext
                    SRNC-RelocationInfo-v8d0ext-IEs,
                    nonCriticalExtensions SEQUENCE {} OPTIONAL
                } OPTIONAL
            } OPTIONAL
        } OPTIONAL
    } OPTIONAL
},
criticalExtensions CHOICE {
    r9 SEQUENCE {
        SRNC-RelocationInfo-r9 SRNC-RelocationInfo-r9-IEs,
        SRNC-RelocationInfo-r9-add-ext BIT STRING OPTIONAL,
        v8d0NonCriticalExtensions SEQUENCE {
            SRNC-RelocationInfo-v8d0ext SRNC-RelocationInfo-v8d0ext-IEs,
            v970NonCriticalExtensions SEQUENCE {
                SRNC-RelocationInfo-v970ext
                SRNC-RelocationInfo-v970ext-IEs,
                v9c0NonCriticalExtensions SEQUENCE {
                    SRNC-RelocationInfo-v9c0ext
                    SRNC-RelocationInfo-v9c0ext-IEs,
                    nonCriticalExtensions SEQUENCE {} OPTIONAL
                } OPTIONAL
            }
        }
    } OPTIONAL
}

```



```

    ongoingMeasRepList          OngoingMeasRepList          OPTIONAL,
-- Radio bearer IEs
    predefinedConfigStatusList  PredefinedConfigStatusList,
    srb-InformationList         SRB-InformationSetupList,
    rab-InformationList         RAB-InformationSetupList          OPTIONAL,
-- Transport channel IEs
    ul-CommonTransChInfo       UL-CommonTransChInfo          OPTIONAL,
    ul-TransChInfoList         UL-AddReconfTransChInfoList    OPTIONAL,
    modeSpecificInfo           CHOICE {
        fdd                     SEQUENCE {
            -- dummy and dummy2 are not used in this version of the specification, they should
            -- not be sent and if received they should be ignored.
            dummy                CPCH-SetID                OPTIONAL,
            dummy2              DRAC-StaticInformationList    OPTIONAL
        },
        tdd                     NULL
    },
    dl-CommonTransChInfo       DL-CommonTransChInfo          OPTIONAL,
    dl-TransChInfoList         DL-AddReconfTransChInfoList    OPTIONAL,
-- Measurement report
    measurementReport          MeasurementReport          OPTIONAL
}

SRNC-RelocationInfo-v380ext-IEs ::= SEQUENCE {
-- Ciphering related information IEs
-- In the SRNC-RelocationInfo-r3-IEs, the IE 'cn-DomainIdentity' is used to represent the
-- IE 'Latest configured CN domain' in the tabular.
    cn-DomainIdentity          CN-DomainIdentity,
    cipheringStatusList       CipheringStatusList
}

SRNC-RelocationInfo-v390ext-IEs ::= SEQUENCE {
    cn-DomainInformationList-v390ext  CN-DomainInformationList-v390ext    OPTIONAL,
    ue-RadioAccessCapability-v370ext  UE-RadioAccessCapability-v370ext    OPTIONAL,
    ue-RadioAccessCapability-v380ext  UE-RadioAccessCapability-v380ext    OPTIONAL,
    dl-PhysChCapabilityFDD-v380ext    DL-PhysChCapabilityFDD-v380ext,
    failureCauseWithProtErr          FailureCauseWithProtErr            OPTIONAL
}

SRNC-RelocationInfo-v3a0ext-IEs ::= SEQUENCE {
    cipheringInfoForSRB1-v3a0ext      CipheringInfoPerRB-List-v3a0ext,
    ue-RadioAccessCapability-v3a0ext  UE-RadioAccessCapability-v3a0ext    OPTIONAL,
-- cn-domain identity for IE startValueForCiphering-v3a0ext is specified
-- in subsequent extension (SRNC-RelocationInfo-v3b0ext-IEs)
    startValueForCiphering-v3a0ext    START-Value
}

SRNC-RelocationInfo-v3b0ext-IEs ::= SEQUENCE {
-- cn-domain identity for IE startValueForCiphering-v3a0ext included in previous extension
    cn-DomainIdentity          CN-DomainIdentity,
-- the IE startValueForCiphering-v3b0ext contains the start values for each CN Domain. The
-- value of start indicated by the IE startValueForCiphering-v3a0ext should be set to the
-- same value as the start-Value for the corresponding cn-DomainIdentity in the IE
-- startValueForCiphering-v3b0ext
    startValueForCiphering-v3b0ext    STARTList2          OPTIONAL
}

SRNC-RelocationInfo-v3c0ext-IEs ::= SEQUENCE {
-- IE rb-IdentityForHOMessage includes the identity of the RB used by the source SRNC
-- to send the message contained in the IE "TargetRNC-ToSourceRNC-Container".
-- Only included if type is "UE involved"
    rb-IdentityForHOMessage      RB-Identity          OPTIONAL
}

SRNC-RelocationInfo-v3d0ext-IEs ::= SEQUENCE {
-- User equipment IEs
    ueSpecificBehaviourInformationIdle  UESpecificBehaviourInformationIdle    OPTIONAL,
    ueSpecificBehaviourInformationInterRAT  UESpecificBehaviourInformationInterRAT  OPTIONAL
}

SRNC-RelocationInfo-v3g0ext-IEs ::= SEQUENCE {
    ue-RadioAccessCapability-v3g0ext    UE-RadioAccessCapability-v3g0ext    OPTIONAL
}

SRNC-RelocationInfo-v3h0ext-IEs ::= SEQUENCE {
    tpc-CombinationInfoList          TPC-CombinationInfoList    OPTIONAL,
    nonCriticalExtension              SEQUENCE {}                OPTIONAL
}

```

```

SRNC-RelocationInfo-v4d0ext-IEs ::= SEQUENCE {
    tpc-CombinationInfoList      TPC-CombinationInfoList      OPTIONAL
}

TPC-CombinationInfoList ::= SEQUENCE (SIZE (1..maxRL)) OF
    TPC-Combination-Info

TPC-CombinationInfoList-r9 ::= SEQUENCE (SIZE (1..maxEDCHRL)) OF
    TPC-Combination-Info-r9

STARTList2 ::=
    SEQUENCE (SIZE (2..maxCNdomains)) OF
        STARTSingle

SRNC-RelocationInfo-v4b0ext-IEs ::= SEQUENCE {
    ue-RadioAccessCapability-v4b0ext    UE-RadioAccessCapability-v4b0ext    OPTIONAL
}

SRNC-RelocationInfo-v590ext-IEs ::= SEQUENCE {
    ue-RadioAccessCapability-v590ext    UE-RadioAccessCapability-v590ext    OPTIONAL,
    ue-RATSpecificCapability-v590ext    InterRAT-UE-RadioAccessCapability-v590ext    OPTIONAL
}

SRNC-RelocationInfo-v5a0ext-IEs ::= SEQUENCE {
    storedCompressedModeInfo            StoredCompressedModeInfo            OPTIONAL
}

SRNC-RelocationInfo-v5b0ext-IEs ::= SEQUENCE {
    interRATCellInfoIndication          InterRATCellInfoIndication          OPTIONAL
}

SRNC-RelocationInfo-v5c0ext-IEs ::= SEQUENCE {
    ue-RadioAccessCapability-v5c0ext    UE-RadioAccessCapability-v5c0ext    OPTIONAL
}

CipheringInfoPerRB-List-v3a0ext ::= SEQUENCE {
    dl-UM-SN                             BIT STRING (SIZE (7))
}

CipheringStatusList ::=
    SEQUENCE (SIZE (1..maxCNdomains)) OF
        CipheringStatusCNdomain

CipheringStatusCNdomain ::=
    SEQUENCE {
        cn-DomainIdentity                CN-DomainIdentity,
        cipheringStatus                  CipheringStatus
    }

CodeChangeStatusList ::= SEQUENCE (SIZE (1..maxRL)) OF
    CodeChangeStatus

CodeChangeStatus ::= SEQUENCE {
    primaryCPICH-Info                    PrimaryCPICH-Info,
    scramblingCodeChange                  ScramblingCodeChange
}

StoredCompressedModeInfo ::= SEQUENCE {
    storedTGP-SequenceList                StoredTGP-SequenceList,
    codeChangeStatusList                  CodeChangeStatusList    OPTIONAL
}

StoredCompressedModeInfo-r8 ::= SEQUENCE {
    storedTGP-SequenceList                StoredTGP-SequenceList-r8,
    codeChangeStatusList                  CodeChangeStatusList    OPTIONAL
}

StoredTGP-SequenceList ::=
    SEQUENCE (SIZE (1..maxTGPS)) OF
        StoredTGP-Sequence

StoredTGP-SequenceList-r8 ::=
    SEQUENCE (SIZE (1..maxTGPS)) OF
        StoredTGP-Sequence-r8

StoredTGP-Sequence ::=
    SEQUENCE {
        tgpsi                             TGPSI,
        current-tgps-Status                CHOICE {
            active                         SEQUENCE {
                tgcfn                       TGCFN
            },
            inactive                        NULL
        }
    }

```

```

    },
    tgps-ConfigurationParams          TGPS-ConfigurationParams          OPTIONAL
  }

StoredTGP-Sequence-r8 ::=          SEQUENCE {
  tgpsi                              TGPSI,
  current-tgps-Status                CHOICE {
    active                            SEQUENCE {
      tgcfn                          TGCFN
    },
    inactive                          NULL
  },
  tgps-ConfigurationParams          TGPS-ConfigurationParams-r8    OPTIONAL
}

SRNC-RelocationInfo-r4-IEs ::=    SEQUENCE {
  -- Non-RRC IEs
  -- IE rb-IdentityForHOMessage includes the identity of the RB used by the source SRNC
  -- to send the message contained in the IE "TargetRNC-ToSourceRNC-Container".
  -- Only included if type is "UE involved"
  rb-IdentityForHOMessage            RB-Identity                    OPTIONAL,
  stateOfRRC                        StateOfRRC,
  stateOfRRC-Procedure              StateOfRRC-Procedure,
  -- Ciphering related information IEs
  cipheringStatusList               CipheringStatusList-r4,
  latestConfiguredCN-Domain         CN-DomainIdentity,
  calculationTimeForCiphering       CalculationTimeForCiphering    OPTIONAL,
  count-C-List                      COUNT-C-List                   OPTIONAL,
  cipheringInfoPerRB-List           CipheringInfoPerRB-List-r4    OPTIONAL,
  -- Integrity protection related information IEs
  integrityProtectionStatus         IntegrityProtectionStatus,
  -- The target RNC may ignore the IE srb-SpecificIntegrityProtInfo if the
  -- IE integrityProtectionStatus has the value "not started".
  srb-SpecificIntegrityProtInfo     SRB-SpecificIntegrityProtInfoList,
  implementationSpecificParams      ImplementationSpecificParams  OPTIONAL,
  -- User equipment IEs
  u-RNTI                            U-RNTI,
  c-RNTI                            C-RNTI                        OPTIONAL,
  ue-RadioAccessCapability          UE-RadioAccessCapability-r4,
  ue-RadioAccessCapability-ext      UE-RadioAccessCapabBandFDDList OPTIONAL,
  ue-Positioning-LastKnownPos      UE-Positioning-LastKnownPos   OPTIONAL,
  uESpecificBehaviourInformationIdle UESpecificBehaviourInformationIdle OPTIONAL,
  uESpecificBehaviourInformationInterRAT UESpecificBehaviourInformationInterRAT OPTIONAL,
  -- Other IEs
  ue-RATSpecificCapability          InterRAT-UE-RadioAccessCapabilityList OPTIONAL,
  -- UTRAN mobility IEs
  ura-Identity                      URA-Identity                  OPTIONAL,
  -- Core network IEs
  cn-CommonGSM-MAP-NAS-SysInfo     NAS-SystemInformationGSM-MAP,
  cn-DomainInformationList          CN-DomainInformationListFull  OPTIONAL,
  -- Measurement IEs
  ongoingMeasRepList               OngoingMeasRepList-r4        OPTIONAL,
  -- Radio bearer IEs
  predefinedConfigStatusList        PredefinedConfigStatusList,
  srb-InformationList               SRB-InformationSetupList,
  rab-InformationList               RAB-InformationSetupList-r4   OPTIONAL,
  -- Transport channel IEs
  ul-CommonTransChInfo              UL-CommonTransChInfo-r4      OPTIONAL,
  ul-TransChInfoList                UL-AddReconfTransChInfoList  OPTIONAL,
  -- 'dummy', 'dummy1' and 'dummy2' are not used in this version of the specification,
  -- they should not be sent and if received they should be ignored.
  dummy                             CHOICE {
    fdd                              SEQUENCE {
      dummy1                         CPCH-SetID                    OPTIONAL,
      dummy2                         DRAC-StaticInformationList    OPTIONAL
    },
    tdd                              NULL
  }
  dl-CommonTransChInfo              DL-CommonTransChInfo-r4      OPTIONAL,
  dl-TransChInfoList                DL-AddReconfTransChInfoList-r4 OPTIONAL,
  -- Measurement report
  measurementReport                 MeasurementReport              OPTIONAL,
  failureCause                       FailureCauseWithProtErr       OPTIONAL
}

SRNC-RelocationInfo-r5-IEs ::=    SEQUENCE {
  -- Non-RRC IEs
  -- IE rb-IdentityForHOMessage includes the identity of the RB used by the source SRNC

```

```

-- to send the message contained in the IE "TargetRNC-ToSourceRNC-Container".
-- Only included if type is "UE involved"
rb-IdentityForHOMessage      RB-Identity      OPTIONAL,
stateOfRRC                  StateOfRRC,
stateOfRRC-Procedure        StateOfRRC-Procedure,
-- Ciphering related information IEs
cipheringStatusList         CipheringStatusList-r4,
latestConfiguredCN-Domain   CN-DomainIdentity,
calculationTimeForCiphering CalculationTimeForCiphering      OPTIONAL,
count-C-List                COUNT-C-List      OPTIONAL,
cipheringInfoPerRB-List     CipheringInfoPerRB-List-r4      OPTIONAL,
-- Integrity protection related information IEs
integrityProtectionStatus   IntegrityProtectionStatus,
srb-SpecificIntegrityProtInfo SRB-SpecificIntegrityProtInfoList OPTIONAL,
implementationSpecificParams ImplementationSpecificParams      OPTIONAL,
-- User equipment IEs
u-RNTI                      U-RNTI,
c-RNTI                      C-RNTI      OPTIONAL,
ue-RadioAccessCapability    UE-RadioAccessCapability-r5,
ue-RadioAccessCapability-ext UE-RadioAccessCapabBandFDDList  OPTIONAL,
ue-Positioning-LastKnownPos UE-Positioning-LastKnownPos     OPTIONAL,
ueSpecificBehaviourInformationIdle UESpecificBehaviourInformationIdle OPTIONAL,
ueSpecificBehaviourInformationInterRAT UESpecificBehaviourInformationInterRAT OPTIONAL,
-- Other IEs
ue-RATSpecificCapability    InterRAT-UE-RadioAccessCapabilityList-r5  OPTIONAL,
-- UTRAN mobility IEs
ura-Identity                URA-Identity      OPTIONAL,
-- Core network IEs
cn-CommonGSM-MAP-NAS-SysInfo NAS-SystemInformationGSM-MAP,
cn-DomainInformationList    CN-DomainInformationListFull      OPTIONAL,
-- Measurement IEs
ongoingMeasRepList         OngoingMeasRepList-r5      OPTIONAL,
-- Radio bearer IEs
predefinedConfigStatusList PredefinedConfigStatusList,
srb-InformationList        SRB-InformationSetupList-r5,
rab-InformationList        RAB-InformationSetupList-r5      OPTIONAL,
-- Transport channel IEs
ul-CommonTransChInfo       UL-CommonTransChInfo-r4      OPTIONAL,
ul-TransChInfoList         UL-AddReconfTransChInfoList    OPTIONAL,
-- 'dummy', 'dummy1' and 'dummy2' are not used in this version of the specification,
-- they should not be sent and if received they should be ignored.
dummy                      CHOICE {
    fdd                      SEQUENCE {
        dummy1              CPCH-SetID      OPTIONAL,
        dummy2              DRAC-StaticInformationList  OPTIONAL
    },
    tdd                      NULL
}
dl-CommonTransChInfo       DL-CommonTransChInfo-r4      OPTIONAL,
dl-TransChInfoList         DL-AddReconfTransChInfoList-r5  OPTIONAL,
-- PhyCH IEs
tpc-CombinationInfoList    TPC-CombinationInfoList      OPTIONAL,
-- Measurement report
measurementReport          MeasurementReport      OPTIONAL,
-- Other IEs
failureCause               FailureCauseWithProtErr      OPTIONAL
}

SRNC-RelocationInfo-v690ext-IEs ::= SEQUENCE {
-- User equipment IEs
-- IE ueCapabilityContainer is used for the transparent transfer of capability information
-- received from the UE
ueCapabilityContainer      BIT STRING
                            (CONTAINING UE-CapabilityContainer-IEs) OPTIONAL,
-- IE ueCapabilityContainer-RSC and IE ueCapabilityContainer-UCI are used for the
-- transparent transfer of capability information received from the UE that was introduced
-- in a release independent manner, i.e., transferred within a VLEC. These UE capabilities
-- are included both in the RRC CONNECTION SETUP COMPLETE and the UE CAPABILITY INFORMATION
-- messages. Only the VLEC of one message needs to be included i.e. the one from these
-- messages that was last received.
-- Case 1: If the last received message was a RRC CONNECTION SETUP COMPLETE (RSC)
ueCapabilityContainer-RSC  BIT STRING
                            (CONTAINING RRCConnectionSetupComplete-r3-add-ext-IEs) OPTIONAL,
-- Case 2: If the last received message was a UE CAPABILITY INFORMATION (UCI)
ueCapabilityContainer-UCI  BIT STRING
                            (CONTAINING UECapabilityInformation-r3-add-ext-IEs)  OPTIONAL,
}

```

```

-- Radio bearer IEs
  rab-InformationSetupList      RAB-InformationSetupList-r6-ext  OPTIONAL,
-- Measurement report
  measuredResultsOnRACHinterFreq  MeasuredResultsOnRACHinterFreq  OPTIONAL,
-- MBMS IEs
  mbms-JoinedInformation        MBMS-JoinedInformation-r6        OPTIONAL,
-- Measurement IEs
  intraFreqReportingCriteria    IntraFreqReportingCriteria-r6-ext  OPTIONAL
}

SRNC-RelocationInfo-r6-IEs ::= SEQUENCE {
-- Non-RRC IEs
  -- IE rb-IdentityForHOMessage includes the identity of the RB used by the source SRNC
  -- to send the message contained in the IE "TargetRNC-ToSourceRNC-Container".
  -- Only included if type is "UE involved"
  rb-IdentityForHOMessage      RB-Identity                        OPTIONAL,
  stateOfRRC                   StateOfRRC,
  stateOfRRC-Procedure         StateOfRRC-Procedure,
-- Ciphering related information IEs
  cipheringStatusList          CipheringStatusList-r4,
  latestConfiguredCN-Domain    CN-DomainIdentity,
  calculationTimeForCiphering  CalculationTimeForCiphering      OPTIONAL,
  count-C-List                 COUNT-C-List                       OPTIONAL,
  cipheringInfoPerRB-List      CipheringInfoPerRB-List-r4        OPTIONAL,
-- Integrity protection related information IEs
  integrityProtectionStatus    IntegrityProtectionStatus,
  srb-SpecificIntegrityProtInfo SRB-SpecificIntegrityProtInfoList OPTIONAL,
  implementationSpecificParams ImplementationSpecificParams      OPTIONAL,
-- User equipment IEs
  u-RNTI                       U-RNTI,
  c-RNTI                       C-RNTI                            OPTIONAL,
  ue-RadioAccessCapability      UE-RadioAccessCapability-r6,
  ue-RadioAccessCapability-ext  UE-RadioAccessCapabBandFDDList  OPTIONAL,
  ue-Positioning-LastKnownPos  UE-Positioning-LastKnownPos     OPTIONAL,
  ueSpecificBehaviourInformationlidle
                                UESpecificBehaviourInformationlidle  OPTIONAL,
  ueSpecificBehaviourInformationlinterRAT
                                UESpecificBehaviourInformationlinterRAT  OPTIONAL,
  -- IE ueCapabilityContainer is used for the transparent transfer of capability information
  -- received from the UE
  ueCapabilityContainer        BIT STRING
                                (CONTAINING UE-CapabilityContainer-IEs) OPTIONAL,
  -- IE ueCapabilityContainer-RSC and IE ueCapabilityContainer-UCI are used for the
  -- transparent transfer of capability information received from the UE that was introduced
  -- in a release independent manner, i.e., transferred within a VLEC. These UE capabilities
  -- are included both in the RRC CONNECTION SETUP COMPLETE and the UE CAPABILITY INFORMATION
  -- messages. Only the VLEC of one message needs to be included i.e. the one from these
  -- messages that was last received.
  -- Case 1: If the last received message was a RRC CONNECTION SETUP COMPLETE (RSC)
  ueCapabilityContainer-RSC    BIT STRING
                                (CONTAINING RRConnectionSetupComplete-r3-add-ext-IEs) OPTIONAL,
  -- Case 2: If the last received message was a UE CAPABILITY INFORMATION (UCI)
  ueCapabilityContainer-UCI    BIT STRING
                                (CONTAINING UECapabilityInformation-r3-add-ext-IEs)  OPTIONAL,
-- Other IEs
  ue-RATSpecificCapability      InterRAT-UE-RadioAccessCapabilityList-r5  OPTIONAL,
-- UTRAN mobility IEs
  ura-Identity                  URA-Identity                        OPTIONAL,
-- Core network IEs
  cn-CommonGSM-MAP-NAS-SysInfo NAS-SystemInformationGSM-MAP,
  cn-DomainInformationList     CN-DomainInformationListFull      OPTIONAL,
-- Measurement IEs
  ongoingMeasRepList           OngoingMeasRepList-r6            OPTIONAL,
  interRATCellInfoIndication   InterRATCellInfoIndication       OPTIONAL,
-- Radio bearer IEs
  predefinedConfigStatusList    PredefinedConfigStatusList,
  srb-InformationList           SRB-InformationSetupList-r6,
  rab-InformationSetupList      RAB-InformationSetupList-r6        OPTIONAL,
-- Transport channel IEs
  ul-CommonTransChInfo         UL-CommonTransChInfo-r4          OPTIONAL,
  ul-TransChInfoList           UL-AddReconfTransChInfoList-r6   OPTIONAL,
  dl-CommonTransChInfo         DL-CommonTransChInfo-r4          OPTIONAL,
  dl-TransChInfoList           DL-AddReconfTransChInfoList-r5   OPTIONAL,
-- PhyCH IEs
  tpc-CombinationInfoList       TPC-CombinationInfoList          OPTIONAL,
  storedCompressedModeInfo      StoredCompressedModeInfo          OPTIONAL,
-- Measurement report
  measurementReport            BIT STRING

```



```

        (CONTAINING MeasurementReport)                                OPTIONAL,
-- Other IEs
  failureCause                FailureCauseWithProtErr              OPTIONAL,
-- MBMS IEs
  mbms-JoinedInformation      MBMS-JoinedInformation-r6            OPTIONAL
}

SRNC-RelocationInfo-r6-add-ext-IEs ::= SEQUENCE {
  sRNC-RelocationInfo-v7e0ext  SRNC-RelocationInfo-v7e0ext-IEs,
  v7f0NonCriticalExtensions     SEQUENCE {
    sRNC-RelocationInfo-v7f0ext  SRNC-RelocationInfo-v7f0ext-IEs,
    nonCriticalExtensions         SEQUENCE {} OPTIONAL
  } OPTIONAL
}

SRNC-RelocationInfo-v6b0ext-IEs ::= SEQUENCE {
  -- The order of the RABs in IE rab-InformationSetupListExt is the same as
  -- in IE rab-InformationSetupList that is included in this message
  rab-InformationSetupListExt  RAB-InformationSetupList-v6b0ext  OPTIONAL,
  mbmsSelectedServiceInfo     MBMS-SelectedServiceInfo
}

SRNC-RelocationInfo-r7-IEs ::= SEQUENCE {
  -- Non-RRC IEs
  -- IE rb-IdentityForHOMessage includes the identity of the RB used by the source SRNC
  -- to send the message contained in the IE "TargetRNC-ToSourceRNC-Container".
  -- Only included if type is "UE involved"
  rb-IdentityForHOMessage      RB-Identity                        OPTIONAL,
  stateOfRRC                   StateOfRRC,
  stateOfRRC-Procedure         StateOfRRC-Procedure,
  -- Ciphering related information IEs
  cipheringStatusList          CipheringStatusList-r4,
  latestConfiguredCN-Domain    CN-DomainIdentity,
  calculationTimeForCiphering  CalculationTimeForCiphering  OPTIONAL,
  count-C-List                 COUNT-C-List                  OPTIONAL,
  cipheringInfoPerRB-List      CipheringInfoPerRB-List-r4      OPTIONAL,
  -- Integrity protection related information IEs
  integrityProtectionStatus     IntegrityProtectionStatus,
  srb-SpecificIntegrityProtInfo SRB-SpecificIntegrityProtInfoList  OPTIONAL,
  implementationSpecificParams  ImplementationSpecificParams  OPTIONAL,
  -- User equipment IEs
  u-RNTI                        U-RNTI,
  c-RNTI                        C-RNTI                        OPTIONAL,
  -- IE 'UE-RadioAccessCapability-r6' includes the Rel-5 radio access capability extensions
  -- and earlier. Rel-6 and later extensions are included in IE 'UE-CapabilityContainer-IEs'.
  ue-RadioAccessCapability      UE-RadioAccessCapability-r6,
  ue-RadioAccessCapability-ext  UE-RadioAccessCapabBandFDDList  OPTIONAL,
  ue-Positioning-LastKnownPos   UE-Positioning-LastKnownPos     OPTIONAL,
  uESpecificBehaviourInformationlidle
                                uESpecificBehaviourInformationlidle  OPTIONAL,
  uESpecificBehaviourInformationlinterRAT
                                uESpecificBehaviourInformationlinterRAT  OPTIONAL,
  -- IE ueCapabilityContainer is used for the transparent transfer of capability information
  -- received from the UE
  ueCapabilityContainer          BIT STRING
                                (CONTAINING UE-CapabilityContainer-IEs) OPTIONAL,
  -- IE ueCapabilityContainer-RSC and IE ueCapabilityContainer-UCI are used for the
  -- transparent transfer of capability information received from the UE that was introduced
  -- in a release independent manner, i.e., transferred within a VLEC. These UE capabilities
  -- are included both in the RRC CONNECTION SETUP COMPLETE and the UE CAPABILITY INFORMATION
  -- messages. Only the VLEC of one message needs to be included i.e. the one from these
  -- messages that was last received.
  -- Case 1: If the last received message was a RRC CONNECTION SETUP COMPLETE (RSC)
  ueCapabilityContainer-RSC      BIT STRING
                                (CONTAINING RRConnectionSetupComplete-r3-add-ext-IEs) OPTIONAL,
  -- Case 2: If the last received message was a UE CAPABILITY INFORMATION (UCI)
  ueCapabilityContainer-UCI      BIT STRING
                                (CONTAINING UECapabilityInformation-r3-add-ext-IEs)  OPTIONAL,
  -- Other IEs
  ue-RATSpecificCapability       InterRAT-UE-RadioAccessCapabilityList-r5  OPTIONAL,
  -- UTRAN mobility IEs
  ura-Identity                  URA-Identity                        OPTIONAL,
  srns-t-305                    T-305                          OPTIONAL,
  -- Core network IEs
  cn-CommonGSM-MAP-NAS-SysInfo  NAS-SystemInformationGSM-MAP,
  cn-DomainInformationList       CN-DomainInformationListFull  OPTIONAL,
  -- Measurement IEs
  ongoingMeasRepList            OngoingMeasRepList-r7            OPTIONAL,

```

```

    interRATCellInfoIndication      InterRATCellInfoIndication      OPTIONAL,
-- Radio bearer IEs
    predefinedConfigStatusList      PredefinedConfigStatusList,
    srb-InformationList              SRB-InformationSetupList-r7,
    rab-InformationList              RAB-InformationSetupList-r7      OPTIONAL,
-- Transport channel IEs
    ul-CommonTransChInfo            UL-CommonTransChInfo-r4         OPTIONAL,
    ul-TransChInfoList              UL-AddReconfTransChInfoList-r7  OPTIONAL,
    dl-CommonTransChInfo            DL-CommonTransChInfo-r4         OPTIONAL,
    dl-TransChInfoList              DL-AddReconfTransChInfoList-r7  OPTIONAL,
-- PhyCH IEs
    tpc-CombinationInfoList         TPC-CombinationInfoList         OPTIONAL,
    storedCompressedModeInfo        StoredCompressedModeInfo         OPTIONAL,
-- Measurement report
    measurementReport                BIT STRING
                                     (CONTAINING MeasurementReport)      OPTIONAL,
-- Other IEs
    failureCause                     FailureCauseWithProtErr          OPTIONAL,
-- MBMS IEs
    mbms-JoinedInformation           MBMS-JoinedInformation-r6       OPTIONAL,
    mbmsSelectedServiceInfo         MBMS-SelectedServiceInfo        OPTIONAL,
}

SRNC-RelocationInfo-r7-add-ext-IEs ::= SEQUENCE {
    sRNC-RelocationInfo-v7e0ext      SRNC-RelocationInfo-v7e0ext-IEs,
    v7f0NonCriticalExtensions        SEQUENCE {
        sRNC-RelocationInfo-v7f0ext  SRNC-RelocationInfo-v7f0ext-IEs,
        nonCriticalExtensions         SEQUENCE {} OPTIONAL
    } OPTIONAL
}

SRNC-RelocationInfo-v770ext-IEs ::= SEQUENCE {
    thresholdSFN-GPS-TOW-us          ThresholdSFN-GPS-TOW-us          OPTIONAL,
    srns-t-305                       T-305                           OPTIONAL
}

SRNC-RelocationInfo-v7e0ext-IEs ::= SEQUENCE {
-- User equipment IEs
    ue-RadioAccessCapability         UE-RadioAccessCapability-v7e0ext
}

SRNC-RelocationInfo-v7f0ext-IEs ::= SEQUENCE {
-- User equipment IEs
    ue-RadioAccessCapability         UE-RadioAccessCapability-v7f0ext  OPTIONAL
}

SRNC-RelocationInfo-r8-IEs ::= SEQUENCE {
-- Non-RRC IEs
-- IE rb-IdentityForHOMessage includes the identity of the RB used by the source SRNC
-- to send the message contained in the IE "TargetRNC-ToSourceRNC-Container".
-- Only included if type is "UE involved"
    rb-IdentityForHOMessage          RB-Identity                      OPTIONAL,
    stateOfRRC                      StateOfRRC,
    stateOfRRC-Procedure             StateOfRRC-Procedure,
-- Ciphering related information IEs
    cipheringStatusList              CipheringStatusList-r4,
    latestConfiguredCN-Domain        CN-DomainIdentity,
    calculationTimeForCiphering      CalculationTimeForCiphering      OPTIONAL,
    count-C-List                     COUNT-C-List                    OPTIONAL,
    cipheringInfoPerRB-List          CipheringInfoPerRB-List-r4      OPTIONAL,
-- Integrity protection related information IEs
    integrityProtectionStatus        IntegrityProtectionStatus,
    srb-SpecificIntegrityProtInfo     SRB-SpecificIntegrityProtInfoList  OPTIONAL,
    implementationSpecificParams      ImplementationSpecificParams      OPTIONAL,
-- User equipment IEs
    u-RNTI                           U-RNTI,
    c-RNTI                           C-RNTI                          OPTIONAL,
-- IE 'UE-RadioAccessCapability-r6' includes the Rel-5 radio access capability extensions
-- and earlier. Rel-6 and later extensions are included in IE 'UE-CapabilityContainer-IEs'.
    ue-RadioAccessCapability         UE-RadioAccessCapability-r6,
    ue-RadioAccessCapability-ext      UE-RadioAccessCapabBandFDDList  OPTIONAL,
    ue-Positioning-LastKnownPos      UE-Positioning-LastKnownPos      OPTIONAL,
    uESpecificBehaviourInformationIdle
                                     uESpecificBehaviourInformationIdle  OPTIONAL,
    uESpecificBehaviourInformationInterRAT
                                     uESpecificBehaviourInformationInterRAT  OPTIONAL,
-- IE ueCapabilityContainer is used for the transparent transfer of capability information
-- received from the UE

```

```

ueCapabilityContainer          BIT STRING
                               (CONTAINING UE-CapabilityContainer-IEs) OPTIONAL,
-- IE ueCapabilityContainer-RSC and IE ueCapabilityContainer-UCI are used for the
-- transparent transfer of capability information received from the UE that was introduced
-- in a release independent manner, i.e., transferred within a VLEC. These UE capabilities
-- are included both in the RRC CONNECTION SETUP COMPLETE and the UE CAPABILITY INFORMATION
-- messages. Only the VLEC of one message needs to be included i.e. the one from these
-- messages that was last received.
-- Case 1: If the last received message was a RRC CONNECTION SETUP COMPLETE (RSC)
ueCapabilityContainer-RSC     BIT STRING
                               (CONTAINING RRCConnectionSetupComplete-r3-add-ext-IEs) OPTIONAL,
-- Case 2: If the last received message was a UE CAPABILITY INFORMATION (UCI)
ueCapabilityContainer-UCI     BIT STRING
                               (CONTAINING UECapabilityInformation-r3-add-ext-IEs) OPTIONAL,
-- Other IEs
ue-RATSpecificCapability     InterRAT-UE-RadioAccessCapabilityList-r5  OPTIONAL,
-- UTRAN mobility IEs
ura-Identity                  URA-Identity                            OPTIONAL,
srns-t-305                    T-305                                OPTIONAL,
-- Core network IEs
cn-CommonGSM-MAP-NAS-SysInfo NAS-SystemInformationGSM-MAP,
cn-DomainInformationList     CN-DomainInformationListFull  OPTIONAL,
-- Measurement IEs
ongoingMeasRepList           OngoingMeasRepList-r8        OPTIONAL,
interRATCellInfoIndication   InterRATCellInfoIndication    OPTIONAL,
-- Radio bearer IEs
predefinedConfigStatusList   PredefinedConfigStatusList,
srb-InformationList          SRB-InformationSetupList-r8,
rab-InformationList          RAB-InformationSetupList-r8   OPTIONAL,
-- Transport channel IEs
ul-CommonTransChInfo        UL-CommonTransChInfo-r4      OPTIONAL,
ul-TransChInfoList          UL-AddReconfTransChInfoList-r8  OPTIONAL,
dl-CommonTransChInfo        DL-CommonTransChInfo-r4      OPTIONAL,
dl-TransChInfoList          DL-AddReconfTransChInfoList-r7  OPTIONAL,
-- PhyCH IEs
tpc-CombinationInfoList      TPC-CombinationInfoList      OPTIONAL,
e-RGCH-CombinationInfoList   E-RGCH-CombinationInfoList   OPTIONAL,
storedCompressedModeInfo     StoredCompressedModeInfo-r8   OPTIONAL,
-- Measurement report
measurementReport            BIT STRING
                               (CONTAINING MeasurementReport)          OPTIONAL,
-- Other IEs
failureCause                  FailureCauseWithProtErr       OPTIONAL,
ue-HistoryInformation         UE-HistoryInformation         OPTIONAL,
-- MBMS IEs
mbms-JoinedInformation       MBMS-JoinedInformation-r6     OPTIONAL,
mbmsSelectedServiceInfo      MBMS-SelectedServiceInfo     OPTIONAL
}

SRNC-RelocationInfo-v820ext-IEs ::= SEQUENCE {
-- Radio bearer IEs
rab-InformationList          RAB-InformationSetupList-v820ext  OPTIONAL
}

SRNC-RelocationInfo-v860ext-IEs ::= SEQUENCE {
-- PhyCH IEs
e-RGCH-CombinationInfoList   E-RGCH-CombinationInfoList   OPTIONAL
}

SRNC-RelocationInfo-v8d0ext-IEs ::= SEQUENCE {
--Radio Bearer IEs
pdcP-ROHC-TargetMode        PDCP-ROHC-TargetMode         OPTIONAL
}

SRNC-RelocationInfo-r9-IEs ::= SEQUENCE {
-- Non-RRC IEs
-- IE rb-IdentityForHOMessage includes the identity of the RB used by the source SRNC
-- to send the message contained in the IE "TargetRNC-ToSourceRNC-Container".
-- Only included if type is "UE involved"
rb-IdentityForHOMessage      RB-Identity                    OPTIONAL,
stateOfRRC                  StateOfRRC,
stateOfRRC-Procedure        StateOfRRC-Procedure,
-- Ciphering related information IEs
cipheringStatusList         CipheringStatusList-r4,
latestConfiguredCN-Domain   CN-DomainIdentity,
calculationTimeForCiphering CalculationTimeForCiphering    OPTIONAL,
count-C-List                COUNT-C-List                    OPTIONAL,
cipheringInfoPerRB-List     CipheringInfoPerRB-List-r4    OPTIONAL,

```

```

-- Integrity protection related information IEs
  integrityProtectionStatus      IntegrityProtectionStatus,
  srb-SpecificIntegrityProtInfo  SRB-SpecificIntegrityProtInfoList  OPTIONAL,
  implementationSpecificParams   ImplementationSpecificParams      OPTIONAL,
-- User equipment IEs
  u-RNTI                          U-RNTI,
  c-RNTI                          C-RNTI                                OPTIONAL,
  -- IE 'UE-RadioAccessCapability-r6' includes the Rel-5 radio access capability extensions
  -- and earlier. Rel-6 and later extensions are included in IE 'UE-CapabilityContainer-IEs'.
  ue-RadioAccessCapability        UE-RadioAccessCapability-r6,
  ue-RadioAccessCapability-ext    UE-RadioAccessCapabBandFDDList  OPTIONAL,
  ue-Positioning-LastKnownPos    UE-Positioning-LastKnownPos    OPTIONAL,
  uESpecificBehaviourInformationlidle
                                  UESpecificBehaviourInformationlidle  OPTIONAL,
  uESpecificBehaviourInformationlinterRAT
                                  UESpecificBehaviourInformationlinterRAT  OPTIONAL,
  -- IE ueCapabilityContainer is used for the transparent transfer of capability information
  -- received from the UE
  ueCapabilityContainer           BIT STRING
                                  (CONTAINING UE-CapabilityContainer-IEs) OPTIONAL,
  -- IE ueCapabilityContainer-RSC and IE ueCapabilityContainer-UCI are used for the
  -- transparent transfer of capability information received from the UE that was introduced
  -- in a release independent manner, i.e., transferred within a VLEC. These UE capabilities
  -- are included both in the RRC CONNECTION SETUP COMPLETE and the UE CAPABILITY INFORMATION
  -- messages. Only the VLEC of one message needs to be included i.e. the one from these
  -- messages that was last received.
  -- Case 1: If the last received message was a RRC CONNECTION SETUP COMPLETE (RSC)
  ueCapabilityContainer-RSC       BIT STRING
                                  (CONTAINING RRConnectionSetupComplete-r3-add-ext-IEs)  OPTIONAL,
  -- Case 2: If the last received message was a UE CAPABILITY INFORMATION (UCI)
  ueCapabilityContainer-UCI       BIT STRING
                                  (CONTAINING UECapabilityInformation-r3-add-ext-IEs)  OPTIONAL,
-- Other IEs
  ue-RATSpecificCapability        InterRAT-UE-RadioAccessCapabilityList-r5  OPTIONAL,
-- UTRAN mobility IEs
  ura-Identity                   URA-Identity                                OPTIONAL,
  srns-t-305                     T-305                                    OPTIONAL,
-- Core network IEs
  cn-CommonGSM-MAP-NAS-SysInfo   NAS-SystemInformationGSM-MAP,
  cn-DomainInformationList       CN-DomainInformationListFull  OPTIONAL,
-- Measurement IEs
  ongoingMeasRepList             OngoingMeasRepList-r9          OPTIONAL,
  interRATCellInfoIndication    InterRATCellInfoIndication    OPTIONAL,
-- Radio bearer IEs
  predefinedConfigStatusList     PredefinedConfigStatusList,
  srb-InformationList            SRB-InformationSetupList-r8,
  rab-InformationList            RAB-InformationSetupList-r8    OPTIONAL,
-- Transport channel IEs
  ul-CommonTransChInfo          UL-CommonTransChInfo-r4        OPTIONAL,
  ul-TransChInfoList            UL-AddReconfTransChInfoList-r8  OPTIONAL,
  dl-CommonTransChInfo          DL-CommonTransChInfo-r4        OPTIONAL,
  dl-TransChInfoList            DL-AddReconfTransChInfoList-r9  OPTIONAL,
-- PhyCH IEs
  tpc-CombinationInfoList        TPC-CombinationInfoList        OPTIONAL,
  e-RGCH-CombinationInfoList     E-RGCH-CombinationInfoList     OPTIONAL,
  storedCompressedModeInfo       StoredCompressedModeInfo-r8     OPTIONAL,
  secondary-tpc-CombinationInfoList
                                  TPC-CombinationInfoList-r9    OPTIONAL,
  secondary-e-RGCH-CombinationInfoList
                                  E-RGCH-CombinationInfoList-r9  OPTIONAL,
-- Measurement report
  measurementReport              BIT STRING
                                  (CONTAINING MeasurementReport)  OPTIONAL,
-- Other IEs
  failureCause                   FailureCauseWithProtErr         OPTIONAL,
  ue-HistoryInformation          UE-HistoryInformation          OPTIONAL,
-- MBMS IEs
  mbms-JoinedInformation         MBMS-JoinedInformation-r6      OPTIONAL,
  mbmsSelectedServiceInfo       MBMS-SelectedServiceInfo      OPTIONAL,
}

SRNC-RelocationInfo-v970ext-IEs ::= SEQUENCE {
  -- Measurement IEs
  ongoingMeasRepList            OngoingMeasRepList-v970ext-IE  OPTIONAL
}

SRNC-RelocationInfo-v9c0ext-IEs ::= SEQUENCE {
  -- For 1.28Mcps TDD only
  dl-AddReconfTransChInfoList  DL-AddReconfTransChInfoList-TDD128-v9c0ext  OPTIONAL
}

```

```

SRNC-RelocationInfo-r10-IEs ::=          SEQUENCE {
-- Non-RRC IEs
-- IE rb-IdentityForHOMessage includes the identity of the RB used by the source SRNC
-- to send the message contained in the IE "TargetRNC-ToSourceRNC-Container".
-- Only included if type is "UE involved"
rb-IdentityForHOMessage                    RB-Identity                    OPTIONAL,
stateOfRRC                                StateOfRRC,
stateOfRRC-Procedure                      StateOfRRC-Procedure,
-- Ciphering related information IEs
cipheringStatusList                      CipheringStatusList-r4,
latestConfiguredCN-Domain                CN-DomainIdentity,
calculationTimeForCiphering              CalculationTimeForCiphering    OPTIONAL,
count-C-List                             COUNT-C-List                  OPTIONAL,
cipheringInfoPerRB-List                  CipheringInfoPerRB-List-r4    OPTIONAL,
-- Integrity protection related information IEs
integrityProtectionStatus                IntegrityProtectionStatus,
srb-SpecificIntegrityProtInfo            SRB-SpecificIntegrityProtInfoList OPTIONAL,
implementationSpecificParams            ImplementationSpecificParams  OPTIONAL,
-- User equipment IEs
u-RNTI                                    U-RNTI,
c-RNTI                                    C-RNTI                        OPTIONAL,
-- IE 'UE-RadioAccessCapability-r6' includes the Rel-5 radio access capability extensions
-- and earlier. Rel-6 and later extensions are included in IE 'UE-CapabilityContainer-IEs'.
ue-RadioAccessCapability                  UE-RadioAccessCapability-r6,
ue-RadioAccessCapability-ext              UE-RadioAccessCapabBandFDDList OPTIONAL,
ue-Positioning-LastKnownPos              UE-Positioning-LastKnownPos   OPTIONAL,
ueSpecificBehaviourInformationIdle        UESpecificBehaviourInformationIdle OPTIONAL,
ueSpecificBehaviourInformationInterRAT    UESpecificBehaviourInformationInterRAT OPTIONAL,
-- IE ueCapabilityContainer is used for the transparent transfer of capability information
-- received from the UE
ueCapabilityContainer                      BIT STRING
                                           (CONTAINING UE-CapabilityContainer-IEs) OPTIONAL,
-- IE ueCapabilityContainer-RSC and IE ueCapabilityContainer-UCI are used for the
-- transparent transfer of capability information received from the UE that was introduced
-- in a release independent manner, i.e., transferred within a VLEC. These UE capabilities
-- are included both in the RRC CONNECTION SETUP COMPLETE and the UE CAPABILITY INFORMATION
-- messages. Only the VLEC of one message needs to be included i.e. the one from these
-- messages that was last received.
-- Case 1: If the last received message was a RRC CONNECTION SETUP COMPLETE (RSC)
ueCapabilityContainer-RSC                  BIT STRING
                                           (CONTAINING RRCConnectionSetupComplete-r3-add-ext-IEs) OPTIONAL,
-- Case 2: If the last received message was a UE CAPABILITY INFORMATION (UCI)
ueCapabilityContainer-UCI                  BIT STRING
                                           (CONTAINING UECapabilityInformation-r3-add-ext-IEs) OPTIONAL,
-- Other IEs
ue-RATSpecificCapability                  InterRAT-UE-RadioAccessCapabilityList-r5 OPTIONAL,
-- UTRAN mobility IEs
ura-Identity                              URA-Identity                    OPTIONAL,
srns-t-305                                T-305                          OPTIONAL,
-- Core network IEs
cn-CommonGSM-MAP-NAS-SysInfo              NAS-SystemInformationGSM-MAP,
cn-DomainInformationList                  CN-DomainInformationListFull    OPTIONAL,
-- Measurement IEs
ongoingMeasRepList                       OngoingMeasRepList-r10         OPTIONAL,
interRATCellInfoIndication                InterRATCellInfoIndication      OPTIONAL,
-- Radio bearer IEs
predefinedConfigStatusList                PredefinedConfigStatusList,
srb-InformationList                       SRB-InformationSetupList-r8,
rab-InformationList                       RAB-InformationSetupList-r8     OPTIONAL,
pdcp-ROHC-TargetMode                      PDCP-ROHC-TargetMode          OPTIONAL,
-- Transport channel IEs
ul-CommonTransChInfo                      UL-CommonTransChInfo-r4        OPTIONAL,
ul-TransChInfoList                        UL-AddReconfTransChInfoList-r8 OPTIONAL,
dl-CommonTransChInfo                      DL-CommonTransChInfo-r4        OPTIONAL,
dl-TransChInfoList                        DL-AddReconfTransChInfoList-r9 OPTIONAL,
-- PhyCH IEs
tpc-CombinationInfoList                   TPC-CombinationInfoList        OPTIONAL,
e-RGCH-CombinationInfoList                 E-RGCH-CombinationInfoList     OPTIONAL,
storedCompressedModeInfo                  StoredCompressedModeInfo-r8     OPTIONAL,
secondary-tpc-CombinationInfoList          TPC-CombinationInfoList-r9     OPTIONAL,
secondary-e-RGCH-CombinationInfoList       E-RGCH-CombinationInfoList-r9  OPTIONAL,
-- Measurement report
measurementReport                          BIT STRING
                                           (CONTAINING MeasurementReport) OPTIONAL,
-- Other IEs

```

```

    failureCause                FailureCauseWithProtErr        OPTIONAL,
    ue-HistoryInformation        UE-HistoryInformation        OPTIONAL,
-- MBMS IEs
    mbms-JoinedInformation        MBMS-JoinedInformation-r6    OPTIONAL,
    mbms-SelectedServiceInfo      MBMS-SelectedServiceInfo    OPTIONAL
}

SRNC-RelocationInfo-vab0ext-IEs ::= SRNC-RelocationInfo-v970ext-IEs

SRNC-RelocationInfo-r11-IEs ::= SEQUENCE {
-- Non-RRC IEs
-- IE rb-IdentityForHOMessage includes the identity of the RB used by the source SRNC
-- to send the message contained in the IE "TargetRNC-ToSourceRNC-Container".
-- Only included if type is "UE involved"
    rb-IdentityForHOMessage        RB-Identity                OPTIONAL,
    stateOfRRC                    StateOfRRC,
    stateOfRRC-Procedure          StateOfRRC-Procedure,
-- Ciphering related information IEs
    cipheringStatusList           CipheringStatusList-r4,
    latestConfiguredCN-Domain     CN-DomainIdentity,
    calculationTimeForCiphering   CalculationTimeForCiphering OPTIONAL,
    count-C-List                  COUNT-C-List              OPTIONAL,
    cipheringInfoPerRB-List       CipheringInfoPerRB-List-r4 OPTIONAL,
-- Integrity protection related information IEs
    integrityProtectionStatus     IntegrityProtectionStatus,
    srb-SpecificIntegrityProtInfo SRB-SpecificIntegrityProtInfoList OPTIONAL,
    implementationSpecificParams  ImplementationSpecificParams OPTIONAL,
-- User equipment IEs
    u-RNTI                        U-RNTI,
    c-RNTI                        C-RNTI                    OPTIONAL,
-- IE 'UE-RadioAccessCapability-r6' includes the Rel-5 radio access capability extensions
-- and earlier. Rel-6 and later extensions are included in IE 'UE-CapabilityContainer-IEs'.
    ue-RadioAccessCapability      UE-RadioAccessCapability-r6,
    ue-RadioAccessCapability-ext  UE-RadioAccessCapabBandFDDList OPTIONAL,
    ue-Positioning-LastKnownPos  UE-Positioning-LastKnownPos OPTIONAL,
    uESpecificBehaviourInformationlidle
                                uESpecificBehaviourInformationlidle OPTIONAL,
    uESpecificBehaviourInformationlinterRAT
                                uESpecificBehaviourInformationlinterRAT OPTIONAL,
-- IE ueCapabilityContainer is used for the transparent transfer of capability information
-- received from the UE
    ueCapabilityContainer         BIT STRING
                                (CONTAINING UE-CapabilityContainer-IEs) OPTIONAL,
-- IE ueCapabilityContainer-RSC and IE ueCapabilityContainer-UCI are used for the
-- transparent transfer of capability information received from the UE that was introduced
-- in a release independent manner, i.e., transferred within a VLEC. These UE capabilities
-- are included both in the RRC CONNECTION SETUP COMPLETE and the UE CAPABILITY INFORMATION
-- messages. Only the VLEC of one message needs to be included i.e. the one from these
-- messages that was last received.
-- Case 1: If the last received message was a RRC CONNECTION SETUP COMPLETE (RSC)
    ueCapabilityContainer-RSC     BIT STRING
                                (CONTAINING RRConnectionSetupComplete-r3-add-ext-IEs) OPTIONAL,
-- Case 2: If the last received message was a UE CAPABILITY INFORMATION (UCI)
    ueCapabilityContainer-UCI     BIT STRING
                                (CONTAINING UECapabilityInformation-r3-add-ext-IEs) OPTIONAL,
-- Other IEs
    ue-RATSpecificCapability      InterRAT-UE-RadioAccessCapabilityList-r5 OPTIONAL,
-- UTRAN mobility IEs
    ura-Identity                  URA-Identity                OPTIONAL,
    srns-t-305                    T-305                        OPTIONAL,
-- Core network IEs
    cn-CommonGSM-MAP-NAS-SysInfo NAS-SystemInformationGSM-MAP,
    cn-DomainInformationList      CN-DomainInformationListFull OPTIONAL,
-- Measurement IEs
    ongoingMeasRepList           OngoingMeasRepList-r11     OPTIONAL,
    interRATCellInfoIndication   InterRATCellInfoIndication OPTIONAL,
-- Radio bearer IEs
    predefinedConfigStatusList   PredefinedConfigStatusList,
    srb-InformationList          SRB-InformationSetupList-r11,
    rab-InformationList          RAB-InformationSetupList-r11 OPTIONAL,
    pdcp-ROHC-TargetMode        PDCP-ROHC-TargetMode      OPTIONAL,
-- Transport channel IEs
    ul-CommonTransChInfo        UL-CommonTransChInfo-r4    OPTIONAL,
    ul-TransChInfoList          UL-AddReconfTransChInfoList-r8 OPTIONAL,
    dl-CommonTransChInfo        DL-CommonTransChInfo-r4    OPTIONAL,
    dl-TransChInfoList          DL-AddReconfTransChInfoList-r11 OPTIONAL,
-- PhyCH IEs
    tpc-CombinationInfoList      TPC-CombinationInfoList    OPTIONAL,

```

```

    e-RGCH-CombinationInfoList      E-RGCH-CombinationInfoList      OPTIONAL,
    storedCompressedModeInfo        StoredCompressedModeInfo-r8      OPTIONAL,
    secondary-tpc-CombinationInfoList  TPC-CombinationInfoList-r9      OPTIONAL,
    secondary-e-RGCH-CombinationInfoList  E-RGCH-CombinationInfoList-r9  OPTIONAL,
-- Measurement report
    measurementReport                BIT STRING
                                     (CONTAINING MeasurementReport)      OPTIONAL,
-- Other IEs
    failureCause                     FailureCauseWithProtErr          OPTIONAL,
    ue-HistoryInformation             UE-HistoryInformation           OPTIONAL,
-- MBMS IEs
    mbms-JoinedInformation           MBMS-JoinedInformation-r6       OPTIONAL,
    mbms-SelectedServiceInfo         MBMS-SelectedServiceInfo       OPTIONAL,
}

SRNC-RelocationInfo-r12-IEs ::= SEQUENCE {
-- Non-RRC IEs
-- IE rb-IdentityForHOMessage includes the identity of the RB used by the source SRNC
-- to send the message contained in the IE "TargetRNC-ToSourceRNC-Container".
-- Only included if type is "UE involved"
    rb-IdentityForHOMessage          RB-Identity                      OPTIONAL,
    stateOfRRC                      StateOfRRC,
    stateOfRRC-Procedure             StateOfRRC-Procedure,
-- Ciphering related information IEs
    cipheringStatusList              CipheringStatusList-r4,
    latestConfiguredCN-Domain        CN-DomainIdentity,
    calculationTimeForCiphering      CalculationTimeForCiphering      OPTIONAL,
    count-C-List                     COUNT-C-List                     OPTIONAL,
    cipheringInfoPerRB-List          CipheringInfoPerRB-List-r4      OPTIONAL,
-- Integrity protection related information IEs
    integrityProtectionStatus        IntegrityProtectionStatus,
    srb-SpecificIntegrityProtInfo     SRB-SpecificIntegrityProtInfoList  OPTIONAL,
    implementationSpecificParams     ImplementationSpecificParams     OPTIONAL,
-- User equipment IEs
    u-RNTI                           U-RNTI,
    c-RNTI                           C-RNTI                          OPTIONAL,
-- IE 'UE-RadioAccessCapability-r6' includes the Rel-5 radio access capability extensions
-- and earlier. Rel-6 and later extensions are included in IE 'UE-CapabilityContainer-IEs'.
    ue-RadioAccessCapability         UE-RadioAccessCapability-r6,
    ue-RadioAccessCapability-ext      UE-RadioAccessCapabBandFDDList   OPTIONAL,
    ue-Positioning-LastKnownPos      UE-Positioning-LastKnownPos      OPTIONAL,
    uESpecificBehaviourInformationIdle UESpecificBehaviourInformationIdle  OPTIONAL,
    uESpecificBehaviourInformationInterRAT UESpecificBehaviourInformationInterRAT  OPTIONAL,
-- IE ueCapabilityContainer is used for the transparent transfer of capability information
-- received from the UE
    ueCapabilityContainer             BIT STRING
                                     (CONTAINING UE-CapabilityContainer-IEs)  OPTIONAL,
-- IE ueCapabilityContainer-RSC and IE ueCapabilityContainer-UCI are used for the
-- transparent transfer of capability information received from the UE that was introduced
-- in a release independent manner, i.e., transferred within a VLEC. These UE capabilities
-- are included both in the RRC CONNECTION SETUP COMPLETE and the UE CAPABILITY INFORMATION
-- messages. Only the VLEC of one message needs to be included i.e. the one from these
-- messages that was last received.
-- Case 1: If the last received message was a RRC CONNECTION SETUP COMPLETE (RSC)
    ueCapabilityContainer-RSC         BIT STRING
                                     (CONTAINING RRCConnectionSetupComplete-r3-add-ext-IEs)  OPTIONAL,
-- Case 2: If the last received message was a UE CAPABILITY INFORMATION (UCI)
    ueCapabilityContainer-UCI        BIT STRING
                                     (CONTAINING UECapabilityInformation-r3-add-ext-IEs)  OPTIONAL,
-- Other IEs
    ue-RATSpecificCapability         InterRAT-UE-RadioAccessCapabilityList-r5  OPTIONAL,
-- UTRAN mobility IEs
    ura-Identity                     URA-Identity                     OPTIONAL,
    srns-t-305                       T-305                            OPTIONAL,
-- Core network IEs
    cn-CommonGSM-MAP-NAS-SysInfo     NAS-SystemInformationGSM-MAP,
    cn-DomainInformationList         CN-DomainInformationListFull     OPTIONAL,
-- Measurement IEs
    ongoingMeasRepList               OngoingMeasRepList-r12          OPTIONAL,
    interRATCellInfoIndication       InterRATCellInfoIndication      OPTIONAL,
-- Radio bearer IEs
    predefinedConfigStatusList       PredefinedConfigStatusList,
    srb-InformationList              SRB-InformationSetupList-r11,
    rab-InformationList              RAB-InformationSetupList-r11    OPTIONAL,
    pdcp-ROHC-TargetMode             PDCP-ROHC-TargetMode           OPTIONAL,
-- Transport channel IEs

```

```

    ul-CommonTransChInfo          UL-CommonTransChInfo-r12          OPTIONAL,
    ul-TransChInfoList            UL-AddReconfTransChInfoList-r8      OPTIONAL,
    dl-CommonTransChInfo          DL-CommonTransChInfo-r4        OPTIONAL,
    dl-TransChInfoList            DL-AddReconfTransChInfoList-r11  OPTIONAL,
-- PhyCH IEs
    tpc-CombinationInfoList       TPC-CombinationInfoList      OPTIONAL,
    e-RGCH-CombinationInfoList    E-RGCH-CombinationInfoList  OPTIONAL,
    storedCompressedModeInfo      StoredCompressedModeInfo-r8  OPTIONAL,
    secondary-tpc-CombinationInfoList TPC-CombinationInfoList-r9  OPTIONAL,
    secondary-e-RGCH-CombinationInfoList E-RGCH-CombinationInfoList-r9 OPTIONAL,
    serving-HSDSCH-CellInformation Serving-HSDSCH-CellInformation-r12 OPTIONAL,
    dtx-drx-Info                  DTX-DRX-Info-r12            OPTIONAL,
    ul-SecondaryCellInfoFDD       UL-SecondaryCellInfoFDD-r12  OPTIONAL,
    dch-Enhancements-Info-FDD    DCH-Enhancements-Info-FDD   OPTIONAL,
    dl-CommonInformation          DL-CommonInformation-r12     OPTIONAL,
    dl-InformationPerRL-List      DL-InformationPerRL-List-r12 OPTIONAL,
-- Measurement report
    measurementReport            BIT STRING
                                (CONTAINING MeasurementReport)      OPTIONAL,
-- Other IEs
    failureCause                  FailureCauseWithProtErr      OPTIONAL,
    ue-HistoryInformation         UE-HistoryInformation        OPTIONAL,
-- MBMS IEs
    mbms-JoinedInformation        MBMS-JoinedInformation-r6    OPTIONAL,
    mbmsSelectedServiceInfo      MBMS-SelectedServiceInfo    OPTIONAL,
}

-- IE definitions

CalculationTimeForCipherring ::= SEQUENCE {
    cell-Id                      CellIdentity,
    sfn                          INTEGER (0..4095)
}

CipherringInfoPerRB ::= SEQUENCE {
    dl-HFN                       BIT STRING (SIZE (20..25)),
    ul-HFN                       BIT STRING (SIZE (20..25))
}

CipherringInfoPerRB-r4 ::= SEQUENCE {
    rb-Identity                  RB-Identity,
    dl-HFN                       BIT STRING (SIZE (20..25)),
    dl-UM-SN                     BIT STRING (SIZE (7))          OPTIONAL,
    ul-HFN                       BIT STRING (SIZE (20..25))
}

-- TABULAR: CipherringInfoPerRB-List, multiplicity value numberOfRadioBearers
-- has been replaced with maxRB.
CipherringInfoPerRB-List ::= SEQUENCE (SIZE (1..maxRB)) OF
    CipherringInfoPerRB

CipherringInfoPerRB-List-r4 ::= SEQUENCE (SIZE (1..maxRB)) OF
    CipherringInfoPerRB-r4

CipherringStatus ::= ENUMERATED {
    started, notStarted }

CipherringStatusList-r4 ::= SEQUENCE (SIZE (1..maxCNdomains)) OF
    CipherringStatusCNdomain-r4

CipherringStatusCNdomain-r4 ::= SEQUENCE {
    cn-DomainIdentity           CN-DomainIdentity,
    cipherringStatus            CipherringStatus,
    start-Value                 START-Value
}

CN-DomainInformation-v390ext ::= SEQUENCE {
    cn-DRX-CycleLengthCoeff    CN-DRX-CycleLengthCoefficient
}

CN-DomainInformationList-v390ext ::= SEQUENCE (SIZE (1..maxCNdomains)) OF
    CN-DomainInformation-v390ext

CompressedModeMeasCapability-r4 ::= SEQUENCE {
    fdd-Measurements            BOOLEAN,
    -- TABULAR: The IEs tdd-Measurements, gsm-Measurements and multiCarrierMeasurements
    -- are made optional since they are conditional based on another information element.
}

```



```

-- Their absence corresponds to the case where the condition is not true.
tdd384-Measurements      BOOLEAN      OPTIONAL,
tdd128-Measurements      BOOLEAN      OPTIONAL,
gsm-Measurements         GSM-Measurements  OPTIONAL,
multiCarrierMeasurements BOOLEAN      OPTIONAL
}

COUNT-C-List ::=          SEQUENCE (SIZE (1..maxCNdomains)) OF
                           COUNT-CSingle

COUNT-CSingle ::=        SEQUENCE {
  cn-DomainIdentity       CN-DomainIdentity,
  count-C                  BIT STRING (SIZE (32))
}

DL-PhysChCapabilityFDD-r4 ::= SEQUENCE {
  -- The IE "maxNoDPCH-PDSCH-Codes" only gives information on the maximum number of DPCH Codes.
  maxNoDPCH-PDSCH-Codes   INTEGER (1..8),
  maxNoPhysChBitsReceived MaxNoPhysChBitsReceived,
  supportForSF-512        BOOLEAN,
  -- dummy, dummy2 and dummy3 are not used in this version of the specification
  -- and if received they should be ignored.
  dummy                   BOOLEAN,
  dummy2                  SimultaneousSCCPCH-DPCH-Reception,
  dummy3                  SupportOfDedicatedPilotsForChEstimation  OPTIONAL
}

DL-PhysChCapabilityFDD-r5 ::= SEQUENCE {
  -- The IE "maxNoDPCH-PDSCH-Codes" only gives information on the maximum number of DPCH Codes.
  maxNoDPCH-PDSCH-Codes   INTEGER (1..8),
  maxNoPhysChBitsReceived MaxNoPhysChBitsReceived,
  supportForSF-512        BOOLEAN,
  -- dummy, dummy2 and dummy3 are not used in this version of the specification
  -- and if received they should be ignored.
  dummy                   BOOLEAN,
  dummy2                  SimultaneousSCCPCH-DPCH-Reception,
  dummy3                  SupportOfDedicatedPilotsForChEstimation  OPTIONAL,
  fdd-hspdsch             CHOICE {
    supported              SEQUENCE {
      hsdSCH-physical-layer-category HSDSCH-physical-layer-category,
      -- dummy and dummy2 are not used in this version of the specification
      -- and if received they should be ignored.
      dummy                 BOOLEAN,
      dummy2                BOOLEAN
    },
    unsupported            NULL
  }
}

DL-PhysChCapabilityTDD-r5 ::= SEQUENCE {
  maxTS-PerFrame          MaxTS-PerFrame,
  maxPhysChPerFrame       MaxPhysChPerFrame,
  minimumSF               MinimumSF-DL,
  supportOfPDSCH          BOOLEAN,
  maxPhysChPerTS          MaxPhysChPerTS,
  tdd384-hspdsch         CHOICE {
    supported              HSDSCH-physical-layer-category,
    unsupported            NULL
  }
}

DL-PhysChCapabilityTDD-LCR-r5 ::= SEQUENCE {
  maxTS-PerSubFrame       MaxTS-PerSubFrame-r4,
  maxPhysChPerSubFrame    MaxPhysChPerSubFrame-r4,
  minimumSF               MinimumSF-DL,
  supportOfPDSCH          BOOLEAN,
  maxPhysChPerTS          MaxPhysChPerTS,
  supportOf8PSK           BOOLEAN,
  tdd128-hspdsch         CHOICE {
    supported              HSDSCH-physical-layer-category,
    unsupported            NULL
  }
}

DL-RFC3095-Context ::= SEQUENCE {
  rfc3095-Context-Identity INTEGER (0..16383),
  dl-mode                 ENUMERATED {u, o, r},
  dl-ref-ir               OCTET STRING ( SIZE (1..3000)),
}

```

```

dl-ref-time                INTEGER (0..4294967295)    OPTIONAL,
dl-curr-time               INTEGER (0..4294967295)    OPTIONAL,
dl-syn-offset-id          INTEGER (0..65535)          OPTIONAL,
dl-syn-slope-ts           INTEGER (0..4294967295)    OPTIONAL,
dl-dyn-changed            BOOLEAN
}

E-RGCH-Combination-Info ::= SEQUENCE{
  primaryCPICH-Info       PrimaryCPICH-Info,
  rg-CombinationIndex     INTEGER (0..5)
}

E-RGCH-Combination-Info-r9 ::= SEQUENCE{
  primaryCPICH-Info       PrimaryCPICH-Info,
  rg-CombinationIndex     INTEGER (0..5)
}

E-RGCH-CombinationInfoList ::= SEQUENCE (SIZE (1..maxEDCHRL)) OF
  E-RGCH-Combination-Info

E-RGCH-CombinationInfoList-r9 ::= SEQUENCE (SIZE (1..maxEDCHRL)) OF
  E-RGCH-Combination-Info-r9

ImplementationSpecificParams ::= BIT STRING (SIZE (1..512))

IntegrityProtectionStatus ::= ENUMERATED {
  started, notStarted }

InterRAT-UE-RadioAccessCapabilityList-r5 ::= SEQUENCE {
  interRAT-UE-RadioAccessCapability  InterRAT-UE-RadioAccessCapabilityList,
  geranIu-RadioAccessCapability      GERANIu-RadioAccessCapability          OPTIONAL
}

IntraFreqReportingCriteria-r6-ext ::= SEQUENCE {
  -- The content of the v690 non-critical extension should be
  -- considered as an extension of IE IntraFreqEventCriteriaList
  event                EventIj-r6,
  hysteresis           Hysteresis,
  timeToTrigger        TimeToTrigger,
  reportingCellStatus  ReportingCellStatus          OPTIONAL
}

-- dummy is not used in this version of the specification, it should
-- not be sent and if received it should be ignored.
MaxHcContextSpace-r5 ::= ENUMERATED {
  dummy, by1024, by2048, by4096, by8192,
  by16384, by32768, by65536, by131072 }

MeasurementCapability-r4 ::= SEQUENCE {
  downlinkCompressedMode  CompressedModeMeasCapability-r4,
  uplinkCompressedMode    CompressedModeMeasCapability-r4
}

MeasurementCommandWithType ::= CHOICE {
  setup      MeasurementType,
  modify     NULL,
  release    NULL
}

MeasurementCommandWithType-r4 ::= CHOICE {
  setup      MeasurementType-r4,
  modify     NULL,
  release    NULL
}

MeasurementCommandWithType-r6 ::= CHOICE {
  setup      MeasurementType-r6,
  modify     NULL,
  release    NULL
}

MeasurementCommandWithType-r7 ::= CHOICE {
  setup      MeasurementType-r7,
  modify     NULL,
  release    NULL
}

MeasurementCommandWithType-r8 ::= CHOICE {

```

```

    setup          MeasurementType-r8,
    modify         NULL,
    release        NULL,
}

MeasurementCommandWithType-r9 ::= CHOICE {
    setup          MeasurementType-r9,
    modify         NULL,
    release        NULL,
}

MeasurementCommandWithType-r10 ::= CHOICE {
    setup          MeasurementType-r10,
    modify         NULL,
    release        NULL,
}

MeasurementCommandWithType-r11 ::= CHOICE {
    setup          MeasurementType-r11,
    modify         NULL,
    release        NULL,
}

MeasurementCommandWithType-r12 ::= CHOICE {
    setup          MeasurementType-r12,
    modify         NULL,
    release        NULL,
}

OngoingMeasRep ::= SEQUENCE {
    measurementIdentity          MeasurementIdentity,
    -- TABULAR: The CHOICE Measurement in the tabular description is included
    -- in MeasurementCommandWithType
    measurementCommandWithType  MeasurementCommandWithType,
    measurementReportingMode     MeasurementReportingMode           OPTIONAL,
    additionalMeasurementID-List AdditionalMeasurementID-List      OPTIONAL,
}

OngoingMeasRep-r4 ::= SEQUENCE {
    measurementIdentity          MeasurementIdentity,
    -- TABULAR: The CHOICE Measurement in the tabular description is included
    -- in MeasurementCommandWithType-r4.
    measurementCommandWithType  MeasurementCommandWithType-r4,
    measurementReportingMode     MeasurementReportingMode           OPTIONAL,
    additionalMeasurementID-List AdditionalMeasurementID-List      OPTIONAL,
}

OngoingMeasRep-r5 ::= SEQUENCE {
    measurementIdentity          MeasurementIdentity,
    -- TABULAR: The CHOICE Measurement in the tabular description is included
    -- in MeasurementCommandWithType-r4.
    measurementCommandWithType  MeasurementCommandWithType-r4,
    measurementReportingMode     MeasurementReportingMode           OPTIONAL,
    additionalMeasurementID-List AdditionalMeasurementID-List      OPTIONAL,
    measurementCommand-v590ext  CHOICE {
        -- the choice "intra-frequency" shall be used for the case of intra-frequency measurement,
        -- as well as when intra-frequency events are configured for inter-frequency measurement
        intra-frequency          Intra-FreqEventCriteriaList-v590ext,
        inter-frequency          Inter-FreqEventCriteriaList-v590ext
    }
    OPTIONAL,
    intraFreqReportingCriteria-1b-r5 IntraFreqReportingCriteria-1b-r5  OPTIONAL,
    intraFreqEvent-1d-r5            IntraFreqEvent-1d-r5          OPTIONAL,
}

OngoingMeasRep-r6 ::= SEQUENCE {
    measurementIdentity          MeasurementIdentity,
    measurementCommandWithType  MeasurementCommandWithType-r6,
    measurementReportingMode     MeasurementReportingMode           OPTIONAL,
    additionalMeasurementID-List AdditionalMeasurementID-List      OPTIONAL,
}

OngoingMeasRep-r7 ::= SEQUENCE {
    measurementIdentity          MeasurementIdentity,
    measurementCommandWithType  MeasurementCommandWithType-r7,
    measurementReportingMode     MeasurementReportingMode           OPTIONAL,
    additionalMeasurementID-List AdditionalMeasurementID-List      OPTIONAL,
}

```

```

OngoingMeasRep-r8 ::=                               SEQUENCE {
  measurementIdentity                               MeasurementIdentity,
  measurementCommandWithType                         MeasurementCommandWithType-r8,
  measurementReportingMode                           MeasurementReportingMode           OPTIONAL,
  additionalMeasurementID-List                       AdditionalMeasurementID-List      OPTIONAL
}

OngoingMeasRep-r9 ::=                               SEQUENCE {
  measurementIdentity                               MeasurementIdentity,
  measurementCommandWithType                         MeasurementCommandWithType-r9,
  measurementReportingMode                           MeasurementReportingMode           OPTIONAL,
  -- if any of the additional measurement ID is within the range 17 to 32,
  -- "OngoingMeasRep-v970ext-IEs" should be present and should include
  -- the IE "measurementIdentity" and "additionalMeasurementID-List".
  -- The value of the IE "measurementIdentity" in "OngoingMeasRep-v970ext-IEs"
  -- should be the same as the "measurementIdentity" value in "OngoingMeasRep-r9",
  -- and "additionalMeasurementID-List" should contain the complete list.
  -- The IE "additionalMeasurementID-List" in "OngoingMeasRep-r9" should still
  -- contain the additional measurement ID which value is within the range 1 to 16.
  additionalMeasurementID-List                       AdditionalMeasurementID-List      OPTIONAL
}

-- The IE "OngoingMeasRep-v970ext-IEs" should be included to report
-- measurementIdentity values within the range 17 to 32 and when a
-- "measurementIdentity" in "OngoingMeasRep-r9" needs to contain one of the
-- values within the range 17 to 32 in the IE "additionalMeasurementID-List".

OngoingMeasRep-v970ext-IEs ::=                     SEQUENCE {
  measurementIdentity                               MeasurementIdentity-r9             OPTIONAL,
  additionalMeasurementID-List                       AdditionalMeasurementID-List-r9    OPTIONAL
}

OngoingMeasRep-r10 ::=                             SEQUENCE {
  measurementIdentity                               MeasurementIdentity,
  measurementCommandWithType                         MeasurementCommandWithType-r10,
  measurementReportingMode                           MeasurementReportingMode           OPTIONAL,
  -- if any of the additional measurement ID is within the range 17 to 32,
  -- "OngoingMeasRep-v970ext-IEs" (in SRNC-RelocationInfo-vab0ext-IEs) should be present
  -- and should include the IE "measurementIdentity" and
  -- "additionalMeasurementID-List". In this case, the value of the IE "measurementIdentity" in
  -- "OngoingMeasRep-v970ext-IEs" (in SRNC-RelocationInfo-vab0ext-IEs) should be the same as the
  -- "measurementIdentity" value in "OngoingMeasRep-r10", and "additionalMeasurementID-List"
  -- should contain the complete list.
  -- The IE "additionalMeasurementID-List" in "OngoingMeasRep-r10" should still
  -- contain the additional measurement ID which value is within the range 1 to 16.
  additionalMeasurementID-List                       AdditionalMeasurementID-List      OPTIONAL
}

OngoingMeasRep-r11 ::=                             SEQUENCE {
  measurementIdentity                               MeasurementIdentity-r9,
  measurementCommandWithType                         MeasurementCommandWithType-r11,
  measurementReportingMode                           MeasurementReportingMode           OPTIONAL,
  additionalMeasurementID-List                       AdditionalMeasurementID-List-r9    OPTIONAL
}

OngoingMeasRep-r12 ::=                             SEQUENCE {
  measurementIdentity                               MeasurementIdentity-r9,
  measurementCommandWithType                         MeasurementCommandWithType-r12,
  measurementReportingMode                           MeasurementReportingMode           OPTIONAL,
  additionalMeasurementID-List                       AdditionalMeasurementID-List-r9    OPTIONAL
}

OngoingMeasRepList ::=                             SEQUENCE (SIZE (1..maxNoOfMeas)) OF
  OngoingMeasRep

OngoingMeasRepList-r4 ::=                           SEQUENCE (SIZE (1..maxNoOfMeas)) OF
  OngoingMeasRep-r4

OngoingMeasRepList-r5 ::=                           SEQUENCE (SIZE (1..maxNoOfMeas)) OF
  OngoingMeasRep-r5

OngoingMeasRepList-r6 ::=                           SEQUENCE (SIZE (1..maxNoOfMeas)) OF
  OngoingMeasRep-r6

OngoingMeasRepList-r7 ::=                           SEQUENCE (SIZE (1..maxNoOfMeas)) OF
  OngoingMeasRep-r7

OngoingMeasRepList-r8 ::=                           SEQUENCE (SIZE (1..maxNoOfMeas)) OF

```

```

OngoingMeasRep-r8
OngoingMeasRepList-r9 ::= SEQUENCE (SIZE (1..maxNoOfMeas)) OF
                           OngoingMeasRep-r9
OngoingMeasRepList-v970ext-IE ::= SEQUENCE (SIZE (1..maxNoOfMeas)) OF
                                   OngoingMeasRep-v970ext-IEs
OngoingMeasRepList-r10 ::= SEQUENCE (SIZE (1..maxNoOfMeas)) OF
                             OngoingMeasRep-r10
OngoingMeasRepList-r11 ::= SEQUENCE (SIZE (1..maxNoOfMeas)) OF
                             OngoingMeasRep-r11
OngoingMeasRepList-r12 ::= SEQUENCE (SIZE (1..maxNoOfMeas)) OF
                             OngoingMeasRep-r12

PDCP-Capability-r4 ::= SEQUENCE {
  losslessSRNS-RelocationSupport    BOOLEAN,
  supportForRfc2507                  CHOICE {
    notSupported                      NULL,
    supported                          MaxHcContextSpace
  },
  supportForRfc3095                  CHOICE {
    notSupported                      NULL,
    supported                          SEQUENCE {
      maxROHC-ContextSessions        MaxROHC-ContextSessions-r4  DEFAULT s16,
      reverseCompressionDepth        INTEGER (0..65535)          DEFAULT 0
    }
  }
}

PDCP-Capability-r5 ::= SEQUENCE {
  losslessSRNS-RelocationSupport    BOOLEAN,
  supportForRfc2507                  CHOICE {
    notSupported                      NULL,
    supported                          MaxHcContextSpace-r5
  },
  supportForRfc3095                  CHOICE {
    notSupported                      NULL,
    supported                          SEQUENCE {
      maxROHC-ContextSessions        MaxROHC-ContextSessions-r4  DEFAULT s16,
      reverseCompressionDepth        INTEGER (0..65535)          DEFAULT 0,
      supportForRfc3095ContextRelocation  BOOLEAN
    }
  }
}

PDCP-Capability-r6 ::= SEQUENCE {
  losslessSRNS-RelocationSupport    BOOLEAN,
  losslessDLRLC-PDUSizeChange        ENUMERATED { true }          OPTIONAL,
  supportForRfc2507                  CHOICE {
    notSupported                      NULL,
    supported                          MaxHcContextSpace-r5
  },
  supportForRfc3095                  CHOICE {
    notSupported                      NULL,
    supported                          SEQUENCE {
      maxROHC-ContextSessions        MaxROHC-ContextSessions-r4  DEFAULT s16,
      reverseCompressionDepth        INTEGER (0..65535)          DEFAULT 0,
      supportForRfc3095ContextRelocation  BOOLEAN
    }
  }
}

PhysicalChannelCapability-r4 ::= SEQUENCE {
  fddPhysChCapability                SEQUENCE {
    downlinkPhysChCapability          DL-PhysChCapabilityFDD-r4,
    uplinkPhysChCapability            UL-PhysChCapabilityFDD
  } OPTIONAL,
  tdd384-PhysChCapability            SEQUENCE {
    downlinkPhysChCapability          DL-PhysChCapabilityTDD,
    uplinkPhysChCapability            UL-PhysChCapabilityTDD
  } OPTIONAL,
  tdd128-PhysChCapability            SEQUENCE {
    downlinkPhysChCapability          DL-PhysChCapabilityTDD-LCR-r4,
    uplinkPhysChCapability            UL-PhysChCapabilityTDD-LCR-r4
  } OPTIONAL
}

```

```

}

PhysicalChannelCapability-r5 ::=          SEQUENCE {
    fddPhysChCapability                SEQUENCE {
        downlinkPhysChCapability      DL-PhysChCapabilityFDD-r5,
        uplinkPhysChCapability        UL-PhysChCapabilityFDD
    } OPTIONAL,
    tdd384-PhysChCapability            SEQUENCE {
        downlinkPhysChCapability      DL-PhysChCapabilityTDD-r5,
        uplinkPhysChCapability        UL-PhysChCapabilityTDD
    } OPTIONAL,
    tdd128-PhysChCapability            SEQUENCE {
        downlinkPhysChCapability      DL-PhysChCapabilityTDD-LCR-r5,
        uplinkPhysChCapability        UL-PhysChCapabilityTDD-LCR-r4
    } OPTIONAL
}

RF-Capability-r4 ::=                    SEQUENCE {
    fddRF-Capability                    SEQUENCE {
        ue-PowerClass                  UE-PowerClassExt,
        txRxFrequencySeparation        TxRxFrequencySeparation
    } OPTIONAL,
    tdd384-RF-Capability                SEQUENCE {
        ue-PowerClass                  UE-PowerClassExt,
        radioFrequencyBandTDDList     RadioFrequencyBandTDDList,
        chipRateCapability              ChipRateCapability
    } OPTIONAL,
    tdd128-RF-Capability                SEQUENCE {
        ue-PowerClass                  UE-PowerClassExt,
        radioFrequencyBandTDDList     RadioFrequencyBandTDDList,
        chipRateCapability              ChipRateCapability
    } OPTIONAL
}

RFC3095-ContextInfo ::=                 SEQUENCE {
    rb-Identity                          RB-Identity,
    rfc3095-Context-List                 RFC3095-Context-List
}

RFC3095-Context-List ::=                 SEQUENCE (SIZE (1..maxRFC3095-CID)) OF SEQUENCE {
    dl-RFC3095-Context                   DL-RFC3095-Context    OPTIONAL,
    ul-RFC3095-Context                   UL-RFC3095-Context    OPTIONAL
}

RLC-Capability-r5 ::=                    SEQUENCE {
    totalRLC-AM-BufferSize                TotalRLC-AM-BufferSize-r5,
    maximumRLC-WindowSize                 MaximumRLC-WindowSize,
    maximumAM-EntityNumber                 MaximumAM-EntityNumberRLC-Cap
}

SRB-SpecificIntegrityProtInfo ::=        SEQUENCE {
    ul-RRC-HFN                            BIT STRING (SIZE (28)),
    dl-RRC-HFN                            BIT STRING (SIZE (28)),
    ul-RRC-SequenceNumber                 RRC-MessageSequenceNumber,
    dl-RRC-SequenceNumber                 RRC-MessageSequenceNumber
}

SRB-SpecificIntegrityProtInfoList ::=     SEQUENCE (SIZE (4..maxSRBsetup)) OF
SRB-SpecificIntegrityProtInfo

StateOfRRC ::=                           ENUMERATED {
    cell-DCH, cell-FACH,
    cell-PCH, ura-PCH }

StateOfRRC-Procedure ::=                  ENUMERATED {
    awaitNoRRC-Message,
    awaitRB-ReleaseComplete,
    awaitRB-SetupComplete,
    awaitRB-ReconfigurationComplete,
    awaitTransportCH-ReconfigurationComplete,
    awaitPhysicalCH-ReconfigurationComplete,
    awaitActiveSetUpdateComplete,
    awaitHandoverComplete,
    sendCellUpdateConfirm,
    sendUraUpdateConfirm,
    -- dummy is not used in this version of specification
    -- It should not be sent
}

```

```

        dummy,
        otherStates
    }

TotalRLC-AM-BufferSize-r5 ::= ENUMERATED {
    kb10, kb50, kb100, kb150, kb200,
    kb300, kb400, kb500, kb750, kb1000 }

TPC-Combination-Info ::= SEQUENCE {
    primaryCPICH-Info          PrimaryCPICH-Info,
    tpc-CombinationIndex      TPC-CombinationIndex
}

TPC-Combination-Info-r9 ::= SEQUENCE {
    primaryCPICH-Info          PrimaryCPICH-Info,
    tpc-CombinationIndex      TPC-CombinationIndex
}

UE-MultiModeRAT-Capability-r5 ::= SEQUENCE {
    multiRAT-CapabilityList    MultiRAT-Capability,
    multiModeCapability        MultiModeCapability,
    supportOfUTRAN-ToGERAN-NACC BOOLEAN
}

UE-Positioning-Capability-r4 ::= SEQUENCE {
    standaloneLocMethodsSupported    BOOLEAN,
    ue-BasedOTDOA-Supported          BOOLEAN,
    networkAssistedGPS-Supported     NetworkAssistedGPS-Supported,
    supportForUE-GPS-TimingOfCellFrames    BOOLEAN,
    supportForIPDL                   BOOLEAN,
    rx-tx-TimeDifferenceType2Capable     BOOLEAN,
    validity-CellPCH-UraPCH            ENUMERATED { true }    OPTIONAL,
    sfn-sfnType2Capability             ENUMERATED { true }    OPTIONAL
}

UE-Positioning-LastKnownPos ::= SEQUENCE {
    sfn                INTEGER (0..4095),
    cell-id            CellIdentity,
    positionEstimate   PositionEstimate
}

UE-RadioAccessCapability-r4 ::= SEQUENCE {
    accessStratumReleaseIndicator    AccessStratumReleaseIndicator,
    pdcp-Capability                 PDCP-Capability-r4,
    rlc-Capability                   RLC-Capability,
    transportChannelCapability       TransportChannelCapability,
    rf-Capability                    RF-Capability-r4,
    physicalChannelCapability        PhysicalChannelCapability-r4,
    ue-MultiModeRAT-Capability       UE-MultiModeRAT-Capability,
    securityCapability               SecurityCapability,
    ue-positioning-Capability         UE-Positioning-Capability-r4,
    measurementCapability            MeasurementCapability-r4    OPTIONAL
}

UE-RadioAccessCapability-r5 ::= SEQUENCE {
    accessStratumReleaseIndicator    AccessStratumReleaseIndicator,
    dl-CapabilityWithSimultaneousHS-DSCHConfig    DL-CapabilityWithSimultaneousHS-DSCHConfig    OPTIONAL,
    pdcp-Capability                 PDCP-Capability-r5,
    rlc-Capability                   RLC-Capability-r5,
    transportChannelCapability       TransportChannelCapability,
    rf-Capability                    RF-Capability-r4,
    physicalChannelCapability        PhysicalChannelCapability-r5,
    ue-MultiModeRAT-Capability       UE-MultiModeRAT-Capability-r5,
    securityCapability               SecurityCapability,
    ue-positioning-Capability         UE-Positioning-Capability-r4,
    measurementCapability            MeasurementCapability-r4    OPTIONAL
}

UE-RadioAccessCapability-r6 ::= SEQUENCE {
    accessStratumReleaseIndicator    AccessStratumReleaseIndicator,
    dl-CapabilityWithSimultaneousHS-DSCHConfig    DL-CapabilityWithSimultaneousHS-DSCHConfig    OPTIONAL,
    pdcp-Capability                 PDCP-Capability-r6,
    rlc-Capability                   RLC-Capability-r5,
    transportChannelCapability       TransportChannelCapability,
    rf-Capability                    RF-Capability-r4,
    physicalChannelCapability        PhysicalChannelCapability-r5,

```

```

    ue-MultiModeRAT-Capability
    securityCapability
    ue-positioning-Capability
    measurementCapability
}

UL-RFC3095-Context ::=
    rfc3095-Context-Identity
    ul-mode
    ul-ref-ir
    ul-ref-time
    ul-curr-time
    ul-syn-offset-id
    ul-syn-slope-ts
    ul-ref-sn-1
}

SEQUENCE {
    INTEGER (0..16383),
    ENUMERATED {u, o, r},
    OCTET STRING (SIZE (1..3000)),
    INTEGER (0..4294967295) OPTIONAL,
    INTEGER (0..4294967295) OPTIONAL,
    INTEGER (0..65535) OPTIONAL,
    INTEGER (0..4294967295) OPTIONAL,
    INTEGER (0..65535) OPTIONAL
}

END

```

12 Message transfer syntax

Transfer syntax for RRC PDUs is derived from their ASN.1 definitions by use of Packed Encoding Rules, unaligned as specified in X.691 [49], and with adapted final padding. If special encoding is used, it is indicated in the ECN module defined for each ASN.1 module. The use of special encoding is defined in [14].

The following encoding rules apply in addition to what has been specified in X.691 [49]:

- When a bit string value is placed in a bit-field as specified in 15.6 to 15.11 in [11], the leading bit of the bit string value shall be placed in the leading bit of the bit-field, and the trailing bit of the bit string value shall be placed in the trailing bit of the bit-field.

NOTE: The terms "leading bit" and "trailing bit" are defined in ITU-T Rec. X.680 | ISO/IEC 8824-1. When using the "bstring" notation, the leading bit of the bit string value is on the left, and the trailing bit of the bit string value is on the right.

12.1 Structure of encoded RRC messages

An RRC PDU, which is the bit string that is exchanged between peer entities/ across the radio interface, is the concatenation of a basic production, an extension and padding, in that order.

RRC PDUs shall be mapped to and from RLC SDUs upon transmission and reception as follows:

- when delivering an RRC PDU as an RLC SDU to the RLC layer for transmission, the first bit of the RRC PDU shall be represented as the first bit in the RLC SDU and onwards; and
- upon reception of an RLC SDU from the RLC layer, the first bit of the RLC SDU shall represent the first bit of the RRC PDU and onwards.

12.1.1 Basic production

The 'basic production' is obtained by applying UNALIGNED PER to the abstract syntax value (the ASN.1 description) as specified in X.691, except for the 0 to 7 bits added at the end to produce a multiple of 8 bits. The basic production can have any positive number of bits, not necessarily a multiple of 8 bits.

12.1.2 Extension

Emitters compliant with this version of the specification of the protocol shall, unless indicated otherwise on a PDU type basis, set the extension part empty. Emitters compliant with a later version might send non-empty extensions.

12.1.3 Padding

Emitters compliant with this version of the specification of the protocol shall, unless indicated otherwise on a PDU type basis, pad the basic production with the smallest number of bits required to meet the size constraints of the lower layers. Padding bits shall be set to 0.

Receivers compliant with this version of the specification have no need to distinguish the extension and padding parts, and shall, unless indicated otherwise on a PDU type basis, accept RRC PDUs with any bit string in the extension and padding parts.

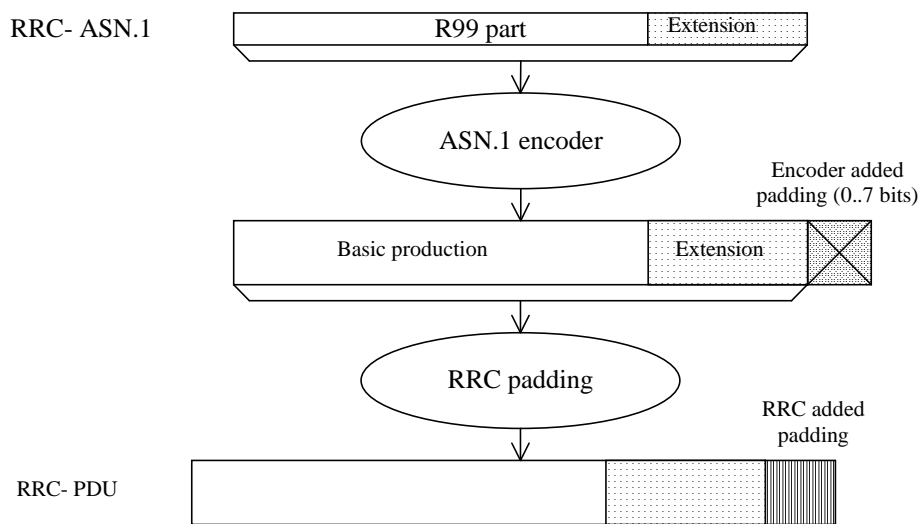

Figure 12.1.3-1: Padding

When using AM or UM mode, RLC requires that the RRC PDU length is a multiple of 8 bits.

When using Tr mode, RLC does neither impose size requirements nor perform padding. This implies that RRC has to take into account the transport format set defined for the transport channel across which the message is to be sent. RRC shall add the lowest number of padding bits required to fit the size specified for the selected transport format. In case of Enhanced Uplink in CELL_FACH state and Idle mode, when using Tr mode, RRC shall add the lowest number of padding bits to ensure octet alignment.

For paging type 1 messages, in case the PCCH is mapped on HS-DSCH, padding needs to apply only to ensure octet alignment.

For SYSTEM INFORMATION CHANGE INDICATION message, in case the BCCH is mapped on HS-DSCH, padding needs to apply only to ensure octet alignment.

For system information blocks, building the PDU involves two steps. The first step is the building of the System Information Blocks, in which step padding is not applied (the rules for extension apply). The second step is the building of the RRC PDUs, involving segmentation and concatenation of System Information Blocks, and then padding as described above for Tr mode if the BCCH carrying the System Information Blocks is mapped on BCH. The procedure is shown by means of an example as described in Figure 12.1.3-2. The example includes two System Information Blocks, SIB_n and SIB_{n+1}, of which only SIB_n includes a protocol extension. The two System Information Blocks used in the example do not require segmentation and are concatenated into one SYSTEM INFORMATION message or one SYSTEM INFORMATION 2 message.

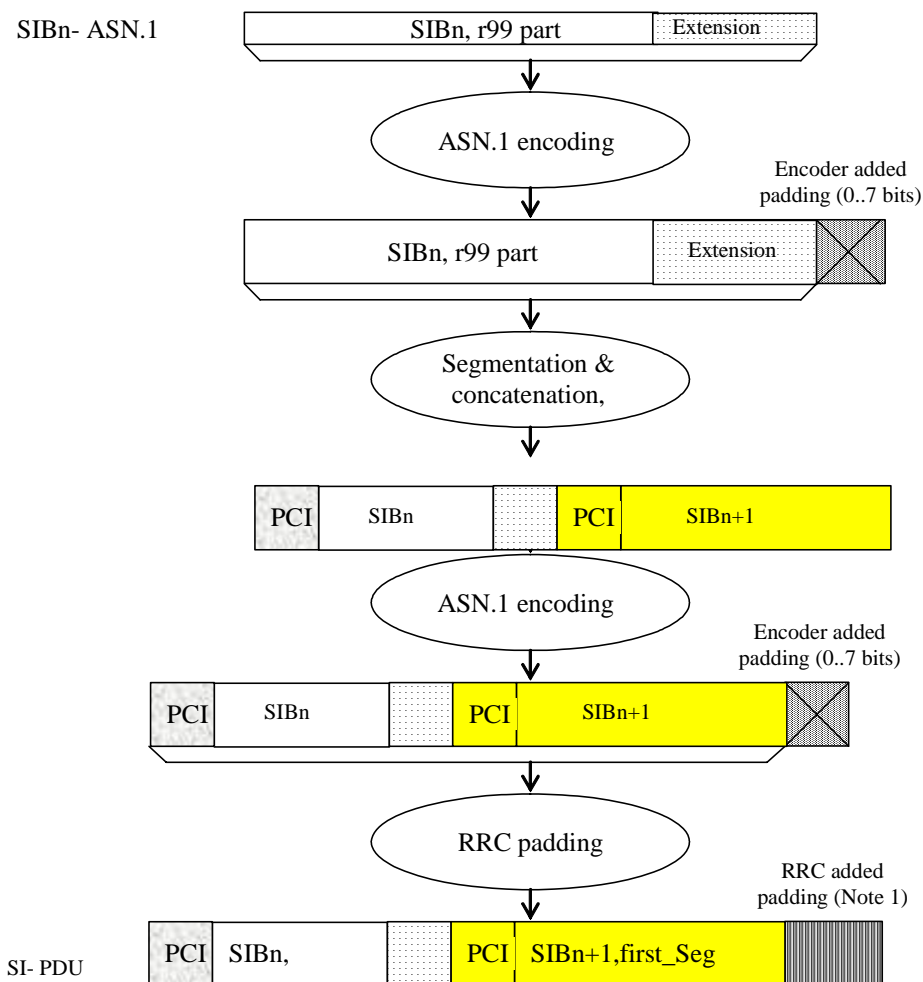

Note 1: RRC padding needs to be added only to octet align BCCH blocks which are mapped onto HS-DSCH

Figure 12.1.3-2: Padding for System Information

PCI: Protocol control information at SYSTEM INFORMATION message or SYSTEM INFORMATION 2 message level

SI: SYSTEM INFORMATION message or SYSTEM INFORMATION 2 message

For system information blocks, RRC may also add padding information at the end of IE "SIB data fixed", used both within IE "Last segment" and IE "Complete SIB". The IE "SIB data fixed" has a fixed length i.e. no length denominator used. In case the remaining amount of "SIB data" information is insufficient to fill the IE completely, RRC includes padding bits.

Since no length denominator is included, the receiving RRC cannot remove the padding added by the sender. However, since the padding used is the same as the padding added by the PER encoder to achieve octet alignment, the receiver can handle it.

NOTE 1 The mechanism described above implies that the PDU provided to the ASN.1 decoder may have more than 7 padding bits included. For a complete System Information Block of length 215 bits, 11 padding bits are added by RRC. Since the decoder requires an octet aligned input, 6 additional bits need to be added. In this (worst) case, a total of 17 padding bits is included.

NOTE 2 For the above cases, use of padding bits is possible and more efficient than including a length denominator.

When using the RRC padding described above, the segment has a fixed length, which completely fills the transport block. Therefore, in this case no RRC padding is added within the SYSTEM INFORMATION message or SYSTEM INFORMATION 2 message. This is illustrated by means of the following figure.

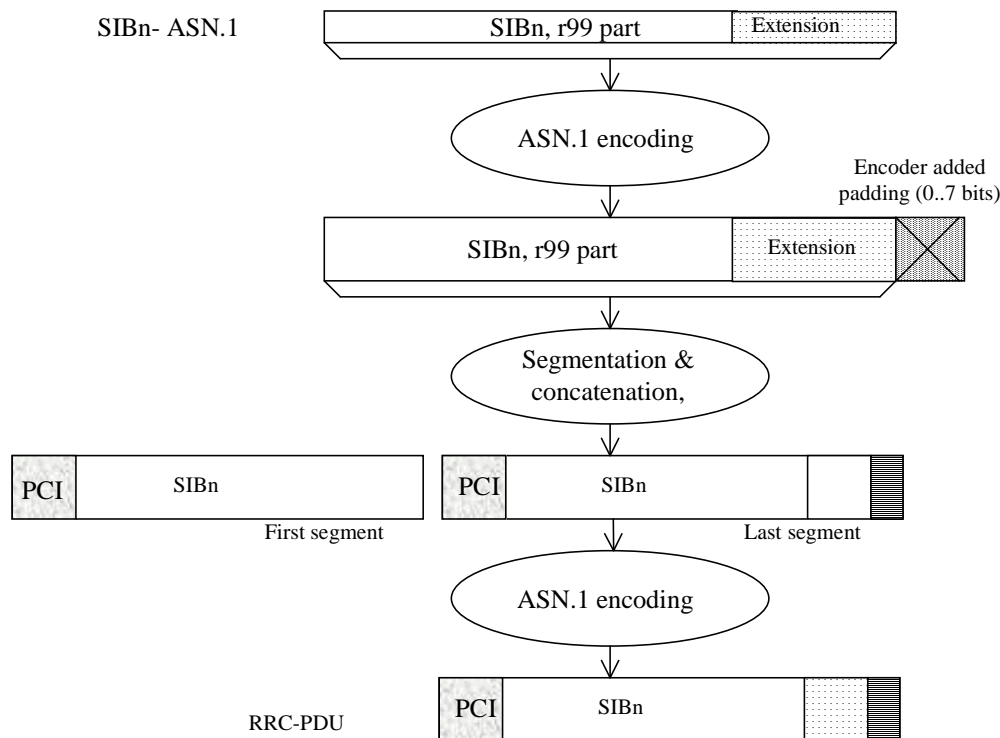

Figure 12.1.3-3: No RRC padding for System Information

12.2 ECN link module for RRC

```

RRC-ECN-Link-Module LINK-DEFINITIONS ::=
BEGIN

IMPORTS
    RRC-encodings          -- Encoding objects for RRC messages
FROM RRC-Encoding-Definitions;

ENCODE Class-definitions
    WITH RRC-encodings
    COMPLETED BY PER-BASIC-UNALIGNED

ENCODE PDU-definitions
    WITH RRC-encodings
    COMPLETED BY PER-BASIC-UNALIGNED

ENCODE InformationElements
    WITH RRC-encodings
    COMPLETED BY PER-BASIC-UNALIGNED

ENCODE Internode-definitions
    WITH RRC-encodings
    COMPLETED BY PER-BASIC-UNALIGNED

END

```

12.3 ECN modules for RRC

The encoding definition module "RRC-Encoding-Definitions" contains definition of the encoding object set "RRC-encodings". The encoding object set contains all the specialized encoding for RRC.

```
RRC-Encoding-Definitions ENCODING-DEFINITIONS ::=
BEGIN

EXPORTS
    RRC-encodings;

RRC-encodings #ENCODINGS ::= {
    -- Trailing bits
    outer-encoding
}

--*****
--
-- The trailing bits in all RRC messages shall be ignored
-- (including unknown message contents & unknown extensions).
-- This overrides the default PER behaviour which pads the last
-- octet with zero bits.
--
--*****

outer-encoding #OUTER ::= {
    ENCODER-DECODER {
    }
    DECODE AS IF {
        POST-PADDING    encoder-option
    }
}

END

Class-definitions-ECN-Module ENCODING-DEFINITIONS ::=
BEGIN
END

PDU-definitions-ECN-Module ENCODING-DEFINITIONS ::=
BEGIN
END

InformationElements-ECN-Module ENCODING-DEFINITIONS ::=
BEGIN
END

Internode-definitions-ECN-Module ENCODING-DEFINITIONS ::=
BEGIN
END
```

12.4 RRC messages encoded otherwise

NOTE: The messages included in this section are not specified by means of ASN.1.

12.4.1 Messages using tabular encoding specification

The encoding of the message is specified by means of a table listing the information elements known in the message and their order of their appearance in the message.

When a field extends over more than one octet, the order of bit values progressively decreases as the octet number increases. The least significant bit of the field is represented by the lowest numbered bit of the highest numbered octet of the field.

12.4.1.1 TRANSPORT FORMAT COMBINATION CONTROL using transparent DCCH

12.4.1.1.1 TRANSPORT FORMAT COMBINATION CONTROL, 3 bit format

The 3 bit format is as follows:

3	2	1	Transport Format Combination Set Identity value
0	0	0	0
0	0	1	1
0	1	0	2
1	1	1	7

12.4.1.1.2 Void

12.4.1.1.3 Void

13 Protocol timers, counters, other parameters and default configurations

The information provided in subclauses 13.1 and 13.2 shall be treated as informative. The normative text is specified in the relevant subclauses in clause 8 and clause 8 shall prevail.

13.1 Timers for UE

Timer	Start	Stop	At expiry
T300	Transmission of RRC CONNECTION REQUEST in case of connection establishment for reasons other than MBMS reception	Reception of RRC CONNECTION SETUP	Retransmit RRC CONNECTION REQUEST if V300 = \leq N300, else go to Idle mode
T302	Transmission of CELL UPDATE/URA UPDATE	Reception of CELL UPDATE CONFIRM/URA UPDATE CONFIRM	Retransmit CELL UPDATE/URA UPDATE if V302 = \leq N302, else, go to Idle mode
T304	Transmission of UE CAPABILITY INFORMATION	Reception of UE CAPABILITY INFORMATION CONFIRM	Retransmit UE CAPABILITY INFORMATION if V304 = \leq N304, else initiate a cell update procedure
T305	Entering CELL_FACH or URA_PCH or CELL_PCH state. Reception of CELL UPDATE CONFIRM/URA UPDATE CONFIRM.	Entering another state.	Transmit CELL UPDATE if T307 is not activated and the UE detects "in service area". Otherwise, if T307 is not active, start T307.
T307	When the timer T305 has expired and the UE detects "out of service area".	When the UE detects "in service area".	Transit to idle mode
T308	Transmission of RRC CONNECTION RELEASE COMPLETE	Not stopped	Transmit RRC CONNECTION RELEASE COMPLETE if V308 = \leq N308, else go to idle mode.
T309	Upon reception of CELL CHANGE ORDER FROM UTRAN message	Successful response to a connection establishment request in the new cell.	Resume the connection to UTRAN
T310	Transmission of PUSCH CAPACITY REQUEST	Reception of PHYSICAL SHARED CHANNEL ALLOCATION	Transmit PUSCH CAPACITY REQUEST if V310 = \leq N310, else procedure stops.
T311	Reception of PHYSICAL SHARED CHANNEL ALLOCATION message with the CHOICE "PUSCH allocation" set to "PUSCH allocation pending".	Reception of PHYSICAL SHARED CHANNEL ALLOCATION message with CHOICE "PUSCH allocation" set to "PUSCH allocation assignment".	UE may initiate a PUSCH capacity request procedure.
T312	When the UE starts to establish dedicated CH. For 1.28 Mcps TDD, it can also apply for physical shared channel establishment. For FDD, timer T312 runs independently for the downlink frequency associated with the primary uplink frequency and for the downlink frequency associated with the secondary uplink frequency.	When the UE detects N312 "in sync" indication from L1.	The criteria for physical channel establishment failure is fulfilled
T313	When the UE detects consecutive N313 "out of sync" indication from L1. For FDD, timer T313 runs independently for the downlink frequency associated with the primary uplink frequency and for the downlink frequency associated with the secondary uplink frequency.	When the UE detects consecutive N315 "in sync" indication from L1.	The criteria for Radio Link failure is fulfilled.

Timer	Start	Stop	At expiry
T314	When the criteria for radio link failure are fulfilled. The timer is started if radio bearer(s) that are associated with T314 exist or if only RRC connection exists only to the CS domain.	When the Cell Update procedure has been completed.	See subclause 8.3.1.13.
T315	When the criteria for radio link failure are fulfilled. The timer is started only if radio bearer(s) that are associated with T315 exist or if RRC connection exists to PS domain.	When the Cell Update procedure has been completed.	See subclause 8.3.1.14.
T316	When the UE detects "out of service area" in URA_PCH or CELL_PCH state	When the UE detects "in service area".	Initiate cell update procedure if in service area is detected. Otherwise start timer T317, transit to CELL_FACH state and initiate cell update procedure when the UE detects "in service area".
T317	When the T316 expires or when in CELL_FACH state, the UE detects "out of service area".	When the UE detects "in service area".	T317 never expires.
T318	Transmission of RRC CONNECTION REQUEST in case of connection establishment for MBMS reception	Reception of RRC CONNECTION SETUP	Enter idle mode
T319	When entering CELL_PCH or URA_PCH.	When leaving CELL_PCH or URA_PCH state.	The UE activates starts the DRX cycle based on "DRX cycle length coefficient".
T320	When receiving the CELL UPDATE CONFIRM message with IE "Wait time" and IE "RRC State Indicator" set to the value "CELL_PCH" or "URA_PCH".	When initiating the cell update or URA update procedure, see subclause 8.3.1.2.	See subclause 8.3.1.16.
T321	See subclause 8.5.49.	See subclause 8.5.49.	See subclause 8.5.49.
T322	When received in UTRAN MOBILITY INFORMATION message in the IE "Dedicated Priority Information" or upon cell (re)selection to UTRA from another RAT with validity time configured for dedicated priorities (in which case the remaining validity time is applied).	When dedicated priorities are cleared, when new dedicated priorities are received, when PLMN selection is performed on request by NAS, or upon cell (re)selection to another RAT (in which case the timer is carried on to the other RAT).	See subclause 8.3.3.7
T323	When transmitting a SIGNALLING CONNECTION RELEASE INDICATION message including the IE "Signalling Connection Release Indication Cause"	See subclauses 8.2.2.3, 8.3.1.6, and 8.5.2.	See subclause 8.1.14.4

Timer	Start	Stop	At expiry
T324	When a measurement report is triggered by intra frequency event 1d and the table "Target cell preconfigurations" in the variable TARGET_CELL_PRECONFIGURATION includes the cell that triggered the event or, when a measurement report is triggered by intra frequency event 1c requesting the serving HS-DSCH cell change and the table "Target cell preconfigurations" in the variable TARGET_CELL_PRECONFIGURATION includes the new best cell that reported in this event 1c report, and an Activation time offset equal to 0 is configured	Upon successful reception of a Target cell HS-SCCH order or after 4 seconds or upon reception of any RRC reconfiguration message or ACTIVE SET UPDATE message	Stop monitoring target cell HS-SCCH
T326	Upon receiving LOGGING MEASUREMENT CONFIGURATION including the Logged Measurements Configuration Info	Upon reception of a new LOGGING MEASUREMENT CONFIGURATION or upon log volume exceeding the available UE memory.	See subclause 8.5.63.4
T327	Upon receiving LOGGING MEASUREMENT CONFIGURATION including the Logged ANR Configuration Info	When reaching the maximum number of entries in the LOG_ANR_REPORT_VARIABLE or the ANR logging info is reported to the network.	See subclause 8.5.63.5
T328	If HS-DSCH DRX in CELL_FACH with 2-level DRX is configured: Upon release of the common E-DCH resource or upon Fallback to R99 PRACH transmission termination, or upon HS-SCCH reception when no common E-DCH resource is allocated.	Upon allocation of a common E-DCH resource or upon initiation of Fallback to R99 PRACH transmission.	See subclause 8.5.49b
T329	If HS-DSCH DRX in CELL_FACH with 1-level DRX is configured: Upon release of the common E-DCH resource or upon Fallback to R99 PRACH transmission termination, or upon HS-SCCH reception when no common E-DCH resource is allocated. If HS-DSCH DRX in CELL_FACH with 2-level DRX is configured: upon expiry of T328.	Upon allocation of a common E-DCH resource, or upon initiation of Fallback to R99 PRACH transmission. If HS-DSCH DRX in CELL_FACH with 2-level DRX is configured: Upon HS-SCCH reception when no common E-DCH resource is allocated.	See subclause 8.5.49b

Timer	Start	Stop	At expiry
T330	When entering Idle mode, CELL_PCH or URA_PCH and the variable WLAN_OFFLOAD_INFO is not empty.	When entering CELL_FACH or CELL_DCH state, or upon cell reselection.	See subclause 8.6.7.30

13.2 Counters for UE

Counter	Reset	Incremented	When reaching max value
V300	When initiating the procedure RRC connection establishment	Upon expiry of T300.	When V300 > N300, the UE enters idle mode.
V302	When initiating the procedure Cell update or URA update	Upon expiry of T302	When V302 > N302 the UE enters idle mode.
V304	When sending the first UE CAPABILITY INFORMATION message.	Upon expiry of T304	When V304 > N304 the UE initiates the Cell update procedure
V308	When sending the first RRC CONNECTION RELEASE COMPLETE message in a RRC connection release procedure.	Upon expiry of T308	When V308 > N308 the UE stops re-transmitting the RRC CONNECTION RELEASE COMPLETE message.
V310	When sending the first PUSCH CAPACITY REQUEST message in a PUSCH capacity request procedure	Upon expiry of T310	When V310 > N310 the UE stops re-transmitting the PUSCH CAPACITY REQUEST message.
V316	At transmission or reception of PS data or signalling on SRB3 or upwards, or entering RRC Connected mode, or successful SRNS relocation.	Upon sending the SIGNALLING CONNECTION RELEASE INDICATION message, with the IE "Signalling Connection Release Indication Cause" set to "UE Requested PS Data session end" in CELL_PCH state or URA_PCH state or in CELL_FACH state and the variable HS_DSCH_DRX_CELL_FACH_2CYCLE_STATUS is set to TRUE and the DRX cycle length in use is equal to or longer than the shorter CN domain specific DRX cycle length for the PS domain and CS domain and V316 < 1.	When V316 >= 1 the UE stops sending any further SIGNALLING CONNECTION RELEASE INDICATION messages, with the IE "Signalling Connection Release Indication Cause" set to "UE Requested PS Data session end" in CELL_PCH state or URA_PCH state or in CELL_FACH state and the variable HS_DSCH_DRX_CELL_FACH_2CYCLE_STATUS is set to TRUE for as long as the DRX cycle length in use is equal to or longer than the shorter CN domain specific DRX cycle length for the PS domain and CS domain.

13.3 UE constants and parameters

Constant	Usage
N300	Maximum number of retransmissions of the RRC CONNECTION REQUEST message
N302	Maximum number of retransmissions of the CELL UPDATE / URA UPDATE message
N304	Maximum number of retransmissions of the UE CAPABILITY INFORMATION message
N308	Maximum number of retransmissions of the RRC CONNECTION RELEASE COMPLETE message
N310	Maximum number of retransmission of the PUSCH CAPACITY REQUEST message
N312	Maximum number of "in sync" received from L1.
N313	Maximum number of successive "out of sync" received from L1.
N315	Maximum number of successive "in sync" received from L1 during T313 is activated.

13.4 UE variables

13.4.ob AM_RLC_ERROR_PENDING_RB234

This variable indicates whether an AM RLC unrecoverable error has been detected during the current cell update procedure on RB 2, 3, or 4.

Information Element/Group name	Need	Multi	Type and reference	Semantics description
AM RLC error pending	MP		Boolean	TRUE means an unrecoverable error was detected on AM RLC during the current cell update procedure.. Set to FALSE when the cell update procedure is completed.

13.4.oc AM_RLC_ERROR_PENDING_RB5_AND_UP

This variable indicates whether an AM RLC unrecoverable error has been detected during the current cell update procedure on RB 5 or above.

Information Element/Group name	Need	Multi	Type and reference	Semantics description
AM RLC error pending	MP		Boolean	TRUE means an unrecoverable error was detected on AM RLC during the current cell update procedure.. Set to FALSE when the cell update procedure is completed.

13.4.0 CELL_INFO_LIST

This variable contains cell information on intra-frequency, inter-frequency and inter-RAT cells, as received in messages System Information Block Type 11, System Information Block Type 11bis, System Information Block Type 12, System Information Block Type 11ter, and MEASUREMENT CONTROL.

The first position in Intra-frequency cell info list corresponds to Intra-frequency cell id 0, the second to Intra-frequency cell id 1, etc.

The first position in Inter-frequency cell info list corresponds to Inter-frequency cell id 0, the second to Inter-frequency cell id 1, etc.

The first position in Inter-RAT cell info list corresponds to Inter-RAT cell id 0, the second to Inter-RAT cell id 1, etc.

This variable shall be cleared at cell re-selection, when leaving UTRA RRC connected mode, when switched off as well as at selection of a new PLMN.

Information Element/Group name	Need	Multi	Type and reference	Semantics description	Version
Intra-frequency cell info	OP	1..<maxCel lMeas>			
>CHOICE <i>position status</i>	MP				
>>Occupied					
>>>Cell info	MP		Cell info 10.3.7.2		
>>Vacant				No data	
Frequency info	OP		Frequency info 10.3.6.36	Frequency info for secondary uplink frequency. NOTE.	REL-9
Intra-frequency cell info on secondary UL frequency	OP	1..<maxCel lMeasOnS ecULFreq>			REL-9
>CHOICE <i>position status</i>	MP				REL-9
>>Occupied					REL-9
>>>Cell info	MP		Cell info 10.3.7.2		REL-9
>>Vacant				No data	REL-9
Inter-frequency cell info	OP	1..<maxCel lMeas>			
		1..<maxCel lMeas-e xt>			REL-12
>CHOICE <i>position status</i>	MP				
>>Occupied					
>>>Frequency info	MP		Frequency info 10.3.6.36		
>>>Cell info	MP		Cell info 10.3.7.2		
>>Vacant				No data	
Adjacent frequency info	OP		Frequency info 10.3.6.36		REL-8
Inter-band frequency info	OP		Frequency info 10.3.6.36		REL-9
Frequency info list for enhanced measurement	OP	1.. < maxFreqM easWithout CM >			REL-10
>Frequency info for enhanced measurement	MP		Frequency info 10.3.6.36		REL-10
Inter-RAT cell info list	OP				REL-5
>Inter-RAT cell info	OP	1..<maxCel lMeas>			
>>CHOICE <i>position status</i>	MP				
>>>Occupied					
>>>>CHOICE <i>Radio Access Technology</i>					
>>>>>GSM					
>>>>>>Cell selection and re- selection info	MP		Cell selection and re- selection info for SIB11/12 10.3.2.4		
>>>>>>>BSIC	MP		BSIC 10.3.8.2		

Information Element/Group name	Need	Multi	Type and reference	Semantics description	Version
>>>>>BCCH ARFCN	MP		Integer (0..1023)	[43]	
>>>>>IS-2000					
>>>>>System specific measurement info			enumerated (frequency, timeslot, colour code, output power, PN offset)	For IS-2000, use fields from TIA/EIA/IS-2000.5, subclause 3. 7.3.3.2.27, <i>Candidate Frequency Neighbour List Message</i>	
>>>Vacant				No data	
>CHOICE <i>indication status</i>	MP				REL-5
>> <i>Present</i>					REL-5
>>>Inter-RAT cell info indication	OP		Integer (0..3)		REL-5
>> <i>Not present</i>				No data	REL-5

NOTE: This IE is not used in this release of the specification.

13.4.00 Void

13.4.0a CELL_UPDATE_STARTED

This variable indicates whether a cell update or URA update procedure is in progress.

Information Element/Group name	Need	Multi	Type and reference	Semantics description
Cell update started	MP		Boolean	TRUE means a cell or URA update procedure is in progress. Set to FALSE when entering UTRA RRC connected mode. Set to FALSE when leaving UTRA RRC connected mode.

13.4.1 CIPHERING_STATUS

This variable contains information about the current status of ciphering in the UE.

Information Element/Group name	Need	Multi	Type and reference	Semantics description
Status for each CN domain	MP	<1 to maxCNDo mains>		
>CN domain identity	MP		CN domain identity 10.3.1.1	
>Status	MP		Enumerated(Not started, Started)	Set to "Not started" when entering UTRA RRC connected mode. Set to "Not started" when leaving UTRA RRC connected mode.
Reconfiguration	MP		Boolean	TRUE means an RRC procedure performing reconfiguration of ciphering is ongoing. Set to FALSE when entering UTRA RRC connected mode.

				Set to FALSE when leaving UTRA RRC connected mode.
--	--	--	--	--

13.4.1a COMMON_E_DCH_TRANSMISSION

This variable indicates whether E-DPDCH and E-DPCCH transmission procedures for FDD or E-RUCCH and E-PUCH transmission procedure for 1.28 Mcps TDD in CELL_FACH state or Idle mode are ongoing. See subclause 8.5.46 for actions related to the setting of this variable.

Information Element/Group name	Need	Multi	Type and reference	Semantics description	Version
Common E-DCH transmission	MP		Boolean	See subclause 8.5.46	REL-8

13.4.2 Void

13.4.2a CONFIGURATION_INCOMPLETE

This variable indicates whether a received measurement control message contains invalid an incomplete measurement configuration.

Information Element/Group name	Need	Multi	Type and reference	Semantics description
Configuration incomplete	MP		Boolean	TRUE: An incomplete configuration has been detected. Set to FALSE when entering UTRA RRC connected mode. Set to FALSE when leaving UTRA RRC connected mode.

13.4.3 C_RNTI

This variable stores the assigned C-RNTI for this UE when in CELL_FACH state. For FDD and 1.28 Mcps TDD, this variable stores the assigned C-RNTI for this UE in CELL_PCH state, if in CELL_PCH state a HS-DSCH transport channel has been allocated.

Information Element/Group name	Need	Multi	Type and reference	Semantics description
C-RNTI	OP		C-RNTI 10.3.3.8	Cleared when entering UTRA RRC connected mode when not otherwise stated in the procedure. Cleared when leaving UTRA RRC connected mode.

13.4.3a DEFERRED_MEASUREMENT_STATUS

Information Element/Group name	Need	Multi	Type and reference	Semantics description	Version
Deferred measurement status	MP		Boolean	If TRUE, the UE can transmit RRC messages on RACH and receive RRC messages commanding it to enter CELL_DCH without having read and acted on SIB11, SIB11bis, SIB12, SIB18 and SIB19.	REL-7

13.4.3b DTX_DRX_PARAMS

NOTE: For FDD only.

Information Element/Group name	Need	Multi	Type and reference	Semantics description	Version
UE parameters for DTX-DRX	MD		DTX-DRX Information in 10.3.6.34a		REL-7

13.4.3c DTX_DRX_STATUS

NOTE: For FDD only.

This variable indicates whether discontinuous UL DPCH transmission and discontinuous reception of F-DPCH and HSPA DL channel procedures are ongoing. See subclause 8.5.34 for actions related to the setting of this variable.

Information Element/Group name	Need	Multi	Type and reference	Semantics description	Version
DTX_DRX_STATUS	MP		Boolean	TRUE: discontinuous transmission and reception is ongoing. Set to FALSE when entering UTRA RRC connected mode when not otherwise stated in the procedure. Set to FALSE when leaving UTRA RRC connected mode.	REL-7

13.4.3d DSAC_PARAM

This variable contains Domain Specific Access Restriction Parameters during the connected mode.

Information Element/Group name	Need	Multi	Type and reference	Semantics description	Version
CS Domain Specific Access Restriction	MP		Domain Access Restriction 10.3.1.3b	This IE contains CS Domain Specific Access Restriction Parameters Cleared when leaving UTRA RRC connected mode.	REL-6
				Cleared upon successful SRNS relocation.	REL-11
PS Domain Specific Access Restriction	MP		Domain Access Restriction 10.3.1.3b	This IE contains PS Domain Specific Access Restriction Parameters Cleared when leaving UTRA RRC connected mode.	REL-6
				Cleared upon successful SRNS relocation.	REL-11

13.4.3e DSCH_RNTI

In TDD this variable stores the assigned DSCH-RNTI for this UE when in CELL_DCH state.

Information Element/Group name	Need	Multi	Type and reference	Semantics description
DSCH-RNTI	OP		DSCH-RNTI 10.3.3.9a	Cleared when entering UTRA RRC connected mode when not otherwise stated in the procedure. Cleared when leaving UTRA RRC connected mode.

13.4.3f DOWNLINK_SECONDARY_CELL_INFO

Information Element/Group name	Need	Multi	Type and reference	Semantics description	Version
Downlink secondary cell info FDD	OP	1 to 7	Downlink secondary cell info FDD 10.3.6.31a		REL-11

13.4.3g EAB_PARAM

This variable contains EAB Parameters during the connected mode.

Information Element/Group name	Need	Multi	Type and reference	Semantics description	Version
Domain Specific EAB Parameters	MP		Domain Specific EAB Parameters 10.3.1.3d	Cleared when leaving UTRA RRC connected mode and cleared upon successful SRNS relocation.	REL-11

13.4.3h DSAC_PARAM_2

This variable contains Domain Specific Access Restriction Parameters during CELL_DCH state.

Information Element/Group name	Need	Multi	Type and reference	Semantics description	Version
CS Domain Specific Access Restriction	MP		Domain Access Restriction 10.3.1.3b	This IE contains CS Domain Specific Access Restriction Parameters. Cleared when leaving CELL_DCH state or upon successful SRNS relocation.	REL-12
PS Domain Specific Access Restriction	MP		Domain Access Restriction 10.3.1.3b	This IE contains PS Domain Specific Access Restriction Parameters. Cleared when leaving CELL_DCH state or upon successful SRNS relocation.	REL-12

13.4.3i CONNECTED_MODE_ACCESS_CONTROL

This variable contains information for controlling access in CELL_FACH state, CELL_PCH state and URA_PCH state.

Information Element/Group name	Need	Multi	Type and reference	Semantics description	Version
Access Group identity	OP		Integer (0..15)	This IE indicates the Access Group to which the UE is assigned. Cleared when leaving UTRA RRC connected mode, and upon successful SRNS relocation.	REL-12
DTCH transmission blocked	OP		Bit string(maxNumAccessGroups)	Bit 0 is the first/leftmost bit of the bit string. Bit n corresponds to the n-th defined Access Group. Value '1' for a bit means UEs in that Access Group are blocked for DTCH transmission in CELL_FACH state, and for DCCH/CCCH due to uplink DTCH transmission in CELL_PCH state and URA_PCH state. Cleared when leaving UTRA RRC connected mode, and upon successful SRNS relocation.	REL-12

13.4.4 Void

13.4.4o E_DCH_TRANSMISSION

This variable indicates whether E-DPDCH and E-DPCCH transmission procedures are ongoing. See subclause 8.5.28 for actions related to the setting of this variable.

Information Element/Group name	Need	Multi	Type and reference	Semantics description	Version
E-DCH transmission	MP		Boolean	TRUE: E-DCH transmission is ongoing. Set to FALSE when entering UTRA RRC connected mode when not otherwise stated in the procedure. Set to FALSE when leaving UTRA RRC connected mode.	REL-6

13.4.4a E_RNTI

Information Element/Group name	Need	Multi	Type and reference	Semantics description	Version
Primary E-RNTI	OP		E-RNTI 10.3.3.10a	Cleared when entering UTRA RRC connected mode when not otherwise stated in the procedure. Cleared when leaving UTRA RRC connected mode.	REL-6
Secondary E-RNTI	OP		E-RNTI 10.3.3.10a	Cleared when entering UTRA RRC connected mode when not otherwise stated in the procedure. Cleared when leaving UTRA RRC connected mode.	REL-6

13.4.5 ESTABLISHED_RABS

This variable is used to store information about the established radio access bearers and signalling radio bearers in the UE.

Information Element/Group name	Need	Multi	Type and reference	Semantics description
RAB information	OP	1 to <maxRABs etup>		For each RAB established. Cleared when entering UTRA RRC connected mode when not otherwise stated in the procedure. Cleared when leaving UTRA RRC connected mode.
>RAB info	MP		RAB info 10.3.4.8	

Information Element/Group name	Need	Multi	Type and reference	Semantics description
>RB information	MP	1 to <maxRBper RAB>		For each RB belonging to the RAB
>>RB identity	MP		RB identity 10.3.4.16	
>>Subflow	MP		Integer(0..<maxSubflow count>)	Reference to the RAB subflow implemented by this RB
>>RB started	MD		Enumerated(stopped, started)	Default value is started
Signalling radio bearer information	OP	1 to <maxSRBsetup>		In the order of RB0 and upwards. Cleared when leaving UTRA RRC connected mode.
>RB started	MD		Enumerated(stopped, started)	Default value is started

13.4.5a ESTABLISHED_SIGNALLING_CONNECTIONS

This variable is used to store information about established signalling connections.

Information Element/Group name	Need	Multi	Type and reference	Semantics description
Signalling connection list	OP	1 to <maxCNdomains>		For each established signalling connection. Cleared when entering UTRA RRC connected mode when not otherwise stated in the procedure. Cleared when leaving UTRA RRC connected mode.
>Signalling connection identity	MP		CN domain identity 10.3.1.1	

13.4.6 ESTABLISHMENT_CAUSE

This variable is used to store the cause for establishment of a signalling connection received by upper layers, to be used at RRC connection establishment or Initial Direct Transfer.

Information Element/Group name	Need	Multi	Type and reference	Semantics description
Establishment cause	OP		Establishment cause 10.3.3.11	Cleared when leaving UTRA RRC connected mode.

13.4.6a EUTRA_FREQUENCY_INFO_LIST

This variable contains cell information on E-UTRA frequencies (possibly with associated blacklists), as received in messages System Information Block Type 19 and MEASUREMENT CONTROL.

Information Element/Group name	Need	Multi	Type and reference	Semantics description	Version
Frequency Info List	MP	1 to <maxNumEUTRAFreqs>			REL-8
>EARFCN	MP		Integer(0 .. 65535)	EARFCN of the downlink carrier frequency [64].	REL-8
			Integer(0..262143)		REL-11
>Measurement Bandwidth	MD		Enumerated(6, 15, 25, 50, 75, 100)	Measurement bandwidth information common for all neighbouring cells on the carrier frequency. It is defined by the parameter Transmission Bandwidth Configuration, N_{RB} [36.104]. The values indicate the number of resource blocks over which the UE could measure. Default value is 6.	REL-8
>Blacklisted cells per freq list	OP	1 to <maxEUTRACellPerFreq>			REL-8
>>Physical Cell identity	MP		Integer (0..503)	A list of blacklisted cells can be signalled per frequency	REL-8
>Wideband RSRQ measurements	OP		Enumerated (TRUE)	If this field is present, the UE shall use a wider bandwidth when performing RSRQ measurements according to TS 36.133 [74].	REL-11

13.4.6b Void

13.4.6c ETWS_INFO_IN_PROGRESS

This variable is not used in this version of the specification.

13.4.7 FAILURE_CAUSE

This variable contains the cause for failure of a UE initiated procedure, to be reported in a retransmitted message.

Information Element/Group name	Need	Multi	Type and reference	Semantics description
Failure cause	OP		Failure cause 10.3.3.13	Cleared when entering UTRA RRC connected mode. Cleared when leaving UTRA RRC connected mode.

13.4.7a FREQUENCY_BAND_INDICATOR_SUPPORT

This variable indicates which frequency bands broadcasted in IE "Frequency Bands Indicator Support" UE supports. For 1.28Mcps TDD, if no frequency band is broadcasted in IE "Frequency Bands Indicator Support", UE sets the variable according to own capability. See subclause 8.1.1.6.5 for actions related to the setting of this variable.

Information Element/Group name	Need	Multi	Type and reference	Semantics description	Version
Support of the first Frequency Band	MP		Boolean	For FDD, cleared when leaving the camped cell or no IE "Frequency Bands Indicator Support" in SIB5/5bis. For 1.28Mcps TDD, cleared when leaving the camped cell.	REL-10
Support of the second Frequency Band	MP		Boolean	For FDD, cleared when leaving the camped cell or no "Frequency Bands Indicator Support" in SIB5/5bis. For 1.28Mcps TDD, cleared when leaving the camped cell.	REL-10

13.4.8 FAILURE_INDICATOR

This variable indicates whether the procedure has failed for a UE initiated procedure.

Information Element/Group name	Need	Multi	Type and reference	Semantics description
Failure indicator	MP		Boolean	TRUE: Procedure has failed. Set to FALSE when entering UTRA RRC connected mode. Set to FALSE when leaving UTRA RRC connected mode.

13.4.8o H_RNTI

This variable stores the assigned H-RNTI for this UE when in CELL-DCH, CELL_FACH (FDD and 1.28 Mcps TDD only) or CELL_PCH (FDD and 1.28 Mcps TDD only) state, and when an HS-DSCH transport channel has been allocated.

Information Element/Group name	Need	Multi	Type and reference	Semantics description	Version
H-RNTI	OP		H-RNTI 10.3.3.14a	Cleared when entering UTRA RRC connected mode when not otherwise stated in the procedure. Cleared when leaving UTRA RRC connected mode.	REL-5

13.4.8oo HS_DSCH_RECEPTION

This variable indicates whether HS-SCCH and HS-DSCH reception procedures are ongoing. See subclause 8.5.25 for actions related to the setting of this variable.

Information Element/Group name	Need	Multi	Type and reference	Semantics description	Version
HS-DSCH reception	MP		Boolean	TRUE: HS-DSCH reception is ongoing. Set to FALSE when entering UTRA RRC connected mode when not otherwise stated in the procedure. Set to FALSE when leaving UTRA RRC connected mode.	REL-5

13.4.8oa HS_DSCH_RECEPTION_CELL_FACH_STATE

This variable indicates whether HS-SCCH and HS-DSCH reception procedures are ongoing in CELL_FACH for BCCH, DCCH and, if configured, DTCH reception. See subclause 8.5.36 for actions related to the setting of this variable.

NOTE: FDD and 1.28 Mcps TDD only.

Information Element/Group name	Need	Multi	Type and reference	Semantics description	Version
HS-DSCH reception in CELL_FACH state	MP		Boolean	TRUE: HS-DSCH reception in CELL_FACH is ongoing. Set to FALSE when entering UTRA RRC connected mode, CELL_PCH, URA_PCH and CELL_DCH. Set to FALSE when leaving UTRA RRC connected mode,	REL-7

13.4.8ob HS_DSCH_RECEPTION_OF_CCCH_ENABLED

This variable indicates whether HS-SCCH and HS-DSCH reception procedures are enabled for CCCH and BCCH, and for SRB1 if the UE is in CELL_FACH state. See subclause 8.5.37 for actions related to the setting of this variable.

NOTE: For FDD and 1.28 Mcps TDD only.

Information Element/Group name	Need	Multi	Type and reference	Semantics description	Version
HS-DSCH reception of CCCH	MP		Boolean	TRUE: HS-DSCH reception for the CCCH is enabled. Set to FALSE when leaving UTRA RRC connected mode. Set to FALSE when entering CELL_PCH, URA_PCH and CELL_DCH.	REL-7

13.4.8oc HS_DSCH_RECEPTION_GENERAL

This variable indicates whether HS-SCCH and HS-DSCH reception procedures are ongoing in CELL_DCH, CELL_FACH, CELL_PCH, or URA_PCH. See subclause 8.5.37a for actions related to the setting of this variable.

NOTE: FDD and 1.28 Mcps TDD only.

Information Element/Group name	Need	Multi	Type and reference	Semantics description	Version
HS-DSCH reception in all states	MP		Boolean	TRUE: HS-DSCH reception in CELL_DCH, CELL_FACH, CELL_PCH or URA_PCH is ongoing. Set to FALSE when entering UTRA RRC connected mode when not otherwise stated in the procedure. Set to FALSE when leaving UTRA RRC connected mode	REL-7

13.4.8od SECONDARY_CELL_HS_DSCH_RECEPTION

Each entry in this variable indicates whether HS-SCCH and HS-DSCH reception procedures are configured for a secondary serving, assisting serving or assisting secondary serving HS-DSCH cell. See subclause 8.5.51 for actions related to the setting of this variable.

Information Element/Group name	Need	Multi	Type and reference	Semantics description	Version
HS-DSCH reception	MP	1 to 7	Boolean	TRUE: HS-DSCH reception is configured for a secondary serving, assisting serving or assisting secondary serving HS-DSCH cell. Set to FALSE when entering UTRA RRC connected mode when not otherwise stated in the procedure. Set to FALSE when leaving UTRA RRC connected mode.	REL-11

13.4.8oe HS_DSCH_DRX_CELL_FACH_STATUS

This variable indicates whether HS-DSCH DRX operation is supported in CELL_FACH. See subclause 8.5.48 for actions related to the setting of this variable.

NOTE: FDD only.

Information Element/Group name	Need	Multi	Type and reference	Semantics description	Version
HS-DSCH DRX in CELL_FACH status	MP		Boolean	TRUE: HS-DSCH DRX operation in CELL_FACH is supported. Set to FALSE when leaving CELL_FACH or when dedicated H-RNTI is cleared.	REL-8

13.4.8of HS_DSCH_RECEPTION_OF_ETWS_ENABLED

This variable is not used in this version of the specification.

13.4.8000 HS_SCCH_LESS_PARAMS

NOTE: For FDD only.

This variable contains the parameters for UE operation in HS-SCCH less mode. The parameters are listed in subclause 10.3.6.36ab.

Information Element/Group name	Need	Multi	Type and reference	Semantics description	Version
UE parameters for HS-SCCH less	MD		HS-SCCH less Information in 10.3.6.36ab		REL-7

13.4.80000 HS_SCCH_LESS_STATUS

NOTE: For FDD only.

This variable indicates whether HS-SCCH less HS-DSCH transmission procedures are ongoing. See subclause 8.5.35 for actions related to the setting of this variable.

Information Element/Group name	Need	Multi	Type and reference	Semantics description	Version
HS_SCCH_LESS_STATUS	MP		Boolean	TRUE: HS-SCCH less HS-DSCH transmission is ongoing. Set to FALSE when entering UTRA RRC connected mode when not otherwise stated in the procedure. Set to FALSE when leaving UTRA RRC connected mode.	REL-7

13.4.8a INCOMPATIBLE_SECURITY_RECONFIGURATION

This variable indicates whether an incompatible simultaneous reconfiguration of a security function has been received.

Information Element/Group name	Need	Multi	Type and reference	Semantics description
Incompatible security reconfiguration	MP		Boolean	TRUE: An incompatible simultaneous security reconfiguration has been detected. Set to FALSE when entering UTRA RRC connected mode. Set to FALSE when leaving UTRA RRC connected mode.

13.4.8b Void

13.4.8c Void

13.4.8d HSPA_RNTI_STORED_CELL_PCH

This variable indicates whether variables H_RNTI, C_RNTI and E_RNTI are stored in CELL_PCH state.

Information Element/Group name	Need	Multi	Type and reference	Semantics description	Version
HSPA RNTI_STORED_CELL_PCH	MP		Boolean	TRUE: variables H_RNTI, C_RNTI and E_RNTI are stored in CELL_PCH state. Set to FALSE when entering UTRA RRC connected mode when not otherwise stated in the procedure. Set to FALSE when leaving UTRA RRC connected mode.	REL-8

13.4.9 INITIAL_UE_IDENTITY

In this variable the identity used by the UE when establishing an RRC connection is stored.

Information Element/Group name	Need	Multi	Type and reference	Semantics description
Initial UE identity	OP		Initial UE identity 10.3.3.15	Cleared when leaving UTRA RRC connected mode.

13.4.9a INTEGRITY_PROTECTION_ACTIVATION_INFO

This variable contains information to be sent to UTRAN about when a new integrity protection configuration shall be activated in the uplink for signalling radio bearers in case of modification of integrity protection.

Information Element/Group name	Need	Multi	Type and reference	Semantics description
Uplink Integrity protection activation info	OP		Integrity protection activation info 10.3.3.17	Cleared when entering UTRA RRC connected mode. Cleared when leaving UTRA RRC connected mode.

13.4.10 INTEGRITY_PROTECTION_INFO

This variable contains information about the current status of the integrity protection in the UE.

Information Element/Group name	Need	Multi	Type and reference	Semantics description
Status	MP		Enumerated(Not started, Started)	Set to "Not started" when entering UTRA RRC connected mode. Set to "Not started" when leaving UTRA RRC connected mode.
Reconfiguration	MP		Boolean	TRUE means a reconfiguration of integrity protection is ongoing. Set to FALSE when entering UTRA RRC connected mode. Set to FALSE when leaving UTRA RRC connected mode.
Signalling radio bearer specific integrity protection information	OP	1 to <maxSRBs etup>		When integrity protection is started, status information for RB0- RB4 in that order. Cleared when entering UTRA RRC connected mode. Cleared when leaving UTRA RRC connected mode.
>Uplink RRC HFN	MP		Bit string (28)	
>Downlink RRC HFN	MP		Bit string (28)	
>Uplink RRC Message sequence number	MP		Integer (0..15)	
>Downlink RRC Message sequence number	OP		Integer (0..15)	

13.4.10a INTER_RAT_HANDBOVER_INFO_TRANSFERRED

This variable stores information about the inter RAT handover info that has been transferred to another RAT.

Information Element/Group name	Need	Multi	Type and reference	Semantics description	Version
Predefined configuration status information	OP		Predefined configuration status information 10.3.4.5 a	Cleared upon entering connected mode in another RAT	
Predefined configuration status information compressed	OP		Predefined configuration status information compressed 10.3.4.5 b	Cleared upon entering connected mode in another RAT	REL-5
UE security information	OP		UE security information 10.3.3.4 2b	Cleared upon entering connected mode in another RAT	
UE security information2	OP		UE security information2 10.3.3.4 2c	Cleared upon entering connected mode in another RAT	REL-6
UE radio access capability	OP		UE radio access capability 10.3.3.4 2	Cleared upon entering connected mode in another RAT	
UE radio access capability extension	OP		UE radio access capability extension 10.3.3.4 2a	Cleared upon entering connected mode in another RAT	
UE radio access capability compressed	OP		UE radio access capability compressed 10.3.3.4 2o		REL-5
UE system specific capability	OP	1 to <maxSystemCapability>	Inter-RAT UE radio access capability 10.3.8.7	Cleared upon entering connected mode in another RAT	

>Inter-RAT UE radio access capability	MP		Inter-RAT UE radio access capability 10.3.8.7		
---------------------------------------	----	--	--	--	--

13.4.11 INVALID_CONFIGURATION

This variable indicates whether a received message contained an invalid configuration, by means of invalid values or invalid combinations of information elements.

Information Element/Group name	Need	Multi	Type and reference	Semantics description
Invalid configuration	MP		Boolean	TRUE: An invalid configuration has been detected. Set to FALSE when entering UTRA RRC connected mode. Set to FALSE when leaving UTRA RRC connected mode.

13.4.11a LATEST_CONFIGURED_CN_DOMAIN

This variable stores the CN-domain that was most recently configured to be used for ciphering and integrity protection.

Information Element/Group name	Need	Multi	Type and reference	Semantics description
Latest configured CN domain	OP		CN domain identity 10.3.1.1	Cleared when entering UTRA RRC connected mode when not stated otherwise in the procedure. Cleared when leaving UTRA RRC connected mode.

13.4.11b LATEST_CONFIGURED_SRB_DELAY_AND_PC_PREAMBLE

This variable stores the SRB delay and PC preamble to be used for establishing the DPCH after failure of hard handover, inter-RAT handover from UTRAN, or cell change order from UTRAN.

Information Element/Group name	Need	Multi	Type and reference	Semantics description
SRB delay	OP		Integer (0..7)	Cleared when entering UTRA RRC connected mode when not stated otherwise in the procedure.
PC preamble	OP		Integer (0..7)	Cleared when entering UTRA RRC connected mode when not stated otherwise in the procedure.

13.4.11c MBMS_ACTIVATED_SERVICES

This variable stores the MBMS multicast services the UE has joined as well as the MBMS broadcast services the UE is interested to receive. Whenever the list of joined multicast services and/ or interested broadcast services changes, upper layers provide an indication upon which the UE shall update the variable accordingly. In case upper layers de-select an MBMS Selected Services, the UE shall remove the concerned service from the variable. Likewise, when upper layers select an MBMS Selected Services, the UE shall add the concerned service to the variable.

Information Element/Group name	Need	Multi	Type and reference	Semantics description
Activated service list	OP	1 to <maxMBMS-Service>		
>Service Identity	MP		MBMS Service identity 10.3.9a.8	
>Service type	MP		Enumerated (Multicast, Broadcast)	
>MBMS Selected Services Indicator	CV- <i>Broadcast</i>		Boolean	TRUE means that the service is currently a MBMS Selected Service

Condition	Explanation
<i>Broadcast</i>	This IE is mandatory present if the IE "Service type" is set to 'Broadcast' and not needed otherwise.

NOTE: An independent instance of the variable MBMS_ACTIVATED_SERVICES is used by UEs supporting reception of MBMS services from cells operating in MBSFN mode and will contain the services available in MBSFN mode only as indicated by higher layers.

13.4.11d MBMS_PREV_FREQUENCY_INFO

This variable stores the frequency information of the cell the UE is camped on, upon moving to the MBMS preferred layer indicated MBMS FLC preferred frequency information.

Information Element/Group name	Need	Multi	Type and reference	Semantics description	Version
PREV Frequency Information					
CHOICE <i>mode</i>					
>FDD cell					
>>UARFCN downlink (Nd)	MP		Integer(0 .. 16383)	[21]	
>3.84 Mcps TDD cell					
>>UARFCN (Nt)	MP		Integer(0 .. 16383)	[22]	
>1.28 Mcps TDD cell list					
>>UARFCN (Nt)	MP		Integer(0 .. 16383)	[22]	

13.4.11e MBMS_PL_SERVICE_RESTRICTION_INFO_DEDICATED

This variable stores the value of the IE "MBMS PL Service Restriction Information" restriction applicable to preferred frequency received in the latest Radio Bearer Control or Cell Update Confirm message.

Information Element/Group name	Need	Multi	Type and reference	Semantics description	Version
MBMS_PL_SERVICE_RESTRICTION_INFO_DEDICATED	MP		Enumerated (TRUE, FALSE)	Set to FALSE when entering UTRA connected mode.	REL-6

13.4.12 MEASUREMENT_IDENTITY

This variable stores the measurements configured in the UE. For each configured measurement, the information below shall be stored.

Information Element/Group name	Need	Multi	Type and reference	Semantics description
MEASUREMENT CONTROL	OP		MEASUREMENT CONTROL 10.2.17, System Information Block type 11 10.2.48.8.14, System Information Block type 12 10.2.48.8.15, System Information Block type 11ter 10.2.48.8.14 b	Information as contained in these messages. Cleared when entering UTRA RRC connected mode when not stated otherwise in the procedure (8.4.1.8-8.4.1.9). Cleared when leaving UTRA RRC connected mode when not stated otherwise in the procedure (8.4.1.9a).

13.4.13 Void

13.4.13a MIMO_PARAMS

This variable indicates the values of the parameters for operation in MIMO mode. See subclause 8.5.32 for actions related to the setting of this variable.

Information Element/Group name	Need	Multi	Type and reference	Semantics description	Version
CHOICE mode	MP				REL-8
>FDD					REL-8
>>MIMO N_cqi_typeA/M_cqi ratio	OP		Enumerated(1/2, 2/3, 3/4, 4/5, 5/6, 6/7, 7/8, 8/9, 9/10, 1/1)		
>>MIMO pilot configuration	OP		MIMO pilot configuration 10.3.6.41b		
>>Precoding weight set restriction	OP		Enumerated (TRUE)	If present, UE applies precoding weight set restriction.	REL-7

>TDD					REL-8
>>CHOICE TDD option	MP				REL-8
>>>1.28 Mcps TDD					REL-8
>>>>MIMO SF Mode for HS-PDSCH dual stream	MP		Enumerated (SF1, SF1/SF16)		REL-8
>>>>>HS-SICH Reference Signal Info	OP	<1 to maxHSSC CHs >		The order of the list corresponds to the order of HS-SCCHs in HS-SCCH info	REL-8
>>>>> Reference Signal Midamble configuration	MP		Integer (2, 4, 6, 8, 10, 12, 14, 16)	Midamble Allocation mode is UE specific midamble allocation	REL-8
>>>>>Reference Signal Midamble Shift	MP		Integer (0..15)	The allocated midamble shift.	REL-8
>>>>>Reference Signal Timeslot number	MP		Integer (1..5)		REL-8
>>>>>3.84 Mcps TDD or 7.68 Mcps TDD				(no data)	REL-8

13.4.13b MIMO_STATUS

This variable indicates whether the UE is operating in MIMO mode. See subclause 8.5.33 for actions related to the setting of this variable.

Information Element/Group name	Need	Multi	Type and reference	Semantics description	Version
MIMO status	MP		Boolean	TRUE means the UE is operating in MIMO mode. Cleared when leaving CELL_DCH state.	

13.4.14 ORDERED_RECONFIGURATION

This variable stores information about an ongoing Reconfiguration procedure.

Information Element/Group name	Need	Multi	Type and reference	Semantics description
Ordered reconfiguration	MP		Boolean	TRUE means that a Reconfiguration procedure is ongoing. Set to FALSE when entering UTRA RRC connected mode. Set to FALSE when leaving UTRA RRC connected mode.

13.4.14o OTHER_TTI_EDCH_CONFIGURATION

This variable stores information about the other TTI length which is not currently configured in the UE.

Information Element/Group name	Need	Multi	Type and reference	Semantics description	Version
2ms TTI Configuration Information	OP		Other TTI E-DCH Configuration Information 10.3.6.152		REL-12
10ms TTI Configuration Information	OP		Other TTI E-DCH Configuration Information 10.3.6.152		REL-12

13.4.14a PDCP_ROHC_TARGET_MODE

This variable contains the ROHC target mode.

Information Element/Group name	Need	Multi	Type and reference	Semantics description	Version
Target Mode	OP		Enumerated (O-mode, R-mode)	The UE shall only transit to the signalled mode for operation of ROHC as described in [36].	REL-5

13.4.15 PDCP_SN_INFO

This variable contains PDCP receive sequence numbers for one or several radio bearers to be included in a response message to UTRAN.

Information Element/Group name	Need	Multi	Type and reference	Semantics description
RB with PDCP information list	OP	1 to <maxRBall RABs>		Cleared when entering UTRA RRC connected mode. Cleared when leaving UTRA RRC connected mode.
>RB with PDCP information	MP		RB with PDCP information 10.3.4.22	

13.4.15a PHYSICAL_SHARED_CHANNEL_CONFIGURATION

This variable is used only for TDD to store information about the physical shared channel configuration in the UE.

Information Element/Group name	Need	Multi	Type and reference	Semantics description
PUSCH configuration	OP			Cleared when entering and leaving UTRA RRC connected mode.
>PUSCH info	MP		PUSCH info 10.3.6.63	
>PUSCH Identity	OP		Integer(1..hiPUSCHidentities)	
>PUSCH power control info	OP		PUSCH power control info 10.3.6.65	
PDSCH configuration	OP			Cleared when entering and leaving UTRA RRC connected mode.
>PDSCH Info	MP		PDSCH Info 10.3.6.44	
>PDSCH Identity	OP		Integer(1..hiPDSCHidentities)	
>PDSCH power control info	OP		PDSCH power control info 10.3.6.45	
ISCP Timeslot list	OP	1 to maxTS		Cleared when entering and leaving UTRA RRC connected mode.
>Timeslot number	MP		Timeslot number 10.3.6.84	Timeslot numbers, for which the UE shall report the timeslot ISCP in PUSCH CAPACITY REQUEST message

13.4.15b PPAC_PARAM

This variable contains Paging Permission with Access Control Parameters during the connected mode.

Information Element/Group name	Need	Multi	Type and reference	Semantics description	Version
Paging Response Restriction Indication	MP		Enumerated(All, CS, PS, None)	Cleared when leaving UTRA RRC connected mode.	REL-8
				Cleared upon successful SRNS relocation.	REL-11
Location/Registration Restriction Indicator	MP		Enumerated(All, CS, PS)	Cleared when leaving UTRA RRC connected mode.	REL-8
				Cleared upon successful SRNS relocation.	REL-11
Location/Registration	MP		Location /Registration Parameters 10.3.1.7oa	Cleared when leaving UTRA RRC connected mode.	REL-8
				Cleared upon successful SRNS relocation.	REL-11

13.4.15c PRIORITY_INFO_LIST

This variable contains cell information on UTRA and inter-RAT priorities to be applied to neighbour cells stored in CELL_INFO_LIST and EUTRA_FREQUENCY_INFO_LIST, as received in messages System Information Block Type 19 and UTRAN MOBILITY INFORMATION.

The contents of this variable are inherited at inter-RAT cell (re)selection, including the remaining validity time (i.e., T320 in E-UTRAN, T322 in UTRAN, and T3230 in GERAN), if configured.

This variable can be configured in CELL_DCH, CELL_FACH, CELL_PCH, URA_PCH and Idle states. However, it is only used in CELL_FACH, CELL_PCH, URA_PCH and Idle states.

In *Camped on any cell* in [4], the UE implicitly takes actions as described in subclause 8.1.1.6.19 assuming the IE "Priority status" equals "sys_info_priority" using stored System information Block type 19. In *Camped normally* in [4], if the UE assumes it has valid UE specific priorities according to [4], the UE implicitly takes actions as described in subclause 8.6.7.23 without stopping T322 using stored IE "Dedicated Priority Information".

For UTRA and E-UTRA frequencies, a UE that supports multi-band cells for the concerned RAT considers the dedicated priorities to be common for all overlapping bands (i.e. independent of the ARFCN that is used).

Information Element/Group name	Need	Multi	Type and reference	Semantics description	Version
Priority status	MP		Enumerated (sys_info_priority, dedicated_priority)		REL-8
UTRA Serving Cell	OP				REL-8
>priority	OP		Integer (0..<maxPriority-1>)	Absence of this IE indicates that the lowest priority is assigned to the serving frequency (lower than any assigned priority)	REL-8
>S _{prioritysearch1}	MP		Integer (0..62 by step of 2)	RSCP, dB	REL-8
>S _{prioritysearch2}	MD		Integer (0..7 by step of 1)	dB, default value is 0	REL-8
>Thresh _{serving,low}	MP		Integer (0..62 by step of 2)	RSCP, dB	REL-8
>Thresh _{serving,low2}	MD		Integer (0..31)	Ec/N0, [dB], default value is 0	REL-9
Priority Info List	OP	1 to <maxNumPrio>			REL-8
>priority	OP		Integer (0..<maxPriority-1>)	Absence of this IE indicates that no priority is assigned to the indicated frequencies	REL-8
>CHOICE Radio Access Technology	MP				REL-8
>>UTRA FDD					REL-8
>>>Frequency List		1 to <maxNumFDD Freqs>			
>>>>UARFCN	MP		Integer (0..16383)		REL-8
>>>>QqualminFDD	MD		Integer (-24..0)	Ec/N0, [dB] Default value is -24.	REL-8
>>>>QrxlevminFDD	MD		Integer (-119..-25 by step of 2)	RSCP, dBm Default value is -119.	REL-8
>>>>Thresh _{x, high}	OP		Integer (0..62 by step of 2)	RSCP, dB	REL-8
>>>>Thresh _{x, low}	OP		Integer (0..62 by step of 2)	RSCP, dB	REL-8
>>UTRA TDD					REL-8
>>>Frequency List		1 to <maxNumTDD Freqs>			
>>>>UARFCN	MP		Integer (0..16383)		REL-8
>>>>QrxlevminTDD	MD		Integer (-119..-25 by step of 2)	RSCP, dBm Default value is -119.	REL-8
>>>>Thresh _{x, high}	OP		Integer (0..62 by step of 2)	RSCP, dB	REL-8

>>>>Thresh _{x, low}	OP		Integer (0..62 by step of 2)	RSRP, dB	REL-8
>>E-UTRA					REL-8
>>>Frequency List		1 to <maxNumEUTRAFreqs>			
>>>>EARFCN	MP		Integer(0 .. 65535)	EARFCN of the downlink carrier frequency [64]	REL-8
			Integer(0..262143)		REL-11
>>>>QrxlevminEUTRA	MD		Integer (-140..-44 by step of 2)	RSRP, dBm Default value is -140.	REL-8
>>>>Thresh _{x, high}	OP		Integer (0..62 by step of 2)	RSRP, dB	REL-8
>>>>Thresh _{x, low}	OP		Integer (0..62 by step of 2)	RSRP, dB	REL-8
>>>>QqualminEUTRA	MD		Integer (-34..-3)	RSRQ, dB default value is negative infinity	REL-9
>>>>Thresh _{x, high2}	OP		Integer (0..31)	RSRQ, dB	REL-9
>>>>Thresh _{x, low2}	OP		Integer (0..31)	RSRQ, dB	REL-9
>>>>EUTRA-RSRQ-offsetWB	OP		Integer (-31..31)	Offset in dB used for Measured results on RACH	REL-11
>>>>EUTRARSRQ-OnAllSymbolsOffset	OP		Integer (-31..31)	RSRQ all OFDM symbols Offset in dB used for Measured results on RACH	REL-12
>>GSM					REL-8
>>>NCC permitted	MD		Bit string (8) {NCC 0 to 7}	Bitmap indicating NCC values; reselection of GERAN cells is permitted when the corresponding NCC bit = "1". Default is "11111111"	
>>>Frequency List	MP	1 to <maxCellMeas>			REL-8
>>>>Band indicator	MP		Enumerated (DCS 1800 band used, PCS 1900 band used)	Indicates how to interpret the BCCH ARFCN	REL-8
>>>>BCCH ARFCN	MP		Integer (0..1023)	[45]	REL-8
>>>>QrxlevminGSM	MD		Integer (-115..-56 by step of 2)	GSM RSSI, dBm Default value is -115.	REL-8
>>>>Thresh _{x, high}	OP		Integer (0..62 by step of 2)	GSM RSSI, dB	REL-8
>>>>Thresh _{x, low}	OP		Integer (0..62 by step of 2)	GSM RSSI, dB	REL-8

E-UTRA detection	OP		Boolean	'TRUE' means that the UE may detect the presence of a E-UTRA cell and report to NAS	REL-8
------------------	----	--	---------	---	-------

13.4.15d PPAC_PARAM_2

This variable contains Paging Permission with Access Control Parameters during CELL_DCH state.

Information Element/Group name	Need	Multi	Type and reference	Semantics description	Version
Paging Response Restriction Indication	MP		Enumerated(All, CS, PS, None)	Cleared when leaving CELL_DCH state or upon successful SRNS relocation.	REL-12
Location/Registration Restriction Indicator	MP		Enumerated(All, CS, PS)	Cleared when leaving CELL_DCH state or upon successful SRNS relocation.	REL-12
Location/Registration	MP		Location /Registration Parameters 10.3.1.7oa	Cleared when leaving CELL_DCH state or upon successful SRNS relocation.	REL-12

13.4.16 PROTOCOL_ERROR_INDICATOR

This variable indicates whether there exist a protocol error that is to be reported to UTRAN.

Information Element/Group name	Need	Multi	Type and reference	Semantics description
Protocol error indicator	MP		Protocol error indicator 10.3.3.27	Set to FALSE when entering UTRA RRC connected mode. Set to FALSE when leaving UTRA RRC connected mode.

13.4.17 PROTOCOL_ERROR_INFORMATION

This variable contains diagnostics to be reported to UTRAN for a message that was not completely understood.

Information Element/Group name	Need	Multi	Type and reference	Semantics description
Protocol error information	OP		Protocol error information 10.3.8.12	Cleared when entering UTRA RRC connected mode. Cleared when leaving UTRA RRC connected mode.

13.4.18 PROTOCOL_ERROR_REJECT

This variable indicates whether there has occurred a severe protocol error causing the ongoing procedure to fail.

Information Element/Group name	Need	Multi	Type and reference	Semantics description
Protocol error reject	MP		Boolean	TRUE: a severe protocol error has occurred. Set to FALSE when entering UTRA RRC connected mode. Set to FALSE when leaving UTRA RRC connected mode.

13.4.19 RB_TIMER_INDICATOR

This variable contains information to be sent to UTRAN if any of the timers T314 or T315 has expired when the UE sends a cell update with cause RL failure.

Information Element/Group name	Need	Multi	Type and reference	Semantics description
RB timer indicator	OP		RB timer indicator 10.3.3.28	Cleared when entering UTRA RRC connected mode. Cleared when leaving UTRA RRC connected mode.

13.4.20 RB_UPLINK_CIPHERING_ACTIVATION_TIME_INFO

This variable contains information to be sent to UTRAN about when a new ciphering configuration shall be activated in the uplink for radio bearers using RLC-AM or RLC-UM.

Information Element/Group name	Need	Multi	Type and reference	Semantics description
RB uplink ciphering activation time info	OP		RB activation time info 10.3.4.13	Cleared when entering UTRA RRC connected mode. Cleared when leaving UTRA RRC connected mode.

13.4.20o RNC_CAPABILITY_CHANGE_SUPPORT

This variable indicates whether the serving RNC supports changes of UE capability in connected mode.

Information Element/Group name	Need	Multi	Type and reference	Semantics description
RNC support for change of UE capability	MP		Boolean	Cleared when leaving UTRA RRC connected mode.

13.4.20oo READY_FOR_COMMON_EDCH

In CELL_FACH state or Idle mode, this variable indicates whether E-DPDCH and E-DPCCH transmission procedures for FDD or E-RUCCH and E-PUCH transmission procedure for 1.28 Mcps can be immediately started by the UE. See subclause 8.5.47 for actions related to the setting of this variable.

Information Element/Group name	Need	Multi	Type and reference	Semantics description	Version
Ready for common EDCH	MP		Boolean	See subclause 8.5.47	REL-8

13.4.20a SECURITY_MODIFICATION

This variable contains information on which CN domain is affected by the ongoing security reconfiguration.

Information Element/Group name	Need	Multi	Type and reference	Semantics description
Status for each CN domain	MP	<1 to maxCNDo mains>		
>CN domain identity	MP		CN domain identity 10.3.1.1	
>Status	MP		Enumerated(Affected, Not Affected)	

13.4.21 Void

13.4.22 START_THRESHOLD

This variable contains information about the maximum allowed value of the START for a CN domain.

Information Element/Group name	Need	Multi	Type and reference	Semantics description
THRESHOLD	OP		Integer (0..1048576)	20 bits. Cleared when entering UTRA RRC connected mode when not stated otherwise in the procedure. Cleared when leaving UTRA RRC connected mode.

13.4.23 START_VALUE_TO_TRANSMIT

This variable contains the value of START for new radio bearer(s) to be transmitted in a response message.

Information Element/Group name	Need	Multi	Type and reference	Semantics description
START	OP		START 10.3.3.38	Cleared when entering UTRA RRC connected mode. Cleared when leaving UTRA RRC connected mode.

13.4.23a TARGET_CELL_PRECONFIGURATION

This variable indicates whether HS-SCCH reception procedures are configured for a target cell for which HS-DSCH serving Cell Change may be initiated by HS-SCCH order sent from target cell. See subclause 8.3.4.3 and 8.5.52 for actions related to the setting of this variable.

NOTE: FDD only.

Information Element/Group name	Need	Multi	Type and reference	Semantics description	Version
Serving Cell Change MAC reset	OP		Boolean		REL-8
Serving Cell Change Message Type	OP		Enumerated (RadioBearerSetup, RadioBearerReconfiguration, TransportChannelReconfiguration, PhysicalChannelReconfiguration)		REL-8
Serving Cell Change Transaction Id	OP		Integer (0..3)		REL-8
Target cell preconfigurations	OP	1 to <maxRL>			REL-8
>Primary scrambling code	MP		Integer(0..511)		REL-8
>Target cell preconfiguration information	MP		Target cell preconfiguration information 10.3.6.79a		REL-8
Enhanced Serving Cell Change for Event 1c Support Indicator	OP		Enumerated (TRUE)	TRUE means that Enhanced Serving Cell Change for Event 1c for CELL_DCH UE is enabled	REL-12

13.4.24 TFC_SUBSET

This variable contains information about the TFC subset(s) applicable to the UE.

Information Element/Group name	Need	Multi	Type and reference	Semantics description	Version
CHOICE <i>mode</i>	MP				
>FDD					
>>Current TFC subset	MP		Transport Format Combination Subset 10.3.5.22	Set to "Full transport format set" when entering UTRA RRC connected mode when not stated otherwise in the procedure.	
>>Duration	OP		TFC Control duration 10.3.6.80	Cleared when entering UTRA RRC connected mode. Cleared when leaving UTRA RRC connected mode.	
>>Default TFC subset	OP		Transport Format Combination Subset 10.3.5.22	The TFC subset to go back to when any temporary limitation is released. Cleared when entering UTRA RRC connected mode. Cleared when leaving UTRA RRC connected mode.	

Information Element/Group name	Need	Multi	Type and reference	Semantics description	Version
>>TFC subset list	MP	1 to <maxTF Csub>			REL-4
>>>TFC subset	MP		Transport Format Combination Subset 10.3.5.22		REL-4
>TDD					
>>TFCS list	MP	1 to <maxCCT rCH >		One TFCS is created when entering UTRA RRC connected mode when not stated otherwise in the procedure.	
>>>TFCS identity	MP		Transport Format Combination Set Identity 10.3.5.21	"TFCS ID" is set to 1 when entering UTRA RRC connected mode when not stated otherwise in the procedure. "Shared channel indicator" is set to FALSE when entering UTRA RRC connected mode when not stated otherwise in the procedure.	
>>>>Current TFC subset	MP		Transport Format Combination Subset 10.3.5.22	Set to "Full transport format set" when entering UTRA RRC connected mode when not stated otherwise in the procedure.	
>>>>>Duration	OP		TFC Control duration 10.3.6.80	Cleared when entering UTRA RRC connected mode. Cleared when leaving UTRA RRC connected mode.	
>>>>>Default TFC subset	OP		Transport Format Combination Subset 10.3.5.22	The TFC subset to go back to when any temporary limitation is released. Cleared when entering UTRA RRC connected mode. Cleared when leaving UTRA RRC connected mode.	
>>TFC subset list	MP	1 to <maxTF Csub2>			REL-4
>>>TFCS identity	MP		Transport Format Combination Set Identity 10.3.5.21		REL-4
>>>>TFC subset	MP		Transport Format Combination Subset 10.3.5.22		REL-4

13.4.25 TGPS_IDENTITY

This variable contains the configuration parameters of all the configured compressed mode transmission gap pattern sequences.

Information Element/Group name	Need	Multi	Type and reference	Semantics description
Transmission gap pattern sequence	OP	1 to <maxTGP S>		Cleared when entering UTRA RRC connected mode. Cleared when leaving UTRA RRC connected mode.
>TGPSI	MP		TGPSI 10.3.6.82	
>TGPS Status Flag	MP		Enumerated(activate, deactivate)	This flag indicates whether the Transmission Gap Pattern Sequence shall be activated or deactivated.
> Current TGPS Status Flag	MP		Enumerated(active, inactive)	This flag indicates the current status of the Transmission Gap Pattern Sequence, whether it is active or inactive
>TGCFN	CV-Active		Integer (0..255)	Connection Frame Number of the first frame of the first pattern within the Transmission Gap Pattern Sequence.
>Transmission gap pattern sequence configuration parameters	MP			Information as contained in the IE group "Transmission gap pattern sequence configuration parameters" in IE "DPCH compressed mode info" 10.3.6.33.

Condition	Explanation
<i>Active</i>	This IE is mandatory present when the value of the IE "TGPS Status Flag" is "Activate" and not needed otherwise.

13.4.26 TGSN_REPORTED

This variable specifies whether an IE "Proposed TGSN" was reported to the UTRAN

Information Element/Group name	Need	Multi	Type and reference	Semantics description
Proposed TGSN reported	MP		Boolean	Set to FALSE when entering UTRA RRC connected mode. Set to FALSE when leaving UTRA RRC connected mode.

13.4.26a TIMERS_AND_CONSTANTS

This variable contains the values for all timers and constants used in connected mode.

Information Element/Group name	Need	Multi	Type and reference	Semantics description
UE Timers and constants in connected mode	MD		UE Timers and constants in connected mode 10.3.3.43	Default value means that for all timers and constants - for parameters with need MD, the defaults specified in 10.3.3.43 apply and - for parameters with need OP, the parameters are absent. All parameters are set to the default value when leaving UTRA RRC connected mode to another RAT.

13.4.27 TRANSACTIONS

This variable stores the identifications of the ongoing RRC procedure transactions.

Information Element/Group name	Need	Multi	Type and reference	Semantics description
Accepted transactions	OP	1 to <maxtrans actions>		Cleared when leaving UTRA RRC connected mode.
>Message type	MP		Message Type	
>RRC transaction identifier	MP		RRC transaction identifier 10.3.3.36	
>Measurement identity	CV- <i>MeasCtrl</i>		Measurement identity 10.3.7.48	
Rejected transactions	OP	1 to <maxtrans actions>		Cleared when leaving UTRA RRC connected mode.
>Message type	MP		Message Type	
>RRC transaction identifier	MP		RRC transaction identifier 10.3.3.36	
>Measurement identity	CV- <i>MeasCtrl</i>		Measurement identity 10.3.7.48	
Processed transactions	OP	1 to <maxtrans actions>		Cleared when leaving UTRA RRC connected.
>Message type	MP		Message Type	
>RRC transaction identifier	MP		RRC transaction identifier 10.3.3.36	

Condition	Explanation
<i>MeasCtrl</i>	The IE is mandatory if IE "Message type" is set to MEASUREMENT CONTROL, otherwise it is not needed.

13.4.27o Void

13.4.27a TRIGGERED_1A_EVENT

This variable contains information about a 1a event that has been triggered in the UE. There is one such variable per 1a event per active set configured in the UE.

Information Element/Group name	Need	Multi	Type and reference	Semantics description
Cells triggered	OP	1 to < maxCellMeas>		Cleared when entering UTRA RRC connected mode. Cleared when leaving UTRA RRC connected mode.
>primary CPICH	MP		Primary CPICH info 10.3.6.60	
>sent reports	MP		Integer(1..Infinity)	Number of reports sent to UTRAN in case of event triggered periodical reporting
Cells recently triggered	OP	1 to < maxCellMeas>		
>primary CPICH	MP		Primary CPICH info 10.3.6.60	
>sent reports	MP		Integer(1..Infinity)	Number of reports sent to UTRAN in case of event triggered periodical reporting
Periodical reporting running	MP		Boolean	

13.4.27b TRIGGERED_1B_EVENT

This variable contains information about a 1b event that has been triggered in the UE. There is one such variable per 1b event per active set configured in the UE.

Information Element/Group name	Need	Multi	Type and reference	Semantics description	Version
Cells triggered	OP	1 to < maxCell Meas>		Cleared when entering UTRA RRC connected mode. Cleared when leaving UTRA RRC connected mode.	
>primary CPICH	MP		Primary CPICH info 10.3.6.60		
>sent reports	MP		Integer(1..Infinity)	Number of reports sent to UTRAN in case of event triggered periodical reporting	REL-5
Cells recently triggered	OP	1 to < maxCell Meas>			REL-5
>primary CPICH	MP		Primary CPICH info 10.3.6.60		REL-5
>sent reports	MP		Integer(1..Infinity)	Number of reports sent to UTRAN in case of event triggered periodical reporting.	REL-5
Periodical reporting running	MP		Boolean		REL-5

13.4.27c TRIGGERED_1C_EVENT

This variable contains information about a 1c event that has been triggered in the UE. There is one such variable per 1c event per active set configured in the UE.

Information Element/Group name	Need	Multi	Type and reference	Semantics description
Cells triggered	OP	1 to < maxCellMeas>		Cleared when entering UTRA RRC connected mode. Cleared when leaving UTRA RRC connected mode.
>primary CPICH	MP		Primary CPICH info 10.3.6.60	
>sent reports	MP		Integer(1..Infinity)	Number of reports sent to UTRAN in case of event triggered periodical reporting
Cells recently triggered	OP	1 to < maxCellMeas>		
>primary CPICH	MP		Primary CPICH info 10.3.6.60	
>sent reports	MP		Integer(1..Infinity)	Number of reports sent to UTRAN in case of event triggered periodical reporting
Periodical reporting running	MP		Boolean	

13.4.27dBEST_CELL_1D_EVENT

This variable contains information about a 1d event that has been triggered in the UE. There is one such variable per 1d event configured in the UE.

Information Element/Group name	Need	Multi	Type and reference	Semantics description
Best cell	OP		Primary CPICH info 10.3.6.60	Cleared when entering UTRA RRC connected mode. Cleared when leaving UTRA RRC connected mode.

13.4.27e TRIGGERED_1E_EVENT

This variable contains information about a 1e event that has been triggered in the UE. There is one such variable per 1e event per active set configured in the UE.

Information Element/Group name	Need	Multi	Type and reference	Semantics description
Cells triggered	OP	1 to < maxCellMe as>		Cleared when entering UTRA RRC connected mode. Cleared when leaving UTRA RRC connected mode.
>primary CPICH	MP		Primary CPICH info 10.3.6.60	
Cells recently triggered	OP	1 to < maxCellMe as>		
>primary CPICH	MP		Primary CPICH info 10.3.6.60	

13.4.27f TRIGGERED_1F_EVENT

This variable contains information about a 1f event that has been triggered in the UE. There is one such variable per 1f event per active set configured in the UE.

Information Element/Group name	Need	Multi	Type and reference	Semantics description
Cells triggered	OP	1 to < maxCellMe as>		Cleared when entering UTRA RRC connected mode. Cleared when leaving UTRA RRC connected mode.
>primary CPICH	MP		Primary CPICH info 10.3.6.60	
Cells recently triggered	OP	1 to < maxCellMe as>		
>primary CPICH	MP		Primary CPICH info 10.3.6.60	

13.4.27f1 TRIGGERED_1G_EVENT

This variable contains information about a 1g event that has been triggered in the UE.

Information Element/Group name	Need	Multi	Type and reference	Semantics description
Cells triggered	OP	1 to < maxCellMeas>		
>Primary CCPCH info	MP		Primary CCPCH info 10.3.6.57	

13.4.27f2 TRIGGERED_1H_EVENT

This variable contains information about a 1h event that has been triggered in the UE.

Information Element/Group name	Need	Multi	Type and reference	Semantics description
Cells triggered	OP	1 to < maxCellMeas>		
>Primary CCPCH info	MP		Primary CCPCH info 10.3.6.57	

13.4.27f3 TRIGGERED_1I_EVENT

This variable contains information about a 1i event that has been triggered in the UE.

Information Element/Group name	Need	Multi	Type and reference	Semantics description
Cells triggered	OP	1 to < maxCellMeas>		
>Primary CCPCH info	MP		Primary CCPCH info 10.3.6.57	

13.4.27f4 BEST_FREQUENCY_2A_EVENT

This variable contains information about a 2a event that has been configured in the UE. For FDD, there is one such variable per virtual active set used per 2a event configured in the UE. For TDD, there is one such variable per 2a event configured in the UE.

Information Element/Group name	Need	Multi	Type and reference	Semantics description
Best frequency	MP		Frequency info 10.3.6.36	

13.4.27f5 TRIGGERED_2B_EVENT

This variable contains information about a 2b event that has been configured in the UE. For FDD, there is one such variable per virtual active set used per 2b event configured in the UE. For TDD, there is one such variable per 2b event configured in the UE.

Information Element/Group name	Need	Multi	Type and reference	Semantics description
Frequency triggered	OP	1 to < maxCellMeas>		

>Frequency	MP	Frequency info 10.3.6.36		
------------	----	-----------------------------	--	--

13.4.27f6 TRIGGERED_2C_EVENT

This variable contains information about a 2c event that has been configured in the UE. For FDD, there is one such variable per virtual active set used per 2c event configured in the UE. For TDD, there is one such variable per 2c event configured in the UE.

Information Element/Group name	Need	Multi	Type and reference	Semantics description
Frequency triggered	OP	1 to <maxCellMeas>		
>Frequency	MP	Frequency info 10.3.6.36		

13.4.27f7 TRIGGERED_2D_EVENT

This variable contains information about a 2d event that has been configured in the UE. There is one such variable per 2d event configured in the UE.

Information Element/Group name	Need	Multi	Type and reference	Semantics description
Event triggered	OP		Boolean	

13.4.27f8 TRIGGERED_2E_EVENT

This variable contains information about a 2e event that has been configured in the UE. For FDD, there is one such variable per virtual active set used per 2e event configured in the UE. For TDD, there is one such variable per 2e event configured in the UE.

Information Element/Group name	Need	Multi	Type and reference	Semantics description
Frequency triggered	OP	1 to <maxCellMeas>		
>Frequency	MP	Frequency info 10.3.6.36		

13.4.27f9 TRIGGERED_2F_EVENT

This variable contains information about a 2f event that have been configured in the UE. There is one such variable per 2f event configured in the UE.

Information Element/Group name	Need	Multi	Type and reference	Semantics description
Event triggered	OP		Boolean	

13.4.27f10 TRIGGERED_3A_EVENT

This variable contains information about a 3a event that has been configured in the UE. There is one such variable per event 3a configured in the UE.

Information Element/Group name	Need	Multi	Type and reference	Semantics description	Version
CHOICE <i>system</i>	OP				
>GSM					
>>CHOICE <i>BSIC</i>	MP				
>>>Verified BSIC		0 to <maxCellMeas>			
>>>>Inter-RAT cell id	MP		Integer (0..<maxCellMeas>-1)		
>>>Non verified BSIC		0 to <maxCellMeas>			
>>>>BCCH ARFCN	MP		Integer (0..1023)		
>E-UTRA					REL-8
>>E-UTRA Carrier Frequency list	MP	1 to <maxReportedEUTRAFreqs>			REL-8
		1 to <maxReportedEUTRAFreqs-ext>			REL-12
>>>E-UTRA Carrier Frequency	MP		Integer (0..65535)	EARFCN of the downlink carrier frequency [64].	REL-8
			Integer (0..262143)		REL-11
>>>>Cell list	MP	1 to <maxReportedEUTRACellsPerFreq>			REL-8
>>>>>Physical Cell Identity	MP		Integer (0..503)		REL-8

13.4.27f11 TRIGGERED_3B_EVENT

This variable contains information about a 3b event that has been configured in the UE. There is one such variable per event 3b configured in the UE.

Information Element/Group name	Need	Multi	Type and reference	Semantics description	Version
CHOICE <i>system</i>	OP				
>GSM					
>>CHOICE <i>BSIC</i>	MP				
>>>Verified BSIC		0 to <maxCellMeas>			
>>>>Inter-RAT cell id	MP		Integer (0..<maxCellMeas>-1)		
>>>Non verified BSIC		0 to <maxCellMeas>			
>>>>BCCH ARFCN	MP		Integer (0..1023)		
>E-UTRA					REL-8
>>E-UTRA Carrier Frequency list	MP	1 to <maxReportedEUTRAFreqs>			REL-8
		1 to <maxReportedEUTRAFreqs-ext>			REL-12
>>>E-UTRA Carrier Frequency	MP		Integer (0..65535)	EARFCN of the downlink carrier frequency [64].	REL-8
			Integer (0..262143)		REL-11
>>>>Cell list	MP	1 to <maxReportedEUTRACellsPerFreq>			REL-8
>>>>>Physical Cell Identity	MP		Integer (0..503)		REL-8

13.4.27f12 TRIGGERED_3C_EVENT

This variable contains information about a 3c event that has been configured in the UE. There is one such variable per event 3c configured in the UE.

Information Element/Group name	Need	Multi	Type and reference	Semantics description	Version
CHOICE <i>system</i>	OP				
>GSM					
>>CHOICE <i>BSIC</i>	MP				
>>>Verified BSIC		0 to <maxCellMeas>			
>>>>Inter-RAT cell id	MP		Integer (0..<maxCellMeas>-1)		
>>>Non verified BSIC		0 to <maxCellMeas>			
>>>>BCCH ARFCN	MP		Integer (0..1023)		
>E-UTRA					REL-8
>>E-UTRA Carrier Frequency list	MP	1 to <maxReportedEUTRAFreqs>			REL-8
		1 to <maxReportedEUTRAFreqs-ext>			REL-12
>>>E-UTRA Carrier Frequency	MP		Integer (0..65535)	EARFCN of the downlink carrier frequency [64].	REL-8
			Integer (0..262143)		REL-11
>>>>Cell list	MP	1 to <maxReportedEUTRACellsPerFreq>			REL-8
>>>>>Physical Cell Identity	MP		Integer (0..503)		REL-8

13.4.27f13 BEST_CELL_3D_EVENT

This variable contains information about a 3d event that has been configured in the UE. There is one such variable per event 3d configured in the UE.

Information Element/Group name	Need	Multi	Type and reference	Semantics description	Version
CHOICE <i>system</i>					
>GSM					
>>CHOICE <i>BSIC</i>	MP				
>>>Verified BSIC					
>>>>Inter-RAT cell id	MP		Integer (0..<maxCell Meas>-1)		
>>>Non verified BSIC					
>>>>BCCH ARFCN	MP		Integer (0..1023)		
>E-UTRA					REL-8
>>E-UTRA Carrier Frequency	MP		Integer (0..65535)	EARFCN of the downlink carrier frequency [64].	REL-8
			Integer (0..262143)		REL-11
>>Physical Cell Identity	MP		Integer (0..503)		REL-8

13.4.27f14 TRIGGERED_6A_EVENT

This variable contains information about a 6a event that has been configured in the UE. There is one such variable per 6a event configured in the UE.

Information Element/Group name	Need	Multi	Type and reference	Semantics description
Event triggered	OP		Boolean	

13.4.27f15 TRIGGERED_6B_EVENT

This variable contains information about a 6b event that has been configured in the UE. There is one such variable per 6b event configured in the UE.

Information Element/Group name	Need	Multi	Type and reference	Semantics description
Event triggered	OP		Boolean	

13.4.27f16 TRIGGERED_6C_EVENT

This variable contains information about a 6c event that has been configured in the UE. There is one such variable per 6c event configured in the UE.

Information Element/Group name	Need	Multi	Type and reference	Semantics description
Event triggered	OP		Boolean	

13.4.27f17 TRIGGERED_6D_EVENT

This variable contains information about a 6d event that has been configured in the UE. There is one such variable per 6d event configured in the UE.

Information Element/Group name	Need	Multi	Type and reference	Semantics description
Event triggered	OP		Boolean	

13.4.27f18 TRIGGERED_6E_EVENT

This variable contains information about a 6e event that has been configured in the UE. There is one such variable per 6e event configured in the UE.

Information Element/Group name	Need	Multi	Type and reference	Semantics description
Event triggered	OP		Boolean	

13.4.27f19 TRIGGERED_6F_EVENT

This variable contains information about a 6f event that has been configured in the UE. There is one such variable per 6f event configured in the UE.

Information Element/Group name	Need	Multi	Type and reference	Semantics description	Version
CHOICE mode					
>FDD					
Event triggered_RL	OP	<maxRL >	Boolean		
>1.28 Mcps TDD					REL-4
>>T _{ADV}	MP		TADV info 10.3.7.11 2		REL-4

13.4.27f20 TRIGGERED_6G_EVENT

This variable contains information about a 6g event that has been configured in the UE. There is one such variable per 6g event configured in the UE.

Information Element/Group name	Need	Multi	Type and reference	Semantics description
Event triggered_RL	OP	<maxRL>	Boolean	

13.4.27f21 TRIGGERED_1J_EVENT

This variable contains information about a 1j event that has been triggered in the UE. There is one such variable per 1j event configured in the UE.

Information Element/Group name	Need	Multi	Type and reference	Semantics description	Version
Cells triggered	OP	1 to < maxCellMeas>		Cleared when entering UTRA RRC connected mode. Cleared when leaving UTRA RRC connected mode.	REL-6
>primary CPICH	MP		Primary CPICH info 10.3.6.60		REL-6
>sent reports	MP		Integer(1..Infinity)	Number of reports sent to UTRAN in case of event triggered periodical reporting	REL-6
Cells recently triggered	OP	1 to < maxCellMeas>			REL-6
>primary CPICH	MP		Primary CPICH info 10.3.6.60		REL-6
>sent reports	MP		Integer(1..Infinity)	Number of reports sent to UTRAN in case of event triggered periodical reporting	REL-6
Periodical reporting running	MP		Boolean		REL-6

13.4.27f22 BEST_CELL_2G_EVENT

This variable contains information about a 2g event that has been triggered in the UE. There is one such variable per 2g event configured in the UE.

Information Element/Group name	Need	Multi	Type and reference	Semantics description
Frequency triggered	OP	1 to < maxCellMeas>		Cleared when entering UTRA RRC connected mode. Cleared when leaving UTRA RRC connected mode.
>Frequency	MP		Frequency info 10.3.6.36	
>Best cell	MP		Primary CPICH info 10.3.6.60	

13.4.27g UE_CAPABILITY_REQUESTED

This variable stores information about the UE capabilities that have been requested by UTRAN but that have not yet been transferred to UTRAN.

Information Element/Group name	Need	Multi	Type and reference	Semantics description
UE radio access capability	OP		UE radio access capability 10.3.3.42	Cleared when entering UTRA RRC connected mode. Cleared when leaving UTRA RRC connected mode.
UE radio access capability extension	OP		UE radio access capability extension 10.3.3.42a	Cleared when entering UTRA RRC connected mode. Cleared when leaving UTRA RRC connected mode.
UE system specific capability	OP	1 to < maxInterSy sMessages >		
>Inter-RAT UE radio access capability	MP		Inter-RAT UE radio access capability 10.3.8.7	Includes inter-RAT classmark. Cleared when entering UTRA RRC connected mode. Cleared when leaving UTRA RRC connected mode.

13.4.28 UE_CAPABILITY_TRANSFERRED

This variable stores information about which UE capabilities that have been transferred to UTRAN.

Information Element/Group name	Need	Multi	Type and reference	Semantics description	Version
UE radio access capability	OP		UE radio access capability 10.3.3.42	Cleared when entering UTRA RRC connected mode when not stated otherwise in the procedure. Cleared when leaving UTRA RRC connected mode.	
UE radio access capability extension	OP		UE radio access capability extension 10.3.3.42a	Cleared when entering UTRA RRC connected mode when not stated otherwise in the procedure. Cleared when leaving UTRA RRC connected mode.	
UE system specific capability	OP	1 to <maxSystemCapability>			
>Inter-RAT UE radio access capability	MP		Inter-RAT UE radio access capability 10.3.8.7	Includes inter-RAT classmark. Cleared when entering UTRA RRC connected mode when not stated otherwise in the procedure. Cleared when leaving UTRA RRC connected mode.	
UE radio access capability compressed	OP		UE radio access capability compressed 10.3.3.42o		REL-5
Security capability	OP		Security capability 10.3.3.37		REL-5

13.4.28a UE_POSITIONING_GPS_DATA

Information Element/Group name	Need	Multi	Type and reference	Semantics description
GPS Data ciphering info	OP		UE positioning Ciphering info 10.3.7.86	
GPS Deciphering Keys	OP			
>Current deciphering key	MP		Bit string(56)	
>Next deciphering key	MP		Bit string(56)	
UE positioning GPS reference time	OP		UE positioning GPS reference time 10.3.7.96	
UE positioning GPS reference UE position	OP		Ellipsoid point with altitude and uncertainty ellipsoid 10.3.8.4c	A priori knowledge of UE 3-D position.
UE positioning GPS DGPS corrections	OP		UE positioning GPS DGPS corrections 10.3.7.91	
UE positioning GPS navigation model	OP	1 to <maxSat>		
>SatID	MP		Enumerated(0..63)	Satellite ID
>GPS Ephemeris and Clock Correction parameters	MP		UE positioning GPS Ephemeris and Clock Correction parameters 10.3.7.91a	
UE positioning GPS ionospheric model	OP		UE positioning GPS ionospheric model 10.3.7.92	
UE positioning GPS UTC model	OP		UE positioning GPS UTC model 10.3.7.97	
UE positioning GPS almanac	OP			
>SatID	MP	1 to <maxSatAlmanacStorage>		
>>WN _a	MP			Same as IE in 10.3.7.89
>>DataID	MP			Same as IE in 10.3.7.89
>>e	MP			Same as IE in 10.3.7.89
>>t _{oa}	MP			Same as IE in 10.3.7.89
>>δI	MP			Same as IE in 10.3.7.89
>>OMEGADOT	MP			Same as IE in 10.3.7.89
>>SV Health	MP			Same as IE in 10.3.7.89
>>A ^{1/2}	MP			Same as IE in 10.3.7.89
>>OMEGA ₀	MP			Same as IE in 10.3.7.89
>>M ₀	MP			Same as IE in 10.3.7.89

Information Element/Group name	Need	Multi	Type and reference	Semantics description
>>ω	MP			Same as IE in 10.3.7.89
>>af ₀	MP			Same as IE in 10.3.7.89
>>af ₁	MP			Same as IE in 10.3.7.89
>SV Global Health	OP			Same as IE in 10.3.7.89
UE positioning GPS acquisition assistance	OP		UE positioning GPS acquisition assistance 10.3.7.88	
UE positioning GPS real-time integrity	OP		UE positioning GPS real-time integrity 10.3.7.95	

13.4.28b UE_POSITIONING_OTDOA_DATA_UE_ASSISTED

Information Element/Group name	Need	Multi	Type and reference	Semantics description
UE positioning OTDOA reference cell info for UE-assisted	OP		UE positioning OTDOA reference cell info 10.3.7.108	
UE positioning OTDOA neighbour cell list for UE-assisted	OP	1 to <maxCellMeas>		
>UE positioning OTDOA neighbour cell info for UE-assisted	MP		UE positioning OTDOA neighbour cell info 10.3.7.106	

13.4.28c UE_POSITIONING_OTDOA_DATA_UE_BASED

Information Element/Group name	Need	Multi	Type and reference	Semantics description
OTDOA Deciphering Keys	OP			
>Current deciphering key	MP		Bit string(56)	
>Next deciphering key	MP		Bit string(56)	
OTDOA Data ciphering info	OP		UE positioning Ciphering info 10.3.7.86	
UE positioning OTDOA reference cell info for UE-based	OP		UE positioning OTDOA reference cell info for UE-based 10.3.7.108a	
UE positioning OTDOA neighbour cell list for UE-based	OP	1 to <maxCellMeas>		
>UE positioning OTDOA neighbour cell info for UE-based	MP		UE positioning OTDOA neighbour cell info for UE-based 10.3.7.106	

13.4.28d UE_POSITIONING_GANSS_DATA

Information Element/Group name	Need	Multi	Type and reference	Semantics description	Version
GANSS Data ciphering info	OP		UE positioning Ciphering info 10.3.7.86		REL-7
GANSS Deciphering Keys	OP				REL-7
>Current deciphering key	MP		Bit string(56)		REL-7
>Next deciphering key	MP		Bit string(56)		REL-7
UE positioning GANSS reference time	OP		UE positioning GANSS reference time 10.3.7.96o		REL-7
UE positioning GANSS reference UE position	OP		Ellipsoid point with altitude and uncertainty ellipsoid 10.3.8.4c	A priori knowledge of UE 3-D position.	REL-7
UE positioning GANSS additional ionospheric model	OP		UE positioning GANSS ionospheric model 10.3.7.92b		REL-8
UE positioning GANSS Earth orientation parameters	OP		UE positioning GANSS Earth orientation parameters 10.3.7.92c		REL-8
UE positioning GANSS ionospheric model	OP		UE positioning GANSS ionospheric model 10.3.7.92a		REL-7
GANSS Generic DataList	OP	1 to <maxGANSS>			REL-7
>GANSS ID	OP		Integer (0..7)	Same as IE in 10.3.7.90b	REL-7
>SBAS ID	CV- GANSS-ID -SBAS		UE positioning GANSS SBAS ID 10.3.7.97e		REL-8
>GANSS Time Models List		1 to <maxGANSS-1>			REL-7
>>Positioning GANSS Time Model	OP		UE positioning GANSS time model 10.3.7.97a		
>UE positioning DGANSS corrections	OP		UE positioning DGANSS corrections 10.3.7.91b		REL-7

Information Element/Group name	Need	Multi	Type and reference	Semantics description	Version
>UE positioning DBDS corrections	CV- GANSS-ID -BDS		UE positioning DBDS corrections 10.3.7.92e		REL-12
>UE positioning BDS Ionospheric Grid Model	CV- GANSS-ID -BDS		UE positioning BDS Ionospheric Grid Model 10.3.7.92d		REL-12
>UE positioning GANSS navigation model	OP		UE positioning GANSS navigation model 10.3.7.94a		REL-7
>UE positioning GANSS additional navigation models	OP		UE positioning GANSS additional navigation models 10.3.7.94b		REL-8
>UE positioning GANSS real-time integrity	OP		UE positioning GANSS real-time integrity 10.3.7.95a		REL-7
>UE positioning GANSS data bit assistance	OP		UE positioning GANSS data bit assistance 10.3.7.97b		REL-7
>UE positioning GANSS reference measurement information	OP		UE positioning GANSS reference measurement information 10.3.7.88b		REL-7
>UE positioning GANSS almanac	OP		UE positioning GANSS almanac 10.3.7.89a		REL-7
>UE positioning GANSS UTC model	OP		UE positioning GANSS UTC model 10.3.7.97c		REL-7
>UE positioning GANSS additional UTC models	OP		UE positioning GANSS additional UTC models 10.3.7.97d		REL-8
>UE positioning GANSS auxiliary information	OP		UE positioning GANSS auxiliary information 10.3.7.97f		REL-8

Condition	Explanation
GANSS-ID-SBAS	The IE is mandatory present if the IE "GANSS ID" is "SBAS" and never stored otherwise.
GANSS-ID-BDS	The IE is optionally present if the IE "GANSS ID" is "BDS" and never stored otherwise.

13.4.29 UNSUPPORTED_CONFIGURATION

This variable indicates whether a received message contained a configuration that is not supported by the UE.

Information Element/Group name	Need	Multi	Type and reference	Semantics description
Unsupported configuration	MP		Boolean	TRUE: An unsupported configuration has been detected. Set to FALSE when entering UTRA RRC connected mode. Set to FALSE when leaving UTRA RRC connected mode.

13.4.30 URA_IDENTITY

This variable stores the assigned URA identity for this UE when in URA_PCH state.

Information Element/Group name	Need	Multi	Type and reference	Semantics description
URA identity	OP		URA identity 10.3.2.6	Cleared when entering UTRA RRC connected mode. Cleared when leaving UTRA RRC connected mode.

13.4.31 U_RNTI

This variable stores the assigned U-RNTI for this UE.

Information Element/Group name	Need	Multi	Type and reference	Semantics description
U-RNTI	OP		U-RNTI 10.3.3.47	Cleared when leaving UTRA RRC connected mode.

13.4.32 VALUE_TAG

This variable contains information about the value tag for the last received system information block of a given type, for all system information blocks using value tags. The UE shall maintain one instance of this variable for the current selected cell. The UE may store several instances of this variable, one for each cell, to be used if the UE returns to these cells.

All IEs in this variable shall be cleared when switched off. All IEs in this variable except for the IE "SIB 16 value tag list" shall be cleared at selection of a new cell and this cell broadcasts an IE "PLMN Identity" in the MIB which is different from the IE "PLMN Identity" broadcast in the MIB in the previously selected cell. The IE "SIB 16 value tag list" is cleared when NAS informs AS about a new selected PLMN.

Information Element/Group name	Need	Multi	Type and reference	Semantics description	Version
MIB value tag	OP		MIB value tag 10.3.8.9	Value tag for the master information block	

Information Element/Group name	Need	Multi	Type and reference	Semantics description	Version
SB 1 value tag	OP		Cell value tag 10.3.8.4	Value tag for the scheduling block type 1	
SB 2 value tag	OP		Cell value tag 10.3.8.4	Value tag for the scheduling block type 2	
SB 3 value tag	OP		Cell Value tag 2 10.3.8.4o	Value tag for the scheduling block type 3	
SIB 1 value tag	CV-GSM		PLMN value tag 10.3.8.10	Value tag for the system information block type 1 Note: IE 'PLMN value tag' is used for SIB1 but the area scope for SIB 1 is Cell.	
SIB 2 value tag	OP		Cell value tag 10.3.8.4	Value tag for the system information block type 2	
SIB 3 value tag	OP		Cell value tag 10.3.8.4 or Cell Value tag 2 10.3.8.4o	Value tag for the system information block type 3	
SIB 4 value tag	OP		Cell value tag 10.3.8.4	Value tag for the system information block type 4	
SIB 5 value tag	OP		Cell value tag 10.3.8.4 or Cell Value tag 2 10.3.8.4o	Value tag for the system information block type 5 or 5bis	
SIB 6 value tag	OP		Cell value tag 10.3.8.4	Value tag for the system information block type 6	
CHOICE <i>mode</i>	MP				
>FDD					
>TDD				(no data)	
SIB 11 value tag	OP		Cell value tag 10.3.8.4	Value tag for the system information block type 11	
SIB 11bis value tag	OP		Cell value tag 10.3.8.4	Value tag for the system information block type 11bis	REL-6
SIB 11ter value tag	OP		Cell value tag 10.3.8.4	Value tag for the system information block type 11ter	REL-12
SIB 12 value tag	OP		Cell value tag 10.3.8.4	Value tag for the system information block type 12	
SIB 13 value tag	CV-ANSI		Cell value tag 10.3.8.4	Value tag for the system information block type 13	
SIB 13.1 value tag	CV-ANSI		Cell value tag 10.3.8.4	Value tag for the system	

Information Element/Group name	Need	Multi	Type and reference	Semantics description	Version
				information block type 13.1	
SIB 13.2 value tag	CV-ANSI		Cell value tag 10.3.8.4	Value tag for the system information block type 13.2	
SIB 13.3 value tag	CV-ANSI		Cell value tag 10.3.8.4	Value tag for the system information block type 13.3	
SIB 13.4 value tag	CV-ANSI		Cell value tag 10.3.8.4	Value tag for the system information block type 13.4	
SIB 15 value tag	OP		Cell value tag 10.3.8.4	Value tag for the system information block type 15	
SIB 15bis value tag	OP		Cell value tag 10.3.8.4	Value tag for the system information block type 15bis	REL-7
SIB 15.1 value tag	OP		Cell value tag 10.3.8.4	Value tag for the system information block type 15.1	
SIB 15.1ter value tag	OP		Cell value tag 10.3.8.4	Value tag for the system information block type 15.1ter	REL-12
SIB 15.2 value tag list	OP	1 to <maxSat>		List of value tags for all stored occurrences of system information block type 15.2	
>SIB 15.2 value tag	MP		Cell value tag 10.3.8.4		
>SIB occurrence identity and value tag	MP		SIB occurrence identity and value tag 10.3.8.20b		
SIB 15.3 value tag list	OP	1 to <maxSat>		List of value tags for all stored occurrences of system information block type 15.3	
>SIB 15.3 value tag	MP		PLMN value tag 10.3.8.10	Value tag for the system information block type 15.3	
>SIB occurrence identity and value tag	MP		SIB occurrence identity and value tag 10.3.8.20b		
SIB 15.4 value tag	OP		Cell value tag 10.3.8.4	Value tag for the system information block type 15.4	

Information Element/Group name	Need	Multi	Type and reference	Semantics description	Version
SIB 15.5 value tag	OP		Cell value tag 10.3.8.4	Value tag for the system information block type 15.5	
GANSS specific SIBs	OP	1 to <maxGANSS>			REL-7
>GANSS ID	MD		Integer(0..7)	Identifier for GANSS, absence of this IE means Galileo. For coding description see NOTE 1 in 10.3.7.90b.	REL-7
>SBAS ID	CV- GANSS-ID -SBAS		UE positioning GANSS SBAS ID 10.3.7.97e		REL-8
>SIB 15.1bis value tag	OP		Cell value tag 10.3.8.4	Value tag for the system information block type 15.1bis	REL-7
>SIB 15.2bis value tag list	OP	1 to <maxSat>		List of value tags for all stored occurrences of system information block type 15.2bis	REL-7
>>SIB 15.2bis value tag	MP		Cell value tag 10.3.8.4		REL-7
>>SIB occurrence identity and value tag	MP		SIB occurrence identity and value tag 10.3.8.20b		REL-7
>SIB 15.2ter value tag list	OP	1 to <maxSat>		List of value tags for all stored occurrences of system information block type 15.2ter	REL-8
>>SIB 15.2ter value tag	MP		Cell value tag 10.3.8.4		REL-8
>>SIB occurrence identity and value tag	MP		SIB occurrence identity and value tag 10.3.8.20b		REL-8
>SIB 15.3bis value tag list	OP	1 to <maxSat>		List of value tags for all stored occurrences of system information block type 15.3bis	REL-7
>>SIB 15.3bis value tag	MP		PLMN value tag 10.3.8.10	Value tag for the system information block type 15.3bis	REL-7
>>SIB occurrence identity and value tag	MP		SIB occurrence identity and value tag 10.3.8.20b		REL-7

Information Element/Group name	Need	Multi	Type and reference	Semantics description	Version
>SIB 15.6 value tag	OP		Cell value tag 10.3.8.4	Value tag for the system information block type 15.6	REL-7
>SIB 15.7 value tag	OP		Cell value tag 10.3.8.4	Value tag for the system information block type 15.7	REL-7
>SIB 15.8 value tag	OP		Cell value tag 10.3.8.4	Value tag for the system information block type 15.8	REL-7
SIB 16 value tag list	OP	1 to <maxPred efConfig>		List of value tags for all stored occurrences of the system information block type 16	
>Predefined configuration identity and value tag	MP		Predefined configuration identity and value tag 10.3.8.11		
SIB 18 value tag	OP		Cell value tag 10.3.8.4	Value tag for the system information block type 18	
SIB 19 value tag	OP		Cell value tag 10.3.8.4	Value tag for the system information block type 19	REL-8
SIB 20 value tag	OP		Cell value tag 10.3.8.4	Value tag for the system information block type 20	REL-8
SIB 21 value tag	OP		Cell value tag 10.3.8.4 or Cell Value tag 2 10.3.8.4o	Value tag for the system information block type 21	REL-11
SIB 22 value tag	OP		Cell value tag 10.3.8.4 or Cell Value tag 2 10.3.8.4o	Value tag for the system information block type 22	REL-11
SIB 23 value tag	OP		Cell value tag 10.3.8.4	Value tag for the system information block type 23	REL-12

Condition	Explanation
<i>GSM</i>	This information is optional when the UE is operating in "GSM-MAP mode" and never stored otherwise.
<i>ANSI</i>	This information is optional when the UE is operating in "ANSI-41 mode" and never stored otherwise.
<i>GANSS-ID-SBAS</i>	The IE is mandatory present if the IE "GANSS ID" is "SBAS" and never stored otherwise.

13.4.33 CONTROL_CHANNEL_DRX_PARAMS

NOTE: For 1.28 Mcps TDD only.

Information Element/Group name	Need	Multi	Type and reference	Semantics description	Version
UE parameters for Control Channel DRX	MP		Control Channel DRX Information 1.28Mcps TDD in 10.3.6.107		REL-8

13.4.34 CONTROL_CHANNEL_DRX_STATUS

NOTE: For 1.28 Mcps TDD only.

This variable indicates whether discontinuous reception of Control Channel procedures is enable. See subclause 8.5.53 for actions related to the setting of this variable.

Information Element/Group name	Need	Multi	Type and reference	Semantics description	Version
CONTROL_CHANNEL_DRX_STATUS	MP		Boolean	TRUE: control channel discontinuous reception is enable. Set to FALSE when entering UTRA RRC connected mode when not otherwise stated in the procedure. Set to FALSE when leaving UTRA RRC connected mode.	REL-8

13.4.35 E_DCH_SPS_PARAMS

NOTE: For 1.28 Mcps TDD only.

This variable contains the parameters for E-DCH Semi-persistent Scheduling. The parameters are listed in subclause 10.3.6.111.

Information Element/Group name	Need	Multi	Type and reference	Semantics description	Version
UE parameters for E-DCH SPS	MP		E-DCH SPS Information 1.28Mcps TDD in 10.3.6.111		REL-8

13.4.36 E_DCH_SPS_STATUS

NOTE: For 1.28 Mcps TDD only.

This variable indicates whether E-DCH Semi-persistent Scheduling procedures are ongoing. See subclause 8.5.54 for actions related to the setting of this variable.

Information Element/Group name	Need	Multi	Type and reference	Semantics description	Version
E_DCH_SPS_STATUS	MP		Boolean	TRUE: E-DCH SPS operation is ongoing. Set to FALSE when entering UTRA RRC connected mode when not otherwise stated in the procedure. Set to FALSE when leaving UTRA RRC connected mode.	REL-8

13.4.37 HS_DSCH_SPS_PARAMS

NOTE: For 1.28 Mcps only.

This variable contains the parameters for HS-DSCH Semi-persistent Scheduling. The parameters are listed in subclause 10.3.6.112.

Information Element/Group name	Need	Multi	Type and reference	Semantics description	Version
UE parameters for HS-DSCH SPS	MP		HS-DSCH SPS Information 1.28Mcps TDD in 10.3.6.112		REL-8

13.4.38 HS_DSCH_SPS_STATUS

NOTE: For 1.28 Mcps only.

This variable indicates whether HS-DSCH Semi-persistent Scheduling procedures are ongoing. See subclause 8.5.55 for actions related to the setting of this variable.

Information Element/Group name	Need	Multi	Type and reference	Semantics description	Version
HS_DSCH_SPS_STATUS	MP		Boolean	TRUE: HS-DSCH SPS is ongoing. Set to FALSE when entering UTRA RRC connected mode when not otherwise stated in the procedure. Set to FALSE when leaving UTRA RRC connected mode.	REL-8

13.4.39 SECONDARY_CELL_MIMO_PARAMS

This variable indicates the values of the parameters for operation in MIMO mode in the secondary serving HS-DSCH cell. See subclause 8.5.57 for actions related to the setting of this variable.

Information Element/Group name	Need	Multi	Type and reference	Semantics description	Version
MIMO N_cqi_typeA/M_cqi ratio	OP	1 to 7	Enumerated(1/2, 2/3, 3/4, 4/5, 5/6, 6/7, 7/8, 8/9, 9/10, 1/1)		REL-11
MIMO pilot configuration	OP	1 to 7	MIMO pilot configuration 10.3.6.41b		REL-11
Precoding weight set restriction	OP	1 to 7	Enumerated (TRUE)		REL-11

13.4.40 SECONDARY_CELL_MIMO_STATUS

This variable indicates whether the secondary serving HS-DSCH cells are operating in MIMO mode. See subclause 8.5.57 for actions related to the setting of this variable.

Information Element/Group name	Need	Multi	Type and reference	Semantics description	Version
MIMO status	MP	1 to 7	Boolean	TRUE means the secondary cell of the UE is operating in MIMO mode. Cleared when leaving CELL_DCH state or leaving multi-cell operation.	REL-11

13.4.41 SECONDARY_CELL_E_DCH_TRANSMISSION

This variable indicates whether E-DPCCH and E-DPDCH transmission procedures are configured on the secondary UL frequency. See subclause 8.5.58 for actions related to the setting of this variable.

Information Element/Group name	Need	Multi	Type and reference	Semantics description	Version
Secondary cell E-DCH transmission	MP		Boolean	TRUE: E-DCH transmission is configured on the secondary uplink frequency. Set to FALSE when entering UTRA RRC connected mode when not otherwise stated in the procedure. Set to FALSE when leaving UTRA RRC connected mode.	REL-9

13.4.42 CELL_INFO_CSG_LIST

This variable contains CSG/Hybrid cell information on intra-frequency and inter-frequency cells as received in MEASUREMENT CONTROL message.

This variable shall be cleared at cell re-selection, when leaving UTRA RRC connected mode, when switched off as well as at selection of a new PLMN.

Information Element/Group name	Need	Multi	Type and reference	Semantics description	Version
CSG Intra-frequency cell info	OP		10.3.7.121		REL-9
CSG Inter-frequency cell info	OP		10.3.7.120		REL-9

13.4.43 DCH_MOPS_IDENTITY

This variable is use to store the CELL_DCH measurement occasion pattern sequences configured to the UE for 1.28Mcps TDD.

Information Element/Group name	Need	Multi	Type and reference	Semantics description
CELL_DCH measurement occasion pattern sequence	OP		CELL_DCH measurement occasion info LCR 10.3.7.126	Information as contained in these messages. Cleared when leaving CELL_DCH state.

13.4.44 SYSTEM_INFORMATION_CONTAINER

This variable contains the system information for the current serving cell.

Information Element/Group name	Need	Multi	Type and reference	Semantics description	Version
System Information Container	OP		System Information Container 10.2.48a	Cleared when entering UTRA RRC connected mode, when leaving UTRA RRC connected mode and when UE changes a serving cell to the other cell than the cell associated with this variable.	REL-9

13.4.45 MU_MIMO_INFO

This variable contains MU-MIMO parameters for 1.28 Mcps TDD.

Information Element/Group name	Need	Multi	Type and reference	Semantics description
MU-MIMO info	MP		MU-MIMO info 1.28 Mcps TDD 10.3.6.122	

13.4.46 MU_MIMO_STATUS

This variable indicates whether the UE is operating in MU-MIMO mode. See subclause 8.5.61 for actions related to the setting of this variable.

Information Element/Group name	Need	Multi	Type and reference	Semantics description	Version
MU_MIMO status	MP		Boolean	TRUE means the UE is operating in	REL-10

				MU-MIMO mode. Cleared when leaving CELL_DCH and CELL_FACH state.	
--	--	--	--	---	--

13.4.47 MULTI_CARRIER_E_DCH_TRANSMISSION

NOTE: For 1.28 Mcps TDD only.

This variable indicates whether multi-carrier E-PUCH transmission procedures are configured on the additional E-DCH carrier. See subclause 8.5.62 for actions related to the setting of this variable.

Information Element/Group name	Need	Multi	Type and reference	Semantics description	Version
Multi carrier E-DCH transmission	MP		Boolean	TRUE: E-DCH transmission is configured on the additional E-DCH carrier. Set to FALSE when entering UTRA RRC connected mode when not otherwise stated in the procedure. Set to FALSE when leaving UTRA RRC connected mode.	REL-10

13.4.48 LOGGED_MEAS_CONFIG

This variable contains parameters related to Logged Measurements. This variable should not be deleted upon transition to Idle mode and when the UE move to another RAT.

Information Element/Group name	Need	Multi	Type and reference	Semantics description	Version
Logged Measurements Configuration Info	MP		Logged Measurements Configuration Info 10.3.7.132		REL-10

13.4.49 LOGGED_MEAS_REPORT_VARIABLE

This variable includes the logged measurements information. This variable should not be deleted upon transition to Idle mode and when the UE move to another RAT. The UE shall store the logged measurements during 48 hours after expiry of the timer T326.

Information Element/Group name	Need	Multi	Type and reference	Semantics description	Version
Trace reference	MP		Trace Reference 10.3.7.133	Parameter trace reference: See TS 32.422 [81]	REL-10
Trace recording session	MP		Trace Recording Session 10.3.7.134	Parameter trace recording session reference: See TS 32.422 [81]	REL-10
TCE Id	MP		TCE Id 10.3.7.135	Parameter TCE Id: See TS 32.422 [81]	REL-10
Absolute Time Info	MP		Bit Sting (48)	Indicates the reference to network absolute time <i>absoluteTimeInfo</i> provided at the point of measurement logging configuration. Format is YY-MM-DD HH:MM:SS using BCD encoding	REL-10
CHOICE mode	MP				REL-10
>FDD					REL-10
>>List of measurements FDD		0..MaxLoggedMeas			REL-10
>>>Logged Measurement Info-FDD	MP		Logged Measurement Info-FDD 10.3.7.129		REL-10
>TDD					REL-10
>>List of measurements TDD		0..MaxLoggedMeas			REL-10
>>>Logged Measurement Info-TDD	MP		Logged Measurement Info-TDD 10.3.7.130		REL-10
PLMN Identity List	OP	1..MaxnumMDTPLMN			REL-11
>PLMN identity	MP		PLMN identity 10.3.1.11		REL-11

13.4.50 LOG_ANR_CONFIG

This variable contains parameters related to logged ANR measurements. This variable should not be deleted upon transition to Idle mode and when the UE move to another RAT or a PLMN not included in the IE "PLMN Identity" or IE "Equivalent PLMN Identity List" stored in variable LOG_ANR_REPORT_VARIABLE.

Information Element/Group name	Need	Multi	Type and reference	Semantics description	Version
Logged ANR Configuration Info	MP		Logged ANR Configuration Info 10.3.7.42a		REL-10

13.4.51 LOG_ANR_REPORT_VARIABLE

This variable includes the logged ANR measurements information. This variable should not be deleted upon transition to Idle mode and when the UE move to another RAT or a PLMN not included in the IE "PLMN Identity" or IE "Equivalent PLMN Identity List" stored in variable LOG_ANR_REPORT_VARIABLE. The UE shall store the logged measurements during 48 hours after start of the timer T327.

Information Element/Group name	Need	Multi	Type and reference	Semantics description	Version
PLMN Identity	MP		PLMN identity 10.3.1.11	RPLMN when receiving the LOGGING MEASUREMENT CONFIGURATION message	REL-10
Equivalent PLMN Identity List	OP	1..15			REL-10
>Equivalent PLMN Identity			PLMN identity 10.3.1.11	Equivalent PLMN Identity of the RPLMN when receiving the LOGGING MEASUREMENT CONFIGURATION message	REL-10
Logged ANR Report Info	MP		Logged ANR Report Info 10.3.7.42b		REL-10

13.4.52 UPLINK_CLTD_TRANSMISSION

This variable indicates whether the UE is operating in uplink CLTD transmission. See subclause 8.5.69 for actions related to the setting of this variable.

Information Element/Group name	Need	Multi	Type and reference	Semantics description	Version
Uplink CLTD transmission	MP		Boolean	TRUE means the UE is operating in uplink CLTD transmission. Set to FALSE when leaving UTRA RRC connected mode.	REL-11

13.4.53 UPLINK_OLTD_TRANSMISSION

This variable indicates whether the UE is operating in uplink OLTD transmission. See subclause 8.5.70 for actions related to the setting of this variable.

Information Element/Group name	Need	Multi	Type and reference	Semantics description	Version
Uplink OLTD transmission	MP		Boolean	TRUE means the UE is operating in uplink OLTD transmission. Set to FALSE when leaving UTRA RRC connected mode.	REL-11

13.4.54 LOGGED_CONNECTION_ESTABLISHMENT_FAILURE

This variable includes the logged information from the latest failed RRC connection establishment. This variable should not be deleted upon transition to Idle mode and when the UE move to another RAT. The UE shall store the logged information during 48 hours or until reported to the network and UE may keep the information beyond 48 hours. The UE may discard the variable upon switch off or detach.

Information Element/Group name	Need	Multi	Type and reference	Semantics description	Version
PLMN identity	MP		PLMN identity 10.3.1.11		REL-11
CHOICE mode	MP				REL-11
>FDD					REL-11
>> Logged Connection Establishment Failure Info-FDD	MP		Logged Connection Establishment Failure Info-FDD 10.3.7.129a		REL-11
>TDD					REL-11
>> Logged Connection Establishment Failure Info-TDD	MP		Logged Connection Establishment Failure Info-TDD 10.3.7.130a		REL-11

13.4.55 MULTIFLOW_STATUS

This variable indicates whether the UE is configured with Multiflow operation. See subclause 8.5.71 for actions related to the setting of this variable.

Information Element/Group name	Need	Multi	Type and reference	Semantics description	Version
Multiflow status	MP		Boolean	TRUE means that the Multiflow transmission is configured for the UE. Set to FALSE when entering the RRC connected mode, or when leaving the CELL_DCH state, or when leaving the RRC connected mode.	REL-11

13.4.56 CELL_RESELECTION_INFO_LCRTDD

NOTE: For 1.28 Mcps TDD only.

This variable contains the the frequencies and PCCPCH RSCP threshold information used for cell reselection from GERAN to 1.28 Mcps TDD. The variable should not be cleared unless UE receives SIB3 without mapping info for 3.84 Mcps TDD.

Information Element/Group name	Need	Multi	Type and Reference	Semantics description	Version
Mapping Info	OP		Mapping info 10.3.2.5		REL-11

13.4.57 EUTRA_FREQUENCY_INFO_LIST_FACH

NOTE: For FDD only.

This variable contains E-UTRA frequency information to be measured under CELL_FACH state, as received in MEASUREMENT CONTROL, and the E-UTRA frequency RACH reporting information as received in System Information Block Type 19.

Information Element/Group name	Need	Multi	Type and reference	Semantics description	Version
E-UTRA Frequency Info List	MP	1 to <maxNumEUTRAFreqs_FACH>			REL-11
		1 to <maxNumEUTRAFreqs_FACH-ext>			REL-12
>EARFCN	MP		Integer(0 .. 262143)	EARFCN of the downlink carrier frequency [64].	REL-11
E-UTRA frequency RACH reporting information	OP			E-UTRA frequency RACH reporting information 10.3.7.139	REL-11

13.4.58 FALLBACK_R99_PRACH_ENABLED

For FDD, in CELL_FACH state or Idle mode, this variable indicates whether R99 PRACH transmission procedure is ongoing to transmit CCCH or DCCH data even when/if READY_FOR_COMMON_EDCH is set to TRUE. See subclause 8.5.76 for actions related to the setting of this variable.

Information Element/Group name	Need	Multi	Type and reference	Semantics description	Version
Fallback R99 PRACH Enabled	MP		Boolean	See subclause 8.5.76	REL-11

13.4.59 HS_DSCH_DRX_CELL_FACH_2CYCLE_STATUS

This variable indicates whether HS-DSCH DRX operation with second DRX cycle is supported in CELL_FACH. See subclause 8.5.48 for actions related to the setting of this variable.

NOTE: FDD only.

Information Element/Group name	Need	Multi	Type and reference	Semantics description	Version
HS-DSCH DRX in CELL_FACH with second DRX cycle status	MP		Boolean	TRUE: HS-DSCH DRX operation in CELL_FACH with second DRX cycle is supported. Set to FALSE when leaving CELL_FACH or when dedicated H-RNTI is cleared.	REL-11

13.4.60 READY_FOR_COMMON_ERGCH

NOTE: For FDD only.

In CELL_FACH or CELL_PCH state, this variable indicates whether the UE has been configured for E-RGCH reception on radio links other than the serving E-DCH radio link. See subclause 8.5.75 for actions related to the setting of this variable.

Information Element/Group name	Need	Multi	Type and reference	Semantics description	Version
Ready for common ERGCH	MP		Boolean	See subclause 8.5.75	REL-11

13.4.61 READY_FOR_FALLBACK_R99_PRACH

For FDD, in CELL_FACH state or Idle mode, this variable indicates whether a NACK on the E-AI in AICH indicates to the UE that the UE should initiate the R99 PRACH procedure to transmit CCCH or DCCH data even when/if READY_FOR_COMMON_EDCH is set to TRUE. See subclause 8.5.77 for actions related to the setting of this variable.

Information Element/Group name	Need	Multi	Type and reference	Semantics description	Version
Ready for Fallback R99 PRACH	MP		Boolean	See subclause 8.5.77	REL-11

13.4.62 MIMO_MODE_WITH_FOUR_TRANSMIT_ANTENNAS_PARAMS

This variable indicates the values of the parameters for operation in MIMO mode with four transmit antennas. See subclause 8.5.78 for actions related to the setting of this variable.

Information Element/Group name	Need	Multi	Type and reference	Semantics description	Version
MIMO N_cqi_typeA/M_cqi ratio	OP		Enumerated(1/2, 2/3, 3/4, 4/5, 5/6, 6/7, 7/8, 8/9, 9/10, 1/1)		REL-11
MIMO mode with four transmit antennas pilot configuration	OP		MIMO mode with four transmit antennas pilot configuration 10.3.6.143		REL-11
Precoding weight set restriction	OP		Bit string (64)		REL-11

13.4.63 MIMO_MODE_WITH_FOUR_TRANSMIT_ANTENNAS_STATUS

This variable indicates whether the UE is operating in MIMO mode with four transmit antennas. See subclause 8.5.79 for actions related to the setting of this variable.

Information Element/Group name	Need	Multi	Type and reference	Semantics description	Version
MIMO mode with four transmit antennas status	MP		Boolean	TRUE means the UE is operating in MIMO mode with four transmit antennas. Cleared when leaving CELL_DCH state.	REL-11

13.4.64

SECONDARY_CELL_MIMO_MODE_WITH_FOUR_TRANSMIT_ANTENNAS_PARAMS

This variable indicates the values of the parameters for operation in MIMO mode with four transmit antennas in the secondary serving HS-DSCH cell. See subclause 8.5.80 for actions related to the setting of this variable.

Information Element/Group name	Need	Multi	Type and reference	Semantics description	Version
MIMO mode with four transmit antennas N_cqi_typeA/M_cqi ratio	OP	1 to 3	Enumerated(1/2, 2/3, 3/4, 4/5, 5/6, 6/7, 7/8, 8/9, 9/10, 1/1)		REL-11
MIMO mode with four transmit antennas pilot configuration	OP	1 to 3	MIMO mode with four transmit antennas pilot configuration 10.3.6.143		REL-11
Precoding weight set restriction	OP	1 to 3	Bit string (64)		REL-11

13.4.65

SECONDARY_CELL_MIMO_MODE_WITH_FOUR_TRANSMIT_ANTENNAS_STATUS

This variable indicates whether the secondary serving HS-DSCH cells are operating in MIMO mode with four transmit antennas. See subclause 8.5.80 for actions related to the setting of this variable.

Information Element/Group name	Need	Multi	Type and reference	Semantics description	Version
Secondary cell MIMO mode with four transmit antennas status	MP	1 to 3	Boolean	TRUE means the secondary cell of the UE is operating in MIMO mode with four transmit antennas. Cleared when leaving CELL_DCH state or leaving multi-cell operation.	REL-11

13.4.66 UPLINK_MIMO_TRANSMISSION

This variable indicates whether the UE is operating in uplink MIMO transmission. See subclause 8.5.81 for actions related to the setting of this variable.

Information Element/Group name	Need	Multi	Type and reference	Semantics description	Version
Uplink MIMO transmission	MP		Boolean	TRUE means the UE is operating in uplink MIMO transmission. Set to FALSE when leaving UTRA RRC connected mode or the DCH state.	REL-11

13.4.67 BCCH_MODIFICATION_ACCESS_PROHIBITION

This variable indicates whether any RRC connection establishment except for emergency call and CS connection setup is prohibited or not.

Information Element/Group name	Need	Multi	Type and reference	Semantics description	Version
BCCH modification access prohibition	MP		Boolean	TRUE means any RRC connection establishment except for emergency call and CS connection setup is prohibited. It is cleared when entering idle mode, receiving SIB3 after the detection of the value tag change for SIB3, detecting that SIB3 value tag has not changed during the BCCH modification or reselection to another UTRA cell.	REL-11

13.4.68 NON_RECTANGULAR_RESOURCE_ALLOCATION_STATUS

For 1.28 Mcps TDD only. This variable indicates whether the UE is configured for non-rectangular resource allocation. See subclause 8.5.82 for actions related to the setting of this variable.

Information Element/Group name	Need	Multi	Type and reference	Semantics description	Version
NON_RECTANGULAR_RESOURCE_ALLOCATION_STATUS	MP		Boolean	For 1.28 Mcps TDD only. TRUE means the non-rectangular resource	REL-12

				allocation is configured	
--	--	--	--	--------------------------	--

13.4.69 WLAN_OFFLOAD_INFO

This variable contains dedicated parameters for RAN-assisted WLAN interworking.

Information Element/Group name	Need	Multi	Type and reference	Semantics description	Version
T330	OP		Integer (5, 10, 20, 30, 60, 120, 180)		REL-12
WLAN Offload Configuration	MP		WLAN Offload Configuration 10.3.9b.1		REL-12
WLAN Identifier List	OP	1 to <maxWLANID>			REL-12
>WLAN Identifier	MP		WLAN Identifier 10.3.9b.2		REL-12

13.4.70 SYSTEM_INFO_WLAN_OFFLOAD_INFO

This variable contains the broadcasted parameters for RAN-assisted WLAN interworking.

Information Element/Group name	Need	Multi	Type and reference	Semantics description	Version
WLAN Offload Configuration	OP		WLAN Offload Configuration 10.3.9b.1		REL-12
WLAN Identifier List	OP	1 to <maxWLANID>			REL-12
>WLAN Identifier	MP		WLAN Identifier 10.3.9b.2		REL-12

13.4.71 DPCCH2_TRANSMISSION

NOTE: For FDD only.

This variable indicates whether the UE is operating in DPCCH2 transmission. See subclause 8.5.83 for actions related to the setting of this variable.

Information Element/Group name	Need	Multi	Type and reference	Semantics description	Version
DPCCH2 transmission	MP		Boolean	TRUE means the UE is operating in DPCCH2 transmission. Set to FALSE when leaving CELL_DCH state.	REL-12

13.4.72 DCH_ENHANCEMENTS_INFO

This variable indicates the values of the parameters for operation with DCH Enhancements. See subclause 8.6.6.64 for actions related to the setting of this variable.

Information Element/Group name	Need	Multi	Type and reference	Semantics description	Version
DCH Enhancements info FDD	OP		DCH Enhancements info FDD 10.3.6.149	Indicates the values of the parameters for operation with DCH Enhancements	REL-12

13.4.73 DCH_ENHANCEMENTS_STATUS

This variable indicates whether the UE is operating with DCH Enhancements. See subclause 8.5.84 for actions related to the setting of this variable.

Information Element/Group name	Need	Multi	Type and reference	Semantics description	Version
DCH Enhancements Status	MP		Boolean	TRUE means the UE is operating with DCH Enhancements. Set to FALSE when leaving UTRA RRC connected mode.	REL-12

13.5 UE RRC Procedure Performance

This subclause defines the performance requirements related to RRC procedures in the UE. Where the total delay is impacted by processing of variable length on the physical layer (e.g. physical layer synchronisation), references to appropriate specifications are given.

13.5.1 Definitions

The following definitions of N1 and N2 are valid only for this UE RRC Procedure Performance specification.

N1 = upper limit on the time required to execute modifications in UE after the reception of a UTRAN -> UE message has been completed. Where applicable (e.g. the physical layer transmission is impacted), the changes shall be adopted in the beginning of the next TTI starting after N1. N1 is specified as a multiple of 10 ms.

N2 = number of 10 ms radio frames from end of reception of UTRAN -> UE message on UE physical layer before the transmission of the UE -> UTRAN response message must be ready to start on a transport channel with no access delay other than the TTI alignment (e.g. DCH, therefore excluding delays caused by RACH procedure etc). The UE response message transmission from the physical layer shall begin at the latest $(N2 \cdot 10) + TTI$ ms after completion of the reception of the last TTI carrying the triggering UTRAN -> UE message. When Target State is CELL_DCH, the UE response message transmission from the physical layer may be additionally delayed by the value of IE "SRB delay".

N1 and N2 are independent (e.g. $N2 - N1$ is not restricted to being less than or equal to 10ms).

13.5.2 RRC procedure performance values

NOTE: Times indicated in the table do not include cell reselection.

Procedure title:	UTRAN -> UE	UE -> UTRAN	N1	N2	Notes
RRC Connection Management Procedures					

Procedure title:	UTRAN -> UE	UE -> UTRAN	N1	N2	Notes
Broadcast of system information	SYSTEM INFORMATION				N2 is not applicable for any system information messages, because there is no response message from the UE.
Master Information Block	SYSTEM INFORMATION		5	NA	No system information data shall be lost due to processing of a MIB received with no detectable errors. This means that the UE shall buffer all system information data received after the MIB until the data can be processed according to the information in the MIB, unless the MIB was received erroneously.
System Information Block type 1	SYSTEM INFORMATION		10	NA	
System Information Block type 2	SYSTEM INFORMATION		10	NA	
System Information Block type 3	SYSTEM INFORMATION		10	NA	
System Information Block type 4	SYSTEM INFORMATION		10	NA	
System Information Block type 5 or System Information Block type 5bis	SYSTEM INFORMATION		10	NA	
System Information Block type 6	SYSTEM INFORMATION		10	NA	
System Information Block type 7	SYSTEM INFORMATION		5	NA	
System Information Block type 11 or System Information Block type 11bis	SYSTEM INFORMATION		10	NA	
System Information Block type 11ter	SYSTEM INFORMATION		10	NA	
System Information Block type 12	SYSTEM INFORMATION		10	NA	
System Information Block type 13	SYSTEM INFORMATION		10	NA	
System Information Block type 14	SYSTEM INFORMATION		10	NA	
System Information Block type 15 or 15bis or 15.1 or 15.1bis or 15.1ter or 15.2 or 15.2bis or 15.2ter or 15.3 or 15.3bis or 15.4 or 15.5 or 15.6 or 15.7 or 15.8	SYSTEM INFORMATION		10	NA	
System Information Block type 16	SYSTEM INFORMATION		10	NA	
System Information Block type 18	SYSTEM INFORMATION		10	NA	
System Information Block type 19	SYSTEM INFORMATION		10	NA	
System Information Block type 20	SYSTEM INFORMATION		10	NA	
System Information Block type 21	SYSTEM INFORMATION		10	NA	
System Information Block type 22	SYSTEM INFORMATION		10	NA	
System Information Block type 23	SYSTEM INFORMATION		10	NA	
System Information Block type 24	SYSTEM INFORMATION		5	NA	
System Information Change Indication	SYSTEM INFORMATION		10	NA	

Procedure title:	UTRAN -> UE	UE -> UTRAN	N1	N2	Notes
RRC connection establishment <i>Target state CELL_DCH</i>	RRC CONNECTION SETUP	RRC CONNECTION SETUP COMPLETE	10	NA	N1 measures time to the start of tx / rx on DPCH. N2 cannot be specified, because RRC CONNECTION SETUP COMPLETE message is transmitted only after physical layer synchronisation, which also depends on the Node B. The performance of the physical layer synchronisation procedure is specified in [19] and [20]
RRC connection establishment <i>Target state CELL_FACH</i>	RRC CONNECTION SETUP	RRC CONNECTION SETUP COMPLETE	10	11	N1 and N2 applicable as defined (N2 can be tested from the initiation of the power ramp on RACH).
RRC connection release <i>From CELL_DCH state</i>	RRC CONNECTION RELEASE	RRC CONNECTION RELEASE COMPLETE	5	8	N1 sets the requirement for the time from the completion of the last repetition of the RRC CONNECTION RELEASE COMPLETE message to the release of the physical channel. N2 sets the requirement from the end of successful reception of the RRC CONNECTION RELEASE message to the start of the first transmission of the RRC CONNECTION RELEASE COMPLETE message.
RRC connection release <i>From CELL_FACH state</i>	RRC CONNECTION RELEASE	RRC CONNECTION RELEASE COMPLETE	NA	11	N1 represents UE internal configuration that cannot be externally observed.
Paging	PAGING TYPE 1	CELL UPDATE	10	11+ T	T is the repetition period of SIB7 (applicable for FDD) and SIB14 (applicable for TDD)
UE capability enquiry	UE CAPABILITY ENQUIRY	UE CAPABILITY INFORMATION	NA	8	N1 is not applicable because the UE configuration does not change.
Security mode control	SECURITY MODE COMMAND	SECURITY MODE COMPLETE	5	8	
Signalling connection release procedure	SIGNALLING CONNECTION RELEASE		5	NA	N2 is not applicable because there is no response message.
Counter check	COUNTER CHECK	COUNTER CHECK RESPONSE	NA	8	N1 is not applicable because the UE configuration does not change.
ETWS Primary Notification with Security	ETWS PRIMARY NOTIFICATION WITH SECURITY		10	NA	N2 is not applicable because there is no response message.
Radio Bearer control procedures					
Radio bearer establishment <i>Target state CELL_DCH</i>	RADIO BEARER SETUP	RADIO BEARER SETUP COMPLETE / FAILURE	10	NA	N2 cannot be specified, because the RADIO BEARER SETUP COMPLETE / FAILURE message is transmitted only after physical layer synchronisation, which depends also on Node B.

Procedure title:	UTRAN -> UE	UE -> UTRAN	N1	N2	Notes
Radio bearer establishment <i>From state CELL_FACH to state CELL_FACH</i>	RADIO BEARER SETUP	RADIO BEARER SETUP COMPLETE / FAILURE	10	11	
Radio bearer establishment <i>From CELL_DCH to CELL_FACH</i>	RADIO BEARER SETUP	RADIO BEARER SETUP COMPLETE	NA	NA	N1 and N2 cannot be specified, because UE need to read SIBs on BCH before sending RADIO BEARER SETUP COMPLETE
Radio bearer reconfiguration <i>Target state CELL_DCH</i>	RADIO BEARER RECONFIGURATION	RADIO BEARER RECONFIGURATION COMPLETE / FAILURE	5 or 10	NA	N2 cannot be specified, because the RADIO BEARER RECONFIGURATION COMPLETE / FAILURE message is transmitted only after physical layer synchronisation, which depends also on Node B. NOTE 1
Radio bearer reconfiguration <i>From Idle Mode and state CELL_FACH to state CELL_DCH</i>	RADIO BEARER RECONFIGURATION	RADIO BEARER RECONFIGURATION COMPLETE / FAILURE	10	11	This requirement applies when the UE has a common E-DCH resource and is not required to perform any synchronization.
Radio bearer reconfiguration <i>From state CELL_FACH to state CELL_FACH</i>	RADIO BEARER RECONFIGURATION	RADIO BEARER RECONFIGURATION COMPLETE / FAILURE	10	11	
Radio bearer reconfiguration <i>From state CELL_DCH to state CELL_FACH</i>	RADIO BEARER RECONFIGURATION	RADIO BEARER RECONFIGURATION COMPLETE	NA	NA	N1 and N2 cannot be specified, because UE need to read SIBs on BCH before sending RADIO BEARER RECONFIGURATION COMPLETE
Radio bearer release <i>Target state CELL_DCH</i>	RADIO BEARER RELEASE	RADIO BEARER RELEASE COMPLETE / FAILURE	10	11	
Radio bearer release <i>From state CELL_FACH to state CELL_FACH</i>	RADIO BEARER RELEASE	RADIO BEARER RELEASE COMPLETE / FAILURE	10	11	
Radio bearer release <i>From state CELL_DCH to state CELL_FACH</i>	RADIO BEARER RELEASE	RADIO BEARER RELEASE COMPLETE	NA	NA	N1 and N2 cannot be specified, because UE need to read SIBs on BCH before sending RADIO BEARER RECONFIGURATION COMPLETE
Transport channel reconfiguration <i>Target state CELL_DCH</i>	TRANSPORT CHANNEL RECONFIGURATION	TRANSPORT CHANNEL RECONFIGURATION COMPLETE / FAILURE	5 or 10	NA	N2 cannot be specified, because the TRANSPORT CHANNEL RECONFIGURATION COMPLETE / FAILURE message is transmitted only after physical layer synchronisation, which depends also on Node B. NOTE 1
Transport channel reconfiguration <i>From state CELL_FACH to state CELL_FACH</i>	TRANSPORT CHANNEL RECONFIGURATION	TRANSPORT CHANNEL RECONFIGURATION COMPLETE / FAILURE	10	11	

Procedure title:	UTRAN -> UE	UE -> UTRAN	N1	N2	Notes
Transport channel reconfiguration <i>From state CELL_DCH to state CELL_FACH</i>	TRANSPORT CHANNEL RECONFIGURATION	TRANSPORT CHANNEL RECONFIGURATION COMPLETE	NA	NA	N1 and N2 cannot be specified, because UE need to read SIBs on BCH before sending TRANSPORT CHANNEL RECONFIGURATION COMPLETE
Transport format combination control <i>AM or UM RLC mode</i>	TRANSPORT FORMAT COMBINATION CONTROL	TRANSPORT FORMAT COMBINATION CONTROL FAILURE	5	8	
Transport format combination control <i>Transparent mode</i>	TRANSPORT FORMAT COMBINATION CONTROL		5	NA	N2 is not applicable because no response message is defined.
Physical channel reconfiguration <i>Target state CELL_DCH</i>	PHYSICAL CHANNEL RECONFIGURATION	PHYSICAL CHANNEL RECONFIGURATION COMPLETE / FAILURE	5 or 8	NA	N2 cannot be specified, because the PHYSICAL CHANNEL RECONFIGURATION COMPLETE / FAILURE message is transmitted only after physical layer synchronisation, which depends also on Node B. NOTE 1
Physical channel reconfiguration <i>From state CELL_FACH to state CELL_FACH</i>	PHYSICAL CHANNEL RECONFIGURATION	PHYSICAL CHANNEL RECONFIGURATION COMPLETE / FAILURE	8	9	
Physical channel reconfiguration <i>From state CELL_DCH to state CELL_FACH</i>	PHYSICAL CHANNEL RECONFIGURATION	PHYSICAL CHANNEL RECONFIGURATION COMPLETE	NA	NA	N1 and N2 cannot be specified, because UE need to read SIBs on BCH before sending PHYSICAL CHANNEL RECONFIGURATION COMPLETE
Physical Shared Channel Allocation [TDD only]	PHYSICAL SHARED CHANNEL ALLOCATION		5	NA	N2 is not applicable because no response message is defined.
Uplink Physical Channel Control [TDD only]	UPLINK PHYSICAL CHANNEL CONTROL		8	NA	Requirements for outer loop and timing advance adjustments are defined in [22] and [20]. N2 is not applicable because there is no response message.
RRC connection mobility procedures					
Cell update	CELL UPDATE CONFIRM	UTRAN MOBILITY INFORMATION CONFIRM	5	8	
		PHYSICAL CHANNEL RECONFIGURATION COMPLETE <i>Target state CELL_FACH</i>	8	9	

Procedure title:	UTRAN -> UE	UE -> UTRAN	N1	N2	Notes
		PHYSICAL CHANNEL RECONFIGURATION COMPLETE <i>Target state</i> <i>CELL_DCH</i>	8	NA	N2 cannot be specified, because the PHYSICAL CHANNEL RECONFIGURATION COMPLETE / FAILURE message is transmitted only after physical layer synchronisation, which depends also on Node B.
		TRANSPORT CHANNEL RECONFIGURATION COMPLETE <i>Target state</i> <i>CELL_FACH</i>	10	11	
		TRANSPORT CHANNEL RECONFIGURATION COMPLETE <i>Target state</i> <i>CELL_DCH</i>	10	NA	N2 cannot be specified, because the PHYSICAL CHANNEL RECONFIGURATION COMPLETE / FAILURE message is transmitted only after physical layer synchronisation, which depends also on Node B.
		RADIO BEARER RECONFIGURATION COMPLETE <i>Target state</i> <i>CELL_FACH</i>	10	11	
		RADIO BEARER RECONFIGURATION COMPLETE <i>Target state</i> <i>CELL_DCH</i>	10	NA	N2 cannot be specified, because the PHYSICAL CHANNEL RECONFIGURATION COMPLETE / FAILURE message is transmitted only after physical layer synchronisation, which depends also on Node B.
		RADIO BEARER RELEASE COMPLETE <i>Target state</i> <i>CELL_DCH</i>	10	11	
URA update	URA UPDATE CONFIRM	UTRAN MOBILITY INFORMATION CONFIRM	5	8	
UTRAN mobility information	UTRAN MOBILITY INFORMATION	UTRAN MOBILITY INFORMATION CONFIRM / FAILURE	5	8	
Active set update	ACTIVE SET UPDATE	ACTIVE SET UPDATE COMPLETE / FAILURE	NA	5	The requirements on UE combining and power control performance for both UL and DL are specified by RAN WG4 in [21] and [19]. Also in case of branch addition the COMPLETE / FAILURE message is transmitted without waiting for the new branch to stabilise, therefore N2 is specified.

Procedure title:	UTRAN -> UE	UE -> UTRAN	N1	N2	Notes
Inter-RAT handover to UTRAN	HANDOVER TO UTRAN COMMAND (other system)	HANDOVER TO UTRAN COMPLETE	NA	NA	The performance of this procedure is specified in 3GPP TS 45.010 in case of handover from GSM and 3GPP TS 36.133 in case of handover from E-UTRA.
Inter-RAT handover from UTRAN	HANDOVER FROM UTRAN COMMAND	HANDOVER FROM UTRAN FAILURE	NA	NA	The performance of this procedure is specified in [19] and [20].
Measurement procedures					
Measurement control	MEASUREMENT CONTROL	MEASUREMENT CONTROL FAILURE	5	8	Response to measurement inquiry depends on physical layer measurement. Response time is defined in [19] and [20]. N1 and N2 only define the processing of the message.
UE INFORMATION					
UE INFORMATION	UE INFORMATION REQUEST	UE INFORMATION RESPONSE	5	8	

NOTE 1: The lower value applies when the UE is ordered to do a serving HS-DSCH cell change, changing no other information than contained in the IE "H-RNTI", the IE "Downlink HS-PDSCH information", the IE "Uplink DPCH power control info" and/or the IE "Serving HS-DSCH radio link indicator" (FDD only).

13.6 RB information parameters for signalling radio bearer RB 0

The following Radio Bearer parameter values apply for signalling radio bearer RB0 for TDD and for FDD, if either UE or UTRAN do not support common channel mapping on HS-DSCH:

Information element/ Group name	Value	Comment
RLC info		
>Uplink RLC mode	TM	
>>Transmission RLC discard	omitted	Neither discard is used, nor will there be a reset
>>Segmentation indication	FALSE	
>Downlink RLC mode	UM	
>>Length indicator size	7	
RB mapping info		Single multiplexing option
>Uplink mapping info		
>>UL transport channel	RACH	RACH corresponding with selected PRACH
>>RLC size list	N/A	If available the size in the IE "Additional Dynamic Transport Format Information for CCCH" for the transport channel used. Else the first TF defined in the Transport Format Set for the transport channel is used.
>>MAC logical channel priority	1	
>Downlink mapping info		
>>DL transport channel	FACH	

Procedure descriptions in subclause 8.6.4.8 shall not be applied for the IE "RB mapping info" that is used for signalling radio bearer RB0.

13.6a RB information parameters for SHCCH

The following Radio Bearer parameter values apply for SHCCH:

Information element/ Group name	Value	Comment
RLC info		
>Uplink RLC mode	TM	
>>Transmission RLC discard	omitted	Neither discard is used, nor will there be a reset
>>Segmentation indication	FALSE	
>Downlink RLC mode	UM	
RB mapping info		
>Uplink mapping info		Option 1
>>UL transport channel	RACH	RACH corresponding with selected PRACH
>>RLC size list	N/A	The first TF defined in the Transport Format Set for the transport channel that is used
>>MAC logical channel priority	1	
>Downlink mapping info		
>>DL transport channel	FACH	
>Uplink mapping info		Option 2
>>UL transport channel	USCH	
>>UL Transport Channel Identity	1	
>>MAC logical channel priority	1	
>>RLC size list	N/A	The first TF defined in the Transport Format Set for the transport channel that is used
>Downlink mapping info		
>>DL transport channel	DSCH	
>>DL Transport Channel Identity	1	

13.6b RB information parameters for BCCH mapped to FACH

The following Radio Bearer parameter values apply for BCCH mapped to FACH:

Information element/ Group name	Value	Comment
Downlink RLC mode	TM	
Segmentation indication	FALSE	

13.6c RB information parameters for PCCH mapped to PCH

The following Radio Bearer parameter values apply for PCCH mapped to PCH:

Information element/ Group name	Value	Comment
Downlink RLC mode	TM	
Segmentation indication	FALSE	

13.6d Parameters for BCCH mapped to BCH

The transport format parameters for BCH are specified in [34].

13.6e RB information parameters for signalling radio bearer RB 0 mapped on HS-DSCH and RACH

The following Radio Bearer parameter values apply for signalling radio bearer RB0, if UE and UTRAN support common channel mapping on HS-DSCH:

NOTE: FDD only.

Information element/ Group name	Value	Comment
RLC info		
>Uplink RLC mode	TM	
>>Transmission RLC discard	omitted	Neither discard is used, nor will there be a reset
>>Segmentation indication	FALSE	
>Downlink RLC mode	UM	
>>Length indicator size	7	
RB mapping info		Single multiplexing option
>Uplink mapping info		
>>UL transport channel	RACH	RACH corresponding with selected PRACH
>>RLC size list	N/A	If available the size in the IE "Additional Dynamic Transport Format Information for CCCH" for the transport channel used. Else the first TF defined in the Transport Format Set for the transport channel is used.
>>MAC logical channel priority	1	
>Downlink mapping info		
>>DL transport channel	HS-DSCH	

13.6f RB information parameters for BCCH mapped to HS-DSCH

The following Radio Bearer parameter values apply for BCCH mapped to HS-DSCH:

NOTE: FDD and 1.28 Mcps TDD only.

Information element/ Group name	Value	Comment
Downlink RLC mode	TM	
Segmentation indication	FALSE	
MAC-ehs reordering queue	N/A	No MAC-ehs reordering queue is configured for BCCH reception.

13.6g RB information parameters for PCCH mapped to HS-DSCH

The following Radio Bearer parameter values apply for PCCH mapped to HS-DSCH:

NOTE: FDD and 1.28 Mcps TDD only.

Information element/ Group name	Value	Comment
Downlink RLC mode	TM	
Segmentation indication	FALSE	
MAC-ehs reordering queue	N/A	No MAC-ehs reordering queue is configured for PCCH reception.

13.6h RB information parameters for signalling radio bearer RB 0 mapped on HS-DSCH and common E-DCH

The following Radio Bearer parameter values apply for signalling radio bearer RB0, if UE and UTRAN support common channel mapping on HS-DSCH and E-DCH:

NOTE: FDD and 1.28 Mcps TDD only.

Information element/ Group name	Value	Comment
RLC info		
>Uplink RLC mode	TM	
>>Transmission RLC discard	omitted	Neither discard is used, nor will there be a reset
>>Segmentation indication	FALSE	
>Downlink RLC mode	UM	
>>Length indicator size	7	
RB mapping info		Single multiplexing option
>Uplink mapping info		
>>UL transport channel	E-DCH	E-DCH corresponding with the Node B allocated common E-DCH resource, i.e. UL DPCCH/E-DPCCH/E-DPDCH.
>>RLC size list	N/A	
>>MAC logical channel priority	1	
>Downlink mapping info		
>>DL transport channel	HS-DSCH	

13.6i Parameters for BCCH mapped to BCH on SCCPCH

The transport format parameters for second system information broadcast channel are specified in [34].

13.7 Parameter values for default radio configurations

The UE shall support the use of the default radio configurations that are specified in the following.

In each of the tables that are used to specify the parameter values for these default configurations, the following principle is used:

- Optional IEs that are not used are omitted;

NOTE 1: These configurations are based on [41] and cover a number of RAB and signalling connection configurations.

NOTE 2: If needed, signalling radio bearer RB4 is established after the completion of handover.

NOTE 3: For each default configuration, the value of FDD, 3.84 Mcps TDD, 7.68 Mcps TDD and 1.28 Mcps TDD parameters are specified. All parameters apply to FDD, 3.84 Mcps TDD, 7.68 Mcps and 1.28 Mcps TDD modes, unless explicitly stated otherwise. It should be noted that in this respect default configurations differ from pre-defined configurations, which only include parameter values for one mode.

NOTE 4: The transport format sizes, indicated in the following table, concern the RLC PDU size, since all configurations concern dedicated channels. The transport block sizes indicated in TS 34.108 are different since these include the size of the MAC header.

NOTE 5: The tabular values included in this subclause, represent the actual IE values as in clause 10, and not the ASN.1 representation of these values.

NOTE 5A: Default configuration identity 11 can not be used with release 4 UEs

NOTE 6: The difference between default configuration #22 and default configuration #1 (13.6 kbps signalling) resides in the RLC configuration and the DCH quality target

NOTE 7: The difference between default configuration #23 and default configuration #17 (Signalling on E-DCH & HS-DSCH) resides in the IE "E-DCH MAC-d flow identity" and IE "MAC-d Flow Identity" (6 in #23, 0 in #17), in IE "transmissionGrantType" (scheduledTransmissionGrantInfo in #23, non-ScheduledTransGrantInfo in #17) and in IE "Include in Scheduling Info" (TRUE in #23, FALSE in #17).

13.7.1 Default configuration 3.4 kbps signalling

Parameters	Value
Ref 34.108	2
Default configuration identity	0
RB INFORMATION	
rb-Identity	RB1: 1, RB2: 2, RB3: 3
rlc-InfoChoice	Rlc-info
>ul-RLC-Mode	RB1: UM RB2- RB3: AM
>>transmissionRLC-DiscardMode	RB1: N/A RB2- RB3: NoDiscard
>>>maxDat	RB1: N/A RB2- RB3: 15
>>transmissionWindowSize	RB1: N/A RB2- RB3: 128 for UEs with more than 10 kbyte "total RLC AM buffer size" and 32 otherwise
>>timerRST	RB1: N/A RB2- RB3: 300
>>max-RST	RB1: N/A RB2- RB3: 1
>>pollingInfo	RB1: N/A RB2- RB3: as below
>>>lastTransmissionPDU-Poll	RB2- RB3: FALSE
>>>lastRetransmissionPDU-Poll	RB2- RB3: FALSE
>>>timerPollPeriodic	RB2- RB3: 300
>>segmentationIndication	RB1- RB3: N/A
>dl-RLC-Mode	RB1: UM RB2- RB3: AM
>>inSequenceDelivery	RB1: N/A RB2- RB3: TRUE

Parameters	Value
>>receivingWindowSize	RB1: N/A RB2- RB3: 128 for UEs with more than 10 kbyte "total RLC AM buffer size" and 32 otherwise
>>dl-RLC-StatusInfo	RB1: N/A RB2- RB3: as below
>>>timerStatusProhibit	RB2- RB3: 100
>>>missingPDU-Indicator	RB2- RB3: FALSE
>>>timerStatusPeriodic	RB2- RB3: 300
>>segmentationIndication	RB1- RB3: N/A
rb-MappingInfo	
>UL-LogicalChannelMappings	OneLogicalChannel
>>ul-TransportChannelType	Dch
>>>transportChannelIdentity	RB1- RB3: 1
>>logicalChannelIdentity	RB1: 1, RB2: 2, RB3: 3
>>rlc-SizeList	RB1- RB3: configured
>>mac-LogicalChannelPriority	RB1: 1, RB2: 2, RB3: 3
>DL-logicalChannelMappingList	
>>Mapping option 1	One mapping option
>>>dl-TransportChannelType	Dch
>>>>transportChannelIdentity	RB1- RB3: 1
>>>logicalChannelIdentity	RB1: 1, RB2: 2, RB3: 3
TrCH INFORMATION PER TrCH	
UL-AddReconfTransChInfoList	
>Uplink transport channel type	dch
>transportChannelIdentity	TrCH1: 1
>transportFormatSet	DedicatedTransChTFS
>>dynamicTF-information	
>>>tf0/ tf0,1	TrCH1: (0x144, 1x144)
>>>>rlcSize	BitMode
>>>>>sizeType	TrCH1: type 2, part1= 2, part2= 0 (144)
>>>>numberOfTbSizeList	TrCH1: Zero, one
>>>>logicalChannelList	All
>>>tf 1	N/A
>>>>numberOfTransportBlocks	
>>>>rlc-Size	
>>>>>sizeType	
>>>>numberOfTbSizeList	
>>>>logicalChannelList	
>>>tf 2	N/A
>>>>numberOfTransportBlocks	
>>>>rlc-Size	
>>>>>sizeType	
>>>>numberOfTbSizeList	
>>>>logicalChannelList	
>>semistaticTF-Information	
>>>tti	TrCH1: 40
>>>channelCodingType	Convolutional
>>>>codingRate	TrCH1: Third
>>>rateMatchingAttribute	TrCH1: 160
>>>crc-Size	TrCH1: 16
DL-AddReconfTransChInfoList	
>Downlink transport channel type	dch
>dl-TransportChannelIdentity (should be as for UL)	TrCH1: 1
>tfs-SignallingMode	SameAsUL
>>transportFormatSet	
>>>dynamicTF-information	
>>>>tf0/ tf0,1	
>>>>rlcSize	
>>>>>sizeType	
>>>>numberOfTbSizeList	
>>>>logicalChannelList	
>>ULTrCH-Id	TrCH1: 1
>dch-QualityTarget	

Parameters	Value
>>bler-QualityValue	TrCH1: 5×10^{-2}
TrCH INFORMATION, COMMON	
ul-CommonTransChInfo	
>tfcs-ID (TDD only)	1
>sharedChannelIndicator (TDD only)	FALSE
>tfcs-Subset	Absent, not required
>ul-TFCS	Normal TFCI signalling
>>explicitTFCS-ConfigurationMode	Complete
>>>ctfcSize	Ctfc2Bit
>>>>TFCS representation	Addition
>>>>>TFCS list	
>>>>>>TFCS 1	(TF0)
>>>>>>>ctfc	0
>>>>>>>gainFactorInformation	Computed
>>>>>>>referenceTFCId	0
>>>>>>>TFCS 2	(TF1)
>>>>>>>ctfc	1
>>>>>>>gainFactorInformation	Signalled
>>>>>>> β_c (FDD only)	11
>>>>>>> β_d	15
>>>>>>>referenceTFCId	0
>>>>>>>TFCS 3	
>>>>>>>ctfc	
>>>>>>>gainFactorInformation	
>>>>>>>referenceTFCId	
>>>>>>>TFCS 4	
>>>>>>>ctfc	
>>>>>>>gainFactorInformation	
>>>>>>> β_c (FDD only)	
>>>>>>> β_d	
>>>>>>>referenceTFCId	
>>>>>>>TFCS 5	
>>>>>>>ctfc	
>>>>>>>gainFactorInformation	
>>>>>>>referenceTFCId	
>>>>>>>TFCS 6	
>>>>>>>ctfc	
>>>>>>>gainFactorInformation	
>>>>>>> β_c (FDD only)	
>>>>>>> β_d	
>>>>>>>referenceTFCId	
dl-CommonTransChInfo	
>tfcs-SignallingMode	Same as UL
PhyCH INFORMATION FDD	
UL-DPCH-InfoPredef	
>ul-DPCH-PowerControlInfo	
>>powerControlAlgorithm	Algorithm 1
>>>tpcStepSize	1 dB
>tfci-Existence	TRUE
>puncturingLimit	1
DL-CommonInformationPredef	
>dl-DPCH-InfoCommon	
>>spreadingFactor	256
>>tfci-Existence	FALSE
>>pilotBits	4
>>positionFixed	N/A
PhyCH INFORMATION 3.84/7.68 Mcps TDD	
UL-DPCH-InfoPredef	
>ul-DPCH-PowerControlInfo	
>>dpch-ConstantValue	0
>commonTimeslotInfo	

Parameters	Value
>>secondInterleavingMode	frameRelated
>>tfci-Coding	8
>>puncturingLimit	1
>>repetitionPeriodAndLength	repetitionPeriod1
DL-CommonInformationPredef	
>dl-DPCH-InfoCommon	
>>commonTimeslotInfo	
>>>secondInterleavingMode	frameRelated
>>>tfci-Coding	8
>>>puncturingLimit	1
>>>repetitionPeriodAndLength	repetitionPeriod1
PhyCH INFORMATION 1.28 Mcps TDD	
UL-DPCH-InfoPredef	
>commonTimeslotInfo	
>>secondInterleavingMode	frameRelated
>>tfci-Coding	8
>>puncturingLimit	1
>>repetitionPeriodAndLength	repetitionPeriod1
DL-CommonInformationPredef	
>dl-DPCH-InfoCommon	
>>commonTimeslotInfo	
>>>secondInterleavingMode	frameRelated
>>>tfci-Coding	8
>>>puncturingLimit	1
>>>repetitionPeriodAndLength	repetitionPeriod1

13.7.2 Default configuration 13.6 kbps signalling

Parameters	Value
Ref 34.108	1
Default configuration identity	1
RB INFORMATION	
rb-Identity	RB1: 1, RB2: 2, RB3: 3
rlc-InfoChoice	Rlc-info
>ul-RLC-Mode	RB1: UM RB2- RB3: AM
>>transmissionRLC-DiscardMode	RB1: N/A RB2- RB3: NoDiscard
>>>maxDat	RB1: N/A RB2- RB3: 15
>>transmissionWindowSize	RB1: N/A RB2- RB3: 128 for UEs with more than 10 kbyte "total RLC AM buffer size" and 32 otherwise
>>timerRST	RB1: N/A RB2- RB3: 300
>>max-RST	RB1: N/A RB2- RB3: 1
>>pollingInfo	RB1: N/A RB2- RB3: as below
>>>lastTransmissionPDU-Poll	RB2- RB3: FALSE
>>>lastRetransmissionPDU-Poll	RB2- RB3: FALSE
>>>timerPollPeriodic	RB2- RB3: 100
>>segmentationIndication	RB1- RB3: N/A
>dl-RLC-Mode	RB1: UM RB2- RB3: AM
>>inSequenceDelivery	RB1: N/A RB2- RB3: TRUE
>>receivingWindowSize	RB1: N/A RB2- RB3: 128 for UEs with more than 10 kbyte "total RLC AM buffer size" and 32 otherwise

Parameters	Value
>>dl-RLC-StatusInfo	RB1: N/A RB2- RB3: as below
>>>timerStatusProhibit	RB2- RB3: 100
>>>missingPDU-Indicator	RB2- RB3: FALSE
>>>timerStatusPeriodic	RB2- RB3: 100
>>segmentationIndication	RB1- RB3: N/A
rb-MappingInfo	
>UL-LogicalChannelMappings	OneLogicalChannel
>>ul-TransportChannelType	Dch
>>>transportChannelIdentity	RB1- RB3: 1
>>logicalChannelIdentity	RB1: 1, RB2: 2, RB3: 3
>>rlc-SizeList	RB1- RB3: configured
>>mac-LogicalChannelPriority	RB1: 1, RB2: 2, RB3: 3
>DL-logicalChannelMappingList	
>>Mapping option 1	One mapping option
>>>dl-TransportChannelType	Dch
>>>>transportChannelIdentity	RB1- RB3: 1
>>>>logicalChannelIdentity	RB1: 1, RB2: 2, RB3: 3
TrCH INFORMATION PER TrCH	
UL-AddReconfTransChInfoList	
>Uplink transport channel type	dch
>transportChannelIdentity	TrCH1: 1
>transportFormatSet	DedicatedTransChTFS
>>dynamicTF-information	
>>>tf0/ tf0,1	TrCH1: (0x144, 1x144)
>>>>rlcSize	BitMode
>>>>>sizeType	TrCH1: type 2, part1= 2, part2= 0 (144)
>>>>numberOfTbSizeList	TrCH1: Zero, one
>>>>logicalChannelList	All
>>>tf 1	N/A
>>>>numberOfTransportBlocks	
>>>>rlc-Size	
>>>>>sizeType	
>>>>numberOfTbSizeList	
>>>>logicalChannelList	
>>>tf 2	N/A
>>>>numberOfTransportBlocks	
>>>>rlc-Size	
>>>>>sizeType	
>>>>numberOfTbSizeList	
>>>>logicalChannelList	
>>semistaticTF-Information	
>>>tfti	TrCH1: 10
>>>channelCodingType	Convolutional
>>>>codingRate	TrCH1: Third
>>>rateMatchingAttribute	TrCH1: 160
>>>crc-Size	TrCH1: 16
DL-AddReconfTransChInfoList	
>Downlink transport channel type	dch
>dl-TransportChannelIdentity (should be as for UL)	TrCH1: 1
>tfs-SignallingMode	SameAsUL
>>transportFormatSet	
>>>dynamicTF-information	
>>>>tf0/ tf0,1	
>>>>rlcSize	
>>>>>sizeType	
>>>>numberOfTbSizeList	
>>>>logicalChannelList	
>>ULTrCH-Id	TrCH1: 1
>dch-QualityTarget	
>>bler-QualityValue	TrCH1: 5×10^{-2}
TrCH INFORMATION, COMMON	
ul-CommonTransChInfo	

Parameters	Value
>tfc-ID (TDD only)	1
>sharedChannelIndicator (TDD only)	FALSE
>tfc-Subset	Absent, not required
>ul-TFCS	Normal TFCI signalling
>>explicitTFCS-ConfigurationMode	Complete
>>>ctfcSize	Ctfc2Bit
>>>>TFCS representation	Addition
>>>>>TFCS list	
>>>>>>TFCS 1	(TF0)
>>>>>>>ctfc	0
>>>>>>>gainFactorInformation	Computed
>>>>>>>>referenceTFCId	0
>>>>>>>>TFCS 2	(TF1)
>>>>>>>>ctfc	1
>>>>>>>>gainFactorInformation	Signalled
>>>>>>>>> β c (FDD only)	11
>>>>>>>>> β d	15
>>>>>>>>>>referenceTFCId	0
>>>>>>>>>>TFCS 3	
>>>>>>>>>>>ctfc	
>>>>>>>>>>>gainFactorInformation	
>>>>>>>>>>>>referenceTFCId	
>>>>>>>>>>>>TFCS 4	
>>>>>>>>>>>>>ctfc	
>>>>>>>>>>>>>gainFactorInformation	
>>>>>>>>>>>>>> β c (FDD only)	
>>>>>>>>>>>>>> β d	
>>>>>>>>>>>>>>>referenceTFCId	
>>>>>>>>>>>>>>>>TFCS 5	
>>>>>>>>>>>>>>>>>ctfc	
>>>>>>>>>>>>>>>>>gainFactorInformation	
>>>>>>>>>>>>>>>>>>referenceTFCId	
>>>>>>>>>>>>>>>>>>>TFCS 6	
>>>>>>>>>>>>>>>>>>>>ctfc	
>>>>>>>>>>>>>>>>>>>>>gainFactorInformation	
>>>>>>>>>>>>>>>>>>>>>> β c (FDD only)	
>>>>>>>>>>>>>>>>>>>>>>> β d	
>>>>>>>>>>>>>>>>>>>>>>>>referenceTFCId	
dl-CommonTransChInfo	
>tfc-SignallingMode	Same as UL
PhyCH INFORMATION FDD	
UL-DPCH-InfoPredef	
>ul-DPCH-PowerControlInfo	
>>powerControlAlgorithm	Algorithm 1
>>>tpcStepSize	1 dB
>tfc-Existence	TRUE
>puncturingLimit	1
DL-CommonInformationPredef	
>dl-DPCH-InfoCommon	
>>spreadingFactor	128
>>tfc-Existence	FALSE
>>pilotBits	4
>>positionFixed	N/A
PhyCH INFORMATION 3.84/7.68 Mcps TDD	
UL-DPCH-InfoPredef	
>ul-DPCH-PowerControlInfo	
>>dpch-ConstantValue	0
>commonTimeslotInfo	
>>secondInterleavingMode	frameRelated
>>tfc-Coding	8
>>puncturingLimit	0.92
>>repetitionPeriodAndLength	repetitionPeriod1

Parameters	Value
DL-CommonInformationPredef	
>dl-DPCH-InfoCommon	
>>commonTimeslotInfo	
>>>secondInterleavingMode	frameRelated
>>>tfc-Coding	8
>>>puncturingLimit	0.92
>>>repetitionPeriodAndLength	repetitionPeriod1
PhyCH INFORMATION 1.28 Mcps TDD	
UL-DPCH-InfoPredef	
>commonTimeslotInfo	
>>secondInterleavingMode	frameRelated
>>tfc-Coding	8
>>puncturingLimit	0.64
>>repetitionPeriodAndLength	repetitionPeriod1
DL-CommonInformationPredef	
>dl-DPCH-InfoCommon	
>>commonTimeslotInfo	
>>>secondInterleavingMode	frameRelated
>>>tfc-Coding	8
>>>puncturingLimit	0.64
>>>repetitionPeriodAndLength	repetitionPeriod1

13.7.3 Default configuration 12.2 kbps Speech & 3.4 kbps signalling

Parameters	Value
Ref 34.108	4a
Default configuration identity	3
RB INFORMATION	
rb-Identity	RB1: 1, RB2: 2, RB3: 3, RB5: 5, RB6: 6, RB7: 7
rlc-InfoChoice	Rlc-info
>ul-RLC-Mode	RB1: UM RB2- RB3: AM RB5-RB7: TM
>>transmissionRLC-DiscardMode	RB1: N/A RB2- RB3: NoDiscard RB5- RB7: N/A
>>>maxDat	RB1: N/A RB2- RB3: 15 RB5- RB7: N/A
>>transmissionWindowSize	RB1: N/A RB2- RB3: 128 for UEs with more than 10 kbyte "total RLC AM buffer size" and 32 otherwise RB5- RB7: N/A
>>timerRST	RB1: N/A RB2- RB3: 300 RB5- RB7: N/A
>>max-RST	RB1: N/A RB2- RB3: 1 RB5- RB7: N/A
>>pollingInfo	RB1: N/A RB2- RB3: as below RB5- RB7: N/A
>>>lastTransmissionPDU-Poll	RB2- RB3: FALSE
>>>lastRetransmissionPDU-Poll	RB2- RB3: FALSE
>>>timerPollPeriodic	RB2- RB3: 300
>>segmentationIndication	RB1- RB3: N/A RB5- RB7: FALSE
>dl-RLC-Mode	RB1: UM RB2- RB3: AM RB5- RB7: TM

Parameters	Value
>>inSequenceDelivery	RB1: N/A RB2- RB3: TRUE RB5- RB7: N/A
>>receivingWindowSize	RB1: N/A RB2- RB3: 128 for UEs with more than 10 kbyte "total RLC AM buffer size" and 32 otherwise RB5- RB7: N/A
>>dl-RLC-StatusInfo	RB1: N/A RB2- RB3: as below RB5- RB7: N/A
>>>timerStatusProhibit	RB2- RB3: 100
>>>missingPDU-Indicator	RB2- RB3: FALSE
>>>timerStatusPeriodic	RB2- RB3: 300
>>segmentationIndication	RB1- RB3: N/A RB5- RB7: FALSE
rb-MappingInfo	
>UL-LogicalChannelMappings	OneLogicalChannel
>>ul-TransportChannelType	Dch
>>>transportChannelIdentity	RB1- RB3: 4 RB5: 1, RB6: 2, RB7: 3
>>logicalChannelIdentity	RB1: 1, RB2: 2, RB3: 3 RB5- RB7: N/A
>>rlc-SizeList	RB1- RB3: configured RB5- RB7: N/A
>>mac-LogicalChannelPriority	RB1: 1, RB2: 2, RB3: 3 RB5- RB7: 5
>DL-logicalChannelMappingList	
>>Mapping option 1	One mapping option
>>>dl-TransportChannelType	Dch
>>>>transportChannelIdentity	RB1- RB3: 4 RB5: 1, RB6: 2, RB7: 3
>>>logicalChannelIdentity	RB1: 1, RB2: 2, RB3: 3 RB5- RB7: N/A
TrCH INFORMATION PER TrCH	
UL-AddReconfTransChInfoList	
>Uplink transport channel type	dch
>transportChannelIdentity	TrCH1: 1, TrCH2: 2, TrCH3: 3, TrCH4: 4
>transportFormatSet	DedicatedTransChTFS
>>dynamicTF-information	
>>>tf0/ tf0,1	TrCH1: (0x81) TrCH2: (0x 103, 1x103) TrCH3: (0x 60, 1x60) TrCH4: (0x144, 1x144)
>>>>rlcSize	BitMode
>>>>>sizeType	TrCH1: type 1: 81 TrCH2: type 1: 103 TrCH3: type 1: 60 TrCH4: 2: type 2, part1= 2, part2= 0 (144)
>>>>numberOfTbSizeList	TrCH1: Zero TrCH2-4: Zero, one
>>>>logicalChannelList	All
>>>>tf 1	TrCH1: (1x39) TrCH2- TrCH4: N/A
>>>>numberOfTransportBlocks	TrCH1: One
>>>>rlc-Size	TrCH1: BitMode
>>>>>sizeType	TrCH1: 1: 39
>>>>>numberOfTbSizeList	TrCH1: One
>>>>>logicalChannelList	TrCH1: all
>>>>tf 2	TrCH1: (1x81) TrCH2- TrCH4: N/A
>>>>numberOfTransportBlocks	TrCH1: One
>>>>rlc-Size	TrCH1: BitMode
>>>>>sizeType	TrCH1: type 1: 81
>>>>>numberOfTbSizeList	TrCH1: One

Parameters	Value
>>>>logicalChannelList	TrCH1: all
>>semistaticTF-Information	
>>>tfti	TrCH1- TrCH3: 20 TrCH4: 40
>>>channelCodingType	Convolutional
>>>>codingRate	TrCH1- TrCH2: Third TrCH3: Half TrCH4: Third
>>>rateMatchingAttribute	TrCH1: 200 TrCH2: 190 TrCH3: 235 TrCH4: 160
>>>crc-Size	TrCH1: 12 TrCH2- TrCH3: 0 TrCH4: 16
DL-AddReconfTransChInfoList	
>Downlink transport channel type	dch
>dl-TransportChannelIdentity (should be as for UL)	TrCH1: 1, TrCH2: 2, TrCH3: 3, TrCH4: 4
>tfs-SignallingMode	Explicit <Only tf0 on TrCH1 is different and shown below>
>>transportFormatSet	DedicatedTransChTFS
>>>dynamicTF-information	
>>>>tf0/ tf0,1	TrCH1: (1x0)
>>>>rlcSize	bitMode
>>>>>sizeType	TrCH1: type 1: 0
>>>>numberOfTbSizeList	TrCH1: One
>>>>>logicalChannelList	All
>>ULTrCH-Id	TrCH1: 1, TrCH2: 2, TrCH3: 3, TrCH4: 4
>dch-QualityTarget	
>>bler-QualityValue	TrCH1: 7×10^{-3} TrCH2- TrCH4: Absent
TrCH INFORMATION, COMMON	
ul-CommonTransChInfo	
>tfc-ID (TDD only)	1
>sharedChannelIndicator (TDD only)	FALSE
>tfc-Subset	Absent, not required
>ul-TFCS	Normal TFCS signalling
>>explicitTFCS-ConfigurationMode	Complete
>>>ctfcSize	Ctfc6Bit
>>>>TFCS representation	Addition
>>>>>TFCS list	
>>>>>>TFCS 1	(TF0, TF0, TF0, TF0)
>>>>>>>ctfc	0
>>>>>>>>gainFactorInformation	Computed
>>>>>>>>referenceTFCSId	0
>>>>>>>TFCS 2	(TF1, TF0, TF0, TF0)
>>>>>>>>ctfc	1
>>>>>>>>gainFactorInformation	Computed
>>>>>>>>> β_c (FDD only)	N/A
>>>>>>>>> β_d	N/A
>>>>>>>>>referenceTFCSId	0
>>>>>>>TFCS 3	(TF2, TF1, TF1, TF0)
>>>>>>>>ctfc	11
>>>>>>>>>gainFactorInformation	Computed
>>>>>>>>>referenceTFCSId	0
>>>>>>>TFCS 4	(TF0, TF0, TF0, TF1)
>>>>>>>>ctfc	12
>>>>>>>>>gainFactorInformation	Computed
>>>>>>>>>> β_c (FDD only)	N/A
>>>>>>>>>> β_d	N/A
>>>>>>>>>>referenceTFCSId	0
>>>>>>>TFCS 5	(TF1, TF0, TF0, TF1)

Parameters	Value
>>>>>>ctfc	13
>>>>>>gainFactorInformation	Computed
>>>>>>referenceTFCId	0
>>>>>TFCS 6	(TF2, TF1, TF1, TF1)
>>>>>>ctfc	23
>>>>>>gainFactorInformation	Signalled
>>>>>> β_c (FDD only)	11
>>>>>> β_d	15
>>>>>>referenceTFCId	0
dl-CommonTransChInfo	
>tfc-SignallingMode	Same as UL
PhyCH INFORMATION FDD	
UL-DPCH-InfoPredef	
>ul-DPCH-PowerControlInfo	
>>powerControlAlgorithm	Algorithm 1
>>>tpcStepSize	1 dB
>tfc-Existence	TRUE
>puncturingLimit	0.88
DL-CommonInformationPredef	
>dl-DPCH-InfoCommon	
>>spreadingFactor	128
>>tfc-Existence	FALSE
>>pilotBits	4
>>positionFixed	Fixed
PhyCH INFORMATION 3.84/7.68 Mcps TDD	
UL-DPCH-InfoPredef	
>ul-DPCH-PowerControlInfo	
>>dpch-ConstantValue	0
>commonTimeslotInfo	
>>secondInterleavingMode	frameRelated
>>tfc-Coding	16
>>puncturingLimit	0.88
>>repetitionPeriodAndLength	repetitionPeriod1
DL-CommonInformationPredef	
>dl-DPCH-InfoCommon	
>>commonTimeslotInfo	
>>>secondInterleavingMode	frameRelated
>>>tfc-Coding	16
>>>puncturingLimit	0.92
>>>repetitionPeriodAndLength	repetitionPeriod1
PhyCH INFORMATION 1.28 Mcps TDD	
UL-DPCH-InfoPredef	
>commonTimeslotInfo	
>>secondInterleavingMode	frameRelated
>>tfc-Coding	16
>>puncturingLimit	0.60
>>repetitionPeriodAndLength	repetitionPeriod1
DL-CommonInformationPredef	
>dl-DPCH-InfoCommon	
>>commonTimeslotInfo	
>>>secondInterleavingMode	frameRelated
>>>tfc-Coding	16
>>>puncturingLimit	0.60
>>>repetitionPeriodAndLength	repetitionPeriod1

13.7.4 Default configuration 28.8 kbps conv. CS- data & 3.4 kbps signalling

Parameters	Value
Ref 34.108	4a
Default configuration identity	4
RB INFORMATION	

Parameters	Value
rb-Identity	RB1: 1, RB2: 2, RB3: 3, RB5: 5
rlc-InfoChoice	Rlc-info
>ul-RLC-Mode	RB1: UM RB2- RB3: AM RB5: TM
>>transmissionRLC-DiscardMode	RB1: N/A RB2- RB3: NoDiscard RB5: N/A
>>>maxDat	RB1: N/A RB2- RB3: 15 RB5: N/A
>>transmissionWindowSize	RB1: N/A RB2- RB3: 128 for UEs with more than 10 kbyte "total RLC AM buffer size" and 32 otherwise RB5: N/A
>>timerRST	RB1: N/A RB2- RB3: 300 RB5: N/A
>>max-RST	RB1: N/A RB2- RB3: 1 RB5: N/A
>>pollingInfo	RB1: N/A RB2- RB3: as below RB5: N/A
>>>lastTransmissionPDU-Poll	RB2- RB3: FALSE
>>>lastRetransmissionPDU-Poll	RB2- RB3: FALSE
>>>timerPollPeriodic	RB2- RB3: 300
>>segmentationIndication	RB1- RB3: N/A RB5: FALSE
>dl-RLC-Mode	RB1: UM RB2- RB3: AM RB5: TM
>>inSequenceDelivery	RB1: N/A RB2- RB3: TRUE RB5: N/A
>>receivingWindowSize	RB1: N/A RB2- RB3: 128 for UEs with more than 10 kbyte "total RLC AM buffer size" and 32 otherwise RB5: N/A
>>dl-RLC-StatusInfo	RB1: N/A RB2- RB3: as below RB5: N/A
>>>timerStatusProhibit	RB2- RB3: 100
>>>missingPDU-Indicator	RB2- RB3: FALSE
>>>timerStatusPeriodic	RB2- RB3: 300
>>segmentationIndication	RB1- RB3: N/A RB5: FALSE
rb-MappingInfo	
>UL-LogicalChannelMappings	OneLogicalChannel
>>ul-TransportChannelType	Dch
>>>transportChannelIdentity	RB1- RB3: 2 RB5: 1
>>logicalChannelIdentity	RB1: 1, RB2: 2, RB3: 3 RB5: N/A
>>rlc-SizeList	RB1- RB3: configured RB5: N/A
>>mac-LogicalChannelPriority	RB1: 1, RB2: 2, RB3: 3 RB5: 5
>DL-logicalChannelMappingList	
>>Mapping option 1	One mapping option
>>>dl-TransportChannelType	Dch
>>>>transportChannelIdentity	RB1- RB3: 2 RB5: 1
>>>logicalChannelIdentity	RB1: 1, RB2: 2, RB3: 3 RB5: N/A

Parameters	Value
TrCH INFORMATION PER TrCH	
UL-AddReconfTransChInfoList	
>Uplink transport channel type	dch
>transportChannelIdentity	TrCH1: 1, TrCH2: 2
>transportFormatSet	DedicatedTransChTFS
>>dynamicTF-information	
>>>tf0/ tf0,1	TrCH1: (0x576, 1x576, 2x576) TrCH2: (0x144, 1x144)
>>>>rlcSize	TrCH1: OctetMode TrCH2: BitMode
>>>>>sizeType	TrCH1: type 2, part1= 9, part2= 2 (576) TrCH2: type 2, part1= 2, part2= 0 (144)
>>>>numberOfTbSizeList	TrCH1: Zero,1, 2 TrCH2: Zero, one
>>>>logicalChannelList	All
>>semiStaticTF-Information	
>>>tii	TrCH1: 40 TrCH2: 40
>>>channelCodingType	TrCH1: Turbo TrCH2: Convolutional
>>>>codingRate	TrCH1: N/A TrCH2: Third
>>>rateMatchingAttribute	TrCH1: 180 TrCH2: 160
>>>crc-Size	TrCH1: 16 TrCH2: 16
DL-AddReconfTransChInfoList	
>Downlink transport channel type	dch
>dl-TransportChannelIdentity (should be as for UL)	TrCH1: 1, TrCH2: 2
>tfs-SignallingMode	SameAsUL
>>transportFormatSet	
>>>dynamicTF-information	
>>>>tf0/ tf0,1	
>>>>rlcSize	
>>>>>sizeType	
>>>>numberOfTbSizeList	
>>>>logicalChannelList	
>>ULTrCH-Id	TrCH1: 1, TrCH2: 2
>dch-QualityTarget	
>>bler-QualityValue	TrCH1: 2×10^{-3} TrCH2: Absent
TrCH INFORMATION, COMMON	
ul-CommonTransChInfo	
>tfc-ID (TDD only)	1
>sharedChannelIndicator (TDD only)	FALSE
>tfc-Subset	Absent, not required
>ul-TFCS	Normal TFCl signalling
>>explicitTFCS-ConfigurationMode	Complete
>>>ctfcSize	Ctfc4Bit
>>>>TFCS representation	Addition
>>>>>TFCS list	
>>>>>>TFCS 1	(TF0, TF0)
>>>>>>>ctfc	0
>>>>>>>gainFactorInformation	Computed
>>>>>>>referenceTFClId	0
>>>>>>>TFCS 2	(TF1, TF0)
>>>>>>>ctfc	1
>>>>>>>gainFactorInformation	Computed
>>>>>>>> β c (FDD only)	N/A
>>>>>>>> β d	N/A
>>>>>>>>referenceTFClId	0
>>>>>>>>TFCS 3	(TF2, TF0)
>>>>>>>>ctfc	2

Parameters	Value
>>>>>>gainFactorInformation	Computed
>>>>>>referenceTFCLd	0
>>>>>TFCS 4	(TF0, TF1)
>>>>>>ctfc	3
>>>>>>gainFactorInformation	Computed
>>>>>> β c (FDD only)	N/A
>>>>>> β d	N/A
>>>>>>referenceTFCLd	0
>>>>>TFCS 5	(TF1, TF1)
>>>>>>ctfc	4
>>>>>>gainFactorInformation	Computed
>>>>>>referenceTFCLd	0
>>>>>TFCS 6	(TF2, TF1)
>>>>>>ctfc	5
>>>>>>gainFactorInformation	Signalled
>>>>>> β c (FDD only)	8
>>>>>> β d	15
>>>>>>referenceTFCLd	0
>>>>>TFCS 7	
>>>>>>ctfc	
>>>>>>gainFactorInformation	
>>>>>>referenceTFCLd	
>>>>>TFCS 8	
>>>>>>ctfc	
>>>>>>gainFactorInformation	
>>>>>>referenceTFCLd	
>>>>>TFCS 9	
>>>>>>ctfc	
>>>>>>gainFactorInformation	
>>>>>>referenceTFCLd	
>>>>>TFCS 10	
>>>>>>ctfc	
>>>>>>gainFactorInformation	
>>>>>> β c (FDD only)	
>>>>>> β d	
>>>>>>referenceTFCLd	
dl-CommonTransChInfo	
>tfcs-SignallingMode	Same as UL
PhyCH INFORMATION FDD	
UL-DPCH-InfoPredef	
>ul-DPCH-PowerControllInfo	
>>powerControlAlgorithm	Algorithm 1
>>>tpcStepSize	1 dB
>tfci-Existence	TRUE
>puncturingLimit	0.92
DL-CommonInformationPredef	
>dl-DPCH-InfoCommon	
>>spreadingFactor	64
>>tfci-Existence	TRUE
>>pilotBits	8
>>positionFixed	Flexible
PhyCH INFORMATION 3.84/7.68 Mcps TDD	
UL-DPCH-InfoPredef	
>ul-DPCH-PowerControllInfo	
>>dpch-ConstantValue	0
>commonTimeslotInfo	
>>secondInterleavingMode	frameRelated
>>tfci-Coding	16
>>puncturingLimit	0.44
>>repetitionPeriodAndLength	repetitionPeriod1
DL-CommonInformationPredef	
>dl-DPCH-InfoCommon	

Parameters	Value
>>commonTimeslotInfo	
>>>secondInterleavingMode	frameRelated
>>>tfc-Coding	16
>>>puncturingLimit	0.44
>>>repetitionPeriodAndLength	repetitionPeriod1
PhyCH INFORMATION 1.28 Mcps TDD	
UL-DPCH-InfoPredef	
>commonTimeslotInfo	
>>secondInterleavingMode	frameRelated
>>tfc-Coding	16
>>puncturingLimit	0.64
>>repetitionPeriodAndLength	repetitionPeriod1
DL-CommonInformationPredef	
>dl-DPCH-InfoCommon	
>>commonTimeslotInfo	
>>>secondInterleavingMode	frameRelated
>>>tfc-Coding	16
>>>puncturingLimit	0.64
>>>repetitionPeriodAndLength	repetitionPeriod1

13.7.5 Default configuration 32 kbps conversational CS- data & 3.4 kbps signalling

Parameters	Value
Ref 34.108	4a
Default configuration identity	5
RB INFORMATION	
rb-Identity	RB1: 1, RB2: 2, RB3: 3, RB5: 5
rlc-InfoChoice	Rlc-info
>ul-RLC-Mode	RB1: UM RB2- RB3: AM RB5: TM
>>transmissionRLC-DiscardMode	RB1: N/A RB2- RB3: NoDiscard RB5: N/A
>>>maxDat	RB1: N/A RB2- RB3: 15 RB5: N/A
>>transmissionWindowSize	RB1: N/A RB2- RB3: 128 for UEs with more than 10 kbyte "total RLC AM buffer size" and 32 otherwise RB5: N/A
>>timerRST	RB1: N/A RB2- RB3: 300 RB5: N/A
>>max-RST	RB1: N/A RB2- RB3: 1 RB5: N/A
>>pollingInfo	RB1: N/A RB2- RB3: as below RB5: N/A
>>>lastTransmissionPDU-Poll	RB2- RB3: FALSE
>>>lastRetransmissionPDU-Poll	RB2- RB3: FALSE
>>>timerPollPeriodic	RB2- RB3: 300
>>segmentationIndication	RB1- RB3: N/A RB5: FALSE
>dl-RLC-Mode	RB1: UM RB2- RB3: AM RB5: TM
>>inSequenceDelivery	RB1: N/A RB2- RB3: TRUE RB5: N/A

Parameters	Value
>>receivingWindowSize	RB1: N/A RB2- RB3: 128 for UEs with more than 10 kbyte "total RLC AM buffer size" and 32 otherwise RB5: N/A
>>dl-RLC-StatusInfo	RB1: N/A RB2- RB3: as below RB5: N/A
>>>timerStatusProhibit	RB2- RB3: 100
>>>missingPDU-Indicator	RB2- RB3: FALSE
>>>timerStatusPeriodic	RB2- RB3: 300
>>segmentationIndication	RB1- RB3: N/A RB5: FALSE
rb-MappingInfo	
>UL-LogicalChannelMappings	OneLogicalChannel
>>ul-TransportChannelType	Dch
>>>transportChannelIdentity	RB1- RB3: 2 RB5: 1
>>logicalChannelIdentity	RB1: 1, RB2: 2, RB3: 3 RB5: N/A
>>rlc-SizeList	RB1- RB3: configured RB5: N/A
>>mac-LogicalChannelPriority	RB1: 1, RB2: 2, RB3: 3 RB5: 5
>DL-logicalChannelMappingList	
>>Mapping option 1	One mapping option
>>>dl-TransportChannelType	Dch
>>>>transportChannelIdentity	RB1- RB3: 2 RB5: 1
>>>logicalChannelIdentity	RB1: 1, RB2: 2, RB3: 3 RB5: N/A
TrCH INFORMATION PER TrCH	
UL-AddReconfTransChInfoList	
>Uplink transport channel type	dch
>transportChannelIdentity	TrCH1: 1, TrCH2: 2
>transportFormatSet	DedicatedTransChTFS
>>dynamicTF-information	
>>>tf0/ tf0,1	TrCH1: (0x640, 1x640) TrCH2: (0x144, 1x144)
>>>>rlcSize	TrCH1: OctetMode TrCH2:BitMode
>>>>>sizeType	TrCH1: type 2, part1= 11, part2= 2 (640) TrCH2: type 2, part1= 2, part2= 0 (144)
>>>>numberOfTbSizeList	TrCH1: Zero, one TrCH2: Zero, one
>>>>logicalChannelList	All
>>semiStaticTF-Information	
>>>tti	TrCH1: 20 TrCH2: 40
>>>>channelCodingType	TrCH1: Turbo TrCH2: Convolutional
>>>>>codingRate	TrCH1: N/A TrCH2: Third
>>>>rateMatchingAttribute	TrCH1: 185 TrCH2: 160
>>>>crc-Size	TrCH1: 16 TrCH2: 16
DL-AddReconfTransChInfoList	
>Downlink transport channel type	dch
>dl-TransportChannelIdentity (should be as for UL)	TrCH1: 1, TrCH2: 2
>tfs-SignallingMode	SameAsUL
>>transportFormatSet	
>>>dynamicTF-information	
>>>>tf0/ tf0,1	
>>>>>rlcSize	

Parameters	Value
>>>>sizeType	
>>>>numberOfTbSizeList	
>>>>logicalChannelList	
>>ULTrCH-Id	TrCH1: 1, TrCH2: 2
>dch-QualityTarget	
>>bler-QualityValue	TrCH1: 2×10^{-3} TrCH2: Absent
TrCH INFORMATION, COMMON	
ul-CommonTransChInfo	
>tfcs-ID (TDD only)	1
>sharedChannelIndicator (TDD only)	FALSE
>tfcs-Subset	Absent, not required
>ul-TFCS	Normal TFCS signalling
>>explicitTFCS-ConfigurationMode	Complete
>>>ctfcSize	Ctfc2Bit
>>>>TFCS representation	Addition
>>>>TFCS list	
>>>>>TFCS 1	(TF0, TF0)
>>>>>>ctfc	0
>>>>>>gainFactorInformation	Computed
>>>>>>referenceTFCSId	0
>>>>>TFCS 2	(TF1, TF0)
>>>>>>ctfc	1
>>>>>>gainFactorInformation	Computed
>>>>>> β_c (FDD only)	N/A
>>>>>> β_d	N/A
>>>>>>referenceTFCSId	0
>>>>>TFCS 3	(TF0, TF1)
>>>>>>ctfc	2
>>>>>>gainFactorInformation	Computed
>>>>>>referenceTFCSId	0
>>>>>TFCS 4	(TF1, TF1)
>>>>>>ctfc	3
>>>>>>gainFactorInformation	Signalled
>>>>>> β_c (FDD only)	8
>>>>>> β_d	15
>>>>>>referenceTFCSId	0
>>>>>TFCS 5	N/A
>>>>>>ctfc	
>>>>>>gainFactorInformation	
>>>>>>referenceTFCSId	
>>>>>TFCS 6	N/A
>>>>>>ctfc	
>>>>>>gainFactorInformation	
>>>>>> β_c (FDD only)	
>>>>>> β_d	
>>>>>>referenceTFCSId	
>>>>>TFCS 7	
>>>>>>ctfc	
>>>>>>gainFactorInformation	
>>>>>>referenceTFCSId	
>>>>>TFCS 8	
>>>>>>ctfc	
>>>>>>gainFactorInformation	
>>>>>>referenceTFCSId	
>>>>>TFCS 9	
>>>>>>ctfc	
>>>>>>gainFactorInformation	
>>>>>>referenceTFCSId	
>>>>>TFCS 10	
>>>>>>ctfc	

Parameters	Value
>>>>>>gainFactorInformation	
>>>>>>>>βc (FDD only)	
>>>>>>>>βd	
>>>>>>>>referenceTFCId	
dl-CommonTransChInfo	
>tfcs-SignallingMode	Same as UL
PhyCH INFORMATION FDD	
UL-DPCH-InfoPredef	
>ul-DPCH-PowerControlInfo	
>>powerControlAlgorithm	Algorithm 1
>>>tpcStepSize	1 dB
>tfci-Existence	TRUE
>puncturingLimit	0.8
DL-CommonInformationPredef	
>dl-DPCH-InfoCommon	
>>spreadingFactor	64
>>tfci-Existence	TRUE
>>pilotBits	8
>>positionFixed	Flexible
PhyCH INFORMATION 3.84/7.68 Mcps TDD	
UL-DPCH-InfoPredef	
>ul-DPCH-PowerControlInfo	
>>dpch-ConstantValue	0
>commonTimeslotInfo	
>>secondInterleavingMode	frameRelated
>>tfci-Coding	16
>>puncturingLimit	0.8
>>repetitionPeriodAndLength	repetitionPeriod1
DL-CommonInformationPredef	
>dl-DPCH-InfoCommon	
>>commonTimeslotInfo	
>>>secondInterleavingMode	frameRelated
>>>tfci-Coding	16
>>>puncturingLimit	0.64
>>>repetitionPeriodAndLength	repetitionPeriod1
PhyCH INFORMATION 1.28 Mcps TDD	
UL-DPCH-InfoPredef	
>commonTimeslotInfo	
>>secondInterleavingMode	frameRelated
>>tfci-Coding	16
>>puncturingLimit	0.60
>>repetitionPeriodAndLength	repetitionPeriod1
DL-CommonInformationPredef	
>dl-DPCH-InfoCommon	
>>commonTimeslotInfo	
>>>secondInterleavingMode	frameRelated
>>>tfci-Coding	16
>>>puncturingLimit	0.60
>>>repetitionPeriodAndLength	repetitionPeriod1

13.7.6 Default configuration 64 kbps conversational CS- data & 3.4 kbps signalling

Parameters	Value
Ref 34.108	4a
Default configuration identity	6
RB INFORMATION	
rb-Identity	RB1: 1, RB2: 2, RB3: 3, RB5: 5
rlc-InfoChoice	Rlc-info

Parameters	Value
>ul-RLC-Mode	RB1: UM RB2- RB3: AM RB5: TM
>>transmissionRLC-DiscardMode	RB1: N/A RB2- RB3: NoDiscard RB5: N/A
>>>maxDat	RB1: N/A RB2- RB3: 15 RB5: N/A
>>transmissionWindowSize	RB1: N/A RB2- RB3: 128 for UEs with more than 10 kbyte "total RLC AM buffer size" and 32 otherwise RB5: N/A
>>timerRST	RB1: N/A RB2- RB3: 300 RB5: N/A
>>max-RST	RB1: N/A RB2- RB3: 1 RB5: N/A
>>pollingInfo	RB1: N/A RB2- RB3: as below RB5: N/A
>>>lastTransmissionPDU-Poll	RB2- RB3: FALSE
>>>lastRetransmissionPDU-Poll	RB2- RB3: FALSE
>>>timerPollPeriodic	RB2- RB3: 300
>>segmentationIndication	RB1- RB3: N/A RB5: FALSE
>dl-RLC-Mode	RB1: UM RB2- RB3: AM RB5: TM
>>inSequenceDelivery	RB1: N/A RB2- RB3: TRUE RB5: N/A
>>receivingWindowSize	RB1: N/A RB2- RB3: 128 for UEs with more than 10 kbyte "total RLC AM buffer size" and 32 otherwise RB5: N/A
>>dl-RLC-StatusInfo	RB1: N/A RB2- RB3: as below RB5: N/A
>>>timerStatusProhibit	RB2- RB3: 100
>>>missingPDU-Indicator	RB2- RB3: FALSE
>>>timerStatusPeriodic	RB2- RB3: 300
>>segmentationIndication	RB1- RB3: N/A RB5: FALSE
rb-MappingInfo	
>UL-LogicalChannelMappings	OneLogicalChannel
>>ul-TransportChannelType	Dch
>>>transportChannelIdentity	RB1- RB3: 2 RB5: 1
>>logicalChannelIdentity	RB1: 1, RB2: 2, RB3: 3 RB5: N/A
>>rlc-SizeList	RB1- RB3: configured RB5: N/A
>>mac-LogicalChannelPriority	RB1: 1, RB2: 2, RB3: 3 RB5: 5
>DL-logicalChannelMappingList	
>>Mapping option 1	One mapping option
>>>dl-TransportChannelType	Dch
>>>>transportChannelIdentity	RB1- RB3: 2 RB5: 1
>>>logicalChannelIdentity	RB1: 1, RB2: 2, RB3: 3 RB5: N/A
TrCH INFORMATION PER TrCH	
UL-AddReconfTransChInfoList	

Parameters	Value
>Uplink transport channel type	dch
>transportChannelIdentity	TrCH1: 1, TrCH2: 2
>transportFormatSet	DedicatedTransChTFS
>>dynamicTF-information	
>>>tf0/ tf0,1	TrCH1: (0x640, 2x640) TrCH2: (0x144, 1x144)
>>>>rlcSize	TrCH1: OctetMode TrCH2: BitMode
>>>>>sizeType	TrCH1: type 2, part1= 11, part2= 2 (640) TrCH2: type 2, part1= 2, part2= 0 (144)
>>>>numberOfTbSizeList	TrCH1: Zero, 2 TrCH2: Zero, one
>>>>logicalChannelList	All
>>semiStaticTF-Information	
>>>tti	TrCH1: 20 TrCH2: 40
>>>channelCodingType	TrCH1: Turbo TrCH2: Convolutional
>>>>codingRate	TrCH1: N/A TrCH2: Third
>>>rateMatchingAttribute	TrCH1: 170 TrCH2: 160
>>>crc-Size	TrCH1: 16 TrCH2: 16
DL-AddReconfTransChInfoList	
>Downlink transport channel type	dch
>dl-TransportChannelIdentity (should be as for UL)	TrCH1: 1, TrCH2: 2
>fs-SignallingMode	SameAsUL
>>transportFormatSet	
>>>dynamicTF-information	
>>>>tf0/ tf0,1	
>>>>rlcSize	
>>>>>sizeType	
>>>>numberOfTbSizeList	
>>>>logicalChannelList	
>>ULTrCH-Id	TrCH1: 1, TrCH2: 2
>dch-QualityTarget	
>>bler-QualityValue	TrCH1: 2×10^{-3} TrCH2: Absent
TrCH INFORMATION, COMMON	
ul-CommonTransChInfo	
>tfcs-ID (TDD only)	1
>sharedChannelIndicator (TDD only)	FALSE
>tfcs-Subset	Absent, not required
>ul-TFCS	Normal TFCS signalling
>>explicitTFCS-ConfigurationMode	Complete
>>>ctfcSize	Ctfc2Bit
>>>>TFCS representation	Addition
>>>>>TFCS list	
>>>>>>TFCS 1	(TF0, TF0)
>>>>>>>ctfc	0
>>>>>>>>gainFactorInformation	Computed
>>>>>>>>>referenceTFCSId	0
>>>>>>>>>TFCS 2	(TF1, TF0)
>>>>>>>>>>ctfc	1
>>>>>>>>>>>gainFactorInformation	Computed
>>>>>>>>>>>> β c (FDD only)	N/A
>>>>>>>>>>>>> β d	N/A
>>>>>>>>>>>>>>referenceTFCSId	0
>>>>>>>>>>>>>>>TFCS 3	(TF0, TF1)
>>>>>>>>>>>>>>>>ctfc	2
>>>>>>>>>>>>>>>>>gainFactorInformation	Computed
>>>>>>>>>>>>>>>>>>referenceTFCSId	0

Parameters	Value
>>>>>TFCS 4	(TF1, TF1)
>>>>>ctfc	3
>>>>>gainFactorInformation	Signalled
>>>>>> β c (FDD only)	8
>>>>>> β d	15
>>>>>>referenceTFClId	0
>>>>>TFCS 5	N/A
>>>>>ctfc	
>>>>>gainFactorInformation	
>>>>>>referenceTFClId	
>>>>>TFCS 6	N/A
>>>>>ctfc	
>>>>>gainFactorInformation	
>>>>>> β c (FDD only)	
>>>>>> β d	
>>>>>>referenceTFClId	
>>>>>TFCS 7	
>>>>>ctfc	
>>>>>gainFactorInformation	
>>>>>>referenceTFClId	
>>>>>TFCS 8	
>>>>>ctfc	
>>>>>gainFactorInformation	
>>>>>>referenceTFClId	
>>>>>TFCS 9	
>>>>>ctfc	
>>>>>gainFactorInformation	
>>>>>>referenceTFClId	
>>>>>TFCS 10	
>>>>>ctfc	
>>>>>gainFactorInformation	
>>>>>> β c (FDD only)	
>>>>>> β d	
>>>>>>referenceTFClId	
dl-CommonTransChInfo	
>tfcs-SignallingMode	Same as UL
PhyCH INFORMATION FDD	
UL-DPCH-InfoPredef	
>ul-DPCH-PowerControllInfo	
>>powerControlAlgorithm	Algorithm 1
>>tpcStepSize	1 dB
>tfci-Existence	TRUE
>puncturingLimit	0.92
DL-CommonInformationPredef	
>dl-DPCH-InfoCommon	
>>spreadingFactor	32
>>tfci-Existence	TRUE
>>pilotBits	8
>>positionFixed	Flexible
PhyCH INFORMATION 3.84/7.68 Mcps TDD	
UL-DPCH-InfoPredef	
>ul-DPCH-PowerControllInfo	
>>dpch-ConstantValue	0
>commonTimeslotInfo	
>>secondInterleavingMode	frameRelated
>>tfci-Coding	16
>>puncturingLimit	0.56
>>repetitionPeriodAndLength	repetitionPeriod1
DL-CommonInformationPredef	
>dl-DPCH-InfoCommon	
>>commonTimeslotInfo	
>>>secondInterleavingMode	frameRelated

Parameters	Value
>>>tfci-Coding	16
>>>puncturingLimit	0.56
>>>repetitionPeriodAndLength	repetitionPeriod1
PhyCH INFORMATION 1.28 Mcps TDD	
UL-DPCH-InfoPredef	
>commonTimeslotInfo	
>>secondInterleavingMode	frameRelated
>>tfci-Coding	16
>>puncturingLimit	0.64
>>repetitionPeriodAndLength	repetitionPeriod1
DL-CommonInformationPredef	
>dl-DPCH-InfoCommon	
>>commonTimeslotInfo	
>>>secondInterleavingMode	frameRelated
>>>tfci-Coding	16
>>>puncturingLimit	0.64
>>>repetitionPeriodAndLength	repetitionPeriod1

13.7.7 Default configuration 14.4 kbps streaming CS- data & 3.4 kbps signalling

Parameters	Value
Ref 34.108	2
Default configuration identity	7
RB INFORMATION	
rb-Identity	RB1: 1, RB2: 2, RB3: 3, RB5: 5
rlc-InfoChoice	Rlc-info
>ul-RLC-Mode	RB1: UM RB2- RB3: AM RB5: TM
>>transmissionRLC-DiscardMode	RB1: N/A RB2- RB3: NoDiscard RB5: N/A
>>>maxDat	RB1: N/A RB2- RB3: 15 RB5: N/A
>>transmissionWindowSize	RB1: N/A RB2- RB3: 128 for UEs with more than 10 kbyte "total RLC AM buffer size" and 32 otherwise RB5: N/A
>>timerRST	RB1: N/A RB2- RB3: 300 RB5: N/A
>>max-RST	RB1: N/A RB2- RB3: 1 RB5: N/A
>>pollingInfo	RB1: N/A RB2- RB3: as below RB5: N/A
>>>lastTransmissionPDU-Poll	RB2- RB3: FALSE
>>>lastRetransmissionPDU-Poll	RB2- RB3: FALSE
>>>timerPollPeriodic	RB2- RB3: 300
>>segmentationIndication	RB1- RB3: N/A RB5: FALSE
>dl-RLC-Mode	RB1: UM RB2- RB3: AM RB5: TM
>>inSequenceDelivery	RB1: N/A RB2- RB3: TRUE RB5: N/A

Parameters	Value
>>receivingWindowSize	RB1: N/A RB2- RB3: 128 for UEs with more than 10 kbyte "total RLC AM buffer size" and 32 otherwise RB5: N/A
>>dl-RLC-StatusInfo	RB1: N/A RB2- RB3: as below RB5: N/A
>>>timerStatusProhibit	RB2- RB3: 100
>>>missingPDU-Indicator	RB2- RB3: FALSE
>>>timerStatusPeriodic	RB2- RB3: 300
>>segmentationIndication	RB1- RB3: N/A RB5: FALSE
rb-MappingInfo	
>UL-LogicalChannelMappings	OneLogicalChannel
>>ul-TransportChannelType	Dch
>>>transportChannelIdentity	RB1- RB3: 2 RB5: 1
>>logicalChannelIdentity	RB1: 1, RB2: 2, RB3: 3 RB5: N/A
>>rlc-SizeList	RB1- RB3: configured RB5: N/A
>>mac-LogicalChannelPriority	RB1: 1, RB2: 2, RB3: 3 RB5: 5
>DL-logicalChannelMappingList	
>>Mapping option 1	One mapping option
>>>dl-TransportChannelType	Dch
>>>>transportChannelIdentity	RB1- RB3: 2 RB5: 1
>>>logicalChannelIdentity	RB1: 1, RB2: 2, RB3: 3 RB5: N/A
TrCH INFORMATION PER TrCH	
UL-AddReconfTransChInfoList	
>Uplink transport channel type	dch
>transportChannelIdentity	TrCH1: 1, TrCH2: 2
>transportFormatSet	DedicatedTransChTFS
>>dynamicTF-information	
>>>tf0/ tf0,1	TrCH1: (0x576, 1x576) TrCH2: (0x144, 1x144)
>>>>rlcSize	TrCH1: OctetMode TrCH2: BitMode
>>>>>sizeType	TrCH1: type 2, part1= 9, part2= 2 (576) TrCH2: type 2, part1= 2, part2= 0 (144)
>>>>numberOfTbSizeList	TrCH1: Zero, one, TrCH2: Zero, one
>>>>logicalChannelList	All
>>semiStaticTF-Information	
>>>tti	TrCH1: 40 TrCH2: 40
>>>channelCodingType	TrCH1: Turbo TrCH2: Convolutional
>>>>codingRate	TrCH1: N/A TrCH2: Third
>>>rateMatchingAttribute	TrCH1: 165 TrCH2: 160
>>>crc-Size	TrCH1: 16 TrCH2: 16
DL-AddReconfTransChInfoList	
>Downlink transport channel type	dch
>dl-TransportChannelIdentity (should be as for UL)	TrCH1: 1, TrCH2: 2
>dfs-SignallingMode	SameAsUL
>>transportFormatSet	
>>>dynamicTF-information	

Parameters	Value
>>>>tf0/ tf0,1	
>>>>rlcSize	
>>>>>sizeType	
>>>>numberOfTbSizeList	
>>>>logicalChannelList	
>>ULTrCH-Id	TrCH1: 1, TrCH2: 2
>dch-QualityTarget	
>>bler-QualityValue	TrCH1: 1×10^{-2} TrCH2: Absent
TrCH INFORMATION, COMMON	
ul-CommonTransChInfo	
>tfcs-ID (TDD only)	1
>sharedChannelIndicator (TDD only)	FALSE
>tfcs-Subset	Absent, not required
>ul-TFCS	Normal TFCS signalling
>>explicitTFCS-ConfigurationMode	Complete
>>>ctfcSize	Ctfc4Bit
>>>>TFCS representation	Addition
>>>>>TFCS list	
>>>>>>TFCS 1	(TF0, TF0)
>>>>>>>ctfc	0
>>>>>>>gainFactorInformation	Computed
>>>>>>>referenceTFCSId	0
>>>>>>>TFCS 2	(TF1, TF0)
>>>>>>>ctfc	1
>>>>>>>gainFactorInformation	Computed
>>>>>>>> β c (FDD only)	N/A
>>>>>>>> β d	N/A
>>>>>>>>referenceTFCSId	0
>>>>>>>>TFCS 3	(TF0, TF1)
>>>>>>>>ctfc	2
>>>>>>>>gainFactorInformation	Computed
>>>>>>>>referenceTFCSId	0
>>>>>>>>TFCS 4	(TF1, TF1)
>>>>>>>>ctfc	3
>>>>>>>>gainFactorInformation	Signalled
>>>>>>>>> β c (FDD only)	11
>>>>>>>>> β d	15
>>>>>>>>>referenceTFCSId	0
>>>>>>>>>TFCS 5	N/A
>>>>>>>>>ctfc	
>>>>>>>>>gainFactorInformation	
>>>>>>>>>referenceTFCSId	
>>>>>>>>>TFCS 6	N/A
>>>>>>>>>ctfc	
>>>>>>>>>gainFactorInformation	
>>>>>>>>>> β c (FDD only)	
>>>>>>>>>> β d	
>>>>>>>>>>referenceTFCSId	
>>>>>>>>>>TFCS 7	
>>>>>>>>>>ctfc	
>>>>>>>>>>gainFactorInformation	
>>>>>>>>>>referenceTFCSId	
>>>>>>>>>>TFCS 8	
>>>>>>>>>>ctfc	
>>>>>>>>>>gainFactorInformation	
>>>>>>>>>>referenceTFCSId	
>>>>>>>>>>TFCS 9	
>>>>>>>>>>ctfc	
>>>>>>>>>>gainFactorInformation	
>>>>>>>>>>referenceTFCSId	

Parameters	Value
>>>>>TFCS 10	
>>>>>ctfc	
>>>>>gainFactorInformation	
>>>>>> β_c (FDD only)	
>>>>>> β_d	
>>>>>>referenceTFCId	
dl-CommonTransChInfo	
>tfcs-SignallingMode	Same as UL
PhyCH INFORMATION FDD	
UL-DPCH-InfoPredef	
>ul-DPCH-PowerControlInfo	
>>powerControlAlgorithm	Algorithm 1
>>>tpcStepSize	1 dB
>tfci-Existence	TRUE
>puncturingLimit	1
DL-CommonInformationPredef	
>dl-DPCH-InfoCommon	
>>spreadingFactor	128
>>tfci-Existence	TRUE
>>pilotBits	8
>>positionFixed	Flexible
PhyCH INFORMATION 3.84/7.68 Mcps TDD	
UL-DPCH-InfoPredef	
>ul-DPCH-PowerControlInfo	
>>dpch-ConstantValue	0
>commonTimeslotInfo	
>>secondInterleavingMode	frameRelated
>>tfci-Coding	16
>>puncturingLimit	0.8
>>repetitionPeriodAndLength	repetitionPeriod1
DL-CommonInformationPredef	
>dl-DPCH-InfoCommon	
>>commonTimeslotInfo	
>>>secondInterleavingMode	frameRelated
>>>tfci-Coding	16
>>>puncturingLimit	0.8
>>>repetitionPeriodAndLength	repetitionPeriod1
PhyCH INFORMATION 1.28 Mcps TDD	
UL-DPCH-InfoPredef	
>commonTimeslotInfo	
>>secondInterleavingMode	frameRelated
>>tfci-Coding	16
>>puncturingLimit	1
>>repetitionPeriodAndLength	repetitionPeriod1
DL-CommonInformationPredef	
>dl-DPCH-InfoCommon	
>>commonTimeslotInfo	
>>>secondInterleavingMode	frameRelated
>>>tfci-Coding	16
>>>puncturingLimit	0.88
>>>repetitionPeriodAndLength	repetitionPeriod1

13.7.8 Default configuration 28 kbps streaming CS- data & 3.4 kbps signalling

Parameters	Value
Ref 34.108	2
Default configuration identity	8
RB INFORMATION	
rb-Identity	RB1: 1, RB2: 2, RB3: 3, RB5: 5
rlc-InfoChoice	Rlc-info

Parameters	Value
>ul-RLC-Mode	RB1: UM RB2- RB3: AM RB5: TM
>>transmissionRLC-DiscardMode	RB1: N/A RB2- RB3: NoDiscard RB5: N/A
>>>maxDat	RB1: N/A RB2- RB3: 15 RB5: N/A
>>transmissionWindowSize	RB1: N/A RB2- RB3: 128 for UEs with more than 10 kbyte "total RLC AM buffer size" and 32 otherwise RB5: N/A
>>timerRST	RB1: N/A RB2- RB3: 300 RB5: N/A
>>max-RST	RB1: N/A RB2- RB3: 1 RB5: N/A
>>pollingInfo	RB1: N/A RB2- RB3: as below RB5: N/A
>>>lastTransmissionPDU-Poll	RB2- RB3: FALSE
>>>lastRetransmissionPDU-Poll	RB2- RB3: FALSE
>>>timerPollPeriodic	RB2- RB3: 300
>>segmentationIndication	RB1- RB3: N/A RB5: FALSE
>dl-RLC-Mode	RB1: UM RB2- RB3: AM RB5: TM
>>inSequenceDelivery	RB1: N/A RB2- RB3: TRUE RB5: N/A
>>receivingWindowSize	RB1: N/A RB2- RB3: 128 for UEs with more than 10 kbyte "total RLC AM buffer size" and 32 otherwise RB5: N/A
>>dl-RLC-StatusInfo	RB1: N/A RB2- RB3: as below RB5: N/A
>>>timerStatusProhibit	RB2- RB3: 100
>>>missingPDU-Indicator	RB2- RB3: FALSE
>>>timerStatusPeriodic	RB2- RB3: 300
>>segmentationIndication	RB1- RB3: N/A RB5: FALSE
rb-MappingInfo	
>UL-LogicalChannelMappings	OneLogicalChannel
>>ul-TransportChannelType	Dch
>>>transportChannelIdentity	RB1- RB3: 2 RB5: 1
>>logicalChannelIdentity	RB1: 1, RB2: 2, RB3: 3 RB5: N/A
>>rlc-SizeList	RB1- RB3: configured RB5: N/A
>>mac-LogicalChannelPriority	RB1: 1, RB2: 2, RB3: 3 RB5: 5
>DL-logicalChannelMappingList	
>>Mapping option 1	One mapping option
>>>dl-TransportChannelType	Dch
>>>>transportChannelIdentity	RB1- RB3: 2 RB5: 1
>>>logicalChannelIdentity	RB1: 1, RB2: 2, RB3: 3 RB5: N/A
TrCH INFORMATION PER TrCH	
UL-AddReconfTransChInfoList	

Parameters	Value
>Uplink transport channel type	dch
>transportChannelIdentity	TrCH1: 1, TrCH2: 2
>transportFormatSet	DedicatedTransChTFS
>>dynamicTF-information	
>>>tf0/ tf0,1	TrCH1: (0x576, 1x576, 2x576) TrCH2: (0x144, 1x144)
>>>>rlcSize	TrCH1: OctetMode TrCH2: BitMode
>>>>>sizeType	TrCH1: type 2, part1= 9, part2= 2 (576) TrCH2: type 2, part1= 2, part2= 0 (144)
>>>>numberOfTbSizeList	TrCH1: Zero, one, 2 TrCH2: Zero, one
>>>>logicalChannelList	All
>>>tf 1	
>>>>numberOfTransportBlocks	
>>>>rlc-Size	
>>>>>sizeType	
>>>>numberOfTbSizeList	
>>>>logicalChannelList	
>>>tf 2	
>>>>numberOfTransportBlocks	
>>>>rlc-Size	
>>>>>sizeType	
>>>>numberOfTbSizeList	
>>>>logicalChannelList	
>>>tf 3	
>>>>numberOfTransportBlocks	
>>>>rlc-Size	
>>>>>sizeType	
>>>>numberOfTbSizeList	
>>>>logicalChannelList	
>>>tf 4	
>>>>numberOfTransportBlocks	
>>>>rlc-Size	
>>>>>sizeType	
>>>>numberOfTbSizeList	
>>>>logicalChannelList	
>>>tf 5	
>>>>numberOfTransportBlocks	
>>>>rlc-Size	
>>>>>sizeType	
>>>>numberOfTbSizeList	
>>>>logicalChannelList	
>>semiStaticTF-Information	
>>>tti	TrCH1: 40 TrCH2: 40
>>>channelCodingType	TrCH1: Turbo TrCH2: Convolutional
>>>>codingRate	TrCH1: N/A TrCH2: Third
>>>rateMatchingAttribute	TrCH1: 155 TrCH2: 160
>>>crc-Size	TrCH1: 16 TrCH2: 16
DL-AddReconfTransChInfoList	
>Downlink transport channel type	dch
>dl-TransportChannelIdentity (should be as for UL)	TrCH1: 1, TrCH2: 2
>tfs-SignallingMode	SameAsUL
>>transportFormatSet	
>>>dynamicTF-information	
>>>>tf0/ tf0,1	
>>>>rlcSize	

Parameters	Value
>>>>sizeType	
>>>>numberOfTbSizeList	
>>>>logicalChannelList	
>>ULTrCH-Id	TrCH1: 1, TrCH2: 2
>dch-QualityTarget	
>>bler-QualityValue	TrCH1: 1×10^{-2} TrCH2: Absent
TrCH INFORMATION, COMMON	
ul-CommonTransChInfo	
>tfcs-ID (TDD only)	1
>sharedChannelIndicator (TDD only)	FALSE
>tfcs-Subset	Absent, not required
>ul-TFCS	Normal TFCS signalling
>>explicitTFCS-ConfigurationMode	Complete
>>>ctfcSize	Ctfc4Bit
>>>>TFCS representation	Addition
>>>>TFCS list	
>>>>>TFCS 1	(TF0, TF0)
>>>>>>ctfc	0
>>>>>>gainFactorInformation	Computed
>>>>>>referenceTFCSId	0
>>>>>TFCS 2	(TF1, TF0)
>>>>>>ctfc	1
>>>>>>gainFactorInformation	Computed
>>>>>> β_c (FDD only)	N/A
>>>>>> β_d	N/A
>>>>>>referenceTFCSId	0
>>>>>TFCS 3	(TF2, TF0)
>>>>>>ctfc	2
>>>>>>gainFactorInformation	Computed
>>>>>>referenceTFCSId	0
>>>>>TFCS 4	(TF0, TF1)
>>>>>>ctfc	3
>>>>>>gainFactorInformation	Computed
>>>>>> β_c (FDD only)	N/A
>>>>>> β_d	N/A
>>>>>>referenceTFCSId	0
>>>>>TFCS 5	(TF1, TF1)
>>>>>>ctfc	4
>>>>>>gainFactorInformation	Computed
>>>>>>referenceTFCSId	0
>>>>>TFCS 6	(TF2, TF1)
>>>>>>ctfc	5
>>>>>>gainFactorInformation	Signalled
>>>>>> β_c (FDD only)	8
>>>>>> β_d	15
>>>>>>referenceTFCSId	0
>>>>>TFCS 7	
>>>>>>ctfc	
>>>>>>gainFactorInformation	
>>>>>>referenceTFCSId	
>>>>>TFCS 8	
>>>>>>ctfc	
>>>>>>gainFactorInformation	
>>>>>>referenceTFCSId	
>>>>>TFCS 9	
>>>>>>ctfc	
>>>>>>gainFactorInformation	
>>>>>>referenceTFCSId	
>>>>>TFCS 10	
>>>>>>ctfc	

Parameters	Value
>>>>>>gainFactorInformation	
>>>>>>> β_c (FDD only)	
>>>>>>> β_d	
>>>>>>>referenceTFCId	
>>>>>TFCS 11	
>>>>>>ctfc	
>>>>>>gainFactorInformation	
>>>>>>>referenceTFCId	
>>>>>TFCS 12	
>>>>>>ctfc	
>>>>>>gainFactorInformation	
>>>>>>> β_c (FDD only)	
>>>>>>> β_d	
>>>>>>>referenceTFCId	
dl-CommonTransChInfo	
>tfcS-SignallingMode	Same as UL
PhyCH INFORMATION FDD	
UL-DPCH-InfoPredef	
>ul-DPCH-PowerControlInfo	
>>powerControlAlgorithm	Algorithm 1
>>>tpcStepSize	1 dB
>tfcI-Existence	TRUE
>puncturingLimit	1
DL-CommonInformationPredef	
>dl-DPCH-InfoCommon	
>>spreadingFactor	64
>>tfcI-Existence	TRUE
>>pilotBits	8
>>positionFixed	Flexible
PhyCH INFORMATION 3.84/7.68 Mcps TDD	
UL-DPCH-InfoPredef	
>ul-DPCH-PowerControlInfo	
>>dpch-ConstantValue	0
>commonTimeslotInfo	
>>secondInterleavingMode	frameRelated
>>tfcI-Coding	16
>>puncturingLimit	0.44
>>repetitionPeriodAndLength	repetitionPeriod1
DL-CommonInformationPredef	
>dl-DPCH-InfoCommon	
>>commonTimeslotInfo	
>>>secondInterleavingMode	frameRelated
>>>tfcI-Coding	16
>>>puncturingLimit	0.44
>>>repetitionPeriodAndLength	repetitionPeriod1
PhyCH INFORMATION 1.28 Mcps TDD	
UL-DPCH-InfoPredef	
>commonTimeslotInfo	
>>secondInterleavingMode	frameRelated
>>tfcI-Coding	16
>>puncturingLimit	0.64
>>repetitionPeriodAndLength	repetitionPeriod1
DL-CommonInformationPredef	
>dl-DPCH-InfoCommon	
>>commonTimeslotInfo	
>>>secondInterleavingMode	frameRelated
>>>tfcI-Coding	16
>>>puncturingLimit	0.64
>>>repetitionPeriodAndLength	repetitionPeriod1

13.7.9 Default configuration 57.6 kbps streaming CS- data & 3.4 kbps signalling

Parameters	Value
Ref 34.108	2
Default configuration identity	9
RB INFORMATION	
rb-Identity	RB1: 1, RB2: 2, RB3: 3, RB5: 5
rlc-InfoChoice	Rlc-info
>ul-RLC-Mode	RB1: UM RB2- RB3: AM RB5: TM
>>transmissionRLC-DiscardMode	RB1: N/A RB2- RB3: NoDiscard RB5: N/A
>>>maxDat	RB1: N/A RB2- RB3: 15 RB5: N/A
>>transmissionWindowSize	RB1: N/A RB2- RB3: 128 for UEs with more than 10 kbyte "total RLC AM buffer size" and 32 otherwise RB5: N/A
>>timerRST	RB1: N/A RB2- RB3: 300 RB5: N/A
>>max-RST	RB1: N/A RB2- RB3: 1 RB5: N/A
>>pollingInfo	RB1: N/A RB2- RB3: as below RB5: N/A
>>>lastTransmissionPDU-Poll	RB2- RB3: FALSE
>>>lastRetransmissionPDU-Poll	RB2- RB3: FALSE
>>>timerPollPeriodic	RB2- RB3: 300
>>segmentationIndication	RB1- RB3: N/A RB5: FALSE
>dl-RLC-Mode	RB1: UM RB2- RB3: AM RB5: TM
>>inSequenceDelivery	RB1: N/A RB2- RB3: TRUE RB5: N/A
>>receivingWindowSize	RB1: N/A RB2- RB3: 128 for UEs with more than 10 kbyte "total RLC AM buffer size" and 32 otherwise RB5: N/A
>>dl-RLC-StatusInfo	RB1: N/A RB2- RB3: as below RB5: N/A
>>>timerStatusProhibit	RB2- RB3: 100
>>>missingPDU-Indicator	RB2- RB3: FALSE
>>>timerStatusPeriodic	RB2- RB3: 300
>>segmentationIndication	RB1- RB3: N/A RB5: FALSE
rb-MappingInfo	
>UL-LogicalChannelMappings	OneLogicalChannel
>>ul-TransportChannelType	Dch
>>>transportChannelIdentity	RB1- RB3: 2 RB5: 1
>>logicalChannelIdentity	RB1: 1, RB2: 2, RB3: 3 RB5: N/A
>>rlc-SizeList	RB1- RB3: configured RB5: N/A
>>mac-LogicalChannelPriority	RB1: 1, RB2: 2, RB3: 3 RB5: 5

Parameters	Value
>DL-logicalChannelMappingList	
>>Mapping option 1	One mapping option
>>>dl-TransportChannelType	Dch
>>>>transportChannelIdentity	RB1- RB3: 2 RB5: 1
>>>logicalChannelIdentity	RB1: 1, RB2: 2, RB3: 3 RB5: N/A
TrCH INFORMATION PER TrCH	
UL-AddReconfTransChInfoList	
>Uplink transport channel type	dch
>transportChannelIdentity	TrCH1: 1, TrCH2: 2
>transportFormatSet	DedicatedTransChTFS
>>dynamicTF-information	
>>>tf0/ tf0,1	TrCH1: (0x576, 1x576, 2x576, 3x576, 4x576) TrCH2: (0x144, 1x144)
>>>>rlcSize	TrCH1: OctetMode TrCH2: BitMode
>>>>>sizeType	TrCH1: type 2, part1= 9, part2= 2 (576) TrCH2: type 2, part1= 2, part2= 0 (144)
>>>>numberOfTbSizeList	TrCH1: Zero, one, 2, 3, 4 TrCH2: Zero, one
>>>>logicalChannelList	All
>>>>tf 1	
>>>>>numberOfTransportBlocks	
>>>>>rlc-Size	
>>>>>>sizeType	
>>>>>numberOfTbSizeList	
>>>>>logicalChannelList	
>>>>>tf 2	
>>>>>>numberOfTransportBlocks	
>>>>>>rlc-Size	
>>>>>>>sizeType	
>>>>>>numberOfTbSizeList	
>>>>>>logicalChannelList	
>>>>>>tf 3	
>>>>>>>numberOfTransportBlocks	
>>>>>>>rlc-Size	
>>>>>>>>sizeType	
>>>>>>>numberOfTbSizeList	
>>>>>>>logicalChannelList	
>>>>>>>tf 4	
>>>>>>>>numberOfTransportBlocks	
>>>>>>>>rlc-Size	
>>>>>>>>>sizeType	
>>>>>>>>numberOfTbSizeList	
>>>>>>>>logicalChannelList	
>>>>>>>>tf 5	
>>>>>>>>>numberOfTransportBlocks	
>>>>>>>>>rlc-Size	
>>>>>>>>>>sizeType	
>>>>>>>>>numberOfTbSizeList	
>>>>>>>>>logicalChannelList	
>>semiStaticTF-Information	
>>>tti	TrCH1: 40 TrCH2: 40
>>>channelCodingType	TrCH1: Turbo TrCH2: Convolutional
>>>>codingRate	TrCH1: N/A TrCH2: Third
>>>>>rateMatchingAttribute	TrCH1: 145 TrCH2: 160

Parameters	Value
>>>crc-Size	TrCH1: 16 TrCH2: 16
DL-AddReconfTransChInfoList	
>Downlink transport channel type	dch
>dl-TransportChannelIdentity (should be as for UL)	TrCH1: 1, TrCH2: 2
>dfs-SignallingMode	SameAsUL
>>transportFormatSet	
>>>dynamicTF-information	
>>>>tf0/ tf0,1	
>>>>rlcSize	
>>>>>sizeType	
>>>>numberOfTbSizeList	
>>>>logicalChannelList	
>>ULTrCH-Id	TrCH1: 1, TrCH2: 2
>dch-QualityTarget	
>>bler-QualityValue	TrCH1: 1×10^{-2} TrCH2: Absent
TrCH INFORMATION, COMMON	
ul-CommonTransChInfo	
>tfcs-ID (TDD only)	1
>sharedChannelIndicator (TDD only)	FALSE
>tfcs-Subset	Absent, not required
>ul-TFCS	Normal TFCS signalling
>>explicitTFCS-ConfigurationMode	Complete
>>>ctfcSize	Ctfc4Bit
>>>>TFCS representation	Addition
>>>>>TFCS list	
>>>>>>TFCS 1	(TF0, TF0)
>>>>>>>ctfc	0
>>>>>>>>gainFactorInformation	Computed
>>>>>>>>referenceTFCSId	0
>>>>>>>>TFCS 2	(TF1, TF0)
>>>>>>>>>ctfc	1
>>>>>>>>>gainFactorInformation	Computed
>>>>>>>>>> β_c (FDD only)	N/A
>>>>>>>>>> β_d	N/A
>>>>>>>>>>>referenceTFCSId	0
>>>>>>>>>>>TFCS 3	(TF2, TF0)
>>>>>>>>>>>>ctfc	2
>>>>>>>>>>>>>gainFactorInformation	Computed
>>>>>>>>>>>>>referenceTFCSId	0
>>>>>>>>>>>>>TFCS 4	(TF3, TF0)
>>>>>>>>>>>>>>ctfc	3
>>>>>>>>>>>>>>>gainFactorInformation	Computed
>>>>>>>>>>>>>>>> β_c (FDD only)	N/A
>>>>>>>>>>>>>>>> β_d	N/A
>>>>>>>>>>>>>>>>>referenceTFCSId	0
>>>>>>>>>>>>>>>>>TFCS 5	(TF4, TF0)
>>>>>>>>>>>>>>>>>>ctfc	4
>>>>>>>>>>>>>>>>>>>gainFactorInformation	Computed
>>>>>>>>>>>>>>>>>>>>referenceTFCSId	0
>>>>>>>>>>>>>>>>>>>>TFCS 6	(TF0, TF1)
>>>>>>>>>>>>>>>>>>>>>ctfc	5
>>>>>>>>>>>>>>>>>>>>>>gainFactorInformation	Computed
>>>>>>>>>>>>>>>>>>>>>>> β_c (FDD only)	N/A
>>>>>>>>>>>>>>>>>>>>>>> β_d	N/A
>>>>>>>>>>>>>>>>>>>>>>>>referenceTFCSId	0
>>>>>>>>>>>>>>>>>>>>>>>>TFCS 7	(TF1, TF1)
>>>>>>>>>>>>>>>>>>>>>>>>>ctfc	6
>>>>>>>>>>>>>>>>>>>>>>>>>>>gainFactorInformation	Computed
>>>>>>>>>>>>>>>>>>>>>>>>>>>>referenceTFCSId	0
>>>>>>>>>>>>>>>>>>>>>>>>>>>>>TFCS 8	(TF2, TF1)

Parameters	Value
>>>>>>ctfc	7
>>>>>>gainFactorInformation	Computed
>>>>>>referenceTFClId	0
>>>>>>TFCS 9	(TF3, TF1)
>>>>>>ctfc	8
>>>>>>gainFactorInformation	Computed
>>>>>>referenceTFClId	0
>>>>>>TFCS 10	(TF4, TF1)
>>>>>>ctfc	9
>>>>>>gainFactorInformation	Signalled
>>>>>>> β c (FDD only)	8
>>>>>>> β d	15
>>>>>>>referenceTFClId	0
>>>>>>>TFCS 11	
>>>>>>>ctfc	
>>>>>>>gainFactorInformation	
>>>>>>>referenceTFClId	
>>>>>>>TFCS 12	
>>>>>>>ctfc	
>>>>>>>gainFactorInformation	
>>>>>>>> β c (FDD only)	
>>>>>>>> β d	
>>>>>>>>referenceTFClId	
dl-CommonTransChInfo	
>tfcs-SignallingMode	Same as UL
PhyCH INFORMATION FDD	
UL-DPCH-InfoPredef	
>ul-DPCH-PowerControlInfo	
>>powerControlAlgorithm	Algorithm 1
>>>tpcStepSize	1 dB
>tfci-Existence	TRUE
>puncturingLimit	1
DL-CommonInformationPredef	
>dl-DPCH-InfoCommon	
>>spreadingFactor	32
>>tfci-Existence	TRUE
>>pilotBits	8
>>positionFixed	Flexible
PhyCH INFORMATION 3.84/7.68 Mcps TDD	
UL-DPCH-InfoPredef	
>ul-DPCH-PowerControlInfo	
>>dpch-ConstantValue	0
>commonTimeslotInfo	
>>secondInterleavingMode	frameRelated
>>>tfci-Coding	16
>>>puncturingLimit	0.48
>>>repetitionPeriodAndLength	repetitionPeriod1
DL-CommonInformationPredef	
>dl-DPCH-InfoCommon	
>>commonTimeslotInfo	
>>>secondInterleavingMode	frameRelated
>>>>tfci-Coding	16
>>>>puncturingLimit	0.48
>>>>repetitionPeriodAndLength	repetitionPeriod1
PhyCH INFORMATION 1.28 Mcps TDD	
UL-DPCH-InfoPredef	
>commonTimeslotInfo	
>>secondInterleavingMode	frameRelated
>>>tfci-Coding	16
>>>puncturingLimit	0.72
>>>repetitionPeriodAndLength	repetitionPeriod1
DL-CommonInformationPredef	

Parameters	Value
>dl-DPCH-InfoCommon	
>>commonTimeslotInfo	
>>>secondInterleavingMode	frameRelated
>>>tfci-Coding	16
>>>puncturingLimit	0.72
>>>repetitionPeriodAndLength	repetitionPeriod1

13.7.10 Default configuration 12.2/7.95/5.9/4.75 kbps speech & 3.4 kbps signalling

Parameters	Value
Ref 34.108	4a
Default configuration identity	10
RB INFORMATION	
rb-Identity	RB1: 1, RB2: 2, RB3: 3, RB5: 5, RB6: 6, RB7: 7
rlc-InfoChoice	Rlc-info
>ul-RLC-Mode	RB1: UM RB2- RB3: AM RB5-RB7: TM
>>transmissionRLC-DiscardMode	RB1: N/A RB2- RB3: NoDiscard RB5- RB7: N/A
>>>maxDat	RB1: N/A RB2- RB3: 15 RB5- RB7: N/A
>>transmissionWindowSize	RB1: N/A RB2- RB3: 128 for UEs with more than 10 kbyte "total RLC AM buffer size" and 32 otherwise RB5- RB7: N/A
>>timerRST	RB1: N/A RB2- RB3: 300 RB5- RB7: N/A
>>>max-RST	RB1: N/A RB2- RB3: 1 RB5- RB7: N/A
>>pollingInfo	RB1: N/A RB2- RB3: as below RB5- RB7: N/A
>>>lastTransmissionPDU-Poll	RB2- RB3: FALSE
>>>lastRetransmissionPDU-Poll	RB2- RB3: FALSE
>>>timerPollPeriodic	RB2- RB3: 300
>>segmentationIndication	RB1- RB3: N/A RB5- RB7: FALSE
>dl-RLC-Mode	RB1: UM RB2- RB3: AM RB5- RB7: TM
>>inSequenceDelivery	RB1: N/A RB2- RB3: TRUE RB5- RB7: N/A
>>receivingWindowSize	RB1: N/A RB2- RB3: 128 for UEs with more than 10 kbyte "total RLC AM buffer size" and 32 otherwise RB5- RB7: N/A
>>dl-RLC-StatusInfo	RB1: N/A RB2- RB3: as below RB5- RB7: N/A
>>>timerStatusProhibit	RB2- RB3: 100
>>>missingPDU-Indicator	RB2- RB3: FALSE
>>>timerStatusPeriodic	RB2- RB3: 300
>>segmentationIndication	RB1- RB3: N/A RB5- RB7: FALSE

Parameters	Value
rb-MappingInfo	
>UL-LogicalChannelMappings	OneLogicalChannel
>>ul-TransportChannelType	Dch
>>>transportChannelIdentity	RB1- RB3: 4 RB5: 1, RB6: 2, RB7: 3
>>logicalChannelIdentity	RB1: 1, RB2: 2, RB3: 3 RB5- RB7: N/A
>>rlc-SizeList	RB1- RB3: configured RB5- RB7: N/A
>>mac-LogicalChannelPriority	RB1: 1, RB2: 2, RB3: 3 RB5- RB7: 5
>DL-logicalChannelMappingList	
>>Mapping option 1	One mapping option
>>>dl-TransportChannelType	Dch
>>>>transportChannelIdentity	RB1- RB3: 4 RB5: 1, RB6: 2, RB7: 3
>>>logicalChannelIdentity	RB1: 1, RB2: 2, RB3: 3 RB5- RB7: N/A
TrCH INFORMATION PER TrCH	
UL-AddReconfTransChInfoList	
>Uplink transport channel type	dch
>transportChannelIdentity	TrCH1: 1, TrCH2: 2, TrCH3: 3, TrCH4: 4
>transportFormatSet	DedicatedTransChTFS
>>dynamicTF-information	
>>>tf0/ tf0,1	TrCH1: (0x81) TrCH2: (0x 103) TrCH3: (0x 60) TrCH4: (0x144)
>>>>rlcSize	BitMode
>>>>>sizeType	TrCH1: type 1: 81 TrCH2: type 1: 103 TrCH3: type 1: 60 TrCH4: type 2, part1= 2, part2= 0 (144)
>>>>numberOfTbSizeList	TrCH1-4: Zero
>>>>logicalChannelList	All
>>>>tf 1	TrCH1: (1x39) TrCH2: (1x53) TrCH3: (1x60) TrCH4: (1x144)
>>>>numberOfTransportBlocks	TrCH1-4: One
>>>>rlc-Size	TrCH1-3: BitMode
>>>>>sizeType	TrCH1: type 1: 39 TrCH2: type 1: 53 TrCH3: type 1: 60 TrCH4: type 2, part1= 2, part2= 0 (144)
>>>>numberOfTbSizeList	TrCH1-4: One
>>>>logicalChannelList	TrCH1-4: all
>>>>tf 2	TrCH1: (1x42) TrCH2: (1x63) TrCH3- TrCH4: N/A
>>>>numberOfTransportBlocks	TrCH1-2: One
>>>>rlc-Size	TrCH1: BitMode
>>>>>sizeType	TrCH1: type 1: 42 TrCH2: type 1: 63
>>>>numberOfTbSizeList	TrCH1-2: One
>>>>logicalChannelList	TrCH1: all
>>>>tf 3	TrCH1: (1x55) TrCH2: (1x84) TrCH3- TrCH4: N/A
>>>>numberOfTransportBlocks	TrCH1-2: One
>>>>rlc-Size	TrCH1: BitMode
>>>>>sizeType	TrCH1: type 1: 55 TrCH2: type 1: 84
>>>>numberOfTbSizeList	TrCH1-2: One

Parameters	Value
>>>>logicalChannelList	TrCH1: all
>>>tf 4	TrCH1: (1x75) TrCH2: (1x103) TrCH3- TrCH4: N/A
>>>>numberOfTransportBlocks	TrCH1-2: One
>>>>rlc-Size	TrCH1: BitMode
>>>>>sizeType	TrCH1: type 1: 75 TrCH2: type 1: 103
>>>>numberOfTbSizeList	TrCH1-2: One
>>>>logicalChannelList	TrCH1: all
>>>tf 5	TrCH1: (1x81) TrCH2- TrCH4: N/A
>>>>numberOfTransportBlocks	TrCH1: One
>>>>rlc-Size	TrCH1: BitMode
>>>>>sizeType	TrCH1: type 1: 81
>>>>numberOfTbSizeList	TrCH1: One
>>>>logicalChannelList	TrCH1: all
>>semiStaticTF-Information	
>>>tti	TrCH1- TrCH3: 20 TrCH4: 40
>>>channelCodingType	Convolutional
>>>>codingRate	TrCH1- TrCH2: Third TrCH3: Half TrCH4: Third
>>>rateMatchingAttribute	TrCH1: 200 TrCH2: 190 TrCH3: 235 TrCH4: 160
>>>>crc-Size	TrCH1: 12 TrCH2- TrCH3: 0 TrCH4: 16
DL-AddReconfTransChInfoList	
>Downlink transport channel type	dch
>dl-TransportChannelIdentity (should be as for UL)	TrCH1: 1, TrCH2: 2, TrCH3: 3, TrCH4: 4
>tfS-SignallingMode	Independent <Only tf0 on TrCH1 is different and shown below>
>>transportFormatSet	DedicatedTransChTFS
>>>dynamicTF-information	
>>>>tf0/ tf0,1	TrCH1: (1x0)
>>>>rlcSize	bitMode
>>>>>sizeType	TrCH1: type 1: 0
>>>>numberOfTbSizeList	TrCH1: One
>>>>logicalChannelList	All
>>ULTrCH-Id	TrCH1: 1, TrCH2: 2, TrCH3: 3, TrCH4: 4
>dch-QualityTarget	
>>bler-QualityValue	TrCH1: 7×10^{-3} TrCH2- TrCH4: Absent
TrCH INFORMATION, COMMON	
ul-CommonTransChInfo	
>tfcs-ID (TDD only)	1
>sharedChannelIndicator (TDD only)	FALSE
>tfcs-Subset	Absent, not required
>ul-TFCS	Normal TFCS signalling
>>explicitTFCS-ConfigurationMode	Complete
>>>ctfcSize	Ctfc8Bit
>>>>TFCS representation	Addition
>>>>>TFCS list	
>>>>>>TFCS 1	(TF0, TF0, TF0, TF0)
>>>>>>>ctfc	0
>>>>>>>gainFactorInformation	Computed
>>>>>>>referenceTFCSId	0
>>>>>>>TFCS 2	(TF1, TF0, TF0, TF0)
>>>>>>>>ctfc	1

Parameters	Value
>>>>>>gainFactorInformation	Computed
>>>>>> β_c (FDD only)	N/A
>>>>>> β_d	N/A
>>>>>>referenceTFClId	0
>>>>>TFCS 3	(TF2, TF1, TF0, TF0)
>>>>>>ctfc	8
>>>>>>gainFactorInformation	Computed
>>>>>>referenceTFClId	0
>>>>>TFCS 4	(TF3, TF2, TF0, TF0)
>>>>>>ctfc	15
>>>>>>gainFactorInformation	Computed
>>>>>> β_c (FDD only)	N/A
>>>>>> β_d	N/A
>>>>>>referenceTFClId	0
>>>>>TFCS 5	(TF4, TF3, TF0, TF0)
>>>>>>ctfc	22
>>>>>>gainFactorInformation	Computed
>>>>>>referenceTFClId	0
>>>>>TFCS 6	(TF5, TF4, TF1, TF0)
>>>>>>ctfc	59
>>>>>>gainFactorInformation	Computed
>>>>>> β_c (FDD only)	N/A
>>>>>> β_d	N/A
>>>>>>referenceTFClId	0
>>>>>TFCS 7	(TF0,TF0,TF0,TF1)
>>>>>>ctfc	60
>>>>>>gainFactorInformation	Computed
>>>>>>referenceTFClId	0
>>>>>TFCS 8	(TF1,TF0,TF0,TF1)
>>>>>>ctfc	61
>>>>>>gainFactorInformation	Computed
>>>>>>referenceTFClId	0
>>>>>TFCS 9	(TF2,TF1,TF0,TF1)
>>>>>>ctfc	68
>>>>>>gainFactorInformation	Computed
>>>>>>referenceTFClId	0
>>>>>TFCS 10	(TF3,TF2,TF0,TF1)
>>>>>>ctfc	75
>>>>>>gainFactorInformation	Computed
>>>>>> β_c (FDD only)	N/A
>>>>>> β_d	N/A
>>>>>>referenceTFClId	0
>>>>>TFCS 11	(TF4,TF3,TF0,TF1)
>>>>>>ctfc	82
>>>>>>gainFactorInformation	Computed
>>>>>>referenceTFClId	0
>>>>>TFCS 12	(TF5,TF4,TF1,TF1)
>>>>>>ctfc	119
>>>>>>gainFactorInformation	Signalled
>>>>>> β_c (FDD only)	11
>>>>>> β_d	15
>>>>>>referenceTFClId	0
dl-CommonTransChInfo	
>tfcs-SignallingMode	Same as UL
PhyCH INFORMATION FDD	
UL-DPCH-InfoPredef	
>ul-DPCH-PowerControlInfo	
>>powerControlAlgorithm	Algorithm 1
>>>tpcStepSize	1 dB
>tfci-Existence	TRUE
>puncturingLimit	0.88

Parameters	Value
DL-CommonInformationPredef	
>dl-DPCH-InfoCommon	
>>spreadingFactor	128
>>tfc-Existence	FALSE
>>pilotBits	4
>>positionFixed	Fixed
PhyCH INFORMATION 3.84/7.68 Mcps TDD	
UL-DPCH-InfoPredef	
>ul-DPCH-PowerControlInfo	
>>dpch-ConstantValue	0
>commonTimeslotInfo	
>>secondInterleavingMode	frameRelated
>>tfc-Coding	16
>>puncturingLimit	0.88
>>repetitionPeriodAndLength	repetitionPeriod1
DL-CommonInformationPredef	
>dl-DPCH-InfoCommon	
>>commonTimeslotInfo	
>>>secondInterleavingMode	frameRelated
>>>tfc-Coding	16
>>>puncturingLimit	0.92
>>>repetitionPeriodAndLength	repetitionPeriod1
PhyCH INFORMATION 1.28 Mcps TDD	
UL-DPCH-InfoPredef	
>commonTimeslotInfo	
>>secondInterleavingMode	frameRelated
>>tfc-Coding	16
>>puncturingLimit	0.72
>>repetitionPeriodAndLength	repetitionPeriod1
DL-CommonInformationPredef	
>dl-DPCH-InfoCommon	
>>commonTimeslotInfo	
>>>secondInterleavingMode	frameRelated
>>>tfc-Coding	16
>>>puncturingLimit	0.92
>>>repetitionPeriodAndLength	repetitionPeriod1

13.7.11 Default configuration 12.2/7.4/5.9/4.75 kbps speech & 3.4 kbps signalling (without SRB#5)

Parameters	Value
Ref 34.108	-
Default configuration identity	24
RB INFORMATION	
rb-Identity	RB1: 1, RB2: 2, RB3: 3, RB5: 5, RB6: 6, RB7: 7
rlc-InfoChoice	Rlc-info
>ul-RLC-Mode	RB1: UM RB2- RB3: AM RB5-RB7: TM
>>transmissionRLC-DiscardMode	RB1: N/A RB2- RB3: NoDiscard RB5- RB7: N/A
>>>maxDat	RB1: N/A RB2- RB3: 15 RB5- RB7: N/A
>>transmissionWindowSize	RB1: N/A RB2- RB3: 128 for UEs with more than 10 kbyte "total RLC AM buffer size" and 32 otherwise RB5- RB7: N/A

Parameters	Value
>>timerRST	RB1: N/A RB2- RB3: 300 RB5- RB7: N/A
>>max-RST	RB1: N/A RB2- RB3: 1 RB5- RB7: N/A
>>pollingInfo	RB1: N/A RB2- RB3: as below RB5- RB7: N/A
>>>lastTransmissionPDU-Poll	RB2- RB3: TRUE
>>>lastRetransmissionPDU-Poll	RB2- RB3: TRUE
>>>timerPollPeriodic	RB2- RB3: 300
>>segmentationIndication	RB1- RB3: N/A RB5- RB7: FALSE
>dl-RLC-Mode	RB1: UM RB2- RB3: AM RB5- RB7: TM
>>inSequenceDelivery	RB1: N/A RB2- RB3: TRUE RB5- RB7: N/A
>>receivingWindowSize	RB1: N/A RB2- RB3: 128 for UEs with more than 10 kbyte "total RLC AM buffer size" and 32 otherwise RB5- RB7: N/A
>>dl-RLC-StatusInfo	RB1: N/A RB2- RB3: as below RB5- RB7: N/A
>>>timerStatusProhibit	RB2- RB3: 100
>>>missingPDU-Indicator	RB2- RB3: FALSE
>>>timerStatusPeriodic	RB2- RB3: 300
>>segmentationIndication	RB1- RB3: N/A RB5- RB7: FALSE
rb-MappingInfo	
>UL-LogicalChannelMappings	OneLogicalChannel
>>ul-TransportChannelType	Dch
>>>transportChannelIdentity	RB1- RB3: 4 RB5: 1, RB6: 2, RB7: 3
>>logicalChannelIdentity	RB1: 1, RB2: 2, RB3: 3 RB5- RB7: N/A
>>rlc-SizeList	RB1- RB3: configured RB5- RB7: N/A
>>mac-LogicalChannelPriority	RB1: 1, RB2: 2, RB3: 3 RB5- RB7: 5
>DL-logicalChannelMappingList	
>>Mapping option 1	One mapping option
>>>dl-TransportChannelType	Dch
>>>>transportChannelIdentity	RB1- RB3: 4 RB5: 1, RB6: 2, RB7: 3
>>>logicalChannelIdentity	RB1: 1, RB2: 2, RB3: 3 RB5- RB7: N/A
TrCH INFORMATION PER TrCH	
UL-AddReconfTransChInfoList	
>Uplink transport channel type	dch
>transportChannelIdentity	TrCH1: 1, TrCH2: 2, TrCH3: 3, TrCH4: 4
>transportFormatSet	DedicatedTransChTFS
>>dynamicTF-information	
>>>tf0/ tf0,1	TrCH1: (0x81) TrCH2: (0x 103) TrCH3: (0x 60) TrCH4: (0x144)
>>>>rlcSize	BitMode
>>>>>sizeType	TrCH1: type 1: 81 TrCH2: type 1: 103 TrCH3: type 1: 60 TrCH4: type 2, part1= 2, part2= 0 (144)

Parameters	Value
>>>>numberOfTbSizeList	TrCH1-4: Zero
>>>>logicalChannelList	All
>>>tf 1	TrCH1: (1x39) TrCH2: (1x53) TrCH3: (1x60) TrCH4: (1x144)
>>>>numberOfTransportBlocks	TrCH1-4: One
>>>>rlc-Size	TrCH1-3: BitMode
>>>>>sizeType	TrCH1: type 1: 39 TrCH2: type 1: 53 TrCH3: type 1: 60 TrCH4: type 2, part1= 2, part2= 0 (144)
>>>>numberOfTbSizeList	TrCH1-4: One
>>>>logicalChannelList	TrCH1-4: all
>>>tf 2	TrCH1: (1x42) TrCH2: (1x63) TrCH3- TrCH4: N/A
>>>>numberOfTransportBlocks	TrCH1-2: One
>>>>rlc-Size	TrCH1: BitMode
>>>>>sizeType	TrCH1: type 1: 42 TrCH2: type 1: 63
>>>>numberOfTbSizeList	TrCH1-2: One
>>>>logicalChannelList	TrCH1: all
>>>tf 3	TrCH1: (1x55) TrCH2: (1x87) TrCH3- TrCH4: N/A
>>>>numberOfTransportBlocks	TrCH1-2: One
>>>>rlc-Size	TrCH1: BitMode
>>>>>sizeType	TrCH1: type 1: 55 TrCH2: type 1: 87
>>>>numberOfTbSizeList	TrCH1-2: One
>>>>logicalChannelList	TrCH1: all
>>>tf 4	TrCH1: (1x61) TrCH2: (1x103) TrCH3- TrCH4: N/A
>>>>numberOfTransportBlocks	TrCH1-2: One
>>>>rlc-Size	TrCH1: BitMode
>>>>>sizeType	TrCH1: type 1: 61 TrCH2: type 1: 103
>>>>numberOfTbSizeList	TrCH1-2: One
>>>>logicalChannelList	TrCH1: all
>>>tf 5	TrCH1: (1x81) TrCH2- TrCH4: N/A
>>>>numberOfTransportBlocks	TrCH1: One
>>>>rlc-Size	TrCH1: BitMode
>>>>>sizeType	TrCH1: type 1: 81
>>>>numberOfTbSizeList	TrCH1: One
>>>>logicalChannelList	TrCH1: all
>>semiStaticTF-Information	
>>>tti	TrCH1- TrCH3: 20 TrCH4: 40
>>>channelCodingType	Convolutional
>>>>codingRate	TrCH1- TrCH2: Third TrCH3: Half TrCH4: Third
>>>>rateMatchingAttribute	TrCH1: 200 TrCH2: 190 TrCH3: 235 TrCH4: 160
>>>>crc-Size	TrCH1: 12 TrCH2- TrCH3: 0 TrCH4: 16
DL-AddReconfTransChInfoList	
>Downlink transport channel type	dch

Parameters	Value
>dl-TransportChannelIdentity (should be as for UL)	TrCH1: 1, TrCH2: 2, TrCH3: 3, TrCH4: 4
>tfs-SignallingMode	Independent <Only tf0 on TrCH1 is different and shown below>
>>transportFormatSet	DedicatedTransChTFS
>>>dynamicTF-information	
>>>>tf0/ tf0,1	TrCH1: (1x0)
>>>>rlcSize	bitMode
>>>>>sizeType	TrCH1: type 1: 0
>>>>numberOfTbSizeList	TrCH1: One
>>>>logicalChannelList	All
>>ULTrCH-Id	TrCH1: 1, TrCH2: 2, TrCH3: 3, TrCH4: 4
>dch-QualityTarget	
>>bler-QualityValue	TrCH1: 7×10^{-3} TrCH2- TrCH4: Absent
TrCH INFORMATION, COMMON	
ul-CommonTransChInfo	
>tfc-ID (TDD only)	1
>sharedChannelIndicator (TDD only)	FALSE
>tfc-Subset	Absent, not required
>ul-TFCS	Normal TFCl signalling
>>explicitTFCS-ConfigurationMode	Complete
>>>ctfcSize	Ctfc8Bit
>>>>TFCS representation	Addition
>>>>>TFCS list	
>>>>>>TFCS 1	(TF0, TF0, TF0, TF0)
>>>>>>>ctfc	0
>>>>>>>gainFactorInformation	Computed
>>>>>>>referenceTFClId	0
>>>>>>>TFCS 2	(TF1, TF0, TF0, TF0)
>>>>>>>ctfc	1
>>>>>>>gainFactorInformation	Computed
>>>>>>>> β_c (FDD only)	N/A
>>>>>>>> β_d	N/A
>>>>>>>>referenceTFClId	0
>>>>>>>>TFCS 3	(TF2, TF1, TF0, TF0)
>>>>>>>>ctfc	8
>>>>>>>>gainFactorInformation	Computed
>>>>>>>>referenceTFClId	0
>>>>>>>>TFCS 4	(TF3, TF2, TF0, TF0)
>>>>>>>>ctfc	15
>>>>>>>>gainFactorInformation	Computed
>>>>>>>>> β_c (FDD only)	N/A
>>>>>>>>> β_d	N/A
>>>>>>>>>referenceTFClId	0
>>>>>>>>>TFCS 5	(TF4, TF3, TF0, TF0)
>>>>>>>>>ctfc	22
>>>>>>>>>gainFactorInformation	Computed
>>>>>>>>>referenceTFClId	0
>>>>>>>>>TFCS 6	(TF5, TF4, TF1, TF0)
>>>>>>>>>ctfc	59
>>>>>>>>>gainFactorInformation	Computed
>>>>>>>>>> β_c (FDD only)	N/A
>>>>>>>>>> β_d	N/A
>>>>>>>>>>referenceTFClId	0
>>>>>>>>>>TFCS 7	(TF0,TF0,TF0,TF1)
>>>>>>>>>>ctfc	60
>>>>>>>>>>gainFactorInformation	Computed
>>>>>>>>>>referenceTFClId	0
>>>>>>>>>>TFCS 8	(TF1,TF0,TF0,TF1)
>>>>>>>>>>ctfc	61
>>>>>>>>>>gainFactorInformation	Computed
>>>>>>>>>>referenceTFClId	0

Parameters	Value
>>>>>TFCS 9	(TF2,TF1,TF0,TF1)
>>>>>ctfc	68
>>>>>>gainFactorInformation	Computed
>>>>>>>referenceTFCLd	0
>>>>>TFCS 10	(TF3,TF2,TF0,TF1)
>>>>>ctfc	75
>>>>>>gainFactorInformation	Computed
>>>>>>> β c (FDD only)	N/A
>>>>>>> β d	N/A
>>>>>>>referenceTFCLd	0
>>>>>TFCS 11	(TF4,TF3,TF0,TF1)
>>>>>ctfc	82
>>>>>>gainFactorInformation	Computed
>>>>>>>referenceTFCLd	0
>>>>>TFCS 12	(TF5,TF4,TF1,TF1)
>>>>>ctfc	119
>>>>>>gainFactorInformation	Signalled
>>>>>>> β c (FDD only)	11
>>>>>>> β d	15
>>>>>>>referenceTFCLd	0
dl-CommonTransChInfo	
>tfcs-SignallingMode	Same as UL
PhyCH INFORMATION FDD	
UL-DPCH-InfoPredef	
>ul-DPCH-PowerControlInfo	
>>powerControlAlgorithm	Algorithm 1
>>>tpcStepSize	1 dB
>tfci-Existence	TRUE
>puncturingLimit	0.88
DL-CommonInformationPredef	
>dl-DPCH-InfoCommon	
>>spreadingFactor	128
>>tfci-Existence	FALSE
>>pilotBits	4
>>positionFixed	Fixed
PhyCH INFORMATION 3.84/7.68 Mcps TDD	
UL-DPCH-InfoPredef	
>ul-DPCH-PowerControlInfo	
>>dpch-ConstantValue	0
>commonTimeslotInfo	
>>secondInterleavingMode	frameRelated
>>tfci-Coding	16
>>puncturingLimit	0.88
>>repetitionPeriodAndLength	repetitionPeriod1
DL-CommonInformationPredef	
>dl-DPCH-InfoCommon	
>>commonTimeslotInfo	
>>>secondInterleavingMode	frameRelated
>>>tfci-Coding	16
>>>puncturingLimit	0.92
>>>repetitionPeriodAndLength	repetitionPeriod1
PhyCH INFORMATION 1.28 Mcps TDD	
UL-DPCH-InfoPredef	
>commonTimeslotInfo	
>>secondInterleavingMode	frameRelated
>>tfci-Coding	16
>>puncturingLimit	0.72
>>repetitionPeriodAndLength	repetitionPeriod1
DL-CommonInformationPredef	
>dl-DPCH-InfoCommon	
>>commonTimeslotInfo	
>>>secondInterleavingMode	frameRelated

Parameters	Value
>>>tfc-Coding	16
>>>puncturingLimit	0.92
>>>repetitionPeriodAndLength	repetitionPeriod1

13.7.12 Default configuration 10.2/6.7/5.9/4.75 kbps speech & 3.4 kbps signalling & 0.15 kbps SRB#5

Parameters	Value
Ref 34.108	5a
Default configuration identity	11
RB INFORMATION	
rb-Identity	RB1: 1, RB2: 2, RB3: 3, RB5: 5, RB6: 6, RB7: 7, RB8: 8
rlc-InfoChoice	Rlc-info
>ul-RLC-Mode	RB1: UM RB2- RB3: AM RB5-RB7: TM
>>transmissionRLC-DiscardMode	RB1: N/A RB2- RB3: NoDiscard RB5- RB7: N/A
>>>maxDat	RB1: N/A RB2- RB3: 15 RB5- RB7: N/A
>>transmissionWindowSize	RB1: N/A RB2- RB3: 128 for UEs with more than 10 kbyte "total RLC AM buffer size" and 32 otherwise RB5- RB7: N/A
>>timerRST	RB1: N/A RB2- RB3: 300 RB5- RB7: N/A
>>max-RST	RB1: N/A RB2- RB3: 1 RB5- RB7: N/A
>>pollingInfo	RB1: N/A RB2- RB3: as below RB5- RB7: N/A
>>>lastTransmissionPDU-Poll	RB2- RB3: FALSE
>>>lastRetransmissionPDU-Poll	RB2- RB3: FALSE
>>>timerPollPeriodic	RB2- RB3: 300
>>segmentationIndication	RB1- RB3: N/A RB5- RB7: FALSE
>dl-RLC-Mode	RB1: UM RB2- RB3: AM RB5- RB7: TM RB8: TM
>>inSequenceDelivery	RB1: N/A RB2- RB3: TRUE RB5- RB8: N/A
>>receivingWindowSize	RB1: N/A RB2- RB3: 128 for UEs with more than 10 kbyte "total RLC AM buffer size" and 32 otherwise RB5- RB8: N/A
>>dl-RLC-StatusInfo	RB1: N/A RB2- RB3: as below RB5- RB8: N/A
>>>timerStatusProhibit	RB2- RB3: 100
>>>missingPDU-Indicator	RB2- RB3: FALSE
>>>timerStatusPeriodic	RB2- RB3: 300
>>segmentationIndication	RB1- RB3: N/A RB5- RB8: FALSE
rb-MappingInfo	
>UL-LogicalChannelMappings	OneLogicalChannel
>>ul-TransportChannelType	Dch
>>>transportChannelIdentity	RB1- RB3: 4 RB5: 1, RB6: 2, RB7: 3,
>>logicalChannelIdentity	RB1: 1, RB2: 2, RB3: 3 RB5- RB7: N/A
>>rlc-SizeList	RB1- RB3: configured RB5- RB7: N/A
>>mac-LogicalChannelPriority	RB1: 1, RB2: 2, RB3: 3 RB5- RB7: 5
>DL-logicalChannelMappingList	
>>Mapping option 1	One mapping option

>>>dl-TransportChannelType	Dch
>>>>transportChannelIdentity	RB1- RB3: 4 RB5: 1, RB6: 2, RB7: 3, RB8: 5
>>>logicalChannelIdentity	RB1: 1, RB2: 2, RB3: 3 RB5- RB8: N/A
TrCH INFORMATION PER TrCH	
UL-AddReconfTransChInfoList	
>Uplink transport channel type	dch
>transportChannelIdentity	TrCH1: 1, TrCH2: 2, TrCH3: 3, TrCH4: 4
>transportFormatSet	DedicatedTransChTFS
>>dynamicTF-information	
>>>tf0/ tf0,1	TrCH1: (0x65) TrCH2: (0x 99) TrCH3: (0x 40, 1x40) TrCH4: (0x144, 1x144)
>>>>rlcSize	BitMode
>>>>>sizeType	TrCH1: type 1: 65 TrCH2: type 1: 99 TrCH3: type 1: 40 TrCH4: 2: type 2, part1= 2, part2= 0 (144)
>>>>numberOfTbSizeList	TrCH1-2: Zero TrCH3-4: Zero, one
>>>>logicalChannelList	All
>>>>tf 1	TrCH1: (1x39) TrCH2: (1x 53) TrCH3- TrCH4: N/A
>>>>>numberOfTransportBlocks	TrCH1: One TrCH2: One
>>>>>rlc-Size	TrCH1-2: BitMode
>>>>>>sizeType	TrCH1: 1: 39 TrCH2: 1: 53
>>>>>numberOfTbSizeList	TrCH1-2: One
>>>>>logicalChannelList	TrCH1: all
>>>>>tf 2	TrCH1: (1x42) TrCH2: (1x63) TrCH3- TrCH4: N/A
>>>>>>numberOfTransportBlocks	TrCH1: One TrCh2: One
>>>>>>rlc-Size	TrCH1: BitMode
>>>>>>>sizeType	TrCH1: type 1: 42 TrCH2: type 1: 63
>>>>>>numberOfTbSizeList	TrCH1: One TrCH2: One
>>>>>>logicalChannelList	TrCH1: all TrCH2: all
>>>>>>tf 3	TrCH1: (1x55) TrCH2: (1x76) TrCH3- TrCH4: N/A
>>>>>>>numberOfTransportBlocks	TrCH1: One TrCh2: One
>>>>>>>rlc-Size	TrCH1: BitMode
>>>>>>>>sizeType	TrCH1: type 1: 55 TrCH2: type 1: 76
>>>>>>>numberOfTbSizeList	TrCH1: One TrCH2: One
>>>>>>>logicalChannelList	TrCH1: all TrCH2: all
>>>>>>>tf 4	TrCH1: (1x58) TrCH2: (1x99) TrCH3- TrCH4: N/A
>>>>>>>>numberOfTransportBlocks	TrCH1: One TrCh2: One
>>>>>>>>rlc-Size	TrCH1: BitMode
>>>>>>>>>sizeType	TrCH1: type 1: 58 TrCH2: type 1: 99

>>>>numberOfTbSizeList	TrCH1: One TrCH2: One
>>>>logicalChannelList	TrCH1: all TrCH2: all
>>>tf 5	TrCH1: (1x65) TrCH2- TrCH4: N/A
>>>>numberOfTransportBlocks	TrCH1: One
>>>>rlc-Size	TrCH1: BitMode
>>>>>sizeType	TrCH1: type 1: 65
>>>>numberOfTbSizeList	TrCH1: One
>>>>logicalChannelList	TrCH1: all
>>semistaticTF-Information	
>>>tti	TrCH1- TrCH3: 20 TrCH4: 40
>>>channelCodingType	Convolutional
>>>>codingRate	TrCH1- TrCH2: Third TrCH3: Half TrCH4: Third
>>>>rateMatchingAttribute	TrCH1: 200 TrCH2: 190 TrCH3: 235 TrCH4: 160
>>>crc-Size	TrCH1: 12 TrCH2- TrCH3: 0 TrCH4: 16
DL-AddReconfTransChInfoList	
>Downlink transport channel type	dch
>dl-TransportChannelIdentity	TrCH1: 1, TrCH2: 2, TrCH3: 3, TrCH4: 4, TrCH5: 5
>tfs-SignallingMode	Independent <Only tf0 on TrCH1 and tf0/tf1 on TrCH5 are different and shown below>
>>transportFormatSet	
>>>dynamicTF-information	
>>>>tf0/ tf0,1	TrCH1: (1x0) TrCH5: (0x3, 1x3)
>>>>rlcSize	BitMode
>>>>>sizeType	TrCH1: type 1: 0 TrCH5: type 1: 3
>>>>numberOfTbSizeList	TrCH1: One TrCH5: Zero, one
>>>>logicalChannelList	All
>>>semistaticTF-Information	same as UL except for TrCH5
>>>>tti	TrCH5: 20
>>>>channelCodingType	Convolutional
>>>>>codingRate	TrCH5: Third
>>>>>rateMatchingAttribute	TrCH5: 200
>>>>>crc-Size	TrCH5: 12
>>ULTrCH-Id	TrCH1: 1, TrCH2: 2, TrCH3: 3, TrCH4: 4,
>dch-QualityTarget	
>>bler-QualityValue	TrCH1: 7×10^{-3} TrCH2- TrCH5: Absent
TrCH INFORMATION, COMMON	
ul-CommonTransChInfo	
>tfs-ID (TDD only)	1
>sharedChannelIndicator (TDD only)	FALSE
> tfc-Subset	Absent, not required
>ul-TFCS	Normal TFCI signalling
>>explicitTFCS-ConfigurationMode	Complete
>>>ctfcSize	Ctfc8Bit
>>>>TFCS representation	Addition
>>>>>TFC list	
>>>>>>TFC 1	(TF0, TF0, TF0, TF0)
>>>>>>>ctfc	0
>>>>>>>>gainFactorInformation	Computed
>>>>>>>>>referenceTFCId	0

>>>>>TFC 2	(TF1, TF0, TF0, TF0)
>>>>>ctfc	1
>>>>>gainFactorInformation	Computed
>>>>>> β c (FDD only)	N/A
>>>>>> β d	N/A
>>>>>>referenceTFCId	0
>>>>>TFC 3	(TF2, TF1, TF0, TF0)
>>>>>ctfc	8
>>>>>gainFactorInformation	Computed
>>>>>>referenceTFCId	0
>>>>>TFC 4	(TF3, TF2, TF0, TF0)
>>>>>ctfc	15
>>>>>gainFactorInformation	Computed
>>>>>> β c (FDD only)	
>>>>>> β d	
>>>>>>referenceTFCId	0
>>>>>TFC 5	(TF4, TF3, TF0, TF0)
>>>>>ctfc	22
>>>>>gainFactorInformation	Computed
>>>>>>referenceTFCId	0
>>>>>TFC 6	(TF5, TF4, TF1, TF0)
>>>>>ctfc	59
>>>>>gainFactorInformation	Computed
>>>>>> β c (FDD only)	
>>>>>> β d	
>>>>>>referenceTFCId	0
>>>>>TFC 7	(TF0, TF0, TF0, TF1)
>>>>>ctfc	60
>>>>>gainFactorInformation	Computed
>>>>>>referenceTFCId	0
>>>>>TFC 8	(TF1, TF0, TF0, TF1)
>>>>>ctfc	61
>>>>>gainFactorInformation	computed
>>>>>> β c (FDD only)	
>>>>>> β d	
>>>>>>referenceTFCId	0
>>>>>TFC 9	(TF2, TF1, TF0, TF1)
>>>>>ctfc	68
>>>>>gainFactorInformation	computed
>>>>>>referenceTFCId	0
>>>>>TFC 10	(TF3, TF2, TF0, TF1)
>>>>>ctfc	75
>>>>>gainFactorInformation	computed
>>>>>> β c (FDD only)	
>>>>>> β d	
>>>>>>referenceTFCId	0
>>>>>TFC 11	(TF4, TF3, TF0, TF1)
>>>>>ctfc	82
>>>>>gainFactorInformation	computed
>>>>>>referenceTFCId	0
>>>>>TFC 12	(TF5, TF4, TF1, TF1)
>>>>>ctfc	119
>>>>>gainFactorInformation	signalled
>>>>>> β c (FDD only)	11
>>>>>> β d	15
>>>>>>referenceTFCId	0
> TFC subset list	
>>TFC subset 1	(speech rate 10.2)
>>> Allowed transport format combination list	(TFC1, TFC2, TFC3, TFC4, TFC5, TFC7, TFC8, TFC6, TFC9, TFC10, TFC11, TFC12)
>>TFC subset 2	(speech rate 6.7)

>>> Allowed transport format combination list	(TFC1, TFC2, TFC3, TFC4, TFC7, TFC8, TFC5, TFC9, TFC10, TFC11)
>>TFC subset 3	(speech rate 5.9)
>>> Allowed transport format combination list	(TFC1, TFC2, TFC3, TFC7, TFC8, TFC4, TFC9, TFC10)
>>TFC subset 4	(speech rate 4.75)
>>> Allowed transport format combination list	(TFC1, TFC2, TFC7, TFC8, TFC3, TFC9)
dl-CommonTransChInfo	
>tfc-SignallingMode	Independent
>tfc-ID (TDD only)	1
>sharedChannelIndicator (TDD only)	FALSE
> tfc-Subset	Absent, not required
>dl-TFCS	Normal TFCS signalling
>>explicitTFCS-ConfigurationMode	Complete
>>>ctfcSize	Ctfc8Bit
>>>>TFCS representation	Addition
>>>>>TFCS list	
>>>>>>TFC 1	(TF0, TF0, TF0, TF0, TF0)
>>>>>>>ctfc	0
>>>>>>TFC 2	(TF1, TF0, TF0, TF0, TF0)
>>>>>>>ctfc	1
>>>>>>TFC 3	(TF2, TF1, TF0, TF0, TF0)
>>>>>>>ctfc	8
>>>>>>TFC 4	(TF3, TF2, TF0, TF0, TF0)
>>>>>>>ctfc	15
>>>>>>TFC 5	(TF4, TF3, TF0, TF0, TF0)
>>>>>>>ctfc	22
>>>>>>TFC 6	(TF5, TF4, TF1, TF0, TF0)
>>>>>>>ctfc	59
>>>>>>TFC 7	(TF0, TF0, TF0, TF1, TF0)
>>>>>>>ctfc	60
>>>>>>TFC 8	(TF1, TF0, TF0, TF1, TF0)
>>>>>>>ctfc	61
>>>>>>TFC 9	(TF2, TF1, TF0, TF1, TF0)
>>>>>>>ctfc	68
>>>>>>TFC 10	(TF3, TF2, TF0, TF1, TF0)
>>>>>>>ctfc	75
>>>>>>TFC 11	(TF4, TF3, TF0, TF1, TF0)
>>>>>>>ctfc	82
>>>>>>TFC 12	(TF5, TF4, TF1, TF1, TF0)
>>>>>>>ctfc	119
>>>>>>TFC 13	(TF0, TF0, TF0, TF0, TF1)
>>>>>>>ctfc	120
>>>>>>TFC 14	(TF1, TF0, TF0, TF0, TF1)
>>>>>>>ctfc	121
>>>>>>TFC 15	(TF2, TF1, TF0, TF0, TF1)
>>>>>>>ctfc	128
>>>>>>TFC 16	(TF3, TF2, TF0, TF0, TF1)
>>>>>>>ctfc	135
>>>>>>TFC 17	(TF4, TF3, TF0, TF0, TF1)
>>>>>>>ctfc	142
>>>>>>TFC 18	(TF5, TF4, TF1, TF0, TF1)
>>>>>>>ctfc	179
>>>>>>TFC 19	(TF0, TF0, TF0, TF1, TF1)
>>>>>>>ctfc	180
>>>>>>TFC 20	(TF1, TF0, TF0, TF1, TF1)
>>>>>>>ctfc	181
>>>>>>TFC 21	(TF2, TF1, TF0, TF1, TF1)
>>>>>>>ctfc	188
>>>>>>TFC 22	(TF3, TF2, TF0, TF1, TF1)
>>>>>>>ctfc	195
>>>>>>TFC 23	(TF4, TF3, TF0, TF1, TF1)
>>>>>>>ctfc	202
>>>>>>TFC 24	(TF5, TF4, TF1, TF1, TF1)

>>>>>>ctfc	239
PhyCH INFORMATION FDD	
UL-DPCH-InfoPredef	
>ul-DPCH-PowerControlInfo	
>>powerControlAlgorithm	Algorithm 1
>>>tpcStepSize	1 dB
>tfc-Existence	TRUE
>puncturingLimit	0.88
DL-CommonInformationPredef	
>dl-DPCH-InfoCommon	
>>spreadingFactor	128
>>tfc-Existence	FALSE
>>pilotBits	4
>>positionFixed	Fixed
PhyCH INFORMATION 3.84/7.68 Mcps TDD	
UL-DPCH-InfoPredef	
>ul-DPCH-PowerControlInfo	
>>dpch-ConstantValue	0
>commonTimeslotInfo	
>>secondInterleavingMode	frameRelated
>>tfc-Coding	16
>>puncturingLimit	0.60
>>repetitionPeriodAndLength	repetitionPeriod1
DL-CommonInformationPredef	
>dl-DPCH-InfoCommon	
>>commonTimeslotInfo	
>>>secondInterleavingMode	frameRelated
>>>tfc-Coding	16
>>>puncturingLimit	0.60
>>>repetitionPeriodAndLength	repetitionPeriod1
PhyCH INFORMATION 1.28 Mcps TDD	
UL-DPCH-InfoPredef	
>commonTimeslotInfo	
>>secondInterleavingMode	frame Related
>>tfc-Coding	16
>>puncturingLimit	0.64
>>repetitionPeriodAndLength	repetitionPeriod1
DL-CommonInformationPredef	
>dl-DPCH-InfoCommon	
>>commonTimeslotInfo	
>>>secondInterleavingMode	frame Related
>>>tfc-Coding	16
>>>puncturingLimit	0.64
>>>repetitionPeriodAndLength	repetitionPeriod1

13.7.13 Default configuration 7.4/6.7/5.9/4.75 kbps speech & 3.4 kbps signalling & 0.15 kbps SRB#5

Parameters	Value
Ref 34.108	7a
Default configuration identity	12
RB INFORMATION	
rb-Identity	RB1: 1, RB2: 2, RB3: 3, RB5: 5, RB6: 6, RB7: 7
rlc-InfoChoice	Rlc-info
>ul-RLC-Mode	RB1: UM RB2- RB3: AM RB5-RB6: TM
>>transmissionRLC-DiscardMode	RB1: N/A RB2- RB3: NoDiscard RB5- RB6: N/A
>>>maxDat	RB1: N/A RB2- RB3: 15 RB5- RB6: N/A
>>transmissionWindowSize	RB1: N/A RB2- RB3: 128 for UEs with more than 10 kbyte "total RLC AM buffer size" and 32 otherwise RB5- RB6: N/A
>>timerRST	RB1: N/A RB2- RB3: 300 RB5- RB6: N/A
>>max-RST	RB1: N/A RB2- RB3: 1 RB5- RB6: N/A
>>pollingInfo	RB1: N/A RB2- RB3: as below RB5- RB6: N/A
>>>lastTransmissionPDU-Poll	RB2- RB3: FALSE
>>>lastRetransmissionPDU-Poll	RB2- RB3: FALSE
>>>timerPollPeriodic	RB2- RB3: 300
>>segmentationIndication	RB1- RB3: N/A RB5- RB6: FALSE
>dl-RLC-Mode	RB1: UM RB2- RB3: AM RB5- RB6: TM RB7: TM
>>inSequenceDelivery	RB1: N/A RB2- RB3: TRUE RB5- RB7: N/A
>>receivingWindowSize	RB1: N/A RB2- RB3: 128 for UEs with more than 10 kbyte "total RLC AM buffer size" and 32 otherwise RB5- RB7: N/A
>>dl-RLC-StatusInfo	RB1: N/A RB2- RB3: as below RB5- RB7: N/A
>>>timerStatusProhibit	RB2- RB3: 100
>>>missingPDU-Indicator	RB2- RB3: FALSE
>>>timerStatusPeriodic	RB2- RB3: 300
>>segmentationIndication	RB1- RB3: N/A RB5- RB7: FALSE
rb-MappingInfo	
>UL-LogicalChannelMappings	OneLogicalChannel
>>ul-TransportChannelType	Dch
>>>transportChannelIdentity	RB1- RB3: 3 RB5: 1, RB6: 2
>>logicalChannelIdentity	RB1: 1, RB2: 2, RB3: 3 RB5- RB6: N/A
>>rlc-SizeList	RB1- RB3: configured RB5- RB6: N/A
>>mac-LogicalChannelPriority	RB1: 1, RB2: 2, RB3: 3 RB5- RB6: 5
>DL-logicalChannelMappingList	
>>Mapping option 1	One mapping option
>>>dl-TransportChannelType	Dch

>>>>transportChannelIdentity	RB1- RB3: 3 RB5: 1, RB6: 2, RB7:4
>>>logicalChannelIdentity	RB1: 1, RB2: 2, RB3: 3 RB5- RB7: N/A
TrCH INFORMATION PER TrCH	
UL-AddReconfTransChInfoList	
>Uplink transport channel type	dch
>transportChannelIdentity	TrCH1: 1, TrCH2: 2, TrCH3: 3
>transportFormatSet	DedicatedTransChTFS
>>dynamicTF-information	
>>>tf0/ tf0,1	TrCH1: (0x61) TrCH2: (0x 87) TrCH3: (0x 144, 1x144)
>>>>rlcSize	BitMode
>>>>>sizeType	TrCH1: type 1: 61 TrCH2: type 1: 87 TrCH3: 2: type 2, part1= 2, part2= 0 (144)
>>>>numberOfTbSizeList	TrCH1-2: Zero TrCH3: Zero, one
>>>>logicalChannelList	All
>>>tf 1	TrCH1: (1x39) TrCH2: (1x53) TrCH3: N/A
>>>>numberOfTransportBlocks	TrCH1: One TrCH2: One
>>>>rlc-Size	TrCH1-2: BitMode
>>>>>sizeType	TrCH1: 1: 39 TrCH1: 1: 53
>>>>numberOfTbSizeList	TrCH1-2: One
>>>>logicalChannelList	TrCH1: all
>>>tf 2	TrCH1: (1x42) TrCH2: (1x63) TrCH3: N/A
>>>>numberOfTransportBlocks	TrCH1: One TrCh2: One
>>>>rlc-Size	TrCH1: BitMode
>>>>>sizeType	TrCH1: type 1: 42 TrCH2: type 1: 63
>>>>numberOfTbSizeList	TrCH1: One TrCH2: One
>>>>logicalChannelList	TrCH1: all TrCH2: all
>>>tf 3	TrCH1: (1x55) TrCH2: (1x76) TrCH3: N/A
>>>>numberOfTransportBlocks	TrCH1: One TrCh2: One
>>>>rlc-Size	TrCH1: BitMode
>>>>>sizeType	TrCH1: type 1: 55 TrCH2: type 1: 76
>>>>numberOfTbSizeList	TrCH1: One TrCH2: One
>>>>logicalChannelList	TrCH1: all TrCH2: all
>>>tf 4	TrCH1: (1x58) TrCH2: (1x87) TrCH3: N/A
>>>>numberOfTransportBlocks	TrCH1: One TrCh2: One
>>>>rlc-Size	TrCH1: BitMode
>>>>>sizeType	TrCH1: type 1: 58 TrCH2: type 1: 87
>>>>numberOfTbSizeList	TrCH1: One TrCH2: One
>>>>logicalChannelList	TrCH1: all TrCH2: all

>>>tf 5	TrCH1: (1x61) TrCH2- TrCH4: N/A
>>>>numberOfTransportBlocks	TrCH1: One
>>>>rlc-Size	TrCH1: BitMode
>>>>>sizeType	TrCH1: type 1: 61
>>>>numberOfTbSizeList	TrCH1: One
>>>>logicalChannelList	TrCH1: all
>>semistaticTF-Information	
>>>tti	TrCH1- TrCH2: 20 TrCH3: 40
>>>channelCodingType	Convolutional
>>>>codingRate	TrCH1- TrCH2: Third TrCH3: Third
>>>rateMatchingAttribute	TrCH1: 200 TrCH2: 190 TrCH3: 160
>>>crc-Size	TrCH1: 12 TrCH2: 0 TrCH3: 16
DL-AddReconfTransChInfoList	
>Downlink transport channel type	dch
>dl-TransportChannelIdentity	TrCH1: 1, TrCH2: 2, TrCH3: 3, TrCH4: 4
>tfS-SignallingMode	Independent <Only tf0 on TrCH1 and tf0/1 on TrCH4 are different and shown below>
>>transportFormatSet	
>>>dynamicTF-information	
>>>>tf0/ tf0,1	TrCH1: (1x0) TrCH4: (0x3, 1x3)
>>>>rlcSize	bitMode
>>>>>sizeType	TrCH1: type 1: 0 TrCH4: type 1: 3
>>>>numberOfTbSizeList	TrCH1: One TrCH4: Zero, one
>>>>logicalChannelList	All
>>>semistaticTF-Information	same as UL except for TrCH4
>>>>tti	TrCH4: 20
>>>>channelCodingType	Convolutional
>>>>>codingRate	TrCH4: Third
>>>>rateMatchingAttribute	TrCH4: 200
>>>>crc-Size	TrCH4: 12
>>ULTrCH-Id	TrCH1: 1, TrCH2: 2, TrCH3: 3
>dch-QualityTarget	
>>bler-QualityValue	TrCH1: 7×10^{-3} TrCH2- TrCH4: Absent
TrCH INFORMATION, COMMON	
ul-CommonTransChInfo	
>tfcs-ID (TDD only)	1
>sharedChannelIndicator (TDD only)	FALSE
> tfc-Subset	Absent, not required
>ul-TFCS	Normal TFCl signalling
>>explicitTFCS-ConfigurationMode	Complete
>>>ctfcSize	Ctfc6Bit
>>>>TFCS representation	Addition
>>>>>TFC list	
>>>>>>TFC 1	(TF0, TF0, TF0)
>>>>>>>ctfc	0
>>>>>>>gainFactorInformation	Computed
>>>>>>>referenceTFCId	0
>>>>>>TFC 2	(TF1, TF0, TF0)
>>>>>>>ctfc	1
>>>>>>>gainFactorInformation	Computed
>>>>>>>> β_c (FDD only)	N/A
>>>>>>>> β_d	N/A

>>>>>>referenceTFCId	0
>>>>>TFC 3	(TF2, TF1, TF0)
>>>>>ctfc	8
>>>>>gainFactorInformation	Computed
>>>>>>referenceTFCId	0
>>>>>TFC 4	(TF3, TF2, TF0)
>>>>>ctfc	15
>>>>>gainFactorInformation	Computed
>>>>>> β_c (FDD only)	
>>>>>> β_d	
>>>>>>referenceTFCId	0
>>>>>TFC 5	(TF4, TF3, TF0)
>>>>>ctfc	22
>>>>>gainFactorInformation	Computed
>>>>>>referenceTFCId	0
>>>>>TFC 6	(TF5, TF4, TF0)
>>>>>ctfc	29
>>>>>gainFactorInformation	Computed
>>>>>> β_c (FDD only)	
>>>>>> β_d	
>>>>>>referenceTFCId	0
>>>>>TFC 7	(TF0, TF0, TF1)
>>>>>ctfc	30
>>>>>gainFactorInformation	Computed
>>>>>>referenceTFCId	0
>>>>>TFC 8	(TF1, TF0, TF1)
>>>>>ctfc	31
>>>>>gainFactorInformation	computed
>>>>>> β_c (FDD only)	
>>>>>> β_d	
>>>>>>referenceTFCId	0
>>>>>TFC 9	(TF2, TF1, TF1)
>>>>>ctfc	38
>>>>>gainFactorInformation	computed
>>>>>>referenceTFCId	0
>>>>>TFC 10	(TF3, TF2, TF1)
>>>>>ctfc	45
>>>>>gainFactorInformation	computed
>>>>>> β_c (FDD only)	
>>>>>> β_d	
>>>>>>referenceTFCId	0
>>>>>TFC 11	(TF4, TF3, TF1)
>>>>>ctfc	52
>>>>>gainFactorInformation	computed
>>>>>>referenceTFCId	0
>>>>>TFC 12	(TF5, TF4, TF1)
>>>>>ctfc	59
>>>>>gainFactorInformation	signalled
>>>>>> β_c (FDD only)	11
>>>>>> β_d	15
>>>>>>referenceTFCId	0
> TFC subset list	
>>TFC subset 1	(speech rate 7.4)
>>> Allowed transport format combination list	(TFC1, TFC2, TFC3, TFC4, TFC5, TFC7, TFC8, TFC6, TFC9, TFC10, TFC11, TFC12)
>>TFC subset 2	(speech rate 6.7)
>>> Allowed transport format combination list	(TFC1, TFC2, TFC3, TFC4, TFC7, TFC8, TFC5, TFC9, TFC10, TFC11)
>>TFC subset 3	(speech rate 5.9)
>>> Allowed transport format combination list	(TFC1, TFC2, TFC3, TFC7, TFC8, TFC4, TFC9, TFC10)
>>TFC subset 4	(speech rate 4.75)

>>> Allowed transport format combination list	(TFC1, TFC2, TFC7, TFC8, TFC3, TFC9)
dl-CommonTransChInfo	
>tfc-SignallingMode	Independent
>tfc-ID (TDD only)	1
>sharedChannelIndicator (TDD only)	FALSE
> tfc-Subset	Absent, not required
>dl-TFCS	Normal TFCS signalling
>>explicitTFCS-ConfigurationMode	Complete
>>>ctfcSize	Ctfc8Bit
>>>>TFCS representation	Addition
>>>>>TFCS list	
>>>>>>TFC 1	(TF0, TF0, TF0, TF0)
>>>>>>>ctfc	0
>>>>>>>TFC 2	(TF1, TF0, TF0, TF0)
>>>>>>>ctfc	1
>>>>>>>TFC 3	(TF2, TF1, TF0, TF0)
>>>>>>>ctfc	8
>>>>>>>TFC 4	(TF3, TF2, TF0, TF0)
>>>>>>>ctfc	15
>>>>>>>TFC 5	(TF4, TF3, TF0, TF0)
>>>>>>>ctfc	22
>>>>>>>TFC 6	(TF5, TF4, TF0, TF0)
>>>>>>>ctfc	29
>>>>>>>TFC 7	(TF0, TF0, TF1, TF0)
>>>>>>>ctfc	30
>>>>>>>TFC 8	(TF1, TF0, TF1, TF0)
>>>>>>>ctfc	31
>>>>>>>TFC 9	(TF2, TF1, TF1, TF0)
>>>>>>>ctfc	38
>>>>>>>TFC 10	(TF3, TF2, TF1, TF0)
>>>>>>>ctfc	45
>>>>>>>TFC 11	(TF4, TF3, TF1, TF0)
>>>>>>>ctfc	52
>>>>>>>TFC 12	(TF5, TF4, TF1, TF0)
>>>>>>>ctfc	59
>>>>>>>TFC 13	(TF0, TF0, TF0, TF1)
>>>>>>>ctfc	60
>>>>>>>TFC 14	(TF1, TF0, TF0, TF1)
>>>>>>>ctfc	61
>>>>>>>TFC 15	(TF2, TF1, TF0, TF1)
>>>>>>>ctfc	68
>>>>>>>TFC 16	(TF3, TF2, TF0, TF1)
>>>>>>>ctfc	75
>>>>>>>TFC 17	(TF4, TF3, TF0, TF1)
>>>>>>>ctfc	82
>>>>>>>TFC 18	(TF5, TF4, TF0, TF1)
>>>>>>>ctfc	89
>>>>>>>TFC 19	(TF0, TF0, TF1, TF1)
>>>>>>>ctfc	90
>>>>>>>TFC 20	(TF1, TF0, TF1, TF1)
>>>>>>>ctfc	91
>>>>>>>TFC 21	(TF2, TF1, TF1, TF1)
>>>>>>>ctfc	98
>>>>>>>TFC 22	(TF3, TF2, TF1, TF1)
>>>>>>>ctfc	105
>>>>>>>TFC 23	(TF4, TF3, TF1, TF1)
>>>>>>>ctfc	112
>>>>>>>TFC 24	(TF5, TF4, TF1, TF1)
>>>>>>>ctfc	119
PhyCH INFORMATION FDD	
UL-DPCH-InfoPredef	
>ul-DPCH-PowerControlInfo	
>>powerControlAlgorithm	Algorithm 1
>>>tpcStepSize	1 dB

>tfc-Existence	TRUE
>puncturingLimit	0.88
DL-CommonInformationPredef	
>dl-DPCH-InfoCommon	
>>spreadingFactor	128
>>tfc-Existence	FALSE
>>pilotBits	4
>>positionFixed	Fixed
PhyCH INFORMATION 3.84/7.68 Mcps TDD	
UL-DPCH-InfoPredef	
>ul-DPCH-PowerControlInfo	
>>dpch-ConstantValue	0
>commonTimeslotInfo	
>>secondInterleavingMode	frameRelated
>>tfc-Coding	16
>>puncturingLimit	0.60
>>repetitionPeriodAndLength	repetitionPeriod1
DL-CommonInformationPredef	
>dl-DPCH-InfoCommon	
>>commonTimeslotInfo	
>>>secondInterleavingMode	frameRelated
>>>tfc-Coding	16
>>>puncturingLimit	0.60
>>>repetitionPeriodAndLength	repetitionPeriod1
PhyCH INFORMATION 1.28 Mcps TDD	
UL-DPCH-InfoPredef	
>commonTimeslotInfo	
>>secondInterleavingMode	frame Related
>>tfc-Coding	16
>>puncturingLimit	0.64
>>repetitionPeriodAndLength	repetitionPeriod1
DL-CommonInformationPredef	
>dl-DPCH-InfoCommon	
>>commonTimeslotInfo	
>>>secondInterleavingMode	frame Related
>>>tfc-Coding	16
>>>puncturingLimit	0.64
>>>repetitionPeriodAndLength	repetitionPeriod1

13.7.14 Default configuration 12.65/8.85/6.6 kbps speech & 3.4 kbps signalling & 0.15 kbps SRB#5

Parameters	Value
Ref 34.108	62
Default configuration identity	13
RB INFORMATION	
rb-Identity	RB1: 1, RB2: 2, RB3: 3, RB5: 5, RB6: 6, RB7: 7, RB8: 8
rlc-InfoChoice	Rlc-info
>ul-RLC-Mode	RB1: UM RB2- RB3: AM RB5-RB7: TM
>>transmissionRLC-DiscardMode	RB1: N/A RB2- RB3: NoDiscard RB5- RB7: N/A
>>>maxDat	RB1: N/A RB2- RB3: 15 RB5- RB7: N/A
>>transmissionWindowSize	RB1: N/A RB2- RB3: 128 for UEs with more than 10 kbyte "total RLC AM buffer size" and 32 otherwise RB5- RB7: N/A
>>timerRST	RB1: N/A RB2- RB3: 300 RB5- RB7: N/A
>>max-RST	RB1: N/A RB2- RB3: 1 RB5- RB7: N/A
>>pollingInfo	RB1: N/A RB2- RB3: as below RB5- RB7: N/A
>>>lastTransmissionPDU-Poll	RB2- RB3: FALSE
>>>lastRetransmissionPDU-Poll	RB2- RB3: FALSE
>>>timerPollPeriodic	RB2- RB3: 300
>>segmentationIndication	RB1- RB3: N/A RB5- RB7: FALSE
>dl-RLC-Mode	RB1: UM RB2- RB3: AM RB5- RB7: TM RB8: TM
>>inSequenceDelivery	RB1: N/A RB2- RB3: TRUE RB5- RB7: N/A RB8: N/A
>>receivingWindowSize	RB1: N/A RB2- RB3: 128 for UEs with more than 10 kbyte "total RLC AM buffer size" and 32 otherwise RB5- RB7: N/A RB8: N/A
>>dl-RLC-StatusInfo	RB1: N/A RB2- RB3: as below RB5- RB7: N/A RB8: N/A
>>>timerStatusProhibit	RB2- RB3: 100
>>>missingPDU-Indicator	RB2- RB3: FALSE
>>>timerStatusPeriodic	RB2- RB3: 300
>>segmentationIndication	RB1- RB3: N/A RB5- RB7: FALSE RB8: FALSE
rb-MappingInfo	
>UL-LogicalChannelMappings	OneLogicalChannel
>>ul-TransportChannelType	Dch
>>>transportChannelIdentity	RB1- RB3: 4 RB5: 1, RB6: 2, RB7: 3.
>>logicalChannelIdentity	RB1: 1, RB2: 2, RB3: 3 RB5- RB7: N/A
>>rlc-SizeList	RB1- RB3: configured RB5- RB7: N/A

>>mac-LogicalChannelPriority	RB1: 1, RB2: 2, RB3: 3 RB5- RB7: 5
>DL-logicalChannelMappingList	
>>Mapping option 1	One mapping option
>>>dl-TransportChannelType	Dch
>>>>transportChannelIdentity	RB1- RB3: 4 RB5: 1, RB6: 2, RB7: 3, RB8: 5
>>>logicalChannelIdentity	RB1: 1, RB2: 2, RB3: 3 RB5- RB7: N/A RB8: N/A
TrCH INFORMATION PER TrCH	
UL-AddReconfTransChInfoList	
>Uplink transport channel type	dch
>transportChannelIdentity	TrCH1: 1, TrCH2: 2, TrCH3: 3, TrCH4: 4
>transportFormatSet	DedicatedTransChTFS
>>dynamicTF-information	
>>>tf0/ tf0,1	TrCH1: (0x72) TrCH2: (0x 181) TrCH3: (0x60) TrCH4: (0x144, 1x144)
>>>>rlcSize	BitMode
>>>>>sizeType	TrCH1: type 1: 72 TrCH2: type 2: part1= 6, part2= 5 TrCH3: type1: 60 TrCH4: 2: type 2, part1= 2, part2= 0 (144)
>>>>numberOfTbSizeList	TrCH1-3: Zero TrCH4: Zero, one
>>>>logicalChannelList	All
>>>>tf 1	TrCH1: (1x40) TrCH2: (1x 78) TrCH3: N/A TrCH4: N/A
>>>>>numberOfTransportBlocks	TrCH1: One TrCH2: One
>>>>>rlc-Size	TrCH1-2: BitMode
>>>>>>sizeType	TrCH1: 1: 40 TrCH2: 1: 78
>>>>>>numberOfTbSizeList	TrCH1-2: One
>>>>>>logicalChannelList	TrCH1: all
>>>>>>tf 2	TrCH1: (1x54) TrCH2: (1x113) TrCH3: N/A TrCH4: N/A
>>>>>>>numberOfTransportBlocks	TrCH1: One TrCh2: One
>>>>>>>rlc-Size	TrCH1: BitMode
>>>>>>>>sizeType	TrCH1: type 1: 54 TrCH2: type 1: 113
>>>>>>>>numberOfTbSizeList	TrCH1: One TrCH2: One
>>>>>>>>logicalChannelList	TrCH1: all TrCH2: all
>>>>>>>>tf 3	TrCH1: (1x64) TrCH2: (1x181) TrCH3: N/A TrCH4: N/A
>>>>>>>>>numberOfTransportBlocks	TrCH1: One TrCh2: One
>>>>>>>>>rlc-Size	TrCH1: BitMode
>>>>>>>>>>sizeType	TrCH1: type 1: 64 TrCH2: type 2: part1=6, part2= 5
>>>>>>>>>>numberOfTbSizeList	TrCH1: One TrCH2: One
>>>>>>>>>>logicalChannelList	TrCH1: all TrCH2: all

>>>tf 4	TrCH1: (1x72) TrCH2: N/A TrCH3: N/A TrCH4: N/A
>>>>numberOfTransportBlocks	TrCH1: One
>>>>rlc-Size	TrCH1: BitMode
>>>>>sizeType	TrCH1: type 1: 72
>>>>numberOfTbSizeList	TrCH1: One
>>>>logicalChannelList	TrCH1: all
>>semistaticTF-Information	
>>>tti	TrCH1- TrCH3: 20 TrCH4: 40
>>>channelCodingType	Convolutional
>>>>codingRate	TrCH1- TrCH3: Third TrCH4: Third
>>>>rateMatchingAttribute	TrCH1: 200 TrCH2: 190 TrCH3: 256 TrCH4: 170
>>>>crc-Size	TrCH1: 12 TrCH2: 0 TrCH3: 0 TrCH4: 16
DL-AddReconfTransChInfoList	
>Downlink transport channel type	dch
>dl-TransportChannelIdentity	TrCH1: 1, TrCH2: 2, TrCH3: 3, TrCH4: 4, TrCH5: 5
>tfs-SignallingMode	Independent <Only tf0 on TrCH1 and tf0/tf1 on TrCH5 are different and shown below>
>>transportFormatSet	
>>>dynamicTF-information	
>>>>tf0/ tf0,1	TrCH1: (1x0) TrCH5: (0x3, 1x3)
>>>>rlcSize	BitMode
>>>>>sizeType	TrCH1: type 1: 0 TrCH5: type 1: 3
>>>>numberOfTbSizeList	TrCH1: One TrCH5: Zero, one
>>>>logicalChannelList	All
>>>semistaticTF-Information	same as UL except for TrCH5
>>>>tti	TrCH5: 20
>>>>channelCodingType	Convolutional
>>>>>codingRate	TrCH5: Third
>>>>>rateMatchingAttribute	TrCH5: 205
>>>>>crc-Size	TrCH5: 8
>>ULTrCH-Id	TrCH1: 1, TrCH2: 2, TrCH3: 3, TrCH4: 4,
>dch-QualityTarget	
>>bler-QualityValue	TrCH1: 7×10^{-3} TrCH2: Absent TrCH3: Absent TrCH4- TrCH5: Absent
TrCH INFORMATION, COMMON	
ul-CommonTransChInfo	
>tfs-ID (TDD only)	1
>sharedChannelIndicator (TDD only)	FALSE
> tfc-Subset	Absent, not required
>ul-TFCS	Normal TFCI signalling
>>explicitTFCS-ConfigurationMode	Complete
>>>ctfcSize	Ctfc6Bit
>>>>TFCS representation	Addition
>>>>>TFC list	
>>>>>>TFC 1	(TF0, TF0, TF0, TF0)
>>>>>>>ctfc	0
>>>>>>>>gainFactorInformation	Computed
>>>>>>>>referenceTFCId	0

>>>>>TFC 2	(TF1, TF0, TF0, TF0)
>>>>>ctfc	1
>>>>>gainFactorInformation	Computed
>>>>>> β c (FDD only)	N/A
>>>>>> β d	N/A
>>>>>>referenceTFCId	0
>>>>>TFC 3	(TF2, TF1, TF0, TF0)
>>>>>ctfc	7
>>>>>gainFactorInformation	Computed
>>>>>>referenceTFCId	0
>>>>>TFC 4	(TF3, TF2, TF0, TF0)
>>>>>ctfc	13
>>>>>gainFactorInformation	Computed
>>>>>> β c (FDD only)	
>>>>>> β d	
>>>>>>referenceTFCId	0
>>>>>TFC 5	(TF4, TF3, TF0, TF0)
>>>>>ctfc	19
>>>>>gainFactorInformation	Computed
>>>>>>referenceTFCId	0
>>>>>TFC 6	(TF0, TF0, TF0, TF1)
>>>>>ctfc	20
>>>>>gainFactorInformation	Computed
>>>>>> β c (FDD only)	
>>>>>> β d	
>>>>>>referenceTFCId	0
>>>>>TFC 7	(TF1, TF0, TF0, TF1)
>>>>>ctfc	21
>>>>>gainFactorInformation	Computed
>>>>>>referenceTFCId	0
>>>>>TFC 8	(TF2, TF1, TF0, TF1)
>>>>>ctfc	27
>>>>>gainFactorInformation	computed
>>>>>> β c (FDD only)	
>>>>>> β d	
>>>>>>referenceTFCId	0
>>>>>TFC 9	(TF3, TF2, TF0, TF1)
>>>>>ctfc	33
>>>>>gainFactorInformation	computed
>>>>>>referenceTFCId	0
>>>>>TFC 10	(TF4, TF3, TF0, TF1)
>>>>>ctfc	39
>>>>>gainFactorInformation	signalled
>>>>>> β c (FDD only)	11
>>>>>> β d	15
>>>>>>referenceTFCId	0
> TFC subset list	
>>TFC subset 1	(speech rate 6.6)
>>> Allowed transport format combination list	(TFC1, TFC2, TFC3, TFC6, TFC7, TFC8)
>>TFC subset 2	(speech rate 8.85)
>>> Allowed transport format combination list	(TFC1, TFC2, TFC3, TFC4, TFC6, TFC7, TFC8, TFC9)
>>TFC subset 3	(speech rate 12.65)
>>> Allowed transport format combination list	(TFC1, TFC2, TFC3, TFC4, TFC5, TFC6, TFC7, TFC8, TFC9, TFC10)
dl-CommonTransChInfo	
>tfc-SignallingMode	Independent
ul-CommonTransChInfo	
>tfc-ID (TDD only)	1
>sharedChannelIndicator (TDD only)	FALSE
> tfc-Subset	Absent, not required
>dl-TFCS	Normal TFCI signalling

>>explicitTFCS-ConfigurationMode	Complete
>>>ctfcSize	Ctfc8Bit
>>>>TFCS representation	Addition
>>>>>TFCS list	
>>>>>>TFC 1	(TF0, TF0, TF0, TF0, TF0)
>>>>>>>ctfc	0
>>>>>>>TFC 2	(TF1, TF0, TF0, TF0, TF0)
>>>>>>>ctfc	1
>>>>>>>TFC 3	(TF2, TF1, TF0, TF0, TF0)
>>>>>>>ctfc	7
>>>>>>>TFC 4	(TF3, TF2, TF0, TF0, TF0)
>>>>>>>ctfc	13
>>>>>>>TFC 5	(TF4, TF3, TF0, TF0, TF0)
>>>>>>>ctfc	19
>>>>>>>TFC 6	(TF0, TF0, TF0, TF1, TF0)
>>>>>>>ctfc	20
>>>>>>>TFC 7	(TF1, TF0, TF0, TF1, TF0)
>>>>>>>ctfc	21
>>>>>>>TFC 8	(TF2, TF1, TF0, TF1, TF0)
>>>>>>>ctfc	27
>>>>>>>TFC 9	(TF3, TF2, TF0, TF1, TF0)
>>>>>>>ctfc	33
>>>>>>>TFC 10	(TF4, TF3, TF0, TF1, TF0)
>>>>>>>ctfc	39
>>>>>>>TFC 11	(TF0, TF0, TF0, TF0, TF1)
>>>>>>>ctfc	40
>>>>>>>TFC 12	(TF1, TF0, TF0, TF0, TF1)
>>>>>>>ctfc	41
>>>>>>>TFC 13	(TF2, TF1, TF0, TF0, TF1)
>>>>>>>ctfc	47
>>>>>>>TFC 14	(TF3, TF2, TF0, TF0, TF1)
>>>>>>>ctfc	53
>>>>>>>TFC 15	(TF4, TF3, TF0, TF0, TF1)
>>>>>>>ctfc	59
>>>>>>>TFC 16	(TF0, TF0, TF0, TF1, TF1)
>>>>>>>ctfc	60
>>>>>>>TFC 17	(TF1, TF0, TF0, TF1, TF1)
>>>>>>>ctfc	61
>>>>>>>TFC 18	(TF2, TF1, TF0, TF1, TF1)
>>>>>>>ctfc	67
>>>>>>>TFC 19	(TF3, TF2, TF0, TF1, TF1)
>>>>>>>ctfc	73
>>>>>>>TFC 20	(TF4, TF3, TF0, TF1, TF1)
>>>>>>>ctfc	79
PhyCH INFORMATION FDD	
UL-DPCH-InfoPredef	
>ul-DPCH-PowerControlInfo	
>>powerControlAlgorithm	Algorithm 1
>>>tpcStepSize	1 dB
>tfc-Existence	TRUE
>puncturingLimit	0.84
DL-CommonInformationPredef	
>dl-DPCH-InfoCommon	
>>spreadingFactor	128
>>tfc-Existence	FALSE
>>pilotBits	4
>>positionFixed	Fixed

13.7.15 Default configuration 12.2/7.4/5.9/4.75 kbps speech & 3.4 kbps signalling & 0.15 kbps SRB#5

Parameters	Value
Ref 34.108	4b
Default configuration identity	14
RB INFORMATION	
rb-Identity	RB1: 1, RB2: 2, RB3: 3, RB5: 5, RB6: 6, RB7: 7, RB8: 8
rlc-InfoChoice	Rlc-info
>ul-RLC-Mode	RB1: UM RB2- RB3: AM RB5-RB7: TM
>>transmissionRLC-DiscardMode	RB1: N/A RB2- RB3: NoDiscard RB5- RB7: N/A
>>>maxDat	RB1: N/A RB2- RB3: 25 RB5- RB7: N/A
>>transmissionWindowSize	RB1: N/A RB2- RB3: 32 RB5- RB7: N/A
>>timerRST	RB1: N/A RB2- RB3: 200 RB5- RB7: N/A
>>max-RST	RB1: N/A RB2- RB3: 1 RB5- RB7: N/A
>>pollingInfo	RB1: N/A RB2- RB3: as below RB5- RB7: N/A
>>>TimerPoll	RB2- RB3: 200
>>>PollPDU	RB2- RB3: n/a
>>>PollSDU	RB2- RB3: 1
>>>lastTransmissionPDU-Poll	RB2- RB3: FALSE
>>>lastRetransmissionPDU-Poll	RB2- RB3: TRUE
>>>PollWindow	RB2- RB3: 99
>>segmentationIndication	RB1- RB3: N/A RB5- RB7: FALSE
>dl-RLC-Mode	RB1: UM RB2- RB3: AM RB5- RB7: TM RB8: TM
>>inSequenceDelivery	RB1: N/A RB2- RB3: TRUE RB5- RB8: N/A
>>receivingWindowSize	RB1: N/A RB2- RB3: 32 RB5- RB8: N/A
>>dl-RLC-StatusInfo	RB1: N/A RB2- RB3: as below RB5- RB8: N/A
>>>timerStatusProhibit	RB2- RB3: 100
>>>missingPDU-Indicator	RB2- RB3: TRUE
>>segmentationIndication	RB1- RB3: N/A RB5- RB8: FALSE
rb-MappingInfo	
>UL-LogicalChannelMappings	OneLogicalChannel
>>ul-TransportChannelType	Dch
>>>transportChannelIdentity	RB1- RB3: 9 RB5: 1, RB6: 2, RB7: 3.
>>logicalChannelIdentity	RB1: 1, RB2: 2, RB3: 3 RB5- RB7: N/A
>>rlc-SizeList	RB1- RB3: configured RB5- RB7: N/A

Parameters	Value
>>mac-LogicalChannelPriority	RB1: 1, RB2: 2, RB3: 3 RB5- RB7: 5
>DL-logicalChannelMappingList	
>>Mapping option 1	One mapping option
>>>dl-TransportChannelType	Dch
>>>>transportChannelIdentity	RB1- RB3: 9 RB5: 1, RB6: 2, RB7: 3, RB8: 5
>>>logicalChannelIdentity	RB1: 1, RB2: 2, RB3: 3 RB5- RB8: N/A
TrCH INFORMATION PER TrCH	
UL-AddReconfTransChInfoList	
>Uplink transport channel type	dch
>transportChannelIdentity	TrCH1: 1, TrCH2: 2, TrCH3: 3, TrCH4: 9
>transportFormatSet	DedicatedTransChTFS
>>dynamicTF-information	
>>>tf0/ tf0,1	TrCH1: (0x81) TrCH2: (0x 103) TrCH3: (0x60) TrCH4: (0x144, 1x144)
>>>>rlcSize	BitMode
>>>>>sizeType	TrCH1: type 1: 81 TrCH2: type 1: 103 TrCH3: type1: 60 TrCH4: 2: type 2, part1= 2, part2= 0 (144)
>>>>numberOfTbSizeList	TrCH1-3: Zero TrCH4: Zero, one
>>>>logicalChannelList	All
>>>>tf 1	TrCH1: (1x39) TrCH2: (1x53) TrCH3: (1x60) TrCH4: (1x144)
>>>>>numberOfTransportBlocks	TrCH1-3: One
>>>>>rlc-Size	TrCH1-3: BitMode
>>>>>>sizeType	TrCH1: 1: 39 TrCH2: 1: 53 TrCH3: 1: 60
>>>>>numberOfTbSizeList	TrCH1-3: One
>>>>>logicalChannelList	TrCH1-3: all
>>>>>tf 2	TrCH1: (1x42) TrCH2: (1x63) TrCH3- TrCH4: N/A
>>>>>>numberOfTransportBlocks	TrCH1-2: One
>>>>>>rlc-Size	TrCH1: BitMode
>>>>>>>sizeType	TrCH1: type 1: 42 TrCH2: type 1: 63
>>>>>>numberOfTbSizeList	TrCH1-2: One
>>>>>>logicalChannelList	TrCH1: all
>>>>>>tf 3	TrCH1: (1x55) TrCH2: (1x87) TrCH3- TrCH4: N/A
>>>>>>>numberOfTransportBlocks	TrCH1-2: One
>>>>>>>rlc-Size	TrCH1: BitMode
>>>>>>>>sizeType	TrCH1: type 1: 55 TrCH2: type 1: 87
>>>>>>>numberOfTbSizeList	TrCH1-2: One
>>>>>>>logicalChannelList	TrCH1: all
>>>>>>>tf 4	TrCH1: (1x61) TrCH2: (1x103) TrCH3- TrCH4: N/A
>>>>>>>>numberOfTransportBlocks	TrCH1-2: One
>>>>>>>>rlc-Size	TrCH1: BitMode
>>>>>>>>>sizeType	TrCH1: type 1: 61 TrCH2: type 1: 103
>>>>>>>>numberOfTbSizeList	TrCH1-2: One

Parameters	Value
>>>>logicalChannelList	TrCH1: all
>>>tf 5	TrCH1: (1x81) TrCH2- TrCH4: N/A
>>>>numberOfTransportBlocks	TrCH1: One
>>>>rlc-Size	TrCH1: BitMode
>>>>>sizeType	TrCH1: type 1: 81
>>>>numberOfTbSizeList	TrCH1: One
>>>>logicalChannelList	TrCH1: all
>>semiStaticTF-Information	
>>>tti	TrCH1- TrCH3: 20 TrCH4: 40
>>>channelCodingType	Convolutional
>>>>codingRate	TrCH1- TrCH2: Third TrCH3: Half TrCH4: Third
>>>>rateMatchingAttribute	TrCH1: 200 TrCH2: 190 TrCH3: 235 TrCH4: 160
>>>>crc-Size	TrCH1: 12 TrCH2- TrCH3: 0 TrCH4: 16
DL-AddReconfTransChInfoList	
>Downlink transport channel type	
>dl-TransportChannelIdentity	TrCH1: 1, TrCH2: 2, TrCH3: 3, TrCH4: 9, TrCH5: 5
>dfs-SignallingMode	Independent <Only tf0 on TrCH1 and tf0/tf1 on TrCH5 are different and shown below>
>>transportFormatSet	
>>>dynamicTF-information	
>>>>tf0/ tf0,1	TrCH1: (1x0) TrCH5: (0x3, 1x3)
>>>>rlcSize	bitMode
>>>>>sizeType	TrCH1: type 1: 0 TrCH5: type 1: 3
>>>>numberOfTbSizeList	TrCH1: One TrCH5: Zero, one
>>>>logicalChannelList	all
>>>semistaticTF-Information	same as UL except for TrCH5
>>>>tti	TrCH5: 20
>>>>channelCodingType	Convolutional
>>>>>codingRate	TrCH5: Third
>>>>>rateMatchingAttribute	TrCH5: 205
>>>>>crc-Size	TrCH5: 8
>>ULTrCH-Id	TrCH1: 1, TrCH2: 2, TrCH3: 3, TrCH4: 9
>dch-QualityTarget	
>>bler-QualityValue	TrCH1: 7×10^{-3} TrCH2: Absent TrCH3: Absent TrCH4- TrCH5: Absent
TrCH INFORMATION, COMMON	
ul-CommonTransChInfo	
>tfcs-ID (TDD only)	1
>sharedChannelIndicator (TDD only)	FALSE
>tfcs-Subset	Absent, not required
>ul-TFCS	Normal TFCS signalling
>>explicitTFCS-ConfigurationMode	Complete
>>>ctfcSize	Ctfc8Bit
>>>>TFCS representation	Addition
>>>>>TFCS list	
>>>>>>TFCS 1	(TF0, TF0, TF0, TF0)
>>>>>>>ctfc	0
>>>>>>>>gainFactorInformation	Computed
>>>>>>>>>referenceTFCSId	0

Parameters	Value
>>>>>TFCS 2	(TF1, TF0, TF0, TF0)
>>>>>ctfc	1
>>>>>gainFactorInformation	Computed
>>>>>> β c (FDD only)	N/A
>>>>>> β d	N/A
>>>>>>referenceTFClId	0
>>>>>TFCS 3	(TF2, TF1, TF0, TF0)
>>>>>ctfc	8
>>>>>gainFactorInformation	Computed
>>>>>>referenceTFClId	0
>>>>>TFCS 4	(TF3, TF2, TF0, TF0)
>>>>>ctfc	15
>>>>>gainFactorInformation	Computed
>>>>>> β c (FDD only)	N/A
>>>>>> β d	N/A
>>>>>>referenceTFClId	0
>>>>>TFCS 5	(TF4, TF3, TF0, TF0)
>>>>>ctfc	22
>>>>>gainFactorInformation	Computed
>>>>>>referenceTFClId	0
>>>>>TFCS 6	(TF5, TF4, TF1, TF0)
>>>>>ctfc	59
>>>>>gainFactorInformation	Computed
>>>>>> β c (FDD only)	N/A
>>>>>> β d	N/A
>>>>>>referenceTFClId	0
>>>>>TFCS 7	(TF0,TF0,TF0,TF1)
>>>>>ctfc	60
>>>>>gainFactorInformation	Computed
>>>>>>referenceTFClId	0
>>>>>TFCS 8	(TF1,TF0,TF0,TF1)
>>>>>ctfc	61
>>>>>gainFactorInformation	Computed
>>>>>>referenceTFClId	0
>>>>>TFCS 9	(TF2,TF1,TF0,TF1)
>>>>>ctfc	68
>>>>>gainFactorInformation	Computed
>>>>>>referenceTFClId	0
>>>>>TFCS 10	(TF3,TF2,TF0,TF1)
>>>>>ctfc	75
>>>>>gainFactorInformation	Computed
>>>>>> β c (FDD only)	N/A
>>>>>> β d	N/A
>>>>>>referenceTFClId	0
>>>>>TFCS 11	(TF4,TF3,TF0,TF1)
>>>>>ctfc	82
>>>>>gainFactorInformation	Computed
>>>>>>referenceTFClId	0
>>>>>TFCS 12	(TF5,TF4,TF1,TF1)
>>>>>ctfc	119
>>>>>gainFactorInformation	Signalled
>>>>>> β c (FDD only)	11
>>>>>> β d	15
>>>>>>referenceTFClId	0
> TFC subset list	
>>TFC subset 1	(speech rate 4.75)
>>> Allowed transport format combination list	(TFC1, TFC2, TFC3, TFC7, TFC8, TFC9)
>>TFC subset 2	(speech rate 5.9)
>>> Allowed transport format combination list	(TFC1, TFC2, TFC3, TFC4, TFC7, TFC8, TFC9, TFC10)
>>TFC subset 3	(speech rate 7.4)

Parameters	Value
>>> Allowed transport format combination list	(TFC1, TFC2, TFC3, TFC4, TFC5, TFC7, TFC8, TFC9, TFC10, TFC11)
>>TFC subset 4	(speech rate 12.2)
>>> Allowed transport format combination list	(TFC1, TFC2, TFC3, TFC4, TFC5, TFC6, TFC7, TFC8, TFC9, TFC10, TFC11, TFC12)
dl-CommonTransChInfo	
>tfcs-SignallingMode	Independent
ul-CommonTransChInfo	
>tfcs-ID (TDD only)	1
>sharedChannelIndicator (TDD only)	FALSE
> tfc-Subset	Absent, not required
>dl-TFCS	Normal TFCl signalling
>>explicitTFCS-ConfigurationMode	Complete
>>>ctfcSize	Ctfc8Bit
>>>>TFCS representation	Addition
>>>>>TFCS list	
>>>>>>TFC 1	(TF0, TF0, TF0, TF0, TF0)
>>>>>>>ctfc	0
>>>>>>>TFC 2	(TF1, TF0, TF0, TF0, TF0)
>>>>>>>ctfc	1
>>>>>>>TFC 3	(TF2, TF1, TF0, TF0, TF0)
>>>>>>>ctfc	8
>>>>>>>TFC 4	(TF3, TF2, TF0, TF0, TF0)
>>>>>>>ctfc	15
>>>>>>>TFC 5	(TF4, TF3, TF0, TF0, TF0)
>>>>>>>ctfc	22
>>>>>>>TFC 6	(TF5,TF4,TF1,TF0,TF0)
>>>>>>>ctfc	59
>>>>>>>TFC 7	(TF0, TF0, TF0, TF1, TF0)
>>>>>>>ctfc	60
>>>>>>>TFC 8	(TF1, TF0, TF0, TF1, TF0)
>>>>>>>ctfc	61
>>>>>>>TFC 9	(TF2, TF1, TF0, TF1, TF0)
>>>>>>>ctfc	68
>>>>>>>TFC 10	(TF3, TF2, TF0, TF1, TF0)
>>>>>>>ctfc	75
>>>>>>>TFC 11	(TF4, TF3, TF0, TF1, TF0)
>>>>>>>ctfc	82
>>>>>>>TFC 12	(TF5,TF4,TF1,TF1,TF0)
>>>>>>>ctfc	119
>>>>>>>TFC 13	(TF0, TF0, TF0, TF0, TF1)
>>>>>>>ctfc	120
>>>>>>>TFC 14	(TF1, TF0, TF0, TF0, TF1)
>>>>>>>ctfc	121
>>>>>>>TFC 15	(TF2, TF1, TF0, TF0, TF1)
>>>>>>>ctfc	128
>>>>>>>TFC 16	(TF3, TF2, TF0, TF0, TF1)
>>>>>>>ctfc	135
>>>>>>>TFC 17	(TF4, TF3, TF0, TF0, TF1)
>>>>>>>ctfc	142
>>>>>>>TFC 18	(TF5,TF4,TF1,TF0,TF1)
>>>>>>>ctfc	179
>>>>>>>TFC 19	(TF0, TF0, TF0, TF1, TF1)
>>>>>>>ctfc	180
>>>>>>>TFC 20	(TF1, TF0, TF0, TF1, TF1)
>>>>>>>ctfc	181
>>>>>>>TFC 21	(TF2, TF1, TF0, TF1, TF1)
>>>>>>>ctfc	188
>>>>>>>TFC 22	(TF3, TF2, TF0, TF1, TF1)
>>>>>>>ctfc	195
>>>>>>>TFC 23	(TF4, TF3, TF0, TF1, TF1)
>>>>>>>ctfc	202

Parameters	Value
>>>>>TFC 24	(TF5,TF4,TF1,TF1,TF1)
>>>>>>ctfc	239
PhyCH INFORMATION FDD	
UL-DPCH-InfoPredef	
>ul-DPCH-PowerControlInfo	
>>powerControlAlgorithm	Algorithm 1
>>>tpcStepSize	1 dB
>tfc-Existence	TRUE
>puncturingLimit	0.84
DL-CommonInformationPredef	
>dl-DPCH-InfoCommon	
>>spreadingFactor	128
>>tfc-Existence	FALSE
>>pilotBits	4
>>positionFixed	Fixed
PhyCH INFORMATION 3.84/7.68 Mcps TDD	
UL-DPCH-InfoPredef	
>ul-DPCH-PowerControlInfo	
>>dpch-ConstantValue	
>commonTimeslotInfo	
>>secondInterleavingMode	
>>tfc-Coding	
>>puncturingLimit	
>>repetitionPeriodAndLength	
DL-CommonInformationPredef	
>dl-DPCH-InfoCommon	
>>commonTimeslotInfo	
>>>secondInterleavingMode	
>>>tfc-Coding	
>>>puncturingLimit	
>>>repetitionPeriodAndLength	
PhyCH INFORMATION 1.28 Mcps TDD	
UL-DPCH-InfoPredef	
>commonTimeslotInfo	
>>secondInterleavingMode	
>>tfc-Coding	
>>puncturingLimit	
>>repetitionPeriodAndLength	
DL-CommonInformationPredef	
>dl-DPCH-InfoCommon	
>>commonTimeslotInfo	
>>>secondInterleavingMode	
>>>tfc-Coding	
>>>puncturingLimit	
>>>repetitionPeriodAndLength	

13.7.16 Default configuration 7.95 kbps speech & 3.4 kbps signalling

Parameters	Value
Ref 34.108	6
Default configuration identity	15
RB INFORMATION	
rb-Identity	RB1: 1, RB2: 2, RB3: 3, RB5: 5, RB6: 6, RB7: 7
rlc-InfoChoice	Rlc-info
>ul-RLC-Mode	RB1: UM RB2- RB3: AM RB5-RB7: TM
>>transmissionRLC-DiscardMode	RB1: N/A RB2- RB3: NoDiscard RB5- RB7: N/A

Parameters	Value
>>>maxDat	RB1: N/A RB2- RB3: 25 RB5- RB7: N/A
>>transmissionWindowSize	RB1: N/A RB2- RB3: 32 RB5- RB7: N/A
>>timerRST	RB1: N/A RB2- RB3: 200 RB5- RB7: N/A
>>max-RST	RB1: N/A RB2- RB3: 1 RB5- RB7: N/A
>>pollingInfo	RB1: N/A RB2- RB3: as below RB5- RB7: N/A
>>>TimerPoll	RB2- RB3: 200
>>>PollPDU	RB2- RB3: n/a
>>>PollSDU	RB2- RB3: 1
>>>lastTransmissionPDU-Poll	RB2- RB3: FALSE
>>>lastRetransmissionPDU-Poll	RB2- RB3: TRUE
>>>PollWindow	RB2- RB3: 99
>>segmentationIndication	RB1- RB3: N/A RB5- RB7: FALSE
>dl-RLC-Mode	RB1: UM RB2- RB3: AM RB5- RB7: TM
>>inSequenceDelivery	RB1: N/A RB2- RB3: TRUE RB5- RB7: N/A
>>receivingWindowSize	RB1: N/A RB2- RB3: 32 RB5- RB7: N/A
>>dl-RLC-StatusInfo	RB1: N/A RB2- RB3: as below RB5- RB7: N/A
>>>timerStatusProhibit	RB2- RB3: 100
>>>missingPDU-Indicator	RB2- RB3: TRUE
>>segmentationIndication	RB1- RB3: N/A RB5- RB7: FALSE
rb-MappingInfo	
>UL-LogicalChannelMappings	OneLogicalChannel
>>ul-TransportChannelType	Dch
>>>transportChannelIdentity	RB1- RB3: 9 RB5: 1, RB6: 2, RB7: 3
>>logicalChannelIdentity	RB1: 1, RB2: 2, RB3: 3 RB5- RB7: N/A
>>rlc-SizeList	RB1- RB3: configured RB5- RB7: N/A
>>mac-LogicalChannelPriority	RB1: 1, RB2: 2, RB3: 3 RB5- RB7: 5
>DL-logicalChannelMappingList	
>>Mapping option 1	One mapping option
>>>dl-TransportChannelType	Dch
>>>>transportChannelIdentity	RB1- RB3: 9 RB5: 1, RB6: 2, RB7: 3
>>>>logicalChannelIdentity	RB1: 1, RB2: 2, RB3: 3 RB5- RB7: N/A
TrCH INFORMATION PER TrCH	
UL-AddReconfTransChInfoList	
>Uplink transport channel type	dch
>transportChannelIdentity	TrCH1: 1, TrCH2: 2, TrCH3:3, TrCH4: 9
>transportFormatSet	DedicatedTransChTFS
>>dynamicTF-information	

Parameters	Value
>>>tf0/ tf0,1	TrCH1: (0x75) TrCH2: (0x 84 1x84) TrCH3: (0x 60) TrCH4: (0x144, 1x144)
>>>>rlcSize	BitMode
>>>>>sizeType	TrCH1: type 1: 75 TrCH2: type 1: 84 TrCH3: type 1: 60 TrCH4: 2: type 2, part1= 2, part2= 0 (144)
>>>>numberOfTbSizeList	TrCH1: Zero TrCH2-4: Zero, one
>>>>logicalChannelList	All
>>>tf 1	TrCH1: (1x39) TrCH2- TrCH4: N/A
>>>>numberOfTransportBlocks	TrCH1: One
>>>>rlc-Size	TrCH1: BitMode
>>>>>sizeType	TrCH1: 1: 39
>>>>numberOfTbSizeList	TrCH1: One
>>>>logicalChannelList	TrCH1: all
>>>tf 2	TrCH1: (1x75) TrCH2- TrCH4: N/A
>>>>numberOfTransportBlocks	TrCH1: One
>>>>rlc-Size	TrCH1: BitMode
>>>>>sizeType	TrCH1: type 1: 75
>>>>numberOfTbSizeList	TrCH1: One
>>>>logicalChannelList	TrCH1: all
>>semistaticTF-Information	
>>>tft	TrCH1- TrCH3: 20 TrCH4: 40
>>>channelCodingType	Convolutional
>>>>codingRate	TrCH1- TrCH2: Third TrCH3: Half TrCH4: Third
>>>rateMatchingAttribute	TrCH1: 200 TrCH2: 190 TrCH3: 235 TrCH4: 160
>>>>crc-Size	TrCH1: 12 TrCH2-TrCH3: 0 TrCH4: 16
DL-AddReconfTransChInfoList	
>Downlink transport channel type	Dch
>dl-TransportChannelIdentity (should be as for UL)	TrCH1: 1, TrCH2: 2, TrCH3: 3, TrCH4: 9
>tfs-SignallingMode	Explicit <Only tf0 on TrCH1 is different and shown below>
>>transportFormatSet	DedicatedTransChTFS
>>>dynamicTF-information	
>>>>tf0/ tf0,1	TrCH1: (1x0)
>>>>>rlcSize	BitMode
>>>>>>sizeType	TrCH1: type 1: 0
>>>>numberOfTbSizeList	TrCH1: One
>>>>logicalChannelList	All
>>ULTrCH-Id	TrCH1: 1, TrCH2: 2, TrCH3:3, TrCH4: 9
>dch-QualityTarget	
>>bler-QualityValue	TrCH1: 7x10-3 TrCH2- TrCH4: Absent
TrCH INFORMATION, COMMON	
ul-CommonTransChInfo	
>tfs-ID (TDD only)	1
>sharedChannelIndicator (TDD only)	FALSE
>tfc-Subset	Absent, not required
>ul-TFCS	Normal TFCSI signalling
>>explicitTFCS-ConfigurationMode	Complete
>>>ctfcSize	Ctfc4Bit

Parameters	Value
>>>>TFCS representation	Addition
>>>>TFCS list	
>>>>>TFCS 1	(TF0, TF0, TF0, TF0)
>>>>>>ctfc	0
>>>>>>gainFactorInformation	Computed
>>>>>>referenceTFCLd	0
>>>>>TFCS 2	(TF1, TF0, TF0, TF0)
>>>>>>ctfc	1
>>>>>>gainFactorInformation	Computed
>>>>>>> β c (FDD only)	N/A
>>>>>>> β d	N/A
>>>>>>>referenceTFCLd	0
>>>>>TFCS 3	(TF2, TF1, TF0, TF0)
>>>>>>ctfc	5
>>>>>>gainFactorInformation	Computed
>>>>>>>referenceTFCLd	0
>>>>>TFCS 4	(TF0, TF0, TF0, TF1)
>>>>>>ctfc	6
>>>>>>gainFactorInformation	Computed
>>>>>>> β c (FDD only)	N/A
>>>>>>> β d	N/A
>>>>>>>referenceTFCLd	0
>>>>>TFCS 5	(TF1, TF0, TF0, TF1)
>>>>>>ctfc	7
>>>>>>gainFactorInformation	Computed
>>>>>>>referenceTFCLd	0
>>>>>TFCS 6	(TF2, TF1, TF0, TF1)
>>>>>>ctfc	11
>>>>>>gainFactorInformation	Signalled
>>>>>>> β c (FDD only)	11
>>>>>>> β d	15
>>>>>>>referenceTFCLd	0
dl-CommonTransChInfo	
>tfcs-SignallingMode	Same as UL
PhyCH INFORMATION FDD	
UL-DPCH-InfoPredef	
>ul-DPCH-PowerControlInfo	
>>powerControlAlgorithm	Algorithm 1
>>>tpcStepSize	1 dB
>tfci-Existence	TRUE
>puncturingLimit	0.96
DL-CommonInformationPredef	
>dl-DPCH-InfoCommon	
>>spreadingFactor	128
>>tfci-Existence	FALSE
>>pilotBits	4
>>positionFixed	Fixed
PhyCH INFORMATION 3.84/7.68 Mcps TDD	
UL-DPCH-InfoPredef	
>ul-DPCH-PowerControlInfo	
>>dpch-ConstantValue	0
>commonTimeslotInfo	
>>secondInterleavingMode	frameRelated
>>tfci-Coding	16
>>puncturingLimit	0.52
>>repetitionPeriodAndLength	repetitionPeriod1
DL-CommonInformationPredef	
>dl-DPCH-InfoCommon	
>>commonTimeslotInfo	
>>>secondInterleavingMode	frameRelated
>>>tfci-Coding	16
>>>puncturingLimit	0.52

Parameters	Value
>>>repetitionPeriodAndLength	repetitionPeriod1
PhyCH INFORMATION 1.28 Mcps TDD	
UL-DPCH-InfoPredef	
>commonTimeslotInfo	
>>secondInterleavingMode	frameRelated
>>tfc-Coding	16
>>puncturingLimit	0.80
>>repetitionPeriodAndLength	repetitionPeriod1
DL-CommonInformationPredef	
>dl-DPCH-InfoCommon	
>>commonTimeslotInfo	
>>>secondInterleavingMode	frameRelated
>>>tfc-Coding	16
>>>puncturingLimit	0.80
>>>repetitionPeriodAndLength	repetitionPeriod1

13.7.17 Default configuration 12.65/8.85/6.6 kbps speech & 3.4 kbps signalling (without SRB#5)

Parameters	Value
Ref 25.993	7.1.106
Default configuration identity	16
RB INFORMATION	
rb-Identity	RB1: 1, RB2: 2, RB3: 3, RB5: 5, RB6: 6, RB7: 7,
rlc-InfoChoice	Rlc-info
>ul-RLC-Mode	RB1: UM RB2- RB3: AM RB5-RB7: TM
>>transmissionRLC-DiscardMode	RB1: N/A RB2- RB3: NoDiscard RB5- RB7: N/A
>>>maxDat	RB1: N/A RB2- RB3: 25 RB5- RB7: N/A
>>transmissionWindowSize	RB1: N/A RB2- RB3: 32 RB5- RB7: N/A
>>timerRST	RB1: N/A RB2- RB3: 200 RB5- RB7: N/A
>>max-RST	RB1: N/A RB2- RB3: 1 RB5- RB7: N/A
>>pollingInfo	RB1: N/A RB2- RB3: as below RB5- RB7: N/A
>>>TimerPoll	RB2- RB3: 200
>>>PollPDU	RB2- RB3: n/a
>>>PollSDU	RB2- RB3: 1
>>>lastTransmissionPDU-Poll	RB2- RB3: FALSE
>>>lastRetransmissionPDU-Poll	RB2- RB3: TRUE
>>>PollWindow	RB2- RB3: 99
>>segmentationIndication	RB1- RB3: N/A RB5- RB7: FALSE
>dl-RLC-Mode	RB1: UM RB2- RB3: AM RB5- RB7: TM
>>inSequenceDelivery	RB1: N/A RB2- RB3: TRUE RB5- RB7: N/A
>>receivingWindowSize	RB1: N/A RB2- RB3: 32 RB5- RB7: N/A
>>dl-RLC-StatusInfo	RB1: N/A RB2- RB3: as below RB5- RB7: N/A
>>>timerStatusProhibit	RB2- RB3: 100
>>>missingPDU-Indicator	RB2- RB3: TRUE
>>segmentationIndication	RB1- RB3: N/A RB5- RB7: FALSE
rb-MappingInfo	
>UL-LogicalChannelMappings	OneLogicalChannel
>>ul-TransportChannelType	Dch
>>>transportChannelIdentity	RB1- RB3: 9 RB5: 1, RB6: 2, RB7: 3.
>>logicalChannelIdentity	RB1: 1, RB2: 2, RB3: 3 RB5- RB7: N/A
>>rlc-SizeList	RB1- RB3: configured RB5- RB7: N/A
>>mac-LogicalChannelPriority	RB1: 1, RB2: 2, RB3: 3 RB5- RB7: 5
>DL-logicalChannelMappingList	
>>Mapping option 1	One mapping option
>>>dl-TransportChannelType	Dch

>>>>transportChannelIdentity	RB1- RB3: 9 RB5: 1, RB6: 2, RB7: 3,
>>>logicalChannelIdentity	RB1: 1, RB2: 2, RB3: 3 RB5- RB7: N/A
TrCH INFORMATION PER TrCH	
UL-AddReconfTransChInfoList	
>Uplink transport channel type	Dch
>transportChannelIdentity	TrCH1: 1, TrCH2: 2, TrCH3: 3, TrCH4: 9
>transportFormatSet	DedicatedTransChTFS
>>dynamicTF-information	
>>>tf0/ tf0,1	TrCH1: (0x72) TrCH2: (0x 181) TrCH3: (0x60) TrCH4: (0x144, 1x144)
>>>>rlcSize	BitMode
>>>>>sizeType	TrCH1: type 1: 72 TrCH2: type 2: part1= 6, part2= 5 TrCH3: type1: 60 TrCH4: 2: type 2, part1= 2, part2= 0 (144)
>>>>numberOfTbSizeList	TrCH1-3: Zero TrCH4: Zero, one
>>>>logicalChannelList	All
>>>>tf 1	TrCH1: (1x40) TrCH2: (1x 78) TrCH3: N/A TrCH4: N/A
>>>>>numberOfTransportBlocks	TrCH1: One TrCH2: One
>>>>>rlc-Size	TrCH1-2: BitMode
>>>>>>sizeType	TrCH1: 1: 40 TrCH2: 1: 78
>>>>>numberOfTbSizeList	TrCH1-2: One
>>>>>logicalChannelList	TrCH1: all
>>>>>tf 2	TrCH1: (1x54) TrCH2: (1x113) TrCH3: N/A TrCH4: N/A
>>>>>>numberOfTransportBlocks	TrCH1: One TrCh2: One
>>>>>>rlc-Size	TrCH1: BitMode
>>>>>>>sizeType	TrCH1: type 1: 54 TrCH2: type 1: 113
>>>>>>numberOfTbSizeList	TrCH1: One TrCH2: One
>>>>>>logicalChannelList	TrCH1: all TrCH2: all
>>>>>>tf 3	TrCH1: (1x64) TrCH2: (1x181) TrCH3: N/A TrCH4: N/A
>>>>>>>numberOfTransportBlocks	TrCH1: One TrCh2: One
>>>>>>>rlc-Size	TrCH1: BitMode
>>>>>>>>sizeType	TrCH1: type 1: 64 TrCH2: type 2: part1=6, part2= 5
>>>>>>>>numberOfTbSizeList	TrCH1: One TrCH2: One
>>>>>>>>logicalChannelList	TrCH1: all TrCH2: all
>>>>>>>>tf 4	TrCH1: (1x72) TrCH2: N/A TrCH3: N/A TrCH4: N/A
>>>>>>>>>numberOfTransportBlocks	TrCH1: One
>>>>>>>>>rlc-Size	TrCH1: BitMode
>>>>>>>>>>sizeType	TrCH1: type 1: 72

>>>>numberOfTbSizeList	TrCH1: One
>>>>logicalChannelList	TrCH1: all
>>semistaticTF-Information	
>>>tfti	TrCH1- TrCH3: 20 TrCH4: 40
>>>channelCodingType	Convolutional
>>>>codingRate	TrCH1- TrCH3: Third TrCH4: Third
>>>>rateMatchingAttribute	TrCH1: 200 TrCH2: 190 TrCH3: 256 TrCH4: 170
>>>crc-Size	TrCH1: 12 TrCH2: 0 TrCH3: 0 TrCH4: 16
DL-AddReconfTransChInfoList	
>Downlink transport channel type	Dch
>dl-TransportChannelIdentity	
>tfs-SignallingMode	Independent <Only tf0 on TrCH1 is different and shown below>
>>transportFormatSet	
>>>dynamicTF-information	
>>>>tf0/ tf0,1	TrCH1: (1x0)
>>>>rlcSize	BitMode
>>>>>sizeType	TrCH1: type 1: 0
>>>>>numberOfTbSizeList	TrCH1: One
>>>>>logicalChannelList	All
>>>>semistaticTF-Information	same as UL
>>ULTrCH-Id	TrCH1: 1, TrCH2: 2, TrCH3: 3, TrCH4: 9,
>dch-QualityTarget	
>>bler-QualityValue	TrCH1: 7×10^{-3} TrCH2: Absent TrCH3: Absent TrCH4: Absent
TrCH INFORMATION, COMMON	
ul-CommonTransChInfo	
>tfc-ID (TDD only)	1
>sharedChannelIndicator (TDD only)	FALSE
> tfc-Subset	Absent, not required
>ul-TFCS	Normal TFCS signalling
>>explicitTFCS-ConfigurationMode	Complete
>>>ctfcSize	Ctfc6Bit
>>>>TFCS representation	Addition
>>>>>TFC list	
>>>>>>TFC 1	(TF0, TF0, TF0, TF0)
>>>>>>>ctfc	0
>>>>>>>>gainFactorInformation	Computed
>>>>>>>>referenceTFCId	0
>>>>>>TFC 2	(TF1, TF0, TF0, TF0)
>>>>>>>ctfc	1
>>>>>>>>gainFactorInformation	Computed
>>>>>>>>> β_c (FDD only)	N/A
>>>>>>>>> β_d	N/A
>>>>>>>>>referenceTFCId	0
>>>>>>TFC 3	(TF2, TF1, TF0, TF0)
>>>>>>>ctfc	7
>>>>>>>>gainFactorInformation	Computed
>>>>>>>>>referenceTFCId	0
>>>>>>TFC 4	(TF3, TF2, TF0, TF0)
>>>>>>>ctfc	13
>>>>>>>>gainFactorInformation	Computed
>>>>>>>>> β_c (FDD only)	
>>>>>>>>> β_d	

>>>>>>referenceTFCId	0
>>>>>TFC 5	(TF4, TF3, TF0, TF0)
>>>>>ctfc	19
>>>>>gainFactorInformation	Computed
>>>>>>referenceTFCId	0
>>>>>TFC 6	(TF0, TF0, TF0, TF1)
>>>>>ctfc	20
>>>>>gainFactorInformation	Computed
>>>>>> β_c (FDD only)	
>>>>>> β_d	
>>>>>>referenceTFCId	0
>>>>>TFC 7	(TF1, TF0, TF0, TF1)
>>>>>ctfc	21
>>>>>gainFactorInformation	Computed
>>>>>>referenceTFCId	0
>>>>>TFC 8	(TF2, TF1, TF0, TF1)
>>>>>ctfc	27
>>>>>gainFactorInformation	computed
>>>>>> β_c (FDD only)	
>>>>>> β_d	
>>>>>>referenceTFCId	0
>>>>>TFC 9	(TF3, TF2, TF0, TF1)
>>>>>ctfc	33
>>>>>gainFactorInformation	computed
>>>>>>referenceTFCId	0
>>>>>TFC 10	(TF4, TF3, TF0, TF1)
>>>>>ctfc	39
>>>>>gainFactorInformation	signalled
>>>>>> β_c (FDD only)	11
>>>>>> β_d	15
>>>>>>referenceTFCId	0
> TFC subset list	
>>TFC subset 1	(speech rate 6.6)
>>> Allowed transport format combination list	(TFC1, TFC2, TFC3, TFC6, TFC7, TFC8)
>>TFC subset 2	(speech rate 8.85)
>>> Allowed transport format combination list	(TFC1, TFC2, TFC3, TFC4, TFC6, TFC7, TFC8, TFC9)
>>TFC subset 3	(speech rate 12.65)
>>> Allowed transport format combination list	(TFC1, TFC2, TFC3, TFC4, TFC5, TFC6, TFC7, TFC8, TFC9, TFC10)
dl-CommonTransChInfo	
>tfc-SignallingMode	Same as UL
ul-CommonTransChInfo	
>tfc-ID (TDD only)	1
>sharedChannelIndicator (TDD only)	FALSE
PhyCH INFORMATION FDD	
UL-DPCH-InfoPredef	
>ul-DPCH-PowerControlInfo	
>>powerControlAlgorithm	Algorithm 1
>>>tpcStepSize	1 dB
>tfc-Existence	TRUE
>puncturingLimit	0.84
DL-CommonInformationPredef	
>dl-DPCH-InfoCommon	
>>spreadingFactor	128
>>tfc-Existence	FALSE
>>pilotBits	4
>>positionFixed	Fixed

13.7.18 Default configuration Signalling on E-DCH on UL depending based on minimum E-DCH UE category & Signalling on HS-DSCH based minimum HS-DSCH UE category

Parameters	Value
Ref 25.993	7.5.10
Default configuration identity	17
RB INFORMATION	
rb-Identity	RB1: 1, RB2: 2, RB3: 3
rlc-InfoChoice	Rlc-info
>ul-RLC-Mode	RB1: UM RB2- RB3: AM
>>transmissionRLC-DiscardMode	RB1: N/A RB2- RB3: NoDiscard
>>>maxDat	RB1: N/A RB2- RB3: 25
>>transmissionWindowSize	RB1: N/A RB2- RB3: 128
>>timerRST	RB1: N/A RB2- RB3: 200
>>max-RST	RB1: N/A RB2- RB3: 1
>>pollingInfo	RB1: N/A RB2- RB3: as below
>>>TimerPoll	RB2- RB3: 100
>>>PollPDU	RB2- RB3: n/a
>>>PollSDU	RB2- RB3: 1
>>>lastTransmissionPDU-Poll	RB2- RB3: FALSE
>>>lastRetransmissionPDU-Poll	RB2- RB3: FALSE
>>>PollWindow	RB2- RB3: 99
>>segmentationIndication	RB1- RB3: N/A
>dl-RLC-Mode	RB1: UM RB2- RB3: AM
>>DL RLC PDU size	RB1-RB3: 144
>>inSequenceDelivery	RB1: N/A RB2- RB3: TRUE
>>receivingWindowSize	RB1: N/A RB2- RB3: 128
>>dl-RLC-StatusInfo	RB1: N/A RB2- RB3: as below
>>>timerStatusProhibit	RB2- RB3: 100
>>>missingPDU-Indicator	RB2- RB3: TRUE
>>segmentationIndication	RB1- RB3: N/A
>>dl-UM-RLC-LI-size	7
Rb-MappingInfo	
>UL-LogicalChannelMappings	OneLogicalChannel
>>UplinkTransport ChannelTypeChoice	
>>ul-TransportChannelType	E-DCH
>>>logicalChannelIdentity	RB1: 1, RB2: 2, RB3: 3
>>>E-DCH MAC-d flow identity	RB1-RB3:0
>>>DDI	RB1: 1, RB2: 2, RB3: 3
>>>>RLC PDU size	144
>>>Include in Scheduling Info	FALSE
>>mac-LogicalChannelPriority	RB1: 1, RB2: 2, RB3: 3
>DL-logicalChannelMappings	OneLogicalChannel
>>Mapping option 1	One mapping option
>>>dl-TransportChannelType	HS-DSCH
>>>>Mac-d flow identity	RB1- RB3: 0
>>>logicalChannelIdentity	RB1: 1, RB2: 2, RB3: 3
TrCH INFORMATION PER TrCH	
UL-AddReconfTransChInfoList	
>Uplink transport channel type	E-DCH
>UL Transport channel identity	

Parameters	Value
> UL-ParametersChoice	
>> E-DCH Transmission Time Interval	10
>> HARQ info for E-DCH	
>>> HARQ RV Configuration	Rvtable
>> Added or reconfigured E-DCH MAC-d flow	One MAC-d flow
>>> E-DCH MAC-d flow identity	0
>>> E-DCH MAC-d flow power offset	4
>>> E-DCH MAC-d flow maximum number of retransmissions	5
>>> E-DCH MAC-d flow multiplexing list	0
>>> transmission grant typeChoice	
>>>> Non-scheduled transmission grant info	Non-scheduled
>>>>> Max MAC-e PDU contents size	162
DL-AddReconfTransChInfoList	
>Downlink transport channel type	HS-DSCH
>DL-ParametersChoice	
>>HARQ Info	
>>>Number of Processes	6
>>>Memory PartitioningChoice	
>>>>Implicit	
>>Added or reconfigured MAC-d flow	
>>> MAC-hs queue to add or reconfigure list	
>>>>MAC-hs queue Id	0
>>>>MAC-d Flow Identity	0
>>>>T1	100
>>>>MAC-hs window size	12
>>>>MAC-d PDU size info	
>>>>>MAC-d PDU size	148
>>>>>MAC-d PDU size index	0
TrCH INFORMATION, COMMON	Null

13.7.19 Default configuration 12.2 kbps speech &13.6 kbps signalling

Parameters	Value
Ref 25.993	7.1.131
Default configuration identity	18
RB INFORMATION	
rb-Identity	RB1: 1, RB2: 2, RB3: 3, RB5: 5, RB6: 6, RB7: 7
rlc-InfoChoice	Rlc-info
>ul-RLC-Mode	RB1: UM RB2- RB3: AM RB5-RB7: TM
>>transmissionRLC-DiscardMode	RB1: N/A RB2- RB3: NoDiscard RB5- RB7: N/A
>>>maxDat	RB1: N/A RB2- RB3: 15 RB5- RB7: N/A
>>transmissionWindowSize	RB1: N/A RB2- RB3: 32 RB5- RB7: N/A
>>timerRST	RB1: N/A RB2- RB3: 200 RB5- RB7: N/A
>>max-RST	RB1: N/A RB2- RB3: 1 RB5- RB7: N/A
>>pollingInfo	RB1: N/A RB2- RB3: as below RB5- RB7: N/A
>>>TimerPoll	RB2- RB3: 100

Parameters	Value
>>>PollPDU	RB2- RB3: n/a
>>>PollSDU	RB2- RB3: 1
>>>lastTransmissionPDU-Poll	RB2- RB3: FALSE
>>>lastRetransmissionPDU-Poll	RB2- RB3: TRUE
>>>PollWindow	RB2- RB3: 99
>>>timerPollPeriodic	RB2- RB3: n/a
>>segmentationIndication	RB1- RB3: N/A RB5- RB7: FALSE
>dl-RLC-Mode	RB1: UM RB2- RB3: AM RB5- RB7: TM
>>inSequenceDelivery	RB1: N/A RB2- RB3: TRUE RB5- RB7: N/A
>>receivingWindowSize	RB1: N/A RB2- RB3: 32 RB5- RB7: N/A
>>dl-RLC-StatusInfo	RB1: N/A RB2- RB3: as below RB5- RB7: N/A
>>>timerStatusProhibit	RB2- RB3: 100
>>>missingPDU-Indicator	RB2- RB3: TRUE
>>>timerStatusPeriodic	RB2- RB3: n/a
>>segmentationIndication	RB1- RB3: N/A RB5- RB7: FALSE
rb-MappingInfo	
>UL-LogicalChannelMappings	OneLogicalChannel
>>ul-TransportChannelType	Dch
>>>transportChannelIdentity	RB1- RB3: 9 RB5: 1, RB6: 2, RB7: 3
>>logicalChannelIdentity	RB1: 1, RB2: 2, RB3: 3 RB5- RB7: N/A
>>rlc-SizeList	RB1- RB3: configured RB5- RB7: N/A
>>mac-LogicalChannelPriority	RB1: 1, RB2: 2, RB3: 3 RB5- RB7: 5
>DL-logicalChannelMappingList	
>>Mapping option 1	One mapping option
>>>dl-TransportChannelType	Dch
>>>>transportChannelIdentity	RB1- RB3: 9 RB5: 1, RB6: 2, RB7: 3
>>>logicalChannelIdentity	RB1: 1, RB2: 2, RB3: 3 RB5- RB7: N/A
TrCH INFORMATION PER TrCH	
UL-AddReconfTransChInfoList	
>Uplink transport channel type	dch
>transportChannelIdentity	TrCH1: 1, TrCH2: 2, TrCH3: 3, TrCH4: 9
>transportFormatSet	DedicatedTransChTFS
>>dynamicTF-information	
>>>tf0/ tf0,1	TrCH1: (0x81) TrCH2: (0x 103, 1x103) TrCH3: (0x 60, 1x60) TrCH4: (0x144, 1x144, 2x144, 3x144, 4x144)
>>>>rlcSize	BitMode
>>>>>sizeType	TrCH1: type 1: 81 TrCH2: type 1: 103 TrCH3: type 1: 60 TrCH4: 2: type 2, part1= 2, part2= 0 (144)
>>>>numberOfTbSizeList	TrCH1: Zero TrCH2-3: Zero, One TrCH4: Zero, one, 2, 3, 4
>>>>logicalChannelList	All

Parameters	Value
>>>tf 1	TrCH1: (1x39) TrCH2- TrCH4: N/A
>>>>numberOfTransportBlocks	TrCH1: One
>>>>rlc-Size	TrCH1: BitMode
>>>>>sizeType	TrCH1: 1: 39
>>>>numberOfTbSizeList	TrCH1: One
>>>>logicalChannelList	TrCH1: all
>>>tf 2	TrCH1: (1x81) TrCH2- TrCH4: N/A
>>>>numberOfTransportBlocks	TrCH1: One
>>>>rlc-Size	TrCH1: BitMode
>>>>>sizeType	TrCH1: type 1: 81
>>>>numberOfTbSizeList	TrCH1: One
>>>>logicalChannelList	TrCH1: all
>>>tf 3	
>>>>numberOfTransportBlocks	
>>>>rlc-Size	
>>>>>sizeType	
>>>>numberOfTbSizeList	
>>>>logicalChannelList	
>>>tf 4	
>>>>numberOfTransportBlocks	
>>>>rlc-Size	
>>>>>sizeType	
>>>>numberOfTbSizeList	
>>>>logicalChannelList	
>>>tf 5	
>>>>numberOfTransportBlocks	
>>>>rlc-Size	
>>>>>sizeType	
>>>>numberOfTbSizeList	
>>>>logicalChannelList	
>>semistaticTF-Information	
>>>tti	TrCH1- TrCH3: 20 TrCH4: 40
>>>channelCodingType	Convolutional
>>>>codingRate	TrCH1- TrCH2: Third TrCH3: Half TrCH4: Third
>>>>rateMatchingAttribute	TrCH1: 200 TrCH2: 190 TrCH3: 235 TrCH4: 160
>>>>crc-Size	TrCH1: 12 TrCH2- TrCH3: 0 TrCH4: 16
DL-AddReconfTransChInfoList	
>Downlink transport channel type	dch
>dl-TransportChannelIdentity (should be as for UL)	TrCH1: 1, TrCH2: 2, TrCH3: 3, TrCH4: 9
>tfs-SignallingMode	Explicit <Only tf0 on TrCH1 is different and shown below>
>>transportFormatSet	DedicatedTransChTFS
>>>dynamicTF-information	
>>>>tf0/ tf0,1	TrCH1: (1x0)
>>>>rlcSize	bitMode
>>>>>sizeType	TrCH1: type 1: 0
>>>>numberOfTbSizeList	TrCH1: One
>>>>logicalChannelList	All
>>ULTrCH-Id	TrCH1: 1, TrCH2: 2, TrCH3: 3, TrCH4: 9
>dch-QualityTarget	
>>bler-QualityValue	TrCH1: 7×10^{-3} TrCH2- TrCH4: Absent
TrCH INFORMATION, COMMON	

Parameters	Value
ul-CommonTransChInfo	
>tfcs-ID (TDD only)	1
>sharedChannelIndicator (TDD only)	FALSE
>tfcs-Subset	Absent, not required
>ul-TFCS	Normal TFCS signalling
>>explicitTFCS-ConfigurationMode	Complete
>>>ctfcSize	Ctfc6Bit
>>>>TFCS representation	Addition
>>>>>TFCS list	
>>>>>>TFC 1	(TF0, TF0, TF0, TF0)
>>>>>>>ctfc	0
>>>>>>>gainFactorInformation	Computed
>>>>>>>referenceTFCId	0
>>>>>>TFC 2	(TF1, TF0, TF0, TF0)
>>>>>>>ctfc	1
>>>>>>>gainFactorInformation	Computed
>>>>>>>referenceTFCId	0
>>>>>>TFC 3	(TF2, TF1, TF1, TF0)
>>>>>>>ctfc	11
>>>>>>>gainFactorInformation	Computed
>>>>>>>referenceTFCId	0
>>>>>>TFC 4	(TF0, TF0, TF0, TF1)
>>>>>>>ctfc	12
>>>>>>>gainFactorInformation	Computed
>>>>>>>referenceTFCId	0
>>>>>>TFC 5	(TF1, TF0, TF0, TF1)
>>>>>>>ctfc	13
>>>>>>>gainFactorInformation	Computed
>>>>>>>referenceTFCId	0
>>>>>>TFC 6	(TF2, TF1, TF1, TF1)
>>>>>>>ctfc	23
>>>>>>>gainFactorInformation	Signalled
>>>>>>>>βc (FDD only)	10
>>>>>>>>βd	15
>>>>>>>>referenceTFCId	0
>>>>>>TFC 7	(TF0, TF0, TF0, TF2)
>>>>>>>ctfc	24
>>>>>>>gainFactorInformation	Computed
>>>>>>>>referenceTFCId	0
>>>>>>TFC 8	(TF1, TF0, TF0, TF2)
>>>>>>>ctfc	25
>>>>>>>gainFactorInformation	Computed
>>>>>>>>referenceTFCId	0
>>>>>>TFC 9	(TF0, TF0, TF0, TF3)
>>>>>>>ctfc	36
>>>>>>>gainFactorInformation	Computed
>>>>>>>>referenceTFCId	0
>>>>>>TFC 10	(TF1, TF0, TF0, TF3)
>>>>>>>ctfc	37
>>>>>>>gainFactorInformation	Computed
>>>>>>>>referenceTFCId	0
>>>>>>TFC 11	(TF0, TF0, TF0, TF4)
>>>>>>>ctfc	48
>>>>>>>gainFactorInformation	Computed
>>>>>>>>referenceTFCId	0
>>>>>>TFC 12	
>>>>>>>ctfc	
>>>>>>>gainFactorInformation	
>>>>>>>>βc (FDD only)	
>>>>>>>>βd	
>>>>>>>>referenceTFCId	
>>>>>>TFC 13	

Parameters	Value
>>>>>>ctfc	
>>>>>>gainFactorInformation	
>>>>>>referenceTFCId	
>>>>>TFC 14	
>>>>>>ctfc	
>>>>>>gainFactorInformation	
>>>>>>referenceTFCId	
>>>>>TFC 15	
>>>>>>ctfc	
>>>>>>gainFactorInformation	
>>>>>>referenceTFCId	
>>>>>TFC 16	
>>>>>>ctfc	
>>>>>>gainFactorInformation	
>>>>>>referenceTFCId	
>>>>>TFC 17	
>>>>>>ctfc	
>>>>>>gainFactorInformation	
>>>>>>referenceTFCId	
dl-CommonTransChInfo	
>tfc-SignallingMode	Same as UL
PhyCH INFORMATION FDD	
UL-DPCH-InfoPredef	
>ul-DPCH-PowerControlInfo	
>>powerControlAlgorithm	Algorithm 1
>>>tpcStepSize	1 dB
>tfc-Existence	TRUE
>puncturingLimit	0.84
DL-CommonInformationPredef	
>dl-DPCH-InfoCommon	
>>spreadingFactor	128
>>tfc-Existence	TRUE
>>pilotBits	4
>>positionFixed	Flexible

13.7.20 Default configuration 12.2/7.95/5.9/4.75 kbps speech & 13.6 kbps signalling

Parameters	Value
Ref 25.993	7.1.132
Default configuration identity	19
RB INFORMATION	
rb-Identity	RB1: 1, RB2: 2, RB3: 3, RB5: 5, RB6: 6, RB7: 7
rlc-InfoChoice	Rlc-info
>ul-RLC-Mode	RB1: UM RB2- RB3: AM RB5-RB7: TM
>>transmissionRLC-DiscardMode	RB1: N/A RB2- RB3: NoDiscard RB5- RB7: N/A
>>>maxDat	RB1: N/A RB2- RB3: 15 RB5- RB7: N/A
>>transmissionWindowSize	RB1: N/A RB2- RB3: 32 RB5- RB7: N/A
>>timerRST	RB1: N/A RB2- RB3: 200 RB5- RB7: N/A

Parameters	Value
>>max-RST	RB1: N/A RB2- RB3: 1 RB5- RB7: N/A
>>pollingInfo	RB1: N/A RB2- RB3: as below RB5- RB7: N/A
>>>TimerPoll	RB2- RB3: 100
>>>>PollPDU	RB2- RB3: n/a
>>>>PollSDU	RB2- RB3: 1
>>>>lastTransmissionPDU-Poll	RB2- RB3: FALSE
>>>>lastRetransmissionPDU-Poll	RB2- RB3: TRUE
>>>>PollWindow	RB2- RB3: 99
>>>>timerPollPeriodic	RB2- RB3: n/a
>>segmentationIndication	RB1- RB3: N/A RB5- RB7: FALSE
>dl-RLC-Mode	RB1: UM RB2- RB3: AM RB5- RB7: TM
>>inSequenceDelivery	RB1: N/A RB2- RB3: TRUE RB5- RB7: N/A
>>receivingWindowSize	RB1: N/A RB2- RB3: 32 RB5- RB7: N/A
>>>dl-RLC-StatusInfo	RB1: N/A RB2- RB3: as below RB5- RB7: N/A
>>>>timerStatusProhibit	RB2- RB3: 100
>>>>missingPDU-Indicator	RB2- RB3: TRUE
>>>>timerStatusPeriodic	RB2- RB3: n/a
>>segmentationIndication	RB1- RB3: N/A RB5- RB7: FALSE
rb-MappingInfo	
>UL-LogicalChannelMappings	OneLogicalChannel
>>ul-TransportChannelType	Dch
>>>>transportChannelIdentity	RB1- RB3: 9 RB5: 1, RB6: 2, RB7: 3
>>>logicalChannelIdentity	RB1: 1, RB2: 2, RB3: 3 RB5- RB7: N/A
>>>>rlc-SizeList	RB1- RB3: configured RB5- RB7: N/A
>>>mac-LogicalChannelPriority	RB1: 1, RB2: 2, RB3: 3 RB5- RB7: 5
>DL-logicalChannelMappingList	
>>Mapping option 1	One mapping option
>>>>dl-TransportChannelType	Dch
>>>>>transportChannelIdentity	RB1- RB3: 9 RB5: 1, RB6: 2, RB7: 3
>>>>>logicalChannelIdentity	RB1: 1, RB2: 2, RB3: 3 RB5- RB7: N/A
TrCH INFORMATION PER TrCH	
UL-AddReconfTransChInfoList	
>Uplink transport channel type	dch
>transportChannelIdentity	TrCH1: 1, TrCH2: 2, TrCH3: 3, TrCH4: 9
>transportFormatSet	DedicatedTransChTFS
>>dynamicTF-information	
>>>>tf0/ tf0,1	TrCH1: (0x 81) TrCH2: (0x 103) TrCH3: (0x 60) TrCH4: (0x144)

Parameters	Value
>>>>rlcSize	BitMode
>>>>>sizeType	TrCH1: type 1: 81 TrCH2: type 1: 103 TrCH3: type 1: 60 TrCH4: 2: type 2, part1= 2, part2= 0 (144)
>>>>numberOfTbSizeList	TrCH1-4: Zero
>>>>logicalChannelList	All
>>>tf 1	TrCH1: (1x39) TrCH2: (1x53) TrCH3: (1x60) TrCH4: (1x144, 2x144, 3x144, 4x144)
>>>>numberOfTransportBlocks	TrCH1-3: One TrCH4: One, 2, 3, 4
>>>>rlc-Size	TrCH1: BitMode
>>>>>sizeType	TrCH1: 1: 39 TrCH2: 1: 53 TrCH3: 1: 60 TrCH4: 2: type 2, part1= 2, part2= 0 (144)
>>>>numberOfTbSizeList	TrCH1: One
>>>>logicalChannelList	TrCH1: all
>>>tf 2	TrCH1: (1x42) TrCH2: (1x63) TrCH3- TrCH4: N/A
>>>>numberOfTransportBlocks	TrCH1-2: One
>>>>rlc-Size	TrCH1: BitMode
>>>>>sizeType	TrCH1: type 1: 42 TrCH2: type 1: 63
>>>>numberOfTbSizeList	TrCH1: One
>>>>logicalChannelList	TrCH1: all
>>>tf 3	TrCH1: (1x55) TrCH2: (1x84) TrCH3- TrCH4: N/A
>>>>numberOfTransportBlocks	TrCH1-2: One
>>>>rlc-Size	TrCH1: BitMode
>>>>>sizeType	TrCH1: type 1: 55 TrCH2: type 1: 84
>>>>numberOfTbSizeList	TrCH1-2: One
>>>>logicalChannelList	TrCH1: all
>>>tf 4	TrCH1: (1x75) TrCH2: (1x103) TrCH3- TrCH4: N/A
>>>>numberOfTransportBlocks	TrCH1-2: One
>>>>rlc-Size	TrCH1: BitMode
>>>>>sizeType	TrCH1: type 1: 75 TrCH2: type 1: 103
>>>>numberOfTbSizeList	TrCH1-2: One
>>>>logicalChannelList	TrCH1: all
>>>tf 5	TrCH1: (1x81) TrCH2- TrCH4: N/A
>>>>numberOfTransportBlocks	TrCH1: One
>>>>rlc-Size	TrCH1: BitMode
>>>>>sizeType	TrCH1: type 1: 81
>>>>numberOfTbSizeList	TrCH1: One
>>>>logicalChannelList	TrCH1: all
>>semistaticTF-Information	
>>>tft	TrCH1- TrCH3: 20 TrCH4: 40
>>>channelCodingType	Convolutional
>>>>codingRate	TrCH1- TrCH2: Third TrCH3: Half TrCH4: Third
>>>rateMatchingAttribute	TrCH1: 200 TrCH2: 190 TrCH3: 235 TrCH4: 160

Parameters	Value
>>>crc-Size	TrCH1: 12 TrCH2- TrCH3: 0 TrCH4: 16
DL-AddReconfTransChInfoList	
>Downlink transport channel type	dch
>dl-TransportChannelIdentity (should be as for UL)	TrCH1: 1, TrCH2: 2, TrCH3: 3, TrCH4: 9
>fs-SignallingMode	Explicit <Only tf0 on TrCH1 is different and shown below>
>>transportFormatSet	DedicatedTransChTFS
>>>dynamicTF-information	
>>>>tf0/ tf0,1	TrCH1: (1x0)
>>>>rlcSize	bitMode
>>>>sizeType	TrCH1: type 1: 0
>>>>numberOfTbSizeList	TrCH1: One
>>>>logicalChannelList	All
>>ULTrCH-Id	TrCH1: 1, TrCH2: 2, TrCH3: 3, TrCH4: 9
>dch-QualityTarget	
>>bler-QualityValue	TrCH1: 7×10^{-3} TrCH2- TrCH4: Absent
TrCH INFORMATION, COMMON	
ul-CommonTransChInfo	
>tfcs-ID (TDD only)	1
>sharedChannelIndicator (TDD only)	FALSE
>tfcs-Subset	Absent, not required
>ul-TFCS	Normal TFCS signalling
>>explicitTFCS-ConfigurationMode	Complete
>>>ctfcSize	Ctfc8Bit
>>>>TFCS representation	Addition
>>>>>TFCS list	
>>>>>>TFC 1	(TF0, TF0, TF0, TF0)
>>>>>>>ctfc	0
>>>>>>>>gainFactorInformation	Computed
>>>>>>>>>referenceTFCId	0
>>>>>>>TFC 2	(TF1, TF0, TF0, TF0)
>>>>>>>>ctfc	1
>>>>>>>>>gainFactorInformation	Computed
>>>>>>>>>>referenceTFCId	0
>>>>>>>TFC 3	(TF2, TF1, TF0, TF0)
>>>>>>>>ctfc	8
>>>>>>>>>gainFactorInformation	Computed
>>>>>>>>>>referenceTFCId	0
>>>>>>>TFC 4	(TF3, TF2, TF0, TF0)
>>>>>>>>ctfc	15
>>>>>>>>>gainFactorInformation	Computed
>>>>>>>>>>referenceTFCId	0
>>>>>>>TFC 5	(TF4, TF3, TF0, TF0)
>>>>>>>>ctfc	22
>>>>>>>>>gainFactorInformation	Computed
>>>>>>>>>>referenceTFCId	0
>>>>>>>TFC 6	(TF5, TF4, TF1, TF0)
>>>>>>>>ctfc	59
>>>>>>>>>gainFactorInformation	Computed
>>>>>>>>>>> β c (FDD only)	N/A
>>>>>>>>>>> β d	N/A
>>>>>>>>>>>>referenceTFCId	0
>>>>>>>>TFC 7	(TF0,TF0,TF0,TF1)
>>>>>>>>>ctfc	60
>>>>>>>>>>gainFactorInformation	Computed
>>>>>>>>>>>>referenceTFCId	0
>>>>>>>>TFC 8	(TF1,TF0,TF0,TF1)
>>>>>>>>>ctfc	61
>>>>>>>>>>>gainFactorInformation	Computed

Parameters	Value
>>>>>>referenceTFCId	0
>>>>>TFC 9	(TF2,TF1,TF0,TF1)
>>>>>>ctfc	68
>>>>>>gainFactorInformation	Computed
>>>>>>referenceTFCId	0
>>>>>TFC 10	(TF3,TF2,TF0,TF1)
>>>>>>ctfc	75
>>>>>>gainFactorInformation	Computed
>>>>>>referenceTFCId	0
>>>>>TFC 11	(TF4,TF3,TF0,TF1)
>>>>>>ctfc	82
>>>>>>gainFactorInformation	Computed
>>>>>>referenceTFCId	0
>>>>>TFC 12	(TF5,TF4,TF1,TF1)
>>>>>>ctfc	119
>>>>>>gainFactorInformation	Signalled
>>>>>>> β c (FDD only)	10
>>>>>>> β d	15
>>>>>>>referenceTFCId	0
>>>>>TFC 13	(TF0,TF0,TF0,TF2)
>>>>>>ctfc	120
>>>>>>gainFactorInformation	Computed
>>>>>>>referenceTFCId	0
>>>>>TFC 14	(TF1, TF0, TF0, TF2)
>>>>>>ctfc	121
>>>>>>gainFactorInformation	Computed
>>>>>>>referenceTFCId	0
>>>>>TFC 15	(TF0,TF0,TF0,TF3)
>>>>>>ctfc	180
>>>>>>gainFactorInformation	Computed
>>>>>>>referenceTFCId	0
>>>>>TFC 16	(TF1, TF0, TF0, TF3)
>>>>>>ctfc	181
>>>>>>gainFactorInformation	Computed
>>>>>>>referenceTFCId	0
>>>>>TFC 17	(TF0,TF0,TF0,TF4)
>>>>>>ctfc	240
>>>>>>gainFactorInformation	Computed
>>>>>>>referenceTFCId	0
dl-CommonTransChInfo	
>tfc-SignallingMode	Same as UL
PhyCH INFORMATION FDD	
UL-DPCH-InfoPredef	
>ul-DPCH-PowerControlInfo	
>>powerControlAlgorithm	Algorithm 1
>>>tpcStepSize	1 dB
>tfc-Existence	TRUE
>puncturingLimit	0.84
DL-CommonInformationPredef	
>dl-DPCH-InfoCommon	
>>spreadingFactor	128
>>tfc-Existence	TRUE
>>pilotBits	4
>>positionFixed	Flexible

13.7.21 Default configuration 64 kbps conversation CS-data & 13.6 kbps signalling

Parameter	Value
Ref 25.993	7.1.133
Default configuration identity	20
RB INFORMATION	
Rb-Identity	RB1: 1, RB2: 2, RB3: 3, RB5: 5
rlc-InfoChoice	Rlc-info
>ul-RLC-Mode	RB1: UM RB2- RB3: AM RB5: TM
>>transmissionRLC-DiscardMode	RB1: N/A RB2- RB3: NoDiscard RB5: N/A
>>>maxDat	RB1: N/A RB2- RB3: 25 RB5: N/A
>>transmissionWindowSize	RB1: N/A RB2- RB3: 32 RB5: N/A
>>timerRST	RB1: N/A RB2- RB3: 200 RB5: N/A
>>max-RST	RB1: N/A RB2- RB3: 1 RB5: N/A
>>pollingInfo	RB1: N/A RB2- RB3: as below RB5: N/A
>>>TimerPoll	RB2- RB3: 100
>>>PollPDU	RB2- RB3: n/a
>>>PollSDU	RB2- RB3: 1
>>>lastTransmissionPDU-Poll	RB2- RB3: FALSE
>>>lastRetransmissionPDU-Poll	RB2- RB3: TRUE
>>>PollWindow	RB2- RB3: 99
>>segmentationIndication	RB1- RB3: N/A RB5: FALSE
>dl-RLC-Mode	RB1: UM RB2- RB3: AM RB5: TM
>>inSequenceDelivery	RB1: N/A RB2- RB3: TRUE RB5: N/A
>>receivingWindowSize	RB1: N/A RB2- RB3: 32 RB5: N/A
>>dl-RLC-StatusInfo	RB1: N/A RB2- RB3: as below RB5: N/A
>>>timerStatusProhibit	RB2- RB3: 100
>>>missingPDU-Indicator	RB2- RB3: TRUE
>>segmentationIndication	RB1- RB3: N/A RB5: FALSE
rb-MappingInfo	
>UL-LogicalChannelMappings	OneLogicalChannel
>>ul-TransportChannelType	Dch
>>>transportChannelIdentity	RB1- RB3: 9 RB5: 1
>>logicalChannelIdentity	RB1: 1, RB2: 2, RB3: 3 RB5: N/A
>>rlc-SizeList	RB1- RB3: configured RB5: N/A
>>mac-LogicalChannelPriority	RB1: 1, RB2: 2, RB3: 3 RB5: 5
>DL-logicalChannelMappingList	
>>Mapping option 1	One mapping option
>>>dl-TransportChannelType	Dch

>>>>transportChannelIdentity	RB1- RB3: 9 RB5: 1
>>>logicalChannelIdentity	RB1: 1, RB2: 2, RB3: 3 RB5: N/A
TrCH INFORMATION PER TrCH	
UL-AddReconfTransChInfoList	
>Uplink transport channel type	dch
>transportChannelIdentity	TrCH1: 1, TrCH2: 9
>transportFormatSet	DedicatedTransChTFS
>>dynamicTF-information	
>>>tf0/ tf0,1,2,3,4	TrCH1: (0x640, 2x640) TrCH2: (0x144, 1x144, 2x144, 3x144, 4x144)
>>>>rlcSize	TrCH1: OctetMode TrCH2: BitMode
>>>>>sizeType	TrCH1: type 2, part1= 11, part2= 2 (640) TrCH2: type 2, part1= 2, part2= 0 (144)
>>>>numberOfTbSizeList	TrCH1: Zero, 2 TrCH2: Zero, one, 2, 3, 4
>>>>logicalChannelList	All
>>>tf 1	
>>>>numberOfTransportBlocks	
>>>>rlc-Size	
>>>>>sizeType	
>>>>numberOfTbSizeList	
>>>>logicalChannelList	
>>>tf 2	
>>>>numberOfTransportBlocks	
>>>>rlc-Size	
>>>>>sizeType	
>>>>numberOfTbSizeList	
>>>>logicalChannelList	
>>>tf 3	
>>>>numberOfTransportBlocks	
>>>>rlc-Size	
>>>>>sizeType	
>>>>numberOfTbSizeList	
>>>>logicalChannelList	
>>>tf 4	
>>>>numberOfTransportBlocks	
>>>>rlc-Size	
>>>>>sizeType	
>>>>numberOfTbSizeList	
>>>>logicalChannelList	
>>semistaticTF-Information	
>>>tti	TrCH1: 20 TrCH2: 40
>>>channelCodingType	TrCH1: Turbo TrCH2: Convolutional
>>>>codingRate	TrCH1: N/A TrCH2: Third
>>>rateMatchingAttribute	TrCH1: 170 TrCH2: 160
>>>>crc-Size	TrCH1: 16 TrCH2: 16
DL-AddReconfTransChInfoList	
>Downlink transport channel type	dch
>dl-TransportChannelIdentity	TrCH1: 1, TrCH2: 9

>tfs-SignallingMode	SameAsUL
>>transportFormatSet	
>>>dynamicTF-information	
>>>>tf0/ tf0,1	
>>>>rlcSize	
>>>>>sizeType	
>>>>>numberOfTbSizeList	
>>>>>logicalChannelList	
>>>semistaticTF-Information	
>>ULTrCH-Id	TrCH1: 1, TrCH2: 9
>dch-QualityTarget	
>>bler-QualityValue	TrCH1: 2×10^{-3} TrCH2: Absent
TrCH INFORMATION, COMMON	
ul-CommonTransChInfo	
>tfc-ID (TDD only)	1
>sharedChannelIndicator (TDD only)	FALSE
> tfc-Subset	Absent, not required
>ul-TFCS	Normal TFCSI signalling
>>explicitTFCS-ConfigurationMode	Complete
>>>ctfcSize	Ctfc4Bit
>>>>TFCS representation	Addition
>>>>>TFC list	
>>>>>>TFC 1	(TF0, TF0)
>>>>>>>ctfc	0
>>>>>>>gainFactorInformation	Computed
>>>>>>>referenceTFCId	0
>>>>>TFC 2	(TF1, TF0)
>>>>>>ctfc	1
>>>>>>gainFactorInformation	Computed
>>>>>>> β_c (FDD only)	N/A
>>>>>>> β_d	N/A
>>>>>>>referenceTFCId	0
>>>>>TFC 3	(TF0, TF1)
>>>>>>ctfc	2
>>>>>>gainFactorInformation	Computed
>>>>>>>referenceTFCId	0
>>>>>TFC 4	(TF1, TF1)
>>>>>>ctfc	3
>>>>>>gainFactorInformation	Signalled
>>>>>>> β_c (FDD only)	8
>>>>>>> β_d	15

>>>>>>referenceTFCId	0
>>>>>TFC 5	(TF0, TF2)
>>>>>ctfc	4
>>>>>gainFactorInformation	Computed
>>>>>>referenceTFCId	0
>>>>>TFC 6	(TF0, TF3)
>>>>>ctfc	6
>>>>>gainFactorInformation	Computed
>>>>>>referenceTFCId	0
>>>>>TFC 7	(TF0, TF4)
>>>>>ctfc	8
>>>>>gainFactorInformation	Computed
>>>>>>referenceTFCId	0
>>>>>TFC 8	
>>>>>ctfc	
>>>>>gainFactorInformation	
>>>>>>referenceTFCId	
>>>>>TFC 9	
>>>>>ctfc	
>>>>>gainFactorInformation	
>>>>>>referenceTFCId	
>>>>>TFC 10	
>>>>>ctfc	
>>>>>gainFactorInformation	
>>>>>> β c (FDD only)	
>>>>>> β d	
>>>>>>>referenceTFCId	
>>>>>TFC 11	
>>>>>ctfc	
>>>>>gainFactorInformation	
>>>>>>referenceTFCId	
>>>>>TFC 12	
>>>>>ctfc	
>>>>>gainFactorInformation	
>>>>>>referenceTFCId	
>>>>>TFC 13	
>>>>>ctfc	
>>>>>gainFactorInformation	
>>>>>>referenceTFCId	
>>>>>TFC 14	
>>>>>ctfc	
>>>>>gainFactorInformation	
>>>>>>referenceTFCId	
>>>>>TFC 15	
>>>>>ctfc	
>>>>>gainFactorInformation	
>>>>>>referenceTFCId	
dl-CommonTransChInfo	
>tfc-SignallingMode	Same as UL
ul-CommonTransChInfo	
>tfc-ID (TDD only)	
>sharedChannelIndicator (TDD only)	
> tfc-Subset	
PhyCH INFORMATION FDD	
UL-DPCH-InfoPredef	
>ul-DPCH-PowerControllInfo	
>>powerControlAlgorithm	Algorithm 1
>>>tpcStepSize	1 dB
>tfc-Existence	TRUE
>puncturingLimit	0.88
DL-CommonInformationPredef	
>dl-DPCH-InfoCommon	
>>spreadingFactor	32

>>tfc-Existence	TRUE
>>pilotBits	8
>>positionFixed	Flexible
PhyCH INFORMATION 3.84 Mcps TDD	
UL-DPCH-InfoPredef	
>ul-DPCH-PowerControlInfo	
>>dpch-ConstantValue	
>commonTimeslotInfo	
>>secondInterleavingMode	
>>tfc-Coding	
>>puncturingLimit	
>>repetitionPeriodAndLength	
DL-CommonInformationPredef	
>dl-DPCH-InfoCommon	
>>commonTimeslotInfo	
>>>secondInterleavingMode	
>>>tfc-Coding	
>>>puncturingLimit	
>>>repetitionPeriodAndLength	
PhyCH INFORMATION 1.28 Mcps TDD	
UL-DPCH-InfoPredef	
>commonTimeslotInfo	
>>secondInterleavingMode	
>>tfc-Coding	
>>puncturingLimit	
>>repetitionPeriodAndLength	
DL-CommonInformationPredef	
>dl-DPCH-InfoCommon	
>>commonTimeslotInfo	
>>>secondInterleavingMode	
>>>tfc-Coding	
>>>puncturingLimit	
>>>repetitionPeriodAndLength	

13.7.22 Default configuration 12.65/8.85/6.6 kbps speech & 13.6 kbps signalling (without SRB#5)

Parameters	Value
Ref 25.993	7.1.134
Default configuration identity	21
RB INFORMATION	
Rb-Identity	RB1: 1, RB2: 2, RB3: 3, RB5: 5, RB6: 6, RB7: 7,
rlc-InfoChoice	Rlc-info
>ul-RLC-Mode	RB1: UM RB2- RB3: AM RB5-RB7: TM
>>transmissionRLC-DiscardMode	RB1: N/A RB2- RB3: NoDiscard RB5- RB7: N/A
>>>maxDat	RB1: N/A RB2- RB3: 25 RB5- RB7: N/A
>>transmissionWindowSize	RB1: N/A RB2- RB3: 32 RB5- RB7: N/A
>>timerRST	RB1: N/A RB2- RB3: 200 RB5- RB7: N/A
>>max-RST	RB1: N/A RB2- RB3: 1 RB5- RB7: N/A
>>pollingInfo	RB1: N/A RB2- RB3: as below RB5- RB7: N/A
>>>TimerPoll	RB2- RB3: 100
>>>PollPDU	RB2- RB3: n/a
>>>PollSDU	RB2- RB3: 1
>>>lastTransmissionPDU-Poll	RB2- RB3: FALSE
>>>lastRetransmissionPDU-Poll	RB2- RB3: TRUE
>>>PollWindow	RB2- RB3: 99
>>segmentationIndication	RB1- RB3: N/A RB5- RB7: FALSE
>dl-RLC-Mode	RB1: UM RB2- RB3: AM RB5- RB7: TM
>>inSequenceDelivery	RB1: N/A RB2- RB3: TRUE RB5- RB7: N/A
>>receivingWindowSize	RB1: N/A RB2- RB3: 32 RB5- RB7: N/A
>>dl-RLC-StatusInfo	RB1: N/A RB2- RB3: as below RB5- RB7: N/A
>>>timerStatusProhibit	RB2- RB3: 100
>>>missingPDU-Indicator	RB2- RB3: TRUE
>>segmentationIndication	RB1- RB3: N/A RB5- RB7: FALSE
rb-MappingInfo	
>UL-LogicalChannelMappings	OneLogicalChannel
>>ul-TransportChannelType	Dch
>>>transportChannelIdentity	RB1- RB3: 9 RB5: 1, RB6: 2, RB7: 3.
>>logicalChannelIdentity	RB1: 1, RB2: 2, RB3: 3 RB5- RB7: N/A
>>rlc-SizeList	RB1- RB3: configured RB5- RB7: N/A
>>mac-LogicalChannelPriority	RB1: 1, RB2: 2, RB3: 3 RB5- RB7: 5
>DL-logicalChannelMappingList	
>>Mapping option 1	One mapping option
>>>dl-TransportChannelType	Dch

>>>>transportChannelIdentity	RB1- RB3: 9 RB5: 1, RB6: 2, RB7: 3,
>>>logicalChannelIdentity	RB1: 1, RB2: 2, RB3: 3 RB5- RB7: N/A
TrCH INFORMATION PER TrCH	
UL-AddReconfTransChInfoList	
>Uplink transport channel type	Dch
>transportChannelIdentity	TrCH1: 1, TrCH2: 2, TrCH3: 3, TrCH4: 9
>transportFormatSet	DedicatedTransChTFS
>>dynamicTF-information	
>>>tf0/ tf0,1,2,3,4	TrCH1: (0x72) TrCH2: (0x 181) TrCH3: (0x60) TrCH4: (0x144, 1x144, 2x144, 3x144, 4x144)
>>>>rlcSize	BitMode
>>>>>sizeType	TrCH1: type 1: 72 TrCH2: type 2: part1= 6, part2= 5 TrCH3: type1: 60 TrCH4: 2: type 2, part1= 2, part2= 0 (144)
>>>>numberOfTbSizeList	TrCH1-3: Zero TrCH4: Zero, one, 2, 3, 4
>>>>logicalChannelList	All
>>>>tf 1	TrCH1: (1x40) TrCH2: (1x 78) TrCH3: N/A TrCH4: N/A
>>>>>numberOfTransportBlocks	TrCH1: One TrCH2: One
>>>>>rlc-Size	TrCH1-2: BitMode
>>>>>>sizeType	TrCH1: 1: 40 TrCH2: 1: 78
>>>>>numberOfTbSizeList	TrCH1-2: One
>>>>>logicalChannelList	TrCH1: all
>>>>>tf 2	TrCH1: (1x54) TrCH2: (1x113) TrCH3: N/A TrCH4: N/A
>>>>>>numberOfTransportBlocks	TrCH1: One TrCh2: One
>>>>>>rlc-Size	TrCH1: BitMode
>>>>>>>sizeType	TrCH1: type 1: 54 TrCH2: type 1: 113
>>>>>>numberOfTbSizeList	TrCH1: One TrCH2: One
>>>>>>logicalChannelList	TrCH1: all TrCH2: all
>>>>>>tf 3	TrCH1: (1x64) TrCH2: (1x181) TrCH3: N/A TrCH4: N/A
>>>>>>>numberOfTransportBlocks	TrCH1: One TrCh2: One
>>>>>>>rlc-Size	TrCH1: BitMode
>>>>>>>>sizeType	TrCH1: type 1: 64 TrCH2: type 2: part1=6, part2= 5
>>>>>>>>numberOfTbSizeList	TrCH1: One TrCH2: One
>>>>>>>>logicalChannelList	TrCH1: all TrCH2: all
>>>>>>>>tf 4	TrCH1: (1x72) TrCH2: N/A TrCH3: N/A TrCH4: N/A
>>>>>>>>>numberOfTransportBlocks	TrCH1: One
>>>>>>>>>rlc-Size	TrCH1: BitMode
>>>>>>>>>>sizeType	TrCH1: type 1: 72

>>>>numberOfTbSizeList	TrCH1: One
>>>>logicalChannelList	TrCH1: all
>>semistaticTF-Information	
>>>tti	TrCH1- TrCH3: 20 TrCH4: 40
>>>channelCodingType	Convolutional
>>>>codingRate	TrCH1- TrCH3: Third TrCH4: Third
>>>>rateMatchingAttribute	TrCH1: 200 TrCH2: 190 TrCH3: 256 TrCH4: 170
>>>crc-Size	TrCH1: 12 TrCH2: 0 TrCH3: 0 TrCH4: 16
DL-AddReconfTransChInfoList	
>Downlink transport channel type	Dch
>dl-TransportChannelIdentity	
>tfs-SignallingMode	Independent <Only tf0 on TrCH1 is different and shown below>
>>transportFormatSet	
>>>dynamicTF-information	
>>>>tf0/ tf0,1	TrCH1: (1x0)
>>>>rlcSize	BitMode
>>>>>sizeType	TrCH1: type 1: 0
>>>>>numberOfTbSizeList	TrCH1: One
>>>>>logicalChannelList	All
>>>>>semistaticTF-Information	same as UL
>>ULTrCH-Id	TrCH1: 1, TrCH2: 2, TrCH3: 3, TrCH4: 9,
>dch-QualityTarget	
>>bler-QualityValue	TrCH1: 7×10^{-3} TrCH2: Absent TrCH3: Absent TrCH4: Absent
TrCH INFORMATION, COMMON	
ul-CommonTransChInfo	
>tfc-ID (TDD only)	1
>sharedChannelIndicator (TDD only)	FALSE
> tfc-Subset	Absent, not required
>ul-TFCS	Normal TFCS signalling
>>explicitTFCS-ConfigurationMode	Complete
>>>ctfcSize	Ctfc6Bit
>>>>TFCS representation	Addition
>>>>>TFC list	
>>>>>>TFC 1	(TF0, TF0, TF0, TF0)
>>>>>>>ctfc	0
>>>>>>>gainFactorInformation	Computed
>>>>>>>referenceTFCId	0
>>>>>>>TFC 2	(TF1, TF0, TF0, TF0)
>>>>>>>>ctfc	1
>>>>>>>>gainFactorInformation	Computed
>>>>>>>>> β_c (FDD only)	N/A
>>>>>>>>> β_d	N/A
>>>>>>>>>referenceTFCId	0
>>>>>>>>>TFC 3	(TF2, TF1, TF0, TF0)
>>>>>>>>>>ctfc	7
>>>>>>>>>>gainFactorInformation	Computed
>>>>>>>>>>referenceTFCId	0
>>>>>>>>>>TFC 4	(TF3, TF2, TF0, TF0)
>>>>>>>>>>>ctfc	13
>>>>>>>>>>>gainFactorInformation	Computed
>>>>>>>>>>>> β_c (FDD only)	N/A

>>>>>>>βd	N/A
-----------	-----

>>>>>>referenceTFCId	0
>>>>>TFC 5	(TF4, TF3, TF0, TF0)
>>>>>ctfc	19
>>>>>gainFactorInformation	Computed
>>>>>>referenceTFCId	0
>>>>>TFC 6	(TF0, TF0, TF0, TF1)
>>>>>ctfc	20
>>>>>gainFactorInformation	Computed
>>>>>>referenceTFCId	0
>>>>>TFC 7	(TF1, TF0, TF0, TF1)
>>>>>ctfc	21
>>>>>gainFactorInformation	Computed
>>>>>>referenceTFCId	0
>>>>>TFC 8	(TF2, TF1, TF0, TF1)
>>>>>ctfc	27
>>>>>gainFactorInformation	computed
>>>>>>referenceTFCId	0
>>>>>TFC 9	(TF3, TF2, TF0, TF1)
>>>>>ctfc	33
>>>>>gainFactorInformation	computed
>>>>>>referenceTFCId	0
>>>>>TFC 10	(TF4, TF3, TF0, TF1)
>>>>>ctfc	39
>>>>>gainFactorInformation	signalled
>>>>>> β c (FDD only)	10
>>>>>> β d	15
>>>>>>>referenceTFCId	0
>>>>>TFC 11	(TF0, TF0, TF0, TF2)
>>>>>ctfc	40
>>>>>gainFactorInformation	Computed
>>>>>>referenceTFCId	0
>>>>>TFC 12	(TF1, TF0, TF0, TF2)
>>>>>ctfc	41
>>>>>gainFactorInformation	Computed
>>>>>>referenceTFCId	0
>>>>>TFC 13	(TF0, TF0, TF0, TF3)
>>>>>ctfc	60
>>>>>gainFactorInformation	Computed
>>>>>>referenceTFCId	0
>>>>>TFC 14	(TF1, TF0, TF0, TF3)
>>>>>ctfc	61
>>>>>gainFactorInformation	Computed
>>>>>>referenceTFCId	0
>>>>>TFC 15	(TF0, TF0, TF0, TF4)
>>>>>ctfc	80
>>>>>gainFactorInformation	Computed
>>>>>>referenceTFCId	0
dl-CommonTransChInfo	
>tfc-SignallingMode	Same as UL
ul-CommonTransChInfo	
>tfc-ID (TDD only)	1
>sharedChannelIndicator (TDD only)	FALSE
> tfc-Subset	Absent, not required
PhyCH INFORMATION FDD	
UL-DPCH-InfoPredef	
>ul-DPCH-PowerControllInfo	
>>powerControlAlgorithm	Algorithm 1
>>>tpcStepSize	1 dB
>tfc-Existence	TRUE
>puncturingLimit	0.84
DL-CommonInformationPredef	
>dl-DPCH-InfoCommon	
>>spreadingFactor	128

>>tfc-Existence	TRUE
>>pilotBits	4
>>positionFixed	Flexible
PhyCH INFORMATION 3.84 Mcps TDD	
UL-DPCH-InfoPredef	
>ul-DPCH-PowerControlInfo	
>>dpch-ConstantValue	
>commonTimeslotInfo	
>>secondInterleavingMode	
>>tfc-Coding	
>>puncturingLimit	
>>repetitionPeriodAndLength	
DL-CommonInformationPredef	
>dl-DPCH-InfoCommon	
>>commonTimeslotInfo	
>>>secondInterleavingMode	
>>>tfc-Coding	
>>>puncturingLimit	
>>>repetitionPeriodAndLength	
PhyCH INFORMATION 1.28 Mcps TDD	
UL-DPCH-InfoPredef	
>commonTimeslotInfo	
>>secondInterleavingMode	
>>tfc-Coding	
>>puncturingLimit	
>>repetitionPeriodAndLength	
DL-CommonInformationPredef	
>dl-DPCH-InfoCommon	
>>commonTimeslotInfo	
>>>secondInterleavingMode	
>>>tfc-Coding	
>>>puncturingLimit	
>>>repetitionPeriodAndLength	

13.7.23 Default configuration 13.6 kbps signalling

Parameter	Value
Ref 34.108	3
Default configuration identity	22
RB INFORMATION	
rb-Identity	RB1: 1, RB2: 2, RB3: 3
rlc-InfoChoice	Rlc-info
>ul-RLC-Mode	RB1: UM RB2- RB3: AM
>>transmissionRLC-DiscardMode	RB1: N/A RB2- RB3: NoDiscard
>>>maxDat	RB1: N/A RB2- RB3: 25
>>transmissionWindowSize	RB1: N/A RB2- RB3: 32
>>timerRST	RB1: N/A RB2- RB3: 200
>>max-RST	RB1: N/A RB2- RB3: 1
>>pollingInfo	RB1: N/A RB2- RB3: as below
>>>TimerPoll	RB2- RB3: 100
>>>PollPDU	RB2- RB3: n/a
>>>PollSDU	RB2- RB3: 1
>>>lastTransmissionPDU-Poll	RB2- RB3: FALSE
>>>lastRetransmissionPDU-Poll	RB2- RB3: TRUE
>>>PollWindow	RB2- RB3: 99

Parameter	Value
>>segmentationIndication	RB1- RB3: N/A
>dl-RLC-Mode	RB1: UM RB2- RB3: AM
>>inSequenceDelivery	RB1: N/A RB2- RB3: TRUE
>>receivingWindowSize	RB1: N/A RB2- RB3: 32
>>>dl-RLC-StatusInfo	RB1: N/A RB2- RB3: as below
>>>>timerStatusProhibit	RB2- RB3: 100
>>>>missingPDU-Indicator	RB2- RB3: TRUE
>>segmentationIndication	RB1- RB3: N/A
rb-MappingInfo	
>UL-LogicalChannelMappings	OneLogicalChannel
>>ul-TransportChannelType	Dch
>>>transportChannelIdentity	RB1- RB3:9
>>>>logicalChannelIdentity	RB1: 1, RB2: 2, RB3: 3
>>>>rlc-SizeList	RB1- RB3: configured
>>>>mac-LogicalChannelPriority	RB1: 1, RB2: 2, RB3: 3
>DL-logicalChannelMappingList	
>>Mapping option 1	One mapping option
>>>>dl-TransportChannelType	Dch
>>>>>transportChannelIdentity	RB1- RB3: 9
>>>>>logicalChannelIdentity	RB1: 1, RB2: 2, RB3: 3
TrCH INFORMATION PER TrCH	
UL-AddReconfTransChInfoList	
>Uplink transport channel type	Dch
>transportChannelIdentity	TrCH1: 9
>transportFormatSet	DedicatedTransChTFS
>>dynamicTF-information	
>>>>tf0/ tf0,1	TrCH1: (0x144, 1x144)
>>>>>rlcSize	BitMode
>>>>>>sizeType	TrCH1: type 2, part1= 2, part2= 0 (144)
>>>>>>numberOfTbSizeList	TrCH1: Zero, one
>>>>>>logicalChannelList	All
>>>>tf 1	N/A
>>>>>numberOfTransportBlocks	
>>>>>rlc-Size	
>>>>>>sizeType	
>>>>>>numberOfTbSizeList	
>>>>>>logicalChannelList	
>>>>tf 2	N/A
>>>>>numberOfTransportBlocks	
>>>>>rlc-Size	
>>>>>>sizeType	
>>>>>>numberOfTbSizeList	
>>>>>>logicalChannelList	
>>semistaticTF-Information	
>>>>tti	TrCH1: 10
>>>>channelCodingType	Convolutional
>>>>>codingRate	TrCH1: Third
>>>>>rateMatchingAttribute	TrCH1: 160
>>>>>crc-Size	TrCH1: 16
DL-AddReconfTransChInfoList	
>Downlink transport channel type	Dch
>dl-TransportChannelIdentity (should be as for UL)	TrCH1: 9
>fs-SignallingMode	SameAsUL
>>transportFormatSet	
>>>>dynamicTF-information	
>>>>>tf0/ tf0,1	
>>>>>rlcSize	
>>>>>>sizeType	
>>>>>>numberOfTbSizeList	

Parameter	Value
>>>>logicalChannelList	
>>ULTrCH-Id	TrCH1: 9
>dch-QualityTarget	
>>bler-QualityValue	TrCH1: 1×10^{-2}
TrCH INFORMATION, COMMON	
ul-CommonTransChInfo	
>tfc-ID (TDD only)	1
>sharedChannelIndicator (TDD only)	FALSE
>tfc-Subset	Absent, not required
>ul-TFCS	Normal TFCI signalling
>>explicitTFCS-ConfigurationMode	Complete
>>>ctfcSize	Ctfc2Bit
>>>>TFCS representation	Addition
>>>>>TFCS list	
>>>>>>TFCS 1	(TF0)
>>>>>>>ctfc	0
>>>>>>>gainFactorInformation	Computed
>>>>>>>referenceTFCId	0
>>>>>>TFCS 2	(TF1)
>>>>>>>ctfc	1
>>>>>>>gainFactorInformation	Signalled
>>>>>>> β_c (FDD only)	11
>>>>>>> β_d	15
>>>>>>>referenceTFCId	0
dl-CommonTransChInfo	
>tfc-SignallingMode	Same as UL
PhyCH INFORMATION FDD	
UL-DPCH-InfoPredef	
>ul-DPCH-PowerControlInfo	
>>powerControlAlgorithm	Algorithm 1
>>>tpcStepSize	1 dB
>tfc-Existence	TRUE
>puncturingLimit	1
DL-CommonInformationPredef	
>dl-DPCH-InfoCommon	
>>spreadingFactor	128
>>tfc-Existence	FALSE
>>pilotBits	4
>>positionFixed	N/A
PhyCH INFORMATION 3.84 / 7.68 Mcps TDD	
UL-DPCH-InfoPredef	
>ul-DPCH-PowerControlInfo	
>>dpch-ConstantValue	0
>commonTimeslotInfo	
>>secondInterleavingMode	frameRelated
>>tfc-Coding	8
>>puncturingLimit	0.92
>>repetitionPeriodAndLength	repetitionPeriod1
DL-CommonInformationPredef	
>dl-DPCH-InfoCommon	
>>commonTimeslotInfo	
>>>secondInterleavingMode	frameRelated
>>>tfc-Coding	8
>>>puncturingLimit	0.92
>>>repetitionPeriodAndLength	repetitionPeriod1
PhyCH INFORMATION 1.28 Mcps TDD	
UL-DPCH-InfoPredef	
>commonTimeslotInfo	
>>secondInterleavingMode	frameRelated
>>tfc-Coding	8
>>puncturingLimit	0.64
>>repetitionPeriodAndLength	repetitionPeriod1

Parameter	Value
DL-CommonInformationPredef	
>dl-DPCH-InfoCommon	
>>commonTimeslotInfo	
>>>secondInterleavingMode	frameRelated
>>>tfc-Coding	8
>>>puncturingLimit	0.64
>>>repetitionPeriodAndLength	repetitionPeriod1

13.7.24 Default configuration Signalling on E-DCH & HS-DSCH; Scheduled

Parameter	Value
Ref 25.993	-
Default configuration identity	23
RB INFORMATION	
rb-Identity	RB1: 1, RB2: 2, RB3: 3
rlc-InfoChoice	Rlc-info
>ul-RLC-Mode	RB1: UM RB2- RB3: AM
>>transmissionRLC-DiscardMode	RB1: N/A RB2- RB3: NoDiscard
>>>maxDat	RB1: N/A RB2- RB3: 25
>>transmissionWindowSize	RB1: N/A RB2- RB3: 128
>>timerRST	RB1: N/A RB2- RB3: 200
>>max-RST	RB1: N/A RB2- RB3: 1
>>pollingInfo	RB1: N/A RB2- RB3: as below
>>>TimerPoll	RB2- RB3: 100
>>>PollPDU	RB2- RB3: n/a
>>>PollSDU	RB2- RB3: 1
>>>lastTransmissionPDU-Poll	RB2- RB3: FALSE
>>>lastRetransmissionPDU-Poll	RB2- RB3: FALSE
>>>PollWindow	RB2- RB3: 99
>>segmentationIndication	RB1- RB3: N/A
>dl-RLC-Mode	RB1: UM RB2- RB3: AM
>>DL RLC PDU size	RB1-RB3: 144
>>inSequenceDelivery	RB1: N/A RB2- RB3: TRUE
>>receivingWindowSize	RB1: N/A RB2- RB3: 128
>>dl-RLC-StatusInfo	RB1: N/A RB2- RB3: as below
>>>timerStatusProhibit	RB2- RB3: 100
>>>missingPDU-Indicator	RB2- RB3: TRUE
>>segmentationIndication	RB1- RB3: N/A
>>dl-UM-RLC-LI-size	7
Rb-MappingInfo	
>UL-LogicalChannelMappings	OneLogicalChannel
>>UplinkTransport ChannelTypeChoice	
>>ul-TransportChannelType	E-DCH
>>>logicalChannelIdentity	RB1: 1, RB2: 2, RB3: 3
>>>E-DCH MAC-d flow identity	RB1-RB3: 6
>>>DDI	RB1: 1, RB2: 2, RB3: 3
>>>>RLC PDU size	144
>>>Include in Scheduling Info	TRUE
>>mac-LogicalChannelPriority	RB1: 1, RB2: 2, RB3: 3
>DL-logicalChannelMappings	OneLogicalChannel

Parameter	Value
>>Mapping option 1	One mapping option
>>>dl-TransportChannelType	HS-DSCH
>>>>Mac-d flow identity	RB1- RB3: 6
>>>logicalChannelIdentity	RB1: 1, RB2: 2, RB3: 3
TrCH INFORMATION PER TrCH	
UL-AddReconfTransChInfoList	
>Uplink transport channel type	E-DCH
>UL Transport channel identity	
> UL-ParametersChoice	
>> E-DCH Transmission Time Interval	10
>> HARQ info for E-DCH	
>>> HARQ RV Configuration	Rvtable
>> Added or reconfigured E-DCH MAC-d flow	One MAC-d flow
>>> E-DCH MAC-d flow identity	6
>>> E-DCH MAC-d flow power offset	4
>>> E-DCH MAC-d flow maximum number of retransmissions	5
>>> E-DCH MAC-d flow multiplexing list	0
>>> transmission grant typeChoice	
>>>> Scheduled transmission grant info	
DL-AddReconfTransChInfoList	
>Downlink transport channel type	HS-DSCH
>DL-ParametersChoice	
>>HARQ Info	
>>>Number of Processes	6
>>>Memory PartitioningChoice	
>>>>Implicit	
>>Added or reconfigured MAC-d flow	
>>> MAC-hs queue to add or reconfigure list	
>>>>MAC-hs queue Id	0
>>>>MAC-d Flow Identity	6
>>>>T1	100
>>>>MAC-hs window size	12
>>>>MAC-d PDU size info	
>>>>>MAC-d PDU size	148
>>>>>MAC-d PDU size index	0
TrCH INFORMATION, COMMON	Null

13.8 Parameter values for default radio configurations in CELL_FACH

The UE shall support the use of the default parameter values that are specified in the following. Optional IEs that are not used, are omitted. The tabular values included in this subclause, represent the actual IE values as in clause 10, and not the ASN.1 representation of these values.

The UE shall for each RB with radio bearer identity n listed in the default configuration with the Default configuration identity given in IE "Default configuration identity for CELL_FACH":

- 1> if a multiplexing option containing the combination "FACH" for the DL and "RACH" for the UL for a RB with radio bearer identity n is included in the default configuration:
 - 2> if the radio bearer identity n is listed in explicit or another default configuration in the message received by the UE:
 - 3> if there is no multiplexing option containing the combination "FACH" for the DL and "RACH" for the UL for this radio bearer identity n:
 - 4> append the radio bearer mapping information in accordance with the default parameters for RB with radio bearer identity n to the radio bearer mapping information for RB with radio bearer identity n.
 - 2> else

- 3> store the radio bearer mapping information in accordance with the default parameters for RB with radio bearer identity n and configure the transmitting and receiving RLC entities in the UE for that radio bearer according to Table 13.8.1
- 1> if a multiplexing option containing the combination "HS-DSCH" for the DL and "RACH" for the UL for a RB with radio bearer identity n is included in the default configuration:
 - 2> if the radio bearer identity n is listed in explicit or another default configuration in the message received by the UE:
 - 3> if there is no multiplexing option containing the combination "HS-DSCH" for the DL and "RACH" for the UL for this radio bearer identity n:
 - 4> append the radio bearer mapping information in accordance with the default parameters for RB with radio bearer identity n to the radio bearer mapping information for RB with radio bearer identity n.
 - 2> else
 - 3> store the radio bearer mapping information in accordance with the default parameters for RB with radio bearer identity n and configure the transmitting and receiving RLC entities in the UE for that radio bearer according to Table 13.8.1
 - 1> if a multiplexing option containing the combination "HS-DSCH" for the DL and "E-DCH" for the UL for a RB with radio bearer identity n is included in the default configuration:
 - 2> if the radio bearer identity n is listed in explicit or another default configuration in the message received by the UE:
 - 3> if there is no multiplexing option containing the combination "HS-DSCH" for the DL and "E-DCH" for the UL for this radio bearer identity n:
 - 4> append the radio bearer mapping information in accordance with the default parameters for RB with radio bearer identity n to the radio bearer mapping information for RB with radio bearer identity n.
 - 2> else
 - 3> store the radio bearer mapping information in accordance with the default parameters for RB with radio bearer identity n and configure the transmitting and receiving RLC entities in the UE for that radio bearer according to Table 13.8.1

Table 13.8.1: Default radio configuration 0 in CELL_FACH

Ref 34.108 / 25.993	
Default configuration identity	0
RB INFORMATION	
rb-Identity	RB1: 1, RB2: 2, RB3: 3, RB4: 4
rlc-InfoChoice	RLC info for CELL_FACH signalling
>ul-RLC-Mode	RB1: UM, RB2-RB4: AM
>>transmissionRLC-DiscardMode	RB1: N/A, RB2-RB4: NoDiscard
>>>maxDat	RB1: N/A, RB2-RB4: 40
>>transmissionWindowSize	RB1: N/A, RB2-RB4: 64
>>timerRST	RB1: N/A, RB2-RB4: 200
>>max-RST	RB1: N/A, RB2-RB4: 1
>>pollingInfo	RB1: N/A, RB2-RB4: as below
>>>TimerPoll	RB1: N/A, RB2-RB4: 1000
>>>PollSDU	RB1: N/A, RB2-RB4: 1
>>>lastTransmissionPDU-Poll	RB1: N/A, RB2-RB4: FALSE
>>>lastRetransmissionPDU-Poll	RB1: N/A, RB2-RB4: TRUE
>>>PollWindow	RB1: N/A, RB2-RB4: 99
>dl-RLC-Mode	RB1: UM, RB2-RB4: AM
>>dl-RLC-PDU-size	RB1: N/A, RB2-RB4: 128 (actual size 144 bits)
>>inSequenceDelivery	RB1: N/A, RB2-RB4: TRUE
>>receivingWindowSize	RB1: N/A, RB2-RB4: 64
>>dl-RLC-StatusInfo	RB1: N/A, RB2-RB4: as below
>>>missingPDU-Indicator	RB1: N/A, RB2-RB4: TRUE
>>dl-UM-RLC-LI-size	RB1: 7, RB2-RB4: N/A
rlc-OneSidedReEst	RB1-RB4: FALSE
rb-MappingInfo	For RACH/FACH as a mapping option
>UL-LogicalChannelMappings	
>>ul-TransportChannelType	RACH
>>logicalChannelIdentity	RB1: 1, RB2: 2, RB3: 3, RB4: 4
>>rlc-SizeList	RB1-RB4: explicitList (refers to SIB5/6)
>>>rlc-SizeIndex	1 (refers to RACH TFS in SIB5/6)
>>mac-LogicalChannelPriority	RB1: 1, RB2: 2, RB3: 3, RB4: 4
>DL-logicalChannelMappingList	
>>>dl-TransportChannelType	FACH
>>>logicalChannelIdentity	RB1: 1, RB2: 2, RB3: 3, RB4: 4

NOTE: In SRNC relocation, the target SRNC shall check IE "Signalling RB information" in IE "SRNS RELOCATION INFO" to find out the current RLC info and RB mapping info used by the UE.

14 Specific functions

14.1 Intra-frequency measurements

14.1.1 Intra-frequency measurement quantities

A measurement quantity is used to evaluate whether an intra-frequency event has occurred or not. It can be:

- 1 Downlink E_c/N_0 .
- 2 Downlink path loss.

For FDD:

Pathloss in dB = Primary CPICH Tx power - CPICH RSCP.

For Primary CPICH Tx power the IE "Primary CPICH Tx power" shall be used. The unit is dBm.

CPICH RSCP is the result of the CPICH RSCP measurement. The unit is dBm.

For TDD:

Pathloss in dB = Primary CCPCH TX power - Primary CCPCH RSCP.

For Primary CCPCH TX power the IE "Primary CCPCH TX Power" shall be used. The unit is dBm.

Primary CCPCH RSCP is the result of the Primary CCPCH RSCP measurement. The unit is dBm.

If necessary Pathloss shall be rounded up to the next higher integer.

Results higher than 158 shall be reported as 158.

Results lower than 46 shall be reported as 46.

- 3 Downlink received signal code power (RSCP) after despreading.
- 4 ISCP measured on Timeslot basis.

A description of those values can be found in [7] and [8].

14.1.2 Intra-frequency reporting events for FDD

Within the measurement reporting criteria field in the Measurement Control message the UTRAN notifies the UE which events should trigger a measurement report. If present, the "reporting criteria for secondary UL frequency" notifies the UE which events should trigger a measurement report for the secondary uplink frequency. The listed events are the toolbox from which the UTRAN can choose the reporting events that are needed for the implemented handover evaluation function, or other radio network functions. If present, the IE "Cells to be excluded in detected set cells" notifies the UE to exclude cells from corresponding measurement report and UE shall exclude indicated cells from measurement report for intra-frequency measurement.

All the specified events are measured with respect to any of the measurement quantities given in subclause 14.1.1. The measurement quantities are measured on the monitored primary common pilot channels (CPICH) of the cell defined in the measurement object and measurement object on secondary UL frequency.

Special mechanisms for the events are illustrated in subclause 14.1.4 and 14.1.5.

NOTE: The events below are numbered 1A, 1B, 1C,... since all intra-frequency reporting events would be labelled 1X, inter-frequency reporting events would be labelled 2X, and so on for the other measurement types.

When one intra-frequency measurement identity corresponds to multiple intra-frequency events with identical event identities, the UE behaviour is not specified.

14.1.2.1 Reporting event 1A: A Primary CPICH enters the reporting range

When an intra-frequency measurement configuring event 1a is set up, the UE shall:

- 1> create a variable TRIGGERED_1A_EVENT per active set related to that measurement, which shall initially be empty;
- 1> delete the corresponding variable when the measurement is released.

When event 1A is configured in the UE, the UE shall:

- 1> if "Measurement quantity" is "pathloss" and Equation 1 below is fulfilled for one or more primary CPICHs, or if "Measurement quantity" is "CPICH Ec/N0" or "CPICH RSCP", and Equation 2 below is fulfilled for one or more primary CPICHs, for each of these primary CPICHs:
 - 2> if all required reporting quantities are available for that cell; and
 - 2> if the equations have been fulfilled for a time period indicated by "Time to trigger", and if that primary CPICH is part of cells allowed to trigger the event according to "Triggering condition 2", and if that primary CPICH is not included in the "cells triggered" in the corresponding variable TRIGGERED_1A_EVENT:

- 3> include that primary CPICH in the "cells recently triggered" in the corresponding variable TRIGGERED_1A_EVENT.
- 1> if the value of "Reporting deactivations threshold" for this event is greater than or equal to the current number of cells in the active set or equal to 0 and any primary CPICHs are stored in the "cells recently triggered" in the corresponding variable TRIGGERED_1A_EVENT:
 - 2> if "Reporting interval" for this event is not equal to 0:
 - 3> if the IE "Periodical reporting running" in the corresponding variable TRIGGERED_1A_EVENT is set to FALSE:
 - 4> start a timer with the value of "Reporting interval" for this event and set the IE "Periodical reporting running" in the corresponding variable TRIGGERED_1A_EVENT to TRUE;
 - 3> set "sent reports" for the primary CPICHs in "cells recently triggered" in the corresponding variable TRIGGERED_1A_EVENT to 1.
 - 2> send a measurement report with IEs set as below:
 - 3> set in "intra-frequency measurement event results" or in "cell measurement event results on secondary UL frequency": "Intrafrequency event identity" to "1a"; and
 - 3> include in "cell measurement event results" or in "cell measurement event results on secondary UL frequency" all entries of the "cells recently triggered" in the corresponding variable TRIGGERED_1A_EVENT in descending order according to the configured measurement quantity taking into account the cell individual offset for each of those cells;
 - 3> set the IE "measured results" and the IE "additional measured results", and/or the IE "measured results on secondary UL frequency" and the IE "additional measured results on secondary UL frequency" according to subclause 8.4.2, not taking into account the cell individual offset for each cell.
 - 2> move all entries from "cells recently triggered" to "cells triggered" in the corresponding variable TRIGGERED_1A_EVENT.
- 1> if the timer for the corresponding periodical reporting has expired:
 - 2> if any primary CPICH is included in the "cells triggered" in the corresponding variable TRIGGERED_1A_EVENT:
 - 3> if "Reporting interval" for this event is not equal to 0, and if "Amount of reporting" is greater than "sent reports" stored for any of these primary CPICHs, in "cells triggered" in the corresponding variable TRIGGERED_1A_EVENT:
 - 4> increment the stored counter "sent reports" for all CPICHs in "cell triggered" in the corresponding variable TRIGGERED_1A_EVENT;
 - 4> start a timer with the value of "Reporting interval" for this event;
 - 4> send a measurement report with IEs set as below:
 - 5> set in "intra-frequency measurement event results" or in "cell measurement event results on secondary UL frequency": "Intrafrequency event identity" to "1a"; and
 - 5> include in "cell measurement event results" or in "cell measurement event results on secondary UL frequency" all entries of the corresponding variable TRIGGERED_1A_EVENT with value of IE "sent reports" equal to or smaller than value of "Amount of reporting" in descending order according to the configured measurement quantity taking into account the cell individual offset for each of those cells;
 - 5> set the IE "measured results" and the IE "additional measured results", and/or the IE "measured results on secondary UL frequency" and the IE "additional measured results on secondary UL frequency" according to subclause 8.4.2, not taking into account the cell individual offset for each cell.

- 4> if "sent reports" in the corresponding variable TRIGGERED_1A_EVENT is equal to "Amount of reporting" for all entries:
 - 5> set the IE "Periodical Reporting running" in the corresponding variable TRIGGERED_1A_EVENT to FALSE and disable the timer for the corresponding periodical reporting.
- 1> if "Measurement quantity" is "pathloss" and Equation 3 below is fulfilled for a primary CPICH, or if "Measurement quantity" is "CPICH Ec/N0" or "CPICH RSCP", and Equation 4 below is fulfilled for a primary CPICH; or
- 1> if a primary CPICH is no longer part of the cells allowed to trigger the event according to the "Triggering condition 2":
 - 2> if that primary CPICH is included in the "cells triggered" or "cells recently triggered" in the corresponding variable TRIGGERED_1A_EVENT:
 - 3> remove the entry of that primary CPICH from "cells triggered" or "cells recently triggered" in the corresponding variable TRIGGERED_1A_EVENT.
 - 3> if no entry in the corresponding variable TRIGGERED_1A_EVENT has a value of "sent reports" smaller than "Amount of reporting"; or
 - 3> if there is no entry in the corresponding variable TRIGGERED_1A_EVENT:
 - 4> if the corresponding reporting interval timer is running:
 - 5> stop the reporting interval timer;
 - 5> set the IE "Periodical reporting running" in the corresponding variable TRIGGERED_1A_EVENT to FALSE.

This event is only applicable to the CELL_DCH state. When the measurement is setup in CELL_DCH or upon transition to CELL_DCH the UE shall:

- 1> if the "Triggering condition 2" includes active set cells:
 - 2> include the primary CPICH of all cells in the current active set into the "cells triggered" in the variable TRIGGERED_1A_EVENT with the counter "sent reports" set to "Amount of reporting".

Equation 1 (Triggering condition for pathloss)

$$10 \cdot \text{Log}M_{New} + CIO_{New} \leq W \cdot 10 \cdot \text{Log} \left(1 / \sum_{i=1}^{N_A} (1/M_i) \right) + (1-W) \cdot 10 \cdot \text{Log}M_{Best} + (R_{1a} - H_{1a} / 2),$$

Equation 2 (Triggering condition for all the other measurement quantities)

$$10 \cdot \text{Log}M_{New} + CIO_{New} \geq W \cdot 10 \cdot \text{Log} \left(\sum_{i=1}^{N_A} M_i \right) + (1-W) \cdot 10 \cdot \text{Log}M_{Best} - (R_{1a} - H_{1a} / 2),$$

Equation 3 (Leaving triggering condition for pathloss)

$$10 \cdot \text{Log}M_{New} + CIO_{New} > W \cdot 10 \cdot \text{Log} \left(1 / \sum_{i=1}^{N_A} (1/M_i) \right) + (1-W) \cdot 10 \cdot \text{Log}M_{Best} + (R_{1a} + H_{1a} / 2),$$

Equation 4 (Leaving triggering condition for all the other measurement quantities)

$$10 \cdot \text{Log}M_{New} + CIO_{New} < W \cdot 10 \cdot \text{Log} \left(\sum_{i=1}^{N_A} M_i \right) + (1-W) \cdot 10 \cdot \text{Log}M_{Best} - (R_{1a} + H_{1a} / 2),$$

The variables in the formula are defined as follows:

M_{New} is the measurement result of the cell entering the reporting range.

CIO_{New} is the individual cell offset for the cell entering the reporting range if an individual cell offset is stored for that cell. Otherwise it is equal to 0.

M_i is a measurement result of a cell not forbidden to affect reporting range in the active set.

N_A is the number of cells not forbidden to affect reporting range in the current active set.

For pathloss

M_{Best} is the measurement result of the cell not forbidden to affect reporting range in the active set with the lowest measurement result, not taking into account any cell individual offset.

for other measurements quantities.

M_{Best} is the measurement result of the cell not forbidden to affect reporting range in the active set with the highest measurement result, not taking into account any cell individual offset.

W is a parameter sent from UTRAN to UE.

R_{1a} is the reporting range constant.

H_{1a} is the hysteresis parameter for the event 1a.

If the measurement results are pathloss or CPICH-Ec/No then M_{New} , M_i and M_{Best} are expressed as ratios.

If the measurement result is CPICH-RSCP then M_{New} , M_i and M_{Best} are expressed in mW.

14.1.2.2 Reporting event 1B: A primary CPICH leaves the reporting range

When an intra-frequency measurement configuring event 1b is set up, the UE shall:

- 1> create a variable TRIGGERED_1B_EVENT per active set related to that measurement, which shall initially be empty;
- 1> delete the corresponding variable when the measurement is released.

When event 1B is configured in the UE, the UE shall:

- 1> if "Measurement quantity" is "pathloss" and Equation 1 below is fulfilled for one or more primary CPICHs, or if "Measurement quantity" is "CPICH Ec/No" or "CPICH RSCP", and Equation 2 below is fulfilled for one or more primary CPICHs, for each of these primary CPICHs:
 - 2> if all required reporting quantities are available for that cell, and if the equations have been fulfilled for a time period indicated by "Time to trigger", and if that primary CPICH is part of cells allowed to trigger the event according to "Triggering condition 1", and if that primary CPICH is not included in the "cells triggered" in the corresponding variable TRIGGERED_1B_EVENT:
 - 3> include that primary CPICH in the "cells recently triggered" in the corresponding variable TRIGGERED_1B_EVENT.
- 1> if any primary CPICHs are stored in the "cells recently triggered" in the corresponding variable TRIGGERED_1B_EVENT:
 - 2> if "Periodic reporting info-1b" is present, and "Reporting interval" for this event is not equal to 0:
 - 3> if the IE "Periodical reporting running" in the corresponding variable TRIGGERED_1B_EVENT is set to FALSE:
 - 4> start a timer with the value of "Reporting interval" for this event and set the IE "Periodical reporting running" in the corresponding variable TRIGGERED_1B_EVENT to TRUE;
 - 3> set "sent reports" for the primary CPICHs in "cells recently triggered" in the corresponding variable TRIGGERED_1B_EVENT to 1.
 - 2> send a measurement report with IEs set as below:

- 3> set in "intra-frequency measurement event results" or in "cell measurement event results on secondary UL frequency": "Intrafrequency event identity" to "1b"; and
 - 3> include in "cell measurement event results" or in "cell measurement event results on secondary UL frequency" all entries of "cells recently triggered" in the corresponding variable TRIGGERED_1B_EVENT in ascending order according to the configured measurement quantity taking into account the cell individual offset for each of those cells;
 - 3> set the IE "measured results" and the IE "additional measured results", and/or the IE "measured results on secondary UL frequency" and the IE "additional measured results on secondary UL frequency" according to subclause 8.4.2, not taking into account the cell individual offset for each cell.
- 2> move all entries from IE "cells recently triggered" to "cells triggered" in the corresponding variable TRIGGERED_1B_EVENT.
- 1> if the timer for the corresponding periodical reporting has expired:
 - 2> if any primary CPICH is included in the "cells triggered" in the corresponding variable TRIGGERED_1B_EVENT:
 - 3> if "Periodic reporting info-1b" is present:
 - 4> if "Reporting interval" is not equal to 0, and if "Amount of reporting" is greater than "sent reports" stored for any of these primary CPICHs, in "cells triggered" in the corresponding variable TRIGGERED_1B_EVENT:
 - 5> increment the stored counter "sent reports" for all CPICHs in "cell triggered" in the corresponding variable TRIGGERED_1B_EVENT;
 - 5> start a timer with the value of "Reporting interval-1b" for this event;
 - 5> send a measurement report with IEs set as below:
 - 6> set in "intra-frequency measurement event results" or in "cell measurement event results on secondary UL frequency": "Intrafrequency event identity" to "1b"; and
 - 6> include in "cell measurement event results" or in "measurement event results on secondary UL frequency" all entries of the corresponding variable TRIGGERED_1B_EVENT with value of IE "sent reports" equal to or smaller than value of "Amount of reporting" in ascending order according to the configured measurement quantity taking into account the cell individual offset for each of those cells;
 - 6> set the IE "measured results" and the IE "additional measured results", and/or the IE "measured results on secondary UL frequency" and the IE "additional measured results on secondary UL frequency" according to subclause 8.4.2, not taking into account the cell individual offset for each cell.
 - 5> if "sent reports" in the corresponding variable TRIGGERED_1B_EVENT is equal to "Amount of reporting" for all entries:
 - 6> set the IE "Periodical Reporting running" in the corresponding variable TRIGGERED_1B_EVENT to FALSE and disable the timer for the corresponding periodical reporting.
- 1> if "Measurement quantity" is "pathloss" and Equation 3 below is fulfilled for a primary CPICH, or if "Measurement quantity" is "CPICH Ec/N0" or "CPICH RSCP", and Equation 4 below is fulfilled for a primary CPICH; or
 - 1> if a primary CPICH is no longer part of the cells allowed to trigger the event according to the "Triggering condition 1":
 - 2> if that primary CPICH is included in the "cells triggered" in the corresponding variable TRIGGERED_1B_EVENT:
 - 3> remove the entry of that primary CPICH from "cells triggered" in the corresponding variable TRIGGERED_1B_EVENT;

3> if there is no entry in the corresponding variable TRIGGERED_1B_EVENT:

4> if the corresponding reporting interval timer is running:

5> stop the reporting interval timer;

5> set the IE "Periodical reporting running" in the corresponding variable TRIGGERED_1B_EVENT to FALSE.

Equation 1 (Triggering condition for pathloss)

$$10 \cdot \text{Log}M_{Old} + CIO_{Old} \geq W \cdot 10 \cdot \text{Log} \left(1 / \sum_{i=1}^{N_A} (1 / M_i) \right) + (1 - W) \cdot 10 \cdot \text{Log}M_{Best} + (R_{1b} + H_{1b} / 2),$$

Equation 2 (Triggering condition for all the other measurement quantities)

$$10 \cdot \text{Log}M_{Old} + CIO_{Old} \leq W \cdot 10 \cdot \text{Log} \left(\sum_{i=1}^{N_A} M_i \right) + (1 - W) \cdot 10 \cdot \text{Log}M_{Best} - (R_{1b} + H_{1b} / 2),$$

Equation 3 (Leaving triggering condition for pathloss)

$$10 \cdot \text{Log}M_{Old} + CIO_{Old} < W \cdot 10 \cdot \text{Log} \left(1 / \sum_{i=1}^{N_A} (1 / M_i) \right) + (1 - W) \cdot 10 \cdot \text{Log}M_{Best} + (R_{1b} - H_{1b} / 2),$$

Equation 4 (Leaving triggering condition for all the other measurement quantities)

$$10 \cdot \text{Log}M_{Old} + CIO_{Old} > W \cdot 10 \cdot \text{Log} \left(\sum_{i=1}^{N_A} M_i \right) + (1 - W) \cdot 10 \cdot \text{Log}M_{Best} - (R_{1b} - H_{1b} / 2),$$

The variables in the formula are defined as follows:

M_{Old} is the measurement result of the cell leaving the reporting range.

CIO_{Old} is the individual cell offset for the cell leaving the reporting range if an individual cell offset is stored for that cell. Otherwise it is equal to 0.

M_i is a measurement result of a cell not forbidden to affect reporting range in the active set.

N_A is the number of cells not forbidden to affect reporting range in the current active set.

For pathloss

M_{Best} is the measurement result of the cell not forbidden to affect reporting range in the active set with the lowest measurement result, not taking into account any cell individual offset.

for other measurements quantities.

M_{Best} is the measurement result of the cell not forbidden to affect reporting range in the active set with the highest measurement result, not taking into account any cell individual offset.

W is a parameter sent from UTRAN to UE.

R_{1b} is the reporting range constant.

H_{1b} is the hysteresis parameter for the event 1b.

If the measurement results are pathloss or CPICH-Ec/No then M_{Old} , M_i and M_{Best} are expressed as ratios.

If the measurement result is CPICH-RSCP then M_{Old} , M_i and M_{Best} are expressed in mW.

14.1.2.3 Reporting event 1C: A non-active primary CPICH becomes better than an active primary CPICH

When an intra-frequency measurement configuring event 1c is set up, the UE shall:

- 1> create a variable TRIGGERED_1C_EVENT per active set related to that measurement, which shall initially be empty;
- 1> delete the corresponding variable when the measurement is released.

When event 1C is configured in the UE, the UE shall:

- 1> if "Measurement quantity" is "pathloss" and Equation 1 below is fulfilled for one or more primary CPICHs, or if "Measurement quantity" is "CPICH Ec/N0" or "CPICH RSCP", and Equation 2 below is fulfilled for one or more primary CPICHs, for each of these primary CPICHs:
 - 2> if all required reporting quantities are available for that cell; and
 - 2> if the equations have been fulfilled for a time period indicated by "Time to trigger", and if the primary CPICH that is better is not included in the active set but the other primary CPICH is any of the primary CPICHs included in the active set, and if that first primary CPICH is not included in the "cells triggered" in the corresponding variable TRIGGERED_1C_EVENT:
 - 3> include that primary CPICH in the "cells recently triggered" in the corresponding variable TRIGGERED_1C_EVENT.
- 1> if the value of "Replacement activation threshold" for this event is less than or equal to the current number of cells in the active set or equal to 0 and if any primary CPICHs are stored in the "cells recently triggered" in the corresponding variable TRIGGERED_1C_EVENT:
 - 2> if "Reporting interval" for this event is not equal to 0:
 - 3> if the IE "Periodical reporting running" in the corresponding variable TRIGGERED_1C_EVENT is set to FALSE:
 - 4> start a timer for with the value of "Reporting interval" for this event and set the IE "Periodical reporting running" in the corresponding variable TRIGGERED_1C_EVENT to TRUE.
 - 3> set "sent reports" for that primary CPICH in the corresponding variable TRIGGERED_1C_EVENT to 1.
 - 2> send a measurement report with IEs set as below:
 - 3> set in "intra-frequency measurement event results" or in "cell measurement event results on secondary UL frequency": "Intrafrequency event identity" to "1c"; and
 - 3> include in "cell measurement event results" or in "cell measurement event results on secondary UL frequency" all entries of the "cells recently triggered" in the corresponding variable TRIGGERED_1C_EVENT not in the active set as well as the "primary CPICH info" of all the primary CPICHs in the active set for which the measured value is worse (i.e. greater for pathloss and less for the other measurement quantities) than the one of the entry in "cell recently triggered" that has the best measured value taking into account their cell individual offset. The "primary CPICH info" for those cells shall be ordered according to their measured value taking into account their cell individual offset, beginning with the best cell to the worst one;
 - 3> set the IE "measured results" and the IE "additional measured results", and/or the IE "measured results on secondary UL frequency" and the IE "additional measured results on secondary UL frequency" according to subclause 8.4.2, not taking into account the cell individual offset for each cell.
 - 2> move all entries from "cells recently triggered" to "cells triggered" in the corresponding variable TRIGGERED_1C_EVENT.
- 1> if the timer for the periodical reporting has expired:
 - 2> if any primary CPICH is included in the "cells triggered" in the corresponding variable TRIGGERED_1C_EVENT, and not included in the current active set:
 - 3> if "Reporting interval" for this event is not equal to 0, and if "Amount of reporting" is greater than "sent reports" stored for that primary CPICH, in "cells triggered" in the corresponding variable TRIGGERED_1C_EVENT:

- 4> increment the stored counter "sent reports" for all CPICH in "cell triggered" in the corresponding variable TRIGGERED_1C_EVENT;
- 4> start a timer with the value of "Reporting interval" for this event;
- 4> send a measurement report with IEs set as below:
 - 5> set in "intra-frequency measurement event results" or in "cell measurement event results on secondary UL frequency": "Intrafrequency event identity" to "1c"; and
 - 5> include in "cell measurement event results" or in "measurement event results on secondary UL frequency" all entries of the corresponding variable TRIGGERED_1C_EVENT with value of IE "sent report" equal to or smaller than value of "Amount of reporting" and that are not part of the active set as well as the "primary CPICH info" of all the primary CPICHs in the active set for which the measured value is worse (i.e. greater for pathloss and less for the other measurement quantities) than the one of the entry in "cell triggered" that has the best measured value, ordering the "primary CPICH info" according to their measured value beginning with the best cell to the worst one, taking into account the cell individual offset for each cell;
 - 5> set the IE "measured results" and the IE "additional measured results", and/or the IE "measured results on secondary UL frequency" and the IE "additional measured results on secondary UL frequency" according to subclause 8.4.2, not taking into account the cell individual offset for each cell.
- 4> if "sent reports" in the corresponding variable TRIGGERED_1C_EVENT is equal to "Amount of reporting" for all entries:
 - 5> set the IE "Periodical Reporting running" in the corresponding variable TRIGGERED_1C_EVENT to FALSE and disable the timer for the corresponding periodical reporting.
- 1> if "Measurement quantity" is "pathloss" and Equation 3 below is fulfilled for a primary CPICH, or if "Measurement quantity" is "CPICH Ec/N0" or "CPICH RSCP", and Equation 4 below is fulfilled for a primary CPICH or;
- 1> if a primary CPICH is added to the active set:
 - 2> if that primary CPICH is included in the "cells triggered" or "cells recently triggered" in the corresponding variable TRIGGERED_1C_EVENT:
 - 3> remove the entry of that primary CPICH from "cells triggered" or "cells recently triggered" in the variable TRIGGERED_1C_EVENT.
 - 3> if no entry in the corresponding variable TRIGGERED_1C_EVENT has a value of "sent reports" smaller than "Amount of reporting" or
 - 3> if there is no entry in the corresponding variable TRIGGERED_1C_EVENT:
 - 4> if the corresponding reporting interval timer is running:
 - 5> stop the reporting interval timer;
 - 5> set the IE "Periodical reporting running" in the corresponding variable TRIGGERED_1C_EVENT to FALSE.

Equation 1 (Triggering condition for pathloss)

$$10 \log M_{New} + CIQ_{New} \leq 10 \log M_{mAS} + CIQ_{mAS} - H_{lc} / 2$$

Equation 2 (Triggering condition for all the other measurement quantities)

$$10 \log M_{New} + CIQ_{New} \geq 10 \log M_{mAS} + CIQ_{mAS} + H_{lc} / 2$$

Equation 3 (Leaving triggering condition for pathloss)

$$10 \log M_{New} + CIO_{New} > 10 \log M_{inAS} + CIO_{inAS} + H_{1c} / 2$$

Equation 4 (Leaving triggering condition for all the other measurement quantities)

$$10 \log M_{New} + CIO_{New} < 10 \log M_{inAS} + CIO_{inAS} - H_{1c} / 2$$

The variables in the formula are defined as follows:

M_{New} is the measurement result of the cell not included in the active set.

CIO_{New} is the individual cell offset for the cell becoming better than the cell in the active set if an individual cell offset is stored for that cell. Otherwise it is equal to 0.

For pathloss:

M_{inAS} is the measurement result of the cell in the active set with the highest measurement result.

For other measurement quantities:

M_{inAS} is the measurement result of the cell in the active set with the lowest measurement result.

CIO_{inAS} is the individual cell offset for the cell in the active set that is becoming worse than the new cell.

H_{1c} is the hysteresis parameter for the event 1c.

If the measurement results are pathloss or CPICH-Ec/No then M_{New} and M_{inAS} are expressed as ratios.

If the measurement result is CPICH-RSCP then M_{New} and M_{inAS} are expressed in mW.

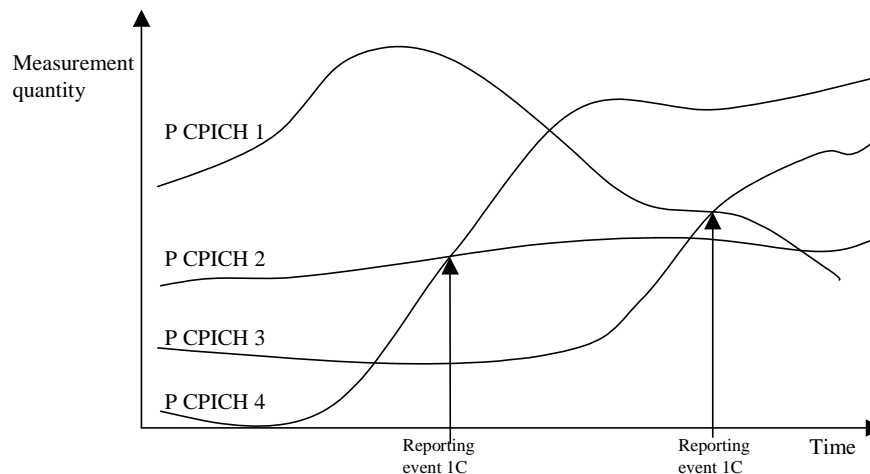

Figure 14.1.2.3-1 [Informative]: A primary CPICH that is not included in the active set becomes better than a primary CPICH that is in the active set

In this figure, the parameters hysteresis and time to trigger, as well as the cell individual offsets for all cells are equal to 0. In this example the cells belonging to primary CPICH 1 and 2 are in the active set, but the cells transmitting primary CPICH 3 and CPICH 4 are not (yet) in the active set.

The first measurement report is sent when primary CPICH 4 becomes better than primary CPICH 2. The "cell measurement event result" of the measurement report contains the information of primary CPICH 4 and CPICH 2.

Assuming that the active set has been updated after the first measurement report (active set is now primary CPICH 1 and primary CPICH 4), the second report is sent when primary CPICH 3 becomes better than primary CPICH 1. The "cell measurement event result" of the second measurement report contains the information of primary CPICH 3 and primary CPICH 1.

14.1.2.4 Reporting event 1D: Change of best cell

When an intra-frequency measurement configuring event 1d is set up, the UE shall:

- 1> create a variable BEST_CELL_1D_EVENT related to that measurement, which shall initially contain the best cell in the active set when the measurement is initiated;
- 1> delete this variable when the measurement is released.
- 1> As soon as the best cell in the active set has been evaluated by the UE (and stored in the BEST_CELL_1D_EVENT variable) and provided that there is more than one cell in the active set, trigger an immediate measurement report with IEs set as below:
 - 2> set in "intra-frequency measurement event results"; "Intrafrequency event identity" to "1d" and "cell measurement event results" to the CPICH info of the primary CPICH stored in the BEST_CELL_1D_EVENT variable;
 - 2> set the IE "measured results" and the IE "additional measured results", and the IE "measured results on secondary UL frequency" and the IE "additional measured results on secondary UL frequency" according to subclause 8.4.2

When event 1D is configured in the UE, the UE shall:

- 1> if IE "useCIO" is present and its value is TRUE, take into account the Cell Individual Offset for evaluation of the Equation 1 and 2, otherwise do not take it into account.
- 1> if "Measurement quantity" is "pathloss" and Equation 1 below is fulfilled for a primary CPICH that is not stored in "Best cell" in variable BEST_CELL_1D_EVENT, or if "Measurement quantity" is "CPICH Ec/N0" or "CPICH RSCP", and Equation 2 below is fulfilled for a primary CPICH that is not stored in "Best cell" in variable BEST_CELL_1D_EVENT:

NOTE: If the equations are simultaneously fulfilled for more than one primary CPICH, the UE should report only one event 1D, triggered by the best primary CPICH.

 - 2> if all required reporting quantities are available for that cell, and if the equations have been fulfilled for a time period indicated by "Time to trigger" and if IE "Triggering condition 2" is absent or if it is present and that primary CPICH is part of cells allowed to trigger the event according to "Triggering condition 2":
 - 3> set "best cell" in the variable BEST_CELL_1D_EVENT to that primary CPICH that triggered the event;
 - 3> send a measurement report with IEs set as below:
 - 4> set in "intra-frequency measurement event results"; "Intrafrequency event identity" to "1d" and "cell measurement event results" to the CPICH info of the primary CPICH that triggered the report.
 - 4> set the IE "measured results" and the IE "additional measured results", and the IE "measured results on secondary UL frequency" and the IE "additional measured results on secondary UL frequency" according to subclause 8.4.2.

This event is only applicable to the CELL_DCH state. Upon transition to CELL_DCH the UE shall:

- 1> set "best cell" in the variable BEST_CELL_1D_EVENT to the best cell of the primary CPICHs included in the active set.

Equation 1 (Triggering condition for pathloss)

$$10 \log M_{NotBest} + CIO_{NotBest} \leq 10 \log M_{Best} + CIO_{Best} - H_{1d} / 2,$$

Equation 2 (Triggering condition for all the other measurement quantities)

$$10 \log M_{NotBest} + CIO_{NotBest} \geq 10 \log M_{Best} + CIO_{Best} + H_{1d} / 2,$$

The variables in the formula are defined as follows:

$M_{NotBest}$ is the measurement result of a cell not stored in "best cell" in the variable BEST_CELL_1D_EVENT.

$CIO_{NotBest}$ is the cell individual offset of a cell not stored in "best cell" in the variable BEST_CELL_1D_EVENT.

M_{Best} is the measurement result of the cell stored in "best cell" in variable BEST_CELL_1D_EVENT.

CIO_{Best} is the cell individual offset of a cell stored in "best cell" in the variable BEST_CELL_1D_EVENT.

H_{1d} is the hysteresis parameter for the event 1d.

If the measurement results are pathloss or CPICH-Ec/No then $M_{Not\ Best}$ and M_{Best} are expressed as ratios.

If the measurement result is CPICH-RSCP then $M_{Not\ Best}$ and M_{Best} are expressed in mW.

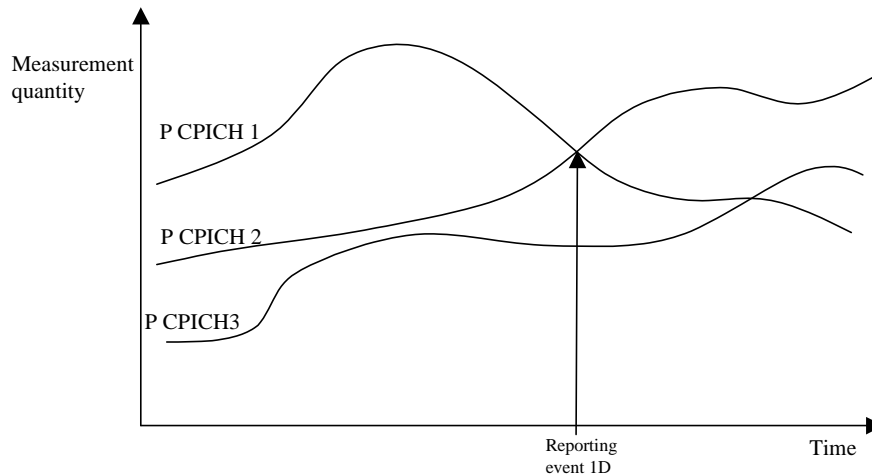

Figure 14.1.2.4-1 [Informative]: A primary CPICH becomes better than the previously best primary CPICH

In this figure, the parameters hysteresis and time to trigger, as well as the cell individual offsets for all cells are equal to 0.

14.1.2.5 Reporting event 1E: A Primary CPICH becomes better than an absolute threshold

When an intra-frequency measurement configuring event 1e is set up, the UE shall:

- 1> create a variable TRIGGERED_1E_EVENT per active set related to that measurement, which shall initially be empty;
- 1> delete the corresponding variable when the measurement is released.

When event 1E is configured in the UE, the UE shall:

- 1> if "Measurement quantity" is "pathloss" and Equation 1 below is fulfilled for a primary CPICH, or if "Measurement quantity" is "CPICH Ec/N0" or "CPICH RSCP", and Equation 2 below is fulfilled for one or more primary CPICHs, for each of these primary CPICHs:
 - 2> if all required reporting quantities are available for that cell, and if the equations have been fulfilled for a time period indicated by "Time to trigger", and if that primary CPICH is part of cells allowed to trigger the event according to "Triggering condition 2", and that primary CPICH is not included in the "cells triggered" in the corresponding variable TRIGGERED_1E_EVENT:
 - 3> include that primary CPICH in the "cells recently triggered" in the corresponding variable TRIGGERED_1E_EVENT.
- 1> if any primary CPICHs are stored in the "cells recently triggered" in the corresponding variable TRIGGERED_1E_EVENT:
 - 2> send a measurement report with IEs set as below:
 - 3> set in "intra-frequency measurement event results" or in "cell measurement event results on secondary UL frequency": "Intrafrequency event identity" to "1e"; and

- 3> include in "cell measurement event results" or in "cell measurement event results on secondary UL frequency" all entries of the "cells recently triggered" in the corresponding variable TRIGGERED_1E_EVENT in descending order according to the configured measurement quantity taking into account the cell individual offset for each of those cells;
- 3> set the IE "measured results" and the IE "additional measured results", and/or the IE "measured results on secondary UL frequency" and the IE "additional measured results on secondary UL frequency" according to subclause 8.4.2, not taking into account the cell individual offset for each cell.
- 2> move all entries from "cells recently triggered" to "cells triggered" in the corresponding variable TRIGGERED_1E_EVENT.
- 1> if "Measurement quantity" is "pathloss" and Equation 3 below is fulfilled for a primary CPICH, or if "Measurement quantity" is "CPICH Ec/N0" or "CPICH RSCP", and Equation 4 below is fulfilled for a primary CPICH; or
- 1> if a primary CPICH is no longer part of the cells allowed to trigger the event according to the "Triggering condition 2":
 - 2> if that primary CPICH is included in the "cells triggered" in the corresponding variable TRIGGERED_1E_EVENT:
 - 3> remove that primary CPICH and sent reports from "cells triggered" in the corresponding variable TRIGGERED_1E_EVENT.

This event is only applicable to the CELL_DCH state. When the measurement is setup in CELL_DCH or upon transition to CELL_DCH the UE shall:

- 1> if the "Triggering condition 2" includes active set cells:
 - 2> include the primary CPICH of all cells in the current active set that fulfil the equations 1 or 2 according to the "Measurement quantity" of event 1e into the "cells triggered" in the corresponding variable TRIGGERED_1E_EVENT.

Equation 1 (Triggering condition for pathloss)

$$10 \log M_{New} + CIO_{New} \leq T_{1e} - H_{1e} / 2,$$

Equation 2 (Triggering condition for all the other measurement quantities)

$$10 \log M_{New} + CIO_{New} \geq T_{1e} + H_{1e} / 2,$$

Equation 3 (Leaving triggering condition for pathloss)

$$10 \log M_{New} + CIO_{New} > T_{1e} + H_{1e} / 2,$$

Equation 4 (Leaving triggering condition for all the other measurement quantities)

$$10 \log M_{New} + CIO_{New} < T_{1e} - H_{1e} / 2,$$

The variables in the formula are defined as follows:

M_{New} is the measurement result of a cell that becomes better than an absolute threshold.

CIO_{New} is the individual cell offset for the cell becoming better than the absolute threshold. Otherwise it is equal to 0.

T_{1e} is an absolute threshold.

H_{1e} is the hysteresis parameter for the event 1e.

If the measurement results are pathloss or CPICH-Ec/No then M_{New} is expressed as ratios.

If the measurement result is CPICH-RSCP then M_{New} is expressed in mW.

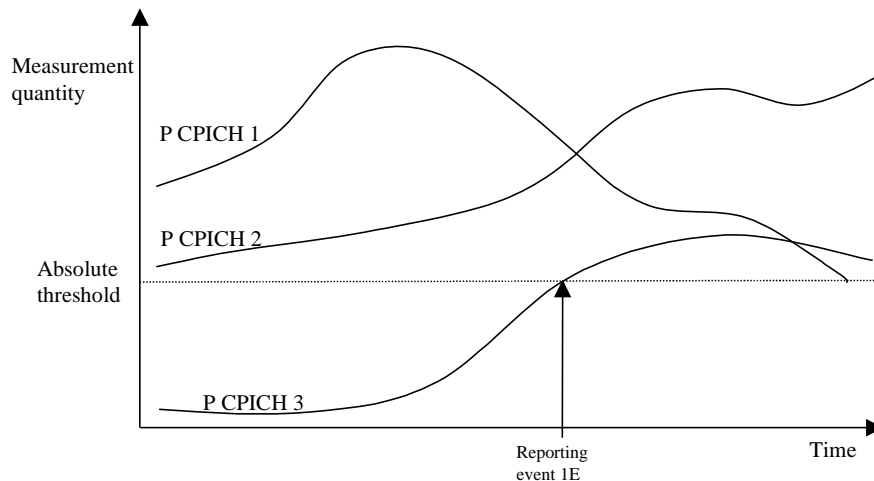

Figure 14.1.2.5-1 [Informative]: Event-triggered report when a Primary CPICH becomes better than an absolute threshold

In this figure, the parameters hysteresis and time to trigger, as well as the cell individual offsets for all cells are equal to 0.

14.1.2.6 Reporting event 1F: A Primary CPICH becomes worse than an absolute threshold

When an intra-frequency measurement configuring event 1F is set up, the UE shall:

- 1> create a variable TRIGGERED_1F_EVENT per active set related to that measurement, which shall initially be empty;
- 1> delete the corresponding variable when the measurement is released.

When event 1F is configured in the UE, the UE shall:

- 1> if "Measurement quantity" is "pathloss" and Equation 1 below is fulfilled for one or more primary CPICHs, or if "Measurement quantity" is "CPICH E_c/N_0 " or "CPICH RSCP", and Equation 2 below is fulfilled for one or more primary CPICHs, for each of these primary CPICHs:
 - 2> if all required reporting quantities are available for that cell, and if the equations have been fulfilled for a time period indicated by "Time to trigger", and if that primary CPICH is part of cells allowed to trigger the event according to "Triggering condition 1", and that primary CPICH is not included in the "cells triggered" in the corresponding variable TRIGGERED_1F_EVENT:
 - 3> include that primary CPICH in the "cells recently triggered" in the corresponding variable TRIGGERED_1F_EVENT.
- 1> if any primary CPICHs are stored in the "cells recently triggered" in the corresponding variable TRIGGERED_1F_EVENT:
 - 2> send a measurement report with IEs set as below:
 - 3> set in "intra-frequency event measurement results" or in "cell measurement event results on secondary UL frequency": "Intrafrequency event identity" to "1f"; and
 - 3> include in "cell measurement event results" or in "cell measurement event results on secondary UL frequency" all entries of the "cells recently triggered" in the corresponding variable TRIGGERED_1F_EVENT in descending order according to the configured measurement quantity taking into account the cell individual offset for each of those cells;
 - 3> set the IE "measured results" and the IE "additional measured results", and/or the IE "measured results on secondary UL frequency" and the IE "additional measured results on secondary UL frequency" according to subclause 8.4.2, not taking into account the cell individual offset for each cell;

- 2> move all entries from "cells recently triggered" to "cells triggered" in the corresponding variable TRIGGERED_1F_EVENT.
- 1> if "Measurement quantity" is "pathloss" and Equation 3 below is fulfilled for a primary CPICH, or if "Measurement quantity" is "CPICH Ec/N0" or "CPICH RSCP", and Equation 4 below is fulfilled for a primary CPICH; or
- 1> if a primary CPICH is no longer part of the cells allowed to trigger the event according to the "Triggering condition 1":
 - 2> if that primary CPICH is included in the "cells triggered" in the corresponding variable TRIGGERED_1F_EVENT:
 - 3> remove that primary CPICH from "cells triggered" in the corresponding variable TRIGGERED_1F_EVENT.

Equation 1 (Triggering condition for pathloss)

$$10 \text{Log}M_{Ola} + CIO_{Ola} \geq T_{If} + H_{If}/2$$

Equation 2 (Triggering condition for all the other measurement quantities)

$$10 \text{Log}M_{Ola} + CIO_{Ola} \leq T_{If} - H_{If}/2$$

Equation 3 (Leaving triggering condition for pathloss)

$$10 \text{Log}M_{Ola} + CIO_{Ola} < T_{If} - H_{If}/2$$

Equation 4 (Leaving triggering condition for all the other measurement quantities)

$$10 \text{Log}M_{Ola} + CIO_{Ola} > T_{If} + H_{If}/2$$

The variables in the formula are defined as follows:

M_{Ola} is the measurement result of a cell that becomes worse than an absolute threshold

CIO_{Ola} is the individual cell offset for the cell becoming worse than the absolute threshold. Otherwise it is equal to 0.

T_{If} is an absolute threshold

H_{If} is the hysteresis parameter for the event 1f.

If the measurement results are pathloss or CPICH-Ec/No then M_{Ola} is expressed as ratios.

If the measurement result is CPICH-RSCP then M_{Ola} is expressed in mW.

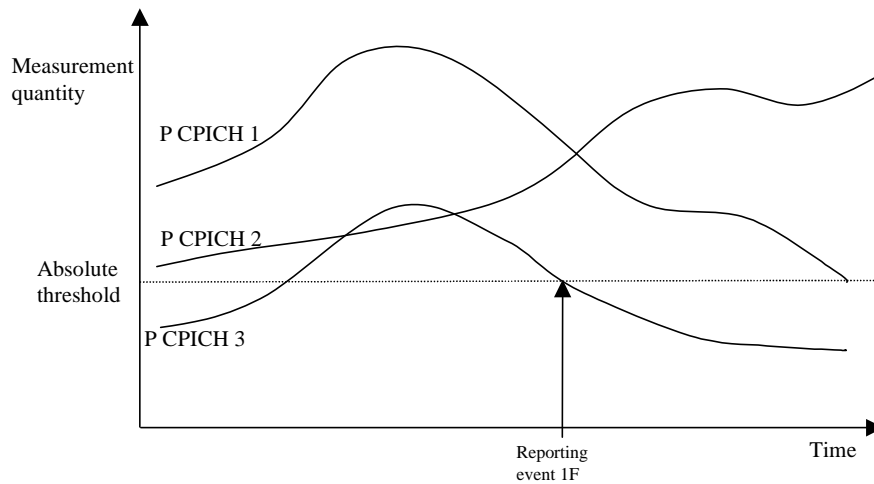

Figure 14.1.2.6-1 [Informative]: Event-triggered report when a Primary CPICH becomes worse than an absolute threshold

In this figure, the parameters hysteresis and time to trigger, as well as the cell individual offsets for all cells are equal to 0.

14.1.2.7 Reporting event 1J: A non-active E-DCH but active DCH primary CPICH becomes better than an active E-DCH primary CPICH

When an intra-frequency measurement configuring event 1j is set up, the UE shall:

- 1> create a variable TRIGGERED_1J_EVENT related to that measurement, which shall initially be empty;
- 1> delete this variable when the measurement is released.

When event 1J is configured in the UE, the UE shall:

- 1> if "Measurement quantity" is "pathloss" and Equation 1 below is fulfilled for one or more primary CPICHs, or if "Measurement quantity" is "CPICH Ec/N0" or "CPICH RSCP", and Equation 2 below is fulfilled for one or more primary CPICHs, for each of these primary CPICHs:
 - 2> if all required reporting quantities are available for that cell; and
 - 2> if the equations have been fulfilled for a time period indicated by "Time to trigger", and if the primary CPICH that is better is not included in the E-DCH active set but included in DCH active set and the other primary CPICH is any of the primary CPICHs included in the E-DCH active set, and if that first primary CPICH is not included in the "cells triggered" in the variable TRIGGERED_1J_EVENT:
 - 3> include that primary CPICH in the "cells recently triggered" in the variable TRIGGERED_1J_EVENT.
- 1> if the value of "Replacement activation threshold" for this event is less than or equal to the current number of cells in the E-DCH active set or equal to 0 and if any primary CPICHs are stored in the "cells recently triggered" in the variable TRIGGERED_1J_EVENT:
 - 2> if "Reporting interval" for this event is not equal to 0:
 - 3> if the IE "Periodical reporting running" in the variable TRIGGERED_1J_EVENT is set to FALSE:
 - 4> start a timer for with the value of "Reporting interval" for this event and set the IE "Periodical reporting running" in the variable TRIGGERED_1J_EVENT to TRUE.
 - 3> set "sent reports" for that primary CPICH in the variable TRIGGERED_1J_EVENT to 1.
 - 2> send a measurement report with IEs set as below:
 - 3> set in "intra-frequency measurement event results": "Intrafrequency event identity" to "1J"; and

- 3> include in "cell measurement event results" all entries of the "cells recently triggered" in the variable TRIGGERED_1J_EVENT not in the E-DCH active set but included in DCH active set as well as the "primary CPICH info" of all the primary CPICHs in the E-DCH active set for which the measured value is worse (i.e. greater for pathloss and less for the other measurement quantities) than the one of the entry in "cell recently triggered" that has the best measured value taking into account their cell individual offset. The "primary CPICH info" for those cells shall be ordered according to their measured value taking into account their cell individual offset, beginning with the best cell to the worst one;
- 3> set the IE "measured results" and the IE "additional measured results" according to subclause 8.4.2, not taking into account the cell individual offset for each cell.
- 2> move all entries from "cells recently triggered" to "cells triggered" in the variable TRIGGERED_1J_EVENT.
- 1> if the timer for the periodical reporting has expired:
 - 2> if any primary CPICH is included in the "cells triggered" in the variable TRIGGERED_1J_EVENT, and not included in the current E-DCH active set but included in DCH active set:
 - 3> if "Reporting interval" for this event is not equal to 0, and if "Amount of reporting" is greater than "sent reports" stored for that primary CPICH, in "cells triggered" in the variable TRIGGERED_1J_EVENT:
 - 4> increment the stored counter "sent reports" for all CPICH in "cell triggered" in variable TRIGGERED_1J_EVENT;
 - 4> start a timer with the value of "Reporting interval" for this event;
 - 4> send a measurement report with IEs set as below:
 - 5> set in "intra-frequency measurement event results": "Intrafrequency event identity" to "1J"; and
 - 5> include in "cell measurement event results" all entries of the variable TRIGGERED_1J_EVENT with value of IE "sent report" equal to or smaller than value of "Amount of reporting" and that are not part of the E-DCH active set but included in DCH active set as well as the "primary CPICH info" of all the primary CPICHs in the E-DCH active set for which the measured value is worse (i.e. greater for pathloss and less for the other measurement quantities) than the one of the entry in "cell triggered" that has the best measured value, ordering the "primary CPICH info" according to their measured value beginning with the best cell to the worst one, taking into account the cell individual offset for each cell;
 - 5> set the IE "measured results" and the IE "additional measured results" according to subclause 8.4.2, not taking into account the cell individual offset for each cell.
 - 4> if "sent reports" in variable TRIGGERED_1J_EVENT is equal to "Amount of reporting" for all entries:
 - 5> set the IE "Periodical Reporting running" in the variable TRIGGERED_1J_EVENT to FALSE and disable the timer for the periodical reporting.
 - 1> if "Measurement quantity" is "pathloss" and Equation 3 below is fulfilled for a primary CPICH, or if "Measurement quantity" is "CPICH Ec/N0" or "CPICH RSCP", and Equation 4 below is fulfilled for a primary CPICH or;
 - 1> if a primary CPICH is added to the E-DCH active set:
 - 2> if that primary CPICH is included in the "cells triggered" or "cells recently triggered" in the variable TRIGGERED_1J_EVENT:
 - 3> remove the entry of that primary CPICH from "cells triggered" or "cells recently triggered" in the variable TRIGGERED_1J_EVENT.
 - 3> if no entry in the variable TRIGGERED_1J_EVENT has a value of "sent reports" smaller than "Amount of reporting" or
 - 3> if there is no entry in the variable TRIGGERED_1J_EVENT:
 - 4> if the reporting interval timer is running:

5> stop the reporting interval timer;

5> set the IE "Periodical reporting running" in the variable TRIGGERED_1J_EVENT to FALSE.

Equation 1 (Triggering condition for pathloss)

$$10 \log M_{New} + CIO_{New} \leq 10 \log M_{inAS} + CIO_{inAS} - H_{1j} / 2$$

Equation 2 (Triggering condition for all the other measurement quantities)

$$10 \log M_{New} + CIO_{New} \geq 10 \log M_{inAS} + CIO_{inAS} + H_{1j} / 2$$

Equation 3 (Leaving triggering condition for pathloss)

$$10 \log M_{New} + CIO_{New} > 10 \log M_{inAS} + CIO_{inAS} + H_{1j} / 2$$

Equation 4 (Leaving triggering condition for all the other measurement quantities)

$$10 \log M_{New} + CIO_{New} < 10 \log M_{inAS} + CIO_{inAS} - H_{1j} / 2$$

The variables in the formula are defined as follows:

M_{New} is the measurement result of the cell not included in the E-DCH active set but included in DCH active set.

CIO_{New} is the individual cell offset for the cell not included in the E-DCH active set but included in DCH active set becoming better than the cell in the E-DCH active set if an individual cell offset is stored for that cell. Otherwise it is equal to 0.

For pathloss:

M_{inAS} is the measurement result of the cell in the E-DCH active set with the highest measurement result.

For other measurement quantities:

M_{inAS} is the measurement result of the cell in the E-DCH active set with the lowest measurement result.

CIO_{inAS} is the individual cell offset for the cell in the E-DCH active set that is becoming worse than the new cell.

H_{1j} is the hysteresis parameter for the event 1J.

If the measurement results are pathloss or CPICH-Ec/No then M_{New} and M_{inAS} are expressed as ratios.

If the measurement result is CPICH-RSCP then M_{New} and M_{inAS} are expressed in mW.

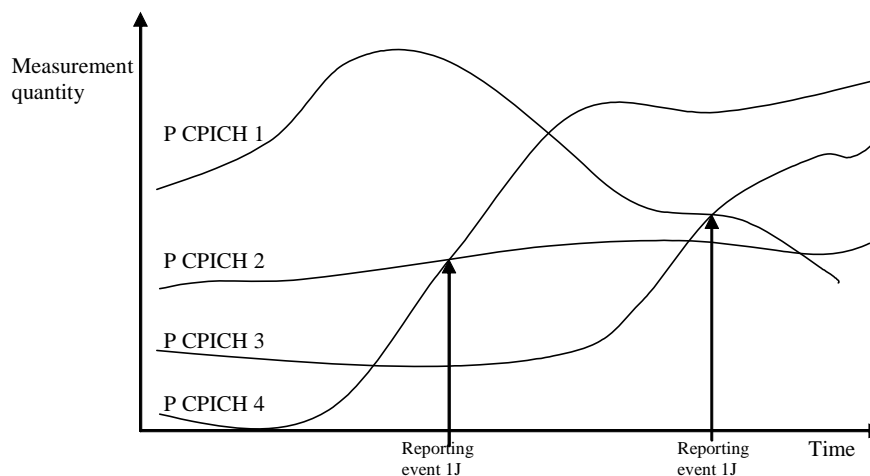

Figure 14.1.2.7-1 [Informative]: A primary CPICH that is not included in the E-DCH active set but included in DCH active set becomes better than a primary CPICH that is in the E-DCH active set

In this figure, the parameters hysteresis and time to trigger, as well as the cell individual offsets for all cells are equal to 0 and replacement activation threshold is equal to 0 or 1 or 2. In this example the cells belonging to primary CPICH 1 and 2 are in the E-DCH active set, but the cells transmitting primary CPICH 3 and CPICH 4 are not (yet) in the E-DCH active set but included in DCH active set.

The first measurement report is sent when primary CPICH 4 becomes better than primary CPICH 2. The "cell measurement event result" of the measurement report contains the information of primary CPICH 4 and CPICH 2.

Assuming that the E-DCH active set has been updated after the first measurement report (E-DCH active set is now primary CPICH 1 and primary CPICH 4), the second report is sent when primary CPICH 3 becomes better than primary CPICH 1. The "cell measurement event result" of the second measurement report contains the information of primary CPICH 3 and primary CPICH 1.

14.1.3 Intra-frequency reporting events for TDD

14.1.3.1 Reporting event 1G: Change of best cell (TDD)

When an intra-frequency measurement configuring event 1g is set up, the UE shall

- 1> create a variable TRIGGERED_1G_EVENT related to that measurement, which shall initially be empty.
- 1> store the P-CCPCH of the serving cell in the variable TRIGGERED_1G_EVENT as the best cell .
- 1> delete this variable when the measurement is released.

When event 1G is configured in the UE, the UE shall:

- 1> if the equation 1 is fulfilled for one or more P-CCPCHs during the time "Time to trigger"
 - 2> if those P-CCPCHs are not included in the "primary CCPCH info" in the variable TRIGGERED_1G_EVENT:
 - 3> include those P-CCPCHs in "cells triggered" in the variable TRIGGERED_1G_EVENT;
 - 2> update the prebest cell to the best P-CCPCH and for each cell in the variable TRIGGERED_1G_EVENT:
 - 3> if Equation 2 below is fulfilled for a primary CCPCH:
 - 4> remove the entry of that primary CCPCH from "cells triggered" in the variable TRIGGERED_1G_EVENT;
 - 2> send a measurement report with IEs set as below:
 - 3> set in "intra-frequency measurement event results": "Intrafrequency event identity" to "1g";
 - 3> set the first entry in "cell measurement event results" to the "Cell parameters ID" of the P-CCPCH which was stored in the variable TRIGGERED_1G_EVENT;
 - 3> include all entries in "cells triggered" in variable TRIGGERED_1G_EVENT in "cell measurement event results" in the measurement report in descending order according to:

$$10 \cdot \text{Log}M + O$$

where M is the P-CCPCH RSCP and O the individual offset of a cell;

- 3> set the IE "measured results" and the IE "additional measured results" according to subclause 8.4.2, not taking into account the cell individual offset for each cell.
- 1> if Equation 2 below is fulfilled for a primary CCPCH:
 - 2> if a primary CCPCH is included in the "cells triggered" in the variable TRIGGERED_1G_EVENT:
 - 3> remove the entry of that primary CCPCH from "cells triggered" in the variable TRIGGERED_1G_EVENT;

The UE shall use the equations below for evaluation of reporting event 1g:

Equation 1

$$10 \cdot \text{Log}M_i + O_i - H_{1g} > 10 \cdot \text{Log}M_{\text{previous_best}} + O_{\text{previous_best}}$$

The variables in the formula are defined as follows:

$M_{\text{previous_best}}$ is the current P-CCPCH RSCP of the previous best cell expressed in mW

$O_{\text{previous_best}}$ is the cell individual offset of the previous best cell

M_i is the current P-CCPCH RSCP of the currently evaluated cell i expressed in mW

O_i is the cell individual offset of the currently evaluated cell i

H_{1g} is the hysteresis parameter for the event 1g.

Equation 2

$$10 \cdot \text{Log}M_i + O_i + H_{1g} < 10 \cdot \text{Log}M_{\text{previous_best}} + O_{\text{previous_best}}$$

The variables in the formula are defined as follows:

$M_{\text{previous_best}}$ is the current P-CCPCH RSCP of the previous best cell expressed in mW

$O_{\text{previous_best}}$ is the cell individual offset of the previous best cell

M_i is the current P-CCPCH RSCP of the currently evaluated cell i expressed in mW

O_i is the cell individual offset of the currently evaluated cell i

H_{1g} is the hysteresis parameter for the event 1g.

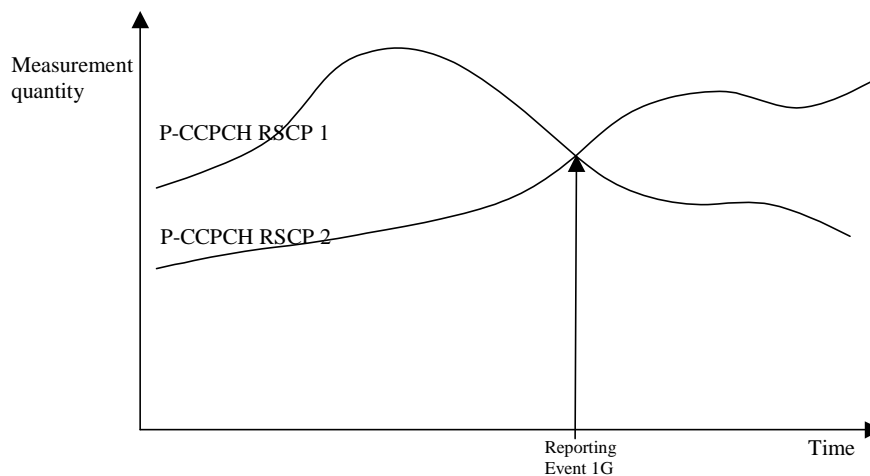

Figure 14.1.3.1-1: A P-CCPCH RSCP becomes better than the previous best P-CCPCH RSCP

14.1.3.2 Reporting event 1H: Timeslot ISCP below a certain threshold (TDD)

When an intra-frequency measurement configuring event 1h is set up, the UE shall:

- 1> create a variable TRIGGERED_1H_EVENT related to that measurement, which shall initially be empty;
- 1> delete this variable when the measurement is released.

When event 1h is configured in the UE, the UE shall:

- 1> if equation 1 is fulfilled for a time period indicated by "Time to trigger" and if that P-CCPCH is not included in the IE "cells triggered" in the variable TRIGGERED_1H_EVENT:

- 2> include that P-CCPCH in the IE "cells triggered" in the variable TRIGGERED_1H_EVENT;
- 2> send a measurement report with the IEs set as below:
 - 3> set in "intra-frequency measurement event results": "Intrafrequency event identity" to "1h" and in "cell measurement event results" the "Cell parameters ID" of the P-CCPCH that triggered the report;
 - 3> include in "Cell measured results" the "Timeslot ISCP" of those cells that are included in the variable TRIGGERED_1H_EVENT and "additional measured results" according to subclause 8.4.2, not taking into account the cell individual offset for each cell.
- 1> if Equation 2 below is fulfilled for a primary CCPCH:
 - 2> if a primary CCPCH is included in the "cells triggered" in the variable TRIGGERED_1H_EVENT:
 - 3> remove the entry of that primary CCPCH from "cells triggered" in the variable TRIGGERED_1H_EVENT.

The UE shall use the equations below for evaluation of reporting event 1h:

Equation 1

$$10 \cdot \text{Log} M_i + H_{1h} + O_i < T_{1h},$$

Equation 2

$$10 \cdot \text{Log} M_i - H_{1h} + O_i > T_{1h},$$

The variables in the formula are defined as follows:

M_i is the Timeslot ISCP of the currently evaluated cell i expressed in mW

O_i is the cell individual offset of the currently evaluated cell i

T_{1h} is the Threshold for event 1h

H_{1h} is the hysteresis parameter for the event 1h.

Before any evaluation is done, the Timeslot ISCP expressed in mW is filtered according to subclause 8.6.7.2.

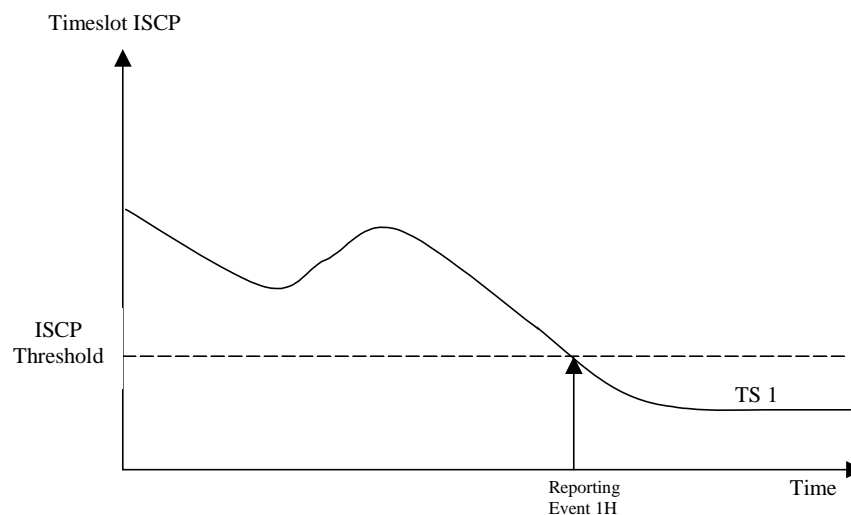

Figure 14.1.3.2-1: An ISCP value of a timeslot drops below an absolute threshold

14.1.3.3 Reporting event 1i: Timeslot ISCP above a certain threshold (TDD)

When an intra-frequency measurement configuring event 1i is set up, the UE shall:

- 1> create a variable TRIGGERED_1I_EVENT related to that measurement, which shall initially be empty;
- 1> delete this variable when the measurement is released.

When event 1i is configured in the UE, the UE shall:

- 1> if equation 1 is fulfilled for a time period indicated by "Time to trigger" and if that P-CCPCH is not included in the IE "cells triggered" in the variable TRIGGERED_1I_EVENT:
 - 2> include that P-CCPCH in the IE "cells triggered" in the variable TRIGGERED_1I_EVENT;
 - 2> send a measurement report with the IEs set as below:
 - 3> set in "intra-frequency measurement event results": "Intrafrequency event identity" to "1i" and in "cell measurement event results" to the "Cell parameters ID" of the P-CCPCH that triggered the report;
 - 3> include in "measured results" the "Timeslot ISCP" of those cells that are included in the variable TRIGGERED_1I_EVENT and "additional measured results" according to 8.4.2, not taking into account the cell individual offset for each cell.
- 1> if Equation 2 below is fulfilled for a primary CCPCH:
 - 2> if a primary CCPCH is included in the "cells triggered" in the variable TRIGGERED_1I_EVENT:
 - 3> remove the entry of that primary CCPCH from "cells triggered" in the variable TRIGGERED_1I_EVENT.

The UE shall use the equation below for evaluation of reporting event 1i:

Equation 1

$$10 \cdot \text{Log}M_i - H_{1i} + O_i > T_{1i},$$

Equation 2

$$10 \cdot \text{Log}M_i - H_{1i} + O_i < T_{1i},$$

The variables in the formula are defined as follows:

M_i is the Timeslot ISCP of the currently evaluated cell i expressed in mW

O_i is the cell individual offset of the currently evaluated cell i

T_{1i} is the Threshold for event 1i

H_{1i} is the hysteresis parameter for the event 1i.

Before any evaluation is done, the Timeslot ISCP expressed in mW is filtered according to subclause 8.6.7.2.

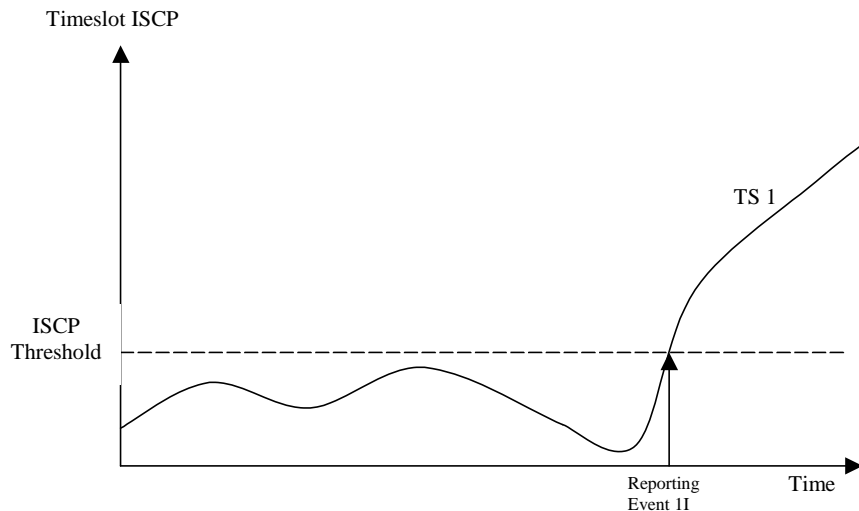

Figure 14.1.3.3-1: An ISCP value of a timeslot exceeds a certain threshold

14.1.4 Event-triggered periodic intra-frequency measurement reports (informative)

14.1.4.1 Cell addition failure (FDD only)

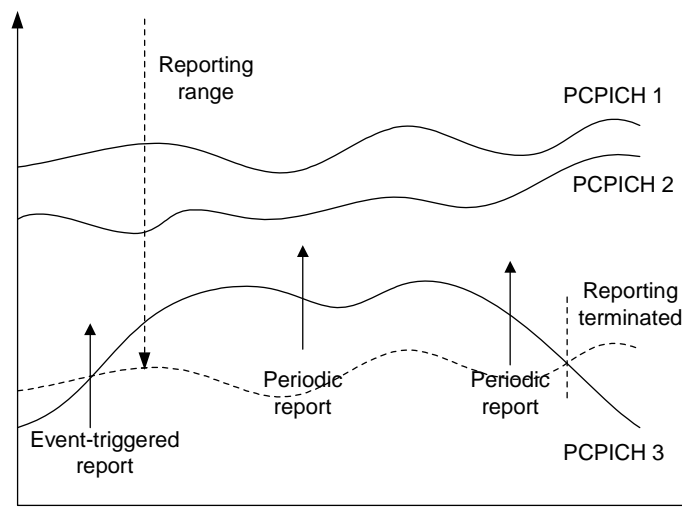

Figure 14.1.4.1-1: Periodic reporting triggered by event 1A

When a cell enters the reporting range and triggers event 1A, the UE shall transmit a MEASUREMENT REPORT to the UTRAN and typically this may result in an update of the active set. However, in some situations the UTRAN may be unable to add a strong cell to corresponding the active set typically due to capacity shortage for example.

The UE shall continue reporting after the initial report by reverting to periodical measurement reporting if the reported cell is not added to the corresponding active set. This is illustrated in Figure 14.1.4.1-1. During periodic reporting the UE shall transmit MEASUREMENT REPORT messages to the UTRAN at predefined intervals. The reports shall include reporting information of the cells in the current active set and of the monitored cell(s) in the reporting range.

Event-triggered periodic measurement reporting shall be terminated if:

- 1> there are no longer any monitored cell(s) within the reporting range; or
- 1> the UTRAN has added cells to the corresponding active set so that it includes the maximum number of cells (defined by the **reporting deactivation threshold** parameter), which are allowed for event 1A to be triggered; or

1> the UE has sent the maximum number of MEASUREMENT REPORT messages (defined by the **amount of reporting** parameter).

The reporting period is assigned by the UTRAN (with the **Reporting interval** parameter). If the reporting interval is set to zero event-triggered periodic measurement reporting shall not be applied.

14.1.4.1a Cell removal failure (FDD only)

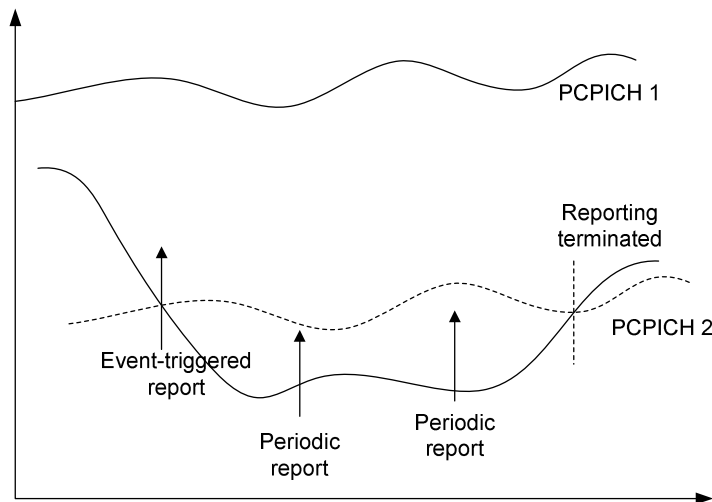

Figure 14.1.4.1a: Periodic reporting triggered by event 1B

When a cell enters the removal range and triggers event 1B, the UE shall transmit a MEASUREMENT REPORT to the UTRAN and typically this may result in the removal of the weakest active cell. If the UTRAN is unable to receive MEASUREMENT REPORT after the maximum retransmission, it is beneficial to receive continuous reports in this case as well.

The UE shall revert to periodical measurement reporting if the UTRAN does not update the corresponding active set after the transmission of the measurement report. This is illustrated in Figure 14.1.4.1a. During periodic reporting the UE shall transmit MEASUREMENT REPORT messages to the UTRAN at predefined intervals.

Event-triggered periodic measurement reporting shall be terminated if:

- 1> there are no longer any monitored cell(s) within the removal range; or
- 1> the UTRAN has removed cells from the corresponding active set so that there are no longer the minimum amount of active cells for event 1B to be triggered; or
- 1> the UE has sent the maximum number of MEASUREMENT REPORT messages (defined by the "amount of reporting" parameter).

The reporting period is assigned by the UTRAN (with the "Reporting interval" parameter). If the reporting interval is set to zero, event-triggered periodic measurement reporting shall not be applied.

14.1.4.2 Cell replacement failure (FDD only)

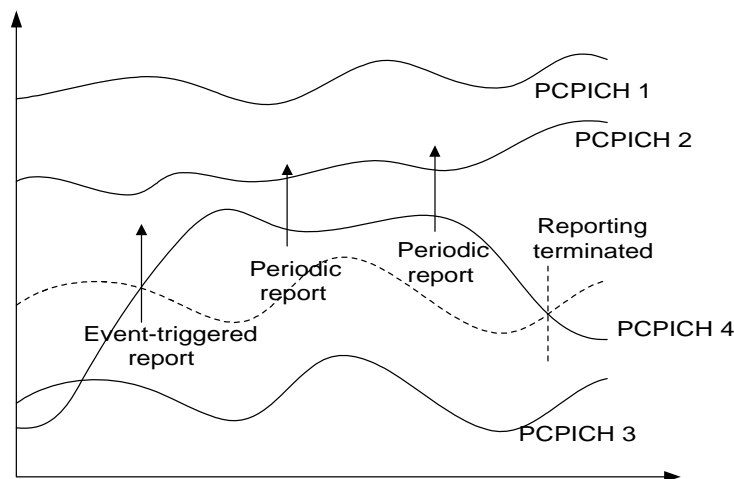

Figure 14.1.4.1-2: Periodic reporting triggered by event 1C

When a cell enters the replacement range and triggers event 1C, the UE shall transmit a MEASUREMENT REPORT to the UTRAN and typically this may result in the replacement of the weakest active cell. If the UTRAN is unable to replace the cell due to for example capacity shortage, it is beneficial to receive continuous reports in this case as well.

The UE shall revert to periodical measurement reporting if the UTRAN does not update the corresponding active set after the transmission of the measurement report. This is illustrated in Figure 14.1.4.1-2. During periodic reporting the UE shall transmit MEASUREMENT REPORT messages to the UTRAN at predefined intervals. The reports shall include reporting information of the cells in the current active set and of the monitored cell(s) in the replacement range.

Event-triggered periodic measurement reporting shall be terminated if:

- 1> there are no longer any monitored cell(s) within the replacement range; or
- 1> the UTRAN has removed cells from the corresponding active set so that there are no longer the minimum amount of active cells for event 1C to be triggered (as defined by the **replacement activation threshold** parameter); or
- 1> the UE has sent the maximum number of MEASUREMENT REPORT messages (defined by the **amount of reporting** parameter).

The reporting period is assigned by the UTRAN (with the **Reporting interval** parameter). If the reporting interval is set to zero, event-triggered periodic measurement reporting shall not be applied.

14.1.5 Mechanisms available for modifying intra-frequency measurement reporting behaviour (informative)

14.1.5.1 Hysteresis

To limit the amount of event-triggered reports, a hysteresis parameter may be connected with each reporting event given above. The value of the hysteresis is given to the UE in the Reporting criteria field of the Measurement Control message.

In the example in Figure 14.1.5.1-1, the hysteresis ensures that the event 1D (FDD) or IG(TDD) (primary CPICH(FDD)/CCPCH(TDD) 2 becomes the best cell) is not reported until the difference is equal to the hysteresis value. The fact that primary CPICH(FDD)/CCPCH(TDD) 1 becomes best afterwards is not reported at all in the example since the primary CPICH(FDD)/CCPCH(TDD) 1 does not become sufficiently better than the primary CPICH(FDD)/CCPCH(TDD) 2.

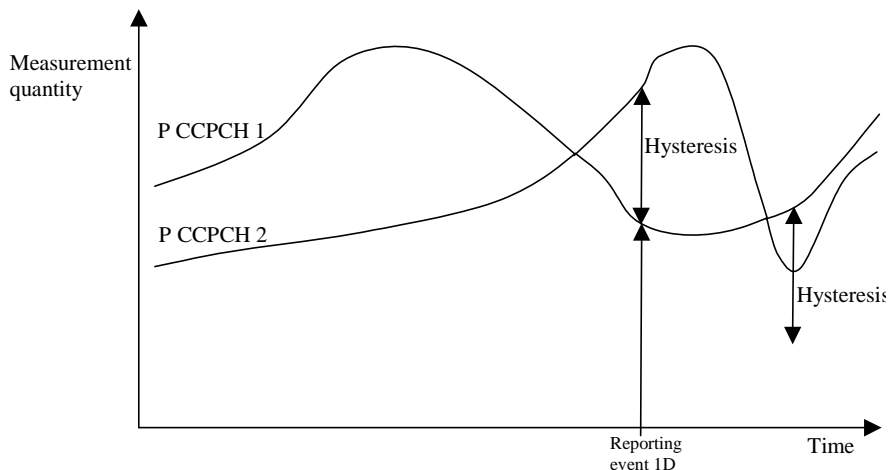

Figure 14.1.5.1-1: Hysteresis limits the amount of measurement reports

14.1.5.2 Time-to-trigger

To limit the measurement signalling load, a time-to-trigger parameter could be connected with each reporting event given above. The value of the time-to-trigger is given to the UE in the Reporting criteria field of the Measurement Control message.

The effect of the time-to-trigger is that the report is triggered only after the conditions for the event have existed for the specified time-to-trigger. In the following FDD example in Figure 14.1.5.2-1, the use of time-to-trigger means that the event (primary CPICH 3 enters the reporting range) is not reported until is has been within the range for the time given by the time-to-trigger parameter.

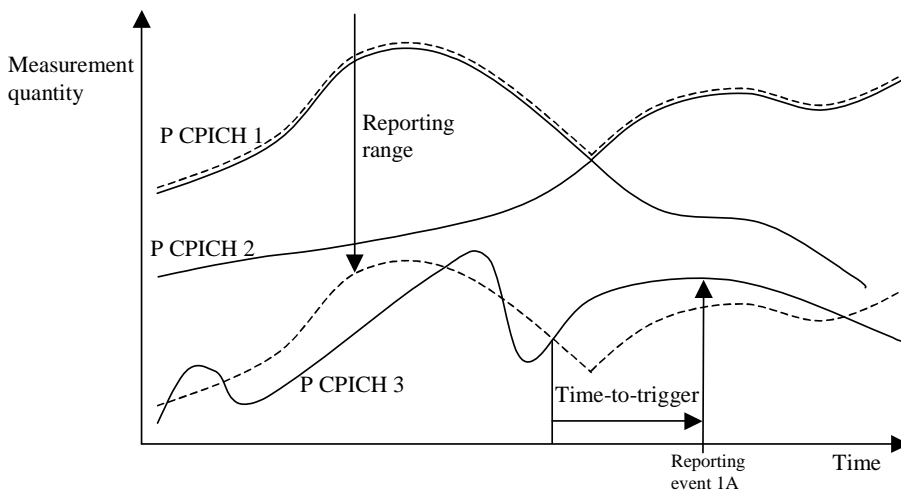

Figure 14.1.5.2-1: Time-to-trigger limits the amount of measurement reports

In the following TDD example in Figure 14.1.5.2-2, the use of time-to-trigger means that the event (Timeslot ISCP upon certain threshold) is not reported until it has been upon the threshold for the time given by the time-to trigger parameter.

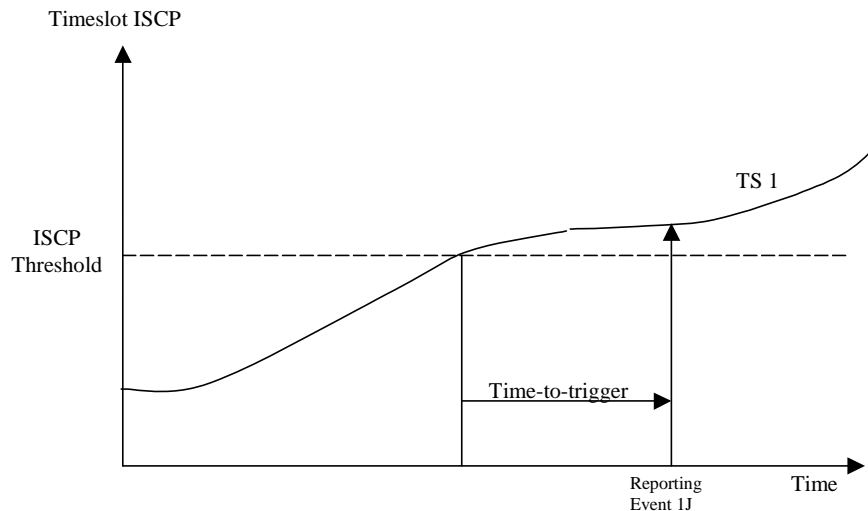

Figure 14.1.5.2-2: Time-to-trigger limits the amount of measurement reports

NOTE: The time-to-trigger could be combined with hysteresis, i.e. a hysteresis value is added to the measurement quantity before evaluating if the time-to-trigger timer should be started.

14.1.5.3 Cell individual offsets

For each cell that is monitored, an offset can be assigned with inband signalling. The offset can be either positive or negative. The offset is added to the measurement quantity before the UE evaluates if an event has occurred. The UE receives the cell individual offsets for each primary CPICH(FDD)/CCPCH(TDD) in the IE "Cell individual offset" included in the IE "Cell info" associated with each measurement object and with each measurement object on secondary UL frequency included in the MEASUREMENT CONTROL message.

For the FDD example, in Figure 14.1.5.3-1, since an offset is added to primary CPICH 3, it is the dotted curve that is used to evaluate if an event occurs. Hence, this means that measurement reports from UE to UTRAN are triggered when primary CPICH plus the corresponding offset, i.e. the dotted curve, leaves and enters the reporting range and when it gets better than primary CPICH 1 (if these events have been ordered by UTRAN). This offset mechanism provides the network with an efficient tool to change the reporting of an individual primary CPICH.

By applying a positive offset, as in Figure 14.1.5.3-1, the UE will send measurement reports as if the primary CPICH is offset x dB better than what it really is. This could be useful if the operator knows that a specific cell is interesting to monitor more carefully, even though it is not so good for the moment. In the example in Figure 14.1.5.3-1, the operator might know by experience that in this area primary CPICH 3 can become good very quickly (e.g. due to street corners) and therefore that it is worth reporting more intensively. Depending on the implemented handover evaluation algorithm, this may result in the cell with primary CPICH 3 being included in the active set earlier than would have been the case without the positive offset.

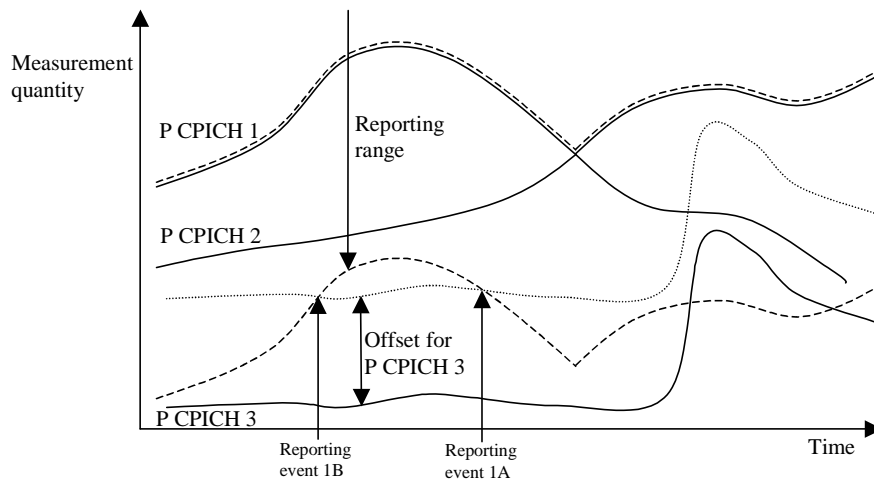

Figure 14.1.5.3-1: A positive offset is applied to primary CPICH 3 before event evaluation in the UE

For the TDD example, in Figure 14.1.5.3-2, an offset is added to primary CCPCH2, it is the dotted curve that is used to evaluate if the primary CCPCH2 becomes better than primary CCPCH1 (ordered by the UTRAN).

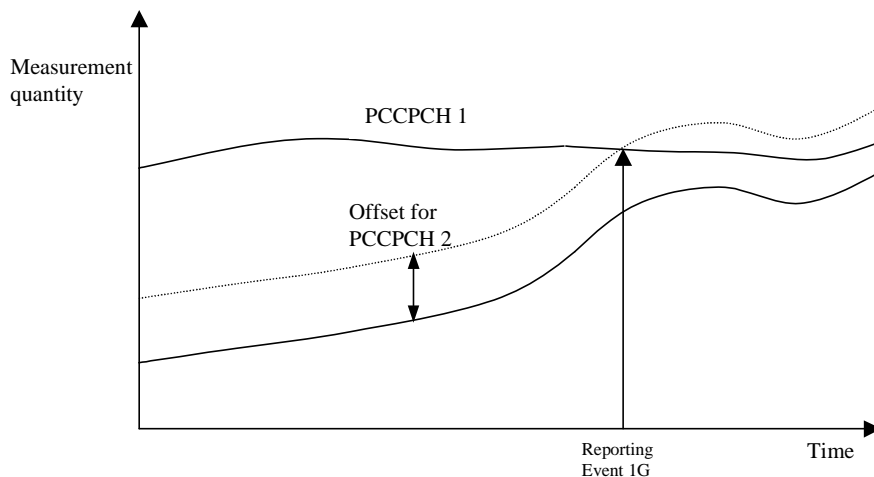

Figure 14.1.5.3-2: A positive offset is applied to primary CCPCH 2

Correspondingly, the operator can choose to apply a negative offset to a primary CCPCH. Then the reporting on that primary CCPCH is limited and the corresponding cell may be, at least temporarily excluded from the active set or as a target cell for handover.

It is important to note that the offset is added before triggering events, i.e. the offset is added by the UE before evaluating if a measurement report should be sent as opposed to offsets that are applied in the network and used for the actual handover evaluation. It should also be noted that the cell individual offset is not used in all measurement reporting events, and that it is not applied to all events in the same way.

14.1.5.4 Forbid a Primary CPICH to affect the reporting range (FDD only)

The reporting range affects the reporting events 1A and 1B presented above. The reporting range is defined as a function of all the Primary CPICHs in the active set (see 14.1.2.1 and 14.1.2.2). If the parameter W is set to 0, the reporting range is defined relative to the best Primary CPICH. However, there could be cases where it is good to forbid a specific Primary CPICH to affect the reporting range. For example in Figure 14.1.5.4-1 the network has requested the UE to not let Primary CPICH 3 affect the reporting range. This mechanism could be effective if the operator knows by experience that the quality of Primary CPICH 3 is very unstable in a specific area and therefore should not affect the reporting of the other Primary CPICHs.

The UE shall ignore that a Primary CPICH is forbidden to affect the reporting range if all of the following conditions are fulfilled:

- the Primary CPICH is included in active set; and
- all cells in active set are defined as Primary CPICHs forbidden to affect the reporting range.

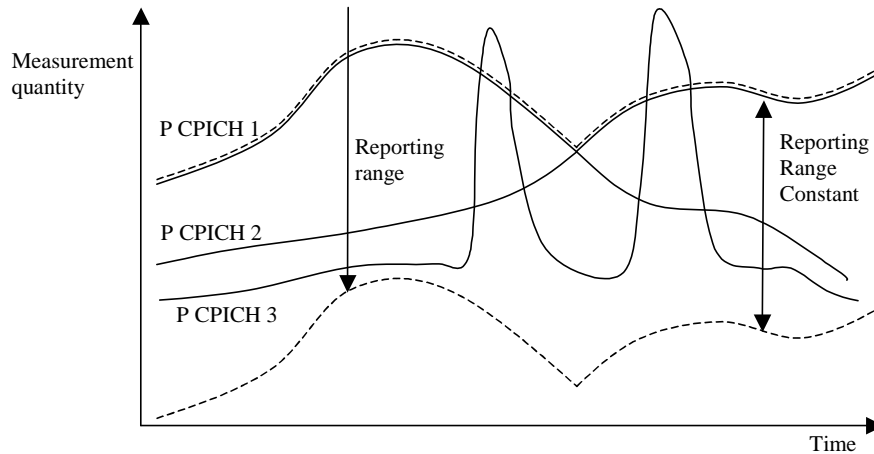

Figure 14.1.5.4-1: Primary CPICH 3 is forbidden to affect the reporting range

14.1.6 Report quantities in intra-frequency measurements

The quantities that the UE shall report to UTRAN when the event is triggered for an intra-frequency measurement are given by the IE "Intra-frequency reporting quantity" stored for this measurement and can be the following:

- 1 SFN-SFN observed time difference
- 2 Cell synchronisation information
- 3 Cell Identity
- 4 Downlink E_c/N_0 (FDD).
- 5 Downlink path loss.

For FDD:

$$\text{Pathloss in dB} = \text{Primary CPICH Tx power} - \text{CPICH RSCP.}$$

- For Primary CPICH Tx power the IE "Primary CPICH Tx power" shall be used. The unit is dBm.
- CPICH RSCP is the result of the CPICH RSCP measurement. The unit is dBm.

For TDD:

$$\text{Pathloss in dB} = \text{Primary CCPCH TX power} - \text{Primary CCPCH RSCP.}$$

- For Primary CCPCH TX power the IE "Primary CCPCH TX Power" shall be used. The unit is dBm.
- Primary CCPCH RSCP is the result of the Primary CCPCH RSCP measurement. The unit is dBm.

If necessary Pathloss shall be rounded up to the next higher integer.

Results higher than 158 shall be reported as 158.

Results lower than 46 shall be reported as 46.

- 6 Downlink received signal code power (RSCP) after despreading (of a primary CPICH for FDD, and of a primary CCPCH for TDD).
- 7 ISCP measured on Timeslot basis. (TDD)

8 Proposed TGSN (TDD)

A description of those values can be found in [7] and [8].

14.1.7 Intra-frequency Common E-RGCH RL Determination (FDD only)

For reception of E-RGCH from radio links other than the serving E-DCH radio link in CELL_FACH state, the UE shall:

- 1> if Equation 1 below is fulfilled for a primary CPICH of a cell to be evaluated for performing E-RGCH reception:
- 2> if the equation has been fulfilled for a time period indicated by "Time to trigger" equal to 0:
- 3> consider the radio link as a Common E-RGCH RL.

Equation 1:

$$10 \cdot \text{Log}M_{\text{New}} + \text{CIO}_{\text{New}} \geq 10 \cdot \text{Log}M_{\text{Best}} - R_{\text{Ia-E-RGCH}}$$

The variables in the formula are defined as follows:

M_{New} is the CPICH Ec/N0 measurement result for the cell under evaluation for E-RGCH reception.

CIO_{New} is the individual cell offset for the cell under evaluation for E-RGCH reception, if an individual cell offset is provided in the system information for that cell. Otherwise it is equal to 0.

M_{Best} is the CPICH Ec/N0 measurement result for the serving E-DCH cell, not taking into account any cell individual offset.

$R_{\text{Ia-E-RGCH}}$ is the reporting range constant.

M_{New} and M_{Best} are expressed as ratios.

14.2 Inter-frequency measurements

14.2.0a Inter-frequency measurement quantities

The two first measurement quantities listed below are used by the UE to evaluate whether an inter-frequency measurement event has occurred or not, through the computation of a frequency quality estimate. The quantity to use to compute the frequency quality estimate for an inter-frequency measurement is given in the "Inter-frequency measurement quantity" stored for that measurement.

- 1 Downlink Ec/No (FDD)
- 2 Downlink received signal code power (RSCP) after despreading.
- 3 Downlink path loss.

For FDD:

$$\text{Pathloss in dB} = \text{Primary CPICH Tx power} - \text{CPICH RSCP.}$$

- For Primary CPICH Tx power the IE "Primary CPICH Tx power" shall be used. The unit is dBm.
- CPICH RSCP is the result of the CPICH RSCP measurement. The unit is dBm.

For TDD:

$$\text{Pathloss in dB} = \text{Primary CCPCH TX power} - \text{Primary CCPCH RSCP.}$$

- For Primary CCPCH TX power the IE "Primary CCPCH TX Power" shall be used. The unit is dBm.
- Primary CCPCH RSCP is the result of the Primary CCPCH RSCP measurement. The unit is dBm.

A description of those values can be found in [7] and [8].

14.2.0b Frequency quality estimate

14.2.0b.1 FDD cells

The frequency quality estimate used in events 2a, 2b 2c, 2d, 2e and 2f is defined as:

$$Q_{frequency\ j} = 10 \cdot \text{Log}M_{frequency\ j} = W_j \cdot 10 \cdot \text{Log} \left(\sum_{i=1}^{N_{A\ j}} M_{i\ j} \right) + (1 - W_j) \cdot 10 \cdot \text{Log}M_{Best\ j},$$

The variables in the formula are defined as follows ("the virtual active set on frequency j" should be understood as the active set if frequency j is the used frequency or understood as the secondary E-DCH active set if frequency j is the downlink frequency associated with the secondary uplink frequency. If frequency j is a non-used frequency and is not the downlink frequency associated with the secondary uplink frequency, the way the virtual active set is initiated and updated is described in subclause 14.11):

$Q_{frequency\ j}$ is the estimated quality of the virtual active set on frequency j.

$M_{frequency\ j}$ is the estimated quality of the virtual active set on frequency j.

$M_{i\ j}$ is a measurement result of cell i in the virtual active set on frequency j.

$N_{A\ j}$ is the number of cells in the virtual active set on frequency j.

$M_{Best\ j}$ is the measurement result of the cell in the virtual active set on frequency j with the highest measurement result.

W_j is a parameter sent from UTRAN to UE and used for frequency j.

If the measurement result is CPICH-Ec/No then $M_{Frequency}$, $M_{i\ j}$ and M_{Best} are expressed as ratios.

If the measurement result is CPICH-RSCP or PCCPCH-RSCP then $M_{Frequency}$, $M_{i\ j}$ and M_{Best} are expressed in mW.

14.2.0b.2 TDD cells

$$Q_{i,\ frequency\ j} = 10 \cdot \text{Log}M_i + O_{i,\ j},$$

$Q_{i,\ frequency\ j}$ is the estimated quality of cell i on frequency j.

M_i is the measurement result for Primary CCPCH RSCP of cell i on the primary frequency expressed in mW.

$O_{i,\ j}$ is the cell individual offset of the currently evaluated cell i on frequency j. $O_{i,\ j}$ is set by IE "Cell individual offset"

14.2.0c Inter-frequency reporting quantities

The quantities that the UE shall report for each cell to UTRAN when the event is triggered for an inter-frequency measurement is given by the "Inter-frequency reporting quantity" IE stored for this measurement and can be the following, from 1 to 8. The quantity number 9 can be reported for each frequency that triggered the report.

- 1 Cell identity
- 2 SFN-SFN observed time difference
- 3 Cell synchronisation information
- 4 Downlink Ec/No (FDD)
- 5 Downlink path loss.

For FDD:

Pathloss in dB = Primary CPICH Tx power - CPICH RSCP.

- For Primary CPICH Tx power the IE "Primary CPICH Tx power" shall be used. The unit is dBm.
- CPICH RSCP is the result of the CPICH RSCP measurement. The unit is dBm.

For TDD:

Pathloss in dB = Primary CCPCH TX power - Primary CCPCH RSCP.

- For Primary CCPCH TX power the IE "Primary CCPCH TX Power" shall be used. The unit is dBm.
- Primary CCPCH RSCP is the result of the Primary CCPCH RSCP measurement. The unit is dBm.

If necessary Pathloss shall be rounded up to the next higher integer.

Results higher than 158 shall be reported as 158.

Results lower than 46 shall be reported as 46.

- 6 Downlink received signal code power (RSCP) after despreading (of a primary CPICH for FDD, and of a primary CCPCH for TDD).
- 7 ISCP measured on Timeslot basis. (TDD)
- 8 Proposed TGSN (TDD)
- 9 UTRA carrier RSSI

A description of those values can be found in [7] and [8].

14.2.1 Inter-frequency reporting events

Within the measurement reporting criteria field in the MEASUREMENT CONTROL message UTRAN notifies the UE which events should trigger the UE to send a MEASUREMENT REPORT message. The listed events are the toolbox from which the UTRAN can choose the reporting events that are needed for the implemented handover evaluation function, or other radio network functions.

All events are evaluated with respect to one of the measurement quantities given in subclause 14.2.0a. The measurement quantities are measured on the monitored primary common pilot channels (CPICH) in FDD mode and the monitored primary common control channels (PCCPCH) in TDD mode of the cell defined in the measurement object. A "non-used frequency" is a frequency that the UE has been ordered to measure upon but is not used for the connection. A "used frequency" is a frequency that the UE has been ordered to measure upon and is also currently used for the connection. An exception to the definition of used and non-used frequency is the frequency of the first secondary serving HS-DSCH cell which shall be treated as a non-used frequency for the purpose of inter-frequency measurement, and when more than one uplink frequency is configured, shall be treated as a used frequency for the purposes of intra-frequency measurement.

If the non-used frequency is the downlink frequency associated with the secondary uplink frequency and if intra-frequency measurement reporting on this frequency is configured, the "monitored set on non-used frequency" consists of cells in the IE "Intra-frequency cell info on secondary UL frequency" in the variable CELL_INFO_LIST that are not part of the secondary E-DCH active set; Otherwise, the "monitored set on non-used frequency" consists of cells in "cells for measurement" (or all cells in CELL_INFO_LIST if "cells for measurement" is not present) in the IE "Inter-frequency cell info" in the variable CELL_INFO_LIST that are not part of the virtual active set on that non-used frequency.

The "detected set on non-used frequency" consists of all cells that are not part of the virtual active set on that non-used frequency and are not in the CELL_INFO_LIST.

The IE "Cells to be excluded in non-used frequency detected cells" notifies the UE to exclude indicated cells from corresponding measurement report and UE shall exclude indicated cells from measurement report for inter-frequency detected set measurement.

If a measurement is configured with IE "Triggering Condition non-used frequency detected cells" the UE maintains 2 virtual active sets and 2 variables (1 variable for event 2g), in order to evaluate the event according to the rules below using one virtual active set and one variable for cells only in the CELL_INFO_LIST, and in parallel using another

virtual active set and another variable for all cells (including detected set cells not indicated in "Cells to be excluded in non-used frequency detected cells").

When one inter-frequency measurement identity corresponds to multiple inter-frequency events with identical event identities, the UE behaviour is not specified.

14.2.1.1 Event 2a: Change of best frequency.

When an inter-frequency measurement configuring event 2a is set up, the UE shall:

- 1> create a variable BEST_FREQUENCY_2A_EVENT per virtual active set related to that measurement, which shall initially contain the used frequency;
- 1> delete this variable when the measurement is released.

When event 2a is configured in the UE within a measurement, the UE shall:

- 1> when the measurement is initiated or resumed:
 - 2> store the used frequency in the variable BEST_FREQUENCY_2A_EVENT.
- 1> if equation 1 below has been fulfilled for a time period indicated by "Time to trigger" while not considering detected set cells for a frequency included for that event and which is not stored in the variable BEST_FREQUENCY_2A_EVENT used for evaluation without detected set cells; or
- 1> if equation 1 below has been fulfilled for a time period indicated by "Time to trigger" while considering detected set cells but not simultaneously fulfilled for that time while not considering detected set cells, for a frequency included for that event and which is not stored either in the variable BEST_FREQUENCY_2A_EVENT used for evaluation without detected set cells or in the variable BEST_FREQUENCY_2A_EVENT used for evaluation with detected set cells; or
- 1> if the CSG virtual active set has been updated, since the last measurement report for this event associated with CSG measurement, and equation 1 below has been fulfilled for a time period indicated by "Time to trigger", for a frequency included for that event and which is stored in the variable BEST_FREQUENCY_2A_EVENT:
 - 2> send a measurement report with IEs set as below:
 - 3> set in "inter-frequency measurement event results":
 - 4> "inter-frequency event identity" to "2a"; and
 - 4> "Frequency info" to the frequency that triggered the event; and
 - 4> "Non frequency related measurement event results" to the "Primary CPICH info" of the best primary CPICH for FDD cells in case of non-CSG measurements or "Primary CPICH info" of the cell present in CSG virtual active set in case of CSG measurements or "Primary CCPCH info" to the "Cells parameters ID" of the best primary CCPCH for TDD cells on that frequency, not taking into account the cell individual offset.
 - 4> if the frequency triggered the event due to considering detected set cells:
 - 5> set the IE "Detected Set Trigger".
 - 3> if a non-used frequency triggered the measurement report:
 - 4> include in IE "Inter-frequency measured results list" the measured results for the non-used frequency that triggered the event, not taking into account the cell individual offset.
 - 3> if the used frequency triggered the measurement report:
 - 4> do not include the IE "Inter-frequency measured results list" in the measurement report.
 - 3> set the IE "additional measured results" according to subclause 8.4.2, not taking into account the cell individual offset;

- 2> update the variable BEST_FREQUENCY_2A_EVENT corresponding to the virtual active set being evaluated with that frequency.
- 1> if equation 1 below has been fulfilled but the CSG virtual active set is updated for a frequency included for that event:
 - 2> restart evaluation of this event for this frequency.

Equation 1:

$$Q_{NotBest} \geq Q_{Best} + H_{2a} / 2$$

The variables in the formula are defined as follows:

$Q_{NotBest}$ is the quality estimate of a frequency not stored the "best frequency" in the variable BEST_FREQUENCY_2A_EVENT.

Q_{Best} is the quality estimate of the frequency stored in "best frequency" in the variable BEST_FREQUENCY_2A_EVENT.

H_{2a} is the hysteresis parameter for the event 2a in that measurement.

14.2.1.2 Event 2b: The estimated quality of the currently used frequency is below a certain threshold **and** the estimated quality of a non-used frequency is above a certain threshold.

When an inter-frequency measurement configuring event 2b is set up, the UE shall:

- 1> create a variable TRIGGERED_2B_EVENT per virtual active set related to that measurement, which shall initially be empty;
- 1> delete this variable when the measurement is released.

When event 2b is configured in the UE within a measurement, the UE shall:

- 1> if equations 1 and 2 below have been fulfilled for a time period indicated by "Time to Trigger" from the same instant, respectively for one or several non-used frequencies included for that event and for the used frequency:
 - 2> if any of those non-used frequency triggered while not considering detected set cells and is not stored in the variable TRIGGERED_2B_EVENT used for evaluation without detected set cells; or
 - 2> if any of those non-used frequency triggered while considering detected set cells but did not simultaneously trigger while not considering detected set cells and is not stored either in the variable TRIGGERED_2B_EVENT used for evaluation without detected set cells or the variable TRIGGERED_2B_EVENT used for evaluation with detected set cells; or
 - 2> if the CSG virtual active set has been updated, since the last measurement report for this event associated with CSG measurement, for any of those non-used frequency which are stored in the variable TRIGGERED_2B_EVENT:
 - 3> store the non-used frequencies that triggered the event and that were not previously stored in the variable TRIGGERED_2B_EVENT corresponding to the virtual active set being evaluated into that variable;
 - 3> send a measurement report with IEs set as below:
 - 4> set in "inter-frequency measurement event results":
 - 5> "inter-frequency event identity" to "2b"; and
 - 5> for each non-used frequency that triggered the event, beginning with the best frequency:
 - 6> "Frequency info" to that non-used frequency; and
 - 6> "Non frequency related measurement event results" to the "Primary CPICH info" of the best primary CPICH for FDD cells in case of non-CSG measurements or "Primary CPICH info" of

the cell present in CSG virtual active set in case of CSG measurements or "Primary CCPCH info" to the "Cell parameters ID" of the best primary CCPCH for TDD cells on that non-used frequency, not taking into account the cell individual offset.

6> if the frequency triggered the event due to considering detected set cells:

7> set the IE "Detected Set Trigger".

4> include in IE "Inter-frequency measured results list" the measured results for each non-used frequency that triggered the event, not taking into account the cell individual offset;

4> set the IE "additional measured results" according to subclause 8.4.2, not taking into account the cell individual offset.

1> if this equations 1 and 2 below have been fulfilled but the CSG virtual active set is updated for a frequency included for that event:

2> restart evaluation of this event for this frequency.

1> if equation 3 below is fulfilled for a non-used frequency stored in the variable TRIGGERED_2B_EVENT:

2> remove that non-used frequency from the variable TRIGGERED_2B_EVENT corresponding to the virtual active set being evaluated.

1> if equation 4 below is fulfilled for the used frequency:

2> clear the variable TRIGGERED_2B_EVENT.

Triggering conditions:

Equation 1:

$$Q_{Nonused} \geq T_{Nonused2b} + H_{2b}/2$$

The variables in the formula are defined as follows:

$Q_{Non used}$ is the quality estimate of a non-used frequency that becomes better than an absolute threshold.

$T_{Non used 2b}$ is the absolute threshold that applies for this non-used frequency in that measurement.

H_{2b} is the hysteresis parameter for the event 2b.

Equation 2:

$$Q_{Used} \leq T_{Used2b} - H_{2b}/2$$

The variables in the formula are defined as follows:

Q_{Used} is the quality estimate of the used frequency.

$T_{Used 2b}$ is the absolute threshold that applies for the used frequency in that measurement.

H_{2b} is the hysteresis parameter for the event 2b.

Leaving triggered state condition:

Equation 3:

$$Q_{Nonused} < T_{Nonused2b} - H_{2b}/2$$

The variables in the formula are defined as follows:

$Q_{Non used}$ is the quality estimate of a non-used frequency that is stored in the variable TRIGGERED_2B_EVENT.

$T_{Non used 2b}$ is the absolute threshold that applies for this non-used frequency in that measurement.

H_{2b} is the hysteresis parameter for the event 2b.

Equation 4:

$$Q_{Used} > T_{Used_{2b}} + H_{2b} / 2$$

The variables in the formula are defined as follows:

Q_{Used} is the quality estimate of the used frequency.

$T_{Used_{2b}}$ is the absolute threshold that applies for the used frequency in that measurement.

H_{2b} is the hysteresis parameter for the event 2b.

14.2.1.3 Event 2c: The estimated quality of a non-used frequency is above a certain threshold

When an inter-frequency measurement configuring event 2c is set up, the UE shall:

- 1> create a variable TRIGGERED_2C_EVENT per virtual active set related to that measurement, which shall initially be empty;
- 1> delete this variable when the measurement is released.

When event 2c is configured in the UE within a measurement, the UE shall:

- 1> if equation 1 below has been fulfilled for one or several non-used frequencies included for that event during the time "Time to trigger":
 - 2> if any of those non-used frequencies triggered while not considering detected set cells and is not stored in the variable TRIGGERED_2C_EVENT used for evaluation without detected set cells; or
 - 2> if any of those non-used frequency triggered while considering detected set cells but did not simultaneously trigger while not considering detected set cells and is not stored either in the variable TRIGGERED_2C_EVENT used for evaluation without detected set cells or in the variable TRIGGERED_2C_EVENT used for evaluation with detected set cells; or
 - 2> if the CSG virtual active set has been updated, since the last measurement report for this event associated with CSG measurement, for any of those non-used frequency which are stored in the variable TRIGGERED_2C_EVENT:
 - 3> store the non-used frequencies that triggered the event and that were not previously stored in the variable TRIGGERED_2C_EVENT corresponding to the virtual active set being evaluated into that variable;
 - 3> send a measurement report with IEs set as below:
 - 4> set in "inter-frequency measurement event results":
 - 5> "inter-frequency event identity" to "2c"; and
 - 5> for each non-used frequency that triggered the event, beginning with the best frequency:
 - 6> "Frequency info" to that non-used frequency; and
 - 6> "Non frequency related measurement event results" to the "Primary CPICH info" of the best primary CPICH for FDD cells in case of non-CSG measurements or "Primary CPICH info" of the cell present in CSG virtual active set in case of CSG measurements or "Primary CCPCH info" to the "Cell parameters ID" of the best primary CCPCH for TDD cells on that non-used frequency, not taking into account the cell individual offset.
 - 6> if the frequency triggered the event due to considering detected set cells:
 - 7> set the IE "Detected Set Trigger".
 - 4> include in IE "Inter-frequency measured results list" the measured results for each non-used frequency that triggered the event, not taking into account the cell individual offset;

4> set the IE "additional measured results" according to subclause 8.4.2 not taking into account the cell individual offset.

1> if equation 1 below has been fulfilled but the CSG virtual active set is updated for a non-used frequency included for that event:

2> restart evaluation of this event for this frequency.

1> if equation 2 below is fulfilled for a non-used frequency stored in the variable TRIGGERED_2C_EVENT:

2> remove that non-used frequency from the variable TRIGGERED_2C_EVENT corresponding to the virtual active set being evaluated.

Triggering condition:

Equation 1:

$$Q_{Nonused} \geq T_{Nonusedc} + H_{2c} / 2$$

The variables in the formula are defined as follows:

$Q_{Nonused}$ is the quality estimate of a non-used frequency that becomes better than an absolute threshold.

$T_{Nonused 2c}$ is the absolute threshold that applies for this non-used frequency in that measurement.

H_{2c} is the hysteresis parameter for the event 2c.

Leaving triggered state condition:

Equation 2:

$$Q_{Nonused} < T_{Nonusedc} - H_{2c} / 2$$

The variables in the formula are defined as follows:

$Q_{Nonused}$ is the quality estimate of a non-used frequency stored in the variable TRIGGERED_2C_EVENT.

$T_{Nonused 2c}$ is the absolute threshold that applies for this non-used frequency in that measurement.

H_{2c} is the hysteresis parameter for the event 2c.

14.2.1.4 Event 2d: The estimated quality of the currently used frequency is below a certain threshold

A UE shall be able to perform this measurement and the corresponding event reporting without requiring compressed mode.

When an inter-frequency measurement configuring event 2d is set up, the UE shall:

- 1> create a variable TRIGGERED_2D_EVENT related to that measurement, which shall initially be set to FALSE;
- 1> delete this variable when the measurement is released.

When event 2d is configured in the UE within a measurement, the UE shall:

- 1> if equation 1 below has been fulfilled for the used frequency during the time "Time to trigger":
- 2> if the variable TRIGGERED_2D_EVENT is set to FALSE:
 - 3> set the variable TRIGGERED_2D_EVENT to TRUE;
 - 3> send a measurement report with IEs set as below:
 - 4> set in "inter-frequency event results": "inter-frequency event identity" to "2d" and no IE "Inter-frequency cells", not taking into account the cell individual offset;

- 4> include in IE "Inter-frequency measured results list" the measured results for the used frequency, not taking into account the cell individual offset;
- 4> set the IE "additional measured results" according to subclause 8.4.2, not taking into account the cell individual offset.

1> if the variable TRIGGERED_2D_EVENT is set to TRUE and if equation 2 is fulfilled for the used frequency:

2> set the variable TRIGGERED_2D_EVENT to FALSE.

Triggering condition:

Equation 1:

$$Q_{Used} \leq T_{Used2d} - H_{2d}/2$$

The variables in the formula are defined as follows:

Q_{Used} is the quality estimate of the used frequency.

T_{Used2d} is the absolute threshold that applies for the used frequency and event 2d.

H_{2d} is the hysteresis parameter for the event 2d.

Leaving triggered state condition:

Equation 2:

$$Q_{Used} > T_{Used2d} + H_{2d}/2$$

The variables in the formula are defined as follows:

Q_{Used} is the quality estimate of the used frequency.

T_{Used2d} is the absolute threshold that applies for the used frequency and event 2d.

H_{2d} is the hysteresis parameter for the event 2d.

14.2.1.5 Event 2e: The estimated quality of a non-used frequency is below a certain threshold

When an inter-frequency measurement configuring event 2e is set up, the UE shall:

- 1> create a variable TRIGGERED_2E_EVENT per virtual active set related to that measurement, which shall initially be empty;
- 1> delete this variable when the measurement is released.

When event 2e is configured in the UE within a measurement, the UE shall:

- 1> if equation 1 below has been fulfilled for one or several non-used frequencies included for that event during the time "Time to trigger":
 - 2> if any of those non-used frequencies triggered while not considering detected set cells and is not stored in the variable TRIGGERED_2E_EVENT used for evaluation without detected set cells; or
 - 2> if any of those non-used frequency triggered while considering detected set cells but did not simultaneously trigger while not considering detected set cells and is not stored either in the variable TRIGGERED_2E_EVENT used for evaluation without detected set cells or in the variable TRIGGERED_2E_EVENT used for evaluation with detected set cells; or
 - 2> if the CSG virtual active set has been updated, since the last measurement report for this event associated with CSG measurement, for any of those non-used frequency which are stored in the variable TRIGGERED_2E_EVENT:

- 3> store the non-used frequencies that triggered the event and that were not previously stored in the variable TRIGGERED_2E_EVENT corresponding to the virtual active set being evaluated into that variable;
- 3> send a measurement report with IEs set as below:
 - 4> set in "inter-frequency measurement event results":
 - 5> "inter-frequency event identity" to "2e"; and
 - 5> for each non-used frequency that triggered the event, beginning with the best frequency:
 - 6> "Frequency info" to that non-used frequency; and
 - 6> "Non frequency related measurement event results" to the "Primary CPICH info" of the best primary CPICH for FDD cells in case of non-CSG measurements or "Primary CPICH info" of the cell present in CSG virtual active set in case of CSG measurements or "Primary CCPCH info" to the "Cell parameters ID" of the best primary CCPCH for TDD cells on that non-used frequency, not taking into account the cell individual offset.
 - 6> if the frequency triggered the event due to considering detected set cells:
 - 7> set the IE "Detected Set Trigger".
 - 4> include in the IE "Inter-frequency measured results list" the measured results for each non-used frequency that triggered the event, not taking into account the cell individual offset;
 - 4> set the IE "additional measured results" according to subclause 8.4.2, not taking into account the cell individual offset.
- 1> if equation 1 below has been fulfilled but the CSG virtual active set is updated for a non-used frequency included for that event:
 - 2> restart evaluation of this event for this frequency.
- 1> if equation 2 below is fulfilled for a non-used frequency stored in the variable TRIGGERED_2E_EVENT:
 - 2> remove that non-used frequency from the variable TRIGGERED_2E_EVENT corresponding to the virtual active set being evaluated.

Triggering condition:

Equation 1:

$$Q_{Nonused} \leq T_{Nonused2e} - H_{2e} / 2$$

The variables in the formula are defined as follows:

$Q_{Non used}$ is the quality estimate of a non-used frequency that becomes worse than an absolute threshold.

$T_{Non used 2e}$ is the absolute threshold that applies for that non-used frequency for that event.

H_{2e} is the hysteresis parameter for the event 2e.

Leaving triggered state condition:

Equation 2:

$$Q_{Nonused} > T_{Nonused2e} + H_{2e} / 2$$

The variables in the formula are defined as follows:

$Q_{Non used}$ is the quality estimate of a non-used frequency stored in the variable TRIGGERED_2E_EVENT.

$T_{Non used 2e}$ is the absolute threshold that applies for that non-used frequency for that event.

H_{2e} is the hysteresis parameter for the event 2e.

14.2.1.6 Event 2f: The estimated quality of the currently used frequency is above a certain threshold

A UE shall be able to perform this measurement and the corresponding event reporting without requiring compressed mode.

When an inter-frequency measurement configuring event 2f is set up, the UE shall:

- 1> create a variable TRIGGERED_2F_EVENT related to that measurement, which shall initially be set to FALSE;
- 1> delete this variable when the measurement is released.

When event 2f is configured in the UE within a measurement, the UE shall:

- 1> if equation 1 below has been fulfilled for the used frequency during the time "Time to trigger":
 - 2> if the variable TRIGGERED_2F_EVENT is set to FALSE:
 - 3> set the variable TRIGGERED_2F_EVENT to TRUE;
 - 3> send a measurement report with IEs set as below:
 - 4> set in "inter-frequency event results": "inter-frequency event identity" to "2f", and no IE "Inter-frequency cells";
 - 4> include in IE "Inter-frequency measured results list" the measured results for the used frequency, not taking into account the cell individual offset;
 - 4> set the IE "additional measured results" according to subclause 8.4.2, not taking into account the cell individual offset.
- 1> if the variable TRIGGERED_2F_EVENT is set to TRUE and if equation 2 is fulfilled for the used frequency:
 - 2> set the variable TRIGGERED_2F_EVENT to FALSE.

Triggering condition:

Equation 1:

$$Q_{Used} \geq T_{Use2f} + H_{2f}/2$$

The variables in the formula are defined as follows:

Q_{Used} is the quality estimate of the used frequency.

$T_{Used 2f}$ is the absolute threshold that applies for the used frequency and event 2f.

H_{2f} is the hysteresis parameter for the event 2f.

Leaving triggered state condition:

Equation 2:

$$Q_{Used} < T_{Use2f} - H_{2f}/2$$

The variables in the formula are defined as follows:

Q_{Used} is the quality estimate of the used frequency.

$T_{Used 2f}$ is the absolute threshold that applies for the used frequency and event 2f.

H_{2f} is the hysteresis parameter for the event 2f.

14.2.1.7 Event 2g: Change of best cell on a configured secondary downlink frequency (FDD only)

In the description below, the "virtual active set" should be understood as the secondary E-DCH active set if the frequency is the downlink frequency associated with the secondary uplink frequency. Otherwise, the "virtual active set" is the virtual active set for cells only in the CELL_INFO_LIST. The way the virtual active set is initiated and updated is described in subclause 14.11.

When an inter-frequency measurement configuring event 2g is set up, the UE shall:

- 1> create a variable BEST_CELL_2G_EVENT per virtual active set related to that measurement, which shall initially contain the secondary serving HS-DSCH cell on each secondary downlink frequency;
- 1> delete this variable when the measurement is released.

When event 2g is configured in the UE within a measurement, the UE shall:

- 1> if IE "useCIO" is present and its value is TRUE, take into account the Cell Individual Offset for evaluation of the Equation 1, otherwise do not take it into account;
- 1> if Equation 1 below has been fulfilled for a time period indicated by "time to trigger" for a primary CPICH that is not stored in "Best cell" in variable BEST_CELL_2G_EVENT for one or several non-used frequencies:

NOTE: If the equations are simultaneously fulfilled for more than one primary CPICH on one frequency, the UE should report only one event 2g on that frequency, triggered by the best primary CPICH.

- 2> if all required reporting quantities are available for that cell, and that primary CPICH is part of cells in "Cells for measurement" or in CELL_INFO_LIST if "Cells for measurement" is not present:
- 3> set the "Frequency" to the frequency that triggered the event and "best cell" to that primary CPICH that triggered the event in the variable BEST_CELL_2G_EVENT;
- 3> send a measurement report with IEs set as below:
 - 4> set in "inter-frequency measurement event results":
 - 5> "inter-frequency event identity" to "2g"; and
 - 5> for each non-used frequency that triggered the event:
 - 6> "Frequency info" to that frequency; and
 - 6> "Non frequency related measurement event results" to the "Primary CPICH info" of the primary CPICH stored in the BEST_CELL_2G_EVENT variable.
 - 4> include in IE "Inter-frequency measured results list" the measured results for each non-used frequency that triggered the event;
 - 4> set the IE "additional measured results" according to subclause 8.4.2.

This event is only applicable to the CELL_DCH state. Upon transition to CELL_DCH the UE shall:

- 1> set the "Frequency" to each secondary downlink frequency and "best cell" in the variable BEST_CELL_2G_EVENT to the secondary serving HS-DSCH cell on each secondary downlink frequency.

Equation 1

$$10 \log M_{NotBest} + CIO_{NotBest} \geq 10 \log M_{Best} + CIO_{Best} + H_{2g} / 2$$

The variables in the formula are defined as follows:

$M_{NotBest}$ is the measurement result of a cell not stored in "best cell" in the variable BEST_CELL_2G_EVENT on the related frequency.

$CIO_{NotBest}$ is the cell individual offset of a cell not stored in "best cell" in the variable BEST_CELL_2G_EVENT on the related frequency.

M_{Best} is the measurement result of the cell stored in "best cell" in variable BEST_CELL_2G_EVENT on the related frequency.

CIO_{Best} is the cell individual offset of a cell stored in "best cell" in the variable BEST_CELL_2G_EVENT on the related frequency.

H_{2g} is the hysteresis parameter for the event 2g.

If the measurement result is CPICH-Ec/No then $M_{Not\ Best}$ and M_{Best} are expressed as ratios.

If the measurement result is CPICH-RSCP then $M_{Not\ Best}$ and M_{Best} are expressed in mW.

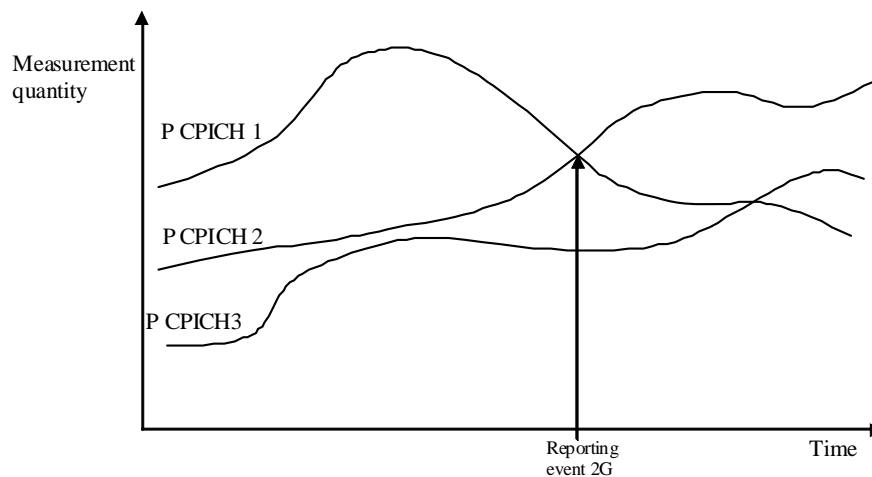

Figure 14.2.1.7-1 [Informative]: A primary CPICH becomes better than the previously best primary CPICH on a configured secondary downlink frequency

In this figure, the parameters hysteresis and time to trigger, as well as the cell individual offsets for all cells are equal to 0.

14.3 Inter-RAT measurements

14.3.0a Inter-RAT measurement quantities

A measurement quantity is used by the UE to evaluate whether an inter-RAT measurement event has occurred or not.

The measurement quantity for UTRAN is used to compute the frequency quality estimate for the active set, as described in the next subclause, and can be:

- 1 Downlink Ec/No.
- 2 Downlink received signal code power (RSCP) after despreading.

The measurement quantity for GSM can be:

- 1 GSM Carrier RSSI

The measurement quantity for E-UTRA can be:

- 1 E-UTRA RSRP
- 2 E-UTRA RSRQ

A description of those values can be found in [7] and [8].

14.3.0b Frequency quality estimate of the UTRAN frequency

The estimated quality of the active set in UTRAN in event 3a is defined as:

$$Q_{UTRAN} = 10 \cdot \text{Log} M_{UTRAN} = W \cdot 10 \cdot \text{Log} \left(\sum_{i=1}^{N_A} M_i \right) + (1 - W) \cdot 10 \cdot \text{Log} M_{Best},$$

The variables in the formula are defined as follows:

Q_{UTRAN} is the estimated quality of the active set on the currently used UTRAN frequency.

M_{UTRAN} is the estimated quality of the active set on currently used UTRAN frequency expressed in another unit.

M_i is the measurement result of cell i in the active set, according to what is indicated in the IE "Measurement quantity for UTRAN quality estimate".

N_A is the number of cells in the active set.

M_{Best} is the measurement result of the cell in the active set with the highest measurement result.

W is a parameter sent from UTRAN to UE.

If the measurement result is CPICH-Ec/No M_{UTRAN} , M_i and M_{Best} are expressed as ratios.

If the measurement result is CPICH-RSCP or PCCPCH-RSCP, M_{UTRAN} , M_i and M_{Best} are expressed in mW.

14.3.0c Inter-RAT reporting quantities

The quantities that the UE shall report to UTRAN when the event is triggered for an inter-RAT measurement are given by the IE "Inter-RAT reporting quantity" stored for that measurement, and can be the following:

In the case the other RAT is GSM:

- 1 GSM carrier RSSI

In the case the other RAT is E-UTRA:

- 1 Measurement Quantity: In case the measurement quantity is RSRP then only RSRP is reported; in case the measurement quantity is RSRQ then only RSRQ is reported.
- 2 Both: both RSRP and RSRQ are reported.

A description of those values can be found in [7], [8] and [74].

14.3.1 Inter-RAT reporting events

Within the measurement reporting criteria field in the MEASUREMENT CONTROL message the UTRAN notifies the UE which events should trigger the UE to send a MEASUREMENT REPORT message. The listed events are the toolbox from which the UTRAN can choose the reporting events that are needed for the implemented handover evaluation function, or other radio network functions.

All events are measured with respect to one of the measurement quantities given in subclause 14.3.0a, and of the frequency quality estimate given in subclause 14.3.0b. For UTRAN the measurement quantities are measured on the monitored primary common pilot channels (CPICH) in FDD mode and the monitored primary common control channels (PCCPCH) in TDD mode of the cell defined in the measurement object. For other RATs the measurement quantities are system-specific. A "used UTRAN frequency" is a frequency that the UE have been ordered to measure upon and is also currently used for the connection to UTRAN. "Other system" is e.g. GSM or E-UTRA.

In the text below describing the events:

- "The BCCH ARFCN and BSIC combinations considered in that inter-RAT measurement" shall be understood as the BCCH ARFCN and BSIC combinations of the inter-RAT cells pointed at in the IE "Cells for measurement" if it has been received for that inter-RAT measurement, or otherwise of the cells included in the "inter-RAT cell info" part of the variable CELL_INFO LIST.

- "The BCCH ARFCNs considered in that inter-RAT measurement" shall be understood as the BCCH ARFCNs of the inter-RAT cells pointed at in the IE "Cells for measurement" if it has been received for that inter-RAT measurement, or otherwise of the cells included in the "inter-RAT cell info" part of the variable CELL_INFO LIST.
- "The E-UTRA frequencies considered in that inter-RAT measurement" shall be understood as the E-UTRA frequencies whose EARFCNs is included in the the variable EUTRA_FREQUENCY_INFO LIST.

When one inter-RAT measurement identity corresponds to multiple inter-RAT events with identical event identities, the UE behaviour is not specified.

14.3.1.1 Event 3a: The estimated quality of the currently used UTRAN frequency is below a certain threshold **and** the estimated quality of the other system is above a certain threshold.

When an inter-RAT measurement configuring event 3a is set up, the UE shall:

- 1> create a variable TRIGGERED_3A_EVENT related to that measurement, which shall initially be empty;
- 1> delete this variable when the measurement is released.

When event 3a is configured in the UE within a measurement, the UE shall:

- 1> if the other RAT is GSM, and if IE "BSIC verification required" is set to "required":
 - 2> if equations 1 and 2 below have both been fulfilled for a time period indicated by "Time to trigger" from the same instant, respectively for the used UTRAN frequency and for one or several GSM cells that match any of the BCCH ARFCN and BSIC combinations considered in that inter-RAT measurement:
 - 3> if the Inter-RAT cell id of any of those GSM cells is not stored in the variable TRIGGERED_3A_EVENT:
 - 4> store the Inter-RAT cell ids of the GSM cells that triggered the event and that were not previously stored in the variable TRIGGERED_3A_EVENT into that variable.
 - 4> send a measurement report with IEs set as below:
 - 5> in "inter-RAT measurement event result": "inter-RAT event identity" to "3a", "CHOICE BSIC" to "verified BSIC" and "Inter-RAT cell id" to the GSM cells that triggered the event (best one first), taking into account the cell individual offset of the GSM cells;
 - 5> "measured results" and possible "additional measured results" according to subclause 8.6.7.5 and 8.4.2, respectively, not taking into account the cell individual offset.
 - 2> if equation 4 is fulfilled for a GSM cell whose inter-RAT cell id is stored in the variable TRIGGERED_3A_EVENT:
 - 3> remove the inter-RAT cell id of that GSM cell from the variable TRIGGERED_3A_EVENT.
 - 2> if equation 3 is fulfilled for the used frequency in UTRAN:
 - 3> clear the variable TRIGGERED_3A_EVENT.
- 1> if the other RAT is GSM, and if IE "BSIC verification required" is set to "not required":
 - 2> if equations 1 and 2 below have been fulfilled for a time period indicated by "Time to trigger" from the same instant, respectively for the used UTRAN frequency and for one or several BCCH ARFCNs considered in that inter-RAT measurement:
 - 3> if any of those BCCH ARFCNs is not stored into the variable TRIGGERED_3A_EVENT:
 - 4> store the BCCH ARFCNs that triggered the event and that were not previously stored in the variable TRIGGERED_3A_EVENT into that variable;
 - 4> send a measurement report with IEs set as below:

- 5> in "inter-RAT measurement event result": "inter-RAT event identity" to "3a", "CHOICE BSIC" to "non verified BSIC" and "BCCH ARFCN" to BCCH ARFCNs that triggered the event (best one first), taking into account the cell individual offset of the GSM cells;
 - 5> "measured results" and possible "additional measured results" according to subclause 8.6.7.5 and 8.4.2, respectively, not taking into account the cell individual offset.
- 2> if equation 4 is fulfilled for a BCCH ARFCN that is stored in the variable TRIGGERED_3A_EVENT:
 - 3> remove that BCCH ARFCN from the variable TRIGGERED_3A_EVENT.
 - 2> if equation 3 is fulfilled for the used frequency in UTRAN:
 - 3> clear the variable TRIGGERED_3A_EVENT.
- 1> if the other RAT is E-UTRA:
- 2> if equations 1 and 2 below have been fulfilled for a time period indicated by "Time to trigger" from the same instant, respectively for the used UTRAN frequency and for one or several E-UTRA cells on any of the frequencies considered in that inter-RAT measurement and that are not included in the blacklist:
 - 3> if any of those E-UTRA cells are not stored into the variable TRIGGERED_3A_EVENT:
 - 4> store the E-UTRA cells that triggered the event and that were not previously stored in the variable TRIGGERED_3A_EVENT into that variable;
 - 4> send a measurement report with IEs set as below:
 - 5> in "E-UTRA event results": "inter-RAT event identity" to "3a", and "E-UTRA carrier frequency" and "Physical cell identity" to the EARFCN and physical cell identity of the cells that triggered the event (best one first);
 - 5> "E-UTRA measured results" according to subclause 8.6.7.5.
 - 2> if equation 4 is fulfilled for a cell that is stored in the variable TRIGGERED_3A_EVENT:
 - 3> remove that cell from the variable TRIGGERED_3A_EVENT.
 - 2> if equation 3 is fulfilled for the used frequency in UTRAN:
 - 3> clear the variable TRIGGERED_3A_EVENT.

Triggering conditions:

Equation 1:

$$Q_{Used} \leq T_{Used} - H_{3a} / 2$$

The variables in the formula are defined as follows:

Q_{Used} is the quality estimate of the used UTRAN frequency.

T_{Used} is the absolute threshold that applies for the used frequency in that measurement.

H_{3a} is the hysteresis parameter for event 3a.

Equation 2:

$$M_{Other RAT} + CIO_{Other RAT} \geq T_{Other RAT} + H_{3a} / 2$$

The variables in the formula are defined as follows:

$M_{Other RAT}$ is the measurement quantity for the cell of the other system.

$CIO_{Other RAT}$ is the cell individual offset for the cell of the other system.

$T_{Other RAT}$ is the absolute threshold that applies for the other system in that measurement.

H_{3a} is the hysteresis parameter for event 3a.

Leaving triggered state conditions:

Equation 3:

$$Q_{Used} > T_{Used} + H_{3a} / 2$$

The variables in the formula are defined as follows:

Q_{Used} is the quality estimate of the used UTRAN frequency.

T_{Used} is the absolute threshold that applies for the used frequency in that measurement.

H_{3a} is the hysteresis parameter for event 3a.

Equation 4:

$$M_{Other\ RAT} + CIO_{Other\ RAT} < T_{Other\ RAT} - H_{3a} / 2$$

The variables in the formula are defined as follows:

$M_{Other\ RAT}$ is the measurement quantity for the cell of the other system. $M_{Other\ RAT}$ is expressed in dBm.

$CIO_{Other\ RAT}$ is the cell individual offset for the cell of the other system.

$T_{Other\ RAT}$ is the absolute threshold that applies for the other system in that measurement.

H_{3a} is the hysteresis parameter for event 3a.

14.3.1.2 Event 3b: The estimated quality of other system is below a certain threshold

When an inter-RAT measurement configuring event 3b is set up, the UE shall:

- 1> create a variable TRIGGERED_3B_EVENT related to that measurement, which shall initially be empty;
- 1> delete this variable when the measurement is released.

When event 3b is configured in the UE within a measurement, the UE shall:

- 1> if the other RAT is GSM, and if IE "BSIC verification required" is set to "required":
 - 2> if equation 1 below has been fulfilled for a time period indicated by "time to trigger" for one or several GSM cells that match any of the BCCH ARFCN and BSIC combinations considered in that inter-RAT measurement:
 - 3> if the inter-RAT cell id of any of those GSM cell is not stored in the variable TRIGGERED_3B_EVENT:
 - 4> store the inter-RAT cell ids of the GSM cells that triggered the event and that were not previously stored in the variable TRIGGERED_3B_EVENT into that variable;
 - 4> send a measurement report with IEs set as below:
 - 5> set in "inter-RAT measurement event result": "inter-RAT event identity" to "3b", "CHOICE BSIC" to "verified BSIC" and "Inter-RAT cell id" to the GSM cells that triggered the event (worst one first), taking into account the cell individual offset of the GSM cells;
 - 5> set the IE "measured results" and the IE "additional measured results" according to subclause 8.6.7.5 and 8.4.2, respectively, not taking into account the cell individual offset.
 - 2> if equation 2 below is fulfilled for a GSM cell whose inter-RAT cell id is stored in the variable TRIGGERED_3B_EVENT:
 - 3> remove the inter-RAT cell id of that GSM cell from the variable TRIGGERED_3B_EVENT.
 - 1> if the other RAT is GSM, and if IE "BSIC verification required" is set to "not required":

- 2> if equation 1 below has been fulfilled for a time period indicated by "time to trigger" for one or several of the BCCH ARFCNs considered in that inter-RAT measurement:
- 3> if any of those BCCH ARFCN is not stored into the variable TRIGGERED_3B_EVENT:
- 4> store the BCCH ARFCNs that triggered the event and that were not previously stored in the variable TRIGGERED_3B_EVENT into that variable;
- 4> send a measurement report with IEs set as below:
- 5> set in "inter-RAT measurement event result": "inter-RAT event identity" to "3b", "CHOICE BSIC" to "non verified BSIC" and "BCCH ARFCN" to BCCH ARFCNs that triggered the event (worst one first), taking into account the cell individual offset of the GSM cells;
- 5> set the IE "measured results" and the IE "additional measured results" according to subclause 8.6.7.5 and 8.4.2, respectively, not taking into account the cell individual offset.
- 2> if equation 2 below is fulfilled for a BCCH ARFCN that is stored in the variable TRIGGERED_3B_EVENT:
- 3> remove that BCCH ARFCN from the variable TRIGGERED_3B_EVENT.
- 1> if the other RAT is E-UTRA:
- 2> if equation 1 below has been fulfilled for a time period indicated by "time to trigger" for one or several of the E-UTRA cells on any of the frequencies considered in that inter-RAT measurement and that are not included in the blacklist:
- 3> if any of those E-UTRA cells is not stored into the variable TRIGGERED_3B_EVENT:
- 4> store the E-UTRA cells that triggered the event and that were not previously stored in the variable TRIGGERED_3B_EVENT into that variable;
- 4> send a measurement report with IEs set as below:
- 5> set in "E-UTRA event results": "inter-RAT event identity" to "3b", and "E-UTRA carrier frequency" and "Physical cell identity" to the EARFCN and physical cell identity of the cells that triggered the event (worst one first);
- 5> set the IE "E-UTRA measured results" according to subclause 8.6.7.5.
- 2> if equation 2 below is fulfilled for a cell that is stored in the variable TRIGGERED_3B_EVENT:
- 3> remove that cell from the variable TRIGGERED_3B_EVENT.

Triggering condition:

Equation 1:

$$M_{Other\ RAT} + CIO_{Other\ RAT} \leq T_{Other\ RAT} - H_{3b} / 2$$

The variables in the formula are defined as follows:

$M_{Other\ RAT}$ is the measurement quantity for the cell of the other system.

$CIO_{Other\ RAT}$ is the cell individual offset for the cell of the other system.

$T_{Other\ RAT}$ is the absolute threshold that applies for the other system in that measurement.

H_{3b} is the hysteresis parameter for event 3b.

Leaving triggered state condition:

Equation 2:

$$M_{Other\ RAT} + CIO_{Other\ RAT} > T_{Other\ RAT} + H_{3b} / 2$$

The variables in the formula are defined as follows:

$M_{Other\ RAT}$ is the measurement quantity for the cell of the other system. $M_{Other\ RAT}$ is expressed in dBm.

$CIO_{Other\ RAT}$ is the cell individual offset for the cell of the other system.

$T_{Other\ RAT}$ is the absolute threshold that applies for the other system in that measurement.

H_{3b} is the hysteresis parameter for event 3b.

14.3.1.3 Event 3c: The estimated quality of other system is above a certain threshold

When an inter-RAT measurement configuring event 3c is set up, the UE shall:

- 1> create a variable TRIGGERED_3C_EVENT related to that measurement, which shall initially be empty;
- 1> delete this variable when the measurement is released.

When event 3c is configured in the UE within a measurement, the UE shall:

- 1> if the other RAT is GSM, and if IE "BSIC verification required" is set to "required":
 - 2> if equation 1 below has been fulfilled for a time period indicated by "time to trigger" for one or several GSM cells that match any of the BCCH ARFCN and BSIC combinations considered in that inter-RAT measurement:
 - 3> if the inter-RAT cell id of any of those GSM cell is not stored in the variable TRIGGERED_3C_EVENT:
 - 4> store the Inter-RAT cell ids of the GSM cells that triggered the event and that were not previously stored in the variable TRIGGERED_3C_EVENT into that variable;
 - 4> send a measurement report with IEs set as below:
 - 5> set in "inter-RAT measurement event result": "inter-RAT event identity" to "3c", "CHOICE BSIC" to "verified BSIC" and "Inter-RAT cell id" to the GSM cells that triggered the event (best one first), taking into account the cell individual offset of the GSM cells;
 - 5> set the IE "measured results" and the IE "additional measured results" according to subclause 8.6.7.5 and 8.4.2, respectively, not taking into account the cell individual offset.
 - 2> if equation 2 below is fulfilled for a GSM cell whose inter-RAT cell id is stored in the variable TRIGGERED_3C_EVENT:
 - 3> remove the inter-RAT cell id of that GSM cell from the variable TRIGGERED_3C_EVENT.
- 1> if the other RAT is GSM, and if IE "BSIC verification required" is set to "not required":
 - 2> if equation 1 below has been fulfilled for a time period indicated by "time to trigger" for one or several of the BCCH ARFCNs considered in that inter-RAT measurement:
 - 3> if any of those BCCH ARFCN is not stored into the variable TRIGGERED_3C_EVENT:
 - 4> store the BCCH ARFCNs that triggered the event and that were not previously stored in the variable TRIGGERED_3C_EVENT into that variable;
 - 4> send a measurement report with IEs set as below:
 - 5> set in "inter-RAT measurement event result": "inter-RAT event identity" to "3c", "CHOICE BSIC" to "non verified BSIC" and "BCCH ARFCN" to BCCH ARFCNs that triggered the event (best one first), taking into account the cell individual offset of the GSM cells;
 - 5> set the IE "measured results" and the IE "additional measured results" according to subclause 8.6.7.5 and 8.4.2, respectively, not taking into account the cell individual offset.
 - 2> if equation 2 is fulfilled for a BCCH ARFCN that is stored in the variable TRIGGERED_3C_EVENT:
 - 3> remove that BCCH ARFCN from the variable TRIGGERED_3C_EVENT.
- 1> if the other RAT is E-UTRA:

- 2> if equation 1 below has been fulfilled for a time period indicated by "time to trigger" for one or several E-UTRA cells on any of the frequencies considered in that inter-RAT measurement and that are not included in the blacklist:
 - 3> if any of those E-UTRA cells is not stored into the variable TRIGGERED_3C_EVENT:
 - 4> store the E-UTRA cells that triggered the event and that were not previously stored in the variable TRIGGERED_3C_EVENT into that variable;
 - 4> send a measurement report with IEs set as below:
 - 5> set in "E-UTRA event results": "inter-RAT event identity" to "3c", and "E-UTRA carrier frequency" and "Physical cell identity" to the EARFCN and physical cell identity of the cells that triggered the event (best one first);
 - 5> set the IE "E-UTRA measured results" according to subclause 8.6.7.5.
- 2> if equation 2 is fulfilled for a cell that is stored in the variable TRIGGERED_3C_EVENT:
 - 3> remove that cell from the variable TRIGGERED_3C_EVENT.

Triggering condition:

Equation 1:

$$M_{Other\ RAT} + CIO_{Other\ RAT} \geq T_{Other\ RAT} + H_{3c}/2$$

The variables in the formula are defined as follows:

$M_{Other\ RAT}$ is the measurement quantity for the cell of the other system. $M_{Other\ RAT}$ is expressed in dBm.

$CIO_{Other\ RAT}$ is the cell individual offset for the cell of the other system.

$T_{Other\ RAT}$ is the absolute threshold that applies for the other system in that measurement.

H_{3c} is the hysteresis parameter for event 3c.

Leaving triggered state condition:

Equation 2:

$$M_{Other\ RAT} + CIO_{Other\ RAT} < T_{Other\ RAT} - H_{3c}/2$$

The variables in the formula are defined as follows:

$M_{Other\ RAT}$ is the measurement quantity for the cell of the other system. $M_{Other\ RAT}$ is expressed in dBm.

$CIO_{Other\ RAT}$ is the cell individual offset for the cell of the other system.

$T_{Other\ RAT}$ is the absolute threshold that applies for the other system in that measurement.

H_{3c} is the hysteresis parameter for event 3c.

14.3.1.4 Event 3d: Change of best cell in other system

When an inter-RAT measurement configuring event 3d is set up, the UE shall:

- 1> create a variable BEST_CELL_3D_EVENT related to that measurement;
- 1> delete this variable when the measurement is released.

When event 3d is configured in the UE within a measurement, the UE shall:

- 1> if the other RAT is GSM, and if IE "BSIC verification required" is set to "required":
 - 2> when the measurement is initiated or resumed:
 - 3> store in the variable BEST_CELL_3D_EVENT the Inter-RAT cell id of the GSM cell that has the best measured quantity among the GSM cells that match any of the BCCH ARFCN and BSIC combinations considered in that inter-RAT measurement, not taking into account the cell individual offset of the GSM cells;
 - 3> send a measurement report with IE set as below:
 - 4> set in "inter-RAT measurement event result": "inter-RAT event identity" to "3d", "CHOICE BSIC" to "verified BSIC" and "Inter-RAT cell id" to the GSM cell that is stored in the variable BEST_CELL_3D_EVENT;
 - 4> set the IE "measured results" and the IE "additional measured results" according to subclause 8.6.7.5 and 8.4.2, respectively, not taking into account the cell individual offset.
 - 2> if equation 1 has been fulfilled for a time period indicated by "time to trigger" for a GSM cell that is different from the one stored in BEST_CELL_3D_EVENT and that matches any of the BCCH ARFCN and BSIC combinations considered in that inter-RAT measurement:
 - 3> store the Inter-RAT cell id of that GSM cell in the variable BEST_CELL_3D_EVENT;
 - 3> send a measurement report with IEs set as below:
 - 4> set in "inter-RAT measurement event result": "inter-RAT event identity" to "3d", "CHOICE BSIC" to "verified BSIC" and "Inter-RAT cell id" to the GSM cell is now stored in BEST_CELL_3D_EVENT;
 - 4> set the IE "measured results" and the IE "additional measured results" according to subclause 8.6.7.5 and 8.4.2, respectively, not taking into account the cell individual offset.
- 1> if the other RAT is GSM, and if IE "BSIC verification required" is set to "not required":
 - 2> when the measurement is initiated or resumed:
 - 3> store in the variable BEST_CELL_3D_EVENT the BCCH ARFCN of the GSM cell that has the best measured quantity among the BCCH ARFCNs considered in that inter-RAT measurement;
 - 3> send a measurement report with IE set as below:
 - 4> set in "inter-RAT measurement event result": "inter-RAT event identity" to "3d", "CHOICE BSIC" to "non verified BSIC" and "BCCH ARFCN" to the BCH ARFCN that is stored in the variable BEST_CELL_3D_EVENT;
 - 4> set the IE "measured results" and the IE "additional measured results" according to subclause 8.6.7.5 and 8.4.2, respectively, not taking into account the cell individual offset.
 - 2> if equation 1 below has been fulfilled for a time period indicated by "time to trigger" for one of the BCCH ARFCNs considered in that inter-RAT measurement and different from the one stored in BEST_CELL_3D_EVENT:
 - 3> store the BCCH ARFCN of that GSM cell in the variable BEST_CELL_3D_EVENT;
 - 3> send a measurement report with IEs set as below:
 - 4> set in "inter-RAT measurement event result": "inter-RAT event identity" to "3d", "CHOICE BSIC" to "non verified BSIC" and "BCCH ARFCN" to the BCCH ARFCN that is now stored in the variable BEST_CELL_3D_EVENT;
 - 4> set the IE "measured results" and the IE "additional measured results" according to subclause 8.4.2, not taking into account the cell individual offset.
- 1> if the other RAT is E-UTRA:
 - 2> when the measurement is initiated or resumed:

- 3> store in the variable BEST_CELL_3D_EVENT the EARFCN and Physical Cell Identity of the E-UTRA cell that has the best measured quantity among the EARFCNs considered in that inter-RAT measurement;
- 3> send a measurement report with IE set as below:
 - 4> set in "E-UTRA measurement results": "inter-RAT event identity" to "3d", and "E-UTRA Carrier Frequency" and "Physical Cell Identity" to the EARFCN and the Physical Cell Identity that are stored in the variable BEST_CELL_3D_EVENT;
 - 4> set the IE "E-UTRA measured results" according to subclause 8.6.7.5.
- 2> if equation 1 below has been fulfilled for a time period indicated by "time to trigger" for a cell on one of the EARFCNs considered in that inter-RAT measurement and different from the cell stored in BEST_CELL_3D_EVENT:
 - 3> store the EARFCN and Physical Cell Identity of that E-UTRA cell in the variable BEST_CELL_3D_EVENT;
 - 3> send a measurement report with IEs set as below:
 - 4> set in "E-UTRA event results": "inter-RAT event identity" to "3d", and "E-UTRA carrier frequency" and "Physical Cell Identity" to the EARFCN and the Physical Cell Identity that are now stored in the variable BEST_CELL_3D_EVENT;
 - 4> set the IE "E-UTRA measured results" according to subclause 8.6.7.5.

Equation 1:

$$M_{New} \geq M_{Best} + H_{3d} / 2$$

The variables in the formula are defined as follows:

M_{New} is the measurement quantity for a cell of the other system that is not stored in the variable BEST_CELL_3D_EVENT.

M_{Best} is the measurement quantity for a cell of the other system that is stored in the variable BEST_CELL_3D_EVENT.

H_{3d} is the hysteresis parameter for event 3d.

14.3.2 GSM measurements in compressed mode

14.3.2.1 GSM RSSI measurements

The UE shall perform GSM RSSI measurements in the gaps of compressed mode pattern sequence specified for GSM RSSI measurement purpose.

14.3.2.2 Initial BSIC identification

The UE shall perform Initial BSIC identification in compressed mode pattern sequence specified for Initial BSIC identification measurement purpose.

The parameter "N identify abort" in the IE "DPCH compressed mode info" indicates the maximum number of patterns that the UE shall use to attempt to decode the unknown BSIC of the GSM cell in the initial BSIC identification procedure.

The BSIC identification procedure is defined in detail in [19].

14.3.2.3 BSIC re-confirmation

The UE shall perform BSIC re-confirmation in compressed mode pattern sequence specified for BSIC re-confirmation measurement purpose.

The parameter "T reconfirm abort" in the IE "DPCH compressed mode info" indicates the maximum time allowed for the re-confirmation of the BSIC of one GSM cell in the BSIC re-confirmation procedure.

The BSIC re-confirmation procedure is defined in detail in [19].

14.3.3 E-UTRA measurements in compressed mode

14.3.3.1 E-UTRA RSRP measurements

The UE shall perform E-UTRA RSRP measurements in the gaps of compressed mode pattern sequence specified for E-UTRA measurement purpose.

14.3.3.2 E-UTRA RSRQ measurements

The UE shall perform E-UTRA RSRQ measurements in the gaps of compressed mode pattern sequence specified for E-UTRA measurement purpose.

14.4 Traffic Volume Measurements

14.4.1 Traffic Volume Measurement Quantity

Traffic volume measurements may be configured by RRC to assist with dynamic radio bearer control. The reported quantities that can be configured are:

- 1 Buffer Occupancy.
- 2 Average of Buffer Occupancy.
- 3 Variance of Buffer Occupancy.

A description of these values can be found in [15].

When a report is triggered, the UE shall provide the requested quantities for the acknowledged and unacknowledged mode RBs mapped onto the transport channels identified.

When the RLC buffer payload, Average of RLC buffer payload or Variance of RLC buffer payload is reported, the measured quantity shall be rounded upwards to the closest higher value possible to report. When the measured quantity is over the highest value possible to report, it shall be set to the highest value.

14.4.2 Traffic Volume reporting triggers

Traffic volume measurement reports can be triggered using two different mechanisms, periodical and event triggered. The reporting criteria are specified in the measurement control message.

All the specified events are evaluated with respect to the Transport Channel Traffic Volume (TCTV). This quantity is equal to the sum of the Buffer Occupancy for all logical channels mapped onto a transport channel. The events on a given transport channel shall be evaluated at least at every TTI (may be more often) as described in [15].

When one traffic volume measurement identity corresponds to multiple traffic volume events with identical event identities for the same transport channel, the UE behaviour is not specified.

When a traffic volume measurement is set up, the UE shall:

- 1> for FDD, if variable `READY_FOR_COMMON_EDCH` is set to `TRUE`:
- 2> if one transport channel that is referenced in the IE "Traffic volume measurement object" as "DCH" and IE "measurement validity" is set to "all states except `CELL_DCH`":
- 3> the uplink transport channel on which the UE is supposed to report in `CELL_FACH` state is of type E-DCH.

1> for 1.28 Mcps TDD, if one transport channel that is referenced in the IE "Traffic volume measurement object" as "USCH" and the IE "UL target transport channel id" is set to 32 and and IE "measurement validity" is set to "all states" or "all states except CELL_DCH":

2> the uplink transport channel on which the UE is supposed to report is of type E-DCH.

1> if the IE "report criteria" is set to "Traffic volume measurement reporting criteria":

2> for each IE "Parameters sent for each transport channel":

3> if the IE "Uplink transport channel type" is not included; or

3> if the IE "Uplink Transport Channel Type" has the value "DCH" or "USCH" and the IE "UL transport channel id" is not included:

4> for each IE "Parameters required for each Event":

5> for each uplink transport channel on which the UE is supposed to report (see below):

6> configure an event trigger defined by the values in the IEs "Measurement Identity", "Traffic volume event identity", "Reporting threshold", "Time to trigger", "Pending time after trigger" and "Tx Interruption after trigger".

3> else:

4> for each IE "Parameters required for each Event":

5> for the uplink transport channel defined by the IEs "Uplink transport channel type" and "UL transport channel id":

6> configure an event trigger defined by the values in the IEs "Measurement Identity", "Traffic volume event identity", "Reporting threshold", "Time to trigger", "Pending time after trigger" and "Tx Interruption after trigger".

1> else:

2> if the IE "report criteria" is set to "Periodical reporting criteria":

2> configure periodical triggers with period equal to the value in the IE "Reporting Interval" and with number of transmissions equal to the value in the IE "Amount of reporting" for the measurement identified by the IE "Measurement Identity".

For each transport channel for which an event trigger has been configured, the UE shall:

1> for each event configured for this transport channel:

2> if the TCTV is larger than the threshold in IE "Reporting threshold" at TVM setup or modify; or

2> if the TCTV becomes larger than the threshold in IE "Reporting threshold" while the event is configured:

3> if the IE "Traffic volume event identity" has value "4a":

4> if the IE "Time to trigger" is not present; and

4> if the Pending-time-after-trigger timer for this event is not active:

5> if the IE "Pending time after trigger" is included:

6> start the Pending-time-after-trigger timer for this event with the value in this IE.

5> trigger a report for the measurement identified by the IE "Measurement Identity".

4> else:

5> start the Time-to-trigger timer for this event with the value in the IE "Time to trigger".

3> if the IE "Traffic volume event identity" has value "4b":

- 4> if the Time-to-trigger timer for this event is active:
 - 5> stop this timer.
- 2> if the TCTV is smaller than the threshold in IE "Reporting threshold" at TVM setup or modify; or
- 2> if the TCTV becomes smaller than the threshold in IE "Reporting threshold" while the event is configured:
 - 3> if the IE "Traffic volume event identity" has value "4a":
 - 4> if the Time-to-trigger timer for this event is active:
 - 5> stop this timer.
 - 3> if the IE "Traffic volume event identity" has value "4b":
 - 4> if the IE "Time to trigger" is not present; and
 - 4> if the Pending-time-after-trigger timer for this event is not active:
 - 5> if the IE "Pending time after trigger" is included:
 - 6> start the Pending-time-after-trigger timer for this event with the value in this IE.
 - 5> trigger a report for the measurement identified by the IE "Measurement Identity".
 - 4> else:
 - 5> start the Time-to-trigger timer for this event with the value in the IE "Time to trigger".

When the Time-to-trigger timer for an event elapses:

- 1> if the Pending-time-after-trigger timer for this event is not active:
 - 2> trigger a report for the measurement identified by the IE "Measurement Identity" corresponding to this event;
- 2> if the IE "Pending time after trigger" is included:
 - 3> start the Pending-time-after-trigger timer for this event with the value in this IE.

When the Pending-time-after-trigger for an event elapses:

- 1> if the IE "Traffic volume event identity" has value "4a":
 - 2> if the TCTV is larger than the threshold in IE "Reporting threshold":
 - 3> if the IE "Time to trigger" is not present:
 - 4> trigger a report for the measurement identified by the IE "Measurement Identity" corresponding to this event;
 - 4> start the Pending-time-after-trigger timer for this event with the value in the IE "Pending time after trigger".
 - 3> else:
 - 4> start the Time-to-trigger timer for this event with the value in the IE "Time to trigger".
- 1> if the IE "Traffic volume event identity" has value "4b":
 - 2> if the TCTV is smaller than the threshold in IE "Reporting threshold":
 - 3> if the IE "Time to trigger" is not present:
 - 4> trigger a report for the measurement identified by the IE "Measurement Identity" corresponding to this event;
 - 4> start the Pending-time-after-trigger timer for this event with the value in the IE "Pending time after trigger".

3> else:

4> start the Time-to-trigger timer for this event with the value in the IE "Time to trigger".

When a periodical trigger elapses, the UE shall:

1> trigger a report for the measurement identified by the IE "Measurement Identity";

1> if the number of reports triggered by this periodical trigger reaches the value in the IE "Amount of reporting":

2> disable this periodical trigger.

When a report is triggered for a given IE "Measurement Identity", the UE shall:

1> consider the variable MEASUREMENT_IDENTITY corresponding to this measurement identity;

1> if the report is triggered by an event trigger:

2> include the IE "Event results";

2> if variable READY_FOR_COMMON_EDCH is set to FALSE:

3> set the IE "Uplink transport channel type causing the event" to the type of the transport channel which triggered the report;

3> if the transport channel type is "DCH" or "USCH":

4> include the IE "UL Transport Channel identity" and set it to the identity of the transport channel which triggered the report.

3> else:

4> not include the IE "UL Transport Channel identity".

2> else:

3> for FDD:

4> set the IE "Uplink transport channel type causing the event" to the value "DCH";

4> include the IE "UL Transport Channel identity" and set it to any value.

3> for 1.28 Mcps TDD:

4> include the IE "UL Transport Channel identity" and set it to the identity of the transport channel which triggered the report.

2> set the IE "Traffic volume event identity" to the identity of the event that triggered the report;

2> if the IE "Tx interruption after trigger" for the event that triggered the report is included:

3> if the UE is in CELL_FACH state and

3> if the variable READY_FOR_COMMON_EDCH is set to FALSE:

4> prohibit DTCH transmissions on the RACH;

4> if the Tx interruption timer is not running; or

4> if the Tx interruption timer is running and still has a value larger than the IE "Tx interruption after trigger" for the event, i.e. it was started earlier by another event with a larger value in IE "Tx interruption after trigger":

5> start the Tx interruption timer with the value in the IE "Tx interruption after trigger" for this event.

4> when it receives from the UTRAN a message causing the transition to CELL_DCH state; or

4> when the Tx interruption timer elapses:

- 5> stop the timer;
- 5> resume these transmissions.
- 1> if the IE "Traffic volume measurement object" is not included:
 - 2> report on all the uplink transport channels as specified below.
- 1> if the IE "Traffic volume measurement object" is included:
 - 2> report on the uplink transport channels identified in this IE as specified below.
- 1> for each UM or AM RB mapped onto a transport channel on which the UE is expected to report:
 - 2> add an element in the IE "Traffic volume measurement results";
 - 2> set the value of the IE "RB Identity" to the identity of the considered radio bearer;
 - 2> if the RB is mapped onto one logical channel:
 - 3> if the IE "RLC Buffer Payload for each RB" is set to TRUE:
 - 4> include the IE "RLC Buffers Payload" and set it to the Buffer Occupancy value for this logical channel, rounded up to the next allowed value.
 - 3> if the IE "Average of RLC Buffer Payload for each RB" is set to TRUE:
 - 4> include and set the IE "Average of RLC Buffer Payload" to the Buffer Occupancy for this logical channel averaged over the interval specified in the IE "Time Interval to take an average or a variance" (see [15]), rounded up to the next allowed value.
 - 3> if the IE "Variance of RLC Buffer Payload for each RB" is set to TRUE:
 - 4> include and set the IE "Variance of RLC Buffer Payload" to the variance of the Buffer Occupancy for this logical channel computed over the interval specified in the IE "Time Interval to take an average or a variance" (see [15]), rounded up to the next allowed value.
 - 2> if the RB is mapped onto two logical channels:
 - 3> if one logical channel is mapped onto transport channels on which the UE is supposed to report:
 - 4> if the IE "RLC Buffer Payload for each RB" is set to TRUE:
 - 5> include and set the IE "RLC Buffers Payload" to the Buffer Occupancy value for this logical channel, rounded up to the next allowed value.
 - 4> if the IE "Average of RLC Buffer Payload for each RB" is set to TRUE:
 - 5> include and set the IE "Average of RLC Buffer Payload" to the Buffer Occupancy for this logical channel averaged over the interval specified in the IE "Time Interval to take an average or a variance" (see [15]), rounded up to the next allowed value.
 - 4> if the IE "Variance of RLC Buffer Payload for each RB" is set to TRUE:
 - 5> include and set the IE "Variance of RLC Buffer Payload" to the variance of the Buffer Occupancy for this logical channel computed over the interval specified in the IE "Time Interval to take an average or a variance" (see [15]), rounded up to the next allowed value.
 - 3> if both logical channels are mapped onto transport channels on which the UE is supposed to report:
 - 4> if the IE "RLC Buffer Payload for each RB" is set to TRUE:
 - 5> include and set the IE "RLC Buffers Payload" to the sum of the Buffer Occupancy values for the two logical channels, rounded up to the next allowed value.
 - 4> if the IE "Average of RLC Buffer Payload for each RB" is set to TRUE:

5> include and set the IE "Average of RLC Buffer Payload" to the sum of the Buffer Occupancy for the two logical channels averaged over the interval specified in the IE "Time Interval to take an average or a variance" (see [15]) and rounded up to the next allowed value.

4> if the IE "Variance of RLC Buffer Payload for each RB" is set to TRUE:

5> include and set the IE "Variance of RLC Buffer Payload" to the variance of the sum of the Buffer Occupancy for the two logical channels, computed over the interval specified in the IE "Time Interval to take an average or a variance" (see [15]) and rounded up to the next allowed value.

14.4.2.1 Reporting event 4 A: Transport Channel Traffic Volume becomes larger than an absolute threshold

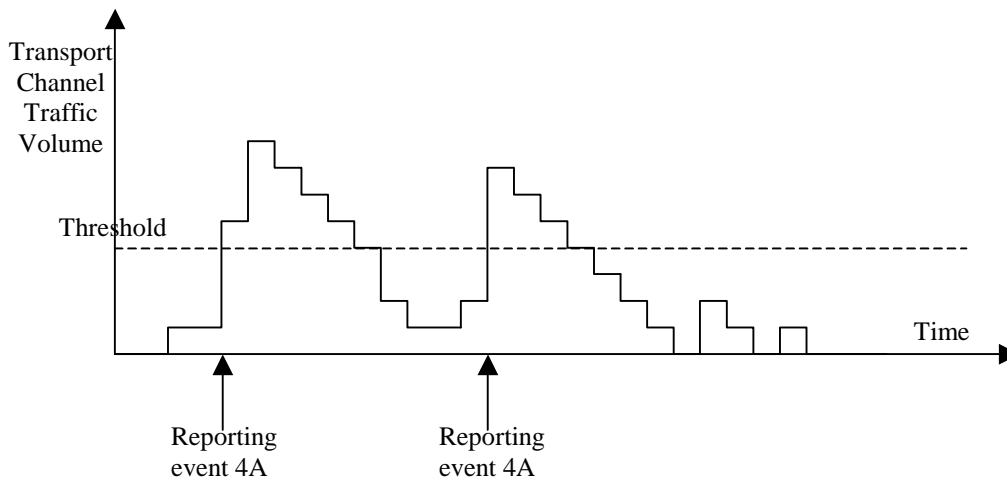

Figure 14.4.2.1-1: Event triggered report when Transport Channel Traffic Volume becomes larger than a certain threshold

If the monitored Transport Channel Traffic Volume (TCTV) [15] is larger than an absolute threshold at TVM setup or modify, or is larger at activation of the monitored transport channel, or becomes larger than an absolute threshold while the event is configured i.e. if $TCTV > \text{Reporting threshold}$, this event could trigger a report. The event could be triggered again only if TCTV becomes smaller than the Reporting threshold and later $TCTV > \text{Reporting threshold}$ is verified again.

14.4.2.2 Reporting event 4 B: Transport Channel Traffic Volume becomes smaller than an absolute threshold

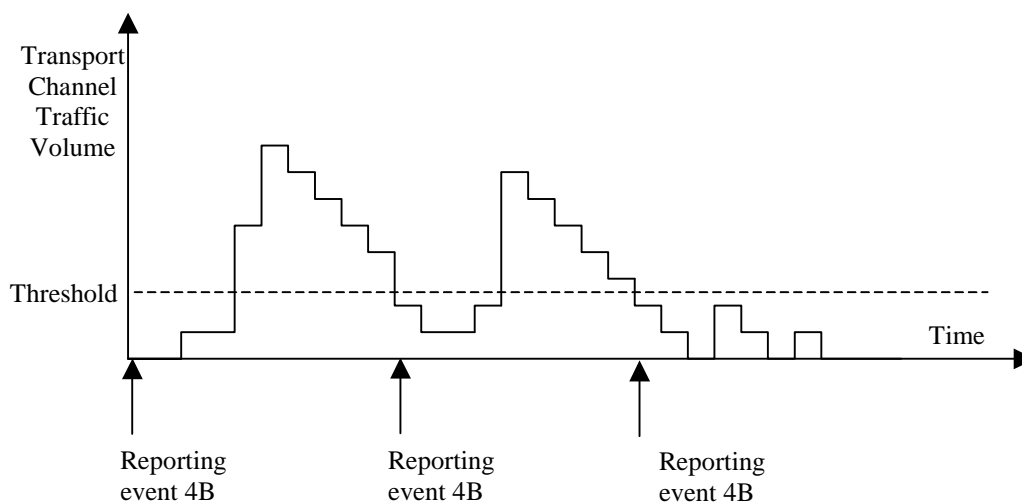

Figure 14.4.2.1-2: Event triggered report when Transport Channel Traffic Volume becomes smaller than certain threshold

If the monitored Transport Channel Traffic Volume (TCTV) [15] is smaller than an absolute threshold at TVM setup or modify, or is smaller at activation of the monitored transport channel, or becomes smaller than an absolute threshold while the event is configured i.e. if $TCTV < \text{Reporting threshold}$, this event could trigger a report. The event could be triggered again only if TCTV becomes bigger than the Reporting threshold and later $TCTV < \text{Reporting threshold}$ is verified again.

14.4.3 Traffic volume reporting mechanisms

Traffic volume measurement triggering could be associated with both a *time-to-trigger* and a *pending time after trigger*. The time-to-trigger is used to get time domain hysteresis, i.e. the condition must be fulfilled during the time-to-trigger time before a report is sent. Pending time after trigger is used to limit consecutive reports when one traffic volume measurement report already has been sent and enables periodic reporting while the TCTV remains above(4a) or below(4b) the threshold. This is described in detail below.

14.4.3.1 Pending time after trigger

This timer is started in the UE when a measurement report has been triggered by a given event. The UE is then forbidden to send new measurement reports triggered by the same event during this time period. Instead the UE waits until the timer has expired. If the Transport Channel Traffic Volume [15] is still above the threshold for event 4a, or below the threshold for event 4b when the timer expires, the UE sends a new measurement report, and the timer is restarted. Otherwise it waits for a new triggering.

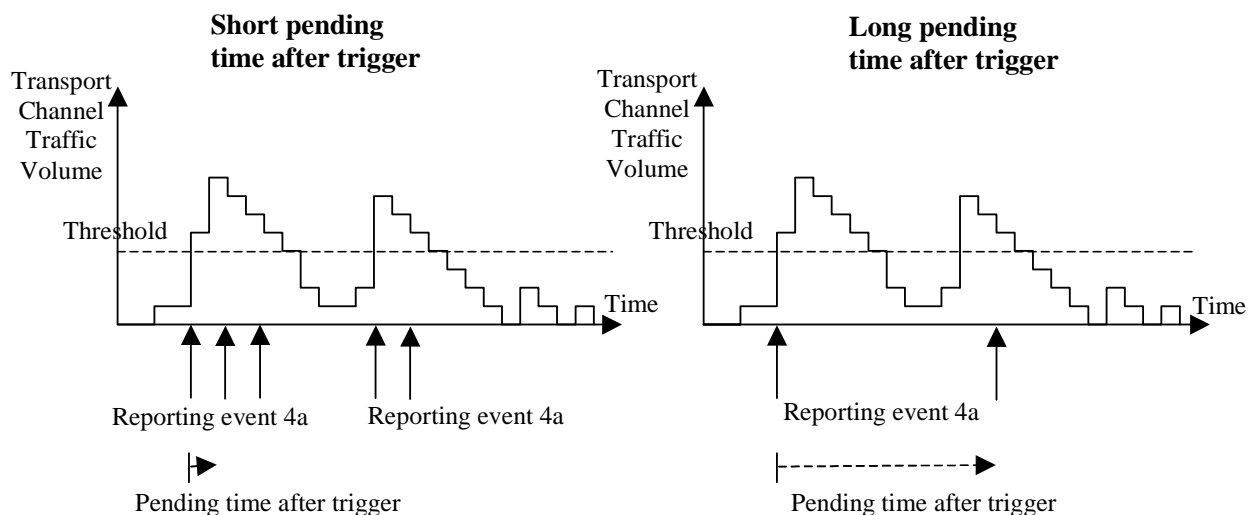

Figure 14.4.3.1-1: Pending time after trigger limits the amount of consecutive measurement reports

Figure 14.4.3.1-1 shows that by increasing the pending time after trigger a triggered second event does not result in a measurement report. The figure assumes absence of the IE "Time to trigger".

14.4.3.2 Time-to-trigger

The timer is started in the UE when the Transport Channel Traffic Volume triggers the event. If the TCTV crosses the threshold before the timer expires, the timer is stopped. If the timer expires then a report is triggered.

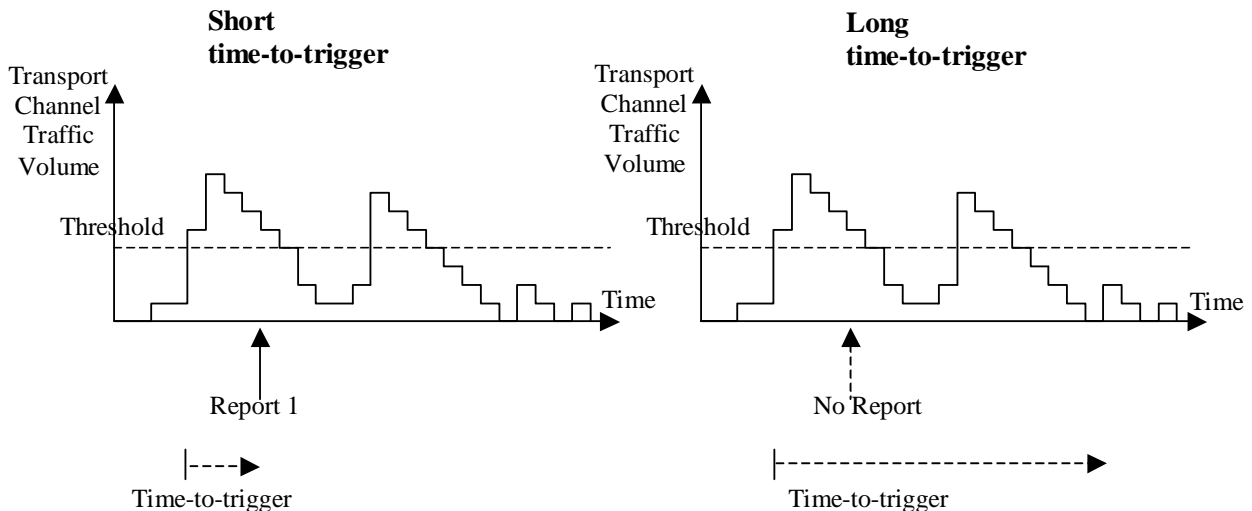

Figure 14.4.3.1-2: Time-to-trigger is used to achieve time hysteresis

Figure 14.4.3.1-2 shows that by increasing the time-to-trigger the report is not triggered.

14.4.4 Interruption of user data transmission

By including the IE "Tx Interruption after trigger", a UE in CELL_FACH state may be instructed by the UTRAN to prohibit transmission of user data on the RACH temporarily after a measurement report has been triggered.

The UE shall only resume transmission of user data, when:

- 1> it receives from the UTRAN a message allocating a dedicated physical channel, leading to the transition to CELL_DCH state; or
- 1> the time period indicated by the IE "Tx Interruption after trigger" elapses.

The transmission on signalling radio bearers shall not be interrupted.

14.5 Quality Measurements

14.5.1 Quality reporting measurement quantities

For quality measurements, the following measurement quantities are used:

1. Downlink transport channel BLER
2. Timeslot SIR (TDD only)

14.5.2 Quality reporting events

When one measurement identity corresponds to multiple quality events for the same transport channel, the UE behaviour is not specified.

14.5.2.1 Reporting event 5A: A predefined number of bad CRCs is exceeded

When this event is ordered by UTRAN in a measurement control message, the UE shall send a measurement report when the amount of bad CRCs during a predefined sliding window exceeds a predefined number.

The following three parameters are used in the scheme:

- **Total CRC** = the length of the sliding window over which the number of bad CRCs are counted.

- **Bad CRC** = the number of bad CRC that is required within the latest "Total CRC" received CRCs for the event to be triggered.
- **Pending after trigger** = a new event can not be triggered until "Pending after trigger" CRCs have been received.

When a DCH is established, the UE shall begin to count the number of bad CRCs within the last "Total CRC" received CRCs. No event can be triggered until at least "Total CRC" CRCs have been received. For each new received CRC, the UE shall compare the number of bad CRCs within the latest "Total CRC" received CRCs with the parameter "Bad CRC". An event shall be triggered if the number of bad CRCs is equal or larger than "Bad CRC".

At the time when the event is triggered a pending time after trigger timer is started with the length of "Pending after trigger" CRCs. A new event can not be triggered until "Pending after trigger" CRCs have been received. When "Pending after trigger" CRCs have been received the event evaluation start again and a new event can be triggered.

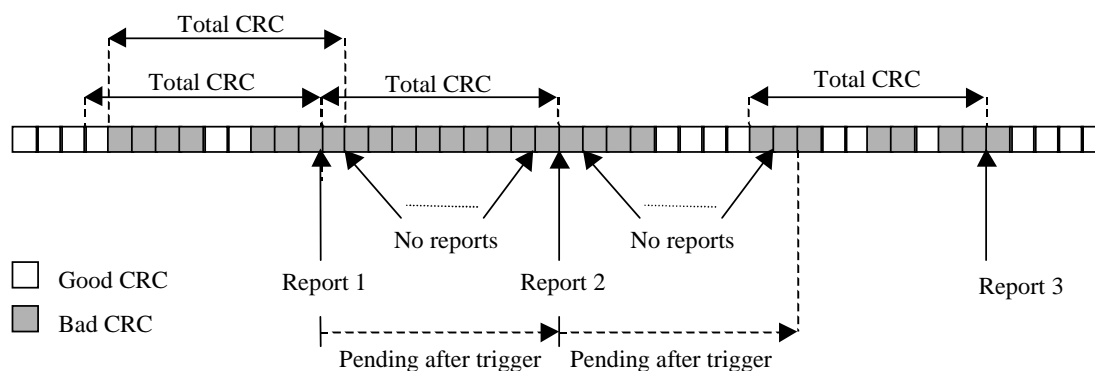

Figure 14.5.2.1-1: Event triggered CRC error reporting

14.6 UE internal measurements

14.6.1 UE internal measurement quantities

For UE internal measurements the following measurement quantities exist:

1. UE transmission (Tx) power, for TDD measured on a timeslot basis.
2. UE received signal strength power (RSSI).
3. UE Rx-Tx time difference (FDD only).
4. T_{ADV} (1.28 Mcps TDD).

14.6.2 UE internal measurement reporting events

In the Measurement reporting criteria field in the Measurement Control messages, the UTRAN notifies the UE of which events should trigger a measurement report. UE internal measurement reporting events that can trigger a report are given below. The reporting events are marked with vertical arrows in the figures below. All events can be combined with time-to-trigger.

NOTE: The reporting events are numbered 6A, 6B, 6C,.. where 6 denotes that the event belongs to the type UE internal measurements.

When one measurement identity corresponds to multiple internal events with identical event identities, the UE behaviour is not defined.

14.6.2.1 Reporting event 6A: The UE Tx power becomes larger than an absolute threshold

When a UE internal measurement configuring event 6a is set up, the UE shall:

- 1> create a variable TRIGGERED_6A_EVENT related to that measurement, which shall initially be set to FALSE;
- 1> delete this variable when the measurement is released.

When this event is ordered by UTRAN in a measurement control message, the UE shall:

- 1> if the UE Tx power (for TDD within a single TS) is greater than the value in IE "UE Transmitted Power Tx power threshold" stored for this event in the variable MEASUREMENT_IDENTITY for a time period indicated by the IE "time_to_trigger":
 - 2> if the variable TRIGGERED_6A_EVENT is set to FALSE:
 - 3> set the variable TRIGGERED_6A_EVENT to TRUE;
 - 3> send a measurement report with IEs set as below:
 - 4> set in "UE internal measurement event results": "UE internal event identity" to "6a";
 - 4> set the IE "measured results" and the IE "additional measured results" according to 8.4.2.
 - 1> if the variable TRIGGERED_6A_EVENT is set to TRUE and if the UE Tx power (for TDD within a single TS) is less or equal the value in IE "UE Transmitted Power Tx power threshold" stored for this event in the variable MEASUREMENT_IDENTITY:
 - 2> set the variable TRIGGERED_6A_EVENT to FALSE.

14.6.2.2 Reporting event 6B: The UE Tx power becomes less than an absolute threshold

When a UE internal measurement configuring event 6b is set up, the UE shall:

- 1> create a variable TRIGGERED_6B_EVENT related to that measurement, which shall initially be set to FALSE;
- 1> delete this variable when the measurement is released.

When this event is ordered by UTRAN in a measurement control message, the UE shall:

- 1> if the UE Tx power (for TDD within a single TS) is less than the value in IE "UE Transmitted Power Tx power threshold" stored for this event in the variable MEASUREMENT_IDENTITY for a time period indicated by the IE "time_to_trigger":
 - 2> if the variable TRIGGERED_6B_EVENT is set to FALSE:
 - 3> set the variable TRIGGERED_6B_EVENT to TRUE;
 - 3> send a measurement report with IEs set as below:
 - 4> set in "UE internal measurement event results": "UE internal event identity" to "6b";
 - 4> set the IE "measured results" and the IE "additional measured results" according to 8.4.2.
 - 1> if the variable TRIGGERED_6B_EVENT is set to TRUE and if the UE Tx power (for TDD within a single TS) is greater or equal the value in IE "UE Transmitted Power Tx power threshold" stored for this event in the variable MEASUREMENT_IDENTITY:
 - 2> set the variable TRIGGERED_6B_EVENT to FALSE.

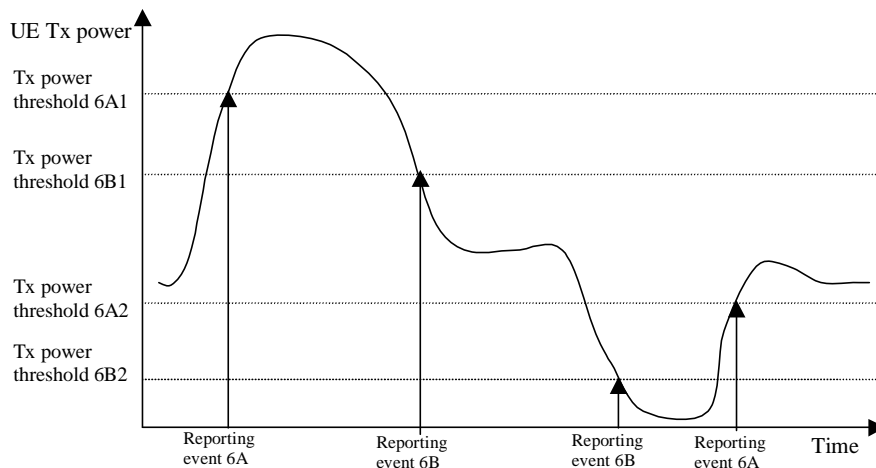

Figure 14.6.2.2-1: Event-triggered measurement reports when the UE Tx power becomes larger or less than absolute thresholds

14.6.2.3 Reporting event 6C: The UE Tx power reaches its minimum value

When a UE internal measurement configuring event 6c is set up, the UE shall:

- 1> create a variable TRIGGERED_6C_EVENT related to that measurement, which shall initially be set to FALSE;
- 1> delete this variable when the measurement is released.

When this event is ordered by UTRAN in a measurement control message, the UE shall:

- 1> if the UE Tx power is equal its minimum value (for TDD its minimum value on a single TS) for a time period indicated by the IE "time_to_trigger":
 - 2> if the variable TRIGGERED_6C_EVENT is set to FALSE:
 - 3> set the variable TRIGGERED_6C_EVENT to TRUE;
 - 3> send a measurement report with IEs set as below:
 - 4> set in "UE internal measurement event results": "UE internal event identity" to "6c";
 - 4> set the IE "measured results" and the IE "additional measured results" according to 8.4.2.
 - 1> if the variable TRIGGERED_6C_EVENT is set to TRUE and if the UE Tx power is greater than its minimum value:
 - 2> set the variable TRIGGERED_6C_EVENT to FALSE.

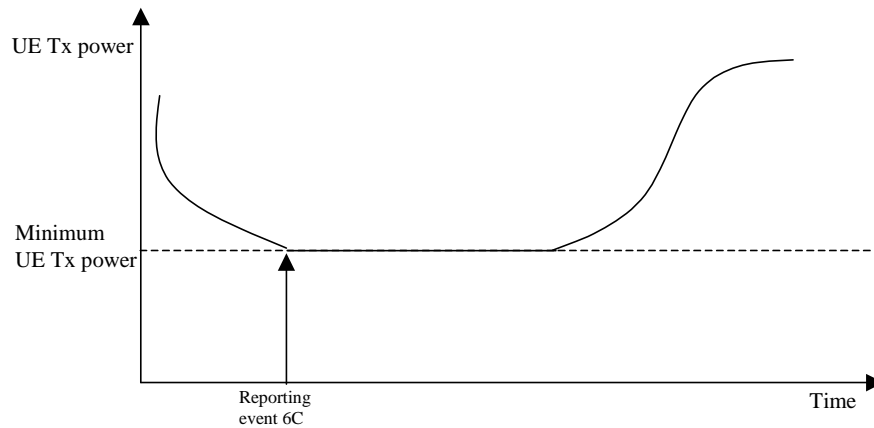

Figure 14.6.2.3-1: Event-triggered measurement report when the UE Tx power reaches its minimum value

14.6.2.4 Reporting event 6D: The UE Tx power reaches its maximum value

When a UE internal measurement configuring event 6d is set up, the UE shall:

- 1> create a variable TRIGGERED_6D_EVENT related to that measurement, which shall initially be set to FALSE;
- 1> delete this variable when the measurement is released.

When this event is ordered by UTRAN in a measurement control message, the UE shall:

- 1> if the UE Tx power equals the maximum power the UE can transmit, i.e. the maximum UE TX power reduced by the power reduction used by the UE (for TDD its maximum value on a single TS) for a time period indicated by the IE "time_to_trigger":
 - 2> if the variable TRIGGERED_6D_EVENT is set to FALSE:
 - 3> set the variable TRIGGERED_6D_EVENT to TRUE;
 - 3> send a measurement report with IEs set as below:
 - 4> set in "UE internal measurement event results": "UE internal event identity" to "6d";
 - 4> set the IE "measured results" and the IE "additional measured results" according to 8.4.2.
 - 1> if the variable TRIGGERED_6D_EVENT is set to TRUE and if the UE Tx power is less than the maximum UE TX power:
 - 2> set the variable TRIGGERED_6D_EVENT to FALSE.

NOTE: The maximum UE TX power is defined in subclause 8.6.6.8 and the maximum allowed power reduction is defined in subclause 6.2.2 in [21].

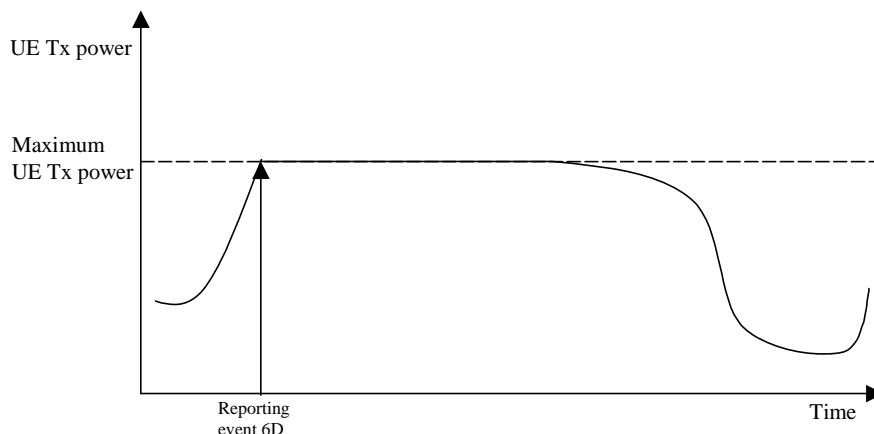

Figure 14.6.2.4-1: Event-triggered report when the UE Tx power reaches its maximum value

14.6.2.5 Reporting event 6E: The UE RSSI reaches the UE's dynamic receiver range

When a UE internal measurement configuring event 6e is set up, the UE shall:

- 1> create a variable TRIGGERED_6E_EVENT related to that measurement, which shall initially be set to FALSE;
- 1> delete this variable when the measurement is released.

When this event is ordered by UTRAN in a measurement control message, the UE shall:

- 1> if the UE RSSI is greater or equal the UE's dynamic receiver range for a time period indicated by the IE "time_to_trigger":
 - 2> if the variable TRIGGERED_6E_EVENT is set to FALSE:
 - 3> set the variable TRIGGERED_6E_EVENT to TRUE;
 - 3> send a measurement report with IEs set as below:
 - 4> set in "UE internal measurement event results": "UE internal event identity" to "6e";
 - 4> set the IE "measured results" and the IE "additional measured results" according to subclause 8.4.2.
 - 1> if the variable TRIGGERED_6E_EVENT is set to TRUE and if the UE RSSI is less than the UE's dynamic receiver range:
 - 2> set the variable TRIGGERED_6E_EVENT to FALSE.

14.6.2.6 Reporting event 6F (FDD): The UE Rx-Tx time difference for a RL included in the active set becomes larger than an absolute threshold

When a UE internal measurement configuring event 6f is set up, the UE shall:

- 1> create a variable TRIGGERED_6F_EVENT related to that measurement, which shall initially be set to FALSE for each RL;
- 1> delete this variable when the measurement is released.

When this event is ordered by UTRAN in a measurement control message, the UE shall:

- 1> if the UE Rx-Tx time difference for a RL included in the active set is greater than the value in the IE "UE Rx-Tx time difference threshold" stored for this event in the variable MEASUREMENT_IDENTITY for a time period indicated by the IE "time_to_trigger":
 - 2> if the variable TRIGGERED_6F_EVENT is set to FALSE for this RL:

- 3> set the variable TRIGGERED_6F_EVENT to TRUE for this RL;
- 3> send a measurement report with IEs set as below:
 - 4> set in "UE internal measurement event results": "UE internal event identity" to "6f";
 - 4> set the IE "measured results" and the IE "additional measured results" according to subclause 8.4.2.
- 1> if the variable TRIGGERED_6F_EVENT is set to TRUE for a RL and if the UE RX-Tx time difference for this RL included in the active set is less than or equal to the value in the IE "UE Rx-Tx time difference threshold" stored for this event in the variable MEASUREMENT_IDENTITY:
 - 2> set the variable TRIGGERED_6F_EVENT to FALSE for this RL.

14.6.2.6a Reporting event 6F (1.28 Mcps TDD): The time difference indicated by T_{ADV} becomes larger than an absolute threshold

When a UE internal measurement configuring event 6f is set up, the UE shall:

- 1> create a variable TRIGGERED_6F_EVENT related to that measurement, which shall initially be set to the currently measured T_{ADV} ;
- 1> delete this variable when the measurement is released.

When this event is ordered by UTRAN in a measurement control message, the UE shall:

- 1> if the absolute value of the difference between the measured T_{ADV} and the T_{ADV} stored in the variable TRIGGERED_6F_EVENT is greater than the predefined threshold configured with the IE "T_{ADV} Threshold" for this event in the variable MEASUREMENT_IDENTITY for a time period indicated by the IE "time_to_trigger":
 - 2> set the variable TRIGGERED_6F_EVENT to the currently measured T_{ADV} ;
 - 2> send a measurement report with IEs set as below:
 - 3> set the IE "T_{ADV}" to the measured value, and the IE "SFN" to the SFN during which the latest measurement was performed, in the IE "T_{ADV} Info";
 - 3> set the IE "measured results" and the IE "additional measured results" according to subclause 8.4.2.

14.6.2.7 Reporting event 6G: The UE Rx-Tx time difference for a RL included in the active set becomes less than an absolute threshold

When a UE internal measurement configuring event 6g is set up, the UE shall:

- 1> create a variable TRIGGERED_6G_EVENT related to that measurement, which shall initially be set to FALSE for each RL;
- 1> delete this variable when the measurement is released.

When this event is ordered by UTRAN in a measurement control message, the UE shall:

- 1> if the UE Rx-Tx time difference for a RL included in the active set is less than the value in IE "UE Rx-Tx time difference threshold" stored for this event in the variable MEASUREMENT_IDENTITY for a time period indicated by the IE "time_to_trigger":
 - 2> if the variable TRIGGERED_6G_EVENT is set to FALSE for this RL:
 - 3> set the variable TRIGGERED_6G_EVENT to TRUE for this RL;
 - 3> send a measurement report with IEs set as below:
 - 4> set in "UE internal measurement event results": "UE internal event identity" to "6g";
 - 4> set the IE "measured results" and the IE "additional measured results" according to subclause 8.4.2.

1> if the variable TRIGGERED_6G_EVENT is set to TRUE for a RL and if the UE RX-Tx time difference for this RL included in the active set is greater or equal the value in IE "UE Rx-Tx time difference threshold" stored for this event in the variable MEASUREMENT_IDENTITY:

2> set the variable TRIGGERED_6G_EVENT to FALSE for this RL.

14.7 UE positioning measurements

14.7.1 UE positioning measurement quantities

The quantity to measure for UE positioning is dependent on the positioning method and the method type requested in the IE "UE positioning reporting quantity".

- 1 SFN-SFN observed time difference type 2, optional.
- 2 Rx-Tx time difference type 2, optional.
- 3 GPS timing of cell frames, optional.

The definition of other GPS measurements is not within the scope of this specification.

14.7.2 Void

14.7.3 UE positioning reporting events

In the IE "UE positioning reporting criteria" in the Measurement Control messages, the UTRAN notifies the UE of which events should trigger a measurement report. UE positioning reporting events that can trigger a report are given below. The content of the measurement report is dependant on the positioning method and method type requested in the IE "UE positioning reporting quantity" of the Measurement Control message and is described in detail in [18].

When one measurement identity corresponds to multiple positioning events with identical event identities, the UE behaviour is not defined.

14.7.3.1 Reporting Event 7a: The UE position changes more than an absolute threshold

This event is used for UE-based methods only.

When this event is ordered by UTRAN in a measurement control message, the UE shall:

- 1> if the UE changes its position compared to the last reported position by more than the threshold defined by the IE "Threshold position change"; or
- 1> if no position has been reported since the event was configured and the UE changes its position compared to the first position estimate obtained after the event was configured by more than the threshold defined by the IE "Threshold position change":
 - 2> send a measurement report as specified in subclause 8.6.7.19.1b;
 - 2> if the value of IE "Amount of Reporting" in variable MEASUREMENT_IDENTITY for this event is greater than zero:
 - 3> decrease IE "Amount of Reporting" in variable MEASUREMENT_IDENTITY for this event by one.
 - 2> if the value of IE "Amount of Reporting" in variable MEASUREMENT_IDENTITY for this event is equal to zero:
 - 3> delete this event from the list of events in variable MEASUREMENT_IDENTITY.
- 1> if the UE is unable to evaluate the event because a position measurement is not available:
 - 2> not send a report.

14.7.3.2 Reporting Event 7b: SFN-SFN measurement changes more than an absolute threshold

When this event is ordered by UTRAN in a measurement control message, the UE shall:

- 1> send a measurement report when the SFN-SFN time difference measurement type 2 of any measured cell changes more than the threshold defined by the IE "Threshold SFN-SFN change"; and
- 1> if UTRAN set IE "Method Type" in "UE positioning reporting quantity" in the MEASUREMENT CONTROL message to "UE-based":
 - 2> act as specified in subclause 8.6.7.19.1b.
- 1> if UTRAN set IE "Method Type" in "UE positioning reporting quantity" in the MEASUREMENT CONTROL message to "UE-assisted":
 - 2> act as specified in subclause 8.6.7.19.1a.
- 1> if UTRAN set IE "Method Type" in "UE positioning reporting quantity" in the MEASUREMENT CONTROL message to "UE-assisted preferred but UE-based allowed" or "UE-based preferred but UE-assisted allowed":
 - 2> the UE may choose to act according to either subclause 8.6.7.19.1a or 8.6.7.19.1b.
- 1> if the value of IE "Amount of Reporting" in variable MEASUREMENT_IDENTITY for this event is greater than zero:
 - 2> decrease IE "Amount of Reporting" in variable MEASUREMENT_IDENTITY for this event by one.
- 1> if the value of IE "Amount of Reporting" in variable MEASUREMENT_IDENTITY for this event is equal to zero:
 - 2> delete this event from the list of events in variable MEASUREMENT_IDENTITY.

14.7.3.3 Reporting Event 7c: GPS time and SFN time have drifted apart more than an absolute threshold

When this event is ordered by UTRAN in a measurement control message, the UE shall:

- 1> send a measurement report when the GPS Time Of Week and the SFN timer have drifted apart more than the threshold defined by the IE "Threshold SFN-GPS TOW"; and
- 1> if UTRAN set IE "Method Type" in "UE positioning reporting quantity" in the MEASUREMENT CONTROL message to "UE based":
 - 2> act as specified in subclause 8.6.7.19.1b.
- 1> if UTRAN set IE "Method Type" in "UE positioning reporting quantity" in the MEASUREMENT CONTROL message to "UE assisted":
 - 2> act as specified in subclause 8.6.7.19.1a.
- 1> if UTRAN set IE "Method Type" in "UE positioning reporting quantity" in the MEASUREMENT CONTROL message to "UE assisted preferred but UE based allowed" or "UE based preferred but UE assisted allowed":
 - 2> act as specified in subclause 8.6.7.19.1a or in subclause 8.6.7.19.1b depending on the method type chosen by the UE.
- 1> if the value of IE "Amount of Reporting" in variable MEASUREMENT_IDENTITY for this event is greater than zero:
 - 2> decrease IE "Amount of Reporting" in variable MEASUREMENT_IDENTITY for this event by one.
- 1> if the value of IE "Amount of Reporting" in variable MEASUREMENT_IDENTITY for this event is equal to zero:
 - 2> delete this event from the list of events in variable MEASUREMENT_IDENTITY.

14.7.3.4 Reporting Event 7d: GANSS time and SFN time have drifted apart more than an absolute threshold

When this event is ordered by UTRAN in a measurement control message, the UE shall:

- 1> send a measurement report when the GANSS Time Of Week and the SFN timer have drifted apart more than the threshold defined by the IE "Threshold SFN-GANSS TOW"; and
- 1> if UTRAN set IE "Method Type" in "UE positioning reporting quantity" in the MEASUREMENT CONTROL message to "UE based":
 - 2> act as specified in subclause 8.6.7.19.1b.
- 1> if UTRAN set IE "Method Type" in "UE positioning reporting quantity" in the MEASUREMENT CONTROL message to "UE assisted":
 - 2> act as specified in subclause 8.6.7.19.1a.
- 1> if UTRAN set IE "Method Type" in "UE positioning reporting quantity" in the MEASUREMENT CONTROL message to "UE assisted preferred but UE based allowed" or "UE based preferred but UE assisted allowed":
 - 2> act as specified in subclause 8.6.7.19.1a or in subclause 8.6.7.19.1b depending on the method type chosen by the UE.
- 1> if the value of IE "Amount of Reporting" in variable MEASUREMENT_IDENTITY for this event is greater than zero:
 - 2> decrease IE "Amount of Reporting" in variable MEASUREMENT_IDENTITY for this event by one.
- 1> if the value of IE "Amount of Reporting" in variable MEASUREMENT_IDENTITY for this event is equal to zero:
 - 2> delete this event from the list of events in variable MEASUREMENT_IDENTITY.

14.7a Measurements related to CSG/Hybrid cells

14.7a.1 Intra-frequency measurements for CSG/Hybrid cells

For each cell reported in the IE "Cell measured results" of an intra-frequency Measurement Report, which is also included in the IE "Intra-frequency SI Acquisition" associated with the measurement:

- 1> if the UE managed to acquire the valid system information of the concerned cell:
 - 2> include the following IEs in the IE "Cell measured results":
 - 3> "Cell Identity" IE.
 - 3> if the concerned cell broadcasts a CSG identity:
 - 4> "CSG Identity" IE.
 - 4> if the concerned cell is CSG member cell:
 - 5> "CSG Member indication" IE and set it to "member";
 - 5> "CSG PLMN Identity" IE of all PLMNs broadcast that fulfil the CSG member cell definition.

The system information of the reported cell(s) can be acquired by the UE without any measurement gaps.

14.7a.2 Inter-frequency measurements for CSG/Hybrid cells

For each cell reported in the IE "Cell measured results" of an inter-frequency Measurement Report, which is also included in the IE "Inter-frequency SI Acquisition" associated with the measurement:

- 1> if the UE managed to acquire the system information of the concerned cell:
 - 2> include the following IEs in the IE "Cell measured results":
 - 3> "Cell Identity" IE;
 - 3> if the concerned cell broadcasts a CSG identity:
 - 4> "CSG Identity" IE.
 - 4> if the concerned cell is CSG member cell:
 - 5> "CSG Member indication" IE and set it to "member";
 - 5> "CSG PLMN Identity" IE of all PLMNs broadcast that fulfil the CSG member cell definition.

If the UE needs measurement gaps to read the system information on the non-used frequency, the system information of the reported cell can be acquired by the UE via autonomous measurement gaps when the IE "Inter-frequency SI Acquisition" is received by the UE, i.e., UE is allowed to temporarily abort communication with the serving cell to perform SI acquisition within the limits as specified in [19]. UE shall send the measurement report before the maximum provided time specified in IE "Periodical reporting criteria" if the UE is able to acquire SI early.

14.7a.3 CSG Proximity detection

The UE shall:

- 1> if the IE "UTRA CSG Proximity detection" is present and has the value "enable":
 - 2> enable the proximity detection function of entering or leaving the proximity of UTRA CSG member cell(s) .
- 1> else:
 - 2> disable the proximity detection function of entering or leaving the proximity of UTRA CSG member cell(s) .
- 1> if the IE "E-UTRA CSG Proximity detection" is present and has the value "enable":
 - 2> enable the proximity detection function of entering or leaving the proximity of E-UTRA CSG member cell(s) .
- 1> else:
 - 2> disable the proximity detection function of entering or leaving the proximity of E-UTRA CSG member cell(s) .

14.7a.4 CSG Proximity Indication

If proximity detection function is enabled for a RAT, the UE shall initiate the transmission and set the contents of IE "CSG Proximity Indication" in the MEASUREMENT REPORT message as follows:

- 1> if the UE is aware that it is in the proximity of one or more CSG member cell(s) on a frequency of the enabled RAT, the UE shall:
 - 2> if the UE has not transmitted a "CSG Proximity Indication" for the RAT and frequency since the enabling of proximity detection function, or

- 2> if the last "CSG Proximity Indication" transmitted for the concerned RAT and frequency was a leaving indication, and more than 5 s has elapsed since its transmission,
 - 3> set the IE "CSG Proximity Indication" to "entering";
 - 3> set the IE "CSG Frequency info for UTRA" or "CSG Frequency info for E-UTRA " to the frequency of the cell(s) for which the Proximity Indication was triggered.
- 1> if the UE leaves the proximity of all the CSG member cell(s) on a frequency of the enabled RAT, the UE shall:
 - 2> if the last "CSG Proximity Indication" transmitted for the concerned RAT and frequency was an entering indication, and more than 5 s has elapsed since its transmission,
 - 3> set the IE "CSG Proximity Indication" to "leaving";
 - 3> set the IE "CSG Frequency info for UTRA" or "CSG Frequency info for E-UTRA" to the frequency of the cell(s) for which the Proximity Indication was triggered.

14.7a.5 E-UTRA measurements for CSG/Hybrid cells

For each cell reported in the IE "E-UTRA measured results" of an E-UTRA inter-RAT Measurement Report, which is also included in the IE "E-UTRA SI Acquisition" associated with the measurement:

- 1> if the UE acquired the system information of the concerned cell:
 - 2> include the following IEs in the IE "E-UTRA Results for SI Acquisition":
 - 3> "CGI-Info" IE;
 - 3> if the concerned cell broadcasts a CSG identity:
 - 4> "CSG Identity" IE;
 - 4> if the concerned cell is CSG member cell:
 - 5> "CSG Member indication" IE and set it to "member";
 - 5> "Primary PLMN Suitable" if the Primary PLMN Identity meets the CSG member cell definition;
 - 5> "CSG PLMN Identity" IE of all other PLMNs broadcast that fulfil the CSG member cell definition.

If the UE needs measurement gaps to read the system information on the E-UTRA cell, the system information of the reported cell can be acquired by the UE via autonomous measurement gaps when the IE "E-UTRA SI Acquisition" is received by the UE, i.e., UE is allowed to temporarily abort communication with the serving cell to perform SI acquisition within the limits as specified in [74]. UE shall send the measurement report before the maximum provided time specified in IE "Periodical reporting criteria" if the UE is able to acquire SI early.

14.8 Void

14.9s Downlink power control

14.9.1 Generalities

This function is implemented in the UE in order to set the SIR target value on each CCTrCH used for the downlink power control. This SIR value shall be adjusted according to an autonomous function in the UE in order to achieve the same measured quality as the quality target set by UTRAN. The quality target is set as the transport channel BLER value for each transport channel as signalled by UTRAN.

When transport channel BLER is used the UE shall run a quality target control loop such that the quality requirement is met for each transport channel, which has been assigned a BLER target.

The UE shall set the SIR target when the physical channel has been set up or reconfigured. It shall not increase the SIR target value before the power control has converged on the current value. The UE may estimate whether the power control has converged on the current value, by comparing the averaged measured SIR to the SIR target value.

NOTE: The power control function for F-DPCH is specified in [29].

14.9.2 Downlink power control in compressed mode

In compressed mode, the target SIR needs to be changed in several frames compared to normal mode. For this purpose, four values ΔSIR_1 , $\Delta\text{SIR}_{\text{after}1}$, ΔSIR_2 and $\Delta\text{SIR}_{\text{after}2}$ are signalled by the UTRAN to the UE (see subclause 10.3.6.33).

For each frame, the target SIR offset during compressed mode, compared to normal mode is:

$$\Delta\text{SIR} = \max(\Delta\text{SIR}_{1_compression}, \dots, \Delta\text{SIR}_{n_compression}) + \Delta\text{SIR}_{1_coding} + \Delta\text{SIR}_{2_coding}$$

where n is the number of TTI lengths for all TrChs of the CCTrCh, F_i is the length in number of frames of the i -th TTI and where $\Delta\text{SIR}_{coding}$ fulfils:

- $\Delta\text{SIR}_{1_coding} = \Delta\text{SIR}_1$ if the start of the first transmission gap in the transmission gap pattern is within the current frame.
- $\Delta\text{SIR}_{1_coding} = \Delta\text{SIR}_{\text{after}1}$ if the current frame just follows a frame containing the start of the first transmission gap in the transmission gap pattern.
- $\Delta\text{SIR}_{2_coding} = \Delta\text{SIR}_2$ if the start of the second transmission gap in the transmission gap pattern is within the current frame.
- $\Delta\text{SIR}_{2_coding} = \Delta\text{SIR}_{\text{after}2}$ if the current frame just follows a frame containing the start of the second transmission gap in the transmission gap pattern.
- $\Delta\text{SIR}_{1_coding} = 0$ and $\Delta\text{SIR}_{2_coding} = 0$ otherwise.

and $\Delta\text{SIR}_{i_compression}$ is defined by :

- $\Delta\text{SIR}_{i_compression} = 3$ dB for downlink frames compressed by reducing the spreading factor by 2.
- $\Delta\text{SIR}_{i_compression} = 0$ dB in all other cases.

Several compressed mode patterns applying to the same frames should be avoided as much as possible.

In case several compressed mode patterns are used simultaneously, a ΔSIR offset is computed for each compressed mode pattern and the sum of all ΔSIR offsets is applied to the frame.

14.10 Calculated Transport Format Combination

The Calculated Transport Format Combination (CTFC) is a tool for efficient signalling of transport format combinations.

Let I be the number of transport channels that are included in the transport format combination. For DCHs, all configured DCHs are included in the transport format combination. Each transport channel TrCH_i , $i = 1, 2, \dots, I$, has L_i transport formats, i.e. the transport format indicator TFI_i can take L_i values, $\text{TFI}_i \in \{0, 1, 2, \dots, L_i - 1\}$.

Define $P_i = \prod_{j=0}^{i-1} L_j$, where $i = 1, 2, \dots, I$, and $L_0 = 1$.

Let $\text{TFC}(\text{TFI}_1, \text{TFI}_2, \dots, \text{TFI}_I)$ be the transport format combination for which TrCH_1 has transport format TFI_1 , TrCH_2 has transport format TFI_2 , etc. The corresponding $\text{CTFC}(\text{TFI}_1, \text{TFI}_2, \dots, \text{TFI}_I)$ is then computed as:

$$CTFC(TFI_1, TFI_2, \dots, TFI_I) = \sum_{i=1}^I TFI_i \cdot P_i.$$

For FACH and PCH transport channels, "TrCH₁" corresponds to the transport channel listed at the first position in IE "FACH/PCH information" in IE "Secondary CCPCH System Information", "TrCH₂" corresponds to the transport channel listed at the second position in IE "FACH/PCH information" and so on.

For all other transport channels in FDD and for all configured transport channels of the same transport channel type (i.e. DCH, DSCH, USCH) in TDD, "TrCH₁" corresponds to the transport channel having the lowest transport channel identity in the transport format combination mapped to the TFCI field. "TrCH₂" corresponds to the transport channel having the next lowest transport channel identity, and so on.

14.10.1 Default TFCS for MBMS

14.10.1.1 S-CCPCH configuration including a FACH carrying MSCH

In case the S-CCPCH configuration includes a FACH carrying MSCH, the default TFCS is defined according to the following:

Let TrCH 1 be the FACH carrying MSCH, TrCH 2 be the first TrCH carrying MTCH listed in the IE "TrCh information list", TrCH 3 be the second TrCH carrying MTCH listed in the IE "TrCh information list" etc. and let TrCH I be the last TrCH carrying MTCH listed in the IE "TrCh information list".

Each transport channel TrCH_{*i*}, *i* = 1, 2, ..., *I*, has *L_i* transport formats, i.e. the transport format indicator TFI_{*i*} can take *L_i* values.

Each transport format combination set is defined by the transport formats of each transport channel mapped on this S-CCPCH:

$$TFC = (TFI_1, TFI_2, \dots, TFI_I).$$

The "MBMS implicit TFCS" contains then the following set of TFCs:

$$\begin{aligned} \text{TFCS} = \{ & (0,0,\dots,0), (0,1,\dots,0), \dots, (0,L_2,\dots,0), (0,0,1,\dots,0), \dots, (0,0,L_3,\dots,0), \dots, (0,0,0,\dots,1), \dots, (0,0,0,\dots,L_I), \\ & (1,0,\dots,0), (1,1,\dots,0), \dots, (1,L_2,\dots,0), (1,0,1,\dots,0), \dots, (1,0,L_3,\dots,0), \dots, (1,0,0,\dots,1), \dots, (1,0,0,\dots,L_I), \\ & (2,0,\dots,0), \dots, (L_1,0,\dots,0) \} \end{aligned}$$

14.10.1.2 S-CCPCH configuration not including a FACH carrying MSCH

In case the S-CCPCH configuration does not include a FACH carrying MSCH, the default TFCS is defined according to the following:

Let TrCH 1 be the first TrCH listed in the IE "TrCh information list", TrCH 2 be the second TrCH listed in the IE "TrCh information list" etc. and let TrCH I be the last TrCH listed in the IE "TrCh information list".

Each transport channel TrCH_{*i*}, *i* = 1, 2, ..., *I*, has *L_i* transport formats, i.e. the transport format indicator TFI_{*i*} can take *L_i* values.

Each transport format combination set is defined by the transport formats of each transport channel mapped on this S-CCPCH:

$$TFC = (TFI_1, TFI_2, \dots, TFI_I).$$

The "MBMS implicit TFCS" contains then the following set of TFCs:

$$\text{TFCS} = \{ (0,\dots,0), (1,\dots,0), \dots, (L_1,\dots,0), (0,1,\dots,0), \dots, (0,L_2,\dots,0), \dots, (0,0,\dots,1), \dots, (0,0,\dots,L_I) \}$$

14.11 UE autonomous update of virtual active set on non-used frequency (FDD only)

In the text that follows:

- a "non-used frequency" is a frequency that the UE has been ordered to measure upon but is not used for the connection. A "used frequency" is a frequency that the UE has been ordered to measure upon and is also currently used for the connection;
- a "non-used frequency (resp. cell) considered in an inter-frequency measurement" shall be understood as a non-used frequency (resp. cell) included in the list of cells pointed at in the IE "cells for measurement" if it was received for that measurement, or otherwise as a non-used frequency (resp. cell) included in the "Inter-frequency cell info" part of the variable CELL_INFO_LIST.

For event-triggered inter frequency measurements it is possible to use intra-frequency measurement reporting events for support of maintenance of an active set associated with a non-used frequency considered in that measurement, a "virtual active set" and used in the evaluation of the frequency quality estimates. The "initial virtual active set" for a frequency is the virtual active set that is associated to that frequency just after a message was received that sets up or modifies the inter-frequency measurement.

The way the virtual active sets are initiated and updated for the non-used frequencies considered in an inter-frequency measurement is described in the two subclauses below.

The UE shall support a single virtual active set per non-used frequency for non-CSG measurements if detected set cells are not considered for that frequency.

The UE shall support two virtual active sets per non-used frequency for non-CSG measurements if detected set cells are considered for that frequency – both virtual active sets are maintained using the same rules, and in parallel, however the first virtual active set is maintained considering only cells stored in CELL_INFO_LIST, and the second virtual active set is maintained additionally considering any detected cells (cells stored in CELL_INFO_LIST and cells not stored in CELL_INFO_LIST) and excluding cells indicated in IE "Cells to be excluded in non-used frequency detected cells". This is in order to allow the UE to determine whether or not detected set cells affect the measurement event result. In the following subclauses, the term "virtual active set" applies to both of these virtual active sets (i.e. the virtual active set not containing detected set cells, and the virtual active set containing detected set cells). Elsewhere in the specification, unless stated otherwise, the term "virtual active set" is used to refer to the virtual active set not containing detected set cells.

If any measurement is configured for CSG cells (using CELL_INFO_CSG_LIST) then the UE shall additionally maintain a "CSG virtual active set" for this purpose.

The virtual active set is not initialised and maintained for an inter frequency measurement with periodic reporting. A virtual active set initialised and maintained by another inter-frequency measurement does not affect reporting of the periodic inter-frequency measurement.

14.11.1 Initial virtual active set

If the UE receives a MEASUREMENT CONTROL message that sets up or modifies an inter-frequency measurement and includes the IE "Inter-frequency set update"; or

If at least one cell can be measured on a non-used frequency for which the current virtual active set is empty (see subclause 14.11.2), the UE shall:

- 1> for each non-used frequency F_i considered in the measurement where cells can be measured:
- 2> if event 1a is configured for the used frequency in an intra-frequency measurement and the CSG virtual active set is not used:
- 3> include in the initial virtual active set the N_i cells that have either the greatest downlink E_c/N_0 or the greatest downlink RSCP after despreading or the lowest pathloss (the measurement quantity to be used is determined by the IE "intra-frequency measurement quantity" of the intra-frequency measurement from which the event 1a configuration is taken), among the cells on frequency F_i considered in that inter-frequency measurement, where:

$$N_i = \min(N_{1a}, N_{Cells\ F_i}) \text{ if } N_{1a} \neq 0 \text{ and } N_i = N_{Cells\ F_i} \text{ otherwise.}$$

where:

N_{1a} is the "Reporting deactivation threshold" included in the intra-frequency measurement for the first event 1a defined in the intra-frequency measurement with the lowest identity at the time the inter-frequency measurement was received with the IE "Inter-frequency set update" present.

$N_{Cells\ F_i}$ is the number of cells on frequency F_i considered in that inter-frequency measurement.

- 2> else if the CSG virtual active set is used and event 1c is configured for the used frequency in an intra-frequency measurement:
- 3> include in the initial CSG virtual active set 1 cell that has either the greatest downlink E_c/N_0 or the greatest downlink RSCP after despreading or the lowest pathloss (the measurement quantity to be used is determined by the IE "intra-frequency measurement quantity" of the intra-frequency measurement from which the event 1c configuration is taken), among the cells on frequency F_i in CELL_INFO_CSG_LIST.

$$N_i = 1$$

2> else:

$$N_i = N_{Cells\ F_i}$$

where:

$N_{Cells\ F_i}$ is the number of cells on frequency F_i considered in that inter-frequency measurement.

- NOTE1: The UE initialises the virtual active set with up to the maximum number of inter-frequency cells supported by the UE as defined in [19].
- NOTE2: If the UTRAN configures more than one measurement using events 2A, 2B, 2C or 2E the UE measurement capabilities may be exceeded due to the necessary copying of 1A, 1B, 1C criteria. To avoid this the UTRAN may configure one measurement to apply to multiple frequencies so that the 1A, 1B, and 1C criteria will only be copied once.
- NOTE3: After a hard handover (see subclause 8.3.5), if the MEASUREMENT CONTROL message that restarts an inter-frequency measurement using the virtual active set does not include the IE "Inter-frequency set update", the UE behaviour regarding the virtual active set is not specified.

14.11.2 Virtual active set update during an inter-frequency measurement

For an inter-frequency measurement, the UE shall:

- 1> apply the events of type 1a, 1b and 1c that were defined for the used frequency in other stored measurements of type "intra-frequency" at the time the inter-frequency measurement was last received with the IE "Inter-frequency set update" present; and
- 1> update the virtual active set for the non-used frequencies considered in that measurement according to the following rules:
 - 2> if several events of type 1c were defined for the used frequency when the inter-frequency measurement was last received with the IE "Inter-frequency set update" present, and the inter-frequency measurement applies to cells in the CELL_INFO_CSG_LIST then only the first 1c event that was defined in the measurement with the lowest measurement identity shall apply to the non-used frequencies and replace the "Replacement activation threshold" with 0 to update the CSG virtual active set;
 - 2> if several events of type 1a (resp. 1b,1c) were defined for the used frequency when the inter-frequency measurement was last received with the IE "Inter-frequency set update" present, only the first 1a event (resp.

1b, 1c) that was defined in the measurement with the lowest measurement identity shall apply to the non-used frequencies;

- 2> all the cells considered in the inter-frequency measurements shall be able to affect the reporting range for event 1a and 1b. (i.e. the IE "Cells forbidden to affect reporting range" possibly stored for the intra-frequency measurements on the used frequency does not apply to the non-used frequencies considered in the inter-frequency measurement);
- 2> the IEs "amount of reporting" and "reporting interval" that were stored for the intra-frequency measurements on the used frequency shall not be considered if reports of the virtual active set updates are needed.
- 2> the measurement quantity and filter coefficient to be used is determined by the IE "intra-frequency measurement quantity" of the intra-frequency measurement from which the intra-frequency event configuration is taken.

NOTE: If the measurement quantity and filter coefficients to be used differ for the 1a, 1b, and 1c events applied then the UE behaviour is unspecified.

- 1> if event 1a is applicable to the non-used frequencies considered in the inter-frequency measurement, always only consider monitored cells that are not in the virtual active set for this event, and:
 - 2> when this event is triggered (according to the criteria described in subclause 14.1.2.1) by a cell for a non-used frequency considered in that measurement:
 - 3> if the "Reporting deactivation threshold" is equal to 0, or if the "Reporting deactivation threshold" is different from 0 and the number of cells included in the virtual active set for that frequency is less than or equal to the "Reporting deactivation threshold":
 - 4> add the primary CPICH that enters the reporting range to the "virtual active set".
 - 2> if event 1b is applicable for the non-used frequencies considered in that inter-frequency measurement, always only consider cells in the virtual active set for this event, and when this event is triggered (according to the criteria described in subclause 14.1.2.2) by a cell for a non-used frequency considered in that measurement:
 - 3> if the number of cells included in the virtual active set is greater than 1:
 - 4> remove the primary CPICH that leaves the reporting range from the "virtual active set".
 - 2> if event 1c is applicable for the non-used frequencies considered in that inter-frequency measurement, always only consider monitored cells for this event, and when this event is triggered (according to the criteria described in subclause 14.1.2.3) by a cell for a non-used frequency considered in that measurement:
 - 3> if the "Replacement activation threshold" is equal to 0, or if the "Replacement activation threshold" is different from 0 and the number of cells included in the virtual active set for that frequency is greater than or equal to the "Replacement activation threshold":
 - 4> rank all active and non-active primary CPICHs and take the n best cells to create a new "virtual active set", where n is the number of active primary CPICHs in the "virtual active set".
- 1> if event 1c is applicable to the non-used frequencies considered in the inter-frequency measurement applying to cells in the CELL_INFO_CSG_LIST, always only consider cells in the CELL_INFO_CSG_LIST, and when this event is triggered (according to the criteria described in subclause 14.1.2.3) by a cell for a non-used frequency considered in that measurement :
 - 2> rank all active and non-active primary CPICHs and take the best cell to create a new "CSG virtual active set".
- 1> if Event 1a is not defined for the used frequency in other stored measurements of type "intra-frequency" at the time the inter-frequency measurement was set up and the CSG virtual active set is not used for the measurement:
 - 2> the UE shall continuously update the virtual active set to consist of all cells on frequency F_i considered in that inter-frequency measurement.

NOTE: The UE needs to only update the virtual active set with up to the maximum number of interfrequency cells supported by the UE as defined in [19].

If none of the cells that are considered in the measurement on this frequency were measured, the UE may treat the virtual active set as empty and follow the appropriate initialisation procedure in subclause 14.11.1 when any relevant cell can first be measured.

If a cell is a member of the virtual active set and is removed from the variable CELL_INFO_LIST or removed from the list of cells pointed at by the IE "Cells for measurement" for the inter-frequency measurement then the UE shall remove the cell from the virtual active set. (This rule is not applicable for the virtual active set which is used for evaluating detected set cells).

If an inter-frequency measurement that initialised a virtual active set is released, then any virtual active set associated with this measurement shall also be released.

14.12 Provision and reception of RRC information between network nodes

14.12.0 General

In certain cases, e.g., when performing handover to UTRAN or when performing SRNC relocation, RRC information may need to be transferred between UTRAN nodes, between UTRAN and another RAT, between nodes within another RAT or between the UE and another RAT.

The RRC information exchanged between network nodes or between the UE and another RAT is typically transferred by means of RRC information containers. An RRC information container is a self-contained and extensible RRC information unit that may be used to transfer a number of different RRC messages, one at a time. As stated before, RRC information containers may be used to transfer RRC messages across interfaces other than the Uu interface. The RRC messages that may be included in RRC information containers have similar characteristics as the RRC messages that are transferred across the Uu interface.

The RRC messages that are sent to/ from the UE, e.g., HANDOVER TO UTRAN COMMAND, INTER RAT HANDOVER INFO are covered by (sub)clauses 8, 9, 10, 11.0-11.4 and 12 of this specification. The following subclauses concern RRC messages exchanged between network nodes.

In future versions of this specification, it is possible to extend the RRC messages transferred across interfaces other than Uu. For these RRC messages the same extension mechanism applies as defined for RRC messages transferred across the Uu interface, as is specified in subclause 10.1, i.e., both critical and non-critical extensions may be added.

The transfer syntax for RRC information containers and RRC messages transferred between network nodes is derived from their ASN.1 definitions by use of Packed Encoding Rules, unaligned (X.691). It should be noted that the encoder adds final padding to achieve octet alignment. The resulting octet string is, carried in a container, transferred between the network nodes.

When using a separate RRC information container for each endpoint, the receiving RRC protocol entity is able to interpret the received container; this means that the receiver need not take into account information about the (network interface) message used in transferring the container.

The following encoding rules apply in addition to what has been specified in X.691 [49]:

- 1> When a bit string value is placed in a bit-field as specified in 15.6 to 15.11 in [11], the leading bit of the bit string value shall be placed in the leading bit of the bit-field, and the trailing bit of the bit string value shall be placed in the trailing bit of the bit-field.

NOTE: The terms "leading bit" and "trailing bit" are defined in ITU-T Rec. X.680 | ISO/IEC 8824-1. When using the "bstring" notation, the leading bit of the bit string value is on the left, and the trailing bit of the bit string value is on the right.

14.12.0a General error handling for RRC messages exchanged between network nodes

The error handling for RRC messages that are exchanged between network nodes applies the same principles as defined for other RRC messages.

Although the same principles apply for network nodes receiving unknown, unforeseen and erroneous RRC messages received in RRC information containers, the notification of the error should be done in a different manner, as specified in the following:

The network node receiving an invalid RRC message from another network node should:

- 1> if the received RRC message was unknown, unforeseen or erroneous:
 - 2> prepare an RRC FAILURE INFO message, including the IE "Failure cause" set to "Protocol error" and the IE "Protocol error information" including an IE "Protocol error cause" which should be set as follows:
 - 3> to "ASN.1 violation or encoding error" upon receiving an RRC message for which the encoded message does not result in any valid abstract syntax value;
 - 3> to "Message type non-existent or not implemented" upon receiving an unknown RRC message type;
 - 3> to "Message extension not comprehended" upon receiving an RRC message including an undefined critical message extension;
 - 3> to "Information element value not comprehended" upon receiving an RRC message including an mandatory IE for which no default value is defined and for which either the value is set to spare or for which the encoded IE does not result in a valid transfer syntax. The same applies for conditional IEs, for which the conditions for presence are met, the IE is present but has a value set to spare or for which the encoded IE does not result in a valid transfer syntax;
 - 3> to "Information element missing" upon receiving an RRC information container with an absent conditional IE for which the conditions for presence are met.
- 1> if there was another failure to perform the operation requested by the received RRC message:
 - 2> prepare an RRC FAILURE INFO message, including the IE "Failure cause" set to a value that reflects the failure cause.
- 1> send the RRC FAILURE INFO message to the network node from which the invalid RRC protocol information was received.

NOTE 1: The appropriate (failure) messages used across the network interfaces may not support the inclusion of a RRC information container. In this case, the information contained in the RRC FAILURE INFO message may need to be transferred otherwise e.g. by mapping to a cause value (e.g. a cause value in the RR-HANDOVER FAILURE message when there is a error associated with the RRC-HANDOVER TO UTRAN COMMAND message).

NOTE 2 In case the RRC procedure used to perform SRNS relocation fails e.g. due to non comprehension, the source RNC may notify the target RNC by including the diagnostics information (IEs "Protocol error" and "Protocol error information") in the "RRC message "SRNS Relocation" Info sent in the RRC information container" used for a subsequent relocation request.

14.12.1 RRC Information to target RNC

The RRC information container "RRC Information to target RNC" may either be sent from source RNC or from another RAT. In case of handover to UTRAN, this information originates from another RAT, while in case of SRNC relocation the RRC information originates from the source RNC. In case of handover to UTRAN, the RRC information transferred may provide UTRAN specific information, as defined in the INTER RAT HANDOVER INFO WITH INTER RAT CAPABILITIES message, that the target RNC needs when preparing the handover command message. In case of SRNC relocation and handover/cell reselection from GERAN *Iu mode*, the RRC information transferred specifies the configuration of RRC and the lower layers it controls, e.g., including the radio bearer and transport channel configuration. It is used by the target RNC to initialise RRC and the lower layer protocols to facilitate SRNC relocation and handover/cell reselection from GERAN *Iu mode* in a manner transparent to the UE.

RFC 3095 CONTEXT INFO is used to transfer the compressor and decompressor context information of the ROHC [83], [84] protocol from source RNC to target RNC.

Information Element/Group Name	Need	Multi	Type and reference	Semantics description	Version
CHOICE <i>case</i>	MP			At least one spare choice, Criticality: Reject, is needed	
>Handover to UTRAN			INTER RAT HANDOVER INFO WITH INTER RAT CAPABILITIES 14.12.4.1		
>SRNC relocation			SRNS RELOCATION INFO 14.12.4.2		
>RFC 3095 context info			RFC 3095 CONTEXT INFO 14.12.4.4		REL-5

14.12.2 RRC information, target RNC to source RNC

There are 2 possible cases for RNC relocation:

1. The UE is already under control of target RNC; and
2. The SRNC Relocation with Hard Handover (UE still under control of SRNC), but UE is moving to a location controlled by the target RNC (based on measurement information).

In case 1 the relocation is transparent to the UE and there is no "reverse" direction container. The SRNC just assigns the 'serving' function to the target RNC, which then becomes the Serving RNC.

In case 2 the relocation is initiated by SRNC, which also provides the RRC Initialisation Information to the target RNC. Base on this information, the target RNC prepares the Hard Handover Message ("Physical channel reconfiguration" (subclause 8.2.6), "radio bearer establishment" (subclause 8.2.1), "Radio bearer reconfiguration" (subclause 8.2.2), "Radio bearer release" (subclause 8.2.3) or "Transport channel reconfiguration" (subclause 8.2.4)).

In case 2 two possibilities are defined in order to transmit the relocation message from the target RNC to the source RNC which can be chosen by the source RNC by including or not including the IE "RB Id for handover message" in the IE "SRNS Relocation Info".

In case the IE "RB Id for handover message" has been received by the target RNC in the IE "SRNS Relocation Info", the target RNC should choose the IE "DL DCCH message" and include the DL DCCH message that should be transmitted transparently to the UE by the source RNC. In that case, the target RNC is integrity protecting the message if applicable.

If the target RNC did not receive the IE "RB Id for handover message" in the IE "SRNS Relocation Info" the target RNC should use another choice. In that case, the source RNC should integrity protect the message before transmitting it to the UE if applicable.

The source RNC then transmits the Handover Message to the UE, which then performs the handover.

In the successful case, the UE transmits an XXX COMPLETE message, using the new configuration, to the target RNC.

In case of failure, the UE transmits an XXX FAILURE, using the old configuration, to the source RNC and the RRC context remains unchanged (has to be confirmed and checked with the SRNS relocation procedure).

Information Element/Group name	Need	Multi	Type and reference	Semantics description
CHOICE <i>RRC message</i>	MP			At least one spare choice, Criticality: Reject, is needed
>RADIO BEARER SETUP			RADIO BEARER SETUP	

Information Element/Group name	Need	Multi	Type and reference	Semantics description
			10.2.33	
>RADIO BEARER RECONFIGURATION			RADIO BEARER RECONFIGURATION 10.2.27	
>RADIO BEARER RELEASE			RADIO BEARER RELEASE 10.2.30	
>TRANSPORT CHANNEL RECONFIGURATION			TRANSPORT CHANNEL RECONFIGURATION 10.2.50	
>PHYSICAL CHANNEL RECONFIGURATION			PHYSICAL CHANNEL RECONFIGURATION 10.2.22	
>RRC FAILURE INFO			RRC FAILURE INFO 10.2.41 a	
>DL DCCH message			OCTET STRING	

14.12.3 Void

14.12.4 RRC messages exchanged between network nodes

14.12.4.0 HANDOVER TO UTRAN COMMAND

This RRC message is sent between network nodes to transfer the actual handover command including the details of the radio configuration to be used upon handover to UTRAN as compiled by the target RNC.

Direction: target RNC →source RAT

The message is exactly the same as the HANDOVER TO UTRAN COMMAND defined in subclause 10.2.16a.

14.12.4.0a INTER RAT HANDOVER INFO

This RRC message is sent between network nodes to transfer information relevant for the target RNC when preparing for handover to UTRAN.

Direction: source RAT node→target RAT node

The message is exactly the same as the INTER RAT HANDOVER INFO defined in subclause 10.2.16d.

14.12.4.1 INTER RAT HANDOVER INFO WITH INTER RAT CAPABILITIES

This RRC message is sent between network nodes when preparing for an inter RAT handover to UTRAN.

The radio access capabilities for the source RAT and target RAT shall always be included; the radio access capabilities for other RATs may be included if available at the source RAT.

Direction: source RAT→target RNC

Information Element/Group Name	Need	Multi	Type and reference	Semantics description	Version
UE Information elements					
Predefined configuration status information	OP		Predefined configuration status information 10.3.4.5a		
Predefined configuration status information compressed	OP		Predefined configuration status information compressed 10.3.4.5b		REL-5
UE security information	OP		UE security information 10.3.3.42b		
UE security information2	OP		UE security information2 10.3.3.42c		REL-6
UE Specific Behaviour Information 1 interRAT	OP		UE Specific Behaviour Information 1 interRAT 10.3.3.52	This IE shall not be included in this version of the protocol	
UE capability container	OP				
>UE radio access capability	MP		UE radio access capability 10.3.3.42		
>UE radio access capability extension	MP		UE radio access capability extension 10.3.3.42a	Although this IE is not always required, the need has been set to MP to align with the ASN.1	

Information Element/Group Name	Need	Multi	Type and reference	Semantics description	Version
UE radio access capability compressed	OP		UE radio access capability compressed 10.3.3.42o		REL-5
UE radio access capability comp 2	OP		UE radio access capability comp 2 10.3.3.42oa		REL-6
Other Information elements					
UE system specific capability	OP	1 to <maxSystemCapability>			
>Inter-RAT UE radio access capability	MP		Inter-RAT UE radio access capability 10.3.8.7		
Failure cause	OP		Failure cause 10.3.3.13	Diagnostics information related to an earlier handover to UTRAN request	
Protocol error information	CV-ProtErr		Protocol error information 10.3.8.12		
UE inactivity period	OP		Integer (1..120)	Provides expired time since last u-plane activity. If the integer value x is between 1 and 59, it represents the expired time x in seconds. If the integer value x is between 60 and 119, it represents the expired time (x-59) in minutes. If integer value is set to 120, no u-plane activity has been for 60 minutes or more.	REL-9

Condition	Explanation
<i>ProtErr</i>	This IE is mandatory present if the IE "Protocol error indicator" is included and has the value TRUE. Otherwise it is not needed.

NOTE1: To facilitate that network nodes can transparently forward the RRC information received, the INTER RAT HANDOVER INFO WITH INTER RAT CAPABILITIES should include the entire INTER RAT HANDOVER INFO message. The network node, which may not be able to decode the information received, may only append some information to what was received.

NOTE2: The above table does not need to reflect the order of the information elements in the actual encoded message. The order, that is reflected in the ASN.1, should be chosen in a manner that avoids that network nodes need to perform reordering of information elements.

14.12.4.2 SRNS RELOCATION INFO

This RRC message is sent between network nodes when preparing for an SRNS relocation or a handover/cell reselection from GERAN *Iu mode*.

With the presence or absence of the IE "RB identity for Hard Handover message" the source RNC indicates to the target SRNC whether the source RNC expects to receive the choice "DL DCCH message" in the IE "RRC information, target RNC to source RNC" in case the SRNS relocation is of type "UE involved". Furthermore the target RNC uses this information for the calculation of the MAC-I.

Direction: source RNC/RAT→target RNC

Information Element/Group Name	Need	Multi	Type and reference	Semantics description	Version
Non RRC IEs					
>RB identity for Handover message	OP		RB identity 10.3.4.16	Gives the id of the radio bearer on which the source RNC will transmit the RRC message in the case the relocation is of type "UE involved". In handover from GERAN <i>lu mode</i> this IE is always set to 2.	
>State of RRC	MP		RRC state indicator, 10.3.3.35a		
>State of RRC procedure	MP		Enumerated (await no RRC message, await RB Release Complete, await RB Setup Complete, await RB Reconfiguration Complete, await Transport CH Reconfiguration Complete, await Physical CH Reconfiguration Complete, await Active Set Update Complete, await Handover Complete, send Cell Update Confirm, send URA Update Confirm, , others)		
Ciphering related information					
>Ciphering status for each CN domain	MP	<1 to maxCNDomain>			
>>CN domain identity	MP		CN domain identity 10.3.1.1		
>>Ciphering status	MP		Enumerated(Not started, Started)		
>>START	MP		START 10.3.3.38	START value to be used in this CN domain.	
>Latest configured CN domain	MP		CN domain identity 10.3.1.1	Value contained in the variable of the same name.	

Information Element/Group Name	Need	Multi	Type and reference	Semantics description	Version
				In case this variable is empty, the source RNC can set any CN domain identity. In that case, the Ciphering status and the Integrity protection status should be Not started and the target RNC should not initialise the variable Latest configured CN domain.	
>Calculation time for ciphering related information	CV- <i>Ciphering</i>			Time when the ciphering information of the message were calculated, relative to a cell of the target RNC. In handover and cell reselection from GERAN <i>lu mode</i> this field is not present.	
>>Cell Identity	MP		Cell Identity 10.3.2.2	Identity of one of the cells under the target RNC and included in the active set of the current call	
>>SFN	MP		Integer(0..4095)		
>COUNT-C list	OP	1 to <maxCNdo mains>		COUNT-C values for radio bearers using transparent mode RLC	
>>CN domain identity	MP		CN domain identity 10.3.1.1		
>>COUNT-C	MP		Bit string(32)		
>Ciphering info per radio bearer	OP	1 to <maxRB>		For signalling radio bearers this IE is mandatory.	
>>RB identity	MP		RB identity 10.3.4.16		
>>Downlink HFN	MP		Bit string(20..25)	This IE is either RLC AM HFN (20 bits) or RLC UM HFN (25 bits)	
>>Downlink SN	CV- <i>SRB1</i>		Bit String(7)	VT(US) of RLC UM	
>>Uplink HFN	MP		Bit string(20..25)	This IE is either RLC AM HFN (20 bits) or RLC UM HFN (25 bits)	
Integrity protection related information					
>Integrity protection status	MP		Enumerated(Not started, Started)		
>Signalling radio bearer specific integrity protection information	CV- <i>IP</i>	4 to <maxSRBs etup>			
>>Uplink RRC HFN	MP		Bit string (28)	For each SRB, in the case activation times for the next IP configuration to be applied on this SRB have already been reached this IE corresponds to the last value used. Else this value corresponds to the value the source would have initialized the HFN to at the activation time, not considering any increment of HFN due to RRC SN roll over. Increment of HFN due to RRC SN roll over is taken care of by target based on value sent by the source.	
>>Downlink RRC HFN	MP		Bit string (28)	For each SRB, in the case activation times for the next IP	

Information Element/Group Name	Need	Multi	Type and reference	Semantics description	Version
				configuration to be applied on this SRB have already been reached this IE corresponds to the last value used. Else this value corresponds to the value the source would have initialized the HFN to at the activation time, not considering any increment of HFN due to RRC SN roll over. Increment of HFN due to RRC SN roll over is taken care of by target based on value sent by the source. In particular, for SRB2, this IE should not take into account the RRC message that will trigger the relocation. NOTE: In order to have the possibility of sending downlink messages after the construction of the IE "SRNS RELOCATION INFO", the source may choose a value ahead of the last value used.	
>>Uplink RRC Message sequence number	MP		Integer (0..15)	For each SRB, this IE corresponds to the last value received or in the case activation time was not reached for a configuration the value equals (activation time - 1).	
>>Downlink RRC Message sequence number	MP		Integer (0..15)	For each SRB, this IE corresponds to the last value used or in the case activation time was not reached for a configuration the value equals (activation time - 1). In particular, for SRB2, this IE should not take into account the RRC message that will trigger the relocation. NOTE: In order to have the possibility of sending downlink messages after the construction of the IE "SRNS RELOCATION INFO", the source may choose a value ahead of the last value used for SRB3 and SRB4.	
>Implementation specific parameters	OP		Bit string (1..512)		
RRC IEs					
UE Information elements					
>U-RNTI	MP		U-RNTI 10.3.3.47	G-RNTI is placed in this field when performing handover or cell reselection from GERAN <i>lu mode</i> .	
>C-RNTI	OP		C-RNTI 10.3.3.8		
>UE radio access Capability	MP		UE radio access capability 10.3.3.42		
>UE radio access capability extension	OP		UE radio access capability		

Information Element/Group Name	Need	Multi	Type and reference	Semantics description	Version
			extension 10.3.3.42a		
>Last known UE position	OP				
>>SFN	MP		Integer (0..4095)	Time when position was estimated	
>>Cell ID	MP		Cell identity; 10.3.2.2	Indicates the cell, the SFN is valid for.	
>>CHOICE <i>Position estimate</i>	MP				
>>>Ellipsoid Point			Ellipsoid Point; 10.3.8.4a		
>>>Ellipsoid point with uncertainty circle			Ellipsoid point with uncertainty circle 10.3.8.4d		
>>>Ellipsoid point with uncertainty ellipse			Ellipsoid point with uncertainty ellipse 10.3.8.4e		
>>>Ellipsoid point with altitude			Ellipsoid point with altitude 10.3.8.4b		
>>>Ellipsoid point with altitude and uncertainty ellipsoid			Ellipsoid point with altitude and uncertainty ellipsoid 10.3.8.4c		
>UE Specific Behaviour Information 1 idle	OP		UE Specific Behaviour Information 1 10.3.3.51	This IE should be included if received via the "INTER RAT HANDOVER INFO", the "RRC CONNECTION REQUEST", the IE "SRNS RELOCATION INFO" or the "Inter RAT Handover Info with Inter RAT Capabilities"	
>UE Specific Behaviour Information 1 interRAT	OP		UE Specific Behaviour Information 1 interRAT 10.3.3.52	This IE should be included if received via the "INTER RAT HANDOVER INFO", the "RRC CONNECTION REQUEST", the IE "SRNS RELOCATION INFO" or the "Inter RAT Handover Info with Inter RAT Capabilities"	
Other Information elements					
>UE system specific capability	OP	1 to <maxSystemCapability>			
>>Inter-RAT UE radio access capability	MP		Inter-RAT UE radio access capability 10.3.8.7		
UTRAN Mobility Information elements					
>URA Identifier	OP		URA identity 10.3.2.6		
>T305	OP		Integer (5, 10, 30, 60, 120, 360, 720, infinity)	If UE is in CELL_FACH state, this information element shall be included. Value in minutes. Infinity means no update.	REL-7

Information Element/Group Name	Need	Multi	Type and reference	Semantics description	Version
CN Information Elements					
>CN common GSM-MAP NAS system information	MP		NAS system information (GSM-MAP) 10.3.1.9		
>CN domain related information	OP	1 to <MaxCNdomains>		CN related information to be provided for each CN domain	
>>CN domain identity	MP				
>>CN domain specific GSM-MAP NAS system info	MP		NAS system information (GSM-MAP) 10.3.1.9		
>>CN domain specific DRX cycle length coefficient	MP		CN domain specific DRX cycle length coefficient, 10.3.3.6		
Measurement Related Information elements					
>For each ongoing measurement reporting	OP	1 to <MaxNoOf Meas>		The source RNC should include the measurement IEs for each measurement configured and ongoing in the UE.	
>>Measurement Identity	MP		Measurement identity 10.3.7.48		
>>Measurement Command	MP		Measurement command 10.3.7.46	This IE should have the value Setup.	
>>Measurement Type	CV-Setup		Measurement type 10.3.7.50		
>>Measurement Reporting Mode	OP		Measurement reporting mode 10.3.7.49		
>>Additional Measurements list	OP		Additional measurements list 10.3.7.1		
>>CHOICE <i>Measurement</i>	CV-Setup				
>>>Intra-frequency					
>>>>Intra-frequency cell info	OP		Intra-frequency cell info list 10.3.7.33		
>>>>Intra-frequency cell info on secondary UL frequency	OP		Intra-frequency cell info list on secondary UL frequency 10.3.7.116		
>>>>Intra-frequency measurement quantity	OP		Intra-frequency measurement quantity 10.3.7.38		
>>>>Intra-frequency reporting quantity	OP		Intra-frequency reporting quantity 10.3.7.41		

Information Element/Group Name	Need	Multi	Type and reference	Semantics description	Version
>>>>Reporting cell status	OP		Reporting cell status 10.3.7.61		
>>>>Measurement validity	OP		Measurement validity 10.3.7.51		
>>>>CHOICE <i>report criteria</i>	OP				
>>>>>Intra-frequency measurement reporting criteria			Intra-frequency measurement reporting criteria 10.3.7.39		
>>>>>Periodical reporting			Periodical reporting criteria 10.3.7.53		
>>>>>No reporting			NULL		
>>>>Inter-frequency					
>>>>Inter-frequency cell info	OP		Inter-frequency cell info list 10.3.7.13		
>>>>Inter-frequency measurement quantity	OP		Inter-frequency measurement quantity 10.3.7.18		
>>>>Inter-frequency reporting quantity	OP		Inter-frequency reporting quantity 10.3.7.21		
>>>>Reporting cell status	OP		Reporting cell status 10.3.7.61		
>>>>Measurement validity	OP		Measurement validity 10.3.7.51		
>>>>Inter-frequency set update	OP		Inter-frequency set update 10.3.7.22		
>>>>CHOICE <i>report criteria</i>	MP				
>>>>>Intra-frequency measurement reporting criteria			Intra-frequency measurement reporting criteria 10.3.7.39		
>>>>>Inter-frequency measurement reporting criteria			Inter-frequency measurement reporting criteria 10.3.7.19		
>>>>>Periodical reporting			Periodical reporting criteria 10.3.7.53		
>>>>>No reporting			NULL		
>>>>Inter-RAT					
>>>>Inter-RAT cell info	OP		Inter-RAT cell info list 10.3.7.23		

Information Element/Group Name	Need	Multi	Type and reference	Semantics description	Version
>>>>Inter-RAT measurement quantity	OP		Inter-RAT measurement quantity 10.3.7.29		
>>>>Inter-RAT reporting quantity	OP		Inter-RAT reporting quantity 10.3.7.32		
>>>>Reporting cell status	OP		Reporting cell status 10.3.7.61		
>>>>Measurement validity	OP		Measurement validity 10.3.7.51		
>>>>E-UTRA frequency list	OP		E-UTRA frequency list 10.3.7.6b		REL-8
>>>>CHOICE <i>report criteria</i>	MP				
>>>>>Inter-RAT measurement reporting criteria			Inter-RAT measurement reporting criteria 10.3.7.30		
>>>>>Periodical reporting			Periodical reporting criteria 10.3.7.53		
>>>>>No reporting			NULL		
>>>>Traffic Volume					
>>>>>Traffic volume measurement Object	OP		Traffic volume measurement object 10.3.7.70		
>>>>>Traffic volume measurement quantity	OP		Traffic volume measurement quantity 10.3.7.71		
>>>>>Traffic volume reporting quantity	OP		Traffic volume reporting quantity 10.3.7.74		
>>>>>Measurement validity	OP		Measurement validity 10.3.7.51		
>>>>>CHOICE <i>report criteria</i>	MP				
>>>>>>Traffic volume measurement reporting criteria			Traffic volume measurement reporting criteria 10.3.7.72		
>>>>>>Periodical reporting			Periodical reporting criteria 10.3.7.53		
>>>>>>No reporting			NULL		
>>>>>Quality					
>>>>>>Quality measurement quantity	OP		Quality measurement quantity 10.3.7.59		

Information Element/Group Name	Need	Multi	Type and reference	Semantics description	Version
>>>>CHOICE <i>report criteria</i>	MP				
>>>>>Quality measurement reporting criteria			Quality measurement reporting criteria 10.3.7.58		
>>>>>Periodical reporting			Periodical reporting criteria 10.3.7.53		
>>>>>No reporting			NULL		
>>>UE internal					
>>>>>UE internal measurement quantity	OP		UE internal measurement quantity 10.3.7.79		
>>>>>UE internal reporting quantity	OP		UE internal reporting quantity 10.3.7.82		
>>>>CHOICE <i>report criteria</i>	MP				
>>>>>UE internal measurement reporting criteria			UE internal measurement reporting criteria 10.3.7.80		
>>>>>Periodical reporting			Periodical reporting criteria 10.3.7.53		
>>>>>No reporting			NULL		
>>>UE positioning					
>>>>>LCS reporting quantity	OP		LCS reporting quantity 10.3.7.111		
>>>>CHOICE <i>report criteria</i>	MP				
>>>>>LCS reporting criteria			LCS reporting criteria 10.3.7.110		
>>>>>Periodical reporting			Periodical reporting criteria 10.3.7.53		
>>>>>No reporting					
Radio Bearer Information Elements					
>Predefined configuration status information	OP		Predefined configuration status information 10.3.4.5a		
>Signalling RB information list	MP	1 to <maxSRBs etup>		For each signalling radio bearer	
>>Signalling RB information	MP		Signalling RB information to setup 10.3.4.24		
>RAB information list	OP	1 to <maxRABs etup>		Information for each RAB	

Information Element/Group Name	Need	Multi	Type and reference	Semantics description	Version
>>RAB information	MP		RAB information to setup 10.3.4.10		
>PDCP ROHC target mode	OP		PDCP ROHC target mode 10.3.4.2a		REL-8
Transport Channel Information Elements					
Uplink transport channels					
>UL Transport channel information common for all transport channels	OP		UL Transport channel information common for all transport channels 10.3.5.24		
>UL transport channel information list	OP	1 to <MaxTrCH >			
>>UL transport channel information	MP		Added or reconfigured UL TrCH information 10.3.5.2		
Downlink transport channels					
>DL Transport channel information common for all transport channels	OP		DL Transport channel information common for all transport channels 10.3.5.6		
>DL transport channel information list	OP	1 to <MaxTrCH >			
>>DL transport channel information	MP		Added or reconfigured DL TrCH information 10.3.5.1		

Information Element/Group Name	Need	Multi	Type and reference	Semantics description	Version
PhyCH information elements					
>TPC Combination Info list	OP	1 to <maxRL>			
>>Primary CPICH info	MP		Primary CPICH info 10.3.6.60		
>>TPC combination index	MP		TPC combination index 10.3.6.85		
>TPC Combination Info list on secondary UL frequency	OP	1 to <maxEDCH RL>			REL-9
>>Primary CPICH info	MP		Primary CPICH info 10.3.6.60		REL-9
>>TPC combination index	MP		TPC combination index 10.3.6.85		REL-9
>E-RGCH Combination Info list	OP	1 to <maxEDC HRL>			REL-8
>>Primary CPICH info	MP		Primary CPICH info 10.3.6.60		REL-8
>>RG combination index	MP		Integer (0..5)		REL-8
>E-RGCH Combination Info list on secondary UL frequency	OP	1 to <maxEDC HRL>			REL-9
>>Primary CPICH info	MP		Primary CPICH info 10.3.6.60		REL-9
>>RG combination index	MP		Integer (0..5)		REL-9
>Transmission gap pattern sequence	OP	1 to <maxTGP S>			REL-5
>>TGPSI	MP		TGPSI 10.3.6.82		REL-5
>> Current TGPS Status Flag	MP		Enumerated(active, inactive)	This flag indicates the current status of the Transmission Gap Pattern Sequence, whether it is active or inactive	REL-5
>>TGCFN	CV-Active		Integer (0..255)	Connection Frame Number of the latest past frame of the first pattern within the Transmission Gap Pattern Sequence.	REL-5
>>Transmission gap pattern sequence configuration parameters	OP				REL-5

Information Element/Group Name	Need	Multi	Type and reference	Semantics description	Version
>>>TGMP	MP		Enumerated(TDD measurement, FDD measurement, GSM carrier RSSI measurement, GSM Initial BSIC identification, GSM BSIC re-confirmation, Multi-carrier measurement,	Transmission Gap pattern sequence Measurement Purpose.	REL-5
			E-UTRA measurements)		REL-8
>>>TGPRC	MP		Integer (1..511, Infinity)	The number of remaining transmission gap patterns within the Transmission Gap Pattern Sequence.	REL-5
>>>TGSN	MP		Integer (0..14)	Transmission Gap Starting Slot Number The slot number of the first transmission gap slot within the TGCFN.	REL-5
>>>TGL1	MP		Integer(1..14)	The length of the first Transmission Gap within the transmission gap pattern expressed in number of slots	REL-5
>>>TGL2	MD		Integer (1..14)	The length of the second Transmission Gap within the transmission gap pattern. If omitted, then TGL2=TGL1. The value of TGL2 shall be ignored if TGD is set to "undefined"	REL-5
>>>TGD	MP		Integer(15..269, undefined)	Transmission gap distance indicates the number of slots between starting slots of two consecutive transmission gaps within a transmission gap pattern. If there is only one transmission gap in the transmission gap pattern, this parameter shall be set to undefined.	REL-5
>>>TGPL1	MP		Integer (1..144)	The duration of transmission gap pattern 1.	REL-5
>>>RPP	MP		Enumerated (mode 0, mode 1).	Recovery Period Power control mode during the frame after the transmission gap within the compressed frame. Indicates whether normal PC mode or compressed PC mode is applied	REL-5
>>>ITP	MP		Enumerated (mode 0, mode 1).	Initial Transmit Power is the uplink power control method to be used to compute the initial transmit power after the compressed mode gap.	REL-5
>>>CHOICE <i>UL/DL mode</i>	MP				REL-5

Information Element/Group Name	Need	Multi	Type and reference	Semantics description	Version
>>>>DL only				Compressed mode used in DL only	REL-5
>>>>>Downlink compressed mode method	MP		Enumerated (SF/2, higher layer scheduling)	Method for generating downlink compressed mode gap	REL-5
>>>>UL only				Compressed mode used in UL only	REL-5
>>>>>Uplink compressed mode method	MP		Enumerated (SF/2, higher layer scheduling)	Method for generating uplink compressed mode gap	REL-5
>>>>UL and DL				Compressed mode used in UL and DL	REL-5
>>>>>Downlink compressed mode method	MP		Enumerated (SF/2, higher layer scheduling)	Method for generating downlink compressed mode gap	REL-5
>>>>>Uplink compressed mode method	MP		Enumerated (SF/2, higher layer scheduling)	Method for generating uplink compressed mode gap	REL-5
>>>Downlink frame type	MP		Enumerated (A, B)		REL-5
>>>DeltaSIR1	MP		Real(0..3 by step of 0.1)	Delta in DL SIR target value to be set in the UE during the frame containing the start of the first transmission gap in the transmission gap pattern (without including the effect of the bit-rate increase)	REL-5
>>>DeltaSIRafter1	MP		Real(0..3 by step of 0.1)	Delta in DL SIR target value to be set in the UE one frame after the frame containing the start of the first transmission gap in the transmission gap pattern.	REL-5
>>>DeltaSIR2	OP		Real(0..3 by step of 0.1)	Delta in DL SIR target value to be set in the UE during the frame containing the start of the second transmission gap in the transmission gap pattern (without including the effect of the bit-rate increase) When omitted, DeltaSIR2 = DeltaSIR1.	REL-5
>>>DeltaSIRafter2	OP		Real(0..3 by step of 0.1)	Delta in DL SIR target value to be set in the UE one frame after the frame containing the start of the second transmission gap in the transmission gap pattern. When omitted, DeltaSIRafter2 = DeltaSIRafter1.	REL-5
>>>N Identify abort	CV-Initial BSIC		Integer(1..128)	Indicates the maximum number of repeats of patterns that the UE shall use to attempt to decode the unknown BSIC of the GSM cell in the initial BSIC identification procedure	REL-5

Information Element/Group Name	Need	Multi	Type and reference	Semantics description	Version
>>>T Reconfirm abort	CV- <i>Re-confirm BSIC</i>		Real(0.5..10.0 by step of 0.5)	Indicates the maximum time allowed for the re-confirmation of the BSIC of one GSM cell in the BSIC re-confirmation procedure. The time is given in steps of 0.5 seconds.	REL-5
>Scrambling Code Change List	CH-SF/2	1 to <maxRL>			REL-5
>>Primary CPICH info	MP		Primary CPICH info 10.3.6.60		REL-5
>>Scrambling code change	MP		Enumerated (code change, no code change)	Indicates whether the alternative scrambling code is used for compressed mode method 'SF/2'.	REL-5
>Serving HS-DSCH cell information	OP		Serving HS-DSCH cell information 10.3.6.74a		REL-12
>DTX-DRX Information	OP		DTX-DRX Information 10.3.6.34a		REL-12
>Uplink secondary cell info FDD	OP		Uplink secondary cell info FDD 10.3.6.115		REL-12
>DCH Enhancements info FDD	OP		DCH Enhancements info FDD 10.3.6.149		REL-12
>Downlink information common for all radio links	OP		Downlink information common for all radio links 10.3.6.24		REL-12
>Downlink information per radio link list	OP	1 to <maxRL>		Send downlink information for each radio link to be set-up	REL-12
>>Downlink information for each radio link	MP		Downlink information for each radio link 10.3.6.27		REL-12
Other Information elements					
>Measurement report	OP		MEASUREMENT REPORT 10.2.19	The source RNC should include the Measurement report the UE sent that triggered the SRNS relocation. This information could e.g. be used by the target RNC to set initial power when establishing a DCH.	
>Failure cause	OP		Failure cause 10.3.3.13	Diagnostics information related to an earlier SRNC Relocation request (see NOTE 2 in 14.12.0a)	
>Protocol error information	CV- <i>ProtErr</i>		Protocol error information 10.3.8.12		
UE history information	OP		UE history information 10.3.8.23		REL-8
MBMS information elements					
MBMS joined information	OP			Included if the UE has joined one or more MBMS services	REL-6

Information Element/Group Name	Need	Multi	Type and reference	Semantics description	Version
>P-TMSI	OP		P-TMSI (GSM-MAP) 10.3.1.13	In case the UE is in PMM-Idle	REL-6
MBMS Selected Service Info	OP		MBMS Selected Services Info 10.3.9a.7b		REL-6

Multi Bound	Explanation
MaxNoOfMeas	Maximum number of active measurements, upper limit 16

Condition	Explanation
<i>Setup</i>	The IE is mandatory present when the IE Measurement command has the value "Setup", otherwise the IE is not needed.
<i>Ciphering</i>	The IE is mandatory present when the IE Ciphering Status has the value "started" and the ciphering counters need not be reinitialised, otherwise the IE is not needed.
<i>IP</i>	The IE is mandatory present when the IE Integrity protection status has the value "started" and the integrity protection counters need not be reinitialised, otherwise the IE is not needed.
<i>ProtErr</i>	This IE is mandatory present if the IE "Protocol error indicator" is included and has the value TRUE. Otherwise it is not needed.
<i>SRB1</i>	The IE is mandatory present for RB1. Otherwise it is not needed.
<i>Active</i>	This IE is mandatory present when the value of the IE "Current TGPS Status Flag" is "Active" and not needed otherwise.
<i>Initial BSIC</i>	This IE is mandatory present when the value of the IE "TGMP" is set to "GSM Initial BSIC identification" and not needed otherwise.
<i>Re-confirm BSIC</i>	This IE is mandatory present when the value of the IE "TGMP" is set to "GSM BSIC re-confirmation" and not needed otherwise.
<i>SF/2</i>	The IE is mandatory present if the IE "Transmission Gap Pattern Sequence" is included and has the value "SF/2" as the compressed mode method, and already sent the UE the IE "Scrambling Code Change" for each RL in the active set. Otherwise the IE is not needed.

14.12.4.3 Void

14.12.4.4 RFC 3095 CONTEXT INFO

This RRC message is sent between network nodes in SRNS relocation. It is used to transfer the compressor and decompressor context information of the ROHC protocol.

Direction: source RNC →target RNC

Information Element/Group name	Need	Multi	Type and reference	Semantics description	Version
RFC 3095 context	MP	1 to <maxRBall RABs>			REL-5
>RB identity	MP		RB identity 10.3.4.16		REL-5
>RFC 3095 context list	MP	1 to <maxRFC3095-CID>			REL-5
>>Downlink RFC 3095 context	OP				REL-5
>>>Downlink RFC 3095 context identity	MP		Integer (0..16383)		REL-5
>>>DL_MODE	MP		Enumerated (u, o, r)	ROHC mode in downlink before SRNS relocation.	REL-5
>>>REF_IR	MP		Octet string (1..3000)	The RTP IR header (see section 5.7.7 of RFC3095 for detailed format) corresponding to the oldest header in the compressor sliding window.	REL-5
>>>REF_TIME	OP		Integer (0..4294967295)	Arrival time (at the compressor) of REF_IR in milliseconds. See sections 4.5.4 and 6.5.1 of RFC3095.	REL-5
>>>CURR_TIME	OP		Integer (0..4294967295)	Current time in milliseconds. See section 6.5.1 of RFC3095.	REL-5
>>>SYN_OFFSET_ID	OP		Integer (0..65535)	Last synchronized offset of IP-ID. See section 4.5.5 and 6.5.1 of RFC3095 (termed "Offset_I"). It is related to the compression and decompression of IP-ID and is the synchronized offset between the IP-ID value and the SN value (in the same header) during the last SO state before the relocation procedure.	REL-5

>>>SYN_SLOPE_TS	OP		Integer (0..4294967 295)	Last synchronized slope of TS. See sections 5.5.1.2 and 5.7 of RFC3095. In SO state, $TS(n) = TS(m) + (n-m) * SYN_SLOPE_TS$, where n and m are, the RTP SN of the current and the reference packet, respectively. The unit of SYN_SLOPE_TS depends on whether TS is scaled before compression or not.	REL-5
>>>DYN_CHANGED	MP		Boolean	Information whether dynamic fields other than RTP SN, RTP TS and IP-ID have changed in the headers that are stored in the sliding window. Set to TRUE if changed and FALSE if not changed.	REL-5
>>Uplink RFC 3095 context	OP				REL-5
>>>Uplink RFC 3095 context identity	MP		Integer (0..16383)		REL-5
>>>UL_MODE	MP		Enumerated (u, o, r)	ROHC mode in uplink	REL-5
>>>REF_IR	MP		Octet string (1..3000)	The RTP IR header (see section 5.7.7 of IETF RFC3095 for detailed format) corresponding to the last correctly decompressed header.	REL-5
>>>REF_TIME	OP		Integer (0..4294967 295)	Arrival time (at the decompressor) of REF_IR in milliseconds. See sections 4.5.4 and 6.5.1 of RFC3095.	REL-5
>>>CURR_TIME	OP		Integer (0..4294967 295)	Current time in milliseconds. See section 6.5.1 of RFC3095.	REL-5

>>>SYN_OFFSET_ID	OP		Integer (0..65535)	Last synchronized offset of IP-ID. See sections 4.5.5 and 6.5.1 of RFC3095 (termed "Offset_I"). It is related to the compression and decompression of IP-ID and is the synchronized offset between the IP-ID value and the SN value (in the same header) during the last SO state before the relocation procedure.	REL-5
>>>SYN_SLOPE_TS	OP		Integer (0..4294967295)	Last synchronized slope of TS. See sections 5.5.1.2 and 5.7 of RFC3095. In SO state, $TS(n) = TS(m) + (n-m) * SYN_SLOPE_TS$, where n and m are, the RTP SN of the current and the reference packet, respectively. The unit of SYN_SLOPE_TS depends on whether TS is scaled before compression or not.	REL-5
>>>REF_SN_1	OP		Integer (0..65535)	Corresponds to the RTP Sequence Number of the predecessor of the latest RTP packet. This could be used to perform local repair of context by decompressor in U or O mode (see "ref - 1" in section 5.3.2.2.5 in IETF RFC3095 for further explanation).	REL-5

14.13 Void

14.14 Void

14.15 E-UTRA measurement for CELL_FACH (FDD only)

The measurement is performed only when the UE is in CELL_FACH state. The UE shall, taking advantage of non-transmission gaps, perform E-UTRA RSRP or RSRQ measurements and reporting according to the configuration received in the MEASUREMENT CONTROL message.

14.15.1 E-UTRA measurement for CELL_FACH measurement quantities (FDD only)

A measurement quantity is used by the UE to evaluate whether an E-UTRA measurement for CELL_FACH event has occurred or not.

The measurement quantity for E-UTRA measurement for CELL_FACH can be:

- 1 E-UTRA RSRP
- 2 E-UTRA RSRQ

A description of those values can be found in [7] and [8].

14.15.2 E-UTRA measurement for CELL_FACH reporting (FDD only)

For cells whose carrier frequency matches any of the EARFCNs in the list of E-UTRA frequencies that the UE has stored in the variable "EUTRA_FREQUENCY_INFO_LIST_FACH", and for which the Physical Cell Identity is not included in the blacklist for that frequency, the UE shall:

- 1> for event-triggered reporting, trigger one measurement report if the measured quality of any cell on a configured E-UTRA frequency exceeds the threshold specified by the IE "Reporting Threshold":
 - 2> for those E-UTRA frequencies where at least one cell exceeds the threshold, set the corresponding bit of the IE "E-UTRA frequency indicator" to 1 in the IE "E-UTRA results for CELL_FACH".
- 1> for periodical reporting, trigger one periodical report when valid measurements are available:
 - 2> for those E-UTRA frequencies whose at least one cell exceeds the threshold, set the corresponding bit of the IE "E-UTRA frequency indicator" to 1 in the IE "E-UTRA results for CELL_FACH".

After the UE has sent the MEASUREMENT REPORT message, the UE shall:

- 1> stop the measurement associated with the identity given in the IE "measurement identity".

Annex A (informative): USIM parameters

A.1 Introduction

This annex contains recommendations about the RRC parameters to be stored in the USIM.

A.2 Cipherring information

Information Element/Group name	Need	Multi	Type and reference	Semantics description
Cipher key for each CN domain	MP	<1 to maxCNDo mains>		Cipher key is described in [40].
>CK	MP		Bit string (128)	
Integrity key for each CN domain	MP	<1 to maxCNDo mains>		Integrity key is described in [40].
>IK	MP		Bit string (128)	
THRESHOLD	MP		Bit string (20)	
START value for each CN domain	MP	<1 to maxCNDo mains>		START value is described in [40].
>START	MP		Bit string (20)	
KSI, Key set identifier for each CN domain	MP	<1 to maxCNDo mains>		Key set identifier is described in [40].
>KSI	MP		Bit string (3)	

A.3 Frequency information

Neighbour cell list.

Information Element/Group name	Need	Multi	Type and reference	Semantics description	Version
FDD cell list	OP	<1 to maxFDDFr eqList>			
>UARFCN downlink (Nd)	MP		Integer(0 .. 16383)	[21]	
>Primary scrambling code	OP	<1 to maxFDDFr eqCellList>	Primary CPICH info 10.3.6.60		
3.84 Mcps TDD cell list	OP	<1 to maxTDDFr eqList>			
>UARFCN (Nt)	MP		Integer(0 .. 16383)	[22]	
>Cell parameters ID	OP	<1 to maxTDDFr eqCellList>	Integer (0..127)	The Cell parameters ID is described in [32].	
1.28 Mcps TDD cell list	OP	<1 to maxTDDFr eqList>			REL-4
>UARFCN (Nt)	MP		Integer(0 .. 16383)	[22]	REL-4

Information Element/Group name	Need	Multi	Type and reference	Semantics description	Version
>Cell parameters ID	OP	<1 to maxTDDFreqCellList>	Integer (0..127)	The Cell parameters ID is described in [32].	REL-4
GSM Neighbour cell list	OP				
>GSM neighbour cell info	MP	<1 to maxGSMCellList>			
>>BSIC	MP				
>>BCCH ARFCN	MP				

A.4 Multiplicity values and type constraint values

Constant	Explanation	Value
Ciphering information		
maxCNDomains	Maximum number of CN domains	4
Frequency information		
maxFDDFreqList	Maximum number of FDD carrier frequencies to be stored in USIM	4
maxTDDFreqList	Maximum number of TDD carrier frequencies to be stored in USIM	4
maxFDDFreqCellList	Maximum number of neighbouring FDD cells on one carrier to be stored in USIM	32
maxTDDFreqCellList	Maximum number of neighbouring TDD cells on one carrier to be stored in USIM	32
maxGSMCellList	Maximum number of GSM cells to be stored in USIM	32

Annex B (informative): Description of RRC state transitions including GSM and E- UTRA

This annex contains Stage 2 description of RRC states and state transitions.

B.1 RRC states and state transitions

After power on, the UE stays in Idle Mode until it transmits a request to establish an RRC Connection. In Idle Mode the connection of the UE is closed on all layers of the access stratum. In Idle Mode the UE is identified by non-access stratum identities such as IMSI, TMSI and P-TMSI. In addition, the UTRAN has no own information about the individual Idle Mode UEs, and it can only address e.g. all UEs in a cell or all UEs monitoring a paging occasion. The UE behaviour within this mode is described in [4].

The UTRA RRC Connected Mode is entered when the RRC Connection is established. The UE is assigned a radio network temporary identity (RNTI) to be used as UE identity on common transport channels.

The RRC states within UTRA RRC Connected Mode reflect the level of UE connection and which transport channels that can be used by the UE.

For inactive stationary data users the UE may fall back to PCH on both the Cell and URA levels. That is, upon the need for paging, the UTRAN checks the current level of connection of the given UE, and decides whether the paging message is sent within the URA, or should it be sent via a specific cell.

B.2 Transition from Idle Mode to UTRA RRC Connected Mode

The transition to the UTRA RRC Connected Mode from the Idle Mode can only be initiated by the UE by transmitting a request for an RRC Connection. The event is triggered either by a paging request from the network or by a request from upper layers in the UE.

When the UE receives a message from the network that confirms the RRC connection establishment, the UE enters the CELL_FACH or CELL_DCH state of UTRA RRC Connected Mode.

In the case of a failure to establish the RRC Connection the UE goes back to Idle Mode. Possible causes are radio link failure, a received reject response from the network or lack of response from the network (timeout).

B.2.1 Transitions for Emergency Calls

Refer to [4] for all states and procedures referred to in this subclause. When UE leaves idle mode from state *Camped on any cell* in order to make an emergency call, moving to state *Connected mode (emergency calls only)*, the UE shall attempt to access the current serving cell. If the access attempt to the serving cell fails the UE shall use the *Cell Reselection* procedure. If no acceptable cell is found, the UE shall use the *Any cell selection*. When returning to idle mode, the UE shall use the procedure *Cell selection when leaving connected mode* in order to find an acceptable cell to camp on, state *Camped on any cell*.

B.3 UTRA RRC Connected Mode States and Transitions

B.3.1 CELL_DCH state

The CELL_DCH state is characterised by

- For TDD: A dedicated physical channel is allocated to the UE in uplink and downlink or a dedicated physical channel is allocated to the UE in the uplink and HS_DSCH_RECEPTION is set to TRUE.

- A dedicated physical channel is allocated to the UE in uplink and downlink.
- For TDD:
 - E_DCH_TRANSMISSION is set to TRUE and HS_DSCH_RECEPTION is set to TRUE.
 - E_DCH_TRANSMISSION is set to TRUE and a dedicated physical channel is allocated to the UE in the downlink.
- The UE is known on cell level according to its current active set.
- Dedicated transport channels, downlink and uplink (TDD) shared transport channels, and a combination of these transport channels can be used by the UE.

The CELL_DCH-state is entered from the Idle Mode through the setup of an RRC connection, or by establishing a dedicated physical channel from the CELL_FACH state.

In TDD a PDSCH may be assigned to the UE in this state, to be used for a DSCH. A PUSCH may also be assigned to the UE in this state, to be used for a USCH. If PDSCH or PUSCH are used for TDD, a FACH transport channel may be assigned to the UE for reception of physical shared channel allocation messages.

B.3.1.1 Transition from CELL_DCH to Idle Mode

Transition to Idle Mode is realised through the release of the RRC connection.

B.3.1.2 Transition from CELL_DCH to CELL_FACH state

Transition to CELL_FACH state occurs when all dedicated channels have been released, which may be

- a) via explicit signalling (e.g. PHYSICAL CHANNEL RECONFIGURATION, RADIO BEARER RECONFIGURATION, RADIO BEARER RELEASE, RADIO BEARER SETUP, TRANSPORT CHANNEL RECONFIGURATION, etc.).

at the end of the time period for which the dedicated channel was allocated (TDD)

B.3.1.3 Transition from CELL_DCH to CELL_PCH state

Transition to CELL_PCH state occurs via explicit signalling (e.g. PHYSICAL CHANNEL RECONFIGURATION, RADIO BEARER RECONFIGURATION, RADIO BEARER RELEASE, RADIO BEARER SETUP, TRANSPORT CHANNEL RECONFIGURATION, etc.).

B.3.1.4 Transition from CELL_DCH to URA_PCH state

Transition to URA_PCH state occurs via explicit signalling (e.g. PHYSICAL CHANNEL RECONFIGURATION, RADIO BEARER RECONFIGURATION, RADIO BEARER RELEASE, RADIO BEARER SETUP, TRANSPORT CHANNEL RECONFIGURATION, etc.).

B.3.1.5 Radio Resource Allocation tasks (CELL_DCH)

For the DCH, several physical channel allocation strategies may be applied. The allocations can be either permanent (needing a DCH release message) or based on time or amount-of-data.

Resource allocation can be done separately for each packet burst with fast signalling on the DCH

For each radio frame the UE and the network indicate the current data rate (in uplink and downlink respectively) using the transport format combination indicator (TFCI). However, in TDD, DCH and DSCH or USCH may be mapped on different CCTrCHs, their TFCI are totally independent. DCH transmission is not modified by the simultaneous existence of DSCH/USCH. If the configured set of combinations (i.e. transport format set for one transport channel) are found to be insufficient to retain the QoS requirements for a transport channel, the network initiates a reconfiguration of the transport format set (TFS) for that transport channel. This reconfiguration can be done during or in between data transmission. Further, the network can reconfigure the physical channel allowing an increase or decrease of the peak data rate.

For the uplink data transmission, the UE reports the observed traffic volume to the network in order for the network to re-evaluate the current allocation of resources. This report contains e.g. the amount of data to be transmitted or the buffer status in the UE.

B.3.1.6 RRC Connection mobility tasks (CELL_DCH)

Depending on the amount and frequency of data macrodiversity (soft handover) may or may not be applied.

The RRC Connection mobility is handled by measurement reporting, soft handover and Timing re-initialised or Timing-maintained hard handover procedures.

B.3.1.7 UE Measurements (CELL_DCH)

The UE performs measurements and transmit measurement reports according to the measurement control information.

The UE uses the connected mode measurement control information received in other states until new measurement control information has been assigned to the UE.

B.3.1.8 Acquisition of system information (CELL_DCH)

TDD UEs reads the BCH to acquire valid system information. For each acquisition, the UE may need different combinations of system information broadcast on BCH. The scheduling on the broadcast channel is done in such way that the UE knows when the requested information can be found.

B.3.2 CELL_FACH state

The CELL_FACH state is characterised by:

- No dedicated physical channel is allocated to the UE.
- The UE continuously monitors in the downlink:
 - In 3.84 Mcps TDD and 7.68 Mcps TDD mode:
 - a FACH.
 - In FDD and 1.28 Mcps TDD mode:
 - a FACH; or
 - an HS-DSCHs and optionally a FACH for MBMS reception.
- The UE is assigned a default common or shared transport channel in the uplink (e.g. RACH or common E-DCH (FDD and 1.28 Mcps TDD only)) that it can use anytime according to the access procedure for that transport channel.
- The position of the UE is known by UTRAN on cell level according to the cell where the UE last made a cell update.
- In TDD mode, one or several USCH or DSCH transport channels may have been established.

B.3.2.1 Transition from CELL_FACH to CELL_DCH state

A transition occurs, when a dedicated physical channel is established via explicit signalling (e.g. PHYSICAL CHANNEL RECONFIGURATION, RADIO BEARER RECONFIGURATION, RADIO BEARER RELEASE, RADIO BEARER SETUP, TRANSPORT CHANNEL RECONFIGURATION, etc.).

B.3.2.2 Transition from CELL_FACH to CELL_PCH state

The transition occurs when UTRAN orders the UE to move to CELL_PCH state, which is done via explicit signalling (e.g. CELL UPDATE CONFIRM, RADIO BEARER RECONFIGURATION, etc.).

B.3.2.3 Transition from CELL_FACH to Idle Mode

Upon release of the RRC connection, the UE moves to the idle mode.

B.3.2.4 Transition from CELL_FACH to URA_PCH State

The transition occurs when UTRAN orders the UE to move to URA_PCH state, which is done via explicit signalling (e.g. URA UPDATE CONFIRM, RADIO BEARER RECONFIGURATION, etc.).

B.3.2.5 Radio Resource Allocation Tasks (CELL_FACH)

For 3.84 Mcps TDD and 7.68 Mcps TDD, in the CELL_FACH state the UE will monitor a FACH.

For FDD in the CELL_FACH state the UE will monitor a FACH, if the UE does not support HS-DSCH reception in CELL_FACH state or IE "HS-DSCH common system information" is not included in the system information. Otherwise the UE will monitor the common HS-DSCH(s), and FACH monitoring is restricted to MBMS reception.

For 1.28 Mcps TDD in the CELL_FACH state the UE will monitor a FACH, if the UE does not support HS-DSCH reception or IE "HS-DSCH common system information" and IE "Common E-DCH system info" are not included in the system information. Otherwise the UE will monitor the common HS-DSCH(s), and FACH monitoring is restricted to MBMS reception.

For 3.84 Mcps TDD and 7.68 Mcps TDD, the UE is enabled to transmit uplink control signals and it may be able to transmit small data packets on the RACH.

For FDD and 1.28 Mcps TDD, the UE is enabled to transmit uplink control signals and it may be able to transmit small data packets on the RACH, if the UE does not support Enhanced Uplink in CELL_FACH state and Idle mode, and if IE "HS-DSCH common system information" and IE "Common E-DCH system info" are not included in the system information. Otherwise the UE is enabled to transmit uplink control signals and it may be able to transmit data packets on common E-DCH.

The network can assign the UE transport channel parameters (e.g. transport format sets) in advance, to be used when a DCH is used. Upon assignment of the physical channel for DCH, the UE moves to CELL_DCH state and uses the pre-assigned TFS for the DCH.

If no UE dedicated physical channel or transport channel configuration has been assigned, the UE uses the common physical channel and transport channel configuration according to the system information.

For the uplink data transmission, the UE reports the observed traffic volume to the network in order for the network to re-evaluate the current allocation of resources. This report contains e.g. the amount of data to be transmitted or the buffer status in the UE.

When there is either user or control data to transmit, a selection procedure determines whether the data should be transmitted on a common transport channel, or if a transition to CELL_DCH should be executed. The selection is dynamic and depends on e.g. traffic parameters (amount of data, packet burst frequency).

In the TDD mode, the UTRAN can assign USCH / DSCH resources to the UE in CELL_FACH state. When USCH / DSCH resources are assigned, the UE will continue to monitor FACHs, depending on the UE capability. The UE may use the USCH / DSCH to transmit signalling messages or user data in the uplink and / or the downlink using USCH and / or DSCH when resources are allocated to cell and UE is assigned use of those USCH / DSCH.

For the uplink data transmission on USCH the UE reports to the network the traffic volume (current size of RLC data buffers), The UTRAN can use these measurement reports to re-evaluate the current allocation of the USCH / DSCH resources.

B.3.2.6 RRC Connection mobility tasks (CELL_FACH)

In this state the location of the UE is known on cell level. A cell update procedure is used to report to the UTRAN, when the UE selects a new cell to observe the common downlink channels of a new cell. Downlink data transmission on the FACH or HS-DSCH (FDD and 1.28 Mcps TDD only) can be started without prior paging.

The UE monitors the broadcast channel and system information on BCCH of its own and neighbour cells and from this the need for the updating of cell location is identified.

The UE performs cell reselection and upon selecting a new UTRA cell, it initiates a cell update procedure. Upon selecting a new cell belonging to another radio access system than UTRA, the UE enters idle mode and makes an access to that system according to its specifications.

B.3.2.7 UE Measurements (CELL_FACH)

The UE performs measurements and transmit measurement reports according to the measurement control information.

By default, the UE uses the measurement control information broadcast within the system information. However, for measurements for which the network also provides measurement control information within a MEASUREMENT CONTROL message, the latter information takes precedence.

B.3.2.8 Transfer and update of system information (CELL_FACH)

The UE reads the BCH to acquire valid system information. For each acquisition, the UE may need different combinations of system information broadcast on BCH. The scheduling on the broadcast channel is done in such way that the UE knows when the requested information can be found.

When the system information is modified, the scheduling information is updated to reflect the changes in system information transmitted on BCH. The new scheduling information is broadcast on FACH and/or on the common HS-DSCH(s) (FDD and 1.28 Mcps TDD only) in order to inform UEs about the changes. If the changes are applicable for the UE, the modified system information is read on BCH.

B.3.3 CELL_PCH state

The CELL_PCH state is characterised by:

- For FDD, if "HS-DSCH paging system information" is not included in System Information or the UE does not support HS-DSCH reception in CELL_PCH and URA_PCH state, and for TDD, no dedicated physical channel is allocated to the UE.

For FDD, if "HS-DSCH paging system information" is included in System Information and the UE does support HS-DSCH reception in CELL_PCH and URA_PCH state, dedicated physical channel may be allocated to the UE.

- For FDD, if "HS-DSCH paging system information" is not included in System Information or the UE does not support HS-DSCH reception in CELL_PCH and URA_PCH state, and for TDD, the UE selects a PCH with the algorithm specified in subclause 8.5.19, and uses DRX for monitoring the selected PCH via an associated PICH.
- For FDD and 1.28 Mcps TDD, if "HS-DSCH paging system information" is included in System Information and the UE supports HS-DSCH reception in CELL_PCH and URA_PCH state, the UE selects a HS-DSCH mapped on the HS-PDSCH with algorithms specified in 8.5.41, 8.5.39 and 8.5.40 for FDD and 8.5.40a for 1.28 Mcps TDD, and uses DRX for monitoring the selected HS-DSCH via an associated PICH.
- No uplink activity is possible.
- The position of the UE is known by UTRAN on cell level according to the cell where the UE last made a cell update in CELL_FACH state.

The DCCH and DTCH logical channels can only be used in this state if HS-DSCH is used and a dedicated H-RNTI is configured and for 1.28 Mcps TDD a dedicated E-RNTI is configured. Otherwise, if the network wants to initiate any activity, it needs to make a paging request on the PCCH logical channel in the known cell to initiate any downlink activity.

B.3.3.1 Transition from CELL_PCH to CELL_FACH state

The UE is transferred to CELL_FACH state:

- a) by paging from UTRAN (PAGING TYPE1 message)
- b) through any uplink access

B.3.3.2 Radio Resource Allocation Tasks (CELL_PCH)

In CELL_PCH state no resources have been granted for data transmission. For this purpose, a transition to another state has to be executed.

The UE may use Discontinuous Reception (DRX) in order to reduce power consumption. When DRX is used the UE needs only to receive at one paging occasion per DRX cycle. The UE may be instructed to use specific DRX cycle lengths by the network. The UE determines its paging occasions in the same way as for Idle Mode, see [4].

B.3.3.3 RRC Connection mobility tasks (CELL_PCH)

In the CELL_PCH state, the UE mobility is performed through cell reselection procedures, which may differ from the one defined in [4].

The UE performs cell reselection and upon selecting a new UTRA cell, it moves to CELL_FACH state and initiates a cell update procedure in the new cell. After the cell update procedure has been performed, the UE changes its state back to CELL_PCH state if neither the UE nor the network has any more data to transmit.

Upon selecting a new cell belonging to another radio access system than UTRA, the UE enters idle mode and make an access to that system according to its specifications.

In case of low UE activity, UTRAN may want to reduce the cell-updating overhead by ordering the UE to move to the URA_PCH State. This transition is made via the CELL_FACH state. UTRAN may apply an inactivity timer, and optionally, a counter, which counts the number of cell updates e.g. UTRAN orders the UE to move to URA_PCH when the number of cell updates has exceeded certain limits (network parameter).

B.3.3.4 UE Measurements (CELL_PCH)

The UE performs measurements and transmit measurement reports according to the measurement control information.

The UE uses the measurement control information according to the system information when no UE dedicated measurement control information has been assigned.

B.3.3.5 Transfer and update of system information (CELL_PCH)

The UE reads the BCH to acquire valid system information. For each acquisition, the UE may need different combinations of system information broadcast on BCH. The scheduling on the broadcast channel is done in such way that the UE knows when the requested information can be found.

B.3.4 URA_PCH State

The URA_PCH state is characterised by:

- No dedicated channel is allocated to the UE.
- For FDD and 1.28 Mcps TDD, if "HS-DSCH paging system information" is not included in System Information or the UE does not support HS-DSCH reception in CELL_PCH and URA_PCH state, and for TDD, the UE selects a PCH with the algorithm specified in subclause 8.5.19, and uses DRX for monitoring the selected PCH via an associated PICH.

- For FDD and 1.28 Mcps TDD, if "HS-DSCH paging system information" is included in System Information and the UE supports HS-DSCH reception in CELL_PCH and URA_PCH state, the UE selects a HS-DSCH mapped on the HS-PDSCH with algorithms specified in 8.5.41, 8.5.39 and 8.5.40 for FDD and 8.5.40a for 1.28 Mcps TDD, and uses DRX for monitoring the selected HS-DSCH via an associated PICH.
- No uplink activity is possible.
- The location of the UE is known on UTRAN Registration area level according to the URA assigned to the UE during the last URA update in CELL_FACH state.

The DCCH logical channel cannot be used in this state. If the network wants to initiate any activity, it needs to make a paging request on the PCCH logical channel within the URA where the location of the UE is known. If the UE needs to transmit anything to the network, it goes to the CELL_FACH state. The transition to URA_PCH State can be controlled with an inactivity timer, and optionally, with a counter that counts the number of cell updates. When the number of cell updates has exceeded certain limits (a network parameter), then the UE changes to the URA_PCH State.

URA updating is initiated by the UE, which, upon the detection of the Registration area, sends the network the Registration area update information on the RACH of the new cell.

B.3.4.1 Transition from URA_PCH State to CELL_FACH State (URA_PCH)

Any activity causes the UE to be transferred to CELL_FACH State.

- a) Uplink access is performed by RACH.
- b) by paging from UTRAN (PAGING TYPE1 message).

NOTE: The release of an RRC connection is possible in the URA_PCH state. UE in URA_PCH is able to go to idle when triggered by paging type 1 message in case "Release indicator" has the value "Release".

B.3.4.2 Radio Resource Allocation Tasks (URA_PCH)

In URA_PCH State no resources have been granted for data transmission. For this purpose, a transition to CELL_FACH State has to be executed.

The UE may use Discontinuous Reception (DRX) in order to reduce power consumption. When DRX is used the UE needs only to receive at one paging occasion per DRX cycle. The UE may be instructed to use specific DRX cycle lengths by the network. The UE determines its paging occasions in the same way as for Idle Mode, see [4].

B.3.4.3 RRC Connection mobility tasks (URA_PCH)

In URA_PCH State the location of a UE is known on UTRAN Registration area level.

In this state, the UE mobility is performed through URA reselection procedures, which may differ from the definitions in [4]. The UE performs cell reselection and upon selecting a new UTRA cell belonging to a URA that does not match the URA used by the UE, the UE moves to CELL_FACH state and initiates a URA update towards the network. After the URA update procedure has been performed, the UE changes its state back to URA_PCH state if neither the UE nor the network has any more data to transmit.

Upon selecting a new cell belonging to another radio access system than UTRA, the UE enters idle mode and makes an access to that system according to its specifications.

B.3.4.4 UE Measurements (URA_PCH)

The UE performs measurements and transmit measurement reports according to the measurement control information.

The UE uses the measurement control information according to the system information when no UE dedicated measurement control information has been assigned.

B.3.4.5 Transfer and update of system information (URA_PCH)

The same mechanisms to transfer and update system information as for state CELL_PCH are applicable for UEs in URA_PCH state.

B.3.5 States and Transitions for Cell Reselection in URA_PCH, CELL_PCH, and CELL_FACH

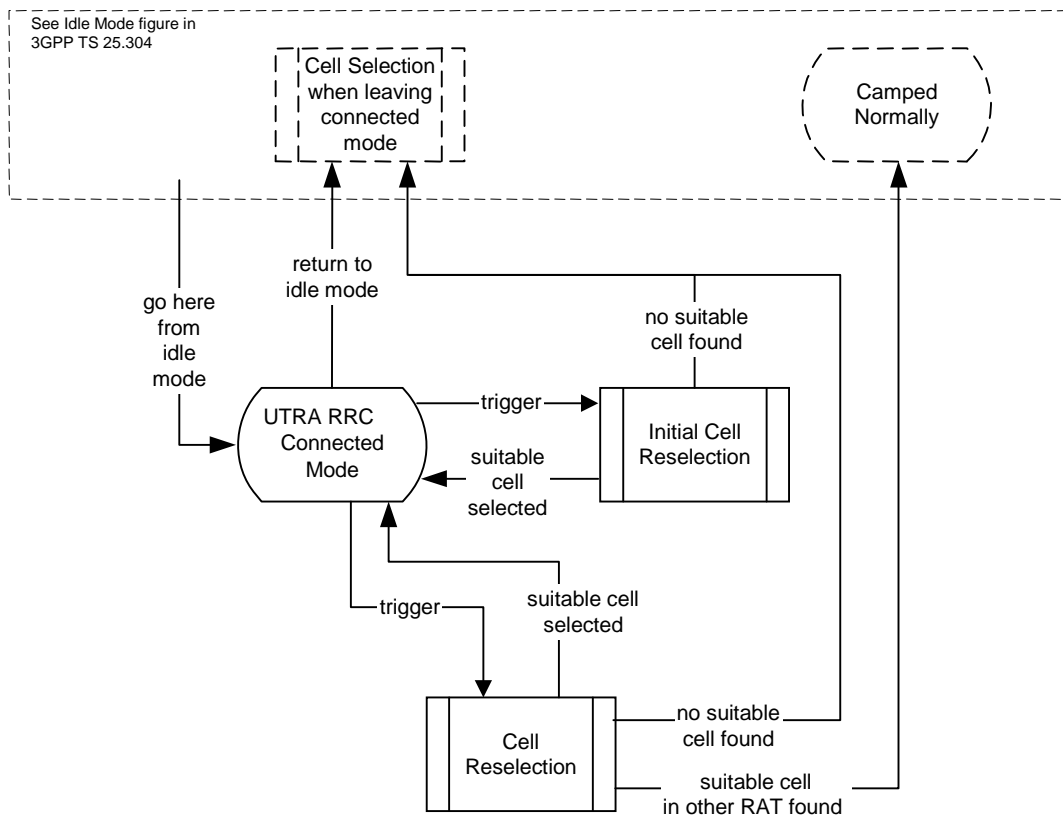

Figure B.3.5-1: UTRA RRC Connected mode cell reselection for URA_PCH, CELL_PCH, and CELL_FACH

In some states the UE performs cell reselection procedures. The UE selects a suitable cell (defined in [4]) and radio access technology based on connected mode radio measurements and cell reselection criteria.

Figure B.3.5-1 shows the states and procedures in the cell reselection process in connected mode.

When a cell reselection is triggered, the UE evaluates the cell reselection criteria based on radio measurements, and if a better cell is found that cell is selected, procedure Cell reselection (see [4]). If the change of cell implies a change of radio access technology, the RRC connection is released, and the UE enters idle mode of the other RAT. If no suitable cell is found in the cell reselection procedure, the UE eventually enters idle mode.

When an Initial cell reselection is triggered, the UE shall use the Initial cell reselection procedure (see [4]) to find a suitable cell. One example where this procedure is triggered is at radio link failure, where the UE may trigger an initial cell reselection in order to request re-establishment of the RRC connection. If the UE is unable to find a suitable cell, the UE eventually enters idle mode.

B.4 Inter-RAT handover with CS domain services

When using CS domain services, UTRAN is using an Inter-Radio access system Handover Procedure and GSM is using a Handover procedure for the transition from UTRA RRC Connected Mode to GSM Connected Mode.

B.5 Inter-RAT handover with PS domain services

When using PS domain services, the UE can initiate cell reselection from a GSM/GPRS cell to a UTRAN cell and then uses the RRC Connection Establishment procedure for the transition to UTRA RRC Connected mode. It is also possible for the BSS to initiate a UTRA Inter-RAT Handover to seamlessly relocate the UE to UTRAN. In this latter case there is no need to return the UE to Idle Mode (GPRS Packet Idle Mode) and the UE immediately moves to RRC connected state in the UTRAN.

In the case that cell reselection is used, when the RRC Connection is established from Idle Mode (GPRS Packet Idle Mode) the RRC CONNECTION REQUEST message contains an indication, that UTRAN needs to continue an already established GPRS UE context from the CN. This indication allows UTRAN to e.g. prioritise the RRC CONNECTION REQUEST from the UE.

It is possible for a E-UTRA eNodeB to initiate a Inter-RAT Handover to UTRAN to seamlessly relocate the UE to the RRC connected state in UTRAN.

In UTRA RRC connected mode UTRAN may use UE or network initiated cell reselection to change from a UTRAN cell to a GSM/GPRS cell. If the cell reselection was successful the UE enters Idle Mode (GPRS Packet Idle Mode). The UE sends a packet channel request from Idle Mode (GPRS Packet Idle mode) to establish a Temporary Block flow and enter GPRS Packet Transfer Mode. In the GPRS Packet Transfer Mode the UE sends a RA Update request message. The RA Update Request message sent from the UE contains an indication that GSM/GPRS need to continue an already established UTRAN UE context from the CN. This means that the RA Update request is always sent for the transition from UTRA RRC Connected Mode to GSM/GPRS regardless if the RA is changed or not.

Alternatively, the UTRAN may use an Inter-System Relocation (PS Handover) to relocate a UTRA RRC connected UE directly to GPRS Packet Transfer Mode in GERAN.

NOTE: The reason for using RA update instead of a new message is to reduce the impact on the existing GSM/GPRS specification.

The UTRAN may use an Inter-RAT Handover to relocate a UTRA RRC connected UE directly to RRC_CONNECTED mode in E-UTRAN.

B.6 Inter-RAT handover with simultaneous PS and CS domain services

B.6.1 Inter-RAT handover UTRAN to GSM / BSS

For a UE in CELL_DCH state using both CS and PS Domain services the Inter-RAT handover procedure is based on measurement reports from the UE but initiated from UTRAN.

The UE performs the Inter-RAT handover from UTRA RRC Connected Mode to GSM Connected Mode first. When the UE has sent handover complete message to GSM / BSS the UE initiates a temporary block flow towards GPRS and sends a RA update request.

If the Inter-RAT handover from UTRA RRC Connected Mode to GSM Connected Mode was successful the handover is considered as successful regardless if the UE was able to establish a temporary block flow or not towards GPRS.

In case of Inter-RAT handover failure the UE has the possibility to go back to UTRA RRC Connected Mode and re-establish the connection in the state it originated from.

B.6.2 Inter-RAT handover GSM / BSS to UTRAN

For a UE in GSM Connected Mode using both CS and PS domain services the Inter-RAT handover procedure is based on measurement reports from the UE but initiated from GSM / BSS.

The UE performs the Inter-RAT handover from GSM Connected Mode to UTRA RRC Connected Mode.

In UTRA RRC Connected Mode both services are established in parallel.

If the Inter-RAT handover from GSM Connected mode to UTRA RRC Connected Mode was successful the handover is considered as successful.

In case of Inter-RAT handover failure the UE has the possibility to go back to GSM Connected Mode and re-establish the connection in the state it originated from.

Annex C (informative): Description for the Compressed Coding of Pre-defined configurations included in the INTER RAT HANDOVER INFO message

This annex contains a description of the compressed coding of the IE "Predefined configuration status information compressed" (see subclause 10.3.4.5b) included in the INTER RAT HANDOVER INFO message.

C.1 Definitions

Pre-defined configuration set with different value tags: This is a set of consecutive positions for which pre-defined configurations are stored with different value tags. The set cannot include positions for which no pre-defined configuration is stored.

Pre-defined configuration list with variable size: This is the variable sized list consisting of the value tags corresponding to the remaining positions after the "Pre-defined configuration sets with different value tags" have been formed. This will also indicate not stored pre-defined configurations, either explicitly or implicitly (i.e. in the case that there are no more stored configurations until the end of the variable sized list). This is highlighted in figures C.2-1 and C.2-2.

C.2 Examples of the methodology

From figure C.2-1 it can be seen that there are two "Pre-defined configuration sets with different value tags".

The start position of Set1 is "1" with a list of 7 pre-defined configurations {1, 2, 3, 4, 5, 6, 7}.

The start position of Set2 is "10" with a list of 6 pre-defined configurations {10, 11, 12, 13, 14, 15}.

The "Pre-defined configurations list with variable size" has a start position of 0, and includes all of the pre-defined configurations not included in the sets {0, 8, 9}. The value tag at position 9 is not stored. This does not need to be explicitly indicated in the coding as "not stored" because there are no stored pre-defined configurations positioned after this in the list.

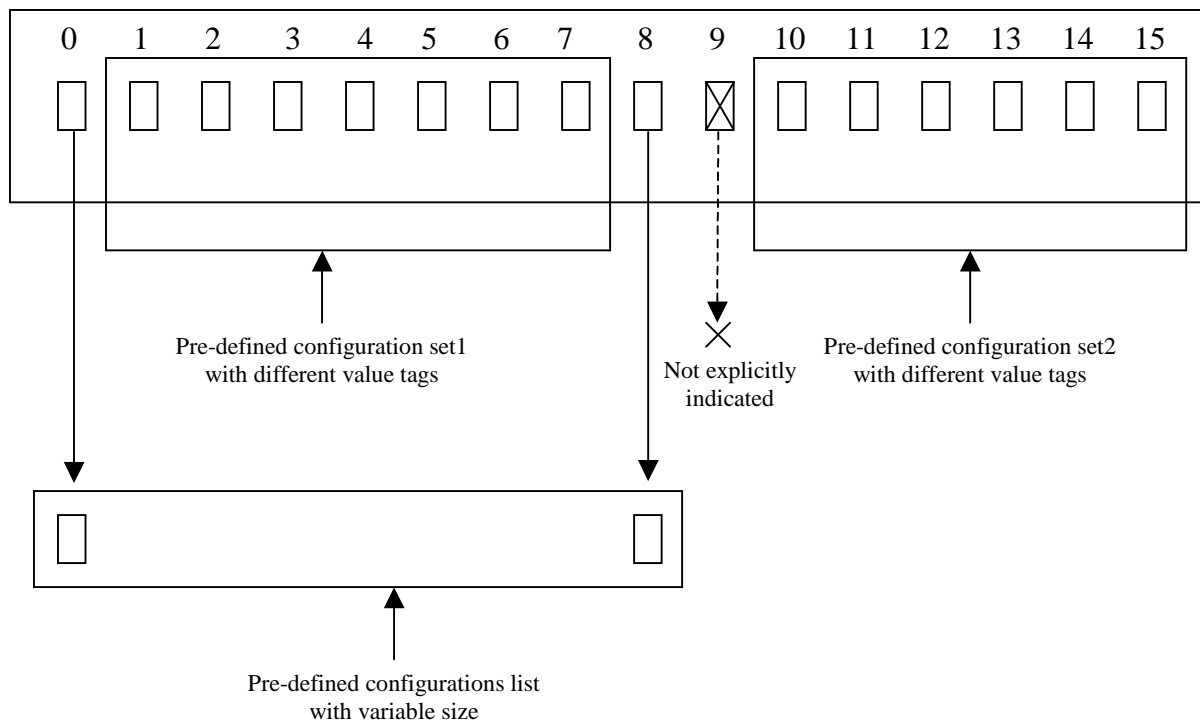

Figure C.2-1: Example scenario where non-stored pre-defined configurations do not need to be explicitly indicated

Figure C.2-2 is similar to Figure C.2-1. However in this case for the "Pre-defined configurations list with variable size", the pre-defined configuration in position 8 is not stored. This needs to be explicitly indicated in the coding as "not stored" because there is a stored pre-defined configuration (position 9) positioned after this in the list.

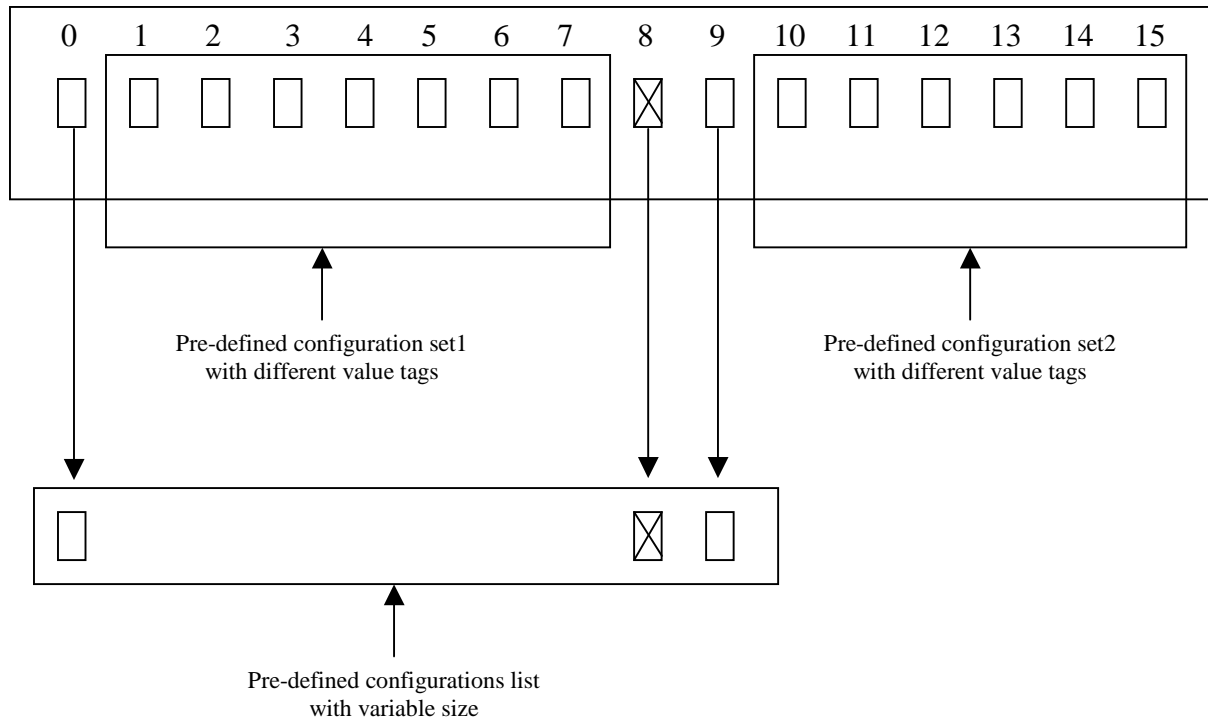

Figure C.2-2: Example scenario where non-stored pre-defined configurations need to be explicitly indicated

Annex D (Normative): Implementation of Domain Specific Access Control (DSAC) in UEs of 3GPP Release 5

UEs of 3GPP Release 5 implementing the domain specific access class control feature but not implementing the network sharing feature shall act on the domain specific access class restriction indicated by the IE "Domain Specific Access Restriction Parameters For PLMN Of MIB" if present, and otherwise apply the access restrictions indicated by the IE "Cell Access Restriction".

Annex E (Normative): EUTRA Feature group indicators

This annex contains the definitions of the bits in EUTRA Feature Group Indicators.

In this release of the specification the UE shall include the optional EUTRA Feature Group Indicators IE in the UE multi-mode/multi RAT capability IE of the RRC message. For a specific indicator, if all functionalities for a feature group listed in Table E.1 have been implemented and tested, the UE shall set the indicator as "true" (as one), else (i.e., if any one of the functionalities in a feature group listed in Table E.1 have not been implemented or tested), the UE shall set the indicator as "false" (as zero).

The UE shall set all indicators that correspond to RATs not supported by the UE as "false" (as zero).

The UE shall set all indicators, which do not have a definition in Table E.1, as "false" (as zero).

If the optional EUTRA Feature Group Indicators IE is not included by a UE of a future release, the network may assume that all features pertaining to the RATs supported by the UE, listed in Table E.1 and deployed in the network, have been implemented and tested by the UE.

Table E.1: Definitions of feature group indicators

Index of indicator (bit number)	Definition (description of the supported functionality, if indicator set to 'true')	Notes
1 (leftmost bit)	- UTRA CELL_PCH to EUTRA RRC_IDLE cell reselection - UTRA URA_PCH to EUTRA RRC_IDLE cell reselection	UE supporting E-UTRAN shall set this bit to 'TRUE' in this version of specification.
2	EUTRAN measurements and reporting in connected mode	UE supporting E-UTRAN shall set this bit to 'TRUE' in this version of specification.
3	- UTRA CELL_FACH absolute priority cell reselection for high priority layers	UE supporting E-UTRAN shall set this bit to 'TRUE' in this version of specification.
4	- UTRA CELL_FACH absolute priority cell reselection for all layers	UE supporting E-UTRAN shall set this bit to 'TRUE' in this version of specification.

Clarification for mobility to EUTRAN

For mobility to E-UTRAN, it is assumed that we have 9 main "functions":

- A. Support of measurements and cell reselection procedure in idle mode
- B. Support of measurements and cell reselection procedure in CELL/URA_PCH
- C. Support of RRC release with redirection procedure
- D. Support of RRC reject with redirection procedure
- E. Support of EUTRAN measurements and reporting in connected mode
- F. Support of handover procedure in connected mode
- G. Support of high priority layer measurements and cell reselection procedure in CELL_FACH
- H. Support of all priority layer measurements and cell reselection procedure in CELL_FACH
- I. Support of E-UTRA measurement for CELL_FACH for E-UTRA FDD and E-UTRA TDD

Of the above, all UEs that indicate support of E-UTRA in UE capability signalling "Support of E-UTRA FDD" or "Support of E-UTRA TDD" support A), C) and D) for all EUTRA bands they support.

For B) above, UEs indicates support by the Group 1 indicator bit (if Group 1 is set to "true", it is supported for all EUTRA bands the UE supports).

For E) above, UEs indicate support by the Group 2 indicator bit (if Group 2 is set to "true", it is supported for all EUTRA bands the UE supports). The compressed mode capability for supported E-UTRA frequency bands ('Need for compressed mode') in "Measurement capability extension" is ignored by the network when Group 2 is set to "false". In this version of the specification, the UE supporting E-UTRAN shall set the Group 2 indicator bit to "true".

For F) above, UEs indicate support by the separate UE capability signaling "Support of Inter-RAT PS Handover to E-UTRA FDD/TDD" defined in TS 25.306 (if this bit is set to "true", PS handover is supported for all EUTRA bands the UE supports). This bit can only be set to "true" if the UE has set the Group 2 indicator bit to "true".

For G) above, UEs indicates support by the Group 3 indicator bit (if Group 3 is set to "true", it is supported for all EUTRA bands the UE supports). If the separate UE capability "Support for absolute priority based cell re-selection in UTRAN" is also set to "true", UEs indicate support of high priority layer measurements and cell reselection procedure in CELL_FACH also for UTRA inter-frequency.

For H) above, UEs indicates support by the Group 4 indicator bit (if Group 4 is set to "true", it is supported for all EUTRA bands the UE supports). If the separate UE capability "Support for absolute priority based cell re-selection in UTRAN" is also set to "true", UEs indicate support of all priority layer measurements and cell reselection procedure in CELL_FACH also for UTRA inter-frequency. UEs that indicate support for H also indicate support for G.

For I) above, UEs indicate support by the separate UE capability signaling "Support of E-UTRA FDD measurements and reporting in CELL_FACH" and "Support of E-UTRA TDD measurements and reporting in CELL_FACH" defined in TS 25.306 (if the corresponding bit is set to "true", E-UTRA measurement for CELL_FACH for E-UTRA FDD and E-UTRA TDD is supported for all EUTRA FDD and TDD bands respectively, that the UE supports).

Annex F (Normative): Support of Multiple Frequency Band Indicators (Multiple FBI) in UE

For UEs of 3GPP Release 9 or earlier, implementation of the multiple frequency band indicators feature is optional if the UE supports a band which has overlap with other bands defined in 3GPP [85], otherwise not applicable. Note that these other bands may not be supported by the UE, but the UE shall understand the UARFCN signalling for all bands, that overlap with the bands supported by the UE, and that are defined in the earliest version of [21] that includes all UE supported band(s).

For UEs of 3GPP from Release 10, implementation of the multiple frequency band indicators feature is mandatory if the UE supports a band which has overlap with other bands defined in 3GPP [85], otherwise not applicable. Note that these other bands may not be supported by the UE, but the UE shall understand the UARFCN signalling for all bands, that overlap with the bands supported by the UE, and that are defined in the earliest version of [21] that includes all UE supported bands.

Annex G (informative): Signalling of Multiple Frequency Band Indicators (Multiple FBI)

This annex contains a Stage 2 description of the mapping between the respective Multiple Frequency Band Indicators (MFBI) lists and the:

- Frequency Band signalled in System Information Block type 5, System Information Block type 5bis and System Information Block type 6
- UARFCN's signalled in System Information Block type 11, System Information Block type 11bis, System Information Block type 11ter and System Information Block type 12
- EARFCN's and extended EARFCN's signalled in System Information Block type 19

G.1 Mapping between "Frequency band indicator", "Frequency band indicator 2" or "Frequency band indicator 3" and "Multiple Frequency Info list"

In System Information Block type 5, System Information Block type 5bis and System Information Block type 6 a single UTRA Frequency Band may be broadcast in one of the IE's "Frequency band indicator", "Frequency band indicator 2" or "Frequency band indicator 3". This UTRA Frequency band can then have up to 8 additional overlapping UTRA Frequency bands broadcast in the IE "Multiple Frequency Band indicator list".

G.2 Mapping between "New Inter-frequency cells" and "Multiple Frequency Info List FDD"

In System Information Block type 11, System Information Block type 11bis, System Information Block type 11ter and System Information Block type 12 a list of up to 80 inter-frequency UTRA cells may be broadcast in the IE "New Inter-frequency cells". Additionally, for up to 8 of the UARFCN broadcast in the IE "New Inter-frequency cells" there can be up to 8 additional overlapping UTRA Frequency bands broadcast in the IE "Multiple Frequency Info List FDD".

The following criteria regarding the signalling of the Inter-frequency cells in SIB11/11bis/11ter should be considered:

- The "Frequency info" IE should appear only once in "New Inter-frequency cells" for each UARFCN i.e. for the first Inter-frequency neighbour cell using that UARFCN. For each subsequent Inter-frequency neighbour cell having the same UARFCN, the "Frequency info" should not be included, but rather the Mandatory Default (MD) value will be used.
- All Inter-frequency neighbour cells having the same UARFCN should be listed contiguously within the IE "New Inter-frequency cells" in SIB11/11bis/11ter.
- Each occurrence of the IE "Frequency info" included in the IE "New Inter-frequency cells" will have one corresponding entry in "Multiple Frequency Info List FDD" i.e. the first "Frequency info" maps to the first entry in "Multiple Frequency Info List FDD", the second "Frequency info" maps to the second entry in "Multiple Frequency Info List FDD" and so on.
- If a specific instance of "Frequency info" included in the IE "New Inter-frequency cells" does not have any overlapping band(s), the corresponding entry in "Multiple Frequency Info List FDD" should be empty.

Example:

The following inter-frequency UTRA cells are broadcast in System Information Block type 11

- Cell1 (UARFCN A)
- Cell2 (UARFCN A)
- Cell3 (UARFCN B)
- Cell4 (UARFCN B)

- Cell5 (UARFCN C)

The following overlapping UTRA frequency bands (listed in priority order) are broadcast for UARFCN B

- UTRA frequency Band X
- UTRA frequency Band Y
- UTRA frequency Band Z

The mapping between the "Inter-frequency cell info list" and the "Multiple Frequency Info List FDD" is shown in Figure G.2.1:

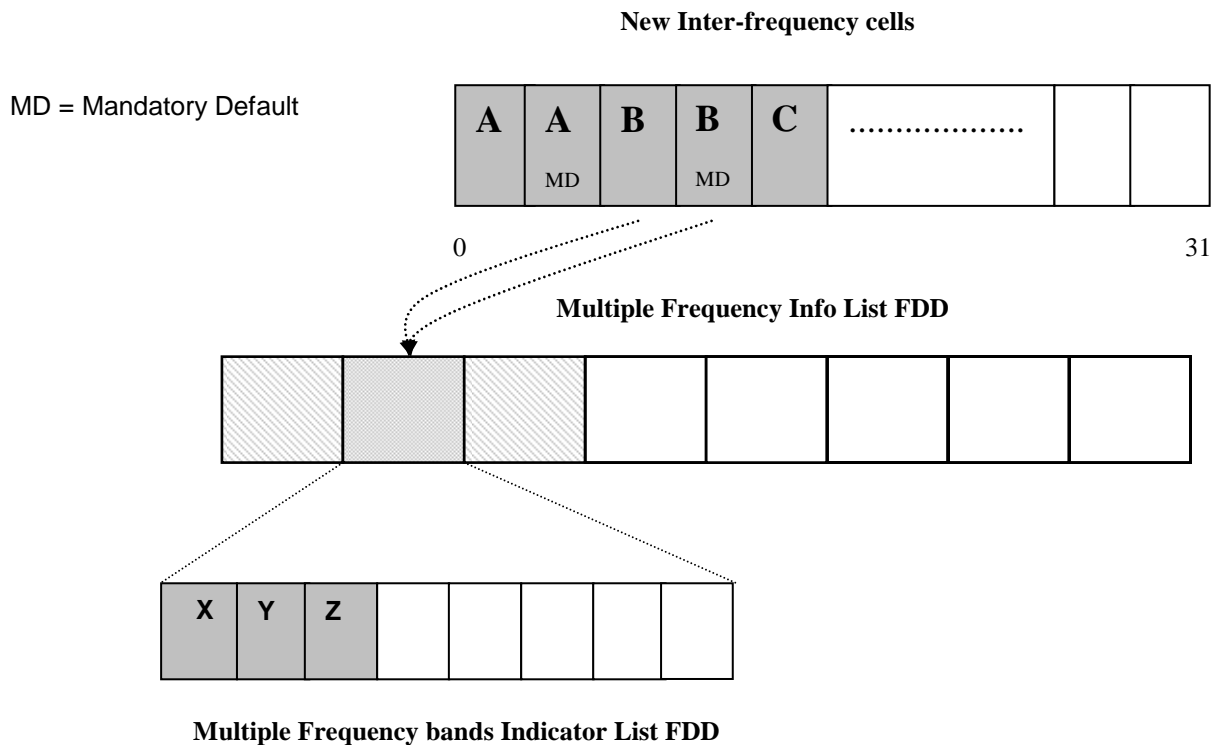

Figure: G.2.1 – Overlapping inter-frequency UTRA cells

G.3 Mapping between "E-UTRA frequency and priority" and "Multiple E-UTRA Frequency Info list" or "Multiple E-UTRA Frequency Info extension list"

In System Information Block type 19, a list of up to 8 EARFCNs associated with E-UTRA frequencies may be broadcast between the IE's "E-UTRA frequency and priority" and "E-UTRA frequency and priority extension". For each of the broadcast EARFCN's, there can be upto 8 additional overlapping E-UTRA Frequency bands broadcast in the IE "Multiple E-UTRA frequency info list" and/or "Multiple E-UTRA frequency info extension list".

When both "E-UTRA frequency and priority" and "E-UTRA frequency and priority extension" lists are included in System Information Block type 19, then the IE "**Number of applicable EARFCN**" is used to inform the UE of how many instances should be read from the "E-UTRA frequency and priority":

- If the IE "Number of Applicable EARFCN" is not signalled in the System Information Block type 19, then all the entries in the "Multiple E-UTRA frequency info list" are mapped to "E-UTRA frequency and priority".
- If the IE "Number of Applicable EARFCN" is present in the System Information Block type 19 and is not set to 0, then the first "Number of Applicable EARFCN" entries in the "Multiple E-UTRA frequency info list" are mapped to "E-UTRA frequency and priority", with the remaining entries in the "Multiple E-UTRA frequency info list" mapped to "E-UTRA frequency and priority extension".

- If the IE "Number of Applicable EARFCN" is present in the System Information Block type 19 and is set to 0, then all the entries in the "Multiple E-UTRA frequency info list" are mapped to "E-UTRA frequency and priority extension".

Based on the presence of IE "Number of Applicable EARFCN", each entry in the "Multiple E-UTRA frequency info list" is mapped to either an entry in the "E-UTRA frequency and priority" list or an entry in "E-UTRA frequency and priority extension" list.

The number of signaled entries in the IE's "Multiple E-UTRA frequency info list" and "Multiple E-UTRA frequency info extension list" is the same, and is equal to the sum of ("Number of Applicable EARFCN" + number of entries in "E-UTRA frequency and priority extension").

Example:

The following EARFCN's are broadcast in System Information Block type 19

- E-UTRA frequency and priority
 - EARFCN A (0.. 65535)
 - EARFCN X (0.. 65535)
 - EARFCN Y (0.. 65535)
- E-UTRA frequency and priority extension
 - EARFCN E (65536..262143)
 - EARFCN F (65536.. 262143)

The second entry in the "E-UTRA frequency and priority" list, EARFCN X, has the following overlapping E-UTRA frequency bands:

- E-UTRA frequency Band B (<64)
- Extended E-UTRA frequency Band D (>64)
- E-UTRA frequency Band C (<64)

The second entry in the "E-UTRA frequency and priority extension" list, EARFCN F, has the overlapping E-UTRA frequency band Z (<64).

The IE "Number of Applicable EARFCN" in this example will be set to a value of 3 by the NW. This means that the first 3 positions in the "Multiple E-UTRA frequency info list" correspond to the corresponding entries in the "E-UTRA frequency and priority" list. The two entries in the "E-UTRA frequency and priority extension" list are then mapped to the "Multiple E-UTRA frequency info list", using an offset of the value of the IE "Number of Applicable EARFCN".

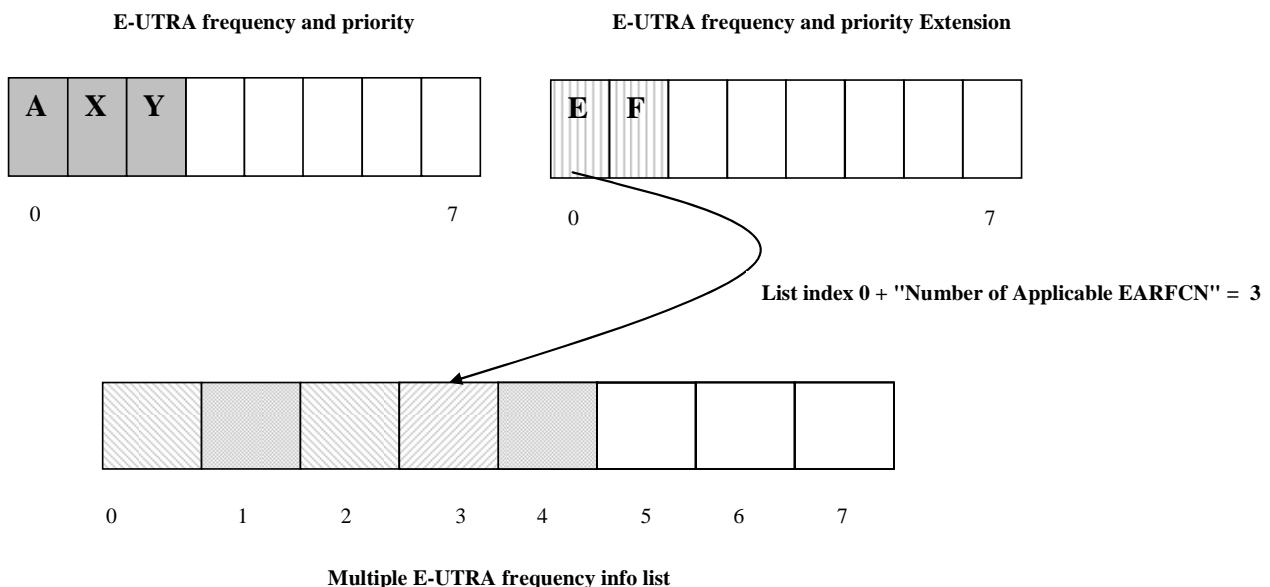

Figure: G.3.1 – Mapping of EARFCN's to Multiple E-UTRA frequency info list

The IE "Multiple E-UTRA frequency info list" is a list of SIZE (1..8), where each entry in the list contains an optional instance of the IE "Multiple E-UTRA frequency band indicator list". In this example, the network would signal the "Multiple E-UTRA frequency info list" with 5 instances, but for indices 0, 2 and 3 the optional list "Multiple E-UTRA

frequency band indicator list" would not be included, given that there are no overlapping bands defined for the EARFCN A, EARFCN Y and (extended) EARFCN E.

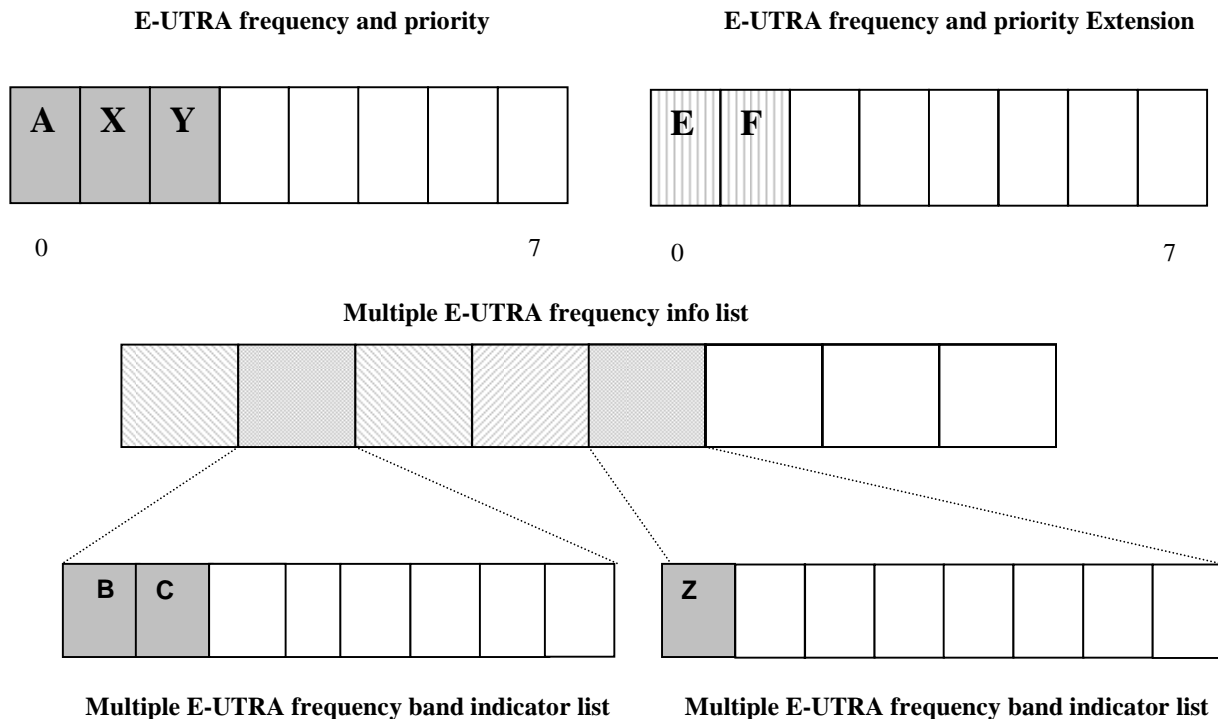

Figure: G.3-2 – Mapping of EARFCN's to Multiple E-UTRA frequency info

Each entry of the IE "Multiple E-UTRA frequency band indicator list" contains the E-UTRA Frequency Band (1..64) which overlaps with the E-UTRA Frequency Band associated with the EARFCN broadcast in the "E-UTRA frequency and priority" or "E-UTRA frequency and priority extension" lists.

Each entry of the IE "Multiple E-UTRA frequency band extension indicator list" contains the E-UTRA Frequency Band (65..256) which overlaps with the E-UTRA Frequency Band associated with the EARFCN broadcast in the "E-UTRA frequency and priority" or "E-UTRA frequency and priority extension" lists.

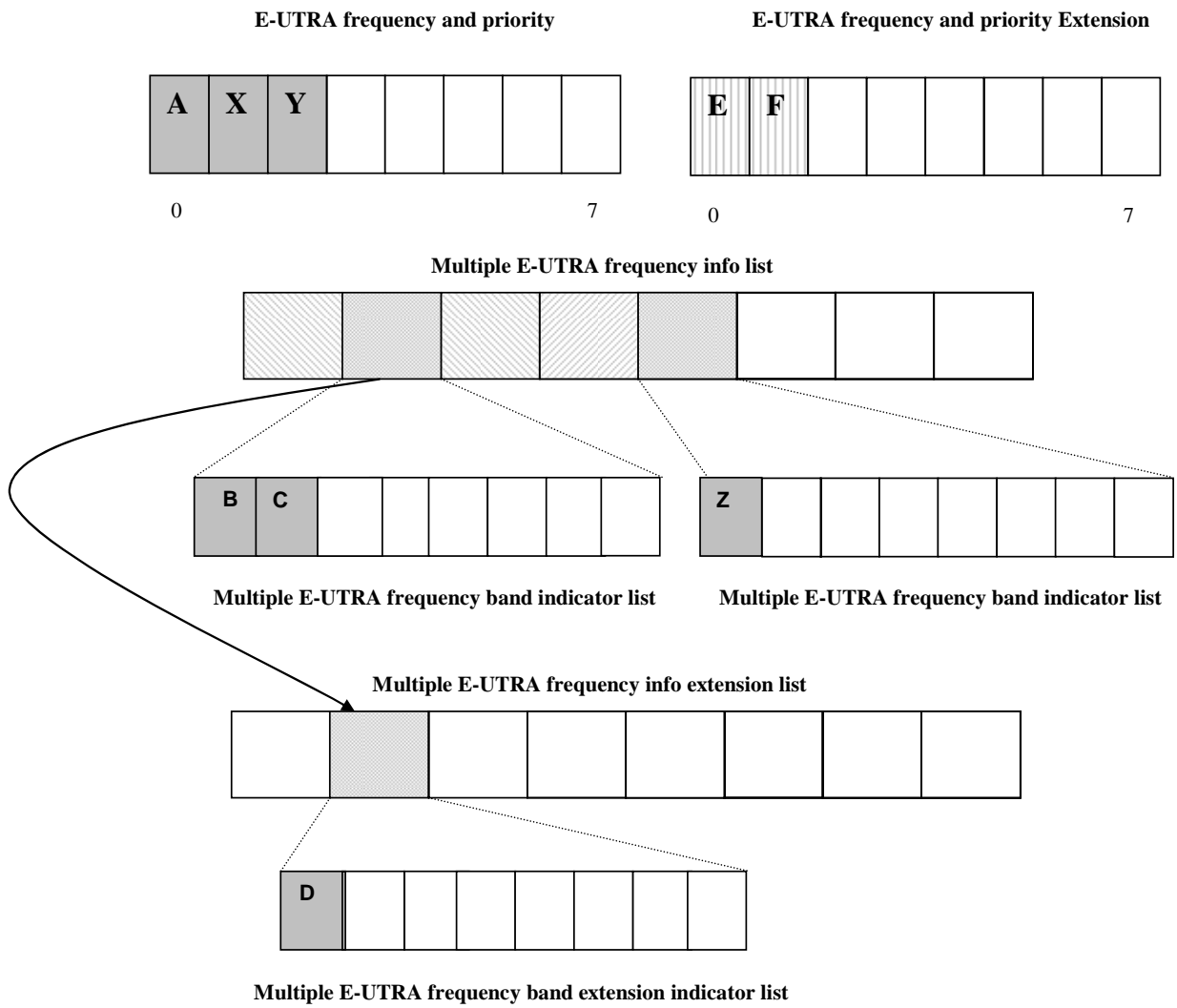

Figure: G.3.3 – Mapping of EARFCN's to extended E-UTRA frequency bands

Annex H (informative): Change history

Change history							
Date	TSG #	TSG Doc.	CR	Rev	Cat	Subject/Comment	New

10/1999	RP-05	RP-99524	-		Approved at TSG-RAN #5 and placed under Change Control	3.0.0
12/1999	RP-06	RP-99650	001		Modification of RRC procedure specifications	3.1.0
	RP-06	RP-99654	005	1	Introduction of Information Element for Power Control Algorithm	3.1.0
	RP-06	RP-99654	007	1	RRC parameters for SSdT	3.1.0
	RP-06	RP-99656	009	1	Inclusion of information elements for integrity protection	3.1.0
	RP-06	RP-99656	010	2	Security mode control procedure	3.1.0
	RP-06	RP-99656	011	3	Updates of the system information procedure	3.1.0
	RP-06	RP-99656	012	2	Inter-frequency measurements and reporting	3.1.0
	RP-06	RP-99656	013	1	Inter-system measurements and reporting	3.1.0
	RP-06	RP-99656	014	1	Additional measurements in RRC measurement messages	3.1.0
	RP-06	RP-99656	015	3	Value range for Measurement Information Elements	3.1.0
	RP-06	RP-99656	016	2	Message contents for inter system handover to UTRAN	3.1.0
	RP-06	RP-99652	017		Inclusion of ciphering information elements	3.1.0
	RP-06	RP-99651	018		Corrections and editorial changes	3.1.0
	RP-06	RP-99654	019	1	Algorithm for CTCF Calculation	3.1.0
	RP-06	RP-99651	025		Logical CH for RRC Connection Re-establishment (RRC Connection Re-establishment deleted in RAN_10, RP-000715)	3.1.0
	RP-06	RP-99719	026	1	Gain Factors	3.1.0
	RP-06	RP-99654	027	1	Parameters for CELL UPDATE CONFIRM message	3.1.0
	RP-06	RP-99651	028		Cell Update Cause	3.1.0
	RP-06	RP-99654	029	1	RRC Initialisation Information	3.1.0
	RP-06	RP-99656	034	1	Open loop power control for PRACH	3.1.0
	RP-06	RP-99652	038		Addition of the UE controlled AMR mode adaptation	3.1.0
	RP-06	RP-99651	039		Information elements for RLC reset	3.1.0
	RP-06	RP-99656	040		Support for DS-41 Initial UE Identity	3.1.0
	RP-06	RP-99656	042	2	Integration of Cell Broadcast Service (CBS)	3.1.0
	RP-06	RP-99654	044	1	Gated transmission of DPCCCH	3.1.0
	RP-06	RP-99656	045		Modification to the Transport Format Combination Control message	3.1.0
	RP-06	RP-99656	046		New Information elements and modifications to messages required in order to support configuration and re-configuration of the DSCH in FDD mode	3.1.0
	RP-06	RP-99654	047	1	Editorial Corrections and Alignments with Layer 1 specifications	3.1.0
	RP-06	RP-99654	048	1	Information elements for TDD shared channel operation	3.1.0
	RP-06	RP-99656	049		Description of CN dependent IEs in Master Information Block	3.1.0
	RP-06	RP-99650	050		UE capability information elements	3.1.0
	RP-06	RP-99656	051	1	UTRAN response time to uplink feedback commands of TX diversity control	3.1.0
	RP-06	RP-99654	052		New and corrected CPCH parameters	3.1.0
	RP-06	RP-99654	053	2	Compressed mode parameters without gating	3.1.0
	RP-06	RP-99654	054		Transport format combination set and transport format combination subset	3.1.0
	RP-06	RP-99656	055	1	Information elements for cell selection and reselection	3.1.0
	RP-06	RP-99654	056		Corrections and Alignments of the RRC to the L1 for TDD	3.1.0
	RP-06	RP-99656	057	1	Introduction of a SCCH procedure	3.1.0
	RP-06	RP-99656	061		Support for DS-41 Paging UE Identity	3.1.0
	RP-06	RP-99656	062	2	Support for cdma2000 Hard Handover	3.1.0
	RP-06	RP-99656	063	1	Provide necessary signalling to support FDD DSCH	3.1.0
	RP-06	RP-99654	064		RRC procedure interactions	3.1.0
	RP-06	RP-99654	066	1	Transfer of UE capabilities	3.1.0
	RP-06	RP-99654	067		Selection of initial UE identity	3.1.0
	RP-06	RP-99657	069		UE capability verification in the security mode control procedure	3.1.0
	RP-06	RP-99657	070	1	DPCH initial power	3.1.0
	RP-06	RP-99657	071		Actions when entering idle mode	3.1.0
	RP-06	RP-99657	072		Specification of inter-frequency and inter-system reporting events for FDD	3.1.0
	RP-06	RP-99657	073	1	Signalling radio bearers	3.1.0
	RP-06	RP-99654	074		CN information elements	3.1.0
	RP-06	RP-99654	076		UE information elements	3.1.0
	RP-06	RP-99657	077	1	Radio bearer, transport channel and physical channel information elements	3.1.0
	RP-06	RP-99654	078		Other information elements	3.1.0
	RP-06	RP-99657	079	2	RRC signalling for PDCP	3.1.0
	RP-06	RP-99654	080		Content of Measurement Control Messages	3.1.0

	RP-06	RP-99654	081			RRC Information Elements to support Block STTD transmission diversity in TDD	3.1.0
	RP-06	RP-99657	082	1		Signalling connection release	3.1.0
	RP-06	RP-99657	083	1		Addition of cell access restriction information elements to System Information	3.1.0
	RP-06	RP-99655	085	1		RRC Connection Establishment parameters	3.1.0
	RP-06	RP-99657	092	1		Support of UE autonomous update of a active set on a non-used frequency	3.1.0
	RP-06	RP-99657	095	1		TPC combining for power control	3.1.0
	RP-06	RP-99653	096	1		Editorial Modification of IEs in RRC messages	3.1.0
	RP-06	RP-99655	097			Selection of SCCPCH	3.1.0
	RP-06	RP-99655	098	1		RRC Initialisation Information	3.1.0
	RP-06	RP-99657	100	1		Support of physical channel establishment and failure criteria in the UE	3.1.0
	RP-06	RP-99655	102	1		RRC Connection Re-establishment (Message deleted in RAN_10, RP-000715)	3.1.0
	RP-06	RP-99657	106	1		System information on FACH	3.1.0
	RP-06	RP-99657	108	1		SAPs and Primitives for DS-41 mode	3.1.0
	RP-06	RP-99655	109	1		TX Diversity Mode for Dedicated Channel	3.1.0
	RP-06	RP-99657	110	1		RACH message length signalling on System Information	3.1.0
	RP-06	RP-99657	113	1		Routing of NAS messages in UTRAN	3.1.0
	RP-06	RP-99655	116	3		TBS Identification in TFS	3.1.0
	RP-06	RP-99657	117	1		Merging the hard handover and some radio bearer control procedures	3.1.0
	RP-06	RP-99653	120	1		Selected RRC message transfer syntax	3.1.0
	RP-06	RP-99657	121			Efficient rate command signalling	3.1.0
03/2000	RP-07	RP-000043	122			TDD Mode BCH Reception in Cell DCH State	3.2.0
	RP-07	RP-000043	123			Uplink Outer Loop Power Control in TDD Mode	3.2.0
	RP-07	RP-000043	124	1		TFS TB Size Calculation with Bit Aligned TDD MAC Headers	3.2.0
	RP-07	RP-000043	125			Grouping of DRAC IEs, and detailed definitions of these IEs	3.2.0
	RP-07	RP-000043	126			Correction of specifications for the 'Dynamic Resource Allocation Control of Uplink DCH' Procedure	3.2.0
	RP-07	RP-000043	131	2		Clarification of PDCP info and PDCP capability IEs	3.2.0
	RP-07	RP-000043	132			Editorial change to "Specification of system information block characteristics"	3.2.0
	RP-07	RP-000043	133			Additions of CBS related Information Elements	3.2.0
	RP-07	RP-000043	134			Signalling for computed gain factors	3.2.0
	RP-07	RP-000043	137	1		General error handling procedures	3.2.0
	RP-07	RP-000043	138	1		RRC message extensions	3.2.0
	RP-07	RP-000043	139			Padding of RRC messages using RLC transparent mode	3.2.0
	RP-07	RP-000043	140	2		UE information elements	3.2.0
	RP-07	RP-000043	141			Other information elements	3.2.0
	RP-07	RP-000043	142	3		Integrity protection function	3.2.0
	RP-07	RP-000043	143	4		RAB-RB relations	3.2.0
	RP-07	RP-000043	144	1		Inter-system handover from UTRAN	3.2.0
	RP-07	RP-000043	145	3		Handover to UTRAN including procedure for pre- configuration	3.2.0
	RP-07	RP-000043	146	2		RRC measurement filtering parameters	3.2.0
	RP-07	RP-000043	147			New event "RL out of UE Rx window"	3.2.0
	RP-07	RP-000044	148	1		Access control on RACH	3.2.0
	RP-07	RP-000044	149	2		cdma2000 Hard Handover	3.2.0
	RP-07	RP-000044	150	1		CPCH parameters with corrections	3.2.0
	RP-07	RP-000044	152			U-plane AM RLC reconfiguration by cell update procedure	3.2.0
	RP-07	RP-000044	154	3		CPCH	3.2.0
	RP-07	RP-000044	155	1		Information elements for ASC in TDD	3.2.0
	RP-07	RP-000044	156			Addition of timing advance value in handover related messages	3.2.0
	RP-07	RP-000044	157	2		Physical channel description for TDD	3.2.0
	RP-07	RP-000044	159			Message contents for the intersystem command message to UTRAN operating in TDD mode	3.2.0
	RP-07	RP-000044	160			Corrections on use of PUSCH power control info and minor corrections	3.2.0
	RP-07	RP-000044	162	2		UE individual DRX cycles in CELL_PCH and URA_PCH states	3.2.0
	RP-07	RP-000044	163			Correction to Transport Format Combination Control procedure	3.2.0
	RP-07	RP-000044	164	3		Downlink outer loop power control	3.2.0
	RP-07	RP-000044	165	2		Redirection of RRC connection setup	3.2.0
	RP-07	RP-000044	166	2		Inter-frequency measurements in CELL_FACH state	3.2.0
	RP-07	RP-000044	167			List of found editorial mistakes in the Dec99 version of 25.331 (V3.1.0)	3.2.0

	RP-07	RP-000044	168	1	Transport block size	3.2.0
	RP-07	RP-000044	169	1	Cell Access Restriction	3.2.0
	RP-07	RP-000044	170		Editorial modification	3.2.0
	RP-07	RP-000044	171		Modification of DPCH info	3.2.0
	RP-07	RP-000045	172	1	Measurement control message	3.2.0
	RP-07	RP-000045	173	2	Reporting cell status	3.2.0
	RP-07	RP-000045	174		Additional IE for RB release	3.2.0
	RP-07	RP-000045	175		Available SF in PRACH info	3.2.0
	RP-07	RP-000045	176		Traffic volume measurement event	3.2.0
	RP-07	RP-000045	177		Report of multiple cells on an event result	3.2.0
	RP-07	RP-000045	178		Editorial modification on Direct Transfer	3.2.0
	RP-07	RP-000045	179		Correction of the Security Mode Control procedure	3.2.0
	RP-07	RP-000045	180	1	Maximum calculated Transport Format Combination	3.2.0
	RP-07	RP-000045	183		Additional DPCH IEs to align 25.331 with 25.214	3.2.0
	RP-07	RP-000045	184	1	RB – DCH mapping	3.2.0
	RP-07	RP-000045	188	1	Modifications related to FDD mode DSCH	3.2.0
	RP-07	RP-000045	189	1	Identification of Shared Channel Physical Configuration in TDD Mode	3.2.0
	RP-07	RP-000045	192	1	Uplink Outer Loop Power Control During Hard Handover	3.2.0
	RP-07	RP-000045	193		Support of Multiple CCTrCH's in TDD Mode	3.2.0
	RP-07	RP-000045	194	1	Uplink Physical Channel Control in TDD Mode	3.2.0
	RP-07	RP-000045	201	1	Transfer of initial information from UE to target RNC prior to handover to UTRAN	3.2.0
	RP-07	RP-000045	202	1	CN information elements	3.2.0
	RP-07	RP-000045	203		UTRAN mobility information elements	3.2.0
	RP-07	RP-000045	204	1	RB information elements	3.2.0
	RP-07	RP-000046	205	1	Physical channel information elements	3.2.0
	RP-07	RP-000046	206	1	UE capability information elements	3.2.0
	RP-07	RP-000046	207		UE variables	3.2.0
	RP-07	RP-000046	208	1	Actions when entering idle mode	3.2.0
	RP-07	RP-000046	209		Usage of pilot bits	3.2.0
	RP-07	RP-000046	210		System information procedure corrections	3.2.0
	RP-07	RP-000046	212		Reconfiguration of ciphering	3.2.0
	RP-07	RP-000046	213	1	Enhancements to RRC connection re-establishment procedure (Message subsequently deleted in RAN !), RP-000715)	3.2.0
	RP-07	RP-000046	215		Updates to RRC Initialisation Information transparent container and addition of reverse direction container description	3.2.0
	RP-07	RP-000046	220	1	Changes in RRC messages to support lossless SRNC relocation	3.2.0
	RP-07	RP-000046	229	1	Measurements of unlisted neighbouring cells	3.2.0
	RP-07	RP-000046	234	2	Inclusion of Location Services	3.2.0
	RP-07	RP-000046	236	1	Application of Access Service Classes and relation to Access Classes	3.2.0
	RP-07	RP-000046	252	1	DRX indicator presence and state entering mechanism at the end of a procedure	3.2.0
	RP-07	RP-000046	254	1	Physical shared channel allocation procedure	3.2.0
	RP-07	RP-000046	255		Corrections to TDD specific parameters in PICH info	3.2.0
	RP-07	RP-000046	256		Editorial modifications	3.2.0
	RP-07	RP-000046	259	2	Introduction of mapping function information in Cell selection and	3.2.0
	RP-07	RP-000046	263		Ciphering and integrity HFN	3.2.0
	RP-07	RP-000046	267		New SIB for UP	3.2.0
	RP-07	RP-000047	268		Removal of synchronization Case 3	3.2.0
	RP-07	RP-000047	271		TX Diversity	3.2.0
	RP-07	RP-000047	272		Update of tabular format clause 10	3.2.0
	RP-07	RP-000047	273		ASN.1 description	3.2.0
06/2000	RP-08	RP-000222	228	5	Downlink power control in compressed mode	3.3.0
	RP-08	RP-000222	260	1	Clarification on physical channel allocations in TDD	3.3.0
	RP-08	RP-000222	261	4	TDD Measurements and Reporting	3.3.0
	RP-08	RP-000222	262	4	Signalling of IEs related to System Information on FACH	3.3.0
	RP-08	RP-000222	265	3	Transport Format Combination Control	3.3.0
	RP-08	RP-000222	269	1	Signalling of partial failure in radio bearer related procedures	3.3.0
	RP-08	RP-000222	275		Clarification on PDCP info	3.3.0
	RP-08	RP-000222	279		Editorial modification on Transport Ch capability	3.3.0
	RP-08	RP-000222	280		Editorial modification on CN IE	3.3.0

	RP-08	RP-000222	281	3		Editorial modification on Physical CH IE	3.3.0
	RP-08	RP-000222	282	1		Editorial modification on ASN.1 description	3.3.0
	RP-08	RP-000222	283	1		IEs on SIB5/6	3.3.0
	RP-08	RP-000222	285	2		Re-establishment timer	3.3.0
	RP-08	RP-000222	286	1		CN DRX cycle coefficient	3.3.0
	RP-08	RP-000222	287	1		Cell Access Restriction	3.3.0
	RP-08	RP-000222	288	1		Cell selection and re-selection parameters	3.3.0
	RP-08	RP-000222	289	2		Modification on Measurement IE	3.3.0
	RP-08	RP-000222	291	1		RACH Transmission parameters	3.3.0
	RP-08	RP-000222	292	1		SCCPCH System Info	3.3.0
	RP-08	RP-000222	293	1		Addition of HFN for RRC CONNECTION RE-ESTABLISHMENT COMPLETE	3.3.0
	RP-08	RP-000223	294	1		RLC reconfiguration indicator	3.3.0
	RP-08	RP-000223	296	3		RLC Info	3.3.0
	RP-08	RP-000223	297	1		Usage of Transport CH ID	3.3.0
	RP-08	RP-000223	298	2		Transport format combination set	3.3.0
	RP-08	RP-000223	300	1		Usage of U-RNTI and C-RNTI in DL DCCH message	3.3.0
	RP-08	RP-000223	301			Description of Cell Update Procedure	3.3.0
	RP-08	RP-000223	304	1		System information modification procedure	3.3.0
	RP-08	RP-000223	305			Functional descriptions of the RRC messages	3.3.0
	RP-08	RP-000223	306			Clarification of CTFC calculation	3.3.0
	RP-08	RP-000223	307	3		Compressed mode parameters	3.3.0
	RP-08	RP-000223	309	2		Signalling procedure for periodic local authentication	3.3.0
	RP-08	RP-000223	310	5		Editorial corrections on security	3.3.0
	RP-08	RP-000223	311	2		Security capability	3.3.0
	RP-08	RP-000223	312	1		Corrections on ASN.1 definitions	3.3.0
	RP-08	RP-000223	313	2		DRX cycle lower limit	3.3.0
	RP-08	RP-000223	314	1		Removal of CPICH SIR measurement quantity	3.3.0
	RP-08	RP-000223	315	1		Signalling connection release request	3.3.0
	RP-08	RP-000223	318	1		Change to IMEI coding from BCD to hexadecimal	3.3.0
	RP-08	RP-000223	319	1		Removal of RLC sequence numbers from RRC initialisation information	3.3.0
	RP-08	RP-000223	320	3		Addition of the length of PDCP sequence numbers into PDCP info	3.3.0
	RP-08	RP-000224	323	1		BSIC verification of GSM cells	3.3.0
	RP-08	RP-000224	324			Reporting cell status	3.3.0
	RP-08	RP-000224	325			RRC measurement filtering parameters	3.3.0
	RP-08	RP-000224	326			Cell-reselection parameter signalling	3.3.0
	RP-08	RP-000224	328	3		Multiplicity values	3.3.0
	RP-08	RP-000224	329			Quality measurements	3.3.0
	RP-08	RP-000224	330	4		CPCH Status Indication mode correction	3.3.0
	RP-08	RP-000224	331	4		End of CPCH transmission	3.3.0
	RP-08	RP-000224	332			Handover to UTRAN procedure	3.3.0
	RP-08	RP-000224	333			Harmonization of access service classes in FDD and TDD	3.3.0
	RP-08	RP-000224	334	1		Correction to usage of primary CCPCH info and primary CPICH info	3.3.0
	RP-08	RP-000224	335			Corrections and clarifications on system information handling	3.3.0
	RP-08	RP-000224	336			Editorial corrections	3.3.0
	RP-08	RP-000224	337	1		Editorial corrections on uplink timing advance	3.3.0
	RP-08	RP-000224	339			Correction of Transport Format Combination tabular format and ASN.1	3.3.0
	RP-08	RP-000224	340	1		UE variables	3.3.0
	RP-08	RP-000224	342	1		General error handling	3.3.0
	RP-08	RP-000224	344	1		System Information extensibility in ASN.1 definitions	3.3.0
	RP-08	RP-000224	345			Usage of pilot bits	3.3.0
	RP-08	RP-000224	346	3		RRC connection release procedure	3.3.0
	RP-08	RP-000225	347	1		Alignment of Section 10.3 on methodology defined in 25.921	3.3.0
	RP-08	RP-000225	348			Modifications of cell (re)selection parameters	3.3.0
	RP-08	RP-000225	350	1		GPS time-of-week represented as seconds and fractions of seconds	3.3.0
	RP-08	RP-000225	351	2		CPCH corrections	3.3.0
	RP-08	RP-000225	352			PLMN type selection	3.3.0
	RP-08	RP-000225	353	3		Paging and establishment cause values	3.3.0
	RP-08	RP-000225	354			Common channel configurations	3.3.0
	RP-08	RP-000225	355	2		Clarification of prioritization of logical channels in UE	3.3.0

	RP-08	RP-000225	357	2	UE capability corrections	3.3.0
	RP-08	RP-000225	358	2	Clarification of HFN	3.3.0
	RP-08	RP-000225	359	3	Clarification of Integrity Protection	3.3.0
	RP-08	RP-000225	360	1	RRC message size optimization regarding TrCH parameters	3.3.0
	RP-08	RP-000225	361		Protocol extensions in ASN	3.3.0
	RP-08	RP-000225	362	1	Downloading of pre- defined configurations via SIB 16	3.3.0
	RP-08	RP-000225	363	1	Optimization of System Information	3.3.0
	RP-08	RP-000225	364	1	CPCH gain factor	3.3.0
	RP-08	RP-000225	368	2	SFN Transmission Rate in TDD Mode	3.3.0
	RP-08	RP-000225	371	1	Integrity Control	3.3.0
	RP-08	RP-000225	372		Modification to measurement event evaluation	3.3.0
	RP-08	RP-000225	373		System Information related parameters	3.3.0
	RP-08	RP-000226	375	1	Changes in RB mapping info	3.3.0
	RP-08	RP-000226	377		Editorial corrections to PRACH system information and Cell info	3.3.0
	RP-08	RP-000226	378		Editorial Corrections to 25.331 Procedures and Tabular Format	3.3.0
	RP-08	RP-000226	379	1	Corrections to figures and procedures for the failure cases	3.3.0
	RP-08	RP-000226	380		Corrections on use of ORDERED_CONFIG	3.3.0
	RP-08	RP-000226	382	1	Corrections to Transport Channel and RB Reconfiguration procedures	3.3.0
	RP-08	RP-000226	383	1	Corrections to INITIAL DIRECT TRANSFER and UE CAPABILITY INFORMATION CONFIRM procedures	3.3.0
	RP-08	RP-000226	384		Corrections to Transparent mode signalling info Tabular format and ASN.1	3.3.0
	RP-08	RP-000226	385		Corrections to Soft Handover messages and procedures	3.3.0
	RP-08	RP-000226	387		Corrections to RRC CONNECTION REJECT procedures	3.3.0
	RP-08	RP-000226	388	1	Transport format combination in TDD and Transport channel ID	3.3.0
	RP-08	RP-000226	389	1	Signalling for dynamic TTI in TDD	3.3.0
	RP-08	RP-000226	390	1	Usage of DCCH for Shared Channel Allocation message	3.3.0
	RP-08	RP-000226	391	1	Correction to physical channel IEs in TDD	3.3.0
	RP-08	RP-000226	392	1	TDD preconfiguration for Handover to UTRAN	3.3.0
	RP-08	RP-000226	393		Corrections to measurement control descriptions and messages	3.3.0
	RP-08	RP-000226	394	1	Corrections on ASN.1 definitions	3.3.0
	RP-08	RP-000226	395		Addition of the Segmentation indication field for transparent mode RLC in the RLC Info	3.3.0
	RP-08	RP-000226	396	1	Radio Bearer identity for CCCH	3.3.0
	RP-08	RP-000226	397	1	ASN.1 definitions for RRC information between network nodes	3.3.0
	RP-08	RP-000227	398	1	NAS Routing	3.3.0
	RP-08	RP-000227	399		DPCCH power control preamble	3.3.0
	RP-08	RP-000227	400	2	Modifications of Assisted GPS Messages	3.3.0
	RP-08	RP-000227	401		Choice of Initial UE Identity	3.3.0
	RP-08	RP-000227	402		ANSI-41 information elements	3.3.0
	RP-08	RP-000227	404	1	RLC value ranges	3.3.0
	RP-08	RP-000227	408	1	HFN Reset	3.3.0
	RP-08	RP-000227	409	1	Clarification on ciphering parameters and integrity protection procedure in case of SRNS relocation	3.3.0
	RP-08	RP-000227	410	1	Clarification of compressed mode activation and configuration failure	3.3.0
	RP-08	RP-000227	412	1	Modification of the RLC Size IE	3.3.0
	RP-08	RP-000227	414		CPCH DL Power control	3.3.0
	RP-08	RP-000227	415	1	SFN measurements in TDD	3.3.0
09/2000	RP-09	RP-000361	356	3	Clarification on multiplicity of PCH and PICH and S-CCPCH selection	3.4.0
	RP-09	RP-000361	403	3	Parameters to be stored in the USIM	3.4.0
	RP-09	RP-000361	413	3	Optimization of Inter-system handover message	3.4.0
	RP-09	RP-000361	416	2	Timing Advance in Handover Procedures	3.4.0
	RP-09	RP-000361	417	2	Synchronization of Timing Advance and Timing Deviation Measurement	3.4.0
	RP-09	RP-000361	418		Downlink Physical Channels Per Timeslot	3.4.0
	RP-09	RP-000361	419		TDD Mode DCH Reception in Cell DCH State	3.4.0
	RP-09	RP-000361	420	2	Downlink Power Control During DTX in TDD Mode	3.4.0
	RP-09	RP-000361	421	1	Paging Indicator Length Definition	3.4.0
	RP-09	RP-000361	422		Updating & alignment of RRC containers & handover to UTRAN information transfer	3.4.0
	RP-09	RP-000361	424		Default values for UE timers and counters	3.4.0
	RP-09	RP-000361	425	1	Security mode control	3.4.0
	RP-09	RP-000361	426	1	Corrections and Editorial updates to chapter 8	3.4.0

	RP-09	RP-000361	427			Corrections and editorial updates to chapter 10	3.4.0
	RP-09	RP-000361	428			Transition from CELL_DCH to CELL_PCH and URA_PCH state	3.4.0
	RP-09	RP-000361	430			Assisted GPS Messaging and Procedures	3.4.0
	RP-09	RP-000361	431	2		Corrections to Activation Time use	3.4.0
	RP-09	RP-000361	432			Editorial Corrections to measurement reporting range	3.4.0
	RP-09	RP-000361	434	4		Default DPCH offset value and DPCH offset	3.4.0
	RP-09	RP-000361	435	3		RLC info	3.4.0
	RP-09	RP-000362	437			Clarification of the description of IE semantics in "RB with PDCP information"	3.4.0
	RP-09	RP-000362	438	1		Editorial corrections on security	3.4.0
	RP-09	RP-000362	439			Editorial correction to RB mapping info	3.4.0
	RP-09	RP-000362	440	1		Compressed mode configuration failure	3.4.0
	RP-09	RP-000362	441			Gain factors for TDD	3.4.0
	RP-09	RP-000362	442			Introduction of Default DPCH Offset Value in TDD	3.4.0
	RP-09	RP-000362	444	1		Optimization of handover to UTRAN command	3.4.0
	RP-09	RP-000362	445			Editorial corrections	3.4.0
	RP-09	RP-000362	448	1		Mapping of channelisation code	3.4.0
	RP-09	RP-000362	449	2		DL TFCS Limitation	3.4.0
	RP-09	RP-000362	450			SIB offset	3.4.0
	RP-09	RP-000362	451			RRC CONNECTION RELEASE cause	3.4.0
	RP-09	RP-000362	452			Addition of RACH TFCS	3.4.0
	RP-09	RP-000362	453	2		Cell Identity	3.4.0
	RP-09	RP-000362	454			Editorial Modifications	3.4.0
	RP-09	RP-000362	455	1		TDD PRACH Power Control for Spreading Factor 8/16	3.4.0
	RP-09	RP-000362	456			TDD CCTrCH Repetition Length Definition	3.4.0
	RP-09	RP-000362	457	1		Reporting threshold of traffic volume measurements	3.4.0
	RP-09	RP-000362	459	2		UP GPS assistance data for SIB	3.4.0
	RP-09	RP-000362	461	1		Support of cell update confirm on CCCH	3.4.0
	RP-09	RP-000363	462	1		Max Window Size in RLC capabilities	3.4.0
	RP-09	RP-000363	463	3		UE handling of CFN	3.4.0
	RP-09	RP-000363	464	1		Correction of padding description in clause 12	3.4.0
	RP-09	RP-000363	465	1		Window size in RLC info	3.4.0
	RP-09	RP-000363	466	1		TFC Control Duration	3.4.0
	RP-09	RP-000363	467			System Information Block Tabular Information	3.4.0
	RP-09	RP-000363	469	1		Frequency encoding in inter-system handover messages	3.4.0
	RP-09	RP-000363	470			RRC message size optimization regarding TFS parameters	3.4.0
	RP-09	RP-000363	471	2		RACH selection	3.4.0
	RP-09	RP-000363	472			DRX cycle lower limit	3.4.0
	RP-09	RP-000363	474			Rx window size in RLC info	3.4.0
	RP-09	RP-000363	476	1		Corrections & optimizations regarding system information blocks of length 215..221	3.4.0
	RP-09	RP-000363	477	1		Corrections on 8.1.1 resulting from RRC review at R2#14	3.4.0
	RP-09	RP-000363	478	1		Corrections to the RRC connection release procedure	3.4.0
	RP-09	RP-000363	479	1		New release cause for signalling connection re-establishment	3.4.0
	RP-09	RP-000363	480	1		Correction to IE midamble shift and burst type	3.4.0
	RP-09	RP-000363	481	1		Correction in RLC info	3.4.0
	RP-09	RP-000363	483			Description of CTCH occasions	3.4.0
	RP-09	RP-000363	485	1		TDD CCTrCH UL/DL Pairing for Inner Loop Power Control	3.4.0
	RP-09	RP-000363	486	1		DCCH and BCCH Signalling of TDD UL OL PC Information	3.4.0
	RP-09	RP-000364	487	1		Broadcast SIBs for TDD UL OL PC Information	3.4.0
	RP-09	RP-000364	490	1		CPCH corrections	3.4.0
	RP-09	RP-000364	492	3		Corrections to Security IEs	3.4.0
	RP-09	RP-000364	494	1		Corrections to parameters to be stored in the USIM	3.4.0
	RP-09	RP-000364	496			Editorial corrections	3.4.0
	RP-09	RP-000364	497	2		Physical Shared Channel Allocation procedure	3.4.0
	RP-09	RP-000364	498			Correction to Transport Format Combination Control Message	3.4.0
	RP-09	RP-000364	499	1		Usage of Cell Parameter ID	3.4.0
	RP-09	RP-000364	500			RB description for SHCCH	3.4.0
	RP-09	RP-000364	501	1		Use of LI in UM	3.4.0
	RP-09	RP-000364	502	1		Minor Corrections to RRC Protocol Specification	3.4.0
	RP-09	RP-000364	503	1		Correction to Cell Update Cause	3.4.0

	RP-09	RP-000364	504		Correction on T307 definition	3.4.0
	RP-09	RP-000364	505		Corrections to relative priorities in RRC Protocol	3.4.0
	RP-09	RP-000364	506		Unification of Reconfiguration Procedures	3.4.0
	RP-09	RP-000364	507	1	Changes to section 8.2 proposed at Paris RRC Ad Hoc	3.4.0
	RP-09	RP-000364	508		Establishment Cause	3.4.0
	RP-09	RP-000364	509	1	PRACH partitioning	3.4.0
	RP-09	RP-000364	510		Editorial Correction on Active Set Update	3.4.0
	RP-09	RP-000364	511		Editorial Correction regarding system information	3.4.0
	RP-09	RP-000365	512	1	Clarification on Reporting Cell Status	3.4.0
	RP-09	RP-000365	513	1	Editorial corrections on RRC Connection Establishment and Release procedures NOTE: In subclause 8.1.4.6, the change from "decrease" to "increase" for V308 was decided to be incorrect after discussion on the TSG-RAN WG2 reflector and was not implemented	3.4.0
	RP-09	RP-000365	514		Gated Transmission Control Info	3.4.0
	RP-09	RP-000365	515	1	Cell selection/reselection parameters for SIB 3/4	3.4.0
	RP-09	RP-000365	516		Implementation of Ec/N0 parameters and optimization of SIB 11/12	3.4.0
	RP-09	RP-000365	517		PRACH Info	3.4.0
	RP-09	RP-000365	518	1	Uplink DPCH power control info	3.4.0
	RP-09	RP-000365	519		AICH power offset value range	3.4.0
	RP-09	RP-000365	520		Direct paging of RRC connected UE in CELL_PCH/URA_PCH NOTE: This CR was postponed in TSG-RAN #9 and was wrongly included in v3.4.0. This was corrected in v3.4.1	3.4.0
	RP-09	RP-000365	521		Corrections to Sections 1-7	3.4.0
	RP-09	RP-000365	522		Error handling for Uplink Physical Channel Control procedure	3.4.0
	RP-09	RP-000365	523		Corrections to downlink outer loop power control in compressed mode	3.4.0
	RP-09	RP-000365	524	1	Clarification on measurement procedure using compressed mode	3.4.0
	RP-09	RP-000365	525	1	Updates to cell and URA update procedures based on RRC Ad Hoc	3.4.0
	RP-09	RP-000365	526	1	Updates to RNTI allocation procedure based on RRC Ad Hoc	3.4.0
	RP-09	RP-000365	528		PRACH constant value	3.4.0
	RP-09	RP-000365	530	1	Corrections to the paging procedure	3.4.0
	RP-09	RP-000365	532	1	Moving of text from 25.304	3.4.0
	RP-09	RP-000365	533	1	Message extensibility	3.4.0
	RP-09	RP-000365	534	1	Additions to "State of RRC Procedure" in RRC Initialisation information, source RNC to target RNC	3.4.0
	RP-09	RP-000365	535	1	Support of codec negotiation	3.4.0
	-	-	-		Removal of contents of CR 520 from v3.4.0, because it was postponed at TSG-RAN #9 and by accident included anyway.	3.4.1
12/2000	RP-10	RP-000570	536		Downlink outer-loop power control in compressed mode	3.5.0
	RP-10	RP-000570	537	1	Correction in the use of "U-RNTI Short"	3.5.0
	RP-10	RP-000570	538		Corrections related to UE Timing	3.5.0
	RP-10	RP-000570	539		Corrections to SFN-SFN definition	3.5.0
	RP-10	RP-000570	541	1	Corrections to definition and use of Activation Time	3.5.0
	RP-10	RP-000570	542		Corrections to logical channel priorities	3.5.0
	RP-10	RP-000570	543	1	Correction to codec negotiation	3.5.0
	RP-10	RP-000570	544	1	CFN-SFN observed time difference measurement	3.5.0
	RP-10	RP-000570	545	1	Correction to timing indication for hard handover	3.5.0
	RP-10	RP-000570	546	1	UE Radio Access Capability Corrections	3.5.0
	RP-10	RP-000570	548	1	RRC establishment and paging causes for NAS signalling	3.5.0
	RP-10	RP-000570	549		Corrections to Intra-frequency measurements and Traffic volume measurements	3.5.0
	RP-10	RP-000570	551	1	PRACH/RACH System information	3.5.0
	RP-10	RP-000570	553	1	GSM Measurement reporting	3.5.0
	RP-10	RP-000570	554	1	BLER measurement and quality target	3.5.0
	RP-10	RP-000570	556	1	Clarification of PDCP sequence number window terminology	3.5.0
	RP-10	RP-000570	559	1	Clarification on Error Handling	3.5.0
	RP-10	RP-000570	560		Removal of compressed mode measurement purpose "other"	3.5.0
	RP-10	RP-000570	561		Clarification of compressed mode measurement purpose "GSM"	3.5.0
	RP-10	RP-000570	564	2	Reporting multiple GSM cells	3.5.0
	RP-10	RP-000571	566	1	Number of RLCs that can be removed in Active Set update	3.5.0
	RP-10	RP-000571	568	1	Clarification on Segment Index	3.5.0
	RP-10	RP-000571	571	3	RRC procedure performance requirements	3.5.0

	RP-10	RP-000571	572	1	Correction of newInterSystemCellList and MeasurementControlSysInfo in ASN.1	3.5.0
	RP-10	RP-000571	573	4	Removal of Flow Id concept while maintaining lu interface flexibility	3.5.0
	RP-10	RP-000571	574	2	Ciphering and reset	3.5.0
	RP-10	RP-000571	575	1	Corrections and clarifications concerning inter-RAT change procedures	3.5.0
	RP-10	RP-000571	576	1	General Security Clarifications	3.5.0
	RP-10	RP-000571	577		Clarification on RB 0	3.5.0
	RP-10	RP-000571	578		Clarification on the transition of RRC state	3.5.0
	RP-10	RP-000571	580	1	UP measurements for RRC information to target RNC	3.5.0
	RP-10	RP-000571	581		Correction on LCS reporting criteria	3.5.0
	RP-10	RP-000574	583	1	CSICH Corrections	3.5.0
	RP-10	RP-000571	584	1	Clarification to handling of satellite health issues	3.5.0
	RP-10	RP-000571	585		Clarification on activation time	3.5.0
	RP-10	RP-000571	586		Clarification on activation time for ciphering in TM	3.5.0
	RP-10	RP-000571	587	2	Measurement procedures and messages	3.5.0
	RP-10	RP-000571	590	1	Inter-RAT UE radio access capability	3.5.0
	RP-10	RP-000571	592	1	Clarification on cell update/URA update procedures	3.5.0
	RP-10	RP-000571	595	4	Protocol States and Process	3.5.0
	RP-10	RP-000571	596	1	System Information	3.5.0
	RP-10	RP-000715	597	5	RRC Connection Management Procedures, Generic procedures and actions	3.5.0
	RP-10	RP-000572	598	1	Paging Procedures	3.5.0
	RP-10	RP-000572	599		NAS signalling Procedures	3.5.0
	RP-10	RP-000572	600	3	Radio Bearer Control Procedures	3.5.0
	RP-10	RP-000572	601	1	Corrections to the Counter Check Procedure	3.5.0
	RP-10	RP-000572	602		Tabular Information and ASN.1	3.5.0
	RP-10	RP-000572	604	2	Corrections to Measurement Occasion concept	3.5.0
	RP-10	RP-000572	606		Corrections concerning optimisation of RB information	3.5.0
	RP-10	RP-000572	608	1	Corrections to security	3.5.0
	RP-10	RP-000572	609	1	Ciphering activation time for DPCH	3.5.0
	RP-10	RP-000572	610		Confirmation of signalling connection establishment	3.5.0
	RP-10	RP-000572	611	2	RACH Sub-channel signalling	3.5.0
	RP-10	RP-000572	613	2	Assistance data delivery for UP	3.5.0
	RP-10	RP-000572	614	1	Clarification of LCS measurements	3.5.0
	RP-10	RP-000572	615	2	Configuration of RLC PDU sizes for logical channels	3.5.0
	RP-10	RP-000574	616		PICH power offset for TDD	3.5.0
	RP-10	RP-000572	617		Correction for PDSCH power control for TDD	3.5.0
	RP-10	RP-000574	618		Usage of dynamic spreading factor in uplink	3.5.0
	RP-10	RP-000572	619		Correction of Midamble Shift for Burst Type 3	3.5.0
	RP-10	RP-000572	621		Correction of text concerning Scheduling of System Information	3.5.0
	RP-10	RP-000572	622	1	Alignment of GSM'99 BA Range concept and its inclusion in UTRA	3.5.0
	RP-10	RP-000572	623	1	Clarification of RB mapping info	3.5.0
	RP-10	RP-000572	624	1	Correction to UE multi-RAT capability	3.5.0
	RP-10	RP-000573	625		Correction to PDCP sequence number exchange during hard handover	3.5.0
	RP-10	RP-000573	628	2	DCH Quality Target	3.5.0
	RP-10	RP-000573	629	1	Simultaneous release of RBs and signalling connection	3.5.0
	RP-10	RP-000573	630		Correction on Transport Channel Reconfiguration	3.5.0
	RP-10	RP-000573	631		Limitation of DRX cycle length	3.5.0
	RP-10	RP-000574	632		Signalling of the alpha value in TDD for open loop power control	3.5.0
	RP-10	RP-000573	633		Support for improved compressed mode handling for TDD measurements	3.5.0
	RP-10	RP-000573	636		Usage of secondary CPICH and secondary scrambling code	3.5.0
	RP-10	RP-000573	639		Expiration time of SIB type 7, 14	3.5.0
	RP-10	RP-000573	640		Correction to integrity protection	3.5.0
	RP-10	RP-000684	641		Downlink Outer Loop Control	3.5.0
03/2001	RP-11	RP-010029	642	2	RL Failure in cell update procedure	3.6.0
	RP-11	RP-010029	645	1	Clarification on COUNTER CHECK	3.6.0
	RP-11	RP-010029	646	2	Traffic Volume Measurement corrections	3.6.0
	RP-11	RP-010029	650	2	Reserved TFCI for the TDD Special Burst	3.6.0
	RP-11	RP-010029	653		Correction to description of RRC state transitions	3.6.0
	RP-11	RP-010029	657		RLC re-establish correction	3.6.0
	RP-11	RP-010029	658	1	Removal of RLC logical channel mapping indicator	3.6.0

	RP-11	RP-010029	659			New paging and establishment cause "Unknown"	3.6.0
	RP-11	RP-010029	660	1		Miscellaneous procedure corrections	3.6.0
	RP-11	RP-010029	661			Corrections to compressed mode pattern sequence handling	3.6.0
	RP-11	RP-010029	662			Inter-system change clarifications	3.6.0
	RP-11	RP-010029	663	1		RLC status transmission in CELL_PCH and URA_PCH	3.6.0
	RP-11	RP-010029	665	1		Clarification of RB information parameter values for SRB0	3.6.0
	RP-11	RP-010029	666			Encoding for RRC- container	3.6.0
	RP-11	RP-010029	667	2		Update of message extension and encoding descriptions	3.6.0
	RP-11	RP-010032	668	4		Introduction of default pre-defined configurations	3.6.0
	RP-11	RP-010029	669	2		Security corrections	3.6.0
	RP-11	RP-010029	670			Clarifications on Blind Handover Support	3.6.0
	RP-11	RP-010029	671	1		Missing descriptions of UE actions	3.6.0
	RP-11	RP-010029	672	2		Corrections on UE Positioning information	3.6.0
	RP-11	RP-010029	674	1		Security related corrections to SRNS	3.6.0
	RP-11	RP-010032	675	2		Downlink power offsets	3.6.0
	RP-11	RP-010274	676	2		Checking the integrity of UE security capabilities	3.6.0
	RP-11	RP-010030	678	1		Clarification to Secondary CCPCCH info	3.6.0
	RP-11	RP-010030	679	1		Miscellaneous corrections	3.6.0
	RP-11	RP-010030	680			Removal of Layer 3 filtering for RACH	3.6.0
	RP-11	RP-010030	681	2		Correction of compressed mode parameters	3.6.0
	RP-11	RP-010030	682			Removal of immediate cell evaluation	3.6.0
	RP-11	RP-010030	684	2		Scheduling of SIB 15.2 and SIB 15.3	3.6.0
	RP-11	RP-010030	685	1		Correction to ECN modules	3.6.0
	RP-11	RP-010030	686	1		Improvement of the description of timing advance for TDD	3.6.0
	RP-11	RP-010030	687			Correction on timing advance and allocation for shared channels	3.6.0
	RP-11	RP-010030	688	1		Clarification on SF 1 signalling	3.6.0
	RP-11	RP-010030	689	1		Correction to power control in TDD	3.6.0
	RP-11	RP-010030	690			Midamble - Channelisation code association for TDD	3.6.0
	RP-11	RP-010030	691			Network requested reporting for physical shared channel allocation	3.6.0
	RP-11	RP-010030	693			System Information	3.6.0
	RP-11	RP-010030	694	1		Clarification on Transport Channel Identity	3.6.0
	RP-11	RP-010030	696	1		Editorial Correction	3.6.0
	RP-11	RP-010030	698	2		Correction to add coding of intra domain NAS node selector	3.6.0
	RP-11	RP-010030	700	1		Corrections to system information block characteristics in TDD	3.6.0
	RP-11	RP-010030	701	2		ASN.1 corrections	3.6.0
	RP-11	RP-010030	702	2		Measurement related corrections	3.6.0
	RP-11	RP-010031	703	1		Clarifications on TFC Control procedure	3.6.0
	RP-11	RP-010031	704	2		Association of PLMN ID to neighbour cells	3.6.0
	RP-11	RP-010031	705	1		TFCS Selection Guidelines	3.6.0
	RP-11	RP-010031	710			Special Burst Scheduling During DTX in TDD	3.6.0
	RP-11	RP-010031	711	1		Radio Link Failure Criteria in TDD	3.6.0
	RP-11	RP-010031	712	1		Correction & Clarification to TDD RACH Subchannels	3.6.0
	RP-11	RP-010031	713	1		Number of retransmission of RRC CONNECTION REQUEST	3.6.0
	RP-11	RP-010031	714			Uplink Frequency Notification	3.6.0
	RP-11	RP-010031	715			Clarification of Radio Bearer Mapping for DCH/DSCH Transport Channels	3.6.0
	RP-11	RP-010031	716			Correction of mismatches between tabular and ASN.1	3.6.0
	RP-11	RP-010031	717			Correction to discontinuous reception in TDD	3.6.0
	RP-11	RP-010031	718			Power control preamble	3.6.0
	RP-11	RP-010031	719			Maximum number of AM entity	3.6.0
	RP-11	RP-010031	720	1		Real-time Integrity Broadcast	3.6.0
	RP-11	RP-010031	721	3		Moving Real-time Integrity description to different chapter	3.6.0
	RP-11	RP-010031	723	1		Removal of the payload unit concept	3.6.0
	RP-11	RP-010031	724			Security related corrections to SRNS	3.6.0
	RP-11	RP-010031	725			Periodic PLMN selection correction	3.6.0
	RP-11	RP-010042	683	1		Modification of "SSDT Information" IE parameters to indicate if SSDT is used in the UL only	4.0.0
	RP-11	RP-010041	692	1		Idle allocation for Node B synchronisation	4.0.0
	RP-11	RP-010037	706	1		Physical channel configuration information elements for 1.28 Mcps TDD	4.0.0
	RP-11	RP-010037	707	2		Changes to Measurement Related Signalling and Introduction of Cell (Re)selection Parameters for 1.28Mcps TDD	4.0.0
	RP-11	RP-010037	708	1		Introduction of RACH Parameters for 1.28 Mcps TDD	4.0.0

	RP-11	RP-010037	709			Introduction of UE radio access capability Parameters for 1.28 Mcps TDD	4.0.0
	RP-11	RP-010040	722	1		Introduction of IPDLs for TDD	4.0.0
	RP-11	RP-010039	726	1		ROHC updates to RRC	4.0.0
06/2001	RP-12	RP-010311	731			Clarification of the IE 'spreading factor' in Uplink DPCH info for FDD mode	4.1.0
	RP-12	RP-010311	733			Correction of UE Radio Access Capability depending on UTRAN FDD bands	4.1.0
	RP-12	RP-010311	735			Clarification on Security mode control	4.1.0
	RP-12	RP-010311	738			Correction of TrCH parameter handling	4.1.0
	RP-12	RP-010311	740			TFC Subsets in TDD	4.1.0
	RP-12	RP-010311	746			RRC containers	4.1.0
	RP-12	RP-010311	748			Various corrections	4.1.0
	RP-12	RP-010311	750			General error handling for system information	4.1.0
	RP-12	RP-010311	752			Order of elements in strings	4.1.0
	RP-12	RP-010311	754			Configuration consistency checks	4.1.0
	RP-12	RP-010312	756			Compressed mode corrections	4.1.0
	RP-12	RP-010312	758			Correction concerning inter-RAT procedures	4.1.0
	RP-12	RP-010312	762			Measurement corrections	4.1.0
	RP-12	RP-010312	764			RLC Tr Discard	4.1.0
	RP-12	RP-010312	766			Annex B CPCH Correction	4.1.0
	RP-12	RP-010312	768			SIB Correction for CSICH Power Offset	4.1.0
	RP-12	RP-010312	770			Transfer of Last known position in case of SRNS relocation	4.1.0
	RP-12	RP-010312	772			Corrections to UE Positioning measurements	4.1.0
	RP-12	RP-010312	779			GSM measurements in compressed mode	4.1.0
	RP-12	RP-010312	781			Correction of Activation Time in Inter-Rat HO Commands	4.1.0
	RP-12	RP-010313	785			Clarification of FRESH in SRNS relocation	4.1.0
	RP-12	RP-010313	789			Correction to UE timers and constants in idle mode	4.1.0
	RP-12	RP-010313	793			Clarification on multiframe allocation in TDD	4.1.0
	RP-12	RP-010313	795			Predefined parameters for logical channels	4.1.0
	RP-12	RP-010313	797			Pathloss calculation	4.1.0
	RP-12	RP-010313	799			Clarification on periodic measurement reporting	4.1.0
	RP-12	RP-010313	803	1		Handling of IE PRACH TFCS and Primary CPICH/Primary CCPCH info	4.1.0
	RP-12	RP-010313	805			Correction to FACH measurement occasion in TDD	4.1.0
	RP-12	RP-010313	807			Clarification of L1 synchronization procedures	4.1.0
	RP-12	RP-010313	809			Correction of Activation Time definition	4.1.0
	RP-12	RP-010314	813			Corrections to RRC procedure performance	4.1.0
	RP-12	RP-010314	815			Removal of mapping function	4.1.0
	RP-12	RP-010314	817			Security clarifications	4.1.0
	RP-12	RP-010314	819			Corrections to UE Positioning	4.1.0
	RP-12	RP-010314	825			Definition of DPCH numbering	4.1.0
	RP-12	RP-010314	827			Corrections to System Information Procedure	4.1.0
	RP-12	RP-010314	829			Relation between DOFF and DPCH Frame Offset	4.1.0
	RP-12	RP-010314	831			Procedures for "same as UL"	4.1.0
	RP-12	RP-010314	837			Editorial and minor corrections	4.1.0
	RP-12	RP-010314	839			Editorial Correction	4.1.0
	RP-12	RP-010315	843			Corrections on OTDOA-IPDL specific burst parameter semantic description	4.1.0
	RP-12	RP-010315	845			Error handling for messages sent from another RAT	4.1.0
	RP-12	RP-010315	849			Needed TFC in the TFCS for TDD	4.1.0
	RP-12	RP-010315	855			Clarification of TFCS selection guidelines	4.1.0
	RP-12	RP-010315	861			Clarification of Traffic Volume measurements	4.1.0
	RP-12	RP-010315	863			CFN synchronisation problems at timing re-initialised hard handover	4.1.0
	RP-12	RP-010315	866			Corrections on UP Assistance Message Descriptions	4.1.0
	RP-12	RP-010315	868			Correction on Area Scope of SIB 15.3	4.1.0
	RP-12	RP-010315	872			Correction to AICH power offset	4.1.0
	RP-12	RP-010316	875			Clarification on IE 'Downlink rate matching restriction information'	4.1.0
	RP-12	RP-010316	877			Corrections on Tabular/ASN.1	4.1.0
	RP-12	RP-010316	879			Corrections on Tabular and ASN.1 inconsistencies	4.1.0
	RP-12	RP-010316	881			Editorial corrections on Tabular and ASN.1 inconsistencies	4.1.0
	RP-12	RP-010316	883			UE Positioning corrections to ASN.1 and tabular	4.1.0
	RP-12	RP-010316	885			Corrections to resolve inconsistencies between Tabular and ASN.1	4.1.0
	RP-12	RP-010316	887			UE positioning OTDOA Neighbour Cell Info	4.1.0

	RP-12	RP-010316	889		DRAC corrections	4.1.0
	RP-12	RP-010316	893		ASN.1 Correction of IE TFCS ID	4.1.0
	RP-12	RP-010316	895		Correction of IE IODE range in AGPS Positioning	4.1.0
	RP-12	RP-010317	897		Correction to BurstModeParameters in IPDL	4.1.0
	RP-12	RP-010317	899		Corrections on inconsistencies between Tabular and ASN.1	4.1.0
	RP-12	RP-010317	901		Naming of message abstract types in ASN.1	4.1.0
	RP-12	RP-010317	904		Information elements outside the extension container	4.1.0
	RP-12	RP-010317	906		Correction concerning DRX cycle upon inter-RAT change towards UTRAN	4.1.0
	RP-12	RP-010323	773		Corrections to IPDLs for TDD	4.1.0
	RP-12	RP-010323	850	2	Correction to 1.28Mcps TDD RACH parameters and operation	4.1.0
	RP-12	RP-010323	851		TFCl coding in case of 8PSK	4.1.0
	RP-12	RP-010323	902	1	Structure and naming of information elements	4.1.0
09/2001	RP-13	RP-010544	0870		UL Transport Channel Type Correction	4.2.0
	RP-13	RP-010544	0908		Guidelines concerning conditions, spares, defaults and correction of inconsistencies	4.2.0
	RP-13	RP-010544	0910		Correction to TDD DL DPCH Common Timeslot Info	4.2.0
	RP-13	RP-010544	0912		TDD System Information Update in Cell_DCH	4.2.0
	RP-13	RP-010544	0914		Editorial Corrections	4.2.0
	RP-13	RP-010544	0916		UL DPCH Power Control Info in TDD	4.2.0
	RP-13	RP-010544	0918		CN-originated paging in CELL_PCH and URA_PCH state	4.2.0
	RP-13	RP-010544	0920		Corrections to UE variable handling	4.2.0
	RP-13	RP-010544	0922		Inter-frequency measurements	4.2.0
	RP-13	RP-010544	0924		Inter-RAT measurements	4.2.0
	RP-13	RP-010671	0926	1	Intra-frequency measurements	4.2.0
	RP-13	RP-010545	0928		Multiplexing configuration corrections	4.2.0
	RP-13	RP-010545	0930		Reception of non-dedicated control channels mapped on FACH in CELL_FACH state	4.2.0
	RP-13	RP-010545	0932		Removal of C-RNTI when entering CELL_DCH	4.2.0
	RP-13	RP-010545	0935		TF and TFC set definition	4.2.0
	RP-13	RP-010545	0937		Correction of remaining ASN.1/Tabular inconsistencies	4.2.0
	RP-13	RP-010545	0939		CPICH Ec/N0 Range	4.2.0
	RP-13	RP-010545	0941		Priorities for IDNNS coding	4.2.0
	RP-13	RP-010545	0943		Dedicated pilots and S-CPICH specification related to UE specific beamforming	4.2.0
	RP-13	RP-010545	0945		Security corrections	4.2.0
	RP-13	RP-010546	0953		Intra-frequency measurement events for TDD corrections	4.2.0
	RP-13	RP-010546	0955		Inconsistencies between ASN.1 and tabular format	4.2.0
	RP-13	RP-010546	0957		TDD PICH corrections and clarifications	4.2.0
	RP-13	RP-010546	0959		Messages on CCCH	4.2.0
	RP-13	RP-010546	0961		Clarification of Parameter Values for Default Radio Configurations	4.2.0
	RP-13	RP-010546	0963		Clarification to usage of default values in "Cell Selection and Reselection for SIB11/12Info"	4.2.0
	RP-13	RP-010546	0965		Clarification of handling of System information block 14	4.2.0
	RP-13	RP-010546	0967		Description of UE behaviour when receiving UE positioning related information	4.2.0
	RP-13	RP-010546	0982		Clarification on periodic measurement reporting	4.2.0
	RP-13	RP-010546	0984		Corrections and clarifications on Measurement procedures description	4.2.0
	RP-13	RP-010547	0986		Lossless Criteria in PDCP Info	4.2.0
	RP-13	RP-010547	0988		Corrections to cell reselection parameter values	4.2.0
	RP-13	RP-010547	0990		Correction to signalling connection release	4.2.0
	RP-13	RP-010547	0992		Corrections to cell update procedures	4.2.0
	RP-13	RP-010547	0994		PDCP configuration and PS domain configuration checks	4.2.0
	RP-13	RP-010547	0996		Correction to handling of RRC transaction identifier for Cell Update, URA Update and RRC connection setup	4.2.0
	RP-13	RP-010547	0998	1	Correction of UE capabilities regarding Rx-Tx time difference type 2 measurement	4.2.0
	RP-13	RP-010547	1000		Correction to handling of IE 'Downlink info for each radio link'	4.2.0
	RP-13	RP-010547	1004		Redundant IE in Traffic volume measurement system information	4.2.0
	RP-13	RP-010547	1006		Editorial corrections	4.2.0
	RP-13	RP-010548	1008		MAC logical channel priority added to definition of RB0 and SHCCH	4.2.0
	RP-13	RP-010548	1010		Control of primary CCPCH RSCP measurement in PUSCH CAPACITY REQUEST message	4.2.0
	RP-13	RP-010548	1014		Various minor corrections	4.2.0

	RP-13	RP-010548	1016		Range of T312	4.2.0
	RP-13	RP-010548	1018		Bitstring of channelisationCodeIndices	4.2.0
	RP-13	RP-010548	1020		Transmission of UE CAPABILITY INFORMATION message	4.2.0
	RP-13	RP-010548	1022		Multiple UE capabilities procedures	4.2.0
	RP-13	RP-010548	1024		Corrections to information elements outside the extension container	4.2.0
	RP-13	RP-010548	1026		SFN reporting	4.2.0
	RP-13	RP-010548	1028		TFCI combining indicator	4.2.0
	RP-13	RP-010549	1030		RLC reset on a Signalling Radio Bearer	4.2.0
	RP-13	RP-010549	1034		Quality Indication for UE Positioning Parameters	4.2.0
	RP-13	RP-010549	1036		Editorial Correction for UE Positioning	4.2.0
	RP-13	RP-010549	1038		Clarification on the current status of ciphering	4.2.0
	RP-13	RP-010549	1048		Clarification on HFN initialization at SRB and RB setup	4.2.0
	RP-13	RP-010549	1050		Clarification on Inter-RAT measurement	4.2.0
	RP-13	RP-010549	1052		Clarification on re-assembly of segments	4.2.0
	RP-13	RP-010549	1062		Minor Corrections	4.2.0
	RP-13	RP-010549	1066		Support of dedicated pilots for channel estimation	4.2.0
	RP-13	RP-010549	1068		Correction to SRNS relocation handling	4.2.0
	RP-13	RP-010550	1076		Correction to RLC state variables	4.2.0
	RP-13	RP-010550	1082		Reading of CN information in SIB 1 in RRC Connected Mode	4.2.0
	RP-13	RP-010550	1086		Restricting the maximum amount of preconfigurations in case of equivalent PLMNs	4.2.0
	RP-13	RP-010554	0933		Order of bits in bitstrings	4.2.0
	RP-13	RP-010554	0946		Selection of the RFC3095 CID transmission	4.2.0
	RP-13	RP-010554	0970		Correction of IPDL parameters for TDD enhancements in ASN.1 description	4.2.0
	RP-13	RP-010554	0971	1	1.28 Mcps TDD PICH, Midamble and UL timing advance control corrections	4.2.0
	RP-13	RP-010554	0972		Introduction of 1.28 Mcps TDD Mode in clause 13.7	4.2.0
	RP-13	RP-010554	0973		Tadv in 1.28 Mcps TDD	4.2.0
	RP-13	RP-010554	0974		Correction and clarification to PRACH in 1.28 Mcps TDD	4.2.0
10/2001	-	-	-		Replacement of incorrect (R'99) version of ASN.1 by correct (Rel-4) version of ASN.1.	4.2.1
12/2001	RP-14	RP-010763	1088		Corrections to RRC information containers	4.3.0
	RP-14	RP-010763	1090		Removal of Block SSTD	4.3.0
	RP-14	RP-010763	1098		COUNT-C-SFN frame difference measurement	4.3.0
	RP-14	RP-010763	1100		Trigger for deletion of ciphering and integrity keys	4.3.0
	RP-14	RP-010763	1102		Correction to P_compensation calculation for GSM neighbour cells	4.3.0
	RP-14	RP-010763	1104		Preconfigurations in case of equivalent PLMNs	4.3.0
	RP-14	RP-010763	1109		Handling of DRX cycle and U-RNTI in RRC connection setup and handling of TrCH information	4.3.0
	RP-14	RP-010763	1111		Correction to Information Element names	4.3.0
	RP-14	RP-010763	1113		Correction of Description of IE "SSDT Information"	4.3.0
	RP-14	RP-010763	1115		Clarification on Cell Identity and correction to reference to BAND_INDICATOR	4.3.0
	RP-14	RP-010764	1117		Clarification to Measured Results on RACH and Measurement Events	4.3.0
	RP-14	RP-010764	1119		Inconsistency between ASN.1 and tabular wrt. RPLMN information	4.3.0
	RP-14	RP-010764	1124		General clarification on Establishment of Access Service Classes	4.3.0
	RP-14	RP-010764	1126		Clarification on TX diversity indicator IE and STTD indicator IE	4.3.0
	RP-14	RP-010764	1132		Different diversity modes used in the same active set	4.3.0
	RP-14	RP-010764	1134		Issues regarding signalling connection establishment and RRC connection release	4.3.0
	RP-14	RP-010764	1136		Presence of AC to ASC mapping in SIB5 and SIB6	4.3.0
	RP-14	RP-010764	1138		RRC establishment cause at inter-RAT cell change order to UTRAN	4.3.0
	RP-14	RP-010764	1142		Start of timers at radio link failure	4.3.0
	RP-14	RP-010765	1144		Handling of the number of FBI bits sent in Uplink DPCH info	4.3.0
	RP-14	RP-010765	1146		Bit string order when using PER	4.3.0
	RP-14	RP-010765	1148		Clarification on DRX cycle length in connected mode	4.3.0
	RP-14	RP-010765	1152		Correction to error condition on downlink information for each radio link	4.3.0
	RP-14	RP-010765	1154		Correction of inconsistencies between tabular and ASN.1	4.3.0
	RP-14	RP-010765	1156		Measurement related corrections	4.3.0
	RP-14	RP-010765	1158		Inconsistency between hard-coded preconfigurations parameters and procedure text	4.3.0
	RP-14	RP-010765	1166		PLMN search in CELL_PCH/URA_PCH states with 80ms DRX cycle	4.3.0

	RP-14	RP-010765	1168		Correction to CFN calculation for FDD	4.3.0
	RP-14	RP-010765	1170		Correction to radio bearer control	4.3.0
	RP-14	RP-010766	1172		Handling of IE "frequency info"	4.3.0
	RP-14	RP-010766	1174		Correction to Radio Bearer Release	4.3.0
	RP-14	RP-010940	1178	1	Correction to RACH reporting	4.3.0
	RP-14	RP-010766	1180		Correction to URA/Cell update and other minor corrections	4.3.0
	RP-14	RP-010766	1182		Correction to Active Set Update	4.3.0
	RP-14	RP-010766	1184		Correction of Traffic Volume Measurement Criteria	4.3.0
	RP-14	RP-010941	1186	1	Correction of UE Positioning	4.3.0
	RP-14	RP-010766	1203		Invalid RRC CONNECTION REJECT	4.3.0
	RP-14	RP-010766	1214		Security baseline for corrections	4.3.0
	RP-14	RP-010766	1220		Pending integrity protection activation time for UL RB0	4.3.0
	RP-14	RP-010767	1222		Correction of rate matching restriction function	4.3.0
	RP-14	RP-010773	1096		Usage of UM RLC Special Length Indicator	4.3.0
	RP-14	RP-010773	1120		Corrections to REL-4 LCR Tabular Description and ASN1 Code	4.3.0
	RP-14	RP-010773	1199		Correction of FPACH parameter definition for 1.28Mcps TDD	4.3.0
	RP-14	RP-010773	1200		Correction of 1.28Mcps TDD	4.3.0
	RP-14	RP-010773	1201		Correction and Clarification to Open Loop Power Control in 1.28 Mcps TDD	4.3.0
	RP-14	RP-010773	1206		Extensions of IE value ranges in tabular	4.3.0
03/2002	RP-15	RP-020070	1229		Constant value range correction for DPCH and PUSCH in TDD mode	4.4.0
	RP-15	RP-020070	1231		Corrections to open loop power control for TDD and RB information parameters for SHCCH	4.4.0
	RP-15	RP-020070	1233		Removal of unnecessary replication of TFCS ID in Physical Shared Channel Allocation message	4.4.0
	RP-15	RP-020070	1237		Correction to TF selection when using UL RLC TM	4.4.0
	RP-15	RP-020070	1239		Correction to the UE behaviour in case of SRNS relocation	4.4.0
	RP-15	RP-020070	1241		Header Compression protocols re-initialisation during SRNS Relocation	4.4.0
	RP-15	RP-020070	1243		Misalignments between tabular and ASN.1 related to UE Positioning, tabular correction	4.4.0
	RP-15	RP-020070	1245		Corrections to comments in ASN.1	4.4.0
	RP-15	RP-020070	1247		Correction to restarting of T308	4.4.0
	RP-15	RP-020070	1249		Clarification of the use of T309 during inter-RAT cell reselections	4.4.0
	RP-15	RP-020071	1251		Measurement Corrections	4.4.0
	RP-15	RP-020239	1253	1	Existence of TFCI bits	4.4.0
	RP-15	RP-020071	1258		Corrections of inconsistency between procedural description, tabular and ASN.1	4.4.0
	RP-15	RP-020071	1260		Corrections to Expiration Time Factor and Expiration Time formula for SIB 7 and SIB 14	4.4.0
	RP-15	RP-020071	1262		Corrections to Reporting Cell Status	4.4.0
	RP-15	RP-020071	1268		Correction to inter frequency measurements	4.4.0
	RP-15	RP-020071	1271		Actions at reception of system information block type 1	4.4.0
	RP-15	RP-020071	1273		Tx diversity and no diversity in the same active set	4.4.0
	RP-15	RP-020071	1275		Correction to cell update	4.4.0
	RP-15	RP-020071	1277		Successful and unsuccessful procedures	4.4.0
	RP-15	RP-020072	1279		Measurement related corrections	4.4.0
	RP-15	RP-020072	1281		Clarifications on Event 1D	4.4.0
	RP-15	RP-020205	1283	1	Security corrections	4.4.0
	RP-15	RP-020072	1285		Transition from CELL_DCH to CELL_FACH state	4.4.0
	RP-15	RP-020072	1287		Corrections and clarifications of Radio link timing	4.4.0
	RP-15	RP-020072	1289		Spare values in ASN.1	4.4.0
	RP-15	RP-020072	1294		Actions on reception of measurement related IEs	4.4.0
	RP-15	RP-020231	1296	1	Removal of channel coding option "no coding" for FDD and 3.84 Mcps TDD	4.4.0
	RP-15	RP-020072	1298		Timing Indication when moving to CELL_DCH state	4.4.0
	RP-15	RP-020072	1307		Correction to processing RB mapping info	4.4.0
	RP-15	RP-020072	1313		RRC Connection Release following network authentication failure	4.4.0
	RP-15	RP-020072	1317		Clarification on serving cell in SIB11	4.4.0
	RP-15	RP-020073	1319		Treatment of optional elements in RB control messages	4.4.0
	RP-15	RP-020073	1323		Procedure Performance for TDD UL physical Channel Control	4.4.0
	RP-15	RP-020250	1331	1	Clarification to physical channel establishment criteria	4.4.0
	RP-15	RP-020249	1333	1	OTDOA Assistance Data	4.4.0

	RP-15	RP-020073	1337			Retransmission of uplink direct transfer at RLC re-establishment and inter-RAT change	4.4.0
	RP-15	RP-020073	1339			Correction to IE "UL interference" for UTRA TDD	4.4.0
	RP-15	RP-020074	1343			Corrections of UE Positioning requirements	4.4.0
	RP-15	RP-020074	1345			Multimode speech in default configurations	4.4.0
	RP-15	RP-020073	1347			Correction to UE Id for DSCH	4.4.0
	RP-15	RP-020073	1349			Corrections to support combined Cell/URA update and SRNS relocation	4.4.0
	RP-15	RP-020073	1351			Number of UTRAN and Inter-RAT frequencies	4.4.0
	RP-15	RP-020073	1353			Abortion of signalling connection establishment	4.4.0
	RP-15	RP-020073	1358			Modification of GPS timing representation to avoid large integers	4.4.0
	RP-15	RP-020074	1360			Additional TFCS selection guidelines	4.4.0
	RP-15	RP-020074	1362			Clarification of layer 3 filtering of measurements in the UE	4.4.0
	RP-15	RP-020210	1364			Improved readability of procedural text	4.4.0
	RP-15	RP-020228	1366			Clarification on ICS version within UE radio access capabilities	4.4.0
	RP-15	RP-020233	1368			Clarification of Maximum number of TFC in the TFCS	4.4.0
	RP-15	RP-020238	1370			Support of UP measurement reporting in CELL_PCH/URA_PCH	4.4.0
	RP-15	RP-020082	1122	2		Correction to include Cell ID for Cell_DCH state	4.4.0
	RP-15	RP-020082	1187	2		Correction of Transparent mode signalling for UL rate control	4.4.0
	RP-15	RP-020082	1188	2		Introduction of default radio configurations for UMTS_AMR2 with four speech modes	4.4.0
	RP-15	RP-020082	1223	1		Acquisition of PLMN identity of neighbour cells via SIB 18	4.4.0
	RP-15	RP-020082	1254			Various ASN.1 Corrections	4.4.0
	RP-15	RP-020082	1290			Handover from UTRAN failure	4.4.0
	RP-15	RP-020082	1335			Corrections to indicate that SIB 14 is not used by 1.28 TDD	4.4.0
	RP-15	RP-020084	1129	2		Support of flexible hard split mode	5.0.0
	RP-15	RP-020090	1225	1		Introduction of the parameters of OTDOA with IPDL for 1.28 Mcps TDD	5.0.0
	RP-15	RP-020085	1291	1		Radio link timing	5.0.0
	RP-15	RP-020094	1305	2		Introduction of HSDPA	5.0.0
06/2002	RP-16	RP-020330	1373			ASN.1 Corrections	5.1.0
	RP-16	RP-020330	1376			Clarification of unnecessary MP IEs in RADIO BEARER RECONFIGURATION	5.1.0
	RP-16	RP-020330	1379			Correction on SIB type	5.1.0
	RP-16	RP-020330	1382			Clarification to the handling of IE "Cells for measurement" received in SIB 11/12	5.1.0
	RP-16	RP-020330	1385	1		Correction to Cell Update procedure	5.1.0
	RP-16	RP-020330	1388			Correction to handling of FACH measurement occasion info in SIB12	5.1.0
	RP-16	RP-020331	1392			Actions when optional IE "Maximum allowed UL TX power" is missing	5.1.0
	RP-16	RP-020331	1395			Corrections concerning default configurations	5.1.0
	RP-16	RP-020331	1398			Correction concerning when hard handover specific handling applies	5.1.0
	RP-16	RP-020331	1401			Handling of variables CELL_INFO_LIST and MEASUREMENT_IDENTITY	5.1.0
	RP-16	RP-020331	1404			IE "Cell Synchronisation Information"	5.1.0
	RP-16	RP-020331	1407			Corrections to Cell Individual Offset	5.1.0
	RP-16	RP-020332	1410			Clarification to Compressed Mode Status Info	5.1.0
	RP-16	RP-020332	1413			Clarification of OTDOA quality figure	5.1.0
	RP-16	RP-020332	1416			Correction to Cell Access Restriction for SIB4	5.1.0
	RP-16	RP-020332	1419			Corrections concerning spare values and comments	5.1.0
	RP-16	RP-020332	1423			Variable for shared channel configurations	5.1.0
	RP-16	RP-020332	1426	1		Integrity protection on RB0	5.1.0
	RP-16	RP-020333	1429	1		Periodic cell update clarifications	5.1.0
	RP-16	RP-020333	1432			Multiple cells triggering event 1D	5.1.0
	RP-16	RP-020333	1435			Disjoint Active Sets in the Active Set Update procedure	5.1.0
	RP-16	RP-020333	1438			Deletion on compressed mode patterns when moving to CELL_FACH state	5.1.0
	RP-16	RP-020333	1441			TDD C-RNTI in Cell DCH	5.1.0
	RP-16	RP-020333	1444	1		CCTrCH Release in TDD	5.1.0
	RP-16	RP-020334	1447			Layer 3 retransmission of SIGNALLING CONNECTION RELEASE INDICATION	5.1.0
	RP-16	RP-020334	1450			Alignment of tabular and ASN.1 for UTRAN GPS timing of cell frames resolution	5.1.0
	RP-16	RP-020334	1453			Correction to Default Radio Configuration Timers	5.1.0
	RP-16	RP-020334	1456			Clarification to number of L3 filters	5.1.0
	RP-16	RP-020334	1459	1		Correction to 3G to 2G Inter-RAT handover for multi-domain RABs	5.1.0
	RP-16	RP-020334	1462			DCH quality target	5.1.0

	RP-16	RP-020335	1465			Correction to RB Mapping Info	5.1.0
	RP-16	RP-020335	1468	1		Ciphering activation for TM bearers	5.1.0
	RP-16	RP-020335	1471			TFCS selection guideline correction	5.1.0
	RP-16	RP-020382	1480	1		Clarification of Measurement Validity and Valid Measurement Objects	5.1.0
	RP-16	RP-020363	1483			Remaining clarification of Measurement Validity and Valid Measurement Objects	5.1.0
	RP-16	RP-020381	1486	1		Traffic Volume Measurement clarifications	5.1.0
	RP-16	RP-020335	1489			Correction to handling of IE 'Downlink information for each RL'	5.1.0
	RP-16	RP-020336	1492			Corrections to Security procedure on Missing integrity protection reset on relocation and counter check response actions for asymmetric bearer configurations	5.1.0
	RP-16	RP-020336	1495			Corrections to cell update interactions with security and SRNS Relocation	5.1.0
	RP-16	RP-020336	1498			"Out of service" area definition	5.1.0
	RP-16	RP-020339	1473			RRC connection release procedure in CELL_DCH state	5.1.0
	RP-16	RP-020339	1475			Correction to DL TM DCCH TF size for Default Configurations	5.1.0
	RP-16	RP-020339	1477			Corrections in ASN.1 related to SRNS relocation	5.1.0
	RP-16	RP-020341	1499			HS-DSCH related corrections	5.1.0
	RP-16	RP-020341	1500			Removal of BLER threshold from IE "Measurement Feedback info"	5.1.0
	RP-16	RP-020345	1501			RFC 3095 context relocation	5.1.0
09/2002	RP-17	RP-020541	1504	1		UE behaviour when active set cells are not included in CELL_INFO_LIST	5.2.0
	RP-17	RP-020541	1507	1		Corrections to handling of IE "Cells for measurement"	5.2.0
	RP-17	RP-020541	1510			Clarification on the use of UE radio access capability extensions within the INTER RAT HANDOVER INFO message	5.2.0
	RP-17	RP-020541	1513			Correction to RRC connection procedure	5.2.0
	RP-17	RP-020541	1516			Correction to the variable TGPS_IDENTITY	5.2.0
	RP-17	RP-020541	1522			Missing IEs in RLC info	5.2.0
	RP-17	RP-020542	1528	1		Corrections of UE internal measurement reporting events	5.2.0
	RP-17	RP-020542	1531	2		UE behaviour upon reception of reconfiguration	5.2.0
	RP-17	RP-020542	1534			Application of integrity keys in case of a pending CN domain switch during a SRNS relocation	5.2.0
	RP-17	RP-020542	1537	1		Clarifications on Quality Measurements	5.2.0
	RP-17	RP-020542	1540			Correction of DPCH constant value in TDD default radio configurations	5.2.0
	RP-17	RP-020542	1543			Handling of UE internal measurement information in broadcast	5.2.0
	RP-17	RP-020543	1546			Observed time difference to GSM reporting indicator	5.2.0
	RP-17	RP-020543	1551			Corrections on Security relative to ciphering of TM bearers and to SRNS relocation	5.2.0
	RP-17	RP-020543	1554			Coding of IE NC mode	5.2.0
	RP-17	RP-020543	1557			Clarification to filtered measurement quantities	5.2.0
	RP-17	RP-020543	1560			Inconsistencies in triggering and reporting for events 1a, 1b,1c, 1e and 1f	5.2.0
	RP-17	RP-020543	1563	1		Optional and Mandatory fields in Measurement Control	5.2.0
	RP-17	RP-020544	1566			Clarifications to Reporting Cell Status	5.2.0
	RP-17	RP-020544	1569			Clarification to minimum SF	5.2.0
	RP-17	RP-020544	1572			Clarifications to inter-frequency measurements	5.2.0
	RP-17	RP-020544	1578	2		Ciphering when HO to UMTS of signalling only connection	5.2.0
	RP-17	RP-020544	1581			Inter RAT handover from UTRAN	5.2.0
	RP-17	RP-020544	1584			Correction to Cell Update procedure with cause "Radio link failure"	5.2.0
	RP-17	RP-020545	1587			Correction to the handling of IE "UTRAN DRX cycle length coefficient" in CELL/URA UPDATE procedure	5.2.0
	RP-17	RP-020545	1590			Correction to RLC unrecoverable error occurs in CELL_DCH state	5.2.0
	RP-17	RP-020545	1593			Use of scrambling change when activating CM pattern using SF/2 by MEASUREMENT CONTROL	5.2.0
	RP-17	RP-020545	1596			Actions when optional IE "Maximum allowed UL TX power" is missing	5.2.0
	RP-17	RP-020630	1599	1		IP_offset correction	5.2.0
	RP-17	RP-020545	1602			Clarification on the IE "Frequency Info"	5.2.0
	RP-17	RP-020546	1605			Correction of RNTI used in PUSCH capacity request and physical shared channel allocation	5.2.0
	RP-17	RP-020546	1608			Correction to allowed logical channel list choice for RACH transport channels	5.2.0
	RP-17	RP-020654	1611	1		Clarification of SRNS Relocation Info	5.2.0
	RP-17	RP-020546	1614			DCH quality target	5.2.0
	RP-17	RP-020546	1617			Handling of variables CELL_INFO_LIST and MEASUREMENT_IDENTITY(2)	5.2.0
	RP-17	RP-020546	1620	1		Correction of secondary CCPCH selection and PRACH selection	5.2.0
	RP-17	RP-020547	1623			RRC TVM Corrections	5.2.0

	RP-17	RP-020547	1626			Correction of Transmission Gap Distance semantics description	5.2.0
	RP-17	RP-020547	1629			Corrections to Active Set Update and simultaneous reconfiguration	5.2.0
	RP-17	RP-020547	1632			UE behaviour following RLC size change	5.2.0
	RP-17	RP-020547	1635			RRC SN in uplink	5.2.0
	RP-17	RP-020547	1638			Multiplexing of Tr mode RBs of different CN domains on the same transport channel	5.2.0
	RP-17	RP-020548	1641			Security clarifications	5.2.0
	RP-17	RP-020548	1644			Correction to the actions of "out of service area" and "in service area"	5.2.0
	RP-17	RP-020548	1647			TVM: pending time after trigger and initial conditions	5.2.0
	RP-17	RP-020548	1650	1		Handling of Downlink information for each RL in reconfiguration messages	5.2.0
	RP-17	RP-020548	1655			Corrections to Cell Update/URA Update Procedure in case of nested cell updates and simultaneous SRNS relocation	5.2.0
	RP-17	RP-020548	1670			Corrections to security	5.2.0
	RP-17	RP-020631	1673	1		SRNS relocation with integrity	5.2.0
	RP-17	RP-020549	1676			Reception of MEASUREMENT CONTROL in state CELL_FACH	5.2.0
	RP-17	RP-020549	1679			Unsupported configuration	5.2.0
	RP-17	RP-020549	1682			Handover corrections	5.2.0
	RP-17	RP-020558	1575	1		Correction of SFN-SFN Measurement	5.2.0
	RP-17	RP-020559	1661			Corrections to Synchronisation for 1.28 Mcps TDD	5.2.0
	RP-17	RP-020553	1657			Corrections on Power Control for 1.28 Mcps TDD	5.2.0
	RP-17	RP-020553	1659			Correction to RLC entity re-establishment during SRNS relocation	5.2.0
	RP-17	RP-020553	1663			Reintroduction of IE "SRB delay" in Rel-4 ASN.1	5.2.0
	RP-17	RP-020553	1665			Corrections to ASN.1 for SRNC relocation container	5.2.0
	RP-17	RP-020553	1667			Unused elements in ASN.1	5.2.0
	RP-17	RP-020557	1547			Correction on Radio link timing	5.2.0
	RP-17	RP-020662	1651	2		Physical layer IEs for HSDPA	5.2.0
	RP-17	RP-020557	1652			Transport channel information elements for HSDPA	5.2.0
	RP-17	RP-020590	1683			TX diversity on radio links in the active set	5.2.0
	RP-17	RP-020557	1684			Mandatory Support of dedicated pilots for channel estimation	5.2.0
12/2002	RP-18	RP-020721	1687			Corrections to IEs "Ellipsoid point with Altitude and uncertainty Ellipsoid" and "Ellipsoid point with uncertainty Ellipse"	5.3.0
	RP-18	RP-020721	1690	1		Handling of Ciphering and integrity protection activation times	5.3.0
	RP-18	RP-020721	1693			Handling of measurements at state transitions to/from DCH state.	5.3.0
	RP-18	RP-020721	1696	2		Measurement related corrections	5.3.0
	RP-18	RP-020721	1699			ASN.1 of the SRNS relocation info	5.3.0
	RP-18	RP-020721	1710	1		Corrections to PRACH selection	5.3.0
	RP-18	RP-020722	1713			TDD Downlink Path Loss for interfrequency measurement	5.3.0
	RP-18	RP-020892	1716	1		Correction on coding of GSM Classmark 2 and 3	5.3.0
	RP-18	RP-020722	1719			Correction on Frame Allocation Calculation	5.3.0
	RP-18	RP-020722	1722			Inter-frequency measurements	5.3.0
	RP-18	RP-020722	1725			Maximum Allowed UL TX Power	5.3.0
	RP-18	RP-020722	1728			START values for the initialisation of SRB counters and UTRAN incorrect actions	5.3.0
	RP-18	RP-020723	1731			Correction to the RRC transaction table management	5.3.0
	RP-18	RP-020723	1803			Use of DCH Quality Target with Blind Transport Format Detection	5.3.0
	RP-18	RP-020723	1742			Correction to storing current TFC subset in variable TFC_SUBSET for TDD	5.3.0
	RP-18	RP-020723	1745			Security at inter-RAT handover	5.3.0
	RP-18	RP-020723	1748			Integrity protection activations times	5.3.0
	RP-18	RP-020723	1751			Additional measurements	5.3.0
	RP-18	RP-020724	1754			DPCH compressed mode info in Downlink information common for all RLS	5.3.0
	RP-18	RP-020724	1757	1		Handling of RB mapping	5.3.0
	RP-18	RP-020724	1766			RLC window size in default configurations	5.3.0
	RP-18	RP-020724	1769			Corrections to Activation time	5.3.0
	RP-18	RP-020724	1772			Numbering of "ASC Setting" IEs included in "PRACH partitioning" IE	5.3.0
	RP-18	RP-020724	1779	2		Correction on support for compressed mode	5.3.0
	RP-18	RP-020903	1734	3		Introduction of backwards compatible correction mechanism	5.3.0
	RP-18	RP-020727	1776			Signalling of the timing adjustment mode for closed loop Tx diversity	5.3.0
	RP-18	RP-020893	1810			Handling of hyper frame numbers	5.3.0
	RP-18	RP-020726	1760	2		Early UE Specific Behaviour Information in RRC Connection Request / interRAT info	5.3.0
	RP-18	RP-020858	1701			Correction of ASN1 IE "InterFreqCellInfoList-r4"	5.3.0

	RP-18	RP-020858	1703			Correction of Special Burst Scheduling for TDD	5.3.0
	RP-18	RP-020858	1705			Correction of measurement reporting event 6f for 1.28 Mcps TDD	5.3.0
	RP-18	RP-020858	1781			Ciphering during SRNS relocation without reuse of COUNT-C	5.3.0
	RP-18	RP-020858	1783			Correction to IE "Intra Domain NAS Node Selector"	5.3.0
	RP-18	RP-020858	1785			Correction to PRACH selection	5.3.0
	RP-18	RP-020859	1787			Correction to reporting event 6f for FDD	5.3.0
	RP-18	RP-020859	1802			ASN.1 corrections	5.3.0
	RP-18	RP-020859	1805			Asymmetric ROHC Configuration	5.3.0
	RP-18	RP-020859	1807			Reference Cell for GSM OTD Measurement	5.3.0
	RP-18	RP-020736	1707			RRC container for RFC3095 context	5.3.0
	RP-18	RP-020736	1791			Correction to IE "Access stratum release indicator"	5.3.0
	RP-18	RP-020736	1792			RLC capability for HSDPA	5.3.0
	RP-18	RP-020736	1794			Dedicated pilot bits for HS-DSCH	5.3.0
	RP-18	RP-020736	1795			Expansion of CPICH RSCP range	5.3.0
	RP-18	RP-020736	1796			L3 Retransmission of event 1b	5.3.0
	RP-18	RP-020736	1797			DPC mode change in ACTIVE SET UPDATE message	5.3.0
	RP-18	RP-020736	1798			Correction to handling of IE 'Downlink information for each RL'	5.3.0
	RP-18	RP-020896	1793	2		HSDPA parameter value ranges	5.3.0
03/2003	RP-19	RP-030103	1813			ASN.1 of the SRNS relocation Info	5.4.0
	RP-19	RP-030103	1816			Correction to procedural text for Physical Shared Channel Allocation (TDD only)	5.4.0
	RP-19	RP-030103	1819	1		CM and state transition related to measurements, additional measurements, virtual active set and periodic measurements	5.4.0
	RP-19	RP-030103	1822			Physical channel failure and radio link re-establishment	5.4.0
	RP-19	RP-030103	1825			Correction concerning bit numbering convention	5.4.0
	RP-19	RP-030104	1831			Additional Measurement reporting list	5.4.0
	RP-19	RP-030104	1834	2		Correction on RRC integrity protection procedure	5.4.0
	RP-19	RP-030104	1837			Reporting Cell Status and Event 2A	5.4.0
	RP-19	RP-030104	1840			Correction to the handling of variable TGPS_IDENTITY and IE "Triggering condition 1/2"	5.4.0
	RP-19	RP-030104	1843	1		Hard handover with pending ciphering activation times	5.4.0
	RP-19	RP-030105	1846			Correction of default configurations	5.4.0
	RP-19	RP-030105	1849			Correction to UE behaviour on entering RRC Connected mode	5.4.0
	RP-19	RP-030105	1855			Update of Start values in USIM on inter-RAT transitions and transitions to idle mode	5.4.0
	RP-19	RP-030082	1858			Corrections to Channelisation Code TFCI Mapping for TDD	5.4.0
	RP-19	RP-030111	1860			Correction of PNBSCH for 1.28Mcps TDD	5.4.0
	RP-19	RP-030111	1862			Correction of SFN-SFN observed time difference for 1.28Mcps TDD	5.4.0
	RP-19	RP-030111	1864	3		ASN.1 corrections concerning missing UE capability extensions	5.4.0
	RP-19	RP-030111	1866			Extensions for 1.28 Mcps specific elements in system information	5.4.0
	RP-19	RP-030111	1868			Corrections to power control parameter signalling for 1.28 Mcps TDD	5.4.0
	RP-19	RP-030117	1872			TDD HS-SICH Power Control	5.4.0
	RP-19	RP-030117	1873			Usage of separate scrambling code for HSDPA	5.4.0
	RP-19	RP-030119	1874			TDD HS-DSCH midamble shift and burst type	5.4.0
	RP-19	RP-030117	1875			Corrections to the IE "Added or Reconfigured MAC-d flow" and the associated table in 10.3.10	5.4.0
	RP-19	RP-030117	1877	1		Network Assisted Cell Change from UTRAN to GERAN	5.4.0
	RP-19	RP-030117	1878	1		Defining more than one DSCH / USCH transport channel in PDSCH and PUSCH system information (TDD only)	5.4.0
	RP-19	RP-030117	1879			Introducing the use of pre-defined configurations within UTRA	5.4.0
	RP-19	RP-030120	1880			Group release (without security)	5.4.0
	RP-19	RP-030105	1884			Correction to Inter-RAT Measurement Report	5.4.0
	RP-19	RP-030106	1887			Correction of signalling of transport block size for DSCH	5.4.0
	RP-19	RP-030106	1890			PS service continuity when moving between 3G and 2G	5.4.0
	RP-19	RP-030106	1893	1		Multiple activations of the same compressed mode pattern	5.4.0
	RP-19	RP-030106	1896			Setting of ciphering activation time for TM bearers	5.4.0
	RP-19	RP-030117	1897			Correction of shadow CR implementation	5.4.0
	RP-19	RP-030111	1899			Removal of MRRU parameter in PDCP info	5.4.0
	RP-19	RP-030117	1900			Measurement event for evaluation of best HS-DSCH cel	5.4.0
	RP-19	RP-030105	1902	1		NAS and Integrity procedure interaction	5.4.0
	RP-19	RP-030117	1903			Correction to USB1	5.4.0
	RP-19	RP-030187	1909			GPS navigation model update mechanism	5.4.0

	RP-19	RP-030201	1910			Layer 3 filtering definition	5.4.0
	RP-20	RP-030293	1913			Handling of UP Assistance Data	5.5.0
	RP-20	RP-030293	1916	1		Concerns on Procedures for Cell-ID Positioning Method	5.5.0
	RP-20	RP-030293	1919			Inconsistency between Procedural, ASN.1, and Tabular Aspects of UE Positioning Error	5.5.0
	RP-20	RP-030293	1922			Removal of FFS (For further Study) and references to other working groups	5.5.0
	RP-20	RP-030293	1926			Key handling when entering idle mode and coding of security capabilities	5.5.0
	RP-20	RP-030293	1929			Security actions when SIM is present on RRC Connection Request	5.5.0
	RP-20	RP-030294	1932			Update of interfrequency measurement cell info list, reading of SIB11/12, inclusion of Measured Results on RACH	5.5.0
	RP-20	RP-030294	1937			Additional measurements without measurement validity	5.5.0
	RP-20	RP-030294	1940			Handover to UTRAN in macrodiversity	5.5.0
	RP-20	RP-030294	1943	1		TVM Reporting in CELL_PCH state	5.5.0
	RP-20	RP-030294	1946	1		Initialisation of the Virtual Active Set	5.5.0
	RP-20	RP-030295	1949			IE "Tx diversity mode" in ACTIVE SET UPDATE message	5.5.0
	RP-20	RP-030295	1952	1		Correction to transport channel traffic volume measurement events 4a and 4b	5.5.0
	RP-20	RP-030295	1955			Maximum Number of GPS Almanac Messages to be Stored in UE_POSITIONING_GPS_DATA	5.5.0
	RP-20	RP-030374	1958	2		Stopping of RLC entities at relocation	5.5.0
	RP-20	RP-030369	1978	4		Ciphering Mode info IE in 2G-3G Handover	5.5.0
	RP-20	RP-030295	1981			START values on 2G-3G handover	5.5.0
	RP-20	RP-030298	1983			ROHC profile signalling	5.5.0
	RP-20	RP-030298	1959	1		Optimisation of the INTER RAT HANDOVER INFO message	5.5.0
	RP-20	RP-030350	1987	2		Corrections to security procedures in case of pending security configurations at SRNS Relocation	5.5.0
	RP-20	RP-030371	1990			Setting of T317 to infinity and out of service behaviour	5.5.0
	RP-20	RP-030303	1960			Correction to the IE 'HS-DSCH capability class'	5.5.0
	RP-20	RP-030303	1961			Correction of "RB mapping info" in case HS-DSCH + DCH	5.5.0
	RP-20	RP-030303	1963			Explanation of CV-UE for the IE MidambleShift in the tabular	5.5.0
09/2003	RP-21	RP-030484	1993			Handling of key sets at Inter-RAT Handover to UTRAN	5.6.0
	RP-21	RP-030484	1996			Correction to UE Positioning privacy procedures	5.6.0
	RP-21	RP-030520	2003	2		START calculation in connected mode	5.6.0
	RP-21	RP-030506	2000	1		Reconfiguration with state transition to an indicated cell on a different frequency	5.6.0
	RP-21	RP-030484	2006			PRACH channelisation code list limitation to align with TS 25.221	5.6.0
	RP-21	RP-030484	2009			Handling of transport channel information at radio bearer release	5.6.0
	RP-21	RP-030485	2015			Corrections for TDD for the IEs "Downlink DPCH info common for all radio links"	5.6.0
	RP-21	RP-030485	2018			TFCS selection guidelines for TFC Subset	5.6.0
	RP-21	RP-030485	2025			Value range of UE Rx-Tx time difference type 2 measurement	5.6.0
	RP-21	RP-030485	2033			Activation Time for DSCH	5.6.0
	RP-21	RP-030485	2044			Correction of PDCP Configuration for RFC 2507	5.6.0
	RP-21	RP-030486	2048			Corrections to event list handling	5.6.0
	RP-21	RP-030486	2051			Corrections to RACH reporting	5.6.0
	RP-21	RP-030486	2054			Corrections to modification of Additional Measurement lists	5.6.0
	RP-21	RP-030486	2057			UE positioning support in the UE	5.6.0
	RP-21	RP-030478	2064			Elimination of EPC mechanism	5.6.0
	RP-21	RP-030486	2069			UE behaviour in transition from CELL_DCH to CELL_FACH/CELL_PCH/URA_PCH and Out of Service is detected	5.6.0
	RP-21	RP-030505	2072	1		Radio link failure during reconfiguration procedure	5.6.0
	RP-21	RP-030491	2020			Ciphering of TM SRBs	5.6.0
	RP-21	RP-030491	2022	1		Correction on PDCP Header compression Configuration	5.6.0
	RP-21	RP-030491	2027			Corrections for TDD PUSCH	5.6.0
	RP-21	RP-030495	1997			Correction to UE behaviour on T317 expiry	5.6.0
	RP-21	RP-030495	2029			Correcting value range of MAC-hs buffer ID	5.6.0
	RP-21	RP-030495	2030			Correction of handling of IE "MAC-hs reset indicator" in Added or Reconfigured DL TrCH information	5.6.0
	RP-21	RP-030495	2035	1		UE capability signalling for UMTS1800	5.6.0
	RP-21	RP-030495	2039			Handover between UTRAN and GERAN Iu mode	5.6.0
	RP-21	RP-030495	2040			Updated references to the RRC State Indicator IE	5.6.0
	RP-21	RP-030495	2041			Corrections to Event 1D	5.6.0
	RP-21	RP-030449	2028			Reconfiguration of MAC-d flow	5.6.0

	RP-21	RP-030462	2061			HS-SCCH transmit diversity mode	5.6.0
	RP-21	RP-030503	2066			Scrambling code & phase reference combinations for HS-DSCH (solution 2)	5.6.0
12/2003	RP-22	RP-030617	2075			Unsuccessful security mode control procedure and Integrity Protection	5.7.0
	RP-22	RP-030625	2076			START value calculation for RLC size change	5.7.0
	RP-22	RP-030617	2079			UE Positioning UE based assisted GPS	5.7.0
	RP-22	RP-030617	2085			Handling of zero-rate TrCHs in TFCS	5.7.0
	RP-22	RP-030617	2091	3		Measurement control for A-GPS	5.7.0
	RP-22	RP-030621	2093			Corrections to 1.28 Mcps TDD power control: ASN1/Tabular consistency, correction of omissions	5.7.0
	RP-22	RP-030621	2095			UpPCH power control for 1.28Mcps	5.7.0
	RP-22	RP-030617	2102	1		Interaction between compressed mode pattern activation and message activation time	5.7.0
	RP-22	RP-030625	2103			Initialisation of virtual active set	5.7.0
	RP-22	RP-030611	2106	1		Correction to Redirection procedure at RRC Connection Setup	5.7.0
	RP-22	RP-030610	2112	2		SFN associated with GPS timing of cell frame	5.7.0
	RP-22	RP-030618	2115			Correction to Handling SIB1	5.7.0
	RP-22	RP-030618	2118			Measurement Handling In State Transition for UE Positioning	5.7.0
	RP-22	RP-030618	2124			Corrections to UE positioning reporting for UE assisted and UE based methods	5.7.0
	RP-22	RP-030662	2127	1		SIB 7 reading	5.7.0
	RP-22	RP-030662	2130			HFN initialisation in case of pending security configurations	5.7.0
	RP-22	RP-030621	2132	1		General protocol error handling failure for DL CCCH messages due to ASN.1 error	5.7.0
	RP-22	RP-030621	2136			Corrections relating to 1.28 Mcps TDD	5.7.0
	RP-22	RP-030621	2138			Missing CHOICE RLC Info type in the ASN.1 IE 'RB-InformationSetup-r4'	5.7.0
	RP-22	RP-030625	2139	1		RRM in PCH/FACH	5.7.0
	RP-22	RP-030625	2140			Correction of operating band reference	5.7.0
	RP-22	RP-030713	2141	1		Re-ordering Queue and HARQ Ids	5.7.0
	RP-22	RP-030625	2142			Correction to the procedural description: Reconfiguration of MAC-d flow	5.7.0
	RP-22	RP-030625	2143	1		Enhancement of RRC transaction identifier for measurement control message	5.7.0
	RP-22	RP-030629	2144			Inclusion of a default configuration identity for AMR-WB	5.7.0
	RP-22	RP-030625	2145			TDD C-RNTI in Cell DCH	5.7.0
	RP-22	RP-030662	2148			Additional Measurements List Modify	5.7.0
	RP-22	RP-030625	2149			IP activation time for RB0	5.7.0
	RP-22	RP-030722	2152	3		Minimum UE capability class	5.7.0
	RP-22	RP-030612	2158	4		Measured results on RACH	5.7.0
	RP-22	RP-030625	2159			COUNT-I reverting in case Security Mode Control procedure failure	5.7.0
	RP-21	RP-030548	2034	1		Maintaining the RRC Connection while Emergency camped on a F-PLMN during OOS (note: it was decided that this CR would not be implemented until the Rel-6 would be created)	6.0.0
	RP-22	RP-030630	2133			Introduction of UMTS800	6.0.0
	RP-22	RP-030721	2134	1		AS capability indication	6.0.0
	RP-22	RP-030630	2160			Introduction of new bands	6.0.0
		Editorial				Repair of corrupted figures	6.0.1
03/2004	RP-23	RP-040095	2168	2		Response on SRNS Relocation with Cell Update	6.1.0
	RP-23	RP-040095	2172			TPC Combination Index in SRNC relocation	6.1.0
	RP-23	RP-040107	2176	1		Correction to "Current TGPS Status Flag"	6.1.0
	RP-23	RP-040095	2180	1		Invalidation of START value in USIM/UE.	6.1.0
	RP-23	RP-040095	2184	1		Uplink Integrity protection handling in case of N302 increment	6.1.0
	RP-23	RP-040095	2188	1		Amount of reporting for UE-based and UE assisted A-GPS	6.1.0
	RP-23	RP-040101	2191	1		Ensuring decoding possibility related to Introduction of new bands	6.1.0
	RP-23	RP-040101	2197	2		Clarification to multimode indication	6.1.0
	RP-23	RP-040101	2200			Correction for 1.28 Mcps TDD Power Control	6.1.0
	RP-23	RP-040101	2203			Missing "pdcp-SN-info" in ASN.1 IE "RB-InformationReconfig-r4"	6.1.0
	RP-23	RP-040107	2207			Correction to HS-SCCH info	6.1.0
	RP-23	RP-040107	2209			Correction to HS-SCCH info	6.1.0
	RP-23	RP-040107	2213			Correction to activation time for HS-DSCH reconfiguration in TDD	6.1.0
	RP-23	RP-040131	2217	3		Connected mode handling IE 'CN domain system information' in SIB1	6.1.0
	RP-23	RP-040096	2221			Correction to event 6D	6.1.0
	RP-23	RP-040096	2225	1		Correction to UE positioning reporting for GPS standalone operation mode	6.1.0
	RP-23	RP-040092	2229			Frequency band alignment with 25.101	6.1.0

	RP-23	RP-040096	2235			UTRAN setting of the activation time for TM bearers in Ciphering Mode info IE	6.1.0
	RP-23	RP-040096	2239			Corrections to "Entered parameter"	6.1.0
	RP-23	RP-040097	2243			Corrections to TFC Subset Functionality	6.1.0
	RP-23	RP-040097	2247	1		Waiting for RLC-ACK on UMI	6.1.0
	RP-23	RP-040105	2249			Invalid Simultaneous Reconfiguration Criteria	6.1.0
	RP-23	RP-040101	2252	1		General correction and alignment of the ASN.1 and tabular	6.1.0
	RP-23	RP-040121	2253	1		Introduction of UMTS1700/2100 (Band IV)	6.1.0
	RP-23	RP-040091	2254			Introduction of UMTS850 (Band V)	6.1.0
	RP-23	RP-040101	2257			Introduction of VLEC in every message branch	6.1.0
	RP-23	RP-040107	2259			Simultaneous Reception of S-CCPCH and HS-DSCH	6.1.0
	RP-23	RP-040107	2261			Cell reselection between UTRAN and GERAN lu mode	6.1.0
	RP-23	RP-040108	2263			HSDPA related corrections on buffer flushing on state transitions, RAT transitions, error cases, MAC-hs reconfiguration and readiness to receive HS-PDSCH	6.1.0
	RP-23	RP-040106	2265	2		Signalling of MAC-hs Reset	6.1.0
	RP-23	RP-040131	2267	2		Modification of Inter-frequency CELL_INFO_LIST	6.1.0
	RP-23	RP-040131	2269	1		[VAS] 1B-1C conflicts when 1A is not configured	6.1.0
	RP-23	RP-040131	2271	1		Handling of wait time in RRC connection reject	6.1.0
	RP-23	RP-040108	2274			Misalignments between R'99 and Rel-5 procedures	6.1.0
	RP-23	RP-040097	2281			Issues related to Inter-RAT and Inter-frequency handovers	6.1.0
	RP-23	RP-040097	2285	1		Corrections to reconfiguration scenarios and ciphering of TM RBs	6.1.0
	RP-23	RP-040110	2286	4		Addition of "cell selection indication" for cell selection at release of RRC connection and RRC connection reject with re-direction	6.1.0
	RP-23	RP-040129	2288			HSDPA capability for multimode FDD-TDD terminals	6.1.0
	RP-23	RP-040095	2168	2		Response on SRNS Relocation with Cell Update	6.1.0
06/2004	RP-24	RP-040203	2292			Empty non-critical extensions	6.2.0
	RP-24	RP-040211	2294	1		Missing "v3g0" extension in the UE CAPABILITY INFORMATION	6.2.0
	RP-24	RP-040203	2303			Correction on System Information in TDD	6.2.0
	RP-24	RP-040236	2305			Corrections to Cell Change Order from UTRAN procedure	6.2.0
	RP-24	RP-040206	2308			Correction on SFN-SFN time difference misalignment in 1.28 Mcps TDD	6.2.0
	RP-24	RP-040207	2311			ASN.1 correction leftovers	6.2.0
	RP-24	RP-040210	2313			Closing the REL-5 extensions in the ASN.1	6.2.0
	RP-24	RP-040207	2316			Incorrect presence of UE-RadioAccessCapability extension in RRC CONNECTION SETUP COMPLETE	6.2.0
	RP-24	RP-040210	2318			Unnecessary MAC-d flow identity in the IE "DL-TrCH-Type-r5"	6.2.0
	RP-24	RP-040211	2320	1		UE capability enquiry for GERAN lu mode	6.2.0
	RP-24	RP-040207	2323			Clean up of SRNS Relocation Info REL-4 version	6.2.0
	RP-24	RP-040210	2325			Tabular correction for RADIO BEARER RELEASE message	6.2.0
	RP-24	RP-040210	2327			Misalignments between R'99 and Rel-5 procedures	6.2.0
	RP-24	RP-040210	2329			Erroneous setting of Re-establish Indicator in case of SRNS relocation	6.2.0
	RP-24	RP-040207	2332			Correction to IE "Cell Info"	6.2.0
	RP-24	RP-040210	2334			Correction Concerning UE Positioning Measurement	6.2.0
	RP-24	RP-040236	2336			Pending compressed mode reconfigurations	6.2.0
		RP-040236	2338			Active compressed mode patterns with same measurement purpose	6.2.0
	RP-24	RP-040211	2340			Correction to Information Elements for UE Rx-Tx time difference	6.2.0
	RP-24	RP-040210	2342			Naming correction in the HS-DSCH IE Measurement Feedback Information	6.2.0
	RP-24	RP-040206	2345			Clarification about open loop power control in 1.28Mcps TDD	6.2.0
	RP-24	RP-040206	2348			Clarification about measurement control system information in TDD mode	6.2.0
	RP-24	RP-040211	2350			Correction to timing-maintained hard handover regarding the UL transmission timing	6.2.0
	RP-24	RP-040236	2354	2		Selection of suitable cell	6.2.0
	RP-24	RP-040236	2356			Check of the PLMN identity in the MIB when selecting a new cell	6.2.0
	RP-24	RP-040211	2358			Compressed INTER RAT HANDOVER INFO message modifications/corrections	6.2.0
	RP-24	RP-040215	2359			The ASN.1 definition of IE "SysInfoType5bis"	6.2.0
	RP-24	RP-040224	2361			RLC size handling and RLC re-establishment	6.2.0
	RP-24	RP-040212	2363			Restrict operation of the virtual active set	6.2.0
	RP-24	RP-040213	2365			Usage of different RB mapping info	6.2.0
	RP-24	RP-040256	2367	1		Clarification on UE procedure in case of HHO failure	6.2.0

09/2004	RP-25	RP-040327	2373			TDD misalignment between tabular and ASN.1 definitions of UL Transport channel information common for all transport channels and special burst scheduling	6.3.0
	RP-25	RP-040327	2377			Definition of parameters for UE-assisted A-GPS	6.3.0
	RP-25	RP-040339	2378	2		Addition of UMTS850 (Band V) in the tabular	6.3.0
	RP-25	RP-040360	2381			Default Configurations for multiple AMR Rate Configurations	6.3.0
	RP-25	RP-040319	2384			Correction on PRACH selection in 1.28Mcps TDD	6.3.0
	RP-25	RP-040334	2386			Inconsistency in UE action for HFN initialisation	6.3.0
	RP-25	RP-040334	2388			Usage of different RB mapping info for TDD	6.3.0
	RP-25	RP-040334	2390			TDD HS-DSCH Corrections	6.3.0
	RP-25	RP-040334	2392			Alignment of Tabular Definition with ASN.1 for HS-SCCH Info	6.3.0
	RP-25	RP-040348	2394	1		Correction to HS-DSCH reception conditions	6.3.0
	RP-25	RP-040334	2396			Correction to RB mapping check	6.3.0
	RP-25	RP-040334	2398			Position Timestamp for A-GPS	6.3.0
	RP-25	RP-040334	2400			Pending compressed mode reconfigurations	6.3.0
	RP-25	RP-040335	2402			Predefined configurations for the RRC connection request	6.3.0
	RP-25	RP-040335	2404			Cell update during reconfiguration from CELL_FACH to CELL_PCH	6.3.0
	RP-25	RP-040335	2406			UE actions for Delta_ACK/NACK and repetition factor	6.3.0
	RP-25	RP-040335	2408			Calculation of UL transmit power for HS-SICH (TDD)	6.3.0
	RP-25	RP-040335	2410			Handling of Timer T302 Expiry	6.3.0
	RP-25	RP-040335	2412			Correct naming for HS-DSCH with DCH multiplexing option	6.3.0
	RP-25	RP-040335	2414			Compressed Pre-defined configurations description in new Annex C	6.3.0
	RP-25	RP-040335	2416			Integration between integrity protection and the sending of downlink messages during SRNS relocation	6.3.0
	RP-25	RP-040328	2418			Corrections to restrictions of operation of the virtual active set	6.3.0
	RP-25	RP-040336	2420			UE actions for received new keys	6.3.0
	RP-25	RP-040336	2422	1		Scrambling Code Change	6.3.0
	RP-25	RP-040328	2428			Clarifications to VAS functionality	6.3.0
	RP-25	RP-040336	2430			UE security capability in INTER_RAT handover	6.3.0
	RP-25	RP-040336	2432			Correction to the Radio Link Failure behaviour	6.3.0
12/2004	RP-26	RP-040481	2434			Correction to measured results on RACH	6.4.0
	RP-26	RP-040481	2436			T305 handling upon a state transition	6.4.0
	RP-26	RP-040481	2438			Handling of pending AM RLC unrecoverable errors signalled by cell update	6.4.0
	RP-26	RP-040476	2442			Correction to maximum length of CTCH period	6.4.0
	RP-26	RP-040481	2444			TPC step size in default configurations	6.4.0
	RP-26	RP-040474	2448			References to ITU-T Recommendations on ASN.1	6.4.0
	RP-26	RP-040477	2451			ASN.1 clarification on Measurement Report for 1.28 Mcps TDD	6.4.0
	RP-26	RP-040481	2453			Correction to HS-DSCH reception conditions	6.4.0
	RP-26	RP-040481	2455	1		MAC-hs Reset procedure	6.4.0
	RP-26	RP-040526	2457	2		Cell selection and reselection parameters	6.4.0
	RP-26	RP-040482	2459	1		Clarification the PDCP capability- Max HC context space	6.4.0
	RP-26	RP-040482	2461			Corrections to IE "WAIT TIME" = 0	6.4.0
	RP-26	RP-040482	2463	1		RRC transaction identifier in the MEASUREMENT CONTROL message	6.4.0
	RP-26	RP-040482	2465			Correction to intra-frequency measurement handling in SIB11	6.4.0
	RP-26	RP-040477	2468	1		Missing OTDOA TDD related v4b0 extension in MEASUREMENT CONTROL	6.4.0
	RP-26	RP-040482	2470	2		Clarification of Radio Bearer Downlink Ciphering Activation Time Info	6.4.0
	RP-26	RP-040520	2472	2		TFC Subset Variable Usage and Application of Transport Format Combination Subset	6.4.0
	RP-26	RP-040505	2474			Use of preconfiguration in the RADIO BEARER RECONFIGURATION message	6.4.0
	RP-26	RP-040505	2476			UTRAN setting of ciphering activation time for SRB2	6.4.0
	RP-26	RP-040505	2478			Correction to ASN1 IE "srb-SpecificIntegrityProtInfo"	6.4.0
	RP-26	RP-040522	2480	2		Criteria for initiating cell update on receiving "Frequency info" IE in CELL UPDATE CONFIRM message	6.4.0
	RP-26	RP-040505	2482			Traffic volume measurements in PCH states	6.4.0
	RP-26	RP-040505	2484			Failure cause indication on Cell Update	6.4.0
	RP-26	RP-040495	2487	1		Network Sharing and multiple PLMN identities	6.4.0
	RP-26	RP-040505	2493			Inter-RAT measurement control information used	6.4.0
	RP-26	RP-040491	2494			ASN.1 update for the introduction of MBMS	6.4.0
	RP-26	RP-040491	2495	1		Introduction of MBMS	6.4.0
	RP-26	RP-040543	2496	2		Preamble and Postamble to reduce HS-DPCCH transmit power	6.4.0

	RP-26	RP-040507	2497			Introduction of E-DCH	6.4.0
03/2005	RP-27	RP-050038	2491	2		Removal of TGPL2	6.5.0
	RP-27	RP-050069	2499			Minor HSDPA related corrections	6.5.0
	RP-27	RP-050169	2501			Integrity protection related information in the SRNS relocation info	6.5.0
	RP-27	RP-050069	2503			Number of timeslots that can be used for HS-PDSCH resource for 3.84 Mcps TDD	6.5.0
	RP-27	RP-050089	2504			HS-DSCH operation without a DL DPCH for 3.84 Mcps TDD	6.5.0
	RP-27	RP-050114	2506			Removal of unnecessary cell updates on receiving "Frequency info" IE in CELL UPDATE CONFIRM message	6.5.0
	RP-27	RP-050069	2508			ASN.1 clarification on Cell and Channel Identity info for 1.28 Mcps TDD	6.5.0
	RP-27	RP-050070	2510			Handling of TM SRB's at radio link failure	6.5.0
	RP-27	RP-050070	2513			Removal of the UARFCN uplink (Nu) in the informative Annex A.3	6.5.0
	RP-27	RP-050070	2515	1		Correction on PRACH selection	6.5.0
	RP-27	RP-050067	2517	3		Lossless DL RLC PDU size change	6.5.0
	RP-27	RP-050069	2519			Clarification of GERAN (P)SI message coding in NACC	6.5.0
	RP-27	RP-050070	2521			Unsupported RLC mode reconfigurations	6.5.0
	RP-27	RP-050070	2523			Correction to Inter RAT cell info indication	6.5.0
	RP-27	RP-050086	2524			Correction to network sharing functionality	6.5.0
	RP-27	RP-050086	2525			Network sharing corrections	6.5.0
	RP-27	RP-050110	2526	1		CN domain specific Access Class Barring	6.5.0
	RP-27	RP-050081	2527			Corrections to "selected PLMN" in access stratum	6.5.0
	RP-27	RP-050074	2528			Introduction of F-DPCH	6.5.0
	RP-27	RP-050084	2529			Minor E-DCH related corrections	6.5.0
	RP-27	RP-050079	2530	2		Miscellaneous MBMS corrections	6.5.0
	RP-27	RP-050087	2532			Additional Frequency Bands	6.5.0
	RP-27	RP-050084	2534			Introduction of E-DCH in the ASN.1	6.5.0
	RP-27	RP-050097	2535			Improvements to uplink closed loop power control for 1.28 Mcps TDD	6.5.0
	RP-27	RP-050079	2536	1		MBMS Corrections to 25.331 ASN.1	6.5.0
	RP-27	RP-050128	2538	1		Correction to cell selection and reselection parameters to enable enhanced cell reselection	6.5.0
06/2005	RP-28	RP-050253	2539	3		Faster L1 DCH synchronization	6.6.0
	RP-28	RP-050339	2540	3		Timing maintained hard handover	6.6.0
	RP-28	RP-050320	2541	1		Removal of unnecessary Start values	6.6.0
	RP-28	RP-050329	2542			Merged CR alignment w.r.t. network sharing functionality	6.6.0
	RP-28	RP-050302	2545			Timing Reinitialized Handover & Radio Link Timing Adjustmen	6.6.0
	RP-28	RP-050302	2547			Addition of omitted IE "report criteria" in MEASUREMENT CONTROL message "modify" command	6.6.0
	RP-28	RP-050316	2548	2		Miscellaneous MBMS corrections (set II)	6.6.0
	RP-28	RP-050316	2549	1		Correction to MBMS notification procedure	6.6.0
	RP-28	RP-050316	2550	1		FACH Measurement Occasion when UE receives MBMS	6.6.0
	RP-28	RP-050316	2551			Frequency layer dispersion	6.6.0
	RP-28	RP-050303	2553	2		Signalling of target mode for ROHC operation	6.6.0
	RP-28	RP-050320	2554	2		Introduction of inter-frequency RACH measurement reporting	6.6.0
	RP-28	RP-050324	2555			Closed-Loop Power Control Improvements for 1.28 Mcps TDD – ASN1 Corrections	6.6.0
	RP-28	RP-050322	2556			Release 6 HS-DSCH operation without a DL DPCH for 3.84 Mcps TDD – Setting of Dhs-sync	6.6.0
	RP-28	RP-050320	2557	1		Correction to the Amount of Reporting	6.6.0
	RP-28	RP-050320	2558			Measurement report message definition when Inter-RAT cell info indication is used	6.6.0
	RP-28	RP-050320	2559			Direct transition to DCH	6.6.0
	RP-28	RP-050316	2560	1		Addition of the number of MBMS Neighbour Cell PTM Information messages to the MBMS Modified Services Information message	6.6.0
	RP-28	RP-050316	2561	1		Addition of MBMS counting for UEs in Cell_PCH and Cell_FACH states and addition of UE requested p-t-p bearer establishment	6.6.0
	RP-28	RP-050320	2562			Introduction of IE "RB information to reconfigure" in RB SETUP, RB RELEASE messages	6.6.0
	RP-28	RP-050320	2564			Including HS-DSCH serving cell change in ASU	6.6.0
	RP-28	RP-050320	2566	1		Detection of Activation CFN wraparound in the UE during HS-DSCH cell change	6.6.0
	RP-28	RP-050304	2568			Correction to handling of keys at inter-RAT handover	6.6.0
	RP-28	RP-050302	2572			CTFC calculation for DCH	6.6.0
	RP-28	RP-050302	2574			Default RB identity in IE 'Signalling RB information to setup	6.6.0
	RP-28	RP-050302	2576			Default configuration 13	6.6.0

	RP-28	RP-050320	2577			UE L3 requirements for HS-DSCH mobility	6.6.0
	RP-28	RP-050374	2579	3		Support for out-of-sequence PDUs in RLC-UM	6.6.0
	RP-28	RP-050305	2581			Feature Clean Up: Removal of 80 ms TTI for DCH for all other cases but when the UE supports SF512	6.6.0
	RP-28	RP-050306	2583			Feature Clean Up: Removal of observed time difference to GSM cell	6.6.0
	RP-28	RP-050307	2585			Feature Clean Up: Removal of SSDT	6.6.0
	RP-28	RP-050308	2586			Feature Clean-up: Removal of DSCH (FDD)	6.6.0
	RP-28	RP-050309	2589			Feature Clean Up: Removal of CPCH	6.6.0
	RP-28	RP-050310	2591			Feature Clean Up: Removal of dedicated pilot as sole phase reference	6.6.0
	RP-28	RP-050311	2593			Feature Clean Up: Removal of DRAC	6.6.0
	RP-28	RP-050312	2595			Feature Clean Up: Removal of TX diversity closed loop mode 2	6.6.0
	RP-28	RP-050313	2597			Feature Clean Up: Removal of Compressed mode by puncturing	6.6.0
	RP-28	RP-050327	2598	2		Alignment of EUDCH RRC Stage-3 to Stage-2 status, including handling of 2 E-RNTIs	6.6.0
	RP-28	RP-050336	2599			Radio link failure in F-DPCH	6.6.0
	RP-28	RP-050323	2600	1		Setting up F-DPCH and E-DCH in RRC connection setup	6.6.0
	RP-28	RP-050316	2601	1		Validity of PtM configurations	6.6.0
	RP-28	RP-050392	2602	1		CCCH message enhancements	6.6.0
	RP-28	RP-050320	2604			Quality measurement corrections	6.6.0
	RP-28	RP-050328	2605			Clean-up of R6 ASN.1 leftovers	6.6.0
	RP-28	RP-050346	2607	2		UE behaviour for DCH SIR target setting for Downlink power control	6.6.0
	RP-28	RP-050317	2608			RLC LI Optimization for VoIP	6.6.0
	RP-28	RP-050316	2609	2		Introduction of an S-CCPCH power offset difference in order to improve cell selection for soft and selective combining	6.6.0
	RP-28	RP-050320	2610			Erroneous implementation of CR#2501 in RRC specification v6.5.0.	6.6.0
	RP-28	RP-050329	2611			Correction to network sharing	6.6.0
	RP-28	RP-050316	2613			MBMS asn1 issues	6.6.0
	RP-28	RP-050316	2614			SCCPCH timing offset information for FDD MBMS soft combining	6.6.0
	RP-28	RP-050316	2615			MBMS corrections on signalling optimization	6.6.0
09/2005	RP-29	RP-050486	2616			Support of Domain Specific Access control in Rel-5 Ues	6.7.0
	RP-29	RP-050465	2619			ASN1 update for InterRATReportingQuantity	6.7.0
	RP-29	RP-050465	2621	1		IE "RB information to reconfigure" for RADIO BEARER RECONFIGURATION message	6.7.0
	RP-29	RP-050465	2623			Size of TFC Subset List for Transport Format Combination Control	6.7.0
	RP-29	RP-050465	2626			RB mapping rules	6.7.0
	RP-29	RP-050587	2628	3		Rules for triggering hard handover	6.7.0
	RP-29	RP-050465	2630			RSCP value range extension	6.7.0
	RP-29	RP-050465	2632			H-RNTI validity	6.7.0
	RP-29	RP-050482	2633			Removal RLC-SDU alignment capability	6.7.0
	RP-29	RP-050458	2635	2		Feature Clean Up: Removal of DRAC	6.7.0
	RP-29	RP-050458	2637			DRAC & Dedicated pilots removal leftovers (asn1)	6.7.0
	RP-29	RP-050458	2639			DRAC & CPCH removal leftovers (sib8,9,10)	6.7.0
	RP-29	RP-050458	2641	1		Feature remove (Tabular/asn1 alignment)	6.7.0
	RP-29	RP-050482	2642			Correction to UE L3 requirements for HS-DSCH mobility	6.7.0
	RP-29	RP-050482	2643			Rate Control Correction	6.7.0
	RP-29	RP-050482	2644			Introduction of container to facilitate transparent transfer of UE capabilities	6.7.0
	RP-29	RP-050482	2645			Minor ASN.1 correction for TDD IEs Beacon PL Est and DHS-Sync	6.7.0
	RP-29	RP-050482	2646			Addition of ongoing reconfiguration indicator in cell update	6.7.0
	RP-29	RP-050482	2648			Faster L1 DCH synchronization	6.7.0
	RP-29	RP-050482	2649			Direct transition to DCH	6.7.0
	RP-29	RP-050482	2650			PSI messages in CELL CHANGE ORDER FROM UTRAN	6.7.0
	RP-29	RP-050482	2651			SRNS relocation info	6.7.0
	RP-29	RP-050482	2652			Correction to UE-assisted OTDOA support	6.7.0
	RP-29	RP-050482	2653			Correction to undefined UE behaviour in case of Cell-ID positioning with method type UE-based	6.7.0
	RP-29	RP-050482	2654			Receiving "Frequency info" IE in CELL UPDATE CONFIRM message	6.7.0
	RP-29	RP-050483	2655			Re-entry in service in CELL_PCH before T316 expiry	6.7.0
	RP-29	RP-050483	2656			ASN.1 alignment to Rel-5 of InterRATCellInfoIndication	6.7.0
	RP-29	RP-050483	2657			Addition of Inter-frequency measurements reporting on RACH reporting in the ASN.1 of RRC CONNECTION REQUEST and CELL UPDATE messages	6.7.0
	RP-29	RP-050483	2658			Correction to the Amount of Reporting	6.7.0

	RP-29	RP-050483	2659		Minor correction of HS-DSCH/ E-DCH capability indication	6.7.0
	RP-29	RP-050476	2660		Modification of TPC command error rate granularity and range	6.7.0
	RP-29	RP-050473	2661	1	Introduction of PS handover between UTRAN and GERAN	6.7.0
	RP-29	RP-050483	2662		Including HS-DPCCH power offset and HARQ preamble mode in active set update	6.7.0
	RP-29	RP-050468	2663		Minor MBMS corrections (set IV)	6.7.0
	RP-29	RP-050468	2664		Clarification on MBMS modified services information IE	6.7.0
	RP-29	RP-050468	2665		MBMS correction for recounting	6.7.0
	RP-29	RP-050468	2666	1	MBMS asn1 issues	6.7.0
	RP-29	RP-050471	2667		E-DCH corrections and additions	6.7.0
	RP-29	RP-050471	2668		E-DCH corrections	6.7.0
	RP-29	RP-050472	2669	4	E-DCH additions to active set update	6.7.0
	RP-29	RP-050471	2670	1	UE capabilities for E-DCH in 25.331	6.7.0
	RP-29	RP-050468	2671		Conditional suspension of CELL_FACH measurements to enable reception of MCCH	6.7.0
	RP-29	RP-050468	2672		MBMS message order on MCCH	6.7.0
	RP-29	RP-050468	2673		MSCH configuration information in case of soft combining Timing Offset	6.7.0
	RP-29	RP-050469	2674	1	Removal of fixed position for S-CCPCHs carrying MBMS channels	6.7.0
	RP-29	RP-050467	2675		Introduction of Band VII	6.7.0
	RP-29	RP-050483	2676		Introducing pre- configuration upon radio bearer establishment	6.7.0
	RP-29	RP-050484	2677	1	Introduction of the device type indication in UE capability	6.7.0
	RP-29	RP-050471	2680		E-DCH TTI Reconfiguration	6.7.0
	RP-29	RP-050483	2681		Maximum number of reference ETFCI's	6.7.0
	RP-29	RP-050561	2682		F-DPCH power control	6.7.0
12/2005	RP-30	RP-050801	2617	2	Introduction of UMTS1700	6.8.0
	RP-30	RP-050787	2683	4	Introduction of the HSDPA and E-DCH Capable Cell Indicator	6.8.0
	RP-30	RP-050785	2685	1	PRACH for CCCH in SIB 6	6.8.0
	RP-30	RP-050796	2686	1	Tx/Rx frequency separation capability (FDD)	6.8.0
	RP-30	RP-050827	2687	1	E-DCH mobility corrections and multi-step handling for E-RGCH	6.8.0
	RP-30	RP-050797	2688	1	L1 synchronisation at HHO	6.8.0
	RP-30	RP-050786	2690		Correction to UE positioning measurements in CELL_PCH/URA_PCH state	6.8.0
	RP-30	RP-050785	2692		Clarification of Delta in Inter/Intra-frequency measurement reporting criteria	6.8.0
	RP-30	RP-050785	2694		Clarification of the usage of "Ack-Nack Power Offset" in HSDPA for TDD	6.8.0
	RP-30	RP-050785	2696		Modification of WB-AMR default configuration	6.8.0
	RP-30	RP-050785	2698		Serving E-DCH radio link indication	6.8.0
	RP-30	RP-050800	2699		Introduction of UMTS 900 (Band VIII)	6.8.0
	RP-30	RP-050788	2700		MCCH configuration information	6.8.0
	RP-30	RP-050788	2701		Correction of default TFCS for MBMS	6.8.0
	RP-30	RP-050797	2702		Unidirectional RLC reconfiguration	6.8.0
	RP-30	RP-050793	2703	1	Misalignments for E-DCH	6.8.0
	RP-30	RP-050793	2704		Update for E-DCH Serving Grant IE value range	6.8.0
	RP-30	RP-050793	2705		Clarification on MAC-d flow multiplexing list	6.8.0
	RP-30	RP-050793	2706		Addition of E-DCH power offsets to active set update	6.8.0
	RP-30	RP-050793	2707		E-RNTI validity	6.8.0
	RP-30	RP-050793	2708		Clarification of bit strings for EUL	6.8.0
	RP-30	RP-050793	2709	1	Modification of SI periodicity	6.8.0
	RP-30	RP-050793	2710		E-DCH PO signalling	6.8.0
	RP-30	RP-050793	2711	1	MAC es/e reset indicator	6.8.0
	RP-30	RP-050788	2714	1	MBMS corrections on default TFCS, service identity and PL Service Information	6.8.0
	RP-30	RP-050831	2717	1	Corrections of inconsistencies in Rel-6 RRC messages (ASN.1 review)	6.8.0
	RP-30	RP-050861	2718	1	Introduction of Support of Handover to GAN	6.8.0
03/2006	RP-31	RP-060087	2716	5	E-DCH Measurement Event 1J	6.9.0
	RP-31	RP-060083	2720	-	Default configuration 11 for multirate AMR with SRB5	6.9.0
	RP-31	RP-060081	2722	1	Addition of synchronization parameters in RRC for HS-SICH in 1.28Mcps TDD	6.9.0
	RP-31	RP-060091	2723	-	Integrity Protection check for NAS messages	6.9.0
	RP-31	RP-060087	2724	-	E-DCH radio link addition using ASU of RL already in DCH active set	6.9.0
	RP-31	RP-060087	2725	-	Addition of SF128 and SF256 in E-DCH maximum channelisation codes	6.9.0
	RP-31	RP-060087	2726	2	RRC signaling efficiency changes for E-DCH	6.9.0

	RP-31	RP-060087	2727	-	E-DCH HARQ Info signalling	6.9.0
	RP-31	RP-060087	2728	-	Secondary Scrambling Code in F-DPCH RL information	6.9.0
	RP-31	RP-060087	2729	-	Correction to E-DCH IEs	6.9.0
	RP-31	RP-060087	2730	-	Non-scheduled grant	6.9.0
	RP-31	RP-060087	2731	-	IE handling for E-DCH	6.9.0
	RP-31	RP-060087	2732	-	E-RNTI handling in Active Set Update procedure	6.9.0
	RP-31	RP-060087	2733	-	Editorial correction on "E-DCH information"	6.9.0
	RP-31	RP-060120	2734	1	Corrections of inconsistencies in Rel-6 RRC messages (ASN.1 review)	6.9.0
	RP-31	RP-060091	2735	-	Correction to Modifying Integrity Protection Configuration for TM SRB	6.9.0
	RP-31	RP-060091	2736	-	Correction to Security Mode Control Procedure	6.9.0
	RP-31	RP-060091	2737	-	Resolving problems from CR implementation	6.9.0
	RP-31	RP-060093	2738	-	Removal of GPRS encryption algorithm info	6.9.0
	RP-31	RP-060092	2739	1	Default configurations for Multi-mode AMR	6.9.0
	RP-31	RP-060091	2740	-	Periodic URA Update in OOS	6.9.0
	RP-31	RP-060091	2741	-	Correction in IE UE positioning capability	6.9.0
	RP-31	RP-060091	2742	-	F-DPCH, HSDPA and E-DCH in HANDOVER TO UTRAN COMMAND (Rel-6 ASN.1 review issue 013)	6.9.0
	RP-31	RP-060091	2743	-	Representation of IE "latestConfiguredCN-Domain" in the r3 branch of SRNS Relocation Info	6.9.0
	RP-31	RP-060083	2746	1	7.95kbps NB AMR Default Configuration removal	6.9.0
	RP-31	RP-060091	2747	-	Periodic BMC Schedule Message	6.9.0
	RP-31	RP-060092	2748	1	Introduction of additional Default configuration identities	6.9.0
	RP-31	RP-060095	2749	1	PS default configurations	6.9.0
	RP-31	RP-060091	2751	-	Configuration of DL TFCS as 'Same as UL'	6.9.0
	RP-31	RP-060091	2752	-	NAS synchronization indicator in RB setup	6.9.0
	RP-31	RP-060088	2753	-	General error handling in case of ASN.1 violation and for MBMS channels	6.9.0
	RP-31	RP-060091	2754	-	Clarification of UE action upon receiving the IE RB information to change list	6.9.0
	RP-31	RP-060091	2755	-	Removal of unnecessary checking for HS-DSCH and E-DCH configuration	6.9.0
	RP-31	RP-060091	2756	-	Introduction of WB-AMR default configuration without SRB#5	6.9.0
	RP-31	RP-060091	2757	-	Initial DPCH frame offset for F-DPCH	6.9.0
	RP-31	RP-060086	2760	1	Support for different E-DCH and HS-DSCH serving cells	6.9.0
	RP-31	RP-060088	2761	-	Correction to S-CCPCH power offset for MBMS	6.9.0
	RP-31	RP-060093	2764	-	Inter-RAT PS Handover capability	6.9.0
	RP-31	RP-060095	2765	-	Indication of HSPA capability and conversation call type for CS	6.9.0
	RP-31	RP-060097	2713	3	Enabling the Providing of Velocity	7.0.0
	RP-31	RP-060096	2758		Release 7 HS-DSCH operation without a DL DPCH for 1.28 Mcps TDD – synchronisation and power control of UL DPCH via PLCCH	7.0.0
	RP-31	RP-060098	2759		7.68 Mcps TDD Option (Release 7)	7.0.0
	RP-31	RP-060099	2762		Introduction of REL-7 access stratum release indicator	7.0.0
06/2006	RP-32	RP-060374	2769	1	RoHC Segmentation, padding and Packet_sizes_allowed parameter removal	7.1.0
	RP-32	RP-060360	2772	1	Corrections of procedures dealing with "Serving HS-DSCH radio link indicator" and "Serving E-DCH radio link indicator"	7.1.0
	RP-32	RP-060361	2774	1	MAC-HS handling for "return in case of failure"	7.1.0
	RP-32	RP-060383	2776	1	"RB" terminology in security procedures	7.1.0
	RP-32	RP-060368	2778	-	Clarification on IE "MBMS re-acquire MCCH"	7.1.0
	RP-32	RP-060368	2780	-	Clarification on MCCH Acquisition Initiation	7.1.0
	RP-32	RP-060368	2782	-	Clarification of encoding of TB size for FDD common transport channels	7.1.0
	RP-32	RP-060368	2784	-	HCS parameters for MBMS cell reselection	7.1.0
	RP-32	RP-060354	2786	-	Clarification on MAC-e/es reset	7.1.0
	RP-32	RP-060361	2788	-	Modification to the "BLER target" configuration method in RRC spec for 3.84Mcps TDD	7.1.0
	RP-32	RP-060361	2790	-	Add some IEs regarding HS-SICH power control parameter updating in UPLINK PHYSICAL CHANNEL CONTROL message in 1.28Mcps TDD mode	7.1.0
	RP-32	RP-060364	2792	-	Corrections on Inter-RAT cell info indication	7.1.0
	RP-32	RP-060364	2794	-	Clarifications regarding virtual active set	7.1.0
	RP-32	RP-060358	2796	-	PS Handover Capability	7.1.0
	RP-32	RP-060364	2798	-	Handling of System Information Block type 5bis.	7.1.0
	RP-32	RP-060364	2800	-	Introducing container for Measurement Report informaton within SRNS relocation	7.1.0
	RP-32	RP-060364	2802	-	Removal of GSM OTD reference cell	7.1.0

	RP-32	RP-060364	2804	-		Error handling of 'dummy' IEs introduced in ASN.1 by recent feature removal	7.1.0
	RP-32	RP-060365	2806	-		START value in Cell Update	7.1.0
	RP-32	RP-060365	2808	-		Default configurations 10 and 13	7.1.0
	RP-32	RP-060365	2810	-		Inter-frequency measurement reporting on RACH	7.1.0
	RP-32	RP-060365	2812	-		Radio bearer mapping for SRBs	7.1.0
	RP-32	RP-060365	2814	-		Correction to RLC default configuration	7.1.0
	RP-32	RP-060366	2816	-		New standalone SRB default configuration	7.1.0
	RP-32	RP-060366	2818	-		Introduction of default configurations with 'flexible TFCS'	7.1.0
	RP-32	RP-060366	2820	-		Small IE corrections: "RB information to change list", "Access Class Barred"	7.1.0
	RP-32	RP-060366	2822	-		Correction to IE Default Configuration Identity	7.1.0
	RP-32	RP-060366	2824	-		Correction to TFC subset for default configurations 11&12	7.1.0
	RP-32	RP-060366	2826	-		HSDPA/E-DCH info in INTER RAT HANDOVER INFO WITH INTER RAT CAPABILITIES	7.1.0
	RP-32	RP-060373	2827	1		Adding CS Call Type to Cell Update Message	7.1.0
	RP-32	RP-060359	2829	-		Correct indication of Rel-7 tabular entries	7.1.0
	RP-32	RP-060359	2830	-		Corrections to REL-7 ASN.1	7.1.0
	RP-32	RP-060362	2831	-		Measurement control ASN.1 error	7.1.0
	RP-32	RP-060368	2833	-		Clarification on MBMS Radio Bearer Release	7.1.0
	RP-32	RP-060354	2835	-		Correction on E-DCH DL Scrambling Code	7.1.0
	RP-32	RP-060366	2837	-		Reinstatement of missing IE "Periodical reporting information-1b" in ASN.1	7.1.0
	RP-32	RP-060366	2839	-		SRB2 suspension	7.1.0
	RP-32	RP-060369	2842	-		Release 7 Timing Advance (3.84 Mcps and 7.68 Mcps TDD)	7.1.0
	RP-32	RP-060369	2843	-		Introduction of REL-7 access stratum release indicator	7.1.0
	RP-32	RP-060369	2844	-		Positioning velocity ASN.1	7.1.0
	RP-32	RP-060386	2845	1		Correction of positioning confidence reporting inconsistencies	7.1.0
09/2006	RP-33	RP-060573	2848	-		Removal of CID indication in PDCP PID	7.2.0
	RP-33	RP-060574	2852	-		Correction to the tabulars for Serving Grant value	7.2.0
	RP-33	RP-060575	2854	-		Range of the encoding of E-DCH physical layer category and HS-DSCH physical layer category	7.2.0
	RP-33	RP-060574	2856	-		3-index step 2-index step clarifications	7.2.0
	RP-33	RP-060597	2858	2		Introduction of SIB 11bis	7.2.0
	RP-33	RP-060581	2859	-		Power class for UMTS2600 (VII) internal / 900 (VIII)	7.2.0
	RP-33	RP-060576	2861	-		Corrections to MBMS Downlink Timeslots and Codes for TDD	7.2.0
	RP-33	RP-060576	2865	-		Clarification on MBMS notification for UEs in CELL_DCH state	7.2.0
	RP-33	RP-060576	2867	-		Clarification on MBMS p-t-m activation time IE	7.2.0
	RP-33	RP-060576	2869	-		Access probability factor	7.2.0
	RP-33	RP-060575	2871	-		Modification to the HS-SCCH set configuration method in RRC spec for 1.28Mcps TDD	7.2.0
	RP-33	RP-060575	2873	-		Correction to tabular for IE "Delay restriction Flag"	7.2.0
	RP-33	RP-060575	2877	-		Correition on 3G-2G Handover	7.2.0
	RP-33	RP-060575	2879	-		Pending security configuration for SRB2	7.2.0
	RP-33	RP-060593	2881	-		UE radio access capability for Single-band UE	7.2.0
	RP-33	RP-060593	2883	-		Inter-RAT handover to UTRAN (HSPA)	7.2.0
	RP-33	RP-060593	2885	-		Tabular & reference corrections	7.2.0
	RP-33	RP-060593	2887	-		F-DPCH Tx Diversity	7.2.0
	RP-33	RP-060593	2889	1		Expiration of RRC timer T314/T315 associated to CS/PS RABs	7.2.0
	RP-33	RP-060583	2892	-		Clarification on Exceeding Variance in Traffic Volume Measurement	7.2.0
	RP-33	RP-060573	2897	1		Use of CM_PATTERN_ACTIVATION_ABORTED	7.2.0
	RP-33	RP-060573	2900	1		Corrections of procedures dealing with Hard Handover	7.2.0
	RP-33	RP-060585	2901	-		Correction to spreading factors used for 7.68 Mcps TDD PRACH	7.2.0
	RP-33	RP-060583	2902	-		Corrections to ASN.1 (3.84 Mcps and 7.68 Mcps TDD)	7.2.0
	RP-33	RP-060586	2903	-		Introduction of 3.84 Mcps and 7.68 Mcps TDD E-DCH	7.2.0
	RP-33	RP-060582	2904	-		Support of 2570 – 2620 MHz band for TDD	7.2.0
	RP-33	RP-060593	2907	-		ASN1 correction on Inter-frequency RACH measurement reporting, backward compatible solution	7.2.0
	RP-33	RP-060584	2908	-		CS Call type indication in CELL_FACH	7.2.0
	RP-33	RP-060584	2910	1		UE behaviour in RRC Connection Re-establishment scenarios	7.2.0
	RP-33	RP-060624	2911	2		Enhancing MBMS support for Mobile TV	7.2.0
	RP-33	RP-060574	2913	-		E-DCH gain factor computation	7.2.0
	RP-33	RP-060593	2915	-		Correction to default configuration #22	7.2.0

	RP-33	RP-060622	2917			Correction to coding of PLCCCH for 1.28Mcps TDD	7.2.0
	RP-33	RP-060578	2919			MAC-hs reset	7.2.0
12/2006	RP-34	RP-060722	2916	2		UE based OTDOA positioning in WCDMA cells with extended range	7.3.0
	RP-34	RP-060717	2922	1		Correction on acceptable configurations for compression entities	7.3.0
	RP-34	RP-060715	2923	-		Introduction of Band X (Extended UMTS 1.7/2.1 GHz) in 25.331	7.3.0
	RP-34	RP-060716	2925	-		Grant and MAC-e/es headers for E-DCH and References	7.3.0
	RP-34	RP-060804	2927	2		Correction to E-DCH reconfiguration	7.3.0
	RP-34	RP-060718	2931	-		Removal of MSCH configuration information from S-CCPCH system information	7.3.0
	RP-34	RP-060718	2933	-		Correction relating to the formation of a list of services	7.3.0
	RP-34	RP-060718	2935	-		Indentation error in handling MBMS establishment cause values	7.3.0
	RP-34	RP-060718	2936	-		MSCH configuration information	7.3.0
	RP-34	RP-060719	2938	-		Tabular/ASN.1 mismatch for IE "UE radio access capability comp 2"	7.3.0
	RP-34	RP-060716	2940	-		Correction to Radio Bearer Mapping for UE in CELL_DCH state	7.3.0
	RP-34	RP-060726	2941	1		State transition diagram from URA_PCH/Cell_PCH to idle	7.3.0
	RP-34	RP-060719	2943	-		Usage of Band Indicator in Inter-RAT cell info list	7.3.0
	RP-34	RP-060716	2945	-		Correction for support of HS-DSCH in RRC Connection Setup	7.3.0
	RP-34	RP-060720	2947	-		Corrections related to 3.84 and 7.68 Mcps TDD E-DCH and the support of TDD at 2.6 GHz	7.3.0
	RP-34	RP-060712	2948	1		Introduction of the UE speed information at the CELL_DCH transition	7.3.0
	RP-34	RP-060713	2949	2		Introduction of the new security algorithms UEA2 and UIA2.	7.3.0
	RP-34	RP-060718	2951	-		RAB ID for mobile TV	7.3.0
	RP-34	RP-060718	2953	-		MBMS PL Service Restriction Information and preferred frequency layer	7.3.0
	RP-34	RP-060724	2954	2		Introduction of inter-RAT DTM Handover	7.3.0
	RP-34	RP-060718	2956	-		MBMS short transmission ID and Mobile TV	7.3.0
03/2007	RP-35	RP-070159	2957	2		Deferred SIB11/12 reading and acting	7.4.0
	RP-35	RP-070159	2958	-		UE Positioning Fine Time Assistance for GPS	7.4.0
	RP-35	RP-070159	2959	-		Correction of "Threshold SFN-GPS TOW"	7.4.0
	RP-35	RP-070159	2960	1		Correction to standalone UE positioning	7.4.0
	RP-35	RP-070159	2961	-		Clarification on introduction of the new security algorithms	7.4.0
	RP-35	RP-070159	2962	-		Change to area scope of SIB1 value tag	7.4.0
	RP-35	RP-070159	2963	-		Correction of the tabular description of the IE Downlink information for each radio link Post	7.4.0
	RP-35	RP-070159	2964	-		Removal of redundant ASN1 element DL-CCTrChTPCList	7.4.0
	RP-35	RP-070151	2966	-		Correction of MBMS MODIFICATION REQUEST	7.4.0
	RP-35	RP-070151	2968	-		Wording of MBMS PL Service Restriction Information and preferred frequency layer	7.4.0
	RP-35	RP-070151	2970	-		maxMBMS-Services definition	7.4.0
	RP-35	RP-070151	2972	1		MBMS selected services indication	7.4.0
	RP-35	RP-070151	2973	1		Correction of RAB release procedure for Mobile TV	7.4.0
	RP-35	RP-070153	2975	-		Tabular Alignment for Uplink DPCH Info	7.4.0
	RP-35	RP-070151	2977	1		Update the IE" RAB information to reconfigure" for Mobile TV	7.4.0
	RP-35	RP-070154	2979	-		Absence of MS Classmark 2 and 3 in IE "Inter-RAT UE radio access capability"	7.4.0
	RP-35	RP-070153	2981	-		Handling of TFCS with no DCH configured	7.4.0
	RP-35	RP-070163	2983	1		Introducing 64QAM downlink support	7.4.0
	RP-35	RP-070157	2984	-		Introduction of 1.28 Mcps TDD E-DCH	7.4.0
	RP-35	RP-070161	2985	1		Introducing MIMO in RRC specification	7.4.0
	RP-35	RP-070172	2986	-		Alignment of Tabular with ASN.1	7.4.0
	RP-35	RP-070160	2987	-		Corrections to Tabular for 3.84 and 7.68 McpsTDD E-DCH	7.4.0
	RP-35	RP-070151	2989	1		MICH reception for services scheduled with MSCH	7.4.0
	RP-35	RP-070158	2990	-		Introduction of DTX-DRX and HS-SCCH less in RRC	7.4.0
06/2007	RP-36	RP-070402	2982	6		Introducing 16QAM uplink support	7.5.0
	RP-36	RP-070407	2992			Use of Integrity protection algorithm UIA/2: removal of a 'shall' in a note	7.5.0
	RP-36	RP-070407	2993			RRC Cellid encoding alignment on RANAP	7.5.0
	RP-36	RP-070407	2994			Signalling connection release at T314/315 expiry	7.5.0
	RP-36	RP-070408	2995			Cell Update Confirm with RLC re-establish indicator	7.5.0
	RP-36	RP-070408	2996			Correction of STTD Indicator for F-DPCH Tx Diversity	7.5.0
	RP-36	RP-070395	2997			Introduction of GAN PS handover	7.5.0
	RP-36	RP-070408	2998			Feature Clean Up leftover: Removal of DRAC leftover	7.5.0
	RP-36	RP-070408	2999			Initialisation of CFN calculation for CELL_FACH	7.5.0
	RP-36	RP-070408	3000			PLMN selection ping-pong control	7.5.0

	RP-36	RP-070408	3001			Optimization of switching between MBMS broadcast TV channels transmitted on ptp bearers (MBMS for Mobile TV)	7.5.0
	RP-36	RP-070408	3002			Alignment of tabular for ASN.1 for SIB11/SIB12 and event 1J	7.5.0
	RP-36	RP-070403	3003	2		Introduction of HS-DSCH reception in CELL_FACH, URA_PCH and CELL_PCH	7.5.0
	RP-36	RP-070408	3004	1		Introduction two DRX schemes in URA_PCH and CELL_PCH	7.5.0
	RP-36	RP-070416	3008			Maintenance of PMM connection for MBMS PTP reception	7.5.0
	RP-36	RP-070401	3010			Content of MSI message when sent on DCCH	7.5.0
	RP-36	RP-070401	3012			Relative ordering of MBMS Selected Services when indicated to the network	7.5.0
	RP-36	RP-070416	3013			Background scan during MBMS PTM reception	7.5.0
	RP-36	RP-070401	3015			Default MBMS activation time and 'MBMS all unmodified p-t-m services'	7.5.0
	RP-36	RP-070401	3017			Problem with the IE 'MBMS service identity' included in the IE 'RAB info'	7.5.0
	RP-36	RP-070406	3019			Correction of SRB delay	7.5.0
	RP-36	RP-070406	3021			Incorrect reference to 25.993 for default configuration 17	7.5.0
	RP-36	RP-070416	3022			Removal of redundant IE 'MBMS-PreferredFreqRequest-r6'	7.5.0
	RP-36	RP-070406	3024			Correction to CTFC for default configuration 12	7.5.0
	RP-36	RP-070404	3025	1		Introduction of Improved L2 support for high data rates	7.5.0
	RP-36	RP-070400	3026			MBMS TDD and FDD Physical Layer Improvements	7.5.0
	RP-36	RP-070408	3027			Introduction of Wait time to Cell Update Confirm	7.5.0
	RP-36	RP-070415	3028			Removing the limitation of SRNC identity size	7.5.0
	RP-36	RP-070408	3029			Using special value of HE field to indicate end of an SDU for RLC AM	7.5.0
	RP-36	RP-070408	3030	1		T305 timer in RRC container at SRNS relocation	7.5.0
	RP-36	RP-070408	3031			Support for signalling of F-DPCH slot formats	7.5.0
	RP-36	RP-070398	3032	1		A-GNSS in UTRAN (RRC)	7.5.0
	RP-36	RP-070397	3034			Addition of E-DCH Scheduling Information Power Offset in TDD mode	7.5.0
	RP-36	RP-070397	3035	1		Corrections to tabular for non-scheduled transmission for LCR TDD	7.5.0
	RP-36	RP-070397	3036			Introduction of PRACH configuration in messages triggering E-DCH serving cell change in LCR TDD mode	7.5.0
	RP-36	RP-070417	3037			Correction to definition of maxNumE-AGCH for TDD	7.5.0
	RP-36	RP-070394	3038			Correction to definition of Power Resource Related Information (TDD only)	7.5.0
	RP-36	RP-070401	3039			MBMS Scheduling Information	7.5.0
	RP-36	RP-070401	3040			MBMS Notification	7.5.0
	RP-36	RP-070401	3041			Minor correction on text	7.5.0
	RP-36	RP-070504	3043	2		Indication for F-DPCH support status	7.5.0
09/2007	RP-37	RP-070623	3047	1		Correction to E-DCH STTD operation	7.6.0
	RP-37	RP-070625	3048	1		Requirement on MICH reading	7.6.0
	RP-37	RP-070624	3050			START values in cell update before security is enabled	7.6.0
	RP-37	RP-070671	3053	1		Clarification on Enhanced CELL_FACH State	7.6.0
	RP-37	RP-070671	3054			Correction of UTRAN MOBILITY INFORMATION extension	7.6.0
	RP-37	RP-070626	3055	1		Lossless reconfiguration between fixed and flexible RLC PDU size	7.6.0
	RP-37	RP-070630	3056			Restriction on the number of MIMO processes	7.6.0
	RP-37	RP-070670	3057			Correction on 16 QAM Category	7.6.0
	RP-37	RP-070632	3058	1		Correction to MBSFN TDM	7.6.0
	RP-37	RP-070631	3059			Corrections to Tabular (alignment with ASN.1)	7.6.0
	RP-37	RP-070631	3060			CR implementation issues 25.331 v7.4.0 (2007-03)	7.6.0
	RP-37	RP-070636	3061			Incomplete exception description in UE-based OTDOA	7.6.0
	RP-37	RP-070636	3062			Correction of inconsistency in 25.331 related to UE-sending of capabilities	7.6.0
	RP-37	RP-070625	3064	1		MBMS Counting completion in RRC	7.6.0
	RP-37	RP-070625	3066	1		MBMS ptp service change	7.6.0
	RP-37	RP-070623	3068	1		Clarification on logical channel multiplexing	7.6.0
	RP-37	RP-070625	3072			Integrity Protection and MBMS: Correction to Procedural Text (alignment with ASN.1)	7.6.0
	RP-37	RP-070625	3074			MBMS services naming	7.6.0
	RP-37	RP-070671	3077			Removal of RRC padding on BCCH and PCCH carried on HS-DSCH	7.6.0
	RP-37	RP-070671	3078			Periodic MAC-ehs reset	7.6.0
	RP-37	RP-070671	3079			Correction to UE behavior to disable HS-DSCH operation when HS-DSCH reception is unavailable	7.6.0
	RP-37	RP-070671	3080			Cell reselection issues during RRC connection establishment procedure	7.6.0
	RP-37	RP-070671	3081			Additional cases of MAC-ehs reset for UEs operating in Enhanced CELL_FACH	7.6.0
	RP-37	RP-070634	3082	2		UE Capabilities for Rel-7, with 'improved L2' optional	7.6.0
	RP-37	RP-070627	3083			Correction to CPC UL DTX for addition of a new cell in the active set.	7.6.0

	RP-37	RP-070627	3084	1	Handling of DPCCH Slot Format 4	7.6.0
	RP-37	RP-070627	3085		Correction to the related IEs of DTX-DRX operation in RRC	7.6.0
	RP-37	RP-070627	3086	1	Restriction of HS-SCCH less operation and MIMO	7.6.0
	RP-37	RP-070627	3087	1	HS-SCCH less virtual IR buffer size	7.6.0
	RP-37	RP-070629	3088		Timing Advance Corrections for 3.84/7.68 Mcps TDD E-DCH	7.6.0
	RP-37	RP-070631	3089		3.84/7.68 Mcps TDD EDCH Sending Scheduling Information Periodically	7.6.0
	RP-37	RP-070670	3090		Correction on 64QAM and MIMO UE capability in RRC	7.6.0
	RP-37	RP-070670	3092	1	Starting and stopping operation in 16QAM mode	7.6.0
	RP-37	RP-070623	3093		The range of E-TFCL_ed,switch	7.6.0
	RP-37	RP-070650	3094		Introduction of multi-frequency operation for LCR TDD	7.6.0
	RP-37	RP-070624	3096		F-DPCH TPC error rate target	7.6.0
	RP-37	RP-070624	3098		Correction to CTFC for default configuration 14	7.6.0
	RP-37	RP-070624	3100		Correction to default configuration 16	7.6.0
	RP-37	RP-070624	3102		Security correction on PS handover to UTRAN	7.6.0
	RP-37	RP-070626	3103		IE Common RB mapping info	7.6.0
	RP-37	RP-070626	3104		Common-MAC-ehs-ReorderingQueues	7.6.0
	RP-37	RP-070627	3105	2	Correction to CPC Parameters	7.6.0
	RP-37	RP-070632	3107		Change Request for 25.331 ASN.1 for MBMS TDD and FDD Physical Layer Improvements	7.6.0
	RP-37	RP-070628	3108		Update of GANSS elements improving GANSS ambiguity resolution	7.6.0
	RP-37	RP-070636	3109		Corrections to DRX schemes in URA_PCH and CELL_PCH	7.6.0
	RP-37	RP-070636	3112		Clarification on reconfiguration of T305	7.6.0
	RP-37	RP-070628	3113		Introduction of SIB type extension for SIB type 15.8	7.6.0
	RP-37	RP-070636	3114		Correction for configuration of RFC2507 header compression	7.6.0
	RP-37	RP-070636	3115		Correction for CS call type	7.6.0
	RP-37	RP-070636	3116		Add the frequency info to identify the neighbour cells when report the OTDOA measurement results	7.6.0
	RP-37	RP-070624	3120		Corrections in the default radio configurations 11/12/13	7.6.0
	RP-37	RP-070624	3122		Miscellaneous corrections in the default radio configurations	7.6.0
	RP-37	RP-070764	3123	1	For the creation of RRC Rel-8	8.0.0
	RP-37	RP-070633	3069		Introduction of Band XI	8.0.0
12/2007	RP-38	RP-071011	3126	2	UE setting for the "Extension indicator" in the frequency band IEs	8.1.0
	RP-38	RP-070898	3133		Correction to Measurement Report Initiation Procedure with UEs in CELL_PCH	8.1.0
	RP-38	RP-070899	3135		START value and reconfiguration from fixed to flexible	8.1.0
	RP-38	RP-070900	3137		UE DTX capability in RRC Connection Request	8.1.0
	RP-38	RP-070903	3141	1	Introduction of an additional UE category for 1.28Mcps TDD E-DCH	8.1.0
	RP-38	RP-070905	3143		UE Waiting during Cell Update Procedure	8.1.0
	RP-38	RP-070905	3145	1	Correction for radio bearer mapping for FDD	8.1.0
	RP-38	RP-070903	3147		Add E-RUCCH SYNC-UL info for handover procedure for LCR TDD	8.1.0
	RP-38	RP-070895	3151		Correction on MMSI reception on DCCH	8.1.0
	RP-38	RP-070894	3154	2	RADIO BEARER SETUP using default configurations	8.1.0
	RP-38	RP-070895	3157		Correction of integrity protection and checking of MBMS MODIFIED SERVICES INFORMATION message on DCCH	8.1.0
	RP-38	RP-070892	3162		Use of default configuration 12	8.1.0
	RP-38	RP-070903	3164		A Correction about SNPL for 1.28 Mcps TDD	8.1.0
	RP-38	RP-070903	3166		Support of SRB transmission on HSPA for 1.28Mcps TDD	8.1.0
	RP-38	RP-070902	3169		More improvement on Dedicated frequency for 1.28 Mcps TDD MBMS	8.1.0
	RP-38	RP-070903	3171		Clarification of gain factor Beta-e in LCR TDD EUL	8.1.0
	RP-38	RP-070898	3173	2	Iur backward compatibility problem	8.1.0
	RP-38	RP-070898	3175		BCCH reception on HS-DSCH for CELL_PCH UE	8.1.0
	RP-38	RP-070898	3177		Cell_PCH UE behaviour upon reception of activation time in reconfiguration message	8.1.0
	RP-38	RP-070899	3179		CQI Table usage	8.1.0
	RP-38	RP-070938	3181		Scheduled Grant setting in DTX Cycle 2 during CPC operation	8.1.0
	RP-38	RP-070894	3184		Wrong UL Puncturing Limits for default configurations #15, #18, #19, #20 and #21	8.1.0
	RP-38	RP-070906	3186	1	Change of UE capability during an RRC connection	8.1.0
	RP-38	RP-070901	3188		Correction to HS-SCCH numbering assumption for 64QAM encoding	8.1.0
	RP-38	RP-070905	3190		Clarification that "Default DPCH offset value" is required for FACH->DCH reconfiguration	8.1.0
	RP-38	RP-070895	3192		Error in Rel-7 shadow CR concerning MBMS preferred frequency information	8.1.0

	RP-38	RP-070905	3196			Correction to Control Information transmission with two logical channels	8.1.0
	RP-38	RP-070905	3198			Some editorial corrections on Multi-carriers for LCR TDD	8.1.0
	RP-38	RP-070895	3201			Procedure text concerning MBMS offsets and tabular/ASN.1 description are not aligned	8.1.0
	RP-38	RP-070905	3203	1		MBMS Common Physical Channels limitation	8.1.0
	RP-38	RP-070895	3206	1		Correction on MBMS Frequency Layer Dispersion (FLD)	8.1.0
	RP-38	RP-070897	3208	1		Replacement of the almanac Sat Mask by SV ID	8.1.0
	RP-38	RP-070911	3210			Clarification on E-DPDCH power extrapolation/interpolation	8.1.0
	RP-38	RP-070895	3212			BCCH / MCCH consistency for MBMS reception	8.1.0
	RP-38	RP-070910	3214			Introduction of CS voice over HSPA	8.1.0
	RP-38	RP-070907	3215			Introduction of HS-DSCH category for combined MIMO and DL64QAM	8.1.0
	RP-38	RP-070905	3217			Disable reselection to the original RAT when UE receives RRC CONNECTION REJECT	8.1.0
	RP-38	RP-070904	3219			Corrections due to the ASN.1 R7 review (main CR)	8.1.0
	RP-38	RP-070904	3221			Signalling of Rel-7 UE capabilities (ASN.1 R7 review)	8.1.0
	RP-38	RP-070912	3223			Augmentation of GANSS Signal ID field	8.1.0
	RP-38	RP-070905	3225			Delta T2TP Parameter	8.1.0
03/2008	RP-39	RP-080178	3231	-		Clarification on MAX_CID	8.2.0
	RP-39	RP-080189	3233	-		FACH measurement occasion Calculation	8.2.0
	RP-39	RP-080189	3235	-		Clarification on "Default DPCH offset value"	8.2.0
	RP-39	RP-080189	3237	-		Synchronised modification of system information blocks	8.2.0
	RP-39	RP-080189	3239	-		Clarification on "Measured Results on RACH" in enhanced CELL_FACH	8.2.0
	RP-39	RP-080186	3241	-		Correction to conditions for setting MIMO_STATUS variable	8.2.0
	RP-39	RP-080188	3243	-		Correction to HS-SCCH numbering assumption for 64QAM encoding	8.2.0
	RP-39	RP-080181	3245	-		Use of cell selection and reselection info in the case that a cell is providing MBSFN only service	8.2.0
	RP-39	RP-080191	3247	-		Corrections due to the RRC Rel-7 ASN.1 review	8.2.0
	RP-39	RP-080177	3250	-		L2-combining in MBMS CURRENT CELL P-T-M RB INFORMATION message	8.2.0
	RP-39	RP-080189	3253	-		Traffic volum measurement for CELL_PCH UE	8.2.0
	RP-39	RP-080190	3255	-		Support of octet aligned HS-DSCH transport block sizes for non-64QAM	8.2.0
	RP-39	RP-080186	3257	1		Correction to MIMO with the message PHYSICAL CHANNEL RECONFIGURATION	8.2.0
	RP-39	RP-080182	3259	-		Supporting multi-frequency for 1.28 Mcps TDD MBMS	8.2.0
	RP-39	RP-080185	3261	-		Modification of variable E_DCH_TRANSMISSION setting	8.2.0
	RP-39	RP-080185	3263	-		Correction and Clarification of non-scheduled E-PUCH allocation for LCR TDD	8.2.0
	RP-39	RP-080185	3265	-		Modifications on the values of T-RUCCH timer for LCR TDD	8.2.0
	RP-39	RP-080184	3267	-		Persistence scaling values for 3.84/7.68 Mcps TDD E-DCH	8.2.0
	RP-39	RP-080178	3270	-		Correction to default configuration 17	8.2.0
	RP-39	RP-080203	3271	-		Signaling of default configuration 17 in HANDOVER TO UTRAN COMMAND message	8.2.0
	RP-39	RP-080200	3272	-		Introduction of UMTS 700 MHz (Bands XII – XIV) in 25.331	8.2.0
	RP-39	RP-080201	3273	1		CS-HSPA UL AMR Rate and maximum jitter time	8.2.0
	RP-39	RP-080201	3274	2		Proposal for RRC based rate control	8.2.0
	RP-39	RP-080202	3275	-		Introducing Improved L2 for uplink	8.2.0
	RP-39	RP-080204	3276	-		Introduction of PPAC	8.2.0
05/2008	RP-40	RP-080390	3282	1		Interpretation of the "Neighbouring cell identity" in MBMS NEIGHBOURING CELL PTM RB INFO	8.3.0
	RP-40	RP-080390	3285	-		Clarification on MBMS dispersion	8.3.0
	RP-40	RP-080403	3287	-		Minor ASN.1 corrections due errors detected during v780 implementation	8.3.0
	RP-40	RP-080414	3288	2		Configurable values for the minimum and maximum RLC PDU size	8.3.0
	RP-40	RP-080417	3289	-		Introduction of 64QAM in RRC for LCR TDD	8.3.0
	RP-40	RP-080396	3291	-		Correction on the attribute of Treset in system information	8.3.0
	RP-40	RP-080396	3293	-		Editorial correction to reconfigure MAC-ehs reordering queue	8.3.0
	RP-40	RP-080403	3295	-		Editorial correction to variable description of CELL_INFO_LIST	8.3.0
	RP-40	RP-080393	3298	-		Correction to the calculation of DPCH frame offset for F-DPCH on timing re-initialised hard handover	8.3.0
	RP-40	RP-080403	3300	-		Handling of TRANSPORT FORMAT COMBINATION CONTROL	8.3.0
	RP-40	RP-080404	3302	-		Completion of the mechanism for Scheduling Information transmission on MAC-e PDU alone for 1.28 Mcps TDD in EUL	8.3.0
	RP-40	RP-080443	3304	1		Counter and timers for Scheduling Information Reporting of LCR TDD	8.3.0
	RP-40	RP-080398	3306	-		Clarification of the definition of PRRI for TDD	8.3.0
	RP-40	RP-080400	3308	1		Correction and Clarification of E-RUCCH Info for LCR TDD	8.3.0

	RP-40	RP-080395	3312	-		Re-establishment condition for RLC reconfiguration to fixed from flexible PDU size	8.3.0
	RP-40	RP-080418	3313	-		Early Implementation of PPAC	8.3.0
	RP-40	RP-080402	3315	-		MBSFN Corrections	8.3.0
	RP-40	RP-080405	3316	1		RAB reconfiguration for CS HSPA	8.3.0
	RP-40	RP-080419	3317	-		Various corrections due to editorial problems detected during CR implementation after RAN-39	8.3.0
	RP-40	RP-080419	3319	-		Correction of missing Rel-7 VLEC in the Radio Bearer Reconfiguration message and other non-editorial corrections due to problems discovered during CR implementation	8.3.0
	RP-40	RP-080396	3321	-		RRC connection release for Cell_PCH	8.3.0
	RP-40	RP-080384	3322	-		Introduce a new band E for LCR TDD	8.3.0
	RP-40	RP-080396	3324	-		Correction of CELL_PCH in Reconfiguration Procedure	8.3.0
	RP-40	RP-080401	3329	-		Extended power control gap for E-PUCH in LCR TDD	8.3.0
	RP-40	RP-080300	3332	-		GANSS corrections	8.3.0
	RP-40	RP-080442	3340	-		Correction to note on reference E-TFCI configuration	8.3.0
	RP-40	RP-080394	3342	-		Correction to relation between DTX-DRX timing and DTX-DRX configuration	8.3.0
	RP-40	RP-080400	3344	1		Clarification on Number of E-UCCH for LCR TDD	8.3.0
	RP-40	RP-080400	3346	1		Presence clarification of E-HICH Information per radio link for TDD	8.3.0
	RP-40	RP-080400	3348	-		Correction on the non-scheduled E-PUCH configuration	8.3.0
	RP-40	RP-080403	3349	-		Correction of missing Rel-7 VLEC in the Radio Bearer Reconfiguration message	8.3.0
	RP-40	RP-080403	3350	-		Various ASN.1 corrections	8.3.0
	RP-40	RP-080394	3352	-		Correction to signaling of Uplink DPCCCH slot format information	8.3.0
	RP-40	RP-080403	3353	-		Uncorrect way to delete MAC-ehs re-ordering queue	8.3.0
	RP-40	RP-080442	3355	1		Indication for E-DPCCH Power Boosting support status	8.3.0
	RP-40	RP-080440	3356	-		HS-SCCH orders for HS-SCCH-less operation	8.3.0
08/2008	-	-	-	-		Fix Word problem	8.3.1
09/2008	RP-41	RP-080681	3358	-		Correct the description of UE behaviour during HS-DSCH Reception in CELL_PCH and URA_PCH	8.4.0
	RP-41	RP-080679	3360	1		Correction on the non-scheduled E-PUCH configuration for 1.28Mcps TDD	8.4.0
	RP-41	RP-080680	3362	2		MBSFN Corrections	8.4.0
	RP-41	RP-080686	3363	3		RRC procedures for configuring Improved layer 2 for UL	8.4.0
	RP-41	RP-080681	3365	-		Deletion of Duplicate Definition of CELL_FACH HS-DSCH Variables	8.4.0
	RP-41	RP-080684	3367	-		Modification of GANSS timing representation to avoid large integers	8.4.0
	RP-41	RP-080701	3373	-		Reading Traffic Volume Measurement System Information in SIB11	8.4.0
	RP-41	RP-080678	3376	4		Clarification of the UE behavior on DSAC	8.4.0
	RP-41	RP-080701	3382	-		Correction to signalling of multiple PLMNs in SIB18	8.4.0
	RP-41	RP-080685	3386	2		Reconfiguration of inactive RABs to DCH	8.4.0
	RP-41	RP-080696	3387	3		Introduction of Enhanced Uplink in CELL_FACH in 25.331	8.4.0
	RP-41	RP-080682	3389	-		Correction to MIMO parameters	8.4.0
	RP-41	RP-080679	3391	-		Persistence value (Pi) completion for E-RUCCH in LCR TDD	8.4.0
	RP-41	RP-080679	3395	-		Introduce E-DCH Traffic volume measurement for LCR TDD	8.4.0
	RP-41	RP-080685	3397	-		Introduce QrxlevminOffset in 25.331 for TDD	8.4.0
	RP-41	RP-080679	3400	1		Correction of E-RUCCH configuration for LCR TDD EUL	8.4.0
	RP-41	RP-080687	3401	2		Ciphering procedures for CS over HSPA	8.4.0
	RP-41	RP-080694	3403	1		Introduction of absolute priorities reselection	8.4.0
	RP-41	RP-080694	3404	1		UE Capabilities and redirection (UTRA-LTE)	8.4.0
	RP-41	RP-080697	3405	2		Introduction of CELL_FACH DRX	8.4.0
12/2008	RP-42	RP-081022	3414	-		HARQ feedback with Enhanced Uplink in Cell_FACH state	8.5.0
	RP-42	RP-081013	3415	-		Clarification for LI size decision for UM RLC uplink	8.5.0
	RP-42	RP-081014	3416	-		Correction to measurement behaviour for CELL_FACH UE	8.5.0
	RP-42	RP-080999	3419	-		Typo in IE 'Domain Specific Access Restriction'	8.5.0
	RP-42	RP-081005	3421	-		Misplaced IEs in RADIO BEARER RECONFIGURATION	8.5.0
	RP-42	RP-081022	3422	1		Replacement of E-AICH in 25.331	8.5.0
	RP-42	RP-081004	3424	1		Resetting the periodic cell update timer T305 after autonomous state transition to CELL_FACH in Enhanced CELL_FACH	8.5.0
	RP-42	RP-081022	3425	2		Resetting the periodic cell update timer T305 after autonomous state transition to CELL_FACH in Enhanced Uplink in CELL_FACH state	8.5.0
	RP-42	RP-081022	3426	1		Clarification of common E-DCH resource usage in 25.331	8.5.0
	RP-42	RP-081022	3427	1		Corrections for Enhanced Uplink in CELL_FACH in 25.331	8.5.0
	RP-42	RP-081014	3428	1		Smaller value ranges for DRX burst length	8.5.0

	RP-42	RP-081003	3430	1		Clarification to the scope of Uplink DPCH slot format 4 feature	8.5.0
	RP-42	RP-081007	3432	-		Introduce Intra-Secondary Frequency Indicator for LCR TDD	8.5.0
	RP-42	RP-081030	3433	-		Clarification of non-used frequency definition for secondary frequency in DC-HSDPA	8.5.0
	RP-42	RP-081004	3435	2		correct the description of UE behaviour during HS-DSCH Reception in CELL_PCH	8.5.0
	RP-42	RP-081014	3436	-		Some corrections for Enhanced UE DRX	8.5.0
	RP-42	RP-081003	3438	-		Modification of the conditions for disabling HS-SCCH less operation	8.5.0
	RP-42	RP-081029	3439	-		Support for additional navigation satellite systems in RRC	8.5.0
	RP-42	RP-081022	3445	1		SIB7 reading time with Enhanced Uplink for CELL_FACH state in 25.331	8.5.0
	RP-42	RP-081033	3446	-		Introduction of new default configurations	8.5.0
	RP-42	RP-081022	3447	-		Clarification of HS-DPCH usage for Enhanced Uplink in CELL_FACH	8.5.0
	RP-42	RP-081033	3448	-		Inclusion of UE historical information in SRNC RELOCATION INFO	8.5.0
	RP-42	RP-081033	3453	-		Size constraints on UE band capabilities	8.5.0
	RP-42	RP-081102	3458	3		Introduction of UE Measurement Capability on frequency adjacent to intra-frequency	8.5.0
	RP-42	RP-081015	3460	1		Prevention of excessive OOS due to failure of Squal criterion	8.5.0
	RP-42	RP-081033	3462	2		Improved EUL power control at UE power limitation	8.5.0
	RP-42	RP-080857	3463	-		Introduction of ETWS PRIMARY NOTIFICATION WITH SECURITY message	8.5.0
	RP-42	RP-081000	3466	1		MBMS frequency selection	8.5.0
	RP-42	RP-081003	3468	-		Correction to DRX and CQI reporting	8.5.0
	RP-42	RP-081030	3469	1		Introduction of Dual Cell HSDPA operation	8.5.0
	RP-42	RP-081028	3470	2		Introduction of HS-DSCH cell change enhancements	8.5.0
	RP-42	RP-081033	3471	3		Introduction of optional features in Release 8	8.5.0
	RP-42	RP-081015	3473	-		Detection of E-UTRA cell in idle mode	8.5.0
	RP-42	RP-081033	3476	-		Add the max number of the extended bands for TDD	8.5.0
	RP-42	RP-081003	3478	-		Clarification to the use of 'F-DPCH slot format' IE	8.5.0
	RP-42	RP-081015	3480	1		Corrections to absolute priority reselection and redirection to EUTRA procedures and parameters	8.5.0
	RP-42	RP-081015	3481	1		PS handover to/from E-UTRAN	8.5.0
	RP-42	RP-081015	3482	1		Measurement and measurement reporting of E-UTRAN cells	8.5.0
	RP-42	RP-081033	3483	2		Fast Dormancy for UMTS	8.5.0
	RP-42	RP-081005	3484	-		Corrections related to the cell update wait timer T320	8.5.0
	RP-42	RP-081012	3485	-		Correction of the small typo	8.5.0
	RP-42	RP-081012	3486	-		RLF handling during CS over HSPA reconfiguration	8.5.0
	RP-42	RP-081015	3487	-		UE behaviour of NAS message transmission when inter-RAT change	8.5.0
	RP-42	RP-081005	3489	-		Correction to IDT procedure	8.5.0
	RP-42	RP-081006	3492	-		Clarification for 16QAM UL E-AGCH table mapping	8.5.0
	RP-42	RP-081025	3494	2		Introduction of enhanced CELL_FACH, CELL_PCH and URA_PCH for 1.28Mcps TDD	8.5.0
	RP-42	RP-080998	3499	-		Correction of measurement event 1l	8.5.0
	RP-42	RP-081007	3501	-		Clarification of Persistence Value (Pi) for E-RUCCH in LCR TDD	8.5.0
	RP-42	RP-081024	3505	-		Introduction of additional UE categories for 1.28Mcps TDD 64QAM DL	8.5.0
	RP-42	RP-081005	3509	-		Correction to "DL RLC PDU size" explicit configuration to prevent security issue	8.5.0
	RP-42	RP-081003	3511	-		Clarification to the use of 'DTX-DRX timing information' for hard handover	8.5.0
	RP-42	RP-081030	3512	1		Clarification of current frequency in DC-HSDPA	8.5.0
	RP-42	RP-081005	3514	1		Correction of measurement event 1H	8.5.0
	RP-42	RP-081014	3515	1		Add indication of enhanced DRX capability into CELL_UPDATE	8.5.0
	RP-42	RP-081030	3516	-		Indication of Dual Cell capability in RRC Connection Request and Cell Update	8.5.0
	RP-42	RP-081005	3518	-		Support of Enhanced F-DPCH in RRC CONNECTION REQUEST	8.5.0
	RP-42	RP-081031	3520	1		CR on CSG Support in 25.331	8.5.0
	RP-42	RP-081128	3521	2		Support for 3.84 Mcps MBSFN IMB operation	8.5.0
03/2009	RP-43	RP-090144	3532	2		Support for 3.84 Mcps MBSFN IMB operation	8.6.0
	RP-43	RP-090115	3535	1		UMTS frequency information in IE "Rplmn information"	8.6.0
	RP-43	RP-090115	3538	-		CN system information after PS HO	8.6.0
	RP-43	RP-090119	3540	-		Correction to the UE behaviour when entering URA_PCH state	8.6.0
	RP-43	RP-090117	3542	1		Condition to set the 'Security capability indication' flag	8.6.0
	RP-43	RP-090117	3544	2		Ciphering for intra-UTRAN Radio Bearer Setup - Rel 7	8.6.0
	RP-43	RP-090139	3545	-		T321 Timer Start Time Clarification	8.6.0
	RP-43	RP-090136	3546	1		Clarification of ACK/NACK reporting for Enhanced Uplink in CELL_FACH	8.6.0

	RP-43	RP-090149	3547	1		Introduction of MIMO for 1.28Mcps TDD	8.6.0
	RP-43	RP-090141	3548	2		Correction to GANSS additional assistance data request	8.6.0
	RP-43	RP-090140	3549	-		CS-HSPA information in RAB information to reconfigure	8.6.0
	RP-43	RP-090136	3550	-		Addition of E-RNTI and H-RNTI in URA UPDATE CONFIRM message	8.6.0
	RP-43	RP-090135	3551	1		CSG corrections	8.6.0
	RP-43	RP-090147	3552	3		Introduction of Continuous Connectivity for packet data users for 1.28Mcps TDD	8.6.0
	RP-43	RP-090142	3553	1		Corrections to Enhanced Serving Cell Change	8.6.0
	RP-43	RP-090139	3554	3		Corrections for Enhanced UE DRX	8.6.0
	RP-43	RP-090151	3555	1		General default configuration for CELL_FACH	8.6.0
	RP-43	RP-090132	3556	-		Corrections to detection of E-UTRA cell	8.6.0
	RP-43	RP-090144	3558	-		Correction on MBSFN frequency list IE in 3.84Mcps TDD MBSFN IMB	8.6.0
	RP-43	RP-090150	3559	-		Correction to activation/deactivation of secondary cell reception	8.6.0
	RP-43	RP-090132	3561	-		Missing reference to E-UTRAN DL-DCCH-Message at Inter-RAT Handover	8.6.0
	RP-43	RP-090139	3562	-		Corrections for enhanced UE DRX	8.6.0
	RP-43	RP-090132	3563	1		Clearing of START and Pre-defined configurations at Inter-RAT Handover UTRAN to E-UTRAN	8.6.0
	RP-43	RP-090148	3565	-		Introduction of SR-VCC operations	8.6.0
	RP-43	RP-090136	3566	1		Removal of redundant Cell Update procedure	8.6.0
	RP-43	RP-090142	3567	-		Processed transactions initialisation upon SRB re-establishment	8.6.0
	RP-43	RP-090118	3569	-		Clarification of scope of signaled transport block sizes for HS-SCCH less operation	8.6.0
	RP-43	RP-090132	3573	1		Support E-UTRAN Inter-RAT measurement by UTRA TDD UE	8.6.0
	RP-43	RP-090117	3575	-		25.331 Rel 8 CR UE restrictions on E-TFCI	8.6.0
	RP-43	RP-090151	3577	2		Corrections related to UTRA R8 ASN.1 issues	8.6.0
	RP-43	RP-090115	3580	-		Correction to handling of CELL_INFO_LIST when 'Inter-frequency cell info list' is received in System Information Block Type 11bis	8.6.0
	RP-43	RP-090115	3583	1		Corrections for PS handover to UTRAN	8.6.0
	RP-43	RP-090121	3585	1		Correction to RRC handling of AG and SG tables when 16QAM UL is configured	8.6.0
	RP-43	RP-090118	3587	1		Correction to handling of DTX-DRX information	8.6.0
	RP-43	RP-090132	3592	-		Corrections to UTRA to EUTRA mobility	8.6.0
	RP-43	RP-090132	3593	-		Correction to serving cell dedicated priority handling when no priority is available	8.6.0
	RP-43	RP-090133	3594	-		EUTRA Feature Group Support Indicators in UTRA	8.6.0
	RP-43	RP-090364	3595	4		Revised RAN2 REL-8 CRs for LTE on Feature Group Indicators	8.6.0
	RP-43	RP-090135	3596	2		Correction to CSG PSC signalling	8.6.0
	RP-43	RP-090151	3601	-		Addition of E-RGCH Combination Info in SRNS RELOCATION INFO(R8)	8.6.0
	RP-43	RP-090150	3603	-		Corrections to Dual Cell HSDPA operation	8.6.0
	RP-43	RP-090142	3605	-		Corrections to HS-DSCH cell change enhancements(R8MIMO)	8.6.0
	RP-43	RP-090142	3607	-		Some corrections to Serving Cell Change enhancements	8.6.0
	RP-43	RP-090132	3608	-		Corrections to absolute priority reselection	8.6.0
	RP-43	RP-090139	3609	-		Clarification of enhanced UE DRX operation	8.6.0
	RP-43	RP-090132	3610	-		Inheriting of dedicated priorities at inter-RAT reselection	8.6.0
	RP-43	RP-090137	3613	1		Corrections to enhanced CELL_FACH in 1.28Mcps TDD	8.6.0
	RP-43	RP-090122	3614	1		Clarification of 64QAM TB Table applicability	8.6.0
	RP-43	RP-090151	3615	-		Correction of Uplink DPCH power control info IE	8.6.0
	RP-43	RP-090146	3617	-		Introduction of UMTS Band f in 25.331	8.6.0
	RP-43	RP-090136	3618	-		Correction on F-DPCH slot format for E-DCH in CELL_FACH	8.6.0
	RP-43	RP-090326	3619	1		Addition of CSG capability indication	8.6.0
	RP-43	RP-090145	3620	-		Correction for UTRA ETWS duplicate detection	8.6.0
	RP-43	RP-090117	3622	-		Adding the MBMS PTM RB release cause in the MCCH message when releasing the MBMS service for 1.28Mcps TDD	8.6.0
	RP-43	RP-090326	3624	-		Addition of CSG capability indication in Initial Direct Transfer	8.6.0
06/2009	RP-44	RP-090498	3629	1		Removal of description of CPCH feature	8.7.0
	RP-44	RP-090505	3631	1		Error in UE capability update procedure	8.7.0
	RP-44	RP-090505	3633	1		Correction on deferredMeasurementControlReading	8.7.0
	RP-44	RP-090500	3635	-		Clarification for setting the HS_SCCH_LESS_STATUS variable	8.7.0
	RP-44	RP-090506	3636	-		Removal of FFS in reference to GERAN timer T3230	8.7.0
	RP-44	RP-090517	3637	1		Addition of semantics description for support of CSG	8.7.0
	RP-44	RP-090506	3638	1		Clarification of setting measurement capability TDD in INTER RAT HANDOVER INFOR message	8.7.0

	RP-44	RP-090519	3639	-		Correction to enhanced Serving Cell Change procedure	8.7.0
	RP-44	RP-090519	3640	-		Correction of the "else" clause in Target cell HS-SCCH reception	8.7.0
	RP-44	RP-090519	3641	-		SIB7 and enhanced UE DRX operation	8.7.0
	RP-44	RP-090519	3642	2		Correction to statement of SPS operation for 1.28Mcps TDD	8.7.0
	RP-44	RP-090506	3643	1		Preserving dedicated priorities in camped on any cell state	8.7.0
	RP-44	RP-090505	3645	-		Correction on UE Mobility State Indicator	8.7.0
	RP-44	RP-090500	3647	-		Correction to CPC activation/deactivation	8.7.0
	RP-44	RP-090519	3648	-		Procedure requirements for ETWS primary notification with security	8.7.0
	RP-44	RP-090519	3649	-		Handling of dual cell HS-SCCH orders at serving cell change	8.7.0
	RP-44	RP-090519	3650	-		Corrections to common E-DCH operation	8.7.0
	RP-44	RP-090607	3656	4		Specification of CPC restored state upon physical layer failure	8.7.0
	RP-44	RP-090501	3658	2		Correction to non-scheduled transmission for 1.28 Mcps TDD	8.7.0
	RP-44	RP-090503	3660	-		Clarification of CQI reporting for 1.28Mcps TDD	8.7.0
	RP-44	RP-090503	3662	-		Correction to Improved L2 support for high data rates for TDD	8.7.0
	RP-44	RP-090518	3663	-		Missing CS over HSPA operation in SR-VCC	8.7.0
	RP-44	RP-090519	3664	-		Correction on CPICH Secondary CCPCCH power offset in 3.84 Mcps TDD MBSFN IMB	8.7.0
	RP-44	RP-090502	3665	1		Correction on p-t-m bearer release in 3.84 Mcps TDD MBSFN IMB	8.7.0
	RP-44	RP-090517	3667	1		Addition of CSG cell reservation signalling	8.7.0
	RP-44	RP-090499	3671	-		Clarification to the support of 2 different layer 3 filters per measurement type	8.7.0
	RP-44	RP-090505	3673	1		Clarification to handling of IE "Use special value of HE field"	8.7.0
	RP-44	RP-090500	3675	-		Removal of slot format 3 from IE "Uplink DPCCH slot format information" in "DTX-DRX information"	8.7.0
	RP-44	RP-090519	3676	1		Correction to TargetCellPreconfigInfo asn1	8.7.0
	RP-44	RP-090506	3680	-		Correction for E-UTRA measurement and reporting quantity CR for 25.331	8.7.0
	RP-44	RP-090506	3681	-		Corrections to absolute priority reselection	8.7.0
	RP-44	RP-090504	3683	-		Correction to Enhanced CELL_FACH Capability	8.7.0
	RP-44	RP-090519	3684	-		Configuration of EAI power offset	8.7.0
	RP-44	RP-090519	3688	-		Correction to RRC transaction identifier handling	8.7.0
	RP-44	RP-090500	3690	1		Corrections to CPC when E-DCH TTI is reconfigured (Rel8)	8.7.0
	RP-44	RP-090505	3692	-		Call Type Inclusion condition	8.7.0
	RP-44	RP-090506	3694	2		Transfer of INTER RAT HANDOVER INFO upon handover from UTRAN	8.7.0
	RP-44	RP-090519	3695	-		Clarification of SIB7 reading for enhanced uplink in CELL_FACH state	8.7.0
09/2009	RP-45	RP-090906	3700	1		Correction for the value range of threshold other system in case E-UTRA measurement Alt1	8.8.0
	RP-45	RP-090906	3701	-		Inconsistency between ASN.1 and Tabular format of E-UTRA target info	8.8.0
	RP-45	RP-090906	3702	3		Clarification on signalling connection initialisation upon HO to UTRAN	8.8.0
	RP-45	RP-090901	3704	-		Missing RRC messages in RRC procedure performance values section	8.8.0
	RP-45	RP-090912	3705	-		Corrections to handling of secondary cell HS-DSCH information in DC-HSDPA	8.8.0
	RP-45	RP-090905	3708	-		Correction to HS-SCCH less operation (Rel-8)	8.8.0
	RP-45	RP-090914	3709	1		Correction to the reception of a Target cell HS-SCCH order	8.8.0
	RP-45	RP-090911	3710	-		Corrections related to CSG	8.8.0
	RP-45	RP-090916	3713	-		Actions upon CS over HSPA is configured in 'RB information to setup' IE	8.8.0
	RP-45	RP-090916	3715	-		Validation of PDCP configuration in case of CS voice over HSPA	8.8.0
	RP-45	RP-090908	3717	1		E-DCH TTI restriction for 16QAM	8.8.0
	RP-45	RP-090917	3718	-		Clarification that a configuration with simultaneous RB mapping options for mac-is/i and mac-es/e is invalid	8.8.0
	RP-45	RP-090912	3719	-		Dual Cell HSDPA: clarification of setting of variable SECONDARY_CELL_HS_DSCH_RECEPTION	8.8.0
	RP-45	RP-090913	3722	-		Inconsistency with ASN.1 for TVM for Enhanced UL for CELL_FACH	8.8.0
	RP-45	RP-090902	3728	1		Making features "Using special value of HE field to indicate end of an SDU for RLC AM" optional, octet aligned HS-DSCH transport block table optional for non-64QAM UEs and "Removing the constraint that the same HS-SCCH should be used in contiguous TTIs" optional	8.8.0
	RP-45	RP-090912	3735	1		Clarification of H-ARQ Info for DC-HSDPA	8.8.0
	RP-45	RP-090912	3736	-		Correction in the use of H-RNTI for the secondary cell of Dual Cell HSDPA operation	8.8.0
	RP-45	RP-090916	3738	-		Correction to response message of Cell Update Confirm message in case of Voice Type Transition i.e. "CS over HSPA" to "CS over DCH" or vice-versa	8.8.0
	RP-45	RP-090909	3742	-		Clarification for UE behaviour on RLC unrecoverable error when UE has not received L2 Ack for a Reconfig Complete msg	8.8.0

	RP-45	RP-090910	3743	1		Clarification on common E-DCH MAC flow configuration in enhanced CELL_FACH for 1.28 Mcps TDD	8.8.0
	RP-45	RP-090910	3745	1		Correction to periodical cell update for 1.28 Mcps TDD	8.8.0
	RP-45	RP-090910	3747	1		Clarification on UE category of enhanced CELL_FACH for 1.28Mcps TDD	8.8.0
	RP-45	RP-090901	3749	-		Clarification of multi-frequency info for 1.28Mcps TDD	8.8.0
	RP-45	RP-090915	3750	-		Security threat with duplicate detection for ETWS	8.8.0
	RP-45	RP-090904	3754	-		Correction to the description of MIMO parameters	8.8.0
	RP-45	RP-090917	3755	-		Ambiguity on the RLC PDU type of SRB	8.8.0
	RP-45	RP-090902	3759	-		Making features "F-DPCH" and "Introduction of Wait time to Cell Update Confirm" optional	8.8.0
	RP-45	RP-090907	3760	-		25.331 Features to be made optional in release 8: E-DPCCH power boosting	8.8.0
	RP-45	RP-090918	3761	-		Correction regarding SRVCC	8.8.0
	RP-45	RP-090906	3762	1		Clarification on key mapping and storing after successful handover from EUTRAN	8.8.0
	RP-45	RP-090899	3764	2		Making features "Two DRX schemes in URA_PCH and CELL_PCH" and "E-DPDCH power interpolation formula" optional	8.8.0
	RP-45	RP-090917	3765	-		Clarification that DDI is not used with mac-i/is configuration	8.8.0
	RP-45	RP-090916	3769	-		CS voice over HSPA UE capability in RRC CONNECTION REQUEST	8.8.0
	RP-45	RP-090920	3776	-		Corrections to the CONTROL_CHANNEL_DRX_STATUS of 1.28Mcps TDD	8.8.0
	RP-45	RP-090903	3778	-		Clarification on the Power Resource Related Information of 1.28Mcps TDD	8.8.0
	RP-45	RP-090903	3780	-		Clarification on the configuration of T-SI-NST for 1.28Mcps TDD	8.8.0
	RP-45	RP-090910	3781	-		Clarification on fach measurement occasion for 1.28Mcps TDD	8.8.0
	RP-45	RP-090917	3785	-		Clarification on Scheduling Information transmission	8.8.0
	RP-45	RP-090920	3788	-		Clarification on the number of RxTx Pattern of SPS operation for 1.28Mcps TDD	8.8.0
	RP-45	RP-090909	3792	1		25.331 on Addition of LCR TDD R8 extend capability info in Inter-RAT Handover info	8.8.0
	RP-45	RP-090909	3800	-		Missing RRC messages in RRC procedure performance values section	8.8.0
	RP-45	RP-090900	3803	-		Clarification on Inter-frequency RACH reporting quantity for TDD	8.8.0
	RP-45	RP-090900	3807	-		E-AGCH channel and E_RNTI variable corrections	8.8.0
	RP-45	RP-090874	3810	4		Making features "Absolute priority reselection to GERAN", "Absolute priority reselection to UTRA inter-frequency" and "Improved EUL power control" optional	8.8.0
	RP-45	RP-090901	3813	-		Enhancing the Category Handling in UMTS	8.8.0
	RP-45	RP-090902	3814	-		Making the bit of feature "UEA2/UIA2" reformulated	8.8.0
	RP-45	RP-090900	3816	-		RLC Size - SizeInfoType2 correction	8.8.0
09/2009	RP-45	RP-090921	3685	1		Introduction of Band XIX	9.0.0
	RP-45	RP-090925	3726	1		Introduction of single stream MIMO (TxAA fallback mode)	9.0.0
	RP-45	RP-090923	3727	2		Introduction of Dual Band HSDPA in 25.331	9.0.0
	RP-45	RP-090924	3774	1		25.331 Stage 3 CR Introduction of DC-HSDPA and MIMO	9.0.0
12/2009	RP-46	RP-091307	3820	-		Adding missing reference for HS_SCCH_LESS_STATUS variable	9.1.0
	RP-46	RP-091306	3824	-		Clarification on deferred measurement control reading	9.1.0
	RP-46	RP-091321	3826	1		Clarification for initial SPS Tx pattern parameter for 1.28Mcps TDD	9.1.0
	RP-46	RP-091327	3831	2		Clarification of common E-DCH mac-d flow for CCCH transmission	9.1.0
	RP-46	RP-091310	3834	1		Clarification of Power Offset for Scheduling Info for 1.28Mcps TDD (change 1)	9.1.0
	RP-46	RP-091310	3836	1		Clarification of Power Offset for Scheduling Info for 1.28Mcps TDD (change 2)	9.1.0
	RP-46	RP-091325	3841	-		Clarification on the configuration of TX diversity mode on DPCH in DC-HSDPA	9.1.0
	RP-46	RP-091318	3844	-		Correction of nesting levels greater 15 in ASN.1 IE definitions	9.1.0
	RP-46	RP-091324	3846	1		Correction of number of NI per frame for 3.84 Mcps TDD MBSFN IMB	9.1.0
	RP-46	RP-091314	3848	1		Correction of the UE behaviour after RRC connection Reject with redirection to EUTRA	9.1.0
	RP-46	RP-091378	3850	2		One correction to ASN1 of enhanced CELL_FACH state for LCR TDD	9.1.0
	RP-46	RP-091338	3851	-		Corrections to DC-HSDPA combined with MIMO	9.1.0
	RP-46	RP-091338	3852	-		CR on the HARQ configuration options for DC-HSDPA	9.1.0
	RP-46	RP-091347	3853	-		IMS Emergency Support Indication in BCCH	9.1.0
	RP-46	RP-091312	3856	1		MAC-es/e reset when 16QAM operation starts or stops(REL-8)	9.1.0
	RP-46	RP-091315	3858	-		Making features "Absolute priority reselection to GERAN", "Absolute priority reselection to UTRA inter-frequency" optional (Option1)	9.1.0
	RP-46	RP-091321	3862	-		Correction on Control Channel DRX description in CELL_DCH state for 1.28Mcps TDD	9.1.0

	RP-46	RP-091321	3864	-		Clarification of the actions related to HS_DSCH_RECEPTION variable for 1.28Mcps TDD	9.1.0
	RP-46	RP-091306	3868	-		Corrections to the Frequency quality estimate in 1.28Mcps TDD	9.1.0
	RP-46	RP-091317	3872	-		Inconsistency between tabular and ASN.1 for Adjacent Frequency measurements without compressed mode	9.1.0
	RP-46	RP-091347	3873	3		Introduction of TS0 enhancement for 1.28Mcps TDD	9.1.0
	RP-46	RP-091305	3879	1		UE behaviour upon a removal of the serving HS-DSCH/E-DCH radio link	9.1.0
	RP-46	RP-091305	3883	-		Maximum Power Reduction (MPR) and event 6D reporting	9.1.0
	RP-46	RP-091308	3886	2		RRC Signaling of S-CPICH power offset for MIMO UEs	9.1.0
	RP-46	RP-091325	3890	-		Clarification of the definition of the multicell support	9.1.0
	RP-46	RP-091317	3894	-		Clarification on the UE state after fast dormancy request	9.1.0
	RP-46	RP-091327	3898	-		Clarification on the transmission of MAC-c PDUs (R9)	9.1.0
	RP-46	RP-091337	3899	1		Dual band and DC+MIMO capability signalling	9.1.0
	RP-46	RP-091339	3904	-		Introduction of DC-HSDPA combined with TxAA extension	9.1.0
	RP-46	RP-091338	3905	-		Bundling DC-MIMO and TSN extension together in RRC	9.1.0
	RP-46	RP-091338	3906	-		Indication of MIMO support in RRC Connection Request	9.1.0
	RP-46	RP-091338	3910	-		Removal of redundant IE	9.1.0
	RP-46	RP-091346	3911	-		Transmission of UE inactive period during Inter-RAT handover to UTRAN	9.1.0
	RP-46	RP-091336	3914	2		Introduction of DC-HSUPA	9.1.0
	RP-46	RP-091306	3920	2		Modification of inter RAT handover info for 1.28 Mcps TDD	9.1.0
	RP-46	RP-091322	3922	-		Correction to MEASUREMENT CONTROL reception in enhanced CELL_FACH for 1.28 Mcps TDD	9.1.0
	RP-46	RP-091322	3924	-		Clarification of PICH selection scheme for 1.28 Mcps TDD	9.1.0
	RP-46	RP-091321	3928	-		Correction to CPC operation for 1.28 Mcps TDD	9.1.0
	RP-46	RP-091258	3930	1		Synchronization detection window configuration in CPC for 1.28 Mcps TDD	9.1.0
	RP-46	RP-091453	3937	3		UE support for E-UTRAN measurements and reporting in connected mode	9.1.0
	RP-46	RP-091343	3940	2		CR on Support of inbound mobility to CSG cell and Hybrid cell	9.1.0
	RP-46	RP-091325	3948	-		Searching on the adjacent cell without the need for compressed mode - Rel 9	9.1.0
	RP-46	RP-091337	3953	2		Optionality of search on the secondary carrier - Rel 9	9.1.0
	RP-46	RP-091259	3956	1		Carrier-specific STTD configuration for DC-HSDPA	9.1.0
	RP-46	RP-091314	3960	1		Correction to UE behaviour after handover to UTRAN from EUTRAN or GERAN	9.1.0
	RP-46	RP-091329	3966	-		Clarification that a configuration with RB mapping options for flexible RLC PDU size and mac-es/e is invalid	9.1.0
	RP-46	RP-091328	3968	1		UM RLC ciphering error detection and recovery	9.1.0
	RP-46	RP-091328	3970	-		CS voice over HSPA SDU discard timer configuration	9.1.0
	RP-46	RP-091322	3976	-		Supporting CCCH transmission on secondary frequency for 1.28Mcps TDD	9.1.0
	RP-46	RP-091317	3983	-		Update UE variable VALUE_TAG to include SIB types 19 and 20	9.1.0
	RP-46	RP-091306	3986	1		Correction to the reference in section 14.9.2	9.1.0
	RP-46	RP-091308	3989	-		Optional support of Tx diversity on DL control channels for MIMO capable UEs	9.1.0
	RP-46	RP-091347	3990	-		Addition of DGNSS Validity Period	9.1.0
	RP-46	RP-091335	3995	1		Introduction of band XXI - 25.331	9.1.0
	RP-46	RP-091317	4001	-		Standard Time Information Transmission in 1.28Mcps TDD System	9.1.0
	RP-46	RP-091338	4002	-		New values for buffer sizes	9.1.0
	RP-46	RP-091376	4007	-		Common E-DCH MAC-d flow List ASN.1 definition correction	9.1.0
03/2010	RP-47	RP-100199	4010	1		Indication of MIMO codebook restriction	9.2.0
	RP-47	RP-100284	4013	-		Traffic volume measurement in CELL_PCH state	9.2.0
	RP-47	RP-100294	4015	1		Clarification of T323 configuration	9.2.0
	RP-47	RP-100287	4017	-		Clarification to the frequency selection operation for E-FACH of 1.28Mcps TDD	9.2.0
	RP-47	RP-100298	4023	-		Correction to the activation/deactivation of secondary cell MIMO feature	9.2.0
	RP-47	RP-100303	4024	-		Corrections for virtual active set	9.2.0
	RP-47	RP-100306	4025	-		25.331: Fix for CSG measurements without SI report	9.2.0
	RP-47	RP-100302	4026	-		Introduction of band XX (800 MHz)	9.2.0
	RP-47	RP-100308	4027	1		Introduction of CELL_DCH measurement occasion calculation for 1.28Mcps TDD	9.2.0
	RP-47	RP-100306	4028	-		Release 9 UE Capability: UTRA Home Node B Inbound Mobility related features	9.2.0
	RP-47	RP-100294	4030	-		UE behaviour upon RLC re-establishment or inter-RAT change before successful delivery of SCRI for fast dormancy	9.2.0
	RP-47	RP-100306	4031	2		CR on 25331_CRxxxx_(REL-9) Remaining open issues for support of inbound mobility in UMTS	9.2.0

	RP-47	RP-100306	4032	-		Clarification to measurement configuration for SI reporting	9.2.0
	RP-47	RP-100285	4039	1		Correction on measurement to E-UTRA(R9)	9.2.0
	RP-47	RP-100298	4041	-		Corrections to TSN field extension configuration for MAC-ehs entity (alternative version)	9.2.0
	RP-47	RP-100306	4046	1		Clarification on proximity indication reporting in CELL_FACH, CELL_PCH and URA_PCH	9.2.0
	RP-47	RP-100306	4048	-		Reading neighbour HNB System Information Block 3 & Master Information Block	9.2.0
	RP-47	RP-100287	4052	-		Addition of 'Cell Selection and Re-selection Info' in measurement control	9.2.0
	RP-47	RP-100287	4054	-		Addition of HS-SCCH TPC step size for enhanced CELL_FACH for 1.28 Mcps TDD	9.2.0
	RP-47	RP-100287	4056	-		Clarification on E-RUCCH info in enhanced CELL_FACH	9.2.0
	RP-47	RP-100289	4061	1		Corrections to CPC when no DPCH is configured for 1.28 Mcps TDD	9.2.0
	RP-47	RP-100308	4062	1		Corrections related to UTRA Rel-9 ASN.1 issues	9.2.0
	RP-47	RP-100294	4064	1		ASN.1 issue with SIGNALLING CONNECTION RELEASE INDICATION	9.2.0
	RP-47	RP-100294	4069	-		Intra Domain NAS Node Selector Derivation	9.2.0
	RP-47	RP-100284	4073	1		Corrections to HS-DSCH reception in CELL_PCH and CELL_FACH	9.2.0
	RP-47	RP-100283	4079	1		Corrections to the Delta Primary CCPCH RSCP for 1.28Mcps TDD	9.2.0
	RP-47	RP-100289	4081	-		Clarification to the capabilities of SPS and control channel DRX in CELL_UPDATE for 1.28Mcps TDD	9.2.0
	RP-47	RP-100288	4083	1		Correction of RNTIs handling for Enhanced Uplink in CELL_FACH	9.2.0
	RP-47	RP-100303	4084	-		Initial Serving Grant for Secondary Carrier in Dual Cell E-DCH operation	9.2.0
	RP-47	RP-100294	4088	2		UE Fast Dormancy upon SRNS relocation	9.2.0
	RP-47	RP-100309	4092	1		Inter-RAT PS handover of signalling radio bearers only	9.2.0
	RP-47	RP-100294	4097	1		Correction on simultaneous deletion and addition of Transport Channels in a single reconfiguration message	9.2.0
	RP-47	RP-100285	4103	-		Correction to the value range of RSRQ	9.2.0
	RP-47	RP-100293	4105	2		Clarification for PPAC after Inter-RAT Redirection	9.2.0
	RP-47	RP-100308	4107	-		Cell reselection enhancements CR for 25.331	9.2.0
	RP-47	RP-100285	4109	-		Clarification of the IE UE Security Information2	9.2.0
	RP-47	RP-100306	4112	-		Proximity status indication handling at mobility	9.2.0
	RP-47	RP-100308	4113	-		ASN.1 Issue with CellUpdateConfirm	9.2.0
	RP-47	RP-100306	4115	4		CSG measurement release upon SRNS relocation	9.2.0
	RP-47	RP-100299	4116	-		Clarification of UE Categories for TxAA-Non-MIMO	9.2.0
	RP-47	RP-100294	4117	-		Modification to Fast Dormancy in PCH States	9.2.0
	RP-47	RP-100314	4118	-		CR to 25.331 on Redirection enhancements to UTRAN	9.2.0
						Deleted ToC bookmarks for faster file opening	9.2.1
06/2010	RP-48	RP-100557	4119	-		Alignment of tabular to ASN.1 in IE Downlink information for each radio link" for TDD"	9.3.0
	RP-48	RP-100538	4120	-		Clarification on CSG indicator (Release 9)	9.3.0
	RP-48	RP-100541	4122	-		Clarification for Enhanced serving cell change on removal of a RL.	9.3.0
	RP-48	RP-100537	4124	-		Clarification of DL MAC header type setting when MAC-I is configured	9.3.0
	RP-48	RP-100537	4126	-		Clarification of Tx interruption after trigger handling for Enhanced Uplink in CELL_FACH state and Idle mode	9.3.0
	RP-48	RP-100538	4129	-		Correct the inconsistency between tabular and ASN.1 for "Support of CSG" in "UE radio access capability"	9.3.0
	RP-48	RP-100539	4131	1		Correction to the E-RUCCH transmission on the secondary frequency during RRC state transition for 1.28 Mcps TDD	9.3.0
	RP-48	RP-100532	4134	1		Handling of RRC Unrecoverable Error in Enhanced CELL_FACH	9.3.0
	RP-48	RP-100551	4137	-		Prohibit timer for proximity indication	9.3.0
	RP-48	RP-100556	4138	-		Clarification to cell reselection to E-UTRA enhancement	9.3.0
	RP-48	RP-100539	4141	-		Addition of UpPCH position info in enhanced CELL_FACH	9.3.0
	RP-48	RP-100539	4144	2		Clarification on the usage of Treset for 1.28 Mcps TDD	9.3.0
	RP-48	RP-100544	4146	-		Addition of UE capability in INTER RAT HANDOVER INFO for LCR TDD	9.3.0
	RP-48	RP-100534	4149	-		Clarification on UE radio access capability in ASN1 for LCR TDD	9.3.0
	RP-48	RP-100551	4153	-		Correct the Inconsistency between Tabular and ASN.1 for CSG Inbound Mobility Capability	9.3.0
	RP-48	RP-100557	4154	-		Correct the Inconsistency between Tabular and ASN.1 for Device type	9.3.0
	RP-48	RP-100550	4155	-		Dual Cell E-DCH operation correction	9.3.0
	RP-48	RP-100532	4161	-		Clarification on the HS-DSCH reception in enhanced CELL_FACH state	9.3.0
	RP-48	RP-100549	4169	-		Support MAC-ehs in Single Stream MIMO case	9.3.0
	RP-48	RP-100541	4174	-		Enhanced serving cell change - allowing update of the secondary freq for HICH/RGCH other RL	9.3.0
	RP-48	RP-100545	4176	-		Enhanced serving cell Change - allowing the re-addition of a RL in order to update target cell preconfiguration information	9.3.0

	RP-48	RP-100543	4183	1		Clarification of active set for secondary serving HS-DSCH cell	9.3.0
	RP-48	RP-100544	4187	-		Clarification on SRVCC	9.3.0
	RP-48	RP-100532	4189	-		Clarification on the traffic volume measurement in CELL_PCH state	9.3.0
06/2010	RP-48	-				v10.0.0 created based on v9.3.0	10.0.0
	RP-48	RP-100560	4190	-		Preparation for reusing REL-8/9 DL signalling options in REL-10	10.0.0
09/2010	RP-49	RP-100844	4194	-		Incorrect inconsistency check on MAC-ehs reordering queue	10.1.0
	RP-49	RP-100850	4200	-		Correction to VAS updating	10.1.0
	RP-49	RP-100858	4202	-		Clarification of primary uplink frequency and secondary uplink frequency	10.1.0
	RP-49	RP-100856	4206	-		Correction to MIMO_STATUS and SECONDARY_CELL_MIMO_STATUS setting for Single Stream MIMO	10.1.0
	RP-49	RP-100862	4207	-		Introduction of Rel-10 access stratum release indicator	10.1.0
	RP-49	RP-100842	4218	-		Correction to missing ASN.1 for MIMO parameters	10.1.0
	RP-49	RP-100850	4221	-		Correction to deferred SIB11 reading	10.1.0
	RP-49	RP-100859	4223	-		Pre-redirectio n info setting after the redirection/CSFB from E-UTRA	10.1.0
	RP-49	RP-100841	4240	-		Flexible RLC only applies to user RB, not SRB	10.1.0
	RP-49	RP-100883	4245	-		LI size for CCCH(SRB#0) in enhanced CELL_FACH operation	10.1.0
	RP-49	RP-100910	4250	1		Small Technical Enhancements and Improvements for GNSS	10.1.0
	RP-49	RP-100863	4251	1		Introduction of 4C-HSDPA in 25.331	10.1.0
	RP-49	RP-100855	4259	-		Update of virtual active set handling for inter-frequency CSG measurements	10.1.0
	RP-49	RP-100844	4271	-		Correction to default radio configuration #20	10.1.0
	RP-49	RP-100844	4275	-		Clarifications to the intra-frequency measurement event for 1.28Mcps TDD	10.1.0
	RP-49	RP-100858	4286	1		Correction to the state of the secondary uplink frequency in case of hard handover	10.1.0
	RP-49	RP-100846	4289	1		Explicit HARQ Memory partitioning for dual cell operation	10.1.0
	RP-49	RP-100862	4292	-		Editorial Corrections to 25.331	10.1.0
	RP-49	RP-100850	4295	-		Correction to default configuration #23	10.1.0
	RP-49	RP-100862	4296	2		UE supported Frequency band indicator for redirection in RRC CONNECTION REQUEST	10.1.0
	RP-49	RP-100842	4301	-		Clarification of when to clear IE Precoding weight set restriction" from MIMO_PARAMS"	10.1.0
	RP-49	RP-100862	4305	-		Editorial changes for MIMO and storing of E-RGCH information	10.1.0
	RP-49	RP-100862	4308	-		Use of Navigational Model Additional data	10.1.0
	RP-49	RP-100848	4311	1		Security procedures for intra-UTRAN SR-VCC	10.1.0
	RP-49	RP-100851	4315	1		Clarification of FGI setting for inter-RAT features not supported by the UE	10.1.0
	RP-49	RP-100851	4318	1		Removal of SRB only PS handover	10.1.0
	RP-49	RP-100859	4322	-		Introduction of system information container indication	10.1.0
12/2010	RP-50	RP-101205	4331	-		Addition of ROHC target mode in SRNS relocation message	10.2.0
	RP-50	RP-101201	4334	-		Clarification of the operation of RRC for 3.84 Mcps TDD IMB MBSFN	10.2.0
	RP-50	RP-101200	4337	-		Correction on actions related to HSPA_RNTI_STORED_CELL_PCH	10.2.0
	RP-50	RP-101202	4339	-		Correction on CS voice over HSPA SDU discard timer configuration	10.2.0
	RP-50	RP-101200	4342	-		Correction on READY_FOR_COMMON_EDCH definition	10.2.0
	RP-50	RP-101366	4343	-		Correction to the absence of IE additional Cells in 4C-HSDPA	10.2.0
	RP-50	RP-101206	4345	1		Correction to the limitation of SI acquisition	10.2.0
	RP-50	RP-101198	4348	-		CR on T324 timer usage	10.2.0
	RP-50	RP-101199	4351	-		Power offset for Scheduling Info in MAC-i	10.2.0
	RP-50	RP-101366	4352	2		Some clarifications of 4C-HSDPA behavior	10.2.0
	RP-50	RP-101213	4353	1		Some legacy editorial corrections for TEI10	10.2.0
	RP-50	RP-101213	4354	-		Speed dependent scaling rules in HCS environment	10.2.0
	RP-50	RP-101203	4357	-		UE behaviour when PPAC and DSAC parameters not present in SIB3	10.2.0
	RP-50	RP-101204	4360	-		Corrections to ETWS primary notification with security procedure	10.2.0
	RP-50	RP-101205	4369	1		Correction related to inter-RAT and inter-frequency measurements on a frequency other than the used frequency	10.2.0
	RP-50	RP-101213	4375	-		RLC reset on a Signalling Radio Bearer	10.2.0
	RP-50	RP-101366	4382	-		Corrections on 25.331 for 4C-HSDPA	10.2.0
	RP-50	RP-101219	4383	-		Introduction of MU-MIMO for LCR TDD in 25.331	10.2.0
	RP-50	RP-101200	4386	3		SIB5 changes for E-DCH in CELL_FACH and Idle Mode	10.2.0
	RP-50	RP-101264	4393	1		Procedural text to support measurements in the Secondary UL Frequency	10.2.0
	RP-50	RP-101211	4394	3		Precoding weight set restriction setting for secondary cells	10.2.0
	RP-50	RP-101200	4397	-		RRC procedure performance requirements for Enhanced Uplink in CELL_FACH	10.2.0
	RP-50	RP-101213	4398	-		Addition of Rel-10 critical extension in SRNS relocation message adding ROHC target mode	10.2.0

	RP-50	RP-101212	4400	-	Addition of UE ROHC capability in IRAT handover	10.2.0
	RP-50	RP-101365	4403	2	Introduction of MCHSUPA for 1.28Mcsp TDD	10.2.0
	RP-50	RP-101200	4406	-	Correction of HSPA_RNTI_STORED_CELL_PCH handling	10.2.0
	RP-50	RP-101220	4407	1	Introduction of detected set measurements and reporting for Inter-frequency	10.2.0
	RP-50	RP-101198	4411	1	Clarifications for deletion of target cell preconfiguration for existing RL by ASU	10.2.0
	RP-50	RP-101366	4419	1	Corrections to 4C-HSDPA	10.2.0
	RP-50	RP-101213	4427	-	Enhanced Security Mode procedure handling in case of delayed L2 ACK	10.2.0
	RP-50	RP-101200	4434	2	Further corrections on actions related to HSPA_RNTI_STORED_CELL_PCH	10.2.0
03/2011	RP-51	RP-110267	4437	-	Change in the radio bearer mapping due to a system info message	10.3.0
	RP-51	RP-110276	4438	-	Clarification on MU-MIMO capability for LCR TDD	10.3.0
	RP-51	RP-110268	4441	-	Clarification on UE behavior after transtion to enhanced CELL_FACH for LCR TDD	10.3.0
	RP-51	RP-110267	4444	-	Correction of RB mapping option selection for HSPA_RNTI_STORED_CELL_PCH	10.3.0
	RP-51	RP-110274	4446	1	Correction to system information container reference	10.3.0
	RP-51	RP-110268	4449	-	Correction on Scheduling Info parameters for LCR TDD	10.3.0
	RP-51	RP-110279	4450	-	Correction to SRNC relocation asn1 to include Rel-10 measurement types	10.3.0
	RP-51	RP-110266	4453	-	Inconsistency between ASN.1 and tabular format for Active Set Update message	10.3.0
	RP-51	RP-110264	4457	-	PCI Weight set restriction logic	10.3.0
	RP-51	RP-110264	4458	-	RB mapping 'DCH + HS-DSCH' for MAC-ehs	10.3.0
	RP-51	RP-110274	4460	-	Removal of inappropriate comment in ASN.1 for RSRQ based cell reselection parameters	10.3.0
	RP-51	RP-110282	4461	1	UE Capabilities for MDT	10.3.0
	RP-51	RP-110264	4465	-	Use of New H-RNTI in UMI message in CELL_DCH state	10.3.0
	RP-51	RP-110268	4469	-	Handling of variables "PPAC_PARAM" and "DSAC_PARAM"	10.3.0
	RP-51	RP-110264	4476	-	Reconfiguration messages and HS-SSCH orders interaction for DTX/DRX	10.3.0
	RP-51	RP-110277	4482	-	Introduction of a capability indication for the Inter-frequency Detected Set feature	10.3.0
	RP-51	RP-110266	4495	-	Clarification of invalid configuration for enhanced serving HS-DSCH cell change	10.3.0
	RP-51	RP-110279	4496	-	Addition of MAC-ehs in total RLC AM buffer size in RLC capability	10.3.0
	RP-51	RP-110271	4511	-	Correction to CSG Intra-frequency cell info	10.3.0
	RP-51	RP-110286	4512	-	25331_CRxxxx Support of Delay Tolerant access requests	10.3.0
	RP-51	RP-110281	4515	1	Corrections for the configuration of frequencies to measure without CM	10.3.0
	RP-51	RP-110274	4519	3	Correction of conditionally included content in SI container	10.3.0
	RP-51	RP-110279	4520	-	Extend the carrier capability for Multi-Carrier HSDPA for 1.28Mcps TDD	10.3.0
	RP-51	RP-110274	4523	-	Clarification to the measurement occasion of E-FACH for 1.28Mcps TDD	10.3.0
	RP-51	RP-110268	4526	-	Clarification to the intra and inter frequency measurement in E-FACH for 1.28Mcps	10.3.0
	RP-51	RP-110282	4533	2	Introduction of Minimization of Drive Tests	10.3.0
	RP-51	RP-110266	4542	-	Correction of target cell preconfiguration info handling upon reconfiguration	10.3.0
	RP-51	RP-110268	4558	-	Negative values in a 'mod' function	10.3.0
	RP-51	RP-110274	4562	1	Clarification of RRC CONNECTION REJECT with redirection	10.3.0
	RP-51	RP-110422	4565	1	Dual Band Dual Cell MIMO only Release 10 UE not 3C or 4C capable	10.3.0
	RP-51	RP-110279	4566	-	Adding the default Configuration for 12.2/7.4/5.9/4.75 kbps speech + 3.4 kbps (without SRB#5)	10.3.0
	RP-51	RP-110274	4568	-	Rel-8 FGI handling in Rel-9	10.3.0
	RP-51	RP-110266	4571	1	Correction related to handling of DTX, DRX HS-SCCH orders upon enhanced serving cell change	10.3.0
	RP-51	RP-110189	4576	-	Signalling for new band indicator 3	10.3.0
04/2011	-	-	-	-	Correction (to 10.2.36, "LoggedMeasGSMNeighbourCellsList" in 11.3 and to 13.4.0) as wrong specification file was uploaded.	10.3.1
06/2011	RP-52	RP-110838	4579	-	Clarification to setting of dedicated priorities	10.4.0
	RP-52	RP-110829	4582	1	Correction for SR-VCC Parameter Setting	10.4.0
	RP-52	RP-110838	4583	-	Correction to enhanced security mode procedure handling when waiting for delayed L2 ACK	10.4.0
	RP-52	RP-110831	4585	1	Correction to the CELL_DCH measurement occasion for 1.28Mcps TDD	10.4.0
	RP-52	RP-110825	4586	2	Correction to the E-PUCH TS configuration list for 1.28Mcps TDD	10.4.0
	RP-52	RP-110829	4592	-	Correction to the HS-SCCH system info for 1.28Mcps TDD	10.4.0
	RP-52	RP-110829	4595	-	Corrections to T321 and enhanced UE DRX operation upon transition to CELL_FACH state	10.4.0
	RP-52	RP-110829	4598	-	Fast Dormancy correction for releasing radio bearers	10.4.0

	RP-52	RP-110829	4601	1		Further clarification on UE behavior during state transition from CELL_PCH/URA_PCH to CELL_FACH	10.4.0
	RP-52	RP-110837	4602	1		Introduction of extended wait timer in Signalling Connection Release	10.4.0
	RP-52	RP-110826	4606	-		Handling of START value due to an RLC reestablishment when DL RLC PDU size is reconfigured from fixed to flexible with 15-bit LI	10.4.0
	RP-52	RP-110825	4607	1		Removing RoHC discrepancy	10.4.0
	RP-52	RP-110830	4609	1		Reporting of CSG VAS cell in case of CSG Inter-frequency Measurements	10.4.0
	RP-52	RP-110825	4610	1		Tabular and ASN.1 alignment: MBMS	10.4.0
	RP-52	RP-110843	4611	-		TCE ID parameter for logged MDT	10.4.0
	RP-52	RP-110837	4612	-		Updated value range for the Extended Wait Timer	10.4.0
	RP-52	RP-110838	4613	-		Clarification on PICH codes list for LCR TDD	10.4.0
	RP-52	RP-110838	4614	-		Correction of the mismatched names between ASN.1 and tabular for 1.28Mcps TDD	10.4.0
	RP-52	RP-110826	4626	-		Clarification to the number of HARQ processes in HSDPA when switching between MIMO and non-MIMO	10.4.0
	RP-52	RP-110829	4632	-		Reconfiguration messages and HS-SSCH orders interaction for DC-HSDPA	10.4.0
	RP-52	RP-110827	4634	-		Void IE 'Use special value of HE field'	10.4.0
	RP-52	RP-110831	4637	1		Alignment of Tabular and ASN.1 for SNRS Relocation	10.4.0
	RP-52	RP-110825	4642	-		Corrections to the selection of RB multiplexing option	10.4.0
	RP-52	RP-110829	4649	1		Correction of actions related to TARGET_CELL_RECONFIGURATION variable	10.4.0
	RP-52	RP-110829	4652	1		Clearance of the stored frequency info for measure without CM	10.4.0
	RP-52	RP-110829	4657	1		Correction to SIB5 5bis and SIB6 handle for Enhanced Uplink	10.4.0
	RP-52	RP-110842	4658	1		Introduction of UTRAN Automatic Neighbor Relation	10.4.0
	RP-52	RP-110828	4661	1		Corrections to detection of E-UTRA cell	10.4.0
	RP-52	RP-110843	4662	1		Clarification on PLMN checking for MDT logging	10.4.0
	RP-52	RP-110838	4669	1		Corrections related to UTRA REL-10 25.331 ASN.1 issues	10.4.0
	RP-52	RP-110833	4671	-		Correction to the Standalone Midamble Information for 1.28Mcps TDD	10.4.0
	RP-52	RP-110825	4673	-		Tabular and ASN.1 alignment: new-DSCH-RNTI	10.4.0
	RP-52	RP-110829	4674	1		Correction to the physical channel failure in CELL_UPDATE_CONFIRM for 1.28Mcps TDD	10.4.0
	RP-52	RP-110838	4678	-		Procedure text for addition of new band indicator 3 and change of the ASN.1 type	10.4.0
	RP-52	RP-110841	4680	2		Correction to 4C-HSDPA to support signaling for non-adjacent aggregation	10.4.0
	RP-52	RP-110832	4690	-		Introduction of measurement ID extension	10.4.0
	RP-52	RP-110844	4694	1		Addition of new band XXV (Expanded 1900 MHz Band), plus Procedure text for addition of new band indicator 3 and change of the ASN.1 type	10.4.0
	RP-52	RP-110838	4698	1		Introduction of the frequency specific compressed mode	10.4.0
	RP-52	RP-110744	4699	-		Correction to Cell Change Order	10.4.0
09/2011	RP-53	RP-111284	4700	-		Clarification on dual band capability in 4CHSDPA	10.5.0
	RP-53	RP-111275	4705	1		Target cell HS-SCCH order handling	10.5.0
	RP-53	RP-111285	4718	-		Update to RRC performance values for UE Information procedure	10.5.0
	RP-53	RP-111286	4720	1		25.331 CR including ePLMN support for ANR	10.5.0
	RP-53	RP-111285	4726	2		Cleanup corrections for ANR Stage 3 behaviors	10.5.0
	RP-53	RP-111284	4727	-		Missing PWR entries in SECONDARY_CELL_MIMO_PARAMS variable	10.5.0
	RP-53	RP-111274	4731	2		Clarification on Uplink DPCH power control info for Common E-DCH	10.5.0
	RP-53	RP-111278	4748	1		25.331 correction on CSG identity validity to allow introduction of CSG RAN sharing	10.5.0
	RP-53	RP-111284	4755	-		Limit the 4C-HSDPA non-contiguous operation to one band only	10.5.0
	RP-53	RP-111271	4757	-		Correction to HS-DSCH reception in CELL_FACH	10.5.0
	RP-53	RP-111282	4759	1		Clarification of the Pre-Redirection info setting after the redirection from E-UTRA	10.5.0
	RP-53	RP-111293	4761	-		CN Domain for eWaitTime	10.5.0
	RP-53	RP-111276	4770	-		Disabling default configuration 17,23 in Handover To UTRAN Command	10.5.0
	RP-53	RP-111274	4775	-		Use of New E-RNTI in UMI message	10.5.0
	RP-53	RP-111275	4779	3		Removal of AS ETWS duplicate detection	10.5.0
	RP-53	RP-111274	4782	2		PPAC corrections	10.5.0
	RP-53	RP-111274	4785	-		Correction to the SPS resource configuration for 1.28Mcps TDD	10.5.0
	RP-53	RP-111217	4788	1		Memory partitioning for HARQ with simultaneous MIMO and non-MIMO operation in multi-carrier HS-DSCH operation	10.5.0
	RP-53	RP-111277	4802	1		Fast dormancy upon RRC Connection Release	10.5.0
	RP-53	RP-111296	4803	-		Completing the addition of new band indicator 3	10.5.0
	RP-53	RP-111294	4804	-		Add Band XXII for LTE/UMTS 3500 (FDD) to TS 25.331	10.5.0
	RP-53	RP-111275	4805	2		Clarification of RDI indicator of E-AGCH info 1.28Mcps TDD	10.5.0

12/2011	RP-54	RP-111708	4808	-		Correction on the measurement configuration validation for SFN reading	10.6.0
	RP-54	RP-111706	4812	-		Corrections of PS keys handling upon PS ISHO	10.6.0
	RP-54	RP-111702	4813	-		Delete E-HICH, E-RGCH, E-AGCH information when E_DCH is stopped	10.6.0
	RP-54	RP-111701	4822	-		Correction to Default Radio Configurations for TDD: number of TFCI coding bits	10.6.0
	RP-54	RP-111711	4829	-		Clarification of PSC range for CSG cells	10.6.0
	RP-54	RP-111715	4830	-		Alignment of the text description for SIB 18 for UEs in idle mode and connected mode	10.6.0
	RP-54	RP-111715	4833	1		Improved Deferred Measurement Control Reading	10.6.0
	RP-54	RP-111715	4836	-		25.331 trivial corrections	10.6.0
	RP-54	RP-111715	4846	-		Introduction of the frequency specific compressed mode	10.6.0
	RP-54	RP-111703	4864	1		Clarification to the handling of HS-DSCH TB size table	10.6.0
	RP-54	RP-111704	4873	1		Correction of BCCH mapping on HS-DSCH	10.6.0
	RP-54	RP-111713	4874	2		Addressing the issue of inconsistent HARQ memory partitioning for high-peak-rate UEs	10.6.0
	RP-54	RP-111715	4884	1		Correction about the presence of Security Revert Status Indicator in CELL UPDATE Message	10.6.0
	RP-54	RP-111719	4886	1		Support early implementation of uplink OLTD in Rel-10	10.6.0
12/2011	RP-54	-	-	-		TS 25.331 v11.0.0 created based on v10.6.0	11.0.0
	RP-54	RP-111717	4831	1		Introduction of 8C-HSDPA in 25.331	11.0.0
	RP-54	RP-111718	4847	1		Introduction of uplink CLTD in 25.331	11.0.0
	RP-54	RP-111719	4848	1		Introduction of uplink OLTD in 25.331	11.0.0
03/2012	RP-55	RP-120329	4891	-		Specification Cleanup: removal of DRAC left over	11.1.0
	RP-55	RP-120328	4909	-		Addition of new band XXVI (Extending 850 MHz Upper Band (814 - 849 MHz))	11.1.0
	RP-55	RP-120327	4911	1		Additional value for Total RLC AM Buffer Size	11.1.0
	RP-55	RP-120320	4921	2		Clarification on stored HARQ info when HS-DSCH reception is not supported	11.1.0
	RP-55	RP-120321	4929	-		Correction to 25.331 on Cell Reselection enhancements (Rel-11)	11.1.0
	RP-55	RP-120320	4935	-		Clarifications of the UE behaviours when initiating a cell update procedure	11.1.0
	RP-55	RP-120322	4953	-		Correction of default radio configurations in CELL_FACH	11.1.0
06/2012	RP-56	RP-120815	4955	2		Extend the carrier capability for two-carrier HSDPA for 1.28Mcps TDD	11.2.0
	RP-56	RP-120803	4959	-		Reconfiguration messages and HS-SCCH orders interaction for HS-SCCH less	11.2.0
	RP-56	RP-120806	4967	-		Corrections regarding the UE behaviour on evaluating the variable HSPA_RNTI_STORED_CELL_PCH	11.2.0
	RP-56	RP-120806	4971	-		Clarifications of the UE behaviours when initiating a cell update procedure for 1.28Mcps TDD	11.2.0
	RP-56	RP-120806	4975	-		Corrections on DSAC and PPAC	11.2.0
	RP-56	RP-120804	4981	-		Correction of SRB1 mapping info for FACH	11.2.0
	RP-56	RP-120809	4984	-		Clarification on default radio configuration in CELL_FACH	11.2.0
	RP-56	RP-120809	4987	-		Correction to the secondary uplink frequency activation state after reconfiguration procedure	11.2.0
	RP-56	RP-120809	4989	-		Clarification of capability signaling for UE supporting DB-DC-HSDPA with MIMO	11.2.0
	RP-56	RP-120825	4991	1		Modification of security context storage rate on the UICC	11.2.0
	RP-56	RP-120814	4993	-		Correction of nesting levels greater than 15 in ASN.1 for RRC Message HandoverToUTRANCommand	11.2.0
	RP-56	RP-120825	4999	1		SRVCC radio bearer combination	11.2.0
	RP-56	RP-120809	5006	1		Clarifications on the event measurement report for DC-HSUPA	11.2.0
	RP-56	RP-120808	5029	1		Introduction of a CSFB Indicator in RRC Connection Request	11.2.0
	RP-56	RP-120825	5044	-		Corrections to per-band capability signalling	11.2.0
	RP-56	RP-120825	5057	-		Editorial updates to 25.331	11.2.0
	RP-56	RP-120731	5063	1		Introduction of multiple frequency band indicator	11.2.0
09/2012	RP-57	RP-121369	5071	1		Introduction of Multiflow in TS 25.331	11.3.0
	RP-57	RP-121382	5079	-		CR to 25.331 on quasi-fast return	11.3.0
	RP-57	RP-121363	5081	-		Correction on the carrier capability for two-carrier HSDPA for 1.28Mcps TDD	11.3.0
	RP-57	RP-121365	5082	-		Correction on HARQ memory partitioning for 8C-HSDPA	11.3.0
	RP-57	RP-121366	5083	1		Miscellaneous corrections for UL CLTD	11.3.0
	RP-57	RP-121367	5084	-		Remove the event 6D modifications for UL OLTD	11.3.0
	RP-57	RP-121371	5085	-		Introduction of EAB	11.3.0
	RP-57	RP-121422	5091	2		Adding the missing MAC-ehs window size values for 9bits TSN option in 1.28Mcps TDD	11.3.0
	RP-57	RP-121357	5120	-		Re-introduction of default configuration #23	11.3.0

	RP-57	RP-121382	5125	-		Addition of missing IE 'Include in Scheduling Info' in default configuration #17	11.3.0
	RP-57	RP-121428	5129	1		Introduction of MDT enhancements	11.3.0
	RP-57	RP-121359	5130	-		Voice support Capabilities	11.3.0
	RP-57	RP-121365	5142	-		Correction for 8C-HSDPA backwards compatibility	11.3.0
	RP-57	RP-121368	5149	-		Introduction of absolute priority based measurements and reselection in CELL_FACH State in 25.331	11.3.0
	RP-57	RP-121382	5154	-		Introduction of Extended S-RNTI	11.3.0
	RP-57	RP-121383	5168	-		Aligning START value handling when entering idle mode from connected	11.3.0
	RP-57	RP-121363	5174	1		RRC Connection Release: search time for E-UTRA signaled frequencies	11.3.0
	RP-57	RP-121361	5182	-		Correction on the NOTE of IE 'Common E-DCH system info'	11.3.0
	RP-57	RP-121366	5183	1		Remove the event 6D modifications for UL CLTD	11.3.0
12/2012	RP-58	RP-121925	5190	-		Clarification to the handling of IE Different Tx diversity mode configuration from serving HS-DSCH cell	11.4.0
	RP-58	RP-121925	5194	-		Corrections to intra-UTRAN SR-VCC handover procedure	11.4.0
	RP-58	RP-121934	5197	1		Correction to non-backwards compatible ASN.1	11.4.0
	RP-58	RP-121937	5199	-		Clarification to logging of PLMN identity in ANR	11.4.0
	RP-58	RP-121937	5201	-		Corrections to Inter-frequency detected set measurements	11.4.0
	RP-58	RP-121925	5203	-		Removal of SR-VCC triggered by cell update confirm	11.4.0
	RP-58	RP-121941	5206	-		Clarification of absolute priority based measurements and reselection in CELL_FACH State	11.4.0
	RP-58	RP-121957	5207	-		Clarification on the setting of CSFB Indicator in RRC Connection Request	11.4.0
	RP-58	RP-121946	5208	-		Clarifications for Logging of Connection Establishment Failure Information	11.4.0
	RP-58	RP-121943	5209	-		Correction to ACK-NACK repetition factor for Multiflow assisting cells	11.4.0
	RP-58	RP-121957	5210	-		Correction to the IE 'Timing maintained Synchronization indicator' for F-DPCH	11.4.0
	RP-58	RP-121819	5211	1		CR to 25.331 on the Introduction of rSRVCC feature	11.4.0
	RP-58	RP-121942	5212	2		Introduction of 4Tx-HSDPA in 25.331	11.4.0
	RP-58	RP-121943	5213	-		Introduction of additional values for DeltaACK and DeltaNACK	11.4.0
	RP-58	RP-121941	5214	2		Introduction of Further Enhancements to CELL_FACH in 25.331	11.4.0
	RP-58	RP-121945	5215	3		Introduction of UL MIMO with 64QAM in TS 25.331	11.4.0
	RP-58	RP-121943	5216	-		Correction to MAC-hs reset procedure for Multiflow	11.4.0
	RP-58	RP-121943	5217	-		Correction to the indications of multiflow timing	11.4.0
	RP-58	RP-121958	5218	-		Inter-RAT Treselection enhancement	11.4.0
	RP-58	RP-121957	5219	-		Rapporteur's corrections for 25.331 RRC specification	11.4.0
	RP-58	RP-121922	5221	1		Clarification on UE support and prioritisation between bands for Multiple Frequency Band Indicators	11.4.0
	RP-58	RP-121937	5231	1		Removal of invalid condition to stop ANR logging duration timer T327	11.4.0
	RP-58	RP-121957	5233	-		Removing UE behavior discrepancy in case of radio link failure during ongoing reconfiguration	11.4.0
	RP-58	RP-121923	5234	-		Introduction of enhanced serving cell change for UL 16QAM and UL 64QAM	11.4.0
	RP-58	RP-121937	5239	-		Introduction of UM RLC re-establishment via reconfiguration	11.4.0
	RP-58	RP-121935	5243	-		Introduction of a periodic measurement for DC-HSUPA	11.4.0
	RP-58	RP-121937	5252	2		CR to 25.331 on Allow network to exclude some cells being detected and reported in intra&inter-freq detected set operation	11.4.0
	RP-58	RP-121925	5259	-		Correction on the deactivation of the secondary cell reception	11.4.0
	RP-58	RP-121957	5262	-		Correction to the variable SYSTEM_INFORMATION_CONTAINER	11.4.0
	RP-58	RP-121957	5265	-		Delay in checking SRB 1-4 mapping on PCH to FACH transition	11.4.0
	RP-58	RP-121937	5266	1		Range of Logging Relative Threshold for UTRAN ANR	11.4.0
	RP-58	RP-121946	5271	-		Removing the IE Contention Detected in Accessibility Measurement(option 3)	11.4.0
	RP-58	RP-121958	5272	1		Introduction of wideband RSRQ measurements	11.4.0
	RP-58	RP-121934	5275	-		Correction to INTER RAT HANDOVER INFO for UMTS TDD/FDD capable UE	11.4.0
	RP-58	RP-121958	5285	-		Introduction of Inter-frequency measurements on configured carriers without compressed mode	11.4.0
	RP-58	RP-121923	5287	-		Corrections to Cell Update when Cell Update message size exceeds the used transport format size	11.4.0
03/2013	RP-59	RP-130229	5296	1		CR to 25.331 on PRACH preamble control parameters for Enhanced Uplink (R11)	11.5.0
	RP-59	RP-130229	5300	1		Clarification to RRC padding for CCCH transmission in case of EUL FACH	11.5.0
	RP-59	RP-130249	5301	-		Additional value for Total RLC AM Buffer Size	11.5.0
	RP-59	RP-130232	5304	-		Correct the variable in the "Actions related to SECONDARY_CELL_MIMO_STATUS variable"	11.5.0
	RP-59	RP-130235	5309	1		Correction to measured results on RACH in Cell Update message	11.5.0

	RP-59	RP-130249	5310	-	Addition of Cell Update message with optimised encoding	11.5.0
	RP-59	RP-130246	5311	1	Rel-11 ASN.1 Review corrections	11.5.0
	RP-59	RP-130248	5315	1	Handling of Roaming Subscribers in case of RRC Connection Reject	11.5.0
	RP-59	RP-130237	5316	-	Extending E-UTRA Frequency Band and EARFCN value range	11.5.0
	RP-59	RP-130239	5319	-	Miscellaneous corrections for Further Enhancements to CELL_FACH in 25.331	11.5.0
	RP-59	RP-130229	5323	-	Corrections of the UE behavior when variable E_RNTI is not set in CELL_PCH state	11.5.0
	RP-59	RP-130232	5326	1	Evaluation of SECONDARY_CELL_E_DCH_TRANSMISSION variable	11.5.0
	RP-59	RP-130232	5329	1	Inconsistency between ASN.1 and tabular on the presence of the IE 'frequency info'	11.5.0
	RP-59	RP-130236	5330	-	Extend 3G ANR Applicable RRC State	11.5.0
	RP-59	RP-130229	5335	-	UE behavior at activation and deactivation of Enhanced Uplink in CELL_FACH state in SIB5/5bis	11.5.0
	RP-59	RP-130239	5337	-	Clarification on rSRVCC	11.5.0
	RP-59	RP-130247	5339	-	Corrections on definition of CSG member cell for UMTS	11.5.0
	RP-59	RP-130239	5342	1	Miscellaneous corrections to 25.331 on further enhancements to CELL_FACH	11.5.0
	RP-59	RP-130228	5344	-	Invalidation of ETWS with security feature	11.5.0
	RP-59	RP-130239	5346	-	Introducing an indication for support of the extended range of HS-DPCCH power offset	11.5.0
	RP-59	RP-130240	5347	-	Optional Support of Accessibility Measurements Feature	11.5.0
	RP-59	RP-130249	5357	1	Introduction of wideband RSRQ measurements in Idle mode	11.5.0
	RP-59	RP-130239	5359	1	Extending the range of the 2 nd DRX cycle length	11.5.0
	RP-59	RP-130248	5360	1	Behaviour in case of excessive dedicated priority information	11.5.0
	RP-59	RP-130229	5362	-	Clarification of the IE 'Scheduled Transmission configuration' in Enhanced Uplink in CELL_FACH state	11.5.0
	RP-59	RP-130228	5364	-	Prohibit PS connection setup while SIB3 is being updated	11.5.0
	RP-59	RP-130239	5365	-	FE-FACH corrections on PRACH selection	11.5.0
	RP-59	RP-130225	5367	-	Invalid measurement configuration with different (E)ARFCN	11.5.0
	RP-59	RP-130229	5370	-	Clarification on available signature ordering in common E-DCH	11.5.0
	RP-59	RP-130249	5371	1	Introduction of the frequency specific compressed mode for the intra-band non-contiguous operation	11.5.0
	RP-59	RP-130239	5372	1	Simultaneous operation of Multiflow HSDPA and STTD	11.5.0
	RP-59	RP-130248	5373	-	Introduction of Cells excluded from detected set measurements capability signalling	11.5.0
	RP-59	RP-130349	5375	1	Correction to non-backwards compatible asn1 1.28Mcps TDD	11.5.0
06/2013	RP-60	RP-130804	5377	-	Clarification on UE Information procedure	11.6.0
	RP-60	RP-130809	5378	-	Corrections to Extended E-UTRA Frequency Band and EARFCN value ranges	11.6.0
	RP-60	RP-130806	5379	-	SIB7 reading and 2 nd DRX in CELL_FACH	11.6.0
	RP-60	RP-130802	5384	-	LI size and Flexible RLC PDUs in uplink	11.6.0
	RP-60	RP-130807	5391	-	Clarification on Inter-RAT handover to UTRAN	11.6.0
	RP-60	RP-130807	5402	-	Clarification of the security configuration after simultaneous CS and PS inter-RAT Handover	11.6.0
	RP-60	RP-130802	5403	-	Correction for PS connection setup prohibition while SIB3 is being updated	11.6.0
	RP-60	RP-130809	5408	-	Correction to Cell Update message with optimised encoding	11.6.0
	RP-60	RP-130805	5416	-	Corrections to UE selection of legacy frequency band for Multiple Frequency Band Indicators	11.6.0
	RP-60	RP-130806	5417	-	Correction of semantics description of PRACH preamble control parameters extension list Type 1	11.6.0
	RP-60	RP-130806	5423	-	Renumbering of "Available Signatures" for FE-FACH	11.6.0
	RP-60	RP-130802	5430	1	Clarification for the support of DC-HSDPA	11.6.0
09/2013	RP-61	RP-131313	5435	-	Clarification of MAC header combination when MAC-i is configured	11.7.0
	RP-61	RP-131320	5438	-	Rapporteurs corrections for 25.331 RRC specification	11.7.0
	RP-61	RP-131320	5441	-	Clarification on Deferred Measurement Control Reading	11.7.0
	RP-61	RP-131314	5444	1	Physical Channel establishment and Radio Link Failure on the secondary uplink frequency	11.7.0
	RP-61	RP-131316	5447	1	Correction of description for PRACH selection when 'weight' is in use	11.7.0
	RP-61	RP-131316	5449	1	Correction of concurrent deployment of 2ms and 10ms TTI	11.7.0
	RP-61	RP-131316	5450	-	Correction for SIB7 reading and 2 nd DRX in CELL_FACH	11.7.0
	RP-61	RP-131311	5451	-	Introduction of UE capability signalling for wideband RSRQ measurements	11.7.0
	RP-61	RP-131313	5454	-	Delete Access Class barred List, DSAC and PPAC information upon SRNS relocation	11.7.0
	RP-61	RP-131320	5466	-	Expand the EUTRA measurement capability list	11.7.0
	RP-61	RP-131310	5472	2	Applying MAC-hs/ehs reset for state transition	11.7.0

12/2013	RP-62	RP-131985	5475	-		Corrections of intra-frequency and inter-frequency measurements for DC-HSUPA	11.8.0
	RP-62	RP-131981	5477	-		Further corrections on MFBI related issues	11.8.0
	RP-62	RP-131981	5479	-		Introduction of capability bit for E-UTRA Multiple Frequency Band Indicators	11.8.0
	RP-62	RP-131992	5480	-		Adding EARFCN extension to the variable EUTRA_FREQUENCY_INFO_LIST_FACH	11.8.0
	RP-62	RP-131992	5481	-		Clarification for stopping the RLC Timer_Reordering timer	11.8.0
	RP-62	RP-131993	5482	-		Clarification on MDT Accessibility Measurements discard	11.8.0
	RP-62	RP-131995	5483	-		Cleanup of wideband RSRQ measurement capability	11.8.0
	RP-62	RP-131995	5488	-		Rapporteur corrections for 25.331 RRC specification	11.8.0
	RP-62	RP-131992	5489	-		Clarification on handling for 'EARFCN extension' IE in E-UTRA measurement for CELL_FACH	11.8.0
	RP-62	RP-131990	5492	-		Corrections for the UE variable SECONDARY_CELL_HS_DSCH_RECEPTION	11.8.0
	RP-62	RP-131982	5498	1		Correction to Galileo assistance data elements	11.8.0
	RP-62	RP-131983	5499	1		Clarification on the SR-VCC and rSR-VCC procedure definition	11.8.0
	RP-62	RP-131992	5501	-		Clarification for repeated fast dormancy requests with 2 nd DRX cycle in CELL_FACH	11.8.0
	RP-62	RP-132004	5503	-		Introduction of non-contiguous multi-cell with MIMO	11.8.0
	RP-62	RP-131985	5509	1		Deactivate the secondary uplink frequency after synchronisation procedure A	11.8.0
	RP-62	RP-131995	5512	-		Support of Wideband RSRQ measurements for extended EARFCN	11.8.0
	RP-62	-	-	-		TS 25.331 v12.0.0 created based on v11.8.0	12.0.0
	RP-62	RP-131997	5484	1		Introduction of BDS in UTRAN	12.0.0
	RP-62	RP-131998	5485	-		Introduction of UE support for inbound mobility to a shared CSG cell	12.0.0
	RP-62	RP-131996	5486	1		Introduction of HSPA signalling enhancements for more efficient resource usage for LCR TDD	12.0.0
	RP-62	RP-131982	5500	-		Correction to Galileo assistance data elements	12.0.0
03/2014	RP-63	RP-140347	5514	-		Introduction of Cell_FACH with Second DRX to 3G Logged MDT	12.1.0
	RP-63	RP-140348	5529	1		Clarification on TSN field extension for Four Branch MIMO	12.1.0
	RP-63	RP-140341	5539	-		Renumbering and storage of IEs for secondary DL serving cells	12.1.0
	RP-63	RP-140345	5542	-		Activation status for newly added secondary serving HS-DSCH cells	12.1.0
	RP-63	RP-140339	5547	1		Clarification to GANSS Day	12.1.0
	RP-63	RP-140357	5551	-		Correction to CELL_UPDATE message contents to set	12.1.0
	RP-63	RP-140352	5558	-		Correction of Connection Establishment Failure Report	12.1.0
	RP-63	RP-140350	5560	-		Radio Bearer mapping for R99 Fallback	12.1.0
	RP-63	RP-140362	5563	-		Correction to missing SatID interpretation for Galileo	12.1.0
	RP-63	RP-140338	5564	-		Correction to integer code phase field description in UE positioning GANSS reference measurement information	12.1.0
	RP-63	RP-140358	5566	-		Correction to BDS ASN.1	12.1.0
06/2014	RP-64	RP-140872	5572	-		Introduction of the new Band combinations related to Band XXXII	12.2.0
	RP-64	RP-140874	5575	-		Clarification to absolute priority cell reselection in CELL_FACH	12.2.0
	RP-64	RP-140878	5577	-		Correction to E-UTRAN - 1.28Mcps TDD Handover	12.2.0
	RP-64	RP-140867	5582	-		Correction to the handling of IE "E-DPDCH power interpolation" when absent	12.2.0
	RP-64	RP-140874	5583	-		Clarification on MAC-ehs configuration for inter-Node B Multiflow operation	12.2.0
	RP-64	RP-140871	5631	-		Clarification of intra-frequency measurement for Cell_FACH to DC-HSUPA transition	12.2.0
	RP-64	RP-140869	5635	-		RLC re-establishment due to activation and deactivation of Enhanced Uplink in CELL_FACH state in SIB5/5bis	12.2.0
	RP-64	RP-140874	5592	-		Correction of the Multiflow dual-band capability signaling	12.2.0
	RP-64	RP-140873	5600	-		Clarifications for MFBI signaling with Inter-frequency neighbour cell information	12.2.0
	RP-64	RP-140878	5602	-		Clarifications for MFBI signaling with extended EARFCN/E-UTRA Frequency bands	12.2.0
	RP-64	RP-140875	5613	1		Introduction of cell reselection indication during uplink transmission with common E-DCH	12.2.0
	RP-64	RP-140880	5605	1		Introduction of HetNet Mobility Enhancements	12.2.0
	RP-64	RP-140880	5615	1		Introduction of inter-freq neighbour cell list extension	12.2.0
	RP-64	RP-140868	5617	1		Corrections to GNSS Acquisition Assistance Data	12.2.0
	RP-64	RP-140892	5622	1		Introduction of RRC Connection Establishment failure temporary Qoffset handling	12.2.0
09/2014	RP-65	RP-141497	5640	-		Corrections in default radio configuration for CELL_FACH	12.3.0
	RP-65	RP-141501	5666	-		Introduction of E-DCH decoupling operation	12.3.0
	RP-65	RP-141495	5645	-		Correction of ASN.1 of MDT logged connection establishment failure reporting (Alternative 1)	12.3.0

	RP-65	RP-141496	5664	2		Clarification on repetition factors for assisting cells	12.3.0
	RP-65	RP-141492	5680	1		Disable default configuration #23	12.3.0
	RP-65	RP-141511	5665	1		Clarification of exclusion of cells from inter-frequency detected set measurements	12.3.0
	RP-65	RP-141500	5676	2		Introduction of DCH Enhancements	12.3.0
	RP-65	RP-141503	5651	1		Introduction of Further EUL enhancements	12.3.0
	RP-65	RP-141503	5660	2		Introduction of DSAC and PPAC update in CELL_DCH	12.3.0
	RP-65	RP-141511	5669	1		Network-requested LTE Band Combination Capability Signalling	12.3.0
	RP-65	RP-141502	5674	2		Introduction of a second broadcast channel	12.3.0
	RP-65	RP-141501	5667	1		CR to 25.331 on introduction of Radio Links without DPCH/F-DPCH	12.3.0
	RP-65	RP-141501	5668	-		CR to 25.331 on introduction of the DPCH2	12.3.0
	RP-65	RP-141511	5683	2		Correction to stop condition for "Chiba offset"	12.3.0
	RP-65	RP-141504	5650	1		Connected mode procedures and RRC signaling of WLAN/3GPP Radio Interworking for UMTS	12.3.0
	RP-65	RP-141503	5685	1		Introduction of Further EUL enhancements	12.3.0
	RP-65	RP-141599	5689	-		Introduction of Further EUL enhancements	12.3.0
12/2014	RP-66	RP-142111	5690	-		Correction to Galileo Assistance Data	12.4.0
	RP-66	RP-142122	5691	-		Corrections to RRC for WLAN/3GPP Radio interworking in UMTS	12.4.0
	RP-66	RP-142127	5692	-		Cleanup corrections for Access group mechanism	12.4.0
	RP-66	RP-142126	5693	-		CR to 25.331 on the clarification of system information modification for Second Broadcast channel	12.4.0
	RP-66	RP-142127	5694	-		Introduction of the UE capabilities for Further EUL enhancements subfeatures	12.4.0
	RP-66	RP-142113	5696	-		Multi-carrier configuration support at inter-RAT handover	12.4.0
	RP-66	RP-142115	5699	-		Clarification on the case of more than one entry configured for the same physical frequency of E-UTRAN	12.4.0
	RP-66	RP-142122	5700	-		Reduction of possible values for WLAN backhaul rate thresholds in UMTS	12.4.0
	RP-66	RP-142127	5701	-		Corrections on filtered UE power headroom reporting	12.4.0
	RP-66	RP-142140	5702	-		Correction to 25.331 for CSFB UE on cell reselection back to LTE	12.4.0
	RP-66	RP-142116	5703	-		Introduction of the UL CLTD feedback from the Multiflow assisting cell	12.4.0
	RP-66	RP-142126	5720	-		CR to 25.331 on the correction of optional support for the second system information broadcast channel	12.4.0
	RP-66	RP-142122	5711	-		Corrections to WLAN/3GPP Radio Interworking for UMTS	12.4.0
	RP-66	RP-142119	5721	-		BDS Satellite Specific ICD update to version 2.0	12.4.0
	RP-66	RP-142122	5723	1		Clarification on WLAN interworking	12.4.0
	RP-66	RP-142113	5712	-		Correction regarding presence of GANSS Day field	12.4.0
	RP-66	RP-142140	5714	-		Measurement release enhancement	12.4.0
	RP-66	RP-142140	5715	-		Rapporteur corrections for 25.331 RRC specification	12.4.0
	RP-66	RP-142140	5706	-		Corrections about CELL_FACH with Second DRX to 3G Logged MDT	12.4.0
	RP-66	RP-142128	5713	1		Introduction of increased UE carrier monitoring	12.4.0
	RP-66	RP-142140	5704	1		Extension of the MEASUREMENT CONTROL FAILURE message	12.4.0
	RP-66	RP-142140	5730	2		Introduction of extended RSRQ value range and new RSRQ definition	12.4.0
	RP-66	RP-142118	5718	1		CR to 25.331 on clarification of exclusion of cells from intra-frequency detected set measurements	12.4.0
	RP-66	RP-142140	5719	1		CR to 25.331 on clarification of exclusion of cells from inter-frequency detected set measurements	12.4.0
	RP-66	RP-141867	5732	-		Rel-12 ASN.1 Review corrections	12.4.0
	RP-66	RP-141983	5731	-		UE capability signaling for WLAN/3GPP radio interworking	12.4.0
03/2015	RP-67	RP-150372	5736	-		Clarifications for Further EUL enhancements sub-feature Enhanced TTI switching	12.5.0
	RP-67	RP-150372	5737	-		Pre-configuration for Enhanced TTI switching at upswitch to CELL_DCH	12.5.0
	RP-67	RP-150373	5741	-		Clarification for SIB23 reading	12.5.0
	RP-67	RP-150373	5739	-		Cleanup corrections for increased UE carrier monitoring	12.5.0
	RP-67	RP-150376	5735	-		Rapporteur corrections for 25.331 RRC specification	12.5.0
	RP-67	RP-150370	5756	1		Correction to network-requested LTE CA band combination capability reporting	12.5.0
	RP-67	RP-150376	5753	-		Clarification on RSRQ Type	12.5.0
	RP-67	RP-150373	5758	1		Correction on provision of WLAN identifiers	12.5.0
	RP-67	RP-150368	5763	2		Correction of GLONASS system time	12.5.0
	RP-67	RP-150377	5757	2		ASN.1 corrections	12.5.0
06/2015	RP-68	RP-150917	5764	-		Correction to usage of Signalling radio bearer RB4 to transmit UE INFORMATION RESPONSE message	12.6.0
	RP-68	RP-150923	5765	-		Clarification to the setting of RSRQ on all symbols	12.6.0
	RP-68	RP-150918	5769	-		Disable default configuration for CELL_FACH	12.6.0

	RP-68	RP-150919	5767	-		Correction to presence of UE capability Simultaneous support for DCH Enhancements and Compressed Mode operation	12.6.0
	RP-68	RP-150923	5772	-		Clarification for F-DPCH support with HS	12.6.0
	RP-68	RP-150919	5771	-		CR to 25.331 on cleanup corrections of Radio Links without DPCH and F-DPCH	12.6.0
	RP-68	RP-150920	5770	-		CR to 25.331 on cleanup corrections to IncMon	12.6.0
09/2015	RP-69	RP-151443	5785	-		Rapporteur corrections for 25.331 RRC specification	12.7.0
	RP-69	RP-151440	5786	-		Clarification of Beacon RSSI Encoding	12.7.0
	RP-69	RP-151440	5780	1		Clarification for the inter-frequency measurement results on RACH with extended cell ID values	12.7.0
12/2015	RP-70	RP-152052	5791	-		Corrections to WLAN/3GPP radio interworking	12.8.0
	RP-70	RP-152050	5788	1		Clarification for configuring HARQ A/N repetition with Multiflow	12.8.0
	RP-70	RP-152051	5814	1		Correction for UE reading of System Information Block type 24 on timer expiration	12.8.0
	RP-70	RP-152051	5796	1		Correction for Second Broadcast Channel (BCH2) message handling	12.8.0
03/2016	RP-71	RP-160505	5851	2		CR to 25.331 on the clarification to the IE of Extended E-UTRA Frequency Band in RRC connection release for CCCH	12.9.0
	RP-71	RP-160466	5832	2		Correction on signalling transmission control due to access group blocking of DTCH	12.9.0
06/2016	RP-72	RP-161076	5855	1		Clarification for UE behaviour upon reception of requested E-UTRA frequency band list	12.10.0
	RP-72	RP-161083	5858	2		Introduction of DB-DC-HSUPA in earlier release	12.10.0
09/2016	RP-73	RP-161751	5874	2		On DCH-enhancements concurrency with HS/EUL	12.11.0
12/2016	RP-74	RP-162311	5901	-		Clarification on signalling for DCH Enhancements	12.12.0
03/2017	RP-75	RP-170650	5913	-	F	Misalignment between Tabular and ASN.1 for Cell Update Confirm message	12.13.0
03/2017	RP-75	RP-170650	5926	1	F	Correction on implicit grant handling	12.13.0
09/2017	RP-77	RP-171597	5943	-	F	Removal of References to 44.118 (lu mode)	12.14.0

Note: CR3785 "Clarification on Scheduling Information transmission" for TS 25.331 v8.7.0 of RP-090917 which was approved by RAN #45 could not be implemented as it is actually a CR to 25.321 v8.6.0.

Note: CR4678 "Procedure text for addition of new band indicator 3 and change of the ASN.1 type" for TS 25.331 v10.3.1 of RP-110838 which was approved by RAN #52 was not implemented since CR4678 is obsolete after CR4694 rev 1.

History

Document history		
V12.3.0	October 2014	Publication
V12.4.0	February 2015	Publication
V12.5.0	May 2015	Publication
V12.6.0	July 2015	Publication
V12.7.0	October 2015	Publication
V12.8.0	March 2016	Publication
V12.9.0	April 2016	Publication
V12.10.0	August 2016	Publication
V12.11.0	November 2016	Publication
V12.12.0	February 2017	Publication
V12.13.0	April 2017	Publication
V12.14.0	October 2017	Publication