

ETSI TS 125 419 V17.0.0 (2022-04)



**Universal Mobile Telecommunications System (UMTS);
UTRAN Iu-BC interface:
Service Area Broadcast Protocol (SABP)
(3GPP TS 25.419 version 17.0.0 Release 17)**



Reference

RTS/TSGR-0325419vh00

Keywords

UMTS

ETSI

650 Route des Lucioles
F-06921 Sophia Antipolis Cedex - FRANCE

Tel.: +33 4 92 94 42 00 Fax: +33 4 93 65 47 16

Siret N° 348 623 562 00017 - APE 7112B
Association à but non lucratif enregistrée à la
Sous-Préfecture de Grasse (06) N° w061004871

Important notice

The present document can be downloaded from:

<http://www.etsi.org/standards-search>

The present document may be made available in electronic versions and/or in print. The content of any electronic and/or print versions of the present document shall not be modified without the prior written authorization of ETSI. In case of any existing or perceived difference in contents between such versions and/or in print, the prevailing version of an ETSI deliverable is the one made publicly available in PDF format at www.etsi.org/deliver.

Users of the present document should be aware that the document may be subject to revision or change of status.

Information on the current status of this and other ETSI documents is available at

<https://portal.etsi.org/TB/ETSIDeliverableStatus.aspx>

If you find errors in the present document, please send your comment to one of the following services:

<https://portal.etsi.org/People/CommitteeSupportStaff.aspx>

If you find a security vulnerability in the present document, please report it through our
Coordinated Vulnerability Disclosure Program:

<https://www.etsi.org/standards/coordinated-vulnerability-disclosure>

Notice of disclaimer & limitation of liability

The information provided in the present deliverable is directed solely to professionals who have the appropriate degree of experience to understand and interpret its content in accordance with generally accepted engineering or other professional standard and applicable regulations.

No recommendation as to products and services or vendors is made or should be implied.

No representation or warranty is made that this deliverable is technically accurate or sufficient or conforms to any law and/or governmental rule and/or regulation and further, no representation or warranty is made of merchantability or fitness for any particular purpose or against infringement of intellectual property rights.

In no event shall ETSI be held liable for loss of profits or any other incidental or consequential damages.

Any software contained in this deliverable is provided "AS IS" with no warranties, express or implied, including but not limited to, the warranties of merchantability, fitness for a particular purpose and non-infringement of intellectual property rights and ETSI shall not be held liable in any event for any damages whatsoever (including, without limitation, damages for loss of profits, business interruption, loss of information, or any other pecuniary loss) arising out of or related to the use of or inability to use the software.

Copyright Notification

No part may be reproduced or utilized in any form or by any means, electronic or mechanical, including photocopying and microfilm except as authorized by written permission of ETSI.

The content of the PDF version shall not be modified without the written authorization of ETSI.

The copyright and the foregoing restriction extend to reproduction in all media.

© ETSI 2022.
All rights reserved.

Intellectual Property Rights

Essential patents

IPRs essential or potentially essential to normative deliverables may have been declared to ETSI. The declarations pertaining to these essential IPRs, if any, are publicly available for **ETSI members and non-members**, and can be found in ETSI SR 000 314: "*Intellectual Property Rights (IPRs); Essential, or potentially Essential, IPRs notified to ETSI in respect of ETSI standards*", which is available from the ETSI Secretariat. Latest updates are available on the ETSI Web server (<https://ipr.etsi.org/>).

Pursuant to the ETSI Directives including the ETSI IPR Policy, no investigation regarding the essentiality of IPRs, including IPR searches, has been carried out by ETSI. No guarantee can be given as to the existence of other IPRs not referenced in ETSI SR 000 314 (or the updates on the ETSI Web server) which are, or may be, or may become, essential to the present document.

Trademarks

The present document may include trademarks and/or tradenames which are asserted and/or registered by their owners. ETSI claims no ownership of these except for any which are indicated as being the property of ETSI, and conveys no right to use or reproduce any trademark and/or tradename. Mention of those trademarks in the present document does not constitute an endorsement by ETSI of products, services or organizations associated with those trademarks.

DECT™, **PLUGTESTS™**, **UMTS™** and the ETSI logo are trademarks of ETSI registered for the benefit of its Members. **3GPP™** and **LTE™** are trademarks of ETSI registered for the benefit of its Members and of the 3GPP Organizational Partners. **oneM2M™** logo is a trademark of ETSI registered for the benefit of its Members and of the oneM2M Partners. **GSM®** and the GSM logo are trademarks registered and owned by the GSM Association.

Legal Notice

This Technical Specification (TS) has been produced by ETSI 3rd Generation Partnership Project (3GPP).

The present document may refer to technical specifications or reports using their 3GPP identities. These shall be interpreted as being references to the corresponding ETSI deliverables.

The cross reference between 3GPP and ETSI identities can be found under <http://webapp.etsi.org/key/queryform.asp>.

Modal verbs terminology

In the present document "**shall**", "**shall not**", "**should**", "**should not**", "**may**", "**need not**", "**will**", "**will not**", "**can**" and "**cannot**" are to be interpreted as described in clause 3.2 of the [ETSI Drafting Rules](#) (Verbal forms for the expression of provisions).

"**must**" and "**must not**" are **NOT** allowed in ETSI deliverables except when used in direct citation.

Contents

Intellectual Property Rights	2
Legal Notice	2
Modal verbs terminology.....	2
Foreword.....	6
1 Scope	7
2 References	7
3 Definitions and abbreviations.....	7
3.1 Definitions	7
3.2 Abbreviations	8
4 General	8
4.1 Procedure Specification Principles.....	8
4.2 Forwards and Backwards Compatibility	9
4.3 Specification Notations	9
5 Services provided by SABP	9
6 Services expected from the Transport layer	9
7 Functions of SABP.....	10
8 SABP Procedures	10
8.1 Elementary Procedures.....	10
8.2 Write-Replace.....	10
8.2.1 General.....	10
8.2.2 Successful Operation	11
8.2.3 Unsuccessful Operation	12
8.2.4 Abnormal Conditions.....	13
8.3 Kill.....	13
8.3.1 General.....	13
8.3.2 Successful Operation	13
8.3.3 Unsuccessful Operation	14
8.3.4 Abnormal Conditions.....	14
8.4 Load Status Enquiry	14
8.4.1 General.....	14
8.4.2 Successful Operation	14
8.4.3 Unsuccessful Operation	15
8.4.4 Abnormal Conditions.....	15
8.5 Message Status Query	15
8.5.1 General.....	15
8.5.2 Successful Operation	16
8.5.3 Unsuccessful Operation	16
8.5.4 Abnormal Conditions.....	17
8.6 Reset.....	17
8.6.1 General.....	17
8.6.2 Successful Operation	17
8.6.3 Unsuccessful Operation	17
8.6.4 Abnormal Conditions.....	18
8.7 Restart Indication	18
8.7.1 General.....	18
8.7.2 Successful Operation	18
8.7.3 Abnormal Conditions.....	18
8.8 Failure Indication	18
8.8.1 General.....	18
8.8.2 Successful Operation	19
8.8.3 Abnormal Conditions.....	19

8.9	Error Indication	19
8.9.1	General.....	19
8.9.2	Successful Operation	19
8.9.3	Abnormal Conditions.....	20
9	Elements for SABP Communication.....	20
9.1	Message Functional Definition and Content	20
9.1.1	General.....	20
9.1.2	Message Contents	20
9.1.2.1	Presence	20
9.1.2.2	Criticality	20
9.1.2.3	Range	20
9.1.2.4	Assigned Criticality.....	21
9.1.3	WRITE-REPLACE.....	21
9.1.4	WRITE-REPLACE COMPLETE.....	21
9.1.5	WRITE-REPLACE FAILURE.....	21
9.1.6	KILL	22
9.1.7	KILL COMPLETE	22
9.1.8	KILL FAILURE	22
9.1.9	LOAD QUERY	22
9.1.10	LOAD QUERY COMPLETE.....	23
9.1.11	LOAD QUERY FAILURE.....	23
9.1.12	MESSAGE STATUS QUERY.....	23
9.1.13	MESSAGE STATUS QUERY COMPLETE	23
9.1.14	MESSAGE STATUS QUERY FAILURE	24
9.1.15	RESET	24
9.1.16	RESET COMPLETE	24
9.1.17	RESET FAILURE	24
9.1.18	RESTART.....	25
9.1.19	FAILURE	25
9.1.20	ERROR INDICATION.....	25
9.2	Information Element Definitions.....	25
9.2.0	General.....	25
9.2.1	MessageType	26
9.2.2	Broadcast Message Content.....	26
9.2.3	Serial Number	26
9.2.4	Old Serial Number	26
9.2.5	New Serial Number	27
9.2.6	Service Areas List.....	27
9.2.7	Category.....	27
9.2.8	Repetition Period	27
9.2.9	Number of Broadcasts Requested.....	27
9.2.10	Number of Broadcasts Completed List.....	28
9.2.11	Service Area Identifier.....	29
9.2.12	Failure List.....	29
9.2.13	Radio Resource Loading List.....	29
9.2.14	Cause	30
9.2.15	Data Coding Scheme	32
9.2.16	Recovery Indication.....	32
9.2.17	Criticality Diagnostics	32
9.2.18	Available Bandwidth	34
9.2.19	Message Identifier.....	34
9.2.20	Message Structure.....	34
9.2.21	Paging ETWS Indicator.....	35
9.2.22	Warning Type	35
9.2.23	Warning Security Information	36
9.2.24	Broadcast Message Content Validity Indicator.....	36
9.3	Message and Information Element Abstract Syntax (with ASN.1).....	36
9.3.0	General.....	36
9.3.1	Usage of protocol extension mechanism for non-standard use.....	36
9.3.2	Elementary Procedure Definitions.....	38
9.3.3	PDU Definitions	41

9.3.4	Information Element Definitions	51
9.3.5	Common Definitions.....	56
9.3.6	Constant Definitions	57
9.3.7	Container Definitions.....	59
9.4	Message Transfer Syntax	62
10	Handling of Unknown, Unforeseen or Erroneous Protocol Data.....	62
10.1	General	62
10.2	Transfer Syntax Error.....	62
10.3	Abstract Syntax Error.....	62
10.3.1	General.....	62
10.3.2	Criticality Information	63
10.3.3	Presence Information	63
10.3.4	Not comprehended IE/IE group	64
10.3.4.1	Procedure Code	64
10.3.4.1A	Type of Message	64
10.3.4.2	IEs other than the Procedure Code and Type of Message.....	64
10.3.5	Missing IE or IE group	65
10.3.6	IEs or IE groups received in wrong order or with too many occurrences or erroneously present	66
10.4	Logical Error	67
10.5	Exceptions	67
Annex A (informative): Guidelines for Usage of the Criticality Diagnostics IE		68
A.1	EXAMPLE MESSAGE Layout	68
A.2	Example on a Received EXAMPLE MESSAGE	69
A.3	Content of Criticality Diagnostics	70
A.3.1	Example 1	70
A.3.2	Example 2	71
A.3.3	Example 3	72
A.3.4	Example 4	73
A.3.5	Example 5	74
A.4	ASN.1 of EXAMPLE MESSAGE	75
Annex B (informative): Change history		78
History		80

Foreword

This Technical Specification (TS) has been produced by the 3rd Generation Partnership Project (3GPP).

The contents of the present document are subject to continuing work within the TSG and may change following formal TSG approval. Should the TSG modify the contents of the present document, it will be re-released by the TSG with an identifying change of release date and an increase in version number as follows:

Version x.y.z

where:

- x the first digit:
 - 1 presented to TSG for information;
 - 2 presented to TSG for approval;
 - 3 or greater indicates TSG approved document under change control.
- y the second digit is incremented for all changes of substance, i.e. technical enhancements, corrections, updates, etc.
- z the third digit is incremented when editorial only changes have been incorporated in the document.

1 Scope

The present document specifies the *Service Area Broadcast Protocol (SABP)* between the Cell Broadcast Centre (CBC) and the Radio Network Controller (RNC). It fulfils the CBC - RNC communication requirements specified in TS 23.041 [5] and is defined over the Iu-BC – reference point.

2 References

The following documents contain provisions which, through reference in this text, constitute provisions of the present document.

- References are either specific (identified by date of publication, edition number, version number, etc.) or non-specific.
- For a specific reference, subsequent revisions do not apply.
- For a non-specific reference, the latest version applies. In the case of a reference to a 3GPP document (including a GSM document), a non-specific reference implicitly refers to the latest version of that document *in the same Release as the present document*.

- [1] Void
- [2] Void
- [3] Void
- [4] 3GPP TR 25.931: "UTRAN Functions: Examples on Signalling Procedures".
- [5] 3GPP TS 23.041: "Technical realization of Cell Broadcast Service (CBS)".
- [6] 3GPP TS 25.414: "UTRAN Iu Interface Data Transport and Transport Signalling".
- [7] ITU-T Recommendation X.680 (2002-07): "Information Technology - Abstract Syntax Notation One (ASN.1): Specification of basic notation".
- [8] ITU-T Recommendation X.681 (2002-07): "Information Technology - Abstract Syntax Notation One (ASN.1): Information object specification".
- [9] ITU-T Recommendation X.691 (2002-07): "Information Technology - ASN.1 encoding rules - Specification of Packed Encoding Rules (PER)".
- [10] 3GPP TR 25.921 (Version 7.0.0): "Guidelines and Principles for Protocol Description and Error Handling".
- [11] 3GPP TS 25.324: "Broadcast/Multicast Control BMC".
- [12] 3GPP TS 23.003: "Numbering, addressing and identification".

3 Definitions and abbreviations

3.1 Definitions

For the purposes of the present document, the following terms and definitions apply:

Elementary Procedure: SABP consists of Elementary Procedures (EPs). An Elementary Procedure is a unit of interaction between the CN (CBC) and the RNC. These EPs are defined separately and are intended to be used to build up complete sequences in a flexible manner. If the independence between some EPs is restricted, it is described under the relevant EP description. Unless otherwise stated by the restrictions, the EPs may be invoked independently of each

other as stand alone procedures, which can be active in parallel. Examples on using several SABP EPs together with each other and EPs from other interfaces can be found in reference TR 25.931 [4].

An EP consists of an initiating message and possibly a response message. Two kinds of EPs are used:

- **Class 1:** Elementary Procedures with response (success or failure).
- **Class 2:** Elementary Procedures without response.

For Class 1 EPs, the types of responses can be as follows:

Successful

- A signalling message explicitly indicates that the elementary procedure successfully completed with the receipt of the response.

Unsuccessful

- A signalling message explicitly indicates that the EP failed.
- On time supervision expiry (i.e. absence of expected response).

Class 2 EPs are considered always successful.

Message Reference: This is defined as consisting of the following parameters: Message Identifier, Serial Number, and SAI (Service Area Identifier).

3.2 Abbreviations

For the purposes of the present document, the following abbreviations apply:

CBC	Cell Broadcast Centre
CBS	Cell Broadcast Service
CN	Core Network
EP	Elementary Procedure
FP	Frame Protocol
PDU	Protocol Data Unit
RNC	Radio Network Controller
SA	Service Area
SABP	Service Area Broadcast Protocol

4 General

The protocol described in the present document is the protocol between CN (CBC) and RNC needed for the CBC Application. The CBC Application is described in TS 23.041 [5].

4.1 Procedure Specification Principles

The principle for specifying the procedure logic is to specify the functional behaviour of the RNC exactly and completely. The CN functional behaviour is left unspecified.

The following specification principles have been applied for the procedure text in clause 8:

- The procedure text discriminates between:
 - 1) Functionality which "shall" be executed:
 - The procedure text indicates that the receiving node "shall" perform a certain function Y under a certain condition. If the receiving node supports procedure X but cannot perform functionality Y requested in the REQUEST message of a Class 1 EP, the receiving node shall respond with the message used to report unsuccessful outcome for this procedure, containing an appropriate cause value.

2) Functionality which "shall, if supported" be executed:

- The procedure text indicates that the receiving node "shall, if supported," perform a certain function Y under a certain condition. If the receiving node supports procedure X, but does not support functionality Y, the receiving node shall proceed with the execution of the EP, possibly informing the requesting node about the not supported functionality.
- Any required inclusion of an optional IE in a response message is explicitly indicated in the procedure text. If the procedure text does not explicitly indicate that an optional IE shall be included in a response message, the optional IE shall not be included.

4.2 Forwards and Backwards Compatibility

The forwards and backwards compatibility of the protocol is assured by mechanism where all current and future messages, and IEs or groups of related IEs, include Id and criticality fields that are coded in a standard format that will not be changed in the future. These parts can always be decoded regardless of the standard version.

4.3 Specification Notations

For the purposes of the present document, the following notations apply:

Procedure	When referring to an elementary procedure in the specification the Procedure Name is written with the first letters in each word in upper case characters followed by the word "procedure", e.g. Write-Replace procedure.
Message	When referring to a message in the specification the MESSAGE NAME is written with all letters in upper case characters followed by the word "message", e.g. WRITE-REPLACE message.
IE	When referring to an information element (IE) in the specification the <i>Information Element Name</i> is written with the first letters in each word in upper case characters and all letters in Italic font followed by the abbreviation "IE", e.g. <i>Old Serial Number IE</i> .
Value of an IE	When referring to the value of an information element (IE) in the specification the "Value" is written as it is specified in subclause 9.2 enclosed by quotation marks, e.g. "Abstract Syntax Error (Reject)" or "Background".

5 Services provided by SABP

- During normal operation the CN (CBC) initiates all message transfer and query operations. The RNC responds to the message transfer and query operations initiated by the CBC.
- The RNC will open the connection only in case an error (Failure Indication Procedure) or recovery (Restart Indication Procedure) is to be reported.
- The initiator of a connection is responsible for the termination of the connection.

6 Services expected from the Transport layer

Following service is expected from the transport layer:

- in sequence delivery of Signalling data TS 25.414 [6].

7 Functions of SABP

The SABP has the following functions:

- **Message Handling.** This function is responsible for the broadcast of new messages, amend existing broadcasted messages and to stop the broadcasting of specific messages.
- **Load Handling.** This function is responsible for determining the loading of the broadcast channels at any particular point in time.
- **Reset.** This function permits the CBC to end broadcasting in one or more Service Areas.
- **Error Handling.** This function allows the reporting of general error situations, for which function specific error messages have not been defined.

These functions are implemented by one or several SABP elementary procedures described in the following clauses.

8 SABP Procedures

8.1 Elementary Procedures

In the following tables, all EPs are divided into Class 1 and Class 2 Procedures.

Table 1: Class 1

Elementary Procedure	Initiating Message	Successful Outcome	Unsuccessful Outcome
		Response message	Response message
Write-Replace	WRITE-REPLACE	WRITE-REPLACE COMPLETE	WRITE-REPLACE FAILURE
Kill	KILL	KILL COMPLETE	KILL FAILURE
Load Status Enquiry	LOAD QUERY	LOAD QUERY COMPLETE	LOAD QUERY FAILURE
Message Status Query	MESSAGE QUERY	MESSAGE QUERY COMPLETE	MESSAGE QUERY FAILURE
Reset	RESET	RESET COMPLETE	RESET FAILURE

Table 2: Class 2

Elementary Procedure	Message
Restart Indication	RESTART
Failure Indication	FAILURE
Error Indication	ERROR INDICATION

8.2 Write-Replace

8.2.1 General

The purpose of this Write-Replace procedure is to broadcast new information or replace a message already broadcast to a chosen Service Area(s).

8.2.2 Successful Operation

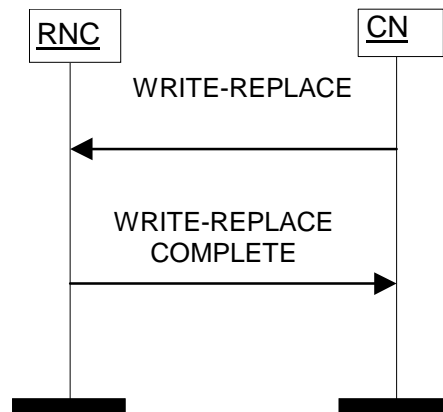

Figure 1: Write-Replace Procedure: Successful Operation

The CN shall initiate the procedure by sending a WRITE-REPLACE message to the RNC.

The presence of a *New Serial Number* IE will indicate that this is a new broadcast. The presence of both the *Old Serial Number* IE and a *New Serial Number* IE will indicate that this message is a replacement of an existing broadcast.

The RNC will initiate broadcasting of a new message or replace a message already broadcast as requested to the service areas as indicated in the *Service Areas List* IE.

The RNC shall uniquely identify the CBS message by the *Message Identifier* IE together with the twelve leftmost bits of the serial number in the *New Serial Number* IE and the *Service Area Identifier* IE.

The RNC shall perform the broadcast according to the value of the *Category* IE as follows:

- The *Category* IE, if given in the WRITE-REPLACE message, shall be treated as follows:
 1. If the value of *Category* IE is indicated as "High Priority", the RNC shall perform the broadcast immediately;
 2. If the value of *Category* IE is indicated as "Background", the RNC shall perform the broadcast when no other broadcast message indicated as "High Priority" or "Normal";
 3. If the value of *Category* IE is indicated as "Normal", the RNC shall perform the broadcast according to the *Repetition Period* IE.
- If the *Category* IE is not given in the WRITE-REPLACE message, the RNC shall perform the broadcast as the same category indicated as "Normal".

The RNC shall pass the *Data Coding Scheme* IE transparently to the radio interface protocol.

The RNC shall pass the *Broadcast Message Content* IE transparently to the radio interface protocol.

The RNC shall broadcast the message frequently according to the value of the *Number of Broadcasts Requested* IE. If the value is set to "0", the RNC shall broadcast the message until the CN requests otherwise. If the value is different than "0", the RNC shall broadcast the message as many times as indicated in the *Number of Broadcasts Requested* IE, and after the completion of the broadcast, the RNC shall release the involved messages and their status stored for each service area.

Upon receipt of the WRITE-REPLACE message the RNC shall respond using the WRITE-REPLACE COMPLETE message containing a *New Serial Number* IE indicating that resources are available as requested for the Service Area(s) specified and a *Number of Broadcasts Completed List* IE to indicate the number of times the version of the old CBS message identified by the *Message Identifier* IE and the *Old Serial Number* IE, has been successfully broadcast to the particular Service Area(s). If the version corresponding to the *Old Serial Number* IE value is not recognized for a particular service area, the number of broadcast completed shall be reported as '0' and the *Number of Broadcasts Completed Info* IE set to 'unknown'.

If the WRITE-REPLACE message sent from the CN:

- contained a *New Serial Number IE* but not an *Old Serial Number IE*, the *Number of Broadcasts IE* within the *Number of Broadcasts Completed List IE* is set to "0" for each included Service Area in the corresponding WRITE-REPLACE COMPLETE message.
- contained both the *New Serial Number IE* and the *Old Serial Number IE*, an entry is made in the *Number of Broadcasts IE* in the *Number of Broadcasts Completed List IE* for each included Service Area in the corresponding WRITE-REPLACE COMPLETE message. The RNC shall also release the involved old messages and their status stored for each service area.

If *Paging ETWS Indicator IE* is included in the WRITE-REPLACE message, the RNC shall construct and send paging message towards the UE. The paging message contains warning information based on *Warning Type IE*. If the *Broadcast Message Content Validity Indicator IE* is included in the WRITE-REPLACE message then the RNC shall ignore the contents of the *Broadcast Message Content IE*, *Repetition Period IE* and *Number of Broadcasts Requested IE*.

If the *Warning Security Information IE* is included in the WRITE-REPLACE message sent from the CN, the RNC shall send the *Warning Security Information IE* together with the paging message.

8.2.3 Unsuccessful Operation

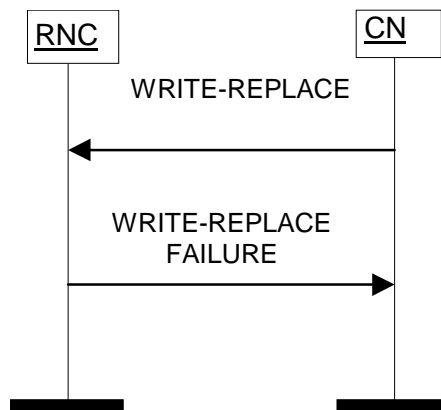

Figure 2: Write-Replace Procedure: Un-Successful Operation

If there is at least one Service Area specified in the WRITE-REPLACE message for which the RNC cannot allocate all the resources requested or for which the RNC cannot complete as requested, then the RNC shall return a WRITE-REPLACE FAILURE message to the CN as an outcome of the procedure. A list of Service Area(s) where the requested resources are unavailable or for which the RNC cannot complete as requested and appropriate cause value shall be provided in this WRITE-REPLACE FAILURE message in the *Failure List IE*.

This WRITE-REPLACE FAILURE message may also include those Service Area(s) where the requested resources were available and shall indicate in the *Number of Broadcasts Completed List IE* those Service Area(s) which completed the request successfully.

If the WRITE-REPLACE message sent from the CN:

- contained a *New Serial Number IE* but not an *Old Serial Number IE*, the *Number of Broadcasts IE* within the *Number of Broadcasts Completed List IE* is set to '0' for each included Service Area in the corresponding WRITE-REPLACE FAILURE message.
- contained a *New Serial Number IE* but not an *Old Serial Number IE*, and the CBS message is already used by the RNC, it shall consider the Write Replace procedure as failed for this Service Area and return a WRITE-REPLACE-FAILURE message with the Service Area Identifier of this particular Service Area included in the *Failure List IE* together with the cause value "Message-reference already-used".

- contained both the *New Serial Number IE* and the *Old Serial Number IE*, an entry is made in *Number of Broadcasts IE* in the *Number of Broadcasts Completed List IE* for each included Service Area in the corresponding WRITE-REPLACE FAILURE message.
- contained both the *New Serial Number IE* and the *Old Serial Number IE*, but if the old CBS message is unknown to the RNC (i.e. it can not execute the kill request) for a particular Service Area, it shall consider the Write Replace procedure as failed for this Service Area. When the procedure is completed, the RNC shall return a WRITE-REPLACE-FAILURE message which includes the Service Area Identifier of this particular Service Area in the *Failure List IE* together with the cause value "Valid-CN-message-not-identified".

8.2.4 Abnormal Conditions

8.3 Kill

8.3.1 General

The purpose of the Kill procedure is to stop the broadcast of the indicated message.

8.3.2 Successful Operation

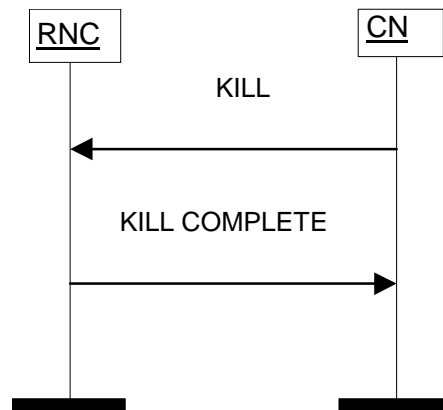

Figure 3: Kill Procedure: Successful Operation

The CN shall initiate the procedure by sending a KILL message to the RNC.

Upon receipt of the KILL message the RNC shall stop broadcasting the CBS message, which is indicated in the *Message Identifier IE* and the twelve leftmost bits of the *Old Serial Number IE*, in the indicated Service Area(s) as indicated in the *Service Areas List IE*.

The RNC shall respond using the KILL COMPLETE message, containing the *Old Serial Number IE* copied from the request and the *Number of Broadcast Completed List IE* when all Service Areas successfully stopped the broadcast. It shall indicate in the *Number of Broadcast Completed List IE* for each of these Service Area(s), the number of times the version of the CBS message identified by the *Message Identifier IE* and the *Old Serial Number IE* received has been sent to this particular Service Area(s) for broadcast. The RNC shall also release the involved messages and their status stored for each service area. If the version corresponding to the *Old Serial Number IE* value is not recognized for a particular service area, the number of broadcast completed shall be reported as '0' and the *Number of Broadcasts Completed Info IE* set to 'unknown'.

8.3.3 Unsuccessful Operation

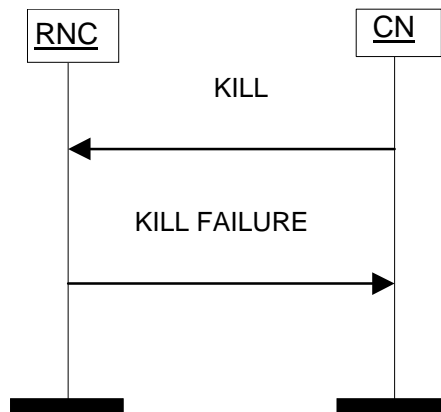

Figure 4: Kill Procedure: Un-Successful Operation

If the RNC fails to stop broadcasting the CBS message as indicated in the KILL message in at least one service area, the RNC shall return the KILL FAILURE message to the CN. A *Failure List* IE indicating the list of Service Area(s) where the CBS message was not recognized or the broadcast could not be stopped together with the appropriate cause value shall be provided in the KILL FAILURE message. This response message may also – if applicable - indicate in the *Number of Broadcasts Completed List* IE those Service Area(s) where the KILL message successfully stopped the broadcast.

8.3.4 Abnormal Conditions

8.4 Load Status Enquiry

8.4.1 General

The purpose of this Load Status Enquiry procedure is to obtain the current permissible bandwidth available for broadcast within particular Service Area(s).

8.4.2 Successful Operation

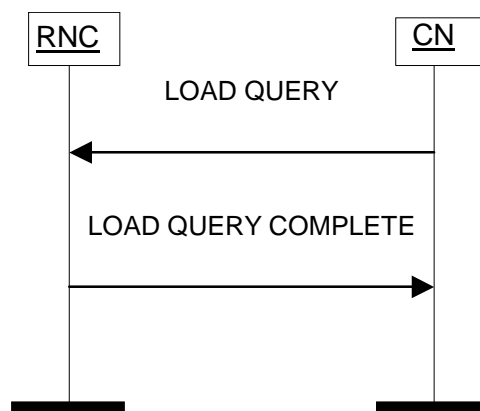

Figure 5: Load Status Enquiry Procedure: Successful Operation

The CN shall initiate the procedure by sending a LOAD QUERY message to the RNC. The message shall include a *Service Areas List* IE. Upon reception of the LOAD QUERY message the RNC shall respond with a LOAD QUERY COMPLETE message containing the *Radio Resource Loading List* IE indicating the available bandwidth of the Service Area(s).

8.4.3 Unsuccessful Operation

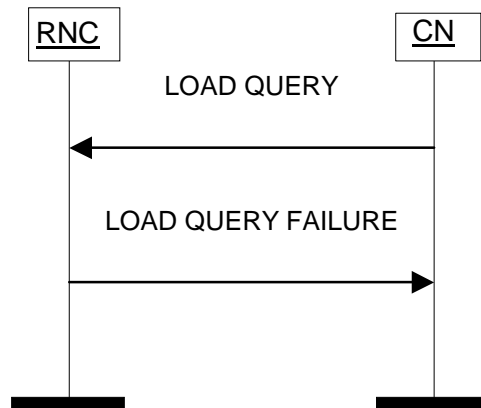

Figure 6: Load Status Enquiry Procedure: Un-Successful Operation

If the RNC contains Service Area(s) for which the RNC was not able to respond to, it shall respond with a LOAD QUERY FAILURE message which includes the *Failure List* IE.

The LOAD QUERY FAILURE response message may – if applicable - also contain a *Radio Resource Loading List* IE for which the LOAD STATUS QUERY reporting was successful.

8.4.4 Abnormal Conditions

8.5 Message Status Query

8.5.1 General

The Message Status Query procedure is used by the CN to obtain the message status of a broadcast message.

8.5.2 Successful Operation

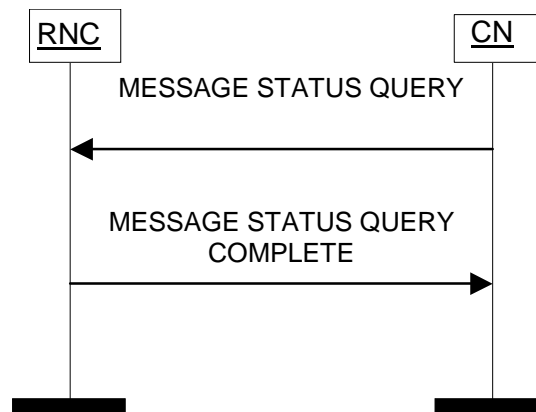

Figure 7: Message Status Query Procedure: Successful Operation

The CN shall initiate the procedure by sending a MESSAGE STATUS QUERY message to the RNC. The message shall contain the *Old Serial Number* IE along with the *Service Areas List* IE containing the Service Area Identifiers the status query is intended for. The status is requested for the version of the CBS message identified by the *Message Identifier* IE and the full value of the *Old Version Number* IE.

Upon receipt of the MESSAGE STATUS QUERY message the RNC shall respond using the MESSAGE STATUS QUERY COMPLETE message.

Within this message the *Number of Broadcasts Completed List* IE contains each Service Area which successfully performed the requested operation and for each of these Service Area(s), the number of times the version of this CBS message has been sent to this particular Service Area(s) for broadcast. If the version corresponding to the *Old Serial Number* IE value is not recognized for a particular service area, the number of broadcast completed shall be reported as '0' and the *Number of Broadcasts Compl Info* IE set to 'unknown'.

8.5.3 Unsuccessful Operation

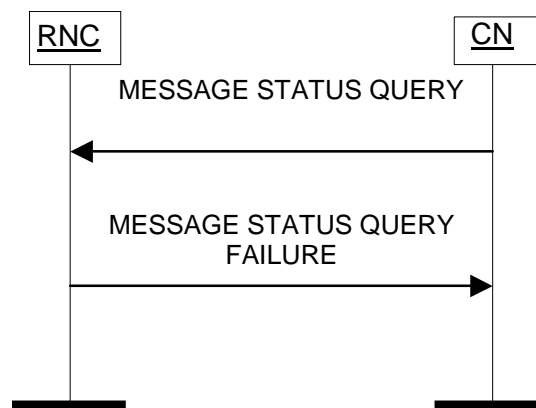

Figure 8: Message Status Query Procedure: Un-Successful Operation

If the requested operation fails (e.g. because the CBS message is unknown, or when the RNC cannot send the status for a known CBS message) the RNC shall send a MESSAGE STATUS QUERY FAILURE message to the CN containing a *Failure List* IE for Service Area(s) for which the requested operation failed.

The MESSAGE STATUS QUERY FAILURE message may – if applicable - also include the *Number of Broadcasts Completed List* IE indicating those Service Area(s) for which the MESSAGE STATUS QUERY message was successful.

8.5.4 Abnormal Conditions

8.6 Reset

8.6.1 General

The purpose of the Reset procedure is to end broadcasting in one or more Service Areas in the RNC.

8.6.2 Successful Operation

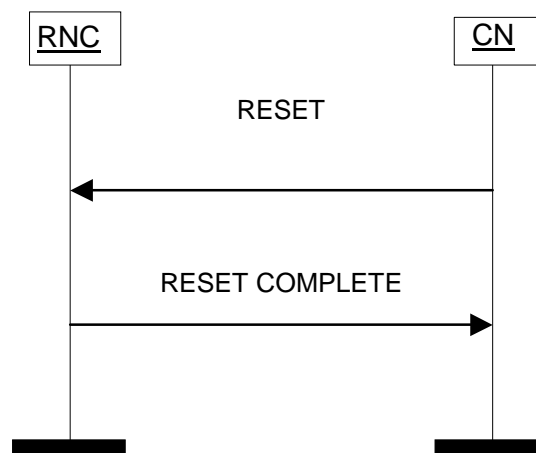

Figure 9: Reset Procedure: Successful Operation

The CN shall initiate the procedure by sending a RESET message to the RNC, in order to end broadcasting in one or more Service Areas of the RNC.

Upon receipt of this message the RNC shall end broadcasting in the indicated Service Area(s) and shall respond using a RESET COMPLETE message.

8.6.3 Unsuccessful Operation

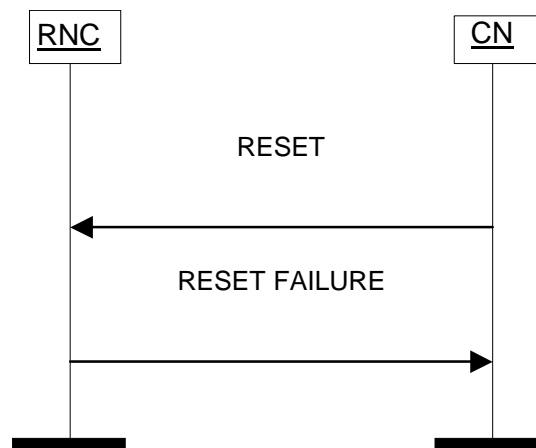

Figure 10: Reset Procedure: Un-Successful Operation

If upon receipt of this message the RNC can not end broadcasting in the indicated Service Area(s), it shall respond using a RESET FAILURE message. The RESET FAILURE message may contain the *Service Areas List* IE and shall contain the *Failure List* IE indicating the relevant Service Area(s) in which the RESET message was successful and unsuccessful respectively, along with the appropriate cause value.

The sum of the Service Area(s) included in the *Service Areas List* and *Failure List* IEs shall be the same as indicated in the *Service Areas List* IE of the initiating RESET message.

8.6.4 Abnormal Conditions

8.7 Restart Indication

8.7.1 General

The purpose of the Restart Indication procedure is for the RNC to indicate to the CN that a Service Area broadcasting related restart situation has occurred in one or more of its Service Areas e.g. when a Service Area becomes operational or when the RNC is initialised.

8.7.2 Successful Operation

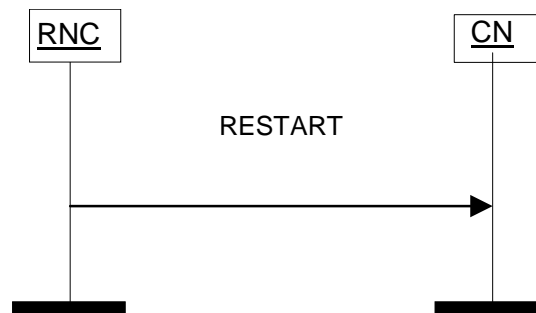

Figure 11: Restart Indication Procedure: Successful Operation

The RNC shall initiate the procedure by sending a RESTART message to the CN. This message shall contain a *Service Areas List* IE for reference and may also include the *Recovery Indication* IE to indicate whether the previous broadcast information needs to be loaded. In the absence of the *Recovery Indication* IE, the CN shall interpret it as "lost".

8.7.3 Abnormal Conditions

8.8 Failure Indication

8.8.1 General

The purpose of the Failure Indication procedure is to indicate to the CN from the RNC that a Service Area broadcasting related problem is occurring in one or more of its Service Areas.

8.8.2 Successful Operation

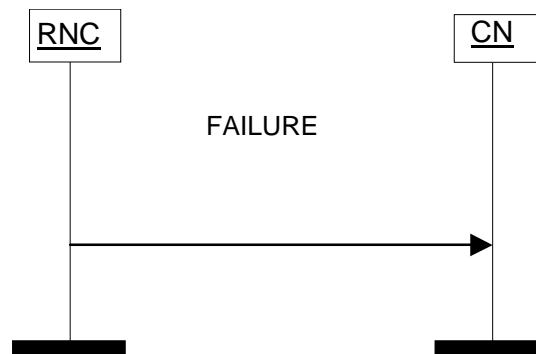

Figure 12: Failure Indication Procedure: Successful Operation

The RNC shall initiate the procedure by sending a FAILURE message to the CN. The FAILURE message shall contain the *Service Areas List* IE to indicate which Service Area(s) has a Service Area broadcasting related problem.

Upon receipt of this FAILURE message, the CN will not generate further WRITE or REPLACE messages for these Service Area(s) until the CN is informed by a RESTART message that the Service Area can resume normal Service Area broadcasting operation.

8.8.3 Abnormal Conditions

8.9 Error Indication

8.9.1 General

The Error Indication procedure is initiated by the RNC to report detected errors in one incoming message, provided they cannot be reported by an appropriate failure message.

8.9.2 Successful Operation

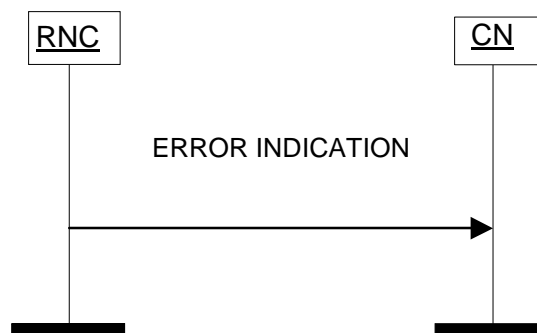

Figure 13: Error Indication Procedure: Successful Operation

When the conditions defined in chapter 10 are fulfilled, the Error Indication procedure is initiated by an ERROR INDICATION message sent from the receiving node.

The ERROR INDICATION message shall contain at least either the *Cause* IE or the *Criticality Diagnostics* IE.

Examples for possible cause values for protocol error indications are:

- "Transfer Syntax Error".
- "Abstract Syntax Error (reject)".

8.9.3 Abnormal Conditions

9 Elements for SABP Communication

9.1 Message Functional Definition and Content

9.1.1 General

Section 9.1 presents the contents of SABP messages in tabular format. The corresponding ASN.1 definition is presented in section 9.3. In case there is contradiction between the tabular format in section 9.1 and the ASN.1 definition, the ASN.1 shall take precedence, except for the definition of conditions for the presence of conditional IEs, where the tabular format shall take precedence.

NOTE: The messages have been defined in accordance to the guidelines specified in TR 25.921 [10].

For each message there is, a table listing the signalling elements in their order of appearance in the transmitted message.

9.1.2 Message Contents

9.1.2.1 Presence

All information elements in the message descriptions below are marked mandatory, optional or conditional according to table 3

Table 3: Meaning of abbreviations used in SABP messages

Abbreviation	Meaning
M	IE's marked as Mandatory (M) will always be included in the message.
O	IE's marked as Optional (O) may or may not be included in the message.
C	IE's marked as Conditional (C) will be included in a message only if the condition is satisfied. Otherwise the IE is not included.

9.1.2.2 Criticality

Each Information Element or Group of Information Elements may have a criticality information applied to it. Following cases are possible.

Table 4: Meaning of content within "Criticality" column

Abbreviation	Meaning
–	No criticality information is applied explicitly.
YES	Criticality information is applied. This is usable only for non-repeatable IEs
GLOBAL	The IE and all its repetitions together have one common criticality information. This is usable only for repeatable IEs.
EACH	Each repetition of the IE has its own criticality information. It is not allowed to assign different criticality values to the repetitions. This is usable only for repeatable IEs.

9.1.2.3 Range

The Range column indicates the allowed number of copies of repetitive IEs/IE groups.

9.1.2.4 Assigned Criticality

This column provides the actual criticality information as defined in subclause 10.3.2, if applicable.

9.1.3 WRITE-REPLACE

This message is sent by the CN to the RNC.

Direction: CN → RNC

PARAMETER	PRESENCE	RANGE	IE Type and Reference	Semantics Description	Criticality	Assigned Criticality
Message Type	M		9.2.1		yes	reject
Message Identifier	M		9.2.19		yes	reject
New Serial Number	M		9.2.5		yes	reject
Old Serial Number	O		9.2.4		yes	ignore
Service Areas List	M		9.2.6		yes	reject
Category	O		9.2.7		yes	ignore
Repetition Period	M		9.2.8		yes	reject
Number of Broadcasts Requested	M		9.2.9		yes	reject
Data Coding Scheme	M		9.2.15		yes	reject
Broadcast Message Content	M		9.2.2		yes	reject
Warning Security Information	O		9.2.23	See TS 23.041 [5].	yes	ignore
Paging ETWS Indicator	O		9.2.21		yes	ignore
Warning Type	O		9.2.22		yes	ignore
Broadcast Message Content Validity Indicator	O		9.2.24		yes	ignore

9.1.4 WRITE-REPLACE COMPLETE

This message will be sent by the RNC to the CN in a successful response to a WRITE-REPLACE message.

Direction: RNC → CN

PARAMETER	PRESENCE	RANGE	IE Type and Reference	Semantics Description	Criticality	Assigned Criticality
Message Type	M		9.2.1		yes	reject
Message Identifier	M		9.2.19		yes	reject
New Serial Number	M		9.2.5		yes	reject
Number of Broadcasts Completed List	M		9.2.10		yes	reject
Criticality Diagnostics	O		9.2.17		yes	ignore

9.1.5 WRITE-REPLACE FAILURE

This message will be sent by the RNC to the CN as an unsuccessful response to a WRITE-REPLACE message.

Direction: RNC → CN

PARAMETER	PRESENCE	RANGE	IE Type and Reference	Semantics Description	Criticality	Assigned Criticality
Message Type	M		9.2.1		yes	reject
Message Identifier	M		9.2.19		yes	reject
New Serial Number	M		9.2.5		yes	reject
Failure List	M		9.2.12		yes	reject
Number of Broadcasts Completed List	O		9.2.10		yes	ignore
Criticality Diagnostics	O		9.2.17		yes	ignore

9.1.6 KILL

This message is sent by the CN to the RNC to stop broadcasting of a specific message.

Direction: CN → RNC

PARAMETER	PRESENCE	RANGE	IE Type and Reference	Semantics Description	Criticality	Assigned Criticality
Message Type	M		9.2.1		yes	reject
Message Identifier	M		9.2.19		yes	reject
Old Serial Number	M		9.2.4		yes	reject
Service Areas List	M		9.2.6		yes	reject

9.1.7 KILL COMPLETE

This message is sent by the RNC to the CN as a successful response to a KILL message.

Direction: RNC → CN

PARAMETER	PRESENCE	RANGE	IE Type and Reference	Semantics Description	Criticality	Assigned Criticality
Message Type	M		9.2.1		yes	reject
Message Identifier	M		9.2.19		yes	reject
Old Serial Number	M		9.2.4		yes	reject
Number of Broadcasts Completed List	M		9.2.10		yes	reject
Criticality Diagnostics	O		9.2.17		yes	ignore

9.1.8 KILL FAILURE

This message is sent by the RNC to the CN as unsuccessful response to a KILL message.

Direction: RNC → CN

PARAMETER	PRESENCE	RANGE	IE Type and Reference	Semantics Description	Criticality	Assigned Criticality
Message Type	M		9.2.1		yes	reject
Message Identifier	M		9.2.19		yes	reject
Old Serial Number	M		9.2.4		yes	reject
Failure List	M		9.2.12		yes	reject
Number of Broadcasts Completed List	O		9.2.10		yes	ignore
Criticality Diagnostics	O		9.2.17		yes	ignore

9.1.9 LOAD QUERY

This message is sent by the CN to the RNC to gain an indication of broadcast resources available.

Direction: CN → RNC

PARAMETER	PRESENCE	RANGE	IE Type and Reference	Semantics Description	Criticality	Assigned Criticality
Message Type	M		9.2.1		yes	reject
Service Areas List	M		9.2.6		yes	reject

9.1.10 LOAD QUERY COMPLETE

This message will be sent by the RNC as a successful response to the LOAD QUERY message.

Direction: RNC → CN

PARAMETER	PRESENCE	RANGE	IE Type and Reference	Semantics Description	Criticality	Assigned Criticality
Message Type	M		9.2.1		yes	reject
Radio Resource Loading List	M		9.2.13		yes	reject
Criticality Diagnostics	O		9.2.17		yes	ignore

9.1.11 LOAD QUERY FAILURE

This message is sent by the RNC to the CN as an unsuccessful response to a LOAD QUERY message.

Direction: RNC → CN

PARAMETER	PRESENCE	RANGE	IE Type and Reference	Semantics Description	Criticality	Assigned Criticality
Message Type	M		9.2.1		yes	reject
Failure List	M		9.2.12		yes	reject
Radio Resource Loading List	O		9.2.13		yes	ignore
Criticality Diagnostics	O		9.2.17		yes	ignore

9.1.12 MESSAGE STATUS QUERY

This message is sent by the CN to the RNC to obtain the current status of a Service Area broadcasting message.

Direction: CN → RNC

PARAMETER	PRESENCE	RANGE	IE Type and Reference	Semantics Description	Criticality	Assigned Criticality
Message Type	M		9.2.1		yes	reject
Message Identifier	M		9.2.19		yes	reject
Old Serial Number	M		9.2.4		yes	reject
Service Areas List	M		9.2.6		yes	reject

9.1.13 MESSAGE STATUS QUERY COMPLETE

This message is sent by the RNC to the CN as a successful response to a MESSAGE QUERY message.

Direction: RNC → CN

PARAMETER	PRESENCE	RANGE	IE Type and Reference	Semantics Description	Criticality	Assigned Criticality
Message Type	M		9.2.1		yes	reject
Message Identifier	M		9.2.19		yes	reject
Old Serial Number	M		9.2.4		yes	reject
Number of Broadcasts Completed List	M		9.2.10		yes	reject
Criticality Diagnostics	O		9.2.17		yes	ignore

9.1.14 MESSAGE STATUS QUERY FAILURE

This message is sent by the RNC to the CN in an unsuccessful response to a MESSAGE QUERY message.

Direction: RNC → CN

PARAMETER	PRESENCE	RANGE	IE Type and Reference	Semantics Description	Criticality	Assigned Criticality
Message Type	M		9.2.1		yes	reject
Message Identifier	M		9.2.19		yes	reject
Failure List	M		9.2.12		yes	reject
Old Serial Number	M		9.2.4		yes	reject
Number of Broadcasts Completed List	O		9.2.10		yes	ignore
Criticality Diagnostics	O		9.2.17		yes	ignore

9.1.15 RESET

The message is sent by the CN to the RNC to request that the RNC end broadcasting in one or more Service Areas.

Direction: CN → RNC

PARAMETER	PRESENCE	RANGE	IE Type and Reference	Semantics Description	Criticality	Assigned Criticality
Message Type	M		9.2.1		yes	reject
Service Areas List	M		9.2.6		yes	reject

9.1.16 RESET COMPLETE

This message is sent from the RNC to the CN as a successful response to a RESET message where indicated Service-Area(s) are now not broadcasting any messages.

Direction: RNC → CN

PARAMETER	PRESENCE	RANGE	IE Type and Reference	Semantics Description	Criticality	Assigned Criticality
Message Type	M		9.2.1		yes	reject
Service Areas List	M		9.2.6		yes	reject
Criticality Diagnostics	O		9.2.17		yes	ignore

9.1.17 RESET FAILURE

This message is sent from the RNC to the CN as an unsuccessful response to a RESET message to indicate that a Service Area broadcasting related problem exists in one or more of its Service Areas.

Direction: RNC → CN

PARAMETER	PRESENCE	RANGE	IE Type and Reference	Semantics Description	Criticality	Assigned Criticality
Message Type	M		9.2.1		yes	reject
Failure List	M		9.2.12		yes	reject
Service Areas List	O		9.2.6		yes	ignore
Criticality Diagnostics	O		9.2.17		yes	ignore

9.1.18 RESTART

This message is sent from the RNC to the CN to indicate a Service Area broadcasting related restart situation in one or more of its Service-Areas.

Direction: RNC → CN

PARAMETER	PRESENCE	RANGE	IE Type and Reference	Semantics Description	Criticality	Assigned Criticality
Message Type	M		9.2.1		yes	ignore
Service Areas List	M		9.2.6		yes	ignore
Recovery Indication	O		9.2.16		yes	ignore

9.1.19 FAILURE

This message is sent from the RNC to the CN to indicate that a Service Area broadcasting related problem exists in one or more of its Service-Areas.

Direction: RNC → CN

PARAMETER	PRESENCE	RANGE	IE Type and Reference	Semantics Description	Criticality	Assigned Criticality
Message Type	M		9.2.1		yes	ignore
Service Areas List	M		9.2.6		yes	ignore

9.1.20 ERROR INDICATION

This message is sent by the RNC to CN and is used to indicate that some errors have been detected in the node.

Direction: RNC → CN

PARAMETER	PRESENCE	RANGE	IE Type and Reference	Semantics Description	Criticality	Assigned Criticality
Message Type	M		9.2.1		yes	ignore
Message Identifier	O		9.2.19		yes	ignore
Serial Number	O		9.2.3		yes	ignore
Cause	O		9.2.14		yes	ignore
Criticality Diagnostics	O		9.2.17		yes	ignore

9.2 Information Element Definitions

9.2.0 General

Section 9.2 presents the SABP IE definitions in tabular format. The corresponding ASN.1 definition is presented in section 9.3. In case there is contradiction between the tabular format in section 9.2 and the ASN.1 definition, the ASN.1 shall take precedence, except for the definition of conditions for the presence of conditional elements, where the tabular format shall take precedence.

When specifying information elements which are to be represented by bitstrings, if not otherwise specifically stated in the semantics description of the concerned IE or elsewhere, the following principle applies with regards to the ordering of bits:

- The first bit (leftmost bit) contains the most significant bit (MSB);
- The last bit (rightmost bit) contains the least significant bit (LSB);
- When importing bitstrings from other specifications, the first bit of the bitstring contains the first bit of the concerned information;

9.2.1 MessageType

Message Type IE uniquely identifies the message being sent. It is mandatory for all messages.

IE/GROUP NAME	PRESENCE	RANGE	IE Type and	Semantics Description
Message Type				
>Procedure Code	M		ENUMERATED (Write-Replace, Kill, Load Status Enquiry, Message Status Query, Reset, Restart Indication, Failure Indication, Error Indication, ...)	
>Type of Message	M		ENUMERATED (Initiating Message, Successful Outcome, Unsuccessful Outcome, Outcome)	

9.2.2 Broadcast Message Content

Broadcast Message Content IE is sent from the CN to the RNC containing user information i.e. the message, and will be broadcast over the radio interface.

IE/GROUP NAME	PRESENCE	RANGE	IE Type and	Semantics Description
Broadcast Message Content	M		BIT STRING (1..9968)	The size of the received bitstring shall be multiple of 8.

9.2.3 Serial Number

Serial Number IE is a 16-bit integer which identifies a particular message from the source and type indicated by the Message Identifier and is altered every time the message with a given Message Identifier is changed.

IE/GROUP NAME	PRESENCE	RANGE	IE Type and	Semantics Description
Serial Number	O		BIT STRING(16)	

9.2.4 Old Serial Number

Old Serial Number IE enables identification of an existing message to be identified. The format of this IE is defined in subclause 9.2.3.

IE/GROUP NAME	PRESENCE	RANGE	IE Type and	Semantics Description
Old Serial Number	M		9.2.3	

9.2.5 New Serial Number

New Serial Number IE enables identification of a new message for broadcast to be identified, and is altered every time the message is changes. The format of this IE is defined in subclause 9.2.3.

IE/GROUP NAME	PRESENCE	RANGE	IE Type and	Semantics Description
New Serial Number	O		9.2.3	

9.2.6 Service Areas List

The *Service Areas List* IE identifies a sequence of one or more Service Areas to which the message(s) apply. The *Service Areas List* IE must include at least one Service Area.

IE/GROUP NAME	PRESENCE	RANGE	IE Type and	Semantics Description
Service Areas List		1 to <maxno of SAI>		
>Service Area Identifier	M		9.2.11	

Range bound	Explanation
MaxnoofSAI	Maximum no. of SAI in Service Areas List. Value is 65535

9.2.7 Category

Category IE is sent from the CN to the RNC, and is used to indicate the priority of the message.

IE/GROUP NAME	PRESENCE	RANGE	IE Type and	Semantics Description
Category	O		Enumerated (High Priority, Background, Normal, Default)	This IE contains the broadcast priority of the message. The value "Default" shall not be used

9.2.8 Repetition Period

Repetition Period IE is sent from the CN to the RNC and indicates the periodicity of message broadcasts.

IE/GROUP NAME	PRESENCE	RANGE	IE Type and	Semantics Description
Repetition Period	M		INTEGER (1..4096)	Range is 1 to 4096 where each unit will represent a repetition of one second to a maximum of once per ~1 hour

9.2.9 Number of Broadcasts Requested

Number of Broadcasts Requested IE is sent from the CN to the RNC and indicates the number of times a message is to be broadcast.

IE/GROUP NAME	PRESENCE	RANGE	IE Type and	Semantics Description
Number of Broadcasts Requested	M	0 to 65535	INTEGER (0..65535)	This specifies the number of times the message is to be broadcast. "0" indicates the message shall be broadcasted until CN request otherwise.

9.2.10 Number of Broadcasts Completed List

Number of Broadcasts Completed List IE is sent from the RNC to the CN, and indicates the number of times that a CN message (all pages) has been sent to each Service Area specified in the *Service Areas List* IE of the request message for broadcast over the radio interface.

IE/GROUP NAME	PRESENCE	RANGE	IE Type and	Semantics Description
Number of Broadcasts Completed List		1 to <maxnoof SAI>		
>Service Area Identifier	M		OCTET STRING (7)	
>Number of Broadcasts	M		INTEGER (0.. 65535)	
>Number of Broadcasts Compl Info	O		ENUMERATED (overflow, unknown)	Overflow indicates that the number of times that CN message sent to the radio interface has been overflow. Unknown indicates that no information regarding the number of times that CN message sent to the radio interface.

Range bound	Explanation
MaxnoofSAI	Maximum no. of SAI in Service Areas List Value is 65535

9.2.11 Service Area Identifier

Service Area Identifier IE in BC domain is used to identify an area consisting of one cell TS 23.003 [12]. Such an area is called a Service Area. For this protocol, only a Service Area that is defined to be applicable to the BC domain shall be used.

IE/Group Name	Presence	Range	IE type and Reference	Semantics description
SAI				
>PLMN identity	M		OCTET STRING (SIZE (3))	<ul style="list-style-type: none"> - digits 0 to 9, two digits per octet, - each digit encoded 0000 to 1001, - 1111 used as filler - bit 4 to 1 of octet n encoding digit 2n-1 - bit 8 to 5 of octet n encoding digit 2n <p>-The PLMN identity consists of 3 digits from MCC followed by either</p> <ul style="list-style-type: none"> -a filler plus 2 digits from MNC (in case of 2 digit MNC) or -3 digits from MNC (in case of a 3 digit MNC).
>LAC	M		OCTET STRING (2)	0000 and FFFE not allowed.
>SAC	M		OCTET STRING (2)	

9.2.12 Failure List

Failure List IE identifies the list of Service-Area(s) for which the RNC could not complete as requested.

IE/GROUP NAME	PRESENCE	RANGE	IE Type and	Semantics Description
Failure List		1 to <maxnoof SAI>		
>Service Area Identifier	M		9.2.11	
>Cause	M		9.2.14	

Range bound	Explanation
MaxnoofSAI	Maximum no. of SAI in Service-Area-List. Value is 65535

9.2.13 Radio Resource Loading List

Radio Resource Loading List IE presents the available bandwidth available for Broadcast purposes of a specific Service Area.

IE/GROUP NAME	PRESENCE	RANGE	IE Type and	Semantics Description
Radio Resource Loading List		1 to <maxnoof SAI>		
>Service Area Identifier	M		9.2.11	
>Available Bandwidth	M		9.2.18	

Range bound	Explanation
MaxnoofSAI	Maximum no. of SAI in Service Area List. Value is 65535

9.2.14 Cause

Cause IE indicates the reason for a particular error event for the SABP protocol.

IE/GROUP NAME	PRESENCE	RANGE	IE Type and Reference	Semantics Description
>Cause	M		INTEGER (Range is 0-255
			Parameter-not-recognised(0),	Sent when the recipient (CN or RNC) was unable to act upon the message received due to an unrecognised parameter. A message should not be rejected only because a parameter is not recognised as this would prevent extensions to the service
			Parameter-value invalid(1),	Sent when a failure occurred due to the value of a parameter being invalid, e.g. out of range, or in Write-Replace, the parameter "no of pages" does not equal the number of pages received
			Valid-CN-message-not-identified(2),	Sent when the RNC does not recognise the CN message reference
			Service-Area-identity-not-valid(3),	Sent when the RNC does not recognise a Service-Area Identity
			Unrecognised-message(4)	Sent when the RNC did not recognise the message at all
			Missing-mandatory-element(5),	Sent when a mandatory element is missing from the message
RNC-capacity-exceeded(6),	Sent when a write-replace fails			

IE/GROUP NAME	PRESENCE	RANGE	IE Type and Reference	Semantics Description
			<p>RNC-memory-exceeded(7),</p> <p>Service-Area-broadcast-not-supported(8),</p> <p>Service-Area-broadcast-not-operational(9),</p> <p>Message-reference already-used(10),</p> <p>Unspecified-error(11),</p> <p>(Transfer Syntax Error(12),</p> <p>Semantic Error (12),</p>	<p>because the RNC cannot meet the requested repetition period because of the cell loading</p> <p>Sent when the RNC is unable to store a CBS message as the RNC memory has been exceeded.</p> <p>Sent when the SABCH/CN related Radio Resource is not configured for a Service-Area</p> <p>Sent when the SABCH/CN related radio resource is not available because of error conditions or due to maintenance activities</p> <p>Sent when the recipient was unable to act upon the Write-Replace message received due to a previous Write-Replace received with the same message reference.</p> <p>Sent when none of the above cause values apply.</p> <p>Sent to indicate transfer syntax error in any message</p> <p>Sent to indicate semantic error any message</p>

IE/GROUP NAME	PRESENCE	RANGE	IE Type and Reference	Semantics Description
			Message not compatible with receiver state (14),	Sent to indicate that received message is not compatible with the receiver state
			Abstract Syntax Error (Reject) (15),	Sent to indicate rejection due to Abstract Syntax Error
			Abstract Syntax Error (Ignore and Notify) (16),	Sent to indicate Abstract Syntax Error in some IE that has been ignored
			Abstract Syntax Error (Falsely Constructed Message) (17))	Sent to indicate Abstract Syntax Error due to false message construction

9.2.15 Data Coding Scheme

Data Coding Scheme IE is sent from the RNC to the CN and identifies the alphabet or coding employed for the message characters and message handling at the UE (it is passed transparently from the CN to the UE).

IE/GROUP NAME	PRESENCE	RANGE	IE Type and	Semantics Description
Data Coding Scheme	M		BIT STRING(8)	

9.2.16 Recovery Indication

Recovery Indication IE is used to indicate whether the CN related data was lost or is still available.

IE/GROUP NAME	PRESENCE	RANGE	IE Type and	Semantics Description
Recovery Indication	O		ENUMERATED (Lost, Available)	

9.2.17 Criticality Diagnostics

For further details on how to use the *Criticality Diagnostics* IE, see annex A.

The *Criticality Diagnostics* IE is sent by the RNC or the CN when parts of a received message have not been comprehended or were missing, or if the message contained logical errors. When applicable, it contains information about which IEs that were not comprehended or were missing.

IE/Group Name	Presence	Range	IE type and reference	Semantics description
Criticality Diagnostics				
>Procedure Code	O		INTEGER (0..255)	Procedure Code is to be used if Criticality Diagnostics is part of Error Indication procedure, and not within the response message of the same procedure that caused the error

IE/Group Name	Presence	Range	IE type and reference	Semantics description
Criticality Diagnostics				
>Triggering Message	O		ENUMERATED(initiating message, successful outcome, unsuccessful outcome, outcome)	The Triggering Message is used only if the Criticality Diagnostics is part of Error Indication procedure.
>Procedure Criticality	O		ENUMERATED(reject, ignore, notify)	This Procedure Criticality is used for reporting the Criticality of the Triggering message (Procedure).
Information Element Criticality Diagnostics		0 to <maxnof errors>		
>IE Criticality	M		ENUMERATED(reject, ignore, notify)	The IE Criticality is used for reporting the criticality of the triggering IE. The value 'ignore' shall not be used.
>IE ID	M		INTEGER (0..65535)	The IE Id of the not understood or missing IE
>Repetition Number	O		INTEGER (0..255)	<p>The <i>Repetition Number</i> IE gives</p> <ul style="list-style-type: none"> in case of a not understood IE: The number of occurrences of the reported IE up to and including the not understood occurrence in case of a missing IE: The number of occurrences up to but not including the missing occurrence. <p>Note: All the counted occurrences of the reported IE must have the same topdown hierarchical message structure of IEs with assigned criticality above them.</p>
>Message Structure	O		9.2.20	The <i>Message Structure</i> IE describes the structure where the not understood or missing IE was detected. This IE is included if the not understood IE is not the top level of the message.
>Type of Error	M		ENUMERATED(not understood, missing, ...)	

Range bound	Explanation
Maxnooferrors	Maximum no. of IE errors allowed to be reported with a single message. The value for maxnooferrors is 256.

9.2.18 Available Bandwidth

Available Bandwidth IE is used to indicate the Bandwidth available for the broadcast of messages.

IE/GROUP NAME	PRESENCE	RANGE	IE Type and Reference	Semantics Description
Available Bandwidth	O		INTEGER (0..20480)	The unit is: bit/second

9.2.19 Message Identifier

Message Identifier IE is set by the CN, transfer to the UE by the RNC.

IE/GROUP NAME	PRESENCE	RANGE	IE Type and Reference	Semantics Description
Message Identifier	M		BIT STRING(16)	This IE is set by the CN, transfer to the UE by the RNC, the RNC needs not to understand what is the meaning of the value but shall treat it as a identifier of a message. The Message Identifier is defined in TS 25.324 [11].

9.2.20 Message Structure

The *Message Structure* IE gives information for each level with assigned criticality in an hierachical message structure from top level down to the lowest level above the reported level for the occurred error (reported in the *Information Element Criticality Diagnostics* IE).

IE/Group Name	Presence	Range	IE type and reference	Semantics description	Criticality	Assigned Criticality
Message structure		1 to <maxnooflevels>		The first repetition of the <i>Message Structure</i> IE corresponds to the top level of the message. The last repetition of the <i>Message Structure</i> IE corresponds to the level above the reported level for the occurred error of the message.	GLOBAL	ignore
>IE ID	M		INTEGER (0..65535)	The IE ID of this level's IE containing the not understood or missing IE.	-	
>Repetition Number	O		INTEGER (1..256)	The <i>Repetition Number</i> IE gives, if applicable, the number of occurrences of this level's reported IE up to and including the occurrence containing the not understood or missing IE. Note: All the counted occurrences of the reported IE must have the same topdown hierarchical message structure of IEs with assigned criticality above them.	-	

Range bound	Explanation
maxnooflevels	Maximum no. of message levels to report. The value for maxnooflevels is 256.

9.2.21 Paging ETWS Indicator

Paging ETWS Indicator IE is used to indicate to the RNC that the received SABP message contains ETWS contents that need to be sent via paging message towards the UE.

IE/GROUP NAME	PRESENCE	RANGE	IE Type and	Semantics Description
Paging ETWS Indicator	M		ENUMERATED (Paging, ...)	

9.2.22 Warning Type

Warning Type IE indicates the types of the disaster. This IE can be used by the UE to differentiate type of alert according to the type of disaster.

IE/GROUP NAME	PRESENCE	RANGE	IE Type and	Semantics Description
Warning Type	M		OCTET STRING (2)	

9.2.23 Warning Security Information

Warning Security Information IE is set by the CN, transferred to the UE by the RNC.

IE/GROUP NAME	PRESENCE	RANGE	IE Type and Reference	Semantics Description
Warning Security Information	M		OCTET STRING(50)	

9.2.24 Broadcast Message Content Validity Indicator

The *Broadcast Message Content Validity Indicator* IE indicates that the *Broadcast Message Content* IE does not contain any valid information.

IE/GROUP NAME	PRESENCE	RANGE	IE Type and Reference	Semantics Description
Broadcast Message Content Validity Indicator	M		ENUMERATED (Broadcast Message Content not valid)	

9.3 Message and Information Element Abstract Syntax (with ASN.1)

9.3.0 General

SABP ASN.1 definition conforms with ITU-T Rec. X.680 [7] and ITU-T Rec. X.681 [8].

The ASN.1 definition specifies the structure and content of SABP messages. SABP messages can contain any IEs specified in the object set definitions for that message without the order or number of occurrence being restricted by ASN.1. However, for this version of the standard, a sending entity shall construct a SABP message according to the PDU definitions module and with the following additional rules (Note that in the following IE means an IE in the object set with an explicit id. If one IE needed to appear more than once in one object set, then the different occurrences have different IE ids):

- IEs shall be ordered (in an IE container) in the order they appear in object set definitions.
- Object set definitions specify how many times IEs may appear. An IE shall appear exactly once if the presence field in an object has value "mandatory". An IE may appear at most once if the presence field in an object has value "optional" or "conditional". If in a tabular format there is multiplicity specified for an IE (i.e. an IE list) then in the corresponding ASN.1 definition the list definition is separated into two parts. The first part defines an IE container list where the list elements reside. The second part defines list elements. The IE container list appears as an IE of its own. For this version of the standard an IE container list may contain only one kind of list elements.

If a SABP message that is not constructed as defined above is received, this shall be considered as Abstract Syntax Error, and the message shall be handled as defined for Abstract Syntax error in subclause 10.3.6.

9.3.1 Usage of protocol extension mechanism for non-standard use

The protocol extension mechanism for non-standard use may be used:

- for special operator- (and/or vendor) specific features considered not to be part of the basic functionality, i.e. the functionality required for a complete and high-quality specification in order to guarantee multivendor interoperability.
- by vendors for research purposes, e.g. to implement and evaluate new algorithms/features before such features are proposed for standardisation.

The extension mechanism shall not be used for basic functionality. Such functionality shall be standardised.

9.3.2 Elementary Procedure Definitions

```
-- *****
--
-- Elementary Procedure definitions
--
-- *****

SABP-PDU-Descriptions {
itu-t (0) identified-organization (4) etsi (0) mobileDomain (0)
umts-Access (20) modules (3) sabp (3) version1 (1) sabp-PDU-Descriptions (0)}

DEFINITIONS AUTOMATIC TAGS ::=

BEGIN

-- *****
--
-- IE parameter types from other modules.
--
-- *****

IMPORTS
    Criticality,
    ProcedureCode
FROM SABP-CommonDataTypes

    Error-Indication,
    Failure,
    Kill,
    Kill-Complete,
    Kill-Failure,
    Load-Query,
    Load-Query-Complete,
    Load-Query-Failure,
    Reset,
    Reset-Complete,
    Reset-Failure,
    Restart,
    Message-Status-Query,
    Message-Status-Query-Complete,
    Message-Status-Query-Failure,
    Write-Replace,
    Write-Replace-Complete,
    Write-Replace-Failure
FROM SABP-PDU-Contents

    id-Error-Indication,
    id-Failure-Indication,
    id-Kill,
    id-Reset,
```

```

    id-Restart-Indication,
    id-Load-Status-Enquiry,
    id-Message-Status-Query,
    id-Write-Replace
FROM SABP-Constants;

-- *****
--
-- Interface Elementary Procedure Class
--
-- *****

SABP-ELEMENTARY-PROCEDURE ::= CLASS {
    &InitiatingMessage      ,
    &SuccessfulOutcome      OPTIONAL,
    &UnsuccessfulOutcome    OPTIONAL,
    &procedureCode          ProcedureCode  UNIQUE,
    &criticality            Criticality    DEFAULT ignore
}
WITH SYNTAX {
    INITIATING MESSAGE      &InitiatingMessage
    [SUCCESSFUL OUTCOME
    &SuccessfulOutcome]
    [UNSUCCESSFUL OUTCOME  &UnsuccessfulOutcome]
    PROCEDURE CODE         &procedureCode
    [CRITICALITY           &criticality]
}

-- *****
--
-- Interface PDU Definition
--
-- *****

SABP-PDU ::= CHOICE {
    initiatingMessage      InitiatingMessage,
    successfulOutcome      SuccessfulOutcome,
    unsuccessfulOutcome    UnsuccessfulOutcome,
    ...
}

InitiatingMessage ::= SEQUENCE {
    procedureCode          SABP-ELEMENTARY-PROCEDURE.&procedureCode      ({SABP-ELEMENTARY-PROCEDURES}),
    criticality            SABP-ELEMENTARY-PROCEDURE.&criticality          ({SABP-ELEMENTARY-PROCEDURES}{@procedureCode}),
    value                  SABP-ELEMENTARY-PROCEDURE.&InitiatingMessage    ({SABP-ELEMENTARY-PROCEDURES}{@procedureCode})
}

SuccessfulOutcome ::= SEQUENCE {
    procedureCode          SABP-ELEMENTARY-PROCEDURE.&procedureCode      ({SABP-ELEMENTARY-PROCEDURES}),
    criticality            SABP-ELEMENTARY-PROCEDURE.&criticality          ({SABP-ELEMENTARY-PROCEDURES}{@procedureCode}),
    value                  SABP-ELEMENTARY-PROCEDURE.&SuccessfulOutcome    ({SABP-ELEMENTARY-PROCEDURES}{@procedureCode})
}

```



```

UnsuccessfulOutcome ::= SEQUENCE {
    procedureCode  SABP-ELEMENTARY-PROCEDURE.&procedureCode    ({SABP-ELEMENTARY-PROCEDURES}),
    criticality    SABP-ELEMENTARY-PROCEDURE.&criticality      ({SABP-ELEMENTARY-PROCEDURES}@procedureCode}),
    value         SABP-ELEMENTARY-PROCEDURE.&UnsuccessfulOutcome ({SABP-ELEMENTARY-PROCEDURES}@procedureCode)
}

-- *****
--
-- Interface Elementary Procedure List
--
-- *****

SABP-ELEMENTARY-PROCEDURES SABP-ELEMENTARY-PROCEDURE ::= {
    SABP-ELEMENTARY-PROCEDURES-CLASS-1 |
    SABP-ELEMENTARY-PROCEDURES-CLASS-2 ,
    ...
}

SABP-ELEMENTARY-PROCEDURES-CLASS-1 SABP-ELEMENTARY-PROCEDURE ::= {
    write-Replace |
    kill |
    load-Status-Enquiry |
    message-Status-Query |
    reset ,
    ...
}

SABP-ELEMENTARY-PROCEDURES-CLASS-2 SABP-ELEMENTARY-PROCEDURE ::= {
    restart-Indication |
    failure-Indication |
    error-Indication ,
    ...
}

write-Replace SABP-ELEMENTARY-PROCEDURE ::= {
    INITIATING MESSAGE  Write-Replace
    SUCCESSFUL OUTCOME  Write-Replace-Complete
    UNSUCCESSFUL OUTCOME Write-Replace-Failure
    PROCEDURE CODE      id-Write-Replace
    CRITICALITY          reject
}

kill SABP-ELEMENTARY-PROCEDURE ::= {
    INITIATING MESSAGE  Kill
    SUCCESSFUL OUTCOME  Kill-Complete
    UNSUCCESSFUL OUTCOME Kill-Failure
    PROCEDURE CODE      id-Kill
    CRITICALITY          reject
}

load-Status-Enquiry SABP-ELEMENTARY-PROCEDURE ::= {
    INITIATING MESSAGE  Load-Query
    SUCCESSFUL OUTCOME  Load-Query-Complete
    UNSUCCESSFUL OUTCOME Load-Query-Failure
}

```

```

    PROCEDURE CODE          id-Load-Status-Enquiry
    CRITICALITY             reject
}

message-Status-Query SABP-ELEMENTARY-PROCEDURE ::= {
    INITIATING MESSAGE      Message-Status-Query
    SUCCESSFUL OUTCOME      Message-Status-Query-Complete
    UNSUCCESSFUL OUTCOME    Message-Status-Query-Failure
    PROCEDURE CODE          id-Message-Status-Query
    CRITICALITY             reject
}

reset SABP-ELEMENTARY-PROCEDURE ::= {
    INITIATING MESSAGE      Reset
    SUCCESSFUL OUTCOME      Reset-Complete
    UNSUCCESSFUL OUTCOME    Reset-Failure
    PROCEDURE CODE          id-Reset
    CRITICALITY             reject
}

restart-Indication SABP-ELEMENTARY-PROCEDURE ::= {
    INITIATING MESSAGE      Restart
    PROCEDURE CODE          id-Restart-Indication
    CRITICALITY             ignore
}

failure-Indication SABP-ELEMENTARY-PROCEDURE ::= {
    INITIATING MESSAGE      Failure
    PROCEDURE CODE          id-Failure-Indication
    CRITICALITY             ignore
}

error-Indication SABP-ELEMENTARY-PROCEDURE ::= {
    INITIATING MESSAGE      Error-Indication
    PROCEDURE CODE          id-Error-Indication
    CRITICALITY             ignore
}

END

```

9.3.3 PDU Definitions

```

-- *****
--
-- PDU definitions for SABP.
--
-- *****

SABP-PDU-Contents {
itu-t (0) identified-organization (4) etsi (0) mobileDomain (0)
umts-Access (20) modules (3) sabp (3) version1 (1) sabp-PDU-Contents (1) }

DEFINITIONS AUTOMATIC TAGS ::=

```

```
BEGIN
-- *****
--
-- IE parameter types from other modules.
--
-- *****

IMPORTS
    Broadcast-Message-Content,
    Category,
    Cause,
Criticality-Diagnostics,
    Data-Coding-Scheme,
    Failure-List,
    Message-Identifier,
    New-Serial-Number,
    Number-of-Broadcasts-Completed-List,
    Number-of-Broadcasts-Requested,
    Old-Serial-Number,
    Paging-ETWS-Indicator,
    Radio-Resource-Loading-List,
    Recovery-Indication,
    Repetition-Period,
    Serial-Number,
    Service-Areas-List,
    WarningSecurityInfo,
    Warning-Type,
    Broadcast-Message-Content-Validity-Indicator
FROM SABP-IEs

    ProtocolExtensionContainer{},
    ProtocolIE-Container{},
    SABP-PROTOCOL-EXTENSION,
    SABP-PROTOCOL-IES
FROM SABP-Containers

    id-Broadcast-Message-Content,
    id-Category,
    id-Criticality-Diagnostics,
    id-Cause,
    id-Data-Coding-Scheme,
    id-Failure-List,
    id-Message-Identifier,
    id-New-Serial-Number,
    id-Number-of-Broadcasts-Completed-List,
    id-Number-of-Broadcasts-Requested,
    id-Old-Serial-Number,
    id-Paging-ETWS-Indicator,
    id-Radio-Resource-Loading-List,
    id-Recovery-Indication,
    id-Repetition-Period,
    id-Serial-Number,
```

```

    id-Service-Areas-List,
    id-WarningSecurityInfo,
    id-Warning-Type,
    id-Broadcast-Message-Content-Validity-Indicator
FROM SABP-Constants;

-- *****
--
-- Write-Replace
--
-- *****

Write-Replace ::= SEQUENCE {
    protocolIEs          ProtocolIE-Container      { {Write-Replace-IEs} },
    protocolExtensions   ProtocolExtensionContainer { {Write-Replace-Extensions} } OPTIONAL,
    ...
}

Write-Replace-IEs SABP-PROTOCOL-IES ::= {
    { ID id-Message-Identifier   CRITICALITY reject   TYPE Message-Identifier       PRESENCE mandatory } |
    { ID id-New-Serial-Number    CRITICALITY reject   TYPE New-Serial-Number         PRESENCE mandatory } |
    { ID id-Old-Serial-Number    CRITICALITY ignore  TYPE Old-Serial-Number        PRESENCE optional  } |
    { ID id-Service-Areas-List   CRITICALITY reject   TYPE Service-Areas-List      PRESENCE mandatory } |
    { ID id-Category             CRITICALITY ignore  TYPE Category                 PRESENCE optional  } |
    { ID id-Repetition-Period    CRITICALITY reject   TYPE Repetition-Period        PRESENCE mandatory } |
    { ID id-Number-of-Broadcasts-Requested
      CRITICALITY reject   TYPE Number-of-Broadcasts-Requested PRESENCE mandatory } |
    { ID id-Data-Coding-Scheme   CRITICALITY reject   TYPE Data-Coding-Scheme       PRESENCE mandatory } |
    { ID id-Broadcast-Message-Content
      CRITICALITY reject   TYPE Broadcast-Message-Content PRESENCE mandatory },
    ...
}

Write-Replace-Extensions SABP-PROTOCOL-EXTENSION ::= {
    { ID id-WarningSecurityInfo   CRITICALITY ignore  EXTENSION WarningSecurityInfo PRESENCE optional } |
    { ID id-Paging-ETWS-Indicator CRITICALITY ignore  EXTENSION Paging-ETWS-Indicator PRESENCE optional } |
    { ID id-Warning-Type          CRITICALITY ignore  EXTENSION Warning-Type        PRESENCE optional } |
    { ID id-Broadcast-Message-Content-Validity-Indicator
      CRITICALITY ignore  EXTENSION Broadcast-Message-Content-Validity-Indicator PRESENCE
optional },
    ...
}

-- *****
--
-- Write-Replace-Complete
--
-- *****

Write-Replace-Complete ::= SEQUENCE {
    protocolIEs          ProtocolIE-Container      { {Write-Replace-Complete-IEs} },
    protocolExtensions   ProtocolExtensionContainer { {Write-Replace-Complete-Extensions} } OPTIONAL,
    ...
}

```

```

Write-Replace-Complete-IEs SABP-PROTOCOL-IES ::= {
  { ID id-Message-Identifier CRITICALITY reject TYPE Message-Identifier PRESENCE mandatory } |
  { ID id-New-Serial-Number CRITICALITY reject TYPE New-Serial-Number PRESENCE mandatory } |
  { ID id-Number-of-Broadcasts-Completed-List
    CRITICALITY reject TYPE Number-of-Broadcasts-Completed-List
    PRESENCE mandatory } |
  { ID id-Criticality-Diagnostics
    CRITICALITY ignore TYPE Criticality-Diagnostics PRESENCE optional },
  ...
}

Write-Replace-Complete-Extensions SABP-PROTOCOL-EXTENSION ::= {
  ...
}

-- *****
--
-- Write-Replace-Failure
--
-- *****

Write-Replace-Failure ::= SEQUENCE {
  protocolIEs ProtocolIE-Container { {Write-Replace-Failure-IEs} },
  protocolExtensions ProtocolExtensionContainer { {Write-Replace-Failure-Extensions} } OPTIONAL,
  ...
}

Write-Replace-Failure-IEs SABP-PROTOCOL-IES ::= {
  { ID id-Message-Identifier CRITICALITY reject TYPE Message-Identifier PRESENCE mandatory } |
  { ID id-New-Serial-Number CRITICALITY reject TYPE New-Serial-Number PRESENCE mandatory } |
  { ID id-Failure-List CRITICALITY reject TYPE Failure-List PRESENCE mandatory } |
  { ID id-Number-of-Broadcasts-Completed-List
    CRITICALITY ignore TYPE Number-of-Broadcasts-Completed-List
    PRESENCE optional } |
  { ID id-Criticality-Diagnostics
    CRITICALITY ignore TYPE Criticality-Diagnostics PRESENCE optional },
  ...
}

Write-Replace-Failure-Extensions SABP-PROTOCOL-EXTENSION ::= {
  ...
}

-- *****
--
-- Kill
--
-- *****

Kill ::= SEQUENCE {
  protocolIEs ProtocolIE-Container {{Kill-IEs}},
  protocolExtensions ProtocolExtensionContainer {{Kill-Extensions}} OPTIONAL,
  ...
}

```

```

Kill-IEs SABP-PROTOCOL-IES ::= {
  { ID id-Message-Identifier  CRITICALITY reject  TYPE Message-Identifier  PRESENCE mandatory } |
  { ID id-Old-Serial-Number   CRITICALITY reject  TYPE Old-Serial-Number   PRESENCE mandatory } |
  { ID id-Service-Areas-List  CRITICALITY reject  TYPE Service-Areas-List   PRESENCE mandatory } ,
  ...
}

Kill-Extensions SABP-PROTOCOL-EXTENSION ::= {
  ...
}

-- *****
--
-- Kill-Complete
--
-- *****

Kill-Complete ::= SEQUENCE {
  protocolIEs          ProtocolIE-Container      {{Kill-Complete-IEs}},
  protocolExtensions  ProtocolExtensionContainer {{Kill-Complete-Extensions}}  OPTIONAL,
  ...
}

Kill-Complete-IEs SABP-PROTOCOL-IES ::= {
  { ID id-Message-Identifier  CRITICALITY reject  TYPE Message-Identifier  PRESENCE mandatory } |
  { ID id-Old-Serial-Number   CRITICALITY reject  TYPE Old-Serial-Number   PRESENCE mandatory } |
  { ID id-Number-of-Broadcasts-Completed-List
    CRITICALITY reject          TYPE Number-of-Broadcasts-Completed-List
    PRESENCE mandatory } |
  { ID id-Criticality-Diagnostics
    CRITICALITY ignore          TYPE Criticality-Diagnostics          PRESENCE optional },
  ...
}

Kill-Complete-Extensions SABP-PROTOCOL-EXTENSION ::= {
  ...
}

-- *****
--
-- Kill-Failure
--
-- *****

Kill-Failure ::= SEQUENCE {
  protocolIEs          ProtocolIE-Container      {{Kill-Failure-IEs}},
  protocolExtensions  ProtocolExtensionContainer {{Kill-Failure-Extensions}}  OPTIONAL,
  ...
}

Kill-Failure-IEs SABP-PROTOCOL-IES ::= {
  { ID id-Message-Identifier  CRITICALITY reject  TYPE Message-Identifier  PRESENCE mandatory } |
  { ID id-Old-Serial-Number   CRITICALITY reject  TYPE Old-Serial-Number   PRESENCE mandatory } |
  { ID id-Failure-List        CRITICALITY reject  TYPE Failure-List        PRESENCE mandatory } |

```

```

    { ID id-Number-of-Broadcasts-Completed-List
      CRITICALITY ignore TYPE Number-of-Broadcasts-Completed-List
      PRESENCE optional } |
  { ID id-Criticality-Diagnostics
    CRITICALITY ignore TYPE Criticality-Diagnostics PRESENCE optional },
  ...
}

Kill-Failure-Extensions SABP-PROTOCOL-EXTENSION ::= {
  ...
}

-- *****
--
-- Load-Query
--
-- *****

Load-Query ::= SEQUENCE {
  protocolIEs ProtocolIE-Container {{Load-Query-IEs}},
  protocolExtensions ProtocolExtensionContainer {{Load-Query-Extensions}} OPTIONAL,
  ...
}

Load-Query-IEs SABP-PROTOCOL-IES ::= {
  { ID id-Service-Areas-List CRITICALITY reject TYPE Service-Areas-List PRESENCE mandatory } ,
  ...
}

Load-Query-Extensions SABP-PROTOCOL-EXTENSION ::= {
  ...
}

-- *****
--
-- Load-Query-Complete
--
-- *****

Load-Query-Complete ::= SEQUENCE {
  protocolIEs ProtocolIE-Container {{Load-Query-Complete-IEs}},
  protocolExtensions ProtocolExtensionContainer {{Load-Query-Complete-Extensions}} OPTIONAL,
  ...
}

Load-Query-Complete-IEs SABP-PROTOCOL-IES ::= {
  { ID id-Radio-Resource-Loading-List
    CRITICALITY reject TYPE Radio-Resource-Loading-List
    PRESENCE mandatory } |
  { ID id-Criticality-Diagnostics
    CRITICALITY ignore TYPE Criticality-Diagnostics PRESENCE optional },
  ...
}

```

```

Load-Query-Complete-Extensions SABP-PROTOCOL-EXTENSION ::= {
    ...
}

-- *****
--
-- Load-Query-Failure
--
-- *****

Load-Query-Failure ::= SEQUENCE {
    protocolIEs          ProtocolIE-Container      {{Load-Query-Failure-IEs}},
    protocolExtensions   ProtocolExtensionContainer {{Load-Query-Failure-Extensions}} OPTIONAL,
    ...
}

Load-Query-Failure-IEs SABP-PROTOCOL-IES ::= {

    { ID id-Failure-List          CRITICALITY reject  TYPE Failure-List          PRESENCE mandatory } |
    { ID id-Radio-Resource-Loading-List
      CRITICALITY ignore  TYPE Radio-Resource-Loading-List
      PRESENCE optional  } |

    { ID id-Criticality-Diagnostics
      CRITICALITY ignore  TYPE Criticality-Diagnostics          PRESENCE optional },
    ...
}

Load-Query-Failure-Extensions SABP-PROTOCOL-EXTENSION ::= {
    ...
}

-- *****
--
-- Message-Status-Query
--
-- *****

Message-Status-Query ::= SEQUENCE {
    protocolIEs          ProtocolIE-Container      {{Message-Status-Query-IEs}},
    protocolExtensions   ProtocolExtensionContainer {{Message-Status-Query-Extensions}} OPTIONAL,
    ...
}

Message-Status-Query-IEs SABP-PROTOCOL-IES ::= {

    { ID id-Message-Identifier  CRITICALITY reject  TYPE Message-Identifier          PRESENCE mandatory } |
    { ID id-Old-Serial-Number   CRITICALITY reject  TYPE Old-Serial-Number           PRESENCE mandatory } |
    { ID id-Service-Areas-List  CRITICALITY reject  TYPE Service-Areas-List         PRESENCE mandatory } ,
    ...
}

Message-Status-Query-Extensions SABP-PROTOCOL-EXTENSION ::= {
    ...
}

```



```

-- *****
--
-- Message-Status-Query-Complete
--
-- *****

Message-Status-Query-Complete ::= SEQUENCE {
    protocolIEs          ProtocolIE-Container      {{Message-Status-Query-Complete-IEs}},
    protocolExtensions   ProtocolExtensionContainer {{Message-Status-Query-Complete-Extensions}} OPTIONAL,
    ...
}

Message-Status-Query-Complete-IEs SABP-PROTOCOL-IES ::= {
    { ID id-Message-Identifier  CRITICALITY reject  TYPE Message-Identifier      PRESENCE mandatory } |
    { ID id-Old-Serial-Number   CRITICALITY reject  TYPE Old-Serial-Number      PRESENCE mandatory } |
    { ID id-Number-of-Broadcasts-Completed-List
      CRITICALITY reject  TYPE Number-of-Broadcasts-Completed-List
      PRESENCE mandatory } |
    { ID id-Criticality-Diagnostics
      CRITICALITY ignore  TYPE Criticality-Diagnostics      PRESENCE optional },
    ...
}

Message-Status-Query-Complete-Extensions SABP-PROTOCOL-EXTENSION ::= {
    ...
}

-- *****
--
-- Message-Status-Query-Failure
--
-- *****

Message-Status-Query-Failure ::= SEQUENCE {
    protocolIEs          ProtocolIE-Container      {{Message-Status-Query-Failure-IEs}},
    protocolExtensions   ProtocolExtensionContainer {{Message-Status-Query-Failure-Extensions}} OPTIONAL,
    ...
}

Message-Status-Query-Failure-IEs SABP-PROTOCOL-IES ::= {
    { ID id-Message-Identifier  CRITICALITY reject  TYPE Message-Identifier      PRESENCE mandatory } |
    { ID id-Failure-List        CRITICALITY reject  TYPE Failure-List          PRESENCE mandatory } |
    { ID id-Old-Serial-Number   CRITICALITY reject  TYPE Old-Serial-Number      PRESENCE mandatory } |
    { ID id-Number-of-Broadcasts-Completed-List
      CRITICALITY ignore  TYPE Number-of-Broadcasts-Completed-List
      PRESENCE optional } |
    { ID id-Criticality-Diagnostics
      CRITICALITY ignore  TYPE Criticality-Diagnostics      PRESENCE optional },
    ...
}

Message-Status-Query-Failure-Extensions SABP-PROTOCOL-EXTENSION ::= {
    ...
}

```

```

-- *****
--
-- Reset
--
-- *****

Reset ::= SEQUENCE {
    protocolIEs          ProtocolIE-Container          {{Reset-IEs}},
    protocolExtensions   ProtocolExtensionContainer {{Reset-Extensions}}  OPTIONAL,
    ...
}

Reset-IEs SABP-PROTOCOL-IES ::= {
    { ID id-Service-Areas-List  CRITICALITY reject  TYPE Service-Areas-List          PRESENCE mandatory } ,
    ...
}

Reset-Extensions SABP-PROTOCOL-EXTENSION ::= {
    ...
}

-- *****
--
-- Reset-Complete
--
-- *****

Reset-Complete ::= SEQUENCE {
    protocolIEs          ProtocolIE-Container          {{Reset-Complete-IEs}},
    protocolExtensions   ProtocolExtensionContainer {{Reset-Complete-Extensions}}  OPTIONAL,
    ...
}

Reset-Complete-IEs SABP-PROTOCOL-IES ::= {
    { ID id-Service-Areas-List  CRITICALITY reject  TYPE Service-Areas-List          PRESENCE mandatory } |
    { ID id-Criticality-Diagnostics
    CRITICALITY ignore  TYPE Criticality-Diagnostics          PRESENCE optional },
    ...
}

Reset-Complete-Extensions SABP-PROTOCOL-EXTENSION ::= {
    ...
}

-- *****
--
-- Reset-Failure
--
-- *****

Reset-Failure ::= SEQUENCE {
    protocolIEs          ProtocolIE-Container          {{Reset-Failure-IEs}},
    protocolExtensions   ProtocolExtensionContainer {{Reset-Failure-Extensions}}  OPTIONAL,

```

```

}
...
}
Reset-Failure-IEs SABP-PROTOCOL-IES ::= {
  { ID id-Failure-List          CRITICALITY reject  TYPE Failure-List          PRESENCE mandatory } |
  { ID id-Service-Areas-List    CRITICALITY reject  TYPE Service-Areas-List      PRESENCE optional } |
  { ID id-Criticality-Diagnostics
  CRITICALITY ignore  TYPE Criticality-Diagnostics  PRESENCE optional } ,
  ...
}

Reset-Failure-Extensions SABP-PROTOCOL-EXTENSION ::= {
  ...
}

-- *****
--
-- Restart
--
-- *****

Restart ::= SEQUENCE {
  protocolIEs          ProtocolIE-Container      {{Restart-IEs}},
  protocolExtensions   ProtocolExtensionContainer {{Restart-Extensions}}  OPTIONAL,
  ...
}

Restart-IEs SABP-PROTOCOL-IES ::= {
  { ID id-Service-Areas-List    CRITICALITY ignore  TYPE Service-Areas-List      PRESENCE mandatory } |
  { ID id-Recovery-Indication    CRITICALITY ignore  TYPE Recovery-Indication    PRESENCE optional } ,
  ...
}

Restart-Extensions SABP-PROTOCOL-EXTENSION ::= {
  ...
}

-- *****
--
-- Failure
--
-- *****

Failure ::= SEQUENCE {
  protocolIEs          ProtocolIE-Container      {{Failure-IEs}},
  protocolExtensions   ProtocolExtensionContainer {{Failure-Extensions}}  OPTIONAL,
  ...
}

Failure-IEs SABP-PROTOCOL-IES ::= {
  { ID id-Service-Areas-List    CRITICALITY ignore  TYPE Service-Areas-List      PRESENCE mandatory } ,
  ...
}

```

```

Failure-Extensions SABP-PROTOCOL-EXTENSION ::= {
  ...
}

-- *****
--
-- Error-Indication
--
-- *****

Error-Indication ::= SEQUENCE {
  protocolIEs          ProtocolIE-Container      {{Error-Indication-IEs}},
  protocolExtensions   ProtocolExtensionContainer {{Error-Indication-Extensions}} OPTIONAL,
  ...
}

Error-Indication-IEs SABP-PROTOCOL-IES ::= {
  { ID id-Message-Identifier CRITICALITY ignore TYPE Message-Identifier PRESENCE optional } |
  { ID id-Serial-Number      CRITICALITY ignore TYPE Serial-Number      PRESENCE optional } |
  { ID id-Cause              CRITICALITY ignore TYPE Cause              PRESENCE optional } |
  { ID id-Criticality-Diagnostics
  CRITICALITY ignore TYPE Criticality-Diagnostics PRESENCE optional },
  ...
}

Error-Indication-Extensions SABP-PROTOCOL-EXTENSION ::= {
  ...
}

END

```

9.3.4 Information Element Definitions

```

-- *****
--
-- Information Element Definitions
--
-- *****

SABP-IEs {
itu-t (0) identified-organization (4) etsi (0) mobileDomain (0)
umts-Access (20) modules (3) sabp (3) version1 (1) sabp-IEs (2) }

DEFINITIONS AUTOMATIC TAGS ::=

BEGIN

IMPORTS
  maxNrOfErrors,
  maxnoofSAI,

```

```
maxNrOfLevels,

id-MessageStructure,
id-TypeOfError

FROM SABP-Constants

Criticality,
ProcedureCode,
TriggeringMessage,
ProtocolIE-ID
FROM SABP-CommonDataTypes

ProtocolExtensionContainer{},

SABP-PROTOCOL-EXTENSION
FROM SABP-Containers;

-- A

Available-Bandwidth ::= INTEGER (0..20480)
-- bits/sec

-- B

Broadcast-Message-Content ::= BIT STRING (SIZE (1..9968))-- This IE is sent from the CN to the RNC containing user information i.e.
-- the message.

Broadcast-Message-Content-Validity-Indicator ::= ENUMERATED {
    broadcast-Message-Content-not-valid,
    ...
}

-- C

Category ::= ENUMERATED {
    high-priority,
    background-priority,
    normal-priority,
    default-priority,
    ...
}

Cause ::= INTEGER {
    parameter-not-recognised (0),
    parameter-value-invalid (1),
    valid-CN-message-not-identified (2),
    service-area-identity-not-valid (3),
    unrecognised-message (4),
    missing-mandatory-element (5),
    rNC-capacity-exceeded (6),
    rNC-memory-exceeded (7),
    service-area-broadcast-not-supported (8),
```

```

    service-area-broadcast-not-operational          (9),
    message-reference-already-used                  (10),
    unspecified-error                               (11),
    transfer-syntax-error                           (12),
    semantic-error                                  (13),
    message-not-compatible-with-receiver-state      (14),
    abstract-syntax-error-reject                    (15),
    abstract-syntax-error-ignore-and-notify         (16),
    abstract-syntax-error-falsely-constructed-message (17)
} (0..255)

Criticality-Diagnostics ::= SEQUENCE {
    procedureCode          ProcedureCode          OPTIONAL,
    triggeringMessage      TriggeringMessage      OPTIONAL,
    procedureCriticality   Criticality            OPTIONAL,
    iEsCriticalityDiagnostics CriticalityDiagnostics-IE-List OPTIONAL,
    iE-Extensions          ProtocolExtensionContainer { {CriticalityDiagnostics-ExtIEs} } OPTIONAL,
    ...
}

CriticalityDiagnostics-ExtIEs SABP-PROTOCOL-EXTENSION ::= {
    ...
}

CriticalityDiagnostics-IE-List ::= SEQUENCE (SIZE (1..maxNrOfErrors)) OF
    SEQUENCE {
        iECriticality          Criticality,
        iE-ID                  ProtocolIE-ID,
        repetitionNumber       RepetitionNumber0          OPTIONAL,
        iE-Extensions          ProtocolExtensionContainer { {CriticalityDiagnostics-IE-List-ExtIEs} } OPTIONAL,
        ...
    }

CriticalityDiagnostics-IE-List-ExtIEs SABP-PROTOCOL-EXTENSION ::= {
    { ID id-MessageStructure      CRITICALITY ignore      EXTENSION MessageStructure      PRESENCE optional } |
    { ID id-TypeOfError           CRITICALITY ignore      EXTENSION TypeOfError          PRESENCE mandatory },
    ...
}

MessageStructure ::= SEQUENCE (SIZE (1..maxNrOfLevels)) OF
    SEQUENCE {
        iE-ID                  ProtocolIE-ID,
        repetitionNumber       RepetitionNumber1          OPTIONAL,
        iE-Extensions          ProtocolExtensionContainer { {MessageStructure-ExtIEs} } OPTIONAL,
        ...
    }

MessageStructure-ExtIEs SABP-PROTOCOL-EXTENSION ::= {
    ...
}

```

```

-- D
Data-Coding-Scheme ::= BIT STRING (SIZE (8))

-- E

-- F

Failure-List ::= SEQUENCE (SIZE (1..maxnoofSAI)) OF Failure-List-Item

Failure-List-Item ::= SEQUENCE {
    service-area-identifier Service-Area-Identifier,
    cause Cause,
    iE-Extensions ProtocolExtensionContainer { {FailureListItemIE-ExtIEs} } OPTIONAL,
    ...
}

FailureListItemIE-ExtIEs SABP-PROTOCOL-EXTENSION ::= {
    ...
}

-- G

-- H

-- I

-- J

-- K

-- L

-- M

Message-Identifier ::= BIT STRING (SIZE (16))

-- N

New-Serial-Number ::= Serial-Number

Number-of-Broadcasts-Completed-List ::= SEQUENCE (SIZE (1..maxnoofSAI)) OF
    Number-of-Broadcasts-Completed-List-Item

Number-of-Broadcasts-Completed-List-Item ::= SEQUENCE {
    service-area-identifier Service-Area-Identifier,
    number-of-broadcasts-completed INTEGER (0..65535),
    number-of-broadcasts-completed-info Number-Of-Broadcasts-Completed-Info OPTIONAL,
    iE-Extensions ProtocolExtensionContainer { {NoOfBroadcastsCompletedListItemIE-ExtIEs} } OPTIONAL,
    ...
}

NoOfBroadcastsCompletedListItemIE-ExtIEs SABP-PROTOCOL-EXTENSION ::= {
    ...
}

```

```
}
Number-Of-Broadcasts-Completed-Info ::= ENUMERATED {
    overflow,
    unknown,
    ...
}
Number-of-Broadcasts-Requested ::= INTEGER {
    broadcast-indefinitely (0)
} (0..65535)
-- O
Old-Serial-Number ::= Serial-Number
-- P
Paging-ETWS-Indicator ::= ENUMERATED {
    paging,
    ...
}
-- Q
-- R
Radio-Resource-Loading-List ::= SEQUENCE (SIZE (1..maxnoofSAI)) OF
    Radio-Resource-Loading-List-Item
Radio-Resource-Loading-List-Item ::= SEQUENCE {
    service-area-identifier Service-Area-Identifier,
    available-bandwidth Available-Bandwidth,
    iE-Extensions ProtocolExtensionContainer { {RadioResourceLoadingListItemIE-ExtIEs} } OPTIONAL,
    ...
}
RadioResourceLoadingListItemIE-ExtIEs SABP-PROTOCOL-EXTENSION ::= {
    ...
}
Recovery-Indication ::= ENUMERATED {
    data-lost,
    data-available
}
RepetitionNumber0 ::= INTEGER(0..255)
RepetitionNumber1 ::= INTEGER(1..256)
Repetition-Period ::= INTEGER (1..4096)
-- Each unit represents a repetition of one second to a maximum of
-- once per 4096 seconds (~1 hour).
```



```

-- S
Serial-Number ::= BIT STRING (SIZE (16))

Service-Area-Identifier ::= SEQUENCE {
    plmnidentity OCTET STRING (SIZE (3))
        -- Digits 0 to 9, two digits per octet. --
        -- Each octet encoded 0000 to 1001. --
        -- 1111 used as filler --
        -- Bit 4 to 1 of octet n encoding digit 2n-1. --
        -- Bit 8 to 5 of octet n encoding digit 2n. --
        -- The PLMN identity consists of 3 digits from MCC --
        -- followed by either a filler plus 2 digits --
        -- from MNC (in case of 2 digit MNC) or 3 digits --
        -- from MNC (in case of 3 digit MNC). -- ,
    lac OCTET STRING (SIZE (2))
        -- 0000 and FFFE not allowed -- ,
    sac OCTET STRING (SIZE (2))
}

-- **TODO** The IE type for these parameters is not known as yet
Service-Areas-List ::= SEQUENCE (SIZE (1..maxnoofSAI)) OF Service-Area-Identifier

-- T
TypeOfError ::= ENUMERATED {
    not-understood,
    missing,
    ...
}

-- U

-- V

-- W
WarningSecurityInfo ::= OCTET STRING (SIZE (50))
Warning-Type ::= OCTET STRING (SIZE(2))

-- X

-- Y
END

```

9.3.5 Common Definitions

```
-- *****
```

```

--
-- Common definitions
--
-- *****

SABP-CommonDataTypes {
itu-t (0) identified-organization (4) etsi (0) mobileDomain (0)
umts-Access (20) modules (3) sabp (3) version1 (1) sabp-CommonDataTypes (3) }

DEFINITIONS AUTOMATIC TAGS ::=

BEGIN

Criticality      ::= ENUMERATED { reject, ignore, notify }

Presence        ::= ENUMERATED { optional, conditional, mandatory }

ProcedureCode    ::= INTEGER (0..255)

ProtocolExtensionID ::= INTEGER (0..65535)

ProtocolIE-ID    ::= INTEGER (0..65535)

TriggeringMessage ::= ENUMERATED { initiating-message, successful-outcome, unsuccessful-outcome, outcome}

END

```

9.3.6 Constant Definitions

```

-- *****
--
-- Constant definitions
--
-- *****

SABP-Constants {
itu-t (0) identified-organization (4) etsi (0) mobileDomain (0)
umts-Access (20) modules (3) sabp (3) version1 (1) sabp-Constants (4) }

DEFINITIONS AUTOMATIC TAGS ::=

BEGIN

-- *****
--
-- Elementary Procedures
--
-- *****

id-Write-Replace      INTEGER ::= 0
id-Kill                INTEGER ::= 1
id-Load-Status-Enquiry  INTEGER ::= 2
id-Message-Status-Query  INTEGER ::= 3

```

```

id-Restart-Indication      INTEGER ::= 4
id-Reset                  INTEGER ::= 5
id-Failure-Indication     INTEGER ::= 6
id-Error-Indication       INTEGER ::= 7

-- *****
--
-- IEs
--
-- *****

id-Broadcast-Message-Content  INTEGER ::= 0
id-Category                  INTEGER ::= 1
id-Cause                     INTEGER ::= 2
id-Criticality-Diagnostics   INTEGER ::= 3
id-Data-Coding-Scheme        INTEGER ::= 4
id-Failure-List              INTEGER ::= 5
id-Message-Identifier        INTEGER ::= 6
id-New-Serial-Number         INTEGER ::= 7
id-Number-of-Broadcasts-Completed-List  INTEGER ::= 8
id-Number-of-Broadcasts-Requested  INTEGER ::= 9
id-Old-Serial-Number         INTEGER ::= 10
id-Radio-Resource-Loading-List  INTEGER ::= 11
id-Recovery-Indication      INTEGER ::= 12
id-Repetition-Period        INTEGER ::= 13
id-Serial-Number            INTEGER ::= 14
id-Service-Areas-List      INTEGER ::= 15
id-MessageStructure         INTEGER ::= 16
id-TypeOfError              INTEGER ::= 17
id-Paging-ETWS-Indicator   INTEGER ::= 18
id-Warning-Type             INTEGER ::= 19
id-WarningSecurityInfo      INTEGER ::= 20
id-Broadcast-Message-Content-Validity-Indicator  INTEGER ::= 21

-- *****
--
-- Extension constants
--
-- *****
--
-- Lists
--
-- *****

maxNrOfErrors              INTEGER ::= 256
maxnoofSAI                 INTEGER ::= 65535

maxProtocolExtensions      INTEGER ::= 65535
maxProtocolIEs            INTEGER ::= 65535
maxNrOfLevels              INTEGER ::= 256

END

```

9.3.7 Container Definitions

```

-- *****
--
-- Container definitions
--
-- *****

SABP-Containers {
itu-t (0) identified-organization (4) etsi (0) mobileDomain (0)
umts-Access (20) modules (3) sabp (3) version1 (1) sabp-Containers (5) }

DEFINITIONS AUTOMATIC TAGS ::=

BEGIN

-- *****
--
-- IE parameter types from other modules.
--
-- *****

IMPORTS
    Criticality,
    Presence,
    ProtocolExtensionID,
    ProtocolIE-ID
FROM SABP-CommonDataTypes

    maxProtocolExtensions,
    maxProtocolIEs
FROM SABP-Constants;

-- *****
--
-- Class Definition for Protocol IEs
--
-- *****

SABP-PROTOCOL-IES ::= CLASS {
    &id          ProtocolIE-ID          UNIQUE,
    &criticality Criticality          DEFAULT ignore,
    &Value,
    &presence    Presence
}
WITH SYNTAX {
    ID          &id
    CRITICALITY &criticality
    TYPE        &Value
    PRESENCE    &presence
}

```

```

-- *****
--
-- Class Definition for Protocol Extensions
--
-- *****

SABP-PROTOCOL-EXTENSION ::= CLASS {
    &id          ProtocolExtensionID    UNIQUE,
    &criticality Criticality            DEFAULT ignore,
    &Extension,
    &presence    Presence
}
WITH SYNTAX {
    ID          &id
    CRITICALITY &criticality
    EXTENSION   &Extension
    PRESENCE    &presence
}

-- *****
--
-- Container for Protocol IEs
--
-- *****

ProtocolIE-Container {SABP-PROTOCOL-IES : IEsSetParam} ::=
    SEQUENCE (SIZE (0..maxProtocolIEs)) OF
        ProtocolIE-Field {{IEsSetParam}}

ProtocolIE-Field {SABP-PROTOCOL-IES : IEsSetParam} ::= SEQUENCE {
    id          SABP-PROTOCOL-IES.&id          ({IEsSetParam}),
    criticality SABP-PROTOCOL-IES.&criticality ({IEsSetParam}@id}),
    value       SABP-PROTOCOL-IES.&Value      ({IEsSetParam}@id)}
}

-- *****
--
-- Container Lists for Protocol IE Containers
--
-- *****

ProtocolIE-ContainerList {INTEGER : lowerBound, INTEGER : upperBound, SABP-PROTOCOL-IES : IEsSetParam} ::=
    SEQUENCE (SIZE (lowerBound..upperBound)) OF
        ProtocolIE-Container {{IEsSetParam}}

-- *****
--
-- Container for Protocol Extensions
--
-- *****

ProtocolExtensionContainer {SABP-PROTOCOL-EXTENSION : ExtensionSetParam} ::=
    SEQUENCE (SIZE (1..maxProtocolExtensions)) OF
        ProtocolExtensionField {{ExtensionSetParam}}

```

```
ProtocolExtensionField {SABP-PROTOCOL-EXTENSION : ExtensionSetParam} ::= SEQUENCE {
  id          SABP-PROTOCOL-EXTENSION.&id          ({ExtensionSetParam}),
  criticality SABP-PROTOCOL-EXTENSION.&criticality  ({ExtensionSetParam}@id}),
  extensionValue SABP-PROTOCOL-EXTENSION.&Extension  ({ExtensionSetParam}@id)
}
```

END

9.4 Message Transfer Syntax

SABP shall use the ASN.1 Basic Packed Encoding Rules (BASIC-PER) Aligned Variant as transfer syntax as specified in ref. ITU-T Rec. X.691 [9].

10 Handling of Unknown, Unforeseen or Erroneous Protocol Data

10.1 General

Protocol Error cases can be divided into three classes:

- Transfer Syntax Error;
- Abstract Syntax Error;
- Logical Error.

Protocol errors can occur in the following functions within a receiving node:

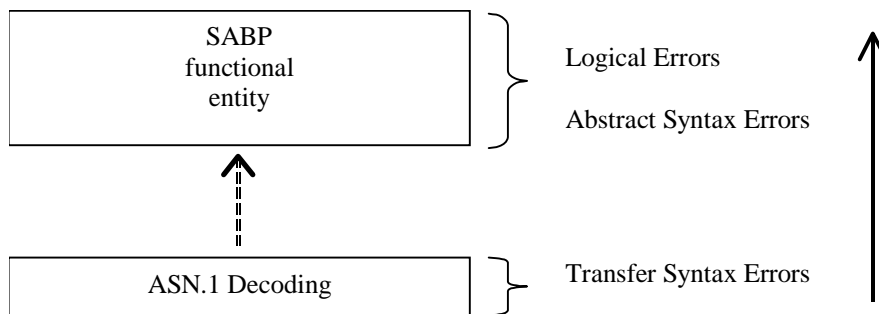

Figure 14: Protocol Errors in SABP

The information stated in subclauses 10.2, 10.3 and 10.4, to be included in the message used when reporting an error, is what at minimum shall be included. Other optional information elements within the message may also be included, if available. This is also valid for the case when the reporting is done with a response message. The latter is an exception to what is stated in subclause 4.1.

10.2 Transfer Syntax Error

A Transfer Syntax Error occurs when the receiver is not able to decode the received physical message. Transfer syntax errors are always detected in the process of ASN.1 decoding. If a Transfer Syntax Error occurs, the receiver should initiate Error Indication procedure with appropriate cause value for the Transfer Syntax protocol error.

10.3 Abstract Syntax Error

10.3.1 General

An Abstract Syntax Error occurs when the receiving functional SABP entity:

1. receives IEs or IE groups that cannot be understood (unknown IE id);
2. receives IEs for which the logical range is violated (e.g.: ASN.1 definition: 0 to 15, the logical range is 0 to 10 (values 11 to 15 are undefined), and 12 will be received; this case will be handled as an abstract syntax error using criticality information sent by the originator of the message);

3. does not receive IEs or IE groups but according to the specified presence of the concerning object, the IEs or IE groups should have been present in the received message;
4. receives IEs or IE groups that are defined to be part of that message in wrong order or with too many occurrences of the same IE or IE group;
5. receives IEs or IE groups but according to the conditional presence of the concerning object and the specified condition, the IEs or IE groups should not have been present in the received message.

Cases 1 and 2 (not comprehended IE/IE group) are handled based on received Criticality information. Case 3 (missing IE/IE group) is handled based on Criticality information and Presence information for the missing IE/IE group specified in the version of the specification used by the receiver. Case 4 (IEs or IE groups in wrong order or with too many occurrences) and Case 5 (erroneously present conditional IEs or IE groups) result in rejecting the procedure.

If an Abstract Syntax Error occurs, the receiver shall read the remaining message and shall then for each detected Abstract Syntax Error act according to the Criticality Information and Presence Information for the IE/IE group due to which Abstract Syntax Error occurred in accordance with subclauses 10.3.4 and 10.3.5. The handling of cases 4 and 5 is specified in subclause 10.3.6.

10.3.2 Criticality Information

In the SABP messages there is criticality information set for individual IEs and/or IE groups. This criticality information instructs the receiver how to act when receiving an IE or an IE group that is not comprehended i.e. the entire item (IE or IE group) which is not (fully or partially) comprehended shall be treated in accordance with its own criticality information as specified in subclause 10.3.4.

In addition, the criticality information is used in case of the missing IE/IE group abstract syntax error (see subclause 10.3.5).

The receiving node shall take different actions depending on the value of the Criticality Information. The three possible values of the Criticality Information for an IE/IE group are:

- Reject IE;
- Ignore IE and Notify Sender;
- Ignore IE.

The following rules restrict when a receiving entity may consider an IE, an IE group or an EP not comprehended (not implemented), and when action based on criticality information is applicable:

1. IE or IE group: When one new or modified IE or IE group is implemented for one EP from a standard version, then other new or modified IEs or IE groups specified for that EP in that standard version shall be considered comprehended by the receiving entity (some may still remain unsupported).
2. EP: The comprehension of different EPs within a standard version or between different standard versions is not mandated. Any EP that is not supported may be considered not comprehended, even if another EP from that standard version is comprehended, and action based on criticality shall be applied.

10.3.3 Presence Information

For many IEs/IE groups which are optional according to the ASN.1 transfer syntax, SABP specifies separately if the presence of these IEs/IE groups is optional or mandatory with respect to RNS application by means of the presence field of the concerning object of class SABP-PROTOCOL-IES, SABP-PROTOCOL-IES-PAIR, SABP-PROTOCOL-EXTENSION or SABP-PRIVATE-IES.

The presence field of the indicated classes supports three values:

1. Optional;
2. Conditional;
3. Mandatory.

If an IE/IE group is not included in a received message and the presence of the IE/IE group is mandatory or the presence is conditional and the condition is true according to the version of the specification used by the receiver, an abstract syntax error occurs due to a missing IE/IE group.

10.3.4 Not comprehended IE/IE group

10.3.4.1 Procedure Code

The receiving node shall treat the different types of received criticality information of the *Procedure Code* according to the following:

Reject IE:

- If a message is received with a *Procedure Code* marked with "*Reject IE*" which the receiving node does not comprehend, the receiving node shall reject the procedure using the Error Indication procedure.

Ignore IE and Notify Sender:

- If a message is received with a *Procedure Code* marked with "*Ignore IE and Notify Sender*" which the receiving node does not comprehend, the receiving node shall ignore the procedure and initiate the Error Indication procedure.

Ignore IE:

- If a message is received with a *Procedure Code* marked with "*Ignore IE*" which the receiving node does not comprehend, the receiving node shall ignore the procedure.

When using the Error Indication procedure to reject a procedure or to report an ignored procedure it shall include the *Procedure Code IE*, the *Triggering Message IE*, and the *Procedure Criticality IE* in the *Criticality Diagnostics IE*.

10.3.4.1A Type of Message

When the receiving node cannot decode the *Type of Message IE*, the Error Indication procedure shall be initiated with an appropriate cause value.

10.3.4.2 IEs other than the Procedure Code and Type of Message

The receiving node shall treat the different types of received criticality information of an IE/IE group other than the *Procedure Code IE* and *Type of Message IE* according to the following:

Reject IE:

- If a message *initiating* a procedure is received containing one or more IEs/IE groups marked with "*Reject IE*" which the receiving node does not comprehend; none of the functional requests of the message shall be executed. The receiving node shall reject the procedure and report the rejection of one or more IEs/IE groups using the message normally used to report unsuccessful outcome of the procedure. In case the information received in the initiating message was insufficient to determine a value for all IEs that are required to be present in the message used to report the unsuccessful outcome of the procedure, the receiving node shall instead terminate the procedure and initiate the Error Indication procedure.
- If a message *initiating* a procedure that does not have a message to report unsuccessful outcome is received containing one or more IEs/IE groups marked with "*Reject IE*" which the receiving node does not comprehend, the receiving node shall terminate the procedure and initiate the Error Indication procedure.
- If a *response* message is received containing one or more IEs marked with "*Reject IE*" which the receiving node does not comprehend, the receiving node shall consider the procedure as unsuccessfully terminated and initiate local error handling.

Ignore IE and Notify Sender:

- If a message *initiating* a procedure is received containing one or more IEs/IE groups marked with "*Ignore IE and Notify Sender*" which the receiving node does not comprehend, the receiving node shall ignore the content of the not comprehended IEs/IE groups, continue with the procedure as if the not comprehended IEs/IE groups were not received (except for the reporting) using the understood IEs/IE groups, and report in the response message of the procedure that one or more IEs/IE groups have been ignored. In case the information received in the initiating message was insufficient to determine a value for all IEs that are required to be present in the response message, the receiving node shall instead terminate the procedure and initiate the Error Indication procedure.
- if a message *initiating* a procedure that does not have a message to report the outcome of the procedure is received containing one or more IEs/IE groups marked with "*Ignore IE and Notify Sender*" which the receiving node does not comprehend, the receiving node shall ignore the content of the not comprehended IEs/IE groups, continue with the procedure as if the not comprehended IEs/IE groups were not received (except for the reporting) using the understood IEs/IE groups, and initiate the Error Indication procedure to report that one or more IEs/IE groups have been ignored.
- If a *response* message is received containing one or more IEs/IE groups marked with "*Ignore IE and Notify Sender*" which the receiving node does not comprehend, the receiving node shall ignore the content of the not comprehended IE/IE groups, continue with the procedure as if the not comprehended IEs/IE groups were not received (except for the reporting) using the understood IEs/IE groups and initiate the Error Indication procedure.

Ignore IE:

- If a message *initiating* a procedure is received containing one or more IEs/IE groups marked with "*Ignore IE*" which the receiving node does not comprehend, the receiving node shall ignore the content of the not comprehended IEs/IE groups and continue with the procedure as if the not comprehended IEs/IE groups were not received using only the understood IEs/IE groups.
- If a *response* message is received containing one or more IEs/IE groups marked with "*Ignore IE*" which the receiving node does not comprehend, the receiving node shall ignore the content of the not comprehended IEs/IE groups and continue with the procedure as if the not comprehended IEs/IE groups were not received using the understood IEs/IE groups.

When reporting not comprehended IEs/IE groups marked with "*Reject IE*" or "*Ignore IE and Notify Sender*" using a response message defined for the procedure, the *Information Element Criticality Diagnostics* IE shall be included in the *Criticality Diagnostics* IE for each reported IE/IE group. In the *Information Element Criticality Diagnostics* IE the *Repetition Number* IE shall be included and in addition, if the not comprehended IE/IE group is not at message hierarchy level 1 (top level; see annex A) also the *Message Structure* IE shall be included.

When reporting not comprehended IEs/IE groups marked with "*Reject IE*" or "*Ignore IE and Notify Sender*" using the Error Indication procedure, the *Procedure Code* IE, the *Triggering Message* IE, *Procedure Criticality* IE, and the *Information Element Criticality Diagnostics* IE shall be included in the *Criticality Diagnostics* IE for each reported IE/IE group. In the *Information Element Criticality Diagnostics* IE the *Repetition Number* IE shall be included and in addition, if the not comprehended IE/IE group is not at message hierarchy level 1 (top level; see annex A) also the *Message Structure* IE shall be included.

10.3.5 Missing IE or IE group

The receiving node shall treat the missing IE/IE group according to the criticality information for the missing IE/IE group in the received message specified in the version of the present document used by the receiver:

Reject IE:

- if a received message *initiating* a procedure is missing one or more IEs/IE groups with specified criticality "*Reject IE*"; none of the functional requests of the message shall be executed. The receiving node shall reject the procedure and report the missing IEs/IE groups using the message normally used to report unsuccessful outcome of the procedure. In case the information received in the initiating message was insufficient to determine a value for all IEs that are required to be present in the message used to report the unsuccessful outcome of the procedure, the receiving node shall instead terminate the procedure and initiate the Error Indication procedure.

- if a received message *initiating* a procedure that does not have a message to report unsuccessful outcome is missing one or more IEs/IE groups with specified criticality "*Reject IE*", the receiving node shall terminate the procedure and initiate the Error Indication procedure.
- if a received *response* message is missing one or more IEs/IE groups with specified criticality "*Reject IE*", the receiving node shall consider the procedure as unsuccessfully terminated and initiate local error handling.

Ignore IE and Notify Sender:

- if a received message *initiating* a procedure is missing one or more IEs/IE groups with specified criticality "*Ignore IE and Notify Sender*", the receiving node shall ignore that those IEs are missing and continue with the procedure based on the other IEs/IE groups present in the message and report in the response message of the procedure that one or more IEs/IE groups were missing. In case the information received in the initiating message was insufficient to determine a value for all IEs that are required to be present in the response message, the receiving node shall instead terminate the procedure and initiate the Error Indication procedure.
- if a received message *initiating* a procedure that does not have a message to report the outcome of the procedure is missing one or more IEs/IE groups with specified criticality "*Ignore IE and Notify Sender*", the receiving node shall ignore that those IEs are missing and continue with the procedure based on the other IEs/IE groups present in the message and initiate the Error Indication procedure to report that one or more IEs/IE groups were missing.
- if a received *response* message is missing one or more IEs/IE groups with specified criticality "*Ignore IE and Notify Sender*", the receiving node shall ignore that those IEs are missing and continue with the procedure based on the other IEs/IE groups present in the message and initiate the Error Indication procedure to report that one or more IEs/IE groups were missing.

Ignore IE:

- if a received message *initiating* a procedure is missing one or more IEs/IE groups with specified criticality "*Ignore IE*", the receiving node shall ignore that those IEs are missing and continue with the procedure based on the other IEs/IE groups present in the message.
- if a received *response* message is missing one or more IEs/IE groups with specified criticality "*Ignore IE*", the receiving node shall ignore that those IEs/IE groups are missing and continue with the procedure based on the other IEs/IE groups present in the message.

When reporting missing IEs/IE groups with specified criticality "*Reject IE*" or "*Ignore IE and Notify Sender*" using a response message defined for the procedure, the *Information Element Criticality Diagnostics* IE shall be included in the *Criticality Diagnostics* IE for each reported IE/IE group. In the *Information Element Criticality Diagnostics* IE the *Repetition Number* IE shall be included and in addition, if the missing IE/IE group is not at message hierarchy level 1 (top level; see annex A) also the *Message Structure* IE shall be included.

When reporting missing IEs/IE groups with specified criticality "*Reject IE*" or "*Ignore IE and Notify Sender*" using the Error Indication procedure, the *Procedure Code* IE, the *Triggering Message* IE, *Procedure Criticality* IE, and the *Information Element Criticality Diagnostics* IE shall be included in the *Criticality Diagnostics* IE for each reported IE/IE group. In the *Information Element Criticality Diagnostics* IE the *Repetition Number* IE shall be included and in addition, if the missing IE/IE group is not at message hierarchy level 1 (top level; see annex A) also the *Message Structure* IE shall be included.

10.3.6 IEs or IE groups received in wrong order or with too many occurrences or erroneously present

If a message with IEs or IE groups in wrong order or with too many occurrences is received or if IEs or IE groups with a conditional presence are present when the condition is not met (i.e. erroneously present), the receiving node shall behave according to the following:

- If a message *initiating* a procedure is received containing IEs or IE groups in wrong order or with too many occurrences or erroneously present, none of the functional requests of the message shall be executed. The receiving node shall reject the procedure and report the cause value "Abstract Syntax Error (Falsely Constructed Message)" using the message normally used to report unsuccessful outcome of the procedure. In case the information received in the initiating message was insufficient to determine a value for all IEs that are required to be present in the message used to report the unsuccessful outcome of the procedure, the receiving node shall instead terminate the procedure and initiate the Error Indication procedure.

- If a message *initiating* a procedure that does not have a message to report unsuccessful outcome is received containing IEs or IE groups in wrong order or with too many occurrences or erroneously present, the receiving node shall terminate the procedure and initiate the Error Indication procedure, and use cause value "Abstract Syntax Error (Falsely Constructed Message)".
- If a *response* message is received containing IEs or IE groups in wrong order or with too many occurrences or erroneously present, the receiving node shall consider the procedure as unsuccessfully terminated and initiate local error handling.

When determining the correct order only the IEs specified in the specification version used by the receiver shall be considered.

10.4 Logical Error

Logical error situations occur when a message is comprehended correctly, but the information contained within the message is not valid (i.e. semantic error), or describes a procedure which is not compatible with the state of the receiver. In these conditions, the following behaviour shall be performed (unless otherwise specified) as defined by the class of the elementary procedure, irrespective of the criticality information of the IE's/IE groups containing the erroneous values.

Class 1:

Where the logical error occurs in a request message of a class 1 procedure, and the procedure has a message to report this unsuccessful outcome, this message shall be sent with an appropriate cause value. Typical cause values are:

- Semantic Error;
- Message not compatible with receiver state.

Where the logical error is contained in a request message of a class 1 procedure, and the procedure does not have a message to report this unsuccessful outcome, the procedure shall be terminated and the Error Indication procedure shall be initiated with an appropriate cause value. The *Procedure Code* IE and the *Triggering Message* IE within the *Criticality Diagnostics* IE shall then be included in order to identify the message containing the logical error.

Where the logical error exists in a response message of a class 1 procedure, the procedure shall be considered as unsuccessfully terminated and local error handling shall be initiated.

Class 2:

Where the logical error occurs in a message of a class 2 procedure, the procedure shall be terminated and the Error Indication procedure shall be initiated with an appropriate cause value. The *Procedure Code* IE and the *Triggering Message* IE within the *Criticality Diagnostics* IE shall then be included in order to identify the message containing the logical error.

10.5 Exceptions

The error handling for all the cases described hereafter shall take precedence over any other error handling described in the other subclauses of clause 10.

- If any type of error (Transfer Syntax Error, Abstract Syntax Error or Logical Error) is detected in the ERROR INDICATION message, it shall not trigger the Error Indication procedure in the receiving Node but local error handling.
- In case a response message or Error Indication message needs to be returned, but the information necessary to determine the receiver of that message is missing, the procedure shall be considered as unsuccessfully terminated and local error handling shall be initiated.
- If an error that terminates a procedure occurs, the returned cause value shall reflect the error that caused the termination of the procedure even if one or more abstract syntax errors with criticality "ignore and notify" have earlier occurred within the same procedure.

Annex A (informative): Guidelines for Usage of the Criticality Diagnostics IE

A.1 EXAMPLE MESSAGE Layout

Assume the following message format:

IE/Group Name	Presence	Range	IE type and reference	Semantics description	Criticality	Assigned Criticality
Message Type	M				YES	reject
A	M				YES	reject
B	M				YES	reject
>E		1..<maxE>			EACH	ignore
>>F		1..<maxF>			-	
>>>G		0..3, ...			EACH	ignore
>>H		1..<maxH>			EACH	ignore
>>>G		0..3, ...			EACH	ignore and notify
>>G	M				YES	reject
>>J		1..<maxJ>			-	
>>>G		0..3, ...			EACH	reject
C	M				YES	reject
>K		1..<maxK>			EACH	ignore and notify
>>L		1..<maxL>			-	
>>>M	O				-	
D	M				YES	reject

Note 1. The IEs F, J, and L do not have assigned criticality. The IEs F, J, and L are consequently realised as the ASN.1 type SEQUENCE OF of "ordinary" ASN.1 type, e.g. INTEGER. On the other hand, the repeatable IEs with assigned criticality are realised as the ASN.1 type SEQUENCE OF of an IE object, e.g. ProtocolIE-Container.

For the corresponding ASN.1 layout, see subclause A.4.

A.2 Example on a Received EXAMPLE MESSAGE

Assume further more that a received message based on the above tabular format is according to figure A.1.

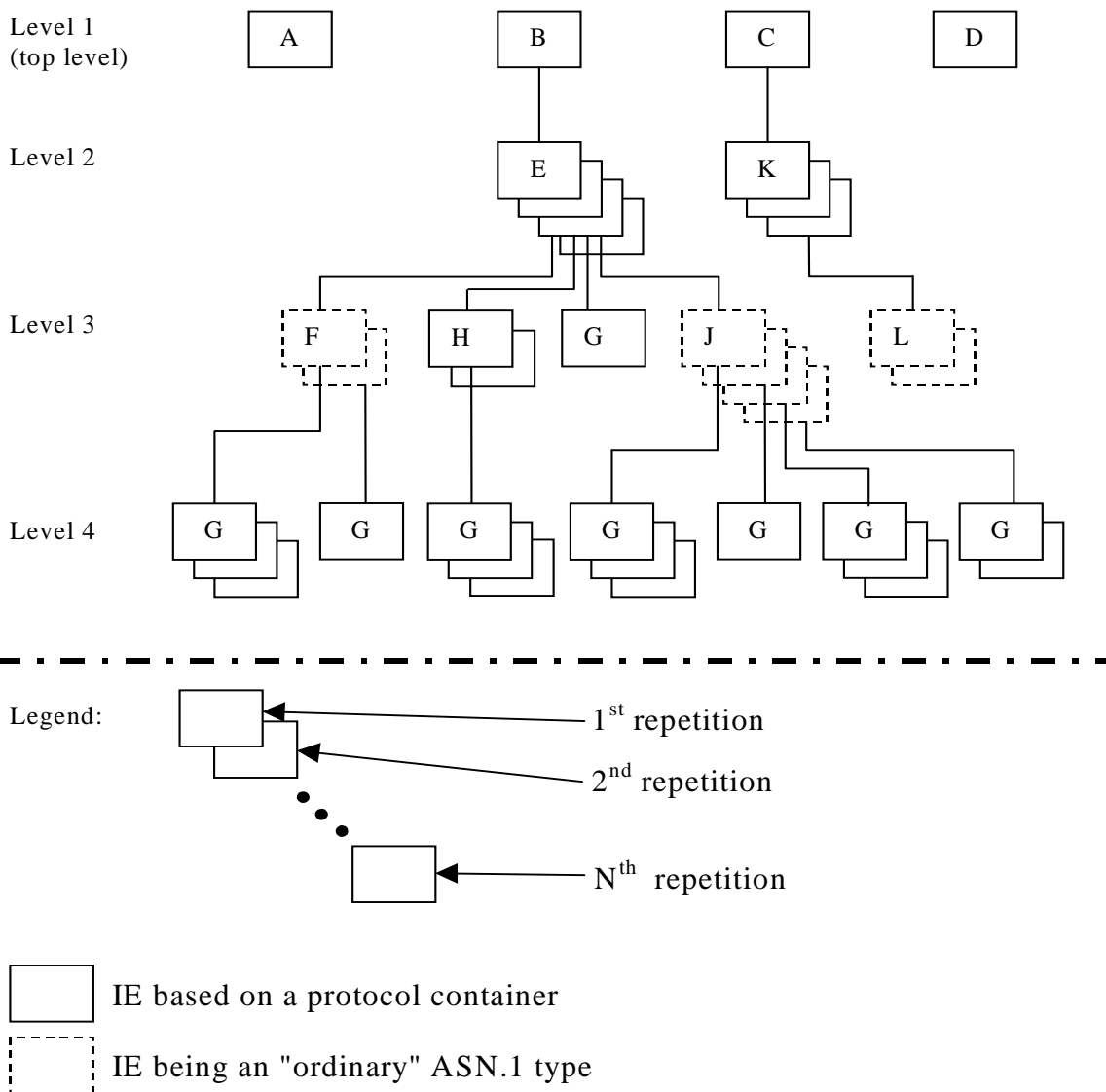

Figure A.1: Example of content of a received SABP message based on the EXAMPLE MESSAGE

A.3 Content of Criticality Diagnostics

A.3.1 Example 1

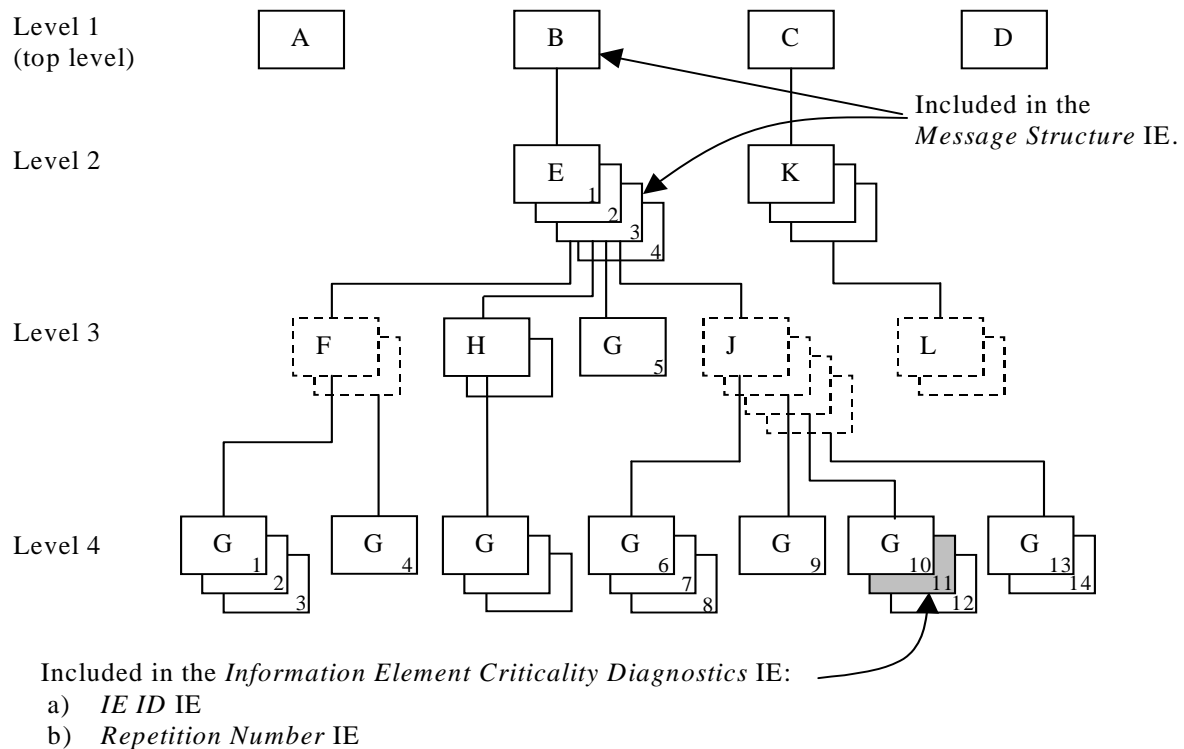

Figure A.2: Example of a received SABP message containing a not comprehended IE

If there is an error within the instance marked as grey in the IE G in the IE J shown in the figure A.2, this will be reported within the *Information Element Criticality Diagnostics IE* within the *Criticality Diagnostics IE* as follows:

IE name	Value	Comment
IE Criticality	reject	Criticality for IE on the reported level, i.e. level 4.
IE ID	id-G	IE ID from the reported level, i.e. level 4.
Repetition Number	11	Repetition number on the reported level, i.e. level 4. (Since the IE E (level 2) is the lowest level included in the <i>Message Structure IE</i> this is the eleventh occurrence of IE G within the IE E (level 2).
Type of Error	not understood	
<i>Message Structure, first repetition</i>		
>IE ID	id-B	IE ID from level 1.
<i>Message Structure, second repetition</i>		
>IE ID	id-E	IE ID from the lowest level above the reported level, i.e. level 2.
>Repetition Number	3	Repetition number from the lowest level above the reported level, i.e. level 2.

Note 2. The IE J on level 3 cannot be included in the *Message Structure IE* since they have no criticality of their own.

Note 3. The repetition number of the reported IE indicates the number of repetitions of IE G received up to the detected erroneous repetition, counting all occurrences of the IE G below the same instance of the previous level with assigned criticality (instance 3 of IE E on level 2).

A.3.2 Example 2

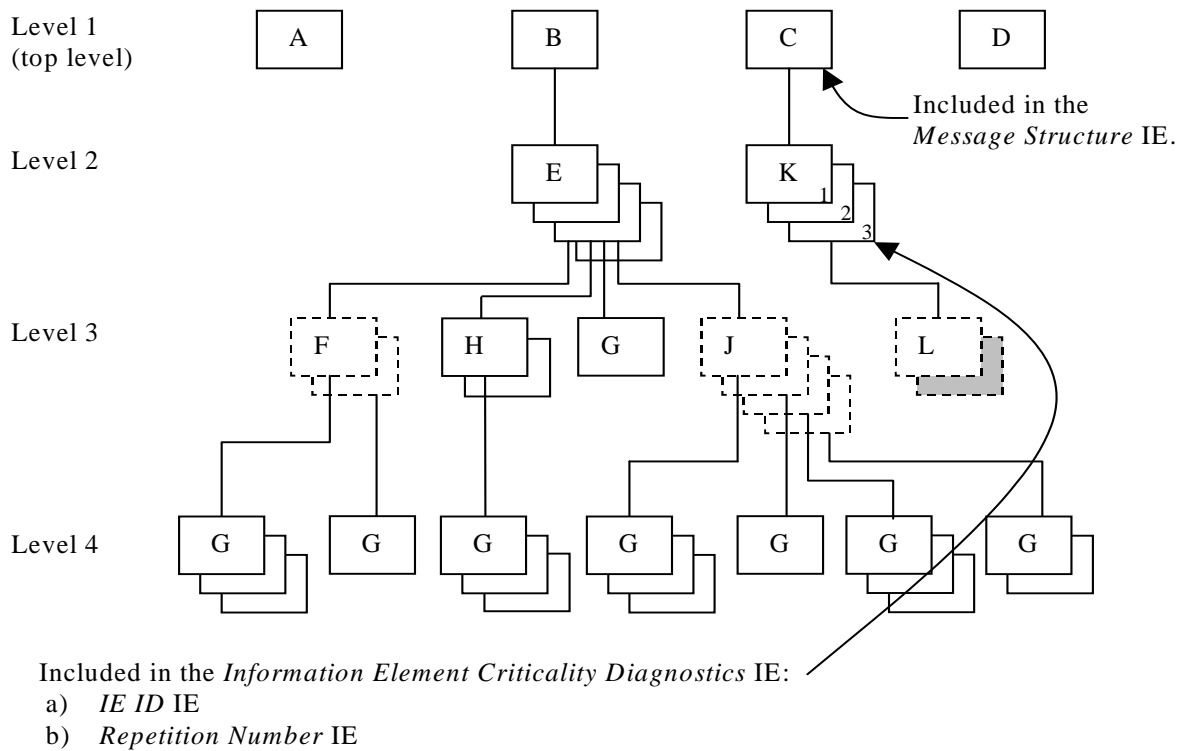

Figure A.3: Example of a received SABP message containing a not comprehended IE

If there is an error within the second instance (marked as grey) in the sequence (IE L in the tabular format) on level 3 below IE K in the structure shown in the figure A.3, this will be reported within the *Information Element Criticality Diagnostics* IE within the *Criticality Diagnostics* IE as follows:

IE name	Value	Comment
IE Criticality	ignore and notify	Criticality for IE on the reported level, i.e. level 2.
IE ID	id-K	IE ID from the reported level, i.e. level 2.
Repetition Number	3	Repetition number on the reported level, i.e. level 2.
Type of Error	not understood	
<i>Message Structure, first repetition</i>		
>IE ID	id-C	IE ID from the lowest level above the reported level, i.e. level 1.

Note 4. The IE L on level 3 cannot be reported individually included in the *Message Structure* IE since it has no criticality of its own.

A.3.3 Example 3

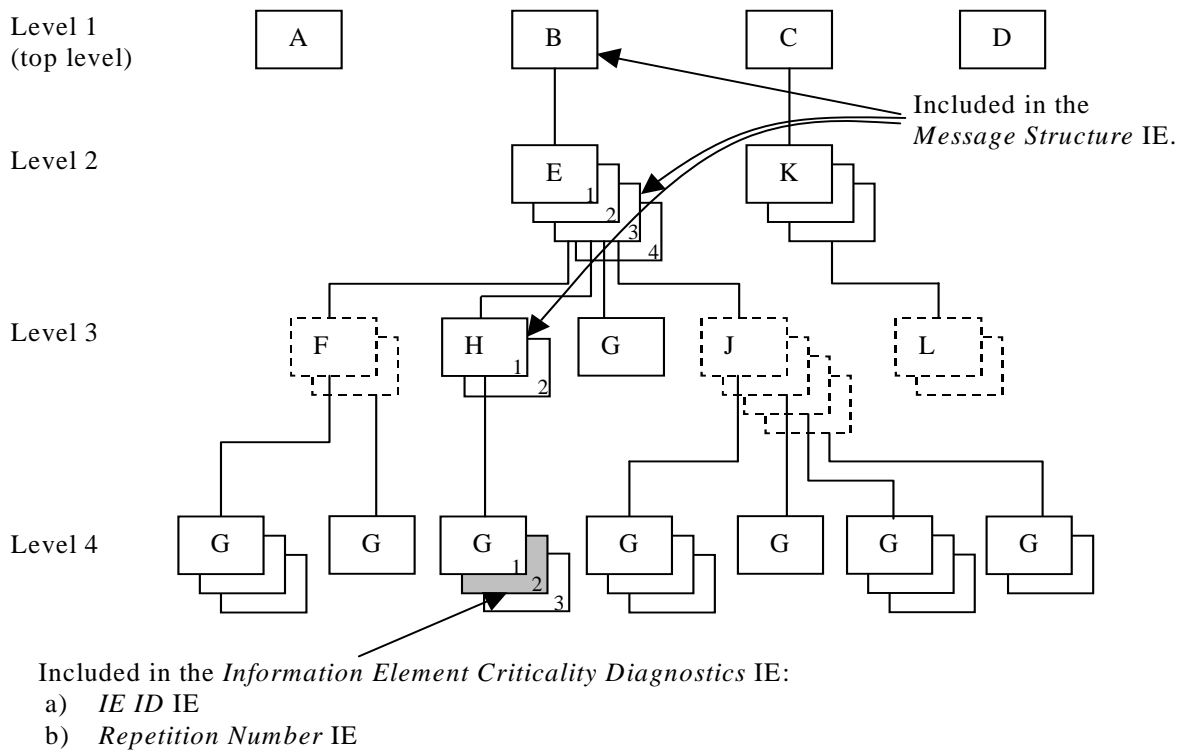

Figure A.4: Example of a received SABP message containing a not comprehended IE

If there is an error within the instance marked as grey in the IE G in the IE H shown in the figure A.4, this will be reported within the *Information Element Criticality Diagnostics* IE within the *Criticality Diagnostics* IE as follows:

IE name	Value	Comment
IE Criticality	ignore and notify	Criticality for IE on the reported level, i.e. level 4.
IE ID	id-G	IE ID from the reported level, i.e. level 4.
Repetition Number	2	Repetition number on the reported level, i.e. level 4.
Type of Error	not understood	
<i>Message Structure, first repetition</i>		
>IE ID	id-B	IE ID from level 1.
<i>Message Structure, second repetition</i>		
>IE ID	id-E	IE ID from level 2.
>Repetition Number	3	Repetition number from level 2.
<i>Message Structure, third repetition</i>		
>IE ID	id-H	IE ID from the lowest level above the reported level, i.e. level 3.
>Repetition Number	1	Repetition number from the lowest level above the reported level, i.e. level 3.

Note 5. The repetition number of level 4 indicates the number of repetitions of IE G received up to the detected erroneous repetition, counted below the same instance of the previous level with assigned criticality (instance 1 of IE H on level 3).

A.3.4 Example 4

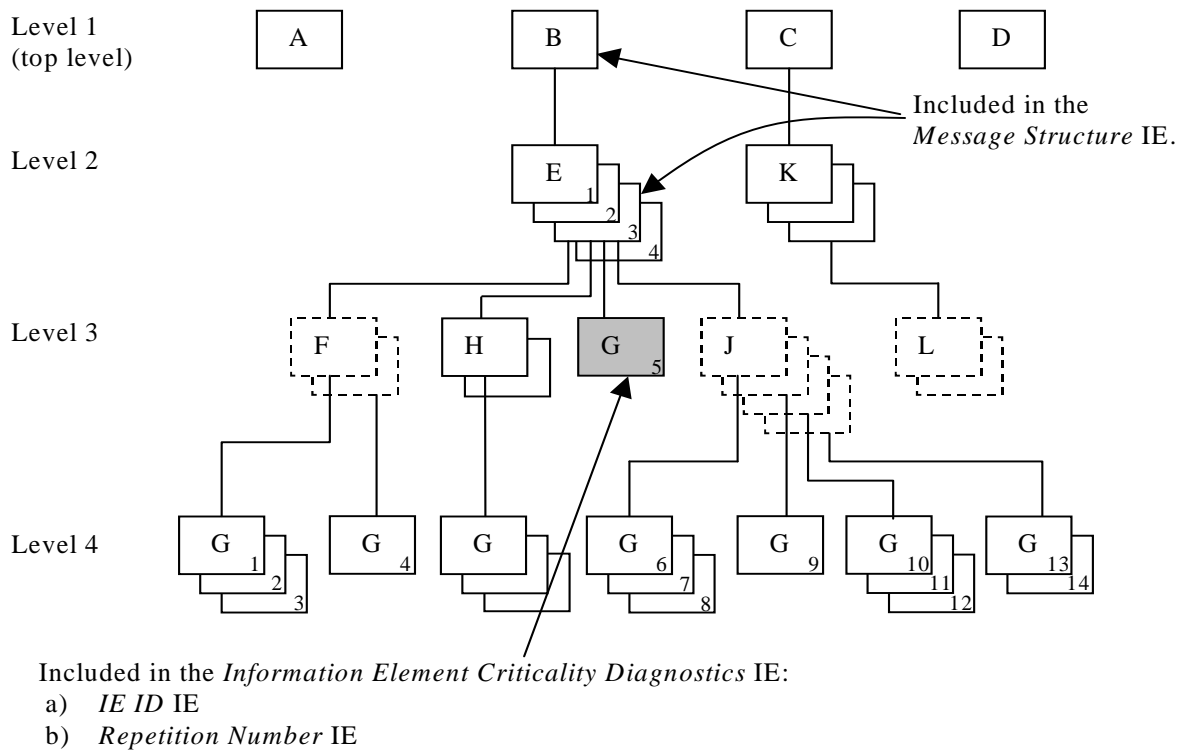

Figure A.5: Example of a received SABP message containing a not comprehended IE

If there is an error within the instance marked as grey in the IE G in the IE E shown in the figure A.5, this will be reported within the *Information Element Criticality Diagnostics* IE within the *Criticality Diagnostics* IE as follows:

IE name	Value	Comment
IE Criticality	reject	Criticality for IE on the reported level, i.e. level 3.
IE ID	id-G	IE ID from the reported level, i.e. level 3.
Repetition Number	5	Repetition number on the reported level, i.e. level 3. (Since the IE E (level 2) is the lowest level included in the <i>Message Structure</i> IE this is the fifth occurrence of IE G within the IE E (level 2).
Type of Error	not understood	
<i>Message Structure, first repetition</i>		
>IE ID	id-B	IE ID from level 1.
<i>Message Structure, second repetition</i>		
>IE ID	id-E	IE ID from the lowest level above the reported level, i.e. level 2.
>Repetition Number	3	Repetition number from the lowest level above the reported level, i.e. level 2.

Note 6. The repetition number of the reported IE indicates the number of repetitions of IE G received up to the detected erroneous repetition, counting all occurrences of the IE G below the same instance of the previous level with assigned criticality (instance 3 of IE E on level 2).

A.3.5 Example 5

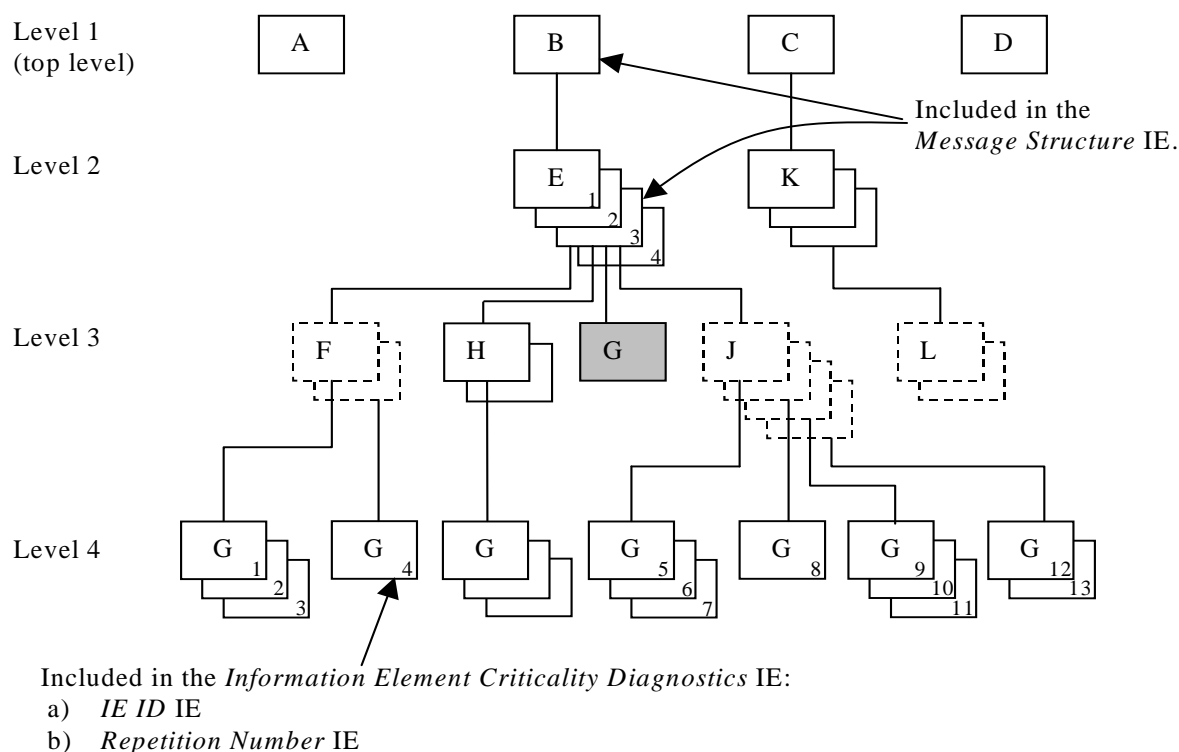

Figure A.6: Example of a received SABP message with a missing IE

If the instance marked as grey in the IE G in the IE E shown in the figure A.6, is missing this will be reported within the *Information Element Criticality Diagnostics* IE within the *Criticality Diagnostics* IE as follows:

IE name	Value	Comment
IE Criticality	reject	Criticality for IE on the reported level, i.e. level 3.
IE ID	id-G	IE ID from the reported level, i.e. level 3.
Repetition Number	4	Repetition number up to the missing IE on the reported level, i.e. level 3. (Since the IE E (level 2) is the lowest level included in the <i>Message Structure</i> IE there have been four occurrences of IE G within the IE E (level 2) up to the missing occurrence.
Type of Error	missing	
<i>Message Structure, first repetition</i>		
>IE ID	id-B	IE ID from level 1.
<i>Message Structure, second repetition</i>		
>IE ID	id-E	IE ID from the lowest level above the reported level, i.e. level 2.
>Repetition Number	3	Repetition number from the lowest level above the reported level, i.e. level 2.

Note 7. The repetition number of the reported IE indicates the number of repetitions of IE G received up to but not including the missing occurrence, counting all occurrences of the IE G below the same instance of the previous level with assigned criticality (instance 3 of IE E on level 2).

A.4 ASN.1 of EXAMPLE MESSAGE

```

ExampleMessage ::= SEQUENCE {
    ProtocolIEs          ProtocolIE-Container          {{ExampleMessage-IEs}},
    ProtocolExtensions  ProtocolExtensionContainer  {{ExampleMessage-Extensions}}  OPTIONAL,
    ...
}

ExampleMessage-IEs SABP-PROTOCOL-IES ::= {
    { ID id-A    CRITICALITY reject  TYPE A  PRESENCE mandatory } |
    { ID id-B    CRITICALITY reject  TYPE B  PRESENCE mandatory } |
    { ID id-C    CRITICALITY reject  TYPE C  PRESENCE mandatory } |
    { ID id-D    CRITICALITY reject  TYPE D  PRESENCE mandatory } ,
    ...
}

B ::= SEQUENCE {
    e          E-List,
    iE-Extensions  ProtocolExtensionContainer { {B-ExtIEs} }  OPTIONAL,
    ...
}

B-ExtIEs SABP-PROTOCOL-EXTENSION ::= {
    ...
}

E-List ::= SEQUENCE (SIZE (1..maxE)) OF ProtocolIE-Container { {E-IEs} }

E-IEs SABP-PROTOCOL-IES ::= {
    { ID id-E    CRITICALITY ignore  TYPE E  PRESENCE mandatory } ,
    ...
}

E ::= SEQUENCE {
    f          F-List,
    h          H-List,
    g          G-List1,
    j          J-List,
    iE-Extensions  ProtocolExtensionContainer { {E-ExtIEs} }  OPTIONAL,
    ...
}

E-ExtIEs SABP-PROTOCOL-EXTENSION ::= {
    ...
}

F-List ::= SEQUENCE (SIZE (1..maxF)) OF F

F ::= SEQUENCE {
    g          G-List2 OPTIONAL,
    iE-Extensions  ProtocolExtensionContainer { {F-ExtIEs} }  OPTIONAL,
    ...
}

F-ExtIEs SABP-PROTOCOL-EXTENSION ::= {
    ...
}

G-List2 ::= SEQUENCE (SIZE (1..3, ...)) OF ProtocolIE-Container { {G2-IEs} }

G2-IEs SABP-PROTOCOL-IES ::= {
    { ID id-G    CRITICALITY ignore  TYPE G  PRESENCE mandatory }
    ...
}

H-List ::= SEQUENCE (SIZE (1..maxH)) OF ProtocolIE-Container { {H-IEs} }

H-IEs SABP-PROTOCOL-IES ::= {
    { ID id-H    CRITICALITY ignore  TYPE H  PRESENCE mandatory } ,
    ...
}

H ::= SEQUENCE {
    g          G-List3 OPTIONAL,
    iE-Extensions  ProtocolExtensionContainer { {H-ExtIEs} }  OPTIONAL,
    ...
}

```

```

H-ExtIEs SABP-PROTOCOL-EXTENSION ::= {
  ...
}

G-List3 ::= SEQUENCE (SIZE (1..3, ...)) OF ProtocolIE-Container { {G3-IEs} }

G3-IEs SABP-PROTOCOL-IES ::= {
  { ID id-G    CRITICALITY notify  TYPE G  PRESENCE mandatory },
  ...
}

G-List1 ::= ProtocolIE-Container { {G1-IEs} }

G1-IEs SABP-PROTOCOL-IES ::= {
  { ID id-G    CRITICALITY reject  TYPE G  PRESENCE mandatory },
  ...
}

J-List ::= SEQUENCE (SIZE (1..maxJ)) OF J

J ::= SEQUENCE {
  g                G-List4 OPTIONAL,
  iE-Extensions   ProtocolExtensionContainer { {J-ExtIEs} } OPTIONAL,
  ...
}

J-ExtIEs SABP-PROTOCOL-EXTENSION ::= {
  ...
}

G-List4 ::= SEQUENCE (SIZE (1..3, ...)) OF ProtocolIE-Container { {G4-IEs} }

G4-IEs SABP-PROTOCOL-IES ::= {
  { ID id-G    CRITICALITY reject  TYPE G  PRESENCE mandatory },
  ...
}

C ::= SEQUENCE {
  k                K-List,
  iE-Extensions   ProtocolExtensionContainer { {C-ExtIEs} } OPTIONAL,
  ...
}

C-ExtIEsA -PROTOCOL-EXTENSION ::= {
  ...
}

K-List ::= SEQUENCE (SIZE (1..maxK)) OF ProtocolIE-Container { {K-IEs} }

K-IEs SABP-PROTOCOL-IES ::= {
  { ID id-K    CRITICALITY notify  TYPE K  PRESENCE mandatory },
  ...
}

K ::= SEQUENCE {
  l                L-List,
  iE-Extensions   ProtocolExtensionContainer { {K-ExtIEs} } OPTIONAL,
  ...
}

K-ExtIEs SABP-PROTOCOL-EXTENSION ::= {
  ...
}

L-List ::= SEQUENCE (SIZE (1..maxL)) OF L

L ::= SEQUENCE {
  m                M OPTIONAL,
  iE-Extensions   ProtocolExtensionContainer { {L-ExtIEs} } OPTIONAL,
  ...
}

L-ExtIEs SABP-PROTOCOL-EXTENSION ::= {
  ...
}

ExampleMessage-Extensions SABP-PROTOCOL-EXTENSION ::= {

```

} ...

Annex B (informative): Change history

Change history					
TSG RAN#	Version	CR	Tdoc RAN	New Version	Subject/Comment
RAN_07	-	-	-	3.0.0	Approved at TSG RAN #7 and placed under Change Control
RAN_08	3.0.0	-	RP-000239	3.1.0	Approved at TSG RAN #8
RAN_09	3.1.0	011 012 014 015 016 017 018 019 020 021 022 023	RP-000377	3.2.0	Approved at TSG RAN #9
RAN_10	3.2.0	024 025 026 027 028 029	RP-000616	3.3.0	Approved at TSG RAN #10
RAN_11	3.3.0	030 031 032 033 034	RP-010114	3.4.0	Approved at TSG RAN #11

Change history							
Date	TSG #	TSG Doc.	CR	Rev	Subject/Comment	Old	New
March 01	11	-	-		Approved at TSG RAN #11 and placed under Change Control	-	4.0.0
06/2001	12	RP-010377	036,0 38,04 0,042 ,043, 044,0 48,05 0		Approved at TSG RAN #12	4.0.0	4.1.0
09/2001	13	RP-010582	051	1	SABP criticality	4.1.0	4.2.0
09/2001	13	RP-010582	052	1	Correction to the Error handling of the ERROR INDICATION message	4.1.0	4.2.0
09/2001	13	RP-010582	056	1	Error handling of the Erroneously Present Conditional Ies	4.1.0	4.2.0
09/2001	13	RP-010582	058	1	Clarification of chapter 10	4.1.0	4.2.0
09/2001	13	RP-010582	060	1	SABP General Corrections	4.1.0	4.2.0
09/2001	13	RP-010582	062	2	Clarification of the usage of the Number of Broadcasts Requested IE	4.1.0	4.2.0
09/2001	13	RP-010582	064	1	Clarification of the usage of the SABP Reset Procedure	4.1.0	4.2.0
09/2001	13	RP-010582	066	2	Clarification of the usage of the Service Areas List IE within the Reset Procedure	4.1.0	4.2.0
12/2001	14	RP-010852	068	1	SAI Clarification	4.2.0	4.3.0
12/2001	14	RP-010852	070		Bitstrings ordering	4.2.0	4.3.0
12/2001	14	RP-010852	072		Procedure Code Criticality in Error Indication	4.2.0	4.3.0
12/2001	14	RP-010852	074	2	Addition of amendment to clarify the PER encoding of bitstrings	4.2.0	4.3.0
12/2001	14	RP-010852	076		Section 9.2.0 missing	4.2.0	4.3.0
12/2001	14	RP-010852	078	2	CR on 25.419 (R4) Usage of "Number of Broadcasts Completed List" IE	4.2.0	4.3.0
12/2001	14	RP-010852	080		Correction the Clause 10 Error Handling	4.2.0	4.3.0
03/2002	15	RP-020167	082		Correction of the value Default in Category IE	4.3.0	4.4.0
03/2002	15	RP-020167	084	1	Correction of the wording of maximum value	4.3.0	4.4.0
03/2002	15	RP-020167	086		Service expected from the transport layer	4.3.0	4.4.0
03/2002	15	RP-020167	088	1	ASN.1 take precedence if contradiction between ASN.1 and tabular	4.3.0	4.4.0
03/2002	15	RP-020167	090	1	Mismatch the type of some IE between 24.419 and 25.324	4.3.0	4.4.0
03/2002	15	RP-020167	092		Correction of the usage of Write-Replace Failure message	4.3.0	4.4.0
03/2002	15	RP-020167	094		Error Indication correction	4.3.0	4.4.0

03/2002	15	-	-		Approved at TSG RAN #15 and placed under Change Control	-	5.0.0
06/2002	16	RP-020404	097		Criticality Information Decoding Failure Handling	5.0.0	5.1.0
06/2002	16	RP-020404	100	1	Clarification for the usage of the cause value	5.0.0	5.1.0
06/2002	16	RP-020404	103		SABP: WRITE-REPLACE Procedure Clarification	5.0.0	5.1.0
09/2002	17	RP-020602	106	1	Correction to ASN.1 coding: criticality information missing	5.1.0	5.2.0
03/2003	19	RP-030057	108	1	Correction of Write and Replace functions	5.2.0	5.3.0
06/2003	20	RP-030315	112	1	Correction of Kill Unsuccessful Outcome	5.3.0	5.4.0
06/2003	20	RP-030326	117		Correction of Failure message used for logical errors	5.3.0	5.4.0
09/2003	21	RP-030445	118		Alignment of title and sub-clause text of chapter 10.3.4.2	5.4.0	5.5.0
09/2003	21	RP-030446	119	1	Removal of the note in chapter 10	5.4.0	5.5.0
09/2003	21	RP-030438	124	2	Correction of number of broadcast to be reported	5.4.0	5.5.0
12/2003	22	RP-030673	130		Correction of finite number of broadcast	5.5.0	5.6.0
12/2003	22	-	-	-	Introduction of Release 6 specification	5.6.0	6.0.0
03/2004	23	RP-040063	132	1	Correction to 25.419 for Broadcast Message Content IE	6.0.0	6.1.0
12/2004	26	RP-040441	133		outdated ITU-T reference	6.1.0	6.2.0
03/2006	31	-	-	-	Introduction of Release 7 specification	6.2.0	7.0.0
12/2008	42	RP-080857	135	2	CR on ETWS support in UTRAN SABP	7.0.0	8.0.0
12/2008	42	RP-080857	136	1	CR on Security Information for Primary Notification	7.0.0	8.0.0
12/2009	46	RP-091179	138	1	Correction of ETWS for Rel8 HSPA	8.0.0	8.1.0
12/2009	-	-	-	-	Creation of Rel-9 version based on v8.1.0	8.1.0	9.0.0
03/2011	SP-49	SP-100629			Clarification on the use of References (TS 21.801 CR#0030)	9.0.0	9.0.1
03/2011					Creation of Rel-10 version based on v9.0.1	9.0.1	10.0.0
06/2011	52	RP-110685	140	-	Removal of unused references	10.0.0	10.1.0
09/2011	53	RP-111223	141	1	Correction of a typo in ASN.1 code	10.1.0	10.2.0
09/2012					Update to Rel-11 version (MCC)	10.2.0	11.0.0
03/2013	59	RP-130212	151	2	Invalidation of ETWS with security feature	11.0.0	11.1.0
09/2014					Update to Rel-12 version (MCC)	11.1.0	12.0.0
01/2014	66	RP-142094	152	3	Adding a new reference of TS 25.921	12.0.0	12.1.0
12/2015					Update to Rel-13 version (MCC)	12.1.0	13.0.0

Change history							
Date	Meeting	TDoc	CR	Rev	Cat	Subject/Comment	New version
2017-03	SA#75					Promotion to Release 14 without technical change	14.0.0
2018-07	SA#80	-	-	-	-	Promotion to Release 15 without technical change	15.0.0
2020-07	SA#88-e	-	-	-	-	Update to Rel-16 version (MCC)	16.0.0
2022-03	SA#95-e					Promotion to Release 17 without technical change	17.0.0

History

Document history		
V17.0.0	April 2022	Publication