

ETSI TS 125 423 V4.12.1 (2004-06)

Technical Specification

**Universal Mobile Telecommunications System (UMTS);
UTRAN Iur interface Radio Network Subsystem
Application Part (RNSAP) signalling
(3GPP TS 25.423 version 4.12.1 Release 4)**



Reference

RTS/TSGR-0325423v4c1

Keywords

UMTS

ETSI

650 Route des Lucioles
F-06921 Sophia Antipolis Cedex - FRANCE

Tel.: +33 4 92 94 42 00 Fax: +33 4 93 65 47 16

Siret N° 348 623 562 00017 - NAF 742 C
Association à but non lucratif enregistrée à la
Sous-Préfecture de Grasse (06) N° 7803/88

Important notice

Individual copies of the present document can be downloaded from:

<http://www.etsi.org>

The present document may be made available in more than one electronic version or in print. In any case of existing or perceived difference in contents between such versions, the reference version is the Portable Document Format (PDF). In case of dispute, the reference shall be the printing on ETSI printers of the PDF version kept on a specific network drive within ETSI Secretariat.

Users of the present document should be aware that the document may be subject to revision or change of status. Information on the current status of this and other ETSI documents is available at

<http://portal.etsi.org/tb/status/status.asp>

If you find errors in the present document, send your comment to:

editor@etsi.org

Copyright Notification

No part may be reproduced except as authorized by written permission.
The copyright and the foregoing restriction extend to reproduction in all media.

© European Telecommunications Standards Institute 2004.
All rights reserved.

DECTTM, **PLUGTESTS**TM and **UMTS**TM are Trade Marks of ETSI registered for the benefit of its Members.
TIPHONTM and the **TIPHON logo** are Trade Marks currently being registered by ETSI for the benefit of its Members.
3GPPTM is a Trade Mark of ETSI registered for the benefit of its Members and of the 3GPP Organizational Partners.

Intellectual Property Rights

IPRs essential or potentially essential to the present document may have been declared to ETSI. The information pertaining to these essential IPRs, if any, is publicly available for **ETSI members and non-members**, and can be found in ETSI SR 000 314: "*Intellectual Property Rights (IPRs); Essential, or potentially Essential, IPRs notified to ETSI in respect of ETSI standards*", which is available from the ETSI Secretariat. Latest updates are available on the ETSI Web server (<http://webapp.etsi.org/IPR/home.asp>).

Pursuant to the ETSI IPR Policy, no investigation, including IPR searches, has been carried out by ETSI. No guarantee can be given as to the existence of other IPRs not referenced in ETSI SR 000 314 (or the updates on the ETSI Web server) which are, or may be, or may become, essential to the present document.

Foreword

This Technical Specification (TS) has been produced by ETSI 3rd Generation Partnership Project (3GPP).

The present document may refer to technical specifications or reports using their 3GPP identities, UMTS identities or GSM identities. These should be interpreted as being references to the corresponding ETSI deliverables.

The cross reference between GSM, UMTS, 3GPP and ETSI identities can be found under <http://webapp.etsi.org/key/queryform.asp>.

Contents

Intellectual Property Rights	2
Foreword.....	2
Foreword.....	14
1 Scope	15
2 References	15
3 Definitions, Symbols and Abbreviations.....	16
3.1 Definitions	16
3.2 Symbols.....	17
3.3 Abbreviations	17
4 General	19
4.1 Procedure Specification Principles.....	19
4.2 Forwards and Backwards Compatibility	20
4.3 Source Signalling Address Handling.....	20
4.4 Specification Notations	20
5 RNSAP Services	21
5.1 RNSAP Procedure Modules	21
5.2 Parallel Transactions	21
6 Services Expected from Signalling Transport.....	21
7 Functions of RNSAP	21
8 RNSAP Procedures	23
8.1 Elementary Procedures.....	23
8.2 Basic Mobility Procedures	25
8.2.1 Uplink Signalling Transfer	25
8.2.1.1 General	25
8.2.1.2 Successful Operation.....	26
8.2.1.3 Abnormal Conditions	26
8.2.2 Downlink Signalling Transfer.....	26
8.2.2.1 General	26
8.2.2.2 Successful Operation.....	27
8.2.2.3 Abnormal Conditions	27
8.2.3 Relocation Commit	27
8.2.3.1 General	27
8.2.3.2 Successful Operation.....	27
8.2.3.3 Abnormal Conditions	28
8.2.4 Paging	28
8.2.4.1 General	28
8.2.4.2 Successful Operation.....	28
8.2.4.3 Abnormal Conditions	28
8.3 DCH Procedures.....	28
8.3.1 Radio Link Setup	28
8.3.1.1 General	28
8.3.1.2 Successful Operation.....	29
8.3.1.3 Unsuccessful Operation	35
8.3.1.4 Abnormal Conditions	36
8.3.2 Radio Link Addition	37
8.3.2.1 General	37
8.3.2.2 Successful Operation.....	37
8.3.2.3 Unsuccessful Operation	42
8.3.2.4 Abnormal Conditions	43
8.3.3 Radio Link Deletion.....	43
8.3.3.1 General	43

8.3.3.2	Successful Operation.....	44
8.3.3.3	Unsuccessful Operation	44
8.3.3.4	Abnormal Conditions	44
8.3.4	Synchronised Radio Link Reconfiguration Preparation.....	44
8.3.4.1	General	44
8.3.4.2	Successful Operation.....	44
8.3.4.3	Unsuccessful Operation	53
8.3.4.4	Abnormal Conditions	53
8.3.5	Synchronised Radio Link Reconfiguration Commit.....	54
8.3.5.1	General	54
8.3.5.2	Successful Operation.....	54
8.3.5.3	Abnormal Conditions	55
8.3.6	Synchronised Radio Link Reconfiguration Cancellation.....	55
8.3.6.1	General	55
8.3.6.2	Successful Operation.....	55
8.3.6.3	Abnormal Conditions	55
8.3.7	Unsynchronised Radio Link Reconfiguration.....	55
8.3.7.1	General	55
8.3.7.2	Successful Operation.....	55
8.3.7.3	Unsuccessful Operation	60
8.3.7.4	Abnormal Conditions	60
8.3.8	Physical Channel Reconfiguration.....	60
8.3.8.1	General	60
8.3.8.2	Successful Operation.....	61
8.3.8.3	Unsuccessful Operation	61
8.3.8.4	Abnormal Conditions	62
8.3.9	Radio Link Failure	62
8.3.9.1	General	62
8.3.9.2	Successful Operation.....	62
8.3.9.3	Abnormal Conditions	63
8.3.10	Radio Link Restoration	63
8.3.10.1	General	63
8.3.10.2	Successful Operation.....	63
8.3.10.3	Abnormal Conditions	64
8.3.11	Dedicated Measurement Initiation	64
8.3.11.1	General	64
8.3.11.2	Successful Operation.....	64
8.3.11.3	Unsuccessful Operation	66
8.3.11.4	Abnormal Conditions	67
8.3.12	Dedicated Measurement Reporting.....	67
8.3.12.1	General	67
8.3.12.2	Successful Operation.....	68
8.3.12.3	Abnormal Conditions	68
8.3.13	Dedicated Measurement Termination	68
8.3.13.1	General	68
8.3.13.2	Successful Operation.....	68
8.3.13.3	Abnormal Conditions	69
8.3.14	Dedicated Measurement Failure	69
8.3.14.1	General	69
8.3.14.2	Successful Operation.....	69
8.3.14.3	Abnormal Conditions	69
8.3.15	Downlink Power Control [FDD]	69
8.3.15.1	General	69
8.3.15.2	Successful Operation.....	70
8.3.15.3	Abnormal Conditions	71
8.3.16	Compressed Mode Command [FDD]	71
8.3.16.1	General	71
8.3.16.2	Successful Operation.....	71
8.3.16.3	Abnormal Conditions	71
8.3.17	Downlink Power Timeslot Control [TDD]	71
8.3.17.1	General	71
8.3.17.2	Successful Operation.....	72

8.3.17.3	Abnormal Conditions	72
8.3.18	Radio Link Pre-emption.....	72
8.3.18.1	General	72
8.3.18.2	Successful Operation.....	72
8.3.18.3	Abnormal Conditions	73
8.3.19	Radio Link Congestion	73
8.3.19.1	General	73
8.3.19.2	Successful Operation.....	73
8.3.19.3	Abnormal Conditions	73
8.4	Common Transport Channel Procedures.....	74
8.4.1	Common Transport Channel Resources Initialisation	74
8.4.1.1	General	74
8.4.1.2	Successful Operation.....	74
8.4.1.3	Unsuccessful Operation	75
8.4.1.4	Abnormal Conditions	75
8.4.2	Common Transport Channel Resources Release	75
8.4.2.1	General	75
8.4.2.2	Successful Operation.....	76
8.4.2.3	Abnormal Conditions	76
8.5	Global Procedures	76
8.5.1	Error Indication.....	76
8.5.1.1	General	76
8.5.1.2	Successful Operation.....	76
8.5.1.3	Abnormal Conditions	77
8.5.2	Common Measurement Initiation	77
8.5.2.1	General	77
8.5.2.2	Successful Operation.....	77
8.5.2.3	Unsuccessful Operation	82
8.5.2.4	Abnormal Conditions	83
8.5.3	Common Measurement Reporting	84
8.5.3.1	General	84
8.5.3.2	Successful Operation.....	84
8.5.3.3	Abnormal Conditions	84
8.5.4	Common Measurement Termination	85
8.5.4.1	General	85
8.5.4.2	Successful Operation.....	85
8.5.4.3	Abnormal Conditions	85
8.5.5	Common Measurement Failure.....	85
8.5.5.1	General	85
8.5.5.2	Successful Operation.....	85
8.5.5.3	Abnormal Conditions	85
8.5.6	Information Exchange Initiation	86
8.5.6.1	General	86
8.5.6.2	Successful Operation.....	86
8.5.6.3	Unsuccessful Operation	87
8.5.6.4	Abnormal Conditions	87
8.5.7	Information Reporting	88
8.5.7.1	General	88
8.5.7.2	Successful Operation.....	88
8.5.7.3	Abnormal Conditions	88
8.5.8	Information Exchange Termination	89
8.5.8.1	General	89
8.5.8.2	Successful Operation.....	89
8.5.8.3	Abnormal Conditions	89
8.5.9	Information Exchange Failure	89
8.5.9.1	General	89
8.5.9.2	Successful Operation.....	89
9	Elements for RNSAP Communication.....	90
9.1	Message Functional Definition and Content	90
9.1.1	General.....	90
9.1.2	Message Contents	90

9.1.2.1	Presence	90
9.1.2.2	Criticality	90
9.1.2.3	Range	90
9.1.2.4	Assigned Criticality.....	90
9.1.3	RADIO LINK SETUP REQUEST	91
9.1.3.1	FDD Message.....	91
9.1.3.2	TDD Message	93
9.1.4	RADIO LINK SETUP RESPONSE	95
9.1.4.1	FDD Message.....	95
9.1.4.2	TDD Message	97
9.1.5	RADIO LINK SETUP FAILURE	101
9.1.5.1	FDD Message.....	101
9.1.5.2	TDD Message	102
9.1.6	RADIO LINK ADDITION REQUEST	103
9.1.6.1	FDD Message.....	103
9.1.6.2	TDD Message	104
9.1.7	RADIO LINK ADDITION RESPONSE.....	105
9.1.7.1	FDD Message.....	105
9.1.7.2	TDD Message	106
9.1.8	RADIO LINK ADDITION FAILURE.....	110
9.1.8.1	FDD Message.....	110
9.1.8.2	TDD Message	111
9.1.9	RADIO LINK DELETION REQUEST.....	111
9.1.10	RADIO LINK DELETION RESPONSE.....	111
9.1.11	RADIO LINK RECONFIGURATION PREPARE	112
9.1.11.1	FDD Message.....	112
9.1.11.2	TDD Message	114
9.1.12	RADIO LINK RECONFIGURATION READY	117
9.1.12.1	FDD Message.....	117
9.1.12.2	TDD Message	118
9.1.13	RADIO LINK RECONFIGURATION COMMIT	121
9.1.14	RADIO LINK RECONFIGURATION FAILURE.....	121
9.1.15	RADIO LINK RECONFIGURATION CANCEL.....	121
9.1.16	RADIO LINK RECONFIGURATION REQUEST.....	122
9.1.16.1	FDD Message.....	122
9.1.16.2	TDD Message	123
9.1.17	RADIO LINK RECONFIGURATION RESPONSE.....	124
9.1.17.1	FDD Message.....	124
9.1.17.2	TDD Message	124
9.1.18	RADIO LINK FAILURE INDICATION	125
9.1.19	RADIO LINK RESTORE INDICATION	126
9.1.20	DL POWER CONTROL REQUEST [FDD].....	126
9.1.21	PHYSICAL CHANNEL RECONFIGURATION REQUEST	127
9.1.21.1	FDD Message.....	127
9.1.21.2	TDD Message	128
9.1.22	PHYSICAL CHANNEL RECONFIGURATION COMMAND	129
9.1.23	PHYSICAL CHANNEL RECONFIGURATION FAILURE	129
9.1.24	UPLINK SIGNALLING TRANSFER INDICATION	130
9.1.24.1	FDD Message.....	130
9.1.24.2	TDD Message	130
9.1.25	DOWNLINK SIGNALLING TRANSFER REQUEST	130
9.1.26	RELOCATION COMMIT	131
9.1.27	PAGING REQUEST	131
9.1.28	DEDICATED MEASUREMENT INITIATION REQUEST.....	132
9.1.29	DEDICATED MEASUREMENT INITIATION RESPONSE.....	133
9.1.30	DEDICATED MEASUREMENT INITIATION FAILURE.....	133
9.1.31	DEDICATED MEASUREMENT REPORT	134
9.1.32	DEDICATED MEASUREMENT TERMINATION REQUEST.....	134
9.1.33	DEDICATED MEASUREMENT FAILURE INDICATION	134
9.1.34	COMMON TRANSPORT CHANNEL RESOURCES RELEASE REQUEST.....	135
9.1.35	COMMON TRANSPORT CHANNEL RESOURCES REQUEST	135
9.1.36	COMMON TRANSPORT CHANNEL RESOURCES RESPONSE.....	135

9.1.36.1	FDD Message.....	135
9.1.36.2	TDD Message	136
9.1.37	COMMON TRANSPORT CHANNEL RESOURCES FAILURE	136
9.1.38	COMPRESSED MODE COMMAND [FDD].....	136
9.1.39	ERROR INDICATION.....	136
9.1.40	DL POWER TIMESLOT CONTROL REQUEST [TDD]	137
9.1.41	RADIO LINK PREEMPTION REQUIRED INDICATION	137
9.1.42	RADIO LINK CONGESTION INDICATION	137
9.1.43	COMMON MEASUREMENT INITIATION REQUEST	138
9.1.44	COMMON MEASUREMENT INITIATION RESPONSE	139
9.1.45	COMMON MEASUREMENT INITIATION FAILURE	139
9.1.46	COMMON MEASUREMENT REPORT	140
9.1.47	COMMON MEASUREMENT TERMINATION REQUEST	140
9.1.48	COMMON MEASUREMENT FAILURE INDICATION.....	140
9.1.49	INFORMATION EXCHANGE INITIATION REQUEST	140
9.1.50	INFORMATION EXCHANGE INITIATION RESPONSE.....	141
9.1.51	INFORMATION EXCHANGE INITIATION FAILURE	141
9.1.52	INFORMATION REPORT	141
9.1.53	INFORMATION EXCHANGE TERMINATION REQUEST	141
9.1.54	INFORMATION EXCHANGE FAILURE INDICATION	142
9.2	Information Element Functional Definition and Contents	142
9.2.0	General.....	142
9.2.1	Common Parameters.....	142
9.2.1.1	Allocation/Retention Priority	142
9.2.1.2	Allowed Queuing Time.....	143
9.2.1.2A	Allowed Rate Information.....	143
9.2.1.2B	Altitude and Direction.....	143
9.2.1.3	Binding ID.....	144
9.2.1.4	BLER	144
9.2.1.4A	Block STTD Indicator.....	144
9.2.1.4B	Burst Mode Parameters	144
9.2.1.5	Cause.....	144
9.2.1.5A	Cell Geographical Area Identity (Cell GAI)	147
9.2.1.5B	Cell Geographical Area Additional Shapes (Cell GAI Additional Shapes)	148
9.2.1.6	Cell Identifier (C-ID)	148
9.2.1.7	Cell Individual Offset.....	148
9.2.1.8	Cell Parameter ID.....	149
9.2.1.9	CFN.....	149
9.2.1.10	CFN Offset.....	149
9.2.1.11	CN CS Domain Identifier.....	149
9.2.1.11A	CN Domain Type	149
9.2.1.12	CN PS Domain Identifier	150
9.2.1.12A	Common Measurement Accuracy	150
9.2.1.12B	Common Measurement Object Type	150
9.2.1.12C	Common Measurement Type	150
9.2.1.12D	Common Measurement Value.....	151
9.2.1.12E	Common Measurement Value Information.....	151
9.2.1.13	Criticality Diagnostics.....	152
9.2.1.14	C-RNTI	154
9.2.1.15	DCH Combination Indicator	154
9.2.1.16	DCH ID	154
9.2.1.16A	DCH Information Response	154
9.2.1.17	Dedicated Measurement Object Type	155
9.2.1.18	Dedicated Measurement Type.....	155
9.2.1.19	Dedicated Measurement Value	155
9.2.1.19A	Dedicated Measurement Value Information	156
9.2.1.19B	DGPS Corrections.....	157
9.2.1.20	Diversity Control Field	157
9.2.1.21	Diversity Indication.....	158
9.2.1.21A	DL Power	158
9.2.1.22	Downlink SIR Target	158
9.2.1.23	DPCH Constant Value	158

9.2.1.24	D-RNTI	158
9.2.1.25	D-RNTI Release Indication	158
9.2.1.26	DRX Cycle Length Coefficient	159
9.2.1.26A	DSCH ID	159
9.2.1.26B	DSCH Flow Control Information	159
9.2.1.26Ba	DSCH-RNTI	159
9.2.1.26Bb	Extended GSM Cell Individual Offset	160
9.2.1.26C	FACH Flow Control Information	160
9.2.1.27	FACH Initial Window Size	160
9.2.1.28	FACH Priority Indicator	160
9.2.1.28A	FN Reporting Indicator	161
9.2.1.29	Frame Handling Priority	161
9.2.1.30	Frame Offset	161
9.2.1.30A	GA Point with Uncertainty	161
9.2.1.30B	GA Ellipsoid Point with Uncertainty Ellipse	161
9.2.1.30C	GA Ellipsoid Point with Altitude	162
9.2.1.30D	GA Ellipsoid Point with Altitude and Uncertainty Ellipsoid	162
9.2.1.30E	GA Ellipsoid Arc	162
9.2.1.30F	Geographical Coordinates	163
9.2.1.30G	GPS Almanac	163
9.2.1.30H	GPS Ionospheric Model	164
9.2.1.30I	GPS Navigation Model and Time Recovery	164
9.2.1.30J	GPS Real-Time Integrity	166
9.2.1.30K	GPS Receiver Geographical Position (GPS RX Pos)	166
9.2.1.30L	GPS UTC Model	166
9.2.1.30M	Guaranteed Rate Information	167
9.2.1.31	IMSI	167
9.2.1.31A	Information Exchange ID	167
9.2.1.31B	Information Exchange Object Type	168
9.2.1.31C	Information Report Characteristics	168
9.2.1.31D	Information Threshold	168
9.2.1.31E	Information Type	168
9.2.1.31F	IPDL Parameters	169
9.2.1.32	L3 Information	170
9.2.1.33	Limited Power Increase	170
9.2.1.33A	Load Value	170
9.2.1.34	MAC-c/sh SDU Length	170
9.2.1.35	Maximum Allowed UL Tx Power	170
9.2.1.35A	Measurement Availability Indicator	170
9.2.1.35B	Measurement Change Time	170
9.2.1.36	Measurement Filter Coefficient	171
9.2.1.36A	Measurement Hysteresis Time	171
9.2.1.37	Measurement ID	171
9.2.1.38	Measurement Increase/Decrease Threshold	171
9.2.1.39	Measurement Threshold	172
9.2.1.39A	Message Structure	174
9.2.1.40	Message Type	174
9.2.1.41	Multiple URAs Indicator	175
9.2.1.41A	Neighbouring UMTS Cell Information	176
9.2.1.41B	Neighbouring FDD Cell Information	176
9.2.1.41C	Neighbouring GSM Cell Information	177
9.2.1.41D	Neighbouring TDD Cell Information	179
9.2.1.41E	Paging Cause	180
9.2.1.41F	Paging Record Type	180
9.2.1.41G	Neighbouring FDD Cell Measurement Information	180
9.2.1.41H	Neighbouring TDD Cell Measurement Information	180
9.2.1.42	Payload CRC Present Indicator	181
9.2.1.43	PCCPCH Power	181
9.2.1.44	Primary CPICH Power	181
9.2.1.45	Primary Scrambling Code	181
9.2.1.46	Puncture Limit	182
9.2.1.46A	QE-Selector	182

9.2.1.47	RANAP Relocation Information	182
9.2.1.48	Report Characteristics	182
9.2.1.48a	Report Periodicity	184
9.2.1.48A	Requested Data Value	184
9.2.1.48B	Requested Data Value Information	185
9.2.1.48C	Restriction State Indicator	185
9.2.1.49	RL ID	185
9.2.1.50	RNC-ID	186
9.2.1.50A	SAT ID	186
9.2.1.51	SCH Time Slot	186
9.2.1.51A	Scheduling Priority Indicator	186
9.2.1.52	Service Area Identifier (SAI)	186
9.2.1.52A	SFN	187
9.2.1.52B	SFN-SFN Measurement Threshold Information	187
9.2.1.52C	SFN-SFN Measurement Value Information.....	187
9.2.1.53	S-RNTI.....	188
9.2.1.54	Sync Case.....	189
9.2.1.55	TFCI Presence.....	189
9.2.1.56	Time Slot.....	189
9.2.1.57	ToAWE	189
9.2.1.58	ToAWS	189
9.2.1.59	Transaction ID.....	190
9.2.1.59A	Transmitted Carrier Power	190
9.2.1.59B	T _{UTRAN-GPS} Accuracy Class.....	190
9.2.1.59C	T _{UTRAN-GPS} Measurement Threshold Information	190
9.2.1.59D	T _{UTRAN-GPS} Measurement Value Information.....	191
9.2.1.60	Transport Bearer ID	191
9.2.1.61	Transport Bearer Request Indicator	192
9.2.1.62	Transport Layer Address.....	192
9.2.1.63	Transport Format Combination Set (TFCS).....	192
9.2.1.64	Transport Format Set.....	194
9.2.1.65	TrCH Source Statistics Descriptor	196
9.2.1.66	UARFCN	196
9.2.1.67	UL FP Mode.....	196
9.2.1.68	UL Interference Level.....	196
9.2.1.68A	Uncertainty Ellipse.....	196
9.2.1.69	Uplink SIR	197
9.2.1.70	URA ID	197
9.2.1.70A	UTRAN Access Point Position	197
9.2.1.70B	URA Information	197
9.2.1.71	UTRAN Cell Identifier (UC-ID).....	197
9.2.1.72	Neighbouring TDD Cell Information LCR	198
9.2.1.73	Permanent NAS UE Identity	198
9.2.1.74	SFN-SFN Measurement Reference Point Position.....	198
9.2.1.75	UTRAN Access Point Position with Altitude	198
9.2.1.76	SFN-SFN Measurement Time Stamp	199
9.2.1.77	SFN-SFN Value	199
9.2.1.78	SCTD Indicator	199
9.2.1.79	Congestion Cause.....	199
9.2.2	FDD Specific Parameters.....	200
9.2.2.A	Active Pattern Sequence Information.....	200
9.2.2.B	Adjustment Period.....	200
9.2.2.C	Adjustment Ratio	200
9.2.2.1	Chip Offset.....	201
9.2.2.2	Closed Loop Mode1 Support Indicator	201
9.2.2.3	Closed Loop Mode2 Support Indicator	201
9.2.2.3A	Closed Loop Timing Adjustment Mode.....	201
9.2.2.4	Compressed Mode Method	202
9.2.2.4A	DCH FDD Information	202
9.2.2.5	D-Field Length.....	202
9.2.2.6	Diversity Control Field	202
9.2.2.7	Diversity Indication.....	202

9.2.2.8	Diversity Mode	202
9.2.2.9	DL DPCH Slot Format	203
9.2.2.10	DL Power	203
9.2.2.11	DL Scrambling Code	203
9.2.2.12	Downlink Frame Type	203
9.2.2.12A	DPC Mode	203
9.2.2.13	DRAC Control	203
9.2.2.13A	DSCH FDD Information	204
9.2.2.13B	DSCH FDD Information Response	204
9.2.2.13Bb	DSCH-RNTI	204
9.2.2.13C	FDD DCHs To Modify	205
9.2.2.13D	Enhanced DSCH PC	205
9.2.2.13E	Enhanced DSCH PC Counter	205
9.2.2.13F	Enhanced DSCH PC Indicator	205
9.2.2.13G	Enhanced DSCH PC Wnd	206
9.2.2.13H	Enhanced DSCH Power Offset	206
9.2.2.14	FDD DL Channelisation Code Number	206
9.2.2.14A	FDD DL Code Information	206
9.2.2.15	FDD S-CCPCH Offset	207
9.2.2.16	FDD TPC Downlink Step Size	207
9.2.2.16A	First RLS Indicator	207
9.2.2.17	Gap Position Mode	207
9.2.2.18	Gap Period (TGP)	208
9.2.2.19	Gap Starting Slot Number (SN)	208
9.2.2.20	IB_SG_POS	208
9.2.2.21	IB_SG_REP	208
9.2.2.21a	Inner Loop DL PC Status	208
9.2.2.21A	Limited Power Increase	208
9.2.2.21B	IPDL FDD Parameters	208
9.2.2.21C	Length of TFCI2	209
9.2.2.22	Max Adjustment Period	209
9.2.2.23	Max Adjustment Step	209
9.2.2.24	Max Number of UL DPDCHs	209
9.2.2.24A	Min DL Channelisation Code Length	209
9.2.2.25	Min UL Channelisation Code Length	209
9.2.2.26	Multiplexing Position	210
9.2.2.26A	Number of DL Channelisation Codes	210
9.2.2.27	Pattern Duration (PD)	210
9.2.2.27a	PC Preamble	210
9.2.2.27A	PDSCH Code Mapping	210
9.2.2.28	Power Adjustment Type	213
9.2.2.29	Power Control Mode (PCM)	213
9.2.2.30	Power Offset	213
9.2.2.31	Power Resume Mode (PRM)	213
9.2.2.31A	Preamble Signatures	213
9.2.2.32	Primary CPICH Ec/No	213
9.2.2.33	Propagation Delay (PD)	214
9.2.2.33A	PRACH Minimum Spreading Factor	214
9.2.2.34	QE-Selector	214
9.2.2.34A	RACH Sub Channel Numbers	214
9.2.2.35	RL Set ID	214
9.2.2.35A	Received Total Wide Band Power	214
9.2.2.36	S-Field Length	214
9.2.2.37	Scrambling Code Change	214
9.2.2.37A	Scrambling Code Number	214
9.2.2.37B	Secondary CCPCH Info	215
9.2.2.38	Secondary CCPCH Slot Format	215
9.2.2.39	Slot Number (SN)	215
9.2.2.39a	Split Type	216
9.2.2.39A	SRB Delay	216
9.2.2.40	SSDT Cell Identity	216
9.2.2.40A	SSDT Cell Identity for EDSCHPC	216

9.2.2.41	SSDT Cell Identity Length.....	216
9.2.2.42	SSDT Indication.....	217
9.2.2.43	SSDT Support Indicator.....	217
9.2.2.44	STTD Indicator.....	217
9.2.2.45	STTD Support Indicator.....	217
9.2.2.46	TFCI Signalling Mode.....	217
9.2.2.47	Transmission Gap Distance (TGD).....	218
9.2.2.47A	Transmission Gap Pattern Sequence Information.....	218
9.2.2.47B	Transmission Gap Pattern Sequence Scrambling Code Information.....	220
9.2.2.48	Transmit Diversity Indicator.....	220
9.2.2.49	Transmit Gap Length (TGL).....	221
9.2.2.50	Tx Diversity Indicator.....	221
9.2.2.51	UL/DL Compressed Mode Selection.....	221
9.2.2.52	UL DPCCCH Slot Format.....	221
9.2.2.53	UL Scrambling Code.....	221
9.2.2.54	Uplink Delta SIR.....	221
9.2.2.55	Uplink Delta SIR After.....	221
9.2.2.56	DPC Mode Change Support Indicator.....	221
9.2.3	TDD Specific Parameters.....	222
9.2.3.a	Alpha Value.....	222
9.2.3.A	Block STTD Indicator.....	222
9.2.3.1	Burst Type.....	222
9.2.3.2	CCTrCH ID.....	222
9.2.3.2A	DCH TDD Information.....	222
9.2.3.2B	DCH TDD Information Response.....	223
9.2.3.2C	DL Timeslot Information.....	223
9.2.3.2D	DL Time Slot ISCP Info.....	224
9.2.3.2E	DL Timeslot Information LCR.....	224
9.2.3.2F	DL Time Slot ISCP Info LCR.....	225
9.2.3.3	DPCH ID.....	225
9.2.3.3a	DSCH TDD Information.....	225
9.2.3.3A	Maximum Number of Timeslots per Frame.....	225
9.2.3.3B	Maximum Number of UL Physical Channels per Timeslot.....	226
9.2.3.3C	Maximum Number of DL Physical Channels per Frame.....	226
9.2.3.4	Midamble Shift And Burst Type.....	226
9.2.3.4A	Minimum Spreading Factor.....	227
9.2.3.4B	IPDL TDD Parameters.....	227
9.2.3.4C	Midamble Shift LCR.....	228
9.2.3.4D	Neighbouring TDD Cell Information LCR.....	228
9.2.3.5	Primary CCPCH RSCP.....	228
9.2.3.5A	PRACH Midamble.....	229
9.2.3.5B	RB Identity.....	229
9.2.3.6	Repetition Length.....	229
9.2.3.7	Repetition Period.....	229
9.2.3.7A	Rx Timing Deviation.....	229
9.2.3.7B	Secondary CCPCH Info TDD.....	229
9.2.3.7C	Secondary CCPCH TDD Code Information.....	230
9.2.3.7D	Special Burst Scheduling.....	230
9.2.3.7E	Synchronisation Configuration.....	230
9.2.3.7F	Secondary CCPCH Info TDD LCR.....	231
9.2.3.7G	Secondary CCPCH TDD Code Information LCR.....	231
9.2.3.8	TDD Channelisation Code.....	232
9.2.3.8a	TDD Channelisation Code LCR.....	232
9.2.3.8A	TDD DPCH Offset.....	232
9.2.3.8B	TDD DCHs To Modify.....	232
9.2.3.8C	TDD DL Code Information.....	233
9.2.3.8D	TDD DL Code Information LCR.....	233
9.2.3.8E	TDD DL DPCH Time Slot Format LCR.....	234
9.2.3.9	TDD Physical Channel Offset.....	234
9.2.3.10	TDD TPC Downlink Step Size.....	234
9.2.3.10a	TDD TPC Uplink Step Size.....	234
9.2.3.10A	TDD UL Code Information.....	235

9.2.3.10B	TDD UL Code Information LCR	235
9.2.3.10C	TDD UL DPCH Time Slot Format LCR.....	235
9.2.3.11	TFCI Coding	236
9.2.3.12	DL Timeslot ISCP.....	236
9.2.3.12a	Time Slot LCR.....	236
9.2.3.12A	Timing Advance Applied.....	236
9.2.3.13	Transport Format Management.....	236
9.2.3.13A	UL Timeslot ISCP.....	236
9.2.3.13B	UL PhysCH SF Variation.....	237
9.2.3.13C	UL Timeslot Information	237
9.2.3.13D	UL Time Slot ISCP Info	237
9.2.3.13E	TSTD Indicator	238
9.2.3.13F	TSTD Support Indicator.....	238
9.2.3.13G	UL Timeslot Information LCR	238
9.2.3.13H	UL Time Slot ISCP Info LCR.....	238
9.2.3.13I	Uplink Synchronisation Frequency.....	239
9.2.3.13J	Uplink Synchronisation Step Size.....	239
9.2.3.13K	Uplink Timing Advance Control LCR.....	239
9.2.3.14	USCH ID.....	239
9.2.3.15	USCH Information	240
9.3	Message and Information Element Abstract Syntax (with ASN.1).....	241
9.3.0	General.....	241
9.3.1	Usage of Private Message Mechanism for Non-standard Use	241
9.3.2	Elementary Procedure Definitions	241
9.3.3	PDU Definitions	252
9.3.4	Information Element Definitions	354
9.3.5	Common Definitions.....	417
9.3.6	Constant Definitions	418
9.3.7	Container Definitions.....	426
9.4	Message Transfer Syntax	430
9.5	Timers	430
10	Handling of Unknown, Unforeseen and Erroneous Protocol Data	430
10.1	General	430
10.2	Transfer Syntax Error.....	431
10.3	Abstract Syntax Error.....	431
10.3.1	General.....	431
10.3.2	Criticality Information	431
10.3.3	Presence Information	432
10.3.4	Not Comprehended IE/IE Group	432
10.3.4.1	Procedure ID	432
10.3.4.1A	Type of Message	433
10.3.4.2	IEs other than the Procedure ID and Type of Message	433
10.3.5	Missing IE or IE Group	434
10.3.6	IEs or IE Groups Received In Wrong Order or With Too Many Occurrences or Erroneously Present.....	435
10.4	Logical Error.....	435
10.5	Exceptions	436
Annex A (normative):	Allocation and Pre-emption of Radio Links in the DRNS	437
A.1	Deriving Allocation Information for a Radio Link	437
A.1.1	Establishment of a New Radio Link.....	437
A.1.2	Modification of an Existing Radio Link.....	437
A.2	Deriving Retention Information for a Radio Link.....	438
A.3	The Allocation/Retention Process	438
A.4	The Pre-emption Process.....	439
Annex B (informative):	Measurement Reporting.....	440
Annex C (informative):	Guidelines for Usage of the Criticality Diagnostics IE	445
C.1	EXAMPLE MESSAGE Layout	445

C.2	Example on a Received EXAMPLE MESSAGE	446
C.3	Content of Criticality Diagnostics	447
C.3.1	Example 1	447
C.3.2	Example 2	448
C.3.3	Example 3	449
C.3.4	Example 4	450
C.3.5	Example 5	451
C.4	ASN.1 of EXAMPLE MESSAGE	452
Annex D (normative): DRNS Behaviour at SRNC or RNSAP Signalling Bearer Failure		454
D.1	Detection of SRNC or RNSAP Signalling Bearer/Connection Failure	454
D.1.1	Termination of All UE Contexts Related to a Specific SRNC	454
D.1.2	Termination of Specific UE Context	454
D.2	DRNC Actions at UE Context Termination	454
Annex E (informative): Change History		455
History		459

Foreword

This Technical Specification (TS) has been produced by the 3rd Generation Partnership Project (3GPP).

The contents of the present document are subject to continuing work within the TSG and may change following formal TSG approval. Should the TSG modify the contents of the present document, it will be re-released by the TSG with an identifying change of release date and an increase in version number as follows:

Version x.y.z

where:

- x the first digit:
 - 1 presented to TSG for information;
 - 2 presented to TSG for approval;
 - 3 or greater indicates TSG approved document under change control.
- y the second digit is incremented for all changes of substance, i.e. technical enhancements, corrections, updates, etc.
- z the third digit is incremented when editorial only changes have been incorporated in the document.

1 Scope

The present document specifies the radio network layer signalling procedures of the control plane between RNCs in UTRAN.

2 References

The following documents contain provisions which, through reference in this text, constitute provisions of the present document.

- References are either specific (identified by date of publication, edition number, version number, etc.) or non-specific.
- For a specific reference, subsequent revisions do not apply.
- For a non-specific reference, the latest version applies. In the case of a reference to a 3GPP document (including a GSM document), a non-specific reference implicitly refers to the latest version of that document *in the same Release as the present document*.

- [1] 3GPP TS 23.003: "Numbering, addressing and identification".
- [2] 3GPP TS 25.413: "UTRAN Iu Interface RANAP Signalling".
- [3] 3GPP TS 25.426: "UTRAN Iur and Iub Interface Data Transport & Transport Layer Signalling for DCH Data Streams".
- [4] 3GPP TS 25.427: "UTRAN Iur and Iub Interface User Plane Protocols for DCH Data Streams".
- [5] 3GPP TS 25.435: "UTRAN Iub interface User Plane Protocols for Common Transport Channel Data Streams".
- [6] 3GPP TS 25.104: "UTRA (BS) FDD; Radio transmission and Reception".
- [7] 3GPP TS 25.105: "UTRA (BS) TDD; Radio Transmission and Reception".
- [8] 3GPP TS 25.211: "Physical Channels and Mapping of Transport Channels onto Physical Channels (FDD)".
- [9] 3GPP TS 25.212: "Multiplexing and Channel Coding (FDD)".
- [10] 3GPP TS 25.214: "Physical Layer Procedures (FDD)".
- [11] 3GPP TS 25.215: "Physical Layer – Measurements (FDD)".
- [12] 3GPP TS 25.221: "Physical Channels and Mapping of Transport Channels onto Physical Channels (TDD)".
- [13] 3GPP TS 25.223: "Spreading and Modulation (TDD)".
- [14] 3GPP TS 25.225: "Physical Layer – Measurements (TDD)".
- [15] 3GPP TS 25.304: "UE Procedures in Idle Mode"
- [16] 3GPP TS 25.331: "RRC Protocol Specification".
- [17] 3GPP TS 25.402: "Synchronisation in UTRAN, Stage 2".
- [18] ITU-T Recommendation X.680 (12/97): "Information technology - Abstract Syntax Notation One (ASN.1): Specification of basic notation".
- [19] ITU-T Recommendation X.681 (12/97): "Information technology - Abstract Syntax Notation One (ASN.1): Information object specification".

- [20] ITU-T Recommendation X.691 (12/97): "Information technology - ASN.1 encoding rules - Specification of Packed Encoding Rules (PER)".
- [21] 3GPP TS 25.213: "Spreading and modulation (FDD)".
- [22] 3GPP TS 25.224: "Physical Layer Procedures (TDD)".
- [23] 3GPP TS 25.133: "Requirements for support of Radio Resource management (FDD)".
- [24] 3GPP TS 25.123: "Requirements for support of Radio Resource management (TDD)".
- [25] 3GPP TS 23.032: "Universal Graphical Area Description (GAD)".
- [26] 3GPP TS 25.302: "Services Provided by the Physical Layer".
- [27] 3GPP TS 25.213: "Spreading and modulation (FDD)".
- [28] 3GPP TR 25.921: "Guidelines and Principles for Protocol Description and Error Handling".
- [29] GSM TS 05.05: "Digital cellular telecommunications system (Phase 2+); Radio transmission and reception".
- [30] ICD-GPS-200: "Navstar GPS Space Segment/Navigation User Interface".
- [31] RTCM-SC104: "RTCM Recommended Standards for Differential GNSS Service (v.2.2)".
- [32] 3GPP TS 25.425: "UTRAN Iur and Iub Interface User Plane Protocols for Common Transport Channel data streams".

3 Definitions, Symbols and Abbreviations

3.1 Definitions

For the purposes of the present document, the following terms and definitions apply:

Elementary Procedure: RNSAP protocol consists of Elementary Procedures (EPs). An Elementary Procedure is a unit of interaction between two RNCs. An EP consists of an initiating message and possibly a response message. Two kinds of EPs are used:

- **Class 1:** Elementary Procedures with response (success or failure);
- **Class 2:** Elementary Procedures without response.

For Class 1 EPs, the types of responses can be as follows:

Successful

- A signalling message explicitly indicates that the elementary procedure has been successfully completed with the receipt of the response.

Unsuccessful

- A signalling message explicitly indicates that the EP failed.

Class 2 EPs are considered always successful.

Prepared Reconfiguration: A Prepared Reconfiguration exists when the Synchronised Radio Link Reconfiguration Preparation procedure has been completed successfully. The Prepared Reconfiguration does not exist any more after either of the procedures Synchronised Radio Link Reconfiguration Commit or Synchronised Radio Link Reconfiguration Cancellation has been completed.

UE Context: The UE Context contains the necessary information for the DRNC to communicate with a specific UE. The UE Context is created by the Radio Link Setup procedure or by the Uplink Signalling Transfer procedure when the UE makes its first access in a cell controlled by the DRNS. The UE Context is deleted by the Radio Link Deletion

procedure, by the Common Transport Channel Resources Release procedure, or by the Downlink Signalling Transfer procedure when neither any Radio Links nor any common transport channels are established towards the concerned UE. The UE Context is identified by the SCCP Connection for messages using connection oriented mode of the signalling bearer and the D-RNTI for messages using connectionless mode of the signalling bearer, unless specified otherwise in the procedure text.

Distant RNC Context: The Distant RNC context is created by the first Common Measurement Initiation Procedure or Information Exchange Initiation Procedure initiated by one RNC and requested from another RNC. The Distant RNC Context is deleted after the Common Measurement Termination, the Common Measurement Failure, the Information Exchange Termination or the Information Exchange Failure procedure when there is no more Common Measurement and no more Information to be provided by the requested RNC to the requesting RNC. The Distant RNC Context is identified by an SCCP connection as, for common measurements and information exchange, only the connection oriented mode of the signalling bearer is used.

3.2 Symbols

Void.

3.3 Abbreviations

For the purposes of the present document, the following abbreviations apply:

A-GPS	Assisted-GPS
ASN.1	Abstract Syntax Notation One
BER	Bit Error Rate
BLER	Block Error Rate
CCCH	Common Control Channel
CCPCH	Common Control Physical Channel
CCTrCH	Coded Composite Transport Channel
CFN	Connection Frame Number
C-ID	Cell Identifier
CM	Compressed Mode
CN	Core Network
CPCH	Common Packet Channel
CPICH	Common Pilot Channel
CRNC	Controlling RNC
C-RNTI	Cell Radio Network Temporary Identifier
CS	Circuit Switched
CTFC	Calculated Transport Format Combination
DCH	Dedicated Channel
DGPS	Differential GPS
DL	Downlink
DPC	Downlink Power Control
DPCCCH	Dedicated Physical Control Channel
DPCH	Dedicated Physical Channel
DPDCH	Dedicated Physical Data Channel
DRAC	Dynamic Radio Access Control
DRNC	Drift RNC
DRNS	Drift RNS
D-RNTI	Drift Radio Network Temporary Identifier
DRX	Discontinuous Reception
DSCH	Downlink Shared Channel
E_c	Energy in single Code
EDSCHPC	Enhanced Downlink Shared Channel Power Control
EP	Elementary Procedure
FACH	Forward Access Channel
FDD	Frequency Division Duplex
FN	Frame Number
FP	Frame Protocol
GA	Geographical Area

GAI	Geographical Area Identifier
GPS	Global Positioning System
GSM	Global System Mobile
HW	Hardware
IB	Information Block
ID	Identity or Identifier
IE	Information Element
IMSI	International Mobile Subscriber Identity
IPDL	Idle Period DownLink
ISCP	Interference Signal Code Power
LAC	Location Area Code
LCR	Low Chip Rate (1.28 Mcps)
LCS	Location Services
MAC	Medium Access Control
NAS	Non Access Stratum
No	Reference Noise
O&M	Operation and Maintenance
OTD	Observed Time Difference
P(-)CCPCH	Primary CCPCH
PCH	Paging Channel
P(-)CPICH	Primary CPICH
PCPCH	Physical Common Packet Channel
PCS	Personal Communication Services
PDSCH	Physical Downlink Shared Channel
PDU	Protocol Data Unit
PhCH	Physical Channel
PICH	Paging Indication Channel
Pos	Position or Positioning
PRACH	Physical Random Access Channel
PS	Packet Switched
QE	Quality Estimate
RAC	Routing Area Code
RACH	Random Access Channel
RAN	Radio Access Network
RANAP	Radio Access Network Application Part
RB	Radio Bearer
RL	Radio Link
RLC	Radio Link Control
RLS	Radio Link Set
RM	Rate Matching
RNC	Radio Network Controller
RNS	Radio Network Subsystem
RNSAP	Radio Network Subsystem Application Part
RNTI	Radio Network Temporary Identifier
RRC	Radio Resource Control
RSCP	Received Signal Code Power
Rx	Receive or Reception
Sat	Satellite
SCCP	Signalling Connection Control Part
S(-)CCPCH	Secondary CCPCH
SCH	Synchronisation Channel
SCTD	Space Code Transmit Diversity
SDU	Service Data Unit
SF	System Frame
SFN	System Frame Number
SHCCH	Shared Control Channel
SIR	Signal-to-Interference Ratio
SRNC	Serving RNC
SRNS	Serving RNS
S-RNTI	Serving Radio Network Temporary Identifier
SSDT	Site Selection Diversity Transmission
STTD	Space Time Transmit Diversity

TDD	Time Division Duplex
TF	Transport Format
TFCI	Transport Format Combination Indicator
TFCS	Transport Format Combination Set
TFS	Transport Format Set
TGCFN	Transmission Gap Connection Frame Number
ToAWE	Time of Arrival Window Endpoint
ToAWS	Time of Arrival Window Startpoint
TPC	Transmit Power Control
TrCh	Transport Channel
TS	Time Slot
TSG	Technical Specification Group
TSTD	Time Switched Transmit Diversity
TTI	Transmission Time Interval
TX	Transmit or Transmission
UARFCN	UTRA Absolute Radio Frequency Channel Number
UC-ID	UTRAN Cell Identifier
UE	User Equipment
UL	Uplink
UMTS	Universal Mobile Telecommunications System
URA	UTRAN Registration Area
U-RNTI	UTRAN Radio Network Temporary Identifier
USCH	Uplink Shared Channel
UTRA	Universal Terrestrial Radio Access
UTRAN	Universal Terrestrial Radio Access Network

4 General

4.1 Procedure Specification Principles

The principle for specifying the procedure logic is to specify the functional behaviour of the DRNC/CRNC exactly and completely. The SRNC functional behaviour is left unspecified. The Physical Channel Reconfiguration procedure is an exception from this principle.

The following specification principles have been applied for the procedure text in subclause 8:

- The procedure text discriminates between:

- 1) Functionality which "shall" be executed

The procedure text indicates that the receiving node "shall" perform a certain function Y under a certain condition. If the receiving node supports procedure X but cannot perform functionality Y requested in the REQUEST message of a Class 1 EP, the receiving node shall respond with the message used to report unsuccessful outcome for this procedure, containing an appropriate cause value.

- 2) Functionality which "shall, if supported" be executed

The procedure text indicates that the receiving node "shall, if supported," perform a certain function Y under a certain condition. If the receiving node supports procedure X, but does not support functionality Y, the receiving node shall proceed with the execution of the EP, possibly informing the requesting node about the not supported functionality.

- Any required inclusion of an optional IE in a response message is explicitly indicated in the procedure text. If the procedure text does not explicitly indicate that an optional IE shall be included in a response message, the optional IE shall not be included. For requirements on including *Criticality Diagnostics* IE, see section 10. For examples on how to use the *Criticality Diagnostics* IE, see Annex C.

4.2 Forwards and Backwards Compatibility

The forwards and backwards compatibility of the protocol is assured by a mechanism in which all current and future messages, and IEs or groups of related IEs, include ID and criticality fields that are coded in a standard format that will not be changed in the future. These parts can always be decoded regardless of the standard version.

4.3 Source Signalling Address Handling

The sender of an RNSAP messages shall include the Source Signalling Address, i.e. the Signalling Address of the sending node.

4.4 Specification Notations

For the purposes of the present document, the following notations apply:

- [FDD] This tagging of a word indicates that the word preceding the tag "[FDD]" applies only to FDD. This tagging of a heading indicates that the heading preceding the tag "[FDD]" and the section following the heading applies only to FDD.
- [TDD] This tagging of a word indicates that the word preceding the tag "[TDD]" applies only to TDD, including 3.84Mcps TDD and 1.28Mcps TDD. This tagging of a heading indicates that the heading preceding the tag "[TDD]" and the section following the heading applies only to TDD, including 3.84Mcps TDD and 1.28Mcps TDD.
- [3.84Mcps TDD] This tagging of a word indicates that the word preceding the tag "[3.84Mcps TDD]" applies only to 3.84Mcps TDD. This tagging of a heading indicates that the heading preceding the tag "[3.84Mcps TDD]" and the section following the heading applies only to 3.84Mcps TDD.
- [1.28Mcps TDD] This tagging of a word indicates that the word preceding the tag "[1.28Mcps TDD]" applies only to 1.28Mcps TDD. This tagging of a heading indicates that the heading preceding the tag "[1.28Mcps TDD]" and the section following the heading applies only to 1.28Mcps TDD.
- [FDD - ...] This tagging indicates that the enclosed text following the "[FDD - " applies only to FDD. Multiple sequential paragraphs applying only to FDD are enclosed separately to enable insertion of TDD specific (or common) paragraphs between the FDD specific paragraphs.
- [TDD - ...] This tagging indicates that the enclosed text following the "[TDD - " applies only to TDD including 3.84Mcps TDD and 1.28Mcps TDD. Multiple sequential paragraphs applying only to TDD are enclosed separately to enable insertion of FDD specific (or common) paragraphs between the TDD specific paragraphs.
- [3.84Mcps TDD - ...] This tagging indicates that the enclosed text following the "[3.84Mcps TDD - " applies only to 3.84Mcps TDD. Multiple sequential paragraphs applying only to 3.84Mcps TDD are enclosed separately to enable insertion of FDD and TDD specific (or common) paragraphs between the 3.84Mcps TDD specific paragraphs.
- [1.28Mcps TDD - ...] This tagging indicates that the enclosed text following the "[1.28Mcps TDD - " applies only to 1.28Mcps TDD. Multiple sequential paragraphs applying only to 1.28Mcps TDD are enclosed separately to enable insertion of FDD and TDD specific (or common) paragraphs between the 1.28Mcps TDD specific paragraphs.
- Procedure When referring to an elementary procedure in the specification, the Procedure Name is written with the first letters in each word in upper case characters followed by the word "procedure", e.g. Radio Link Setup procedure.
- Message When referring to a message in the specification, the MESSAGE NAME is written with all letters in upper case characters followed by the word "message", e.g. RADIO LINK SETUP REQUEST message.

IE	When referring to an information element (IE) in the specification, the <i>Information Element Name</i> is written with the first letters in each word in upper case characters and all letters in Italic font followed by the abbreviation "IE", e.g. <i>Transport Format Set IE</i> .
Value of an IE	When referring to the value of an information element (IE) in the specification, the "Value" is written as it is specified in subclause 9.2 enclosed by quotation marks, e.g. "Abstract Syntax Error (Reject)" or "SSDT Active in the UE".

5 RNSAP Services

5.1 RNSAP Procedure Modules

The Iur interface RNSAP procedures are divided into four modules as follows:

1. RNSAP Basic Mobility Procedures;
2. RNSAP DCH Procedures;
3. RNSAP Common Transport Channel Procedures;
4. RNSAP Global Procedures.

The Basic Mobility Procedures module contains procedures used to handle the mobility within UTRAN.

The DCH Procedures module contains procedures that are used to handle DCHs, DSCHs, and USCHs between two RNSs. If procedures from this module are not used in a specific Iur, then the usage of DCH, DSCH, and USCH traffic between corresponding RNSs is not possible.

The Common Transport Channel Procedures module contains procedures that are used to control common transport channel data streams (excluding the DSCH and USCH) over Iur interface.

The Global Procedures module contains procedures that are not related to a specific UE. The procedures in this module are in contrast to the above modules involving two peer CRNCs.

5.2 Parallel Transactions

Unless explicitly indicated in the procedure specification, at any instance in time one protocol peer shall have a maximum of one ongoing RNSAP DCH procedure related to a certain UE.

6 Services Expected from Signalling Transport

The signalling transport shall provide two different service modes for the RNSAP.

1. Connection oriented data transfer service. This service is supported by a signalling connection between two RNCs. It shall be possible to dynamically establish and release signalling connections based on the need. Each active UE shall have its own signalling connection. The signalling connection shall provide in sequence delivery of RNSAP messages. RNSAP shall be notified if the signalling connection breaks.
2. Connectionless data transfer service. RNSAP shall be notified in case a RNSAP message did not reach the intended peer RNSAP entity.

7 Functions of RNSAP

The RNSAP protocol provides the following functions:

- Radio Link Management. This function allows the SRNC to manage radio links using dedicated resources in a DRNS;

- Physical Channel Reconfiguration. This function allows the DRNC to reallocate the physical channel resources for a Radio Link;
- Radio Link Supervision. This function allows the DRNC to report failures and restorations of a Radio Link;
- Compressed Mode Control [FDD]. This function allows the SRNC to control the usage of compressed mode within a DRNS;
- Measurements on Dedicated Resources. This function allows the SRNC to initiate measurements on dedicated resources in the DRNS. The function also allows the DRNC to report the result of the measurements;
- DL Power Drifting Correction [FDD]. This function allows the SRNC to adjust the DL power level of one or more Radio Links in order to avoid DL power drifting between the Radio Links;
- DCH Rate Control. This function allows the DRNC to limit the rate of each DCH configured for the Radio Link(s) of a UE in order to avoid congestion situations in a cell;
- CCCH Signalling Transfer. This function allows the SRNC and DRNC to pass information between the UE and the SRNC on a CCCH controlled by the DRNS;
- Paging. This function allows the SRNC to page a UE in a URA or a cell in the DRNS;
- Common Transport Channel Resources Management. This function allows the SRNC to utilise Common Transport Channel Resources within the DRNS (excluding DSCH resources for FDD);
- Relocation Execution. This function allows the SRNC to finalise a Relocation previously prepared via other interfaces;
- Reporting of General Error Situations. This function allows reporting of general error situations, for which function specific error messages have not been defined.
- DL Power Timeslot Correction [TDD]. This function enables the DRNS to apply an individual offset to the transmission power in each timeslot according to the downlink interference level at the UE.
- Measurements on Common Resources. This function allows an RNC to request from another RNC to initiate measurements on Common Resources. The function also allows the requested RNC to report the result of the measurements.
- Information Exchange. This function allows an RNC to request from another RNC the transfer of information. The function also allows the requested RNC to report the requested information.

The mapping between the above functions and RNSAP elementary procedures is shown in the Table 1.

Table 1: Mapping between functions and RNSAP elementary procedures

Function	Elementary Procedure(s)
Radio Link Management	a) Radio Link Setup b) Radio Link Addition c) Radio Link Deletion d) Unsynchronised Radio Link Reconfiguration e) Synchronised Radio Link Reconfiguration Preparation f) Synchronised Radio Link Reconfiguration Commit g) Synchronised Radio Link Reconfiguration Cancellation h) Radio Link Pre-emption
Physical Channel Reconfiguration	Physical Channel Reconfiguration
Radio Link Supervision	a) Radio Link Failure b) Radio Link Restoration
Compressed Mode Control [FDD]	a) Radio Link Setup b) Radio Link Addition c) Compressed Mode Command d) Unsynchronised Radio Link Reconfiguration e) Synchronised Radio Link Reconfiguration Preparation f) Synchronised Radio Link Reconfiguration Commit g) Synchronised Radio Link Reconfiguration Cancellation
Measurements on Dedicated Resources	a) Dedicated Measurement Initiation b) Dedicated Measurement Reporting c) Dedicated Measurement Termination d) Dedicated Measurement Failure
DL Power Drifting Correction [FDD]	Downlink Power Control
DCH Rate Control	a) Radio Link Setup b) Radio Link Addition c) Unsynchronised Radio Link Reconfiguration d) Synchronised Radio Link Reconfiguration Preparation e) Radio Link Congestion
CCCH Signalling Transfer	a) Uplink Signalling Transfer b) Downlink Signalling Transfer
Paging	Paging
Common Transport Channel Resources Management	a) Common Transport Channel Resources Initiation b) Common Transport Channel Resources Release
Relocation Execution	Relocation Commit
Reporting of General Error Situations	Error Indication
Measurements on Common Resources	a) Common Measurement Initiation b) Common Measurement Reporting c) Common Measurement Termination d) Common Measurement Failure
Information Exchange	a) Information Exchange Initiation b) Information Reporting c) Information Exchange Termination d) Information Exchange Failure
DL Power Timeslot Correction [TDD]	Downlink Power Timeslot Control

8 RNSAP Procedures

8.1 Elementary Procedures

In the following tables, all EPs are divided into Class 1 and Class 2 EPs.

Table 2: Class 1 Elementary Procedures

Elementary Procedure	Initiating Message	Successful Outcome	Unsuccessful Outcome
		Response message	Response message
Radio Link Setup	RADIO LINK SETUP REQUEST	RADIO LINK SETUP RESPONSE	RADIO LINK SETUP FAILURE
Radio Link Addition	RADIO LINK ADDITION REQUEST	RADIO LINK ADDITION RESPONSE	RADIO LINK ADDITION FAILURE
Radio Link Deletion	RADIO LINK DELETION REQUEST	RADIO LINK DELETION RESPONSE	
Synchronised Radio Link Reconfiguration Preparation	RADIO LINK RECONFIGURATION PREPARE	RADIO LINK RECONFIGURATION READY	RADIO LINK RECONFIGURATION FAILURE
Unsynchronised Radio Link Reconfiguration	RADIO LINK RECONFIGURATION REQUEST	RADIO LINK RECONFIGURATION RESPONSE	RADIO LINK RECONFIGURATION FAILURE
Physical Channel Reconfiguration	PHYSICAL CHANNEL RECONFIGURATION REQUEST	PHYSICAL CHANNEL RECONFIGURATION COMMAND	PHYSICAL CHANNEL RECONFIGURATION FAILURE
Dedicated Measurement Initiation	DEDICATED MEASUREMENT INITIATION REQUEST	DEDICATED MEASUREMENT INITIATION RESPONSE	DEDICATED MEASUREMENT INITIATION FAILURE
Common Transport Channel Resources Initialisation	COMMON TRANSPORT CHANNEL RESOURCES REQUEST	COMMON TRANSPORT CHANNEL RESOURCES RESPONSE	COMMON TRANSPORT CHANNEL RESOURCES FAILURE
Common Measurement Initiation	COMMON MEASUREMENT INITIATION REQUEST	COMMON MEASUREMENT INITIATION RESPONSE	COMMON MEASUREMENT INITIATION FAILURE
Information Exchange Initiation	INFORMATION EXCHANGE INITIATION REQUEST	INFORMATION EXCHANGE INITIATION RESPONSE	INFORMATION EXCHANGE INITIATION FAILURE

Table 3: Class 2 Elementary Procedures

Elementary Procedure	Initiating Message
Uplink Signalling Transfer	UPLINK SIGNALLING TRANSFER INDICATION
Downlink Signalling Transfer	DOWNLINK SIGNALLING TRANSFER REQUEST
Relocation Commit	RELOCATION COMMIT
Paging	PAGING REQUEST
Synchronised Radio Link Reconfiguration Commit	RADIO LINK RECONFIGURATION COMMIT
Synchronised Radio Link Reconfiguration Cancellation	RADIO LINK RECONFIGURATION CANCEL
Radio Link Failure	RADIO LINK FAILURE INDICATION
Radio Link Restoration	RADIO LINK RESTORE INDICATION
Dedicated Measurement Reporting	DEDICATED MEASUREMENT REPORT
Dedicated Measurement Termination	DEDICATED MEASUREMENT TERMINATION REQUEST
Dedicated Measurement Failure	DEDICATED MEASUREMENT FAILURE INDICATION
Downlink Power Control [FDD]	DL POWER CONTROL REQUEST
Compressed Mode Command [FDD]	COMPRESSED MODE COMMAND
Common Transport Channel Resources Release	COMMON TRANSPORT CHANNEL RESOURCES RELEASE REQUEST
Error Indication	ERROR INDICATION
Downlink Power Timeslot Control [TDD]	DL POWER TIMESLOT CONTROL REQUEST
Radio Link Pre-emption	RADIO LINK PREEMPTION REQUIRED INDICATION
Radio Link Congestion	RADIO LINK CONGESTION INDICATION
Common Measurement Reporting	COMMON MEASUREMENT REPORT
Common Measurement Termination	COMMON MEASUREMENT TERMINATION REQUEST
Common Measurement Failure	COMMON MEASUREMENT FAILURE INDICATION
Information Reporting	INFORMATION REPORT
Information Exchange Termination	INFORMATION EXCHANGE TERMINATION REQUEST
Information Exchange Failure	INFORMATION EXCHANGE FAILURE INDICATION

8.2 Basic Mobility Procedures

8.2.1 Uplink Signalling Transfer

8.2.1.1 General

The procedure is used by the DRNC to forward a Uu message received on the CCCH to the SRNC.

This procedure shall use the connectionless mode of the signalling bearer.

8.2.1.2 Successful Operation

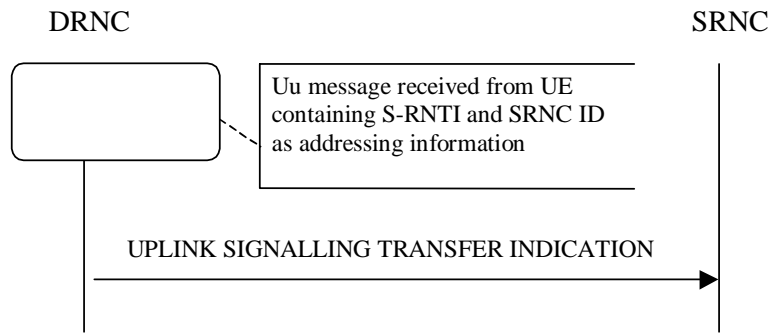

Figure 1: Uplink Signalling Transfer procedure, Successful Operation

When the DRNC receives an Uu message on the CCCH in which the UE addressing information is U-RNTI, i.e. S-RNTI and SRNC-ID, DRNC shall send the UPLINK SIGNALLING TRANSFER INDICATION message to the SRNC identified by the SRNC-ID received from the UE.

If at least one URA Identity is being broadcast in the cell where the Uu message was received (the accessed cell), the DRNC shall include a URA Identity for this cell in the *URA ID IE*, the *Multiple URAs Indicator IE* indicating whether or not multiple URA Identities are being broadcast in the accessed cell, and the RNC Identity of all other RNCs that are having at least one cell within the URA where the Uu message was received in the *URA Information IE* in the UPLINK SIGNALLING TRANSFER INDICATION message.

The DRNC shall include in the message the C-RNTI that it allocates to identify the UE in the radio interface in the accessed cell. If there is no valid C-RNTI for the UE in the accessed cell, the DRNS shall allocate a new C-RNTI for the UE. If the DRNS allocates a new C-RNTI it shall also release any C-RNTI previously allocated for the UE.

If the DRNS has any RACH, [FDD - CPCH], and/or FACH resources allocated for the UE identified by the U-RNTI in another cell than the accessed cell, the DRNS shall release these RACH, [FDD - CPCH,] and/or FACH resources.

If no context exists for this UE in the DRNC, the DRNC shall create a UE Context for this UE, allocate a D-RNTI for the UE Context, and include the *D-RNTI IE* and the identifiers for the CN CS Domain and CN PS Domain that the DRNC is connected to in the UPLINK SIGNALLING TRANSFER INDICATION message. These CN Domain Identifiers shall be based on the LAC and RAC respectively of the cell where the message was received from the UE.

Depending on local configuration in the DRNS, it may include the geographical co-ordinates of the cell, represented either by the *Cell GAI IE* or by the *Cell GA Additional Shapes IE*, where the Uu message was received in the UPLINK SIGNALLING TRANSFER INDICATION message. If the DRNC includes the *Cell GA Additional Shapes IE* in the UPLINK SIGNALLING TRANSFER INDICATION message, it shall also include the *Cell GAI IE*.

[FDD - The DRNC shall include the *DPC Mode Change Support Indicator IE* in the UPLINK SIGNALLING TRANSFER INDICATION message if the accessed cell supports DPC mode change.]

8.2.1.3 Abnormal Conditions

-

8.2.2 Downlink Signalling Transfer

8.2.2.1 General

The procedure is used by the SRNC to request to the DRNC the transfer of a Uu message on the CCCH in a cell. When used, the procedure is in response to a received Uplink Signalling Transfer procedure.

This procedure shall use the connectionless mode of the signalling bearer.

8.2.2.2 Successful Operation



Figure 2: Downlink Signalling Transfer procedure, Successful Operation

The procedure consists of the DOWNLINK SIGNALLING TRANSFER REQUEST message sent by the SRNC to the DRNC.

The message contains the Cell Identifier (C-ID) contained in the received UPLINK SIGNALLING TRANSFER INDICATION message and the D-RNTI.

Upon receipt of the message, the DRNC shall send the L3 Information on the CCCH in the cell indicated by the *C-ID* IE to the UE identified by the *D-RNTI* IE.

If the *D-RNTI Release Indication* IE is set to "Release D-RNTI" and the DRNS has no dedicated resources (DCH, [TDD - USCH,] and/or DSCH) allocated for the UE, the DRNS shall release the D-RNTI, the UE Context, any RACH, [FDD - CPCH,] and FACH resources and any C-RNTI allocated to the UE Context upon receipt of the DOWNLINK SIGNALLING TRANSFER REQUEST message.

If the *D-RNTI Release Indication* IE is set to "Release D-RNTI" and the DRNS has dedicated resources allocated for the UE, the DRNS shall only release any RACH, [FDD - CPCH,] and FACH resources and any C-RNTI allocated to the UE Context upon receipt of the DOWNLINK SIGNALLING TRANSFER REQUEST message.

8.2.2.3 Abnormal Conditions

If the user identified by the *D-RNTI* IE has already accessed another cell controlled by the DRNC than the cell identified by the *C-ID* IE in the DOWNLINK SIGNALLING TRANSFER REQUEST message, the message shall be ignored.

8.2.3 Relocation Commit

8.2.3.1 General

The Relocation Commit procedure is used by source RNC to execute the Relocation. This procedure supports the Relocation procedures described in [2].

This procedure shall use the signalling bearer mode specified below.

8.2.3.2 Successful Operation



Figure 3: Relocation Commit procedure, Successful Operation

The source RNC sends the RELOCATION COMMIT message to the target RNC to request the target RNC to proceed with the Relocation. When the UE is utilising one or more radio links in the DRNC, the message shall be sent using the

connection oriented service of the signalling bearer and no further identification of the UE Context in the DRNC is required. If on the other hand, the UE is not utilising any radio link, the message shall be sent using the connectionless service of the signalling bearer and the *D-RNTI* IE shall be included in the message to identify the UE Context in the DRNC.

Upon receipt of the RELOCATION COMMIT message from the source RNC, the target RNC finalises the Relocation. If the message contains the transparent *RANAP Relocation Information* IE, the target RNC shall use this information when finalising the Relocation.

8.2.3.3 Abnormal Conditions

-

8.2.4 Paging

8.2.4.1 General

This procedure is used by the SRNC to indicate to a CRNC that a UE shall be paged in a cell or URA that is under the control of the CRNC.

This procedure shall use the connectionless mode of the signalling bearer.

8.2.4.2 Successful Operation



Figure 4: Paging procedure, Successful Operation

The procedure is initiated with a PAGING REQUEST message sent from the SRNC to the CRNC.

If the message contains the *C-ID* IE, the CRNC shall page in the indicated cell. Alternatively, if the message contains the *URA-ID* IE, the CRNC shall page in all cells that it controls in the indicated URA.

If the PAGING REQUEST message includes the *CN Originated Page to Connected Mode UE* IE, the CRNC shall include the information contained in the *CN Originated Page to Connected Mode UE* IE when paging the UE.

The CRNC shall calculate the Paging Occasions from the *IMSI* IE and the *DRX Cycle Length Coefficient* IE according to specification in ref. [15] and apply transmission on PICH and PCH accordingly.

8.2.4.3 Abnormal Conditions

-

8.3 DCH Procedures

8.3.1 Radio Link Setup

8.3.1.1 General

This procedure is used for establishing the necessary resources in the DRNS for one or more radio links.

The connection-oriented service of the signalling bearer shall be established in conjunction with this procedure.

8.3.1.2 Successful Operation

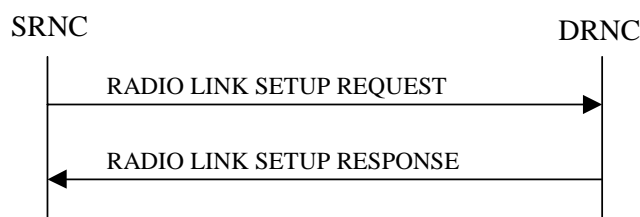

Figure 5: Radio Link Setup procedure: Successful Operation

When the SRNC makes an algorithmic decision to add the first cell or set of cells from a DRNS to the active set of a specific UE-UTRAN connection, the RADIO LINK SETUP REQUEST message is sent to the corresponding DRNC to request establishment of the radio link(s). The Radio Link Setup procedure is initiated with this RADIO LINK SETUP REQUEST message sent from the SRNC to the DRNC.

Upon receipt of the RADIO LINK SETUP REQUEST message, the DRNS shall reserve the necessary resources and configure the new RL(s) according to the parameters given in the message. Unless specified below, the meaning of parameters is specified in other specifications.

The DRNS shall prioritise resource allocation for the RL(s) to be established according to Annex A.

If the RADIO LINK SETUP REQUEST message includes the *Allowed Queuing Time* IE the DRNS may queue the request for a time period not exceeding the value of the *Allowed Queuing Time* IE before starting to execute the request.

Transport Channels Handling:

DCH(s):

[TDD - If the *DCH Information* IE is present in the RADIO LINK SETUP REQUEST message, the DRNS shall configure the new DCHs according to the parameters given in the message.]

If the RADIO LINK SETUP REQUEST message includes a *DCH Information* IE with multiple *DCH Specific Info* IEs, then the DRNS shall treat the DCHs in the *DCH Information* IE as a set of co-ordinated DCHs.

[FDD - For each DCH which does not belong to a set of co-ordinated DCHs, and which includes a *QE-Selector* IE set to "selected", the DRNS shall use the Transport channel BER from that DCH for the QE in the UL data frames. If no Transport channel BER is available for the selected DCH, the DRNS shall use the Physical channel BER for the QE, ref. [4]. If the *QE-Selector* IE is set to "non-selected", the DRNS shall use the Physical channel BER for the QE in the UL data frames, ref. [4].]

For a set of co-ordinated DCHs, the DRNS shall use the Transport channel BER from the DCH with the *QE-Selector* IE set to "selected" for the QE in the UL data frames, ref. [4]. [FDD - If no Transport channel BER is available for the selected DCH, the DRNS shall use the Physical channel BER for the QE, ref. [4]. If all DCHs have *QE-Selector* IE set to "non-selected", the DRNS shall use the Physical channel BER for the QE, ref. [4].] [TDD - If no Transport channel BER is available for the selected DCH, the DRNS shall use 0 for the QE, ref. [4].]

The DRNS shall use the included *UL DCH FP Mode* IE for a DCH or a set of co-ordinated DCHs as the DCH FP Mode in the Uplink of the user plane for the DCH or the set of co-ordinated DCHs.

The DRNS shall use the included *ToAWS* IE for a DCH or a set of co-ordinated DCHs as the Time of Arrival Window Start Point in the user plane for the DCH or the set of co-ordinated DCHs.

The DRNS shall use the included *ToAWE* IE for a DCH or a set of co-ordinated DCHs as the Time of Arrival Window End Point in the user plane for the DCH or the set of co-ordinated DCHs.

The *Frame Handling Priority* IE defines the priority level that should be used by the DRNS to prioritise between different frames of the data frames of the DCHs in the downlink on the radio interface in congestion situations once the new RL(s) have been activated.

If the *DCH Information IE* contains a *DCH Specific Info IE* which includes the *Guaranteed Rate Information IE*, the DRNS shall treat the included IEs according to the following:

- If the *Guaranteed Rate Information IE* includes the *Guaranteed UL Rate IE*, the DRNS shall apply the Guaranteed Rate in the uplink of this DCH. The DRNS may decide to request the SRNC to limit the user rate of the uplink of the DCH at any point in time. The DRNS may request the SRNC to reduce the user rate of the uplink of the DCH below the guaranteed bit rate, however, whenever possible the DRNS should request the SRNC to only reduce the user rate between the maximum bit rate and the guaranteed bit rate. If the *DCH Specific Info IE* in the *DCH Information IE* does not include the *Guaranteed UL Rate IE*, the DRNS shall not limit the user rate of the uplink of the DCH.
- If the *Guaranteed Rate Information IE* includes the *Guaranteed DL Rate IE*, the DRNS shall apply the Guaranteed Rate in the downlink of this DCH. The DRNS may decide to request the SRNC to limit the user rate of the downlink of the DCH at any point in time. The DRNS may request the SRNC to reduce the user rate of the downlink of the DCH below the guaranteed bit rate, however, whenever possible the DRNS should request the SRNC to only reduce the user rate between the maximum bit rate and the guaranteed bit rate. If the *DCH Specific Info IE* in the *DCH Information IE* does not include the *Guaranteed DL Rate IE*, the DRNS shall not limit the user rate of the downlink of the DCH.

DSCH(s):

If the *DSCH Information IE* is included in the RADIO LINK SETUP REQUEST message, the DRNC shall establish the requested DSCHs [FDD - on the RL indicated by the *PDSCH RL ID IE*]. In addition, the DRNC shall send a valid set of *DSCH Scheduling Priority IE* and *MAC-c/sh SDU Length IE* parameters to the SRNC in the RADIO LINK SETUP RESPONSE message. If the *PDSCH RL ID IE* indicates a radio link in the DRNS, then the DRNC shall allocate a DSCH-RNTI to the UE Context and include the *DSCH-RNTI IE* in the RADIO LINK SETUP RESPONSE message.

[TDD - USCH(s)]:

[TDD - If the *USCH Information IE* is included in the RADIO LINK SETUP REQUEST message, the DRNS shall establish the requested USCHs, and the DRNC shall provide the *USCH Information Response IE* in the RADIO LINK SETUP RESPONSE message.]

[TDD – The DRNS shall use the list of RB Identities in the *RB Info IE* in the *USCH information IE* to map each *RB Identity IE* to the corresponding USCH.]

[TDD – CCTrCH Handling]:

[TDD – If the *UL CCTrCH Information IE* is present in the RADIO LINK SETUP REQUEST message, the DRNS shall configure the new UL CCTrCH(s) according to the parameters given in the message.]

[1.28Mcps TDD - If the *UL CCTrCH Information LCR IE* includes the *TDD TPC Uplink Step Size IE*, the DRNS shall configure the uplink TPC step size according to the parameters given in the message.]

[TDD – If the *DL CCTrCH Information IE* is present in the RADIO LINK SETUP REQUEST message, the DRNS shall configure the new DL CCTrCH(s) according to the parameters given in the message.]

[TDD – If the *TPC CCTrCH List IE* is present in the RADIO LINK SETUP REQUEST message, the DRNS shall configure the identified UL CCTrCHs with TPC according to the parameters given in the message.]

Physical Channels Handling:

[FDD - Compressed Mode]:

[FDD - If the RADIO LINK SETUP REQUEST message includes the *Transmission Gap Pattern Sequence Information IE*, the DRNS shall store the information about the Transmission Gap Pattern Sequences to be used in the Compressed Mode Configuration. This Compressed Mode Configuration shall be valid in the DRNS until the next Compressed Mode Configuration is configured in the DRNS or the last Radio Link is deleted.]

[FDD - If the RADIO LINK SETUP REQUEST message includes the *Transmission Gap Pattern Sequence Information IE* and the *Active Pattern Sequence Information IE*, the DRNS shall use the information to activate the indicated Transmission Gap Pattern Sequence(s) in the new RL. The received *CM Configuration*

Change CFN IE refers to latest passed CFN with that value. The DRNS shall treat the received *TGCFN* IEs as follows:]

- [FDD - If any received *TGCFN* IE has the same value as the received *CM Configuration Change CFN* IE, the DRNS shall consider the concerned Transmission Gap Pattern Sequence as activated at that CFN.]
- [FDD - If any received *TGCFN* IE does not have the same value as the received *CM Configuration Change CFN* IE but the first CFN after the *CM Configuration Change CFN* with a value equal to the *TGCFN* IE has already passed, the DRNS shall consider the concerned Transmission Gap Pattern Sequence as activated at that CFN.]
- [FDD - For all other Transmission Gap Pattern Sequences included in the *Active Pattern Sequence Information* IE, the DRNS shall activate each Transmission Gap Pattern Sequence at the first CFN after the *CM Configuration Change CFN* with a value equal to the *TGCFN* IE for the Transmission Gap Pattern Sequence.][FDD- If the *Downlink Compressed Mode Method* IE in one or more Transmission Gap Pattern Sequence is set to "SF/2" in the RADIO LINK SETUP REQUEST message, the DRNC shall include the *Transmission Gap Pattern Sequence Scrambling Code Information* IE in the RADIO LINK SETUP RESPONSE message indicating for each DL Channelisation Code whether the alternative scrambling code shall be used or not.]

[FDD - DL Code Information]:

[FDD – When more than one DL DPDCH are assigned per RL, the segmented physical channel shall be mapped on to DL DPDCHs according to [8]. When p number of DL DPDCHs are assigned to each RL, the first pair of DL Scrambling Code and FDD DL Channelisation Code Number corresponds to "*PhCH number 1*", the second to "*PhCH number 2*", and so on until the p th to "*PhCH number p*".]

General:

[FDD - If the *Propagation Delay* IE is included, the DRNS may use this information to speed up the detection of UL synchronisation on the Uu interface.]

[FDD – If the received *Limited Power Increase* IE is set to "Used", the DRNS shall, if supported, use Limited Power Increase according to ref. [10] subclause 5.2.1 for the inner loop DL power control.]

Radio Link Handling:

Diversity Combination Control:

[FDD - The *Diversity Control Field* IE indicates for each RL, except for the first RL whether the DRNS shall combine the RL with any of the other RLs or not.

- If the *Diversity Control Field* IE is set to "May" (be combined with another RL), the DRNS shall decide for any of the alternatives.
- If the *Diversity Control Field* IE is set to "Must", the DRNS shall combine the RL with one of the other RLs. When an RL is to be combined, the DRNS shall choose which RL(s) to combine it with.
- If the *Diversity Control Field* IE is set to "Must not", the DRNS shall not combine the RL with any other existing RL.]

[FDD - In the RADIO LINK SETUP RESPONSE message, the DRNC shall indicate for each RL with the Diversity Indication in the *RL Information Response* IE whether the RL is combined or not.

- [FDD - In case of not combining with a RL previously listed in the RADIO LINK SETUP RESPONSE message or for the first RL in the RADIO LINK SETUP RESPONSE message, the DRNC shall include in the *DCH Information Response* IE in the RADIO LINK SETUP RESPONSE message the *Binding ID* IE and *Transport Layer Address* IE for the transport bearer to be established for each DCH of this RL.]
- [FDD - Otherwise in case of combining, the *RL ID* IE indicates (one of) the RL(s) previously listed in this RADIO LINK SETUP RESPONSE message with which the concerned RL is combined.]

[TDD - The DRNC shall always include in the RADIO LINK SETUP RESPONSE message both the *Transport Layer Address* IE and the *Binding ID* IE for the transport bearer to be established for each DCH,] DSCH and USCH] of the RL.]

In the case of a set of co-ordinated DCHs requiring a new transport bearer the *Binding ID IE* and the *Transport Layer Address IE* shall be included in the RADIO LINK SETUP RESPONSE message for only one of the DCHs in the set of co-ordinated DCHs.

[FDD-Transmit Diversity]:

[FDD – If the cell in which the RL is being set up is capable to provide Close loop Tx diversity, the DRNC shall include the *Closed Loop Timing Adjustment Mode IE* in the RADIO LINK SETUP RESPONSE message indicating the configured Closed loop timing adjustment mode of the cell.]

[FDD – When the *Diversity Mode IE* is set to "STTD", "Closed loop mode1", or "Closed loop mode2", the DRNC shall activate/deactivate the Transmit Diversity for each Radio Link in accordance with the *Transmit Diversity Indicator IE*].

DL Power Control:

[FDD - If both the *Initial DL TX Power IE* and *Uplink SIR Target IE* are included in the message, the DRNS shall use the indicated DL TX Power and Uplink SIR Target as initial value. If the value of the *Initial DL TX Power IE* is outside the configured DL TX power range, the DRNS shall apply these constrains when setting the initial DL TX power. The DRNS shall also include the configured DL TX power range defined by *Maximum DL TX Power IE* and *Minimum DL TX Power IE* in the RADIO LINK SETUP RESPONSE message. The DRNS shall not transmit with a higher power than indicated by the *Maximum DL TX Power IE* or lower than indicated by the *Minimum DL TX Power IE* on any DL DPCH of the RL except during compressed mode, when the δP_{curr} , as described in ref.[10] subclause 5.2.1.3, shall be added to the maximum DL power for the associated compressed frame.]

[FDD - If both the *Initial DL TX Power* and the *Uplink SIR Target IEs* are not included in the RADIO LINK SETUP REQUEST message, then DRNC shall determine the initial Uplink SIR Target and include it in the *Uplink SIR Target IE* in the RADIO LINK SETUP RESPONSE message.]

[FDD - If the *Primary CPICH Ec/No IE* is present, the DRNC should use the indicated value when deciding the Initial DL TX Power.]

[TDD - If the *Primary CCPCH RSCP IE* [3.84Mcps TDD - and/or the *DL Time Slot ISCP Info IE*] [1.28Mcps TDD - and/or the *DL Time Slot ISCP Info LCR IE*] are present, the DRNC should use the indicated values when deciding the Initial DL TX Power for the Radio Link. The DRNS shall use the indicated DL Timeslot ISCP when determining the initial DL power per timeslot as specified in [22], i.e. it shall reduce the DL TX power in those downlink timeslots of the radio link where the interference is low, and increase the DL TX power in those timeslots where the interference is high, while keeping the total downlink power in the radio link unchanged.]

[1.28McpsTDD - If the *TSTD Support Indicator IE* is present, the DRNS shall apply this information when configuring the transmit diversity for the new radio link..]

[FDD – The DRNS shall start the DL transmission using the indicated DL TX power level (if received) or the decided DL TX power level on each DL channelisation code of a RL until UL synchronisation is achieved on the Uu interface for the concerned RLS or Power Balancing is activated. No inner loop power control or power balancing shall be performed during this period. The DL power shall then vary according to the inner loop power control (see ref.[10] subclause 5.2.1.2) and the power control procedure (see 8.3.7).]

[TDD – The DRNS shall start the DL transmission using the decided DL TX power level on each DL channelisation code and on each Time Slot of a RL until UL synchronisation is achieved on the Uu interface for the concerned RL. No inner loop power control shall be performed during this period. Then after UL synchronisation, the DL power shall vary according to the inner loop power control (see ref. [22] subclause 4.2.3.3).]

[FDD – If the received *Inner Loop DL PC Status IE* is set to "Active", the DRNS shall activate the inner loop DL power control for all RLS. If *Inner Loop DL PC Status IE* is set to "Inactive", the DRNS shall deactivate the inner loop DL power control for all RLS according to ref. [10].]

[FDD - If the *DPC Mode IE* is present in the RADIO LINK SETUP REQUEST message, the DRNC shall apply the DPC mode indicated in the message, and be prepared that the DPC mode may be changed during the life time of the RL. If the *DPC Mode IE* is not present in the RADIO LINK SETUP REQUEST message, DPC mode 0 shall be applied (see ref. [10]).]

Neighbouring Cell Handling:

If there are UMTS neighbouring cell(s) to the cell in which a Radio Link was established then:

- The DRNC shall include in the RADIO LINK SETUP RESPONSE message the *Neighbouring FDD Cell Information IE* and/or *Neighbouring TDD Cell Information IE* in the *Neighbouring UMTS Cell Information IE* for each neighbouring FDD cell and/or TDD cell respectively. In addition, if the information is available, the DRNC shall include in the RADIO LINK SETUP RESPONSE message the *Frame Offset IE*, *Primary CPICH Power IE*, *Cell Individual Offset IE*, *STTD Support Indicator IE*, *Closed Loop Mode1 Support Indicator IE* and *Closed Loop Mode2 Support Indicator IE* in the *Neighbouring FDD Cell Information IE*, and the *Frame Offset IE*, *Cell Individual Offset IE*, *DPCH Constant Value IE* and the *PCCPCH Power IE* in the *Neighbouring TDD Cell Information IE* or the *Neighbouring TDD Cell Information LCR IE*. If the *Neighbouring TDD Cell Information IE* includes the *Sync Case IE* for the set to "Case1", the DRNC shall include the *Time Slot For SCH IE* in the *Neighbouring TDD Cell Information IE*. If the *Neighbouring TDD Cell Information IE* includes *Sync Case IE* set to "Case2", the DRNC shall include the *SCH Time Slot IE* in the *Neighbouring TDD Cell Information IE*.
- If a UMTS neighbouring cell is not controlled by the same DRNC, the DRNC shall also include in the RADIO LINK SETUP RESPONSE message the *CN PS Domain Identifier IE* and/or *CN CS Domain Identifier IE* which are the identifiers of the CN nodes connected to the RNC controlling the UMTS neighbouring cell.
- If the information is available, the DRNC shall include in the RADIO LINK SETUP RESPONSE message the *DPC Mode Change Support Indicator IE* for each neighbour cell in the *Neighbouring FDD Cell Information IE*.
- For the UMTS neighbouring cells which are controlled by the DRNC, the DRNC shall report in the RADIO LINK SETUP RESPONSE message the restriction state of those cells, otherwise the *Restriction State Indicator IE* may be absent. The DRNC shall include in the RADIO LINK SETUP RESPONSE message the *Restriction State Indicator IE* for the neighbouring cells which are controlled by the DRNC in the *Neighbouring FDD Cell Information IE*, the *Neighbouring TDD Cell Information IE* and the *Neighbouring TDD Cell Information LCR IE*.

If there are GSM neighbouring cells to the cell(s) where a radio link is established, the DRNC shall include in the RADIO LINK SETUP RESPONSE message the *Neighbouring GSM Cell Information IE* for each of the GSM neighbouring cells. If available the DRNC shall include in the RADIO LINK SETUP RESPONSE message the *Cell Individual Offset IE*, and if the *Cell Individual Offset IE* alone cannot represent the value of the offset, the DRNC shall also include the *Extended GSM Cell Individual Offset IE* in the *Neighbouring GSM Cell Information IE*.

[1.28Mcps TDD – Uplink Synchronisation Parameters LCR]:

[1.28Mcps TDD - If the *Uplink Synchronisation Parameters LCR IE* is present, the DRNC shall use the indicated values of *Uplink synchronisation stepsize IE* and *Uplink synchronisation frequency IE* when evaluating the timing of the UL synchronisation.]

[1.28Mcps TDD - Uplink Timing Advance Control LCR]:

[1.28Mcps TDD - The DRNC shall include the *Uplink Timing Advance Control LCR IE* in the RADIO LINK SETUP RESPONSE message.]

General:

[FDD - If the RADIO LINK SETUP REQUEST message includes the *SSDT Cell Identity IE* and the *S-Field Length IE*, the DRNS shall activate SSDT, if supported, using the *SSDT Cell Identity IE* and *SSDT Cell Identity Length IE*.]

[FDD - If the RADIO LINK SETUP REQUEST message includes the *SSDT Cell Identity for EDSCHPC IE*, the DRNS shall activate enhanced DSCH power control, if supported, using the *SSDT Cell Identity for EDSCHPC IE* and *SSDT Cell Identity Length IE* as well as *Enhanced DSCH PC IE* in accordance with ref. [10] subclause 5.2.2. If the RADIO LINK SETUP REQUEST message includes both *SSDT Cell Identity IE* and *SSDT Cell Identity for EDSCHPC IE*, then the DRNS shall ignore the *SSDT Cell Identity for EDSCHPC IE*.]

[FDD - If the *DRAC Control* IE is set to "requested" in the RADIO LINK SETUP REQUEST message for at least one DCH and if the DRNS supports the DRAC, the DRNC shall include in the RADIO LINK SETUP RESPONSE message the *Secondary CCPCH Info* IE for the FACH in which the DRAC information is sent, for each Radio Link established in a cell in which DRAC is active. If the DRNS does not support DRAC, the DRNC shall not provide these IEs in the RADIO LINK SETUP RESPONSE message.]

If no *D-RNTI* IE was included in the RADIO LINK SETUP REQUEST message, the DRNC shall include in the RADIO LINK SETUP RESPONSE message the *D-RNTI* IE, the *CN PS Domain Identifier* IE and/or the *CN CS Domain Identifier* IE for the CN domains (using LAC and RAC of the current cell) to which the DRNC is connected.

[FDD - If the *D-RNTI* IE was included the RADIO LINK SETUP REQUEST message the DRNC shall include in the RADIO LINK SETUP RESPONSE message the *Primary Scrambling Code* IE, the *UL UARFCN* IE and the *DL UARFCN*.]

[TDD – If the *D-RNTI* IE was included in the RADIO LINK SETUP REQUEST message the DRNC shall include in the RADIO LINK SETUP RESPONSE message the *UARFCN* IE, the *Cell Parameter ID* IE and the *SCTD Indicator* IE.]

[3.84Mcps TDD - If the *D-RNTI* IE was included in the RADIO LINK SETUP REQUEST message the DRNC shall include in the RADIO LINK SETUP RESPONSE message the *Sync Case* IE and if the *Sync Case* IE is set to "Case 2", the DRNC shall also include the *SCH Time Slot* IE in the RADIO LINK SETUP RESPONSE message. If the included *Sync Case* IE is set to "Case1", the DRNC shall also include the *Time Slot For SCH* IE]

[3.84Mcps TDD - The DRNC shall include the *Secondary CCPCH Info TDD* IE in the RADIO LINK SETUP RESPONSE message if at least one *DSCH Information Response* IE or *USCH Information Response* IE is included in the message and at least one DCH is configured for the radio link. The DRNC shall also include the *Secondary CCPCH Info TDD* IE in the RADIO LINK SETUP RESPONSE message if at least one *DSCH Information Response* IE or *USCH Information Response* IE is included in the message and the SHCCH messages for this radio link will be transmitted over a different secondary CCPCH than selected by the UE from system information.]

[1.28 Mcps TDD - The DRNC shall include the *Secondary CCPCH Info TDD LCR* IE in the RADIO LINK SETUP RESPONSE message if at least one *DSCH Information Response LCR* IE or *USCH Information Response LCR* IE is included in the message and at least one DCH is configured for the radio link. The DRNC shall also include the *Secondary CCPCH Info TDD LCR* IE in the RADIO LINK SETUP RESPONSE message if at least one *DSCH Information Response LCR* IE or *USCH Information Response LCR* IE is included in the message and the SHCCH messages for this radio link will be transmitted over a different secondary CCPCH than selected by the UE from system information.]

For each Radio Link established in a cell in which at least one URA Identity is being broadcast, the DRNC shall include in the *URA Information* IE within the RADIO LINK SETUP RESPONSE message the URA Information for this cell including the *URA ID* IE, the *Multiple URAs Indicator* IE indicating whether or not multiple URA Identities are being broadcast in the cell, and the *RNC-ID* IEs of all other RNCs that have at least one cell within the URA identified by the *URA ID* IE.

Depending on local configuration in the DRNS, the DRNC may include in the RADIO LINK SETUP RESPONSE message the *UTRAN Access Point Position* IE and the geographical co-ordinates of the cell, represented either by the *Cell GAI* IE or by the *Cell GA Additional Shapes* IE. If the DRNC includes the *Cell GA Additional Shapes* IE in the RADIO LINK SETUP RESPONSE message, it shall also include the *Cell GAI* IE.

If the DRNS need to limit the user rate in the uplink of a DCH due to congestion caused by the UL UTRAN Dynamic Resources (see subclause 9.2.1.79) when starting to utilise a new Radio Link, the DRNC shall include in the RADIO LINK SETUP RESPONSE message the *Allowed UL Rate* IE in the *DCH Information Response* IE for this Radio Link.

If the DRNS needs to limit the user rate in the downlink of a DCH due to congestion caused by the DL UTRAN Dynamic Resources (see subclause 9.2.1.79) when starting to utilise a new Radio Link, the DRNC shall include in the RADIO LINK SETUP RESPONSE message the *Allowed DL Rate* IE in the *DCH Information Response* IE for this Radio Link.

If the *Permanent NAS UE Identity* IE is included in the RADIO LINK SETUP REQUEST message, the DRNS shall store the information for the considered UE Context for the life-time of the UE Context.

If the RADIO LINK SETUP REQUEST message includes the *Permanent NAS UE Identity* IE and a *C-ID* IE corresponding to a cell reserved for operator use, the DRNS shall use this information to determine whether it can set up a Radio Link on this cell or not for the considered UE Context.

The DRNS shall start receiving on the new RL(s) after the RLs are successfully established.

[FDD - Radio Link Set Handling]:

[FDD - The *First RLS Indicator* IE indicates if the concerned RL shall be considered part of the first RLS established towards this UE. The DRNS shall use the *First RLS Indicator* IE to determine the initial TPC pattern in the DL of the concerned RL and all RLs which are part of the same RLS, as described in [10], section 5.1.2.2.1.2.

[FDD – For each RL not having a common generation of the TPC commands in the DL with another RL, the DRNS shall assign to the RL a unique value for the *RL Set ID* IE which uniquely identifies the RL as an RL Set within the UE Context.]

[FDD – For all RLs having a common generation of the TPC commands in the DL with another RL, the DRNS shall assign to each RL the same value for the *RL Set ID* IE which uniquely identifies these RLs as members of the same RL Set within the UE Context.]

[FDD –The UL out-of-sync algorithm defined in ref. [10] shall, for each of the established RL Set(s), use the maximum value of the parameters *N_OUTSYNC_IND* and *T_RLFAILURE* that are configured in the cells supporting the radio links of the RL Set. The UL in-sync algorithm defined in [10] shall, for each of the established RL Set(s), use the minimum value of the parameters *N_INSYNC_IND*, that are configured in the cells supporting the radio links of the RL Set.]

Response Message:

Upon receipt of the RADIO LINK SETUP REQUEST message, the DRNS allocates the requested type of channelisation codes and other physical channel resources for each RL and assigns a binding identifier and a transport layer address for each DCH, for each set of co-ordinated DCHs and for each DSCH [TDD – and USCH]. This information shall be sent to the SRNC in the RADIO LINK SETUP RESPONSE message when all the RLs have been successfully established.

After sending the RADIO LINK SETUP RESPONSE message the DRNS shall continuously attempt to obtain UL synchronisation on the Uu interface. [FDD - The DRNS shall start transmission on the DL DPDCH(s) of the new RL as specified in ref. [4].] [TDD – The DRNS shall start transmission on the new RL immediately as specified in ref. [4].]

8.3.1.3 Unsuccessful Operation

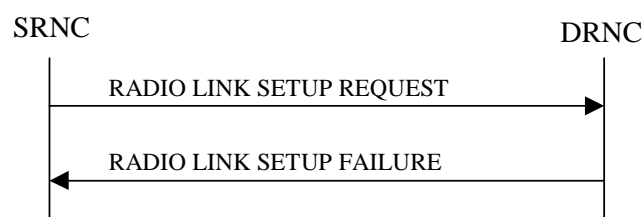

Figure 6: Radio Link Setup procedure: Unsuccessful Operation

If the establishment of at least one radio link is unsuccessful, the DRNC shall respond with a RADIO LINK SETUP FAILURE message. The DRNC shall include in the RADIO LINK SETUP FAILURE message a general *Cause* IE or a *Cause* IE for each failed radio link. The *Cause* IE indicates the reason for failure.

[FDD -If some radio links were established successfully, the DRNC shall indicate this in the RADIO LINK SETUP FAILURE message in the same way as in the RADIO LINK SETUP RESPONSE message.]

[FDD – If the RL identified by the *PDSCH RL ID* IE is a radio link in the DRNS and this RL is successfully established, then the DRNC shall allocate a DSCH-RNTI to the UE Context and include the *DSCH-RNTI* IE in the RADIO LINK SETUP FAILURE message.]

If the RADIO LINK SETUP REQUEST message includes a *C-ID* IE corresponding to a cell reserved for operator use and the *Permanent NAS UE Identity* IE is not present, the DRNC shall reject the procedure and send the RADIO LINK SETUP FAILURE message.

Typical cause values are:

Radio Network Layer Causes:

- [FDD - UL Scrambling Code Already in Use];
- DL Radio Resources not Available;
- UL Radio Resources not Available;
- [FDD - Combining Resources not available];
- Combining not Supported
- Requested Configuration not Supported;
- Cell not Available;
- [FDD - Requested Tx Diversity Mode not Supported];
- Power Level not Supported;
- Number of DL codes not supported;
- Number of UL codes not supported;
- Dedicated Transport Channel Type not Supported;
- DL Shared Channel Type not Supported;
- [TDD - UL Shared Channel Type not Supported];
- [FDD - UL Spreading Factor not Supported];
- [FDD - DL Spreading Factor not Supported];
- CM not Supported;
- [FDD – DPC mode change not Supported];
- Cell reserved for operator use.

Transport Layer Causes:

- Transport Resource Unavailable.

Miscellaneous Causes:

- Control Processing Overload;
- HW Failure;
- Not enough User Plane Processing Resources.

8.3.1.4 Abnormal Conditions

If the DRNC receives either an S-RNTI or a D-RNTI which already has RL(s) established the DRNC shall send the RADIO LINK SETUP FAILURE message to the SRNC, indicating the reason for failure.

[FDD - If the RADIO LINK SETUP REQUEST message includes the *Active Pattern Sequence Information* IE, but the *Transmission Gap Pattern Sequence Information* IE is not present, then the DRNC shall reject the procedure using the RADIO LINK SETUP FAILURE message.]

[FDD – If the RADIO LINK SETUP REQUEST message includes both the *Initial DL TX Power* IE and the *Primary CPICH Ec/No* IE or does not include either of these IEs, then the DRNC shall reject the procedure using the RADIO LINK SETUP FAILURE message.]

If more than one DCH of a set of co-ordinated DCHs has the *QE-Selector* IE set to "selected" [TDD – or no DCH of a set of co-ordinated DCHs has the *QE-Selector* IE set to "selected"], the DRNS shall reject the Radio Link Setup procedure and shall respond with a RADIO LINK SETUP FAILURE message.

[FDD - If only the *Initial DL TX Power* IE or the *Uplink SIR Target* IE is included in the RADIO LINK SETUP REQUEST message, then DRNC shall reject the Radio Link Setup procedure and shall respond with the RADIO LINK SETUP FAILURE message.]

If the RADIO LINK SETUP REQUEST message includes a *DCH Information* IE with multiple *DCH Specific Info* IEs, and if the DCHs in the *DCH Information* IE do not have the same *Transmission Time Interval* IE in the *Semi-static Transport Format Information* IE, then the DRNC shall reject the procedure using the RADIO LINK SETUP FAILURE message.

8.3.2 Radio Link Addition

8.3.2.1 General

This procedure is used for establishing the necessary resources in the DRNS for one or more additional RLs towards a UE when there is already at least one RL established to the concerned UE via this DRNS.

This procedure shall use the signalling bearer connection for the relevant UE Context.

The Radio Link Addition procedure shall not be initiated if a Prepared Reconfiguration exists, as defined in subclause 3.1.

[FDD – The Radio Link Addition procedure serves to establish one or more new Radio Links which do not contain the DSCH. If the DSCH shall be moved into a new Radio Link, the Radio Link reconfiguration procedure shall be applied.]

[TDD – The Radio Link Addition procedure serves to establish a new Radio Link with the DSCH and USCH included, if they existed before.]

8.3.2.2 Successful Operation

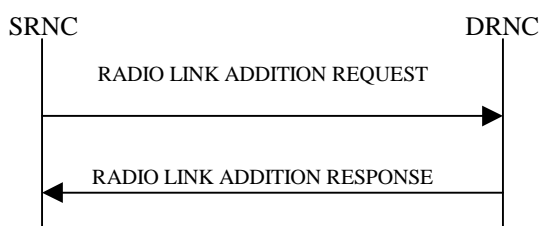

Figure 7: Radio Link Addition procedure: Successful Operation

The procedure is initiated with a RADIO LINK ADDITION REQUEST message sent from the SRNC to the DRNC.

Upon receipt, the DRNS shall reserve the necessary resources and configure the new RL(s) according to the parameters given in the message. Unless specified below, the meaning of parameters is specified in other specifications.

The DRNS shall prioritise resource allocation for the RL(s) to be established according to Annex A.

Transport Channel Handling:

[TDD - The DRNC shall include the *UL/DL DPCH Information* IE within the *UL/DL CCTrCH Information* IE for each CCTrCH that requires DPCHs.]

DSCH:

[TDD - If the radio link to be added includes a DSCH, the DRNC shall include in the RADIO LINK ADDITION RESPONSE message a *DSCH Information Response* IE for each DSCH]

[TDD - USCH:]

[TDD - If the radio link to be added includes any USCHs, the DRNC shall include in the RADIO LINK ADDITION RESPONSE message a *USCH Information Response* IE for each USCH.]

Physical Channels Handling:

[FDD-Compressed Mode:]

[FDD - If the RADIO LINK ADDITION REQUEST message includes the *Active Pattern Sequence Information* IE, the DRNS shall use the information to activate the indicated (all ongoing) Transmission Gap Pattern Sequence(s) in the new RL. The received *CM Configuration Change CFN* IE refers to the latest passed CFN with that value. The DRNS shall treat the received *TGCFN* IEs as follows:]

- [FDD - If any received *TGCFN* IE has the same value as the received *CM Configuration Change CFN* IE, the DRNS shall consider the concerned Transmission Gap Pattern Sequence as activated at that CFN.]
- [FDD - If any received *TGCFN* IE does not have the same value as the received *CM Configuration Change CFN* IE but the first CFN after the *CM Configuration Change CFN* with a value equal to the *TGCFN* IE has already passed, the DRNS shall consider the concerned Transmission Gap Pattern Sequence as activated at that CFN.]
- [FDD - For all other Transmission Gap Pattern Sequences included in the *Active Pattern Sequence Information* IE, the DRNS shall activate each Transmission Gap Pattern Sequence at the first CFN after the *CM Configuration Change CFN* with a value equal to the *TGCFN* IE for the Transmission Gap Pattern Sequence.]

[FDD - If the *Active Pattern Sequence Information* IE is not included, the DRNS shall not activate the ongoing compressed mode pattern in the new RLs, but the ongoing pattern in the existing RL shall be maintained.]

[FDD - If some Transmission Gap Pattern sequences using SF/2 method are initialised in the DRNS, the DRNC shall include the *Transmission Gap Pattern Sequence Scrambling Code Information* IE in the *DL Code Information* IE in the RADIO LINK ADDITION RESPONSE message to indicate the Scrambling code change method that it selects for each channelisation code.]

[FDD-DL Code Information]:

[FDD – When more than one DL DPDCH are assigned per RL, the segmented physical channel shall be mapped on to DL DPDCHs according to [8]. When p number of DL DPDCHs are assigned to each RL, the first pair of DL Scrambling Code and FDD DL Channelisation Code Number corresponds to "*PhCH number 1*", the second to "*PhCH number 2*", and so on until the p th to "*PhCH number p*".]

[TDD - CCTrCH Handling]:

[TDD - If the *UL CCTrCH Information* IE is present, the DRNS shall configure the new UL CCTrCH(s) according to the parameters given in the message.]

[1.28Mcps TDD - If the *UL CCTrCH Information* IE includes the TDD TPC *Uplink Step Size* IE, the DRNS shall configure the uplink TPC step size according to the parameters given in the message, otherwise it shall use the step size configured in other radio link.]

[TDD - If the *DL CCTrCH Information* IE is present, the DRNS shall configure the new DL CCTrCH(s) according to the parameters given in the message.]

[TDD - If the *DL CCTrCH Information* IE includes *TDD TPC Downlink Step Size* IE, the DRNS shall configure the downlink TPC step size according to the parameters given in the message, otherwise it shall use the step size configured in other radio link.]

General:

[FDD - The DRNS shall use the provided Uplink SIR Target value as the current target for the inner-loop power control.]

Radio Link Handling:

Diversity Combination Control:

The *Diversity Control Field* IE indicates for each RL whether the DRNS shall combine the new RL with existing RL(s) or not.

- If the *Diversity Control Field* IE is set to "May" (be combined with another RL), the DRNS shall decide for any of the alternatives.
- If the *Diversity Control Field* IE is set to "Must", the DRNS shall combine the RL with one of the other RL.
- If the *Diversity Control Field* IE is set to "Must not", the DRNS shall not combine the RL with any other existing RL.

When a new RL is to be combined, the DRNS shall choose the RL(s) with which to combine it.

In the case of not combining a RL with a RL established with a previous Radio Link Setup or Radio Link Addition Procedure or a RL previously listed in the RADIO LINK ADDITION RESPONSE message, the DRNC shall indicate with the Diversity Indication in the *RL Information Response* IE in the RADIO LINK ADDITION RESPONSE message that no combining is done. In this case the DRNC shall include in the *DCH Information Response* IE both the *Transport Layer Address* IE and the *Binding ID* IE for the transport bearer to be established for each DCH of the RL in the RADIO LINK ADDITION RESPONSE message.

In the case of combining with a RL established with a previous Radio Link Setup or Radio Link Addition Procedure or with a RL previously listed in this RADIO LINK ADDITION RESPONSE message, the DRNC shall indicate with the Diversity Indication in the *RL Information Response* IE in the RADIO LINK ADDITION RESPONSE message that the RL is combined. In this case, the RL ID IE indicates (one of) the previously established RL(s) or a RL previously listed in this RADIO LINK ADDITION RESPONSE message with which the new RL is combined.

[TDD – The DRNC shall always include in the RADIO LINK ADDITION RESPONSE message both the *Transport Layer Address* IE and the *Binding ID* IE for the transport bearer to be established for each DSCH and USCH of the RL.]

In the case of a set of co-ordinated DCHs, the DRNC shall include in the RADIO LINK ADDITION RESPONSE message the *Binding ID* IE and the *Transport Layer Address* IE for only one of the DCHs in the set of co-ordinated DCHs.

If the DRNS needs to limit the user rate in the uplink of a DCH due to congestion caused by the UL UTRAN Dynamic Resources (see subclause 9.2.1.79) when starting to utilise a new Radio Link, the DRNC shall include in the RADIO LINK ADDITION RESPONSE message the *Allowed UL Rate* IE in the *DCH Information Response* IE for this Radio Link.

If the DRNS needs to limit the user rate in the downlink of a DCH due to congestion caused by the DL UTRAN Dynamic Resources (see subclause 9.2.1.79) when starting to utilise a new Radio Link, the DRNC shall include in the RADIO LINK ADDITION RESPONSE message the *Allowed DL Rate* IE in the *DCH Information Response* IE for this Radio Link.

[FDD-Transmit Diversity]:

The DRNS shall activate any feedback mode diversity according to the received settings.

[FDD – If the cell in which the RL is being added is capable to provide Close loop Tx diversity, the DRNC shall indicate the Closed loop timing adjustment mode of the cell by including the *Closed Loop Timing Adjustment Mode* IE in the RADIO LINK ADDITION RESPONSE message.]

[FDD – When the *Transmit Diversity Indicator* IE is present the DRNS shall activate/deactivate the Transmit Diversity for each new Radio Link in accordance with the *Transmit Diversity Indicator* IE using the diversity mode of the existing Radio Link(s).]

DL Power Control:

[FDD - If the *Primary CPICH Ec/No* IE is included for an RL in the RADIO LINK ADDITION REQUEST message, the DRNS shall use this in the calculation of the Initial DL TX Power for this RL. If the *Primary*

CPICH Ec/No IE is not present, the DRNS shall set the Initial DL TX Power based on the power relative to the Primary CPICH power used by the existing RLS.]

[TDD - If the *Primary CCPCH RSCP* IE [3.84Mcps TDD - and/or the *DL Time Slot ISCP Info* IE] [1.28Mcps TDD - and/or the *DL Time Slot ISCP Info LCR* IE] are included in the RADIO LINK ADDITION REQUEST message, the DRNS shall use them in the calculation of the Initial DL TX Power. If the *Primary CCPCH RSCP* IE [3.84Mcps TDD - and *DL Time Slot ISCP Info* IE] [1.28Mcps TDD - and *DL Time Slot ISCP Info LCR* IE] are not present, the DRNS shall set the Initial DL TX Power based on the power relative to the Primary CCPCH power used by the existing RL.]

[FDD - The Initial DL TX Power shall be applied until UL synchronisation is achieved on the Uu interface for that RLS or Power Balancing is activated. No inner loop power control or power balancing shall be performed during this period. The DL power shall then vary according to the inner loop power control (see ref. [10] subclause 5.2.1.2) and the power control procedure (see 8.3.7)].

[TDD - The Initial DL TX Power shall be applied until UL synchronisation is achieved on the Uu interface for that RL. No inner loop power control shall be performed during this period. The DL power shall then vary according to the inner loop power control (see ref. [22] subclause 4.2.3.3)].

[FDD - If the *DPC Mode* IE is present in the RADIO LINK ADDITION REQUEST message, the DRNC shall apply the DPC mode indicated in the message, and be prepared that the DPC mode may be changed during the lifetime of the RL. If the *DPC Mode* IE is not present in the RADIO LINK ADDITION REQUEST message, DPC mode 0 shall be applied (see ref. [10]).]

UL Power Control:

The DRNC shall also provide the configured UL Maximum SIR and UL Minimum SIR for every new RL to the SRNC in the RADIO LINK ADDITION RESPONSE message. These values are taken into consideration by DRNS admission control and shall be used by the SRNC as limits for the UL inner-loop power control target.

[FDD - The DRNS shall use the provided Uplink SIR Target value as the current target for the inner-loop power control.]

The DRNC shall provide the configured *Maximum DL TX Power* IE and *Minimum DL TX Power* IE for every new RL to the SRNC in the RADIO LINK ADDITION RESPONSE message. The DRNS shall not transmit with a higher power than indicated by the *Maximum DL TX Power* IE or lower than indicated by the *Minimum DL TX Power* IE on any DL DPCH of the RL [FDD - except during compressed mode, when the δP_{curr} , as described in ref. [10] subclause 5.2.1.3, shall be added to the maximum DL power for the associated compressed frame.].

Neighbouring Cell Handling:

If there are UMTS neighbouring cell(s) to the cell in which a Radio Link was established then:

- The DRNC shall include in the RADIO LINK ADDITION RESPONSE message the *Neighbouring FDD Cell Information* IE and/or *Neighbouring TDD Cell Information* IE in the *Neighbouring UMTS Cell Information* IE for each neighbouring FDD cell and/or TDD cell respectively. In addition, if the information is available, the DRNC shall include in the RADIO LINK ADDITION RESPONSE message the *Frame Offset* IE, *Primary CPICH Power* IE, *Cell Individual Offset* IE, *STTD Support Indicator* IE, *Closed Loop Mode1 Support Indicator* IE and *Closed Loop Mode2 Support Indicator* IE in the *Neighbouring FDD Cell Information* IE, and the *Frame Offset* IE, *Cell Individual Offset* IE, *DPCH Constant Value* IE and the *PCCPCH Power* IE in the *Neighbouring TDD Cell Information* IE or the *Neighbouring TDD Cell Information LCR* IE. If the *Neighbouring TDD Cell Information* IE includes the *Sync Case* IE set to "Case1", the DRNC shall include the *Time Slot For SCH* IE in the *Neighbouring TDD Cell Information* IE. If the *Neighbouring TDD Cell Information* IE includes the *Sync Case* IE set to "Case2", the DRNC shall include the *SCH Time Slot* IE in the *Neighbouring TDD Cell Information* IE.
- If a UMTS neighbouring cell is not controlled by the same DRNC, the DRNC shall also include in the RADIO LINK ADDITION RESPONSE message the *CN PS Domain Identifier* IE and/or *CN CS Domain Identifier* IE which are the identifiers of the CN nodes connected to the RNC controlling the UMTS neighbouring cell.

- [FDD - The DRNC shall include in the RADIO LINK ADDITION RESPONSE message the *DPC Mode Change Support Indicator* IE for each neighbour cell in the *Neighbouring FDD Cell Information* IE if this information is available.]
- For the UMTS neighbouring cells which are controlled by the DRNC, the DRNC shall report in the RADIO LINK ADDITION RESPONSE message the restriction state of those cells, otherwise *Restriction State Indicator* IE may be absent. The DRNC shall include the *Restriction State Indicator* IE for the neighbouring cells which are controlled by the DRNC in the *Neighbouring FDD Cell Information* IE, the *Neighbouring TDD Cell Information* IE and the *Neighbouring TDD Cell Information LCR* IE.

If there are GSM neighbouring cells to the cell(s) in which a radio link is established, the DRNC shall include the *Neighbouring GSM Cell Information* IE in the RADIO LINK ADDITION RESPONSE message for each of the GSM neighbouring cells. If available, the DRNC shall include the *Cell Individual Offset* IE, and if the Cell Individual Offset IE alone cannot represent the value of the offset, the DRNC shall also include the Extended GSM Cell Individual Offset IE in the *Neighbouring GSM Cell Information* IE.

[1.28Mcps TDD – Uplink Synchronisation Parameters LCR]:

[1.28Mcps TDD - If the *Uplink Synchronisation Parameters LCR* IE is present, the DRNC shall use the indicated values of *Uplink synchronisation stepsize* IE and *Uplink synchronisation frequency* IE when evaluating the timing of the UL synchronisation.]

[1.28Mcps TDD - Uplink Timing Advance Control LCR]:

[1.28Mcps TDD - The DRNC shall include the *Uplink Timing Advance Control LCR* IE in the RADIO LINK ADDITION RESPONSE message.]

General:

[FDD - If the RADIO LINK ADDITION REQUEST message contains an *SSDT Cell Identity* IE, the DRNS shall, if supported, activate SSDT for the concerned new RL using the indicated SSDT Cell Identity.]

Depending on local configuration in the DRNS, the DRNC may include in the RADIO LINK ADDITION RESPONSE message the *UTRAN Access Point Position* IE and the geographical co-ordinates of the cell, represented either by the *Cell GAI* IE or by the *Cell GA Additional Shapes* IE. If the DRNC includes the *Cell GA Additional Shapes* IE in the RADIO LINK ADDITION RESPONSE message, it shall also include the *Cell GAI* IE.

For each Radio Link established in a cell in which at least one URA Identity is being broadcast, the DRNC shall include in the RADIO LINK ADDITION RESPONSE message a URA Information for this cell including the *URA ID* IE, the *Multiple URAs Indicator* IE indicating whether or not multiple URA Identities are being broadcast in the cell, and the *RNC-ID* IEs of all other RNCs that have at least one cell within the URA identified by the *URA ID* IE.

[FDD - If the UE has been allocated one or several DCH controlled by DRAC and if the DRNS supports the DRAC, the DRNC shall include in the RADIO LINK ADDITION RESPONSE message the *Secondary CCPCH Info* IE for the FACH in which the DRAC information is sent, for each Radio Link established in a cell in which DRAC is active. If the DRNS does not support DRAC, the DRNC shall not provide these IEs in the RADIO LINK ADDITION RESPONSE message.]

[3.84 Mcps TDD - The DRNC shall include the *Secondary CCPCH Info TDD* IE in the RADIO LINK ADDITION RESPONSE message if at least one *DSCH Information Response* IE or *USCH Information Response* IE is included in the message and at least one DCH is configured for the radio link. The DRNC shall also include the *Secondary CCPCH Info TDD* IE in the RADIO LINK ADDITION RESPONSE message if at least one *DSCH Information Response* IE or *USCH Information Response* IE is included in the message and the SHCCH messages for this radio link will be transmitted over a different secondary CCPCH than selected by the UE from system information.]

[1.28 Mcps TDD - The DRNC shall include the *Secondary CCPCH Info TDD LCR* IE in the RADIO LINK ADDITION RESPONSE message if at least one *DSCH Information Response LCR* IE or *USCH Information Response LCR* IE is included in the message and at least one DCH is configured for the radio link. The DRNC shall also include the *Secondary CCPCH Info TDD LCR* IE in the RADIO LINK ADDITION RESPONSE message if at least one *DSCH Information Response LCR* IE or *USCH Information Response*

LCR IE is included in the message and the SHCCH messages for this radio link will be transmitted over a different secondary CCPCH than selected by the UE from system information.]

If the *Permanent NAS UE Identity* IE is present in the RADIO LINK ADDITION REQUEST message, the DRNS shall store the information for the considered UE Context for the life-time of the UE Context.

If the RADIO LINK ADDITION REQUEST message includes a *C-ID* IE corresponding to a cell reserved for operator use and the Permanent NAS UE Identity is available in the DRNC for the considered UE Context, the DRNC shall use this information to determine whether it can add the Radio Link on this cell or not.

The DRNS shall start receiving on the new RL(s) after the RLs are successfully established.

[FDD-Radio Link Set Handling]:

[FDD – For each RL not having a common generation of the TPC commands in the DL with another RL, the DRNS shall assign to the RL a unique value for the *RL Set ID* IE which uniquely identifies the RL as an RL Set within the UE Context.]

[FDD – For all RLs having a common generation of the TPC commands in the DL with another new or existing RL, the DRNS shall assign to each RL the same value for the *RL Set ID* IE which uniquely identifies these RLs as members of the same RL Set within the UE Context.]

[FDD – After addition of the new RL(s), the UL out-of-sync algorithm defined in ref. [10] shall, for each of the previously existing and newly established RL Set(s), use the maximum value of the parameters *N_OUTSYNC_IND* and *T_RLFAILURE* that are configured in the cells supporting the radio links of the RL Set. The UL in-sync algorithm defined in [10] shall, for each of the established RL Set(s), use the minimum value of the parameters *N_INSYNC_IND*, that are configured in the cells supporting the radio links of the RL Set.]

Response message:

If all requested RLs are successfully added, the DRNC shall respond with a RADIO LINK ADDITION RESPONSE message.

After sending the RADIO LINK ADDITION RESPONSE message the DRNS shall continuously attempt to obtain UL synchronisation on the Uu interface. [FDD - The DRNS shall start transmission on the DL DPDCH(s) of the new RL as specified in ref. [4].] [TDD – The DRNS shall start transmission on the new RL immediately as specified in ref. [4].]

8.3.2.3 Unsuccessful Operation

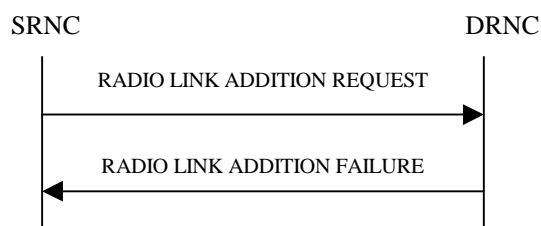

Figure 8: Radio Link Addition procedure: Unsuccessful Operation

If the establishment of at least one RL is unsuccessful, the DRNC shall respond with a RADIO LINK ADDITION FAILURE message. DRNC shall include in the RADIO LINK ADDITION FAILURE message a general *Cause* IE or a *Cause* IE for each failed radio link. The *Cause* IE indicates the reason for failure.

[FDD - If some RL(s) were established successfully, the DRNC shall indicate this in the RADIO LINK ADDITION FAILURE message in the same way as in the RADIO LINK ADDITION RESPONSE message.]

Typical cause values are:

Radio Network Layer Causes:

- DL Radio Resources not Available;
- UL Radio Resources not Available;

- Combining Resources not Available;
- Combining not Supported
- Cell not Available;
- [FDD - Requested Tx Diversity Mode not Supported];
- Power Level not Supported;
- CM not Supported;
- Reconfiguration CFN not Elapsed;
- Number of DL Codes not Supported;
- Number of UL codes not Supported;
- [FDD – DPC mode change not Supported];
- Cell reserved for operator use.

Transport Layer Causes:

- Transport Resource Unavailable.

Miscellaneous Causes:

- Control Processing Overload;
- HW Failure;
- Not enough User Plane Processing Resources.

8.3.2.4 Abnormal Conditions

If the RADIO LINK ADDITION REQUEST message includes a *C-ID* IE corresponding to a cell reserved for operator use and the Permanent NAS UE Identity is not available in the DRNC for the considered UE Context, the DRNC shall reject the procedure for this particular Radio Link and send the RADIO LINK ADDITION FAILURE message.

[FDD – If the RADIO LINK ADDITION REQUEST message includes the *Transmission Gap Pattern Sequence Status* IEs in the *Active Pattern Sequence Information* IE and it does not address exactly all ongoing compressed mode patterns the DRNS shall reject the Radio Link Addition procedure and shall respond with a RADIO LINK ADDITION FAILURE message with the *Cause* IE value "Invalid CM settings".]

[FDD - If the RADIO LINK ADDITION REQUEST message is used to establish a new RL without compressed mode when compressed mode is active for the existing RL(s) (as specified in subclause 8.3.2.2), and if at least one of the new RLs is to be established in a cell that has the same UARFCN (both UL and DL) as at least one cell with an already existing RL, the DRNS shall reject the Radio Link Addition procedure and shall respond with a RADIO LINK ADDITION FAILURE message with the cause value "Invalid CM settings".]

8.3.3 Radio Link Deletion

8.3.3.1 General

The Radio Link Deletion procedure is used to release the resources in a DRNS for one or more established radio links towards a UE.

This procedure shall use the signalling bearer connection for the relevant UE Context.

The Radio Link Deletion procedure may be initiated by the SRNC at any time after establishing a Radio Link.

8.3.3.2 Successful Operation

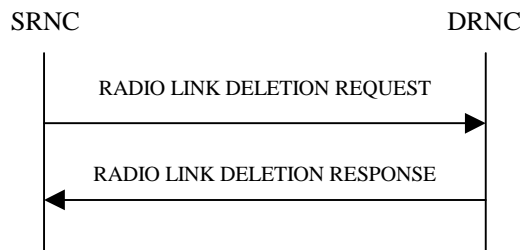

Figure 9: Radio Link Deletion procedure, Successful Operation

The procedure is initiated with a RADIO LINK DELETION REQUEST message sent from the SRNC to the DRNC.

Upon receipt of this message, the DRNS shall delete the radio link(s) identified by the *RL ID* IE(s) in the message, shall release all associated resources and shall respond to the SRNC with a RADIO LINK DELETION RESPONSE message.

If the radio link(s) to be deleted represent the last radio link(s) for the UE in the DRNS and if the UE is not using any common resources in the DRNS, then the DRNC shall release the UE Context.

[FDD – After deletion of the RL(s), the UL out-of-sync algorithm defined in ref. [10] shall for each of the remaining RL Set(s) use the maximum value of the parameters *N_OUTSYNC_IND* and *T_RLFAILURE* that are configured in the cells supporting the radio links of the RL Set. The UL in-sync algorithm defined in ref. [10] shall for each of the remaining RL Set(s) use the minimum value of the parameters *N_INSYNC_IND* that are configured in the cells supporting the radio links of the RL Set].

8.3.3.3 Unsuccessful Operation

-

8.3.3.4 Abnormal Conditions

If the RL indicated by the *RL ID* IE does not exist, the DRNC shall respond with the RADIO LINK DELETION RESPONSE message.

8.3.4 Synchronised Radio Link Reconfiguration Preparation

8.3.4.1 General

The Synchronised Radio Link Reconfiguration Preparation procedure is used to prepare a new configuration of Radio Link(s) related to one UE-UTRAN connection within a DRNS.

This procedure shall use the signalling bearer connection for the relevant UE Context.

The Synchronised Radio Link Reconfiguration Preparation procedure shall not be initiated if a Prepared Reconfiguration exists, as defined in subclause 3.1.

8.3.4.2 Successful Operation

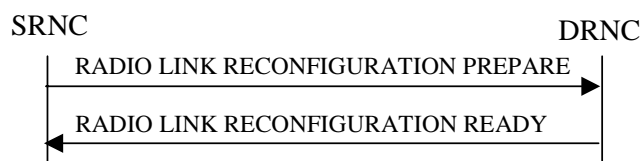

Figure 10: Synchronised Radio Link Reconfiguration Preparation procedure, Successful Operation

The Synchronised Radio Link Reconfiguration Preparation procedure is initiated by the SRNC by sending the RADIO LINK RECONFIGURATION PREPARE message to the DRNC.

Upon receipt, the DRNS shall reserve necessary resources for the new configuration of the Radio Link(s) according to the parameters given in the message. Unless specified below, the meaning of parameters is specified in other specifications.

If the RADIO LINK RECONFIGURATION PREPARE message includes the *Allowed Queuing Time* IE the DRNS may queue the request the time corresponding to the value of the *Allowed Queuing Time* IE before starting to execute the request.

The DRNS shall prioritise resource allocation for the RL(s) to be modified according to Annex A.

DCH Modification:

If the RADIO LINK RECONFIGURATION PREPARE message includes any *DCHs To Modify* IEs then the DRNS shall treat them each as follows:

- If the *DCHs To Modify* IE includes multiple *DCH Specific Info* IEs, the DRNS shall treat the DCHs in the *DCHs To Modify* IE as a set of co-ordinated DCHs. The DRNS shall include these DCHs in the new configuration only if it can include all of them in the new configuration.
- If the *DCHs To Modify* IE includes the *UL FP Mode* IE for a DCH or a set of co-ordinated DCHs to be modified, the DRNS shall apply the new FP Mode in the Uplink of the user plane for the DCH or the set of co-ordinated DCHs in the new configuration.
- If the *DCHs To Modify* IE includes the *ToAWS* IE for a DCH or a set of co-ordinated DCHs to be modified, the DRNS shall apply the new ToAWS in the user plane for the DCH or the set of co-ordinated DCHs in the new configuration.
- If the *DCHs To Modify* IE includes the *ToAWE* IE for a DCH or a set of co-ordinated DCHs to be modified, the DRNS shall apply the new ToAWE in the user plane for the DCH or the set of co-ordinated DCHs in the new configuration.
- If the *DCHs To Modify* IE contains a *DCH Specific Info* IE which includes the *Frame Handling Priority* IE for a DCH, the DRNS should store this information for this DCH in the new configuration. The received Frame Handling Priority should be used when prioritising between different frames in the downlink on the radio interface in congestion situations within the DRNS once the new configuration has been activated.
- If the *DCHs To Modify* IE contains a *DCH Specific Info* IE which includes the *Transport Format Set* IE for the UL of a DCH, the DRNS shall apply the new Transport Format Set in the Uplink of this DCH in the new configuration.
- If the *DCHs To Modify* IE contains a *DCH Specific Info* IE which includes the *Transport Format Set* IE for the DL of a DCH, the DRNS shall apply the new Transport Format Set in the Downlink of this DCH in the new configuration.
- If the *DCHs To Modify* IE contains a *DCH Specific Info* IE which includes the *Allocation/Retention Priority* IE, the DRNS shall apply the new Allocation/Retention Priority to this DCH in the new configuration according to Annex A.
- [FDD – If the *DCHs To Modify* IE contains a *DRAC Control* IE set to "requested" and if the DRNS supports the DRAC, the DRNS shall include in the RADIO LINK RECONFIGURATION READY message the *Secondary CCPCH Info* IE for the FACH in which the DRAC information is sent, for each Radio Link established in a cell in which DRAC is active. If the DRNS does not support DRAC, DRNS shall not provide these IEs in the RADIO LINK RECONFIGURATION READY message.]
- [TDD - If the *DCHs to Modify* IE includes the *CCTrCH ID* IE for the UL, the DRNS shall map the DCH onto the referenced UL CCTrCH in the new configuration.]
- [TDD - If the *DCHs to Modify* IE includes the *CCTrCH ID* IE for the DL, the DRNS shall map the DCH onto the referenced DL CCTrCH in the new configuration.]
- If the *DCHs to Modify* IE contains a *DCH Specific Info* IE which includes the *Guaranteed Rate Information* IE, the DRNS shall treat the included IEs according to the following:
 - If the *Guaranteed Rate Information* IE includes the *Guaranteed UL Rate* IE, the DRNS shall apply the new Guaranteed Rate in the uplink of this DCH in the new configuration. The DRNS may decide to request the

SRNC to limit the user rate in the uplink of the DCH at any point in time after activating the new configuration. The DRNS may request the SRNC to reduce the user rate of the uplink of the DCH below the guaranteed bit rate, however, whenever possible the DRNS should request the SRNC to reduce the user rate between the maximum bit rate and the guaranteed bit rate.

If the *Guaranteed Rate Information* IE includes the *Guaranteed DL Rate* IE, the DRNS shall apply the new Guaranteed Rate in the downlink of this DCH in the new configuration. The DRNS may decide to request the SRNC to limit the user rate in the downlink of the DCH at any point in time after activating the new configuration. The DRNS may request the SRNC to reduce the user rate of the downlink of the DCH below the guaranteed bit rate, however, whenever possible the DRNS should request the SRNC to reduce the user rate between the maximum bit rate and the guaranteed bit rate.

DCH Addition:

If the RADIO LINK RECONFIGURATION PREPARE message includes any *DCHs To Add* IE, the DRNS shall treat them each as follows:

- The DRNS shall reserve necessary resources for the new configuration of the Radio Link(s) according to the parameters given in the message and include these DCH in the new configuration.
- If the *DCHs To Add* IE includes a *DCH Information* IE with multiple *DCH Specific Info* IEs, the DRNS shall treat the DCHs in the *DCHs To Add* IE as a set of co-ordinated DCHs. The DRNS shall include these DCHs in the new configuration only if it can include all of them in the new configuration.
- [FDD - For each DCH which does not belong to a set of co-ordinated DCHs and which includes a *QE-Selector* IE set to "selected", the DRNS shall use the Transport channel BER from that DCH for the QE in the UL data frames. If no Transport channel BER is available for the selected DCH, the DRNS shall use the Physical channel BER for the QE, ref. [4]. If the *QE-Selector* IE is set to "non-selected", the DRNS shall use the Physical channel BER for the QE in the UL data frames, ref. [4].]
- For a set of co-ordinated DCHs, the DRNS shall use the Transport channel BER from the DCH with the *QE-Selector* IE set to "selected" for the QE in the UL data frames, ref. [4]. [FDD - If no Transport channel BER is available for the selected DCH, the DRNS shall use the Physical channel BER for the QE, ref. [4]. If all DCHs have the *QE-Selector* IE set to "non-selected", the DRNS shall use the Physical channel BER for the QE, ref. [4]. [TDD - If no Transport channel BER is available for the selected DCH, the DRNS shall use 0 for the QE, ref. [4].]
- The DRNS should store the *Frame Handling Priority* IE received for a DCH to be added in the new configuration. The received Frame Handling Priority should be used when prioritising between different frames in the downlink on the Uu interface in congestion situations within the DRNS once the new configuration has been activated.
- The DRNS shall use the included *UL FP Mode* IE for a DCH or a set of co-ordinated DCHs to be added as the new FP Mode in the Uplink of the user plane for the DCH or the set of co-ordinated DCHs in the new configuration.
- The DRNS shall use the included *ToAWS* IE for a DCH or a set of co-ordinated DCHs to be added as the new Time of Arrival Window Start Point in the user plane for the DCH or the set of co-ordinated DCHs in the new configuration.
- The DRNS shall use the included *ToAWE* IE for a DCH or a set of co-ordinated DCHs to be added as the new Time of Arrival Window End Point in the user plane for the DCH or the set of co-ordinated DCHs in the new configuration.
- [TDD - The DRNC shall include the *Secondary CCPCH Info TDD* IE in the RADIO LINK RECONFIGURATION READY message if at least one DSCH or USCH exists in the new configuration.]
- [FDD - If the *DRAC Control* IE is set to "requested" in the *DCH Specific Info* IE for at least one DCH and if the DRNS supports the DRAC, the DRNC shall indicate in the RADIO LINK RECONFIGURATION READY message the *Secondary CCPCH Info* IE for the FACH in which the DRAC information is sent, for each radio link supported by a cell in which DRAC is active. If the DRNS does not support DRAC, the DRNC shall not provide these IEs in the RADIO LINK RECONFIGURATION READY message.]
- If the *DCHs to Add* IE contains a *DCH Specific Info* IE which includes the *Guaranteed Rate Information* IE, the DRNS shall treat the included IEs according to the following:

- If the *Guaranteed Rate Information* IE includes the *Guaranteed UL Rate* IE, the DRNS shall apply the new Guaranteed Rate in the uplink of this DCH in the new configuration. The DRNS may decide to request the SRNC to limit the user rate of the uplink of the DCH at any point in time after activating the new configuration. The DRNS may request the SRNC to reduce the user rate of the uplink of the DCH below the guaranteed bit rate, however, whenever possible the DRNS should request the SRNC to reduce the user rate between the maximum bit rate and the guaranteed bit rate. If the *DCH Specific Info* IE in the *DCHs to Add* IE does not include the *Guaranteed UL Rate* IE, the DRNS shall not limit the user rate of the uplink of the DCH.
- If the *Guaranteed Rate Information* IE includes the *Guaranteed DL Rate* IE, the DRNS shall apply the new Guaranteed Rate in the downlink of this DCH in the new configuration. The DRNS may decide to request the SRNC to limit the user rate of the downlink of the DCH at any point in time after activating the new configuration. The DRNS may request the SRNC to reduce the user rate of the downlink of the DCH below the guaranteed bit rate, however, whenever possible the DRNS should request the SRNC to reduce the user rate between the maximum bit rate and the guaranteed bit rate. If the *DCH Specific Info* IE in the *DCHs to Add* IE does not include the *Guaranteed DL Rate* IE, the DRNS shall not limit the user rate of the downlink of the DCH.
- [TDD – The DRNS shall apply the *CCTrCH ID* IE (for the DL) in the Downlink of this DCH in the new configuration.]
- [TDD – The DRNS shall apply the *CCTrCH ID* IE (for the UL) in the Uplink of this DCH in the new configuration configuration.]
- **DCH Deletion:**

If the RADIO LINK RECONFIGURATION PREPARE message includes any *DCH To Delete* IEs, the DRNS shall not include the referenced DCHs in the new configuration.

If all of the DCHs belonging to a set of co-ordinated DCHs are requested to be deleted, the DRNS shall not include this set of co-ordinated DCHs in the new configuration.

Physical Channel Modification:

[FDD - If the RADIO LINK RECONFIGURATION PREPARE message includes an *UL DPCH Information* IE, the DRNS shall apply the parameters to the new configuration as follows:]

- [FDD - If the *UL DPCH Information* IE includes the *Uplink Scrambling Code* IE, the DRNS shall apply this Uplink Scrambling Code to the new configuration.]
- [FDD - If the *UL DPCH Information* IE includes the *Min UL Channelisation Code Length* IE, the DRNS shall apply the new Min UL Channelisation Code Length in the new configuration. The DRNS shall apply the contents of the *Max Number of UL DPDCHs* IE (if it is included) in the new configuration.]
- [FDD - If the *UL DPCH Information* IE includes the *TFCS* IE, the DRNS shall use the *TFCS* IE for the UL when reserving resources for the uplink of the new configuration. The DRNS shall apply the new *TFCS* in the uplink of the new configuration.]
- [FDD - If the *UL DPCH Information* IE includes the *UL DPCCCH Slot Format* IE, the DRNS shall apply the new Uplink *DPCCCH Slot Format* to the new configuration.]
- [FDD – If the *UL DPCH Information* IE includes the *UL SIR Target* IE, the DRNS shall use the value for the UL inner loop power control when the new configuration is being used.]
- [FDD – If the *UL DPCH Information* IE includes the *Puncture Limit* IE, the DRNS shall apply the value in the uplink of the new configuration.]
- [FDD - If the *UL DPCH Information* IE includes the *Diversity Mode* IE, the DRNS shall apply diversity according to the given value.]
- [FDD – If the *UL DPCH Information* IE includes an *SSDT Cell Identity Length* IE and/or an *S-Field Length* IE, the DRNS shall apply the values in the new configuration.]

[FDD - If the RADIO LINK RECONFIGURATION PREPARE message includes a *DL DPCH Information* IE, the DRNS shall apply the parameters to the new configuration as follows:]

- [FDD - If the *DL DPCH Information IE* includes the *Number of DL Channelisation Codes IE*, the DRNS shall allocate given number of Downlink Channelisation Codes per Radio Link and apply the new Downlink Channelisation Code(s) to the new configuration. Each Downlink Channelisation Code allocated for the new configuration shall be included in the RADIO LINK RECONFIGURATION READY message within the *DL Code Information IE* as a *FDD DL Channelisation Code Number IE* when sent to the SRNC. If some Transmission Gap Pattern sequences using 'SF/2' method are already initialised in the DRNS, DRNC shall include the *Transmission Gap Pattern Sequence Scrambling Code Information IE* in the RADIO LINK RECONFIGURATION READY message in case the DRNS selects to change the Scrambling code change method for one or more DL Channelisation Code.]
- [FDD – When more than one DL DPDCH are assigned per RL, the segmented physical channel shall be mapped on to DL DPDCHs according to [8]. When p number of DL DPDCHs are assigned to each RL, the first pair of DL Scrambling Code and FDD DL Channelisation Code Number corresponds to "*PhCH number 1*", the second to "*PhCH number 2*", and so on until the p th to "*PhCH number p*".]
- [FDD - If the *DL DPCH Information IE* includes the *TFCS IE*, the DRNS shall use the *TFCS IE* for the DL when reserving resources for the downlink of the new configuration. The DRNS shall apply the new TFCS in the Downlink of the new configuration.]
- [FDD – If the *DL DPCH Information IE* includes the *DL DPCH Slot Format IE*, the DRNS shall apply the new slot format used in DPCH in DL.]
- [FDD – If the *DL DPCH Information IE* includes the *TFCI Signalling Mode IE*, the DRNS shall apply the new signalling mode of the TFCI.]
- [FDD – If the *DL DPCH Information IE* includes the *Multiplexing Position IE*, the DRNS shall apply the new parameter to define whether fixed or flexible positions of transport channels shall be used in the physical channel.]
- [FDD – If the *DL DPCH Information IE* includes the *Limited Power Increase IE* set to "Used", the DRNS shall, if supported, use Limited Power Increase according to ref. [10] subclause 5.2.1 for the inner loop DL power control in the new configuration.]
- [FDD – If the *DL DPCH Information IE* includes the *Limited Power Increase IE* set to "Not Used", the DRNS shall not use Limited Power Increase for the inner loop DL power control in the new configuration.]

[FDD – If the RADIO LINK RECONFIGURATION PREPARE message includes the *Transmission Gap Pattern Sequence Information IE*, the DRNS shall store the new information about the Transmission Gap Pattern Sequences to be used in the new Compressed Mode Configuration. This new Compressed Mode Configuration shall be valid in the DRNS until the next Compressed Mode Configuration is configured in the DRNS or until the last Radio Link is deleted.]

[FDD – If the RADIO LINK RECONFIGURATION PREPARE message includes the *Transmission Gap Pattern Sequence Information IE* and the *Downlink Compressed Mode Method IE* in one or more Transmission Gap Pattern Sequence within the *Transmission Gap Pattern Sequence Information IE* is set to 'SF/2', the DRNC shall include the *Transmission Gap Pattern Sequence Scrambling Code Information IE* in the RADIO LINK RECONFIGURATION READY message indicating for each Channelisation Code whether the alternative scrambling code shall be used or not].

[TDD - UL/DL CCTrCH Modification]

[TDD - If the RADIO LINK RECONFIGURATION PREPARE message includes any *UL CCTrCH To Modify IEs* or *DL CCTrCH To Modify IEs*, then the DRNS shall treat them each as follows:]

- [TDD - If any of the *UL CCTrCH To Modify IEs* or *DL CCTrCH To Modify IEs* includes any of the *TFCS IE*, *TFCI coding IE*, *Puncture limit IE*, or *TPC CCTrCH ID IEs*, the DRNS shall apply these as the new values, otherwise the previous values specified for this CCTrCH are still applicable.]
- [TDD – If any of the following listed DPCH information IEs are modified in the new prepared configuration, the DRNC shall include in the RADIO LINK RECONFIGURATION READY message the IEs indicating the new values: *Repetition Period IE*, *Repetition Length IE*, *TDD DPCH Offset IE*, [3.84Mcps TDD - *UL Timeslot Information IE*,] [1.28Mcps TDD - *UL Timeslot Information LCR IE*,] [3.84Mcps TDD - *DL Timeslot Information IE*,] [1.28Mcps TDD - *DL Timeslot Information LCR IE*,] [3.84Mcps TDD - *Midamble Shift And Burst Type IE*,] [1.28Mcps TDD - *Midamble Shift LCR IE*,] *TFCI Presence IE* [3.84Mcps TDD - , *TDD*

Channelisation Code IE] [1.28Mcps TDD - and/or *TDD Channelisation Code LCR IE*] [1.28Mcps TDD - *TDD UL DPCH Time Slot Format LCR IE* or *TDD DL DPCH Time Slot Format LCR IE*.]

- [1.28Mcps TDD – If the *UL CCTrCH To Modify IE* includes the *UL SIR Target IE*, the DRNS shall use the value for the UL inner loop power control according [12] and [22] in the new configuration.]
- [TDD - If any of the *DL CCTrCH To Modify IEs* includes any *TPC CCTrCH ID IEs*, the DRNS shall apply these as the new values, otherwise the previous values specified for this CCTrCH are still applicable.]
- [1.28Mcps TDD - If the *UL CCTrCH to Modify IE* includes the *TDD TPC Uplink Step Size IE*, the DRNS shall apply this value to the uplink TPC step size in the new configuration.]
- [TDD - If the *DL CCTrCH to Modify IE* includes the *TDD TPC Downlink Step Size IE*, the DRNS shall apply this value to the downlink TPC step size in the new configuration.]

[TDD – UL/DL CCTrCH Addition]

[TDD – If the RADIO LINK RECONFIGURATION PREPARE message includes any *UL CCTrCH To Add IEs* or *DL CCTrCH To Add IEs*, the DRNS shall include this CCTrCH in the new configuration.]

[TDD – If the RADIO LINK RECONFIGURATION PREPARE message includes any *DCHs to Add IEs*, the DRNC shall include in the RADIO LINK RECONFIGURATION READY message the DPCH information in [3.84Mcps TDD - *UL/DL DPCH to be Added IEs*] [1.28Mcps TDD - *UL/DL DPCH to be Added LCR IEs*]. [3.84Mcps TDD - If no UL DPCH is active before a reconfiguration which adds an UL DPCH, and if a valid Rx Timing Deviation measurement is known in DRNC, then the DRNC shall include the *Rx Timing Deviation IE* in the RADIO LINK RECONFIGURATION READY message.]]

[TDD – If the RADIO LINK RECONFIGURATION PREPARE message includes the *TDD TPC Downlink Step Size IE* within a *DL CCTrCH To Add IE*, the DRNS shall set the TPC step size of that CCTrCH to that value, otherwise the DRNS shall use the same value as the lowest numbered DL CCTrCH in the current configuration.]

[1.28Mcps TDD – The DRNS shall use the *UL SIR Target IE* in the *UL CCTrCH To Add IE* as the UL SIR value for the inner loop power control for this CCTrCH according [12] and [22] in the new configuration.]

[TDD – If any of the *DL CCTrCH To Add IEs* includes any *TPC CCTrCH ID IEs*, the DRNS shall configure the identified UL CCTrCHs with TPC according to the parameters given in the message.]

[1.28Mcps TDD - If the *UL CCTrCH To Add IE* includes the *TDD TPC Uplink Step Size IE*, the DRNS shall apply the uplink TPC step size in the new configuration.]

[TDD – UL/DL CCTrCH Deletion]

[TDD - If the RADIO LINK RECONFIGURATION PREPARE message includes any *UL CCTrCH To Delete IEs* or *DL CCTrCH To Delete IEs*, the DRNS shall remove this CCTrCH in the new configuration, and the DRNC shall include in the RADIO LINK RECONFIGURATION READY message corresponding *UL DPCH to be Deleted IEs* and *DL DPCH to be Deleted IEs*.]

SSDT Activation/Deactivation:

- [FDD - If the *RL Information IE* includes the *SSDT Indication IE* set to "SSDT Active in the UE", then in the new configuration the DRNS shall activate SSDT, if supported, using the *SSDT Cell Identity IE* in *RL Information IE*, and the *SSDT Cell Identity Length IE* in *UL DPCH Information IE*.
- [FDD - If the *RL Information IE* includes the *SSDT Indication IE* set to "SSDT not Active in the UE", the DRNS shall deactivate SSDT in the new configuration.]

DSCH Addition/Modification/Deletion:

If the RADIO LINK RECONFIGURATION PREPARE message includes any *DSCH To Add*, *DSCH To Modify* or *DSCH To Delete IEs*, then the DRNS shall use this information to add/modify/delete the indicated DSCH channels to/from the radio link, in the same way as the DCH info is used to add/modify/release DCHs.

If the RADIO LINK RECONFIGURATION PREPARE message includes any *DSCH To Add IE*, then the DRNS shall use the *Allocation/Retention Priority IE*, *Scheduling Priority Indicator IE* and *TrCH Source Statistics Descriptor IE* to define a set of DSCH Priority classes, each of which is associated with a set of supported MAC-c/sh SDU lengths.

The DRNC shall include in the RADIO LINK RECONFIGURATION READY message both the *Transport Layer Address IE* and the *Binding ID IE* for the transport bearer to be established for each added DSCH.

[FDD - If the *DSCHs To Add IE* includes the *Enhanced DSCH PC IE*, the DRNS shall activate enhanced DSCH power control in accordance with ref. [10] subclause 5.2.2, if supported, using either:]

- [FDD - the *SSDT Cell Identity for EDSCHPC IE* in the *RL Information IE*, if the *SSDT Cell Identity IE* is not included in the *RL Information IE* or]
- [FDD - the *SSDT Cell Identity IE* in the *RL Information IE*, if both the *SSDT Cell Identity IE* and the *SSDT Cell Identity for EDSCHPC* are included in the *RL Information IE*,]

[FDD - together with the *SSDT Cell Identity Length IE* in *UL DPCH Information IE*, and *Enhanced DSCH PC IE*, in the new configuration.]

If the RADIO LINK RECONFIGURATION PREPARE message includes any *DSCH To Modify IE*, then the DRNS shall treat them each as follows:

- The DRNC shall include in the RADIO LINK RECONFIGURATION READY message both the *Transport Layer Address IE* and the *Binding ID IE* for any new transport bearer to be established for each modified DSCH.
- [FDD – If the *DSCH To Modify IE* includes any *DSCH Info IEs*, then the DRNS shall treat them each as follows:]
 - [FDD – If the *DSCH Info IE* includes any of the *Allocation/Retention Priority IE*, *Scheduling Priority Indicator IE* or *TrCH Source Statistics Descriptor IE*, the DRNS shall use them to update the set of DSCH Priority classes each of which is associated with a set of supported MAC-c/sh SDU lengths.]
 - [FDD – If the *DSCH Info IE* includes any of the *Transport Format Set IE* or *BLER IE*, the DRNS shall apply the parameters to the new configuration.]
- [FDD – If the *DSCH To Modify IE* includes the *PDSCH RL ID IE*, then the DRNS shall use it as the new DSCH RL identifier.]
 - [FDD - If the indicated PDSCH RL ID is in the DRNS and there was no DSCH-RNTI allocated to the UE Context, the DRNC shall allocate a DSCH-RNTI to the UE Context and include the *DSCH-RNTI IE* in the RADIO LINK RECONFIGURATION READY message.]
 - [FDD - If the indicated PDSCH RL ID is in the DRNS and there was a DSCH-RNTI allocated to the UE Context, the DRNC shall allocate a new DSCH-RNTI to the UE Context, release the old DSCH-RNTI and include the *DSCH-RNTI IE* in the RADIO LINK RECONFIGURATION READY message.]
 - [FDD - If the indicated PDSCH RL ID is not in the DRNS and there was a DSCH-RNTI allocated to the UE Context, the DRNC shall release this DSCH-RNTI.]
- [FDD – If the *DSCH To Modify IE* includes the *Transport Format Combination Set IE*, then the DRNS shall use it as the new Transport Format Combination Set associated with the DSCH.]
- [TDD – If the *DSCHs To Modify IE* includes the *CCTrCH ID IE*, then the DRNS shall map the DSCH onto the referenced DL CCTrCH.]
- [TDD – If the *DSCHs To Modify IE* includes any of the *Allocation/Retention Priority IE*, *Scheduling Priority Indicator IE* or *TrCH Source Statistics Descriptor IE*, the DRNS shall use them to update the set of DSCH Priority classes each of which is associated with a set of supported MAC-c/sh SDU lengths.]
- [TDD – If the *DSCHs To Modify IE* includes any of the *Transport Format Set IE* or *BLER IE*, the DRNS shall apply the parameters to the new configuration.]
- - [FDD - If the *DSCHs To Modify IE* includes the *Enhanced DSCH PC Indicator IE* set to "Enhanced DSCH PC Active in the UE ", the DRNS shall activate enhanced DSCH power control in accordance with ref. [10] subclause 5.2.2, if supported, using either:]
- [FDD - the *SSDT Cell Identity for EDSCHPC IE* in *RL Information IE*, if the *SSDT Cell Identity IE* is not included in the *RL Information IE* or]

- [FDD - the *SSDT Cell Identity* IE in the *RL Information* IE, if both the *SSDT Cell Identity* IE and the *SSDT Cell Identity for EDSCHPC* are included in the *RL Information* IE,]

[FDD - together with the *SSDT Cell Identity Length* IE in *UL DPCH Information* IE, and *Enhanced DSCH PC* IE, in the new configuration.]

- [FDD - If the *DSCHs To Modify* IE includes the *Enhanced DSCH PC Indicator* IE set to "Enhanced DSCH PC not Active in the UE", the DRNS shall deactivate enhanced DSCH power control in the new configuration.]

[FDD – If the RADIO LINK RECONFIGURATION PREPARE message includes a *DSCHs To Delete* IE requesting the deletion of all DSCH resources for the UE Context, then the DRNC shall release the DSCH-RNTI allocated to the UE Context, if there was one.]

[3.84 Mcps TDD – The DRNC shall include the *Secondary CCPCH Info TDD* IE in the RADIO LINK RECONFIGURATION READY message if a DSCH is added and at least one DCH exists in the new configuration. The DRNC shall also include the *Secondary CCPCH Info TDD* IE in the RADIO LINK RECONFIGURATION READY message if the SHCCH messages for this radio link will be transmitted over a different secondary CCPCH than selected by the UE from system information.]

[FDD - If the RADIO LINK RECONFIGURATION PREPARE message includes the *Enhanced DSCH PC Indicator* IE set to "Enhanced DSCH PC not Active in the UE", the DRNS shall deactivate enhanced DSCH power control in the new configuration.]

If the requested modifications are allowed by the DRNS and the DRNS has successfully reserved the required resources for the new configuration of the Radio Link(s), it shall respond to the SRNC with the RADIO LINK RECONFIGURATION READY message.

[TDD - USCH Addition/Modification/Deletion]

[TDD - If the RADIO LINK RECONFIGURATION PREPARE message includes any *USCH to modify*, *USCH to add* or *USCH To Delete* IEs, then the DRNS shall use this information to add/modify/delete the indicated USCH channels to/from the radio link, in the same way as the DCH info is used to add/modify/release DCHs.]

[TDD - If the RADIO LINK RECONFIGURATION PREPARE message includes any *USCH To Add* IE, then, the DRNS shall use the *Allocation/Retention Priority* IE, *Scheduling Priority Indicator* IE and *TrCH Source Statistics Descriptor* IE to define a set of USCH Priority classes each of which is associated with a set of supported MAC-c/sh SDU lengths.]

[TDD - The DRNC shall include in the RADIO LINK RECONFIGURATION READY message both the *Transport Layer Address* IE and the *Binding ID* IE for the transport bearer to be established for each added USCH.]

[TDD - If the RADIO LINK RECONFIGURATION PREPARE message includes any *USCH To Modify* IE, then the DRNS shall treat them each as follows:]

- [TDD - If the *USCH To Modify* IE includes any of the *Allocation/Retention Priority* IE, *Scheduling Priority Indicator* IE or *TrCH Source Statistics Descriptor* IE, the DRNS shall use them to update the set of USCH Priority classes.]
- [TDD - If the *USCH To Modify* IE includes any of the *CCTrCH ID* IE, *Transport Format Set* IE, *BLER* IE or *RB Info* IE, the DRNS shall apply the parameters to the new configuration.]
- [TDD - The DRNC shall include the *Secondary CCPCH Info TDD* IE in the RADIO LINK RECONFIGURATION READY message if a USCH is added and at least one DCH exists in the new configuration. The DRNC shall also include the *Secondary CCPCH Info TDD* IE in the RADIO LINK RECONFIGURATION READY message if the SHCCH messages for this radio link will be transmitted over a different secondary CCPCH than selected by the UE from system information.]
- [TDD - The DRNC shall include in the RADIO LINK RECONFIGURATION READY message both the *Transport Layer Address* IE and the *Binding ID* IE for any new transport bearer to be established for each modified USCH.]

[1.28Mcps TDD – Uplink Synchronisation Parameters LCR]:

[1.28Mcps TDD - If the *Uplink Synchronisation Parameters LCR* IE is present, the DRNC shall use the indicated values of *Uplink synchronisation stepsize* IE and *Uplink synchronisation frequency* IE when evaluating the timing of the UL synchronisation.]

[1.28Mcps TDD - Uplink Timing Advance Control LCR]:

[1.28Mcps TDD - The DRNC shall include the *Uplink Timing Advance Control LCR* IE in the RADIO LINK RECONFIGURATION READY message, if the Uplink Timing Advance Control parameters have been changed.]

[TDD] DSCH RNTI Addition/Deletion

[TDD - If the RADIO LINK RECONFIGURATION PREPARE message includes the *PDSCH RL ID* IE, then the DRNS shall use it as the new RL identifier for PDSCH and PUSCH..]

- [TDD - If the indicated PDSCH RL ID is in the DRNS and there was no DSCH-RNTI allocated to the UE Context, the DRNC shall allocate a DSCH-RNTI to the UE Context and include the *DSCH-RNTI* IE in the RADIO LINK RECONFIGURATION READY message.]
- [TDD - If the indicated PDSCH RL ID is in the DRNS and there was a DSCH-RNTI allocated to the UE Context, the DRNC shall allocate a new DSCH-RNTI to the UE Context, release the old DSCH-RNTI and include the *DSCH-RNTI* IE in the RADIO LINK RECONFIGURATION READY message.]
- [TDD - If the indicated PDSCH RL ID is not in the DRNS and there was a DSCH-RNTI allocated to the UE Context, the DRNC shall release this DSCH-RNTI.]

[TDD – If the RADIO LINK RECONFIGURATION PREPARE message includes a *DSCHs to Delete* IE and/or a *USCHs to Delete* IE which results in the deletion of all DSCH and USCH resources for the UE Context, then the DRNC shall release the DSCH-RNTI allocated to the UE Context, if there was one.]

General

If the requested modifications are allowed by the DRNC and the DRNC has successfully reserved the required resources for the new configuration of the Radio Link(s), it shall respond to the SRNC with the RADIO LINK RECONFIGURATION READY message. When this procedure has been completed successfully there exists a Prepared Reconfiguration, as defined in subclause 3.1.

The DRNC shall include the *Transport Layer Address* IE and the *Binding ID* IE in the *DCH Information Response* IE for any Transport Channel being added, or any Transport Channel being modified for which a new transport bearer was requested with the *Transport Bearer Request Indicator* IE. In the case of a set of co-ordinated DCHs requiring a new transport bearer on the Iur interface, the *Transport Layer Address* IE and the *Binding ID* IE in the *DCH Information Response* IE shall be included for only one of the DCHs in the set of co-ordinated DCHs.

In the case of a Radio Link being combined with another Radio Link within the DRNS, the *Transport Layer Address* IE and the *Binding ID* IE in the *DCH Information Response* IE shall be included for only one of the combined Radio Links.

Any allowed rate for the uplink of a modified DCH provided for the old configuration will not be valid for the new configuration. If the DRNS needs to limit the user rate in the uplink of a DCH due to congestion caused by the UL UTRAN Dynamic Resources (see subclause 9.2.1.79) in the new configuration for a Radio Link, the DRNC shall include in the RADIO LINK RECONFIGURATION READY message the *Allowed UL Rate* IE in the *DCH Information Response* IE for this Radio Link.

Any allowed rate for the downlink of a modified DCH provided for the old configuration will not be valid for the new configuration. If the DRNS needs to limit the user rate in the downlink of a DCH due to congestion caused by the DL UTRAN Dynamic Resources (see subclause 9.2.1.79) in the new configuration for a Radio Link, the DRNC shall include in the RADIO LINK RECONFIGURATION READY message the *Allowed DL Rate* IE in the *DCH Information Response* IE for this Radio Link.

The DRNS decides the maximum and minimum SIR for the uplink of the Radio Link(s), and the DRNC shall include in the RADIO LINK RECONFIGURATION READY message the *Maximum Uplink SIR* IE and *Minimum Uplink SIR* IE for each Radio Link when these values are changed.

If the DL TX power upper or lower limit has been re-configured, the DRNC shall include in the RADIO LINK RECONFIGURATION RESPONSE message the *Maximum DL TX Power* IE and *Minimum DL TX Power* IE respectively. The DRNS shall not transmit with a higher power than indicated by the *Maximum DL TX Power* IE or

lower than indicated by the *Minimum DL TX Power IE* on any DL DPCH of the RL [FDD – except during compressed mode, when the δP_{curr} , as described in ref.[10] subclause 5.2.1.3, shall be added to the maximum DL power for the associated compressed frame.]

[TDD - If the *Primary CCPCH RSCP IE* and/or the [3.84Mcps TDD - *DL Time Slot ISCP Info IE*][1.28Mcps TDD - *DL Time Slot ISCP Info LCR IE*] are present, the DRNC should use the indicated values when deciding the Initial DL TX Power.]

8.3.4.3 Unsuccessful Operation

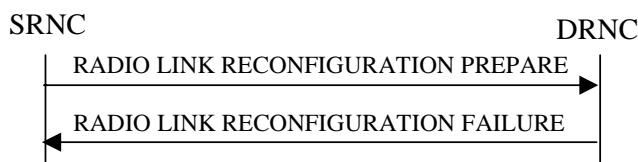

Figure 11: Synchronised Radio Link Reconfiguration Preparation procedure, Unsuccessful Operation

If the DRNS cannot reserve the necessary resources for all the new DCHs of a set of co-ordinated DCHs requested to be added, it shall reject the Synchronised Radio Link Reconfiguration Preparation procedure as having failed.

If the requested Synchronised Radio Link Reconfiguration Preparation procedure fails for one or more RLs, the DRNC shall send the RADIO LINK RECONFIGURATION FAILURE message to the SRNC, indicating the reason for failure for each failed radio link in a *Cause IE*.

Typical cause values are:

Radio Network Layer Causes:

- UL Scrambling Code Already in Use;
- DL Radio Resources not Available;
- UL Radio Resources not Available;
- Requested Configuration not Supported;
- Number of DL Codes not Supported;
- Number of UL Codes not Supported;
- Dedicated Transport Channel Type not Supported;
- DL Shared Channel Type not Supported;
- [TDD - UL Shared Channel Type not Supported];
- [FDD - UL Spreading Factor not Supported];
- [FDD - DL Spreading Factor not Supported];
- CM not Supported.

Miscellaneous Causes:

- Control Processing Overload;
- Not enough User Plane Processing Resources.

8.3.4.4 Abnormal Conditions

If only a subset of all the DCHs belonging to a set of co-ordinated DCHs is requested to be deleted, the DRNS shall reject the Synchronised Radio Link Reconfiguration Preparation procedure as having failed and shall send the RADIO LINK RECONFIGURATION FAILURE message to the SRNC.

If more than one DCH of a set of co-ordinated DCHs has the *QE-Selector* IE set to "selected" [TDD – or no DCH of a set of co-ordinated DCHs has the *QE-Selector* IE set to "selected"] the DRNS shall reject the Synchronised Radio Link Reconfiguration Preparation procedure and the DRNC shall respond with a RADIO LINK RECONFIGURATION FAILURE message.

[FDD - If the *RL Information* IE includes the *SSDT Indication* IE set to "SSDT Active in the UE" and SSDT is not active in the current configuration, the DRNS shall reject the Synchronised Radio Link Reconfiguration Preparation procedure if the *UL DPCH Information* IE does not include the *SSDT Cell Identity Length* IE. The DRNC shall then respond with a RADIO LINK RECONFIGURATION FAILURE message.]

[FDD - If the *DSCHs To Add* IE includes the *Enhanced DSCH PC* IE and the *DSCH To Modify* IE includes the *Enhanced DSCH PC Indicator* IE set to "Enhanced DSCH PC not Active in the UE", then the DRNS shall deactivate enhanced DSCH power control in the new configuration.]

[FDD - If both the *DSCHs To Add* IE and the *DSCH To Modify* IE include *Enhanced DSCH PC* IE, then the DRNS shall ignore the *Enhanced DSCH PC* IE in the *DSCH To Add* IE.]

If the RADIO LINK RECONFIGURATION PREPARE message includes a *DCHs To Modify* IE or *DCHs To Add* IE with multiple *DCH Specific Info* IEs, and if the DCHs in the *DCHs To Modify* IE or *DCHs To Add* IE do not have the same *Transmission Time Interval* IE in the *Semi-static Transport Format Information* IE, then the DRNC shall reject the procedure using the RADIO LINK RECONFIGURATION FAILURE message.

8.3.5 Synchronised Radio Link Reconfiguration Commit

8.3.5.1 General

This procedure is used to order the DRNS to switch to the new configuration for the Radio Link(s) within the DRNS, previously prepared by the Synchronised Radio Link Reconfiguration Preparation procedure.

This procedure shall use the signalling bearer connection for the relevant UE Context.

8.3.5.2 Successful Operation



Figure 12: Synchronised Radio Link Reconfiguration Commit procedure, Successful Operation

The DRNS shall switch to the new configuration previously prepared by the Synchronised Radio Link Reconfiguration Preparation procedure at the next coming CFN with a value equal to the value requested by the SRNC in the *CFN* IE when receiving the RADIO LINK RECONFIGURATION COMMIT message from the SRNC.

[FDD – If the *Active Pattern Sequence Information* IE is included in the RADIO LINK RECONFIGURATION COMMIT message, the *CM Configuration Change CFN* IE in the *Active Pattern Sequence Information* IE shall be ignored by the DRNS.]

When this procedure has been completed the Prepared Reconfiguration does not exist any more, see subclause 3.1

In the case of a transport channel modification for which a new transport bearer was requested and established, the switch to the new transport bearer shall also take place at the indicated CFN. The detailed frame protocol handling during transport bearer replacement is described in [4], subclause 5.10.1 and in [32], subclause 5.3.1..

[FDD - If the RADIO LINK RECONFIGURATION COMMIT includes the *Active Pattern Sequence Information* IE, the DRNS shall deactivate all the ongoing Transmission Gap Pattern Sequences at the *CFN* IE. From that moment on, all Transmission Gap Pattern Sequences included in *Transmission Gap Pattern Sequence Status* IE repetitions shall be started when the indicated *TGCFN* IE elapses. The *CFN* IE and *TGCFN* IE for each sequence refer to the next coming CFN with that value. If the values of the *CFN* IE and the *TGCFN* IE are equal, the concerned Transmission Gap Pattern Sequence shall be started immediately at the CFN with a value equal to the value received in the *CFN* IE.]

8.3.5.3 Abnormal Conditions

If a new transport bearer is required for the new configuration and it is not available at the requested CFN, the DRNS shall initiate the Radio Link Failure procedure.

8.3.6 Synchronised Radio Link Reconfiguration Cancellation

8.3.6.1 General

This procedure is used to order the DRNS to release the new configuration for the Radio Link(s) within the DRNS, previously prepared by the Synchronised Radio Link Reconfiguration Preparation procedure.

This procedure shall use the signalling bearer connection for the relevant UE Context.

8.3.6.2 Successful Operation



Figure 13: Synchronised Radio Link Reconfiguration Cancellation procedure, Successful Operation

Upon receipt of the RADIO LINK RECONFIGURATION CANCEL message from the SRNC, the DRNS shall release the new configuration ([FDD – including the new Transmission Gap Pattern Sequence parameters (if existing)]) previously prepared by the Synchronised RL Reconfiguration Preparation procedure and continue using the old configuration. When this procedure has been completed the Prepared Reconfiguration does not exist any more, see subclause 3.1.

8.3.6.3 Abnormal Conditions

-

8.3.7 Unsynchronised Radio Link Reconfiguration

8.3.7.1 General

The Unsynchronised Radio Link Reconfiguration procedure is used to reconfigure Radio Link(s) related to one UE-UTRAN connection within a DRNS.

The procedure is used when there is no need to synchronise the time of the switching from the old to the new radio link configuration in the cells used by the UE-UTRAN connection within the DRNS.

This procedure shall use the signalling bearer connection for the relevant UE Context.

The Unsynchronised Radio Link Reconfiguration procedure shall not be initiated if a Prepared Reconfiguration exists, as defined in subclause 3.1.

8.3.7.2 Successful Operation

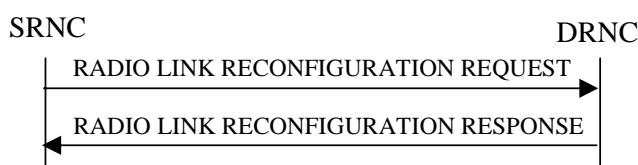

Figure 14: Unsynchronised Radio Link Reconfiguration procedure, Successful Operation

The Unsynchronised Radio Link Reconfiguration procedure is initiated by the SRNC by sending the RADIO LINK RECONFIGURATION REQUEST message to the DRNC.

Upon receipt, the DRNS shall modify the configuration of the Radio Link(s) according to the parameters given in the message. Unless specified below, the meaning of parameters is specified in other specifications.

If the RADIO LINK RECONFIGURATION REQUEST message includes the *Allowed Queuing Time* IE the DRNS may queue the request the time corresponding to the value of the *Allowed Queuing Time* IE before starting to execute the request.

The DRNS shall prioritise resource allocation for the RL to be modified according to Annex A.

DCH Modification:

If the RADIO LINK RECONFIGURATION REQUEST message includes any *DCHs To Modify* IEs, then the DRNS shall treat them as follows:

- If the *DCHs To Modify* IE includes multiple *DCH Specific Info* IEs, then the DRNS shall treat the DCHs as a set of co-ordinated DCHs. The DRNS shall include these DCHs in the new configuration only if it can include all of them in the new configuration.
- If the *DCHs To Modify* IE includes the *UL FP Mode* IE for a DCH or a set of co-ordinated DCHs to be modified, the DRNS shall apply the new FP Mode in the Uplink of the user plane for the DCH or the set of co-ordinated DCHs in the new configuration.
- If the *DCHs To Modify* IE includes the *ToAWS* IE for a DCH or a set of co-ordinated DCHs to be modified, the DRNS shall apply the new ToAWS in the user plane for the DCH or the set of co-ordinated DCHs in the new configuration.
- If the *DCHs To Modify* IE includes the *ToAWE* IE for a DCH or a set of co-ordinated DCHs to be modified, the DRNS shall apply the new ToAWE in the user plane for the DCH or the set of co-ordinated DCHs in the new configuration.
- If the *DCHs To Modify* IE contains a *DCH Specific Info* IE which includes a *Transport Format Set* IE for the UL of a DCH to be modified, the DRNS shall apply the new Transport Format Set in the Uplink of this DCH in the new configuration.
- If the *DCHs To Modify* IE contains a *DCH Specific Info* IE which includes a *Transport Format Set* IE for the DL of a DCH to be modified, the DRNS shall apply the new Transport Format Set in the Downlink of this DCH in the new configuration.
- If the *DCHs To Modify* IE contains a *DCH Specific Info* IE which includes the *Frame Handling Priority* IE, the DRNS should store this information for this DCH in the new configuration. The received Frame Handling Priority should be used when prioritising between different frames in the downlink on the radio interface in congestion situations within the DRNS once the new configuration has been activated.
- If the *DCHs To Modify* IE contains a *DCH Specific Info* IE which includes the *Allocation/Retention Priority* IE, the DRNS shall apply the new Allocation/Retention Priority to this DCH in the new configuration according to Annex A.
- [FDD - If the *DRAC Control* IE is present and set to "requested" in *DCHs to Modify* IE for at least one DCH, and if the DRNS supports the DRAC, the DRNC shall include in the RADIO LINK RECONFIGURATION RESPONSE message the *Secondary CCPCH Info* IE for the FACH in which the DRAC information is sent, for each Radio Link supported by a cell in which DRAC is active.]
- [TDD - If the *DCHs To Modify* IE contains a *DCH Specific Info* IE which includes the *CCTrCH ID* IE for the UL, the DRNS shall map the DCH onto the referenced UL CCTrCH in the new configuration.]
- [TDD - If the *DCHs To Modify* IE contains a *DCH Specific Info* IE which includes the *CCTrCH ID* IE for the DL, the DRNS shall map the DCH onto the referenced DL CCTrCH in the new configuration.]
- If the *DCHs To Modify* IE contains a *DCH Specific Info* IE which includes the *Guaranteed Rate Information* IE, the DRNS shall treat the included IEs according to the following:
 - If the *Guaranteed Rate Information* IE includes the *Guaranteed UL Rate* IE, the DRNS shall apply the new Guaranteed Rate in the uplink of this DCH in the new configuration. The DRNS may decide to request the

SRNC to limit the user rate in the uplink of the DCH at any point in time after activating the new configuration. The DRNS may request the SRNC to reduce the user rate of the uplink of the DCH below the guaranteed bit rate, however, whenever possible the DRNS should request the SRNC to reduce the user rate between the maximum bit rate and the guaranteed bit rate.

- If the *Guaranteed Rate Information* IE includes the *Guaranteed DL Rate* IE, the DRNS shall apply the new Guaranteed Rate in the downlink of this DCH in the new configuration. The DRNS may decide to request the SRNC to limit the user in the downlink of the DCH at any point in time after activating the new configuration. The DRNS may request the SRNC to reduce the user rate of the downlink of the DCH below the guaranteed bit rate, however, whenever possible the DRNS should request the SRNC to reduce the user rate between the maximum bit rate and the guaranteed bit rate.

DCH Addition:

If the RADIO LINK RECONFIGURATION REQUEST message includes any *DCHs To Add* IEs, then the DRNS shall treat them each as follows:

- The DRNS shall reserve necessary resources for the new configuration of the Radio Link(s) according to the parameters given in the message and include these DCH in the new configuration.
- If the *DCHs To Add* IE includes multiple DCH Specific Info IEs then the DRNS shall treat the DCHs in the *DCHs To Add* IE as a set of co-ordinated DCHs. The DRNS shall include these DCHs in the new configuration only if all of them can be in the new configuration.
- [FDD - For each DCH which does not belong to a set of co-ordinated DCHs, and which includes a *QE-Selector* IE set to "selected", the DRNS shall use the Transport channel BER from that DCH for the QE in the UL data frames. If no Transport channel BER is available for the selected DCH, the DRNS shall use the Physical channel BER for the QE, ref. [4]. If the *QE-Selector* IE is set to "non-selected", the DRNS shall use the Physical channel BER for the QE in the UL data frames, ref. [4].]
- For a set of co-ordinated DCHs, the DRNS shall use the Transport channel BER from the DCH with the *QE-Selector* IE set to "selected" for the QE in the UL data frames, ref. [4]. [FDD - If no Transport channel BER is available for the selected DCH, the DRNS shall use the Physical channel BER for the QE, ref. [4]. If all DCHs have the *QE-Selector* IE set to "non-selected", the DRNS shall use the Physical channel BER for the QE, ref. [4].] [TDD - If no Transport channel BER is available for the selected DCH, the DRNS shall use 0 for the QE, ref. [4].]
- The DRNS should store the *Frame Handling Priority* IE received for a DCH to be added in the new configuration. The received Frame Handling Priority should be used when prioritising between different frames in the downlink on the U_u interface in congestion situations within the DRNS once the new configuration has been activated.
- The DRNS shall use the included *UL FP Mode* IE for a DCH or a set of co-ordinated DCHs to be added as the new FP Mode in the Uplink of the user plane for the DCH or the set of co-ordinated DCHs in the new configuration.
- The DRNS shall use the included *ToAWS* IE for a DCH or a set of co-ordinated DCHs to be added as the new Time of Arrival Window Start Point in the user plane for the DCH or the set of co-ordinated DCHs in the new configuration.
- The DRNS shall use the included *ToAWE* IE for a DCH or a set of co-ordinated DCHs to be added as the new Time of Arrival Window End Point in the user plane for the DCH or the set of co-ordinated DCHs in the new configuration.
- [FDD - If the *DRAC Control* IE is set to "requested" in *DCH Specific Info* IE for at least one DCH, and if the DRNS supports the DRAC, the DRNS shall include in the RADIO LINK RECONFIGURATION RESPONSE message the *Secondary CCPCH Info* IE for the FACH in which the DRAC information is sent, for each Radio Link supported by a cell in which DRAC is active. If the DRNS does not support DRAC, the DRNS shall not provide these IEs in the RADIO LINK RECONFIGURATION RESPONSE message.
- If the *DCH Specific Info* IE includes the *Guaranteed Rate Information* IE, the DRNS shall treat the included IEs according to the following:
 - If the *Guaranteed Rate Information* IE includes the *Guaranteed UL Rate* IE, the DRNS shall apply the new Guaranteed Rate in the uplink of this DCH in the new configuration. The DRNS may decide to request the

SRNC to limit the user rate of the uplink of the DCH at any point in time after activating the new configuration. The DRNS may request the SRNC to reduce the user rate of the uplink of the DCH below the guaranteed bit rate, however, whenever possible the DRNS should request the SRNC to reduce the user rate between the maximum bit rate and the guaranteed bit rate. If the *DCH Specific Info* IE in the *DCH Information* IE does not include the *Guaranteed UL Rate* IE, the DRNS shall not limit the user rate of the uplink of the DCH.

- If the *Guaranteed Rate Information* IE includes the *Guaranteed DL Rate* IE, the DRNS shall apply the new Guaranteed Rate in the downlink of this DCH in the new configuration. The DRNS may decide to request the SRNC to limit the user rate of the downlink of the DCH at any point in time after activating the new configuration. The DRNS may request the SRNC to reduce the user rate of the downlink of the DCH below the guaranteed bit rate, however, whenever possible the DRNS should request the SRNC to reduce the user rate between the maximum bit rate and the guaranteed bit rate. If the *DCH Specific Info* IE in the *DCH Information* IE does not include the *Guaranteed DL Rate* IE, the DRNS shall not limit the user rate of the uplink of the DCH.

DCH Deletion:

If the RADIO LINK RECONFIGURATION REQUEST message includes any *DCHs To Delete* IEs, the DRNS shall not include the referenced DCHs in the new configuration.

If all of the DCHs belonging to a set of coordinated DCHs are requested to be deleted, the DRNS shall not include this set of co-ordinated DCHs in the new configuration.

[FDD - Physical Channel Modification]

[FDD - If the RADIO LINK RECONFIGURATION REQUEST message includes an *UL DPCH Information* IE, then the DRNS shall apply the parameters to the new configuration as follows:]

- [FDD - If the *UL DPCH Information* IE includes the *TFCS* IE for the UL, the DRNS shall apply the new TFCS in the Uplink of the new configuration.]

[FDD - If the RADIO LINK RECONFIGURATION REQUEST message includes a *DL DPCH Information* IE, then the DRNS shall apply the parameters to the new configuration as follows:]

- [FDD - If the *DL DPCH Information* IE includes the *TFCS* IE for the DL, the DRNS shall apply the new TFCS in the Downlink of the new configuration.]
- [FDD - If the *DL DPCH Information* IE includes the *TFCI Signalling Mode* IE for the DL, the DRNS shall apply the new TFCI Signalling Mode in the Downlink of the new configuration.]
- [FDD – If the *DL DPCH Information* IE includes the *Limited Power Increase* IE set to "Used", the DRNS shall, if supported, use Limited Power Increase according to ref. [10] subclause 5.2.1 for the inner loop DL power control in the new configuration.]
- [FDD – If the *DL DPCH Information* IE includes the *Limited Power Increase* IE set to "Not Used", the DRNS shall not use Limited Power Increase for the inner loop DL power control in the new configuration.]

[FDD - If the RADIO LINK RECONFIGURATION REQUEST message includes the *Transmission Gap Pattern Sequence Information* IE, the DRNS shall store the new information about the Transmission Gap Pattern Sequences to be used in the new Compressed Mode configuration This new Compressed Mode Configuration shall be valid in the DRNS until the next Compressed Mode Configuration is configured in the DRNS or last Radio Link is deleted.]

[FDD - If the RADIO LINK RECONFIGURATION REQUEST message includes the *Transmission Gap Pattern Sequence Information* IE, and if the *Downlink Compressed Mode Method* IE in one or more Transmission Gap Pattern Sequence within the *Transmission Gap Pattern Sequence Information* IE is set to 'SF/2', the DRNC shall include the *DL Code Information* IE in the RADIO LINK RECONFIGURATION RESPONSE message, without changing any of the DL Channelisation Codes or DL Scrambling Codes, indicating for each DL Channelisation Code whether the alternative scrambling code shall be used or not.]

[TDD - UL/DL CCTrCH Modification]

[TDD – If the RADIO LINK RECONFIGURATION REQUEST message includes any *UL CCTrCH To Modify* IE or *DL CCTrCH To Modify* IE, the DRNS shall reserve necessary resources for the new configuration of the Radio Link(s) according to the parameters given in the message.]

[TDD - If the RADIO LINK RECONFIGURATION REQUEST message includes any *UL CCH Information to modify* IEs or *DL CCH Information to modify* IEs which contain a *TFCS* IE, the DRNS shall apply the included *TFCS* IE as the new value(s) to the referenced CCH. Otherwise the DRNS shall continue to apply the previous value(s) specified for this CCH.]

[1.28Mcps TDD - If the *UL CCH To Modify* IE includes *UL SIR Target* IE, the DRNS shall apply this value as the new configuration and use it for the UL inner loop power control according [12] and [22].]

[TDD – UL/DL CCH Deletion]

[TDD - If the RADIO LINK RECONFIGURATION REQUEST message includes any *UL CCH Information To Delete* IEs or *DL CCH Information To Delete* IEs, the DRNS shall not include the referenced CCHs in the new configuration.]

[1.28Mcps TDD – Uplink Synchronisation Parameters LCR]:

[1.28Mcps TDD - If the *Uplink Synchronisation Parameters LCR* IE is present, the DRNC shall use the indicated values of *Uplink synchronisation stepsize* IE and *Uplink synchronisation frequency* IE when evaluating the timing of the UL synchronisation.]

[1.28Mcps TDD - Uplink Timing Advance Control LCR]:

[1.28Mcps TDD - The DRNC shall include the *Uplink Timing Advance Control LCR* IE in the RADIO LINK RECONFIGURATION RESPONSE message, if the Uplink Timing Advance Control parameters have been changed.]

General:

If the requested modifications are allowed by the DRNS, and if the DRNS has successfully allocated the required resources and changed to the new configuration, the DRNC shall respond to the SRNC with the RADIO LINK RECONFIGURATION RESPONSE message.

The DRNC shall include the *Transport Layer Address* IE and the *Binding ID* IE in the *DCH Information Response* IE for any Transport Channel being added, or any Transport Channel being modified for which a new transport bearer was requested with the *Transport Bearer Request Indicator* IE. The detailed frame protocol handling during transport bearer replacement is described in [4], subclause 5.10.1.

In the case of a set of co-ordinated DCHs requiring a new transport bearer on the Iur interface, the DRNC shall include the *Transport Layer Address* IE and the *Binding ID* IE in the *DCH Information Response* IE only for one of the DCHs in the set of co-ordinated DCHs.

In the case of a Radio Link being combined with another Radio Link within the DRNS, the DRNC shall include the *Transport Layer Address* IE and the *Binding ID* IE in the *DCH Information Response* IE in the RADIO LINK RECONFIGURATION RESPONSE message for only one of the combined Radio Links.

Any allowed rate for the uplink of a modified DCH provided for the old configuration will not be valid for the new configuration. If the DRNS need to limit the user rate in the uplink of a DCH due to congestion caused by the UL UTRAN Dynamic Resources (see subclause 9.2.1.79) in the new configuration for a Radio Link, the DRNC shall include in the RADIO LINK RECONFIGURATION RESPONSE message the *Allowed UL Rate* IE in the *DCH Information Response* IE for this Radio Link.

Any allowed rate for the downlink of a modified DCH provided for the old configuration will not be valid for the new configuration. If the DRNS need to limit the user rate in the downlink of a DCH due to congestion caused by the DL UTRAN Dynamic Resources (see subclause 9.2.1.79) in the new configuration for a Radio Link, the DRNC shall include in the RADIO LINK RECONFIGURATION RESPONSE message the *Allowed DL Rate* IE in the *DCH Information Response* IE for this Radio Link.

The DRNS decides the maximum and minimum SIR for the uplink of the Radio Link(s), and the DRNC shall include in the RADIO LINK RECONFIGURATION RESPONSE message the *Maximum Uplink SIR* IE and *Minimum Uplink SIR* IE for each Radio Link when these values are changed .

If the DL TX power upper or lower limit has been re-configured, the DRNC shall include the new value(s) in the *Maximum DL TX Power* IE and *Minimum DL TX Power* IE in the RADIO LINK RECONFIGURATION RESPONSE message. The DRNS shall not transmit with a higher power than indicated by the *Maximum DL TX Power* IE or lower

than indicated by the *Minimum DL TX Power* IE on any DL DPCH of the RL.[FDD – except during compressed mode, when the δP_{curr} , as described in ref.[10] subclause 5.2.1.3, shall be added to the maximum DL power for the associated compressed frame.].

8.3.7.3 Unsuccessful Operation

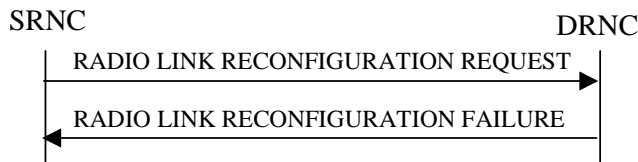

Figure 15: Unsynchronised Radio Link Reconfiguration procedure, Unsuccessful Operation

If the DRNS cannot allocate the necessary resources for all the new DCHs in a set of coordinated DCHs requested to be added, it shall reject the Unsynchronised Radio Link Reconfiguration procedure as having failed.

If the requested Unsynchronised Radio Link Reconfiguration procedure fails for one or more Radio Link(s), the DRNC shall send the RADIO LINK RECONFIGURATION FAILURE message to the SRNC, indicating the reason for failure.

Typical cause values are:

Radio Network Layer Causes:

- UL Scrambling Code Already in Use;
- DL Radio Resources not Available;
- UL Radio Resources not Available;
- Requested Configuration not Supported;
- CM not Supported.

Miscellaneous Causes:

- Control Processing Overload;
- Not enough User Plane Processing Resources.

8.3.7.4 Abnormal Conditions

If only a subset of all the DCHs belonging to a set of co-ordinated DCHs is requested to be deleted, the DRNS shall reject the Unsynchronised Radio Link Reconfiguration procedure as having failed, and the DRNC shall send the RADIO LINK RECONFIGURATION FAILURE message to the SRNC.

If more than one DCH of a set of co-ordinated DCHs has the *QE-Selector* IE set to "selected" [TDD – or no DCH of a set of co-ordinated DCHs has the *QE-Selector* IE set to "selected"], the DRNS shall reject the Unsynchronised Radio Link Reconfiguration procedure, and the DRNC shall respond with a RADIO LINK RECONFIGURATION FAILURE message.

If the RADIO LINK RECONFIGURATION REQUEST message includes a *DCHs To Modify* IE or *DCHs To Add* IE with multiple *DCH Specific Info* IEs, and if the DCHs in the *DCHs To Modify* IE or *DCHs To Add* IE do not have the same *Transmission Time Interval* IE in the *Semi-static Transport Format Information* IE, then the DRNC shall reject the procedure using the RADIO LINK RECONFIGURATION FAILURE message.

8.3.8 Physical Channel Reconfiguration

8.3.8.1 General

The Physical Channel Reconfiguration procedure is used by the DRNS to request the SRNC to reconfigure one of the configured physical channels.

This procedure shall use the signalling bearer connection for the relevant UE Context.

The DRNS shall not initiate the Physical Channel Reconfiguration procedure if a Prepared Reconfiguration exists as defined in subclause 3.1, or if a Synchronised Radio Link Reconfiguration Preparation procedure, Unsynchronised Radio Link Reconfiguration procedure or Radio Link Deletion procedure is ongoing for the relevant UE context.

8.3.8.2 Successful Operation

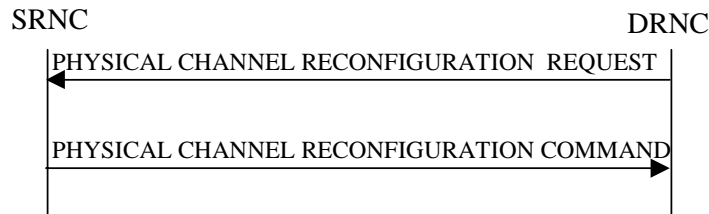

Figure 16: Physical Channel Reconfiguration procedure, Successful Operation

When the DRNC detects the need to modify one of its physical channels, it shall send a PHYSICAL CHANNEL RECONFIGURATION REQUEST to the SRNC.

The PHYSICAL CHANNEL RECONFIGURATION REQUEST message contains the new value(s) of the physical channel parameter(s) of the radio link for which the DRNC is requesting the reconfiguration.

[FDD- If compressed mode is prepared or active and at least one of the downlink compressed mode methods is "SF/2", the DRNC shall include the *Transmission Gap Pattern Sequence Scrambling Code Information* IE in the *DL Code Information* IE in the PHYSICAL CHANNEL RECONFIGURATION REQUEST message indicating for each DL Channelisation Code whether the alternative scrambling code will be used or not if the downlink compressed mode method "SF/2" is activated.]

[TDD – The SRNC shall apply the new values for any of [3.84Mcps TDD - *UL Code Information* IE, *Midamble Shift And Burst Type* IE,] [1.28Mcps TDD - *UL Code Information LCR* IE, *Midamble Shift LCR* IE,] *TDD DPCH Offset* IE, *Repetition Period* IE, *Repetition Length* IE, or *TFCI presence* IE included in the *UL DPCH Information* IE within the PHYSICAL CHANNEL RECONFIGURATION REQUEST message, otherwise the previous values specified for this DPCH shall still apply.]

[TDD – The SRNC shall apply the new values for any of [3.84Mcps TDD - *DL Code Information* IE, *Midamble Shift And Burst Type* IE,] [1.28Mcps TDD - *DL Code Information LCR* IE, *Midamble Shift LCR* IE,] *TDD DPCH Offset* IE, *Repetition Period* IE, *Repetition Length* IE, or *TFCI presence* IE included in the *DL DPCH Information* IE within the PHYSICAL CHANNEL RECONFIGURATION REQUEST message, otherwise the previous values specified for this DPCH shall still apply.]

Upon receipt of the PHYSICAL CHANNEL RECONFIGURATION REQUEST, the SRNC shall decide an appropriate execution time for the change. The SRNC shall respond with a PHYSICAL CHANNEL RECONFIGURATION COMMAND message to the DRNC that includes the *CFN* IE indicating the execution time.

At the CFN, the DRNS shall switch to the new configuration that has been requested, and release the resources related to the old physical channel configuration.

8.3.8.3 Unsuccessful Operation

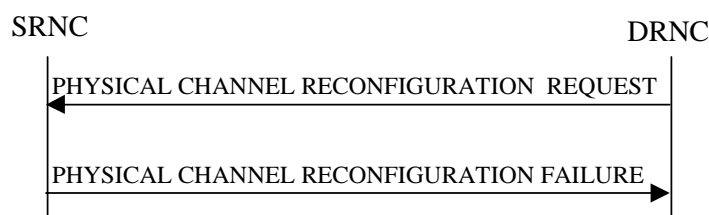

Figure 17: Physical Channel Reconfiguration procedure, Unsuccessful Operation

If the SRNC cannot accept the reconfiguration request it shall send the PHYSICAL CHANNEL RECONFIGURATION FAILURE message to the DRNC, including the reason for the failure in the *Cause IE*.

Typical cause values are:

Radio Network Layer Causes:

- Reconfiguration not Allowed.

8.3.8.4 Abnormal Conditions

While waiting for the PHYSICAL CHANNEL RECONFIGURATION COMMAND message, if the DRNC receives any of the RADIO LINK RECONFIGURATION PREPARE, RADIO LINK RECONFIGURATION REQUEST, or RADIO LINK DELETION REQUEST messages, the DRNC shall abort the Physical Channel Reconfiguration procedure. These messages thus override the DRNC request for physical channel reconfiguration.

When the SRNC receives a PHYSICAL CHANNEL RECONFIGURATION REQUEST message while a Synchronised Radio Link Reconfiguration procedure, Unsynchronised Radio Link Reconfiguration procedure or Radio Link Deletion procedure is ongoing, the SRNC shall ignore the request message and assume that receipt of any of the messages RADIO LINK RECONFIGURATION PREPARE, RADIO LINK RECONFIGURATION REQUEST or RADIO LINK DELETION REQUEST by the DRNC has terminated the Physical Channel Reconfiguration procedure. In this case the SRNC shall not send a PHYSICAL CHANNEL RECONFIGURATION FAILURE message to the DRNC.

8.3.9 Radio Link Failure

8.3.9.1 General

This procedure is started by the DRNS when one or more Radio Links [FDD - or Radio Link Sets][TDD - or CCTrCHs within a Radio Link] are no longer available.

This procedure shall use the signalling bearer connection for the relevant UE Context.

The DRNS may initiate the Radio Link Failure procedure at any time after establishing a Radio Link.

8.3.9.2 Successful Operation

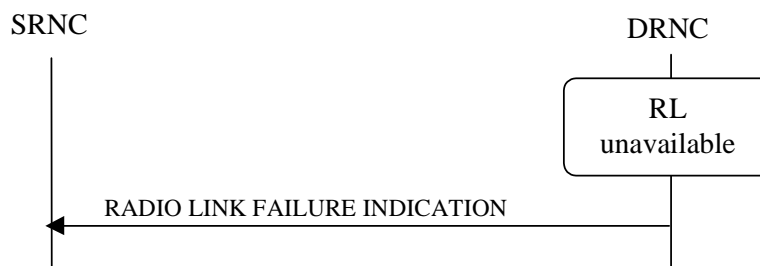

Figure 18: Radio Link Failure procedure, Successful Operation

When the DRNC detects that a one or more Radio Links [FDD - or Radio Link Sets] [TDD - or CCTrCHs within a Radio Link] are no longer available, it shall send the RADIO LINK FAILURE INDICATION message to the SRNC. The message indicates the failed Radio Links [FDD - or Radio Link Sets] [TDD - or CCTrCHs] with the most appropriate cause value defined in the *Cause IE*. If the failure concerns one or more individual Radio Links the DRNC shall include the affected Radio Link(s) using the *RL Information IE*. [FDD - If the failure concerns one or more Radio Link Sets the DRNC shall include the affected Radio Link Set(s) using the *RL Set Information IE*.] [TDD - If the failure concerns only the failure of one or more CCTrCHs within in a radio link the DRNC shall include the affected CCTrCHs using the *CCTrCH ID IE*].

When the RL Failure procedure is used to notify loss of UL synchronisation of a [FDD - Radio Link Set] [TDD - Radio Link or CCTrCHs within a Radio Link] on the Uu interface, the RADIO LINK FAILURE INDICATION message shall be sent with the *Cause IE* set to "Synchronisation Failure" when indicated by the UL synchronisation detection algorithm defined in ref. [10] subclause 4.3 and [22] subclause 4.4.2.

[FDD – When the Radio Link Failure procedure is used to indicate permanent failure in one or more Radio Links/Radio Link Sets due to the occurrence of an UL or DL frame with more than one transmission gap caused by one or more compressed mode pattern sequences, the DL transmission shall be stopped and the RADIO LINK FAILURE INDICATION message shall be sent with the *Cause Value* IE set to 'Invalid CM Settings'. After sending the RADIO LINK FAILURE INDICATION message to notify the permanent failure, the DRNS shall not remove the Radio Link(s)/Radio Link Set(s) from the UE Context, or remove the UE Context itself.]

In the other cases the Radio Link Failure procedure is used to indicate that one or more Radio Links [FDD - or Radio Link Sets] are permanently unavailable and cannot be restored. After sending the RADIO LINK FAILURE INDICATION message to notify the permanent failure, the DRNS shall not remove the Radio Link from the UE Context or remove the UE Context itself. When applicable, the allocation retention priorities associated with the transport channels shall be used by the DRNS to prioritise which Radio Links to indicate as unavailable to the SRNC.

Typical cause values are:

Radio Network Layer Causes:

- Synchronisation Failure;
- Invalid CM Settings.

Transport Layer Causes:

- Transport Resources Unavailable.

Miscellaneous Causes:

- Control Processing Overload;
- HW Failure;
- O&M Intervention.

8.3.9.3 Abnormal Conditions

-

8.3.10 Radio Link Restoration

8.3.10.1 General

This procedure is used to notify establishment and re-establishment of UL synchronisation of one or more [FDD –RL Set(s)] [TDD – Radio Links or CCTrCH(s) within a RadioLink] on the Uu interface.

This procedure shall use the signalling bearer connection for the relevant UE Context.

The DRNC may initiate the Radio Link Restoration procedure at any time after establishing a Radio Link.

8.3.10.2 Successful Operation



Figure 19: Radio Link Restoration procedure, Successful Operation

The DRNC shall send the RADIO LINK RESTORE INDICATION message to the SRNC when and as specified by the UL Uu synchronisation detection algorithm defined in ref. [10] subclause 4.3 and [22] subclause 4.4.2. [FDD – The algorithm in ref. [10] shall use the minimum value of the parameters N_INSYNCR_IND that are configured in the cells supporting the radio links of the RL Set].

[TDD - If the re-established UL Uu synchronisation concerns one or more individual Radio Links the DRNC shall include in the RADIO LINK RESTORE INDICATION message the *RL Information* IE to indicate the affected Radio Link(s).] [TDD – If the re-established synchronisation concerns one or more individual CCTrCHs within a radio link the DRNS shall include in the RADIO LINK RESTORE INDICATION message the *RL Information* IE to indicate the affected CCTrCHs.] [FDD - If the re-established UL Uu synchronisation concerns one or more Radio Link Sets the DRNC shall include in the RADIO LINK RESTORE INDICATION message the *RL Set Information* IE to indicate the affected Radio Link Set(s).]

8.3.10.3 Abnormal Conditions

-

8.3.11 Dedicated Measurement Initiation

8.3.11.1 General

This procedure is used by an SRNS to request the initiation of dedicated measurements in a DRNS.

This procedure shall use the signalling bearer connection for the relevant UE Context.

The Dedicated Measurement Initiation procedure shall not be initiated if a Prepared Reconfiguration exists, as defined in subclause 3.1.

8.3.11.2 Successful Operation

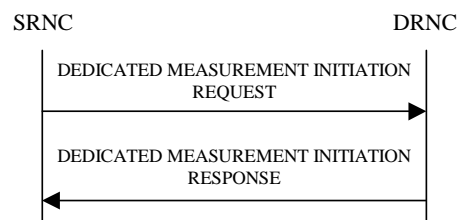

Figure 20: Dedicated Measurement Initiation procedure, Successful Operation

The procedure is initiated with a DEDICATED MEASUREMENT INITIATION REQUEST message sent from the SRNC to the DRNC.

Upon receipt, the DRNC shall initiate the requested dedicated measurement according to the parameters given in the request.

If the Dedicated Measurement Object Type is indicated as being "RL" in the DEDICATED MEASUREMENT INITIATION REQUEST message, measurement results shall be reported for all the indicated Radio Links.

[FDD - If the Dedicated Measurement Object Type is indicated as being "RLS" in the DEDICATED MEASUREMENT INITIATION REQUEST message, measurement results shall be reported for all the indicated Radio Link Sets.]

[FDD - If the Dedicated Measurement Object Type is indicated as being "ALL RL" in the DEDICATED MEASUREMENT INITIATION REQUEST message, measurement results shall be reported for all current and future Radio Links within the UE Context.]

[TDD - If the Dedicated Measurement Object Type is indicated as being "ALL RL" in the DEDICATED MEASUREMENT INITIATION REQUEST message, measurement results shall be reported for one existing DPCH per CCTrCH in each used time slot of current and future Radio Links within the UE Context, provided the measurement type is applicable to the respective DPCH.]

[FDD - If the Dedicated Measurement Object Type is indicated as being "ALL RLS" in the DEDICATED MEASUREMENT INITIATION REQUEST message, measurement results shall be reported for all the existing and future Radio Link Sets within the UE Context.]

[TDD – If the *DPCH ID* IE is provided within the RL Information, the measurement request shall apply for the requested physical channel individually. If no *DPCH ID* IE is provided within the RL Information the measurement request shall apply for one existing DPCH per CCTrCH in each used time slot of the Radio Link, provided the measurement type is applicable to this DPCH.]

Report characteristics

The *Report Characteristics* IE indicates how the reporting of the dedicated measurement shall be performed. See also Annex B.

If the *Report Characteristics* IE is set to "On-Demand" and if the *CFN* IE is not provided, the DRNS shall report the measurement result immediately in the DEDICATED MEASUREMENT INITIATION RESPONSE message. If the *CFN* IE is provided, it indicates the frame for which the measurement value shall be provided. The provided measurement value shall be the one reported by the layer 3 filter, referred to as point C in the measurement model [26].

If the *Report Characteristics* IE is set to "Periodic" and if the *CFN* IE is not provided, the DRNS shall immediately and periodically initiate the Dedicated Measurement Reporting procedure for this measurement, with a frequency as specified by the *Report Periodicity* IE. If the *CFN* IE is provided, the DRNS shall initiate a Dedicated Measurement Reporting procedure for this measurement at the CFN indicated in the *CFN* IE, and shall repeat this initiation periodically thereafter with a frequency as specified by the *Report Periodicity* IE. The provided measurement value shall be the one reported by the layer 3 filter, referred to as point C in the measurement model [26].

If the *Report Characteristics* IE is set to "Event A", the DRNS shall initiate the Dedicated Measurement Reporting procedure when the measured entity rises above the requested threshold, as specified by the *Measurement Threshold* IE, and then stays above the threshold for the requested hysteresis time, as specified by the *Measurement Hysteresis Time* IE. If the *Measurement Hysteresis Time* IE is not included, the DRNC shall use the value zero for the hysteresis time.

If the *Report Characteristics* IE is set to "Event B", the DRNS shall initiate the Dedicated Measurement Reporting procedure when the measured entity falls below the requested threshold, as specified by the *Measurement Threshold* IE, and then stays below the threshold for the requested hysteresis time, as specified by the *Measurement Hysteresis Time* IE. If the *Measurement Hysteresis Time* IE is not included, the DRNC shall use the value zero for the hysteresis time.

If the *Report Characteristics* IE is set to "Event C", the DRNS shall initiate the Dedicated Measurement Reporting procedure when the measured entity rises more than the requested threshold specified by the *Measurement Increase/Decrease Threshold* IE, and only when this rise occurs within the requested rising time specified by the *Measurement Change Time* IE. After reporting this type of event, the DRNS shall not initiate the next C event reporting for the same measurement during the subsequent time specified by the *Measurement Change Time* IE.

If the *Report Characteristics* IE is set to "Event D", the DRNS shall initiate the Dedicated Measurement Reporting procedure when the measured entity falls more than the requested threshold specified by the *Measurement Increase/Decrease Threshold* IE, and only when this falls occurs within the requested falling time specified by the *Measurement Change Time* IE. After reporting this type of event, the DRNS shall not initiate the next D event reporting for the same measurement during the subsequent time specified by the *Measurement Change Time* IE.

If the *Report Characteristics* IE is set to "Event E", the DRNS shall initiate the Dedicated Measurement Reporting procedure when the measured entity rises above the *Measurement Threshold 1* IE and stays above the threshold for the *Measurement Hysteresis Time* IE (Report A). When the conditions for Report A are met and if the *Report Periodicity* IE is provided, the DRNS shall initiate the Dedicated Measurement Reporting procedure periodically with the requested report frequency specified by the *Report Periodicity* IE. If the conditions for Report A have been met and the measured entity falls below the *Measurement Threshold 2* IE and stays below the threshold for the *Measurement Hysteresis Time* IE, the DRNS shall initiate the Dedicated Measurement Reporting procedure (Report B) and shall terminate any corresponding periodic reporting. If the *Measurement Threshold 2* IE is not present, the DRNS shall use the value of the *Measurement Threshold 1* IE instead. If the *Measurement Hysteresis Time* IE is not included, the DRNC shall use the value zero as hysteresis times for both Report A and Report B.

If the *Report Characteristics* IE is set to "Event F", the DRNS shall initiate the Dedicated Measurement Reporting procedure when the measured entity falls below the *Measurement Threshold 1* IE and stays below the threshold for the *Measurement Hysteresis Time* IE (Report A). When the conditions for Report A are met and if the *Report Periodicity* IE is provided, the DRNS shall initiate the Dedicated Measurement Reporting procedure periodically with the requested report frequency specified by the *Report Periodicity* IE. If the conditions for Report A have been met and the measured entity rises above the *Measurement Threshold 2* IE and stays above the threshold for the *Measurement Hysteresis Time* IE, the DRNS shall initiate the Dedicated Measurement Reporting procedure (Report B) and shall terminate any corresponding periodic reporting. If the *Measurement Threshold 2* IE is not present, the DRNS shall use the value of the *Measurement Threshold 1* IE instead. If the *Measurement Hysteresis Time* IE is not included, the DRNC shall use the value zero as hysteresis times for both Report A and Report B.

If the *Report Characteristics* IE is not set to "On Demand", the DRNS is required to perform reporting for a dedicated measurement object, in accordance with the conditions provided in the DEDICATED MEASUREMENT INITIATION REQUEST message, as long as the object exists. If no dedicated measurement object(s) for which a measurement is defined exists any more, the DRNS shall terminate the measurement locally without reporting this to the SRNC.

If at the start of the measurement, the reporting criteria are fulfilled for any of Event A, Event B, Event E or Event F, the DRNS shall initiate the Dedicated Measurement Reporting procedure immediately, and then continue with the measurements as specified in the DEDICATED MEASUREMENT INITIATION REQUEST message.

Higher layer filtering

The *Measurement Filter Coefficient* IE indicates how filtering of the dedicated measurement values shall be performed before measurement event evaluation and reporting.

The averaging shall be performed according to the following formula.

$$F_n = (1 - a) \cdot F_{n-1} + a \cdot M_n$$

The variables in the formula are defined as follows:

F_n is the updated filtered measurement result

F_{n-1} is the old filtered measurement result

M_n is the latest received measurement result from physical layer measurements, the unit used for M_n is the same unit as the reported unit in the DEDICATED MEASUREMENT INITIATION RESPONSE, DEDICATED MEASUREMENT REPORT messages or the unit used in the event evaluation (i.e. same unit as for F_n).

$a = 1/2^{(k/2)}$, where k is the parameter received in the *Measurement Filter Coefficient* IE. If the *Measurement Filter Coefficient* IE is not present, a shall be set to 1 (no filtering)

In order to initialise the averaging filter, F_0 is set to M_1 when the first measurement result from the physical layer measurement is received.

Response message

If the DRNS was able to initiate the measurement requested by the SRN, it shall respond with the DEDICATED MEASUREMENT INITIATION RESPONSE message. The message shall include the same Measurement ID that was used in the DEDICATED MEASUREMENT INITIATION REQUEST message.

In the case in which the *Report Characteristics* IE is set to "On Demand":

- The DRNC shall include the measurement result in the *Dedicated Measurement Value* IE within the DEDICATED MEASUREMENT INITIATION RESPONSE message.
- If the *CFN Reporting Indicator* IE is set to "FN Reporting Required", the *CFN* IE shall be included in the DEDICATED MEASUREMENT INITIATION RESPONSE message. The reported CFN shall be the CFN at the time when the dedicated measurement value was reported by the layer 3 filter, referred to as point C in the measurement model [26].
- [TDD – If the measurement was made on a particular DPCH, the DEDICATED MEASUREMENT INITIATION RESPONSE message shall include the DPCH ID of that DPCH in the *DPCH ID* IE.]

8.3.11.3 Unsuccessful Operation

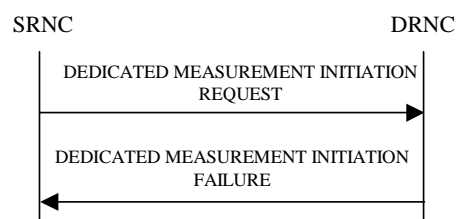

Figure 21: Dedicated Measurement Initiation procedure, Unsuccessful Operation

If the requested measurement cannot be initiated, the DRNC shall send a DEDICATED MEASUREMENT INITIATION FAILURE message. The message shall include the same *Measurement ID IE* that was used in the DEDICATED MEASUREMENT INITIATION REQUEST message and shall include the *Cause IE* set to an appropriate value.

Typical cause values are:

Radio Network Layer Causes:

- Measurement not Supported For The Object
- Measurement Temporarily not Available

Miscellaneous Causes:

- Control Processing Overload
- HW Failure

8.3.11.4 Abnormal Conditions

The allowed combinations of the Dedicated Measurement Type and Report Characteristics Type are shown in the table below marked with "X". For not allowed combinations, the DRNS shall reject the Dedicated Measurement Initiation procedure using the DEDICATED MEASUREMENT INITIATION FAILURE message..

Table 4: Allowed Dedicated Measurement Type and Report Characteristics Type Combinations

Dedicated Measurement Type	Report Characteristics Type								
	On Demand	Periodic	Event A	Event B	Event C	Event D	Event E	Event F	On Modification
SIR	X	X	X	X	X	X	X	X	
SIR Error	X	X	X	X	X	X	X	X	
Transmitted Code Power	X	X	X	X	X	X	X	X	
RSCP	X	X	X	X	X	X	X	X	
Rx Timing Deviation	X	X	X	X			X	X	
Round Trip Time	X	X	X	X	X	X	X	X	

If the Dedicated Measurement Type received in the *Dedicated Measurement Type IE* is not defined in ref. [11] or [14] to be measured on the Dedicated Measurement Object Type received in the DEDICATED MEASUREMENT INITIATION REQUEST message, the DRNS shall reject the Dedicated Measurement Initiation procedure, and the DRNC shall send a DEDICATED MEASUREMENT INITIATION FAILURE message.

If the *CFN IE* is included in the DEDICATED MEASUREMENT INITIATION REQUEST message and the *Report Characteristics IE* is other than "Periodic" or "On Demand", the DRNS shall reject the Dedicated Measurement Initiation procedure, and the DRNC shall send a DEDICATED MEASUREMENT INITIATION FAILURE message.

8.3.12 Dedicated Measurement Reporting

8.3.12.1 General

This procedure is used by the DRNS to report the results of measurements requested by the SRNS with the Dedicated Measurement Initiation procedure.

This procedure shall use the signalling bearer connection for the relevant UE Context.

The DRNC may initiate the Dedicated Measurement Reporting procedure at any time after establishing a Radio Link.

8.3.12.2 Successful Operation



Figure 22: Dedicated Measurement Reporting procedure, Successful Operation

If the requested measurement reporting criteria are met, the DRNS shall initiate the Dedicated Measurement Reporting procedure. If the measurement was initiated (by the Dedicated Measurement Initiation procedure) for multiple dedicated measurement objects, the DRNC may include dedicated measurement values in the *Dedicated Measurement Value Information* IE for multiple objects in the DEDICATED MEASUREMENT REPORT message.

The *Measurement ID* IE shall be set to the Measurement ID provided by the SRNC when initiating the measurement with the Dedicated Measurement Initiation procedure.

If the achieved measurement accuracy does not fulfil the given accuracy requirement specified in ref. [23] and [24], the "Measurement Not Available" shall be reported in the *Dedicated Measurement Value Information* IE in the DEDICATED MEASUREMENT REPORT message, otherwise the DRNC shall include the *Dedicated Measurement Value* IE within the *Dedicated Measurement Value Information* IE.

If the CFN Reporting Indicator when initiating the measurement with the Dedicated Measurement Initiation procedure was set to "FN Reporting Required", the DRNC shall include the *CFN* IE in the DEDICATED MEASUREMENT REPORT message. The reported CFN shall be the CFN at the time when the dedicated measurement value was reported by the layer 3 filter, referred to as point C in the measurement model [26].

[TDD – If the measurement was made on a particular DPCH, the DEDICATED MEASUREMENT REPORT message shall include the DPCH ID of that DPCH in the *DPCH ID* IE.]

8.3.12.3 Abnormal Conditions

-

8.3.13 Dedicated Measurement Termination

8.3.13.1 General

This procedure is used by the SRNS to terminate a measurement previously requested by the Dedicated Measurement Initiation procedure.

This procedure shall use the signalling bearer connection for the relevant UE Context.

The Dedicated Measurement Termination procedure shall not be initiated if a Prepared Reconfiguration exists, as defined in subclause 3.1.

8.3.13.2 Successful Operation

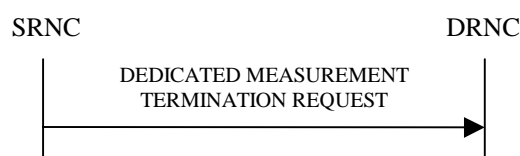

Figure 23: Dedicated Measurement Termination procedure, Successful Operation

This procedure is initiated with a DEDICATED MEASUREMENT TERMINATION REQUEST message, sent from the SRNC to the DRNC.

Upon receipt, the DRNS shall terminate reporting of dedicated measurements corresponding to the received *Measurement ID* IE.

8.3.13.3 Abnormal Conditions

-

8.3.14 Dedicated Measurement Failure

8.3.14.1 General

This procedure is used by the DRNS to notify the SRNS that a measurement previously requested by the Dedicated Measurement Initiation procedure can no longer be reported.

This procedure shall use the signalling bearer connection for the relevant UE Context.

The DRNC may initiate the Dedicated Measurement Failure procedure at any time after establishing a Radio Link.

8.3.14.2 Successful Operation

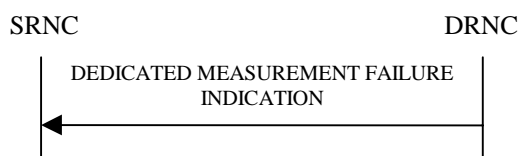

Figure 24: Dedicated Measurement Failure procedure, Successful Operation

This procedure is initiated with a DEDICATED MEASUREMENT FAILURE INDICATION message, sent from the DRNC to the SRNC, to inform the SRNC that a previously requested dedicated measurement can no longer be reported. The DRNC has locally terminated the indicated measurement. The DRNC shall include in the DEDICATED MEASUREMENT FAILURE INDICATION message the reason for the failure in the *Cause* IE.

Typical cause values are:

Miscellaneous Causes:

- Control Processing Overload
- HW Failure
- O&M Intervention

8.3.14.3 Abnormal Conditions

-

8.3.15 Downlink Power Control [FDD]

8.3.15.1 General

The purpose of this procedure is to balance the DL transmission powers of one or more radio links for one UE.

This procedure shall use the signalling bearer connection for the relevant UE Context.

The Downlink Power Control procedure may be initiated by the SRNC at any time after establishing a Radio Link. If the SRNC has initiated in this DRNS the deletion of the last Radio Link for this UE context, the Downlink Power Control procedure shall not be initiated.

8.3.15.2 Successful Operation



Figure 25: Downlink Power Control procedure, Successful Operation

The Downlink Power Control procedure is initiated by the SRNC sending a DL POWER CONTROL REQUEST message to the DRNC.

The *Power Adjustment Type* IE defines the characteristic of the power adjustment.

If the value of the *Power Adjustment Type* IE is "Common", the DRNS shall set the Power Balancing Adjustment Type of the UE Context to "Common". As long as the Power Balancing Adjustment Type of the UE Context is set to "Common", the DRNS shall perform the power adjustment (see below) for all existing and future radio links for the UE Context and use a common DL reference power level.

If the value of the *Power Adjustment Type* IE is "Individual", the DRNS shall set the Power Balancing Adjustment Type of the UE Context to "Individual". The DRNS shall perform the power adjustment (see below) for all radio links addressed in the message using the given DL Reference Power per RL. If the Power Balancing Adjustment Type of the UE Context was set to "Common" before this message was received, power balancing on all radio links not addressed by the DL POWER CONTROL REQUEST message shall remain to be executed in accordance with the existing power balancing parameters which are now considered RL individual parameters. Power balancing will not be started on future radio links without a specific request.

If the value of the *Power Adjustment Type* IE is "None", the DRNS shall set the Power Balancing Adjustment Type of the UE Context to "None", and the DRNS shall suspend on going power adjustments for all radio links for the UE Context.

If the *Inner Loop DL PC Status* IE is present and set to "Active", the DRNS shall activate inner loop DL power control for all radio links for the UE Context. If the *Inner Loop DL PC Status* IE is present and set to "Inactive", the DRNS shall deactivate inner loop DL power control for all radio links for the UE Context according to ref. [10].

Power Adjustment

The power balancing adjustment shall be superimposed on the inner loop power control adjustment (see ref. [10]) if activated. The power balancing adjustment shall be such that:

$$\sum P_{bal} = (1 - r)(P_{ref} + P_{P-CPICH} - P_{init}) \text{ with an accuracy of } \pm 0.5 \text{ dB}$$

where the sum is performed over an adjustment period corresponding to a number of frames equal to the value of the *Adjustment Period* IE, P_{ref} is the value of the *DL Reference Power* IE, $P_{P-CPICH}$ is the power used on the primary CPICH, P_{init} is the code power of the last slot of the previous adjustment period and r is given by the *Adjustment Ratio* IE. If the last slot of the previous adjustment period is within a transmission gap due to compressed mode, P_{init} shall be set to the same value as the code power of the slot just before the transmission gap.

The adjustment within one adjustment period shall in any case be performed with the constraints given by the *Max Adjustment Step* IE and the DL TX power range set by the DRNC.

The power adjustments shall be started at the first slot of a frame with CFN modulo the value of *Adjustment Period* IE equal to 0 and shall be repeated for every adjustment period and shall be restarted at the first slot of a frame with CFN=0, until a new DL POWER CONTROL REQUEST message is received or the RL is deleted.

8.3.15.3 Abnormal Conditions

-

8.3.16 Compressed Mode Command [FDD]

8.3.16.1 General

The Compressed Mode Command procedure is used to activate or deactivate the compressed mode in the DRNS for one UE-UTRAN connection.

This procedure shall use the signalling bearer connection for the relevant UE Context.

The Compressed Mode Command procedure shall not be initiated if a Prepared Reconfiguration exists, as defined in subclause 3.1.

8.3.16.2 Successful Operation



Figure 26: Compressed Mode Command procedure, Successful Operation

The procedure is initiated by the SRNC sending a COMPRESSED MODE COMMAND message to the DRNC.

Upon receipt of the COMPRESSED MODE COMMAND message from the SRNC and at the CFN indicated in the *CM Configuration Change CFN IE*, the DRNS shall deactivate all the ongoing Transmission Gap Pattern Sequences. From that moment on all Transmission Gap Pattern Sequences included in *Transmission Gap Pattern Sequence Status IE* repetitions (if present) shall be started when the indicated *TGCFN IE* elapses. The *CM Configuration Change CFN IE* in the *Active Pattern Sequence Information IE* and *TGCFN IE* for each sequence refer to the next coming CFN with that value.

If the values of the *CM Configuration Change CFN IE* and the *TGCFN IE* are equal, the concerned Transmission Gap Pattern Sequence shall be started immediately at the CFN with a value equal to the value received in the *CM Configuration Change CFN IE*.

8.3.16.3 Abnormal Conditions

-

8.3.17 Downlink Power Timeslot Control [TDD]

8.3.17.1 General

The purpose of this procedure is to provide the DRNS with updated DL Timeslot ISCP values to use when deciding the DL TX Power for each timeslot.

This procedure shall use the signalling bearer connection for the relevant UE Context.

The Downlink Power Timeslot Control procedure can be initiated by the SRNC at any time after establishing a Radio Link. If the SRNC has initiated deletion of the last Radio Link in this DRNS, the Downlink Power Timeslot Control procedure shall not be initiated.

8.3.17.2 Successful Operation



Figure 26A: Downlink Power Timeslot Control procedure, Successful Operation

The Downlink Power Timeslot Control procedure is initiated by the SRNC sending a DL POWER TIMESLOT CONTROL REQUEST message to the DRNC.

Upon receipt of the DL POWER TIMESLOT CONTROL REQUEST message, the DRNS shall use the included [3.84Mcps TDD - *DL Timeslot ISCP Info IE*] [1.28Mcps TDD - *DL Timeslot ISCP Info LCR IE*] value when deciding the DL TX Power for each timeslot as specified in [22], i.e. it shall reduce the DL TX power in those downlink timeslots of the radio link in which the interference is low, and increase the DL TX power in those timeslots in which the interference is high, while keeping the total downlink power in the radio link unchanged.

8.3.17.3 Abnormal Conditions

-

8.3.18 Radio Link Pre-emption

8.3.18.1 General

This procedure is started by the DRNS when resources need to be freed.

This procedure shall use the signalling bearer connection for the UE Context associated with the RL to be pre-empted.

The DRNS may initiate the Radio Link Pre-emption procedure at any time after establishing a Radio Link.

8.3.18.2 Successful Operation

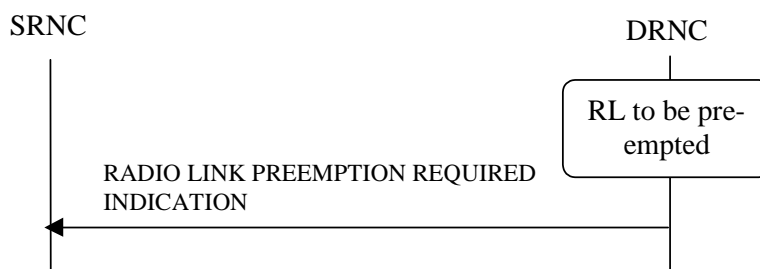

Figure 26B: Radio Link Pre-emption procedure, Successful Operation

When DRNC detects that one or more Radio Links should be pre-empted (see Annex A), it shall send the RADIO LINK PREEMPTION REQUIRED INDICATION message to the SRNC. If all Radio Links for a UE Context should be pre-empted, the *RL Information IE* shall not be included in the message. If one or several but not all Radio Links should be pre-empted for an UE Context, the Radio Links that should be pre-empted shall be indicated in the *RL Information IE*. The Radio Link(s) that should be pre-empted, should be deleted by the SRNC.

8.3.18.3 Abnormal Conditions

-

8.3.19 Radio Link Congestion

8.3.19.1 General

This procedure is started by the DRNS when resource congestion is detected and the rate of one or more DCHs, corresponding to one or more radio links, is preferred to be limited in the UL and/or DL. This procedure is also used by the DRNC to indicate to the SRNC any change of the UL/DL resource congestion situation, affecting these radio links.. This procedure shall use the signalling bearer connection for the relevant UE Context..

The Radio Link Congestion procedure shall not be initiated if a Prepared Reconfiguration exists, as defined in subclause 3.1.

8.3.19.2 Successful Operation



Figure 26C: Radio Link Congestion procedure, Successful Operation

Start of an UL/DL Resource Congestion Situation

When the DRNC detects the start of a UL/DL resource congestion situation and prefers the rate of one or more DCHs for one or more radio links to be limited below the maximum rate currently configured in the UL/DL TFS, it shall send the RADIO LINK CONGESTION INDICATION message to the SRNC. The DRNC shall indicate the cause of the congestion in the *Congestion Cause* IE and shall indicate all the Radio Links for which the rate of a DCH needs to be reduced. For each DCH within the RL with UL congestion, the DRNC shall indicate the desired maximum UL data rate with the *Allowed UL Rate* IE in the *Allowed Rate Information* IE. For each DCH within the RL with DL congestion, the DRNC shall indicate the desired maximum DL data rate with the *Allowed DL Rate* IE in the *Allowed Rate Information* IE.

When receiving the RADIO LINK CONGESTION INDICATION message the SRNC should reduce the rate in accordance with the *Congestion Cause* IE and the indicated *Allowed DL Rate* IE and/or *Allowed UL Rate* IE for a DCH.

Change of UL/DL Resource Congestion Situation

The DRNC shall indicate any change of the UL/DL resource congestion situation by sending the RADIO LINK CONGESTION INDICATION message in which the new allowed rate(s) of the DCHs are indicated by the *Allowed Rate Information* IE. In the case that for at least one DCH the new allowed rate is lower than the previously indicated allowed rate for that DCH, the *Congestion Cause* IE, indicating the cause of the congestion, shall also be included.

When receiving a RADIO LINK CONGESTION INDICATION message indicating a further rate decrease on any DCH(s) on any RL, the SRNC should reduce the rate in accordance with the indicated congestion cause and the indicated allowed rate(s) for the DCH(s).

End of UL/DL Resource Congestion Situation

The end of an UL resource congestion situation, affecting a specific RL shall be indicated by including the TF corresponding to the highest data rate in the *Allowed UL Rate* IE in the *Allowed Rate Information* IE for the concerned RL. The end of a DL resource congestion situation affecting a specific RL shall be indicated by including the TF with the highest data rate in the *Allowed DL Rate* IE in the *Allowed Rate Information* IE for the concerned RL.

8.3.19.3 Abnormal Conditions

-

8.4 Common Transport Channel Procedures

8.4.1 Common Transport Channel Resources Initialisation

8.4.1.1 General

The Common Transport Channel Resources Initialisation procedure is used by the SRNC for the initialisation of the Common Transport Channel user plane towards the DRNC and/or for the initialisation of the Common Transport Channel resources in the DRNC to be used by a UE.

This procedure shall use the connectionless mode of the signalling bearer.

8.4.1.2 Successful Operation

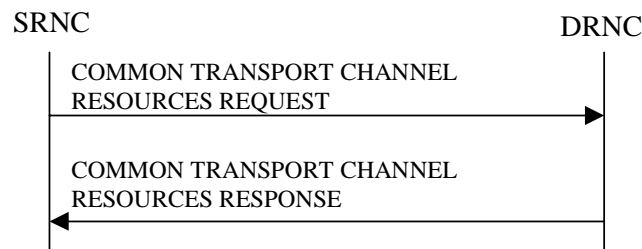

Figure 27: Common Transport Channel Resources Initialisation procedure, Successful Operation

The SRNC initiates the procedure by sending the message COMMON TRANSPORT CHANNEL RESOURCES REQUEST message to the DRNC.

If the value of the *Transport Bearer Request Indicator* IE is set to "Bearer Requested", the DRNC shall store the received *Transport Bearer ID* IE and include the *Binding ID* IE and *Transport Layer Address* IE in the COMMON TRANSPORT CHANNEL RESOURCES RESPONSE message.

If the value of the *Transport Bearer Request Indicator* IE is set to "Bearer not Requested", the DRNC shall use the transport bearer indicated by the *Transport Bearer ID* IE.

If the *C-ID* IE is included in the COMMON TRANSPORT CHANNEL RESOURCES REQUEST message, the DRNC shall allocate a C-RNTI for the indicated cell and include the *C-RNTI* IE in the COMMON TRANSPORT CHANNEL RESOURCES RESPONSE message.

If the *C-ID* IE is included in the COMMON TRANSPORT CHANNEL RESOURCES REQUEST message, the DRNC shall include the *FACH Info for UE Selected S-CCPCH* IE valid for the cell indicated by the *C-ID* IE and the corresponding *C-ID* IE in the COMMON TRANSPORT CHANNEL RESOURCES RESPONSE message. If the *C-ID* IE is not included in the COMMON TRANSPORT CHANNEL RESOURCES REQUEST message, the DRNC shall include the *FACH Info for UE Selected S-CCPCH* IE valid for the cell where the UE is located and the corresponding *C-ID* IE. The DRNC shall include the *FACH Scheduling Priority* IE and *FACH Initial Window Size* IE in the *FACH Flow Control Information* IE of the *FACH Info for UE Selected S-CCPCH* IE for each priority class that the DRNC has determined shall be used. The DRNC may include several *MAC-c/sh SDU Length* IEs for each priority class.

If the DRNS has any RACH, [FDD - CPCH,] and/or FACH resources previously allocated for the UE in another cell than the cell in which resources are currently being allocated, the DRNS shall release the previously allocated RACH, [FDD - CPCH,] and/or FACH resources.

If the DRNS has successfully reserved the required resources, the DRNC shall respond to the SRNC with the COMMON TRANSPORT CHANNEL RESOURCES RESPONSE message.

If the *Permanent NAS UE Identity* IE is present in the COMMON TRANSPORT CHANNEL RESOURCES REQUEST message, the DRNS shall store the information for the considered UE Context for the lifetime of the UE Context.

If the COMMON TRANSPORT CHANNEL RESOURCES REQUEST message includes a *C-ID* IE corresponding to a cell reserved for operator use and the Permanent NAS UE Identity is available in the DRNC for the considered UE

Context, the DRNC shall use this information to determine whether it can reserve resources on a common transport channel in this cell or not.

8.4.1.3 Unsuccessful Operation

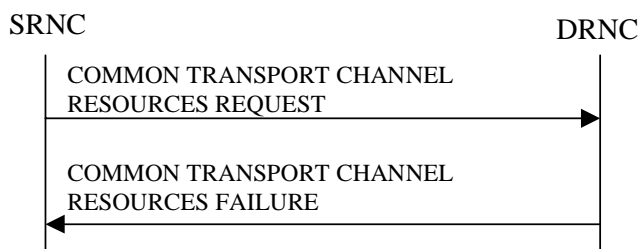

Figure 28: Common Transport Channel Resources Initialisation procedure, Unsuccessful Operation

If the *Transport Bearer Request Indicator* IE is set to "Bearer Requested" and the DRNC is not able to provide a Transport Bearer, the DRNC shall reject the procedure and respond to the SRNC with the COMMON TRANSPORT CHANNEL RESOURCES FAILURE message, including the reason for the failure in the *Cause* IE.

If the COMMON TRANSPORT CHANNEL RESOURCES REQUEST message contains a *C-ID* IE corresponding to a cell reserved for operator use and the Permanent NAS UE Identity is not available for the considered UE Context, the DRNC shall reject the procedure and send the COMMON TRANSPORT CHANNEL RESOURCES FAILURE message, including the reason for the failure in the *Cause* IE.

Typical cause values are:

Radio Network Layer Causes:

- Common Transport Channel Type not Supported;
- Cell reserved for operator use.

Transport Layer Causes:

- Transport Resource Unavailable.

8.4.1.4 Abnormal Conditions

-

8.4.2 Common Transport Channel Resources Release

8.4.2.1 General

This procedure is used by the SRNC to request release of Common Transport Channel Resources for a given UE in the DRNS. The SRNC uses this procedure either to release the UE Context from the DRNC (and thus both the D-RNTI and the C-RNTI) or to release only the C-RNTI.

This procedure shall use the connectionless mode of the signalling bearer.

8.4.2.2 Successful Operation



Figure 29: Common Transport Channel Resources Release procedure, Successful Operation

The SRNC initiates the Common Transport Channel Resources Release procedure by sending the COMMON TRANSPORT CHANNEL RESOURCES RELEASE REQUEST message to the DRNC. Upon receipt of the message, the DRNC shall release the UE Context identified by the D-RNTI and all its related RACH, [FDD - CPCH,] and/or FACH resources, unless the UE is using dedicated resources (DCH, [TDD - USCH,] and/or DSCH) in the DRNS in which case the DRNC shall release only the C-RNTI and all its related RACH, [FDD - CPCH,] and/or FACH resources allocated for the UE.

8.4.2.3 Abnormal Conditions

-

8.5 Global Procedures

8.5.1 Error Indication

8.5.1.1 General

The Error Indication procedure is initiated by a node to report detected errors in a received message, provided they cannot be reported by an appropriate response message.

This procedure shall use the signalling bearer mode specified below.

8.5.1.2 Successful Operation

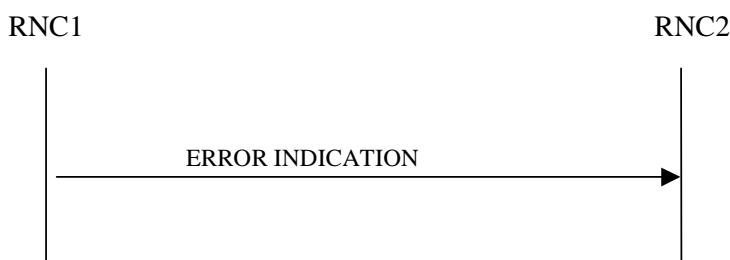

Figure 30: Error Indication procedure, Successful Operation

When the conditions defined in clause 10 are fulfilled, the Error Indication procedure is initiated by an ERROR INDICATION message sent from the receiving node. This message shall use the same mode of the signalling bearer and the same signalling bearer connection (if connection oriented) as the message that triggers the procedure.

When the ERROR INDICATION message is sent from a DRNC to an SRNC using connectionless mode of the signalling bearer, the *S-RNTI* IE shall be included in the message if the UE Context addressed by the *D-RNTI* IE which was received in the message triggering the Error Indication procedure exists. When the ERROR INDICATION message is sent from an SRNC to a DRNC using connectionless mode of the signalling bearer, the *D-RNTI* IE shall be included in the message if the UE addressed by the *S-RNTI* IE which was received in the message triggering the Error Indication procedure exists.

When a message using connectionless mode of the signalling bearer is received in the DRNC and there is no UE Context in the DRNC as indicated by the *D-RNTI* IE, the DRNC shall include the D-RNTI from the received message in the *D-RNTI* IE and set the *Cause* IE to "Unknown RNTI" in the ERROR INDICATION message, unless another handling is specified in the procedure text for the affected procedure.

When a message using connectionless mode of the signalling bearer is received in the SRNC and there is no UE in the SRNC as indicated by the *S-RNTI* IE, the SRNC shall include the S-RNTI from the received message in the *S-RNTI* IE and set the *Cause* IE to "Unknown RNTI" in the ERROR INDICATION message, unless another handling is specified in the procedure text for the affected procedure.

The ERROR INDICATION message shall include either the *Cause* IE, or the *Criticality Diagnostics* IE, or both the *Cause* IE and the *Criticality Diagnostics* IE to indicate the reason for the error indication.

Typical cause values for the ERROR INDICATION message are:

Protocol Causes:

- Transfer Syntax Error
- Abstract Syntax Error (Reject)
- Abstract Syntax Error (Ignore and Notify)
- Message not Compatible with Receiver State
- Unspecified

8.5.1.3 Abnormal Conditions

-

8.5.2 Common Measurement Initiation

8.5.2.1 General

This procedure is used by an RNC to request the initiation of measurements of common resources to another RNC. The requesting RNC is referred to as RNC₁ and the RNC to which the request is sent is referred to as RNC₂.

This procedure uses the signalling bearer connection for the relevant Distant RNC Context.

8.5.2.2 Successful Operation

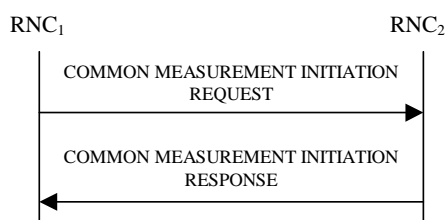

Figure 30A: Common Measurement Initiation procedure, Successful Operation

The procedure is initiated with a COMMON MEASUREMENT INITIATION REQUEST message sent from the RNC₁ to the RNC₂.

Upon receipt, the RNC₂ shall initiate the requested measurement according to the parameters given in the request.

Unless specified below, the meaning of the parameters are given in other specifications.

[TDD- If the [3.84 Mcps TDD - *Time Slot* IE] [1.28 Mcps - *Time Slot LCR* IE] is present in the COMMON MEASUREMENT INITIATION REQUEST message, the measurement request shall apply to the requested time slot individually.]

Common measurement type

If the *Common Measurement Type* IE is set to "SFN-SFN Observed Time Difference", then:

- The RNC₂ shall initiate the SFN-SFN Observed Time Difference measurements between the reference cell identified by the *Reference Cell Identifier* IE and the neighbouring cells identified by the *UTRAN Cell Identifier* IE (*UC-ID*) in the *Neighbouring Cell Measurement Information* IE.
- [3.84 Mcps TDD - The RNC₂ shall perform the measurement using the time slot specified in the *Time Slot* IE in the *Neighbouring TDD Cell Measurement Information* IE and using the midamble shift and burst type specified in the *Midamble Shift And Burst Type* IE in the *Neighbouring TDD Cell Measurement Information* IE, If *Time Slot* IE and *Midamble Shift And Burst Type* IE are not available in the *Neighbouring TDD Cell Measurement Information* IE, the RNC₂ may use any appropriate time slots, midamble shifts and burst types to make the measurement.]

If the *Common Measurement Type* IE is set to "load", the RNC₂ shall initiate measurements of uplink and downlink load on the measured object identified by the *Reference Cell Identifier* IE. If either uplink or downlink load satisfies the requested report characteristics, the RNC₂ shall report the result of both uplink and downlink measurements.

If the *Common Measurement Type* IE is set to "UTRAN GPS Timing of Cell Frames for UE Positioning", "transmitted carrier power", "received total wide band power", or "UL timeslot ISCP" the RNC₂ shall initiate measurements on the measured object identified by the *Reference Cell Identifier* IE.

Report characteristics

The *Report Characteristics* IE indicates how the reporting of the measurement shall be performed. See also Annex B.

If the *Report Characteristics* IE is set to "On Demand" and if the *SFN* IE is not provided, the RNC₂ shall report the result of the requested measurement immediately in the COMMON MEASUREMENT INITIATION RESPONSE message. If the *SFN* IE is provided, it indicates the frame for which the measurement value shall be provided. The provided measurement value shall be the one reported by the layer 3 filter, referred to as point C in the measurement model [26]. Furthermore, if the *SFN* IE is present and if the *Common Measurement Type* IE is set to "SFN-SFN Observed Time Difference", then the *SFN* IE relates to the Radio Frames of the Reference Cell identified by the *Reference Cell Identifier* IE.

If the *Report Characteristics* IE is set to "Periodic" and if the *SFN* IE is not provided, the RNC₂ shall immediately and periodically initiate a Common Measurement Reporting procedure for this measurement, with a frequency as specified by the *Report Periodicity* IE. If the *SFN* IE is provided, the RNC₂ shall initiate a Common Measurement Reporting procedure for this measurement at the SFN indicated in the *SFN* IE, and shall repeat this initiation periodically thereafter with a frequency as specified by the *Report Periodicity* IE. The provided measurement value shall be the one reported by the layer 3 filter, referred to as point C in the measurement model [26]. Furthermore, if the *SFN* IE is present and if the *Common Measurement Type* IE is set to "SFN-SFN Observed Time Difference", then the *SFN* IE relates to the Radio Frames of the Reference Cell identified by the *Reference Cell Identifier* IE..

If the *Report Characteristics* IE is set to "Event A", the RNC₂ shall initiate the Common Measurement Reporting procedure when the measured entity rises above the requested threshold, as specified by the *Measurement Threshold* IE, and then stays above the threshold for the requested hysteresis time, as specified by the *Measurement Hysteresis Time* IE. If the *Measurement Hysteresis Time* IE is not included, the RNC₂ shall use the value zero for the hysteresis time.

If the *Report Characteristics* IE is set to "Event B", the RNC₂ shall initiate the Common Measurement Reporting procedure when the measured entity falls below the requested threshold, as specified by the *Measurement Threshold* IE, and then stays below the threshold for the requested hysteresis time, as specified by the *Measurement Hysteresis Time* IE. If the *Measurement Hysteresis Time* IE is not included, the RNC₂ shall use the value zero for the hysteresis time.

If the *Report Characteristics* IE is set to "Event C", the RNC₂ shall initiate the Common Measurement Reporting procedure when the measured entity rises more than the requested threshold specified by the *Measurement Increase/Decrease Threshold* IE, and only when this rise occurs within the requested rising time specified by the *Measurement Change Time* IE. After reporting this type of event, the RNC₂ shall not initiate the next C event reporting for the same measurement during the subsequent time specified by the *Measurement Change Time* IE.

If the *Report Characteristics* IE is set to "Event D", the RNC₂ shall initiate the Common Measurement Reporting procedure when the measured entity falls more than the requested threshold specified by the *Measurement Increase/Decrease Threshold* IE, and only when this fall occurs within the requested falling time specified by the *Measurement Change Time* IE. After reporting this type of event,, the RNC₂ shall not initiate the next D event reporting for the same measurement during the subsequent time specified by the *Measurement Change Time* IE.

If the *Report Characteristics* IE is set to "Event E", the RNC₂ shall initiate the Common Measurement Reporting procedure when the measured entity rises above the *Measurement Threshold 1* IE and stays above the threshold for the *Measurement Hysteresis Time* IE (Report A). When the conditions for Report A are met and if the *Report Periodicity* IE is provided, the RNC₂ shall initiate the Common Measurement Reporting procedure periodically with the requested report frequency specified by the *Report Periodicity* IE. If the conditions for Report A have been met and the measured entity falls below the *Measurement Threshold 2* IE and stays below the threshold for the *Measurement Hysteresis Time* IE, the RNC₂ shall initiate the Common Measurement Reporting procedure (Report B) and shall terminate any corresponding periodic reporting. If the *Measurement Threshold 2* IE is not present, the RNC₂ shall use the value of the *Measurement Threshold 1* IE instead. If the *Measurement Hysteresis Time* IE is not included, the RNC₂ shall use the value zero as hysteresis times for both Report A and Report B.

If the *Report Characteristics* IE is set to "Event F", the RNC₂ shall initiate the Common Measurement Reporting procedure when the measured entity falls below the *Measurement Threshold 1* IE and stays below the threshold for the *Measurement Hysteresis Time* IE (Report A). When the conditions for Report A are met and if the *Report Periodicity* IE is provided, the RNC₂ shall initiate the Measurement Reporting procedure periodically with the requested report frequency specified by the *Report Periodicity* IE. If the conditions for Report A have been met and the measured entity rises above the *Measurement Threshold 2* IE and stays above the threshold for the *Measurement Hysteresis Time* IE, the RNC₂ shall initiate the Common Measurement Reporting procedure (Report B) and shall terminate any corresponding periodic reporting. If the *Measurement Threshold 2* IE is not present, the RNC₂ shall use the value of the *Measurement Threshold 1* IE instead. If the *Measurement Hysteresis Time* IE is not included, the RNC₂ shall use the value zero as hysteresis times for both Report A and Report B.

If the *Report Characteristics* IE is set to "On Modification" and if the *SFN* IE is not provided, the RNC₂ shall report the result of the requested measurement immediately. If the *SFN* IE is provided, it indicates the frame for which the first measurement value shall be provided. The provided measurement value shall be the one reported by the layer 3 filter, referred to as point C in the measurement model [26]. Furthermore, if the *SFN* IE is present and if the *Common Measurement Type* IE is set to "SFN-SFN Observed Time Difference", then the *SFN* IE relates to the Radio Frames of the Reference Cell identified by the *Reference Cell Identifier* IE. Following the first measurement report, the RNC₂ shall initiate the Common Measurement Reporting procedure in accordance to the following conditions:

1. If the *Common Measurement Type* IE is set to "UTRAN GPS Timing of Cell Frames for UE Positioning":

- If the *T_{UTRAN-GPS} Change Limit* IE is included in the *T_{UTRAN-GPS} Measurement Threshold Information* IE, the RNC₂ shall calculate the change of T_{UTRAN-GPS} value (F_n) each time a new measurement result is received after point C in the measurement model [25]. The RNC₂ shall initiate the Common Measurement Reporting procedure and set n equal to zero when the absolute value of F_n rises above the threshold indicated by the *T_{UTRAN-GPS} Change Limit* IE. The change of T_{UTRAN-GPS} value (F_n) is calculated according to the following:

$$F_n = 0 \text{ for } n=0$$

$$F_n = (M_n - M_{n-1}) \bmod 3715891200000 - ((SFN_n - SFN_{n-1}) \bmod 4096) * 10 * 3.84 * 10^3 * 16 + F_{n-1} \quad \text{for } n > 0$$

F_n is the change of the T_{UTRAN-GPS} value expressed in unit [1/16 chip] when n measurement results have been received after the first Common Measurement Reporting at initiation or after the last event was triggered.

M_n is the latest measurement result received after point C in the measurement model [25], measured at SFN_n.

M_{n-1} is the previous measurement result received after point C in the measurement model [25], measured at SFN_{n-1}.

M₁ is the first measurement result received after point C in the measurement model [25], after first Common Measurement Reporting at initiation or after the last event was triggered.

M₀ is equal to the value reported in the first Common Measurement Reporting at initiation or in the Common Measurement Reporting when the event was triggered.

- If the *Predicted T_{UTRAN-GPS} Deviation Limit* IE is included in the *T_{UTRAN-GPS} Measurement Threshold Information* IE, the RNC₂ shall update the P_n and F_n each time a new measurement result is received after

point C in the measurement model [25]. The RNC₂ shall initiate the Common Measurement Reporting procedure and set n equal to zero when F_n rises above the threshold indicated by the *Predicted T_{UTRAN-GPS} Deviation Limit* IE. The P_n and F_n are calculated according to the following:

$$P_n = b \text{ for } n=0$$

$$P_n = ((a/16) * ((SFN_n - SFN_{n-1}) \bmod 4096) / 100 + ((SFN_n - SFN_{n-1}) \bmod 4096) * 10 * 3.84 * 10^3 * 16 + P_{n-1}) \bmod 37158912000000 \text{ for } n > 0$$

$$F_n = \min((M_n - P_n) \bmod 37158912000000, (P_n - M_n) \bmod 37158912000000) \text{ for } n > 0$$

P_n is the predicted T_{UTRAN-GPS} value when n measurement results have been received after the first Common Measurement Reporting at initiation or after the last event was triggered.

a is the last reported T_{UTRAN-GPS} Drift Rate value.

b is the last reported T_{UTRAN-GPS} value.

F_n is the deviation of the last measurement result from the predicted T_{UTRAN-GPS} value (P_n) when n measurements have been received after the first Common Measurement Reporting at initiation or after the last event was triggered.

M_n is the latest measurement result received after point C in the measurement model [25], measured at SFN_n.

M₁ is the first measurement result received after point C in the measurement model [25], after first Common Measurement Reporting at initiation or after the last event was triggered.

The T_{UTRAN-GPS} Drift Rate is determined by the RN₂ in an implementation-dependent way after point B (see model of physical layer measurements in [26]).

2. If the *Common Measurement Type* IE is set to "SFN-SFN Observed Time Difference":

- If the *SFN-SFN Change Limit* IE is included in the *SFN-SFN Measurement Threshold Information* IE, the RNC₂ shall calculate the change of SFN-SFN value (F_n) each time a new measurement result is received after point C in the measurement model [25]. The RNC₂ shall initiate the Common Measurement Reporting procedure in order to report the particular SFN-SFN measurement which has triggered the event and set n equal to zero when the absolute value of F_n rises above the threshold indicated by the *SFN-SFN Change Limit* IE. The change of the SFN-SFN value is calculated according to the following:

$$F_n = 0 \text{ for } n=0$$

$$[\text{FDD} - F_n = (M_n - a) \bmod 614400 \text{ for } n > 0]$$

$$[\text{TDD} - F_n = (M_n - a) \bmod 40960 \text{ for } n > 0]$$

F_n is the change of the SFN-SFN value expressed in unit [1/16 chip] when n measurement results have been received after the first Common Measurement Reporting at initiation or after the last event was triggered.

a is the last reported SFN-SFN.

M_n is the latest measurement result received after point C in the measurement model [25], measured at SFN_n.

M₁ is the first measurement result received after point C in the measurement model [25], after the first Common Measurement Reporting at initiation or after the last event was triggered.

- If the *Predicted SFN-SFN Deviation Limit* IE is included in the *SFN-SFN Measurement Threshold Information* IE, the RNC₂ shall each time a new measurement result is received after point C in the measurement model [25], update the P_n and F_n. The RNC₂ shall initiate the Common Measurement Reporting procedure in order to report the particular SFN-SFN measurement which has triggered the event and set n equal to zero when F_n rises above the threshold indicated by the *Predicted SFN-SFN Deviation Limit* IE. The P_n and F_n are calculated according to the following:

$$P_n = b \text{ for } n=0$$

$$[\text{FDD} - P_n = ((a/16) * ((SFN_n - SFN_{n-1}) \bmod 4096) / 100 + P_{n-1}) \bmod 614400 \text{ for } n > 0]$$

$$[\text{FDD} - F_n = \min((M_n - P_n) \bmod 614400, (P_n - M_n) \bmod 614400) \text{ for } n > 0]$$

$$[\text{TDD} - P_n = ((a/16) * (15 * (\text{SFN}_n - \text{SFN}_{n-1}) \bmod 4096 + (\text{TS}_n - \text{TS}_{n-1})) / 1500 + P_{n-1}) \bmod 40960 \text{ for } n > 0]$$

$$[\text{TDD} - F_n = \min((M_n - P_n) \bmod 40960, (P_n - M_n) \bmod 40960) \text{ for } n > 0]$$

P_n is the predicted *SFN-SFN* value when n measurement results have been received after the first Common Measurement Reporting at initiation or after the last event was triggered.

a is the last reported *SFN-SFN* Drift Rate value.

b is the last reported *SFN-SFN* value.

F_n is the deviation of the last measurement result from the predicted *SFN-SFN* value (P_n) when n measurements have been received after the first Common Measurement Reporting at initiation or after the last event was triggered.

M_n is the latest measurement result received after point C in the measurement model [25], measured at the [TDD – the Time Slot TS_n of] the Frame SFN_n .

M_j is the first measurement result received after point C in the measurement model [25], after first Common Measurement Reporting at initiation or after the last event was triggered.

The *SFN-SFN* Drift Rate is determined by the RNS_2 in an implementation-dependent way after point B (see model of physical layer measurements in [26]).

If the *Report Characteristics* IE is not set to "On-Demand", the RNC_2 is required to perform reporting for a common measurement object, in accordance with the conditions provided in the COMMON MEASUREMENT INITIATION REQUEST message, as long as the object exists. If no common measurement object(s) for which a measurement is defined exists any more, the RNC_2 shall terminate the measurement locally without reporting this to RNC_1 .

If at the start of the measurement, the reporting criteria are fulfilled for any of Event A, Event B, Event E or Event F, the RNC_2 shall initiate a Measurement Reporting procedure immediately, and then continue with the measurements as specified in the COMMON MEASUREMENT INITIATION REQUEST message.

Common measurement accuracy

If the *Common Measurement Type* IE is set to "UTRAN GPS Timing of Cell Frames for UE Positioning", then the RNC_2 shall use the *UTRAN GPS Timing Measurement Minimum Accuracy Class* IE included in the *Report Characteristics* IE according to the following:

- If the *UTRAN GPS Timing Measurement Minimum Accuracy Class* IE indicates "Class A", then the concerned RNC_2 shall perform the measurement with the highest supported accuracy within the accuracy classes A, B or C.
- If the *UTRAN GPS Timing Measurement Minimum Accuracy Class* IE indicates the "Class B", then the concerned RNC_2 shall perform the measurements with the highest supported accuracy within the accuracy classes B or and
- If the *UTRAN GPS Timing Measurement Minimum Accuracy Class* IE indicates "Class C", then the concerned RNC_2 shall perform the measurements with the highest supported accuracy according to class C.
- If the *Common Measurement Type* IE is set to "SFN-SFN Observed Time Difference", then the concerned RNC_2 shall initiate the SFN-SFN observed Time Difference measurements between the reference cell identified by *UC-ID* IE and the neighbouring cells identified by their UC-ID. The *Report Characteristics* IE applies to each of these measurements.

Higher layer filtering

The *Measurement Filter Coefficient* IE indicates how filtering of the measurement values shall be performed before measurement event evaluation and reporting.

The averaging shall be performed according to the following formula.

$$F_n = (1 - a) \cdot F_{n-1} + a \cdot M_n$$

The variables in the formula are defined as follows

F_n is the updated filtered measurement result

F_{n-1} is the old filtered measurement result

M_n is the latest received measurement result from physical layer measurements, the unit used for M_n is the same unit as the reported unit in the COMMON MEASUREMENT INITIATION RESPONSE, COMMON MEASUREMENT REPORT messages or the unit used in the event evaluation (i.e. same unit as for F_n).

$a = 1/2^{(k/2)}$, where k is the parameter received in the *Measurement Filter Coefficient* IE. If the *Measurement Filter Coefficient* IE is not present, a shall be set to 1 (no filtering).

In order to initialise the averaging filter, F_0 is set to M_1 when the first measurement result from the physical layer measurement is received.

Response message

If the RNC₂ was able to initiate the measurement requested by RNC₁, it shall respond with the COMMON MEASUREMENT INITIATION RESPONSE message. The message shall include the same Measurement ID that was used in the COMMON MEASUREMENT INITIATION REQUEST message.

In the case in which the *Report Characteristics* IE is set to "On-Demand" or "On Modification":

- The RNC₂ shall include the measurement result in the *Common Measurement Value* IE within the COMMON MEASUREMENT INITIATION RESPONSE message. The RNC₂ shall also include the *Common Measurement Achieved Accuracy* IE if the *Common Measurement Type* IE is set to "UTRAN GPS Timing of Cell Frames for UE Positioning".
- If the *Common Measurement Type* IE is not set to "SFN-SFN Observed Time Difference" and if the *SFN Reporting Indicator* IE is set to "FN Reporting Required", then the RNC₂ shall include the *SFN* IE in the COMMON MEASUREMENT INITIATION RESPONSE message. The reported SFN shall be the SFN at the time when the measurement value was reported by the layer 3 filter, referred to as point C in the measurement model [26]. If the *Common Measurement Type* IE is set to "SFN-SFN Observed Time Difference", then the *SFN Reporting Indicator* IE is ignored.
- If the *Common Measurement Type* IE is set to "SFN-SFN Observed Time Difference", then the RNC₂ shall report all the available measurements in the *Successful Neighbouring cell SFN-SFN Observed Time Difference Measurement Information* IE, and the RNC₂ shall report the neighbouring cells with no measurement result available in the *Unsuccessful Neighbouring cell SFN-SFN Observed Time Difference Measurement Information* IE. For all available measurement results, the RNC₂ shall include in the *Successful Neighbouring Cell SFN-SFN Observed Time Difference Measurement Information* IE the *SFN-SFN Quality* IE and the *SFN-SFN Drift Rate Quality* IE, if available.

If the *Common Measurement Type* IE is set to "UTRAN GPS Timing of Cell Frames for UE Positioning" and the *Report Characteristics* IE is set to "On Demand" or "On Modification", the RNC₂ shall include in the *T_{UTRAN-GPS} Measurement Value Information* IE the *T_{UTRAN-GPS} Quality* IE and the *T_{UTRAN-GPS} Drift Rate Quality* IE, if available.

8.5.2.3 Unsuccessful Operation

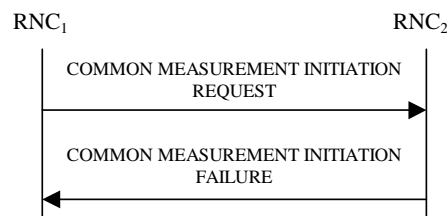

Figure 30B: Common Measurement Initiation procedure, Unsuccessful Operation

If the requested measurement cannot be initiated, the RNC₂ shall send a COMMON MEASUREMENT INITIATION FAILURE message. The message shall include the same *Measurement ID* IE that was used in the COMMON MEASUREMENT INITIATION REQUEST message and shall include the *Cause* IE set to an appropriate value.

Typical cause values are as follows:

Radio Network Layer Cause

- Measurement not supported for the object.
- Measurement Temporarily not Available

8.5.2.4 Abnormal Conditions

If the COMMON MEASUREMENT INITIATION REQUEST message contains the *SFN-SFN Measurement Threshold Information IE* (in the *Measurement Threshold IE* contained in the *Report Characteristics IE*) and it does not contain at least one IE, the RNC₂ shall reject the procedure using the COMMON MEASUREMENT INITIATION FAILURE message.

If the COMMON MEASUREMENT INITIATION REQUEST message contains the *T_{UTRAN-GPS} Measurement Threshold Information IE* (in the *Measurement Threshold IE* contained in the *Report Characteristics IE*) and it does not contain at least one IE, the RNC₂ shall reject the procedure using the COMMON MEASUREMENT INITIATION FAILURE message.

If the *Common Measurement Type IE* is set to "UTRAN GPS Timing of Cell Frames for UE Positioning", but the *T_{UTRAN-GPS} Measurement Minimum Accuracy Class IE* in the *Common Measurement Accuracy IE* is not received in the COMMON MEASUREMENT INITIATION REQUEST message, the RNC₂ shall reject the Common Measurement Initiation procedure using the COMMON MEASUREMENT INITIATION FAILURE message..

If the Common Measurement Type received in the *Common Measurement Type IE* is not "load", and if the Common Measurement Type received in the *Common Measurement Type IE* is not defined in ref. [11] or [15] to be measured on the Common Measurement Object Type indicated in the COMMON MEASUREMENT INITIATION REQUEST message, the RNC₂ shall reject the Common Measurement Initiation procedure using the COMMON MEASUREMENT INITIATION FAILURE message..

If the *Common Measurement Type IE* is set to "SFN-SFN Observed Time Difference", but the *Neighbouring Cell Measurement Information IE* is not received in the COMMON MEASUREMENT INITIATION REQUEST message, the RNC₂ shall reject the Common Measurement Initiation procedure using the COMMON MEASUREMENT INITIATION FAILURE message..

The allowed combinations of the Common Measurement Type and Report Characteristics Type are shown in the table below marked with "X". For not allowed combinations, the RNC₂ shall reject the Common Measurement Initiation procedure using the COMMON MEASUREMENT INITIATION FAILURE message..

Table X: Allowed Common Measurement Type and Report Characteristics Type Combinations

Common measurement type	Report characteristics type								
	On Demand	Periodic	Event A	Event B	Event C	Event D	Event E	Event F	On Modification
Received total wide band power	X	X	X	X	X	X	X	X	
Transmitted Carrier Power	X	X	X	X	X	X	X	X	
UL Timeslot ISCP	X	X	X	X	X	X	X	X	
Load	X	X	X	X	X	X	X	X	
UTRAN GPS Timing of Cell Frames for UE positioning	X	X							X
SFN-SFN Observed Time Difference	X	X							X

[TDD - If the Common Measurement Type requires the Time Slot Information but the [3.84Mcps TDD - *Time Slot IE*] [1.28Mcps TDD - *Time Slot LCR IE*] is not provided in the COMMON MEASUREMENT INITIATION REQUEST message the RNS₂ shall reject the Common Measurement Initiation procedure using the COMMON MEASUREMENT INITIATION FAILURE message..]

If the *SFN IE* is included in the COMMON MEASUREMENT INITIATION REQUEST message and the *Report Characteristics IE* is other than "Periodic", "On Demand" or "On Modification", the RNS₂ shall reject the Common Measurement Initiation procedure using the COMMON MEASUREMENT INITIATION FAILURE message..

8.5.3 Common Measurement Reporting

8.5.3.1 General

This procedure is used by an RNC to report the result of measurements requested by another RNC using the Common Measurement Initiation.

This procedure uses the signalling bearer connection for the relevant Distant RNC Context.

8.5.3.2 Successful Operation

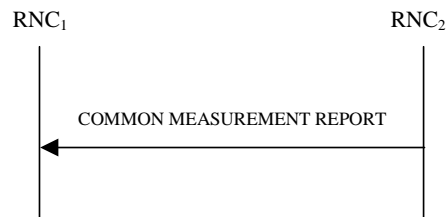

Figure 30C: Common Measurement Reporting procedure, Successful Operation

If the requested measurement reporting criteria are met, the RNC₂ shall initiate the Common Measurement Reporting procedure. Unless specified below, the meaning of the parameters are given in other specifications.

The *Measurement ID* IE shall be set to the Measurement ID provided by RNC₁ when initiating the measurement with the Common Measurement Initiation procedure.

If the achieved measurement accuracy does not fulfil the given accuracy requirement (see ref. [23] and [24]), the *Common Measurement Value Information* IE shall indicate Measurement not Available.

For measurements included in the *Successful Neighbouring Cell SFN-SFN Observed Time Difference Measurement Information* IE, the RNC₂ shall include the *SFN-SFN Quality* IE and the *SFN-SFN Drift Rate Quality* IE if available.

If the Common Measurement Type provided by RNC₁ when initiating the measurement with the Common Measurement Initiation procedure was "UTRAN GPS Timing of Cell Frames for UE Positioning", then the RNC₂ shall include in the *T_{UTRAN-GPS} Measurement Value Information* IE the *T_{UTRAN-GPS} Quality* IE and the *T_{UTRAN-GPS} Drift Rate Quality* IE, if available.

If the Common measurement type provided by RNC₁ when initiating the measurement with the Common Measurement Initiation procedure was "SFN-SFN Observed Time Difference", then RNC₂ shall include in the COMMON MEASUREMENT REPORT all the available measurements in the *Successful Neighbouring cell SFN-SFN Observed Time Difference Measurement Information* IE and shall include the neighbouring cells with no measurement result available in the *Unsuccessful Neighbouring cell SFN-SFN Observed Time Difference Measurement Information* IE.

If the Common measurement type provided by RNC₁ when initiating the measurement with the Common Measurement Initiation procedure was not set to "SFN-SFN Observed Time Difference" and the SFN Reporting Indicator when initiating the measurement was set to "FN Reporting Required", the RNC₂ shall include the *SFN* IE in the COMMON MEASUREMENT REPORT message. The reported SFN shall be the SFN at the time when the measurement value was reported by the layer 3 filter, referred to as point C in the measurement model [26]. If the *Common Measurement Type* IE is set to "SFN-SFN Observed Time Difference", then the *SFN Reporting Indicator* IE is ignored.

8.5.3.3 Abnormal Conditions

-

8.5.4 Common Measurement Termination

8.5.4.1 General

This procedure is used by an RNC to terminate a measurement previously requested by the Common Measurement Initiation procedure.

This procedure uses the signalling bearer connection for the relevant Distant RNC Context.

8.5.4.2 Successful Operation



Figure 30D: Common Measurement Termination procedure, Successful Operation

This procedure is initiated with a COMMON MEASUREMENT TERMINATION REQUEST message.

Upon receipt, RNC₂ shall terminate reporting of common measurements corresponding to the received *Measurement ID* IE.

8.5.4.3 Abnormal Conditions

-

8.5.5 Common Measurement Failure

8.5.5.1 General

This procedure is used by an RNC to notify another RNC that a measurement previously requested by the Common Measurement Initiation procedure can no longer be reported.

This procedure uses the signalling bearer connection for the relevant Distant RNC Context.

8.5.5.2 Successful Operation

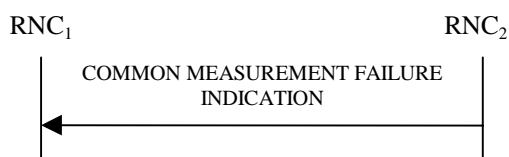

Figure 30E: Common Measurement Failure procedure, Successful Operation

This procedure is initiated with a COMMON MEASUREMENT FAILURE INDICATION message, sent from RNC₂ to RNC₁ to inform the RNC₁ that a previously requested measurement can no longer be reported. RNC₂ has locally terminated the indicated measurement. The RNC₂ shall include in the DEDICATED MEASUREMENT FAILURE INDICATION message the reason for the failure in the *Cause* IE.

8.5.5.3 Abnormal Conditions

-

8.5.6 Information Exchange Initiation

8.5.6.1 General

This procedure is used by a RNC to request the initiation of an information exchange with another RNC.

This procedure uses the signalling bearer connection for the relevant Distant RNC Context.

8.5.6.2 Successful Operation

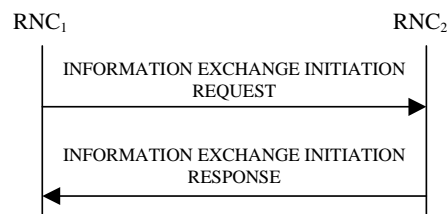

Figure 30F: Information Exchange Initiation procedure, Successful Operation

The procedure is initiated with an INFORMATION EXCHANGE INITIATION REQUEST message sent from RNC₁ to RNC₂.

Upon receipt, the RNC₂ shall provide the requested information according to the parameters given in the request. Unless specified below, the meaning of the parameters are given in other specifications.

Information Report Characteristics:

The *Information Report Characteristics* IE indicates how the reporting of the information shall be performed.

If the *Information Report Characteristics* IE is set to "On Demand", the RNC₂ shall report the requested information immediately.

If the *Information Report Characteristics* IE is set to "Periodic", the RNC₂ shall report the requested information immediately and then shall periodically initiate the Information Reporting procedure for all the requested information, with the report frequency indicated by the *Information Report Periodicity* IE.

If the *Information Report Characteristics* IE is set to "On –Modification", the RNC₂ shall report the requested information immediately if available. If the requested information is not available at the moment of receiving the INFORMATION EXCHANGE INITIATION REQUEST message, but expected to become available after some acquisition time, the RNC₂ shall initiate the Information Reporting procedure when the requested information becomes available. The RNC₂ shall then initiate the Information Reporting procedure in accordance to the following conditions:

- If the *Information Type Item* IE is set to "IPDL Parameters", the RNC₂ shall initiate the Information Reporting procedure when any change in the parameters occurs.
- If the *Information Type Item* IE is set to "DGPS Corrections", the RNC₂ shall initiate the Information Reporting procedure for this specific Information Type when either the PRC has drifted from the previously reported value more than the threshold indicated in the *PRC Deviation* IE or a change has occurred in the IODE.
- If the *Information Type Item* IE is set to "GPS Information" and the *GPS Information Item* IE includes "GPS Navigation Model & Recovery Assistance", the RNC₂ shall initiate the Information Reporting procedure for this specific GPS Information Item when a change has occurred regarding either the IODC or the list of visible satellites, identified by the *SatID* IEs.
- If the *Information Type Item* IE is set to "GPS Information" and the *GPS Information Item* IE includes "GPS Ionospheric Model", the RNC₂ shall initiate the Information Reporting procedure for this specific GPS Information Item when any change has occurred.

- If the *Information Type Item* IE is set to "GPS Information" and the *GPS Information Item* IE includes "GPS UTC Model", the RNC₂ shall initiate the Information Reporting procedure for this specific GPS Information Item when a change has occurred in the t_{ot} or WN_t parameter.
- If the *Information Type Item* IE is set to "GPS Information" and the *GPS Information Item* IE includes "GPS Almanac", the RNC₂ shall initiate the Information Reporting procedure for this specific GPS Information Item when a change in the t_{oa} or WN_a parameter has occurred.
- If the *Information Type Item* IE is set to "GPS Information" and the *GPS Information Item* IE includes "GPS Real-Time Integrity", the RNC₂ shall initiate the Information Reporting procedure for this specific GPS Information Item when any change has occurred.
- If any of the above *Information Type* IEs becomes temporarily unavailable, the RNC₂ shall initiate the Information Reporting procedure for this specific Information Item by indicating "Information Not Available" in the *Requested Data Value Information* IE. If the Information becomes available again, the RNC₂ shall initiate the Information Reporting procedure for this specific Information.

Response message:

If the RNC₂ is able to determine the information requested by the RNC₁, it shall respond with the INFORMATION EXCHANGE INITIATION RESPONSE message. The message shall include the *Information Exchange ID* IE set to the same value that was included in the INFORMATION EXCHANGE INITIATION REQUEST message. When the *Report Characteristics* IE is set to "On Modification" or "Periodic", the INFORMATION EXCHANGE INITIATION RESPONSE message shall contain the *Requested Data Value* IE if the data are available. When the *Report Characteristics* IE is set to "On Demand", the INFORMATION EXCHANGE INITIATION RESPONSE message shall contain the *Requested Data Value* IE.

8.5.6.3 Unsuccessful Operation

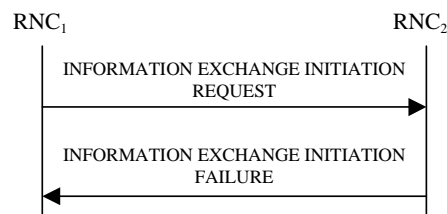

Figure 30G: Information Exchange Initiation procedure, Unsuccessful Operation

If the requested Information Type received in the *Information Type* IE indicates a type of information that RNC₂ cannot provide, the RNC₂ shall reject the Information Exchange Initiation procedure.

If the requested information provision cannot be accessed, the RNC₂ shall reject the procedure and shall send the INFORMATION EXCHANGE INITIATION FAILURE message.

The message shall include the *Information Exchange ID* IE set to the same value that was used in the INFORMATION EXCHANGE INITIATION REQUEST message and the *Cause* IE set to an appropriate value.

Typical cause values are as follows:

Radio Network Layer Cause:

Information temporarily not available.

Information Provision not supported for the object.

8.5.6.4 Abnormal Conditions

If the *Information Report Characteristics* IE is set to "On Modification", and the *Information Type Item* IE is set to "DGPS Corrections", but the *Information Threshold* IE is not received in the INFORMATION EXCHANGE

INITIATION REQUEST message, the RNC₂ shall reject the Information Exchange Initiation procedure and shall send the INFORMATION EXCHANGE INITIATION FAILURE message.

The allowed combinations of the Information type and Information Report Characteristics type are shown in the table below marked with "X". For not allowed combinations, the RNC₂ shall reject the Information Exchange Initiation procedure using the INFORMATION EXCHANGE INITIATION FAILURE message.

Table x: Allowed Information Type and Information Report Characteristics type combinations

Information Type	Information Report Characteristics Type		
	On Demand	Periodic	On Modification
UTRAN Access Point Position with Altitude	X		
UTRAN Access Point Position	X		
IPDL Parameters	X	X	X
GPS Information	X	X	X
DGPS Corrections	X	X	X
GPS RX Pos	X		
,SFN-SFN Measurement Reference Point Position	X		

8.5.7 Information Reporting

8.5.7.1 General

This procedure is used by a RNC to report the result of information requested by another RNC using the Information Exchange Initiation.

This procedure uses the signalling bearer connection for the relevant Distant RNC Context.

8.5.7.2 Successful Operation

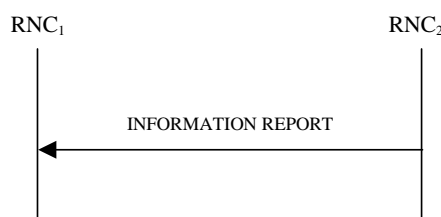

Figure 30H: Information Reporting procedure, Successful Operation

If the requested information reporting criteria are met, the RNC₂ shall initiate an Information Reporting procedure. Unless specified below, the meaning of the parameters are given in other specifications.

The *Information Exchange ID* IE shall be set to the Information Exchange ID provided by the RNC₁ when initiating the information exchange with the Information Exchange Initiation procedure.

The *Requested Data Value* IE shall include at least one IE containing the data to be reported.

8.5.7.3 Abnormal Conditions

-

8.5.8 Information Exchange Termination

8.5.8.1 General

This procedure is used by a RNC to terminate the information exchange requested using the Information Exchange Initiation.

This procedure uses the signalling bearer connection for the relevant Distant RNC Context.

8.5.8.2 Successful Operation



Figure 30I: Information Exchange Termination procedure, Successful Operation

This procedure is initiated with a INFORMATION EXCHANGE TERMINATION REQUEST message.

Upon receipt, the RNC₂ shall terminate the information exchange corresponding to the *Information Exchange ID IE* provided by the RNC₁ when initiating the information exchange with the Information Exchange Initiation procedure.

8.5.8.3 Abnormal Conditions

-

8.5.9 Information Exchange Failure

8.5.9.1 General

This procedure is used by a RNC to notify another that the information exchange it previously requested using the Information Exchange Initiation can no longer be reported.

This procedure uses the signalling bearer connection for the relevant Distant RNC Context.

8.5.9.2 Successful Operation

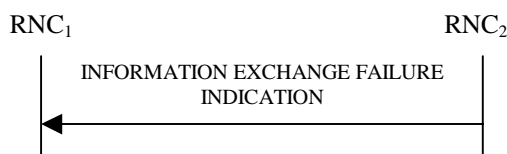

Figure 30J: Information Exchange Failure procedure, Successful Operation

This procedure is initiated with a INFORMATION EXCHANGE FAILURE INDICATION message, sent from the RNC₂ to the RNC₁, to inform the RNC₁ that information previously requested by the Information Exchange Initiation procedure can no longer be reported. The RNC₂ shall include in the INFORMATION EXCHANGE FAILURE INDICATION message the *Information Exchange ID IE* set to the same value provided by the RNC₁ when initiating the information exchange with the Information Exchange Initiation procedure, and the RNC₂ shall include the *Cause IE* set to an appropriate value.

Typical cause values are as follows:

Radio Network Layer Cause:

Information temporarily not available.

9 Elements for RNSAP Communication

9.1 Message Functional Definition and Content

9.1.1 General

This subclause defines the structure of the messages required for the RNSAP protocol in tabular format. The corresponding ASN.1 definition is presented in subclause 9.3. In case there is contradiction between the tabular format in subclause 9.1 and the ASN.1 definition, the ASN.1 shall take precedence, except for the definition of conditions for the presence of conditional IEs, in which the tabular format shall take precedence.

NOTE: The messages have been defined in accordance to the guidelines specified in [28].

9.1.2 Message Contents

9.1.2.1 Presence

An information element can be of the following *types*:

M	IEs marked as Mandatory (M) shall always be included in the message.
O	IEs marked as Optional (O) may or may not be included in the message.
C	IEs marked as Conditional (C) shall be included in a message only if the condition is satisfied. Otherwise the IE shall not be included.

In the case of an Information Element group, the group is preceded by a name for the info group (in bold). It is also indicated how many times a group may be repeated in the message and whether the group is conditional. Each group may be also repeated within one message. The presence field of the Information Elements inside one group defines if the Information Element is mandatory, optional or conditional if the group is present.

9.1.2.2 Criticality

Each information element or Group of information elements may have criticality information applied to it. Following cases are possible:

–	No criticality information is applied explicitly.
YES	Criticality information is applied. 'YES' is usable only for non-repeatable information elements.
GLOBAL	The information element and all its repetitions together have one common criticality information. 'GLOBAL' is usable only for repeatable information elements.
EACH	Each repetition of the information element has its own criticality information. It is not allowed to assign different criticality values to the repetitions. 'EACH' is usable only for repeatable information elements.

9.1.2.3 Range

The Range column indicates the allowed number of copies of repetitive IEs/IE groups.

9.1.2.4 Assigned Criticality

This column provides the actual criticality information as defined in subclause 10.3.2, if applicable.

9.1.3 RADIO LINK SETUP REQUEST

9.1.3.1 FDD Message

IE/Group Name	Presence	Range	IE Type and Reference	Semantics Description	Criticality	Assigned Criticality
Message Type	M		9.2.1.40		YES	reject
Transaction ID	M		9.2.1.59		–	
SRNC-ID	M		RNC-ID 9.2.1.50		YES	reject
S-RNTI	M		9.2.1.53		YES	reject
D-RNTI	O		9.2.1.24		YES	reject
Allowed Queuing Time	O		9.2.1.2		YES	reject
UL DPCH Information		1			YES	reject
>UL Scrambling Code	M		9.2.2.53		–	
>Min UL Channelisation Code Length	M		9.2.2.25		–	
>Max Number of UL DPDCHs	C – CodeLen		9.2.2.24		–	
>Puncture Limit	M		9.2.1.46	For the UL.	–	
>TFCS	M		TFCS for the UL 9.2.1.63		–	
>UL DPCH Slot Format	M		9.2.2.52		–	
>Uplink SIR Target	O		Uplink SIR 9.2.1.69		–	
>Diversity mode	M		9.2.2.8		–	
>SSDT Cell Identity Length	O		9.2.2.41		–	
>S Field Length	O		9.2.2.36		–	
>DPC Mode	O		9.2.2.12A		YES	reject
DL DPCH Information		1			YES	reject
>TFCS	M		TFCS for the DL. 9.2.1.63		–	
>DL DPCH Slot Format	M		9.2.2.9		–	
>Number of DL Channelisation Codes	M		9.2.2.26A		–	
>TFCI Signalling Mode	M		9.2.2.46		–	
>TFCI Presence	C- SlotFormat		9.2.1.55		–	
>Multiplexing Position	M		9.2.2.26		–	
>Power Offset Information		1			–	
>>PO1	M		Power Offset 9.2.2.30	Power offset for the TFCI bits.	–	
>>PO2	M		Power Offset 9.2.2.30	Power offset for the TPC bits.	–	
>>PO3	M		Power Offset 9.2.2.30	Power offset for the pilot bits.	–	
>FDD TPC Downlink Step Size	M		9.2.2.16		–	
>Limited Power Increase	M		9.2.2.21A		–	
>Inner Loop DL PC Status	M		9.2.2.21a		–	
>Split Type	C-IfSplit		9.2.2.39a		YES	reject
>Length of TFCI2	C- SplitType		9.2.2.21C		YES	reject
DCH Information	M		DCH FDD Information 9.2.2.4A		YES	reject
DSCH Information	O		DSCH FDD Information		YES	reject

IE/Group Name	Presence	Range	IE Type and Reference	Semantics Description	Criticality	Assigned Criticality
RL Information		$1 \dots \langle \text{maxnoofRLs} \rangle$	9.2.2.13A		EACH	notify
>RL ID	M		9.2.1.49		–	
>C-ID	M		9.2.1.6		–	
>First RLS Indicator	M		9.2.2.16A		–	
>Frame Offset	M		9.2.1.30		–	
>Chip Offset	M		9.2.2.1		–	
>Propagation Delay	O		9.2.2.33		–	
>Diversity Control Field	C – NotFirstRL		9.2.1.20		–	
>Initial DL TX Power	O		DL Power 9.2.1.21A		–	
>Primary CPICH Ec/No	O		9.2.2.32		–	
>SSDT Cell Identity	O		9.2.2.40		–	
>Transmit Diversity Indicator	C – Diversity mode		9.2.2.48		–	
>SSDT Cell Identity for EDSCHPC	C- EDSCHPC		9.2.2.40A		YES	ignore
Transmission Gap Pattern Sequence Information	O		9.2.2.47A		YES	reject
Active Pattern Sequence Information	O		9.2.2.A		YES	reject
Permanent NAS UE Identity	O		9.2.1.73		YES	ignore

Condition	Explanation
CodeLen	The IE shall be present if <i>Min UL Channelisation Code length</i> IE equals to 4
SlotFormat	The IE shall be present if the <i>DL DPCH Slot Format</i> IE is equal to any of the values from 12 to 16.
NotFirstRL	The IE shall be present if the RL is not the first one in the <i>RL Information</i> IE.
Diversity mode	The IE shall be present if <i>Diversity Mode</i> IE in <i>UL DPCH Information</i> IE is not equal to "none".
EDSCHPC	This IE shall be present if <i>Enhanced DSCH PC</i> IE is present in the <i>DSCH Information</i> IE.
IfSplit	The IE shall be present if the <i>TFCI Signalling Mode</i> IE is set to 'Split'.
SplitType	The IE shall be present if the <i>Split Type</i> IE is set to 'Logical'.

Range bound	Explanation
<i>maxnoofRLs</i>	Maximum number of RLs for one UE.

9.1.3.2 TDD Message

IE/Group Name	Presence	Range	IE Type and Reference	Semantics Description	Criticality	Assigned Criticality
Message Type	M		9.2.1.40		YES	reject
Transaction ID	M		9.2.1.59		–	
SRNC-ID	M		RNC-ID 9.2.1.50		YES	reject
S-RNTI	M		9.2.1.53		YES	reject
D-RNTI	O		9.2.1.24		YES	reject
UL Physical Channel Information		1			YES	reject
>Maximum Number of Timeslots per Frame	M		9.2.3.3A	For the UL	–	
>Minimum Spreading Factor	M		9.2.3.4A	For the UL	–	
>Maximum Number of UL Physical Channels per Timeslot	M		9.2.3.3B		–	
DL Physical Channel Information		1			YES	reject
>Maximum Number of Timeslots per Frame	M		9.2.3.3A	For the DL	–	
>Minimum Spreading Factor	M		9.2.3.4A	For the DL	–	
>Maximum Number of DL Physical Channels per Frame	M		9.2.3.3C		–	
Allowed Queuing Time	O		9.2.1.2		YES	reject
UL CCTrCH Information		0..<maxno of CCTrCHs>		For DCH and USCH	EACH	notify
>CCTrCH ID	M		9.2.3.2		–	
>TFCS	M		9.2.1.63	For the UL.	–	
>TFCI Coding	M		9.2.3.11		–	
>Puncture Limit	M		9.2.1.46		–	
>TDD TPC Uplink Step Size	O		9.2.3.10a	Mandatory for 1.28Mcps TDD, not applicable to 3.84Mcps TDD	YES	reject
DL CCTrCH Information		0..<maxno of CCTrCHs>		For DCH and DSCH	EACH	notify
>CCTrCH ID	M		9.2.3.2		–	
>TFCS	M		9.2.1.63	For the DL.	–	
>TFCI Coding	M		9.2.3.11		–	
>Puncture Limit	M		9.2.1.46		–	
>TDD TPC Downlink Step Size	M		9.2.3.10		–	
>TPC CCTrCH List		0..<maxno CCTrCHs>		List of uplink CCTrCH which provide TPC	–	
>>TPC CCTrCH ID	M		CCTrCH ID 9.2.3.2		–	
DCH Information	O		DCH TDD Information 9.2.3.2A		YES	reject
DSCH Information	O		DSCH TDD Information 9.2.3.3a		YES	reject
USCH Information	O		9.2.3.15		YES	reject

RL Information		1			YES	reject
>RL ID	M		9.2.1.49		-	
>C-ID	M		9.2.1.6		-	
>Frame Offset	M		9.2.1.30		-	
>Special Burst Scheduling	M		9.2.3.7D		-	
>Primary CCPCH RSCP	O		9.2.3.5		-	
>DL Time Slot ISCP Info	O		9.2.3.2D	Applicable to 3.84Mcps TDD only	-	
>DL Time Slot ISCP Info LCR	O		9.2.3.2F	Applicable to 1.28Mcps TDD only	YES	reject
>TSTD Support Indicator	O		9.2.3.13F	Applicable to 1.28Mcps TDD only	YES	ignore
>UL Synchronisation Parameters LCR		0..1			YES	ignore
>>Uplink Synchronisation Step Size	M		9.2.3.13J		-	
>>Uplink Synchronisation Frequency	M		9.2.3.13I		-	
Permanent NAS UE Identity	O		9.2.1.73		YES	ignore
PDSCH -RL -ID	O		RL ID 9.2.1.49		YES	ignore

Range bound	Explanation
<i>maxnoofCCTrCHs</i>	Maximum number of CCTrCH for one UE.

9.1.4 RADIO LINK SETUP RESPONSE

9.1.4.1 FDD Message

IE/Group Name	Presence	Range	IE Type and Reference	Semantics Description	Criticality	Assigned Criticality
Message Type	M		9.2.1.40		YES	reject
Transaction ID	M		9.2.1.59		–	
D-RNTI	O		9.2.1.24		YES	ignore
CN PS Domain Identifier	O		9.2.1.12		YES	ignore
CN CS Domain Identifier	O		9.2.1.11		YES	ignore
RL Information Response		<i>1..<maxno ofRLs></i>			EACH	ignore
>RL ID	M		9.2.1.49		–	
>RL Set ID	M		9.2.2.35		–	
>URA Information	O		9.2.1.70B		–	
>SAI	M		9.2.1.52		–	
>Cell GAI	O		9.2.1.5A		–	
>UTRAN Access Point Position	O		9.2.1.70A		–	
>Received Total Wide Band Power	M		9.2.2.35A		–	
>Secondary CCPCH Info	O		9.2.2.37B		–	
>DL Code Information	M		FDD DL Code Information 9.2.2.14A		–	
>CHOICE <i>Diversity Indication</i>	M				–	
>> <i>Combining</i>					–	
>>>RL ID	M		9.2.1.49	Reference RL ID for the combining	–	
>>>DCH Information Response	O		9.2.1.16A		YES	ignore
>> <i>Non Combining or First RL</i>					–	
>>>DCH Information Response	M		9.2.1.16A		–	
>SSDT Support Indicator	M		9.2.2.43		–	
>Maximum Uplink SIR	M		Uplink SIR 9.2.1.69		–	
>Minimum Uplink SIR	M		Uplink SIR 9.2.1.69		–	
>Closed Loop Timing Adjustment Mode	O		9.2.2.3A		–	
>Maximum Allowed UL Tx Power	M		9.2.1.35		–	
>Maximum DL TX Power	M		DL Power 9.2.1.21A		–	
>Minimum DL TX Power	M		DL Power 9.2.1.21A		–	
>Primary Scrambling Code	O		9.2.1.45		–	
>UL UARFCN	O		UARFCN 9.2.1.66	Corresponds to Nu in ref. [6]	–	
>DL UARFCN	O		UARFCN 9.2.1.66	Corresponds to Nd in ref. [6]	–	
>Primary CPICH Power	M		9.2.1.44		–	
>DSCH Information Response	O		DSCH FDD Information Response 9.2.2.13B		YES	ignore

IE/Group Name	Presence	Range	IE Type and Reference	Semantics Description	Criticality	Assigned Criticality
>Neighbouring UMTS Cell Information	O		9.2.1.41A		–	
>Neighbouring GSM Cell Information	O		9.2.1.41C		–	
>PC Preamble	M		9.2.2.27a		–	
>SRB Delay	M		9.2.2.39A		–	
>Cell GA Additional Shapes	O		9.2.1.5B		YES	ignore
Uplink SIR Target	O		Uplink SIR 9.2.1.69		YES	ignore
Criticality Diagnostics	O		9.2.1.13		YES	ignore
DSCH-RNTI	O		9.2.1.26Ba		YES	ignore

Range bound	Explanation
<i>maxnoofRLs</i>	Maximum number of RLs for one UE.

9.1.4.2 TDD Message

IE/Group Name	Presence	Range	IE Type and Reference	Semantics Description	Criticality	Assigned Criticality
Message Type	M		9.2.1.40		YES	reject
Transaction ID	M		9.2.1.59		–	
D-RNTI	O		9.2.1.24		YES	ignore
CN PS Domain Identifier	O		9.2.1.12		YES	ignore
CN CS Domain Identifier	O		9.2.1.11		YES	ignore
RL Information Response		0..1		Mandatory for 3.84Mcps TDD, not applicable to 1.28Mcps TDD	YES	ignore
>RL ID	M		9.2.1.49		–	
>URA Information	O		9.2.1.70B		–	
>SAI	M		9.2.1.52		–	
>Cell GAI	O		9.2.1.5A		–	
>UTRAN Access Point Position	O		9.2.1.70A		–	
>UL Time Slot ISCP Info	M		9.2.3.13D		–	
>Maximum Uplink SIR	M		Uplink SIR 9.2.1.69		–	
>Minimum Uplink SIR	M		Uplink SIR 9.2.1.69		–	
>Maximum Allowed UL Tx Power	M		9.2.1.35		–	
>Maximum DL TX Power	M		DL Power 9.2.1.21A		–	
>Minimum DL TX Power	M		DL Power 9.2.1.21A		–	
>UARFCN	O		UARFCN 9.2.1.66	Corresponds to Nt in ref. [7]	–	
>Cell Parameter ID	O		9.2.1.8		–	
>Sync Case	O		9.2.1.54		–	
>SCH Time Slot	C-Case2		9.2.1.51		–	
>SCTD Indicator	O		9.2.1.78		–	
>PCCPCH Power	M		9.2.1.43		–	
>Timing Advance Applied	M		9.2.3.12A		–	
>Alpha Value	M		9.2.3.a		–	
>UL PhysCH SF Variation	M		9.2.3.13B		–	
>Synchronisation Configuration	M		9.2.3.7E		–	
>Secondary CCPCH Info TDD	O		9.2.3.7B		–	
>UL CCTrCH Information		0..<maxno of CCTrCHs>		For DCH	GLOBAL	ignore
>>CCTrCH ID	M		9.2.3.2		–	
>>UL DPCH Information		0..1			YES	ignore
>>>Repetition Period	M		9.2.3.7		–	
>>>Repetition Length	M		9.2.3.6		–	
>>>TDD DPCH Offset	M		9.2.3.8A		–	
>>>UL Timeslot Information	M		9.2.3.13C		–	
>DL CCTrCH Information		0..<maxno of CCTrCHs>		For DCH	GLOBAL	ignore
>>CCTrCH ID	M		9.2.3.2		–	
>>DL DPCH Information		0..1			YES	ignore
>>>Repetition Period	M		9.2.3.7		–	
>>>Repetition Length	M		9.2.3.6		–	
>>>TDD DPCH Offset	M		9.2.3.8A		–	

IE/Group Name	Presence	Range	IE Type and Reference	Semantics Description	Criticality	Assigned Criticality
>>>DL Timeslot Information	M		9.2.3.2C			
>DCH Information Response	O		9.2.1.16A		YES	ignore
>DSCH Information Response		0 .. <maxnoof DSCHs>			GLOBAL	ignore
>>DSCH ID	M		9.2.1.26A		–	
>>DSCH Flow Control Information	M		9.2.1.26B		–	
>>Binding ID	O		9.2.1.3		–	
>>Transport Layer Address	O		9.2.1.62		–	
>>Transport Format Management	M		9.2.3.13		–	
>USCH Information Response		0 .. <maxnoof USCHs>			GLOBAL	ignore
>>USCH ID	M		9.2.3.14		–	
>>Binding ID	O		9.2.1.3		–	
>>Transport Layer Address	O		9.2.1.62		–	
>>Transport Format Management	M		9.2.3.13		–	
>Neighbouring UMTS Cell Information	O		9.2.1.41A		–	
>Neighbouring GSM Cell Information	O		9.2.1.41C		–	
>Cell GA Additional Shapes	O		9.2.1.5B		YES	ignore
>Time Slot for SCH	C-Case1		Time Slot 9.2.1.56		YES	ignore
Uplink SIR Target	M		Uplink SIR 9.2.1.69		YES	ignore
Criticality Diagnostics	O		9.2.1.13		YES	ignore
RL Information Response LCR		0..1		Mandatory for 1.28Mcps TDD, not applicable to 3.84Mcps TDD	YES	ignore
>RL ID	M		9.2.1.49		–	
>URA Information	M		9.2.1.70B		–	
>SAI	M		9.2.1.52		–	
>Cell GAI	O		9.2.1.5A		–	
>UTRAN Access Point Position	O		9.2.1.70A		–	
>UL Time Slot ISCP Info LCR	M		9.2.3.13H		–	
>Maximum Uplink SIR	M		Uplink SIR 9.2.1.69		–	
>Minimum Uplink SIR	M		Uplink SIR 9.2.1.69		–	
>Maximum Allowed UL Tx Power	M		9.2.1.35		–	
>Maximum DL TX Power	M		DL Power 9.2.1.21A		–	
>Minimum DL TX Power	M		DL Power 9.2.1.21A		–	
>UARFCN	O		UARFCN 9.2.1.66	Corresponds to Nt in ref. [7]	–	
>Cell Parameter ID	O		9.2.1.8		–	
>SCTD Indicator	O		9.2.1.78		–	
>PCCPCH Power	M		9.2.1.43		–	
>Alpha Value	M		9.2.3.a		–	
>UL PhysCH SF Variation	M		9.2.3.13B		–	

IE/Group Name	Presence	Range	IE Type and Reference	Semantics Description	Criticality	Assigned Criticality
>Synchronisation Configuration	M		9.2.3.7E		–	
>Secondary CCPCH Info TDD LCR	O		9.2.3.7F		–	
>UL CCTrCH Information LCR		<i>0..<maxno of CCTrCHs LCR></i>		For DCH	GLOBAL	ignore
>>CCTrCH ID	M		9.2.3.2		–	
>>UL DPCH Information LCR		<i>0..1</i>			YES	ignore
>>>Repetition Period	M		9.2.3.7		–	
>>>Repetition Length	M		9.2.3.6		–	
>>>TDD DPCH Offset	M		9.2.3.8A		–	
>>>UL Timeslot Information LCR	M		9.2.3.13G		–	
>DL CCTrCH Information LCR		<i>0..<maxno of CCTrCHs LCR></i>		For DCH	GLOBAL	ignore
>>CCTrCH ID	M		9.2.3.2		–	
>>DL DPCH Information LCR		<i>0..1</i>			YES	ignore
>>>Repetition Period	M		9.2.3.7		–	
>>>Repetition Length	M		9.2.3.6		–	
>>>TDD DPCH Offset	M		9.2.3.8A		–	
>>>DL Timeslot Information LCR	M		9.2.3.2E			
>>>TSTD Indicator	M		9.2.3.13E		–	
>DCH Information Response	O		9.2.1.16A		YES	ignore
>DSCH Information Response LCR		<i>0 .. <maxno of DSCHs LCR></i>			GLOBAL	ignore
>>DSCH ID	M		9.2.1.26A		–	
>>DSCH Flow Control Information	M		9.2.1.26B		–	
>>Binding ID	O		9.2.1.3		–	
>>Transport Layer Address	O		9.2.1.62		–	
>>Transport Format Management	M		9.2.3.13		–	
>USCH Information Response LCR		<i>0 .. <maxno of USCHs LCR></i>			GLOBAL	ignore
>>USCH ID	M		9.2.3.14		–	
>>Binding ID	O		9.2.1.3		–	
>>Transport Layer Address	O		9.2.1.62		–	
>>Transport Format Management	M		9.2.3.13		–	
>Neighbouring UMTS Cell Information	O		9.2.1.41A		–	
>Neighbouring GSM Cell Information	O		9.2.1.41C		–	
>Cell GA Additional Shapes	O		9.2.1.5B		YES	ignore
>Uplink Timing Advance Control LCR	M		9.2.3.13K		YES	ignore
DSCH RNTI	O		9.2.1.26Ba		YES	ignore

Condition	Explanation
Case2	The IE shall be present if <i>Sync Case</i> IE is equal to "Case2".
Case1	This IE shall be present if <i>Sync Case</i> IE is equal to "Case1".

Range bound	Explanation
<i>maxnoofDSCHs</i>	Maximum number of DSCHs for one UE for 3.84Mcps TDD.
<i>maxnoofUSCHs</i>	Maximum number of USCHs for one UE for 3.84Mcps TDD.
<i>maxnoofCCTrCHs</i>	Maximum number of CCTrCH for one UE for 3.84Mcps TDD.
<i>maxnoofDSCHsLCR</i>	Maximum number of DSCHs for one UE for 1.28Mcps TDD.
<i>maxnoofUSCHsLCR</i>	Maximum number of USCHs for one UE for 1.28Mcps TDD.
<i>maxnoofCCTrCHsLCR</i>	Maximum number of CCTrCH for one UE for 1.28Mcps TDD.

9.1.5 RADIO LINK SETUP FAILURE

9.1.5.1 FDD Message

IE/Group Name	Presence	Range	IE Type and Reference	Semantics Description	Criticality	Assigned Criticality
Message Type	M		9.2.1.40		YES	reject
Transaction ID	M		9.2.1.59		–	
D-RNTI	O		9.2.1.24		YES	ignore
CN PS Domain Identifier	O		9.2.1.12		YES	ignore
CN CS Domain Identifier	O		9.2.1.11		YES	ignore
CHOICE Cause Level	M				YES	ignore
>General					–	
>>Cause	M		9.2.1.5		–	
>RL Specific					–	
>>Unsuccessful RL Information Response		1..<maxno ofRLs>			EACH	ignore
>>>RL ID	M		9.2.1.49		–	
>>>Cause	M		9.2.1.5		–	
>>Successful RL Information Response		0..<maxno ofRLs-1>			EACH	ignore
>>>RL ID	M		9.2.1.49		–	
>>>RL Set ID	M		9.2.2.35		–	
>>>URA Information	O		9.2.1.70B		–	
>>>SAI	M		9.2.1.52		–	
>>>Cell GAI	O		9.2.1.5A		–	
>>>UTRAN Access Point Position	O		9.2.1.70A		–	
>>>Received Total Wide Band Power	M		9.2.2.35A		–	
>>>Secondary CCPCH Info	O		9.2.2.37B		–	
>>>DL Code Information	M		FDD DL Code Information 9.2.2.14A		–	
>>>CHOICE Diversity Indication	M				–	
>>>>Combining					–	
>>>>>RL ID	M		9.2.1.49	Reference RL ID for the combining	–	
>>>>>DCH Information Response	O		9.2.1.16A		YES	ignore
>>>>>Non Combining or First RL					–	
>>>>>DCH Information Response	M		9.2.1.16A		–	
>>>SSDT Support Indicator	M		9.2.2.43		–	
>>>Maximum Uplink SIR	M		Uplink SIR 9.2.1.69		–	
>>>Minimum Uplink SIR	M		Uplink SIR 9.2.1.69		–	
>>>Closed Loop Timing Adjustment Mode	O		9.2.2.3A		–	
>>>Maximum Allowed UL Tx Power	M		9.2.1.35		–	
>>>Maximum DL TX Power	M		DL Power 9.2.1.21A		–	
>>>Minimum DL TX Power	M		DL Power 9.2.1.21A		–	
>>>Primary CPICH Power	M		9.2.1.44		–	

IE/Group Name	Presence	Range	IE Type and Reference	Semantics Description	Criticality	Assigned Criticality
>>>Primary Scrambling Code	O		9.2.1.45		–	
>>>UL UARFCN	O		UARFCN 9.2.1.66	Corresponds to Nu in ref. [6]	–	
>>>DL UARFCN	O		UARFCN 9.2.1.66	Corresponds to Nd in ref. [6]	–	
>>>DSCH Information Response	O		DSCH FDD Information Response 9.2.2.13B		YES	ignore
>>>Neighbouring UMTS Cell Information	O		9.2.1.41A		–	
>>>Neighbouring GSM Cell Information	O		9.2.1.41C		-	
>>>PC Preamble	M		9.2.2.27a		-	
>>>SRB Delay	M		9.2.2.39A		-	
>>>Cell GA Additional Shapes	O		9.2.1.5B		YES	ignore
>>DSCH-RNTI	O		9.2.1.26Ba		YES	ignore
Uplink SIR Target	O		Uplink SIR 9.2.1.69		YES	ignore
Criticality Diagnostics	O		9.2.1.13		YES	ignore

Range bound	Explanation
<i>maxnoofRLs</i>	Maximum number of RLs for one UE.

9.1.5.2 TDD Message

IE/Group Name	Presence	Range	IE Type and Reference	Semantics Description	Criticality	Assigned Criticality
Message Type	M		9.2.1.40		YES	reject
Transaction ID	M		9.2.1.59		–	
CHOICE <i>Cause Level</i>	M				YES	ignore
> <i>General</i>					–	
>> <i>Cause</i>	M		9.2.1.5		–	
> <i>RL Specific</i>					–	
>> Unsuccessful RL Information Response		1			YES	ignore
>>>RL ID	M		9.2.1.49		–	
>>> <i>Cause</i>	M		9.2.1.5		–	
Criticality Diagnostics	O		9.2.1.13		YES	ignore

9.1.6 RADIO LINK ADDITION REQUEST

9.1.6.1 FDD Message

IE/Group Name	Presence	Range	IE Type and Reference	Semantics Description	Criticality	Assigned Criticality
Message Type	M		9.2.1.40		YES	reject
Transaction ID	M		9.2.1.59		–	
Uplink SIR Target	M		Uplink SIR 9.2.1.69		YES	reject
RL Information		<i>1..<maxnoofRLs-1></i>			EACH	notify
>RL ID	M		9.2.1.49		–	
>C-ID	M		9.2.1.6		–	
>Frame Offset	M		9.2.1.30		–	
>Chip Offset	M		9.2.2.1		–	
>Diversity Control Field	M		9.2.1.20		–	
>Primary CPICH Ec/No	O		9.2.2.32		–	
>SSDT Cell Identity	O		9.2.2.40			
>Transmit Diversity Indicator	O		9.2.2.48		–	
Active Pattern Sequence Information	O		9.2.2A	Either all the already active Transmission Gap Sequence(s) are addressed (Transmission Gap Pattern sequence shall overlap with the existing one) or none of the transmission gap sequences is activated.	YES	reject
DPC Mode	O		9.2.2.12A		YES	reject
Permanent NAS UE Identity	O		9.2.1.73		YES	ignore

Range bound	Explanation
<i>maxnoofRLs</i>	Maximum number of radio links for one UE.

9.1.6.2 TDD Message

IE/Group Name	Presence	Range	IE Type and Reference	Semantics Description	Criticality	Assigned Criticality
Message Type	M		9.2.1.40		YES	reject
Transaction ID	M		9.2.1.59		–	
RL Information		1			YES	reject
>RL ID	M		9.2.1.49		–	
>C-ID	M		9.2.1.6		–	
>Frame Offset	M		9.2.1.30		–	
>Diversity Control Field	M		9.2.1.20		–	
>Primary CCPCH RSCP	O		9.2.3.5		–	
>DL Time Slot ISCP Info	O		9.2.3.2D	Applicable to 3.84Mcps TDD only	–	
>DL Time Slot ISCP Info LCR	O		9.2.3.2F	Applicable to 1.28Mcps TDD only	YES	reject
>UL Synchronisation Parameters LCR		0..1		Mandatory for 1.28Mcps TDD. Not Applicable to 3.84Mcps TDD.	YES	ignore
>>Uplink Synchronisation Sstep Size	M		9.2.3.13J		-	
>>Uplink Synchronisation Frequency	M		9.2.3.13I		-	
Permanent NAS UE Identity	O		9.2.1.73		YES	ignore
UL CCTrCH Information		0..<maxno of CCTrCHs >			EACH	notify
>CCTrCH ID	M		9.2.3.2		–	
>TDD TPC Uplink Step Size	O		9.2.3.10a	Applicable to 1.28Mcps TDD only	–	
DL CCTrCH Information		0..<maxno of CCTrCHs >			EACH	notify
>CCTrCH ID	M		9.2.3.2		–	
>TDD TPC Downlink Step Size	O		9.2.3.10		–	

Range bound	Explanation
<i>maxnoofCCTrCHs</i>	Maximum number of CCTrCH for one UE.

9.1.7 RADIO LINK ADDITION RESPONSE

9.1.7.1 FDD Message

IE/Group Name	Presence	Range	IE Type and Reference	Semantics Description	Criticality	Assigned Criticality
Message Type	M		9.2.1.40		YES	reject
Transaction ID	M		9.2.1.59		–	
RL Information Response		<i>1..<maxnoof RLS-1></i>			EACH	ignore
>RL ID	M		9.2.1.49		–	
>RL Set ID	M		9.2.2.35		–	
>URA Information	O		9.2.1.70B		–	
>SAI	M		9.2.1.52		–	
>Cell GAI	O		9.2.1.5A		–	
>UTRAN Access Point Position	O		9.2.1.70A		–	
>Received Total Wide Band Power	M		9.2.2.35A		–	
>Secondary CCPCH Info	O		9.2.2.37B		–	
>DL Code Information	M		FDD DL Code Information 9.2.2.14A		YES	ignore
>CHOICE <i>Diversity Indication</i>	M				–	
>> <i>Combining</i>					–	
>>>RL ID	M		9.2.1.49	Reference RL ID	–	
>>>DCH Information Response	O		9.2.1.16A		YES	ignore
>> <i>Non Combining</i>					–	
>>>DCH Information Response	M		9.2.1.16A		–	
>SSDT Support Indicator	M		9.2.2.43		–	
>Minimum Uplink SIR	M		Uplink SIR 9.2.1.69		–	
>Maximum Uplink SIR	M		Uplink SIR 9.2.1.69		–	
>Closed Loop Timing Adjustment Mode	O		9.2.2.3A		–	
>Maximum Allowed UL Tx Power	M		9.2.1.35		–	
>Maximum DL TX Power	M		DL Power 9.2.1.21A		–	
>Minimum DL TX Power	M		DL Power 9.2.1.21A		–	
>Neighbouring UMTS Cell Information	O		9.2.1.41A		–	
>Neighbouring GSM Cell Information	O		9.2.1.41C		–	
>PC Preamble	M		9.2.2.27a		–	
>SRB Delay	M		9.2.2.39A		–	
>Primary CPICH Power	M		9.2.1.44		–	
>Cell GA Additional Shapes	O		9.2.1.5B		YES	ignore
Criticality Diagnostics	O		9.2.1.13		YES	ignore

Range bound	Explanation
<i>maxnoofRLs</i>	Maximum number of radio links for one UE.

9.1.7.2 TDD Message

IE/Group Name	Presence	Range	IE Type and Reference	Semantics Description	Criticality	Assigned Criticality
Message Type	M		9.2.1.40		YES	reject
Transaction ID	M		9.2.1.59		–	
RL Information Response		0..1		Mandatory for 3.84Mcps TDD, not applicable to 1.28Mcps TDD	YES	ignore
>RL ID	M		9.2.1.49		–	
>URA Information	O		9.2.1.70B		–	
>SAI	M		9.2.1.52		–	
>Cell GAI	O		9.2.1.5A		–	
>UTRAN Access Point Position	O		9.2.1.70A		–	
>UL Time Slot ISCP Info	M		9.2.3.13D		–	
>Minimum Uplink SIR	M		Uplink SIR 9.2.1.69		–	
>Maximum Uplink SIR	M		Uplink SIR 9.2.1.69		–	
>Maximum Allowed UL Tx Power	M		9.2.1.35		–	
>Maximum DL TX Power	M		DL Power 9.2.1.21A		–	
>Minimum DL TX Power	M		DL Power 9.2.1.21A		–	
>PCCPCH Power	M		9.2.1.43		–	
>Timing Advance Applied	M		9.2.3.12A		–	
>Alpha Value	M		9.2.3.a		–	
>UL PhysCH SF Variation	M		9.2.3.13B		–	
>Synchronisation Configuration	M		9.2.3.7E		–	
>Secondary CCPCH Info TDD	O		9.2.3.7B		–	
>UL CCTrCH Information		0..<maxnoof CCTrCHs>		For DCH	GLOBAL	ignore
>>CCTrCH ID	M		9.2.3.2		–	
>>UL DPCH Information		0..1			YES	ignore
>>>Repetition Period	M		9.2.3.7		–	
>>>Repetition Length	M		9.2.3.6		–	
>>>TDD DPCH Offset	M		9.2.3.8A		–	
>>>UL Timeslot Information	M		9.2.3.13C		–	
>DL CCTrCH Information		0..<maxnoof CCTrCHs>		For DCH	GLOBAL	ignore
>>CCTrCH ID	M		9.2.3.2		–	
>>DL DPCH Information		0..1			YES	ignore
>>>Repetition Period	M		9.2.3.7		–	
>>>Repetition Length	M		9.2.3.6		–	
>>>TDD DPCH Offset	M		9.2.3.8A		–	
>>>DL Timeslot Information	M		9.2.3.2C		–	
>DCH Information		0..1			–	
>>CHOICE Diversity Indication	M				–	
>>>Combining					–	
>>>>RL ID	M		9.2.1.49	Reference RL	–	
>>>>DCH Information	O		9.2.1.16A		YES	ignore

IE/Group Name	Presence	Range	IE Type and Reference	Semantics Description	Criticality	Assigned Criticality
Response						
>>>Non Combining					–	
>>>>DCH Information Response	M		9.2.1.16A		–	
>DSCH Information Response		0 .. <maxnoof DSCHs>			GLOBAL	ignore
>>DSCH ID	M		9.2.1.26A		–	
>>Transport Format Management	M		9.2.3.13		–	
>>DSCH Flow Control Information	M		9.2.1.26B		–	
>>CHOICE Diversity Indication	O				–	
>>>Non Combining					–	
>>>>Binding ID	O		9.2.1.3		–	
>>>>Transport Layer Address	O		9.2.1.62		–	
>USCH Information Response		0 .. <maxnoof USCHs>			GLOBAL	ignore
>>USCH ID	M		9.2.3.14		–	
>>Transport Format Management	M		9.2.3.13		–	
>>CHOICE Diversity Indication	O				–	
>>>Non Combining					–	
>>>>Binding ID	O		9.2.1.3		–	
>>>>Transport Layer Address	O		9.2.1.62		–	
>Neighbouring UMTS Cell Information	O		9.2.1.41A		–	
>Neighbouring GSM Cell Information	O		9.2.1.41C		–	
>Cell GA Additional Shapes	O		9.2.1.5B		YES	ignore
Criticality Diagnostics	O		9.2.1.13		YES	ignore
RL Information Response LCR		0..1		Mandatory for 1.28Mcps TDD, not applicable to 3.84Mcps TDD	YES	ignore
>RL ID	M		9.2.1.49		–	
>URA Information	M		9.2.1.70B		–	
>SAI	M		9.2.1.52		–	
>Cell GAI	O		9.2.1.5A		–	
>UTRAN Access Point Position	O		9.2.1.70A		–	
>UL Time Slot ISCP Info LCR	M		9.2.3.13H		–	
>Maximum Uplink SIR	M		Uplink SIR 9.2.1.69		–	
>Minimum Uplink SIR	M		Uplink SIR 9.2.1.69		–	
>PCCPCH Power	M		9.2.1.43		–	
>Maximum Allowed UL Tx Power	M		9.2.1.35		–	
>Maximum DL TX Power	M		DL Power 9.2.1.21A		–	
>Minimum DL TX Power	M		DL Power 9.2.1.21A		–	
>Alpha Value	M		9.2.3.a		–	

IE/Group Name	Presence	Range	IE Type and Reference	Semantics Description	Criticality	Assigned Criticality
>UL PhysCH SF Variation	M		9.2.3.13B		–	
>Synchronisation Configuration	M		9.2.3.7E		–	
>Secondary CCPCH Info TDD LCR	O		9.2.3.7F		–	
>UL CCTrCH Information LCR		0..<maxnoof CCTrCHsLCR>		For DCH	GLOBAL	ignore
>>CCTrCH ID	M		9.2.3.2		–	
>>UL DPCH Information LCR		0..1			YES	ignore
>>>Repetition Period	M		9.2.3.7		–	
>>>Repetition Length	M		9.2.3.6		–	
>>>TDD DPCH Offset	M		9.2.3.8A		–	
>>>UL Timeslot Information LCR	M		9.2.3.13G		–	
>DL CCTrCH Information LCR		0..<maxnoof CCTrCHsLCR>		For DCH	GLOBAL	ignore
>>CCTrCH ID	M		9.2.3.2		–	
>>DL DPCH Information LCR		0..1			YES	ignore
>>>Repetition Period	M		9.2.3.7		–	
>>>Repetition Length	M		9.2.3.6		–	
>>>TDD DPCH Offset	M		9.2.3.8A		–	
>>>DL Timeslot Information LCR	M		9.2.3.2E		–	
>>>TSTD Indicator	M		9.2.3.13E		–	
>DCH Information Response	O		9.2.1.16A		YES	ignore
>DSCH Information Response LCR		0 .. <maxnoof DSCHsLCR>			GLOBAL	ignore
>>DSCH ID	M		9.2.1.26A		–	
>>DSCH Flow Control Information	M		9.2.1.26B		–	
>>Binding ID	O		9.2.1.3		–	
>>Transport Layer Address	O		9.2.1.62		–	
>>Transport Format Management	M		9.2.3.13		–	
>USCH Information Response LCR		0 .. <maxnoof USCHsLCR>			GLOBAL	ignore
>>USCH ID	M		9.2.3.14		–	
>>Transport Format Management	M		9.2.3.13		–	
>>CHOICE Diversity Indication	O				–	
>>>Non Combining					–	
>>>>Binding ID	O		9.2.1.3		–	
>>>>Transport Layer Address	O		9.2.1.62		–	
>Neighbouring UMTS Cell Information	O		9.2.1.41A		–	
>Neighbouring GSM Cell Information	O		9.2.1.41C		–	
>Cell GA Additional Shapes	O		9.2.1.5B		YES	ignore
>Uplink Timing Advance Control LCR	M		9.2.3.13K		YES	ignore

Range Bound	Explanation
<i>maxnoofDSCHs</i>	Maximum number of DSCHs for one UE for 3.84Mcps TDD.
<i>maxnoofUSCHs</i>	Maximum number of USCHs for one UE for 3.84Mcps TDD.
<i>maxnoofCCTrCHs</i>	Maximum number of CCTrCHs for one UE for 3.84Mcps TDD.
<i>maxnoofDSCHsLCR</i>	Maximum number of DSCHs for one UE for 1.28Mcps TDD.
<i>maxnoofUSCHsLCR</i>	Maximum number of USCHs for one UE for 1.28Mcps TDD.
<i>maxnoofCCTrCHsLCR</i>	Maximum number of CCTrCH for one UE for 1.28Mcps TDD.

9.1.8 RADIO LINK ADDITION FAILURE

9.1.8.1 FDD Message

IE/Group Name	Presence	Range	IE Type and Reference	Semantics Description	Criticality	Assigned Criticality
Message Type	M		9.2.1.40		YES	reject
Transaction ID	M		9.2.1.59		–	
CHOICE Cause Level	M				YES	ignore
>General					–	
>>Cause	M		9.2.1.5		–	
>RL Specific					–	
>>Unsuccessful RL Information Response		1..<maxnoof RLS-1>			EACH	ignore
>>>RL ID	M		9.2.1.49		–	
>>>Cause	M		9.2.1.5		–	
>>Successful RL Information Response		0..<maxnoof RLS-2>			EACH	ignore
>>>RL ID	M		9.2.1.49		–	
>>>RL Set ID	M		9.2.2.35		–	
>>>URA Information	O		9.2.1.70B		–	
>>>SAI	M		9.2.1.52		–	
>>>Cell GAI	O		9.2.1.5A		–	
>>>UTRAN Access Point Position	O		9.2.1.70A		–	
>>>Received Total Wide Band Power	M		9.2.2.35A		–	
>>>Secondary CCPCCH Info	O		9.2.2.37B		–	
>>>DL Code Information	M		FDD DL Code Information 9.2.2.14A		YES	ignore
>>>CHOICE Diversity Indication	M				–	
>>>>Combining					–	
>>>>>RL ID	M		9.2.1.49	Reference RL ID	–	
>>>>>DCH Information Response	O		9.2.1.16A		YES	ignore
>>>>>Non Combining					–	
>>>>>DCH Information Response	M		9.2.1.16A		–	
>>>SSDT Support Indicator	M		9.2.2.43		–	
>>>Minimum Uplink SIR	M		Uplink SIR 9.2.1.69		–	
>>>Maximum Uplink SIR	M		Uplink SIR 9.2.1.69		–	
>>>Closed Loop Timing Adjustment Mode	O		9.2.2.3A		–	
>>>Maximum Allowed UL Tx Power	M		9.2.1.35		–	
>>>Maximum DL TX Power	M		DL Power 9.2.1.21A		–	
>>>Minimum DL TX Power	M		DL Power 9.2.1.21A		–	
>>>Neighbouring UMTS Cell Information	O		9.2.1.41A		–	
>>>Neighbouring GSM Cell Information	O		9.2.1.41C		–	
>>>Primary CPICH	M		9.2.1.44		–	

IE/Group Name	Presence	Range	IE Type and Reference	Semantics Description	Criticality	Assigned Criticality
Power						
>>>PC Preamble	M		9.2.2.27a		-	
>>>SRB Delay	M		9.2.2.39A		-	
>>>Cell GA Additional Shapes	O		9.2.1.5B		YES	ignore
Criticality Diagnostics	O		9.2.1.13		YES	ignore

Range bound	Explanation
<i>maxnoofRLs</i>	Maximum number of radio links for one UE.

9.1.8.2 TDD Message

IE/Group Name	Presence	Range	IE Type and Reference	Semantics Description	Criticality	Assigned Criticality
Message Type	M		9.2.1.40		YES	reject
Transaction ID	M		9.2.1.59		-	
CHOICE <i>Cause Level</i>	M				YES	ignore
> <i>General</i>					-	
>> <i>Cause</i>	M		9.2.1.5		-	
> <i>RL Specific</i>					-	
>> Unsuccessful RL Information Response		1			YES	ignore
>>>RL ID	M		9.2.1.49		-	
>>> <i>Cause</i>	M		9.2.1.5		-	
Criticality Diagnostics	O		9.2.1.13		YES	ignore

9.1.9 RADIO LINK DELETION REQUEST

IE/Group Name	Presence	Range	IE Type and Reference	Semantics Description	Criticality	Assigned Criticality
Message Type	M		9.2.1.40		YES	reject
Transaction ID	M		9.2.1.59		-	
RL Information		1..< <i>maxno ofRLs</i> >			EACH	notify
>RL ID	M		9.2.1.49		-	

Range bound	Explanation
<i>maxnoofRLs</i>	Maximum number of radio links for one UE

9.1.10 RADIO LINK DELETION RESPONSE

IE/Group Name	Presence	Range	IE Type and Reference	Semantics Description	Criticality	Assigned Criticality
Message Type	M		9.2.1.40		YES	reject
Transaction ID	M		9.2.1.59		-	
Criticality Diagnostics	O		9.2.1.13		YES	ignore

9.1.11 RADIO LINK RECONFIGURATION PREPARE

9.1.11.1 FDD Message

IE/Group Name	Presence	Range	IE Type and Reference	Semantics Description	Criticality	Assigned Criticality
Message Type	M		9.2.1.40		YES	reject
Transaction ID	M		9.2.1.59		–	
Allowed Queuing Time	O		9.2.1.2		YES	reject
UL DPCH Information		0..1			YES	reject
>UL Scrambling Code	O		9.2.2.53		–	
>UL SIR Target	O		Uplink SIR 9.2.1.69		–	
>Min UL Channelisation Code Length	O		9.2.2.25		–	
>Max Number of UL DPDCHs	C – CodeLen		9.2.2.24		–	
>Puncture Limit	O		9.2.1.46	For the UL.	–	
>TFCS	O		9.2.1.63	TFCS for the UL.	–	
>UL DPCCH Slot Format	O		9.2.2.52		–	
>Diversity Mode	O		9.2.2.8		–	
>SSDT Cell Identity Length	O		9.2.2.41		–	
>S-Field Length	O		9.2.2.36		–	
DL DPCH Information		0..1			YES	reject
>TFCS	O		9.2.1.63	TFCS for the DL.	–	
>DL DPCH Slot Format	O		9.2.2.9		–	
>Number of DL Channelisation Codes	O		9.2.2.26A		–	
>TFCI Signalling Mode	O		9.2.2.46		–	
>TFCI Presence	C- SlotFormat		9.2.1.55		–	
>Multiplexing Position	O		9.2.2.26		–	
>Limited Power Increase	O		9.2.2.21A		–	
>Split Type	C-IfSplit		9.2.2.39a		YES	reject
>Length of TFCI2	C- SplitType		9.2.2.21C		YES	reject
DCHs To Modify	O		FDD DCHs To Modify 9.2.2.13C		YES	reject
DCHs To Add	O		DCH FDD Information 9.2.2.4A		YES	reject
DCHs To Delete		0..<maxnoof DCHs>			GLOBAL	reject
>DCH ID	M		9.2.1.16		–	
DSCHs To Modify		0..1			YES	reject
>DSCH Info		0..<maxnoof DSCHs>			–	
>>DSCH ID	M		9.2.1.26A		–	
>>TrCH Source Statistics Descriptor	O		9.2.1.65		–	
>>Transport Format Set	O		9.2.1.64	For DSCH	–	
>>Allocation/ Retention Priority	O		9.2.1.1		–	
>>Scheduling Priority Indicator	O		9.2.1.51A		–	
>>BLER	O		9.2.1.4		–	

IE/Group Name	Presence	Range	IE Type and Reference	Semantics Description	Criticality	Assigned Criticality
>>Transport Bearer Request Indicator	M		9.2.1.61		–	
>PDSCH RL ID	O		RL ID 9.2.1.49		–	
>TFCS	O		9.2.1.63	For DSCH	–	
>Enhanced DSCH PC Indicator	O		9.2.2.13F		YES	ignore
>Enhanced DSCH PC	C-EDSCHPC On		9.2.2.13D		YES	ignore
DSCHs To Add	O		DSCH FDD Information 9.2.2.13A		YES	reject
DSCHs To Delete		0..1			YES	reject
>DSCH Info		1..<maxnoof DSCHs>			–	
>>DSCH ID	M		9.2.1.26A		–	
RL Information		0..<maxnoof RLS>			EACH	reject
>RL ID	M		9.2.1.49		–	
>SSDT Indication	O		9.2.2.42		–	
>SSDT Cell Identity	C - SSSTIndON		9.2.2.40		–	
>Transmit Diversity Indicator	C – Diversity mode		9.2.2.48		–	
>SSDT Cell Identity for EDSCHPC	C-EDSCHPC		9.2.2.40A		YES	ignore
Transmission Gap Pattern Sequence Information	O		9.2.2.47A		YES	reject

Condition	Explanation
SSSTIndON	The IE shall be present if the <i>SSDT Indication</i> IE is set to 'SSDT Active in the UE'.
CodeLen	The IE shall be present only if the <i>Min UL Channelisation Code length</i> equals to 4.
SlotFormat	The IE shall only be present if the <i>DL DPCH Slot Format</i> IE is equal to any of the values from 12 to 16.
Diversity mode	The IE shall be present if <i>Diversity Mode</i> IE is present in the <i>UL DPCH Information</i> IE and is not equal to 'none'.
EDSCHPCOn	The IE shall be present if the <i>Enhanced DSCH PC Indicator</i> IE is set to "Enhanced DSCH PC Active in the UE".
EDSCHPC	The IE shall be present if <i>Enhanced DSCH PC</i> IE is present in either the <i>DSCHs To Modify</i> IE or the <i>DSCHs To Add</i> IE.
IfSplit	The IE shall be present if the <i>TFCI Signalling Mode</i> IE is set to 'Split'.
SplitType	The IE shall be present if the <i>Split Type</i> IE is set to 'Logical'.

Range bound	Explanation
<i>maxnoofDCHs</i>	Maximum number of DCHs for a UE.
<i>maxnoofDSCHs</i>	Maximum number of DSCHs for one UE.
<i>maxnoofRLs</i>	Maximum number of RLS for a UE.

9.1.11.2 TDD Message

IE/Group Name	Presence	Range	IE Type and Reference	Semantics Description	Criticality	Assigned Criticality
Message Type	M		9.2.1.40		YES	reject
Transaction ID	M		9.2.1.59		–	
Allowed Queuing Time	O		9.2.1.2		YES	reject
UL CCTrCH To Add		<i>0..<maxno of CCTrCHs></i>		For DCH and USCH	EACH	notify
>CCTrCH ID	M		9.2.3.2		–	
>TFCS	M		9.2.1.63	For the UL.	–	
>TFCI Coding	M		9.2.3.11		–	
>Puncture Limit	M		9.2.1.46		–	
>UL SIR Target	O		Uplink SIR 9.2.1.69	Mandatory for 1.28Mcps TDD; not applicable to 3.84Mcps TDD	YES	reject
>TDD TPC Uplink Step Size	O		9.2.3.10a	Mandatory for 1.28Mcps TDD, not applicable to 3.84Mcps TDD	YES	reject
UL CCTrCH To Modify		<i>0..<maxno of CCTrCHs></i>			EACH	notify
>CCTrCH ID	M		9.2.3.2		–	
>TFCS	O		9.2.1.63	For the UL.	–	
>TFCI Coding	O		9.2.3.11		–	
>Puncture Limit	O		9.2.1.46		–	
>UL SIR Target	O		Uplink SIR 9.2.1.69	Applicable to 1.28Mcps TDD only	YES	reject
>TDD TPC Uplink Step Size	O		9.2.3.10a	Applicable to 1.28Mcps TDD only	YES	reject
UL CCTrCH to Delete		<i>0..<maxno of CCTrCHs></i>			EACH	notify
>CCTrCH ID	M		9.2.3.2		–	
DL CCTrCH To Add		<i>0..<maxno of CCTrCHs></i>		For DCH and DSCH	EACH	notify
>CCTrCH ID	M		9.2.3.2		–	
>TFCS	M		9.2.1.63	For the DL.	–	
>TFCI Coding	M		9.2.3.11		–	
>Puncture Limit	M		9.2.1.46		–	
>TPC CCTrCH List		<i>0..<maxno CCTrCHs></i>		List of uplink CCTrCH which provide TPC	–	
>>TPC CCTrCH ID	M		CCTrCH ID 9.2.3.2		–	
>TDD TPC Downlink Step Size	O		9.2.3.10		YES	reject
DL CCTrCH To Modify		<i>0..<maxno of CCTrCHs></i>			EACH	notify
>CCTrCH ID	M		9.2.3.2		–	
>TFCS	O		9.2.1.63	For the DL.	–	
>TFCI Coding	O		9.2.3.11		–	

IE/Group Name	Presence	Range	IE Type and Reference	Semantics Description	Criticality	Assigned Criticality
>Puncture Limit	O		9.2.1.46		–	
>TPC CCTrCH List		<i>0..<maxno ofCCTrCHs></i>		List of uplink CCTrCH which provide TPC	–	
>>TPC CCTrCH ID	M		CCTrCH ID 9.2.3.2		–	
>TDD TPC Downlink Step Size	O		9.2.3.10		YES	reject
DL CCTrCH To Delete		<i>0..<maxno ofCCTrCHs></i>			EACH	notify
>CCTrCH ID	M		9.2.3.2		–	
DCHs To Modify	O		TDD DCHs To Modify 9.2.3.8B		YES	reject
DCHs To Add	O		DCH TDD Information 9.2.3.2A		YES	reject
DCHs To Delete		<i>0..<maxno ofDCHs></i>			GLOBAL	reject
>DCH ID	M		9.2.1.16		–	
DSCHs To Modify		<i>0..<maxno ofDSCHs></i>			GLOBAL	reject
>DSCH ID	M		9.2.1.26A		–	
>CCTrCH ID	O		9.2.3.2	DL CCTrCH in which the DSCH is mapped.	–	
>TrCH Source Statistics Descriptor	O		9.2.1.65		–	
>Transport Format Set	O		9.2.1.64		–	
>Allocation/Retention Priority	O		9.2.1.1		–	
>Scheduling Priority Indicator	O		9.2.1.51A		–	
>BLER	O		9.2.1.4		–	
>Transport Bearer Request Indicator	M		9.2.1.61		–	
DSCHs To Add	O		DSCH TDD Information 9.2.3.3a		YES	reject
DSCHs To Delete		<i>0..<maxno ofDSCHs></i>			GLOBAL	reject
>DSCH ID	M		9.2.1.26A		–	
USCHs To Modify		<i>0..<maxno ofUSCHs></i>			GLOBAL	reject
>USCH ID	M		9.2.3.14		–	
>CCTrCH ID	O		9.2.3.2	UL CCTrCH in which the USCH is mapped.	–	
>TrCH Source Statistics Descriptor	O		9.2.1.65		–	
>Transport Format Set	O		9.2.1.64		–	
>Allocation/Retention Priority	O		9.2.1.1		–	
>Scheduling Priority Indicator	O		9.2.1.51A		–	
>BLER	O		9.2.1.4		–	
>Transport Bearer	M		9.2.1.61		–	

IE/Group Name	Presence	Range	IE Type and Reference	Semantics Description	Criticality	Assigned Criticality
Request Indicator						
>RB Info		0..<maxno ofRB>		All Radio Bearers using this USCH	-	
>>RB Identity	M		9.2.3.5B		-	
USCHs To Add	O		USCH Information 9.2.3.15		YES	reject
USCHs To Delete		0..<maxno ofUSCHs>			GLOBAL	reject
>USCH ID	M		9.2.3.14		-	
Primary CCPCH RSCP	O		9.2.3.5		YES	ignore
DL Time Slot ISCP Info	O		9.2.3.2D	Applicable to 3.84Mcps TDD only	YES	ignore
DL Time Slot ISCP Info LCR	O		9.2.3.2F	Applicable to 1.28Mcps TDD only	YES	ignore
PDSCH -RL -ID	O		RL ID 9.2.1.49		YES	ignore
UL Synchronisation Parameters LCR		0..1		Mandatory for 1.28Mcps TDD. Not Applicable to 3.84Mcps TDD.	YES	ignore
>Uplink Synchronisation Step Size	M		9.2.3.13J		-	
>>Uplink Synchronisation Frequency	M		9.2.3.13I		-	

Range bound	Explanation
<i>maxnoofDCHs</i>	Maximum number of DCHs for a UE.
<i>maxnoofCCTrCHs</i>	Maximum number of CCTrCHs for a UE.
<i>maxnoofDSCHs</i>	Maximum number of DSCHs for one UE.
<i>maxnoofUSCHs</i>	Maximum number of USCHs for one UE.

9.1.12 RADIO LINK RECONFIGURATION READY

9.1.12.1 FDD Message

IE/Group Name	Presence	Range	IE Type and Reference	Semantics Description	Criticality	Assigned Criticality
Message Type	M		9.2.1.40		YES	reject
Transaction ID	M		9.2.1.59		–	
RL Information Response		<i>0..<maxno ofRLs></i>			EACH	ignore
>RL ID	M		9.2.1.49		–	
>Maximum Uplink SIR	O		Uplink SIR 9.2.1.69		–	
>Minimum Uplink SIR	O		Uplink SIR 9.2.1.69		–	
>Maximum DL TX Power	O		DL Power 9.2.1.21A		–	
>Minimum DL TX Power	O		DL Power 9.2.1.21A		–	
>Secondary CCPCH Info	O		9.2.2.37B		–	
>DL Code Information	O		FDD DL Code Information 9.2.2.14A		YES	ignore
>DCH Information Response	O		9.2.1.16A		YES	ignore
>DSCHs to be Added or Modified	O		DSCH FDD Information Response 9.2.2.13B		YES	ignore
Criticality Diagnostics	O		9.2.1.13		YES	ignore
DSCH-RNTI	O		9.2.1.26Ba		YES	ignore

Range bound	Explanation
<i>maxnoofRLs</i>	Maximum number of RLs for a UE.

9.1.12.2 TDD Message

IE/Group Name	Presence	Range	IE Type and Reference	Semantics Description	Criticality	Assigned Criticality
Message Type	M		9.2.1.40		YES	reject
Transaction ID	M		9.2.1.59		–	
RL Information Response		0..1			YES	ignore
>RL ID	M		9.2.1.49		–	
>Maximum Uplink SIR	O		Uplink SIR 9.2.1.69		–	
>Minimum Uplink SIR	O		Uplink SIR 9.2.1.69		–	
>Maximum DL TX Power	O		DL Power 9.2.1.21A		–	
>Minimum DL TX Power	O		DL Power 9.2.1.21A		–	
>Secondary CCPCH Info TDD	O		9.2.3.7B		–	
>UL CCTrCH Information		0..<maxnoof CCTrCHs>		For DCH	GLOBAL	ignore
>>CCTrCH ID	M		9.2.3.2		–	
>>UL DPCH to be Added		0..1		Applicable to 3.84Mcps TDD only	YES	ignore
>>>Repetition Period	M		9.2.3.7		–	
>>>Repetition Length	M		9.2.3.6		–	
>>>TDD DPCH Offset	M		9.2.3.8A		–	
>>> Rx Timing Deviation	O		9.2.3.7A		–	
>>>UL Timeslot Information	M		9.2.3.13C		–	
>>UL DPCH to be Modified		0..1			YES	ignore
>>>Repetition Period	O		9.2.3.7		–	
>>>Repetition Length	O		9.2.3.6		–	
>>>TDD DPCH Offset	O		9.2.3.8A		–	
>>>UL Timeslot Information		0..<maxnoO fTS>		Applicable to 3.84Mcps TDD only	–	
>>>>Time Slot	M		9.2.1.56		–	
>>>>Midamble Shift And Burst Type	O		9.2.3.4		–	
>>>>TFCI Presence	O		9.2.1.55		–	
>>>>UL Code Information		0..<maxnoO fDPCHs>			–	
>>>>>DPCH ID	M		9.2.3.3		–	
>>>>>TDD Channelisation Code	O		9.2.3.8		–	
>>>UL Timeslot Information LCR		0..<maxnoO fTSLCR>		Applicable to 1.28Mcps TDD only	GLOBAL	ignore
>>>>Time Slot LCR	M		9.2.3.12a		–	
>>>>Midamble Shift LCR	O		9.2.3.4C		–	
>>>>TFCI Presence	O		9.2.1.55		–	
>>>>UL Code Information LCR		0..<maxnoO fDPCHsLCR>			GLOBAL	ignore

IE/Group Name	Presence	Range	IE Type and Reference	Semantics Description	Criticality	Assigned Criticality
		>				
>>>>>DPCH ID	M		9.2.3.3		–	
>>>>>TDD Channelisation Code LCR	O		9.2.3.8a		–	
>>>>> TDD UL DPCH Time Slot Format LCR	O		9.2.3.10C		YES	reject
>>UL DPCH to be Deleted		0..<maxnoof DPCHs>			GLOBAL	ignore
>>>DPCH ID	M		9.2.3.3		–	
>>UL DPCH to be Added LCR		0..1		Applicable to 1.28Mcps TDD only	YES	ignore
>>>Repetition Period	M		9.2.3.7		–	
>>>Repetition Length	M		9.2.3.6		–	
>>>TDD DPCH Offset	M		9.2.3.8A		–	
>>>UL Timeslot Information LCR	M		9.2.3.13G		–	
>DL CCTrCH Information		0..<maxnoof CCTrCHs>		For DCH	GLOBAL	ignore
>>CCTrCH ID	M		9.2.3.2		–	
>>DL DPCH to be Added		0..1		Applicable to 3.84Mcps TDD only	YES	ignore
>>>Repetition Period	M		9.2.3.7		–	
>>>Repetition Length	M		9.2.3.6		–	
>>>TDD DPCH Offset	M		9.2.3.8A		–	
>>>DL Timeslot Information	M		9.2.3.2C		–	
>>DL DPCH to be Modified		0..1			YES	ignore
>>>Repetition Period	O		9.2.3.7		–	
>>>Repetition Length	O		9.2.3.6		–	
>>>TDD DPCH Offset	O		9.2.3.8A		–	
>>>DL Timeslot Information		0..<maxnoO fTS>		Applicable to 3.84Mcps TDD only	–	
>>>>Time Slot	M		9.2.1.56		–	
>>>>Midamble Shift And Burst Type	O		9.2.3.4		–	
>>>>TFCI Presence	O		9.2.1.55		–	
>>>>DL Code Information		0..<maxnoO fDPCHs>			–	
>>>>>DPCH ID	M		9.2.3.3		–	
>>>>>TDD Channelisation Code	O		9.2.3.8		–	
>>>>DL Timeslot Information LCR		0..<maxnoO fTSLCR>		Applicable to 1.28Mcps TDD only	GLOBAL	ignore
>>>>Time Slot LCR	M		9.2.3.12a		–	
>>>>Midamble Shift LCR	O		9.2.3.4C		–	
>>>>TFCI Presence	O		9.2.1.55		–	
>>>>DL Code Information LCR		0..<maxnoO fDPCHsLCR >			GLOBAL	ignore
>>>>>DPCH ID	M		9.2.3.3		–	

IE/Group Name	Presence	Range	IE Type and Reference	Semantics Description	Criticality	Assigned Criticality
>>>>TDD Channelisation Code LCR	O		9.2.3.8a		–	
>>>> TDD DL DPCH Time Slot Format LCR	O		9.2.3.8E		YES	reject
>>DL DPCH to be Deleted		0..<maxnoof DPCHs>			GLOBAL	ignore
>>>DPCH ID	M		9.2.3.3		–	
>>DL DPCH to be Added LCR		0..1		Applicable to 1.28Mcps TDD only	YES	ignore
>>>Repetition Period	M		9.2.3.7		–	
>>>Repetition Length	M		9.2.3.6		–	
>>>TDD DPCH Offset	M		9.2.3.8A		–	
>>>DL Timeslot Information LCR	M		9.2.3.2E		–	
>DCH Information Response	O		9.2.1.16A		YES	ignore
>DSCH to be Added or Modified		0 .. <maxnoof DSCHs>			GLOBAL	ignore
>>DSCH ID	M		9.2.1.26A		–	
>>Transport Format Management	M		9.2.3.13		–	
>>DSCH Flow Control Information	M		9.2.1.26B		–	
>>Binding ID	O		9.2.1.3		–	
>>Transport Layer Address	O		9.2.1.62		–	
>USCH to be Added or Modified		0 .. <maxnoof USCHs>			GLOBAL	ignore
>>USCH ID	M		9.2.3.14		–	
>>Transport Format Management	M		9.2.3.13		–	
>>Binding ID	O		9.2.1.3		–	
>>Transport Layer Address	O		9.2.1.62		–	
>Uplink Timing Advance Control LCR	O		9.2.3.13K	Applicable to 1.28Mcps TDD only	YES	ignore
Criticality Diagnostics	O		9.2.1.13		YES	ignore
DSCH-RNTI	O		9.2.1.26Ba		YES	ignore

Range bound	Explanation
<i>maxnoofDSCHs</i>	Maximum number of DSCHs for one UE.
<i>maxnoofUSCHs</i>	Maximum number of USCHs for one UE.
<i>maxnoofCCTrCHs</i>	Maximum number of CCTrCHs for a UE.
<i>maxnoofTS</i>	Maximum number of Timeslots for a UE for 3.84Mcps TDD.
<i>maxnoofDPCHs</i>	Maximum number of DPCHs for a UE for 3.84Mcps TDD..
<i>maxnoofTSLCR</i>	Maximum number of Timeslots for a UE for 1.28Mcps TDD..
<i>maxnoofDPCHsLCR</i>	Maximum number of DPCHs for a UE for 1.28Mcps TDD..

9.1.13 RADIO LINK RECONFIGURATION COMMIT

IE/Group Name	Presence	Range	IE Type and Reference	Semantics Description	Criticality	Assigned Criticality
Message Type	M		9.2.1.40		YES	ignore
Transaction ID	M		9.2.1.59		–	
CFN	M		9.2.1.9		YES	ignore
Active Pattern Sequence Information	O		9.2.2.A	FDD only	YES	ignore

9.1.14 RADIO LINK RECONFIGURATION FAILURE

IE/Group Name	Presence	Range	IE Type and Reference	Semantics Description	Criticality	Assigned Criticality
Message Type	M		9.2.1.40		YES	reject
Transaction ID	M		9.2.1.59		–	
CHOICE Cause Level	M				YES	ignore
>General					–	
>>Cause	M		9.2.1.5		–	
> RL Specific					–	
>>RLs Causing Reconfiguration Failure		0..<maxnoof RLs>			EACH	ignore
>>>RL ID	M		9.2.1.49		–	
>>>Cause	M		9.2.1.5		–	
Criticality Diagnostics	O		9.2.1.13		YES	ignore

Range bound	Explanation
<i>maxnoofRLs</i>	Maximum number of RLs for a UE.

9.1.15 RADIO LINK RECONFIGURATION CANCEL

IE/Group Name	Presence	Range	IE Type and Reference	Semantics Description	Criticality	Assigned Criticality
Message Type	M		9.2.1.40		YES	ignore
Transaction ID	M		9.2.1.59		–	

9.1.16 RADIO LINK RECONFIGURATION REQUEST

9.1.16.1 FDD Message

IE/Group Name	Presence	Range	IE Type and Reference	Semantics Description	Criticality	Assigned Criticality
Message Type	M		9.2.1.40		YES	reject
Transaction ID	M		9.2.1.59		–	
Allowed Queuing Time	O		9.2.1.2		YES	reject
UL DPCH Information		0..1			YES	reject
>TFCS	O		9.2.1.63	TFCS for the UL.	–	
DL DPCH Information		0..1			YES	reject
>TFCS	O		9.2.1.63	TFCS for the DL.	–	
>TFCI Signalling Mode	O		9.2.2.46		–	
>Limited Power Increase	O		9.2.2.21A		–	
DCHs To Modify	O		FDD DCHs To Modify 9.2.2.13C		YES	reject
DCHs To Add	O		DCH FDD Information 9.2.2.4A		YES	reject
DCHs To Delete		0..<maxno ofDCHs>			GLOBAL	reject
>DCH ID	M		9.2.1.16		–	
Transmission Gap Pattern Sequence Information	O		9.2.2.47A		YES	reject

9.1.16.2 TDD Message

IE/Group Name	Presence	Range	IE Type and Reference	Semantics Description	Criticality	Assigned Criticality
Message Type	M		9.2.1.40		YES	reject
Transaction ID	M		9.2.1.59		–	
Allowed Queuing Time	O		9.2.1.2		YES	reject
UL CCTrCH Information To Modify		<i>0..<maxnoof CCTrCHs></i>			EACH	notify
>CCTrCH ID	M		9.2.3.2		–	
>TFCS	O		9.2.1.63		–	
> UL SIR Target	O		Uplink SIR 9.2.1.69	Applicable to 1.28Mcps TDD only	YES	reject
UL CCTrCH Information To Delete		<i>0..<maxnoof CCTrCHs></i>			EACH	notify
>CCTrCH ID	M		9.2.3.2		–	
DL CCTrCH Information To Modify		<i>0..<maxnoof CCTrCHs></i>			EACH	notify
>CCTrCH ID	M		9.2.3.2		–	
>TFCS	O		9.2.1.63		–	
DL CCTrCH Information To Delete		<i>0..<maxnoof CCTrCHs></i>			EACH	notify
>CCTrCH ID	M		9.2.3.2		–	
DCHs To Modify	O		TDD DCHs To Modify 9.2.3.8B		YES	reject
DCHs To Add	O		DCH TDD Information 9.2.3.2A		YES	reject
DCHs To Delete		<i>0..<maxnoof DCHs></i>			GLOBAL	reject
>DCH ID	M		9.2.1.16		–	
UL Synchronisation Parameters LCR		<i>0..1</i>		Mandatory for 1.28Mcps TDD. Not Applicable to 3.84Mcps TDD.	YES	ignore
>Uplink Synchronisation Step Size	M		9.2.3.13J		-	
>Uplink Synchronisation Frequency	M		9.2.3.13I		-	

Range Bound	Explanation
<i>maxnoofCCTrCHs</i>	Maximum number of CCTrCHs for a UE.
<i>maxnoofDCHs</i>	Maximum number of DCHs for one UE.

9.1.17 RADIO LINK RECONFIGURATION RESPONSE

9.1.17.1 FDD Message

IE/Group Name	Presence	Range	IE Type and Reference	Semantics Description	Criticality	Assigned Criticality
Message Type	M		9.2.1.40		YES	reject
Transaction ID	M		9.2.1.59		–	
RL Information Response		<i>0..<maxno ofRLs></i>			EACH	ignore
>RL ID	M		9.2.1.49		–	
>Maximum Uplink SIR	O		Uplink SIR 9.2.1.69		–	
>Minimum Uplink SIR	O		Uplink SIR 9.2.1.69		–	
>Maximum DL TX Power	O		DL Power 9.2.1.21A		–	
>Minimum DL TX Power	O		DL Power 9.2.1.21A		–	
>Secondary CCPCH Info	O		9.2.2.37B		–	
>DCH Information Response	O		9.2.1.16A		YES	ignore
>DL Code Information	O		FDD DL Code Information 9.2.2.14A		YES	ignore
Criticality Diagnostics	O		9.2.1.13		YES	ignore

Range Bound	Explanation
<i>maxnoofRLs</i>	Maximum number of RLs for a UE.

9.1.17.2 TDD Message

IE/Group Name	Presence	Range	IE Type and Reference	Semantics Description	Criticality	Assigned Criticality
Message Type	M		9.2.1.40		YES	reject
Transaction ID	M		9.2.1.59		–	
RL Information Response		<i>0..1</i>			YES	ignore
>RL ID	M		9.2.1.49		–	
>Maximum Uplink SIR	O		Uplink SIR 9.2.1.69		–	
>Minimum Uplink SIR	O		Uplink SIR 9.2.1.69		–	
>Maximum DL TX Power	O		DL Power 9.2.1.21A		–	
>Minimum DL TX Power	O		DL Power 9.2.1.21A		–	
>DCH Information Response	O		9.2.1.16A		YES	ignore
>Uplink Timing Advance Control LCR	O		9.2.3.13K	Applicable to 1.28Mcps TDD only	YES	ignore
Criticality Diagnostics	O		9.2.1.13		YES	ignore

9.1.18 RADIO LINK FAILURE INDICATION

IE/Group Name	Presence	Range	IE Type and Reference	Semantics Description	Criticality	Assigned Criticality
Message Type	M		9.2.1.40		YES	ignore
Transaction ID	M		9.2.1.59		–	
CHOICE <i>Reporting Object</i>	M			Object for which the Failure shall be reported.	YES	ignore
>RL					–	
>>RL Information		1 .. <maxnoofRLs>			EACH	ignore
>>>RL ID	M		9.2.1.49		–	
>>>Cause	M		9.2.1.5		–	
>RLS				FDD only	–	
>>RL Set Information		1 .. <maxnoofRLSets>			EACH	ignore
>>>RL Set ID	M		9.2.2.35		–	
>>>Cause	M		9.2.1.5		–	
>CCTrCH				TDD only	–	
>>RL ID	M		9.2.1.49		–	
>>CCTrCH List		1..<maxnoCCTrCHs>			EACH	ignore
>>>CCTrCH ID	M		9.2.3.2		–	
>>>Cause	M		9.2.1.5		–	

Range bound	Explanation
<i>maxnoofRLs</i>	Maximum number of RLs for one UE.
<i>maxnoofRLSets</i>	Maximum number of RL Sets for one UE.
<i>maxnoofCCTrCHs</i>	Maximum number of CCTrCHs for a UE.

9.1.19 RADIO LINK RESTORE INDICATION

IE/Group Name	Presence	Range	IE Type and Reference	Semantics Description	Criticality	Assigned Criticality
Message Type	M		9.2.1.40		YES	ignore
Transaction ID	M		9.2.1.59		–	
CHOICE Reporting Object	M			Object for which the Restoration shall be reported.	YES	ignore
>RL				TDD only	–	
>>RL Information		1 .. <maxno ofRLs>			EACH	ignore
>>>RL ID	M		9.2.1.49		–	
>RLS				FDD only	–	
>>RL Set Information		1 .. <maxno ofRLSets>			EACH	ignore
>>>RL Set ID	M		9.2.2.35		–	
>CCTrCH				TDD only	–	
>>RL ID	M		9.2.1.49		–	
>>>CCTrCH List		1..<maxnoCCTrCHs>			EACH	ignore
>>>CCTrCH ID	M		9.2.3.2		–	

Range bound	Explanation
<i>maxnoofRLs</i>	Maximum number of RLs for one UE.
<i>maxnoofRLSets</i>	Maximum number of RL Sets for one UE.
<i>maxnoofCCTrCHs</i>	Maximum number of CCTrCHs for a UE.

9.1.20 DL POWER CONTROL REQUEST [FDD]

IE/Group Name	Presence	Range	IE Type and Reference	Semantics Description	Criticality	Assigned Criticality
Message Type	M		9.2.1.40		YES	ignore
Transaction ID	M		9.2.1.59		–	
Power Adjustment Type	M		9.2.2.28		YES	ignore
DL Reference Power	C-Common		DL Power 9.2.1.21A		YES	ignore
Inner Loop DL PC Status	O		9.2.2.21a		YES	ignore
DL Reference Power Information	C-Individual	1..<maxnofRLs>			EACH	ignore
>RL ID	M		9.2.1.49		–	
>DL Reference Power	M		DL Power 9.2.1.21A		–	
Max Adjustment Step	C-Common O Individual		9.2.2.23		YES	ignore
Adjustment Period	C-Common O Individual		9.2.2.B		YES	ignore
Adjustment Ratio	C-Common O Individual		9.2.2.C		YES	ignore

Condition	Explanation
Common	The IE shall be present if the <i>Power Adjustment Type</i> IE is set to 'Common'.
Individual	The IE shall be present if the <i>Power Adjustment Type</i> IE is set to 'Individual'.
CommonOrIndividual	The IE shall be present if the <i>Power Adjustment Type</i> IE is set to 'Common' or 'Individual'.

Range Bound	Explanation
maxnoofRLs	Maximum number of RLs for one UE.

9.1.21 PHYSICAL CHANNEL RECONFIGURATION REQUEST

9.1.21.1 FDD Message

IE/Group Name	Presence	Range	IE Type and Reference	Semantics Description	Criticality	Assigned Criticality
Message Type	M		9.2.1.40		YES	reject
Transaction ID	M		9.2.1.59		–	
RL Information		1			YES	reject
>RL ID	M		9.2.1.49		–	
>DL Code Information	M		FDD DL Code Information 9.2.2.14A		YES	notify

9.1.21.2 TDD Message

IE/Group Name	Presence	Range	IE Type and Reference	Semantics Description	Criticality	Assigned Criticality
Message Type	M		9.2.1.40		YES	reject
Transaction ID	M		9.2.1.59		–	
RL Information		1			YES	reject
>RL ID	M		9.2.1.49		–	
>UL CCTrCH Information		0.. <maxnoof CCTrCHs>			GLOBAL	reject
>>CCTrCH ID	M		9.2.3.2		–	
>>UL DPCH Information		1			YES	notify
>>>Repetition Period	O		9.2.3.7		–	
>>>Repetition Length	O		9.2.3.6		–	
>>>TDD DPCH Offset	O		9.2.3.8A		–	
>>>UL Timeslot Information		0..<maxno OfTS>		Applicable to 3.84Mcps TDD only	–	
>>>>Time Slot	M		9.2.1.56		–	
>>>>Midamble Shift And Burst Type	O		9.2.3.4		–	
>>>>TFCI Presence	O		9.2.1.55		–	
>>>>UL Code Information	O		TDD UL Code Information 9.2.3.10A		–	
>>>UL Timeslot Information LCR		0..<maxno OfTSLCR >		Applicable to 1.28Mcps TDD only	GLOBAL	reject
>>>>Time Slot LCR	M		9.2.3.12a		–	
>>>>Midamble Shift LCR	O		9.2.3.4C		–	
>>>>TFCI Presence	O		9.2.1.55		–	
>>>>UL Code Information LCR	O		TDD UL Code Information LCR 9.2.3.10B		–	
>DL CCTrCH Information		0..<maxno ofCCTrCH s>			GLOBAL	reject
>>CCTrCH ID	M		9.2.3.2		–	
>>DL DPCH Information		1			YES	notify
>>>Repetition Period	O		9.2.3.7		–	
>>>Repetition Length	O		9.2.3.6		–	
>>>TDD DPCH Offset	O		9.2.3.8A		–	
>>>DL Timeslot Information		0..<maxno OfTS>		Applicable to 3.84Mcps TDD only	–	
>>>>Time Slot	M		9.2.1.56		–	
>>>>Midamble Shift And Burst Type	O		9.2.3.4		–	
>>>>TFCI Presence	O		9.2.1.55		–	
>>>>DL Code Information	O		TDD DL Code Information 9.2.3.8C		–	
>>>DL Timeslot Information LCR		0..<maxno OfTSLCR >		Applicable to 1.28Mcps TDD only	GLOBAL	reject
>>>>Time Slot LCR	M		9.2.3.12a		–	
>>>>Midamble Shift LCR	O		9.2.3.4C		–	
>>>>TFCI Presence	O		9.2.1.55		–	

>>>>DL Code Information LCR	O		TDD DL Code Information LCR 9.2.3.8D		–	
-----------------------------	---	--	--------------------------------------	--	---	--

Range bound	Explanation
<i>maxnoofCCTrCHs</i>	Maximum number of CCTrCHs for a UE.
<i>maxnoofTS</i>	Maximum number of Timeslots for a UE for 3.84Mcps TDD.
<i>maxnoofTSLCR</i>	Maximum number of Timeslots for a UE for 1.28Mcps TDD.

9.1.22 PHYSICAL CHANNEL RECONFIGURATION COMMAND

IE/Group Name	Presence	Range	IE Type and Reference	Semantics Description	Criticality	Assigned Criticality
Message Type	M		9.2.1.40		YES	reject
Transaction ID	M		9.2.1.59		–	
CFN	M		9.2.1.9		YES	ignore
Criticality Diagnostics	O		9.2.1.13		YES	ignore

9.1.23 PHYSICAL CHANNEL RECONFIGURATION FAILURE

IE/Group Name	Presence	Range	IE Type and Reference	Semantics Description	Criticality	Assigned Criticality
Message Type	M		9.2.1.40		YES	reject
Transaction ID	M		9.2.1.59		–	
Cause	M		9.2.1.5		YES	ignore
Criticality Diagnostics	O		9.2.1.13		YES	ignore

9.1.24 UPLINK SIGNALLING TRANSFER INDICATION

9.1.24.1 FDD Message

IE/Group Name	Presence	Range	IE Type and Reference	Semantics Description	Criticality	Assigned Criticality
Message Type	M		9.2.1.40		YES	ignore
Transaction ID	M		9.2.1.59		–	
UC-ID	M		9.2.1.71		YES	ignore
SAI	M		9.2.1.52		YES	ignore
Cell GAI	O		9.2.1.5A		YES	ignore
C-RNTI	M		9.2.1.14		YES	ignore
S-RNTI	M		9.2.1.53		YES	ignore
D-RNTI	O		9.2.1.24		YES	ignore
Propagation Delay	M		9.2.2.33		YES	ignore
STTD Support Indicator	M		9.2.2.45		YES	ignore
Closed Loop Mode1 Support Indicator	M		9.2.2.2		YES	ignore
Closed Loop Mode2 Support Indicator	M		9.2.2.3		YES	ignore
L3 Information	M		9.2.1.32		YES	ignore
CN PS Domain Identifier	O		9.2.1.12		YES	ignore
CN CS Domain Identifier	O		9.2.1.11		YES	ignore
URA Information	O		9.2.1.70B		YES	ignore
Cell GA Additional Shapes	O		9.2.1.5B		YES	ignore
DPC Mode Change Support Indicator	O		9.2.2.56		YES	ignore

9.1.24.2 TDD Message

IE/Group Name	Presence	Range	IE Type and Reference	Semantics Description	Criticality	Assigned Criticality
Message Type	M		9.2.1.40		YES	ignore
Transaction ID	M		9.2.1.59		–	
UC-ID	M		9.2.1.71		YES	ignore
SAI	M		9.2.1.52		YES	ignore
Cell GAI	O		9.2.1.5A		YES	ignore
C-RNTI	M		9.2.1.14		YES	ignore
S-RNTI	M		9.2.1.53		YES	ignore
D-RNTI	O		9.2.1.24		YES	ignore
Rx Timing Deviation	M		9.2.3.7A		YES	ignore
L3 Information	M		9.2.1.32		YES	ignore
CN PS Domain Identifier	O		9.2.1.12		YES	ignore
CN CS Domain Identifier	O		9.2.1.11		YES	ignore
URA Information	O		9.2.1.70B		YES	ignore
Cell GA Additional Shapes	O		9.2.1.5B		YES	ignore

9.1.25 DOWNLINK SIGNALLING TRANSFER REQUEST

IE/Group Name	Presence	Range	IE Type and Reference	Semantics Description	Criticality	Assigned Criticality
Message Type	M		9.2.1.40		YES	ignore
Transaction ID	M		9.2.1.59		–	
C-ID	M		9.2.1.6		YES	ignore
D-RNTI	M		9.2.1.24		YES	ignore
L3 Information	M		9.2.1.32		YES	ignore
D-RNTI Release Indication	M		9.2.1.25		YES	ignore

9.1.26 RELOCATION COMMIT

IE/Group Name	Presence	Range	IE Type and Reference	Semantics Description	Criticality	Assigned Criticality
Message Type	M		9.2.1.40		YES	ignore
Transaction ID	M		9.2.1.59		–	
D-RNTI	O		9.2.1.24		YES	ignore
RANAP Relocation Information	O		9.2.1.47		YES	ignore

9.1.27 PAGING REQUEST

IE/Group Name	Presence	Range	IE Type and Reference	Semantics Description	Criticality	Assigned Criticality
Message Type	M		9.2.1.40		YES	ignore
Transaction ID	M		9.2.1.59		–	
CHOICE <i>Paging Area</i>	M				YES	ignore
>URA					–	
>>URA-ID	M		9.2.1.70		–	
>Cell					–	
>>C-ID	M		9.2.1.6		–	
SRNC-ID	M		RNC-ID 9.2.1.50		YES	ignore
S-RNTI	M		9.2.1.53		YES	ignore
IMSI	M		9.2.1.31		YES	ignore
DRX Cycle Length Coefficient	M		9.2.1.26		YES	ignore
CN Originated Page to Connected Mode UE		0..1			YES	ignore
>Paging Cause	M		9.2.1.41E		–	
>CN Domain Type	M		9.2.1.11A		–	
>Paging Record Type	M		9.2.1.41F		–	

9.1.28 DEDICATED MEASUREMENT INITIATION REQUEST

IE/Group Name	Presence	Range	IE Type and Reference	Semantics Description	Criticality	Assigned Criticality
Message Type	M		9.2.1.40		YES	reject
Transaction ID	M		9.2.1.59		–	
Measurement ID	M		9.2.1.37		YES	reject
CHOICE <i>Dedicated Measurement Object Type</i>	M				YES	reject
>RL					–	
>>RL Information		1..<maxn oofRLs>			EACH	reject
>>>RL-ID	M		9.2.1.49		–	
>>>DPCH ID	O		9.2.3.3	TDD only	–	
>RLS				FDD only	–	
>>RL Set Information		1..<maxn oofRLSets>			EACH	reject
>>>RL-Set-ID	M		9.2.2.35		–	
>ALL RL			NULL		–	
>ALL RLS			NULL	FDD only	–	
Dedicated Measurement Type	M		9.2.1.18		YES	reject
Measurement Filter Coefficient	O		9.2.1.36		YES	reject
Report Characteristics	M		9.2.1.48		YES	reject
CFN reporting indicator	M		FN reporting indicator 9.2.1.28A		YES	reject
CFN	O		9.2.1.9		YES	reject

Range bound	Explanation
<i>maxnoofRLs</i>	Maximum number of individual RLs a measurement can be started on.
<i>maxnoofRLSets</i>	Maximum number of individual RL Sets a measurement can be started on.

9.1.29 DEDICATED MEASUREMENT INITIATION RESPONSE

IE/Group Name	Presence	Range	IE Type and Reference	Semantics Description	Criticality	Assigned Criticality
Message Type	M		9.2.1.40		YES	reject
Transaction ID	M		9.2.1.59		–	
Measurement ID	M		9.2.1.37		YES	ignore
CHOICE <i>Dedicated Measurement Object Type</i>	O			Dedicated Measurement Object Type the measurement was initiated with	YES	ignore
>RL or ALL RL					–	
>>RL Information		1..<maxno ofRLs>			EACH	ignore
>>>RL ID	M		9.2.1.49		–	
>>>DPCH ID	O		9.2.3.3	TDD only	–	
>>>Dedicated Measurement Value	M		9.2.1.19		–	
>>>CFN	O		9.2.1.9	Dedicated Measurement Time Reference	–	
>RLS or ALL RLS				FDD only	–	
>>RL Set Information		1..<maxno ofRLSets>			EACH	ignore
>>>RL Set ID	M		9.2.2.35		–	
>>>Dedicated Measurement Value	M		9.2.1.19		–	
>>>CFN	O		9.2.1.9	Dedicated Measurement Time Reference	–	
Criticality Diagnostics	O		9.2.1.13		YES	Ignore

Range bound	Explanation
<i>maxnoofRLs</i>	Maximum number of individual RLs the measurement can be started on.
<i>maxnoofRLSets</i>	Maximum number of individual RL Sets the measurement can be started on.

9.1.30 DEDICATED MEASUREMENT INITIATION FAILURE

IE/Group Name	Presence	Range	IE Type and Reference	Semantics Description	Criticality	Assigned Criticality
Message Type	M		9.2.1.40		YES	reject
Transaction ID	M		9.2.1.59		–	
Measurement ID	M		9.2.1.37		YES	ignore
Cause	M		9.2.1.5		YES	ignore
Criticality Diagnostics	O		9.2.1.13		YES	ignore

9.1.31 DEDICATED MEASUREMENT REPORT

IE/Group Name	Presence	Range	IE Type and Reference	Semantics Description	Criticality	Assigned Criticality
Message Type	M		9.2.1.40		YES	ignore
Transaction ID	M		9.2.1.59		–	
Measurement ID	M		9.2.1.37		YES	ignore
CHOICE <i>Dedicated Measurement Object Type</i>	M			Dedicated Measurement Object Type the measurement was initiated with	YES	ignore
>RL or ALL RL					–	
>>RL Information		1..<maxnofRLs>			EACH	ignore
>>>RL-ID	M		9.2.1.49		–	
>>>DPCH ID	O		9.2.3.3	TDD only	–	
>>>Dedicated Measurement Value Information	M		9.2.1.19A		–	
>RLS or ALL RLS				FDD only	–	
>>RL Set Information		1..<maxnofRLSets>			EACH	ignore
>>>RL Set ID	M		9.2.2.35		–	
>>>Dedicated Measurement Value Information	M		9.2.1.19A		–	

Range bound	Explanation
<i>maxnofRLs</i>	Maximum number of individual RLs the measurement can be started on.
<i>maxnofRLSets</i>	Maximum number of individual RL Sets the measurement can be started on.

9.1.32 DEDICATED MEASUREMENT TERMINATION REQUEST

IE/Group Name	Presence	Range	IE Type and Reference	Semantics Description	Criticality	Assigned Criticality
Message Type	M		9.2.1.40		YES	ignore
Transaction ID	M		9.2.1.59		–	
Measurement ID	M		9.2.1.37		YES	ignore

9.1.33 DEDICATED MEASUREMENT FAILURE INDICATION

IE/Group Name	Presence	Range	IE Type and Reference	Semantics Description	Criticality	Assigned Criticality
Message Type	M		9.2.1.40		YES	ignore
Transaction ID	M		9.2.1.59		–	
Measurement ID	M		9.2.1.37		YES	ignore
Cause	M		9.2.1.5		YES	ignore

9.1.34 COMMON TRANSPORT CHANNEL RESOURCES RELEASE REQUEST

IE/Group Name	Presence	Range	IE Type and Reference	Semantics Description	Criticality	Assigned Criticality
Message Type	M		9.2.1.40		YES	ignore
Transaction ID	M		9.2.1.59		–	
D-RNTI	M		9.2.1.24		YES	ignore

9.1.35 COMMON TRANSPORT CHANNEL RESOURCES REQUEST

IE/Group Name	Presence	Range	IE Type and Reference	Semantics Description	Criticality	Assigned Criticality
Message Type	M		9.2.1.40		YES	reject
Transaction ID	M		9.2.1.59		–	
D-RNTI	M		9.2.1.24		YES	reject
C-ID	O		9.2.1.6		YES	reject
Transport Bearer Request Indicator	M		9.2.1.61	Request a new transport bearer or to use an existing bearer for the user plane.	YES	reject
Transport Bearer ID	M		9.2.1.60	Indicates the lur transport bearer to be used for the user plane.	YES	reject
Permanent NAS UE Identity	O		9.2.1.73		YES	ignore

9.1.36 COMMON TRANSPORT CHANNEL RESOURCES RESPONSE

9.1.36.1 FDD Message

IE/Group Name	Presence	Range	IE Type and Reference	Semantics Description	Criticality	Assigned Criticality
Message Type	M		9.2.1.40		YES	reject
Transaction ID	M		9.2.1.59		–	
S-RNTI	M		9.2.1.53		YES	ignore
C-RNTI	O		9.2.1.14		YES	ignore
FACH Info for UE Selected S-CCPCH		1			YES	ignore
>FACH Flow Control Information	M		9.2.1.26C		YES	ignore
Transport Layer Address	O		9.2.1.62		YES	ignore
Binding Identity	O		9.2.1.3		YES	ignore
Criticality Diagnostics	O		9.2.1.13		YES	ignore
C-ID	M		9.2.1.6		YES	ignore

9.1.36.2 TDD Message

IE/Group Name	Presence	Range	IE Type and Reference	Semantics Description	Criticality	Assigned Criticality
Message Type	M		9.2.1.40		YES	reject
Transaction ID	M		9.2.1.59		–	
S-RNTI	M		9.2.1.53		YES	ignore
C-RNTI	O		9.2.1.14		YES	ignore
FACH Info for UE Selected S-CCPCHs		1			YES	ignore
>FACH Flow Control Information	M		9.2.1.26C		YES	ignore
Transport Layer Address	O		9.2.1.62		YES	ignore
Binding Identity	O		9.2.1.3		YES	ignore
Criticality Diagnostics	O		9.2.1.13		YES	ignore
C-ID	M		9.2.1.6		YES	ignore

9.1.37 COMMON TRANSPORT CHANNEL RESOURCES FAILURE

IE/Group Name	Presence	Range	IE Type and Reference	Semantics Description	Criticality	Assigned Criticality
Message Type	M		9.2.1.40		YES	reject
Transaction ID	M		9.2.1.59		–	
S-RNTI	M		9.2.1.53		YES	ignore
Cause	M		9.2.1.5		YES	ignore
Criticality Diagnostics	O		9.2.1.13		YES	ignore

9.1.38 COMPRESSED MODE COMMAND [FDD]

IE/Group Name	Presence	Range	IE Type and Reference	Semantics Description	Criticality	Assigned Criticality
Message Type	M		9.2.1.40		YES	ignore
Transaction ID	M		9.2.1.59		–	
Active Pattern Sequence Information	M		9.2.2.A		YES	ignore

9.1.39 ERROR INDICATION

IE/Group Name	Presence	Range	IE Type and Reference	Semantics Description	Criticality	Assigned Criticality
Message Type	M		9.2.1.40		YES	ignore
Transaction ID	M		9.2.1.59		–	
Cause	O		9.2.1.5		YES	ignore
Criticality Diagnostics	O		9.2.1.13		YES	ignore
S-RNTI	O		9.2.1.53		YES	ignore
D-RNTI	O		9.2.1.24		YES	ignore

9.1.40 DL POWER TIMESLOT CONTROL REQUEST [TDD]

IE/Group Name	Presence	Range	IE Type and Reference	Semantics Description	Criticality	Assigned Criticality
Message Type	M		9.2.1.40		YES	ignore
Transaction ID	M		9.2.1.59		–	
DL Time Slot ISCP Info	O		9.2.3.2D	Mandatory for 3.84Mcps TDD, not applicable to 1.28Mcps TDD	YES	ignore
DL Time Slot ISCP Info LCR	O		9.2.3.2F	Mandatory for 1.28Mcps TDD, not applicable to 3.84Mcps TDD	YES	ignore

9.1.41 RADIO LINK PREEMPTION REQUIRED INDICATION

IE/Group Name	Presence	Range	IE Type and Reference	Semantics Description	Criticality	Assigned Criticality
Message Type	M		9.2.1.40		YES	ignore
Transaction ID	M		9.2.1.59		–	
RL Information		<i>0..<maxno ofRLs></i>			EACH	ignore
>RL ID	M		9.2.1.49		–	

Range bound	Explanation
<i>maxnoofRLs</i>	Maximum number of radio links for one UE

9.1.42 RADIO LINK CONGESTION INDICATION

IE/Group Name	Presence	Range	IE Type and Reference	Semantics Description	Criticality	Assigned Criticality
Message Type	M		9.2.1.40		YES	ignore
Transaction ID	M		9.2.1.59		–	
Congestion Cause	O		9.2.1.79		YES	ignore
RL Information		<i>1..<maxno ofRLs></i>			EACH	ignore
>RL ID	M		9.2.1.49		–	
>DCH Rate Information		<i>1..<maxno ofDCHs></i>			EACH	ignore
>>DCH ID	M		9.2.1.16		–	
>>Allowed Rate Information	O		9.2.1.2A		–	

Range bound	Explanation
<i>maxnoofRLs</i>	Maximum number of Radio Links for one UE
<i>maxnoofDCHs</i>	Maximum number of DCHs for one UE.

9.1.43 COMMON MEASUREMENT INITIATION REQUEST

IE/Group Name	Presence	Range	IE Type and Reference	Semantics Description	Criticality	Assigned Criticality
Message Type	M		9.2.1.40		YES	reject
Transaction ID	M		9.2.1.59		–	
Measurement ID	M		9.2.1.37		YES	reject
CHOICE <i>Common Measurement Object Type</i>	M				YES	reject
>Cell					–	
>>Reference Cell Identifier	M		UTRAN Cell Identifier 9.2.1.71		–	
>>Time Slot	O		9.2.1.56	3.84Mcps TDD only	–	
>>Time Slot LCR	O		9.2.3.12a	1.28Mcps TDD only	–	
>>Neighbouring Cell Measurement Information		0..<maxno ofMeasNC ells>			–	
>>>CHOICE Neighbouring Cell Measurement Information					–	
>>>> Neighbouring FDD Cell Measurement Information				FDD only	–	
>>>>> Neighbouring FDD Cell Measurement Information	M		9.2.1.41G		–	
>>>>> Neighbouring TDD Cell Measurement Information				3.84Mcps TDD only	–	
>>>>>> Neighbouring TDD Cell Measurement Information	M		9.2.1.41H		–	
Common Measurement Type	M		9.2.1.12C		YES	reject
Measurement Filter Coefficient	O		9.2.1.36		YES	reject
Report Characteristics	M		9.2.1.48		YES	reject
SFN reporting indicator	M		FN reporting indicator 9.2.1.28A		YES	reject
SFN	O		9.2.1.52A		YES	reject
Common Measurement Accuracy	O		9.2.1.12A		YES	reject

Range bound	Explanation
<i>maxnoofMeasNCell</i>	Maximum number of neighbouring cells on which measurements can be performed.

9.1.44 COMMON MEASUREMENT INITIATION RESPONSE

IE/Group Name	Presence	Range	IE Type and Reference	Semantics Description	Criticality	Assigned Criticality
Message Type	M		9.2.1.40		YES	reject
Transaction ID	M		9.2.1.59		–	
Measurement ID	M		9.2.1.37		YES	ignore
CHOICE <i>Common Measurement Object Type</i>	O			Common Measurement Object Type that the measurement was initiated with.	YES	ignore
>Cell					–	
>>Common Measurement value	M		9.2.1.12D		–	
SFN	O		9.2.1.52A	Common Measurement Time Reference	YES	ignore
Criticality Diagnostics	O		9.2.1.13		YES	ignore
Common Measurement Achieved Accuracy	O		Common Measurement Accuracy 9.2.1.12A		YES	reject

9.1.45 COMMON MEASUREMENT INITIATION FAILURE

IE/Group Name	Presence	Range	IE Type and Reference	Semantics Description	Criticality	Assigned Criticality
Message Type	M		9.2.1.40		YES	reject
Transaction ID	M		9.2.1.59		–	
Measurement ID	M		9.2.1.37		YES	ignore
Cause	M		9.2.1.5		YES	ignore
Criticality Diagnostics	O		9.2.1.13		YES	ignore

9.1.46 COMMON MEASUREMENT REPORT

IE/Group Name	Presence	Range	IE Type and Reference	Semantics Description	Criticality	Assigned Criticality
Message Type	M		9.2.1.40		YES	ignore
Transaction ID	M		9.2.1.59		–	
Measurement ID	M		9.2.1.37		YES	ignore
CHOICE <i>Common Measurement Object Type</i>	M			Common Measurement Object Type that the measurement was initiated with.	YES	ignore
>Cell					–	
>>Common Measurement Value Information	M		9.2.1.12E		–	
SFN	O		9.2.1.52A	Common Measurement Time Reference	YES	ignore

9.1.47 COMMON MEASUREMENT TERMINATION REQUEST

IE/Group Name	Presence	Range	IE Type and Reference	Semantics Description	Criticality	Assigned Criticality
Message Type	M		9.2.1.40		YES	ignore
Transaction ID	M		9.2.1.59		–	
Measurement ID	M		9.2.1.37		YES	ignore

9.1.48 COMMON MEASUREMENT FAILURE INDICATION

IE/Group Name	Presence	Range	IE Type and Reference	Semantics Description	Criticality	Assigned Criticality
Message Type	M		9.2.1.40		YES	ignore
Transaction ID	M		9.2.1.59		–	
Measurement ID	M		9.2.1.37		YES	ignore
Cause	M		9.2.1.5		YES	ignore

9.1.49 INFORMATION EXCHANGE INITIATION REQUEST

IE/Group Name	Presence	Range	IE Type and Reference	Semantics Description	Criticality	Assigned Criticality
Message Type	M		9.2.1.40		YES	reject
Transaction ID	M		9.2.1.59		–	
Information Exchange ID	M		9.2.1.31A		YES	reject
CHOICE <i>Information Exchange Object Type</i>	M				YES	reject
>Cell					–	
>>C-ID	M		9.2.1.6		–	
Information Type	M		9.2.1.31E		YES	reject
Information Report Characteristics	M		9.2.1.31C		YES	reject

9.1.50 INFORMATION EXCHANGE INITIATION RESPONSE

IE/Group Name	Presence	Range	IE Type and Reference	Semantics Description	Criticality	Assigned Criticality
Message Type	M		9.2.1.40		YES	reject
Transaction ID	M		9.2.1.59		-	
Information Exchange ID	M		9.2.1.31A		YES	ignore
CHOICE <i>Information Exchange Object Type</i>	O				YES	ignore
>Cell					-	
>>Requested Data Value	M		9.2.1.48A		-	
Criticality Diagnostics	O		9.2.1.13		YES	ignore

9.1.51 INFORMATION EXCHANGE INITIATION FAILURE

IE/Group Name	Presence	Range	IE Type and Reference	Semantics Description	Criticality	Assigned Criticality
Message Type	M		9.2.1.40		YES	reject
Transaction ID	M		9.2.1.59		-	
Information Exchange ID	M		9.2.1.31A		YES	ignore
Cause	M		9.2.1.5		YES	ignore
Criticality Diagnostics	O		9.2.1.13		YES	ignore

9.1.52 INFORMATION REPORT

IE/Group Name	Presence	Range	IE Type and Reference	Semantics Description	Criticality	Assigned Criticality
Message Type	M		9.2.1.40		YES	ignore
Transaction ID	M		9.2.1.59		-	
Information Exchange ID	M		9.2.1.31A		YES	ignore
CHOICE <i>Information Exchange Object Type</i>	M				YES	ignore
>Cell					-	
>>Requested Data Value Information	M		9.2.1.48B		-	

9.1.53 INFORMATION EXCHANGE TERMINATION REQUEST

IE/Group Name	Presence	Range	IE Type and Reference	Semantics Description	Criticality	Assigned Criticality
Message Type	M		9.2.1.40		YES	ignore
Transaction ID	M		9.2.1.59		-	
Information Exchange ID	M		9.2.1.31A		YES	ignore

9.1.54 INFORMATION EXCHANGE FAILURE INDICATION

IE/Group Name	Presence	Range	IE Type and Reference	Semantics Description	Criticality	Assigned Criticality
Message Type	M		9.2.1.40		YES	ignore
Transaction ID	M		9.2.1.59		–	
Information Exchange ID	M		9.2.1.31A		YES	ignore
Cause	M		9.2.1.5		YES	ignore

9.2 Information Element Functional Definition and Contents

9.2.0 General

Subclause 9.2 presents the RNSAP IE definitions in tabular format. The corresponding ASN.1 definition is presented in subclause 9.3. In case there is a contradiction between the tabular format in subclause 9.2 and the ASN.1 definition, the ASN.1 shall take precedence, except for the definition of conditions for the presence of conditional elements, in which the tabular format shall take precedence.

When specifying information elements which are to be represented by bitstrings, if not otherwise specifically stated in the semantics description of the concerned IE or elsewhere, the following principle applies with regards to the ordering of bits:

- The first bit (leftmost bit) contains the most significant bit (MSB);
- The last bit (rightmost bit) contains the least significant bit (LSB);
- When importing bitstrings from other specifications, the first bit of the bitstring contains the first bit of the concerned information;

9.2.1 Common Parameters

This subclause contains parameters that are common to FDD and TDD.

9.2.1.1 Allocation/Retention Priority

This parameter indicates the priority level in the allocation and retention of transport channel resources in DRNS. DRNS may use the Allocation/Retention priority information of the transport channels composing the RL to prioritise requests for RL Setup/addition and reconfiguration. In similar way, DRNS may use the allocation/Retention priority information of the transport channels composing the RL to prioritise which RL shall be set to failure, in case prioritisation is possible. See Annex A.

IE/Group Name	Presence	Range	IE Type and Reference	Semantics Description
Priority Level	M		INTEGER (0..15)	This IE indicates the priority of the request. Usage: Value "0" means "Spare"; It shall be treated as a logical error if received. Values between 1 and 14 are ordered in decreasing order of priority, '1' being the highest and '14' the lowest. Value "15" means "No Priority".
Pre-emption Capability	M		ENUMERATED (shall not trigger pre-emption, may trigger pre-emption)	
Pre-emption Vulnerability	M		ENUMERATED (not pre-emptable, pre-emptable)	

9.2.1.2 Allowed Queuing Time

This parameter specifies the maximum queuing time that is allowed in the DRNS until the DRNS must start to execute the request.

IE/Group Name	Presence	Range	IE Type and Reference	Semantics Description
Allowed Queuing Time			INTEGER(1..60)	Seconds

9.2.1.2A Allowed Rate Information

The *Allowed Rate Information* IE indicates the TFI corresponding to the highest allowed bit rate for the uplink and/or the downlink of a DCH. The SRNC is allowed to use any rate being lower than or equal to the rate corresponding to the indicated TFI.

IE/Group Name	Presence	Range	IE Type and Reference	Semantics Description
Allowed UL Rate	O		INTEGER(1..maxTFcount)	"1": TFI 0, "2": TFI 1, "3": TFI 2, ...
Allowed DL Rate	O		INTEGER(1..maxTFcount)	"1": TFI 0, "2": TFI 1, "3": TFI 2, ...

9.2.1.2B Altitude and Direction

This IE contains a description of Altitude and Direction.

IE/Group Name	Presence	Range	IE Type and Reference	Semantics Description
Direction of Altitude	M		ENUMERATED (Height, Depth)	
Altitude	M		INTEGER (0..2 ¹⁵ -1)	The relation between the value (N) and the altitude (a) in meters it describes is $N \leq a < N+1$, except for $N=2^{15}-1$ for which the range is extended to include all greater values of (a).

9.2.1.3 Binding ID

The Binding ID is the identifier of a user data stream. It is allocated at the DRNS and it is unique for each transport bearer under establishment to/from the DRNS.

IE/Group Name	Presence	Range	IE Type and Reference	Semantics Description
Binding ID			OCTET STRING (1..4,...)	

9.2.1.4 BLER

This Block Error Rate defines the target radio interface Transport Block Error Rate of the transport channel. BLER is used by the DRNS to determine the needed SIR targets, for admission control and power management reasons.

IE/Group Name	Presence	Range	IE Type and Reference	Semantics Description
BLER			INTEGER (-63..0)	Step 0.1. (Range -6.3...0). It is the Log10 of the BLER

9.2.1.4A Block STTD Indicator

Void.

9.2.1.4B Burst Mode Parameters

The *Burst Mode Parameters* IE provides all the relevant information in order to able IPDL in the Burst mode.

IE/Group name	Presence	Range	IE Type and Reference	Semantics Description
Burst Start	M		INTEGER(0..15)	See [10] and [22]
Burst Length	M		INTEGER(10..25)	See [10] and [22]
Burst freq	M		INTEGER(1..16)	See [10] and [22]

9.2.1.5 Cause

The purpose of the cause information element is to indicate the reason for a particular event for the whole protocol.

IE/Group Name	Presence	Range	IE Type and Reference	Semantics Description
CHOICE <i>Cause Group</i>				
> <i>Radio Network Layer</i>				
>>Radio Network Layer Cause	M		ENUMERATED (Unknown C-ID, Cell not Available, Power Level not Supported, UL Scrambling Code Already in Use, DL Radio Resources not Available, UL Radio Resources not Available, Measurement not Supported For The Object, Combining Resources Not Available, Combining not Supported, Reconfiguration not Allowed, Requested Configuration not Supported, Synchronisation Failure, Requested Tx Diversity Mode not Supported, Measurement Temporarily not Available, Unspecified, Invalid CM Settings, Reconfiguration CFN not Elapsed, Number of DL Codes Not Supported, Dedicated Transport Channel Type not Supported, DL Shared Channel Type not Supported, UL Shared Channel Type not Supported, Common Transport Channel Type not Supported, UL Spreading Factor not Supported, DL Spreading Factor not Supported, CM not Supported, Transaction not Supported by Destination Node B, RL Already Activated/Allocated, ..., Number of UL Codes Not Supported, Cell reserved for operator use, DPC Mode Change not Supported, Information temporarily not available, Information Provision not supported for the object, dummy1, dummy2, dummy3, Unknown RNTI)	
> <i>Transport Layer</i>				
>>Transport Layer Cause	M		ENUMERATED (Transport Resource Unavailable, Unspecified, ...)	
> <i>Protocol</i>				
>>Protocol Cause	M		ENUMERATED (Transfer Syntax Error, Abstract Syntax Error (Reject), Abstract Syntax Error (Ignore and Notify), Message not Compatible with Receiver State, Semantic Error, Unspecified, Abstract Syntax Error (Falsely Constructed Message),...)	
> <i>Misc</i>				
>>Miscellaneous Cause	M		ENUMERATED (Control Processing Overload, Hardware Failure, O&M Intervention, Not enough User Plane Processing Resources, Unspecified,...)	

The meaning of the different cause values is described in the following table. In general, "not supported" cause values indicate that the concerned capability is missing. On the other hand, "not available" cause values indicate that the concerned capability is present, but insufficient resources were available to perform the requested action.

Radio Network Layer cause	Meaning
Cell not Available	The concerned cell is not available
Cell reserved for operator use	The concerned cell is reserved for operator use
Combining not Supported	The DRNS does not support the RL combining for the concerned cells
Combining Resources Not Available	The value of the received <i>Diversity Control Field</i> IE was set to 'Must', but the DRNS cannot perform the requested combining
CM not Supported	The concerned cell(s) do not support Compressed Mode
Common Transport Channel Type not Supported	The concerned cell(s) do not support the RACH and/or FACH and/or CPCH Common Transport Channel Type
Dedicated Transport Channel Type not Supported	The concerned cell(s) do not support the Dedicated Transport Channel Type
DL Radio Resources not Available	The DRNS does not have sufficient DL radio resources available
DL SF not Supported	The concerned cell(s) do not support the requested DL SF
DL Shared Channel Type not Supported	The concerned cell(s) do not support the Downlink Shared Channel Type
DPC Mode Change not Supported	The concerned cells do not support the DPC mode changes
Information Provision not supported for the object	The RNS doesn't support provision of the requested information for the concerned object types
Information temporarily not available	The RNS can temporarily not provide the requested information
Invalid CM Settings	The concerned cell(s) consider the requested Compressed Mode settings invalid
Measurement not Supported For The Object	At least one of the concerned cell(s) does not support the requested measurement on the concerned object type
Measurement Temporarily not Available	The DRNS can temporarily not provide the requested measurement value
Number of DL Codes not Supported	The concerned cell(s) do not support the requested number of DL codes
Number of UL Codes not Supported	The concerned cell(s) do not support the requested number of UL codes
Power Level not Supported	A DL power level was requested which the concerned cell(s) do not support
Reconfiguration CFN not Elapsed	The requested action cannot be performed due to that a COMMIT message was received previously, but the concerned CFN has not yet elapsed
Reconfiguration not Allowed	The SRNC does currently not allow the requested reconfiguration
Requested Configuration not Supported	The concerned cell(s) do not support the requested configuration i.e. power levels, Transport Formats, physical channel parameters,.....
Requested Tx Diversity mode not Supported	The concerned cell(s) do not support the requested transmit diversity mode
RL Already Activated/ Allocated	The DRNS has already allocated an RL with the requested RL ID for this UE Context
Synchronisation Failure	Loss of UL Uu synchronisation
Transaction not Supported by Destination Node B	The requested action cannot be performed due to lack of support of the corresponding action in the destination Node B
UL Radio Resources not Available	The DRNS does not have sufficient UL radio resources available
UL Scrambling Code Already in Use	The concerned UL scrambling code is already in use for another UE
UL SF not Supported	The concerned cell(s) do not support the requested minimum UL SF
UL Shared Channel Type not Supported	The concerned cell(s) do not support the Uplink Shared Channel Type
Unknown C-ID	The DRNS is not aware of a cell with the provided C-ID
Unknown RNTI	The SRNC or DRNC is not aware of a UE indicated with the provided RNTI.

Unspecified	Sent when none of the above cause values applies but still the cause is Radio Network Layer related
-------------	-----------------------------------------------------------------------------------------------------

Transport Network Layer cause	Meaning
Transport resource unavailable	The required transport resources are not available
Unspecified	Sent when none of the above cause values applies but still the cause is Transport Network Layer related

Protocol cause	Meaning
Abstract Syntax Error (Reject)	The received message included an abstract syntax error and the concerned criticality indicated "reject" (see subclause 10.3)
Abstract Syntax Error (Ignore and Notify)	The received message included an abstract syntax error and the concerned criticality indicated "ignore and notify" (see subclause 10.3)
Abstract syntax error (falsely constructed message)	The received message contained IEs or IE groups in wrong order or with too many occurrences (see subclause 10.3)
Message not Compatible with Receiver State	The received message was not compatible with the receiver state (see subclause 10.4)
Semantic Error	The received message included a semantic error (see subclause 10.4)
Transfer Syntax Error	The received message included a transfer syntax error (see subclause 10.2)
Unspecified	Sent when none of the above cause values applies but still the cause is Protocol related

Miscellaneous cause	Meaning
Control Processing Overload	DRNS control processing overload
Hardware Failure	DRNS hardware failure
Not enough User Plane Processing Resources	DRNS has insufficient user plane processing resources available
O&M Intervention	Operation and Maintenance intervention related to DRNS equipment
Unspecified	Sent when none of the above cause values applies and the cause is not related to any of the categories Radio Network Layer, Transport Network Layer or Protocol.

9.2.1.5A Cell Geographical Area Identity (Cell GAI)

The Cell Geographical Area is used to identify the geographical area of a cell. The area is represented as a polygon. See ref. [25].

IE/Group Name	Presence	Range	IE Type and Reference	Semantics Description
Cell GAI Geographical Co-ordinates		1 .. <maxnoofPoints>		
>Latitude Sign	M		ENUMERATED (North, South)	
>Degrees of Latitude	M		INTEGER (0..2 ²³ -1)	The IE value (N) is derived by this formula: N ≤ 2 ²³ X / 90 < N+1 X being the latitude in degree (0°.. 90°)
>Degrees of Longitude	M		INTEGER (-2 ²³ ..2 ²³ -1)	The IE value (N) is derived by this formula: N ≤ 2 ²⁴ X / 360 < N+1 X being the longitude in degree (-180°..+180°)

Range bound	Explanation
<i>maxnoofPoints</i>	Maximum no. of points in polygon.

9.2.1.5B Cell Geographical Area Additional Shapes (Cell GAI Additional Shapes)

This IE is used to provide several descriptions of the geographical area of a cell.

IE/Group Name	Presence	Range	IE Type and Reference	Semantics Description
CHOICE <i>Cell GAI Additional Shapes</i>				
> <i>GA Point With Uncertainty</i>				
>> <i>GA Point With Uncertainty</i>	M		9.2.1.30A	Ellipsoid point with uncertainty circle
> <i>GA Ellipsoid point with uncertainty Ellipse</i>				
>> <i>GA Ellipsoid point with uncertainty Ellipse</i>	M		9.2.1.30B	Ellipsoid point with uncertainty Ellipse
> <i>GA Ellipsoid point with altitude</i>				
>> <i>GA Ellipsoid point with altitude</i>	M		9.2.1.30C	Ellipsoid point with altitude
> <i>GA Ellipsoid point with altitude and uncertainty Ellipsoid</i>				
>> <i>GA Ellipsoid point with altitude and uncertainty Ellipsoid</i>	M		9.2.1.30D	Ellipsoid point with altitude and uncertainty Ellipsoid
> <i>GA Ellipsoid Arc</i>				
>> <i>GA Ellipsoid Arc</i>	M		9.2.1.30E	Ellipsoid Arc

9.2.1.6 Cell Identifier (C-ID)

The C-ID (Cell Identifier) is the identifier of a cell in one RNS.

IE/Group Name	Presence	Range	IE Type and Reference	Semantics Description
C-ID			INTEGER (0..65535)	

9.2.1.7 Cell Individual Offset

Cell individual offset is an offset that will be applied by UE to the measurement results for a Primary-CPICH[FDD]/Primary-CCPCH[TDD] or for GSM Carrier RSSI according to [16].

IE/Group Name	Presence	Range	IE Type and Reference	Semantics Description
Cell Individual Offset			INTEGER (-20..+20)	-20 -> -10dB -19 -> -9.5dB ... +20 -> +10dB

9.2.1.8 Cell Parameter ID

The Cell Parameter ID identifies unambiguously the [3.84 Mcps TDD - Code Groups, Scrambling Codes, Midambles and Toffset] [1.28 Mcps TDD - SYNC-DL and SYNC-UL sequences, the scrambling codes and the midamble codes] (see ref. [20]).

IE/Group Name	Presence	Range	IE Type and Reference	Semantics Description
Cell Parameter ID			INTEGER (0..127,...)	

9.2.1.9 CFN

Connection Frame Number for the radio connection, see ref. [17].

IE/Group Name	Presence	Range	IE Type and Reference	Semantics Description
CFN			INTEGER (0.. 255)	

9.2.1.10 CFN Offset

Void

9.2.1.11 CN CS Domain Identifier

Identification of the CN node in the CS Domain.

IE/Group Name	Presence	Range	IE Type and Reference	Semantics Description
PLMN Identity	M		OCTET STRING (3)	<ul style="list-style-type: none"> - digits 0 to 9, two digits per octet, - each digit encoded 0000 to 1001, - 1111 used as filler - bit 4 to 1 of octet n encoding digit 2n-1 - bit 8 to 5 of octet n encoding digit 2n <p>-The PLMN Identity consists of 3 digits from MCC followed by either</p> <ul style="list-style-type: none"> -a filler plus 2 digits from MNC (in case of 2 digit MNC) or -3 digits from MNC (in case of a 3 digit MNC).
LAC	M		OCTET STRING (2)	0000 and FFFE not allowed

9.2.1.11A CN Domain Type

Identifies the type of core network domain.

IE/Group Name	Presence	Range	IE Type and Reference	Semantics Description
CN Domain Type			ENUMERATED (CS domain, PS domain, Don't care,...)	See in [16]

9.2.1.12 CN PS Domain Identifier

Identification of the CN Node in the PS Domain.

IE/Group Name	Presence	Range	IE Type and Reference	Semantics Description
PLMN Identity	M		OCTET STRING (3)	<ul style="list-style-type: none"> - digits 0 to 9, two digits per octet, - each digit encoded 0000 to 1001, - 1111 used as filler - bit 4 to 1 of octet n encoding digit 2n-1 - bit 8 to 5 of octet n encoding digit 2n <p>-The PLMN Identity consists of 3 digits from MCC followed by either</p> <ul style="list-style-type: none"> -a filler plus 2 digits from MNC (in case of 2 digit MNC) or -3 digits from MNC (in case of a 3 digit MNC).
LAC	M		OCTET STRING (2)	0000 and FFFE not allowed
RAC	M		OCTET STRING (1)	

9.2.1.12A Common Measurement Accuracy

The Common Measurement Accuracy IE indicates the accuracy of the common measurement.

IE/Group Name	Presence	Range	IE Type and Reference	Semantics Description
CHOICE <i>Common Measurement Accuracy</i>				
> <i>T_{UTRAN-GPS} Measurement Accuracy Class</i>				
>> <i>T_{UTRAN-GPS} Measurement Accuracy Class</i>	M		<i>T_{UTRAN-GPS} Accuracy Class</i> 9.2.1.59B	

9.2.1.12B Common Measurement Object Type

Void.

9.2.1.12C Common Measurement Type

The Common Measurement Type identifies which measurement that shall be performed.

IE/Group Name	Presence	Range	IE Type and Reference	Semantics Description
Common Measurement Type			ENUMERATED (UTRAN GPS Timing of Cell Frames for UE Positioning, SFN-SFN Observed Time Difference, load, transmitted carrier power, received total wide band power, UL timeslot ISCP, ...)	UL timeslot ISCP shall only be used by TDD

9.2.1.12D Common Measurement Value

The Common Measurement Value shall be the most recent value for this measurement, for which the reporting criteria were met.

IE/Group Name	Presence	Range	IE Type and Reference	Semantics Description
CHOICE <i>Common Measurement Value</i>				
> <i>T_{UTRAN-GPS} Measurement Value Information</i>				
>>T _{UTRAN-GPS} Measurement Value Information	M		9.2.1.59D	
> <i>SFN-SFN Measurement Value Information</i>				
>>SFN-SFN Measurement Value Information	M		9.2.1.52C	
> <i>Load Value</i>				
>>Load Value	M		9.2.1.33A	
> <i>Transmitted Carrier Power Value</i>				
>>Transmitted Carrier Power Value	M		Transmitted Carrier Power 9.2.1.59A	
> <i>Received Total Wide Band Power Value</i>				
>>Received Total Wide Band Power Value	M		Received Total Wide Band Power 9.2.2.35A	
> <i>UL Timeslot ISCP Value</i>				TDD Only
>>UL Timeslot ISCP Value	M		UL Timeslot ISCP 9.2.3.13A	

9.2.1.12E Common Measurement Value Information

The *Common Measurement Value Information* IE provides information both on whether or not the Common Measurement Value is provided in the message or not and if provided also the Common Measurement Value itself.

IE/Group Name	Presence	Range	IE Type and Reference	Semantics Description
CHOICE <i>Measurement Availability</i>	M			
> <i>Measurement Available</i>				
>>Common Measurement Value	M		9.2.1.12D	
> <i>Measurement not Available</i>			NULL	

9.2.1.13 Criticality Diagnostics

The *Criticality Diagnostics* IE is sent by an RNC when parts of a received message have not been comprehended or were missing, or if the message contained logical errors. When applicable, it contains information about which IEs that were not comprehended or were missing.

For further details on how to use the *Criticality Diagnostics* IE, see Annex C.

IE/Group Name	Presence	Range	IE Type and Reference	Semantics Description	Criticality	Assigned Criticality
Procedure ID		0..1		Procedure ID is to be used if Criticality Diagnostics is part of Error Indication procedure, and not within the response message of the same procedure that caused the error	–	
>Procedure Code	M		INTEGER (0..255)		–	
>Ddmode	M		ENUMERATED (TDD, FDD, Common)	Common = common to FDD and TDD.	–	
Triggering Message	O		ENUMERATED (initiating message, successful outcome, unsuccessful outcome)	The Triggering Message is used only if the Criticality Diagnostics is part of Error Indication.	–	
Procedure Criticality	O		ENUMERATED (reject, ignore, notify)	This Procedure Criticality is used for reporting the Criticality of the Triggering message (Procedure).	–	
Transaction ID	O		9.2.1.59		–	
Information Element Criticality Diagnostics		0..<max noof errors>			–	
>IE Criticality	M		ENUMERATED (reject, ignore, notify)	The IE Criticality is used for reporting the criticality of the triggering IE. The value 'Ignore' shall never be used.	–	
>IE ID	M		INTEGER (0..65535)	The IE ID of the not understood or missing IE as defined in the ASN.1 part of the specification.	–	
>Repetition Number	O		INTEGER (0..255)	The <i>Repetition Number</i> IE gives <ul style="list-style-type: none"> in case of a not understood IE: The number of occurrences of the reported IE up to and including the not understood occurrence in case of a missing IE: The number of occurrences up to but not including the missing occurrence. 	–	
Note: All the counted						

				occurrences of the reported IE must have the same topdown hierarchical message structure of IEs with assigned criticality above them.		
>Message Structure	O		9.2.1.39A	The <i>Message Structure</i> IE describes the structure where the not understood or missing IE was detected. This IE is included if the not understood IE is not the top level of the message.	YES	ignore
>Type of Error	M		ENUMERATED(not understood, missing, ...)		YES	ignore

Range bound	Explanation
<i>maxnooferrors</i>	Maximum number of IE errors allowed to be reported with a single message.

9.2.1.14 C-RNTI

C-RNTI (Cell RNTI) is the UE identifier allocated by the DRNS to be used over the radio interface. It is unique in the cell. One UE Context has one unique C-RNTI value allocated in the DRNS.

IE/Group Name	Presence	Range	IE Type and Reference	Semantics Description
C-RNTI			INTEGER(0..65535)	

9.2.1.15 DCH Combination Indicator

Void

9.2.1.16 DCH ID

The DCH ID is the identifier of an active dedicated transport channel. It is unique for each active DCH among the active DCHs simultaneously allocated for the same UE.

IE/Group Name	Presence	Range	IE Type and Reference	Semantics Description
DCH ID			INTEGER(0..255)	

9.2.1.16A DCH Information Response

The *DCH Information* IE provides information for DCHs that have been established or modified.

IE/Group Name	Presence	Range	IE Type and Reference	Semantics Description	Criticality	Assigned Criticality
DCH Information Response		<i>1..<maxno ofDCHs></i>			–	
>DCH ID	M		9.2.1.16		–	
>Binding ID	O		9.2.1.3		–	
>Transport Layer Address	O		9.2.1.62		–	
>Allowed Rate Information	O		9.2.1.2A		YES	ignore

Range bound	Explanation
<i>maxnoofDCHs</i>	Maximum number of DCHs for one UE.

9.2.1.17 Dedicated Measurement Object Type

Void.

9.2.1.18 Dedicated Measurement Type

The Dedicated Measurement Type identifies the type of measurement that shall be performed.

IE/Group Name	Presence	Range	IE Type and Reference	Semantics Description
Dedicated Measurement Type			ENUMERATED (SIR, SIR Error, Transmitted Code Power, RSCP, Rx Timing Deviation, Round Trip Time, ..., Rx Timing Deviation LCR)	RSCP is used by TDD only, Rx Timing Deviation is used by 3.84 TDD only, Rx Timing Deviation LCR is used by 1.28 TDD only, Round Trip Time, SIR Error are used by FDD only.

NOTE: For definitions of the measurement types refer to ref. [11] and [14].

9.2.1.19 Dedicated Measurement Value

The Dedicated Measurement Value shall be the most recent value for this measurement, for which the reporting criteria were met.

IE/Group Name	Presence	Range	IE Type and Reference	Semantics Description	Criticality	Assigned Criticality
CHOICE <i>Dedicated Measurement Value</i>					–	
> <i>SIR Value</i>					–	
>> <i>SIR Value</i>	M		INTEGER(0..63)	According to mapping in ref. [23] and [24]	–	
> <i>SIR Error Value</i>				FDD Only	–	
>> <i>SIR Error Value</i>	M		INTEGER(0..125)	According to mapping in [23]	–	
> <i>Transmitted Code Power Value</i>					–	
>> <i>Transmitted Code Power Value</i>	M		INTEGER(0..127)	According to mapping in ref. [23] and [24] Values 0 to 9 and 123 to 127 shall not be used.	–	
> <i>RSCP</i>				TDD Only	–	
>> <i>RSCP</i>	M		INTEGER(0..127)	According to mapping in ref. [24]	–	
> <i>Rx Timing Deviation Value</i>				3.84Mcps TDD Only	–	
>> <i>Rx Timing Deviation</i>	M		INTEGER(0..8191)	According to mapping in [24]	–	
> <i>Round Trip Time</i>				FDD Only	–	
>> <i>Round Trip Time</i>	M		INTEGER(0..32767)	According to mapping in [23]	–	
> <i>Additional Dedicated Measurement Values</i>					–	
>> <i>Rx Timing Deviation Value LCR</i>				1.28Mcps TDD Only	–	
>>> <i>Rx Timing Deviation LCR</i>	M		INTEGER(0..511)	According to mapping in [24]	YES	reject

9.2.1.19A Dedicated Measurement Value Information

The *Dedicated Measurement Value Information* IE provides information both on whether or not the Dedicated Measurement Value is provided in the message and if provided also the Dedicated Measurement Value itself.

IE/Group Name	Presence	Range	IE Type and Reference	Semantics Description	Criticality	Assigned Criticality
CHOICE <i>Measurement Availability Indicator</i>	M				–	
> <i>Measurement Available</i>					–	
>> <i>Dedicated Measurement Value</i>	M		9.2.1.19		–	
>> <i>CFN</i>	O		9.2.1.9	Dedicated Measurement Time Reference	–	
> <i>Measurement not Available</i>			NULL		–	

9.2.1.19B DGPS Corrections

The DGPS Corrections IE contains DGPS information used by the UE Positioning A-GPS method. For further details on the meaning of parameters, see [31].

IE/Group Name	Presence	Range	IE Type and Reference	Semantics Description
GPS TOW	M		INTEGER(0..604799)	Time in seconds. This field indicates the baseline time for which the corrections are valid
Status/Health	M		ENUMERATED (UDRE scale 1.0, UDRE scale 0.75, UDRE scale 0.5, UDRE scale 0.3, UDRE scale 0.1, no data, invalid data)	This field indicates the status of the differential corrections
Satellite DGPS Corrections Information		1..<maxNoSat>		
>SatID	M		SAT ID 9.2.1.50A	Satellite ID
>IODE	M		BIT STRING(8)	This IE is the sequence number for the ephemeris for the particular satellite. It can be used to determine if new ephemeris is used for calculating the corrections that are provided. This eight-bit IE is incremented for each new set of ephemeris for the satellite and may occupy the numerical range of [0, 239] during normal operations.
>UDRE	M		ENUMERATED (UDRE $\leq 1.0\text{m}$, $1.0\text{m} < \text{UDRE} \leq 4.0\text{m}$, $4.0\text{m} < \text{UDRE} \leq 8.0\text{m}$, $8.0\text{m} < \text{UDRE}, \dots$)	User Differential Range Error. This field provides an estimate of the uncertainty ($1-\sigma$) in the corrections for the particular satellite. The value in this field shall be multiplied by the UDRE Scale Factor in the common Corrections Status/Health field to determine the final UDRE estimate for the particular satellite
>PRC	M		INTEGER(-2047..2047)	Scaling factor 0.32 meters
>Range Correction Rate	M		INTEGER(-127..127)	Scaling factor 0.032 m/s

Range Bound	Explanation
<i>maxNoSat</i>	Maximum number of satellites for which information can be provided

9.2.1.20 Diversity Control Field

The Diversity Control Field indicates if the current RL may, must or must not be combined with the already existing RLs.

IE/Group Name	Presence	Range	IE Type and Reference	Semantics Description
Diversity Control Field			ENUMERATED (May, Must, Must not)	

9.2.1.21 Diversity Indication

Void.

9.2.1.21A DL Power

The *DL Power* IE indicates a power level relative to the [FDD - primary CPICH power] [TDD - PCCPCH power] configured in a cell [FDD - If referred to a DPCH, it indicates the power of the transmitted DPDCH symbols]. If Transmit Diversity is applied to a downlink physical channel, the *DL Power* IE indicates the power offset between the linear sum of the power for this downlink physical channel on all branches and the [FDD - primary CPICH power] [TDD - PCCPCH power] configured in a cell.

[TDD - If referred to a DPCH, it indicates the power of a spreading factor 16 code, the power for a spreading factor 1 code would be 12 dB higher].

IE/Group Name	Presence	Range	IE Type and Reference	Semantics description
DL Power			INTEGER (-350..150)	Value = DL Power /10 Unit dB Range -35.0 .. +15.0 Step 0.1dB

9.2.1.22 Downlink SIR Target

Void

9.2.1.23 DPCH Constant Value

DPCH Constant Value is the power margin used by a UE to set the proper uplink power.

IE/Group Name	Presence	Range	IE Type and Reference	Semantics Description
DPCH Constant Value			INTEGER (-10..10)	Unit dB Granularity 1 dB.

9.2.1.24 D-RNTI

The D-RNTI identifies the UE Context in the DRNC.

IE/Group Name	Presence	Range	IE Type and Reference	Semantics Description
D-RNTI			INTEGER (0..2 ²⁰ -1)	

9.2.1.25 D-RNTI Release Indication

The D-RNTI Release Indication indicates whether or not a DRNC shall release the D-RNTI allocated for a particular UE.

IE/Group Name	Presence	Range	IE Type and Reference	Semantics Description
D-RNTI Release Indication			ENUMERATED (Release D-RNTI, not Release D-RNTI)	

9.2.1.26 DRX Cycle Length Coefficient

The DRX Cycle Length Coefficient is used as input for the formula to establish the paging occasions to be used in DRX.

IE/Group Name	Presence	Range	IE Type and Reference	Semantics Description
DRX Cycle Length Coefficient			INTEGER (3..9)	Refers to 'k' in the formula as specified in ref. [15], Discontinuous Reception.

9.2.1.26A DSCH ID

The DSCH ID is the identifier of an active downlink shared channel. It is unique for each active DSCH among the active DSCHs simultaneously allocated for the same UE.

IE/Group Name	Presence	Range	IE Type and Reference	Semantics Description
DSCH ID			INTEGER (0..255)	

9.2.1.26B DSCH Flow Control Information

The *DSCH Flow Control Information* IE provides flow control information for each scheduling priority class for the DSCH FP over Iur.

IE/Group Name	Presence	Range	IE Type and Reference	Semantics Description	Criticality	Assigned Criticality
DSCH Flow Control Information		1..16			–	
>DSCH Scheduling Priority	M		Scheduling Priority Indicator 9.2.1.51A		–	
>MAC-c/sh SDU Length		1..<maxNb MAC-c/shSDULength>			–	
>>MAC-c/sh SDU Length	M		9.2.1.34		–	

Range bound	Explanation
maxNbMAC-c/shSDULength	Maximum number of different MAC-c/sh SDU lengths.

9.2.1.26Ba DSCH-RNTI

DSCH-RNTI is the UE identifier allocated by DRNS to be used over the radio interface by UEs having one or several DSCHs [TDD – and/or USCHs]. It is unique within a cell.

IE/Group Name	Presence	Range	IE type and reference	Semantics description
DSCH-RNTI			INTEGER(0..65535)	

9.2.1.26Bb Extended GSM Cell Individual Offset

Extended GSM Cell individual offset is an offset that will be applied by UE to the measurement results for GSM carrier RSSI according to [16]. It shall be used when the offset exceeds the range of values that can be indicated using the *Cell Individual Offset* IE (Subclause 9.2.1.7).

IE/Group Name	Presence	Range	IE Type and Reference	Semantics Description
Extended GSM Cell Individual Offset			INTEGER (-50..-11 11..50)	Unit in dB. Step size is 1 dB.

9.2.1.26C FACH Flow Control Information

The *FACH Flow Control Information* IE provides flow control information for each scheduling priority class for the FACH FP over Iur.

IE/Group Name	Presence	Range	IE Type and Reference	Semantics Description	Criticality	Assigned Criticality
FACH Flow Control Information		1..16			–	
>FACH Scheduling Priority	M		Scheduling Priority Indicator 9.2.1.51A		–	
>MAC-c/sh SDU Length		1..<maxNb MAC-c/shSDULength>			–	
>>MAC-c/sh SDU Length	M		9.2.1.34		–	
>FACH Initial Window Size	M		9.2.1.27		–	

Range bound	Explanation
maxNbMAC-c/shSDULength	Maximum number of different MAC-c/sh SDU lengths.

9.2.1.27 FACH Initial Window Size

Indicates the initial number of MAC-c/sh SDUs that may be transmitted before an acknowledgement is received from the DRNC.

IE/Group Name	Presence	Range	IE Type and Reference	Semantics Description
FACH Initial Window Size			INTEGER (0..255)	Number of frames (MAC-c/sh SDUs.) 255 = Unlimited number of FACH data frames.

9.2.1.28 FACH Priority Indicator

Void

9.2.1.28A FN Reporting Indicator

Frame Number reporting indicator.

Indicates if the SFN or CFN shall be included together with the reported measurement value.

IE/Group Name	Presence	Range	IE Type and Reference	Semantics Description
FN reporting indicator			ENUMERATED(FN reporting required, FN reporting not required)	

9.2.1.29 Frame Handling Priority

This parameter indicates the priority level to be used during the lifetime of the DCH/DSCH for temporary restriction of the allocated resources due overload reason.

IE/Group Name	Presence	Range	IE Type and Reference	Semantics Description
Frame Handling Priority			INTEGER (0..15)	0=Lowest Priority, ... 15=Highest Priority

9.2.1.30 Frame Offset

Frame Offset is the required offset between the dedicated channel downlink transmission frames (CFN, Connection Frame Number) and the broadcast channel frame offset (Cell Frame Number). The Frame_offset is used in the translation between Connection Frame Number (CFN) on Iub/Iur and least significant 8 bits of SFN (System Frame Number) on Uu. The Frame Offset is UE and cell specific.

IE/Group Name	Presence	Range	IE Type and Reference	Semantics Description
Frame Offset			INTEGER (0..255)	Frames

9.2.1.30A GA Point with Uncertainty

This IE contains one of the possible descriptions of a Cell Geographical Area.

IE/Group Name	Presence	Range	IE Type and Reference	Semantics Description
Geographical Coordinates	M		9.2.1.30F	
Uncertainty Code	M		INTEGER(0..127)	The uncertainty "r" is derived from the "uncertainty code" k by $r = 10 \times (1.1^k - 1)$

9.2.1.30B GA Ellipsoid Point with Uncertainty Ellipse

This IE contains one of the possible descriptions of a Cell Geographical Area.

IE/Group Name	Presence	Range	IE Type and Reference	Semantics Description
Geographical Coordinates	M		9.2.1.30F	
Uncertainty Ellipse	M		9.2.1.68A	
Confidence	M		INTEGER(0..127)	

9.2.1.30C GA Ellipsoid Point with Altitude

This IE contains one of the possible descriptions of a Cell Geographical Area.

IE/Group Name	Presence	Range	IE Type and Reference	Semantics Description
Geographical Coordinates	M		9.2.1.30F	
Altitude and direction	M		9.2.1.2B	

9.2.1.30D GA Ellipsoid Point with Altitude and Uncertainty Ellipsoid

This IE contains one of the possible descriptions of a Cell Geographical Area.

IE/Group Name	Presence	Range	IE Type and Reference	Semantics Description
Geographical Coordinates	M		9.2.1.30F	
Altitude and direction	M		9.2.1.2B	
Uncertainty Ellipse	M		9.2.1.68A	
Uncertainty Altitude	M		INTEGER(0..127)	
Confidence	M		INTEGER(0..127)	

9.2.1.30E GA Ellipsoid Arc

This IE contains one of the possible descriptions of a Cell Geographical Area.

IE/Group Name	Presence	Range	IE Type and Reference	Semantics Description
Geographical Coordinates	M		9.2.1.30F	
Inner radius	M		INTEGER (0.. $2^{16}-1$)	The relation between the value (N) and the radius (r) in meters it describes is $5N \leq r < 5(N+1)$, except for $N=2^{16}-1$ for which the range is extended to include all greater values of (r).
Uncertainty radius	M		INTEGER(0..127)	The uncertainty "r" is derived from the "uncertainty code" k by $r = 10 \times (1.1^k - 1)$
Offset angle	M		INTEGER(0..179)	The relation between the value (N) and the angle (a) in degrees it describes is $2N \leq a < 2(N+1)$
Included angle	M		INTEGER(0..179)	The relation between the value (N) and the angle (a) in degrees it describes is $2N < a \leq 2(N+1)$
Confidence	M		INTEGER(0..127)	

9.2.1.30F Geographical Coordinates

This IE contains the description of geographical coordinates.

IE/Group Name	Presence	Range	IE Type and Reference	Semantics Description
Latitude Sign	M		ENUMERATED (North, South)	
Degrees Of Latitude	M		INTEGER (0.. $2^{23}-1$)	The IE value (N) is derived by this formula: $N \leq 2^{23} \times X / 90 < N+1$ X being the latitude in degree (0°.. 90°)
Degrees Of Longitude	M		INTEGER ($-2^{23}..2^{23}-1$)	The IE value (N) is derived by this formula: $N \leq 2^{24} \times X / 360 < N+1$ X being the longitude in degree (-180°..+180°)

9.2.1.30G GPS Almanac

This IE provides the information regarding the GPS Almanac. For further details on the meaning of parameters, see [30].

IE/Group name	Presence	Range	IE Type and Reference	Semantics Description
WN _a	M		BIT STRING(8)	
Satellite Almanac Information	M	1,,<maxNo Sat>		
>DataID	M		INTEGER (0..3)	
>SatID	M		SAT ID 9.2.1.50A	Satellite ID
>e	M		BIT STRING(16)	
>t _{oa}	M		BIT STRING(8)	
>δl	M		BIT STRING(16)	
>OMEGADOT	M		BIT STRING(16)	
>SV Health	M		BIT STRING(8)	
>A ^{1/2}	M		BIT STRING(24)	
>OMEGA ₀	M		BIT STRING(24)	
>M ₀	M		BIT STRING(24)	
>ω	M		BIT STRING(24)	
>af ₀	M		BIT STRING(11)	
>af ₁	M		BIT STRING(11)	
SV Global Health	O		BIT STRING(364)	

Range Bound	Explanation
<i>maxNoSat</i>	Maximum number of satellites for which information can be provided

9.2.1.30H GPS Ionospheric Model

This IE provides the information regarding the GPS Ionospheric Model. For further details on the meaning of parameters, see [30].

IE/Group Name	Presence	Range	IE Type and Reference	Semantics Description
α_0	M		BIT STRING(8)	
α_1	M		BIT STRING(8)	
α_2	M		BIT STRING(8)	
α_3	M		BIT STRING(8)	
β_0	M		BIT STRING(8)	
β_1	M		BIT STRING(8)	
β_2	M		BIT STRING(8)	
β_3	M		BIT STRING(8)	

9.2.1.30I GPS Navigation Model and Time Recovery

This IE contains subframes 1 to 3 of the GPS navigation message. For further details on the meaning of parameters, see [30].

IE/Group Name	Presence	Range	IE Type and Reference	Semantics Description
Navigation Message 1to3		<i>1..<maxNoSat></i>		
>Transmission TOW	M		INTEGER(0..1048575)	Time of the Week when the message is broadcast.
>SatID	M		SAT ID 9.2.1.50A	Satellite ID of the satellite from which the information is obtained
>TLM Message	M		BIT STRING(14)	
>Tlm Revd (C)	M		BIT STRING(2)	
>HO-Word	M		BIT STRING(22)	
>WN	M		BIT STRING(10)	
>C/A or P on L2	M		BIT STRING(2)	
>User Range Accuracy Index	M		BIT STRING(4)	
>SV Health	M		BIT STRING(6)	
>IODC	M		BIT STRING(10)	
>L2 P Data Flag	M		BIT STRING(1)	
>SF 1 Reserved	M		BIT STRING(87)	
>T _{GD}	M		BIT STRING(8)	
>t _{oc}	M		BIT STRING(16)	
>af ₂	M		BIT STRING(8)	
>af ₁	M		BIT STRING(16)	
>af ₀	M		BIT STRING(22)	
>C _{rs}	M		BIT STRING(16)	
>Δn	M		BIT STRING(16)	
>M ₀	M		BIT STRING(32)	
>C _{uc}	M		BIT STRING(16)	
>e	M		BIT STRING(32)	
>C _{us}	M		BIT STRING(16)	
>(A) ^{1/2}	M		BIT STRING(32)	
>t _{oe}	M		BIT STRING(16)	
>Fit Interval Flag	M		BIT STRING(1)	
>AODO	M		BIT STRING(5)	
>C _{ic}	M		BIT STRING(16)	
>OMEGA ₀	M		BIT STRING(32)	
>C _{is}	M		BIT STRING(16)	
>i ₀	M		BIT STRING(32)	
>C _{rc}	M		BIT	

			STRING(16)	
> ω	M		BIT STRING(32)	
>OMEGAdot	M		BIT STRING(24)	
>ldot	M		BIT STRING(14)	
>Spare/zero fill	M		BIT STRING(20)	

Range Bound	Explanation
<i>maxNoSat</i>	Maximum number of satellites for which information can be provided

9.2.1.30J GPS Real-Time Integrity

This IE provides the information regarding the status of the GPS constellation. For further details on the meaning of parameters, see [30].

IE/Group name	Presence	Range	IE Type and Reference	Semantics Description
CHOICE <i>Bad Satellites Presence</i>	M			
> <i>Bad Satellites</i>				
>>Satellite information		1..<maxNoSat>		
>>>BadSatID	M		SAT ID 9.2.1.50A	Satellite ID
> <i>No Bad Satellites</i>			NULL	

Range Bound	Explanation
<i>maxNoSat</i>	Maximum number of satellites for which information can be provided

9.2.1.30K GPS Receiver Geographical Position (GPS RX Pos)

The GPS Receiver Geographical Position is used to identify the geographical coordinates of a GPS receiver relevant for a certain Information Exchange Object.

IE/Group Name	Presence	Range	IE Type and Reference	Semantics Description
Geographical Coordinates	M		9.2.1.30F	
Altitude and direction	M		9.2.1.2B	

9.2.1.30L GPS UTC Model

This IE provides the information regarding the GPS UTC Model. For further details on the meaning of parameters, see [30].

IE/Group name	Presence	Range	IE Type and Reference	Semantics Description
A ₁	M		BIT STRING(24)	
A ₀	M		BIT STRING(32)	
t _{ot}	M		BIT STRING(8)	
Δt _{LS}	M		BIT STRING(8)	
WN _t	M		BIT STRING(8)	
WN _{LSF}	M		BIT STRING(8)	
DN	M		BIT STRING(8)	
Δt _{LSF}	M		BIT STRING(8)	

9.2.1.30M Guaranteed Rate Information

The *Guaranteed Rate Information* IE indicates the TFI corresponding to the guaranteed bit rate for the uplink and/or the downlink of a DCH.

IE/Group Name	Presence	Range	IE Type and Reference	Semantics Description
Guaranteed UL Rate	O		INTEGER(1. .maxTFcount)	"1": TFI 0, "2": TFI 1, "3": TFI 2, ...
Guaranteed DL Rate	O		INTEGER(1. .maxTFcount)	"1": TFI 0, "2": TFI 1, "3": TFI 2, ...

9.2.1.31 IMSI

The IMSI is the permanent UE user Identity, see ref. [1].

IE/Group Name	Presence	Range	IE Type and Reference	Semantics Description
IMSI			OCTET STRING (SIZE(3..8))	-Decimal digits coded in BCD -'1111' used as filler -bit 4 to 1 of octet n is encoding digit 2n-1 -bit 8 to 5 of octet n is encoding digit 2n

9.2.1.31A Information Exchange ID

The Information Exchange ID uniquely identifies any requested information per RNS.

IE/Group Name	Presence	Range	IE Type and Reference	Semantics Description
Information Exchange ID	M		INTEGER(0 .. 2 ²⁰ -1)	

9.2.1.31B Information Exchange Object Type

Void.

9.2.1.31C Information Report Characteristics

The information report characteristics define how the reporting shall be performed.

IE/Group Name	Presence	Range	IE Type and Reference	Semantics Description
CHOICE <i>Information Report Characteristics Type</i>				
> <i>OnDemand</i>			NULL	
> <i>Periodic</i>				
>>CHOICE <i>Information Report Periodicity Scale</i>	M			The frequency with which the Node B shall send information reports.
>>> <i>minute</i>				
>>>>Report Periodicity Value	M		INTEGER (1..60,...)	
>>> <i>hour</i>				
>>>>Report Periodicity Value	M		INTEGER (1..24,...)	
> <i>On Modification</i>				
>>Information Threshold	O		9.2.1.31D	

9.2.1.31D Information Threshold

The Information Threshold indicates which kind of information shall trigger the Information Reporting procedure.

IE/Group Name	Presence	Range	IE Type and Reference	Semantics Description
CHOICE <i>Information Type Item</i>	M			
> <i>DGPS Corrections</i>				
>>PRC Deviation	M		ENUMERATED (1, 2, 5, 10, ...)	PRC deviation in meters from the previously reported value, which shall trigger a report

9.2.1.31E Information Type

The Information Type indicates which kind of information the RNS shall provide.

IE/Group Name	Presence	Range	IE Type and Reference	Semantics Description
Information Type Item	M		ENUMERATED (UTRAN Access Point Position with Altitude, UTRAN Access Point Position, IPDL Parameters, GPS Information, DGPS Corrections, GPS RX Pos, SFN-SFN Measurement Reference Point Position,...)	
GPS Information	C-GPS	<i>1..<maxnoofGPSTypes></i>		
>GPS Information Item			ENUMERATED (GPS Navigation Model and Time Recovery, GPS Ionospheric Model, GPS UTC Model, GPS Almanac, GPS Real-Time Integrity, ...)	

Condition	Explanation
GPS	This IE shall be present if the <i>Information Type Item</i> IE indicates "GPS Information"

Range Bound	Explanation
<i>maxnoofGPSTypes</i>	Maximum number of GPS Information Types supported in one Information Exchange.

9.2.1.31F IPDL Parameters

IE/Group name	Presence	Range	IE Type and Reference	Semantics Description
CHOICE <i>IPDL Parameters</i>				
> <i>IPDL FDD Parameters</i>				
>>IPDL FDD parameters	M		9.2.2.21B	
> <i>IPDL TDD Parameters</i>				
>>IPDL TDD parameters	M		9.2.3.4B	

9.2.1.32 L3 Information

This parameter contains the Layer 3 Information from a Uu message as received from the UE over the Uu interface or the Layer 3 Information for a Uu message to be sent to a UE by the DRNC, as defined in ref. [16].

IE/Group Name	Presence	Range	IE Type and Reference	Semantics Description
L3 Information			BIT STRING	The content is defined in ref. [16]

9.2.1.33 Limited Power Increase

Void.

9.2.1.33A Load Value

The *Load Value* IE contains the load on the measured object relative to the maximum planned load for both the uplink and downlink.

IE/Group Name	Presence	Range	IE Type and Reference	Semantics Description
Uplink Load Value	M		INTEGER(0..100)	Value 0 shall indicate the minimum load, and 100 shall indicate the maximum load. Load should be measured on a linear scale.
Downlink Load Value	M		INTEGER(0..100)	Value 0 shall indicate the minimum load, and 100 shall indicate the maximum load. Load should be measured on a linear scale.

9.2.1.34 MAC-c/sh SDU Length

Indicates the MAC-c/sh SDU Length. Which is used for FACH, DSCH and USCH. There may be multiple MAC-c/sh SDU Lengths per priority class.

IE/Group Name	Presence	Range	IE Type and Reference	Semantics Description
MAC-c/sh SDU Length			INTEGER (1..5000)	Size of the MAC-c/sh SDU in number of bits.

9.2.1.35 Maximum Allowed UL Tx Power

Maximum Allowed UL Tx Power is the maximum power that a UE in a particular cell is allowed to transmit.

IE/Group Name	Presence	Range	IE Type and Reference	Semantics Description
Maximum Allowed UL Tx Power			INTEGER (-50..+33)	dBm

9.2.1.35A Measurement Availability Indicator

Void

9.2.1.35B Measurement Change Time

IE/Group Name	Presence	Range	IE Type and Reference	Semantics Description
Measurement Change Time			INTEGER (1..6000,...)	Unit: ms Range: 10..60000 ms Step: 10 ms

9.2.1.36 Measurement Filter Coefficient

The Measurement Filter Coefficient determines the amount of filtering to be applied for measurements.

IE/Group Name	Presence	Range	IE Type and Reference	Semantics Description
Measurement Filter Coefficient			ENUMERATED(0, 1, 2, 3, 4, 5, 6, 7, 8, 9, 11, 13, 15, 17, 19,...)	

9.2.1.36A Measurement Hysteresis Time

The Measurement Hysteresis Time provides the duration during which a reporting criterion has to be fulfilled for the Measurement Reporting procedure to be triggered.

IE/Group Name	Presence	Range	IE Type and Reference	Semantics Description
Measurement Hysteresis Time			INTEGER (1..6000,...)	Unit: ms Range: 10..60000 ms Step: 10 ms

9.2.1.37 Measurement ID

The Measurement ID uniquely identifies a dedicated measurement within a UE Context or a common measurement within a Distant RNC Context.

IE/Group Name	Presence	Range	IE Type and Reference	Semantics Description
Measurement ID			INTEGER(0 .. 2 ²⁰ -1)	

9.2.1.38 Measurement Increase/Decrease Threshold

The Measurement Increase/Decrease Threshold defines the threshold that shall trigger Event C or D.

IE/Group Name	Presence	Range	IE Type and Reference	Semantics Description	Criticality	Assigned Criticality
CHOICE <i>Measurement Increase/Decrease Threshold</i>					-	
> <i>SIR</i>					-	
>> <i>SIR</i>	M		INTEGER(0..62)	0: 0 dB 1: 0.5 dB 2: 1 dB ... 62: 31dB	-	
> <i>SIR Error</i>				FDD Only	-	
>> <i>SIR Error</i>	M		INTEGER(0..124)	0: 0 dB 1: 0.5 dB 2: 1 dB ... 124: 62 dB	-	
> <i>Transmitted Code Power</i>					-	
>> <i>Transmitted Code Power</i>	M		INTEGER(0..112 ...)	0: 0 dB 1: 0.5 dB 2: 1 dB ... 112: 56 dB	-	
> <i>RSCP</i>				TDD Only	-	
>> <i>RSCP</i>	M		INTEGER(0..126)	0: 0 dB 1: 0.5 dB 2: 1 dB ... 126: 63 dB	-	
> <i>Round Trip Time</i>				FDD Only	-	
>> <i>Round Trip Time</i>	M		INTEGER(0..32766)	0: 0 chips 1: 0.0625 chips 2: 0.1250 chips ... 32766: 2047.875 chips	-	
> <i>Load</i>					-	
>> <i>Load</i>	M		INTEGER(0..100)	Units are the same as for the Uplink <i>Load Value</i> IE and Downlink <i>Load Value</i> IE.	YES	reject
> <i>Transmitted Carrier Power</i>					-	
>> <i>Transmitted Carrier Power</i>	M		INTEGER(0..100)	According to mapping in [23] and [24].	YES	reject
> <i>Received Total Wide Band Power</i>					-	
>> <i>Received Total Wide Band Power</i>	M		INTEGER(0..620)	0: 0dB 1: 0.1dB 2: 0.2dB ... 620: 62dB	YES	reject
> <i>UL Timeslot ISCP</i>				TDD Only	-	
>> <i>UL Timeslot ISCP</i>	M		INTEGER(0..126)	0: 0dB 1: 0.5dB 2: 1dB ... 126: 63dB	YES	reject

9.2.1.39 Measurement Threshold

The Measurement Threshold defines which threshold that shall trigger Event A, B, E, F or On Modification.

IE/Group Name	Presence	Range	IE Type and Reference	Semantics Description	Criticality	Assigned Criticality
CHOICE <i>Measurement Threshold</i>					-	
> <i>SIR</i>					-	
>> <i>SIR</i>	M		INTEGER(0..63)	According to mapping in ref. [23] and [24].	-	
> <i>SIR Error</i>				FDD Only	-	
>> <i>SIR Error</i>	M		INTEGER(0..125)	According to mapping in [23]	-	
> <i>Transmitted Carrier Power</i>					-	
>> <i>Transmitted Code Power</i>	M		INTEGER(0..127)	According to mapping in ref. [23] and [24].	-	
> <i>RSCP</i>				TDD Only	-	
>> <i>RSCP</i>	M		INTEGER(0..127)	According to mapping in ref. [24]	-	
> <i>Rx Timing Deviation</i>				Applicable to 3.84Mcps TDD Only	-	
>> <i>Rx Timing Deviation</i>	M		INTEGER(0..8191)	According to mapping in [24]	-	
> <i>Round Trip Time</i>				FDD Only	-	
>> <i>Round Trip Time</i>	M		INTEGER(0..32767)	According to mapping in [23]	-	
> <i>T_{UTRAN-GPS} Measurement Threshold Information</i>					-	
>> <i>T_{UTRAN-GPS} Measurement Threshold Information</i>	M		9.2.1.59C		YES	reject
> <i>SFN-SFN Measurement Threshold Information</i>					-	
>> <i>SFN-SFN Measurement Threshold Information</i>	M		9.2.1.52B		YES	reject
> <i>Load</i>					-	
>> <i>Load</i>	M		INTEGER(0..100)	0 is the minimum indicated load, and 100 is the maximum indicated load.	YES	reject
> <i>Transmitted Carrier Power</i>					-	
>> <i>Transmitted Carrier Power</i>	M		INTEGER(0..100)	According to mapping in [23] and [24].	YES	reject
> <i>Received Total Wide Band Power</i>					-	
>> <i>Received Total Wide Band Power</i>	M		INTEGER(0..621)	According to mapping in [23] and [24].	YES	reject
> <i>UL Timeslot ISCP</i>				TDD Only	-	
>> <i>UL Timeslot ISCP</i>	M		INTEGER(0..127)	According to mapping in [24]	YES	reject
> <i>Rx Timing Deviation LCR</i>				Applicable to 1.28Mcps TDD Only		
>> <i>Rx Timing Deviation LCR</i>	M		INTEGER(0..511)	According to mapping in [24]	YES	reject

9.2.1.39A Message Structure

The *Message Structure* IE gives information for each level with assigned criticality in an hierarchical message structure from top level down to the lowest level above the reported level for the occurred error (reported in the *Information Element Criticality Diagnostics* IE).

IE/Group Name	Presence	Range	IE Type and Reference	Semantics Description	Criticality	Assigned Criticality
Message structure		1..<maxnooflevels>		The first repetition of the <i>Message Structure</i> IE corresponds to the top level of the message. The last repetition of the <i>Message Structure</i> IE corresponds to the level above the reported level for the occurred error of the message.	GLOBAL	ignore
>IE ID	M		INTEGER (0..65535)	The IE ID of this level's IE containing the not understood or missing IE.	-	
>Repetition Number	O		INTEGER (1..256)	The <i>Repetition Number</i> IE gives, if applicable, the number of occurrences of this level's reported IE up to and including the occurrence containing the not understood or missing IE. Note: All the counted occurrences of the reported IE must have the same topdown hierarchical message structure of IEs with assigned criticality above them.	-	

Range bound	Explanation
<i>maxnooflevels</i>	Maximum no. of message levels to report. The value for <i>maxnooflevels</i> is 256.

9.2.1.40 Message Type

The Message Type uniquely identifies the message being sent.

IE/Group Name	Presence	Range	IE Type and Reference	Semantics Description
Procedure ID		1		
>Procedure Code	M		INTEGER (0..255)	"0" = Common Transport Channel Resources Initialisation "1" = Common Transport Channel Resources Release "2" = Compressed Mode Command "3" = Downlink Power Control "4" = Downlink Power Timeslot Control "5" = Downlink Signalling Transfer "6" = Error Indication "7" = Dedicated Measurement Failure "8" = Dedicated Measurement Initiation "9" = Dedicated Measurement Reporting "10" = Dedicated Measurement Termination "11" = Paging "12" = Physical Channel Reconfiguration "14" = Radio Link Addition "15" = Radio Link Deletion "16" = Radio Link Failure "17" = Radio Link Preemption "18" = Radio Link Restoration "19" = Radio Link Setup "20" = Relocation Commit "21" = Synchronised Radio Link Reconfiguration Cancellation "22" = Synchronised Radio Link Reconfiguration Commit "23" = Synchronised Radio Link Reconfiguration Preparation "24" = UnSynchronised Radio Link Reconfiguration "25" = Uplink Signalling Transfer "26" = Common Measurement Failure "27" = Common MeasurementInitiation "28" = Common Measurement Reporting "29" = Common MeasurementTermination "30" = Information Exchange Failure "31" = Information Exchange Initiation "32" = Information Reporting "33" = Information Exchange Termination "34" = Radio Link Congestion
>Ddmode	M		ENUMERATED (FDD, TDD, Common, ...)	Common = common to FDD and TDD.
Type of Message	M		ENUMERATED (Initiating Message, Successful Outcome, Unsuccessful Outcome, Outcome)	

9.2.1.41 Multiple URAs Indicator

The Multiple URAs Indicator indicates whether the accessed cell has multiple URAs.

IE/Group Name	Presence	Range	IE Type and Reference	Semantics Description
Multiple URAs Indicator			ENUMERATED (Multiple URAs exist, Single URA Exists)	

9.2.1.41A Neighbouring UMTS Cell Information

The *Neighbouring UMTS Cell Information* IE provides information for UMTS Cells that are neighbouring cells to a cell in the DRNC. The neighbouring cell information is provided for each RNC (including the DRNC) that has cells that are neighbouring cells to the cell in the DRNC.

IE/Group Name	Presence	Range	IE Type and Reference	Semantics Description	Criticality	Assigned Criticality
Neighbouring UMTS Cell Information		1..<maxnoofneighbouringRNCs>			EACH	ignore
>RNC-ID	M		9.2.1.50		–	
>CN PS Domain Identifier	O		9.2.1.12		–	
>CN CS Domain Identifier	O		9.2.1.11		–	
>Neighbouring FDD Cell Information	O		9.2.1.41B		–	
>Neighbouring TDD Cell Information	O		9.2.1.41D		–	
>Neighbouring TDD Cell Information LCR	O		9.2.1.72		YES	ignore

Range bound	Explanation
<i>maxnoofneighbouringRNCs</i>	Maximum number of neighbouring RNCs.

9.2.1.41B Neighbouring FDD Cell Information

The *Neighbouring FDD Cell Information* IE provides information for FDD cells that are a neighbouring cells to a cell in the DRNC.

IE/Group Name	Presence	Range	IE Type and Reference	Semantics Description	Criticality	Assigned Criticality
Neighbouring FDD Cell Information		<i>1..<max noofFDD neighbours></i>			–	
>C-ID	M		9.2.1.6		–	
>UL UARFCN	M		UARFCN 9.2.1.66	Corresponds to Nu in ref. [6]	–	
>DL UARFCN	M		UARFCN 9.2.1.66	Corresponds to Nd in ref. [6]	–	
>Frame Offset	O		9.2.1.30		–	
>Primary Scrambling Code	M		9.2.1.45		–	
>Primary CPICH Power	O		9.2.1.44		–	
>Cell Individual Offset	O		9.2.1.7		–	
>Tx Diversity Indicator	M		9.2.2.50		–	
>STTD Support Indicator	O		9.2.2.45		–	
>Closed Loop Mode1 Support Indicator	O		9.2.2.2		–	
>Closed Loop Mode2 Support Indicator	O		9.2.2.3		–	
>Restriction State Indicator	O		9.2.1.48C		YES	ignore
>DPC Mode Change Support Indicator	O		9.2.2.56		YES	ignore

Range bound	Explanation
<i>maxnoofFDDneighbours</i>	Maximum number of neighbouring FDD cell for one cell.

9.2.1.41C Neighbouring GSM Cell Information

The *Neighbouring GSM Cell Information* IE provides information for all GSM Cells that are a neighbouring cell to a cell in the DRNC.

IE/Group Name	Presence	Range	IE Type and Reference	Semantics Description	Criticality	Assigned Criticality
Neighbouring GSM Cell Information		<i>1..<maxno of GSM neighbours></i>			GLOBAL	ignore
>CGI		1		Cell Global Identity as defined in ref. [1].	–	
>>LAI		1			–	
>>>PLMN Identity	M		OCTET STRING (3)	<p>- digits 0 to 9, two digits per octet, - each digit encoded 0000 to 1001, - 1111 used as filler - bit 4 to 1 of octet n encoding digit 2n-1 - bit 8 to 5 of octet n encoding digit 2n</p> <p>-The PLMN Identity consists of 3 digits from MCC followed by either -a filler plus 2 digits from MNC (in case of 2 digit MNC) or -3 digits from MNC (in case of a 3 digit MNC).</p>	–	
>>>LAC	M		OCTET STRING (2)	0000 and FFFE not allowed	–	
>>CI	M		OCTET STRING (2)		–	
>Cell Individual Offset	O		9.2.1.7	The Cell Individual Offset to be used for UEs using DCHs. If the Extended GSM Cell Individual Offset IE is present, the Cell Individual Offset IE shall be set to a) –10dB if the Extended GSM Cell Individual Offset IE is < 10dB and b) 10dB if the Extended GSM Cell Individual Offset IE is > 10dB.	–	
>BSIC		1		Base Station Identity Code as defined in ref. [1].	–	
>>NCC	M		BIT STRING(3)	Network Colour Code.	–	
>>BCC	M		BIT STRING(3)	Base Station Colour Code.	–	

>Band Indicator	M		ENUMERATED (DCS 1800 band, PCS 1900 band, ...)	Indicates whether or not the BCCH ARFCN belongs to the 1800 band or 1900 band of GSM frequencies.	–	
>BCCH ARFCN	M		INTEGER (0..1023)	BCCH Frequency as defined in ref. [29].	–	
>Extended GSM Cell Individual Offset	O		9.2.1.26Bb	The Extended GSM Cell Individual Offset to be used for UEs using DCHs, for values that exceed the range of the <i>Cell Individual Offset</i> IE.	YES	ignore

Range bound	Explanation
<i>maxnoofGSMneighbours</i>	Maximum number of neighbouring GSM cells for one cell.

9.2.1.41D Neighbouring TDD Cell Information

The *Neighbouring TDD Cell Information* IE provides information for 3.84Mcps TDD cells that are a neighbouring cells to a cell in the DRNC.

IE/Group Name	Presence	Range	IE Type and Reference	Semantics Description	Criticality	Assigned Criticality
Neighbouring TDD Cell Information		<i>1..<maxnoofTDDneighbours></i>			–	
>C-ID	M		9.2.1.6		–	
>UARFCN	M		9.2.1.66	Corresponds to <i>Nt</i> in ref. [7]	–	
>Frame Offset	O		9.2.1.30		–	
>Cell Parameter ID	M		9.2.1.8		–	
>Sync Case	M		9.2.1.54		–	
>Time Slot For SCH	C-Case1		Time Slot 9.2.1.56		–	
>SCH Time Slot	C-Case2		9.2.1.51		–	
>SCTD Indicator	M		9.2.1.78		–	
>Cell Individual Offset	O		9.2.1.7		–	
>DPCH Constant Value	O		9.2.1.23		–	
>PCCPCH Power	O		9.2.1.43		–	
>Restriction State Indicator	O		9.2.1.48C		YES	ignore

Condition	Explanation
Case1	The IE shall be present if the <i>Sync Case</i> IE is set to 'Case1'.
Case2	The IE shall be present if the <i>Sync Case</i> IE is set to 'Case2'.

Range bound	Explanation
<i>maxnoofTDDneighbours</i>	Maximum number of neighbouring 3.84Mcps TDD cell for one cell.

9.2.1.41E Paging Cause

Cause for a CN originated page.

IE/Group Name	Presence	Range	IE Type and Reference	Semantics Description
Paging Cause			ENUMERATED(Terminating Conversational Call, Terminating Streaming Call, Terminating Interactive Call, Terminating Background Call, Terminating Low Priority Signalling,... , Terminating High Priority Signalling, Terminating – cause unknown)	See in [16]

9.2.1.41F Paging Record Type

IE/Group Name	Presence	Range	IE Type and Reference	Semantics Description
Paging Record Type			ENUMERATED (IMSI (GSM-MAP), TMSI (GSM-MAP), P-TMSI (GSM-MAP), IMSI (DS-41), TMSI (DS-41),...)	See ref. [16]

9.2.1.41G Neighbouring FDD Cell Measurement Information

This IE provides information on the FDD neighbouring cells used for the purpose of Measurements.

IE/Group Name	Presence	Range	IE Type and Reference	Semantics Description
UTRAN Cell Identifier	M		9.2.1.71	
UARFCN	M		9.2.1.66	Corresponds to Nd [6]
Primary Scrambling Code	M		9.2.1.45	

9.2.1.41H Neighbouring TDD Cell Measurement Information

This IE provides information on the 3.84Mcps TDD neighbouring cells used for the purpose of Measurements. Since the measurement can be performed on every time slot and midamble shift, the *Time slot* IE and *Midamble shift and burst type* IE shall be included if available.

IE/Group Name	Presence	Range	IE Type and Reference	Semantics Description
UTRAN Cell Identifier	M		9.2.1.71	
UARFCN	M		9.2.1.66	Corresponds to Nt [15]
Cell Parameter ID	M		9.2.1.8	
Time slot	O		9.2.1.56	
Midamble Shift And Burst Type	O		9.2.3.4	

9.2.1.42 Payload CRC Present Indicator

This parameter indicates whether FP payload 16 bit CRC is used or not.

IE/Group Name	Presence	Range	IE Type and Reference	Semantics Description
Payload CRC Presence Indicator			ENUMERATED (CRC Included, CRC not included)	

9.2.1.43 PCCPCH Power

Primary CCPCH power is the power that shall be used for reference power value in a TDD cell. The reference point is the antenna connector. If Transmit Diversity is applied to the Primary CCPCH, the PCCPCH Power is the linear sum of the power that is used for transmitting the PCCPCH on all branches.

IE/Group Name	Presence	Range	IE Type and Reference	Semantics Description
PCCPCH Power			INTEGER (-150..400,...)	Unit dBm Range -15.0 to 40.0 dBm, Step size 0.1 dB. -15.0 shall indicate $P_{\leq} -15\text{dBm}$ +40.0 shall indicate $P_{\geq} 40\text{dBm}$.

9.2.1.44 Primary CPICH Power

Primary CPICH power is the power that is used for transmitting the Primary CPICH in a cell. The reference point is the antenna connector. If Transmit Diversity is applied to the Primary CPICH, the Primary CPICH Power is the linear sum of the power that is used for transmitting the Primary CPICH on all branches.

IE/Group Name	Presence	Range	IE Type and Reference	Semantics Description
Primary CPICH Power			INTEGER (-100..500)	Value = Primary CPICH Power/10 Unit dBm Range -10.0..+50.0 Step 0.1 dB

9.2.1.45 Primary Scrambling Code

The Primary scrambling code to be used in the cell.

IE/Group Name	Presence	Range	IE Type and Reference	Semantics Description
Primary Scrambling Code			INTEGER (0 .. 511)	

9.2.1.46 Puncture Limit

The maximum amount of puncturing for a transport channel in rate matching.

IE/Group Name	Presence	Range	IE Type and Reference	Semantics Description
Puncture Limit			INTEGER (0..15)	0: 40% 1: 44 % ... 14: 96% 15: 100% (no puncturing)

9.2.1.46A QE-Selector

The QE-Selector indicates from which source the value for the quality estimate (QE) shall be taken.

IE/Group Name	Presence	Range	IE Type and Reference	Semantics Description
QE-Selector			ENUMERATED(selected, non-selected)	

9.2.1.47 RANAP Relocation Information

This parameter is transparent to the RNSAP. The parameter contains information for the Relocation procedure as defined in [2].

IE/Group Name	Presence	Range	IE Type and Reference	Semantics Description
RANAP Relocation Information			BIT STRING	The contents is defined in ref. [2].

9.2.1.48 Report Characteristics

The Report Characteristics, defines how the reporting shall be performed.

IE/Group Name	Presence	Range	IE Type and Reference	Semantics Description	Criticality	Assigned Criticality
CHOICE <i>Report Characteristics</i>					–	
> <i>OnDemand</i>			NULL		–	
> <i>Periodic</i>					–	
>>Report Periodicity	M		9.2.1.48a	The periodicity with which the DRNS shall send measurement reports.	–	
> <i>Event A</i>					–	
>>Measurement Threshold	M		9.2.1.39	The threshold for which the DRNS shall trigger a measurement report.	–	
>>Measurement Hysteresis Time	O		9.2.1.36A		–	
> <i>Event B</i>					–	
>>Measurement Threshold	M		9.2.1.39	The threshold for which the DRNS shall trigger a measurement report.	–	
>>Measurement Hysteresis Time	O		9.2.1.36A		–	
> <i>Event C</i>					–	
>>Measurement Increase/Decrease Threshold	M		9.2.1.38		–	
>>Measurement Change Time	M		9.2.1.35B	The time within which the measurement entity shall rise, in order to trigger a measurement report.	–	
> <i>Event D</i>					–	
>>Measurement Increase/Decrease Threshold	M		9.2.1.38		–	
>>Measurement Change Time	M		9.2.1.35B	The time within which the measurement entity shall fall, in order to trigger a measurement report.	–	
> <i>Event E</i>					–	
>>Measurement Threshold 1	M		Measurement Threshold 9.2.1.39		–	
>>Measurement Threshold 2	O		Measurement Threshold		–	

IE/Group Name	Presence	Range	IE Type and Reference	Semantics Description	Criticality	Assigned Criticality
			9.2.1.39			
>>Measurement Hysteresis Time	O		9.2.1.36A	The hysteresis time in ms	–	
>>Report Periodicity	O		9.2.1.48a	The periodicity with which the DRNS shall send measurement reports.	–	
>Event F					–	
>>Measurement Threshold 1	M		Measurement Threshold 9.2.1.39		–	
>>Measurement Threshold 2	O		Measurement Threshold 9.2.1.39		–	
>>Measurement Hysteresis Time	O		9.2.1.36A	The hysteresis time in ms	–	
>>Report Periodicity	O		9.2.1.48a	The periodicity with which the DRNS shall send measurement reports.		
>Additional Report Characteristics					–	
>> On Modification					–	
>>>On Modification		1			YES	reject
>>>>Measurement Threshold			9.2.1.39			

9.2.1.48a Report Periodicity

The Report Periodicity defines the frequency at which the Node B shall send measurement reports.

IE/Group Name	Presence	Range	IE Type and Reference	Semantics Description
CHOICE <i>Report Periodicity Scale</i>				
> <i>millisecond</i>				
>>Report Periodicity Value	M		INTEGER (1..6000,...)	Unit: ms Range: 10..60000 ms Step: 10 ms
> <i>minute</i>				
>>Report Periodicity Value	M		INTEGER (1..60,...)	Unit: min Range: 1..60 min Step: 1 min

9.2.1.48A Requested Data Value

The Requested Data Value contains the relevant data concerned the ongoing information exchange. *Requested Data Value* IE shall include at least one of the following IE.

IE/Group Name	Presence	Range	IE Type and Reference	Semantics Description
UTRAN Access Point Position with Altitude	O		9.2.1.75	
IPDL Parameters	O		9.2.1.31F	
DGPS Corrections	O		9.2.1.19B	
GPS Navigation Model and Time Recovery	O		9.2.1.30I	
GPS Ionospheric Model	O		9.2.1.30H	
GPS UTC Model	O		9.2.1.30L	
GPS Almanac	O		9.2.1.30G	
GPS Real-Time Integrity	O		9.2.1.30J	
GPS RX Pos	O		9.2.1.30K	
SFN-SFN Measurement Reference Point Position	O		9.2.1.74	

9.2.1.48B Requested Data Value Information

The *Requested Data Value Information* IE provides information on whether or not the Requested Data Value is available in the message and also the Requested Data Value itself if available. In case of "Periodic" and "On Modification" reporting, "Information Not Available" shall be used when at least one part of the requested information was not available at the moment of initiating the Information Reporting procedure.

IE/Group Name	Presence	Range	IE Type and Reference	Semantics Description	Criticality	Assigned Criticality
CHOICE <i>Information Availability Indicator</i>	M				–	
> <i>Information Available</i>					–	
>>Requested Data Value	M		9.2.1.48A		–	
> <i>Information not Available</i>			NULL		–	

9.2.1.48C Restriction State Indicator

The Restriction state indicator is the identifier indicates whether the cell is "Cell Reserved for Operator Use" or not. It is provided by DRNS and reported to SRNC.

IE/Group Name	Presence	Range	IE Type and Reference	Semantics Description
Restriction state indicator			ENUMERATED(Cell Not Reserved for Operator Use, Cell Reserved for Operator Use, ...)	

9.2.1.49 RL ID

The RL ID is the unique identifier for one RL associated with a UE.

IE/Group Name	Presence	Range	IE Type and Reference	Semantics Description
RL ID			INTEGER (0..31)	

9.2.1.50 RNC-ID

This is the identifier of one RNC in UTRAN.

IE/Group Name	Presence	Range	IE Type and Reference	Semantics Description
RNC-ID			INTEGER (0..4095)	

9.2.1.50A SAT ID

The SAT ID indicates the identity of the satellite.

IE/Group Name	Presence	Range	IE Type and Reference	Semantics Description
SAT ID			INTEGER(0. .63)	

9.2.1.51 SCH Time Slot

The *SCH Time Slot* IE represents the first time slot (k) of a pair of time slots inside a Radio Frame that is assigned to the Physical Channel SCH. The *SCH Time Slot* IE is only applicable if the value of *Sync Case* IE is Case 2 since in this case the SCH is allocated in TS#k and TS#k+8.

IE/Group Name	Presence	Range	IE Type and Reference	Semantics Description
SCH Time Slot			INTEGER(0. .6)	

9.2.1.51A Scheduling Priority Indicator

Indicates the relative priority of the FACH, DSCH, or USCH data frame. Used by the DRNC when scheduling FACH, DSCH, or USCH traffic.

IE/Group Name	Presence	Range	IE Type and Reference	Semantics Description
Scheduling Priority Indicator			INTEGER (0..15)	Relative priority of the FACH, DSCH, or USCH data frame: 0=Lowest Priority ... 15=Highest Priority

9.2.1.52 Service Area Identifier (SAI)

This information element is used to identify an area consisting of one or more cells belonging to the same Location Area. Such an area is called a Service Area and can be used for indicating the location of a UE to the CN. For this protocol, only a Service Area that is defined to be applicable to the PS and CS domains shall be used.

IE/Group Name	Presence	Range	IE Type and Reference	Semantics Description
PLMN Identity	M		OCTET STRING (3)	<ul style="list-style-type: none"> - digits 0 to 9, two digits per octet, - each digit encoded 0000 to 1001, - 1111 used as filler - bit 4 to 1 of octet n encoding digit 2n-1 - bit 8 to 5 of octet n encoding digit 2n <p>-The PLMN Identity consists of 3 digits from MCC followed by either</p> <ul style="list-style-type: none"> -a filler plus 2 digits from MNC (in case of 2 digit MNC) or -3 digits from MNC (in case of a 3 digit MNC).
LAC	M		OCTET STRING (2)	0000 and FFFE not allowed
SAC	M		OCTET STRING (2)	

9.2.1.52A SFN

System Frame Number of the cell, see ref. [17].

IE/Group Name	Presence	Range	IE Type and Reference	Semantics Description
SFN			INTEGER (0..4095)	

9.2.1.52B SFN-SFN Measurement Threshold Information

The SFN-SFN Measurement Threshold Information defines the related thresholds SFN-SFN Observed Time Difference measurements which shall trigger the Event On Modification.

IE/Group Name	Presence	Range	IE Type and Reference	Semantics Description
SFN-SFN Change Limit	O		INTEGER(1..256)	Change of SFN-SFN value compared to previously reported value, which shall trigger a new report. Unit in 1/16 chip.
Predicted SFN-SFN Deviation Limit	O		INTEGER(1..256)	Deviation the Predicted SFN-SFN from the latest measurement result, which shall trigger a new report. Unit in 1/16 chip.

9.2.1.52C SFN-SFN Measurement Value Information

The SFN-SFN Measurement Value Information IE indicates the measurement result related to SFN-SFN Observed Time Difference measurements as well as other related information.

IE/Group Name	Presence	Range	IE Type and Reference	Semantics Description
Successful Neighbouring cell SFN-SFN Observed Time Difference Measurement Information		$1..<maxnoofMeasNCell>$		
>UTRAN Cell Identifier	M		9.2.1.71	
>SFN-SFN Value	M		9.2.1.77	
>SFN-SFN Quality	O		INTEGER(0..255)	Indicates the standard deviation (std) of the SFN-SFN otd (observed time difference) measurements in 1/16 chip. SFN-SFN Quality = $\sqrt{E[(x-\mu)^2]}$ = std of reported SFN-SFN Value, where x is the reported SFN-SFN Value and $\mu = E[x]$ is the expectation value of x.
>SFN-SFN Drift Rate	M		INTEGER(-100..100)	Indicates the SFN-SFN drift rate in 1/256 chip per second. A positive value indicates that the Reference cell clock is running at a greater frequency than the measured neighbouring cell.
>SFN-SFN Drift Rate Quality	O		INTEGER(0..100)	Indicates the standard deviation (std) of the SFN-SFN drift rate measurements in 1/256 chip per second. SFN-SFN Drift Rate Quality = $\sqrt{E[(x-\mu)^2]}$ = std of reported SFN-SFN Drift Rate, where x is the reported SFN-SFN Drift Rate and $\mu = E[x]$ is the expectation value of x.
>SFN-SFN Measurement Time Stamp	M		9.2.1.76	
Unsuccessful Neighbouring cell SFN-SFN Observed Time Difference Measurement Information		$0..<maxnoofMeasNCell-1>$		
>UTRAN Cell Identifier	M		9.2.1.71	

Range bound	Explanation
$maxnoofMeasNCell$	Maximum number of neighbouring cells on which measurements can be performed.

9.2.1.53 S-RNTI

The S-RNTI identifies the UE in the SRNC.

IE/Group Name	Presence	Range	IE Type and Reference	Semantics Description
S-RNTI			INTEGER(0..2 ²⁰ -1)	

9.2.1.54 Sync Case

The SCH and PCCPCH in a TDD cell are mapped on one or two downlink slots per frame. There are two cases of Sync Case as follows:

- Case 1) SCH and PCCPCH allocated in a single TS#k
- Case 2) SCH allocated in two TS: TS#k and TS#k+8
PCCPCH allocated in TS#k

[1.28Mcps TDD - There is no Sync Case indication needed for 1.28Mcps TDD. If the *Sync Case* IE must be included in a message from DRNC to SRNC used for 1.28Mcps TDD, the DRNC shall indicate Sync Case 1 and the SRNC shall ignore it.]

IE/Group Name	Presence	Range	IE Type and Reference	Semantics Description
Sync Case			INTEGER (1..2,...)	

9.2.1.55 TFCI Presence

The TFCI Presence parameter indicates whether the TFCI shall be included. [TDD - If it is present in the timeslot, it will be mapped to the channelisation code defined by [12].]

IE/Group Name	Presence	Range	IE Type and Reference	Semantics Description
TFCI Presence			ENUMERATE D (Present, not present)	

9.2.1.56 Time Slot

The Time Slot represents the time interval assigned to a Physical Channel referred to the start of a Radio Frame.

IE/Group Name	Presence	Range	IE Type and Reference	Semantics Description
Time Slot			INTEGER (0..14)	

9.2.1.57 ToAWE

ToAWE is the window endpoint. DL data frames are expected to be received before this window endpoint. ToAWE is defined with a positive value relative Latest Time of Arrival (LToA). A data frame arriving after ToAWE gives a Timing Adjustment Control frame response.

IE/Group Name	Presence	Range	IE Type and Reference	Semantics Description
ToAWE			INTEGER (0..2559)	msec.

9.2.1.58 ToAWS

ToAWS is the window startpoint. DL data frames are expected to be received after this window startpoint. ToAWS is defined with a positive value relative Time of Arrival Window Endpoint (ToAWE). A data frame arriving before ToAWS gives a Timing Adjustment Control frame response.

IE/Group Name	Presence	Range	IE Type and Reference	Semantics Description
ToAWS			INTEGER (0..1279)	msec.

9.2.1.59 Transaction ID

The Transaction ID is used to associate all the messages belonging to the same procedure. Messages belonging to the same procedure shall use the same Transaction ID.

The Transaction ID is determined by the initiating peer of a procedure.

For procedures addressed to a specific UE Context, the Transaction ID shall uniquely identify a procedure among all ongoing parallel procedures for the same UE using the same procedure code, and initiated by the same protocol peer.

For procedures not addressed to a specific UE Context, the Transaction ID shall uniquely identify a procedure among all ongoing parallel procedures using the same procedure code, and initiated by the same protocol peer.

IE/Group Name	Presence	Range	IE Type and Reference	Semantics Description
CHOICE <i>Transaction ID Length</i>				The Transaction ID shall be interpreted for its integer value, not for the type of encoding ('short' or 'long').
> <i>Short</i>				
>>Transaction ID Value	M		INTEGER (0..127)	
> <i>Long</i>				
>>Transaction ID Value	M		INTEGER (0..32767)	

9.2.1.59A Transmitted Carrier Power

The *Transmitted Carrier Power* IE contains the Transmitted Carrier Power in a cell, as defined in [11] & [14].

IE/Group Name	Presence	Range	IE Type and Reference	Semantics Description
Transmitted Carrier Power			INTEGER(0..100)	According to mapping in [23] and [24].

9.2.1.59B T_{UTRAN-GPS} Accuracy Class

IE/Group Name	Presence	Range	IE Type and Reference	Semantics Description
T _{UTRAN-GPS} Accuracy Class			ENUMERATED(Accuracy Class A, Accuracy Class B, Accuracy Class C,...)	More information about Measurement Accuracy Class is included in [23].

9.2.1.59C T_{UTRAN-GPS} Measurement Threshold Information

The T_{UTRAN-GPS} Measurement Threshold Information defines the related thresholds for UTRAN GPS Timing of Cell Frames for UE Positioning measurements shall trigger the Event On Modification.

IE/Group Name	Presence	Range	IE Type and Reference	Semantics Description
T _{UTRAN-GPS} Change Limit	O		INTEGER(1..256)	Change of T _{UTRAN-GPS} value compared to previously reported value, which shall trigger a new report. Unit in 1/16 chip.
Predicted T _{UTRAN-GPS} Deviation Limit	O		INTEGER(1..256)	Deviation of the Predicted T _{UTRAN-GPS} from the latest measurement result, which shall trigger a new report. Unit in 1/16 chip.

9.2.1.59D T_{UTRAN-GPS} Measurement Value Information

The T_{UTRAN-GPS} *Measurement Value Information* IE indicates the measurement results related to the UTRAN GPS Timing of Cell Frames for UE Positioning measurements.

IE/Group Name	Presence	Range	IE Type and Reference	Semantics Description
T _{UTRAN-GPS}		1		Indicates the UTRAN GPS Timing of Cell Frames for UE Positioning. According to mapping in [23] and [24]; significant values range from 0 to 37158911999999.
>MS	M		INTEGER (0..16383)	Most Significant Part
>LS	M		INTEGER (0..4294967295)	Least Significant Part
T _{UTRAN-GPS} Quality	O		INTEGER(0..255)	Indicates the standard deviation (std) of the T _{UTRAN-GPS} measurements in 1/16 chip. $T_{UTRAN-GPS} \text{ Quality} = \sqrt{E[(x-\mu)^2]}$ = std of reported T _{UTRAN-GPS} Value, where x is the reported T _{UTRAN-GPS} Value and $\mu = E[x]$ is the expectation value of x.
T _{UTRAN-GPS} Drift Rate	M		INTEGER(-50..50)	Indicates the T _{UTRAN-GPS} drift rate in 1/256 chip per second. A positive value indicates that the UTRAN clock is running at a lower frequency than GPS clock.
T _{UTRAN-GPS} Drift Rate Quality	O		INTEGER(0..50)	Indicates the standard deviation (std) of the T _{UTRAN-GPS} drift rate measurements in 1/256 chip per second. $T_{UTRAN-GPS} \text{ Drift Rate Quality} = \sqrt{E[(x-\mu)^2]}$ = std of reported T _{UTRAN-GPS} Drift Rate, where x is the reported T _{UTRAN-GPS} Drift Rate and $\mu = E[x]$ is the expectation value of x.

9.2.1.60 Transport Bearer ID

The Transport Bearer ID uniquely identifies an Iur transport bearer.

IE/Group Name	Presence	Range	IE Type and Reference	Semantics Description
Transport Bearer ID			INTEGER (0..4095)	

9.2.1.61 Transport Bearer Request Indicator

Indicates whether a new Iur transport bearer needs to be established for carrying the corresponding data stream(s), or whether an existing transport bearer will be used.

IE/Group Name	Presence	Range	IE Type and Reference	Semantics Description
Transport Bearer Request Indicator			ENUMERATED(Bearer Requested, Bearer not Requested, ...)	

9.2.1.62 Transport Layer Address

Transport Layer Address defines the transport address of the DRNS. For details on the Transport Address used see [3].

IE/Group Name	Presence	Range	IE Type and Reference	Semantics Description
Transport Layer Address			BIT STRING(1..160, ...)	

9.2.1.63 Transport Format Combination Set (TFCS)

The Transport Format Combination Set is defined as a set of Transport Format Combinations on a Coded Composite Transport Channel. It is the allowed Transport Format Combinations of the corresponding Transport Channels. The DL Transport Format Combination Set is applicable to DL Transport Channels.

[FDD - Where the UE is assigned access to one or more DSCH transport channels then the UTRAN has the choice of two methods for signalling the mapping between TFCI(field 2) values and the corresponding TFC:

Method #1 - TFCI range

The mapping is described in terms of a number of groups, each group corresponding to a given transport format combination (value of CTFC(field2)). The CTFC(field2) value specified in the first group applies for all values of TFCI(field 2) between 0 and the specified 'Max TFCI(field2) value'. The CTFC(field2) value specified in the second group applies for all values of TFCI(field 2) between the 'Max TFCI(field2) value' specified in the last group plus one and the specified 'Max TFCI(field2) value' in the second group. The process continues in the same way for the following groups with the TFCI(field 2) value used by the UE in constructing its mapping table starting at the largest value reached in the previous group plus one.

Method #2 - Explicit

The mapping between TFCI(field 2) value and CTFC(field2) is spelt out explicitly for each value of TFCI (field2)]

IE/Group Name	Presence	Range	IE Type and Reference	Semantics Description
CHOICE DSCH				
>No Split in the TFCI				This choice is made if: a) The TFCS refers to the uplink OR b) The mode is FDD and none of the Radio Links of the concerned UE are assigned any DSCH transport channels OR c) The mode is TDD
>>TFCS		1..<maxnoofTFCs >		The first instance of the parameter corresponds to TFCI zero, the second to 1 and so on. [TDD - The first entry (for TFCI 0) should be ignored by the receiver.]
>>>CTFC	M		INTEGER(0..MaxCTFC)	Integer number calculated according to ref. [16].
>>>CHOICE Gain Factors	C-PhysChan			
>>>>Signalled Gain Factors				
>>>>>Gain Factor β_c	M		INTEGER (0..15)	[FDD - For UL DPCCCH or control part of PRACH ref. [21].] [TDD - β for UL DPCH mapping in accordance to [13].]
>>>>>Gain Factor β_D	M		INTEGER (0..15)	[FDD - For UL DPDCH or data part of PRACH ref. [21].] [TDD - Should be set to 0 by the sender, and shall be ignored by the receiver.]
>>>>>Reference TFC nr	O		INTEGER (0..15)	If this TFC is a reference TFC, this IE indicates the reference number
>>>>>Computed Gain Factors				
>>>>>Reference TFC nr	M		INTEGER (0..15)	Indicates the reference TFC to be used to calculate the gain factors for this TFC
>There is a split in the TFCI				This choice is made if : a) The TFCS refers to the downlink AND b) The mode is FDD and one of the Radio Links of the concerned UE is assigned one or more DSCH transport channels
>>Transport Format Combination_DCH		1..<maxTFCI_1_Comb >		The first instance of the <i>Transport format combination_DCH</i> IE corresponds to TFCI (field 1) = 0, the second to TFCI (field 1) = 1 and so on.
>>>CTFC(field1)	M		INTEGER(0..MaxCTFC)	Integer number calculated according to [16] . The calculation of CTFC ignores any DSCH transport channels which may be assigned
>>Choice Signalling Method				
>>>TFCI Range				

>>>>TFC Mapping on DSCH		1..<maxNoTFCIGroups>		
>>>>>Max TFCI(field2) Value	M		INTEGER(1..<maxTFCI_2_Combs - 1>)	This is the Maximum value in the range of TFCI(field2) values for which the specified CTFC(field2) applies
>>>>>CTFC(field 2)	M		INTEGER(0..MaxCTFC)	Integer number calculated according to [16] The calculation of CTFC ignores any DCH transport channels which may be assigned
>>>Explicit				
>>>>>Transport Format Combination_DSCH		1..<maxTFCI_2_Combs>		The first instance of the Transport format combination_DSCH IE corresponds to TFCI (field2) = 0, the second to TFCI (field 2) = 1 and so on.
>>>>>CTFC(field 2)	M		INTEGER(0..MaxCTFC)	Integer number calculated according to [16] . The calculation of CTFC ignores any DCH transport channels which may be assigned

Condition	Explanation
PhysChan	The choice shall be present if the TFCS concerns a UL DPCH [FDD – or PRACH channel].

Range bound	Explanation
maxnoofTFCs	The maximum number of Transport Format Combinations.
maxTFCI_1_Combs	Maximum number of TFCI (field 1) combinations (given by 2 raised to the power of the length of the TFCI (field 1)).
maxTFCI_2_Combs	Maximum number of TFCI (field 2) combinations (given by 2 raised to the power of the length of the TFCI (field 2)).
maxNoTFCIGroups	Maximum number of groups, each group described in terms of a range of TFCI(field 2) values for which a single value of CTFC(field2) applies.
MaxCTFC	Maximum number of the CTFC value is calculated according to the following: $\sum_{i=1}^I (L_i - 1)P_i$ with the notation according to ref. [16].

9.2.1.64 Transport Format Set

The Transport Format Set is defined as the set of Transport Formats associated to a Transport Channel, e.g. DCH.

[TDD - The Transport Format Set for each transport channel within the same CCTrCH shall have the same value for the 2nd Interleaving Mode IE.]

IE/Group Name	Presence	Range	IE Type and Reference	Semantics Description
Dynamic Transport Format Information		1..<maxTFcount>		The first instance of the parameter corresponds to TFI zero, the second to 1 and so on.
>Number of Transport Blocks	M		INTEGER (0..512)	
>Transport Block Size	C – Blocks		INTEGER (0..5000)	Bits
>CHOICE Mode	M			
>>TDD				
>>>Transmission Time Interval Information	C-TTIdynamic	1..<maxTTIcount>		
>>>>Transmission Time Interval	M		ENUMERATED(10, 20, 40, 80,...)	msec
Semi-static Transport Format Information		1		
>Transmission Time Interval	M		ENUMERATED (10, 20, 40, 80, dynamic, ...)	msec Value 'dynamic' for TDD only
>Type of Channel Coding	M		ENUMERATED (No codingTDD, Convolutional, Turbo,...)	[FDD - The value "No codingTDD" shall be treated as logical error if received]
>Coding Rate	C – Coding		ENUMERATED (1/2, 1/3,...)	
>Rate Matching Attribute	M		INTEGER (1..maxRM)	
>CRC size	M		ENUMERATED (0, 8, 12, 16, 24,...)	
>CHOICE Mode	M			
>>TDD				
>>>2 nd Interleaving Mode	M		ENUMERATED(Frame related, Timeslot related,...)	

Condition	Explanation
Blocks	The IE shall be present if the <i>Number of Transport Blocks</i> IE is set to a value greater than 0.
Coding	The IE shall be present if <i>Type of Channel Coding</i> IE is set to "Convolutional" or "Turbo".
TTIdynamic	The IE shall be present if the <i>Transmission Time Interval</i> IE in the <i>Semi-static Transport Format Information</i> IE is set to 'dynamic'.

Range bound	Explanation
<i>maxTFcount</i>	The maximum number of different transport formats that can be included in the Transport format set for one transport channel.
<i>maxRM</i>	The maximum number that could be set as rate matching attribute for a transport channel.
<i>maxTTIcount</i>	The amount of different TTI that are possible for that transport format is.

9.2.1.65 TrCH Source Statistics Descriptor

Defines the statistics of the data transmitted in the transport channel. This information may be used in reserving resources in the DRNS.

IE/Group Name	Presence	Range	IE Type and Reference	Semantics Description
TrCH Source Statistics Descriptor			ENUMERATED (Speech, RRC, Unknown, ...)	'Speech' = Statistics of the data corresponds to speech. 'RRC' = Statistics of the data corresponds to RRC signalling 'Unknown' = The statistics of the data is unknown

9.2.1.66 UARFCN

The UTRA Absolute Radio Frequency Channel Number defines the carrier.

IE/Group Name	Presence	Range	IE Type and Reference	Semantics Description
UARFCN			INTEGER (0..16383, ...)	Corresponds to: 0.0Hz.. 3276.6MHz see ref. [6] and ref. [7].

9.2.1.67 UL FP Mode

This parameter defines if normal or silent mode of the Frame Protocol shall be used for the UL.

IE/Group Name	Presence	Range	IE Type and Reference	Semantics Description
UL FP Mode			ENUMERATED (Normal, Silent,...)	

9.2.1.68 UL Interference Level

Void

9.2.1.68A Uncertainty Ellipse

This IE contains the uncertainty ellipse used to describe a possible shape of the geographical area of a cell.

IE/Group Name	Presence	Range	IE Type and Reference	Semantics Description
Uncertainty semi-major	M		INTEGER(0..127)	The uncertainty "r" is derived from the "uncertainty code" k by $r = 10 \times (1.1^{k-1})$
Uncertainty semi-minor	M		INTEGER(0..127)	The uncertainty "r" is derived from the "uncertainty code" k by $r = 10 \times (1.1^{k-1})$
Orientation of major axis	M		INTEGER(0..179)	The relation between the IE value (N) and the angle (a) in degrees it describes is $2N \leq a < 2(N+1)$. The values 90..179 shall not be used.

9.2.1.69 Uplink SIR

The UL SIR indicates a received UL SIR.

IE/Group Name	Presence	Range	IE Type and Reference	Semantics Description
Uplink SIR			INTEGER (-82..173)	Value = Uplink SIR/10 Unit dB Range -8.2..+17.3 Step 0.1 dB

9.2.1.70 URA ID

IE/Group Name	Presence	Range	IE Type and Reference	Semantics Description
URA ID			INTEGER (0..65 535)	

9.2.1.70A UTRAN Access Point Position

The UTRAN Access Point Position indicates the exact geographical position of the base station antenna.

IE/Group Name	Presence	Range	IE Type and Reference	Semantics Description
Latitude Sign	M		ENUMERATED (North, South)	
Degrees of Latitude	M		INTEGER (0.. $2^{23}-1$)	The IE value (N) is derived by this formula: $N \leq 2^{23} \times X / 90 < N+1$ X being the latitude in degree (0°.. 90°)
Degrees of Longitude	M		INTEGER (-2^{23} .. $2^{23}-1$)	The IE value (N) is derived by this formula: $N \leq 2^{24} \times X / 360 < N+1$ X being the longitude in degree (-180°..+180°)

9.2.1.70B URA Information

The *URA Information* IE contains URA Information for one cell.

IE/Group Name	Presence	Range	IE Type and Reference	Semantics Description
URA ID	M		9.2.1.70	
Multiple URAs Indicator	M		9.2.1.41	
RNCs with Cells in the Accessed URA		0 .. $\langle \text{maxRNCinURA} - 1 \rangle$		Other RNCs having at least one cell in the URA identified by the <i>URA ID</i> IE.
>RNC-ID	M		9.2.1.50	

Range Bound	Explanation
maxRNCinURA	Maximum number of RNC in one URA.

9.2.1.71 UTRAN Cell Identifier (UC-ID)

The UC-ID (UTRAN Cell identifier) is the identifier of a cell in one UTRAN.

IE/Group Name	Presence	Range	IE Type and Reference	Semantics Description
RNC-ID	M		9.2.1.50	
C-ID	M		9.2.1.6	

9.2.1.72 Neighbouring TDD Cell Information LCR

The *Neighbouring TDD Cell Information LCR* IE provides information for 1.28Mcps TDD cells that are a neighbouring cells to a cell in the DRNC.

IE/Group Name	Presence	Range	IE Type and Reference	Semantics Description	Criticality	Assigned Criticality
Neighbouring TDD Cell Information LCR		<i>1..<maxno ofLCRTDD neighbours></i>			–	
>C-ID	M		9.2.1.6		–	
>UARFCN	M		9.2.1.66	Corresponds to Nt in ref. [7]	–	
>Frame Offset	O		9.2.1.30		–	
>Cell Parameter ID	M		9.2.1.8		–	
>SCTD Indicator	M		9.2.1.78		–	
>Cell Individual Offset	O		9.2.1.7		–	
>DPCH Constant Value	O		9.2.1.23		–	
>PCCPCH Power	O		9.2.1.43		–	
>Restriction State Indicator	O		9.2.1.48C		–	

Range bound	Explanation
<i>maxnoofLCRTDDneighbours</i>	Maximum number of neighbouring 1.28Mcps TDD cell for one cell.

9.2.1.73 Permanent NAS UE Identity

This element is used to identify the UE in UTRAN.

IE/Group Name	Presence	Range	IE Type and Reference	Semantics Description
<i>Choice Permanent NAS UE Identity</i>				
>IMSI				
>>IMSI	M		9.2.1.31	

9.2.1.74 SFN-SFN Measurement Reference Point Position

The SFN-SFN Measurement Reference Point Position indicates the exact geographical position of the SFN-SFN measurement reference point. The altitude shall be included when available.

IE/Group Name	Presence	Range	IE Type and Reference	Semantics Description
Geographical Coordinates	M		9.2.1.30F	
Altitude and direction	O		9.2.1.2B	

9.2.1.75 UTRAN Access Point Position with Altitude

The UTRAN Access Point Position with Altitude indicates the exact geographical position of the base station antenna. The altitude shall be included when available.

IE/Group Name	Presence	Range	IE Type and Reference	Semantics Description
Geographical Coordinates	M		9.2.1.30F	
Altitude and direction	O		9.2.1.2B	

9.2.1.76 SFN-SFN Measurement Time Stamp

IE/Group Name	Presence	Range	IE Type and Reference	Semantics Description
CHOICE <i>Mode</i>				
>FDD				
>>SFN	M		9.2.1.52A	Indicates the SFN of the reference cell at which the measurement has been performed.
>TDD				
>>SFN	M		9.2.1.52A	Indicates the SFN of the reference cell at which the measurement has been performed.
>>Time Slot	M		9.2.1.56	Indicates the Time Slot of the reference cell at which this measurement has been performed.

9.2.1.77 SFN-SFN Value

IE/Group Name	Presence	Range	IE Type and Reference	Semantics Description
CHOICE <i>Mode</i>				
>FDD				
>>SFN-SFN	M		INTEGER(0..614399)	According to mapping in [23].
>TDD				
>>SFN-SFN	M		INTEGER(0..40961)	According to mapping in [24].

9.2.1.78 SCTD Indicator

Indicates if SCTD antenna diversity is applied or not to the PCCPCH and PICH [3.84Mcps TDD].

IE/Group Name	Presence	Range	IE Type and Reference	Semantics Description
SCTD Indicator			ENUMERATED(active, inactive)	

9.2.1.79 Congestion Cause

The *Congestion Cause* IE indicates the cause of a congestion situation:

IE/Group Name	Presence	Range	IE Type and Reference	Semantics Description
Congestion Cause			ENUMERATED (UTRAN Dynamic Resources, UTRAN Semistatic Resources, ...)	

The meaning of the different congestion cause values is described in the following table:

Congestion cause	Meaning
UTRAN Dynamic Resources	UL and/or DL resource congestion situation mainly caused by the UL and/or DL UTRAN Dynamic Resources. This type of congestion situation is, e.g. related to the limitation of the DL transmitted carrier power of the cell(s), or the UL Interference situation in the concerned cell(s).
UTRAN Semistatic Resources	UL and/or DL resource congestion situation mainly related to UTRAN Semistatic Resources (e.g. channelisation codes, Node-B resources, ..).

9.2.2 FDD Specific Parameters

This subclause contains parameters that are specific to FDD.

9.2.2.A Active Pattern Sequence Information

Defines the parameters for the compressed mode gap pattern sequence activation. For details see ref. [16].

IE/Group Name	Presence	Range	IE Type and Reference	Semantics Description
CM Configuration Change CFN	M		CFN 9.2.1.9	
Transmission Gap Pattern Sequence Status		<i>0..<maxTGPS></i>		If the group is not present, none of the pattern sequences are activated.
>TGPSI Identifier	M		INTEGER(1.. <MaxTGPS >)	Establish a reference to the compressed mode pattern sequence. Up to <MaxTGPS> simultaneous compressed mode pattern sequences can be activated.
>TGPRC	M		INTEGER(0.. .511)	The number of transmission gap patterns within the Transmission Gap Pattern Sequence. 0=Infinity.
>TGCFN	M		CFN 9.2.1.9	Connection Frame Number of the first frame of the first pattern 1 within the Transmission Gap Pattern Sequence.

Range bound	Explanation
<i>maxTGPS</i>	Maximum number of active pattern sequences. Value 6.

9.2.2.B Adjustment Period

Adjustment Period IE defines the period to be used for power balancing.

IE/Group Name	Presence	Range	IE Type and Reference	Semantics Description
Adjustment Period			INTEGER (1 .. 256)	Frames

9.2.2.C Adjustment Ratio

Adjustment Ratio IE (*Radj*) defines the convergence rate used for the associated Adjustment Period.

IE/Group Name	Presence	Range	IE Type and Reference	Semantics Description
Adjustment Ratio			INTEGER (0 .. 100)	The Adjustment Ratio is given with a granularity of 0.01 0 -> 0.00 1 -> 0.01 ... 100 -> 1.00

9.2.2.1 Chip Offset

The Chip Offset is defined as the radio timing offset inside a radio frame. The Chip Offset is used as offset for the DL DPCH relative to the Primary CPICH timing.

IE/Group Name	Presence	Range	IE Type and Reference	Semantics Description
Chip Offset			INTEGER (0..38399)	Chips

9.2.2.2 Closed Loop Mode1 Support Indicator

The Closed Loop Mode1 Support Indicator indicates whether the particular cell is capable to support Closed loop mode1 or not

IE/Group Name	Presence	Range	IE Type and Reference	Semantics Description
Closed Loop Mode1 Support Indicator			ENUMERATED (Closed loop mode1 Supported, Closed loop mode1 not supported).	

9.2.2.3 Closed Loop Mode2 Support Indicator

The Closed Loop Mode2 Support Indicator indicates whether the particular cell is capable to support Closed loop mode2 or not.

IE/Group Name	Presence	Range	IE Type and Reference	Semantics Description
Closed Loop Mode2 Support Indicator			ENUMERATED (Closed loop mode2 Supported, Closed loop mode2 not supported).	

9.2.2.3A Closed Loop Timing Adjustment Mode

Indicates when the phase/amplitude adjustment is performed in the DL in relation to the receipt of the UL feedback command in case of closed loop mode transmit diversity on DPCH.

IE/Group Name	Presence	Range	IE Type and Reference	Semantics Description
Closed Loop Timing Adjustment Mode			ENUMERATED (Offset1, Offset2,...)	According to [10] subclause 7.1: Offset1 = slot(j+1)mod15 Offset2 = slot(j+2)mod15

9.2.2.4 Compressed Mode Method

Void

9.2.2.4A DCH FDD Information

The *DCH FDD Information* IE provides information for DCHs to be established.

IE/Group Name	Presence	Range	IE Type and Reference	Semantics Description	Criticality	Assigned Criticality
DCH FDD Information		1..<maxno ofDCHs>			–	
>Payload CRC Presence Indicator	M		9.2.1.42		–	
>UL FP Mode	M		9.2.1.67		–	
>ToAWS	M		9.2.1.58		–	
>ToAWE	M		9.2.1.57		–	
>DCH Specific Info		1..<maxno ofDCHs>			–	
>>DCH ID	M		9.2.1.16		–	
>>TrCH Source Statistics Descriptor	M		9.2.1.65		–	
>>Transport Format Set	M		9.2.1.64	For the UL.	–	
>>Transport Format Set	M		9.2.1.64	For the DL.	–	
>>BLER	M		9.2.1.4	For the UL.	–	
>>BLER	M		9.2.1.4	For the DL.	–	
>>Allocation/Retention Priority	M		9.2.1.1		–	
>>Frame Handling Priority	M		9.2.1.29		–	
>>QE-Selector	M		9.2.1.46A		–	
>>DRAC control	M		9.2.2.13		–	
>>Guaranteed Rate Information	O		9.2.1.30M		YES	ignore

Range bound	Explanation
<i>maxnoofDCHs</i>	Maximum number of DCHs for one UE.

9.2.2.5 D-Field Length

Void

9.2.2.6 Diversity Control Field

Void.

9.2.2.7 Diversity Indication

Void.

9.2.2.8 Diversity Mode

Define the diversity mode to be applied.

IE/Group Name	Presence	Range	IE Type and Reference	Semantics Description
Diversity Mode			ENUMERATED ED(None, STTD, Closed loop mode 1, Closed loop mode2,...)	

9.2.2.9 DL DPCH Slot Format

Indicates the slot format used in DPCH in DL, according to ref. [8].

IE/Group Name	Presence	Range	IE Type and Reference	Semantics Description
DL DPCH Slot Format			INTEGER (0..16,...)	

9.2.2.10 DL Power

Void

9.2.2.11 DL Scrambling Code

DL Scrambling code to be used by the RL. One cell may have multiple DL Scrambling codes available.

IE/Group Name	Presence	Range	IE Type and Reference	Semantics Description
DL Scrambling Code			INTEGER (0..15)	0= Primary scrambling code of the cell 1...15= Secondary scrambling code

9.2.2.12 Downlink Frame Type

Void

9.2.2.12A DPC Mode

The *DPC Mode* IE indicates the DPC mode to be applied [10].

IE/Group Name	Presence	Range	IE Type and Reference	Semantics Description
DPC Mode			ENUMERATED TED (Mode0, Mode1, ...)	Mode0: The DRNS shall estimate the UE transmitted TPC command and update the DL power in every slot Mode1: The DRNS shall estimate the UE transmitted TPC command over three slots and shall update the DL power in every three slots

9.2.2.13 DRAC Control

This IE indicates whether the DCH is control by DRAC or not.

IE/Group Name	Presence	Range	IE Type and Reference	Semantics Description
DRAC Control			ENUMERATED (Requested, Not-Requested)	Requested means that DCH is controlled by DRAC

9.2.2.13A DSCH FDD Information

The *DSCH FDD Information* IE provides information for DSCHs to be established.

IE/Group Name	Presence	Range	IE Type and Reference	Semantics Description	Criticality	Assigned Criticality
DSCH Specific FDD Information		<i>1..<maxno of DSCHs></i>			–	
>DSCH ID	M		9.2.1.26A		–	
>TrCH Source Statistics Descriptor	M		9.2.1.65		–	
>Transport Format Set	M		9.2.1.64	For DSCH	–	
>Allocation/Retention Priority	M		9.2.1.1		–	
>Scheduling Priority Indicator	M		9.2.1.51A		–	
>BLER	M		9.2.1.4		–	
PDSCH RL ID	M		RL ID 9.2.1.49		–	
TFCS	M		9.2.1.63	For DSCH	–	
Enhanced DSCH PC	O		9.2.2.13D		YES	ignore

Range bound	Explanation
<i>maxnoofDSCHs</i>	Maximum number of DSCHs for one UE.

9.2.2.13B DSCH FDD Information Response

The *DSCH FDD Information Response* IE provides information for DSCHs that have been established or modified.

IE/Group Name	Presence	Range	IE Type and Reference	Semantics Description	Criticality	Assigned Criticality
DSCH Specific FDD Information Response		<i>1..<maxno of DSCHs></i>			–	
>DSCH ID	M		9.2.1.26A		–	
>DSCH Flow Control Information	M		9.2.1.26B		–	
>Binding ID	O		9.2.1.3		–	
>Transport Layer Address	O		9.2.1.62		–	
PDSCH Code Mapping	M		9.2.2.27A	PDSCH code mapping to be used	–	

Range bound	Explanation
<i>maxnoofDSCHs</i>	Maximum number of DSCHs for one UE.

9.2.2.13Bb DSCH-RNTI

Void.

9.2.2.13C FDD DCHs To Modify

The *FDD DCHs To Modify* IE provides information for DCHs to be modified.

IE/Group Name	Presence	Range	IE Type and Reference	Semantics Description	Criticality	Assigned Criticality
FDD DCHs To Modify		1..<maxno ofDCHs>			–	
>UL FP Mode	O		9.2.1.67		–	
>ToAWS	O		9.2.1.58		–	
>ToAWE	O		9.2.1.57		–	
>Transport Bearer Request Indicator	M		9.2.1.61		–	
>DCH Specific Info		1..<maxno ofDCHs>			–	
>>DCH ID	M		9.2.1.16		–	
>>Transport Format Set	O		9.2.1.64	For the UL.	–	
>>Transport Format Set	O		9.2.1.64	For the DL.	–	
>>Allocation/Retention Priority	O		9.2.1.1		–	
>>Frame Handling Priority	O		9.2.1.29		–	
>>DRAC Control	O		9.2.2.13		–	
>>Guaranteed Rate Information	O		9.2.1.30M		YES	ignore

Range bound	Explanation
<i>maxnoofDCHs</i>	Maximum number of DCHs for one UE.

9.2.2.13D Enhanced DSCH PC

The Enhanced DSCH PC includes all the parameters which are needed for DSCH power control improvement during soft handover.

IE/Group Name	Presence	Range	IE Type and Reference	Semantics Description
Enhanced DSCH PC Wnd	M		9.2.2.13G	
Enhanced DSCH PC Counter	M		9.2.2.13E	
Enhanced DSCH Power Offset	M		9.2.2.13H	

9.2.2.13E Enhanced DSCH PC Counter

The Enhanced DSCH PC Counter parameter gives the number of correct cell ID command to receive in the averaging window, *Enhance DSCH PC Wnd* IE, see ref. [10] subclause 5.2.2.

IE/Group Name	Presence	Range	IE Type and Reference	Semantics Description
Enhanced DSCH PC Counter			INTEGER(1..50)	

9.2.2.13F Enhanced DSCH PC Indicator

The Enhanced DSCH PC Indicator indicates whether Enhanced DSCH PC is in use by the UE or not.

IE/Group Name	Presence	Range	IE Type and Reference	Semantics Description
Enhanced DSCH PC Indicator			ENUMERATED(Enhanced DSCH PC Active in the UE, Enhanced DSCH PC not Active in the UE)	

9.2.2.13G Enhanced DSCH PC Wnd

The Enhanced DSCH PC Wnd parameter shows the window size to decide primary or non-primary cell, see ref. [10] subclause 5.2.2.

IE/Group Name	Presence	Range	IE Type and Reference	Semantics Description
Enhanced DSCH PC Wnd			INTEGER(1..10)	

9.2.2.13H Enhanced DSCH Power Offset

The Enhanced DSCH Power Offset parameter gives the power offset to be added on DSCH when cell is decided to be primary.

IE/Group Name	Presence	Range	IE Type and Reference	Semantics Description
Enhanced DSCH Power Offset			INTEGER(-15..0)	Unit dB, step 1 dB

9.2.2.14 FDD DL Channelisation Code Number

The DL Channelisation Code Number indicates the DL Channelisation Code number for a specific DL physical channel.

IE/Group Name	Presence	Range	IE Type and Reference	Semantics Description
FDD DL Channelisation Code Number			INTEGER(0..511)	According to the mapping in [27]. The maximum value is equal to the DL spreading factor – 1

9.2.2.14A FDD DL Code Information

The *FDD DL Code Information* IE provides FDD DL Code information for all DPCHs of one Radio Link.

IE/Group Name	Presence	Range	IE Type and Reference	Semantics Description	Criticality	Assigned Criticality
FDD DL Code Information		1.. <maxnoof DLCodes			–	
>DL Scrambling Code	M		9.2.2.11		–	
>FDD DL Channelisation Code Number	M		9.2.2.14		–	
>Transmission Gap Pattern Sequence Scrambling Code Information	O		9.2.2.47B		–	

Range bound	Explanation
maxnoofDLCodes	Maximum number of DL Channelisation Codes for one UE.

9.2.2.15 FDD S-CCPCH Offset

The Secondary CCPCH offset is defined as the time offset towards the Primary CCPCH in the cell. The offset is a multiple of 256 chips.

IE/Group Name	Presence	Range	IE Type and Reference	Semantics Description
FDD S-CCPCH Offset			INTEGER(0..149)	0: 0 chip 1: 256 chip 2: 512 chip .. 149: 38144 chip ref. [8]

9.2.2.16 FDD TPC Downlink Step Size

This parameter indicates step size for the DL power adjustment.

IE/Group Name	Presence	Range	IE Type and Reference	Semantics Description
FDD TPC Downlink Step Size			ENUMERATED (0.5, 1, 1.5, 2,...)	

9.2.2.16A First RLS Indicator

The First *RLS Indicator* IE indicates if a specific Radio Link and all Radio Links which are part of the same Radio Link Set, shall be considered as the first radio links established towards the UE or not.

IE/Group Name	Presence	Range	IE Type and Reference	Semantics Description
First RLS Indicator			ENUMERATED (first RLS, not first RLS)	

9.2.2.17 Gap Position Mode

Void.

9.2.2.18 Gap Period (TGP)

Void.

9.2.2.19 Gap Starting Slot Number (SN)

Void

9.2.2.20 IB_SG_POS

First position of an Information Block segment in the SFN cycle ($IB_SG_POS < IB_SG_REP$).

IE/Group Name	Presence	Range	IE Type and Reference	Semantics Description
IB_SG_POS			INTEGER (0..4094)	Only even positions allowed. Reference [16]

9.2.2.21 IB_SG_REP

Repetition distance for an Information Block segment. The segment shall be transmitted when $SFN \bmod IB_SG_REP = IB_SG_POS$.

IE/Group Name	Presence	Range	IE Type and Reference	Semantics Description
IB_SG_REP			ENUMERATED (4, 8, 16, 32, 64, 128, 256, 512, 1024, 2048, 4096)	Repetition period for the IB segment in frames

9.2.2.21a Inner Loop DL PC Status

The *Inner Loop DL PC Status* IE indicates whether inner loop DL control shall be active or inactive for all radio links for the UE Context.

IE/Group Name	Presence	Range	IE Type and Reference	Semantics Description
Inner Loop DL PC Status			ENUMERATED (Active, Inactive)	

9.2.2.21A Limited Power Increase

The parameter is used for a more efficient use of the inner loop DL power control for non real time data.

If the limited power increase is used, DRNS shall use the limited power increase algorithm as specified in [10], subclause 5.2.

IE/Group Name	Presence	Range	IE Type and Reference	Semantics Description
Limited Power Increase			ENUMERATED (Used, Not used)	

9.2.2.21B IPDL FDD Parameters

The *IPDL FDD Parameters* IE provides the information for the IPDL Configuration applied in FDD mode.

IE/Group name	Presence	Range	IE Type and Reference	Semantics Description
IP spacing FDD	M		ENUMERATED(5,7,10,15,20,30,40,50,...)	See [10]
IP length	M		ENUMERATED(5,10,...)	See [10]
IP offset	M		INTEGER(0..9)	See [10]
Seed	M		INTEGER(0..63)	See [10]
Burst mode parameters	O		9.2.1.4B	

9.2.2.21C Length of TFCI2

This IE indicates the length measured in number of bits of TFCI(field 2). The length of TFCI (field 1) is set to the 10's complement of the length of TFCI(field 2).

IE/Group Name	Presence	Range	IE Type and Reference	Semantics Description
Length of TFCI2			INTEGER (1..10)	

9.2.2.22 Max Adjustment Period

Void.

9.2.2.23 Max Adjustment Step

Defines the maximum allowed value for the change of DL power level during a certain number of slots that can be utilised by the downlink power balancing algorithm. *Max Adjustment Step* IE defines a time period, in terms of number of slots, in which the accumulated power adjustments shall be maximum 1 dB. This value does not include the DL inner loop PC adjustment.

IE/Group Name	Presence	Range	IE Type and Reference	Semantics Description
Max Adjustment Step			INTEGER (1..10)	Slots

9.2.2.24 Max Number of UL DPDCHs

Maximum number of uplink DPDCHs during the connection. Needed by the rate matching algorithm.

IE/Group Name	Presence	Range	IE Type and Reference	Semantics Description
Max Number of UL DPDCHs			INTEGER (1..6)	

9.2.2.24A Min DL Channelisation Code Length

Void

9.2.2.25 Min UL Channelisation Code Length

Minimum UL channelisation code length (spreading factor) of a DPDCH during the connection. Needed by rate matching algorithm.

IE/Group Name	Presence	Range	IE Type and Reference	Semantics Description
Min UL Channelisation Code Length			ENUMERATED(4,8,16,32,64,128,256)	

9.2.2.26 Multiplexing Position

Multiplexing Position specifies whether fixed or flexible positions of transport channels shall be used in the physical channel.

IE/Group Name	Presence	Range	IE Type and Reference	Semantics Description
Multiplexing Position			ENUMERATED(Fixed, Flexible)	

9.2.2.26A Number of DL Channelisation Codes

This parameter notifies DRNS of the number of DL channelisation codes required for the Radio Link(s).

IE/Group Name	Presence	Range	IE Type and Reference	Semantics Description
Number of DL Channelisation Codes			INTEGER(1..8)	

9.2.2.27 Pattern Duration (PD)

Void

9.2.2.27a PC Preamble

Indicates DPDCH power control preamble length see ref. [7].

IE/Group Name	Presence	Range	IE Type and Reference	Semantics Description
PCP Preamble			INTEGER(0..7,...)	In number of frames.

9.2.2.27A PDSCH Code Mapping

This IE indicates the association between each possible value of TFCI(field 2) and the corresponding PDSCH channelisation code. There are three ways which the UTRAN must choose between in order to signal the mapping information, these are described below. The signalling capacity consumed by the different methods will typically vary depending on the way in which the UTRAN configures usage of the DSCH. A fourth option is also provided which allows the UTRAN to replace individual entries in the TFCI(field 2) to PDSCH code mapping table with new PDSCH code values.

Method #1 - Using code range

The mapping is described in terms of a number of groups, each group associated with a given spreading factor. Each TFCI(field2) value corresponds to a given PDSCH channelisation code or set of PDSCH codes for multi-code. The DRNS maps TFCI(field2) values to PDSCH codes in the following way:

- The PDSCH codes used for TFCI(field 2) = 0 are given by the SF of the Code Group 1 (i.e. first instance in *PDSCH code mapping*) and the code numbers between CodeNumber₀ (where CodeNumber₀ = "Start code number" of Code Group 1) and CodeNumber₀ + "multi-code info" - 1.

- This continues with unit increments in the value of TFCI (Field2) mapped to either unit increments in code numbers or groups of contiguous code numbers in case of multi-code, this until "Stop code number" is reached: So the PDSCH codes used for $TFCI(\text{field } 2) = k$ (for $k > 0$ and $k < (\text{"Stop code number"} - \text{"Start code number"} + 1) \text{ DIV } k$) are given by the SF of the Code Group 1 and the code numbers between $\text{CodeNumber}_k = \text{CodeNumber}_{k-1} + \text{"multi-code info"}$ and $\text{CodeNumber}_k + \text{"multi-code info"} - 1$. If $\text{"Stop code number"} = \text{"Start code number"} + \text{"multi-code info"} - 1$ then this is to be interpreted as defining the mapping between the channelisation code(s) and a single TFCI.
- The DRNS constructs its mapping table by repeating this process for all the Code Groups in the order they are instantiated in *PDSCH code mapping*. The first TFCI(field 2) value used in each group is the largest TFCI(field 2) value reached in the previous group incremented by one.

Note: This imposes that $\text{"Stop code number"} - \text{"Start code number"} + 1$ is a multiple of the value "multi-code info" for each instance of *PDSCH code mapping*. Furthermore, in the case where multi-code is not used, then "multi-code info" = 1 and the process above also applies.

Method #2 - Using TFCI range

The mapping is described in terms of a number of groups, each group corresponding to a given PDSCH channelisation code or set of PDSCH codes for multi-code.

- The set of PDSCH codes specified in the first instance applies for all values of TFCI(field 2) between 0 and the specified "Max TFCI(field2)".
- The process continues in the same way for the following groups with the TFCI(field 2) value starting at the largest value reached in the previous instance incremented by one. So the set of PDSCH codes specified in a given instance apply for all the values of TFCI(field 2) between the "Max TFCI(field2) value" specified in the previous instance incremented by one and the specified "Max TFCI(field2)" of the considered instance.

A set of PDSCH codes is composed of all the codes between "Code Number" and "Code Number" + "multicode" - 1. So if multi-code is not used, the set of PDSCH codes is reduced to one element indicated by the *Code Number* IE.

Method #3 - Explicit

The mapping between TFCI (field 2) value and PDSCH channelisation code (or a set of PDSCH codes for multicode) is spelt out explicitly for each value of TFCI (field2).

A set of PDSCH codes is composed of all the codes between "Code Number" and "Code Number" + "multicode" - 1. So if multi-code is not used, the set of PDSCH codes is reduced to one element indicated by the *Code Number* IE.

Method #4 - Replace

The "TFCI (field2)" value(s) for which the mapping to PDSCH channelisation code (or a set of PDSCH codes for multicode) is changed are explicitly signalled. Furthermore, the new mapping between TFCI(field 2) value and PDSCH channelisation code(s) is spelt out explicitly for each value of TFCI (field2).

A set of PDSCH codes is composed of all the codes between "Code Number" and "Code Number" + "multicode" - 1. So if multi-code is not used, the set of PDSCH codes is reduced to one element indicated by the *Code Number* IE.

IE/Group name	Presence	Range	IE Type and Reference	Semantics Description
DL Scrambling Code	M		INTEGER (0..15)	Scrambling code on which PDSCH is transmitted. 0= Primary scrambling code of the cell 1...15 = Secondary scrambling code

<i>Choice Signalling Method</i>				
<i>>Code Range</i>				
>>PDSCH Code Mapping			<i>1..<maxNo CodeGroups></i>	
>>>Spreading Factor	M		ENUMERATED(4, 8, 16, 32, 64, 128, 256)	
>>>Multi-code Info	M		INTEGER(1..16)	
>>>Start Code Number	M		INTEGER(0..maxCodeNumComp-1)	PDSCH code start, Numbering as described in [16]
>>>Stop Code Number	M		INTEGER(0..maxCodeNumComp-1)	PDSCH code stop, Numbering as described in [16]
<i>>TFCI Range</i>				
>>DSCH Mapping			<i>1..<maxNo TFCIGroups></i>	
>>>Max TFCI(field2) Value	M		INTEGER(1..1023)	This is the maximum value in the range of TFCI(field 2) values for which the specified PDSCH code applies
>>>Spreading Factor	M		ENUMERATED(4, 8, 16, 32, 64, 128, 256)	SF of PDSCH code
>>>Multi-code Info	M		INTEGER(1..16)	
>>>Code Number	M		INTEGER(0..maxCodeNumComp-1)	Code number of PDSCH code. Numbering as described in [16]
<i>>Explicit</i>				
>>PDSCH Code			<i>1..<maxTFCI_2_Combos></i>	The first instance of the parameter PDSCH code corresponds to TFCI (field2) = 0, the second to TFCI(field 2) = 1 and so on.
>>>Spreading Factor	M		ENUMERATED(4, 8, 16, 32, 64, 128, 256)	SF of PDSCH code
>>>Multi-code Info	M		INTEGER(1..16)	
>>>Code Number	M		INTEGER(0..maxCodeNumComp-1)	Code number of PDSCH code. Numbering as described in [16]
<i>>Replace</i>				
>>Replaced PDSCH code			<i>1..<maxTFCI_2_Combos></i>	
>>>TFCI (field2)	M		INTEGER (1..1023)	Value of TFCI(field 2) for which PDSCH code mapping will be changed
>>>Spreading Factor	M		ENUMERATED(4, 8, 16, 32, 64, 128, 256)	SF of PDSCH code
>>>Multi-code Info	M		INTEGER(1..16)	
>>>Code Number	M		INTEGER(0..maxCodeNumComp-1)	Code number of PDSCH code. Numbering as described in [16]

Range Bound	Explanation
<i>maxCodeNumComp</i>	Maximum number of codes at the defined spreading factor, within the complete code tree.
<i>maxTFCI_2_Combs</i>	Maximum number of TFCI (field 2) combinations (given by 2 raised to the power of the length of the TFCI field 2)
<i>maxNoTFCIGroups</i>	Maximum number of groups, each group described in terms of a range of TFCI(field 2) values for which a single PDSCH code applies.
<i>maxNoCodeGroups</i>	Maximum number of groups, each group described in terms of a range of PDSCH channelisation code values for which a single spreading factor applies.

9.2.2.28 Power Adjustment Type

Defines the characteristic of the power adjustment.

IE/Group Name	Presence	Range	IE Type and Reference	Semantics Description
Power Adjustment Type			ENUMERATED (None, Common, Individual)	

9.2.2.29 Power Control Mode (PCM)

Void.

9.2.2.30 Power Offset

This IE defines a power offset respect the Downlink transmission power of a DPCH.

IE/Group Name	Presence	Range	IE Type and Reference	Semantics Description
Power Offset			INTEGER (0..24)	Unit dB, Step 0.25 dB, range 0-6 dB

9.2.2.31 Power Resume Mode (PRM)

Void.

9.2.2.31A Preamble Signatures

Void.

9.2.2.32 Primary CPICH Ec/No

Energy per chip divided by the power density per band measured on the Primary CPICH by the terminal.

IE/Group Name	Presence	Range	IE Type and Reference	Semantics Description
Primary CPICH Ec/No			INTEGER (-30..+30)	Unit dB, step 1 dB The value range is typically within the range of -24 dB to 0 dB according to the CPICH Ec/No UE measurement defined in ref. [23].

9.2.2.33 Propagation Delay (PD)

Propagation delay is the one-way propagation delay of the radio signal from the UE to the Node B.

IE/Group Name	Presence	Range	IE Type and Reference	Semantics Description
Propagation Delay			INTEGER (0..255)	Chips. Step size is 3 chips. 0=0 chips, 1=3 chips, ...

9.2.2.33A PRACH Minimum Spreading Factor

Void.

9.2.2.34 QE-Selector

Void.

9.2.2.34A RACH Sub Channel Numbers

Void.

9.2.2.35 RL Set ID

The RL Set ID uniquely identifies one RL Set within a UE Context.

IE/Group Name	Presence	Range	IE Type and Reference	Semantics Description
RL Set ID			INTEGER (0..31)	

9.2.2.35A Received Total Wide Band Power

The parameter indicates the Received total wide band power in a cell, see ref. [11].

IE/Group Name	Presence	Range	IE Type and Reference	Semantics Description
Received Total Wide Band Power			INTEGER(0..621)	According to mapping in [23].

9.2.2.36 S-Field Length

The UE uses the S Field of the UL DPCCH slot to send the SSID Cell ID to the network.

IE/Group Name	Presence	Range	IE Type and Reference	Semantics Description
S Field Length			ENUMERATED (1, 2,...)	

9.2.2.37 Scrambling Code Change

Void.

9.2.2.37A Scrambling Code Number

Void.

9.2.2.37B Secondary CCPCH Info

The *Secondary CCPCH Info* IE provides information on scheduling of broadcast information for DRAC on a Secondary CCPCH in one cell.

IE/Group Name	Presence	Range	IE Type and Reference	Semantics Description	Criticality	Assigned Criticality
FDD S-CCPCH Offset	M		9.2.2.15	Corresponds to: $\tau_{S-CCPCH,k}$, see ref. [8]	–	
DL Scrambling Code	M		9.2.2.11		–	
FDD DL Channelisation Code Number	M		9.2.2.14		–	
TFCS	M		9.2.1.63	For the DL.	–	
Secondary CCPCH Slot Format	M		9.2.2.38		–	
TFCI Presence	C - SlotFormat		9.2.1.55		–	
Multiplexing Position	M		9.2.2.26		–	
STTD Indicator	M		9.2.2.44		–	
FACH/PCH Information		1 .. <maxFACHcount+1>			–	
>TFS			9.2.1.64	For each FACH, and the PCH when multiplexed on the same Secondary CCPCH	–	
IB Scheduling Information		1			–	
>IB_SG_REP	M		9.2.2.21		–	
>IB Segment Information		1.. <maxIBSEG>			–	
>>IB_SG_POS	M		9.2.2.20		–	

Condition	Explanation
SlotFormat	The IE shall be present if the <i>Secondary CCPCH Slot Format</i> IE is equal to any of the values from 8 to 17.

Range bound	Explanation
maxFACHCount	Maximum number of FACHs mapped onto a Secondary CCPCH.
maxIBSEG	Maximum number of segments for one Information Block.

9.2.2.38 Secondary CCPCH Slot Format

IE/Group Name	Presence	Range	IE Type and Reference	Semantics Description
Secondary CCPCH Slot Format			INTEGER (0..17,...)	See ref. [8].

9.2.2.39 Slot Number (SN)

Void

9.2.2.39a Split Type

This parameter indicates if the "Hard" or "Logical" is used for the TFCI.split mode.

IE/Group Name	Presence	Range	IE Type and Reference	Semantics Description
Split Type			ENUMERATED (Hard, Logical)	'Hard': meaning that TFCI (field 1) and TFCI (field 2) are each 5 bits long and each field is block coded separately. 'Logical': meaning that on the physical layer TFCI (field 1) and TFCI (field 2) are concatenated, field 1 taking the most significant bits and field 2 taking the least significant bits). The whole is then encoded with a single block code.

9.2.2.39A SRB Delay

Indicates the number of frames after the PC Preamble period during which transmission of data on some RRC Signalling Bearers shall be prohibited by UE in accordance with ref. [16].

IE/Group Name	Presence	Range	IE Type and Reference	Semantics Description
SRB Delay			INTEGER(0..7,...)	In number of frames.

9.2.2.40 SSDT Cell Identity

The SSDT Cell Identity is a temporary ID for SSDT assigned to a cell.

IE/Group Name	Presence	Range	IE Type and Reference	Semantics Description
SSDT Cell Identity			ENUMERATED (a..h)	

9.2.2.40A SSDT Cell Identity for EDSCHPC

The SSDT Cell Identity for EDSCHPC is a temporary ID for enhanced DSCH power control assigned to a cell.

IE/Group Name	Presence	Range	IE Type and Reference	Semantics Description
SSDT Cell Identity for EDSCHPC			SSDT Cell Identity 9.2.2.40	

9.2.2.41 SSDT Cell Identity Length

The SSDT Cell Identity Length parameter shows the length of the SSDT Cell ID.

IE/Group Name	Presence	Range	IE Type and Reference	Semantics Description
SSDT Cell Identity Length			ENUMERATED(Short, Medium, Long)	

9.2.2.42 SSDT Indication

The SSDT Indication indicates whether SSDT is in use by the UE or not.

IE/Group Name	Presence	Range	IE Type and Reference	Semantics Description
SSDT Indication			ENUMERATED(SSDT Active in the UE, SSDT not Active in the UE)	

9.2.2.43 SSDT Support Indicator

The SSDT Support Indicator indicates whether a RL supports SSDT or not.

IE/Group Name	Presence	Range	IE Type and Reference	Semantics Description
SSDT Support Indicator			ENUMERATED(SSDT Supported, SSDT not supported).	

9.2.2.44 STTD Indicator

Indicates if STTD is active or not.

IE/Group Name	Presence	Range	IE Type and Reference	Semantics Description
STTD Indicator			ENUMERATED(active, inactive)	

9.2.2.45 STTD Support Indicator

The STTD Support Indicator indicates whether the STTD can be applied to DL DPCH in the cell or not.

IE/Group Name	Presence	Range	IE Type and Reference	Semantics Description
STTD Support Indicator			ENUMERATED(STTD Supported, STTD not Supported).	

9.2.2.46 TFCI Signalling Mode

This parameter indicates if the normal or split mode is used for the TFCI.

IE/Group Name	Presence	Range	IE Type and Reference	Semantics Description
TFCI Signalling Mode			ENUMERATED (Normal, Split)	

9.2.2.47 Transmission Gap Distance (TGD)

Void.

9.2.2.47A Transmission Gap Pattern Sequence Information

Defines the parameters for the compressed mode gap pattern sequence. For details see [16].

IE/Group Name	Presence	Range	IE Type and Reference	Semantics Description
Transmission Gap Pattern Sequence Information		1..< maxTGPS >		
>TGPSI Identifier	M		INTEGER(1..<MaxTGPS >)	Transmission Gap Pattern Sequence Identifier Establish a reference to the compressed mode pattern sequence. Up to <MaxTGPS> simultaneous compressed mode pattern sequences can be used.
>TGSN	M		INTEGER (0..14)	Transmission Gap Starting Slot Number The slot number of the first transmission gap slot within the TGCFN.
>TGL1	M		INTEGER(1..14)	The length of the first Transmission Gap within the transmission gap pattern expressed in number of slots.
>TGL2	O		INTEGER (1..14)	The length of the second Transmission Gap within the transmission gap pattern. If omitted, then TGL2=TGL1.
>TGD	M		INTEGER (0, 15.. 269)	Transmission gap distance indicates the number of slots between the starting slots of two consecutive transmission gaps within a transmission gap pattern. If there is only one transmission gap in the transmission gap pattern, this parameter shall be set to 0 (0 =undefined).
>TGPL1	M		INTEGER (1..144,...)	The duration of transmission gap pattern 1 in frames.
>TGPL2	O		INTEGER (1..144,...)	The duration of transmission gap pattern 2 in frames. If omitted, then TGPL2=TGPL1.
>UL/DL mode	M		ENUMERATED (UL only, DL only, UL/DL)	Defines whether only DL, only UL, or combined UL/DL compressed mode is used.
>Downlink Compressed Mode Method	C-DL		ENUMERATED (puncturing, SF/2, higher layer scheduling, ...)	Method for generating downlink compressed mode gap None means that compressed mode pattern is stopped.
>Uplink Compressed Mode Method	C-UL		ENUMERATED (SF/2, higher layer scheduling, ...)	Method for generating uplink compressed mode gap.
>Downlink Frame Type	M		ENUMERATED (A, B,...)	Defines if frame type 'A' or 'B' shall be used in downlink compressed mode.
>DeltaSIR1	M		INTEGER (0..30)	Delta in SIR target value to be set in the DRNS during the frame containing the start of the first transmission gap in the transmission gap pattern (without including the effect of the bit-rate increase) Step 0.1 dB, Range 0-3dB

>DeltaSIRafter1	M		INTEGER (0..30)	Delta in SIR target value to be set in the DRNS one frame after the frame containing the start of the first transmission gap in the transmission gap pattern, Step 0.1 dB, Range 0-3dB
>DeltaSIR2	O		INTEGER (0..30)	Delta in SIR target value to be set in the DRNS during the frame containing the start of the second transmission gap in the transmission gap pattern (without including the effect of the bit-rate increase) When omitted, DeltaSIR2 = DeltaSIR1. Step 0.1 dB, Range 0-3dB
>DeltaSIRafter2	O		INTEGER (0..30)	Delta in SIR target value to be set in the DRNS one frame after the frame containing the start of the second transmission gap in the transmission gap pattern. When omitted, DeltaSIRafter2 = DeltaSIRafter1. Step 0.1 dB, Range 0-3dB

Condition	Explanation
UL	The IE shall be present if the <i>UL/DL mode</i> IE is set to "UL only" or "UL/DL".
DL	The IE shall be present if the <i>UL/DL mode</i> IE is set to "DL only" or "UL/DL".

Range bound	Explanation
<i>maxTGPS</i>	Maximum number of transmission gap pattern sequences.

9.2.2.47B Transmission Gap Pattern Sequence Scrambling Code Information

This IE indicates whether or not the alternative scrambling code will be used in the DRNS for the Downlink compressed mode method 'SF/2' in the Transmission Gap Pattern Sequence. For details see ref. [16].

IE/Group Name	Presence	Range	IE Type and Reference	Semantics Description
Transmission Gap Pattern Sequence Scrambling Code Information			ENUMERATED (code change, no code change)	Code change = alternative scrambling code will be used.

9.2.2.48 Transmit Diversity Indicator

The Transmit Diversity Indicator indicates whether Transmit Diversity shall be active or not.

IE/Group Name	Presence	Range	IE Type and Reference	Semantics Description
Transmit Diversity Indicator			ENUMERATED (active, inactive)	

9.2.2.49 Transmit Gap Length (TGL)

Void

9.2.2.50 Tx Diversity Indicator

The Tx Diversity Indicator indicates if the following conditions are satisfied:

- Primary CPICH is broadcast from two antennas
- STTD is applied to Primary CCPCH
- TSTD is applied to Primary SCH and Secondary SCH

IE/Group Name	Presence	Range	IE Type and Reference	Semantics Description
Tx Diversity Indicator			ENUMERATED (true, false)	

9.2.2.51 UL/DL Compressed Mode Selection

Void

9.2.2.52 UL DPCCH Slot Format

Indicates the slot format used in DPCCH in UL, according to ref. [8].

IE/Group Name	Presence	Range	IE Type and Reference	Semantics Description
UL DPCCH Slot Format			INTEGER (0..5,...)	

9.2.2.53 UL Scrambling Code

The UL Scrambling Code is the scrambling code used by UE. Every UE has its specific UL Scrambling Code.

IE/Group Name	Presence	Range	IE Type and Reference	Semantics Description
UL Scrambling Code Number	M		INTEGER (0.. $2^{24}-1$)	
UL Scrambling Code Length	M		ENUMERATED (Short, Long)	

9.2.2.54 Uplink Delta SIR

Void

9.2.2.55 Uplink Delta SIR After

Void

9.2.2.56 DPC Mode Change Support Indicator

The *DPC Mode Change Support Indicator* IE indicates that the particular cell is capable to support DPC mode change.

IE/Group Name	Presence	Range	IE Type and Reference	Semantics Description
DPC Mode Change Support Indicator			ENUMERATED (DPC Mode Change Supported)	

9.2.3 TDD Specific Parameters

This subclause contains parameters that are specific to TDD.

9.2.3.a Alpha Value

Used to support signalling of cell specific Alpha Value to SRNS.

IE/Group Name	Presence	Range	IE Type and Reference	Semantics Description
Alpha Value			ENUMERATED(0, 1/8, 2/8, 3/8, 4/8, 5/8, 6/8, 7/8, 1)	

9.2.3.A Block STTD Indicator

Void.

9.2.3.1 Burst Type

Void.

9.2.3.2 CCTrCH ID

The CCTrCH ID identifies unambiguously a CCTrCH inside a Radio Link.

IE/Group Name	Presence	Range	IE Type and Reference	Semantics Description
CCTrCH ID			INTEGER (0..15)	

9.2.3.2A DCH TDD Information

The *DCH TDD Information* IE provides information for DCHs to be established.

IE/Group Name	Presence	Range	IE Type and Reference	Semantics Description	Criticality	Assigned Criticality
DCH Information		<i>1..<maxno ofDCHs></i>			–	
>Payload CRC Presence Indicator	M		9.2.1.42		–	
>UL FP Mode	M		9.2.1.67		–	
>ToAWS	M		9.2.1.58		–	
>ToAWE	M		9.2.1.57		–	
>DCH Specific Info		<i>1..<maxno ofDCHs></i>			–	
>>DCH ID	M		9.2.1.16		–	
>>CCTrCH ID	M		9.2.3.2	UL CCTrCH in which the DCH is mapped	–	
>>CCTrCH ID	M		9.2.3.2	DL CCTrCH in which the DCH is mapped	–	
>>TrCH Source Statistics Descriptor	M		9.2.1.65		–	
>>Transport Format Set	M		9.2.1.64	For the UL.	–	
>>Transport Format Set	M		9.2.1.64	For the DL.	–	
>>BLER	M		9.2.1.4	For the UL.	–	
>>BLER	M		9.2.1.4	For the DL.	–	
>>Allocation/Retention Priority	M		9.2.1.1		–	
>>Frame Handling Priority	M		9.2.1.29		–	
>>QE-Selector	C-CoordDCH		9.2.1.46A		–	
>>Guaranteed Rate Information	O		9.2.1.30M		YES	ignore

Condition	Explanation
CoordDCH	The IE shall be present if this DCH is part of a set of coordinated DCHs (number of instances of the <i>DCH Specific Info</i> IE is greater than 1).

Range bound	Explanation
<i>maxnoofDCHs</i>	Maximum number of DCHs for one UE.

9.2.3.2B DCH TDD Information Response

Void

9.2.3.2C DL Timeslot Information

The *DL Timeslot Information* IE provides information on the time slot allocation for a DL DPCH.

IE/Group Name	Presence	Range	IE Type and Reference	Semantics Description	Criticality	Assigned Criticality
DL Timeslot Information		1..<maxno OFTS>			–	
>Time Slot	M		9.2.1.56		–	
>Midamble Shift And Burst Type	M		9.2.3.4		–	
>TFCI Presence	M		9.2.1.55		–	
>DL Code Information	M		TDD DL Code Information 9.2.3.8C		–	

Range bound	Explanation
maxnoofTS	Maximum number of Timeslots for a UE.

9.2.3.2D DL Time Slot ISCP Info

The *DL Time Slot ISCP Info* IE gives interference level for each DL time slot within the Radio Link.

IE/Group Name	Presence	Range	IE Type and Reference	Semantics Description	Criticality	Assigned Criticality
DL Time Slot ISCP Info		1..<maxno ofDLts>			–	
>Time Slot	M		9.2.1.56		–	
>DL Timeslot ISCP	M		9.2.3.12		–	

Range bound	Explanation
maxnoofDLts	Maximum number of downlink time slots per Radio Link for 3.84Mcps TDD.

9.2.3.2E DL Timeslot Information LCR

The *DL Timeslot Information LCR* IE provides information for DL Timeslot to be established for 1.28Mcps TDD.

IE/Group Name	Presence	Range	IE Type and Reference	Semantics Description	Criticality	Assigned Criticality
DL Timeslot Information LCR		1 .. <maxnoof DLtsLCR>			–	
>Time Slot LCR	M		9.2.3.12a		–	
>Midamble Shift LCR	M		9.2.3.4C		–	
>TFCI Presence	M		9.2.1.55		–	
>DL Code Information LCR	M		TDD DL Code Information LCR 9.2.3.8D		–	

Range bound	Explanation
maxnoofDLtsLCR	Maximum number of Downlink time slots per Radio Link for 1.28Mcps TDD.

9.2.3.2F DL Time Slot ISCP Info LCR

The *DL Time Slot ISCP Info LCR* IE provides information for DL Interference level for each time slot within the Radio Link for 1.28Mcps TDD.

IE/Group Name	Presence	Range	IE Type and Reference	Semantics Description	Criticality	Assigned Criticality
DL Time Slot ISCP Info LCR		1 .. <maxnoofULtsLCR>			–	
>Time Slot LCR	M		9.2.3.12a		–	
>DL Timeslot ISCP	M		9.2.3.12		–	

Range bound	Explanation
<i>maxnoofULtsLCR</i>	Maximum number of Uplink time slots per Radio Link for 1.28Mcps TDD

9.2.3.3 DPCH ID

The DPCH ID identifies unambiguously a DPCH inside a Radio Link.

IE/Group Name	Presence	Range	IE Type and Reference	Semantics Description
DPCH ID			INTEGER (0..239)	

9.2.3.3a DSCH TDD Information

The *DSCH TDD Information* IE provides information for DSCHs to be established.

IE/Group Name	Presence	Range	IE Type and Reference	Semantics Description	Criticality	Assigned Criticality
DSCH TDD Information		1..<maxno ofDSCHs>			–	
>DSCH ID	M		9.2.1.26A		–	
>CCTrCH ID	M		9.2.3.2	DL CCTrCH in which the DSCH is mapped.	–	
>TrCH Source Statistics Descriptor	M		9.2.1.65		–	
>Transport Format Set	M		9.2.1.64		–	
>Allocation/Retention Priority	M		9.2.1.1		–	
>Scheduling Priority Indicator	M		9.2.1.51A		–	
>BLER	M		9.2.1.4		–	

Range bound	Explanation
<i>maxnoofDSCHs</i>	Maximum number of DSCHs for one UE.

9.2.3.3A Maximum Number of Timeslots per Frame

Defines the maximum number of timeslots the UE has the capability of receiving or transmitting.

IE/Group Name	Presence	Range	IE Type and Reference	Semantics Description
Maximum Number of Timeslots per Frame			INTEGER (1..14)	

9.2.3.3B Maximum Number of UL Physical Channels per Timeslot

Defines the maximum number of physical channels per frame that the UE is capable to transmit.

IE/Group Name	Presence	Range	IE Type and Reference	Semantics Description
Maximum Number of UL Physical Channels per Timeslot			INTEGER (1..2)	

9.2.3.3C Maximum Number of DL Physical Channels per Frame

Defines the maximum number of physical channels per frame that the UE is capable to receive.

IE/Group Name	Presence	Range	IE Type and Reference	Semantics Description
Maximum Number of DL Physical Channels per Frame			INTEGER (1..224)	

9.2.3.4 Midamble Shift And Burst Type

This information element indicates burst type and midamble allocation.

Three different midamble allocation schemes exist:

- Default midamble: the midamble is allocated by layer 1 depending on the associated channelisation code (DL and UL);
- Common midamble: the midamble is allocated by layer 1 depending on the number of channelisation codes (possible in DL only);
- UE specific midamble: a UE specific midamble is explicitly assigned (DL and UL).

IE/Group Name	Presence	Range	IE Type and Reference	Semantics Description
CHOICE <i>Burst Type</i>				
> <i>Type 1</i>				
>> Midamble Configuration Burst Type 1 And 3	M		ENUMERATED(4, 8, 16)	As defined in [12]
>> Midamble Allocation Mode	M		ENUMERATED (Default midamble, Common midamble, UE specific midamble)	
>> Midamble Shift Long	C-UE		INTEGER(0..15)	
> <i>Type 2</i>				
>> Midamble Configuration Burst Type 2	M		ENUMERATED(3,6)	As defined in [12]
>> Midamble Allocation Mode	M		ENUMERATED (Default midamble, Common midamble, UE specific midamble)	
>> Midamble Shift Short			INTEGER (0..5)	
> <i>Type 3</i>				UL only
>> Midamble Configuration Burst Type 1 And 3	M		ENUMERATED(4, 8, 16)	As defined in [12]
>> Midamble Allocation Mode	M		ENUMERATED (Default midamble, UE specific midamble)	
>> Midamble Shift Long	C-UE		INTEGER(0..15)	

Condition	Explanation
UE	The IE shall be present if the <i>Midamble Allocation Mode</i> IE is set to "UE-specific midamble".

9.2.3.4A Minimum Spreading Factor

Defines the minimum spreading factor the UE has the capability of receiving or transmitting.

IE/Group Name	Presence	Range	IE Type and Reference	Semantics Description
Minimum Spreading Factor			INTEGER (1..16)	

9.2.3.4B IPDL TDD Parameters

The *IPDL TDD Parameters* IE provides the information for the IPDL Configuration applied in TDD mode.

IE/Group name	Presence	Range	IE Type and Reference	Semantics Description
IP Spacing TDD	M		ENUMERATED(30,40,50,70,100,...)	See [22]
IP Start	M		INTEGER(0..4095)	See [22]
IP Slot	M		INTEGER(0..14)	See [22]
IP P-CCPCH	M		ENUMERATED(Switch off 1 frame, Switch off 2 frames)	See [22]
Burst mode parameters	O		9.2.1.4B	

9.2.3.4C Midamble Shift LCR

This information element indicates midamble allocation in 1.28Mcps TDD.

Three different midamble allocation schemes exist:

- Default midamble: the midamble is allocated by layer 1 depending on the associated channelisation code (DL and UL);
- Common midamble: the midamble is allocated by layer 1 depending on the number of channelisation codes (possible in DL only);
- UE specific midamble: a UE specific midamble is explicitly assigned (DL and UL).

IE/Group name	Presence	Range	IE Type and Reference	Semantics Description
Midamble Allocation Mode	M		ENUMERATED (Default midamble, Common midamble, UE specific midamble,...)	
Midamble Shift Long	C-UE		INTEGER(0..15)	
Midamble Configuration LCR	M		ENUMERATED (2, 4, 6, 8, 10, 12, 14, 16, ...)	As defined in [12]

Condition	Explanation
UE	The IE shall be present if the <i>Midamble Allocation Mode</i> IE is set to "UE-specific midamble".

9.2.3.4D Neighbouring TDD Cell Information LCR

Void

9.2.3.5 Primary CCPCH RSCP

Received Signal Code Power is the received power on PCCPCH of the target cell after despreading. The reference point for the RSCP is the antenna connector at the UE, see ref. [14].

IE/Group Name	Presence	Range	IE Type and Reference	Semantics Description
Primary CCPCH RSCP			INTEGER (0..91)	According to mapping in ref. [14].

9.2.3.5A PRACH Midamble

Void.

9.2.3.5B RB Identity

The RB Identity is the identifier of a radio bearer. It is unique for each active Radio bearer among the active radio bearers simultaneously allocated for the same UE.

IE/Group Name	Presence	Range	IE Type and Reference	Semantics Description
RB Identity			INTEGER (0..31)	In line with [16], Ch. 10.3.4.11

9.2.3.6 Repetition Length

The Repetition Length represents the number of consecutive Radio Frames inside a Repetition Period in which the same Time Slot is assigned to the same Physical Channel see ref. [16].

IE/Group Name	Presence	Range	IE Type and Reference	Semantics Description
Repetition Length			INTEGER(1..63)	

9.2.3.7 Repetition Period

The Repetition Period represents the number of consecutive Radio Frames after which the same assignment scheme of Time Slots to a Physical Channel is repeated. This means that if the Time Slot K is assigned to a physical channel in the Radio Frame J , it is assigned to the same physical channel also in all the Radio Frames $J+n*Repetition\ Period$ (where n is an integer) see ref. [16].

IE/Group Name	Presence	Range	IE Type and Reference	Semantics Description
Repetition Period			ENUMERATED (1,2,4,8,16,32,64)	

9.2.3.7A Rx Timing Deviation

Measured Rx Timing Deviation as a basis for timing advance, either measured directly from a RACH burst, or calculated from the Rx Timing Deviation measurement on the USCH by adding the current Timing Advance value. For 1.28Mcps TDD this IE must be set to 0.

IE/Group Name	Presence	Range	IE Type and Reference	Semantics Description
Rx Timing Deviation			INTEGER (0..127)	As specified in [5], Ch. 6.2.7.6

9.2.3.7B Secondary CCPCH Info TDD

The *Secondary CCPCH Info TDD* IE provides information on the Secondary CCPCH that carries the logical channel SHCCH for the UE.

IE/Group Name	Presence	Range	IE Type and Reference	Semantics Description	Criticality	Assigned Criticality
TFCS	M		9.2.1.63	For the DL.	–	
TFCI Coding	M		9.2.3.11		–	
Secondary CCPCH		0..<maxno ofSCCPC Hs>			–	
>Time Slot	M		9.2.1.56		–	
>Midamble Shift And Burst Type	M		9.2.3.4		–	
>TFCI Presence	M		9.2.1.55		–	
> Secondary CCPCH TDD Code Information	M		9.2.3.7C		–	
>TDD Physical Channel Offset	M		9.2.3.9		–	
>Repetition Length	M		9.2.3.6		–	
>Repetition Period	M		9.2.3.7		–	
FACH		0..maxno ofFACHs			–	
> TFS	M		9.2.1.64	For the DL.	–	
PCH		0..1			–	
> TFS	M		9.2.1.64	For the DL.	–	

Range bound	Explanation
<i>maxnoofSCCPCs</i>	Maximum number of Secondary CCPCHs per CCTrCH.
<i>maxnoofFACHs</i>	Maximum number of FACHs mapped onto a Secondary CCPCH.

9.2.3.7C Secondary CCPCH TDD Code Information

The *Secondary CCPCH TDD Code Information* IE provides TDD Channelisation Code information for all SCCPCHs of one Time Slot.

IE/Group Name	Presence	Range	IE Type and Reference	Semantics Description	Criticality	Assigned Criticality
Secondary CCPCH TDD Code Information		1..<maxno ofSCCPC Hs>			–	
>TDD Channelisation Code	M		9.2.3.8		–	

Range bound	Explanation
<i>maxnoofSCCPCs</i>	Maximum number of SCCPCHs for one CCTrCH.

9.2.3.7D Special Burst Scheduling

The number of frames between special burst transmissions during DTX.

IE/Group Name	Presence	Range	IE Type and Reference	Semantics Description
Special Burst Scheduling			INTEGER (1, 2, ..., 256)	Number of frames between special burst transmissions during DTX

9.2.3.7E Synchronisation Configuration

The Synchronisation Configuration parameters that are used by the DRNS in the Radio Link Failure/Restore procedure.

IE/Group Name	Presence	Range	IE Type and Reference	Semantics Description
N_INSYNC_IND	M		INTEGER (1, 2, ..., 256)	
N_OUTSYNC_IND	M		INTEGER (1, 2, ..., 256)	
T_RLFAILURE	M		ENUMERATED (0, 0.1, 0.2, ..., 25.5)	In seconds

9.2.3.7F Secondary CCPCH Info TDD LCR

The *Secondary CCPCH Info TDD LCR* IE provides information on the Secondary CCPCH that carries the logical channel SHCCH for the UE.

IE/Group Name	Presence	Range	IE Type and Reference	Semantics Description	Criticality	Assigned Criticality
TFCS	M		9.2.1.63	For the DL.	–	
TFCI Coding	M		9.2.3.11		–	
Secondary CCPCH		0..<maxno of SCCPC Hs>			–	
>Time Slot LCR	M		9.2.3.12a		–	
>Midamble Shift LCR	M		9.2.3.4C		–	
>TFCI Presence	M		9.2.1.55		–	
> Secondary CCPCH TDD Code Information LCR	M		9.2.3.7G		–	
>TDD Physical Channel Offset	M		9.2.3.9			
>Repetition Length	M		9.2.3.6		–	
>Repetition Period	M		9.2.3.7		–	
FACH		0..<maxno of FACHs>			–	
> TFS	M		9.2.1.64	For the DL.	–	
PCH		0..1			–	
> TFS	M		9.2.1.64	For the DL.	–	

Range bound	Explanation
<i>maxnoofSCCPCHs</i>	Maximum number of Secondary CCPCHs per CCTrCH.
<i>maxnoofFACHs</i>	Maximum number of FACHs mapped onto a Secondary CCPCH.

9.2.3.7G Secondary CCPCH TDD Code Information LCR

The *Secondary CCPCH TDD Code Information LCR* IE provides LCR TDD Channelisation Code information for all SCCPCHs of one Time Slot.

IE/Group Name	Presence	Range	IE Type and Reference	Semantics Description	Criticality	Assigned Criticality
Secondary CCPCH TDD Code Information		1..<maxno of SCCPC Hs>			–	
>TDD Channelisation Code LCR	M		9.2.3.8a		–	
>SCCPCH Time Slot Format LCR	M		TDD DL DPCH Time Slot Format LCR 9.2.3.8E		–	

Range bound	Explanation
<i>maxnoofSCCPCHs</i>	Maximum number of SCCPCHs for one CCTrCH.

9.2.3.8 TDD Channelisation Code

The Channelisation Code Number indicates which Channelisation Code is used for a given Physical Channel. In TDD the Channelisation Code is an Orthogonal Variable Spreading Factor code that can have a spreading factor of 1, 2, 4, 8 or 16.

IE/Group Name	Presence	Range	IE Type and Reference	Semantics Description
TDD Channelisation Code			ENUMERATED ((1/1), (2/1), (2/2), (4/1), .. (4/4), (8/1), .. (8/8), (16/1), .. (16/16),...)	

9.2.3.8a TDD Channelisation Code LCR

The Channelisation Code Number indicates which Channelisation Code is used for a given Physical Channel. In 1.28Mcps TDD the Channelisation Code is an Orthogonal Variable Spreading Factor code, that can have a spreading factor of 1, 2, 4, 8 or 16 and there is a choice between QPSK and 8PSK modulation.

IE/Group Name	Presence	Range	IE Type and Reference	Semantics Description
TDD Channelisation Code	M		ENUMERATED ((1/1), (2/1), (2/2), (4/1),..(4/4), (8/1), .. (8/8), (16/1).. (16/16) ,...)	
Modulation	M		ENUMERATED (QPSK, 8PSK, ...)	Modulation options for 1.28Mcps TDD in contrast to 3.84Mcps TDD

9.2.3.8A TDD DPCH Offset

The Offset represents the phase information for the allocation of a group of dedicated physical channels. The first range is used when a starting offset is not required and the TDD Physical channel offset for each DPCH in the CCTrCH shall be directly determined from the TDD DPCH Offset. The second range is used when a starting offset is required. The TDD DPCH Offset shall map to the CFN and the TDD Physical Channel Offset for each DPCH in this CCTrCH shall be calculated by TDD DPCH Offset *mod* Repetition period, see ref. [16].

IE/Group Name	Presence	Range	IE Type and Reference	Semantics Description
CHOICE <i>Offset Type</i>				
> <i>Initial Offset</i>				
>>TDD DPCH Offset Value	M		INTEGER (0..255)	
> <i>No Initial Offset</i>				
>>TDD DPCH Offset Value	M		INTEGER (0..63)	

9.2.3.8B TDD DCHs To Modify

The *TDD DCHs To Modify* IE provides information for DCHs to be modified.

IE/Group Name	Presence	Range	IE Type and Reference	Semantics Description	Criticality	Assigned Criticality
TDD DCHs To Modify		1..<maxno ofDCHs>			–	
>UL FP Mode	O		9.2.1.67		–	
>ToAWS	O		9.2.1.58		–	
>ToAWE	O		9.2.1.57		–	
>Transport Bearer Request Indicator	M		9.2.1.61		–	
>DCH Specific Info		1..<maxno ofDCHs>			–	
>>DCH ID	M		9.2.1.16		–	
>>CCTrCH ID	O		9.2.3.2	UL CCTrCH in which the DCH is mapped.	–	
>>CCTrCH ID	O		9.2.3.2	DL CCTrCH in which the DCH is mapped	–	
>>Transport Format Set	O		9.2.1.64	For the UL.	–	
>>Transport Format Set	O		9.2.1.64	For the DL.	–	
>>Allocation/Retention Priority	O		9.2.1.1		–	
>>Frame Handling Priority	O		9.2.1.29		–	
>>Guaranteed Rate Information	O		9.2.1.30M		YES	ignore

Range bound	Explanation
<i>maxnoofDCHs</i>	Maximum number of DCHs for one UE.

9.2.3.8C TDD DL Code Information

The *TDD DL Code Information* IE provides TDD DL Code information for all DPCHs of one DL Time Slot.

IE/Group Name	Presence	Range	IE Type and Reference	Semantics Description	Criticality	Assigned Criticality
TDD DL Code Information		1..<maxno OfDPCHs >			–	
>DPCH ID	M		9.2.3.3		–	
>TDD Channelisation Code	M		9.2.3.8		–	

Range bound	Explanation
<i>maxnoofDPCHs</i>	Maximum number of DPCHs for one CCTrCH.

9.2.3.8D TDD DL Code Information LCR

The *TDD DL Code Information LCR* IE provides DL Code information for the RL for 1.28Mcps TDD.

IE/Group Name	Presence	Range	IE Type and Reference	Semantics Description	Criticality	Assigned Criticality
TDD DL Code Information LCR		1 .. <maxnoOf DPCHsLCR R>			–	
>DPCH ID	M		9.2.3.3		–	
>TDD Channelisation Code LCR	M		9.2.3.8a		–	
> TDD DL DPCH Time Slot Format LCR	M		9.2.3.8E		–	

Range bound	Explanation
<i>maxnoOfDPCHsLCR</i>	Maximum number of DPCH in one CCTrCH for 1.28Mcps TDD

9.2.3.8E TDD DL DPCH Time Slot Format LCR

TDD DL DPCH Time Slot Format LCR indicates the time slot formats used in DL DPCH for 1.28Mcps TDD (see ref. [12]).

IE/Group Name	Presence	Range	IE type and reference	Semantics description
<i>CHOICE Modulation</i>				
> <i>QPSK</i>				
>>QPSK TDD DL DPCH Time Slot Format LCR	M		INTEGER (0..24,...)	
> <i>8PSK</i>				
>>8PSK TDD DL DPCH Time Slot Format LCR	M		INTEGER (0..24,...)	

9.2.3.9 TDD Physical Channel Offset

The TDD Physical Channel Offset represents the phase information for the allocation of a non DPCH physical channel. (CFN mod Repetition Period = TDD Physical Channel Offset) see ref. [16].

IE/Group Name	Presence	Range	IE Type and Reference	Semantics Description
TDD Physical Channel Offset			INTEGER (0..63)	

9.2.3.10 TDD TPC Downlink Step Size

This parameter indicates step size for the DL power adjustment (see ref [22]).

IE/Group Name	Presence	Range	IE Type and Reference	Semantics Description
TDD TPC Downlink Step Size			ENUMERATED (1, 2, 3,...)	Unit: dB

9.2.3.10a TDD TPC Uplink Step Size

This parameter indicates step size for the UL power adjustment (see ref [22]).

IE/Group Name	Presence	Range	IE Type and Reference	Semantics Description
TDD TPC Uplink Step Size			ENUMERATED (1, 2, 3,...)	Unit: dB

9.2.3.10A TDD UL Code Information

The *TDD UL Code Information* IE provides TDD UL Code information for all DPCHs of one UL Time Slot.

IE/Group Name	Presence	Range	IE Type and Reference	Semantics Description	Criticality	Assigned Criticality
TDD UL Code Information		1..<maxno OfDPCHs >			–	
>DPCH ID	M		9.2.3.3		–	
>TDD Channelisation Code	M		9.2.3.8		–	

Range bound	Explanation
<i>maxnoofDPCHs</i>	Maximum number of DPCHs for one CCTrCH.

9.2.3.10B TDD UL Code Information LCR

The *TDD UL Code Information LCR* IE provides information for UL Code to be established for 1.28Mcps TDD.

IE/Group Name	Presence	Range	IE Type and Reference	Semantics Description	Criticality	Assigned Criticality
TDD UL Code Information LCR		1 .. <maxno OfDPCH sLCR>			–	
>DPCH ID	M		9.2.3.3		–	
>TDD Channelisation Code LCR	M		9.2.3.8a		–	
> TDD UL DPCH Time Slot Format LCR	M		9.2.3.10C		–	

Range bound	Explanation
<i>maxnoOfDPCHsLCR</i>	Maximum number of DPCHs in one CCTrCH for 1.28Mcps TDD.

9.2.3.10C TDD UL DPCH Time Slot Format LCR

TDD UL DPCH Time Slot Format LCR indicates the time slot formats used in UL DPCH for 1.28Mcps TDD (see ref. [12]).

IE/Group Name	Presence	Range	IE type and reference	Semantics description
<i>CHOICE Modulation</i>				
> QPSK				
>>QPSK TDD UL DPCH Time Slot Format LCR	M		INTEGER (0..69,...)	
> 8PSK				
>>8PSK TDD UL DPCH Time Slot Format LCR	M		INTEGER (0..24,...)	

9.2.3.11 TFCI Coding

The TFCI Coding describes how the TFCI bits are coded. By default 1 TFCI bit is coded with 4 bits, 2 TFCI bits are coded with 8 bits, 3-5 TFCI bits are coded with 16 bits and 6-10 TFCI bits are coded with 32 bits.

IE/Group Name	Presence	Range	IE Type and Reference	Semantics Description
TFCI Coding			ENUMERATED (4, 8, 16, 32,...)	

9.2.3.12 DL Timeslot ISCP

DL Timeslot ISCP is the measured interference in a downlink timeslot at the UE, see ref. [14].

IE/Group Name	Presence	Range	IE Type and Reference	Semantics Description
DL Timeslot ISCP			INTEGER (0..91)	According to mapping in [24].

9.2.3.12a Time Slot LCR

The Time Slot LCR is the number of the traffic time slot within a 5 ms subframe of LCR TDD.

IE/Group Name	Presence	Range	IE Type and Reference	Semantics Description
Time Slot LCR			INTEGER (0..6)	

9.2.3.12A Timing Advance Applied

Defines the need for Timing Advance functions such as Rx Timing Deviation measurement in a particular cell.

IE/Group Name	Presence	Range	IE Type and Reference	Semantics Description
Timing Advance Applied			ENUMERATED (Yes, No)	

9.2.3.13 Transport Format Management

Defines whether the cell transmits the transport format information via broadcast or whether the transport format information is transmitted to the UE using dedicated RRC procedures

IE/Group Name	Presence	Range	IE Type and Reference	Semantics Description
Transport Format Management			ENUMERATED (Cell Based, UE Based,...)	

9.2.3.13A UL Timeslot ISCP

UL Timeslot ISCP is the measured interference in an uplink timeslot at the DRNS, see ref. [14].

IE/Group Name	Presence	Range	IE Type and Reference	Semantics Description
UL Timeslot ISCP			INTEGER (0..127)	According to mapping in [24].

9.2.3.13B UL PhysCH SF Variation

Indicates whether variation of SF in UL is supported by Radio Link or not.

IE/Group Name	Presence	Range	IE Type and Reference	Semantics Description
UL PhysCH SF Variation			ENUMERATED (SF_Variation_supported, SF_Variation_NOT_supported)	

9.2.3.13C UL Timeslot Information

The *UL Timeslot Information* IE provides information on the time slot allocation for a UL DPCH.

IE/Group Name	Presence	Range	IE Type and Reference	Semantics Description	Criticality	Assigned Criticality
UL Timeslot Information		1..<maxnoOfTS>			–	
>Time Slot	M		9.2.1.56		–	
>Midamble Shift And Burst Type	M		9.2.3.4		–	
>TFCI Presence	M		9.2.1.55		–	
>UL Code Information	M		TDD UL Code Information 9.2.3.10A		–	

Range bound	Explanation
<i>maxnoofTS</i>	Maximum number of Timeslots for a UE.

9.2.3.13D UL Time Slot ISCP Info

The *UL Time Slot ISCP Info* IE gives interference level for each UL time slot within the Radio Link.

IE/Group Name	Presence	Range	IE Type and Reference	Semantics Description	Criticality	Assigned Criticality
UL Time Slot ISCP Info		1 .. <maxnoofULts>			–	
>Time Slot	M		9.2.1.56		–	
>UL Timeslot ISCP	M		9.2.3.13A		–	

Range bound	Explanation
<i>maxnoofULts</i>	Maximum number of uplink time slots per Radio Link.

9.2.3.13E TSTD Indicator

Indicates if TSTD shall be active or not for the DL DPCH.

IE/Group Name	Presence	Range	IE Type and Reference	Semantics Description
TSTD Indicator			ENUMERATED(active, inactive)	

9.2.3.13F TSTD Support Indicator

Indicates if UE support TSTD or not for DL DPCH.

IE/Group Name	Presence	Range	IE Type and Reference	Semantics Description
TSTD Support Indicator			ENUMERATED(TSTD supported, TSTD not supported)	

9.2.3.13G UL Timeslot Information LCR

The *UL Timeslot Information LCR* IE provides information on the timeslot allocation for an UL DPCH.

IE/Group Name	Presence	Range	IE Type and Reference	Semantics Description	Criticality	Assigned Criticality
UL Timeslot Information LCR		1 .. <maxnoofULtsLCR>			–	
>Time Slot LCR	M		9.2.3.12a		–	
>Midamble Shift LCR	M		9.2.3.4C		–	
>TFCI Presence	M		9.2.1.57		–	
>UL Code Information LCR	M		TDD UL Code Information LCR 9.2.3.10B			

Range bound	Explanation
<i>maxnoofULtsLCR</i>	Maximum number of Uplink time slots per Radio Link for 1.28Mcps TDD.

9.2.3.13H UL Time Slot ISCP Info LCR

The *UL Time Slot ISCP Info LCR* IE provides information for UL Interference level for each time slot within the Radio Link for 1.28Mcps TDD.

IE/Group Name	Presence	Range	IE Type and Reference	Semantics Description	Criticality	Assigned Criticality
UL Time Slot ISCP Info		1 .. <maxnoofULtsLCR>			–	
>Time Slot LCR	M		9.2.3.12a		–	
>UL Timeslot ISCP	M		9.2.3.13A		–	

Range bound	Explanation
<i>maxnoofULtsLCR</i>	Maximum number of Uplink time slots per Radio Link for 1.28Mcps TDD

9.2.3.13I Uplink Synchronisation Frequency

The *UL Synchronisation Frequency* IE specifies the frequency of the adjustment of the uplink transmission timing.

IE/Group Name	Presence	Range	IE Type and Reference	Semantics Description
Uplink synchronisation frequency			INTEGER (1..8)	Unit: subframe, granularity: 1

9.2.3.13J Uplink Synchronisation Step Size

The *UL Synchronisation Step Size* IE specifies the step size to be used for the adjustment of the uplink transmission timing.

IE/Group Name	Presence	Range	IE Type and Reference	Semantics Description
Uplink synchronisation step size			INTEGER (1..8)	Unit: 1/8 chip, step: 1.

9.2.3.13K Uplink Timing Advance Control LCR

The Uplink Timing Advance Control LCR indicates the parameters which are used to support Uplink Synchronisation for the UE in 1.28Mcps TDD.

IE/Group Name	Presence	Range	IE Type and Reference	Semantics Description
SYNC UL codes bitmap	M		BITSTRING (8)	Each bit indicates the availability of a SYNC_UL code.
FPACH info		1		
>Time Slot LCR	M		9.2.3.12a	
>TDD Channelisation Code LCR	M		9.2.3.8a	
>Midamble Shift LCR	M		9.2.3.4C	
>WT	M		INTEGER (1..4)	Maximum number of subframes to wait for transmission of FPACH.
PRXupPCHdes	M		INTEGER (-120 .. -58, ...)	Desired UpPCH receive power level. Unit: dBm Step size: 1
SYNC UL procedure parameters		1		
>Maximum Sync UL transmissions	M		ENUMERATED (1,2,4,8,...)	
>Power Ramp Step	M		INTEGER (0..3, ...)	
Mmax	M		INTEGER (1..32)	Maximum number of synchronisation attempts

9.2.3.14 USCH ID

The USCH ID is the identifier of an uplink shared channel. It is unique among the USCHs simultaneously allocated for the same UE.

IE/Group Name	Presence	Range	IE Type and Reference	Semantics Description
USCH ID			INTEGER (0..255)	

9.2.3.15 USCH Information

The *USCH Information* IE provides information for USCHs to be established.

IE/Group Name	Presence	Range	IE Type and Reference	Semantics Description	Criticality	Assigned Criticality
USCH Information		1.. <maxnoof USCHs>			–	
>USCH ID	M		9.2.3.14		–	
>CCTrCH ID	M		9.2.3.2	UL CCTrCH in which the USCH is mapped	–	
>TrCH Source Statistics Descriptor	M		9.2.1.65		–	
>Transport Format Set	M		9.2.1.64	For USCH	–	
>Allocation/Retention Priority	M		9.2.1.1		–	
>Scheduling Priority Indicator	M		9.2.1.51A		–	
>BLER	M		9.2.1.4			
>RB Info		1..<maxno ofRB>		All Radio Bearers using this USCH	–	
>>RB Identity	M		9.2.3.5B		–	

Range bound	Explanation
<i>maxnoofUSCHs</i>	Maximum number of USCHs for one UE.
<i>maxnoofRBs</i>	Maximum number of Radio Bearers for one UE.

9.3 Message and Information Element Abstract Syntax (with ASN.1)

9.3.0 General

Subclause 9.3 presents the Abstract Syntax of RNSAP protocol with ASN.1. In case there is contradiction between the ASN.1 definition in this subclause and the tabular format in subclauses 9.1 and 9.2, the ASN.1 shall take precedence, except for the definition of conditions for the presence of conditional elements, where the tabular format shall take precedence.

The ASN.1 definition specifies the structure and content of RNSAP messages. RNSAP messages can contain any IEs specified in the object set definitions for that message without the order or number of occurrence being restricted by ASN.1. However, for this version of the standard, a sending entity shall construct a RNSAP message according to the PDU definitions module and with the following additional rules (Note that in the following IE means an IE in the object set with an explicit id. If one IE needed to appear more than once in one object set, then the different occurrences have different IE ids):

- IEs shall be ordered (in an IE container) in the order they appear in object set definitions.
- Object set definitions specify how many times IEs may appear. An IE shall appear exactly once if the presence field in an object has value "mandatory". An IE may appear at most once if the presence field in an object has value "optional" or "conditional". If in a tabular format there is multiplicity specified for an IE (i.e. an IE list) then in the corresponding ASN.1 definition the list definition is separated into two parts. The first part defines an IE container list where the list elements reside. The second part defines list elements. The IE container list appears as an IE of its own. For this version of the standard an IE container list may contain only one kind of list elements.

If a RNSAP message that is not constructed as defined above is received, this shall be considered as Abstract Syntax Error, and the message shall be handled as defined for Abstract Syntax Error in subclause 10.3.6.

9.3.1 Usage of Private Message Mechanism for Non-standard Use

The private message mechanism for non-standard use may be used:

- for special operator (and/or vendor) specific features considered not to be part of the basic functionality, i.e. the functionality required for a complete and high-quality specification in order to guarantee multivendor inter-operability.
- by vendors for research purposes, e.g. to implement and evaluate new algorithms/features before such features are proposed for standardisation.

The private message mechanism shall not be used for basic functionality. Such functionality shall be standardised.

9.3.2 Elementary Procedure Definitions

```
-- *****
--
-- Elementary Procedure definitions
--
-- *****
```

```
RNSAP-PDU-Descriptions {
```

```
itu-t (0) identified-organization (4) etsi (0) mobileDomain (0)
umts-Access (20) modules (3) rnsap (1) version1 (1) rnsap-PDU-Descriptions (0) }
```

```
DEFINITIONS AUTOMATIC TAGS ::=
```

```
BEGIN
```

```
-- *****
--
-- IE parameter types from other modules.
--
-- *****
```

```
IMPORTS
```

```
    Criticality,
    ProcedureID,
    TransactionID
```

```
FROM RNSAP-CommonDataTypes
```

```
    CommonMeasurementFailureIndication,
    CommonMeasurementInitiationFailure,
    CommonMeasurementInitiationRequest,
    CommonMeasurementInitiationResponse,
    CommonMeasurementReport,
    CommonMeasurementTerminationRequest,
    CommonTransportChannelResourcesFailure,
    CommonTransportChannelResourcesRequest,
    CommonTransportChannelResourcesReleaseRequest,
    CommonTransportChannelResourcesResponseFDD,
    CommonTransportChannelResourcesResponseTDD,
    CompressedModeCommand,
    DedicatedMeasurementFailureIndication,
    DedicatedMeasurementInitiationFailure,
    DedicatedMeasurementInitiationRequest,
    DedicatedMeasurementInitiationResponse,
    DedicatedMeasurementReport,
    DedicatedMeasurementTerminationRequest,
    DL-PowerControlRequest,
    DL-PowerTimeslotControlRequest,
    DownlinkSignallingTransferRequest,
    ErrorIndication,
    InformationExchangeFailureIndication,
    InformationExchangeInitiationFailure,
    InformationExchangeInitiationRequest,
    InformationExchangeInitiationResponse,
    InformationExchangeTerminationRequest,
    InformationReport,
    PagingRequest,
    PhysicalChannelReconfigurationCommand,
    PhysicalChannelReconfigurationFailure,
    PhysicalChannelReconfigurationRequestFDD,
    PhysicalChannelReconfigurationRequestTDD,
    PrivateMessage,
    RadioLinkAdditionFailureFDD,
```

RadioLinkAdditionFailureTDD,
RadioLinkAdditionRequestFDD,
RadioLinkAdditionRequestTDD,
RadioLinkAdditionResponseFDD,
RadioLinkAdditionResponseTDD,
RadioLinkCongestionIndication,
RadioLinkDeletionRequest,
RadioLinkDeletionResponse,
RadioLinkFailureIndication,
RadioLinkPreemptionRequiredIndication,
RadioLinkReconfigurationCancel,
RadioLinkReconfigurationCommit,
RadioLinkReconfigurationFailure,
RadioLinkReconfigurationPrepareFDD,
RadioLinkReconfigurationPrepareTDD,
RadioLinkReconfigurationReadyFDD,
RadioLinkReconfigurationReadyTDD,
RadioLinkReconfigurationRequestFDD,
RadioLinkReconfigurationRequestTDD,
RadioLinkReconfigurationResponseFDD,
RadioLinkReconfigurationResponseTDD,
RadioLinkRestoreIndication,
RadioLinkSetupFailureFDD,
RadioLinkSetupFailureTDD,
RadioLinkSetupRequestFDD,
RadioLinkSetupRequestTDD,
RadioLinkSetupResponseFDD,
RadioLinkSetupResponseTDD,
RelocationCommit,
UplinkSignallingTransferIndicationFDD,
UplinkSignallingTransferIndicationTDD

FROM RNSAP-PDU-Contents

id-commonMeasurementFailure,
id-commonMeasurementInitiation,
id-commonMeasurementReporting,
id-commonMeasurementTermination,
id-commonTransportChannelResourcesInitialisation,
id-commonTransportChannelResourcesRelease,
id-compressedModeCommand,
id-downlinkPowerControl,
id-downlinkSignallingTransfer,
id-downlinkPowerTimeslotControl,
id-errorIndication,
id-informationExchangeFailure,
id-informationExchangeInitiation,
id-informationReporting,
id-informationExchangeTermination,
id-dedicatedMeasurementFailure,
id-dedicatedMeasurementInitiation,
id-dedicatedMeasurementReporting,
id-dedicatedMeasurementTermination,
id-paging,
id-physicalChannelReconfiguration,

```

    id-privateMessage,
    id-radioLinkAddition,
    id-radioLinkCongestion,
    id-radioLinkDeletion,
    id-radioLinkFailure,
    id-radioLinkPreemption,
    id-radioLinkRestoration,
    id-radioLinkSetup,
    id-relocationCommit,
    id-synchronisedRadioLinkReconfigurationCancellation,
    id-synchronisedRadioLinkReconfigurationCommit,
    id-synchronisedRadioLinkReconfigurationPreparation,
    id-unSynchronisedRadioLinkReconfiguration,
    id-uplinkSignallingTransfer
FROM RNSAP-Constants;

-- *****
--
-- Interface Elementary Procedure Class
--
-- *****

RNSAP-ELEMENTARY-PROCEDURE ::= CLASS {
    &InitiatingMessage          '
    &SuccessfulOutcome          OPTIONAL,
    &UnsuccessfulOutcome        OPTIONAL,
    &Outcome                    OPTIONAL,
    &procedureID                ProcedureID    UNIQUE,
    &criticality                Criticality    DEFAULT ignore
}
WITH SYNTAX {
    INITIATING MESSAGE          &InitiatingMessage
    [SUCCESSFUL OUTCOME        &SuccessfulOutcome]
    [UNSUCCESSFUL OUTCOME      &UnsuccessfulOutcome]
    [OUTCOME                   &Outcome]
    PROCEDURE ID               &procedureID
    [CRITICALITY               &criticality]
}

-- *****
--
-- Interface PDU Definition
--
-- *****

RNSAP-PDU ::= CHOICE {
    initiatingMessage    InitiatingMessage,
    successfulOutcome    SuccessfulOutcome,
    unsuccessfulOutcome  UnsuccessfulOutcome,
    outcome              Outcome,
    ...
}

InitiatingMessage ::= SEQUENCE {

```

```

    procedureID RNSAP-ELEMENTARY-PROCEDURE.&procedureID      ({RNSAP-ELEMENTARY-PROCEDURES}),
    criticality RNSAP-ELEMENTARY-PROCEDURE.&criticality      ({RNSAP-ELEMENTARY-PROCEDURES}@procedureID),
    transactionID TransactionID,
    value       RNSAP-ELEMENTARY-PROCEDURE.&InitiatingMessage ({RNSAP-ELEMENTARY-PROCEDURES}@procedureID)
}

SuccessfulOutcome ::= SEQUENCE {
    procedureID RNSAP-ELEMENTARY-PROCEDURE.&procedureID      ({RNSAP-ELEMENTARY-PROCEDURES}),
    criticality RNSAP-ELEMENTARY-PROCEDURE.&criticality      ({RNSAP-ELEMENTARY-PROCEDURES}@procedureID),
    transactionID TransactionID,
    value       RNSAP-ELEMENTARY-PROCEDURE.&SuccessfulOutcome ({RNSAP-ELEMENTARY-PROCEDURES}@procedureID)
}

UnsuccessfulOutcome ::= SEQUENCE {
    procedureID RNSAP-ELEMENTARY-PROCEDURE.&procedureID      ({RNSAP-ELEMENTARY-PROCEDURES}),
    criticality RNSAP-ELEMENTARY-PROCEDURE.&criticality      ({RNSAP-ELEMENTARY-PROCEDURES}@procedureID),
    transactionID TransactionID,
    value       RNSAP-ELEMENTARY-PROCEDURE.&UnsuccessfulOutcome ({RNSAP-ELEMENTARY-PROCEDURES}@procedureID)
}

Outcome ::= SEQUENCE {
    procedureID RNSAP-ELEMENTARY-PROCEDURE.&procedureID      ({RNSAP-ELEMENTARY-PROCEDURES}),
    criticality RNSAP-ELEMENTARY-PROCEDURE.&criticality      ({RNSAP-ELEMENTARY-PROCEDURES}@procedureID),
    transactionID TransactionID,
    value       RNSAP-ELEMENTARY-PROCEDURE.&Outcome          ({RNSAP-ELEMENTARY-PROCEDURES}@procedureID)
}

-- *****
--
-- Interface Elementary Procedure List
--
-- *****

RNSAP-ELEMENTARY-PROCEDURES RNSAP-ELEMENTARY-PROCEDURE ::= {
    RNSAP-ELEMENTARY-PROCEDURES-CLASS-1 |
    RNSAP-ELEMENTARY-PROCEDURES-CLASS-2 |
    RNSAP-ELEMENTARY-PROCEDURES-CLASS-3 ,
    ...
}

RNSAP-ELEMENTARY-PROCEDURES-CLASS-1 RNSAP-ELEMENTARY-PROCEDURE ::= {
    radioLinkSetupFDD |
    radioLinkSetupTDD |
    radioLinkAdditionFDD |
    radioLinkAdditionTDD |
    radioLinkDeletion |
    synchronisedRadioLinkReconfigurationPreparationFDD |
    synchronisedRadioLinkReconfigurationPreparationTDD |
    unSynchronisedRadioLinkReconfigurationFDD |
    unSynchronisedRadioLinkReconfigurationTDD |
    physicalChannelReconfigurationFDD |
    physicalChannelReconfigurationTDD |
    dedicatedMeasurementInitiation |
    commonTransportChannelResourcesInitialisationFDD
}

```

```

    commonTransportChannelResourcesInitialisationTDD      ,
    ...,
    commonMeasurementInitiation                          |
    informationExchangeInitiation                        |
}

RNSAP-ELEMENTARY-PROCEDURES-CLASS-2 RNSAP-ELEMENTARY-PROCEDURE ::= {
    uplinkSignallingTransferFDD                          |
    uplinkSignallingTransferTDD                          |
    downlinkSignallingTransfer                          |
    relocationCommit                                    |
    paging                                                |
    synchronisedRadioLinkReconfigurationCommit           |
    synchronisedRadioLinkReconfigurationCancellation    |
    radioLinkFailure                                     |
    radioLinkPreemption                                  |
    radioLinkRestoration                                 |
    dedicatedMeasurementReporting                       |
    dedicatedMeasurementTermination                    |
    dedicatedMeasurementFailure                         |
    downlinkPowerControlFDD                             |
    downlinkPowerTimeslotControl                       |
    compressedModeCommandFDD                           |
    commonTransportChannelResourcesRelease              |
    errorIndication                                     |
    privateMessage                                       |
    ...,
    radioLinkCongestion                                 |
    commonMeasurementFailure                             |
    commonMeasurementReporting                          |
    commonMeasurementTermination                       |
    informationExchangeFailure                           |
    informationExchangeTermination                       |
    informationReporting                                  |
}

RNSAP-ELEMENTARY-PROCEDURES-CLASS-3 RNSAP-ELEMENTARY-PROCEDURE ::= {
    ...
}

-- *****
--
-- Interface Elementary Procedures
--
-- *****

radioLinkSetupFDD RNSAP-ELEMENTARY-PROCEDURE ::= {
    INITIATING MESSAGE  RadioLinkSetupRequestFDD
    SUCCESSFUL OUTCOME  RadioLinkSetupResponseFDD
    UNSUCCESSFUL OUTCOME RadioLinkSetupFailureFDD
    PROCEDURE ID        { procedureCode id-radioLinkSetup, ddMode fdd }
    CRITICALITY         reject
}

```

```
radioLinkSetupTDD RNSAP-ELEMENTARY-PROCEDURE ::= {
  INITIATING MESSAGE  RadioLinkSetupRequestTDD
  SUCCESSFUL OUTCOME  RadioLinkSetupResponseTDD
  UNSUCCESSFUL OUTCOME  RadioLinkSetupFailureTDD
  PROCEDURE ID        { procedureCode id-radioLinkSetup, ddMode tdd }
  CRITICALITY         reject
}

radioLinkAdditionFDD RNSAP-ELEMENTARY-PROCEDURE ::= {
  INITIATING MESSAGE  RadioLinkAdditionRequestFDD
  SUCCESSFUL OUTCOME  RadioLinkAdditionResponseFDD
  UNSUCCESSFUL OUTCOME  RadioLinkAdditionFailureFDD
  PROCEDURE ID        { procedureCode id-radioLinkAddition , ddMode fdd }
  CRITICALITY         reject
}

radioLinkAdditionTDD RNSAP-ELEMENTARY-PROCEDURE ::= {
  INITIATING MESSAGE  RadioLinkAdditionRequestTDD
  SUCCESSFUL OUTCOME  RadioLinkAdditionResponseTDD
  UNSUCCESSFUL OUTCOME  RadioLinkAdditionFailureTDD
  PROCEDURE ID        { procedureCode id-radioLinkAddition , ddMode tdd }
  CRITICALITY         reject
}

radioLinkDeletion RNSAP-ELEMENTARY-PROCEDURE ::= {
  INITIATING MESSAGE  RadioLinkDeletionRequest
  SUCCESSFUL OUTCOME  RadioLinkDeletionResponse
  PROCEDURE ID        { procedureCode id-radioLinkDeletion, ddMode common }
  CRITICALITY         reject
}

synchronisedRadioLinkReconfigurationPreparationFDD RNSAP-ELEMENTARY-PROCEDURE ::= {
  INITIATING MESSAGE  RadioLinkReconfigurationPrepareFDD
  SUCCESSFUL OUTCOME  RadioLinkReconfigurationReadyFDD
  UNSUCCESSFUL OUTCOME  RadioLinkReconfigurationFailure
  PROCEDURE ID        { procedureCode id-synchronisedRadioLinkReconfigurationPreparation, ddMode fdd }
  CRITICALITY         reject
}

synchronisedRadioLinkReconfigurationPreparationTDD RNSAP-ELEMENTARY-PROCEDURE ::= {
  INITIATING MESSAGE  RadioLinkReconfigurationPrepareTDD
  SUCCESSFUL OUTCOME  RadioLinkReconfigurationReadyTDD
  UNSUCCESSFUL OUTCOME  RadioLinkReconfigurationFailure
  PROCEDURE ID        { procedureCode id-synchronisedRadioLinkReconfigurationPreparation, ddMode tdd }
  CRITICALITY         reject
}

unSynchronisedRadioLinkReconfigurationFDD RNSAP-ELEMENTARY-PROCEDURE ::= {
  INITIATING MESSAGE  RadioLinkReconfigurationRequestFDD
  SUCCESSFUL OUTCOME  RadioLinkReconfigurationResponseFDD
  UNSUCCESSFUL OUTCOME  RadioLinkReconfigurationFailure
  PROCEDURE ID        { procedureCode id-unSynchronisedRadioLinkReconfiguration, ddMode fdd }
  CRITICALITY         reject
}
```



```
unSynchronisedRadioLinkReconfigurationTDD RNSAP-ELEMENTARY-PROCEDURE ::= {
  INITIATING MESSAGE  RadioLinkReconfigurationRequestTDD
  SUCCESSFUL OUTCOME  RadioLinkReconfigurationResponseTDD
  UNSUCCESSFUL OUTCOME RadioLinkReconfigurationFailure
  PROCEDURE ID        { procedureCode id-unSynchronisedRadioLinkReconfiguration, ddMode tdd }
  CRITICALITY         reject
}

physicalChannelReconfigurationFDD RNSAP-ELEMENTARY-PROCEDURE ::= {
  INITIATING MESSAGE  PhysicalChannelReconfigurationRequestFDD
  SUCCESSFUL OUTCOME  PhysicalChannelReconfigurationCommand
  UNSUCCESSFUL OUTCOME PhysicalChannelReconfigurationFailure
  PROCEDURE ID        { procedureCode id-physicalChannelReconfiguration, ddMode fdd }
  CRITICALITY         reject
}

physicalChannelReconfigurationTDD RNSAP-ELEMENTARY-PROCEDURE ::= {
  INITIATING MESSAGE  PhysicalChannelReconfigurationRequestTDD
  SUCCESSFUL OUTCOME  PhysicalChannelReconfigurationCommand
  UNSUCCESSFUL OUTCOME PhysicalChannelReconfigurationFailure
  PROCEDURE ID        { procedureCode id-physicalChannelReconfiguration, ddMode tdd }
  CRITICALITY         reject
}

dedicatedMeasurementInitiation RNSAP-ELEMENTARY-PROCEDURE ::= {
  INITIATING MESSAGE  DedicatedMeasurementInitiationRequest
  SUCCESSFUL OUTCOME  DedicatedMeasurementInitiationResponse
  UNSUCCESSFUL OUTCOME DedicatedMeasurementInitiationFailure
  PROCEDURE ID        { procedureCode id-dedicatedMeasurementInitiation, ddMode common }
  CRITICALITY         reject
}

commonTransportChannelResourcesInitialisationFDD RNSAP-ELEMENTARY-PROCEDURE ::= {
  INITIATING MESSAGE  CommonTransportChannelResourcesRequest
  SUCCESSFUL OUTCOME  CommonTransportChannelResourcesResponseFDD
  UNSUCCESSFUL OUTCOME CommonTransportChannelResourcesFailure
  PROCEDURE ID        { procedureCode id-commonTransportChannelResourcesInitialisation, ddMode fdd }
  CRITICALITY         reject
}

commonTransportChannelResourcesInitialisationTDD RNSAP-ELEMENTARY-PROCEDURE ::= {
  INITIATING MESSAGE  CommonTransportChannelResourcesRequest
  SUCCESSFUL OUTCOME  CommonTransportChannelResourcesResponseTDD
  UNSUCCESSFUL OUTCOME CommonTransportChannelResourcesFailure
  PROCEDURE ID        { procedureCode id-commonTransportChannelResourcesInitialisation, ddMode tdd }
  CRITICALITY         reject
}

uplinkSignallingTransferFDD RNSAP-ELEMENTARY-PROCEDURE ::= {
  INITIATING MESSAGE  UplinkSignallingTransferIndicationFDD
  PROCEDURE ID        { procedureCode id-uplinkSignallingTransfer, ddMode fdd }
  CRITICALITY         ignore
}
```

```
uplinkSignallingTransferTDD RNSAP-ELEMENTARY-PROCEDURE ::= {
  INITIATING MESSAGE UplinkSignallingTransferIndicationTDD
  PROCEDURE ID       { procedureCode id-uplinkSignallingTransfer, ddMode tdd }
  CRITICALITY        ignore
}

downlinkSignallingTransfer RNSAP-ELEMENTARY-PROCEDURE ::= {
  INITIATING MESSAGE DownlinkSignallingTransferRequest
  PROCEDURE ID       { procedureCode id-downlinkSignallingTransfer, ddMode common }
  CRITICALITY        ignore
}

relocationCommit RNSAP-ELEMENTARY-PROCEDURE ::= {
  INITIATING MESSAGE RelocationCommit
  PROCEDURE ID       { procedureCode id-relocationCommit, ddMode common }
  CRITICALITY        ignore
}

paging RNSAP-ELEMENTARY-PROCEDURE ::= {
  INITIATING MESSAGE PagingRequest
  PROCEDURE ID       { procedureCode id-paging, ddMode common }
  CRITICALITY        ignore
}

synchronisedRadioLinkReconfigurationCommit RNSAP-ELEMENTARY-PROCEDURE ::= {
  INITIATING MESSAGE RadioLinkReconfigurationCommit
  PROCEDURE ID       { procedureCode id-synchronisedRadioLinkReconfigurationCommit, ddMode common }
  CRITICALITY        ignore
}

synchronisedRadioLinkReconfigurationCancellation RNSAP-ELEMENTARY-PROCEDURE ::= {
  INITIATING MESSAGE RadioLinkReconfigurationCancel
  PROCEDURE ID       { procedureCode id-synchronisedRadioLinkReconfigurationCancellation, ddMode common }
  CRITICALITY        ignore
}

radioLinkFailure RNSAP-ELEMENTARY-PROCEDURE ::= {
  INITIATING MESSAGE RadioLinkFailureIndication
  PROCEDURE ID       { procedureCode id-radioLinkFailure, ddMode common }
  CRITICALITY        ignore
}

radioLinkPreemption RNSAP-ELEMENTARY-PROCEDURE ::= {
  INITIATING MESSAGE RadioLinkPreemptionRequiredIndication
  PROCEDURE ID       { procedureCode id-radioLinkPreemption, ddMode common }
  CRITICALITY        ignore
}

radioLinkRestoration RNSAP-ELEMENTARY-PROCEDURE ::= {
  INITIATING MESSAGE RadioLinkRestoreIndication
  PROCEDURE ID       { procedureCode id-radioLinkRestoration, ddMode common }
  CRITICALITY        ignore
}
```

```
dedicatedMeasurementReporting RNSAP-ELEMENTARY-PROCEDURE ::= {
  INITIATING MESSAGE  DedicatedMeasurementReport
  PROCEDURE ID        { procedureCode id-dedicatedMeasurementReporting, ddMode common }
  CRITICALITY         ignore
}

dedicatedMeasurementTermination RNSAP-ELEMENTARY-PROCEDURE ::= {
  INITIATING MESSAGE  DedicatedMeasurementTerminationRequest
  PROCEDURE ID        { procedureCode id-dedicatedMeasurementTermination, ddMode common }
  CRITICALITY         ignore
}

dedicatedMeasurementFailure RNSAP-ELEMENTARY-PROCEDURE ::= {
  INITIATING MESSAGE  DedicatedMeasurementFailureIndication
  PROCEDURE ID        { procedureCode id-dedicatedMeasurementFailure, ddMode common }
  CRITICALITY         ignore
}

radioLinkCongestion RNSAP-ELEMENTARY-PROCEDURE ::= {
  INITIATING MESSAGE  RadioLinkCongestionIndication
  PROCEDURE ID        { procedureCode id-radioLinkCongestion, ddMode common }
  CRITICALITY         ignore
}

downlinkPowerControlFDD RNSAP-ELEMENTARY-PROCEDURE ::= {
  INITIATING MESSAGE  DL-PowerControlRequest
  PROCEDURE ID        { procedureCode id-downlinkPowerControl, ddMode fdd }
  CRITICALITY         ignore
}

downlinkPowerTimeslotControl RNSAP-ELEMENTARY-PROCEDURE ::= {
  INITIATING MESSAGE  DL-PowerTimeslotControlRequest
  PROCEDURE ID        { procedureCode id-downlinkPowerTimeslotControl, ddMode tdd }
  CRITICALITY         ignore
}

compressedModeCommandFDD RNSAP-ELEMENTARY-PROCEDURE ::= {
  INITIATING MESSAGE  CompressedModeCommand
  PROCEDURE ID        { procedureCode id-compressedModeCommand, ddMode fdd }
  CRITICALITY         ignore
}

commonTransportChannelResourcesRelease RNSAP-ELEMENTARY-PROCEDURE ::= {
  INITIATING MESSAGE  CommonTransportChannelResourcesReleaseRequest
  PROCEDURE ID        { procedureCode id-commonTransportChannelResourcesRelease, ddMode common }
  CRITICALITY         ignore
}

errorIndication RNSAP-ELEMENTARY-PROCEDURE ::= {
  INITIATING MESSAGE  ErrorIndication
  PROCEDURE ID        { procedureCode id-errorIndication, ddMode common }
  CRITICALITY         ignore
}
```

```
commonMeasurementInitiation RNSAP-ELEMENTARY-PROCEDURE ::= {
  INITIATING MESSAGE      CommonMeasurementInitiationRequest
  SUCCESSFUL OUTCOME      CommonMeasurementInitiationResponse
  UNSUCCESSFUL OUTCOME    CommonMeasurementInitiationFailure
  PROCEDURE ID            { procedureCode id-commonMeasurementInitiation, ddMode common }
  CRITICALITY              reject
}

commonMeasurementReporting RNSAP-ELEMENTARY-PROCEDURE ::= {
  INITIATING MESSAGE      CommonMeasurementReport
  PROCEDURE ID            { procedureCode id-commonMeasurementReporting, ddMode common }
  CRITICALITY              ignore
}

commonMeasurementTermination RNSAP-ELEMENTARY-PROCEDURE ::= {
  INITIATING MESSAGE      CommonMeasurementTerminationRequest
  PROCEDURE ID            { procedureCode id-commonMeasurementTermination, ddMode common }
  CRITICALITY              ignore
}

commonMeasurementFailure RNSAP-ELEMENTARY-PROCEDURE ::= {
  INITIATING MESSAGE      CommonMeasurementFailureIndication
  PROCEDURE ID            { procedureCode id-commonMeasurementFailure, ddMode common }
  CRITICALITY              ignore
}

informationExchangeInitiation RNSAP-ELEMENTARY-PROCEDURE ::= {
  INITIATING MESSAGE      InformationExchangeInitiationRequest
  SUCCESSFUL OUTCOME      InformationExchangeInitiationResponse
  UNSUCCESSFUL OUTCOME    InformationExchangeInitiationFailure
  PROCEDURE ID            { procedureCode id-informationExchangeInitiation, ddMode common }
  CRITICALITY              reject
}

informationReporting RNSAP-ELEMENTARY-PROCEDURE ::= {
  INITIATING MESSAGE      InformationReport
  PROCEDURE ID            { procedureCode id-informationReporting, ddMode common }
  CRITICALITY              ignore
}

informationExchangeTermination RNSAP-ELEMENTARY-PROCEDURE ::= {
  INITIATING MESSAGE      InformationExchangeTerminationRequest
  PROCEDURE ID            { procedureCode id-informationExchangeTermination, ddMode common }
  CRITICALITY              ignore
}

informationExchangeFailure RNSAP-ELEMENTARY-PROCEDURE ::= {
  INITIATING MESSAGE      InformationExchangeFailureIndication
  PROCEDURE ID            { procedureCode id-informationExchangeFailure, ddMode common }
  CRITICALITY              ignore
}

privateMessage RNSAP-ELEMENTARY-PROCEDURE ::= {
```

```
INITIATING MESSAGE PrivateMessage
PROCEDURE ID      { procedureCode id-privateMessage, ddMode common }
CRITICALITY      ignore
}

END
```

9.3.3 PDU Definitions

```
-- *****
--
-- PDU definitions for RNSAP.
--
-- *****

RNSAP-PDU-Contents {
itu-t (0) identified-organization (4) etsi (0) mobileDomain (0)
umts-Access (20) modules (3) rnsap (1) version1 (1) rnsap-PDU-Contents (1) }

DEFINITIONS AUTOMATIC TAGS ::=

BEGIN

-- *****
--
-- IE parameter types from other modules.
--
-- *****

IMPORTS
Active-Pattern-Sequence-Information,
AllocationRetentionPriority,
AllowedQueuingTime,
Allowed-Rate-Information,
AlphaValue,
BLER,
SCTD-Indicator,
BindingID,
C-ID,
C-RNTI,
CCTrCH-ID,
CFN,
ClosedLoopModel-SupportIndicator,
ClosedLoopMode2-SupportIndicator,
Closedlooptimingadjustmentmode,
CN-CS-DomainIdentifier,
CN-PS-DomainIdentifier,
CNDomainType,
Cause,
CellParameterID,
ChipOffset,
CommonMeasurementAccuracy,
CommonMeasurementType,
```

CommonMeasurementValue,
CommonMeasurementValueInformation,
CongestionCause,
CriticalityDiagnostics,
D-RNTI,
D-RNTI-ReleaseIndication,
DCH-FDD-Information,
DCH-ID,
DCH-InformationResponse,
DCH-TDD-Information,
DL-DPCH-SlotFormat,
DL-TimeslotISCP,
DL-Power,
DL-ScramblingCode,
DL-Timeslot-Information,
DL-TimeslotLCR-Information,
DL-TimeSlot-ISCP-Info,
DL-TimeSlot-ISCP-LCR-Information,
DPC-Mode,
DPC-Mode-Change-SupportIndicator,
DPCH-ID,
DRACControl,
DRXCycleLengthCoefficient,
DedicatedMeasurementType,
DedicatedMeasurementValue,
DedicatedMeasurementValueInformation,
DiversityControlField,
DiversityMode,
DSCH-FDD-Information,
DSCH-FDD-InformationResponse,
DSCH-FlowControlInformation,
DSCH-FlowControlItem,
DSCH-TDD-Information,
DSCH-ID,
DSCH-RNTI,
SchedulingPriorityIndicator,
EnhancedDSCHPC,
EnhancedDSCHPCCounter,
EnhancedDSCHPCIndicator,
EnhancedDSCHPCWnd,
EnhancedDSCHPowerOffset,
FACH-FlowControlInformation,
FDD-DCHs-to-Modify,
FDD-DL-ChannelisationCodeNumber,
FDD-DL-CodeInformation,
FDD-S-CCPCH-Offset,
FDD-TPC-DownlinkStepSize,
FirstRLS-Indicator,
FNReportingIndicator,
FrameHandlingPriority,
FrameOffset,
GA-AccessPointPosition,
GA-Cell,
GA-CellAdditionalShapes,

IMSI,
InformationExchangeID,
InformationReportCharacteristics,
InformationType,
InnerLoopDLPCStatus,
L3-Information,
SplitType,
LengthOfTFICI2,
LimitedPowerIncrease,
MaximumAllowedULTxPower,
MaxNrDLPhysicalchannels,
MaxNrOfUL-DPCHs,
MaxNrTimeslots,
MaxNrULPhysicalchannels,
MeasurementFilterCoefficient,
MeasurementID,
MidambleAllocationMode,
MidambleShiftAndBurstType,
MidambleShiftLCR,
MinimumSpreadingFactor,
MinUL-ChannelisationCodeLength,
MultiplexingPosition,
NeighbouringFDDCellMeasurementInformation,
NeighbouringTDDCellMeasurementInformation,
Neighbouring-GSM-CellInformation,
Neighbouring-UMTS-CellInformation,
NrOfDLchannelisationcodes,
PagingCause,
PagingRecordType,
PDSCHCodeMapping,
PayloadCRC-PresenceIndicator,
PCCPCH-Power,
PC-Preamble,
Permanent-NAS-UE-Identity,
PowerAdjustmentType,
PowerOffset,
PrimaryCCPCH-RSCP,
PrimaryCPICH-EcNo,
PrimaryCPICH-Power,
PrimaryScramblingCode,
PropagationDelay,
PunctureLimit,
QE-Selector,
RANAP-RelocationInformation,
RB-Info,
RL-ID,
RL-Set-ID,
RNC-ID,
RepetitionLength,
RepetitionPeriod,
ReportCharacteristics,
Received-total-wide-band-power,
RequestedDataValue,
RequestedDataValueInformation,

RxTimingDeviationForTA,
S-FieldLength,
S-RNTI,
SCH-TimeSlot,
SAI,
SFN,
Secondary-CCPCH-Info,
Secondary-CCPCH-Info-TDD,
Secondary-LCR-CCPCH-Info-TDD,
SpecialBurstScheduling,
SSDT-CellID,
SSDT-CellID-Length,
SSDT-Indication,
SSDT-SupportIndicator,
STTD-Indicator,
STTD-SupportIndicator,
AdjustmentPeriod,
ScaledAdjustmentRatio,
MaxAdjustmentStep,
SecondaryCCPCH-SlotFormat,
SRB-Delay,
SyncCase,
SynchronisationConfiguration,
TDD-ChannelisationCode,
TDD-DCHs-to-Modify,
TDD-DL-Code-Information,
TDD-DPCHOffset,
TDD-PhysicalChannelOffset,
TDD-TPC-DownlinkStepSize,
TDD-ChannelisationCodeLCR,
TDD-DL-Code-LCR-Information,
TDD-UL-Code-Information,
TDD-UL-Code-LCR-Information,
TFCI-Coding,
TFCI-Presence,
TFCI-SignallingMode,
TimeSlot,
TimeSlotLCR,
TimingAdvanceApplied,
ToAWE,
ToAWS,
TransmitDiversityIndicator,
TransportBearerID,
TransportBearerRequestIndicator,
TFCS,
Transmission-Gap-Pattern-Sequence-Information,
TransportFormatManagement,
TransportFormatSet,
TransportLayerAddress,
TrCH-SrcStatisticsDescr,
TSTD-Indicator,
TSTD-Support-Indicator,
UARFCN,
UC-ID,

```

UL-DPCCH-SlotFormat,
UL-SIR,
UL-FP-Mode,
UL-PhysCH-SF-Variation,
UL-ScramblingCode,
UL-Timeslot-Information,
UL-TimeslotLCR-Information,
UL-TimeSlot-ISCP-Info,
UL-TimeSlot-ISCP-LCR-Info,
URA-ID,
URA-Information,
USCH-ID,
USCH-Information,
UL-Synchronisation-Parameters-LCR,
TDD-DL-DPCH-TimeSlotFormat-LCR,
TDD-UL-DPCH-TimeSlotFormat-LCR,
TDD-TPC-UplinkStepSize-LCR,
UL-TimingAdvanceCtrl-LCR
FROM RNSAP-IES

```

```

PrivateIE-Container{},
ProtocolExtensionContainer{},
ProtocolIE-ContainerList{},
ProtocolIE-ContainerPair{},
ProtocolIE-ContainerPairList{},
ProtocolIE-Container{},
ProtocolIE-Single-Container{},
RNSAP-PRIVATE-IES,
RNSAP-PROTOCOL-EXTENSION,
RNSAP-PROTOCOL-IES,
RNSAP-PROTOCOL-IES-PAIR
FROM RNSAP-Containers

```

```

maxNoOfDSCHs,
maxNoOfUSCHs,
maxNrOfCCTrCHs,
maxNrOfDCHs,
maxNrOfTS,
maxNrOfDPCHs,
maxNrOfRLs,
maxNrOfRLSets,
maxNrOfRLs-1,
maxNrOfRLs-2,
maxNrOfULTs,
maxNrOfDLTs,
maxNoOfDSCHsLCR,
maxNoOfUSCHsLCR,
maxNrOfCCTrCHsLCR,
maxNrOfTsLCR,
maxNrOfDLTsLCR,
maxNrOfULTsLCR,
maxNrOfDPCHsLCR,
maxNrOfLCRTDDNeighboursPerRNC,
maxNrOfMeasNCell,

```

id-Active-Pattern-Sequence-Information,
id-AdjustmentRatio,
id-AllowedQueuingTime,
id-BindingID,
id-C-ID,
id-C-RNTI,
id-CFN,
id-CFNReportingIndicator,
id-CN-CS-DomainIdentifier,
id-CN-PS-DomainIdentifier,
id-Cause,
id-CauseLevel-RL-AdditionFailureFDD,
id-CauseLevel-RL-AdditionFailureTDD,
id-CauseLevel-RL-ReconfFailure,
id-CauseLevel-RL-SetupFailureFDD,
id-CauseLevel-RL-SetupFailureTDD,
id-CCTrCH-InformationItem-RL-FailureInd,
id-CCTrCH-InformationItem-RL-RestoreInd,
id-ClosedLoopModel-SupportIndicator,
id-ClosedLoopMode2-SupportIndicator,
id-CNOriginatedPage-PagingRqst,
id-CommonMeasurementAccuracy,
id-CommonMeasurementObjectType-CM-Rprt,
id-CommonMeasurementObjectType-CM-Rqst,
id-CommonMeasurementObjectType-CM-Rsp,
id-CommonMeasurementType,
id-CongestionCause,
id-CriticalityDiagnostics,
id-D-RNTI,
id-D-RNTI-ReleaseIndication,
id-DCHs-to-Add-FDD,
id-DCHs-to-Add-TDD,
id-DCH-DeleteList-RL-ReconfPrepFDD,
id-DCH-DeleteList-RL-ReconfPrepTDD,
id-DCH-DeleteList-RL-ReconfRqstFDD,
id-DCH-DeleteList-RL-ReconfRqstTDD,
id-DCH-FDD-Information,
id-DCH-TDD-Information,
id-FDD-DCHs-to-Modify,
id-TDD-DCHs-to-Modify,
id-DCH-InformationResponse,
id-DCH-Rate-InformationItem-RL-CongestInd,
id-DL-CCTrCH-InformationAddItem-RL-ReconfPrepTDD,
id-DL-CCTrCH-InformationDeleteItem-RL-ReconfPrepTDD,
id-DL-CCTrCH-InformationModifyItem-RL-ReconfPrepTDD,
id-DL-CCTrCH-InformationListIE-RL-ReconfReadyTDD,
id-DL-CCTrCH-InformationModifyItem-RL-ReconfRqstTDD,
id-DL-CCTrCH-InformationDeleteItem-RL-ReconfRqstTDD,
id-DL-CCTrCH-InformationItem-RL-SetupRqstTDD,
id-DL-CCTrCH-InformationListIE-PhyChReconfRqstTDD,
id-DL-CCTrCH-InformationListIE-RL-AdditionRspTDD,
id-DL-CCTrCH-InformationListIE-RL-SetupRspTDD,
id-DL-CCTrCH-InformationAddList-RL-ReconfPrepTDD,

id-DL-CCTrCH-InformationDeleteList-RL-ReconfPrepTDD,
id-DL-CCTrCH-InformationModifyList-RL-ReconfPrepTDD,
id-DL-CCTrCH-InformationDeleteList-RL-ReconfRqstTDD,
id-DL-CCTrCH-InformationModifyList-RL-ReconfRqstTDD,
id-DL-CCTrCH-InformationList-RL-SetupRqstTDD,
id-FDD-DL-CodeInformation,
id-DL-DPCH-Information-RL-ReconfPrepFDD,
id-DL-DPCH-Information-RL-SetupRqstFDD,
id-DL-DPCH-Information-RL-ReconfRqstFDD,
id-DL-DPCH-InformationItem-PhyChReconfRqstTDD,
id-DL-DPCH-InformationItem-RL-AdditionRspTDD,
id-DL-DPCH-InformationItem-RL-SetupRspTDD,
id-DL-DPCH-InformationAddListIE-RL-ReconfReadyTDD,
id-DL-DPCH-InformationDeleteListIE-RL-ReconfReadyTDD,
id-DL-DPCH-InformationModifyListIE-RL-ReconfReadyTDD,
id-DL-Physical-Channel-Information-RL-SetupRqstTDD,
id-DLReferencePower,
id-DLReferencePowerList-DL-PC-Rqst,
id-DL-ReferencePowerInformation-DL-PC-Rqst,
id-DRXCycleLengthCoefficient,
id-DedicatedMeasurementObjectType-DM-Rprt,
id-DedicatedMeasurementObjectType-DM-Rqst,
id-DedicatedMeasurementObjectType-DM-Rsp,
id-DedicatedMeasurementType,
id-DPC-Mode,
id-DPC-Mode-Change-SupportIndicator,
id-DSCHs-to-Add-FDD,
id-DSCHs-to-Add-TDD,
id-DSCH-DeleteList-RL-ReconfPrepTDD,
id-DSCH-Delete-RL-ReconfPrepFDD,
id-DSCH-FDD-Information,
id-DSCH-InformationListIE-RL-AdditionRspTDD,
id-DSCH-InformationListIEs-RL-SetupRspTDD,
id-DSCH-TDD-Information,
id-DSCH-FDD-InformationResponse,
id-DSCH-ModifyList-RL-ReconfPrepTDD,
id-DSCH-Modify-RL-ReconfPrepFDD,
id-DSCH-RNTI,
id-DSCHsToBeAddedOrModified-FDD,
id-DSCHToBeAddedOrModifiedList-RL-ReconfReadyTDD,
id-EnhancedDSCHPC,
id-EnhancedDSCHPCIndicator,
id-FACH-InfoForUESelectedS-CCPCH-CTCH-ResourceRspFDD,
id-FACH-InfoForUESelectedS-CCPCH-CTCH-ResourceRspTDD,
id-GA-Cell,
id-GA-CellAdditionalShapes,
id-IMSI,
id-InformationExchangeID,
id-InformationExchangeObjectType-InfEx-Rprt,
id-InformationExchangeObjectType-InfEx-Rqst,
id-InformationExchangeObjectType-InfEx-Rsp,
id-InformationReportCharacteristics,
id-InformationType,
id-InnerLoopDLPCStatus,

id-SplitType,
id-LengthOfTFCI2,
id-L3-Information,
id-AdjustmentPeriod,
id-MaxAdjustmentStep,
id-MeasurementFilterCoefficient,
id-MeasurementID,
id-PagingArea-PagingRqst,
id-Permanent-NAS-UE-Identity,
id-PDSCH-RL-ID,
id-FACH-FlowControlInformation,
id-PowerAdjustmentType,
id-PropagationDelay,
id-RANAP-RelocationInformation,
id-RL-Information-PhyChReconfRqstFDD,
id-RL-Information-PhyChReconfRqstTDD,
id-RL-Information-RL-AdditionRqstFDD,
id-RL-Information-RL-AdditionRqstTDD,
id-RL-Information-RL-DeletionRqst,
id-RL-Information-RL-FailureInd,
id-RL-Information-RL-ReconfPrepFDD,
id-RL-Information-RL-RestoreInd,
id-RL-Information-RL-SetupRqstFDD,
id-RL-Information-RL-SetupRqstTDD,
id-RL-InformationItem-RL-CongestInd,
id-RL-InformationItem-DM-Rprt,
id-RL-InformationItem-DM-Rqst,
id-RL-InformationItem-DM-Rsp,
id-RL-InformationItem-RL-PreemptRequiredInd,
id-RL-InformationItem-RL-SetupRqstFDD,
id-RL-InformationList-RL-CongestInd,
id-RL-InformationList-RL-AdditionRqstFDD,
id-RL-InformationList-RL-DeletionRqst,
id-RL-InformationList-RL-PreemptRequiredInd,
id-RL-InformationList-RL-ReconfPrepFDD,
id-RL-InformationResponse-RL-AdditionRspTDD,
id-RL-InformationResponse-RL-ReconfReadyTDD,
id-RL-InformationResponse-RL-ReconfRspTDD,
id-RL-InformationResponse-RL-SetupRspTDD,
id-RL-InformationResponseItem-RL-AdditionRspFDD,
id-RL-InformationResponseItem-RL-ReconfReadyFDD,
id-RL-InformationResponseItem-RL-ReconfRspFDD,
id-RL-InformationResponseItem-RL-SetupRspFDD,
id-RL-InformationResponseList-RL-AdditionRspFDD,
id-RL-InformationResponseList-RL-ReconfReadyFDD,
id-RL-InformationResponseList-RL-ReconfRspFDD,
id-RL-InformationResponseList-RL-SetupRspFDD,
id-RL-ReconfigurationFailure-RL-ReconfFail,
id-RL-Set-InformationItem-DM-Rprt,
id-RL-Set-InformationItem-DM-Rqst,
id-RL-Set-InformationItem-DM-Rsp,
id-RL-Set-Information-RL-FailureInd,
id-RL-Set-Information-RL-RestoreInd,
id-ReportCharacteristics,

id-Reporting-Object-RL-FailureInd,
id-Reporting-Object-RL-RestoreInd,
id-RxTimingDeviationForTA,
id-S-RNTI,
id-SAI,
id-SFN,
id-SFNReportingIndicator,
id-SRNC-ID,
id-SSDT-CellIDforEDSCHPC,
id-STTD-SupportIndicator,
id-SuccessfulRL-InformationResponse-RL-AdditionFailureFDD,
id-SuccessfulRL-InformationResponse-RL-SetupFailureFDD,
id-timeSlot-ISCP,
id-TimeSlot-RL-SetupRspTDD,
id-TransportBearerID,
id-TransportBearerRequestIndicator,
id-TransportLayerAddress,
id-UC-ID,
id-Transmission-Gap-Pattern-Sequence-Information,
id-UL-CCTrCH-AddInformation-RL-ReconfPrepTDD,
id-UL-CCTrCH-DeleteInformation-RL-ReconfPrepTDD,
id-UL-CCTrCH-ModifyInformation-RL-ReconfPrepTDD,
id-UL-CCTrCH-InformationDeleteItem-RL-ReconfRqstTDD,
id-UL-CCTrCH-InformationModifyItem-RL-ReconfRqstTDD,
id-UL-CCTrCH-InformationAddList-RL-ReconfPrepTDD,
id-UL-CCTrCH-InformationDeleteList-RL-ReconfPrepTDD,
id-UL-CCTrCH-InformationModifyList-RL-ReconfPrepTDD,
id-UL-CCTrCH-InformationDeleteList-RL-ReconfRqstTDD,
id-UL-CCTrCH-InformationModifyList-RL-ReconfRqstTDD,
id-UL-CCTrCH-InformationItem-RL-SetupRqstTDD,
id-UL-CCTrCH-InformationList-RL-SetupRqstTDD,
id-UL-CCTrCH-InformationListIE-PhyChReconfRqstTDD,
id-UL-CCTrCH-InformationListIE-RL-AdditionRspTDD,
id-UL-CCTrCH-InformationListIE-RL-ReconfReadyTDD,
id-UL-CCTrCH-InformationListIE-RL-SetupRspTDD,
id-UL-DPCH-Information-RL-ReconfPrepFDD,
id-UL-DPCH-Information-RL-ReconfRqstFDD,
id-UL-DPCH-Information-RL-SetupRqstFDD,
id-UL-DPCH-InformationItem-PhyChReconfRqstTDD,
id-UL-DPCH-InformationItem-RL-AdditionRspTDD,
id-UL-DPCH-InformationItem-RL-SetupRspTDD,
id-UL-DPCH-InformationAddListIE-RL-ReconfReadyTDD,
id-UL-DPCH-InformationDeleteListIE-RL-ReconfReadyTDD,
id-UL-DPCH-InformationModifyListIE-RL-ReconfReadyTDD,
id-UL-Physical-Channel-Information-RL-SetupRqstTDD,
id-UL-SIRTarget,
id-URA-Information,
id-UnsuccessfulRL-InformationResponse-RL-AdditionFailureFDD,
id-UnsuccessfulRL-InformationResponse-RL-AdditionFailureTDD,
id-UnsuccessfulRL-InformationResponse-RL-SetupFailureFDD,
id-UnsuccessfulRL-InformationResponse-RL-SetupFailureTDD,
id-USCHs-to-Add,
id-USCH-DeleteList-RL-ReconfPrepTDD,
id-USCH-InformationListIE-RL-AdditionRspTDD,

```

id-USCH-InformationListIEs-RL-SetupRspTDD,
id-USCH-Information,
id-USCH-ModifyList-RL-ReconfPrepTDD,
id-USCHToBeAddedOrModifiedList-RL-ReconfReadyTDD,
id-DL-Timeslot-ISCP-LCR-Information-RL-SetupRqstTDD,
id-RL-LCR-InformationResponse-RL-SetupRspTDD,
id-UL-CCTrCH-LCR-InformationListIE-RL-SetupRspTDD,
id-UL-DPCH-LCR-InformationItem-RL-SetupRspTDD,
id-DL-CCTrCH-LCR-InformationListIE-RL-SetupRspTDD,
id-DL-DPCH-LCR-InformationItem-RL-SetupRspTDD,
id-DSCH-LCR-InformationListIEs-RL-SetupRspTDD,
id-USCH-LCR-InformationListIEs-RL-SetupRspTDD,
id-DL-Timeslot-ISCP-LCR-Information-RL-AdditionRqstTDD,
id-RL-LCR-InformationResponse-RL-AdditionRspTDD,
id-UL-CCTrCH-LCR-InformationListIE-RL-AdditionRspTDD,
id-UL-DPCH-LCR-InformationItem-RL-AdditionRspTDD,
id-DL-CCTrCH-LCR-InformationListIE-RL-AdditionRspTDD,
id-DL-DPCH-LCR-InformationItem-RL-AdditionRspTDD,
id-DSCH-LCR-InformationListIEs-RL-AdditionRspTDD,
id-USCH-LCR-InformationListIEs-RL-AdditionRspTDD,
id-UL-DPCH-LCR-InformationAddListIE-RL-ReconfReadyTDD,
id-UL-Timeslot-LCR-InformationModifyList-RL-ReconfReadyTDD,
id-DL-DPCH-LCR-InformationAddListIE-RL-ReconfReadyTDD,
id-DL-Timeslot-LCR-InformationModifyList-RL-ReconfReadyTDD,
id-UL-Timeslot-LCR-InformationList-PhyChReconfRqstTDD,
id-DL-Timeslot-LCR-InformationList-PhyChReconfRqstTDD,
id-timeSlot-ISCP-LCR-List-DL-PC-Rqst-TDD,
id-TSTD-Support-Indicator-RL-SetupRqstTDD,
id-PrimaryCCPCH-RSCP-RL-ReconfPrepTDD,
id-DL-TimeSlot-ISCP-Info-RL-ReconfPrepTDD,
id-DL-Timeslot-ISCP-LCR-Information-RL-ReconfPrepTDD,
id-UL-Synchronisation-Parameters-LCR,
id-TDD-DL-DPCH-TimeSlotFormatModifyItem-LCR-RL-ReconfReadyTDD,
id-TDD-UL-DPCH-TimeSlotFormatModifyItem-LCR-RL-ReconfReadyTDD,
id-TDD-TPC-UplinkStepSize-LCR-RL-SetupRqstTDD,
id-UL-CCTrCH-InformationList-RL-AdditionRqstTDD,
id-UL-CCTrCH-InformationItem-RL-AdditionRqstTDD,
id-DL-CCTrCH-InformationList-RL-AdditionRqstTDD,
id-DL-CCTrCH-InformationItem-RL-AdditionRqstTDD,
id-TDD-TPC-UplinkStepSize-InformationAdd-LCR-RL-ReconfPrepTDD,
id-TDD-TPC-UplinkStepSize-InformationModify-LCR-RL-ReconfPrepTDD,
id-TDD-TPC-DownlinkStepSize-InformationAdd-RL-ReconfPrepTDD,
id-TDD-TPC-DownlinkStepSize-InformationModify-RL-ReconfPrepTDD,
id-UL-TimingAdvanceCtrl-LCR

FROM RNSAP-Constants;

-- *****
--
-- RADIO LINK SETUP REQUEST FDD
--
-- *****

RadioLinkSetupRequestFDD ::= SEQUENCE {

```

```

    protocolIEs          ProtocolIE-Container    {{RadioLinkSetupRequestFDD-IEs}},
    protocolExtensions  ProtocolExtensionContainer {{RadioLinkSetupRequestFDD-Extensions}}
    ...
}

RadioLinkSetupRequestFDD-IEs RNSAP-PROTOCOL-IES ::= {
  { ID id-SRNC-ID          CRITICALITY reject  TYPE RNC-ID          PRESENCE mandatory } |
  { ID id-S-RNTI          CRITICALITY reject  TYPE S-RNTI          PRESENCE mandatory } |
  { ID id-D-RNTI          CRITICALITY reject  TYPE D-RNTI          PRESENCE optional  } |
  { ID id-AllowedQueuingTime CRITICALITY reject  TYPE AllowedQueuingTime PRESENCE optional  } |
  { ID id-UL-DPCH-Information-RL-SetupRqstFDD CRITICALITY reject  TYPE UL-DPCH-Information-RL-SetupRqstFDD PRESENCE mandatory  } |
  { ID id-DL-DPCH-Information-RL-SetupRqstFDD CRITICALITY reject  TYPE DL-DPCH-Information-RL-SetupRqstFDD PRESENCE mandatory  } |
  { ID id-DCH-FDD-Information CRITICALITY reject  TYPE DCH-FDD-Information PRESENCE mandatory  } |
  { ID id-DSCH-FDD-Information CRITICALITY reject  TYPE DSCH-FDD-Information PRESENCE optional  } |
  { ID id-RL-Information-RL-SetupRqstFDD CRITICALITY notify  TYPE RL-InformationList-RL-SetupRqstFDD PRESENCE mandatory  } |
  { ID id-Transmission-Gap-Pattern-Sequence-Information CRITICALITY reject  TYPE Transmission-Gap-Pattern-Sequence-Information PRESENCE optional  } |
  { ID id-Active-Pattern-Sequence-Information CRITICALITY reject  TYPE Active-Pattern-Sequence-Information PRESENCE optional  },
  ...
}

UL-DPCH-Information-RL-SetupRqstFDD ::= SEQUENCE {
  ul-ScramblingCode          UL-ScramblingCode,
  minUL-ChannelisationCodeLength MinUL-ChannelisationCodeLength,
  maxNrOfUL-DPCHs            MaxNrOfUL-DPCHs          OPTIONAL
  -- This IE shall be present if minUL-ChannelisationCodeLength equals to 4 -- ,
  ul-PunctureLimit           PunctureLimit,
  ul-TFCS                     TFCS,
  ul-DPCCH-SlotFormat         UL-DPCCH-SlotFormat,
  ul-SIRTarget                UL-SIR          OPTIONAL,
  diversityMode               DiversityMode,
  sSDT-CellIDLength           SSDT-CellID-Length    OPTIONAL,
  s-FieldLength               S-FieldLength    OPTIONAL,
  iE-Extensions               ProtocolExtensionContainer { {UL-DPCH-Information-RL-SetupRqstFDD-ExtIEs} } OPTIONAL,
  ...
}

UL-DPCH-Information-RL-SetupRqstFDD-ExtIEs RNSAP-PROTOCOL-EXTENSION ::= {
  { ID id-DPC-Mode          CRITICALITY reject  EXTENSION DPC-Mode PRESENCE optional  },
  ...
}

DL-DPCH-Information-RL-SetupRqstFDD ::= SEQUENCE {
  tFCS                        TFCS,
  dl-DPCH-SlotFormat          DL-DPCH-SlotFormat,
  nrOfDLchannelisationcodes   NrOfDLchannelisationcodes,
  tFCI-SignallingMode         TFCI-SignallingMode,
  tFCI-Presence                TFCI-Presence          OPTIONAL
  -- This IE shall be present if DL DPCH Slot Format IE is equal to any of the values from 12 to 16 -- ,
  multiplexingPosition         MultiplexingPosition,
  powerOffsetInformation       PowerOffsetInformation-RL-SetupRqstFDD,
  fdd-dl-TPC-DownlinkStepSize FDD-TPC-DownlinkStepSize,
  limitedPowerIncrease         LimitedPowerIncrease,
  innerLoopDLPCStatus         InnerLoopDLPCStatus,

```

```

    iE-Extensions          ProtocolExtensionContainer { {DL-DPCH-Information-RL-SetupRqstFDD-ExtIEs} } OPTIONAL,
    ...
}

DL-DPCH-Information-RL-SetupRqstFDD-ExtIEs RNSAP-PROTOCOL-EXTENSION ::= {
  { ID id-SplitType CRITICALITY reject EXTENSION SplitType PRESENCE conditional } |
  -- This IE shall be present if the TFCI signalling mode is split --
  { ID id-LengthOfTFCI2 CRITICALITY reject EXTENSION LengthOfTFCI2 PRESENCE conditional },
  -- This IE shall be present if the split type is logical --
  ...
}

PowerOffsetInformation-RL-SetupRqstFDD ::= SEQUENCE {
  po1-ForTFCI-Bits          PowerOffset,
  po2-ForTPC-Bits          PowerOffset,
  po3-ForPilotBits        PowerOffset,
  iE-Extensions          ProtocolExtensionContainer { { PowerOffsetInformation-RL-SetupRqstFDD-ExtIEs} } OPTIONAL,
  ...
}

PowerOffsetInformation-RL-SetupRqstFDD-ExtIEs RNSAP-PROTOCOL-EXTENSION ::= {
  ...
}

RL-InformationList-RL-SetupRqstFDD ::= SEQUENCE (SIZE (1..maxNrOfRLs)) OF ProtocolIE-Single-Container { {RL-InformationItemIEs-RL-SetupRqstFDD} }

RL-InformationItemIEs-RL-SetupRqstFDD RNSAP-PROTOCOL-IES ::= {
  { ID id-RL-InformationItem-RL-SetupRqstFDD CRITICALITY notify TYPE RL-InformationItem-RL-SetupRqstFDD PRESENCE mandatory }
}

RL-InformationItem-RL-SetupRqstFDD ::= SEQUENCE {
  rL-ID                    RL-ID,
  c-ID                    C-ID,
  firstRLS-indicator      FirstRLS-Indicator,
  frameOffset             FrameOffset,
  chipOffset              ChipOffset,
  propagationDelay        PropagationDelay OPTIONAL,
  diversityControlField   DiversityControlField OPTIONAL
  -- This IE shall be present if the RL is not the first one in the RL-InformationList-RL-SetupRqstFDD --,
  dl-InitialTX-Power      DL-Power OPTIONAL,
  primaryCPICH-EcNo       PrimaryCPICH-EcNo OPTIONAL,
  sSDT-CellID             SSdT-CellID OPTIONAL,
  transmitDiversityIndicator TransmitDiversityIndicator OPTIONAL,
  -- This IE shall be present unless Diversity Mode IE in UL DPCH Information group is "none"
  iE-Extensions          ProtocolExtensionContainer { {RL-InformationItem-RL-SetupRqstFDD-ExtIEs} } OPTIONAL,
  ...
}

RL-InformationItem-RL-SetupRqstFDD-ExtIEs RNSAP-PROTOCOL-EXTENSION ::= {
  { ID id-SSDT-CellIDforEDSCHPC CRITICALITY ignore EXTENSION SSdT-CellID PRESENCE conditional },
  -- This IE shall be present if Enhanced DSCH PC IE is present in the DSCH Information IE.
  ...
}

```



```

RadioLinkSetupRequestFDD-Extensions RNSAP-PROTOCOL-EXTENSION ::= {
  { ID id-Permanent-NAS-UE-Identity          CRITICALITY ignore          EXTENSION Permanent-NAS-UE-Identity  PRESENCE optional },
  ...
}

-- *****
--
-- RADIO LINK SETUP REQUEST TDD
--
-- *****

RadioLinkSetupRequestTDD ::= SEQUENCE {
  protocolIEs          ProtocolIE-Container    {{RadioLinkSetupRequestTDD-IEs}},
  protocolExtensions   ProtocolExtensionContainer {{RadioLinkSetupRequestTDD-Extensions}}          OPTIONAL,
  ...
}

RadioLinkSetupRequestTDD-IEs RNSAP-PROTOCOL-IES ::= {
  { ID id-SRNC-ID          CRITICALITY reject  TYPE RNC-ID          PRESENCE mandatory } |
  { ID id-S-RNTI          CRITICALITY reject  TYPE S-RNTI          PRESENCE mandatory } |
  { ID id-D-RNTI          CRITICALITY reject  TYPE D-RNTI          PRESENCE optional } |
  { ID id-UL-Physical-Channel-Information-RL-SetupRqstTDD CRITICALITY reject  TYPE UL-Physical-Channel-Information-RL-SetupRqstTDD  PRESENCE
mandatory } |
  { ID id-DL-Physical-Channel-Information-RL-SetupRqstTDD CRITICALITY reject  TYPE DL-Physical-Channel-Information-RL-SetupRqstTDD  PRESENCE
mandatory } |
  { ID id-AllowedQueuingTime          CRITICALITY reject  TYPE AllowedQueuingTime          PRESENCE optional } |
  { ID id-UL-CCTrCH-InformationList-RL-SetupRqstTDD CRITICALITY notify  TYPE UL-CCTrCH-InformationList-RL-SetupRqstTDD  PRESENCE optional } |
  { ID id-DL-CCTrCH-InformationList-RL-SetupRqstTDD CRITICALITY notify  TYPE DL-CCTrCH-InformationList-RL-SetupRqstTDD  PRESENCE optional } |
  { ID id-DCH-TDD-Information          CRITICALITY reject  TYPE DCH-TDD-Information          PRESENCE optional } |
  { ID id-DSCH-TDD-Information          CRITICALITY reject  TYPE DSCH-TDD-Information          PRESENCE optional } |
  { ID id-USCH-Information          CRITICALITY reject  TYPE USCH-Information          PRESENCE optional } |
  { ID id-RL-Information-RL-SetupRqstTDD          CRITICALITY reject  TYPE RL-Information-RL-SetupRqstTDD          PRESENCE mandatory},
  ...
}

UL-Physical-Channel-Information-RL-SetupRqstTDD ::= SEQUENCE {
  maxNrTimeslots-UL          MaxNrTimeslots,
  minimumSpreadingFactor-UL  MinimumSpreadingFactor,
  maxNrULPhysicalchannels    MaxNrULPhysicalchannels,
  iE-Extensions              ProtocolExtensionContainer { {UL-Physical-Channel-InformationItem-RL-SetupRqstTDD-ExtIEs} } OPTIONAL,
  ...
}

UL-Physical-Channel-InformationItem-RL-SetupRqstTDD-ExtIEs RNSAP-PROTOCOL-EXTENSION ::= {
  ...
}

DL-Physical-Channel-Information-RL-SetupRqstTDD ::= SEQUENCE {
  maxNrTimeslots-DL          MaxNrTimeslots,
  minimumSpreadingFactor-DL  MinimumSpreadingFactor,
  maxNrDLPhysicalchannels    MaxNrDLPhysicalchannels,
  iE-Extensions              ProtocolExtensionContainer { {DL-Physical-Channel-InformationItem-RL-SetupRqstTDD-ExtIEs} } OPTIONAL,
  ...
}

```

```

}

DL-Physical-Channel-InformationItem-RL-SetupRqstTDD-ExtIEs RNSAP-PROTOCOL-EXTENSION ::= {
    ...
}

UL-CCTrCH-InformationList-RL-SetupRqstTDD ::= SEQUENCE (SIZE (1..maxNrOfCCTrCHs)) OF ProtocolIE-Single-Container { {UL-CCTrCH-
InformationItemIEs-RL-SetupRqstTDD} }

UL-CCTrCH-InformationItemIEs-RL-SetupRqstTDD RNSAP-PROTOCOL-IES ::= {
    { ID id-UL-CCTrCH-InformationItem-RL-SetupRqstTDD CRITICALITY notify TYPE UL-CCTrCH-InformationItem-RL-SetupRqstTDD PRESENCE mandatory }
}

UL-CCTrCH-InformationItem-RL-SetupRqstTDD ::= SEQUENCE {
    cCTrCH-ID CTrCH-ID,
    ul-TFCS TFCS,
    tFCI-Coding TFCI-Coding,
    ul-PunctureLimit PunctureLimit,
    iE-Extensions ProtocolExtensionContainer { {UL-CCTrCH-InformationItem-RL-SetupRqstTDD-ExtIEs} } OPTIONAL,
    ...
}

UL-CCTrCH-InformationItem-RL-SetupRqstTDD-ExtIEs RNSAP-PROTOCOL-EXTENSION ::= {
    { ID id-TDD-TPC-UplinkStepSize-LCR-RL-SetupRqstTDD CRITICALITY reject EXTENSION TDD-TPC-UplinkStepSize-LCR PRESENCE optional },
    -- Mandatory for 1.28Mcps TDD, not applicable to 3.84Mcps TDD
    ...
}

DL-CCTrCH-InformationList-RL-SetupRqstTDD ::= SEQUENCE (SIZE (1..maxNrOfCCTrCHs)) OF ProtocolIE-Single-Container { {DL-CCTrCH-
InformationItemIEs-RL-SetupRqstTDD} }

DL-CCTrCH-InformationItemIEs-RL-SetupRqstTDD RNSAP-PROTOCOL-IES ::= {
    { ID id-DL-CCTrCH-InformationItem-RL-SetupRqstTDD CRITICALITY notify TYPE DL-CCTrCH-InformationItem-RL-SetupRqstTDD PRESENCE mandatory }
}

DL-CCTrCH-InformationItem-RL-SetupRqstTDD ::= SEQUENCE {
    cCTrCH-ID CTrCH-ID,
    dl-TFCS TFCS,
    tFCI-Coding TFCI-Coding,
    dl-PunctureLimit PunctureLimit,
    tdd-TPC-DownlinkStepSize TDD-TPC-DownlinkStepSize,
    cCTrCH-TPCList CCTrCH-TPCList-RL-SetupRqstTDD OPTIONAL,
    iE-Extensions ProtocolExtensionContainer { {DL-CCTrCH-InformationItem-RL-SetupRqstTDD-ExtIEs} } OPTIONAL,
    ...
}

DL-CCTrCH-InformationItem-RL-SetupRqstTDD-ExtIEs RNSAP-PROTOCOL-EXTENSION ::= {
    ...
}

CCTrCH-TPCList-RL-SetupRqstTDD ::= SEQUENCE (SIZE (1..maxNrOfCCTrCHs)) OF CCTrCH-TPCItem-RL-SetupRqstTDD

CCTrCH-TPCItem-RL-SetupRqstTDD ::= SEQUENCE {
    cCTrCH-ID CCTrCH-ID,

```

```

    iE-Extensions          ProtocolExtensionContainer { { CCTrCH-TPCItem-RL-SetupRqstTDD-ExtIEs } } OPTIONAL,
    ...
}

CCTrCH-TPCItem-RL-SetupRqstTDD-ExtIEs RNSAP-PROTOCOL-EXTENSION ::= {
    ...
}

RL-Information-RL-SetupRqstTDD ::= SEQUENCE {
    rL-ID                  RL-ID,
    c-ID                   C-ID,
    frameOffset            FrameOffset,
    specialBurstScheduling SpecialBurstScheduling,
    primaryCCPCH-RSCP      PrimaryCCPCH-RSCP    OPTIONAL,
    dL-TimeSlot-ISCP       DL-TimeSlot-ISCP-Info OPTIONAL,
    --for 3.84Mcps TDD only
    iE-Extensions          ProtocolExtensionContainer { {RL-Information-RL-SetupRqstTDD-ExtIEs} } OPTIONAL,
    ...
}

RL-Information-RL-SetupRqstTDD-ExtIEs RNSAP-PROTOCOL-EXTENSION ::= {
    { ID id-DL-Timeslot-ISCP-LCR-Information-RL-SetupRqstTDD    CRITICALITY reject      EXTENSION    DL-TimeSlot-ISCP-LCR-Information PRESENCE
optional    }|
    { ID id-TSTD-Support-Indicator-RL-SetupRqstTDD              CRITICALITY ignore      EXTENSION    TSTD-Support-Indicator          PRESENCE
optional    }|
    --for 1.28Mcps TDD only
    { ID id-UL-Synchronisation-Parameters-LCR                  CRITICALITY ignore      EXTENSION    UL-Synchronisation-Parameters-LCR PRESENCE
optional    }, -- Mandatory for 1.28Mcps TDD, Not Applicable to 3.84Mcps TDD
    ...
}

RadioLinkSetupRequestTDD-Extensions RNSAP-PROTOCOL-EXTENSION ::= {
    { ID id-Permanent-NAS-UE-Identity          CRITICALITY ignore      EXTENSION Permanent-NAS-UE-Identity PRESENCE optional }|
    { ID id-PDSCH-RL-ID                        CRITICALITY ignore      EXTENSION RL-ID          PRESENCE optional },
    ...
}

-- *****
--
-- RADIO LINK SETUP RESPONSE FDD
--
-- *****

RadioLinkSetupResponseFDD ::= SEQUENCE {
    protocolIEs          ProtocolIE-Container    {{RadioLinkSetupResponseFDD-IEs}},
    protocolExtensions  ProtocolExtensionContainer {{RadioLinkSetupResponseFDD-Extensions}}    OPTIONAL,
    ...
}

RadioLinkSetupResponseFDD-IEs RNSAP-PROTOCOL-IES ::= {
    { ID id-D-RNTI          CRITICALITY ignore TYPE D-RNTI          PRESENCE optional } |
    { ID id-CN-PS-DomainIdentifier CRITICALITY ignore TYPE CN-PS-DomainIdentifier PRESENCE optional } |
    { ID id-CN-CS-DomainIdentifier CRITICALITY ignore TYPE CN-CS-DomainIdentifier PRESENCE optional } |

```

```

    { ID id-RL-InformationResponseList-RL-SetupRspFDD    CRITICALITY ignore    TYPE RL-InformationResponseList-RL-SetupRspFDD    PRESENCE mandatory    }
|
{ ID id-UL-SIRTarget                CRITICALITY ignore    TYPE UL-SIR                PRESENCE optional    } |
{ ID id-CriticalityDiagnostics        CRITICALITY ignore    TYPE CriticalityDiagnostics    PRESENCE optional    },
...
}

RL-InformationResponseList-RL-SetupRspFDD ::= SEQUENCE (SIZE (1..maxNrOfRLs)) OF ProtocolIE-Single-Container { {RL-
InformationResponseItemIEs-RL-SetupRspFDD} }

RL-InformationResponseItemIEs-RL-SetupRspFDD RNSAP-PROTOCOL-IES ::= {
  { ID id-RL-InformationResponseItem-RL-SetupRspFDD    CRITICALITY ignore    TYPE RL-InformationResponseItem-RL-SetupRspFDD    PRESENCE mandatory    }
}

RL-InformationResponseItem-RL-SetupRspFDD ::= SEQUENCE {
  rL-ID                RL-ID,
  rL-Set-ID            RL-Set-ID,
  uRA-Information      URA-Information    OPTIONAL,
  sAI                  SAI,
  gA-Cell              GA-Cell    OPTIONAL,
  gA-AccessPointPosition  GA-AccessPointPosition    OPTIONAL,
  received-total-wide-band-power  Received-total-wide-band-power,
  secondary-CCPCH-Info  Secondary-CCPCH-Info    OPTIONAL,
  dl-CodeInformation    FDD-DL-CodeInformation,
  diversityIndication  DiversityIndication-RL-SetupRspFDD,
  -- This IE represents both the Diversity Indication IE and the choice based on the diversity indication as described in
  -- the tabular message format in subclause 9.1.
  sSDT-SupportIndicator  SSDT-SupportIndicator,
  maxUL-SIR              UL-SIR,
  minUL-SIR              UL-SIR,
  closedloopTimingAdjustmentmode  ClosedloopTimingAdjustmentmode    OPTIONAL,
  maximumAllowedULTxPower  MaximumAllowedULTxPower,
  maximumDLTxPower        DL-Power,
  minimumDLTxPower        DL-Power,
  primaryScramblingCode    PrimaryScramblingCode    OPTIONAL,
  uL-UARFCN                UARFCN    OPTIONAL,
  dL-UARFCN                UARFCN    OPTIONAL,
  primaryCPICH-Power        PrimaryCPICH-Power,
  dSCHInformationResponse  DSCH-InformationResponse-RL-SetupRspFDD    OPTIONAL,
  neighbouring-UMTS-CellInformation  Neighbouring-UMTS-CellInformation    OPTIONAL,
  neighbouring-GSM-CellInformation  Neighbouring-GSM-CellInformation    OPTIONAL,
  pC-Preamble              PC-Preamble,
  sRB-Delay                SRB-Delay,
  iE-Extensions            ProtocolExtensionContainer { {RL-InformationResponseItem-RL-SetupRspFDD-ExtIEs} }    OPTIONAL,
  ...
}

RL-InformationResponseItem-RL-SetupRspFDD-ExtIEs RNSAP-PROTOCOL-EXTENSION ::= {
  { ID id-GA-CellAdditionalShapes        CRITICALITY ignore    EXTENSION    GA-CellAdditionalShapes        PRESENCE optional    },
  ...
}

DiversityIndication-RL-SetupRspFDD ::= CHOICE {
  combining                Combining-RL-SetupRspFDD,

```

```

    nonCombiningOrFirstRL          NonCombiningOrFirstRL-RL-SetupRspFDD
}

Combining-RL-SetupRspFDD ::= SEQUENCE {
    rL-ID          RL-ID,
    iE-Extensions  ProtocolExtensionContainer { { CombiningItem-RL-SetupRspFDD-ExtIEs } } OPTIONAL,
    ...
}

CombiningItem-RL-SetupRspFDD-ExtIEs RNSAP-PROTOCOL-EXTENSION ::= {
    { ID id-DCH-InformationResponse          CRITICALITY ignore  EXTENSION DCH-InformationResponse          PRESENCE optional },
    ...
}

NonCombiningOrFirstRL-RL-SetupRspFDD ::= SEQUENCE {
    dCH-InformationResponse  DCH-InformationResponse,
    iE-Extensions            ProtocolExtensionContainer { { NonCombiningOrFirstRLItem-RL-SetupRspFDD-ExtIEs } } OPTIONAL,
    ...
}

NonCombiningOrFirstRLItem-RL-SetupRspFDD-ExtIEs RNSAP-PROTOCOL-EXTENSION ::= {
    ...
}

DSCH-InformationResponse-RL-SetupRspFDD ::= ProtocolIE-Single-Container { { DSCH-InformationResponseIE-RL-SetupRspFDD } }

DSCH-InformationResponseIE-RL-SetupRspFDD RNSAP-PROTOCOL-IES ::= {
    { ID id-DSCH-FDD-InformationResponse  CRITICALITY ignore  TYPE  DSCH-FDD-InformationResponse  PRESENCE mandatory }
}

RadioLinkSetupResponseFDD-Extensions RNSAP-PROTOCOL-EXTENSION ::= {
    { ID id-DSCH-RNTI          CRITICALITY ignore          EXTENSION DSCH-RNTI          PRESENCE optional },
    ...
}

-- *****
--
-- RADIO LINK SETUP RESPONSE TDD
--
-- *****

RadioLinkSetupResponseTDD ::= SEQUENCE {
    protocolIEs          ProtocolIE-Container  {{RadioLinkSetupResponseTDD-IEs}},
    protocolExtensions  ProtocolExtensionContainer {{RadioLinkSetupResponseTDD-Extensions}}          OPTIONAL,
    ...
}

RadioLinkSetupResponseTDD-IEs RNSAP-PROTOCOL-IES ::= {
    { ID id-D-RNTI          CRITICALITY ignore  TYPE D-RNTI          PRESENCE optional } |
    { ID id-CN-PS-DomainIdentifier          CRITICALITY ignore  TYPE CN-PS-DomainIdentifier          PRESENCE optional } |
    { ID id-CN-CS-DomainIdentifier          CRITICALITY ignore  TYPE CN-CS-DomainIdentifier          PRESENCE optional } |
    { ID id-RL-InformationResponse-RL-SetupRspTDD  CRITICALITY ignore  TYPE RL-InformationResponse-RL-SetupRspTDD  PRESENCE optional } |
    --Mandatory for 3.84Mcps TDD only
    { ID id-UL-SIRTarget          CRITICALITY ignore  TYPE UL-SIR          PRESENCE mandatory } |

```

```

    { ID id-CriticalityDiagnostics          CRITICALITY ignore TYPE CriticalityDiagnostics          PRESENCE optional },
    ...
}

RL-InformationResponse-RL-SetupRspTDD ::= SEQUENCE {
    rL-ID                RL-ID,
    uRA-Information      URA-Information          OPTIONAL,
    sAI                  SAI,
    gA-Cell              GA-Cell          OPTIONAL,
    gA-AccessPointPosition  GA-AccessPointPosition  OPTIONAL,
    ul-TimeSlot-ISCP-Info  UL-TimeSlot-ISCP-Info,
    maxUL-SIR           UL-SIR,
    minUL-SIR           UL-SIR,
    maximumAllowedULTxPower  MaximumAllowedULTxPower,
    maximumDLTxPower    DL-Power,
    minimumDLTxPower    DL-Power,
    uARFCNforNt         UARFCN          OPTIONAL,
    cellParameterID     CellParameterID  OPTIONAL,
    syncCase             SyncCase        OPTIONAL,
    sCH-TimeSlot         SCH-TimeSlot     OPTIONAL,
    -- This IE shall be present if Sync Case IE is Case2. --
    sCTD-Indicator      SCTD-Indicator  OPTIONAL,
    pCCPCH-Power        PCCPCH-Power,
    timingAdvanceApplied  TimingAdvanceApplied,
    alphaValue          AlphaValue,
    ul-PhysCH-SF-Variation  UL-PhysCH-SF-Variation,
    synchronisationConfiguration  SynchronisationConfiguration,
    secondary-CCPCH-Info-TDD  Secondary-CCPCH-Info-TDD  OPTIONAL,
    ul-CCTrCHInformation  UL-CCTrCHInformationList-RL-SetupRspTDD  OPTIONAL,
    dl-CCTrCHInformation  DL-CCTrCHInformationList-RL-SetupRspTDD  OPTIONAL,
    dCH-InformationResponse  DCH-InformationResponseList-RL-SetupRspTDD  OPTIONAL,
    dsch-InformationResponse  DSCH-InformationResponse-RL-SetupRspTDD  OPTIONAL,
    usch-InformationResponse  USCH-InformationResponse-RL-SetupRspTDD  OPTIONAL,
    neighbouring-UMTS-CellInformation  Neighbouring-UMTS-CellInformation  OPTIONAL,
    neighbouring-GSM-CellInformation  Neighbouring-GSM-CellInformation  OPTIONAL,
    iE-Extensions        ProtocolExtensionContainer { {RL-InformationResponse-RL-SetupRspTDD-ExtIEs} } OPTIONAL,
    ...
}

RL-InformationResponse-RL-SetupRspTDD-ExtIEs RNSAP-PROTOCOL-EXTENSION ::= {
    { ID id-GA-CellAdditionalShapes          CRITICALITY ignore EXTENSION  GA-CellAdditionalShapes          PRESENCE optional }|
    { ID id-TimeSlot-RL-SetupRspTDD         CRITICALITY ignore EXTENSION  TimeSlot          PRESENCE conditional },
    -- This IE shall be present if Sync Case IE is Case1. --
    ...
}

UL-CCTrCHInformationList-RL-SetupRspTDD ::= ProtocolIE-Single-Container {{UL-CCTrCHInformationListIEs-RL-SetupRspTDD}}

UL-CCTrCHInformationListIEs-RL-SetupRspTDD RNSAP-PROTOCOL-IES ::= {
    { ID id-UL-CCTrCH-InformationListIE-RL-SetupRspTDD  CRITICALITY ignore TYPE UL-CCTrCHInformationListIE-RL-SetupRspTDD  PRESENCE mandatory }
}

UL-CCTrCHInformationListIE-RL-SetupRspTDD ::= SEQUENCE (SIZE (1..maxNrOfCCTrCHs)) OF UL-CCTrCHInformationItem-RL-SetupRspTDD

```

```

UL-CCTrCHInformationItem-RL-SetupRspTDD ::= SEQUENCE {
    cCTrCH-ID                CCTrCH-ID,
    ul-DPCH-Information      UL-DPCH-InformationList-RL-SetupRspTDD    OPTIONAL,
    iE-Extensions            ProtocolExtensionContainer { {UL-CCTrCHInformationItem-RL-SetupRspTDD-ExtIEs} } OPTIONAL,
    ...
}

UL-CCTrCHInformationItem-RL-SetupRspTDD-ExtIEs RNSAP-PROTOCOL-EXTENSION ::= {
    ...
}

UL-DPCH-InformationList-RL-SetupRspTDD ::= ProtocolIE-Single-Container { {UL-DPCH-InformationListIEs-RL-SetupRspTDD} }

UL-DPCH-InformationListIEs-RL-SetupRspTDD RNSAP-PROTOCOL-IES ::= {
    { ID id-UL-DPCH-InformationItem-RL-SetupRspTDD    CRITICALITY ignore TYPE UL-DPCH-InformationItem-RL-SetupRspTDD PRESENCE mandatory}
}

UL-DPCH-InformationItem-RL-SetupRspTDD ::= SEQUENCE {
    repetitionPeriod        RepetitionPeriod,
    repetitionLength        RepetitionLength,
    tDD-DPCHOffset          TDD-DPCHOffset,
    uL-Timeslot-Information  UL-Timeslot-Information,
    iE-Extensions            ProtocolExtensionContainer { {UL-DPCH-InformationItem-RL-SetupRspTDD-ExtIEs} } OPTIONAL,
    ...
}

UL-DPCH-InformationItem-RL-SetupRspTDD-ExtIEs RNSAP-PROTOCOL-EXTENSION ::= {
    ...
}

DL-CCTrCHInformationList-RL-SetupRspTDD ::= ProtocolIE-Single-Container { {DL-CCTrCHInformationListIEs-RL-SetupRspTDD} }

DL-CCTrCHInformationListIEs-RL-SetupRspTDD RNSAP-PROTOCOL-IES ::= {
    { ID id-DL-CCTrCH-InformationListIE-RL-SetupRspTDD    CRITICALITY ignore TYPE DL-CCTrCHInformationListIE-RL-SetupRspTDD PRESENCE mandatory }
}

DL-CCTrCHInformationListIE-RL-SetupRspTDD ::= SEQUENCE (SIZE (1..maxNrOfCCTrCHs)) OF DL-CCTrCHInformationItem-RL-SetupRspTDD

DL-CCTrCHInformationItem-RL-SetupRspTDD ::= SEQUENCE {
    cCTrCH-ID                CCTrCH-ID,
    dl-DPCH-Information      DL-DPCH-InformationList-RL-SetupRspTDD    OPTIONAL,
    iE-Extensions            ProtocolExtensionContainer { {DL-CCTrCHInformationItem-RL-SetupRspTDD-ExtIEs} } OPTIONAL,
    ...
}

DL-CCTrCHInformationItem-RL-SetupRspTDD-ExtIEs RNSAP-PROTOCOL-EXTENSION ::= {
    ...
}

DL-DPCH-InformationList-RL-SetupRspTDD ::= ProtocolIE-Single-Container { {DL-DPCH-InformationListIEs-RL-SetupRspTDD} }

DL-DPCH-InformationListIEs-RL-SetupRspTDD RNSAP-PROTOCOL-IES ::= {
    { ID id-DL-DPCH-InformationItem-RL-SetupRspTDD    CRITICALITY ignore TYPE DL-DPCH-InformationItem-RL-SetupRspTDD PRESENCE mandatory}
}

```

```

}

DL-DPCH-InformationItem-RL-SetupRspTDD ::= SEQUENCE {
    repetitionPeriod      RepetitionPeriod,
    repetitionLength      RepetitionLength,
    tDD-DPCHOffset        TDD-DPCHOffset,
    dL-Timeslot-Information DL-Timeslot-Information,
    iE-Extensions         ProtocolExtensionContainer { {DL-DPCH-InformationItem-RL-SetupRspTDD-ExtIEs} } OPTIONAL,
    ...
}

DL-DPCH-InformationItem-RL-SetupRspTDD-ExtIEs RNSAP-PROTOCOL-EXTENSION ::= {
    ...
}

DCH-InformationResponseList-RL-SetupRspTDD ::= ProtocolIE-Single-Container {{DCH-InformationResponseListIEs-RL-SetupRspTDD}}

DCH-InformationResponseListIEs-RL-SetupRspTDD RNSAP-PROTOCOL-IES ::= {
    { ID id-DCH-InformationResponse CRITICALITY ignore TYPE DCH-InformationResponse PRESENCE mandatory }
}

DSCH-InformationResponse-RL-SetupRspTDD ::= ProtocolIE-Single-Container {{DSCH-InformationList-RL-SetupRspTDD}}

DSCH-InformationList-RL-SetupRspTDD RNSAP-PROTOCOL-IES ::= {
    { ID id-DSCH-InformationListIEs-RL-SetupRspTDD CRITICALITY ignore TYPE DSCH-InformationListIEs-RL-SetupRspTDD PRESENCE mandatory }
}

DSCH-InformationListIEs-RL-SetupRspTDD ::= SEQUENCE (SIZE(0..maxNoOfDSCHs)) OF DSCHInformationItem-RL-SetupRspTDD

DSCHInformationItem-RL-SetupRspTDD ::= SEQUENCE {
    dsch-ID                DSCH-ID,
    dsch-FlowControlInformation DSCH-FlowControlInformation,
    bindingID              BindingID OPTIONAL,
    transportLayerAddress  TransportLayerAddress OPTIONAL,
    transportFormatManagement TransportFormatManagement,
    iE-Extensions         ProtocolExtensionContainer { {DSCHInformationItem-RL-SetupRspTDD-ExtIEs} } OPTIONAL,
    ...
}

DSCHInformationItem-RL-SetupRspTDD-ExtIEs RNSAP-PROTOCOL-EXTENSION ::= {
    ...
}

USCH-InformationResponse-RL-SetupRspTDD ::= ProtocolIE-Single-Container {{USCH-InformationList-RL-SetupRspTDD}}

USCH-InformationList-RL-SetupRspTDD RNSAP-PROTOCOL-IES ::= {
    { ID id-USCH-InformationListIEs-RL-SetupRspTDD CRITICALITY ignore TYPE USCH-InformationListIEs-RL-SetupRspTDD PRESENCE mandatory }
}

USCH-InformationListIEs-RL-SetupRspTDD ::= SEQUENCE (SIZE(0..maxNoOfUSCHs)) OF USCHInformationItem-RL-SetupRspTDD

USCHInformationItem-RL-SetupRspTDD ::= SEQUENCE {
    usch-ID                USCH-ID,
    bindingID              BindingID OPTIONAL,

```



```

transportLayerAddress      TransportLayerAddress  OPTIONAL,
transportFormatManagement  TransportFormatManagement,
iE-Extensions              ProtocolExtensionContainer { {USCHInformationItem-RL-SetupRspTDD-ExtIEs} } OPTIONAL,
...
}

USCHInformationItem-RL-SetupRspTDD-ExtIEs RNSAP-PROTOCOL-EXTENSION ::= {
...
}

RadioLinkSetupResponseTDD-Extensions RNSAP-PROTOCOL-EXTENSION ::= {
  { ID id-RL-LCR-InformationResponse-RL-SetupRspTDD  CRITICALITY ignore  EXTENSION  RL-LCR-InformationResponse-RL-SetupRspTDD  PRESENCE optional} |
  --Mandatory for 1.28Mcps TDD only
  { ID id-DSCH-RNTI  CRITICALITY ignore  EXTENSION DSCH-RNTI  PRESENCE optional },
  ...
}

RL-LCR-InformationResponse-RL-SetupRspTDD ::= SEQUENCE {
  rL-ID  RL-ID,
  uRA-Information  URA-Information,
  sAI  SAI,
  gA-Cell  GA-Cell  OPTIONAL,
  gA-AccessPointPosition  GA-AccessPointPosition  OPTIONAL,
  ul-TimeSlot-ISCP-LCR-Info  UL-TimeSlot-ISCP-LCR-Info,
  maxUL-SIR  UL-SIR,
  minUL-SIR  UL-SIR,
  maximumAllowedULTxPower  MaximumAllowedULTxPower,
  maximumDLTxPower  DL-Power,
  minimumDLTxPower  DL-Power,
  uARFCNforNt  UARFCN  OPTIONAL,
  cellParameterID  CellParameterID  OPTIONAL,
  sCTD-Indicator  SCTD-Indicator  OPTIONAL,
  pCCPCH-Power  PCCPCH-Power,
  alphaValue  AlphaValue,
  ul-PhysCH-SF-Variation  UL-PhysCH-SF-Variation,
  synchronisationConfiguration  SynchronisationConfiguration,
  secondary-LCR-CCPCH-Info-TDD  Secondary-LCR-CCPCH-Info-TDD  OPTIONAL,
  ul-LCR-CCTrCHInformation  UL-LCR-CCTrCHInformationList-RL-SetupRspTDD  OPTIONAL,
  dl-LCR-CCTrCHInformation  DL-LCR-CCTrCHInformationList-RL-SetupRspTDD  OPTIONAL,
  dCH-InformationResponse  DCH-InformationResponseList-RL-SetupRspTDD  OPTIONAL,
  dsch-LCR-InformationResponse  DSCH-LCR-InformationResponse-RL-SetupRspTDD  OPTIONAL,
  usch-LCR-InformationResponse  USCH-LCR-InformationResponse-RL-SetupRspTDD  OPTIONAL,
  neighbouring-UMTS-CellInformation  Neighbouring-UMTS-CellInformation  OPTIONAL,
  neighbouring-GSM-CellInformation  Neighbouring-GSM-CellInformation  OPTIONAL,
  iE-Extensions  ProtocolExtensionContainer { { RL-LCR-InformationResponseList-RL-SetupRspTDD-ExtIEs} }  OPTIONAL,
  ...
}

RL-LCR-InformationResponseList-RL-SetupRspTDD-ExtIEs RNSAP-PROTOCOL-EXTENSION ::= {
  { ID id-GA-CellAdditionalShapes  CRITICALITY ignore  EXTENSION  GA-CellAdditionalShapes  PRESENCE optional } |
  { ID id-UL-TimingAdvanceCtrl-LCR  CRITICALITY ignore  EXTENSION  UL-TimingAdvanceCtrl-LCR  PRESENCE optional },
  --Mandatory for 1.28Mcps TDD only
  ...
}

```

```

}

UL-LCR-CCTrCHInformationList-RL-SetupRspTDD ::= ProtocolIE-Single-Container {{UL-LCR-CCTrCHInformationListIEs-RL-SetupRspTDD}}

UL-LCR-CCTrCHInformationListIEs-RL-SetupRspTDD RNSAP-PROTOCOL-IES ::= {
  { ID id-UL-CCTrCH-LCR-InformationListIE-RL-SetupRspTDD  CRITICALITY ignore TYPE UL-LCR-CCTrCHInformationListIE-RL-SetupRspTDD  PRESENCE
  mandatory }
}

UL-LCR-CCTrCHInformationListIE-RL-SetupRspTDD ::= SEQUENCE (SIZE (1..maxNrOfCCTrCHsLCR)) OF UL-LCR-CCTrCHInformationItem-RL-SetupRspTDD

UL-LCR-CCTrCHInformationItem-RL-SetupRspTDD ::= SEQUENCE {
  cCTrCH-ID          CCTrCH-ID,
  ul-DPCH-LCR-Information  UL-DPCH-LCR-InformationList-RL-SetupRspTDD  OPTIONAL,
  iE-Extensions      ProtocolExtensionContainer { {UL-LCR-CCTrCHInformationItem-RL-SetupRspTDD-ExtIEs} } OPTIONAL,
  ...
}

UL-LCR-CCTrCHInformationItem-RL-SetupRspTDD-ExtIEs RNSAP-PROTOCOL-EXTENSION ::= {
  ...
}

UL-DPCH-LCR-InformationList-RL-SetupRspTDD ::= ProtocolIE-Single-Container { {UL-DPCH-LCR-InformationListIEs-RL-SetupRspTDD} }

UL-DPCH-LCR-InformationListIEs-RL-SetupRspTDD RNSAP-PROTOCOL-IES ::= {
  { ID id-UL-DPCH-LCR-InformationItem-RL-SetupRspTDD  CRITICALITY ignore TYPE UL-DPCH-LCR-InformationItem-RL-SetupRspTDD  PRESENCE mandatory
  }
}

UL-DPCH-LCR-InformationItem-RL-SetupRspTDD ::= SEQUENCE {
  repetitionPeriod      RepetitionPeriod,
  repetitionLength      RepetitionLength,
  tDD-DPCHOffset        TDD-DPCHOffset,
  uL-TimeslotLCR-Information  UL-TimeslotLCR-Information,
  iE-Extensions      ProtocolExtensionContainer { {UL-DPCH-LCR-InformationItem-RL-SetupRspTDD-ExtIEs} } OPTIONAL,
  ...
}

UL-DPCH-LCR-InformationItem-RL-SetupRspTDD-ExtIEs RNSAP-PROTOCOL-EXTENSION ::= {
  ...
}

DL-LCR-CCTrCHInformationList-RL-SetupRspTDD ::= ProtocolIE-Single-Container {{DL-LCR-CCTrCHInformationListIEs-RL-SetupRspTDD}}

DL-LCR-CCTrCHInformationListIEs-RL-SetupRspTDD RNSAP-PROTOCOL-IES ::= {
  { ID id-DL-CCTrCH-LCR-InformationListIE-RL-SetupRspTDD  CRITICALITY ignore TYPE DL-CCTrCH-LCR-InformationListIE-RL-SetupRspTDD  PRESENCE
  mandatory }
}

DL-CCTrCH-LCR-InformationListIE-RL-SetupRspTDD ::= SEQUENCE (SIZE (1..maxNrOfCCTrCHsLCR)) OF DL-CCTrCH-LCR-InformationItem-RL-SetupRspTDD

DL-CCTrCH-LCR-InformationItem-RL-SetupRspTDD ::= SEQUENCE {
  cCTrCH-ID          CCTrCH-ID,
  dl-DPCH-LCR-Information  DL-DPCH-LCR-InformationList-RL-SetupRspTDD  OPTIONAL,
  iE-Extensions      ProtocolExtensionContainer { {DL-CCTrCH-LCR-InformationItem-RL-SetupRspTDD-ExtIEs} } OPTIONAL,

```

```

}
...
DL-CCTrCH-LCR-InformationItem-RL-SetupRspTDD-ExtIEs RNSAP-PROTOCOL-EXTENSION ::= {
}
...
DL-DPCH-LCR-InformationList-RL-SetupRspTDD ::= ProtocolIE-Single-Container { {DL-DPCH-LCR-InformationListIEs-RL-SetupRspTDD} }

DL-DPCH-LCR-InformationListIEs-RL-SetupRspTDD RNSAP-PROTOCOL-IES ::= {
  { ID id-DL-DPCH-LCR-InformationItem-RL-SetupRspTDD      CRITICALITY ignore  TYPE DL-DPCH-LCR-InformationItem-RL-SetupRspTDD  PRESENCE mandatory
}
}

DL-DPCH-LCR-InformationItem-RL-SetupRspTDD ::= SEQUENCE {
  repetitionPeriod          RepetitionPeriod,
  repetitionLength          RepetitionLength,
  tDD-DPCHOffset           TDD-DPCHOffset,
  dL-Timeslot-LCR-Information  DL-TimeslotLCR-Information,
  tSTD-Indicator           TSTD-Indicator,
  iE-Extensions           ProtocolExtensionContainer { {DL-DPCH-LCR-InformationItem-RL-SetupRspTDD-ExtIEs} } OPTIONAL,
  ...
}

DL-DPCH-LCR-InformationItem-RL-SetupRspTDD-ExtIEs RNSAP-PROTOCOL-EXTENSION ::= {
}
...

DSCH-LCR-InformationResponse-RL-SetupRspTDD ::= ProtocolIE-Single-Container { {DSCH-LCR-InformationList-RL-SetupRspTDD} }

DSCH-LCR-InformationList-RL-SetupRspTDD RNSAP-PROTOCOL-IES ::= {
  { ID id-DSCH-LCR-InformationListIEs-RL-SetupRspTDD      CRITICALITY ignore  TYPE DSCH-LCR-InformationListIEs-RL-SetupRspTDD  PRESENCE mandatory
}
}

DSCH-LCR-InformationListIEs-RL-SetupRspTDD ::= SEQUENCE (SIZE(0..maxNoOfDSCHsLCR)) OF DSCH-LCR-InformationItem-RL-SetupRspTDD

DSCH-LCR-InformationItem-RL-SetupRspTDD ::= SEQUENCE {
  dsch-ID                DSCH-ID,
  dsch-FlowControlInformation  DSCH-FlowControlInformation,
  bindingID              BindingID  OPTIONAL,
  transportLayerAddress  TransportLayerAddress  OPTIONAL,
  transportFormatManagement  TransportFormatManagement,
  iE-Extensions          ProtocolExtensionContainer { {DSCH-LCR-InformationItem-RL-SetupRspTDD-ExtIEs} } OPTIONAL,
  ...
}

DSCH-LCR-InformationItem-RL-SetupRspTDD-ExtIEs RNSAP-PROTOCOL-EXTENSION ::= {
}
...

USCH-LCR-InformationResponse-RL-SetupRspTDD ::= ProtocolIE-Single-Container { {USCH-LCR-InformationList-RL-SetupRspTDD} }

USCH-LCR-InformationList-RL-SetupRspTDD RNSAP-PROTOCOL-IES ::= {

```

```

    { ID id-USCH-LCR-InformationListIEs-RL-SetupRspTDD          CRITICALITY ignore  TYPE USCH-LCR-InformationListIEs-RL-SetupRspTDD PRESENCE mandatory
    }
}

USCH-LCR-InformationListIEs-RL-SetupRspTDD ::= SEQUENCE (SIZE(0..maxNoOfUSCHsLCR)) OF USCH-LCR-InformationItem-RL-SetupRspTDD

USCH-LCR-InformationItem-RL-SetupRspTDD ::= SEQUENCE {
    usch-ID                USCH-ID,
    bindingID              BindingID OPTIONAL,
    transportLayerAddress  TransportLayerAddress OPTIONAL,
    transportFormatManagement TransportFormatManagement,
    iE-Extensions          ProtocolExtensionContainer { {USCH-LCR-InformationItem-RL-SetupRspTDD-ExtIEs} } OPTIONAL,
    ...
}

USCH-LCR-InformationItem-RL-SetupRspTDD-ExtIEs RNSAP-PROTOCOL-EXTENSION ::= {
    ...
}

-- *****
--
-- RADIO LINK SETUP FAILURE FDD
--
-- *****

RadioLinkSetupFailureFDD ::= SEQUENCE {
    protocolIEs                ProtocolIE-Container      {{RadioLinkSetupFailureFDD-IEs}},
    protocolExtensions          ProtocolExtensionContainer {{RadioLinkSetupFailureFDD-Extensions}}          OPTIONAL,
    ...
}

RadioLinkSetupFailureFDD-IEs RNSAP-PROTOCOL-IES ::= {
    { ID id-D-RNTI                CRITICALITY ignore  TYPE D-RNTI                PRESENCE optional } |
    { ID id-CN-PS-DomainIdentifier CRITICALITY ignore  TYPE CN-PS-DomainIdentifier PRESENCE optional } |
    { ID id-CN-CS-DomainIdentifier CRITICALITY ignore  TYPE CN-CS-DomainIdentifier PRESENCE optional } |
    { ID id-CauseLevel-RL-SetupFailureFDD CRITICALITY ignore  TYPE CauseLevel-RL-SetupFailureFDD PRESENCE mandatory } |
    { ID id-UL-SIRTarget           CRITICALITY ignore  TYPE UL-SIR                PRESENCE optional } |
    { ID id-CriticalityDiagnostics CRITICALITY ignore  TYPE CriticalityDiagnostics PRESENCE optional },
    ...
}

CauseLevel-RL-SetupFailureFDD ::= CHOICE {
    generalCause          GeneralCauseList-RL-SetupFailureFDD,
    rLspecificCause       RLspecificCauseList-RL-SetupFailureFDD,
    ...
}

GeneralCauseList-RL-SetupFailureFDD ::= SEQUENCE {
    cause                Cause,
    iE-Extensions        ProtocolExtensionContainer { { GeneralCauseItem-RL-SetupFailureFDD-ExtIEs} } OPTIONAL,
    ...
}

GeneralCauseItem-RL-SetupFailureFDD-ExtIEs RNSAP-PROTOCOL-EXTENSION ::= {

```

```

}
...
}
RLSpecificCauseList-RL-SetupFailureFDD ::= SEQUENCE {
  unsuccessful-RL-InformationRespList-RL-SetupFailureFDD      UnsuccessfulRL-InformationResponseList-RL-SetupFailureFDD,
  successful-RL-InformationRespList-RL-SetupFailureFDD        SuccessfulRL-InformationResponseList-RL-SetupFailureFDD OPTIONAL,
  IE-Extensions                                               ProtocolExtensionContainer { { RLSpecificCauseItem-RL-SetupFailureFDD-ExtIEs} } OPTIONAL,
  ...
}

RLSpecificCauseItem-RL-SetupFailureFDD-ExtIEs RNSAP-PROTOCOL-EXTENSION ::= {
  { ID id-DSCH-RNTI          CRITICALITY ignore          EXTENSION DSCH-RNTI          PRESENCE optional },
  ...
}

UnsuccessfulRL-InformationResponseList-RL-SetupFailureFDD ::= SEQUENCE (SIZE (1..maxNrOfRLs)) OF ProtocolIE-Single-Container { {UnsuccessfulRL-
InformationResponse-RL-SetupFailureFDD-IEs} }

UnsuccessfulRL-InformationResponse-RL-SetupFailureFDD-IEs RNSAP-PROTOCOL-IES ::= {
  { ID id-UnsuccessfulRL-InformationResponse-RL-SetupFailureFDD      CRITICALITY ignore  TYPE UnsuccessfulRL-InformationResponse-RL-
SetupFailureFDD      PRESENCE mandatory }
}

UnsuccessfulRL-InformationResponse-RL-SetupFailureFDD ::= SEQUENCE {
  rL-ID          RL-ID,
  cause          Cause,
  IE-Extensions ProtocolExtensionContainer { {UnsuccessfulRL-InformationResponse-RL-SetupFailureFDD-ExtIEs} } OPTIONAL,
  ...
}

UnsuccessfulRL-InformationResponse-RL-SetupFailureFDD-ExtIEs RNSAP-PROTOCOL-EXTENSION ::= {
  ...
}

SuccessfulRL-InformationResponseList-RL-SetupFailureFDD ::= SEQUENCE (SIZE (0..maxNrOfRLs-1)) OF ProtocolIE-Single-Container { {SuccessfulRL-
InformationResponse-RL-SetupFailureFDD-IEs} }

SuccessfulRL-InformationResponse-RL-SetupFailureFDD-IEs RNSAP-PROTOCOL-IES ::= {
  { ID id-SuccessfulRL-InformationResponse-RL-SetupFailureFDD      CRITICALITY ignore  TYPE SuccessfulRL-InformationResponse-RL-SetupFailureFDD
PRESENCE mandatory }
}

SuccessfulRL-InformationResponse-RL-SetupFailureFDD ::= SEQUENCE {
  rL-ID          RL-ID,
  rL-Set-ID      RL-Set-ID,
  uRA-Information URA-Information      OPTIONAL,
  sAI           SAI,
  gA-Cell       GA-Cell      OPTIONAL,
  gA-AccessPointPosition GA-AccessPointPosition      OPTIONAL,
  received-total-wide-band-power Received-total-wide-band-power,
  secondary-CCPCH-Info Secondary-CCPCH-Info      OPTIONAL,
  dl-CodeInformation FDD-DL-CodeInformation,
  diversityIndication DiversityIndication-RL-SetupFailureFDD,
  -- This IE represents both the Diversity Indication IE and the choice based on the diversity indication as described in

```

```

-- the tabular message format in subclause 9.1.
sSDT-SupportIndicator          SSdT-SupportIndicator,
maxUL-SIR                     UL-SIR,
minUL-SIR                     UL-SIR,
closedlooptimingadjustmentmode Closedlooptimingadjustmentmode OPTIONAL,
maximumAllowedULTxPower       MaximumAllowedULTxPower,
maximumDLTxPower              DL-Power,
minimumDLTxPower              DL-Power,
primaryCPICH-Power            PrimaryCPICH-Power,
primaryScramblingCode         PrimaryScramblingCode OPTIONAL,
uL-UARFCN                     UARFCN OPTIONAL,
dL-UARFCN                     UARFCN OPTIONAL,
dSCH-InformationResponse-RL-SetupFailureFDD DSCH-InformationResponseList-RL-SetupFailureFDD OPTIONAL,
neighbouring-UMTS-CellInformation Neighbouring-UMTS-CellInformation OPTIONAL,
neighbouring-GSM-CellInformation Neighbouring-GSM-CellInformation OPTIONAL,
pC-Preamble                   PC-Preamble,
sRB-Delay                     SRB-Delay,
iE-Extensions                 ProtocolExtensionContainer { {SuccessfulRL-InformationResponse-RL-SetupFailureFDD-ExtIEs} } OPTIONAL,
...
}

SuccessfulRL-InformationResponse-RL-SetupFailureFDD-ExtIEs RNSAP-PROTOCOL-EXTENSION ::= {
  { ID id-GA-CellAdditionalShapes CRITICALITY ignore EXTENSION GA-CellAdditionalShapes PRESENCE optional },
  ...
}

DiversityIndication-RL-SetupFailureFDD ::= CHOICE {
  combining Combining-RL-SetupFailureFDD,
  nonCombiningOrFirstRL NonCombiningOrFirstRL-RL-SetupFailureFDD
}

Combining-RL-SetupFailureFDD ::= SEQUENCE {
  rL-ID RL-ID,
  iE-Extensions ProtocolExtensionContainer { { CombiningItem-RL-SetupFailureFDD-ExtIEs} } OPTIONAL,
  ...
}

CombiningItem-RL-SetupFailureFDD-ExtIEs RNSAP-PROTOCOL-EXTENSION ::= {
  { ID id-DCH-InformationResponse CRITICALITY ignore EXTENSION DCH-InformationResponse PRESENCE optional },
  ...
}

NonCombiningOrFirstRL-RL-SetupFailureFDD ::= SEQUENCE {
  dCH-InformationResponse DCH-InformationResponse,
  iE-Extensions ProtocolExtensionContainer { { NonCombiningOrFirstRLItem-RL-SetupFailureFDD-ExtIEs} } OPTIONAL,
  ...
}

NonCombiningOrFirstRLItem-RL-SetupFailureFDD-ExtIEs RNSAP-PROTOCOL-EXTENSION ::= {
  ...
}

DSCH-InformationResponseList-RL-SetupFailureFDD ::= ProtocolIE-Single-Container { { DSCH-InformationResponseListIEs-RL-SetupFailureFDD } }

```

```

DSCH-InformationResponseListIEs-RL-SetupFailureFDD RNSAP-PROTOCOL-IES ::= {
  { ID id-DSCH-FDD-InformationResponse  CRITICALITY ignore  TYPE DSCH-FDD-InformationResponse  PRESENCE mandatory }
}

RadioLinkSetupFailureFDD-Extensions RNSAP-PROTOCOL-EXTENSION ::= {
  ...
}

-- *****
--
-- RADIO LINK SETUP FAILURE TDD
--
-- *****

RadioLinkSetupFailureTDD ::= SEQUENCE {
  protocolIEs                ProtocolIE-Container    {{RadioLinkSetupFailureTDD-IEs}},
  protocolExtensions          ProtocolExtensionContainer {{RadioLinkSetupFailureTDD-Extensions}}      OPTIONAL,
  ...
}

RadioLinkSetupFailureTDD-IEs RNSAP-PROTOCOL-IES ::= {
  { ID id-CauseLevel-RL-SetupFailureTDD  CRITICALITY ignore  TYPE CauseLevel-RL-SetupFailureTDD  PRESENCE mandatory }|
  { ID id-CriticalityDiagnostics         CRITICALITY ignore  TYPE CriticalityDiagnostics  PRESENCE optional },
  ...
}

CauseLevel-RL-SetupFailureTDD ::= CHOICE {
  generalCause                GeneralCauseList-RL-SetupFailureTDD,
  rLSpecificCause             RLSpecificCauseList-RL-SetupFailureTDD,
  ...
}

GeneralCauseList-RL-SetupFailureTDD ::= SEQUENCE {
  cause                        Cause,
  iE-Extensions                ProtocolExtensionContainer { { GeneralCauseItem-RL-SetupFailureTDD-ExtIEs} }      OPTIONAL,
  ...
}

GeneralCauseItem-RL-SetupFailureTDD-ExtIEs RNSAP-PROTOCOL-EXTENSION ::= {
  ...
}

RLSpecificCauseList-RL-SetupFailureTDD ::= SEQUENCE {
  unsuccessful-RL-InformationRespItem-RL-SetupFailureTDD  Unsuccessful-RL-InformationRespItem-RL-SetupFailureTDD,
  iE-Extensions          ProtocolExtensionContainer { { RLSpecificCauseItem-RL-SetupFailureTDD-ExtIEs} }
  OPTIONAL,
  ...
}

RLSpecificCauseItem-RL-SetupFailureTDD-ExtIEs RNSAP-PROTOCOL-EXTENSION ::= {
  ...
}

```

```

Unsuccessful-RL-InformationRespItem-RL-SetupFailureTDD ::= ProtocolIE-Single-Container { {Unsuccessful-RL-InformationRespItemIE-RL-SetupFailureTDD}
}

Unsuccessful-RL-InformationRespItemIE-RL-SetupFailureTDD RNSAP-PROTOCOL-IES ::= {
  { ID id-UnsuccessfulRL-InformationResponse-RL-SetupFailureTDD CRITICALITY ignore TYPE UnsuccessfulRL-InformationResponse-RL-
  SetupFailureTDD PRESENCE mandatory }
}

UnsuccessfulRL-InformationResponse-RL-SetupFailureTDD ::= SEQUENCE {
  rL-ID RL-ID,
  cause Cause,
  iE-Extensions ProtocolExtensionContainer { {UnsuccessfulRL-InformationResponse-RL-SetupFailureTDD-ExtIEs} } OPTIONAL,
  ...
}

UnsuccessfulRL-InformationResponse-RL-SetupFailureTDD-ExtIEs RNSAP-PROTOCOL-EXTENSION ::= {
  ...
}

RadioLinkSetupFailureTDD-Extensions RNSAP-PROTOCOL-EXTENSION ::= {
  ...
}

-- *****
--
-- RADIO LINK ADDITION REQUEST FDD
--
-- *****

RadioLinkAdditionRequestFDD ::= SEQUENCE {
  protocolIEs ProtocolIE-Container {{RadioLinkAdditionRequestFDD-IEs}},
  protocolExtensions ProtocolExtensionContainer {{RadioLinkAdditionRequestFDD-Extensions}} OPTIONAL,
  ...
}

RadioLinkAdditionRequestFDD-IEs RNSAP-PROTOCOL-IES ::= {
  { ID id-UL-SIRTarget CRITICALITY reject TYPE UL-SIR PRESENCE mandatory } |
  { ID id-RL-InformationList-RL-AdditionRqstFDD CRITICALITY notify TYPE RL-InformationList-RL-AdditionRqstFDD PRESENCE mandatory } |
  { ID id-Active-Pattern-Sequence-Information CRITICALITY reject TYPE Active-Pattern-Sequence-Information PRESENCE optional },
  ...
}

RL-InformationList-RL-AdditionRqstFDD ::= SEQUENCE (SIZE (1..maxNrOfRLs-1)) OF ProtocolIE-Single-Container { {RL-Information-RL-
AdditionRqstFDD-IEs} }

RL-Information-RL-AdditionRqstFDD-IEs RNSAP-PROTOCOL-IES ::= {
  { ID id-RL-Information-RL-AdditionRqstFDD CRITICALITY notify TYPE RL-Information-RL-AdditionRqstFDD PRESENCE mandatory }
}

RL-Information-RL-AdditionRqstFDD ::= SEQUENCE {
  rL-ID RL-ID,
  c-ID C-ID,
  frameOffset FrameOffset,
  chipOffset ChipOffset,

```



```

diversityControlField      DiversityControlField,
primaryCPICH-EcNo         PrimaryCPICH-EcNo      OPTIONAL,
sSDT-CellID               SSdT-CellID           OPTIONAL,
transmitDiversityIndicator TransmitDiversityIndicator OPTIONAL,
IE-Extensions             ProtocolExtensionContainer { {RL-Information-RL-AdditionRqstFDD-ExtIEs} } OPTIONAL,
...
}

RL-Information-RL-AdditionRqstFDD-ExtIEs RNSAP-PROTOCOL-EXTENSION ::= {
...
}

RadioLinkAdditionRequestFDD-Extensions RNSAP-PROTOCOL-EXTENSION ::= {
{ ID id-DPC-Mode          CRITICALITY reject      EXTENSION  DPC-Mode          PRESENCE optional }|
{ ID id-Permanent-NAS-UE-Identity          CRITICALITY ignore      EXTENSION Permanent-NAS-UE-Identity  PRESENCE optional },
...
}

-- *****
--
-- RADIO LINK ADDITION REQUEST TDD
--
-- *****

RadioLinkAdditionRequestTDD ::= SEQUENCE {
protocolIEs          ProtocolIE-Container    {{RadioLinkAdditionRequestTDD-IEs}},
protocolExtensions   ProtocolExtensionContainer {{RadioLinkAdditionRequestTDD-Extensions}}          OPTIONAL,
...
}

RadioLinkAdditionRequestTDD-IEs RNSAP-PROTOCOL-IES ::= {
{ ID id-RL-Information-RL-AdditionRqstTDD  CRITICALITY reject  TYPE RL-Information-RL-AdditionRqstTDD  PRESENCE mandatory },
...
}

RL-Information-RL-AdditionRqstTDD ::= SEQUENCE {
rL-ID                RL-ID,
c-ID                 C-ID,
frameOffset          FrameOffset,
diversityControlField DiversityControlField,
primaryCCPCH-RSCP    PrimaryCCPCH-RSCP    OPTIONAL,
dL-TimeSlot-ISCP-Info DL-TimeSlot-ISCP-Info  OPTIONAL,
--for 3.84Mcps TDD only
IE-Extensions        ProtocolExtensionContainer { {RL-Information-RL-AdditionRqstTDD-ExtIEs} } OPTIONAL,
...
}

RL-Information-RL-AdditionRqstTDD-ExtIEs RNSAP-PROTOCOL-EXTENSION ::= {
{ ID id-DL-Timeslot-ISCP-LCR-Information-RL-AdditionRqstTDD CRITICALITY reject      EXTENSION  DL-TimeSlot-ISCP-LCR-Information  PRESENCE
optional }|
--for 1.28Mcps TDD only
{ ID id-UL-Synchronisation-Parameters-LCR          CRITICALITY ignore      EXTENSION  UL-Synchronisation-Parameters-LCR  PRESENCE
optional }, -- Mandatory for 1.28Mcps TDD, Not Applicable to 3.84Mcps TDD
...
}

```

```

}

RadioLinkAdditionRequestTDD-Extensions RNSAP-PROTOCOL-EXTENSION ::= {
  { ID id-Permanent-NAS-UE-Identity          CRITICALITY ignore  EXTENSION Permanent-NAS-UE-Identity  PRESENCE optional }|
  { ID id-UL-CCTrCH-InformationList-RL-AdditionRqstTDD  CRITICALITY notify  EXTENSION UL-CCTrCH-InformationList-RL-AdditionRqstTDD  PRESENCE
optional } |
  { ID id-DL-CCTrCH-InformationList-RL-AdditionRqstTDD  CRITICALITY notify  EXTENSION DL-CCTrCH-InformationList-RL-AdditionRqstTDD  PRESENCE
optional }, ...
}

UL-CCTrCH-InformationList-RL-AdditionRqstTDD ::= SEQUENCE (SIZE (1..maxNrOfCCTrCHs)) OF ProtocolIE-Single-Container { {UL-CCTrCH-
InformationItemIEs-RL-AdditionRqstTDD} }

UL-CCTrCH-InformationItemIEs-RL-AdditionRqstTDD RNSAP-PROTOCOL-IES ::= {
  { ID id-UL-CCTrCH-InformationItem-RL-AdditionRqstTDD  CRITICALITY notify  TYPE UL-CCTrCH-InformationItem-RL-AdditionRqstTDD  PRESENCE
optional},
  ...
}

UL-CCTrCH-InformationItem-RL-AdditionRqstTDD ::= SEQUENCE {
  cCTrCH-ID          CCTrCH-ID,
  uplinkStepSizeLCR  TDD-TPC-UplinkStepSize-LCR  OPTIONAL,
  -- Applicable to 1.28Mcps TDD only
  iE-Extensions      ProtocolExtensionContainer { {UL-CCTrCH-InformationItem-RL-AdditionRqstTDD-ExtIEs} } OPTIONAL,
  ...
}

UL-CCTrCH-InformationItem-RL-AdditionRqstTDD-ExtIEs RNSAP-PROTOCOL-EXTENSION ::= {
  ...
}

DL-CCTrCH-InformationList-RL-AdditionRqstTDD ::= SEQUENCE (SIZE (1..maxNrOfCCTrCHs)) OF ProtocolIE-Single-Container { {DL-CCTrCH-
InformationItemIEs-RL-AdditionRqstTDD} }

DL-CCTrCH-InformationItemIEs-RL-AdditionRqstTDD RNSAP-PROTOCOL-IES ::= {
  { ID id-DL-CCTrCH-InformationItem-RL-AdditionRqstTDD  CRITICALITY notify  TYPE DL-CCTrCH-InformationItem-RL-AdditionRqstTDD  PRESENCE
optional},
  ...
}

DL-CCTrCH-InformationItem-RL-AdditionRqstTDD ::= SEQUENCE {
  cCTrCH-ID          CCTrCH-ID,
  downlinkStepSize  TDD-TPC-DownlinkStepSize  OPTIONAL,
  iE-Extensions      ProtocolExtensionContainer { {DL-CCTrCH-InformationItem-RL-AdditionRqstTDD-ExtIEs} } OPTIONAL,
  ...
}

DL-CCTrCH-InformationItem-RL-AdditionRqstTDD-ExtIEs RNSAP-PROTOCOL-EXTENSION ::= {
  ...
}
-- *****
--
-- RADIO LINK ADDITION RESPONSE FDD
--

```

```

-- *****
RadioLinkAdditionResponseFDD ::= SEQUENCE {
    protocolIEs                ProtocolIE-Container    {{RadioLinkAdditionResponseFDD-IEs}},
    protocolExtensions          ProtocolExtensionContainer {{RadioLinkAdditionResponseFDD-Extensions}}    OPTIONAL,
    ...
}

RadioLinkAdditionResponseFDD-IEs RNSAP-PROTOCOL-IES ::= {
    { ID id-RL-InformationResponseList-RL-AdditionRspFDD    CRITICALITY ignore    TYPE RL-InformationResponseList-RL-AdditionRspFDD    PRESENCE
    mandatory    } |
    { ID id-CriticalityDiagnostics        CRITICALITY ignore    TYPE CriticalityDiagnostics        PRESENCE optional },
    ...
}

RL-InformationResponseList-RL-AdditionRspFDD ::= SEQUENCE (SIZE (1..maxNrOfRLs-1)) OF ProtocolIE-Single-Container { {RL-
InformationResponseItemIEs-RL-AdditionRspFDD} }

RL-InformationResponseItemIEs-RL-AdditionRspFDD RNSAP-PROTOCOL-IES ::= {
    { ID id-RL-InformationResponseItem-RL-AdditionRspFDD    CRITICALITY ignore    TYPE RL-InformationResponseItem-RL-AdditionRspFDD    PRESENCE
    mandatory    }
}

RL-InformationResponseItem-RL-AdditionRspFDD ::= SEQUENCE {
    rL-ID                RL-ID,
    rL-Set-ID            RL-Set-ID,
    uRA-Information      URA-Information    OPTIONAL,
    sAI                  SAI,
    gA-Cell              GA-Cell    OPTIONAL,
    gA-AccessPointPosition    GA-AccessPointPosition    OPTIONAL,
    received-total-wide-band-power    Received-total-wide-band-power,
    secondary-CCPCH-Info    Secondary-CCPCH-Info    OPTIONAL,
    dl-CodeInformation    DL-CodeInformationList-RL-AdditionRspFDD,
    diversityIndication    DiversityIndication-RL-AdditionRspFDD,
    -- This IE represents both the Diversity Indication IE and the choice based on the diversity indication as described in
    -- the tabular message format in subclause 9.1.
    sSDT-SupportIndicator    SSdT-SupportIndicator,
    minUL-SIR            UL-SIR,
    maxUL-SIR            UL-SIR,
    closedloopTimingadjustmentmode    ClosedloopTimingadjustmentmode    OPTIONAL,
    maximumAllowedULTxPower    MaximumAllowedULTxPower,
    maximumDLTxPower      DL-Power,
    minimumDLTxPower      DL-Power,
    neighbouring-UMTS-CellInformation    Neighbouring-UMTS-CellInformation    OPTIONAL,
    neighbouring-GSM-CellInformation    Neighbouring-GSM-CellInformation    OPTIONAL,
    pC-Preamble           PC-Preamble,
    sRB-Delay             SRB-Delay,
    primaryCPICH-Power    PrimaryCPICH-Power,
    iE-Extensions         ProtocolExtensionContainer { {RL-InformationResponseItem-RL-AdditionRspFDD-ExtIEs} }    OPTIONAL,
    ...
}

RL-InformationResponseItem-RL-AdditionRspFDD-ExtIEs RNSAP-PROTOCOL-EXTENSION ::= {
    { ID id-GA-CellAdditionalShapes        CRITICALITY ignore    EXTENSION    GA-CellAdditionalShapes        PRESENCE optional },

```

```

}
...
DL-CodeInformationList-RL-AdditionRspFDD ::= ProtocolIE-Single-Container {{ DL-CodeInformationListIEs-RL-AdditionRspFDD }}

DL-CodeInformationListIEs-RL-AdditionRspFDD RNSAP-PROTOCOL-IES ::= {
  { ID id-FDD-DL-CodeInformation    CRITICALITY ignore TYPE FDD-DL-CodeInformation    PRESENCE mandatory }
}

DiversityIndication-RL-AdditionRspFDD ::= CHOICE {
  combining                Combining-RL-AdditionRspFDD,
  nonCombining             NonCombining-RL-AdditionRspFDD
}

Combining-RL-AdditionRspFDD ::= SEQUENCE {
  rL-ID                    RL-ID,
  iE-Extensions            ProtocolExtensionContainer { { CombiningItem-RL-AdditionRspFDD-ExtIEs} } OPTIONAL,
  ...
}

CombiningItem-RL-AdditionRspFDD-ExtIEs RNSAP-PROTOCOL-EXTENSION ::= {
  { ID id-DCH-InformationResponse    CRITICALITY ignore EXTENSION DCH-InformationResponse    PRESENCE optional },
  ...
}

NonCombining-RL-AdditionRspFDD ::= SEQUENCE {
  dCH-InformationResponse    DCH-InformationResponse,
  iE-Extensions              ProtocolExtensionContainer { { NonCombiningItem-RL-AdditionRspFDD-ExtIEs} } OPTIONAL,
  ...
}

NonCombiningItem-RL-AdditionRspFDD-ExtIEs RNSAP-PROTOCOL-EXTENSION ::= {
  ...
}

RadioLinkAdditionResponseFDD-Extensions RNSAP-PROTOCOL-EXTENSION ::= {
  ...
}

-- *****
--
-- RADIO LINK ADDITION RESPONSE TDD
--
-- *****

RadioLinkAdditionResponseTDD ::= SEQUENCE {
  protocolIEs                ProtocolIE-Container    {{RadioLinkAdditionResponseTDD-IEs}},
  protocolExtensions          ProtocolExtensionContainer {{RadioLinkAdditionResponseTDD-Extensions}}          OPTIONAL,
  ...
}

RadioLinkAdditionResponseTDD-IEs RNSAP-PROTOCOL-IES ::= {
  { ID id-RL-InformationResponse-RL-AdditionRspTDD    CRITICALITY ignore TYPE RL-InformationResponse-RL-AdditionRspTDD    PRESENCE optional }
}

```

```

--Mandatory for 3.84Mcps TDD only
{ ID id-CriticalityDiagnostics          CRITICALITY ignore  TYPE CriticalityDiagnostics  PRESENCE optional },
...
}

RL-InformationResponse-RL-AdditionRspTDD ::= SEQUENCE {
  rL-ID                RL-ID,
  uRA-Information      URA-Information          OPTIONAL,
  sAI                  SAI,
  gA-Cell              GA-Cell          OPTIONAL,
  gA-AccessPointPosition  GA-AccessPointPosition  OPTIONAL,
  ul-TimeSlot-ISCP-Info  UL-TimeSlot-ISCP-Info,
  minUL-SIR            UL-SIR,
  maxUL-SIR            UL-SIR,
  maximumAllowedULTxPower  MaximumAllowedULTxPower,
  maximumDLTxPower     DL-Power,
  minimumDLTxPower     DL-Power,
  pCCPCH-Power         PCCPCH-Power,
  timingAdvanceApplied TimingAdvanceApplied,
  alphaValue           AlphaValue,
  ul-PhysCH-SF-Variation  UL-PhysCH-SF-Variation,
  synchronisationConfiguration  SynchronisationConfiguration,
  secondary-CCPCH-Info-TDD  Secondary-CCPCH-Info-TDD          OPTIONAL,
  ul-CCTrCHInformation  UL-CCTrCHInformationList-RL-AdditionRspTDD  OPTIONAL,
  dl-CCTrCHInformation  DL-CCTrCHInformationList-RL-AdditionRspTDD  OPTIONAL,
  dCH-Information       DCH-Information-RL-AdditionRspTDD  OPTIONAL,
  dSCH-InformationResponse  DSCH-InformationResponse-RL-AdditionRspTDD  OPTIONAL,
  uSCH-InformationResponse  USCH-InformationResponse-RL-AdditionRspTDD  OPTIONAL,
  neighbouring-UMTS-CellInformation  Neighbouring-UMTS-CellInformation  OPTIONAL,
  neighbouring-GSM-CellInformation  Neighbouring-GSM-CellInformation  OPTIONAL,
  iE-Extensions         ProtocolExtensionContainer { {RL-InformationResponse-RL-AdditionRspTDD-ExtIEs} } OPTIONAL,
  ...
}

RL-InformationResponse-RL-AdditionRspTDD-ExtIEs RNSAP-PROTOCOL-EXTENSION ::= {
  { ID id-GA-CellAdditionalShapes          CRITICALITY ignore  EXTENSION  GA-CellAdditionalShapes  PRESENCE optional },
  ...
}

UL-CCTrCHInformationList-RL-AdditionRspTDD ::= ProtocolIE-Single-Container {{UL-CCTrCHInformationListIEs-RL-AdditionRspTDD}}

UL-CCTrCHInformationListIEs-RL-AdditionRspTDD RNSAP-PROTOCOL-IES ::= {
  { ID id-UL-CCTrCH-InformationListIE-RL-AdditionRspTDD  CRITICALITY ignore  TYPE UL-CCTrCHInformationListIE-RL-AdditionRspTDD  PRESENCE
mandatory }
}

UL-CCTrCHInformationListIE-RL-AdditionRspTDD ::= SEQUENCE (SIZE (1..maxNrOfCCTrCHs)) OF UL-CCTrCHInformationItem-RL-AdditionRspTDD

UL-CCTrCHInformationItem-RL-AdditionRspTDD ::= SEQUENCE {
  cCtRCH-ID                CCTrCH-ID,
  ul-DPCH-Information      UL-DPCH-InformationList-RL-AdditionRspTDD  OPTIONAL,
  iE-Extensions           ProtocolExtensionContainer { {UL-CCTrCHInformationItem-RL-AdditionRspTDD-ExtIEs} } OPTIONAL,
  ...
}

```

```

UL-CCTrCHInformationItem-RL-AdditionRspTDD-ExtIEs RNSAP-PROTOCOL-EXTENSION ::= {
    ...
}

UL-DPCH-InformationList-RL-AdditionRspTDD ::= ProtocolIE-Single-Container { {UL-DPCH-InformationListIEs-RL-AdditionRspTDD} }

UL-DPCH-InformationListIEs-RL-AdditionRspTDD RNSAP-PROTOCOL-IES ::= {
    { ID id-UL-DPCH-InformationItem-RL-AdditionRspTDD          CRITICALITY ignore   TYPE UL-DPCH-InformationItem-RL-AdditionRspTDD   PRESENCE mandatory
    }
}

UL-DPCH-InformationItem-RL-AdditionRspTDD ::= SEQUENCE {
    repetitionPeriod          RepetitionPeriod,
    repetitionLength          RepetitionLength,
    tDD-DPCHOffset            TDD-DPCHOffset,
    uL-Timeslot-Information    UL-Timeslot-Information,
    iE-Extensions             ProtocolExtensionContainer { {UL-DPCH-InformationItem-RL-AdditionRspTDD-ExtIEs} } OPTIONAL,
    ...
}

UL-DPCH-InformationItem-RL-AdditionRspTDD-ExtIEs RNSAP-PROTOCOL-EXTENSION ::= {
    ...
}

DL-CCTrCHInformationList-RL-AdditionRspTDD ::= ProtocolIE-Single-Container {{DL-CCTrCHInformationListIEs-RL-AdditionRspTDD}}

DL-CCTrCHInformationListIEs-RL-AdditionRspTDD RNSAP-PROTOCOL-IES ::= {
    { ID id-DL-CCTrCH-InformationListIE-RL-AdditionRspTDD    CRITICALITY ignore   TYPE DL-CCTrCHInformationListIE-RL-AdditionRspTDD   PRESENCE
    mandatory }
}

DL-CCTrCHInformationListIE-RL-AdditionRspTDD ::= SEQUENCE (SIZE (1..maxNrOfCCTrCHs)) OF DL-CCTrCHInformationItem-RL-AdditionRspTDD

DL-CCTrCHInformationItem-RL-AdditionRspTDD ::= SEQUENCE {
    cCTrCH-ID              CCTrCH-ID,
    dl-DPCH-Information    DL-DPCH-InformationList-RL-AdditionRspTDD          OPTIONAL,
    iE-Extensions          ProtocolExtensionContainer { {DL-CCTrCHInformationItem-RL-AdditionRspTDD-ExtIEs} } OPTIONAL,
    ...
}

DL-CCTrCHInformationItem-RL-AdditionRspTDD-ExtIEs RNSAP-PROTOCOL-EXTENSION ::= {
    ...
}

DL-DPCH-InformationList-RL-AdditionRspTDD ::= ProtocolIE-Single-Container { {DL-DPCH-InformationListIEs-RL-AdditionRspTDD} }

DL-DPCH-InformationListIEs-RL-AdditionRspTDD RNSAP-PROTOCOL-IES ::= {
    { ID id-DL-DPCH-InformationItem-RL-AdditionRspTDD          CRITICALITY ignore   TYPE DL-DPCH-InformationItem-RL-AdditionRspTDD   PRESENCE mandatory
    }
}

DL-DPCH-InformationItem-RL-AdditionRspTDD ::= SEQUENCE {
    repetitionPeriod          RepetitionPeriod,

```

```

    repetitionLength      RepetitionLength,
    tDD-DPCHOffset        TDD-DPCHOffset,
    dL-Timeslot-Information DL-Timeslot-Information,
    iE-Extensions         ProtocolExtensionContainer { {DL-DPCH-InformationItem-RL-AdditionRspTDD-ExtIEs} } OPTIONAL,
    ...
}

DL-DPCH-InformationItem-RL-AdditionRspTDD-ExtIEs RNSAP-PROTOCOL-EXTENSION ::= {
    ...
}

DCH-Information-RL-AdditionRspTDD ::= SEQUENCE {
    diversityIndication      DiversityIndication-RL-AdditionRspTDD,
    -- This IE represents both the Diversity Indication IE and the choice based on the diversity indication as described in
    -- the tabular message format in subclause 9.1.
    iE-Extensions           ProtocolExtensionContainer { { DCH-Information-RL-AdditionRspTDD-ExtIEs} } OPTIONAL,
    ...
}

DCH-Information-RL-AdditionRspTDD-ExtIEs RNSAP-PROTOCOL-EXTENSION ::= {
    ...
}

DiversityIndication-RL-AdditionRspTDD ::= CHOICE {
    combining      Combining-RL-AdditionRspTDD,
    nonCombining  NonCombining-RL-AdditionRspTDD
}

Combining-RL-AdditionRspTDD ::= SEQUENCE {
    rL-ID          RL-ID,
    iE-Extensions ProtocolExtensionContainer { { CombiningItem-RL-AdditionRspTDD-ExtIEs} } OPTIONAL,
    ...
}

CombiningItem-RL-AdditionRspTDD-ExtIEs RNSAP-PROTOCOL-EXTENSION ::= {
    { ID id-DCH-InformationResponse      CRITICALITY ignore EXTENSION DCH-InformationResponse      PRESENCE optional },
    ...
}

NonCombining-RL-AdditionRspTDD ::= SEQUENCE {
    dCH-InformationResponse DCH-InformationResponse,
    iE-Extensions           ProtocolExtensionContainer { { NonCombiningItem-RL-AdditionRspTDD-ExtIEs} } OPTIONAL,
    ...
}

NonCombiningItem-RL-AdditionRspTDD-ExtIEs RNSAP-PROTOCOL-EXTENSION ::= {
    ...
}

DSCH-InformationResponse-RL-AdditionRspTDD ::= ProtocolIE-Single-Container {{DSCH-InformationListIEs-RL-AdditionRspTDD}}

DSCH-InformationListIEs-RL-AdditionRspTDD RNSAP-PROTOCOL-IES ::= {
    { ID id-DSCH-InformationListIE-RL-AdditionRspTDD      CRITICALITY ignore TYPE DSCH-InformationListIE-RL-AdditionRspTDD      PRESENCE mandatory }
}

```

```

DSCH-InformationListIE-RL-AdditionRspTDD ::= SEQUENCE (SIZE(0..maxNoOfDSCHs)) OF DSCHInformationItem-RL-AdditionRspTDD

DSCHInformationItem-RL-AdditionRspTDD ::= SEQUENCE {
    dsch-ID          DSCH-ID,
    transportFormatManagement TransportFormatManagement,
    dsch-FlowControlInformation DSCH-FlowControlInformation,
    diversityIndication DiversityIndication-RL-AdditionRspTDD2 OPTIONAL,
    -- diversityIndication present, if CHOICE = nonCombining
    iE-Extensions    ProtocolExtensionContainer { {DSCHInformationItem-RL-AdditionRspTDD-ExtIEs} } OPTIONAL,
    ...
}

DSCHInformationItem-RL-AdditionRspTDD-ExtIEs RNSAP-PROTOCOL-EXTENSION ::= {
    ...
}

DiversityIndication-RL-AdditionRspTDD2 ::= SEQUENCE {
    bindingID          BindingID OPTIONAL,
    transportLayerAddress TransportLayerAddress OPTIONAL,
    iE-Extensions      ProtocolExtensionContainer { {DiversityIndication-RL-AdditionRspTDD2-ExtIEs} } OPTIONAL,
    ...
}

DiversityIndication-RL-AdditionRspTDD2-ExtIEs RNSAP-PROTOCOL-EXTENSION ::= {
    ...
}

USCH-InformationResponse-RL-AdditionRspTDD ::= ProtocolIE-Single-Container {{USCH-InformationListIEs-RL-AdditionRspTDD}}

USCH-InformationListIEs-RL-AdditionRspTDD RNSAP-PROTOCOL-IES ::= {
    { ID id-USCH-InformationListIE-RL-AdditionRspTDD CRITICALITY ignore TYPE USCH-InformationListIE-RL-AdditionRspTDD PRESENCE mandatory }
}

USCH-InformationListIE-RL-AdditionRspTDD ::= SEQUENCE (SIZE(0..maxNoOfUSCHs)) OF USCHInformationItem-RL-AdditionRspTDD

USCHInformationItem-RL-AdditionRspTDD ::= SEQUENCE {
    usch-ID          USCH-ID,
    transportFormatManagement TransportFormatManagement,
    diversityIndication DiversityIndication-RL-AdditionRspTDD2 OPTIONAL,
    -- diversityIndication present, if CHOICE = nonCombining
    iE-Extensions    ProtocolExtensionContainer { {USCHInformationItem-RL-AdditionRspTDD-ExtIEs} } OPTIONAL,
    ...
}

USCHInformationItem-RL-AdditionRspTDD-ExtIEs RNSAP-PROTOCOL-EXTENSION ::= {
    ...
}

RadioLinkAdditionResponseTDD-Extensions RNSAP-PROTOCOL-EXTENSION ::= {
    { ID id-RL-LCR-InformationResponse-RL-AdditionRspTDD CRITICALITY ignore EXTENSION RL-LCR-InformationResponse-RL-AdditionRspTDD PRESENCE optional },
    --Mandatory for 1.28Mcps TDD only
    ...
}

```



```

RL-LCR-InformationResponse-RL-AdditionRspTDD ::= SEQUENCE {
  rL-ID                RL-ID,
  uRA-Information      URA-Information,
  sAI                  SAI,
  gA-Cell              GA-Cell OPTIONAL,
  gA-AccessPointPosition  GA-AccessPointPosition OPTIONAL,
  ul-TimeSlot-ISCP-LCR-Info  UL-TimeSlot-ISCP-LCR-Info,
  maxUL-SIR            UL-SIR,
  minUL-SIR            UL-SIR,
  pCCPCH-Power        PCCPCH-Power,
  maximumAllowedULTxPower  MaximumAllowedULTxPower,
  maximumDLTxPower    DL-Power,
  minimumDLTxPower    DL-Power,
  alphaValue          AlphaValue,
  ul-PhysCH-SF-Variation  UL-PhysCH-SF-Variation,
  synchronisationConfiguration  SynchronisationConfiguration,
  secondary-LCR-CCPCH-Info-TDD  Secondary-LCR-CCPCH-Info-TDD OPTIONAL,
  ul-CCTrCH-LCR-Information  UL-CCTrCH-LCR-InformationList-RL-AdditionRspTDD OPTIONAL,
  dl-CCTrCH-LCR-Information  DL-CCTrCH-LCR-InformationList-RL-AdditionRspTDD OPTIONAL,
  dCH-InformationResponse  DCH-InformationResponseList-RL-AdditionRspTDD OPTIONAL,
  dsch-LCR-InformationResponse  DSCH-LCR-InformationResponse-RL-AdditionRspTDD OPTIONAL,
  usch-LCR-InformationResponse  USCH-LCR-InformationResponse-RL-AdditionRspTDD OPTIONAL,
  neighbouring-UMTS-CellInformation  Neighbouring-UMTS-CellInformation OPTIONAL,
  neighbouring-GSM-CellInformation  Neighbouring-GSM-CellInformation OPTIONAL,
  iE-Extensions        ProtocolExtensionContainer { { RL-LCR-InformationResponseList-RL-AdditionRspTDD-ExtIEs} }
  OPTIONAL,
  ...
}

RL-LCR-InformationResponseList-RL-AdditionRspTDD-ExtIEs RNSAP-PROTOCOL-EXTENSION ::= {
  { ID id-GA-CellAdditionalShapes      CRITICALITY ignore EXTENSION  GA-CellAdditionalShapes      PRESENCE optional }|
  { ID id-UL-TimingAdvanceCtrl-LCR     CRITICALITY ignore EXTENSION  UL-TimingAdvanceCtrl-LCR     PRESENCE optional },
  --Mandatory for 1.28Mcps TDD only
  ...
}

UL-CCTrCH-LCR-InformationList-RL-AdditionRspTDD ::= ProtocolIE-Single-Container {{UL-CCTrCH-LCR-InformationListIEs-RL-AdditionRspTDD }}

UL-CCTrCH-LCR-InformationListIEs-RL-AdditionRspTDD RNSAP-PROTOCOL-IES ::= {
  { ID id-UL-CCTrCH-LCR-InformationListIE-RL-AdditionRspTDD  CRITICALITY ignore TYPE UL-CCTrCH-LCR-InformationListIE-RL-AdditionRspTDD
  PRESENCE mandatory }
}

UL-CCTrCH-LCR-InformationListIE-RL-AdditionRspTDD ::= SEQUENCE (SIZE (1..maxNrOfCCTrCHsLCR)) OF UL-CCTrCH-LCR-InformationItem-RL-AdditionRspTDD

UL-CCTrCH-LCR-InformationItem-RL-AdditionRspTDD ::= SEQUENCE {
  cCTrCH-ID          CCTrCH-ID,
  ul-DPCH-LCR-Information  UL-DPCH-LCR-InformationList-RL-AdditionRspTDD OPTIONAL,
  iE-Extensions      ProtocolExtensionContainer { {UL-CCTrCH-LCR-InformationItem-RL-AdditionRspTDD-ExtIEs} } OPTIONAL,
  ...
}

UL-CCTrCH-LCR-InformationItem-RL-AdditionRspTDD-ExtIEs RNSAP-PROTOCOL-EXTENSION ::= {

```

```

}
...
}
UL-DPCH-LCR-InformationList-RL-AdditionRspTDD ::= ProtocolIE-Single-Container { {UL-DPCH-LCR-InformationListIEs-RL-AdditionRspTDD} }

UL-DPCH-LCR-InformationListIEs-RL-AdditionRspTDD RNSAP-PROTOCOL-IES ::= {
  { ID id-UL-DPCH-LCR-InformationItem-RL-AdditionRspTDD      CRITICALITY ignore  TYPE UL-DPCH-LCR-InformationItem-RL-AdditionRspTDD  PRESENCE
  mandatory }
}

UL-DPCH-LCR-InformationItem-RL-AdditionRspTDD ::= SEQUENCE {
  repetitionPeriod      RepetitionPeriod,
  repetitionLength      RepetitionLength,
  tDD-DPCHOffset       TDD-DPCHOffset,
  uL-TimeslotLCR-Information  UL-TimeslotLCR-Information,
  iE-Extensions        ProtocolExtensionContainer { {UL-DPCH-LCR-InformationItem-RL-AdditionRspTDD-ExtIEs} } OPTIONAL,
  ...
}

UL-DPCH-LCR-InformationItem-RL-AdditionRspTDD-ExtIEs RNSAP-PROTOCOL-EXTENSION ::= {
  ...
}

DL-CCTrCH-LCR-InformationList-RL-AdditionRspTDD ::= ProtocolIE-Single-Container { {DL-CCTrCH-LCR-InformationListIEs-RL-AdditionRspTDD} }

DL-CCTrCH-LCR-InformationListIEs-RL-AdditionRspTDD RNSAP-PROTOCOL-IES ::= {
  { ID id-DL-CCTrCH-LCR-InformationListIE-RL-AdditionRspTDD  CRITICALITY ignore  TYPE DL-CCTrCH-LCR-InformationListIE-RL-AdditionRspTDD
  PRESENCE mandatory }
}

DL-CCTrCH-LCR-InformationListIE-RL-AdditionRspTDD ::= SEQUENCE (SIZE (1..maxNrOfCCTrCHsLCR)) OF DL-CCTrCH-LCR-InformationItem-RL-AdditionRspTDD

DL-CCTrCH-LCR-InformationItem-RL-AdditionRspTDD ::= SEQUENCE {
  cCTrCH-ID            CCTrCH-ID,
  dl-DPCH-LCR-Information  DL-DPCH-LCR-InformationList-RL-AdditionRspTDD      OPTIONAL,
  iE-Extensions        ProtocolExtensionContainer { {DL-CCTrCH-LCR-InformationItem-RL-AdditionRspTDD-ExtIEs} } OPTIONAL,
  ...
}

DL-CCTrCH-LCR-InformationItem-RL-AdditionRspTDD-ExtIEs RNSAP-PROTOCOL-EXTENSION ::= {
  ...
}

DL-DPCH-LCR-InformationList-RL-AdditionRspTDD ::= ProtocolIE-Single-Container { {DL-DPCH-LCR-InformationListIEs-RL-AdditionRspTDD} }

DL-DPCH-LCR-InformationListIEs-RL-AdditionRspTDD RNSAP-PROTOCOL-IES ::= {
  { ID id-DL-DPCH-LCR-InformationItem-RL-AdditionRspTDD      CRITICALITY ignore  TYPE DL-DPCH-LCR-InformationItem-RL-AdditionRspTDD  PRESENCE
  mandatory }
}

DL-DPCH-LCR-InformationItem-RL-AdditionRspTDD ::= SEQUENCE {
  repetitionPeriod      RepetitionPeriod,
  repetitionLength      RepetitionLength,
  tDD-DPCHOffset       TDD-DPCHOffset,

```

```

    dL-TimeslotLCR-Information      DL-TimeslotLCR-Information,
    tSTD-Indicator                  TSTD-Indicator,
    iE-Extensions                   ProtocolExtensionContainer { {DL-DPCH-LCR-InformationItem-RL-AdditionRspTDD-ExtIEs} } OPTIONAL,
    ...
}

DL-DPCH-LCR-InformationItem-RL-AdditionRspTDD-ExtIEs RNSAP-PROTOCOL-EXTENSION ::= {
    ...
}

DCH-InformationResponseList-RL-AdditionRspTDD ::= ProtocolIE-Single-Container {{DCH-InformationResponseListIEs-RL-AdditionRspTDD}}

DCH-InformationResponseListIEs-RL-AdditionRspTDD RNSAP-PROTOCOL-IES ::= {
    { ID id-DCH-InformationResponse    CRITICALITY ignore    TYPE DCH-InformationResponse    PRESENCE mandatory }
}

DSCH-LCR-InformationResponse-RL-AdditionRspTDD ::= ProtocolIE-Single-Container {{DSCH-LCR-InformationList-RL-AdditionRspTDD}}

DSCH-LCR-InformationList-RL-AdditionRspTDD RNSAP-PROTOCOL-IES ::= {
    { ID id-DSCH-LCR-InformationListIEs-RL-AdditionRspTDD    CRITICALITY ignore    TYPE DSCH-LCR-InformationListIEs-RL-AdditionRspTDD    PRESENCE
    mandatory }
}

DSCH-LCR-InformationListIEs-RL-AdditionRspTDD ::= SEQUENCE (SIZE(0..maxNoOfDSCHsLCR)) OF DSCH-LCR-InformationItem-RL-AdditionRspTDD

DSCH-LCR-InformationItem-RL-AdditionRspTDD ::= SEQUENCE {
    dsch-ID                DSCH-ID,
    dsch-FlowControlInformation    DSCH-FlowControlInformation,
    bindingID              BindingID    OPTIONAL,
    transportLayerAddress    TransportLayerAddress    OPTIONAL,
    transportFormatManagement    TransportFormatManagement,
    iE-Extensions           ProtocolExtensionContainer { {DSCH-LCR-InformationItem-RL-AdditionRspTDD-ExtIEs} } OPTIONAL,
    ...
}

DSCH-LCR-InformationItem-RL-AdditionRspTDD-ExtIEs RNSAP-PROTOCOL-EXTENSION ::= {
    ...
}

USCH-LCR-InformationResponse-RL-AdditionRspTDD ::= ProtocolIE-Single-Container {{USCH-LCR-InformationList-RL-AdditionRspTDD}}

USCH-LCR-InformationList-RL-AdditionRspTDD RNSAP-PROTOCOL-IES ::= {
    { ID id-USCH-LCR-InformationListIEs-RL-AdditionRspTDD    CRITICALITY ignore    TYPE USCH-LCR-InformationListIEs-RL-AdditionRspTDD    PRESENCE
    mandatory }
}

USCH-LCR-InformationListIEs-RL-AdditionRspTDD ::= SEQUENCE (SIZE(0..maxNoOfUSCHsLCR)) OF USCH-LCR-InformationItem-RL-AdditionRspTDD

USCH-LCR-InformationItem-RL-AdditionRspTDD ::= SEQUENCE {
    usch-ID                USCH-ID,
    transportFormatManagement    TransportFormatManagement,
    diversityIndication          DiversityIndication-RL-AdditionRspTDD2    OPTIONAL,
    iE-Extensions              ProtocolExtensionContainer { {USCH-LCR-InformationItem-RL-AdditionRspTDD-ExtIEs} } OPTIONAL,
    ...
}

```

```

}
USCH-LCR-InformationItem-RL-AdditionRspTDD-ExtIEs RNSAP-PROTOCOL-EXTENSION ::= {
  ...
}
-- *****
-- RADIO LINK ADDITION FAILURE FDD
-- *****

RadioLinkAdditionFailureFDD ::= SEQUENCE {
  protocolIEs          ProtocolIE-Container    {{RadioLinkAdditionFailureFDD-IEs}},
  protocolExtensions  ProtocolExtensionContainer {{RadioLinkAdditionFailureFDD-Extensions}}      OPTIONAL,
  ...
}

RadioLinkAdditionFailureFDD-IEs RNSAP-PROTOCOL-IES ::= {
  { ID id-CauseLevel-RL-AdditionFailureFDD          CRITICALITY ignore          TYPE CauseLevel-RL-AdditionFailureFDD
    PRESENCE mandatory }|
  { ID id-CriticalityDiagnostics          CRITICALITY ignore TYPE CriticalityDiagnostics PRESENCE optional },
  ...
}

CauseLevel-RL-AdditionFailureFDD ::= CHOICE {
  generalCause          GeneralCauseList-RL-AdditionFailureFDD,
  rLspecificCause      RLspecificCauseList-RL-AdditionFailureFDD,
  ...
}

GeneralCauseList-RL-AdditionFailureFDD ::= SEQUENCE {
  cause                Cause,
  iE-Extensions        ProtocolExtensionContainer { { GeneralCauseItem-RL-AdditionFailureFDD-ExtIEs} }      OPTIONAL,
  ...
}

GeneralCauseItem-RL-AdditionFailureFDD-ExtIEs RNSAP-PROTOCOL-EXTENSION ::= {
  ...
}

RLspecificCauseList-RL-AdditionFailureFDD ::= SEQUENCE {
  unsuccessful-RL-InformationRespList-RL-AdditionFailureFDD      UnsuccessfulRL-InformationResponseList-RL-AdditionFailureFDD,
  successful-RL-InformationRespList-RL-AdditionFailureFDD        SuccessfulRL-InformationResponseList-RL-AdditionFailureFDD OPTIONAL,
  iE-Extensions          ProtocolExtensionContainer { { RLspecificCauseItem-RL-AdditionFailureFDD-ExtIEs} }      OPTIONAL,
  ...
}

RLspecificCauseItem-RL-AdditionFailureFDD-ExtIEs RNSAP-PROTOCOL-EXTENSION ::= {
  ...
}

UnsuccessfulRL-InformationResponseList-RL-AdditionFailureFDD ::= SEQUENCE (SIZE (1..maxNrOfRLs-1)) OF ProtocolIE-Single-Container {
  {UnsuccessfulRL-InformationResponse-RL-AdditionFailureFDD-IEs} }

```

```

UnsuccessfulRL-InformationResponse-RL-AdditionFailureFDD-IEs RNSAP-PROTOCOL-IES ::= {
  { ID id-UnsuccessfulRL-InformationResponse-RL-AdditionFailureFDD    CRITICALITY ignore  TYPE UnsuccessfulRL-InformationResponse-RL-
AdditionFailureFDD          PRESENCE mandatory }
}

UnsuccessfulRL-InformationResponse-RL-AdditionFailureFDD ::= SEQUENCE {
  rL-ID                RL-ID,
  cause                Cause,
  iE-Extensions       ProtocolExtensionContainer { {UnsuccessfulRL-InformationResponse-RL-AdditionFailureFDD-ExtIEs} } OPTIONAL,
  ...
}

UnsuccessfulRL-InformationResponse-RL-AdditionFailureFDD-ExtIEs RNSAP-PROTOCOL-EXTENSION ::= {
  ...
}

SuccessfulRL-InformationResponseList-RL-AdditionFailureFDD ::= SEQUENCE (SIZE (0..maxNrOfRLs-2)) OF ProtocolIE-Single-Container { {SuccessfulRL-
InformationResponse-RL-AdditionFailureFDD-IEs} }

SuccessfulRL-InformationResponse-RL-AdditionFailureFDD-IEs RNSAP-PROTOCOL-IES ::= {
  { ID id-SuccessfulRL-InformationResponse-RL-AdditionFailureFDD    CRITICALITY ignore  TYPE SuccessfulRL-InformationResponse-RL-
AdditionFailureFDD          PRESENCE mandatory }
}

SuccessfulRL-InformationResponse-RL-AdditionFailureFDD ::= SEQUENCE {
  rL-ID                RL-ID,
  rL-Set-ID            RL-Set-ID,
  uRA-Information      URA-Information    OPTIONAL,
  sAI                  SAI,
  gA-Cell              GA-Cell    OPTIONAL,
  gA-AccessPointPosition GA-AccessPointPosition    OPTIONAL,
  received-total-wide-band-power Received-total-wide-band-power,
  secondary-CCPCH-Info Secondary-CCPCH-Info    OPTIONAL,
  dl-CodeInformation   DL-CodeInformationList-RL-AdditionFailureFDD,
  diversityIndication DiversityIndication-RL-AdditionFailureFDD,
  -- This IE represents both the Diversity Indication IE and the choice based on the diversity indication as described in
  -- the tabular message format in subclause 9.1.
  sSDT-SupportIndicator SSDT-SupportIndicator,
  minUL-SIR            UL-SIR,
  maxUL-SIR            UL-SIR,
  closedlooptimingadjustmentmode Closedlooptimingadjustmentmode    OPTIONAL,
  maximumAllowedULTxPower MaximumAllowedULTxPower,
  maximumDLTxPower    DL-Power,
  minimumDLTxPower    DL-Power,
  neighbouring-UMTS-CellInformation Neighbouring-UMTS-CellInformation    OPTIONAL,
  neighbouring-GSM-CellInformation Neighbouring-GSM-CellInformation    OPTIONAL,
  primaryCPICH-Power   PrimaryCPICH-Power,
  pC-Preamble          PC-Preamble,
  sRB-Delay            SRB-Delay,
  iE-Extensions       ProtocolExtensionContainer { {SuccessfulRL-InformationResponse-RL-AdditionFailureFDD-ExtIEs} } OPTIONAL,
  ...
}

```

```

SuccessfulRL-InformationResponse-RL-AdditionFailureFDD-ExtIEs RNSAP-PROTOCOL-EXTENSION ::= {
  { ID id-GA-CellAdditionalShapes          CRITICALITY ignore  EXTENSION  GA-CellAdditionalShapes  PRESENCE optional },
  ...
}

DL-CodeInformationList-RL-AdditionFailureFDD ::= ProtocolIE-Single-Container {{ DL-CodeInformationListIEs-RL-AdditionFailureFDD }}

DL-CodeInformationListIEs-RL-AdditionFailureFDD RNSAP-PROTOCOL-IES ::= {
  { ID id-FDD-DL-CodeInformation  CRITICALITY ignore  TYPE  FDD-DL-CodeInformation  PRESENCE mandatory }
}

DiversityIndication-RL-AdditionFailureFDD ::= CHOICE {
  combining          Combining-RL-AdditionFailureFDD,
  nonCombining      NonCombining-RL-AdditionFailureFDD
}

Combining-RL-AdditionFailureFDD ::= SEQUENCE {
  rL-ID              RL-ID,
  iE-Extensions     ProtocolExtensionContainer { { CombiningItem-RL-AdditionFailureFDD-ExtIEs} } OPTIONAL,
  ...
}

CombiningItem-RL-AdditionFailureFDD-ExtIEs RNSAP-PROTOCOL-EXTENSION ::= {
  { ID id-DCH-InformationResponse          CRITICALITY ignore  EXTENSION  DCH-InformationResponse          PRESENCE optional },
  ...
}

NonCombining-RL-AdditionFailureFDD ::= SEQUENCE {
  dCH-InformationResponse  DCH-InformationResponse,
  iE-Extensions           ProtocolExtensionContainer { { NonCombiningItem-RL-AdditionFailureFDD-ExtIEs} } OPTIONAL,
  ...
}

NonCombiningItem-RL-AdditionFailureFDD-ExtIEs RNSAP-PROTOCOL-EXTENSION ::= {
  ...
}

RadioLinkAdditionFailureFDD-Extensions RNSAP-PROTOCOL-EXTENSION ::= {
  ...
}

-- *****
--
-- RADIO LINK ADDITION FAILURE TDD
--
-- *****

RadioLinkAdditionFailureTDD ::= SEQUENCE {
  protocolIEs          ProtocolIE-Container  {{RadioLinkAdditionFailureTDD-IEs}},
  protocolExtensions  ProtocolExtensionContainer {{RadioLinkAdditionFailureTDD-Extensions}}          OPTIONAL,
  ...
}

RadioLinkAdditionFailureTDD-IEs RNSAP-PROTOCOL-IES ::= {

```

```

    { ID id-CauseLevel-RL-AdditionFailureTDD    CRITICALITY ignore  TYPE CauseLevel-RL-AdditionFailureTDD  PRESENCE mandatory }|
    { ID id-CriticalityDiagnostics              CRITICALITY ignore  TYPE CriticalityDiagnostics      PRESENCE optional },
    ...
}

CauseLevel-RL-AdditionFailureTDD ::= CHOICE {
    generalCause          GeneralCauseList-RL-AdditionFailureTDD,
    rLSpecificCause      RLSpecificCauseList-RL-AdditionFailureTDD,
    ...
}

GeneralCauseList-RL-AdditionFailureTDD ::= SEQUENCE {
    cause                Cause,
    iE-Extensions        ProtocolExtensionContainer { { GeneralCauseItem-RL-AdditionFailureTDD-ExtIEs } }    OPTIONAL,
    ...
}

GeneralCauseItem-RL-AdditionFailureTDD-ExtIEs RNSAP-PROTOCOL-EXTENSION ::= {
    ...
}

RLSpecificCauseList-RL-AdditionFailureTDD ::= SEQUENCE {
    unsuccessful-RL-InformationRespItem-RL-AdditionFailureTDD  Unsuccessful-RL-InformationRespItem-RL-AdditionFailureTDD,
    iE-Extensions        ProtocolExtensionContainer { { RLSpecificCauseItem-RL-AdditionFailureTDD-ExtIEs } }    OPTIONAL,
    ...
}

RLSpecificCauseItem-RL-AdditionFailureTDD-ExtIEs RNSAP-PROTOCOL-EXTENSION ::= {
    ...
}

Unsuccessful-RL-InformationRespItem-RL-AdditionFailureTDD ::= ProtocolIE-Single-Container { {Unsuccessful-RL-InformationRespItemIE-RL-AdditionFailureTDD} }

Unsuccessful-RL-InformationRespItemIE-RL-AdditionFailureTDD RNSAP-PROTOCOL-IES ::= {
    { ID id-UnsuccessfulRL-InformationResponse-RL-AdditionFailureTDD    CRITICALITY ignore  TYPE UnsuccessfulRL-InformationResponse-RL-AdditionFailureTDD  PRESENCE mandatory}
}

UnsuccessfulRL-InformationResponse-RL-AdditionFailureTDD ::= SEQUENCE {
    rL-ID                RL-ID,
    cause                Cause,
    iE-Extensions        ProtocolExtensionContainer { {UnsuccessfulRL-InformationResponse-RL-AdditionFailureTDD-ExtIEs} }    OPTIONAL,
    ...
}

UnsuccessfulRL-InformationResponse-RL-AdditionFailureTDD-ExtIEs RNSAP-PROTOCOL-EXTENSION ::= {
    ...
}

RadioLinkAdditionFailureTDD-Extensions RNSAP-PROTOCOL-EXTENSION ::= {
    ...
}

```

```

-- *****
--
-- RADIO LINK DELETION REQUEST
--
-- *****

RadioLinkDeletionRequest ::= SEQUENCE {
    protocolIEs          ProtocolIE-Container    {{RadioLinkDeletionRequest-IEs}},
    protocolExtensions   ProtocolExtensionContainer {{RadioLinkDeletionRequest-Extensions}}      OPTIONAL,
    ...
}

RadioLinkDeletionRequest-IEs RNSAP-PROTOCOL-IES ::= {
    { ID id-RL-InformationList-RL-DeletionRqst  CRITICALITY notify  TYPE RL-InformationList-RL-DeletionRqst      PRESENCE mandatory  },
    ...
}

RL-InformationList-RL-DeletionRqst ::= SEQUENCE (SIZE (1..maxNrOfRLs)) OF ProtocolIE-Single-Container { {RL-Information-RL-DeletionRqst-IEs} }

RL-Information-RL-DeletionRqst-IEs RNSAP-PROTOCOL-IES ::= {
    { ID id-RL-Information-RL-DeletionRqst      CRITICALITY notify  TYPE RL-Information-RL-DeletionRqst      PRESENCE mandatory  }
}

RL-Information-RL-DeletionRqst ::= SEQUENCE {
    rL-ID                RL-ID,
    iE-Extensions        ProtocolExtensionContainer { {RL-Information-RL-DeletionRqst-ExtIEs} } OPTIONAL,
    ...
}

RL-Information-RL-DeletionRqst-ExtIEs RNSAP-PROTOCOL-EXTENSION ::= {
    ...
}

RadioLinkDeletionRequest-Extensions RNSAP-PROTOCOL-EXTENSION ::= {
    ...
}

-- *****
--
-- RADIO LINK DELETION RESPONSE
--
-- *****

RadioLinkDeletionResponse ::= SEQUENCE {
    protocolIEs          ProtocolIE-Container    {{RadioLinkDeletionResponse-IEs}},
    protocolExtensions   ProtocolExtensionContainer {{RadioLinkDeletionResponse-Extensions}}      OPTIONAL,
    ...
}

RadioLinkDeletionResponse-IEs RNSAP-PROTOCOL-IES ::= {
    { ID id-CriticalityDiagnostics              CRITICALITY ignore  TYPE CriticalityDiagnostics      PRESENCE optional  },
    ...
}

```



```

}

RadioLinkDeletionResponse-Extensions RNSAP-PROTOCOL-EXTENSION ::= {
  ...
}

-- *****
--
-- RADIO LINK RECONFIGURATION PREPARE FDD
--
-- *****

RadioLinkReconfigurationPrepareFDD ::= SEQUENCE {
  protocolIEs          ProtocolIE-Container    {{RadioLinkReconfigurationPrepareFDD-IEs}},
  protocolExtensions   ProtocolExtensionContainer {{RadioLinkReconfigurationPrepareFDD-Extensions}} OPTIONAL,
  ...
}

RadioLinkReconfigurationPrepareFDD-IEs RNSAP-PROTOCOL-IES ::= {
  { ID id-AllowedQueuingTime          CRITICALITY reject TYPE AllowedQueuingTime          PRESENCE optional } |
  { ID id-UL-DPCH-Information-RL-ReconfPrepFDD          CRITICALITY reject TYPE UL-DPCH-Information-RL-ReconfPrepFDD          PRESENCE optional }
  |
  { ID id-DL-DPCH-Information-RL-ReconfPrepFDD          CRITICALITY reject TYPE DL-DPCH-Information-RL-ReconfPrepFDD          PRESENCE optional }
  |
  { ID id-FDD-DCHs-to-Modify          CRITICALITY reject TYPE FDD-DCHs-to-Modify          PRESENCE optional } |
  { ID id-DCHs-to-Add-FDD             CRITICALITY reject TYPE DCH-FDD-Information          PRESENCE optional } |
  { ID id-DCH-DeleteList-RL-ReconfPrepFDD          CRITICALITY reject TYPE DCH-DeleteList-RL-ReconfPrepFDD          PRESENCE optional } |
  { ID id-DSCH-Modify-RL-ReconfPrepFDD          CRITICALITY reject TYPE DSCH-Modify-RL-ReconfPrepFDD          PRESENCE optional } |
  { ID id-DSCHs-to-Add-FDD            CRITICALITY reject TYPE DSCH-FDD-Information          PRESENCE optional } |
  { ID id-DSCH-Delete-RL-ReconfPrepFDD          CRITICALITY reject TYPE DSCH-Delete-RL-ReconfPrepFDD          PRESENCE optional } |
  { ID id-RL-InformationList-RL-ReconfPrepFDD          CRITICALITY reject TYPE RL-InformationList-RL-ReconfPrepFDD          PRESENCE optional } |
  { ID id-Transmission-Gap-Pattern-Sequence-Information          CRITICALITY reject TYPE Transmission-Gap-Pattern-Sequence-Information          PRESENCE optional },
  ...
}

UL-DPCH-Information-RL-ReconfPrepFDD ::= SEQUENCE {
  ul-ScramblingCode          UL-ScramblingCode          OPTIONAL,
  ul-SIRTarget               UL-SIR                     OPTIONAL,
  minUL-ChannelisationCodeLength          MinUL-ChannelisationCodeLength          OPTIONAL,
  maxNrOfUL-DPCHs           MaxNrOfUL-DPCHs           OPTIONAL
  -- This IE shall be present if minUL-ChannelisationCodeLength equals to 4 --,
  ul-PunctureLimit          PunctureLimit              OPTIONAL,
  tFCS                      TFCS                      OPTIONAL,
  ul-DPCCH-SlotFormat        UL-DPCCH-SlotFormat        OPTIONAL,
  diversityMode              DiversityMode              OPTIONAL,
  sSDT-CellIDLength         SSDT-CellID-Length         OPTIONAL,
  s-FieldLength              S-FieldLength              OPTIONAL,
  iE-Extensions              ProtocolExtensionContainer { {UL-DPCH-Information-RL-ReconfPrepFDD-ExtIEs} } OPTIONAL,
  ...
}

UL-DPCH-Information-RL-ReconfPrepFDD-ExtIEs RNSAP-PROTOCOL-EXTENSION ::= {
  ...
}

```

```

}
DL-DPCH-Information-RL-ReconfPrepFDD ::= SEQUENCE {
    tFCS                TFCS        OPTIONAL,
    dl-DPCH-SlotFormat  DL-DPCH-SlotFormat  OPTIONAL,
    nrOfDLchannelisationcodes  NrOfDLchannelisationcodes  OPTIONAL,
    tFCI-SignallingMode  TFCI-SignallingMode  OPTIONAL,
    tFCI-Presence        TFCI-Presence        OPTIONAL
    -- This IE shall be present if DL DPCH Slot Format IE is from 12 to 16 --,
    multiplexingPosition MultiplexingPosition  OPTIONAL,
    limitedPowerIncrease LimitedPowerIncrease  OPTIONAL,
    iE-Extensions        ProtocolExtensionContainer { {DL-DPCH-Information-RL-ReconfPrepFDD-ExtIEs} } OPTIONAL,
    ...
}
DL-DPCH-Information-RL-ReconfPrepFDD-ExtIEs RNSAP-PROTOCOL-EXTENSION ::= {
    { ID id-SplitType  CRITICALITY reject  EXTENSION  SplitType  PRESENCE conditional  }|
    -- This IE shall be present if the TFCI signalling mode is split --
    { ID id-LengthOfTFCI2  CRITICALITY reject  EXTENSION  LengthOfTFCI2  PRESENCE conditional  },
    -- This IE shall be present if the split type is logical --
    ...
}
DCH-DeleteList-RL-ReconfPrepFDD ::= SEQUENCE (SIZE (0..maxNrOfDCHs)) OF DCH-DeleteItem-RL-ReconfPrepFDD
DCH-DeleteItem-RL-ReconfPrepFDD ::= SEQUENCE {
    dCH-ID                DCH-ID,
    iE-Extensions        ProtocolExtensionContainer { {DCH-DeleteItem-RL-ReconfPrepFDD-ExtIEs} } OPTIONAL,
    ...
}
DCH-DeleteItem-RL-ReconfPrepFDD-ExtIEs RNSAP-PROTOCOL-EXTENSION ::= {
    ...
}
DSCH-Modify-RL-ReconfPrepFDD ::= SEQUENCE {
    dSCH-Information      DSCH-ModifyInfo-RL-ReconfPrepFDD  OPTIONAL,
    pdSCH-RL-ID          RL-ID  OPTIONAL,
    tFCS                TFCS  OPTIONAL,
    iE-Extensions        ProtocolExtensionContainer { {DSCH-Modify-RL-ReconfPrepFDD-ExtIEs} } OPTIONAL,
    ...
}
DSCH-Modify-RL-ReconfPrepFDD-ExtIEs RNSAP-PROTOCOL-EXTENSION ::= {
    { ID id-EnhancedDSCHPCIndicator  CRITICALITY ignore  EXTENSION  EnhancedDSCHPCIndicator  PRESENCE optional}|
    { ID id-EnhancedDSCHPC  CRITICALITY ignore  EXTENSION  EnhancedDSCHPC  PRESENCE conditional},
    -- The IE shall be present if the Enhanced DSCH PC Indicator IE is set to "Enhanced DSCH PC Active in the UE".
    ...
}
DSCH-ModifyInfo-RL-ReconfPrepFDD ::= SEQUENCE (SIZE(0..maxNoOfDSCHs)) OF DSCH-ModifyInformationItem-RL-ReconfPrepFDD
DSCH-ModifyInformationItem-RL-ReconfPrepFDD ::= SEQUENCE {
    dSCH-ID                DSCH-ID,

```

```

trChSourceStatisticsDescriptor      TrCH-SrcStatisticsDescr OPTIONAL,
transportFormatSet                  TransportFormatSet      OPTIONAL,
allocationRetentionPriority          AllocationRetentionPriority  OPTIONAL,
schedulingPriorityIndicator         SchedulingPriorityIndicator  OPTIONAL,
bLER                                BLER                    OPTIONAL,
transportBearerRequestIndicator     TransportBearerRequestIndicator,
iE-Extensions                       ProtocolExtensionContainer { {DSCH-ModifyInformationItem-RL-ReconfPrepFDD-ExtIEs} } OPTIONAL,
...
}

DSCH-ModifyInformationItem-RL-ReconfPrepFDD-ExtIEs RNSAP-PROTOCOL-EXTENSION ::= {
...
}

DSCH-Delete-RL-ReconfPrepFDD ::= SEQUENCE {
  dSCH-Information                DSCH-Info-Delete-RL-ReconfPrepFDD,
  iE-Extensions                   ProtocolExtensionContainer { {DSCH-Delete-RL-ReconfPrepFDD-ExtIEs} } OPTIONAL,
  ...
}

DSCH-Delete-RL-ReconfPrepFDD-ExtIEs RNSAP-PROTOCOL-EXTENSION ::= {
...
}

DSCH-Info-Delete-RL-ReconfPrepFDD ::= SEQUENCE (SIZE(1..maxNoOfDSCHs)) OF DSCH-DeleteInformationItem-RL-ReconfPrepFDD

DSCH-DeleteInformationItem-RL-ReconfPrepFDD ::= SEQUENCE {
  dSCH-ID                        DSCH-ID,
  iE-Extensions                  ProtocolExtensionContainer { {DSCH-DeleteInformationItem-RL-ReconfPrepFDD-ExtIEs} } OPTIONAL,
  ...
}

DSCH-DeleteInformationItem-RL-ReconfPrepFDD-ExtIEs RNSAP-PROTOCOL-EXTENSION ::= {
...
}

RL-InformationList-RL-ReconfPrepFDD ::= SEQUENCE (SIZE (0..maxNrOfRLs)) OF ProtocolIE-Single-Container { {RL-Information-RL-ReconfPrepFDD-IEs} }

RL-Information-RL-ReconfPrepFDD-IEs RNSAP-PROTOCOL-IES ::= {
  { ID id-RL-Information-RL-ReconfPrepFDD      CRITICALITY reject  TYPE RL-Information-RL-ReconfPrepFDD      PRESENCE mandatory  }
}

RL-Information-RL-ReconfPrepFDD ::= SEQUENCE {
  rL-ID                          RL-ID,
  sSDT-Indication                 SSDT-Indication      OPTIONAL,
  sSDT-CellIdentity               SSDT-CellID          OPTIONAL
  -- The IE shall be present if the sSDT-Indication is set to 'sSDT-active-in-the-UE' --,
  transmitDiversityIndicator      TransmitDiversityIndicator  OPTIONAL,
  -- This IE shall be present if Diversity Mode IE is present in UL DPCH Information IE and is not equal to 'none'
  iE-Extensions                   ProtocolExtensionContainer { {RL-Information-RL-ReconfPrepFDD-ExtIEs} } OPTIONAL,
  ...
}

```

```

RL-Information-RL-ReconfPrepFDD-ExtIEs RNSAP-PROTOCOL-EXTENSION ::= {
  { ID id-SSDT-CellIDforEDSCHPC CRITICALITY ignore EXTENSION SSDT-CellID PRESENCE conditional },
  -- This IE shall be present if Enhanced DSCH PC IE is present in either the DSCHs to Modify IE or the DSCHs to Add IE.
  ...
}

RadioLinkReconfigurationPrepareFDD-Extensions RNSAP-PROTOCOL-EXTENSION ::= {
  ...
}

-- *****
--
-- RADIO LINK RECONFIGURATION PREPARE TDD
--
-- *****

RadioLinkReconfigurationPrepareTDD ::= SEQUENCE {
  protocolIEs ProtocolIE-Container {{RadioLinkReconfigurationPrepareTDD-IEs}},
  protocolExtensions ProtocolExtensionContainer {{RadioLinkReconfigurationPrepareTDD-Extensions}} OPTIONAL,
  ...
}

RadioLinkReconfigurationPrepareTDD-IEs RNSAP-PROTOCOL-IES ::= {
  { ID id-AllowedQueuingTime CRITICALITY reject TYPE AllowedQueuingTime PRESENCE optional } |
  { ID id-UL-CCTrCH-InformationAddList-RL-ReconfPrepTDD CRITICALITY notify TYPE UL-CCTrCH-InformationAddList-RL-ReconfPrepTDD PRESENCE optional } |
  { ID id-UL-CCTrCH-InformationModifyList-RL-ReconfPrepTDD CRITICALITY notify TYPE UL-CCTrCH-InformationModifyList-RL-ReconfPrepTDD PRESENCE optional } |
  { ID id-UL-CCTrCH-InformationDeleteList-RL-ReconfPrepTDD CRITICALITY notify TYPE UL-CCTrCH-InformationDeleteList-RL-ReconfPrepTDD PRESENCE optional } |
  { ID id-DL-CCTrCH-InformationAddList-RL-ReconfPrepTDD CRITICALITY notify TYPE DL-CCTrCH-InformationAddList-RL-ReconfPrepTDD PRESENCE optional } |
  { ID id-DL-CCTrCH-InformationModifyList-RL-ReconfPrepTDD CRITICALITY notify TYPE DL-CCTrCH-InformationModifyList-RL-ReconfPrepTDD PRESENCE optional } |
  { ID id-DL-CCTrCH-InformationDeleteList-RL-ReconfPrepTDD CRITICALITY notify TYPE DL-CCTrCH-InformationDeleteList-RL-ReconfPrepTDD PRESENCE optional } |
  { ID id-TDD-DCHs-to-Modify CRITICALITY reject TYPE TDD-DCHs-to-Modify PRESENCE optional } |
  { ID id-DCHs-to-Add-TDD CRITICALITY reject TYPE DCH-TDD-Information PRESENCE optional } |
  { ID id-DCH-DeleteList-RL-ReconfPrepTDD CRITICALITY reject TYPE DCH-DeleteList-RL-ReconfPrepTDD PRESENCE optional } |
  { ID id-DSCH-ModifyList-RL-ReconfPrepTDD CRITICALITY reject TYPE DSCH-ModifyList-RL-ReconfPrepTDD PRESENCE optional } |
  { ID id-DSCHs-to-Add-TDD CRITICALITY reject TYPE DSCH-TDD-Information PRESENCE optional } |
  { ID id-DSCH-DeleteList-RL-ReconfPrepTDD CRITICALITY reject TYPE DSCH-DeleteList-RL-ReconfPrepTDD PRESENCE optional } |
  { ID id-USCH-ModifyList-RL-ReconfPrepTDD CRITICALITY reject TYPE USCH-ModifyList-RL-ReconfPrepTDD PRESENCE optional } |
  { ID id-USCHs-to-Add CRITICALITY reject TYPE USCH-Information PRESENCE optional } |
  { ID id-USCH-DeleteList-RL-ReconfPrepTDD CRITICALITY reject TYPE USCH-DeleteList-RL-ReconfPrepTDD PRESENCE optional },
  ...
}

UL-CCTrCH-InformationAddList-RL-ReconfPrepTDD ::= SEQUENCE (SIZE (0..maxNrOfCCTrCHs)) OF ProtocolIE-Single-Container { {UL-CCTrCH-AddInformation-RL-ReconfPrepTDD-IEs} }

UL-CCTrCH-AddInformation-RL-ReconfPrepTDD-IEs RNSAP-PROTOCOL-IES ::= {
  { ID id-UL-CCTrCH-AddInformation-RL-ReconfPrepTDD CRITICALITY notify TYPE UL-CCTrCH-AddInformation-RL-ReconfPrepTDD PRESENCE mandatory }
}

```

```

UL-CCTrCH-AddInformation-RL-ReconfPrepTDD ::= SEQUENCE {
    cCTrCH-ID          CCTrCH-ID,
    tFCS              TFCS,
    tFCI-Coding       TFCI-Coding,
    punctureLimit     PunctureLimit,
    iE-Extensions     ProtocolExtensionContainer { {UL-CCTrCH-AddInformation-RL-ReconfPrepTDD-ExtIEs} } OPTIONAL,
    ...
}

UL-CCTrCH-AddInformation-RL-ReconfPrepTDD-ExtIEs RNSAP-PROTOCOL-EXTENSION ::= {
    { ID id-UL-SIRTarget          CRITICALITY reject          EXTENSION          UL-SIR          PRESENCE optional}|
    -- This IE shall be mandatory for 1.28Mcps TDD, not applicable for 3.84Mcps TDD.
    { ID id-TDD-TPC-UplinkStepSize-InformationAdd-LCR-RL-ReconfPrepTDD CRITICALITY reject          EXTENSION TDD-TPC-UplinkStepSize-LCR          PRESENCE optional
    },
    -- Mandatory for 1.28Mcps TDD, not applicable to 3.84Mcps TDD
    ...
}

UL-CCTrCH-InformationModifyList-RL-ReconfPrepTDD ::= SEQUENCE (SIZE (0..maxNrOfCCTrCHs)) OF ProtocolIE-Single-Container { {UL-CCTrCH-ModifyInformation-RL-ReconfPrepTDD-IEs} }

UL-CCTrCH-ModifyInformation-RL-ReconfPrepTDD-IEs RNSAP-PROTOCOL-IES ::= {
    { ID id-UL-CCTrCH-ModifyInformation-RL-ReconfPrepTDD          CRITICALITY notify          TYPE UL-CCTrCH-ModifyInformation-RL-ReconfPrepTDD          PRESENCE
    mandatory          }
}

UL-CCTrCH-ModifyInformation-RL-ReconfPrepTDD ::= SEQUENCE {
    cCTrCH-ID          CCTrCH-ID,
    tFCS              TFCS          OPTIONAL,
    tFCI-Coding       TFCI-Coding          OPTIONAL,
    punctureLimit     PunctureLimit          OPTIONAL,
    iE-Extensions     ProtocolExtensionContainer { {UL-CCTrCH-ModifyInformation-RL-ReconfPrepTDD-ExtIEs} } OPTIONAL,
    ...
}

UL-CCTrCH-ModifyInformation-RL-ReconfPrepTDD-ExtIEs RNSAP-PROTOCOL-EXTENSION ::= {
    { ID id-UL-SIRTarget          CRITICALITY reject          EXTENSION          UL-SIR          PRESENCE optional}|
    -- This IE shall be applicable for 1.28Mcps TDD only.
    { ID id-TDD-TPC-UplinkStepSize-InformationModify-LCR-RL-ReconfPrepTDD          CRITICALITY reject          EXTENSION          TDD-TPC-UplinkStepSize-LCR          PRESENCE
    optional },
    -- Applicable to 1.28Mcps TDD only
    ...
}

UL-CCTrCH-InformationDeleteList-RL-ReconfPrepTDD ::= SEQUENCE (SIZE (0..maxNrOfCCTrCHs)) OF ProtocolIE-Single-Container { {UL-CCTrCH-DeleteInformation-RL-ReconfPrepTDD-IEs} }

UL-CCTrCH-DeleteInformation-RL-ReconfPrepTDD-IEs RNSAP-PROTOCOL-IES ::= {
    { ID id-UL-CCTrCH-DeleteInformation-RL-ReconfPrepTDD          CRITICALITY notify          TYPE UL-CCTrCH-DeleteInformation-RL-ReconfPrepTDD          PRESENCE
    mandatory          }
}

UL-CCTrCH-DeleteInformation-RL-ReconfPrepTDD ::= SEQUENCE {

```

```

    cCtRCH-ID                CcTtRCH-ID,
    iE-Extensions            ProtocolExtensionContainer { {UL-CcTtRCH-DeleteInformation-RL-ReconfPrepTDD-ExtIEs} } OPTIONAL,
    ...
}

UL-CcTtRCH-DeleteInformation-RL-ReconfPrepTDD-ExtIEs RNSAP-PROTOCOL-EXTENSION ::= {
    ...
}

DL-CcTtRCH-InformationAddList-RL-ReconfPrepTDD ::= SEQUENCE (SIZE (0..maxNrOfCcTtRCHs)) OF ProtocolIE-Single-Container { {DL-CcTtRCH-
AddInformation-RL-ReconfPrepTDD-IEs} }

DL-CcTtRCH-AddInformation-RL-ReconfPrepTDD-IEs RNSAP-PROTOCOL-IES ::= {
    { ID id-DL-CcTtRCH-InformationAddItem-RL-ReconfPrepTDD    CRITICALITY notify    TYPE DL-CcTtRCH-InformationAddItem-RL-ReconfPrepTDD PRESENCE
mandatory    }
}

DL-CcTtRCH-InformationAddItem-RL-ReconfPrepTDD ::= SEQUENCE {
    cCtRCH-ID                CcTtRCH-ID,
    tFCS                      TFCS,
    tFCI-Coding              TFCI-Coding,
    punctureLimit            PunctureLimit,
    cCtRCH-TPCList           CcTtRCH-TPCAddList-RL-ReconfPrepTDD OPTIONAL,
    iE-Extensions            ProtocolExtensionContainer { {DL-CcTtRCH-InformationAddItem-RL-ReconfPrepTDD-ExtIEs} } OPTIONAL,
    ...
}

DL-CcTtRCH-InformationAddItem-RL-ReconfPrepTDD-ExtIEs RNSAP-PROTOCOL-EXTENSION ::= {
    { ID id-TDD-TPC-DownlinkStepSize-InformationAdd-RL-ReconfPrepTDD    CRITICALITY reject    EXTENSION    TDD-TPC-DownlinkStepSize    PRESENCE optional
}, ...
}

CcTtRCH-TPCAddList-RL-ReconfPrepTDD ::= SEQUENCE (SIZE (1..maxNrOfCcTtRCHs)) OF CcTtRCH-TPCAddItem-RL-ReconfPrepTDD

CcTtRCH-TPCAddItem-RL-ReconfPrepTDD ::= SEQUENCE {
    cCtRCH-ID                CcTtRCH-ID,
    iE-Extensions            ProtocolExtensionContainer { { CcTtRCH-TPCAddItem-RL-ReconfPrepTDD-ExtIEs} } OPTIONAL,
    ...
}

CcTtRCH-TPCAddItem-RL-ReconfPrepTDD-ExtIEs RNSAP-PROTOCOL-EXTENSION ::= {
    ...
}

DL-CcTtRCH-InformationModifyList-RL-ReconfPrepTDD ::= SEQUENCE (SIZE (0..maxNrOfCcTtRCHs)) OF ProtocolIE-Single-Container { {DL-CcTtRCH-
ModifyInformation-RL-ReconfPrepTDD-IEs} }

DL-CcTtRCH-ModifyInformation-RL-ReconfPrepTDD-IEs RNSAP-PROTOCOL-IES ::= {
    { ID id-DL-CcTtRCH-InformationModifyItem-RL-ReconfPrepTDD    CRITICALITY notify    TYPE DL-CcTtRCH-InformationModifyItem-RL-ReconfPrepTDD    PRESENCE
mandatory    }
}

DL-CcTtRCH-InformationModifyItem-RL-ReconfPrepTDD ::= SEQUENCE {
    cCtRCH-ID                CcTtRCH-ID,

```

```

tFCS                TFCS                OPTIONAL,
tFCI-Coding          TFCI-Coding         OPTIONAL,
punctureLimit        PunctureLimit      OPTIONAL,
cCtRCH-TPCList       CCTrCH-TPCModifyList-RL-ReconfPrepTDD  OPTIONAL,
iE-Extensions        ProtocolExtensionContainer { {DL-CCTrCH-InformationModifyItem-RL-ReconfPrepTDD-ExtIEs} } OPTIONAL,
...
}

DL-CCTrCH-InformationModifyItem-RL-ReconfPrepTDD-ExtIEs RNSAP-PROTOCOL-EXTENSION ::= {
  { ID id-TDD-TPC-DownlinkStepSize-InformationModify-RL-ReconfPrepTDD  CRITICALITY reject      EXTENSION  TDD-TPC-DownlinkStepSize  PRESENCE
  optional}, ...
}

CCTrCH-TPCModifyList-RL-ReconfPrepTDD ::= SEQUENCE (SIZE (1..maxNrOfCCTrCHs)) OF CCTrCH-TPCModifyItem-RL-ReconfPrepTDD

CCTrCH-TPCModifyItem-RL-ReconfPrepTDD ::= SEQUENCE {
  cCtRCH-ID          CCTrCH-ID,
  iE-Extensions      ProtocolExtensionContainer { { CCTrCH-TPCModifyItem-RL-ReconfPrepTDD-ExtIEs} } OPTIONAL,
  ...
}

CCTrCH-TPCModifyItem-RL-ReconfPrepTDD-ExtIEs RNSAP-PROTOCOL-EXTENSION ::= {
  ...
}

DL-CCTrCH-InformationDeleteList-RL-ReconfPrepTDD ::= SEQUENCE (SIZE (0..maxNrOfCCTrCHs)) OF ProtocolIE-Single-Container { {DL-CCTrCH-
DeleteInformation-RL-ReconfPrepTDD-IEs} }

DL-CCTrCH-DeleteInformation-RL-ReconfPrepTDD-IEs RNSAP-PROTOCOL-IES ::= {
  { ID id-DL-CCTrCH-InformationDeleteItem-RL-ReconfPrepTDD  CRITICALITY notify  TYPE DL-CCTrCH-InformationDeleteItem-RL-ReconfPrepTDD  PRESENCE
  mandatory }
}

DL-CCTrCH-InformationDeleteItem-RL-ReconfPrepTDD ::= SEQUENCE {
  cCtRCH-ID          CCTrCH-ID,
  iE-Extensions      ProtocolExtensionContainer { {DL-CCTrCH-InformationDeleteItem-RL-ReconfPrepTDD-ExtIEs} } OPTIONAL,
  ...
}

DL-CCTrCH-InformationDeleteItem-RL-ReconfPrepTDD-ExtIEs RNSAP-PROTOCOL-EXTENSION ::= {
  ...
}

DCH-DeleteList-RL-ReconfPrepTDD ::= SEQUENCE (SIZE (0..maxNrOfDCHs)) OF DCH-DeleteItem-RL-ReconfPrepTDD

DCH-DeleteItem-RL-ReconfPrepTDD ::= SEQUENCE {
  dCH-ID            DCH-ID,
  iE-Extensions      ProtocolExtensionContainer { {DCH-DeleteItem-RL-ReconfPrepTDD-ExtIEs} } OPTIONAL,
  ...
}

DCH-DeleteItem-RL-ReconfPrepTDD-ExtIEs RNSAP-PROTOCOL-EXTENSION ::= {
  ...
}

```

```

DSCH-ModifyList-RL-ReconfPrepTDD ::= SEQUENCE (SIZE(0..maxNoOfDSCHs)) OF DSCH-ModifyItem-RL-ReconfPrepTDD

DSCH-ModifyItem-RL-ReconfPrepTDD ::= SEQUENCE {
    dSCH-ID                DSCH-ID,
    dl-ccTrCHID            CTrCH-ID                               OPTIONAL,
    trChSourceStatisticsDescriptor TrCH-SrcStatisticsDescr OPTIONAL,
    transportFormatSet     TransportFormatSet                   OPTIONAL,
    allocationRetentionPriority AllocationRetentionPriority       OPTIONAL,
    schedulingPriorityIndicator SchedulingPriorityIndicator       OPTIONAL,
    bLER                   BLER                                 OPTIONAL,
    transportBearerRequestIndicator TransportBearerRequestIndicator,
    iE-Extensions          ProtocolExtensionContainer { {DSCH-ModifyItem-RL-ReconfPrepTDD-ExtIEs} } OPTIONAL,
    ...
}

DSCH-ModifyItem-RL-ReconfPrepTDD-ExtIEs RNSAP-PROTOCOL-EXTENSION ::= {
    ...
}

DSCH-DeleteList-RL-ReconfPrepTDD ::= SEQUENCE (SIZE(0..maxNoOfDSCHs)) OF DSCH-DeleteItem-RL-ReconfPrepTDD

DSCH-DeleteItem-RL-ReconfPrepTDD ::= SEQUENCE {
    dSCH-ID                DSCH-ID,
    iE-Extensions          ProtocolExtensionContainer { {DSCH-DeleteItem-RL-ReconfPrepTDD-ExtIEs} } OPTIONAL,
    ...
}

DSCH-DeleteItem-RL-ReconfPrepTDD-ExtIEs RNSAP-PROTOCOL-EXTENSION ::= {
    ...
}

USCH-ModifyList-RL-ReconfPrepTDD ::= SEQUENCE (SIZE(0..maxNoOfUSCHs)) OF USCH-ModifyItem-RL-ReconfPrepTDD

USCH-ModifyItem-RL-ReconfPrepTDD ::= SEQUENCE {
    uSCH-ID                USCH-ID,
    ul-ccTrCHID            CTrCH-ID                               OPTIONAL,
    trChSourceStatisticsDescriptor TrCH-SrcStatisticsDescr OPTIONAL,
    transportFormatSet     TransportFormatSet                   OPTIONAL,
    allocationRetentionPriority AllocationRetentionPriority       OPTIONAL,
    schedulingPriorityIndicator SchedulingPriorityIndicator       OPTIONAL,
    bLER                   BLER                                 OPTIONAL,
    transportBearerRequestIndicator TransportBearerRequestIndicator,
    rb-Info                RB-Info                               OPTIONAL,
    iE-Extensions          ProtocolExtensionContainer { {USCH-ModifyItem-RL-ReconfPrepTDD-ExtIEs} } OPTIONAL,
    ...
}

USCH-ModifyItem-RL-ReconfPrepTDD-ExtIEs RNSAP-PROTOCOL-EXTENSION ::= {
    ...
}

USCH-DeleteList-RL-ReconfPrepTDD ::= SEQUENCE (SIZE(0..maxNoOfUSCHs)) OF USCH-DeleteItem-RL-ReconfPrepTDD

```



```

USCH-DeleteItem-RL-ReconfPrepTDD ::= SEQUENCE {
    uSCH-ID                USCH-ID,
    iE-Extensions          ProtocolExtensionContainer { {USCH-DeleteItem-RL-ReconfPrepTDD-ExtIEs} } OPTIONAL,
    ...
}

USCH-DeleteItem-RL-ReconfPrepTDD-ExtIEs RNSAP-PROTOCOL-EXTENSION ::= {
    ...
}

RadioLinkReconfigurationPrepareTDD-Extensions RNSAP-PROTOCOL-EXTENSION ::= {
    { ID id-PrimaryCCPCH-RSCP-RL-ReconfPrepTDD CRITICALITY ignore EXTENSION PrimaryCCPCH-RSCP PRESENCE optional }|
    { ID id-DL-TimeSlot-ISCP-Info-RL-ReconfPrepTDD CRITICALITY ignore EXTENSION DL-TimeSlot-ISCP-Info PRESENCE optional }|
    { ID id-DL-Timeslot-ISCP-LCR-Information-RL-ReconfPrepTDD CRITICALITY ignore EXTENSION DL-TimeSlot-ISCP-LCR-Information PRESENCE
optional }|
    { ID id-PDSCH-RL-ID CRITICALITY ignore EXTENSION RL-ID PRESENCE optional }|
    { ID id-UL-Synchronisation-Parameters-LCR CRITICALITY ignore EXTENSION UL-Synchronisation-Parameters-LCR PRESENCE
optional }, -- Mandatory for 1.28Mcps TDD, Not Applicable to 3.84Mcps TDD
    ...
}

-- *****
--
-- RADIO LINK RECONFIGURATION READY FDD
--
-- *****

RadioLinkReconfigurationReadyFDD ::= SEQUENCE {
    protocolIEs          ProtocolIE-Container {{RadioLinkReconfigurationReadyFDD-IEs}},
    protocolExtensions  ProtocolExtensionContainer {{RadioLinkReconfigurationReadyFDD-Extensions}}
    ...
}

RadioLinkReconfigurationReadyFDD-IEs RNSAP-PROTOCOL-IES ::= {
    { ID id-RL-InformationResponseList-RL-ReconfReadyFDD CRITICALITY ignore TYPE RL-InformationResponseList-RL-ReconfReadyFDD PRESENCE
optional }|
    { ID id-CriticalityDiagnostics CRITICALITY ignore TYPE CriticalityDiagnostics PRESENCE optional },
    ...
}

RL-InformationResponseList-RL-ReconfReadyFDD ::= SEQUENCE (SIZE (0..maxNrOfRLs)) OF ProtocolIE-Single-Container { {RL-InformationResponse-
RL-ReconfReadyFDD-IEs} }

RL-InformationResponse-RL-ReconfReadyFDD-IEs RNSAP-PROTOCOL-IES ::= {
    { ID id-RL-InformationResponseItem-RL-ReconfReadyFDD CRITICALITY ignore TYPE RL-InformationResponseItem-RL-ReconfReadyFDD PRESENCE
mandatory }
}

RL-InformationResponseItem-RL-ReconfReadyFDD ::= SEQUENCE {
    rL-ID                RL-ID,
    max-UL-SIR           UL-SIR          OPTIONAL,
    min-UL-SIR           UL-SIR          OPTIONAL,
    maximumDLTxPower    DL-Power        OPTIONAL,
    minimumDLTxPower    DL-Power        OPTIONAL,
}

```

```

secondary-CCPCH-Info          Secondary-CCPCH-Info          OPTIONAL,
dl-CodeInformationList        DL-CodeInformationList-RL-ReconfReadyFDD  OPTIONAL,
dCHInformationResponse        DCH-InformationResponseList-RL-ReconfReadyFDD  OPTIONAL,
dSCHsToBeAddedOrModified     DSCHsToBeAddedOrModified-RL-ReconfReadyFDD    OPTIONAL,
IE-Extensions                 ProtocolExtensionContainer { {RL-InformationResponseItem-RL-ReconfReadyFDD-ExtIEs} } OPTIONAL,
...
}

RL-InformationResponseItem-RL-ReconfReadyFDD-ExtIEs RNSAP-PROTOCOL-EXTENSION ::= {
...
}

DL-CodeInformationList-RL-ReconfReadyFDD ::= ProtocolIE-Single-Container {{ DL-CodeInformationListIEs-RL-ReconfReadyFDD }}

DL-CodeInformationListIEs-RL-ReconfReadyFDD RNSAP-PROTOCOL-IES ::= {
  { ID id-FDD-DL-CodeInformation  CRITICALITY ignore TYPE FDD-DL-CodeInformation  PRESENCE mandatory }
}

DCH-InformationResponseList-RL-ReconfReadyFDD ::= ProtocolIE-Single-Container { {DCH-InformationResponseListIEs-RL-ReconfReadyFDD} }

DCH-InformationResponseListIEs-RL-ReconfReadyFDD RNSAP-PROTOCOL-IES ::= {
  { ID id-DCH-InformationResponse  CRITICALITY ignore TYPE DCH-InformationResponse  PRESENCE mandatory }
}

DSCHsToBeAddedOrModified-RL-ReconfReadyFDD ::= ProtocolIE-Single-Container { {DSCHsToBeAddedOrModifiedIEs-RL-ReconfReadyFDD} }

DSCHsToBeAddedOrModifiedIEs-RL-ReconfReadyFDD RNSAP-PROTOCOL-IES ::= {
  { ID id-DSCHsToBeAddedOrModified-FDD  CRITICALITY ignore TYPE DSCH-FDD-InformationResponse  PRESENCE mandatory }
}

RadioLinkReconfigurationReadyFDD-Extensions RNSAP-PROTOCOL-EXTENSION ::= {
  { ID id-DSCH-RNTI  CRITICALITY ignore  EXTENSION DSCH-RNTI  PRESENCE optional },
  ...
}

-- *****
--
-- RADIO LINK RECONFIGURATION READY TDD
--
-- *****

RadioLinkReconfigurationReadyTDD ::= SEQUENCE {
  protocolIEs          ProtocolIE-Container  {{RadioLinkReconfigurationReadyTDD-IEs}},
  protocolExtensions   ProtocolExtensionContainer {{RadioLinkReconfigurationReadyTDD-Extensions}}
  ...
}

RadioLinkReconfigurationReadyTDD-IEs RNSAP-PROTOCOL-IES ::= {
  { ID id-RL-InformationResponse-RL-ReconfReadyTDD
    CRITICALITY ignore TYPE RL-InformationResponse-RL-ReconfReadyTDD  PRESENCE optional } |
  { ID id-CriticalityDiagnostics
    CRITICALITY ignore TYPE CriticalityDiagnostics  PRESENCE optional },
  ...
}

```

```

RL-InformationResponse-RL-ReconfReadyTDD ::= SEQUENCE {
    rL-ID                RL-ID,
    max-UL-SIR           UL-SIR           OPTIONAL,
    min-UL-SIR           UL-SIR           OPTIONAL,
    maximumDLTxPower     DL-Power       OPTIONAL,
    minimumDLTxPower     DL-Power       OPTIONAL,
    secondary-CCPCH-Info-TDD Secondary-CCPCH-Info-TDD OPTIONAL,
    ul-CCTrCH-Information UL-CCTrCH-InformationList-RL-ReconfReadyTDD OPTIONAL,
    dl-CCTrCH-Information DL-CCTrCH-InformationList-RL-ReconfReadyTDD OPTIONAL,
    dCHInformationResponse DCH-InformationResponseList-RL-ReconfReadyTDD OPTIONAL,
    dSCHsToBeAddedOrModified DSCHToBeAddedOrModified-RL-ReconfReadyTDD OPTIONAL,
    uSCHsToBeAddedOrModified USCHToBeAddedOrModified-RL-ReconfReadyTDD OPTIONAL,
    iE-Extensions        ProtocolExtensionContainer { {RL-InformationResponse-RL-ReconfReadyTDD-ExtIEs} } OPTIONAL,
    ...
}

RL-InformationResponse-RL-ReconfReadyTDD-ExtIEs RNSAP-PROTOCOL-EXTENSION ::= {
    { ID id-UL-TimingAdvanceCtrl-LCR          CRITICALITY ignore EXTENSION UL-TimingAdvanceCtrl-LCR          PRESENCE optional },
    --For 1.28Mcps TDD only
    ...
}

UL-CCTrCH-InformationList-RL-ReconfReadyTDD ::= ProtocolIE-Single-Container { {UL-CCTrCHInformationListIEs-RL-ReconfReadyTDD} }

UL-CCTrCHInformationListIEs-RL-ReconfReadyTDD RNSAP-PROTOCOL-IES ::= {
    { ID id-UL-CCTrCH-InformationListIE-RL-ReconfReadyTDD CRITICALITY ignore TYPE UL-CCTrCHInformationListIE-RL-ReconfReadyTDD PRESENCE
    mandatory }
}

UL-CCTrCHInformationListIE-RL-ReconfReadyTDD ::= SEQUENCE (SIZE (0..maxNrOfCCTrCHs)) OF UL-CCTrCH-InformationItem-RL-ReconfReadyTDD

UL-CCTrCH-InformationItem-RL-ReconfReadyTDD ::= SEQUENCE {
    cCtRch-ID            CCTrCH-ID,
    ul-DPCH-AddInformation UL-DPCH-InformationAddList-RL-ReconfReadyTDD          OPTIONAL,
    --For 3.84Mcps TDD only
    ul-DPCH-ModifyInformation UL-DPCH-InformationModifyList-RL-ReconfReadyTDD          OPTIONAL,
    --For 3.84Mcps TDD only
    ul-DPCH-DeleteInformation UL-DPCH-InformationDeleteList-RL-ReconfReadyTDD          OPTIONAL,
    iE-Extensions        ProtocolExtensionContainer { {UL-CCTrCH-InformationItem-RL-ReconfReadyTDD-ExtIEs} } OPTIONAL,
    ...
}

UL-CCTrCH-InformationItem-RL-ReconfReadyTDD-ExtIEs RNSAP-PROTOCOL-EXTENSION ::= {
    { ID id-UL-DPCH-LCR-InformationAddListIE-RL-ReconfReadyTDD CRITICALITY ignore EXTENSION UL-DPCH-LCR-InformationAddList-RL-
    ReconfReadyTDD PRESENCE optional },
    --For 1.28Mcps TDD only
    ...
}

UL-DPCH-LCR-InformationAddList-RL-ReconfReadyTDD ::= SEQUENCE {
    repetitionPeriod      RepetitionPeriod,
    repetitionLength      RepetitionLength,
    tDD-DPCHOffset        TDD-DPCHOffset,
    uL-TimeslotLCR-Info    UL-TimeslotLCR-Information,
}

```

```

    iE-Extensions          ProtocolExtensionContainer { {UL-DPCH-LCR-InformationAddItem-RL-ReconfReadyTDD-ExtIEs} } OPTIONAL,
    ...
}

UL-DPCH-LCR-InformationAddItem-RL-ReconfReadyTDD-ExtIEs RNSAP-PROTOCOL-EXTENSION ::= {
    ...
}

UL-DPCH-InformationAddList-RL-ReconfReadyTDD ::= ProtocolIE-Single-Container {{UL-DPCH-InformationAddListIEs-RL-ReconfReadyTDD}}

UL-DPCH-InformationAddListIEs-RL-ReconfReadyTDD RNSAP-PROTOCOL-IES ::= {
    { ID id-UL-DPCH-InformationAddListIE-RL-ReconfReadyTDD    CRITICALITY ignore TYPE UL-DPCH-InformationAddListIE-RL-ReconfReadyTDD    PRESENCE
optional }
}

UL-DPCH-InformationAddListIE-RL-ReconfReadyTDD ::= SEQUENCE {
    repetitionPeriod          RepetitionPeriod,
    repetitionLength          RepetitionLength,
    tDD-DPCHOffset            TDD-DPCHOffset,
    rxTimingDeviationForTA    RxTimingDeviationForTA          OPTIONAL,
    uL-Timeslot-Information    UL-Timeslot-Information,
    iE-Extensions             ProtocolExtensionContainer { {UL-DPCH-InformationAddItem-RL-ReconfReadyTDD-ExtIEs} } OPTIONAL,
    ...
}

UL-DPCH-InformationAddItem-RL-ReconfReadyTDD-ExtIEs RNSAP-PROTOCOL-EXTENSION ::= {
    ...
}

UL-DPCH-InformationModifyList-RL-ReconfReadyTDD ::= ProtocolIE-Single-Container {{UL-DPCH-InformationModifyListIEs-RL-ReconfReadyTDD}}

UL-DPCH-InformationModifyListIEs-RL-ReconfReadyTDD RNSAP-PROTOCOL-IES ::= {
    { ID id-UL-DPCH-InformationModifyListIE-RL-ReconfReadyTDD    CRITICALITY ignore TYPE UL-DPCH-InformationModifyListIE-RL-ReconfReadyTDD
PRESENCE mandatory }
}

UL-DPCH-InformationModifyListIE-RL-ReconfReadyTDD ::= SEQUENCE {
    repetitionPeriod          RepetitionPeriod          OPTIONAL,
    repetitionLength          RepetitionLength          OPTIONAL,
    tDD-DPCHOffset            TDD-DPCHOffset            OPTIONAL,
    uL-Timeslot-InformationModifyList-RL-ReconfReadyTDD    UL-Timeslot-InformationModifyList-RL-ReconfReadyTDD    OPTIONAL,
    --For 3.84Mcps TDD only
    iE-Extensions             ProtocolExtensionContainer { {UL-DPCH-InformationModifyItem-RL-ReconfReadyTDD-ExtIEs} } OPTIONAL,
    ...
}

UL-DPCH-InformationModifyItem-RL-ReconfReadyTDD-ExtIEs RNSAP-PROTOCOL-EXTENSION ::= {
    { ID id-UL-Timeslot-LCR-InformationModifyList-RL-ReconfReadyTDD    CRITICALITY ignore EXTENSION UL-TimeslotLCR-InformationModifyList-RL-
ReconfReadyTDD    PRESENCE optional },
    --For 1.28Mcps TDD only
    ...
}

```

UL-TimeslotLCR-InformationModifyList-RL-ReconfReadyTDD ::= SEQUENCE (SIZE (1..maxNrOfTsLCR)) OF UL-TimeslotLCR-InformationModifyItem-RL-ReconfReadyTDD

```

UL-TimeslotLCR-InformationModifyItem-RL-ReconfReadyTDD ::= SEQUENCE {
    timeSlotLCR                TimeSlotLCR,
    midambleShiftLCR           MidambleShiftLCR           OPTIONAL,
    tFCI-Presence               TFCI-Presence             OPTIONAL,
    tDD-uL-Code-LCR-Information TDD-UL-Code-LCR-InformationModifyList-RL-ReconfReadyTDD OPTIONAL,
    iE-Extensions               ProtocolExtensionContainer { {UL-TimeslotLCR-InformationModifyItem-RL-ReconfReadyTDD-ExtIEs} } OPTIONAL,
    ...
}

```

TDD-UL-Code-LCR-InformationModifyList-RL-ReconfReadyTDD ::= SEQUENCE (SIZE (1..maxNrOfDPCHsLCR)) OF TDD-UL-Code-LCR-InformationModifyItem-RL-ReconfReadyTDD

```

TDD-UL-Code-LCR-InformationModifyItem-RL-ReconfReadyTDD ::= SEQUENCE {
    dPCH-ID                    DPCH-ID,
    tDD-ChannelisationCodeLCR  TDD-ChannelisationCodeLCR   OPTIONAL,
    iE-Extensions               ProtocolExtensionContainer { {TDD-UL-Code-LCR-InformationModifyItem-RL-ReconfReadyTDD-ExtIEs} } OPTIONAL,
    ...
}

```

```

TDD-UL-Code-LCR-InformationModifyItem-RL-ReconfReadyTDD-ExtIEs RNSAP-PROTOCOL-EXTENSION ::= {
    { ID id-TDD-UL-DPCH-TimeSlotFormatModifyItem-LCR-RL-ReconfReadyTDD CRITICALITY reject EXTENSION TDD-UL-DPCH-TimeSlotFormat-LCR
    PRESENCE optional},
    ...
}

```

```

UL-TimeslotLCR-InformationModifyItem-RL-ReconfReadyTDD-ExtIEs RNSAP-PROTOCOL-EXTENSION ::= {
    ...
}

```

UL-Timeslot-InformationModifyList-RL-ReconfReadyTDD ::= SEQUENCE (SIZE (1..maxNrOfTs)) OF UL-Timeslot-InformationModifyItem-RL-ReconfReadyTDD

```

UL-Timeslot-InformationModifyItem-RL-ReconfReadyTDD ::= SEQUENCE {
    timeSlot                TimeSlot,
    midambleShiftAndBurstType MidambleShiftAndBurstType           OPTIONAL,
    tFCI-Presence            TFCI-Presence             OPTIONAL,
    uL-Code-Information      TDD-UL-Code-InformationModifyList-RL-ReconfReadyTDD OPTIONAL,
    iE-Extensions            ProtocolExtensionContainer { {UL-Timeslot-InformationModifyItem-RL-ReconfReadyTDD-ExtIEs} } OPTIONAL,
    ...
}

```

```

UL-Timeslot-InformationModifyItem-RL-ReconfReadyTDD-ExtIEs RNSAP-PROTOCOL-EXTENSION ::= {
    ...
}

```

TDD-UL-Code-InformationModifyList-RL-ReconfReadyTDD ::= SEQUENCE (SIZE (1..maxNrOfDPCHs)) OF TDD-UL-Code-InformationModifyItem-RL-ReconfReadyTDD

```

TDD-UL-Code-InformationModifyItem-RL-ReconfReadyTDD ::= SEQUENCE {
    dPCH-ID                    DPCH-ID,
    tDD-ChannelisationCode     TDD-ChannelisationCode   OPTIONAL,
    iE-Extensions              ProtocolExtensionContainer { {TDD-UL-Code-InformationModifyItem-RL-ReconfReadyTDD-ExtIEs} } OPTIONAL,
    ...
}

```

```

}
TDD-UL-Code-InformationModifyItem-RL-ReconfReadyTDD-ExtIEs RNSAP-PROTOCOL-EXTENSION ::= {
  ...
}
UL-DPCH-InformationDeleteList-RL-ReconfReadyTDD ::= ProtocolIE-Single-Container {{UL-DPCH-InformationDeleteListIEs-RL-ReconfReadyTDD}}
UL-DPCH-InformationDeleteListIEs-RL-ReconfReadyTDD RNSAP-PROTOCOL-IES ::= {
  { ID id-UL-DPCH-InformationDeleteListIE-RL-ReconfReadyTDD  CRITICALITY ignore  TYPE UL-DPCH-InformationDeleteListIE-RL-ReconfReadyTDD
  PRESENCE mandatory }
}
UL-DPCH-InformationDeleteListIE-RL-ReconfReadyTDD ::= SEQUENCE (SIZE (0..maxNrOfDPCHs)) OF UL-DPCH-InformationDeleteItem-RL-ReconfReadyTDD
UL-DPCH-InformationDeleteItem-RL-ReconfReadyTDD ::= SEQUENCE {
  dPCH-ID                DPCH-ID,
  iE-Extensions          ProtocolExtensionContainer { {UL-DPCH-InformationDeleteList-RL-ReconfReadyTDD-ExtIEs} } OPTIONAL,
  ...
}
UL-DPCH-InformationDeleteList-RL-ReconfReadyTDD-ExtIEs RNSAP-PROTOCOL-EXTENSION ::= {
  ...
}
DL-CCTrCH-InformationList-RL-ReconfReadyTDD          ::= ProtocolIE-Single-Container {{DL-CCTrCHInformationListIEs-RL-ReconfReadyTDD}}
DL-CCTrCHInformationListIEs-RL-ReconfReadyTDD RNSAP-PROTOCOL-IES ::= {
  { ID id-DL-CCTrCH-InformationListIE-RL-ReconfReadyTDD  CRITICALITY ignore  TYPE DL-CCTrCHInformationListIE-RL-ReconfReadyTDD  PRESENCE
  mandatory }
}
DL-CCTrCHInformationListIE-RL-ReconfReadyTDD ::= SEQUENCE (SIZE (0..maxNrOfCCTrCHs)) OF DL-CCTrCH-InformationItem-RL-ReconfReadyTDD
DL-CCTrCH-InformationItem-RL-ReconfReadyTDD ::= SEQUENCE {
  cCTrCH-ID                CCTrCH-ID,
  dl-DPCH-AddInformation    DL-DPCH-InformationAddList-RL-ReconfReadyTDD          OPTIONAL,
  --For 3.84Mcps TDD only
  dl-DPCH-ModifyInformation DL-DPCH-InformationModifyList-RL-ReconfReadyTDD      OPTIONAL,
  --For 3.84Mcps TDD only
  dl-DPCH-DeleteInformation DL-DPCH-InformationDeleteList-RL-ReconfReadyTDD      OPTIONAL,
  iE-Extensions            ProtocolExtensionContainer { {DL-CCTrCH-InformationItem-RL-ReconfReadyTDD-ExtIEs} } OPTIONAL,
  ...
}
DL-CCTrCH-InformationItem-RL-ReconfReadyTDD-ExtIEs RNSAP-PROTOCOL-EXTENSION ::= {
  { ID id-DL-DPCH-LCR-InformationAddListIE-RL-ReconfReadyTDD  CRITICALITY ignore          EXTENSION  DL-DPCH-LCR-InformationAddList-RL-
  ReconfReadyTDD  PRESENCE optional},
  --For 1.28Mcps TDD only
  ...
}
DL-DPCH-LCR-InformationAddList-RL-ReconfReadyTDD ::= SEQUENCE {
  repetitionPeriod          RepetitionPeriod,

```

```

    repetitionLength      RepetitionLength,
    tDD-DPCHOffset        TDD-DPCHOffset,
    dL-TimeslotLCR-Info   DL-TimeslotLCR-Information,
    iE-Extensions         ProtocolExtensionContainer { {DL-DPCH-LCR-InformationAddItem-RL-ReconfReadyTDD-ExtIEs} } OPTIONAL,
    ...
}

DL-DPCH-LCR-InformationAddItem-RL-ReconfReadyTDD-ExtIEs RNSAP-PROTOCOL-EXTENSION ::= {
    ...
}

DL-DPCH-InformationAddList-RL-ReconfReadyTDD ::= ProtocolIE-Single-Container {{DL-DPCH-InformationAddListIEs-RL-ReconfReadyTDD}}

DL-DPCH-InformationAddListIEs-RL-ReconfReadyTDD RNSAP-PROTOCOL-IES ::= {
    { ID id-DL-DPCH-InformationAddListIE-RL-ReconfReadyTDD    CRITICALITY ignore TYPE DL-DPCH-InformationAddListIE-RL-ReconfReadyTDD    PRESENCE
mandatory }
}

DL-DPCH-InformationAddListIE-RL-ReconfReadyTDD ::= SEQUENCE {
    repetitionPeriod      RepetitionPeriod,
    repetitionLength      RepetitionLength,
    tDD-DPCHOffset        TDD-DPCHOffset,
    dL-Timeslot-Information DL-Timeslot-Information,
    iE-Extensions         ProtocolExtensionContainer { {DL-DPCH-InformationAddItem-RL-ReconfReadyTDD-ExtIEs} } OPTIONAL,
    ...
}

DL-DPCH-InformationAddItem-RL-ReconfReadyTDD-ExtIEs RNSAP-PROTOCOL-EXTENSION ::= {
    ...
}

DL-DPCH-InformationModifyList-RL-ReconfReadyTDD ::= ProtocolIE-Single-Container {{DL-DPCH-InformationModifyListIEs-RL-ReconfReadyTDD}}

DL-DPCH-InformationModifyListIEs-RL-ReconfReadyTDD RNSAP-PROTOCOL-IES ::= {
    { ID id-DL-DPCH-InformationModifyListIE-RL-ReconfReadyTDD    CRITICALITY ignore TYPE DL-DPCH-InformationModifyListIE-RL-ReconfReadyTDD
PRESENCE mandatory }
}

DL-DPCH-InformationModifyListIE-RL-ReconfReadyTDD ::= SEQUENCE {
    repetitionPeriod      RepetitionPeriod      OPTIONAL,
    repetitionLength      RepetitionLength      OPTIONAL,
    tDD-DPCHOffset        TDD-DPCHOffset        OPTIONAL,
    dL-Timeslot-InformationModifyList-RL-ReconfReadyTDD    DL-Timeslot-InformationModifyList-RL-ReconfReadyTDD    OPTIONAL,
    --For 3.84Mcps TDD only
    iE-Extensions         ProtocolExtensionContainer { {DL-DPCH-InformationModifyItem-RL-ReconfReadyTDD-ExtIEs} } OPTIONAL,
    ...
}

DL-DPCH-InformationModifyItem-RL-ReconfReadyTDD-ExtIEs RNSAP-PROTOCOL-EXTENSION ::= {
    { ID id-DL-Timeslot-LCR-InformationModifyList-RL-ReconfReadyTDD    CRITICALITY ignore    EXTENSION DL-TimeslotLCR-InformationModifyList-RL-
ReconfReadyTDD    PRESENCE optional },
    --For 1.28Mcps TDD only
    ...
}

```

DL-TimeslotLCR-InformationModifyList-RL-ReconfReadyTDD ::= SEQUENCE (SIZE (1..maxNrOfTsLCR)) OF DL-TimeslotLCR-InformationModifyItem-RL-ReconfReadyTDD

```
DL-TimeslotLCR-InformationModifyItem-RL-ReconfReadyTDD ::= SEQUENCE {
    timeSlotLCR                TimeSlotLCR,
    midambleShiftLCR           MidambleShiftLCR                OPTIONAL,
    tFCI-Presence              TFCI-Presence                OPTIONAL,
    tDD-dL-Code-LCR-Information TDD-DL-Code-LCR-InformationModifyList-RL-ReconfReadyTDD OPTIONAL,
    iE-Extensions              ProtocolExtensionContainer { {DL-TimeslotLCR-InformationModifyItem-RL-ReconfReadyTDD-ExtIEs} } OPTIONAL,
    ...
}
```

TDD-DL-Code-LCR-InformationModifyList-RL-ReconfReadyTDD ::= SEQUENCE (SIZE (1..maxNrOfDPCHsLCR)) OF TDD-DL-Code-LCR-InformationModifyItem-RL-ReconfReadyTDD

```
TDD-DL-Code-LCR-InformationModifyItem-RL-ReconfReadyTDD ::= SEQUENCE {
    dPCH-ID                    DPCH-ID,
    tDD-ChannelisationCodeLCR  TDD-ChannelisationCodeLCR                OPTIONAL,
    iE-Extensions              ProtocolExtensionContainer { {TDD-DL-Code-LCR-InformationModifyItem-RL-ReconfReadyTDD-ExtIEs} } OPTIONAL,
    ...
}
```

```
TDD-DL-Code-LCR-InformationModifyItem-RL-ReconfReadyTDD-ExtIEs RNSAP-PROTOCOL-EXTENSION ::= {
    ...
}
```

```
DL-TimeslotLCR-InformationModifyItem-RL-ReconfReadyTDD-ExtIEs RNSAP-PROTOCOL-EXTENSION ::= {
    ...
}
```

DL-Timeslot-InformationModifyList-RL-ReconfReadyTDD ::= SEQUENCE (SIZE (1..maxNrOfTS)) OF DL-Timeslot-InformationModifyItem-RL-ReconfReadyTDD

```
DL-Timeslot-InformationModifyItem-RL-ReconfReadyTDD ::= SEQUENCE {
    timeSlot                    TimeSlot,
    midambleShiftAndBurstType   MidambleShiftAndBurstType                OPTIONAL,
    tFCI-Presence              TFCI-Presence                OPTIONAL,
    dL-Code-Information         TDD-DL-Code-InformationModifyList-RL-ReconfReadyTDD OPTIONAL,
    iE-Extensions              ProtocolExtensionContainer { {DL-Timeslot-InformationModifyItem-RL-ReconfReadyTDD-ExtIEs} } OPTIONAL,
    ...
}
```

```
DL-Timeslot-InformationModifyItem-RL-ReconfReadyTDD-ExtIEs RNSAP-PROTOCOL-EXTENSION ::= {
    ...
}
```

TDD-DL-Code-InformationModifyList-RL-ReconfReadyTDD ::= SEQUENCE (SIZE (1..maxNrOfDPCHs)) OF TDD-DL-Code-InformationModifyItem-RL-ReconfReadyTDD

```
TDD-DL-Code-InformationModifyItem-RL-ReconfReadyTDD ::= SEQUENCE {
    dPCH-ID                    DPCH-ID,
    tDD-ChannelisationCode     TDD-ChannelisationCode                OPTIONAL,
    iE-Extensions              ProtocolExtensionContainer { {TDD-DL-Code-InformationModifyItem-RL-ReconfReadyTDD-ExtIEs} } OPTIONAL,
    ...
}
```



```

TDD-DL-Code-InformationModifyItem-RL-ReconfReadyTDD-ExtIEs RNSAP-PROTOCOL-EXTENSION ::= {
  { ID id-TDD-DL-DPCH-TimeSlotFormatModifyItem-LCR-RL-ReconfReadyTDD    CRITICALITY    reject    EXTENSION TDD-DL-DPCH-TimeSlotFormat-LCR
  PRESENCE    optional},
  ...
}

DL-DPCH-InformationDeleteList-RL-ReconfReadyTDD ::= ProtocolIE-Single-Container {{DL-DPCH-InformationDeleteListIEs-RL-ReconfReadyTDD}}

DL-DPCH-InformationDeleteListIEs-RL-ReconfReadyTDD RNSAP-PROTOCOL-IES ::= {
  { ID id-DL-DPCH-InformationDeleteListIE-RL-ReconfReadyTDD    CRITICALITY    ignore    TYPE DL-DPCH-InformationDeleteListIE-RL-ReconfReadyTDD
  PRESENCE    mandatory }
}

DL-DPCH-InformationDeleteListIE-RL-ReconfReadyTDD ::= SEQUENCE (SIZE (0..maxNrOfDPCHs)) OF DL-DPCH-InformationDeleteItem-RL-ReconfReadyTDD

DL-DPCH-InformationDeleteItem-RL-ReconfReadyTDD ::= SEQUENCE {
  dPCH-ID                DPCH-ID,
  iE-Extensions          ProtocolExtensionContainer { {DL-DPCH-InformationDeleteList-RL-ReconfReadyTDD-ExtIEs} } OPTIONAL,
  ...
}

DL-DPCH-InformationDeleteList-RL-ReconfReadyTDD-ExtIEs RNSAP-PROTOCOL-EXTENSION ::= {
  ...
}

DCH-InformationResponseList-RL-ReconfReadyTDD                ::= ProtocolIE-Single-Container { {DCH-InformationResponseListIEs-RL-ReconfReadyTDD} }

DCH-InformationResponseListIEs-RL-ReconfReadyTDD RNSAP-PROTOCOL-IES ::= {
  { ID id-DCH-InformationResponse    CRITICALITY    ignore    TYPE DCH-InformationResponse    PRESENCE    mandatory }
}

DSCHToBeAddedOrModified-RL-ReconfReadyTDD                ::= ProtocolIE-Single-Container { {DSCHToBeAddedOrModifiedIEs-RL-ReconfReadyTDD} }

DSCHToBeAddedOrModifiedIEs-RL-ReconfReadyTDD RNSAP-PROTOCOL-IES ::= {
  { ID id-DSCHToBeAddedOrModifiedList-RL-ReconfReadyTDD    CRITICALITY    ignore    TYPE DSCHToBeAddedOrModifiedList-RL-ReconfReadyTDD    PRESENCE
  mandatory }
}

DSCHToBeAddedOrModifiedList-RL-ReconfReadyTDD ::= SEQUENCE (SIZE (0..maxNoOfDSCHs)) OF DSCHToBeAddedOrModifiedItem-RL-ReconfReadyTDD

DSCHToBeAddedOrModifiedItem-RL-ReconfReadyTDD ::= SEQUENCE {
  dsch-ID                DSCH-ID,
  transportFormatManagement    TransportFormatManagement,
  dsch-FlowControlInformation    DSCH-FlowControlInformation,
  bindingID                BindingID    OPTIONAL,
  transportLayerAddress    TransportLayerAddress    OPTIONAL,
  iE-Extensions          ProtocolExtensionContainer { {DSCHToBeAddedOrModifiedItem-RL-ReconfReadyTDD-ExtIEs} } OPTIONAL,
  ...
}

DSCHToBeAddedOrModifiedItem-RL-ReconfReadyTDD-ExtIEs RNSAP-PROTOCOL-EXTENSION ::= {
  ...
}

```

```

USCHToBeAddedOrModified-RL-ReconfReadyTDD ::= ProtocolIE-Single-Container { {USCHToBeAddedOrModifiedIEs-RL-ReconfReadyTDD}
}USCHToBeAddedOrModifiedIEs-RL-ReconfReadyTDD RNSAP-PROTOCOL-IES ::= {
  { ID id-USCHToBeAddedOrModifiedList-RL-ReconfReadyTDD CRITICALITY ignore TYPE USCHToBeAddedOrModifiedList-RL-ReconfReadyTDD PRESENCE
mandatory }
}

USCHToBeAddedOrModifiedList-RL-ReconfReadyTDD ::= SEQUENCE (SIZE (0..maxNoOfUSCHs)) OF USCHToBeAddedOrModifiedItem-RL-ReconfReadyTDD

USCHToBeAddedOrModifiedItem-RL-ReconfReadyTDD ::= SEQUENCE {
  uSCH-ID USCH-ID,
  transportFormatManagement TransportFormatManagement,
  bindingID BindingID OPTIONAL,
  transportLayerAddress TransportLayerAddress OPTIONAL,
  iE-Extensions ProtocolExtensionContainer { {USCHToBeAddedOrModifiedItem-RL-ReconfReadyTDD-ExtIEs} } OPTIONAL,
  ...
}

USCHToBeAddedOrModifiedItem-RL-ReconfReadyTDD-ExtIEs RNSAP-PROTOCOL-EXTENSION ::= {
  ...
}

RadioLinkReconfigurationReadyTDD-Extensions RNSAP-PROTOCOL-EXTENSION ::= {
  { ID id-DSCH-RNTI CRITICALITY ignore EXTENSION DSCH-RNTI PRESENCE optional },
  ...
}

-- *****
--
-- RADIO LINK RECONFIGURATION COMMIT
--
-- *****

RadioLinkReconfigurationCommit ::= SEQUENCE {
  protocolIEs ProtocolIE-Container {{RadioLinkReconfigurationCommit-IEs}},
  protocolExtensions ProtocolExtensionContainer {{RadioLinkReconfigurationCommit-Extensions}} OPTIONAL,
  ...
}

RadioLinkReconfigurationCommit-IEs RNSAP-PROTOCOL-IES ::= {
  { ID id-CFN CRITICALITY ignore TYPE CFN PRESENCE mandatory }|
  { ID id-Active-Pattern-Sequence-Information CRITICALITY ignore TYPE Active-Pattern-Sequence-Information PRESENCE optional },--FDD only
  ...
}

RadioLinkReconfigurationCommit-Extensions RNSAP-PROTOCOL-EXTENSION ::= {
  ...
}

-- *****
--
-- RADIO LINK RECONFIGURATION FAILURE
--
-- *****

```

```

RadioLinkReconfigurationFailure ::= SEQUENCE {
    protocolIEs                ProtocolIE-Container    {{RadioLinkReconfigurationFailure-IEs}},
    protocolExtensions         ProtocolExtensionContainer {{RadioLinkReconfigurationFailure-Extensions}}
    ...
}

RadioLinkReconfigurationFailure-IEs RNSAP-PROTOCOL-IES ::= {
    { ID id-CauseLevel-RL-ReconfFailure    CRITICALITY ignore TYPE CauseLevel-RL-ReconfFailure PRESENCE mandatory } |
    { ID id-CriticalityDiagnostics         CRITICALITY ignore TYPE CriticalityDiagnostics PRESENCE optional },
    ...
}

CauseLevel-RL-ReconfFailure ::= CHOICE {
    generalCause                GeneralCauseList-RL-ReconfFailure,
    rLSpecificCause             RLSpecificCauseList-RL-ReconfFailure,
    ...
}

GeneralCauseList-RL-ReconfFailure ::= SEQUENCE {
    cause                        Cause,
    iE-Extensions               ProtocolExtensionContainer { { GeneralCauseItem-RL-ReconfFailure-ExtIEs} }
    ...
}

GeneralCauseItem-RL-ReconfFailure-ExtIEs RNSAP-PROTOCOL-EXTENSION ::= {
    ...
}

RLSpecificCauseList-RL-ReconfFailure ::= SEQUENCE {
    rL-ReconfigurationFailureList-RL-ReconfFailure    RL-ReconfigurationFailureList-RL-ReconfFailure    OPTIONAL,
    iE-Extensions                                     ProtocolExtensionContainer { { RLSpecificCauseItem-RL-ReconfFailure-ExtIEs} }
    OPTIONAL,
    ...
}

RLSpecificCauseItem-RL-ReconfFailure-ExtIEs RNSAP-PROTOCOL-EXTENSION ::= {
    ...
}

RL-ReconfigurationFailureList-RL-ReconfFailure ::= SEQUENCE (SIZE (0..maxNrOfRLs)) OF ProtocolIE-Single-Container { {RL-ReconfigurationFailure-RL-ReconfFailure-IEs} }

RL-ReconfigurationFailure-RL-ReconfFailure-IEs RNSAP-PROTOCOL-IES ::= {
    { ID id-RL-ReconfigurationFailure-RL-ReconfFail CRITICALITY ignore TYPE RL-ReconfigurationFailure-RL-ReconfFail PRESENCE mandatory }
}

RL-ReconfigurationFailure-RL-ReconfFail ::= SEQUENCE {
    rL-ID                RL-ID,
    cause                Cause,
    iE-Extensions        ProtocolExtensionContainer { {RL-ReconfigurationFailure-RL-ReconfFailure-ExtIEs} } OPTIONAL,
    ...
}

```

```

RL-ReconfigurationFailure-RL-ReconfFailure-ExtIEs RNSAP-PROTOCOL-EXTENSION ::= {
  ...
}

RadioLinkReconfigurationFailure-Extensions RNSAP-PROTOCOL-EXTENSION ::= {
  ...
}

-- *****
--
-- RADIO LINK RECONFIGURATION CANCEL
--
-- *****

RadioLinkReconfigurationCancel ::= SEQUENCE {
  protocolIEs          ProtocolIE-Container    {{RadioLinkReconfigurationCancel-IEs}},
  protocolExtensions  ProtocolExtensionContainer {{RadioLinkReconfigurationCancel-Extensions}}      OPTIONAL,
  ...
}

RadioLinkReconfigurationCancel-IEs RNSAP-PROTOCOL-IES ::= {
  ...
}

RadioLinkReconfigurationCancel-Extensions RNSAP-PROTOCOL-EXTENSION ::= {
  ...
}

-- *****
--
-- RADIO LINK RECONFIGURATION REQUEST FDD
--
-- *****

RadioLinkReconfigurationRequestFDD ::= SEQUENCE {
  protocolIEs          ProtocolIE-Container    {{RadioLinkReconfigurationRequestFDD-IEs}},
  protocolExtensions  ProtocolExtensionContainer {{RadioLinkReconfigurationRequestFDD-Extensions}}      OPTIONAL,
  ...
}

RadioLinkReconfigurationRequestFDD-IEs RNSAP-PROTOCOL-IES ::= {
  { ID id-AllowedQueuingTime          CRITICALITY reject TYPE AllowedQueuingTime          PRESENCE optional } |
  { ID id-UL-DPCH-Information-RL-ReconfRqstFDD CRITICALITY reject TYPE UL-DPCH-Information-RL-ReconfRqstFDD PRESENCE optional } |
  { ID id-DL-DPCH-Information-RL-ReconfRqstFDD CRITICALITY reject TYPE DL-DPCH-Information-RL-ReconfRqstFDD PRESENCE optional } |
  { ID id-FDD-DCHs-to-Modify          CRITICALITY reject TYPE FDD-DCHs-to-Modify          PRESENCE optional } |
  { ID id-DCHs-to-Add-FDD             CRITICALITY reject TYPE DCH-FDD-Information          PRESENCE optional } |
  { ID id-DCH-DeleteList-RL-ReconfRqstFDD CRITICALITY reject TYPE DCH-DeleteList-RL-ReconfRqstFDD PRESENCE optional } |
  { ID id-Transmission-Gap-Pattern-Sequence-Information CRITICALITY reject TYPE Transmission-Gap-Pattern-Sequence-Information PRESENCE optional },
  ...
}

UL-DPCH-Information-RL-ReconfRqstFDD ::= SEQUENCE {
  tFCS          TFCS          OPTIONAL,

```

```

    iE-Extensions                ProtocolExtensionContainer { {UL-DPCH-Information-RL-ReconfRqstFDD-ExtIEs} } OPTIONAL,
    ...
}

UL-DPCH-Information-RL-ReconfRqstFDD-ExtIEs RNSAP-PROTOCOL-EXTENSION ::= {
    ...
}

DL-DPCH-Information-RL-ReconfRqstFDD ::= SEQUENCE {
    tFCS                          TFCS          OPTIONAL,
    tFCI-SignallingMode           TFCI-SignallingMode OPTIONAL,
    limitedPowerIncrease          LimitedPowerIncrease OPTIONAL,
    iE-Extensions                ProtocolExtensionContainer { {DL-DPCH-Information-RL-ReconfRqstFDD-ExtIEs} } OPTIONAL,
    ...
}

DL-DPCH-Information-RL-ReconfRqstFDD-ExtIEs RNSAP-PROTOCOL-EXTENSION ::= {
    ...
}

DCH-DeleteList-RL-ReconfRqstFDD          ::= SEQUENCE (SIZE (0..maxNrOfDCHs)) OF DCH-DeleteItem-RL-ReconfRqstFDD

DCH-DeleteItem-RL-ReconfRqstFDD ::= SEQUENCE {
    dCH-ID                          DCH-ID,
    iE-Extensions                ProtocolExtensionContainer { {DCH-DeleteItem-RL-ReconfRqstFDD-ExtIEs} } OPTIONAL,
    ...
}

DCH-DeleteItem-RL-ReconfRqstFDD-ExtIEs RNSAP-PROTOCOL-EXTENSION ::= {
    ...
}

RadioLinkReconfigurationRequestFDD-Extensions RNSAP-PROTOCOL-EXTENSION ::= {
    ...
}

-- *****
--
-- RADIO LINK RECONFIGURATION REQUEST TDD
--
-- *****

RadioLinkReconfigurationRequestTDD ::= SEQUENCE {
    protocolIEs                    ProtocolIE-Container    {{RadioLinkReconfigurationRequestTDD-IEs}},
    protocolExtensions             ProtocolExtensionContainer {{RadioLinkReconfigurationRequestTDD-Extensions}}          OPTIONAL,
    ...
}

RadioLinkReconfigurationRequestTDD-IEs RNSAP-PROTOCOL-IES ::= {
    { ID id-AllowedQueuingTime      CRITICALITY reject  TYPE AllowedQueuingTime          PRESENCE optional } |
    { ID id-UL-CCTrCH-InformationModifyList-RL-ReconfRqstTDD  CRITICALITY notify  TYPE UL-CCTrCH-InformationModifyList-RL-ReconfRqstTDD  PRESENCE optional } |
    { ID id-UL-CCTrCH-InformationDeleteList-RL-ReconfRqstTDD  CRITICALITY notify  TYPE UL-CCTrCH-InformationDeleteList-RL-ReconfRqstTDD  PRESENCE optional } |
}

```

```

    { ID id-DL-CCTrCH-InformationModifyList-RL-ReconfRqstTDD    CRITICALITY notify    TYPE DL-CCTrCH-InformationModifyList-RL-ReconfRqstTDD    PRESENCE
optional    } |
    { ID id-DL-CCTrCH-InformationDeleteList-RL-ReconfRqstTDD    CRITICALITY notify    TYPE DL-CCTrCH-InformationDeleteList-RL-ReconfRqstTDD    PRESENCE
optional    } |
    { ID id-TDD-DCHs-to-Modify    CRITICALITY reject    TYPE TDD-DCHs-to-Modify    PRESENCE optional    } |
    { ID id-DCHs-to-Add-TDD    CRITICALITY reject    TYPE DCH-TDD-Information    PRESENCE optional    } |
    { ID id-DCH-DeleteList-RL-ReconfRqstTDD    CRITICALITY reject    TYPE DCH-DeleteList-RL-ReconfRqstTDD    PRESENCE optional },
    ...
}

UL-CCTrCH-InformationModifyList-RL-ReconfRqstTDD ::= SEQUENCE (SIZE (0..maxNrOfCCTrCHs)) OF ProtocolIE-Single-Container { {UL-CCTrCH-
InformationModifyList-RL-ReconfRqstTDD-IEs} }

UL-CCTrCH-InformationModifyList-RL-ReconfRqstTDD-IEs RNSAP-PROTOCOL-IES ::= {
    { ID id-UL-CCTrCH-InformationModifyItem-RL-ReconfRqstTDD    CRITICALITY notify    TYPE UL-CCTrCH-InformationModifyItem-RL-ReconfRqstTDD    PRESENCE
mandatory    }
}

UL-CCTrCH-InformationModifyItem-RL-ReconfRqstTDD ::= SEQUENCE {
    cCtRCH-ID    CCTrCH-ID,
    tFCS    TFCS    OPTIONAL,
    iE-Extensions    ProtocolExtensionContainer { {UL-CCTrCH-InformationModifyItem-RL-ReconfRqstTDD-ExtIEs} } OPTIONAL,
    ...
}

UL-CCTrCH-InformationModifyItem-RL-ReconfRqstTDD-ExtIEs RNSAP-PROTOCOL-EXTENSION ::= {
    { ID id-UL-SIRTarget    CRITICALITY reject    EXTENSION    UL-SIR    PRESENCE optional    },
    -- Applicable to 1.28Mcps TDD only
    ...
}

UL-CCTrCH-InformationDeleteList-RL-ReconfRqstTDD ::= SEQUENCE (SIZE (0..maxNrOfCCTrCHs)) OF ProtocolIE-Single-Container { {UL-CCTrCH-
InformationDeleteList-RL-ReconfRqstTDD-IEs} }

UL-CCTrCH-InformationDeleteList-RL-ReconfRqstTDD-IEs RNSAP-PROTOCOL-IES ::= {
    { ID id-UL-CCTrCH-InformationDeleteItem-RL-ReconfRqstTDD    CRITICALITY notify    TYPE UL-CCTrCH-InformationDeleteItem-RL-ReconfRqstTDD    PRESENCE
mandatory    }
}

UL-CCTrCH-InformationDeleteItem-RL-ReconfRqstTDD ::= SEQUENCE {
    cCtRCH-ID    CCTrCH-ID,
    iE-Extensions    ProtocolExtensionContainer { {UL-CCTrCH-InformationDeleteItem-RL-ReconfRqstTDD-ExtIEs} } OPTIONAL,
    ...
}

UL-CCTrCH-InformationDeleteItem-RL-ReconfRqstTDD-ExtIEs RNSAP-PROTOCOL-EXTENSION ::= {
    ...
}

DL-CCTrCH-InformationModifyList-RL-ReconfRqstTDD ::= SEQUENCE (SIZE (0..maxNrOfCCTrCHs)) OF ProtocolIE-Single-Container { {DL-CCTrCH-
InformationModifyList-RL-ReconfRqstTDD-IEs} }

DL-CCTrCH-InformationModifyList-RL-ReconfRqstTDD-IEs RNSAP-PROTOCOL-IES ::= {

```

```

    { ID id-DL-CCTrCH-InformationModifyItem-RL-ReconfRqstTDD    CRITICALITY notify    TYPE DL-CCTrCH-InformationModifyItem-RL-ReconfRqstTDD    PRESENCE
mandatory    }
}

DL-CCTrCH-InformationModifyItem-RL-ReconfRqstTDD ::= SEQUENCE {
    cCTrCH-ID                CCTrCH-ID,
    tFCS                      TFCS          OPTIONAL,
    iE-Extensions            ProtocolExtensionContainer { {DL-CCTrCH-InformationModifyItem-RL-ReconfRqstTDD-ExtIEs} } OPTIONAL,
    ...
}

DL-CCTrCH-InformationModifyItem-RL-ReconfRqstTDD-ExtIEs RNSAP-PROTOCOL-EXTENSION ::= {
    ...
}

DL-CCTrCH-InformationDeleteList-RL-ReconfRqstTDD ::= SEQUENCE (SIZE (0..maxNrOfCCTrCHs)) OF ProtocolIE-Single-Container { {DL-CCTrCH-
InformationDeleteList-RL-ReconfRqstTDD-IEs} }

DL-CCTrCH-InformationDeleteList-RL-ReconfRqstTDD-IEs RNSAP-PROTOCOL-IES ::= {
    { ID id-DL-CCTrCH-InformationDeleteItem-RL-ReconfRqstTDD    CRITICALITY notify    TYPE DL-CCTrCH-InformationDeleteItem-RL-ReconfRqstTDD    PRESENCE
mandatory    }
}

DL-CCTrCH-InformationDeleteItem-RL-ReconfRqstTDD ::= SEQUENCE {
    cCTrCH-ID                CCTrCH-ID,
    iE-Extensions            ProtocolExtensionContainer { {DL-CCTrCH-InformationDeleteItem-RL-ReconfRqstTDD-ExtIEs} } OPTIONAL,
    ...
}

DL-CCTrCH-InformationDeleteItem-RL-ReconfRqstTDD-ExtIEs RNSAP-PROTOCOL-EXTENSION ::= {
    ...
}

DCH-DeleteList-RL-ReconfRqstTDD ::= SEQUENCE (SIZE(0..maxNrOfDCHs)) OF DCH-DeleteItem-RL-ReconfRqstTDD

DCH-DeleteItem-RL-ReconfRqstTDD ::= SEQUENCE {
    dCH-ID                DCH-ID,
    iE-Extensions            ProtocolExtensionContainer { {DCH-DeleteItem-RL-ReconfRqstTDD-ExtIEs} } OPTIONAL,
    ...
}

DCH-DeleteItem-RL-ReconfRqstTDD-ExtIEs RNSAP-PROTOCOL-EXTENSION ::= {
    ...
}

RadioLinkReconfigurationRequestTDD-Extensions RNSAP-PROTOCOL-EXTENSION ::= {
    { ID id-UL-Synchronisation-Parameters-LCR                CRITICALITY ignore    EXTENSION    UL-Synchronisation-Parameters-LCR    PRESENCE
optional    }, -- Mandatory for 1.28Mcps TDD, Not Applicable to 3.84Mcps TDD
    ...
}

-- *****
--
-- RADIO LINK RECONFIGURATION RESPONSE FDD

```

```

--
-- *****
RadioLinkReconfigurationResponseFDD ::= SEQUENCE {
    protocolIEs          ProtocolIE-Container    {{RadioLinkReconfigurationResponseFDD-IEs}},
    protocolExtensions  ProtocolExtensionContainer {{RadioLinkReconfigurationResponseFDD-Extensions}}    OPTIONAL,
    ...
}

RadioLinkReconfigurationResponseFDD-IEs RNSAP-PROTOCOL-IES ::= {
    optional { ID id-RL-InformationResponseList-RL-ReconfRspFDD    CRITICALITY ignore    TYPE RL-InformationResponseList-RL-ReconfRspFDD    PRESENCE
    } |
    { ID id-CriticalityDiagnostics    CRITICALITY ignore    TYPE CriticalityDiagnostics    PRESENCE optional },
    ...
}

RL-InformationResponseList-RL-ReconfRspFDD ::= SEQUENCE (SIZE (0..maxNrOfRLs)) OF ProtocolIE-Single-Container { {RL-InformationResponse-RL-
ReconfRspFDD-IEs} }

RL-InformationResponse-RL-ReconfRspFDD-IEs RNSAP-PROTOCOL-IES ::= {
    mandatory { ID id-RL-InformationResponseItem-RL-ReconfRspFDD    CRITICALITY ignore    TYPE RL-InformationResponseItem-RL-ReconfRspFDD    PRESENCE
    }
}

RL-InformationResponseItem-RL-ReconfRspFDD ::= SEQUENCE {
    rL-ID                RL-ID,
    max-UL-SIR           UL-SIR            OPTIONAL,
    min-UL-SIR           UL-SIR            OPTIONAL,
    maximumDLTxPower    DL-Power          OPTIONAL,
    minimumDLTxPower    DL-Power          OPTIONAL,
    secondary-CCPCH-Info Secondary-CCPCH-Info    OPTIONAL,
    dCHsInformationResponseList DCH-InformationResponseList-RL-ReconfRspFDD    OPTIONAL,
    dL-CodeInformationList-RL-ReconfResp DL-CodeInformationList-RL-ReconfRspFDD    OPTIONAL,
    iE-Extensions       ProtocolExtensionContainer { {RL-InformationResponseItem-RL-ReconfRspFDD-ExtIEs} }    OPTIONAL,
    ...
}

RL-InformationResponseItem-RL-ReconfRspFDD-ExtIEs RNSAP-PROTOCOL-EXTENSION ::= {
    ...
}

DCH-InformationResponseList-RL-ReconfRspFDD ::= ProtocolIE-Single-Container { {DCH-InformationResponseListIEs-RL-ReconfRspFDD} }

DCH-InformationResponseListIEs-RL-ReconfRspFDD RNSAP-PROTOCOL-IES ::= {
    { ID id-DCH-InformationResponse    CRITICALITY ignore    TYPE DCH-InformationResponse    PRESENCE mandatory }
}

DL-CodeInformationList-RL-ReconfRspFDD ::= ProtocolIE-Single-Container { { DL-CodeInformationListIEs-RL-ReconfRspFDD } }

DL-CodeInformationListIEs-RL-ReconfRspFDD RNSAP-PROTOCOL-IES ::= {
    { ID id-FDD-DL-CodeInformation    CRITICALITY ignore    TYPE FDD-DL-CodeInformation    PRESENCE optional }
}

RadioLinkReconfigurationResponseFDD-Extensions RNSAP-PROTOCOL-EXTENSION ::= {

```



```

}
...
}
-- *****
--
-- RADIO LINK RECONFIGURATION RESPONSE TDD
--
-- *****

RadioLinkReconfigurationResponseTDD ::= SEQUENCE {
    protocolIEs          ProtocolIE-Container    {{RadioLinkReconfigurationResponseTDD-IEs}},
    protocolExtensions   ProtocolExtensionContainer {{RadioLinkReconfigurationResponseTDD-Extensions}}      OPTIONAL,
    ...
}

RadioLinkReconfigurationResponseTDD-IEs RNSAP-PROTOCOL-IES ::= {
    { ID id-RL-InformationResponse-RL-ReconfRspTDD      CRITICALITY ignore  TYPE RL-InformationResponse-RL-ReconfRspTDD      PRESENCE optional }
    |
    { ID id-CriticalityDiagnostics          CRITICALITY ignore  TYPE CriticalityDiagnostics          PRESENCE optional },
    ...
}

RL-InformationResponse-RL-ReconfRspTDD ::= SEQUENCE {
    rL-ID              RL-ID,
    max-UL-SIR         UL-SIR          OPTIONAL,
    min-UL-SIR         UL-SIR          OPTIONAL,
    maximumDLTxPower   DL-Power       OPTIONAL,
    minimumDLTxPower   DL-Power       OPTIONAL,
    dCHsInformationResponseList DCH-InformationResponseList-RL-ReconfRspTDD OPTIONAL,
    iE-Extensions      ProtocolExtensionContainer { {RL-InformationResponse-RL-ReconfRspTDD-ExtIEs} } OPTIONAL,
    ...
}

RL-InformationResponse-RL-ReconfRspTDD-ExtIEs RNSAP-PROTOCOL-EXTENSION ::= {
    { ID id-UL-TimingAdvanceCtrl-LCR      CRITICALITY ignore  EXTENSION  UL-TimingAdvanceCtrl-LCR      PRESENCE optional },
    --For 1.28Mcps TDD only
    ...
}

DCH-InformationResponseList-RL-ReconfRspTDD ::= ProtocolIE-Single-Container { {DCH-InformationResponseListIEs-RL-ReconfRspTDD} }

DCH-InformationResponseListIEs-RL-ReconfRspTDD RNSAP-PROTOCOL-IES ::= {
    { ID id-DCH-InformationResponse CRITICALITY ignore  TYPE DCH-InformationResponse  PRESENCE optional }
}

RadioLinkReconfigurationResponseTDD-Extensions RNSAP-PROTOCOL-EXTENSION ::= {
    ...
}

-- *****
--
-- RADIO LINK FAILURE INDICATION
--
-- *****

```

```

RadioLinkFailureIndication ::= SEQUENCE {
    protocolIEs                ProtocolIE-Container    {{RadioLinkFailureIndication-IEs}},
    protocolExtensions          ProtocolExtensionContainer {{RadioLinkFailureIndication-Extensions}}
    ...
}

RadioLinkFailureIndication-IEs RNSAP-PROTOCOL-IES ::= {
    { ID id-Reporting-Object-RL-FailureInd CRITICALITY ignore TYPE Reporting-Object-RL-FailureInd PRESENCE mandatory },
    ...
}

Reporting-Object-RL-FailureInd ::= CHOICE {
    rL                        RL-RL-FailureInd,
    rL-Set                    RL-Set-RL-FailureInd, --FDD only
    ...,
    cCTrCH                    CCTrCH-RL-FailureInd --TDD only
}

RL-RL-FailureInd ::= SEQUENCE {
    rL-InformationList-RL-FailureInd    RL-InformationList-RL-FailureInd,
    iE-Extensions                      ProtocolExtensionContainer { { RLItem-RL-FailureInd-ExtIEs } } OPTIONAL,
    ...
}

RLItem-RL-FailureInd-ExtIEs RNSAP-PROTOCOL-EXTENSION ::= {
    ...
}

RL-InformationList-RL-FailureInd ::= SEQUENCE (SIZE (1..maxNrOfRLs)) OF ProtocolIE-Single-Container { {RL-Information-RL-FailureInd-IEs} }

RL-Information-RL-FailureInd-IEs RNSAP-PROTOCOL-IES ::= {
    { ID id-RL-Information-RL-FailureInd CRITICALITY ignore TYPE RL-Information-RL-FailureInd PRESENCE mandatory }
}

RL-Information-RL-FailureInd ::= SEQUENCE {
    rL-ID                      RL-ID,
    cause                      Cause,
    iE-Extensions              ProtocolExtensionContainer { {RL-Information-RL-FailureInd-ExtIEs} } OPTIONAL,
    ...
}

RL-Information-RL-FailureInd-ExtIEs RNSAP-PROTOCOL-EXTENSION ::= {
    ...
}

RL-Set-RL-FailureInd ::= SEQUENCE {
    rL-Set-InformationList-RL-FailureInd    RL-Set-InformationList-RL-FailureInd,
    iE-Extensions                          ProtocolExtensionContainer { { RL-SetItem-RL-FailureInd-ExtIEs } } OPTIONAL,
    ...
}

RL-SetItem-RL-FailureInd-ExtIEs RNSAP-PROTOCOL-EXTENSION ::= {

```

```

}
...
}
RL-Set-InformationList-RL-FailureInd ::= SEQUENCE (SIZE (1..maxNrOfRLSets)) OF ProtocolIE-Single-Container { {RL-Set-Information-RL-
FailureInd-IEs} }

RL-Set-Information-RL-FailureInd-IEs RNSAP-PROTOCOL-IES ::= {
  { ID id-RL-Set-Information-RL-FailureInd          CRITICALITY ignore  TYPE RL-Set-Information-RL-FailureInd  PRESENCE mandatory  }
}

RL-Set-Information-RL-FailureInd ::= SEQUENCE {
  rL-Set-ID          RL-Set-ID,
  cause              Cause,
  iE-Extensions     ProtocolExtensionContainer { {RL-Set-Information-RL-FailureInd-ExtIEs} } OPTIONAL,
  ...
}

RL-Set-Information-RL-FailureInd-ExtIEs RNSAP-PROTOCOL-EXTENSION ::= {
  ...
}

RadioLinkFailureIndication-Extensions RNSAP-PROTOCOL-EXTENSION ::= {
  ...
}

CCTrCH-RL-FailureInd ::= SEQUENCE {
  rL-ID              RL-ID,
  cCTrCH-InformationList-RL-FailureInd  CCTrCH-InformationList-RL-FailureInd,
  iE-Extensions     ProtocolExtensionContainer { { CCTrCHItem-RL-FailureInd-ExtIEs } }      OPTIONAL,
  ...
}

CCTrCHItem-RL-FailureInd-ExtIEs RNSAP-PROTOCOL-EXTENSION ::= {
  ...
}

CCTrCH-InformationList-RL-FailureInd ::= SEQUENCE (SIZE (1..maxNrOfCCTrCHs)) OF ProtocolIE-Single-Container {{ CCTrCH-InformationItemIE-RL-
FailureInd}}

CCTrCH-InformationItemIE-RL-FailureInd RNSAP-PROTOCOL-IES ::= {
  { ID id-CCTrCH-InformationItem-RL-FailureInd          CRITICALITY ignore          TYPE CCTrCH-InformationItem-RL-FailureInd
  PRESENCE mandatory}
}

CCTrCH-InformationItem-RL-FailureInd ::= SEQUENCE {
  cCTrCH-ID          CCTrCH-ID,
  cause              Cause,
  iE-Extensions     ProtocolExtensionContainer { { CCTrCH-InformationItem-RL-FailureInd-ExtIEs } }      OPTIONAL,
  ...
}

CCTrCH-InformationItem-RL-FailureInd-ExtIEs RNSAP-PROTOCOL-EXTENSION ::= {
  ...
}

```

```

-- *****
--
-- RADIO LINK PREEMPTION REQUIRED INDICATION
--
-- *****

RadioLinkPreemptionRequiredIndication ::= SEQUENCE {
    protocolIEs          ProtocolIE-Container    {{RadioLinkPreemptionRequiredIndication-IEs}},
    protocolExtensions  ProtocolExtensionContainer {{RadioLinkPreemptionRequiredIndication-Extensions}}
    ...
}

RadioLinkPreemptionRequiredIndication-IEs RNSAP-PROTOCOL-IES ::= {
    { ID id-RL-InformationList-RL-PreemptRequiredInd  CRITICALITY ignore  TYPE RL-InformationList-RL-PreemptRequiredInd  PRESENCE optional },
    ...
}

RL-InformationList-RL-PreemptRequiredInd ::= SEQUENCE (SIZE (1..maxNrOfRLs)) OF ProtocolIE-Single-Container { {RL-InformationItemIEs-RL-PreemptRequiredInd} }

RL-InformationItemIEs-RL-PreemptRequiredInd RNSAP-PROTOCOL-IES ::= {
    { ID id-RL-InformationItem-RL-PreemptRequiredInd  CRITICALITY ignore  TYPE RL-InformationItem-RL-PreemptRequiredInd  PRESENCE
mandatory }
}

RL-InformationItem-RL-PreemptRequiredInd ::= SEQUENCE {
    rL-ID          RL-ID,
    iE-Extensions ProtocolExtensionContainer { {RL-Information-RL-PreemptRequiredInd-ExtIEs} } OPTIONAL,
    ...
}

RL-Information-RL-PreemptRequiredInd-ExtIEs RNSAP-PROTOCOL-EXTENSION ::= {
    ...
}

RadioLinkPreemptionRequiredIndication-Extensions RNSAP-PROTOCOL-EXTENSION ::= {
    ...
}

-- *****
--
-- RADIO LINK RESTORE INDICATION
--
-- *****

RadioLinkRestoreIndication ::= SEQUENCE {
    protocolIEs          ProtocolIE-Container    {{RadioLinkRestoreIndication-IEs}},
    protocolExtensions  ProtocolExtensionContainer {{RadioLinkRestoreIndication-Extensions}}
    ...
}

RadioLinkRestoreIndication-IEs RNSAP-PROTOCOL-IES ::= {
    { ID id-Reporting-Object-RL-RestoreInd  CRITICALITY ignore  TYPE Reporting-Object-RL-RestoreInd  PRESENCE mandatory },

```

```

    ...
}

Reporting-Object-RL-RestoreInd ::= CHOICE {
    rL                RL-RL-RestoreInd, --TDD only
    rL-Set            RL-Set-RL-RestoreInd, --FDD only
    ...,
    cCTrCH            CCTrCH-RL-RestoreInd --TDD only
}

RL-RL-RestoreInd ::= SEQUENCE {
    rL-InformationList-RL-RestoreInd    RL-InformationList-RL-RestoreInd,
    iE-Extensions                       ProtocolExtensionContainer { { RLItem-RL-RestoreInd-ExtIEs } } OPTIONAL,
    ...
}

RLItem-RL-RestoreInd-ExtIEs RNSAP-PROTOCOL-EXTENSION ::= {
    ...
}

RL-InformationList-RL-RestoreInd ::= SEQUENCE (SIZE (1..maxNrOfRLs)) OF ProtocolIE-Single-Container { {RL-Information-RL-RestoreInd-IEs}
}

RL-Information-RL-RestoreInd-IEs RNSAP-PROTOCOL-IES ::= {
    { ID id-RL-Information-RL-RestoreInd    CRITICALITY ignore    TYPE RL-Information-RL-RestoreInd    PRESENCE mandatory }
}

RL-Information-RL-RestoreInd ::= SEQUENCE {
    rL-ID                RL-ID,
    iE-Extensions        ProtocolExtensionContainer { {RL-Information-RL-RestoreInd-ExtIEs} } OPTIONAL,
    ...
}

RL-Information-RL-RestoreInd-ExtIEs RNSAP-PROTOCOL-EXTENSION ::= {
    ...
}

RL-Set-RL-RestoreInd ::= SEQUENCE {
    rL-Set-InformationList-RL-RestoreInd    RL-Set-InformationList-RL-RestoreInd,
    iE-Extensions                           ProtocolExtensionContainer { { RL-SetItem-RL-RestoreInd-ExtIEs } } OPTIONAL,
    ...
}

RL-SetItem-RL-RestoreInd-ExtIEs RNSAP-PROTOCOL-EXTENSION ::= {
    ...
}

RL-Set-InformationList-RL-RestoreInd ::= SEQUENCE (SIZE (1..maxNrOfRLSets)) OF ProtocolIE-Single-Container { {RL-Set-Information-RL-RestoreInd-IEs} }

RL-Set-Information-RL-RestoreInd-IEs RNSAP-PROTOCOL-IES ::= {
    { ID id-RL-Set-Information-RL-RestoreInd    CRITICALITY ignore    TYPE RL-Set-Information-RL-RestoreInd    PRESENCE mandatory }
}

```

```

RL-Set-Information-RL-RestoreInd ::= SEQUENCE {
    rL-Set-ID                RL-Set-ID,
    iE-Extensions            ProtocolExtensionContainer { {RL-Set-Information-RL-RestoreInd-ExtIEs} } OPTIONAL,
    ...
}

RL-Set-Information-RL-RestoreInd-ExtIEs RNSAP-PROTOCOL-EXTENSION ::= {
    ...
}

RadioLinkRestoreIndication-Extensions RNSAP-PROTOCOL-EXTENSION ::= {
    ...
}

CCTrCH-RL-RestoreInd ::= SEQUENCE {
    rL-ID                    RL-ID,
    cCTrCH-InformationList-RL-RestoreInd    CCTrCH-InformationList-RL-RestoreInd,
    iE-Extensions            ProtocolExtensionContainer { { CCTrCHItem-RL-RestoreInd-ExtIEs } }    OPTIONAL,
    ...
}

CCTrCHItem-RL-RestoreInd-ExtIEs RNSAP-PROTOCOL-EXTENSION ::= {
    ...
}

CCTrCH-InformationList-RL-RestoreInd ::= SEQUENCE (SIZE (1..maxNrOfCCTrCHs)) OF ProtocolIE-Single-Container {{ CCTrCH-InformationItemIE-RL-RestoreInd}}

CCTrCH-InformationItemIE-RL-RestoreInd RNSAP-PROTOCOL-IES ::= {
    { ID      id-CCTrCH-InformationItem-RL-RestoreInd      CRITICALITY    ignore          TYPE CCTrCH-InformationItem-RL-RestoreInd
    PRESENCE  mandatory}
}

CCTrCH-InformationItem-RL-RestoreInd ::= SEQUENCE {
    cCTrCH-ID                CCTrCH-ID,
    iE-Extensions            ProtocolExtensionContainer { { CCTrCH-InformationItem-RL-RestoreInd-ExtIEs } }    OPTIONAL,
    ...
}

CCTrCH-InformationItem-RL-RestoreInd-ExtIEs RNSAP-PROTOCOL-EXTENSION ::= {
    ...
}

-- *****
--
-- DOWNLINK POWER CONTROL REQUEST
--
-- *****

DL-PowerControlRequest ::= SEQUENCE {
    protocolIEs              ProtocolIE-Container    {{DL-PowerControlRequest-IEs}},
    protocolExtensions       ProtocolExtensionContainer {{DL-PowerControlRequest-Extensions}}    OPTIONAL,
    ...
}

```

```

DL-PowerControlRequest-IEs RNSAP-PROTOCOL-IEs ::= {
  { ID id-PowerAdjustmentType          CRITICALITY ignore  TYPE PowerAdjustmentType          PRESENCE mandatory} |
  { ID id-DLReferencePower              CRITICALITY ignore  TYPE DL-Power                                PRESENCE conditional} |
  -- This IE shall be present if Power Adjustment Type IE equals to 'Common'
  { ID id-InnerLoopDLPCStatus           CRITICALITY ignore  TYPE InnerLoopDLPCStatus                    PRESENCE optional } |
  { ID id-DLReferencePowerList-DL-PC-Rqst CRITICALITY ignore  TYPE DL-ReferencePowerInformationList-DL-PC-Rqst PRESENCE conditional} |
  -- This IE shall be present if Power Adjustment Type IE equals to 'Individual'
  { ID id-MaxAdjustmentStep             CRITICALITY ignore  TYPE MaxAdjustmentStep                      PRESENCE conditional} |
  -- This IE shall be present if Power Adjustment Type IE equals to 'Common' or 'Individual'
  { ID id-AdjustmentPeriod              CRITICALITY ignore  TYPE AdjustmentPeriod                      PRESENCE conditional} |
  -- This IE shall be present if Power Adjustment Type IE equals to 'Common' or 'Individual'
  { ID id-AdjustmentRatio               CRITICALITY ignore  TYPE ScaledAdjustmentRatio                 PRESENCE conditional},
  -- This IE shall be present if Power Adjustment Type IE equals to 'Common' or 'Individual'
  ...
}

DL-ReferencePowerInformationList-DL-PC-Rqst ::= SEQUENCE (SIZE (1..maxNrOfRLs)) OF ProtocolIE-Single-Container { {DL-ReferencePowerInformation-DL-PC-Rqst-IEs} }

DL-ReferencePowerInformation-DL-PC-Rqst-IEs RNSAP-PROTOCOL-IEs ::= {
  { ID id-DL-ReferencePowerInformation-DL-PC-Rqst CRITICALITY ignore  TYPE DL-ReferencePowerInformation-DL-PC-Rqst PRESENCE mandatory }
}

DL-ReferencePowerInformation-DL-PC-Rqst ::= SEQUENCE {
  rL-ID          RL-ID,
  dl-Reference-Power  DL-Power,
  iE-Extensions    ProtocolExtensionContainer { {DL-ReferencePowerInformation-DL-PC-Rqst-ExtIEs} } OPTIONAL,
  ...
}

DL-ReferencePowerInformation-DL-PC-Rqst-ExtIEs RNSAP-PROTOCOL-EXTENSION ::= {
  ...
}

DL-PowerControlRequest-Extensions RNSAP-PROTOCOL-EXTENSION ::= {
  ...
}

-- *****
--
-- DOWNLINK POWER TIMESLOT CONTROL REQUEST TDD
--
-- *****

DL-PowerTimeslotControlRequest ::= SEQUENCE {
  protocolIEs          ProtocolIE-Container  {{DL-PowerTimeslotControlRequest-IEs}},
  protocolExtensions   ProtocolExtensionContainer {{DL-PowerTimeslotControlRequest-Extensions}}
  ...
}

DL-PowerTimeslotControlRequest-IEs RNSAP-PROTOCOL-IEs ::= {
  { ID id-timeSlot-ISCP CRITICALITY ignore  TYPE DL-TimeSlot-ISCP-Info PRESENCE optional},
  --Mandatory for 3.84Mcps TDD only
}

```

```

}
...
}
DL-PowerTimeslotControlRequest-Extensions RNSAP-PROTOCOL-EXTENSION ::= {
  { ID id-timeSlot-ISCP-LCR-List-DL-PC-Rqst-TDD CRITICALITY ignore EXTENSION DL-TimeSlot-ISCP-LCR-Information PRESENCE optional},
  --Mandatory for 1.28Mcps TDD only
  ...
}
-- *****
--
-- PHYSICAL CHANNEL RECONFIGURATION REQUEST FDD
--
-- *****

PhysicalChannelReconfigurationRequestFDD ::= SEQUENCE {
  protocolIEs ProtocolIE-Container {{PhysicalChannelReconfigurationRequestFDD-IEs}},
  protocolExtensions ProtocolExtensionContainer {{PhysicalChannelReconfigurationRequestFDD-Extensions}} OPTIONAL,
  ...
}

PhysicalChannelReconfigurationRequestFDD-IEs RNSAP-PROTOCOL-IES ::= {
  { ID id-RL-Information-PhyChReconfRqstFDD CRITICALITY reject TYPE RL-Information-PhyChReconfRqstFDD PRESENCE mandatory },
  ...
}

RL-Information-PhyChReconfRqstFDD ::= SEQUENCE {
  rL-ID RL-ID,
  dl-CodeInformation DL-CodeInformationList-PhyChReconfRqstFDD,
  iE-Extensions ProtocolExtensionContainer { {RL-Information-PhyChReconfRqstFDD-ExtIEs} } OPTIONAL,
  ...
}

RL-Information-PhyChReconfRqstFDD-ExtIEs RNSAP-PROTOCOL-EXTENSION ::= {
  ...
}

DL-CodeInformationList-PhyChReconfRqstFDD ::= ProtocolIE-Single-Container { {DL-CodeInformationListIEs-PhyChReconfRqstFDD} }

DL-CodeInformationListIEs-PhyChReconfRqstFDD RNSAP-PROTOCOL-IES ::= {
  { ID id-FDD-DL-CodeInformation CRITICALITY notify TYPE FDD-DL-CodeInformation PRESENCE mandatory }
}

PhysicalChannelReconfigurationRequestFDD-Extensions RNSAP-PROTOCOL-EXTENSION ::= {
  ...
}
-- *****
--
-- PHYSICAL CHANNEL RECONFIGURATION REQUEST TDD
--
-- *****

PhysicalChannelReconfigurationRequestTDD ::= SEQUENCE {

```



```

    protocolIEs          ProtocolIE-Container    {{PhysicalChannelReconfigurationRequestTDD-IEs}},
    protocolExtensions   ProtocolExtensionContainer {{PhysicalChannelReconfigurationRequestTDD-Extensions}}
    ...
}

PhysicalChannelReconfigurationRequestTDD-IEs RNSAP-PROTOCOL-IES ::= {
    { ID id-RL-Information-PhyChReconfRqstTDD    CRITICALITY reject    TYPE RL-Information-PhyChReconfRqstTDD    PRESENCE mandatory    },
    ...
}

RL-Information-PhyChReconfRqstTDD ::= SEQUENCE {
    rL-ID                RL-ID,
    ul-CCTrCH-Information    UL-CCTrCH-InformationList-PhyChReconfRqstTDD    OPTIONAL,
    dl-CCTrCH-Information    DL-CCTrCH-InformationList-PhyChReconfRqstTDD    OPTIONAL,
    iE-Extensions          ProtocolExtensionContainer { {RL-Information-PhyChReconfRqstTDD-ExtIEs} } OPTIONAL,
    ...
}

RL-Information-PhyChReconfRqstTDD-ExtIEs RNSAP-PROTOCOL-EXTENSION ::= {
    ...
}

UL-CCTrCH-InformationList-PhyChReconfRqstTDD ::= ProtocolIE-Single-Container { {UL-CCTrCH-InformationListIEs-PhyChReconfRqstTDD} }

UL-CCTrCH-InformationListIEs-PhyChReconfRqstTDD RNSAP-PROTOCOL-IES ::= {
    { ID id-UL-CCTrCH-InformationListIE-PhyChReconfRqstTDD    CRITICALITY reject    TYPE UL-CCTrCH-InformationListIE-PhyChReconfRqstTDD    PRESENCE
    mandatory    }
}

UL-CCTrCH-InformationListIE-PhyChReconfRqstTDD ::= SEQUENCE (SIZE (1..maxNrOfCCTrCHs)) OF UL-CCTrCH-InformationItem-PhyChReconfRqstTDD

UL-CCTrCH-InformationItem-PhyChReconfRqstTDD ::= SEQUENCE {
    cCtRch-ID            CCTrCH-ID,
    ul-DPCH-Information    UL-DPCH-InformationList-PhyChReconfRqstTDD,
    iE-Extensions          ProtocolExtensionContainer { {UL-CCTrCH-InformationItem-PhyChReconfRqstTDD-ExtIEs} } OPTIONAL,
    ...
}

UL-CCTrCH-InformationItem-PhyChReconfRqstTDD-ExtIEs RNSAP-PROTOCOL-EXTENSION ::= {
    ...
}

UL-DPCH-InformationList-PhyChReconfRqstTDD ::= ProtocolIE-Single-Container {{UL-DPCH-InformationListIEs-PhyChReconfRqstTDD}}

UL-DPCH-InformationListIEs-PhyChReconfRqstTDD RNSAP-PROTOCOL-IES ::= {
    { ID id-UL-DPCH-InformationItem-PhyChReconfRqstTDD    CRITICALITY notify    TYPE UL-DPCH-InformationItem-PhyChReconfRqstTDD    PRESENCE mandatory    }
}

UL-DPCH-InformationItem-PhyChReconfRqstTDD ::= SEQUENCE {
    repetitionPeriod        RepetitionPeriod    OPTIONAL,
    repetitionLength        RepetitionLength    OPTIONAL,
    tDD-DPCHOffset          TDD-DPCHOffset    OPTIONAL,
    uL-Timeslot-InformationList-PhyChReconfRqstTDD    UL-Timeslot-InformationList-PhyChReconfRqstTDD    OPTIONAL,
    --For 3.84Mcps TDD only
}

```

```

    iE-Extensions          ProtocolExtensionContainer { {UL-DPCH-InformationItem-PhyChReconfRqstTDD-ExtIEs} } OPTIONAL,
    ...
}

UL-DPCH-InformationItem-PhyChReconfRqstTDD-ExtIEs RNSAP-PROTOCOL-EXTENSION ::= {
    { ID id-UL-Timeslot-LCR-InformationList-PhyChReconfRqstTDD    CRITICALITY reject    EXTENSION    UL-TimeslotLCR-InformationList-
PhyChReconfRqstTDD    PRESENCE optional },
    --For 1.28Mcps TDD only
    ...
}

UL-TimeslotLCR-InformationList-PhyChReconfRqstTDD ::= SEQUENCE ( SIZE (1..maxNrOfTsLCR)) OF UL-TimeslotLCR-InformationItem-PhyChReconfRqstTDD

UL-TimeslotLCR-InformationItem-PhyChReconfRqstTDD ::= SEQUENCE {
    timeSlotLCR                TimeSlotLCR,
    midambleShiftLCR           MidambleShiftLCR          OPTIONAL,
    tFCI-Presence               TFCI-Presence          OPTIONAL,
    uL-Code-LCR-Information     TDD-UL-Code-LCR-Information    OPTIONAL,
    iE-Extensions              ProtocolExtensionContainer { {UL-TimeslotLCR-InformationItem-PhyChReconfRqstTDD-ExtIEs} } OPTIONAL,
    ...
}

UL-TimeslotLCR-InformationItem-PhyChReconfRqstTDD-ExtIEs RNSAP-PROTOCOL-EXTENSION ::= {
    ...
}

UL-Timeslot-InformationList-PhyChReconfRqstTDD ::= SEQUENCE ( SIZE (1..maxNrOfTs)) OF UL-Timeslot-InformationItem-PhyChReconfRqstTDD

UL-Timeslot-InformationItem-PhyChReconfRqstTDD ::= SEQUENCE {
    timeSlot                    TimeSlot,
    midambleShiftAndBurstType   MidambleShiftAndBurstType    OPTIONAL,
    tFCI-Presence               TFCI-Presence          OPTIONAL,
    uL-Code-Information         TDD-UL-Code-Information    OPTIONAL,
    iE-Extensions              ProtocolExtensionContainer { {UL-Timeslot-InformationItem-PhyChReconfRqstTDD-ExtIEs} } OPTIONAL,
    ...
}

UL-Timeslot-InformationItem-PhyChReconfRqstTDD-ExtIEs RNSAP-PROTOCOL-EXTENSION ::= {
    ...
}

DL-CCTrCH-InformationList-PhyChReconfRqstTDD ::= ProtocolIE-Single-Container { {DL-CCTrCH-InformationListIEs-PhyChReconfRqstTDD} }

DL-CCTrCH-InformationListIEs-PhyChReconfRqstTDD RNSAP-PROTOCOL-IES ::= {
    { ID id-DL-CCTrCH-InformationListIE-PhyChReconfRqstTDD    CRITICALITY reject    TYPE DL-CCTrCH-InformationListIE-PhyChReconfRqstTDD    PRESENCE
mandatory }
}

DL-CCTrCH-InformationListIE-PhyChReconfRqstTDD ::= SEQUENCE (SIZE (1..maxNrOfCCTrCHs)) OF DL-CCTrCH-InformationItem-PhyChReconfRqstTDD

DL-CCTrCH-InformationItem-PhyChReconfRqstTDD ::= SEQUENCE {
    cCCTrCH-ID                 CCTrCH-ID,
    dl-DPCH-Information         DL-DPCH-InformationList-PhyChReconfRqstTDD,
    iE-Extensions              ProtocolExtensionContainer { {DL-CCTrCH-InformationItem-PhyChReconfRqstTDD-ExtIEs} } OPTIONAL,

```

```

}
...
DL-CCTrCH-InformationItem-PhyChReconfRqstTDD-ExtIEs RNSAP-PROTOCOL-EXTENSION ::= {
}
...
DL-DPCH-InformationList-PhyChReconfRqstTDD ::= ProtocolIE-Single-Container {{DL-DPCH-InformationListIEs-PhyChReconfRqstTDD}}

DL-DPCH-InformationListIEs-PhyChReconfRqstTDD RNSAP-PROTOCOL-IES ::= {
  { ID id-DL-DPCH-InformationItem-PhyChReconfRqstTDD CRITICALITY notify TYPE DL-DPCH-InformationItem-PhyChReconfRqstTDD PRESENCE mandatory }
}

DL-DPCH-InformationItem-PhyChReconfRqstTDD ::= SEQUENCE {
  repetitionPeriod          RepetitionPeriod          OPTIONAL,
  repetitionLength          RepetitionLength          OPTIONAL,
  tDD-DPCHOffset            TDD-DPCHOffset            OPTIONAL,
  dL-Timeslot-InformationList-PhyChReconfRqstTDD      DL-Timeslot-InformationList-PhyChReconfRqstTDD OPTIONAL,
  iE-Extensions             ProtocolExtensionContainer { {DL-DPCH-InformationItem-PhyChReconfRqstTDD-ExtIEs} } OPTIONAL,
  ...
}

DL-DPCH-InformationItem-PhyChReconfRqstTDD-ExtIEs RNSAP-PROTOCOL-EXTENSION ::= {
  { ID id-DL-Timeslot-LCR-InformationList-PhyChReconfRqstTDD CRITICALITY reject EXTENSION DL-TimeslotLCR-InformationList-PhyChReconfRqstTDD PRESENCE optional },
  --For 1.28Mcps TDD only
  ...
}

DL-TimeslotLCR-InformationList-PhyChReconfRqstTDD ::= SEQUENCE ( SIZE (1..maxNrOfTsLCR)) OF DL-TimeslotLCR-InformationItem-PhyChReconfRqstTDD

DL-TimeslotLCR-InformationItem-PhyChReconfRqstTDD ::= SEQUENCE {
  timeSlotLCR              TimeSlotLCR,
  midambleShiftLCR         MidambleShiftLCR          OPTIONAL,
  tFCI-Presence             TFCI-Presence             OPTIONAL,
  dL-Code-Information       TDD-DL-Code-Information   OPTIONAL,
  iE-Extensions             ProtocolExtensionContainer { {DL-TimeslotLCR-InformationItem-PhyChReconfRqstTDD-ExtIEs} } OPTIONAL,
  ...
}

DL-TimeslotLCR-InformationItem-PhyChReconfRqstTDD-ExtIEs RNSAP-PROTOCOL-EXTENSION ::= {
}
...

DL-Timeslot-InformationList-PhyChReconfRqstTDD ::= SEQUENCE ( SIZE (1..maxNrOfTs)) OF DL-Timeslot-InformationItem-PhyChReconfRqstTDD

DL-Timeslot-InformationItem-PhyChReconfRqstTDD ::= SEQUENCE {
  timeSlot                  TimeSlot,
  midambleShiftAndBurstType MidambleShiftAndBurstType OPTIONAL,
  tFCI-Presence             TFCI-Presence             OPTIONAL,
  dL-Code-Information       TDD-DL-Code-Information   OPTIONAL,
  iE-Extensions             ProtocolExtensionContainer { {DL-Timeslot-InformationItem-PhyChReconfRqstTDD-ExtIEs} } OPTIONAL,
  ...
}

```

```

DL-Timeslot-InformationItem-PhyChReconfRqstTDD-ExtIEs RNSAP-PROTOCOL-EXTENSION ::= {
  ...
}

PhysicalChannelReconfigurationRequestTDD-Extensions RNSAP-PROTOCOL-EXTENSION ::= {
  ...
}

-- *****
--
-- PHYSICAL CHANNEL RECONFIGURATION COMMAND
--
-- *****

PhysicalChannelReconfigurationCommand ::= SEQUENCE {
  protocolIEs          ProtocolIE-Container    {{PhysicalChannelReconfigurationCommand-IEs}},
  protocolExtensions  ProtocolExtensionContainer {{PhysicalChannelReconfigurationCommand-Extensions}}
  ...
}

PhysicalChannelReconfigurationCommand-IEs RNSAP-PROTOCOL-IES ::= {
  { ID id-CFN          CRITICALITY ignore TYPE CFN          PRESENCE mandatory } |
  { ID id-CriticalityDiagnostics CRITICALITY ignore TYPE CriticalityDiagnostics PRESENCE optional },
  ...
}

PhysicalChannelReconfigurationCommand-Extensions RNSAP-PROTOCOL-EXTENSION ::= {
  ...
}

-- *****
--
-- PHYSICAL CHANNEL RECONFIGURATION FAILURE
--
-- *****

PhysicalChannelReconfigurationFailure ::= SEQUENCE {
  protocolIEs          ProtocolIE-Container    {{PhysicalChannelReconfigurationFailure-IEs}},
  protocolExtensions  ProtocolExtensionContainer {{PhysicalChannelReconfigurationFailure-Extensions}}
  ...
}

PhysicalChannelReconfigurationFailure-IEs RNSAP-PROTOCOL-IES ::= {
  { ID id-Cause          CRITICALITY ignore TYPE Cause          PRESENCE mandatory } |
  { ID id-CriticalityDiagnostics CRITICALITY ignore TYPE CriticalityDiagnostics PRESENCE optional },
  ...
}

PhysicalChannelReconfigurationFailure-Extensions RNSAP-PROTOCOL-EXTENSION ::= {
  ...
}

-- *****

```

```

--
-- RADIO LINK CONGESTION INDICATION
--
-- *****

RadioLinkCongestionIndication ::= SEQUENCE {
    protocolIEs          ProtocolIE-Container    {{RadioLinkCongestionIndication-IEs}},
    protocolExtensions  ProtocolExtensionContainer {{RadioLinkCongestionIndication-Extensions}}
    ...
}

RadioLinkCongestionIndication-IEs RNSAP-PROTOCOL-IES ::= {
    { ID id-CongestionCause          CRITICALITY ignore  TYPE CongestionCause          PRESENCE optional }|
    { ID id-RL-InformationList-RL-CongestInd  CRITICALITY ignore  TYPE RL-InformationList-RL-CongestInd  PRESENCE mandatory },
    ...
}

RL-InformationList-RL-CongestInd ::= SEQUENCE (SIZE (1..maxNrOfRLs)) OF ProtocolIE-Single-Container { {RL-InformationItemIEs-RL-
CongestInd} }

RL-InformationItemIEs-RL-CongestInd RNSAP-PROTOCOL-IES ::= {
    { ID id-RL-InformationItem-RL-CongestInd          CRITICALITY ignore  TYPE RL-InformationItem-RL-CongestInd  PRESENCE mandatory  }
}

RL-InformationItem-RL-CongestInd ::= SEQUENCE {
    rL-ID          RL-ID,
    dCH-Rate-Information  DCH-Rate-Information-RL-CongestInd,
    iE-Extensions      ProtocolExtensionContainer { {RL-Information-RL-CongestInd-ExtIEs} } OPTIONAL,
    ...
}

DCH-Rate-Information-RL-CongestInd ::= SEQUENCE (SIZE (1..maxNrOfDCHs)) OF ProtocolIE-Single-Container { {DCH-Rate-InformationItemIEs-RL-
CongestInd} }

DCH-Rate-InformationItemIEs-RL-CongestInd RNSAP-PROTOCOL-IES ::= {
    { ID id-DCH-Rate-InformationItem-RL-CongestInd          CRITICALITY ignore  TYPE DCH-Rate-InformationItem-RL-CongestInd  PRESENCE mandatory  }
}

DCH-Rate-InformationItem-RL-CongestInd ::= SEQUENCE {
    dCH-ID          DCH-ID,
    allowed-Rate-Information  Allowed-Rate-Information OPTIONAL,
    iE-Extensions      ProtocolExtensionContainer { {DCH-Rate-InformationItem-RL-CongestInd-ExtIEs} } OPTIONAL,
    ...
}

DCH-Rate-InformationItem-RL-CongestInd-ExtIEs RNSAP-PROTOCOL-EXTENSION ::= {
    ...
}

RL-Information-RL-CongestInd-ExtIEs RNSAP-PROTOCOL-EXTENSION ::= {
    ...
}

RadioLinkCongestionIndication-Extensions RNSAP-PROTOCOL-EXTENSION ::= {

```

```

}
...
-- *****
--
-- UPLINK SIGNALLING TRANSFER INDICATION FDD
--
-- *****

UplinkSignallingTransferIndicationFDD ::= SEQUENCE {
    protocolIEs                ProtocolIE-Container    {{UplinkSignallingTransferIndicationFDD-IEs}},
    protocolExtensions          ProtocolExtensionContainer {{UplinkSignallingTransferIndicationFDD-Extensions}}
    ...
}

UplinkSignallingTransferIndicationFDD-IEs RNSAP-PROTOCOL-IES ::= {
    { ID id-UC-ID                CRITICALITY ignore TYPE UC-ID                PRESENCE mandatory } |
    { ID id-SAI                  CRITICALITY ignore TYPE SAI                  PRESENCE mandatory } |
    { ID id-GA-Cell              CRITICALITY ignore TYPE GA-Cell              PRESENCE optional } |
    { ID id-C-RNTI               CRITICALITY ignore TYPE C-RNTI               PRESENCE mandatory } |
    { ID id-S-RNTI               CRITICALITY ignore TYPE S-RNTI               PRESENCE mandatory } |
    { ID id-D-RNTI               CRITICALITY ignore TYPE D-RNTI               PRESENCE optional } |
    { ID id-PropagationDelay      CRITICALITY ignore TYPE PropagationDelay      PRESENCE mandatory } |
    { ID id-STD-SupportIndicator  CRITICALITY ignore TYPE STD-SupportIndicator  PRESENCE mandatory } |
    { ID id-ClosedLoopModel1-SupportIndicator CRITICALITY ignore TYPE ClosedLoopModel1-SupportIndicator PRESENCE mandatory } |
    { ID id-ClosedLoopMode2-SupportIndicator CRITICALITY ignore TYPE ClosedLoopMode2-SupportIndicator PRESENCE mandatory } |
    { ID id-L3-Information        CRITICALITY ignore TYPE L3-Information        PRESENCE mandatory } |
    { ID id-CN-PS-DomainIdentifier CRITICALITY ignore TYPE CN-PS-DomainIdentifier PRESENCE optional } |
    { ID id-CN-CS-DomainIdentifier CRITICALITY ignore TYPE CN-CS-DomainIdentifier PRESENCE optional } |
    { ID id-URA-Information      CRITICALITY ignore TYPE URA-Information      PRESENCE optional },
    ...
}

UplinkSignallingTransferIndicationFDD-Extensions RNSAP-PROTOCOL-EXTENSION ::= {
    { ID id-GA-CellAdditionalShapes CRITICALITY ignore EXTENSION GA-CellAdditionalShapes PRESENCE optional } |
    { ID id-DPC-Mode-Change-SupportIndicator CRITICALITY ignore EXTENSION DPC-Mode-Change-SupportIndicator PRESENCE optional },
    ...
}

-- *****
--
-- UPLINK SIGNALLING TRANSFER INDICATION TDD
--
-- *****

UplinkSignallingTransferIndicationTDD ::= SEQUENCE {
    protocolIEs                ProtocolIE-Container    {{UplinkSignallingTransferIndicationTDD-IEs}},
    protocolExtensions          ProtocolExtensionContainer {{UplinkSignallingTransferIndicationTDD-Extensions}}
    ...
}

UplinkSignallingTransferIndicationTDD-IEs RNSAP-PROTOCOL-IES ::= {
    { ID id-UC-ID                CRITICALITY ignore TYPE UC-ID                PRESENCE mandatory } |
    { ID id-SAI                  CRITICALITY ignore TYPE SAI                  PRESENCE mandatory } |

```

```

    { ID id-GA-Cell                CRITICALITY ignore TYPE GA-Cell                PRESENCE optional } |
    { ID id-C-RNTI                 CRITICALITY ignore TYPE C-RNTI                 PRESENCE mandatory } |
    { ID id-S-RNTI                 CRITICALITY ignore TYPE S-RNTI                 PRESENCE mandatory } |
    { ID id-D-RNTI                 CRITICALITY ignore TYPE D-RNTI                 PRESENCE optional } |
    { ID id-RxTimingDeviationForTA CRITICALITY ignore TYPE RxTimingDeviationForTA PRESENCE mandatory } |
    { ID id-L3-Information          CRITICALITY ignore TYPE L3-Information          PRESENCE mandatory } |
    { ID id-CN-PS-DomainIdentifier  CRITICALITY ignore TYPE CN-PS-DomainIdentifier  PRESENCE optional } |
    { ID id-CN-CS-DomainIdentifier  CRITICALITY ignore TYPE CN-CS-DomainIdentifier  PRESENCE optional } |
    { ID id-URA-Information        CRITICALITY ignore TYPE URA-Information        PRESENCE optional },
    ...
}

UplinkSignallingTransferIndicationTDD-Extensions RNSAP-PROTOCOL-EXTENSION ::= {
    { ID id-GA-CellAdditionalShapes CRITICALITY ignore EXTENSION GA-CellAdditionalShapes PRESENCE optional },
    ...
}

-- *****
--
-- DOWNLINK SIGNALLING TRANSFER REQUEST
--
-- *****

DownlinkSignallingTransferRequest ::= SEQUENCE {
    protocolIEs          ProtocolIE-Container    {{DownlinkSignallingTransferRequest-IEs}},
    protocolExtensions  ProtocolExtensionContainer {{DownlinkSignallingTransferRequest-Extensions}}
    ...
}

DownlinkSignallingTransferRequest-IEs RNSAP-PROTOCOL-IES ::= {
    { ID id-C-ID          CRITICALITY ignore TYPE C-ID          PRESENCE mandatory } |
    { ID id-D-RNTI       CRITICALITY ignore TYPE D-RNTI       PRESENCE mandatory } |
    { ID id-L3-Information CRITICALITY ignore TYPE L3-Information PRESENCE mandatory } |
    { ID id-D-RNTI-ReleaseIndication CRITICALITY ignore TYPE D-RNTI-ReleaseIndication PRESENCE mandatory },
    ...
}

DownlinkSignallingTransferRequest-Extensions RNSAP-PROTOCOL-EXTENSION ::= {
    ...
}

-- *****
--
-- RELOCATION COMMIT
--
-- *****

RelocationCommit ::= SEQUENCE {
    protocolIEs          ProtocolIE-Container    {{RelocationCommit-IEs}},
    protocolExtensions  ProtocolExtensionContainer {{RelocationCommit-Extensions}}
    ...
}

RelocationCommit-IEs RNSAP-PROTOCOL-IES ::= {

```

```

    { ID id-D-RNTI                CRITICALITY ignore TYPE D-RNTI                PRESENCE optional } |
    { ID id-RANAP-RelocationInformation CRITICALITY ignore TYPE RANAP-RelocationInformation PRESENCE optional },
    ...
}

RelocationCommit-Extensions RNSAP-PROTOCOL-EXTENSION ::= {
    ...
}

-- *****
--
-- PAGING REQUEST
--
-- *****

PagingRequest ::= SEQUENCE {
    protocolIEs                ProtocolIE-Container    {{PagingRequest-IEs}},
    protocolExtensions         ProtocolExtensionContainer {{PagingRequest-Extensions}}    OPTIONAL,
    ...
}

PagingRequest-IEs RNSAP-PROTOCOL-IES ::= {
    { ID id-PagingArea-PagingRqst    CRITICALITY ignore TYPE PagingArea-PagingRqst    PRESENCE mandatory } |
    { ID id-SRNC-ID                  CRITICALITY ignore TYPE RNC-ID                  PRESENCE mandatory } |
    { ID id-S-RNTI                   CRITICALITY ignore TYPE S-RNTI                   PRESENCE mandatory } |
    { ID id-IMSI                     CRITICALITY ignore TYPE IMSI                     PRESENCE mandatory } |
    { ID id-DRXCycleLengthCoefficient CRITICALITY ignore TYPE DRXCycleLengthCoefficient PRESENCE mandatory } |
    { ID id-CNOriginatedPage-PagingRqst CRITICALITY ignore TYPE CNOriginatedPage-PagingRqst PRESENCE optional },
    ...
}

PagingArea-PagingRqst ::= CHOICE {
    uRA                URA-PagingRqst,
    cell               Cell-PagingRqst,
    ...
}

URA-PagingRqst ::= SEQUENCE {
    uRA-ID                URA-ID,
    iE-Extensions         ProtocolExtensionContainer { { URAItem-PagingRqst-ExtIEs } } OPTIONAL,
    ...
}

URAItem-PagingRqst-ExtIEs RNSAP-PROTOCOL-EXTENSION ::= {
    ...
}

Cell-PagingRqst ::= SEQUENCE {
    c-ID                C-ID,
    iE-Extensions         ProtocolExtensionContainer { { CellItem-PagingRqst-ExtIEs } } OPTIONAL,
    ...
}

CellItem-PagingRqst-ExtIEs RNSAP-PROTOCOL-EXTENSION ::= {

```



```

    ...
}

CNOOriginatedPage-PagingRqst ::= SEQUENCE {
    pagingCause          PagingCause,
    cNDomainType        CNDomainType,
    pagingRecordType    PagingRecordType,
    iE-Extensions       ProtocolExtensionContainer { { CNOOriginatedPage-PagingRqst-ExtIEs } } OPTIONAL,
    ...
}

CNOOriginatedPage-PagingRqst-ExtIEs RNSAP-PROTOCOL-EXTENSION ::= {
    ...
}

PagingRequest-Extensions RNSAP-PROTOCOL-EXTENSION ::= {
    ...
}

-- *****
--
-- DEDICATED MEASUREMENT INITIATION REQUEST
--
-- *****

DedicatedMeasurementInitiationRequest ::= SEQUENCE {
    protocolIEs          ProtocolIE-Container    {{{DedicatedMeasurementInitiationRequest-IEs}}},
    protocolExtensions   ProtocolExtensionContainer {{{DedicatedMeasurementInitiationRequest-Extensions}}} OPTIONAL,
    ...
}

DedicatedMeasurementInitiationRequest-IEs RNSAP-PROTOCOL-IES ::= {
    { ID id-MeasurementID          CRITICALITY reject TYPE MeasurementID          PRESENCE mandatory } |
    { ID id-DedicatedMeasurementObjectType-DM-Rqst CRITICALITY reject TYPE DedicatedMeasurementObjectType-DM-Rqst PRESENCE mandatory } |
    -- This IE represents both the Dedicated Measurement Object Type IE and the choice based on the Dedicated Measurement Object Type
    -- as described in the tabular message format in subclause 9.1.
    { ID id-DedicatedMeasurementType          CRITICALITY reject TYPE DedicatedMeasurementType          PRESENCE mandatory } |
    { ID id-MeasurementFilterCoefficient      CRITICALITY reject TYPE MeasurementFilterCoefficient      PRESENCE optional } |
    { ID id-ReportCharacteristics            CRITICALITY reject TYPE ReportCharacteristics            PRESENCE mandatory } |
    { ID id-CFNReportingIndicator            CRITICALITY reject TYPE FNReportingIndicator            PRESENCE mandatory } |
    { ID id-CFN                              CRITICALITY reject TYPE CFN                              PRESENCE optional },
    ...
}

DedicatedMeasurementObjectType-DM-Rqst ::= CHOICE {
    rL          RL-DM-Rqst,
    rLS         RL-Set-DM-Rqst,
    allRL       All-RL-DM-Rqst,
    allRLS      All-RL-Set-DM-Rqst,
    ...
}

RL-DM-Rqst ::= SEQUENCE {
    rL-InformationList-DM-Rqst    RL-InformationList-DM-Rqst,

```

```

    iE-Extensions          ProtocolExtensionContainer { { RLIItem-DM-Rqst-ExtIEs } } OPTIONAL,
    ...
  }

RLItem-DM-Rqst-ExtIEs RNSAP-PROTOCOL-EXTENSION ::= {
  ...
}

RL-InformationList-DM-Rqst          ::= SEQUENCE (SIZE (1..maxNrOfRLs)) OF ProtocolIE-Single-Container { {RL-Information-DM-Rqst-IEs} }

RL-Information-DM-Rqst-IEs RNSAP-PROTOCOL-IES ::= {
  { ID id-RL-InformationItem-DM-Rqst          CRITICALITY reject  TYPE RL-InformationItem-DM-Rqst          PRESENCE mandatory  }
}

RL-InformationItem-DM-Rqst ::= SEQUENCE {
  rL-ID          RL-ID,
  dPCH-ID        DPCH-ID          OPTIONAL,
  iE-Extensions          ProtocolExtensionContainer { {RL-InformationItem-DM-Rqst-ExtIEs} } OPTIONAL,
  ...
}

RL-InformationItem-DM-Rqst-ExtIEs RNSAP-PROTOCOL-EXTENSION ::= {
  ...
}

RL-Set-DM-Rqst ::= SEQUENCE {
  rL-Set-InformationList-DM-Rqst  RL-Set-InformationList-DM-Rqst,
  iE-Extensions          ProtocolExtensionContainer { { RL-SetItem-DM-Rqst-ExtIEs } } OPTIONAL,
  ...
}

RL-SetItem-DM-Rqst-ExtIEs RNSAP-PROTOCOL-EXTENSION ::= {
  ...
}

RL-Set-InformationList-DM-Rqst          ::= SEQUENCE (SIZE (1..maxNrOfRLSets)) OF ProtocolIE-Single-Container { {RL-Set-Information-DM-Rqst-IEs} }

RL-Set-Information-DM-Rqst-IEs RNSAP-PROTOCOL-IES ::= {
  { ID id-RL-Set-InformationItem-DM-Rqst          CRITICALITY reject  TYPE RL-Set-InformationItem-DM-Rqst          PRESENCE mandatory  }
}

RL-Set-InformationItem-DM-Rqst ::= SEQUENCE {
  rL-Set-ID          RL-Set-ID,
  iE-Extensions          ProtocolExtensionContainer { {RL-Set-InformationItem-DM-Rqst-ExtIEs} } OPTIONAL,
  ...
}

RL-Set-InformationItem-DM-Rqst-ExtIEs RNSAP-PROTOCOL-EXTENSION ::= {
  ...
}

All-RL-DM-Rqst ::= NULL

```

```

All-RL-Set-DM-Rqst ::= NULL

DedicatedMeasurementInitiationRequest-Extensions RNSAP-PROTOCOL-EXTENSION ::= {
  ...
}

-- *****
--
-- DEDICATED MEASUREMENT INITIATION RESPONSE
--
-- *****

DedicatedMeasurementInitiationResponse ::= SEQUENCE {
  protocolIEs          ProtocolIE-Container    {{DedicatedMeasurementInitiationResponse-IEs}},
  protocolExtensions   ProtocolExtensionContainer {{DedicatedMeasurementInitiationResponse-Extensions}}
  ...
}

DedicatedMeasurementInitiationResponse-IEs RNSAP-PROTOCOL-IES ::= {
  { ID id-MeasurementID          CRITICALITY ignore TYPE MeasurementID          PRESENCE mandatory } |
  { ID id-DedicatedMeasurementObjectType-DM-Rsp CRITICALITY ignore TYPE DedicatedMeasurementObjectType-DM-Rsp PRESENCE optional } |
  { ID id-CriticalityDiagnostics CRITICALITY ignore TYPE CriticalityDiagnostics PRESENCE optional },
  ...
}

DedicatedMeasurementObjectType-DM-Rsp ::= CHOICE {
  rLs          RL-DM-Rsp,
  rLS          RL-Set-DM-Rsp,
  allRL       RL-DM-Rsp,
  allRLS      RL-Set-DM-Rsp,
  ...
}

RL-DM-Rsp ::= SEQUENCE {
  rL-InformationList-DM-Rsp  RL-InformationList-DM-Rsp,
  iE-Extensions              ProtocolExtensionContainer { { RLItem-DM-Rsp-ExtIEs } } OPTIONAL,
  ...
}

RLItem-DM-Rsp-ExtIEs RNSAP-PROTOCOL-EXTENSION ::= {
  ...
}

RL-Set-DM-Rsp ::= SEQUENCE {
  rL-Set-InformationList-DM-Rsp  RL-Set-InformationList-DM-Rsp,
  iE-Extensions                  ProtocolExtensionContainer { { RL-SetItem-DM-Rsp-ExtIEs } } OPTIONAL,
  ...
}

RL-SetItem-DM-Rsp-ExtIEs RNSAP-PROTOCOL-EXTENSION ::= {
  ...
}

RL-InformationList-DM-Rsp ::= SEQUENCE (SIZE (1..maxNrOfRLs)) OF ProtocolIE-Single-Container { {RL-Information-DM-Rsp-IEs} }

```

```

RL-Information-DM-Rsp-IEs RNSAP-PROTOCOL-IES ::= {
  { ID id-RL-InformationItem-DM-Rsp          CRITICALITY ignore  TYPE RL-InformationItem-DM-Rsp  PRESENCE mandatory  }
}

RL-InformationItem-DM-Rsp ::= SEQUENCE {
  rL-ID                RL-ID,
  dPCH-ID              DPCH-ID                OPTIONAL,
  dedicatedMeasurementValue  DedicatedMeasurementValue,
  cFN                  CFN                    OPTIONAL,
  iE-Extensions        ProtocolExtensionContainer { {RL-InformationItem-DM-Rsp-ExtIEs} } OPTIONAL,
  ...
}

RL-InformationItem-DM-Rsp-ExtIEs RNSAP-PROTOCOL-EXTENSION ::= {
  ...
}

RL-Set-InformationList-DM-Rsp          ::= SEQUENCE (SIZE (1..maxNrOfRLSets)) OF ProtocolIE-Single-Container { {RL-Set-Information-DM-Rsp-IEs} }

RL-Set-Information-DM-Rsp-IEs RNSAP-PROTOCOL-IES ::= {
  { ID id-RL-Set-InformationItem-DM-Rsp          CRITICALITY ignore  TYPE RL-Set-InformationItem-DM-Rsp  PRESENCE mandatory  }
}

RL-Set-InformationItem-DM-Rsp ::= SEQUENCE {
  rL-Set-ID                RL-Set-ID,
  dedicatedMeasurementValue  DedicatedMeasurementValue,
  cFN                      CFN                    OPTIONAL,
  iE-Extensions            ProtocolExtensionContainer { {RL-Set-InformationItem-DM-Rspns-ExtIEs} } OPTIONAL,
  ...
}

RL-Set-InformationItem-DM-Rspns-ExtIEs RNSAP-PROTOCOL-EXTENSION ::= {
  ...
}

DedicatedMeasurementInitiationResponse-Extensions RNSAP-PROTOCOL-EXTENSION ::= {
  ...
}

-- *****
--
-- DEDICATED MEASUREMENT INITIATION FAILURE
--
-- *****

DedicatedMeasurementInitiationFailure ::= SEQUENCE {
  protocolIEs                ProtocolIE-Container  {{DedicatedMeasurementInitiationFailure-IEs}},
  protocolExtensions        ProtocolExtensionContainer {{DedicatedMeasurementInitiationFailure-Extensions}}
  ...
}

DedicatedMeasurementInitiationFailure-IEs RNSAP-PROTOCOL-IES ::= {

```

```

    { ID id-MeasurementID          CRITICALITY ignore TYPE MeasurementID          PRESENCE mandatory } |
    { ID id-Cause                  CRITICALITY ignore TYPE Cause                  PRESENCE mandatory } |
    { ID id-CriticalityDiagnostics CRITICALITY ignore TYPE CriticalityDiagnostics PRESENCE optional },
    ...
}

DedicatedMeasurementInitiationFailure-Extensions RNSAP-PROTOCOL-EXTENSION ::= {
    ...
}

-- *****
--
-- DEDICATED MEASUREMENT REPORT
--
-- *****

DedicatedMeasurementReport ::= SEQUENCE {
    protocolIEs          ProtocolIE-Container    {{DedicatedMeasurementReport-IEs}},
    protocolExtensions   ProtocolExtensionContainer {{DedicatedMeasurementReport-Extensions}}          OPTIONAL,
    ...
}

DedicatedMeasurementReport-IEs RNSAP-PROTOCOL-IES ::= {
    { ID id-MeasurementID          CRITICALITY ignore TYPE MeasurementID          PRESENCE mandatory } |
    { ID id-DedicatedMeasurementObjectType-DM-Rprt CRITICALITY ignore TYPE DedicatedMeasurementObjectType-DM-Rprt PRESENCE mandatory },
    ...
}

DedicatedMeasurementObjectType-DM-Rprt ::= CHOICE {
    rLs          RL-DM-Rprt,
    rLS          RL-Set-DM-Rprt,
    allRL        RL-DM-Rprt,
    allRLS       RL-Set-DM-Rprt,
    ...
}

RL-DM-Rprt ::= SEQUENCE {
    rL-InformationList-DM-Rprt    RL-InformationList-DM-Rprt,
    iE-Extensions                 ProtocolExtensionContainer { { RLItem-DM-Rprt-ExtIEs } } OPTIONAL,
    ...
}

RLItem-DM-Rprt-ExtIEs RNSAP-PROTOCOL-EXTENSION ::= {
    ...
}

RL-Set-DM-Rprt ::= SEQUENCE {
    rL-Set-InformationList-DM-Rprt    RL-Set-InformationList-DM-Rprt,
    iE-Extensions                     ProtocolExtensionContainer { { RL-SetItem-DM-Rprt-ExtIEs } } OPTIONAL,
    ...
}

RL-SetItem-DM-Rprt-ExtIEs RNSAP-PROTOCOL-EXTENSION ::= {
    ...
}

```

```

}
RL-InformationList-DM-Rprt ::= SEQUENCE (SIZE (1..maxNrOfRLs)) OF ProtocolIE-Single-Container { {RL-Information-DM-Rprt-IEs} }
RL-Information-DM-Rprt-IEs RNSAP-PROTOCOL-IES ::= {
  { ID id-RL-InformationItem-DM-Rprt CRITICALITY ignore TYPE RL-InformationItem-DM-Rprt PRESENCE mandatory }
}
RL-InformationItem-DM-Rprt ::= SEQUENCE {
  rL-ID RL-ID,
  dPCH-ID DPCH-ID OPTIONAL,
  dedicatedMeasurementValueInformation DedicatedMeasurementValueInformation,
  iE-Extensions ProtocolExtensionContainer { {RL-InformationItem-DM-Rprt-ExtIEs} } OPTIONAL,
  ...
}
RL-InformationItem-DM-Rprt-ExtIEs RNSAP-PROTOCOL-EXTENSION ::= {
  ...
}
RL-Set-InformationList-DM-Rprt ::= SEQUENCE (SIZE (1..maxNrOfRLSets)) OF ProtocolIE-Single-Container { {RL-Set-Information-DM-
Rprt-IEs} }
RL-Set-Information-DM-Rprt-IEs RNSAP-PROTOCOL-IES ::= {
  { ID id-RL-Set-InformationItem-DM-Rprt CRITICALITY ignore TYPE RL-Set-InformationItem-DM-Rprt PRESENCE mandatory }
}
RL-Set-InformationItem-DM-Rprt ::= SEQUENCE {
  rL-Set-ID RL-Set-ID,
  dedicatedMeasurementValueInformation DedicatedMeasurementValueInformation,
  iE-Extensions ProtocolExtensionContainer { {RL-Set-InformationItem-DM-Rprt-ExtIEs} } OPTIONAL,
  ...
}
RL-Set-InformationItem-DM-Rprt-ExtIEs RNSAP-PROTOCOL-EXTENSION ::= {
  ...
}
DedicatedMeasurementReport-Extensions RNSAP-PROTOCOL-EXTENSION ::= {
  ...
}
-- *****
--
-- DEDICATED MEASUREMENT TERMINATION REQUEST
--
-- *****
DedicatedMeasurementTerminationRequest ::= SEQUENCE {
  protocolIEs ProtocolIE-Container {{DedicatedMeasurementTerminationRequest-IEs}},
  protocolExtensions ProtocolExtensionContainer {{DedicatedMeasurementTerminationRequest-Extensions}} OPTIONAL,
  ...
}

```

```

DedicatedMeasurementTerminationRequest-IEs RNSAP-PROTOCOL-IES ::= {
  { ID id-MeasurementID          CRITICALITY ignore  TYPE MeasurementID          PRESENCE mandatory },
  ...
}

DedicatedMeasurementTerminationRequest-Extensions RNSAP-PROTOCOL-EXTENSION ::= {
  ...
}

-- *****
--
-- DEDICATED MEASUREMENT FAILURE INDICATION
--
-- *****

DedicatedMeasurementFailureIndication ::= SEQUENCE {
  protocolIEs          ProtocolIE-Container    {{DedicatedMeasurementFailureIndication-IEs}},
  protocolExtensions  ProtocolExtensionContainer {{DedicatedMeasurementFailureIndication-Extensions}}
  ...
}
OPTIONAL,

DedicatedMeasurementFailureIndication-IEs RNSAP-PROTOCOL-IES ::= {
  { ID id-MeasurementID          CRITICALITY ignore  TYPE MeasurementID          PRESENCE mandatory } |
  { ID id-Cause                  CRITICALITY ignore  TYPE Cause                  PRESENCE mandatory },
  ...
}

DedicatedMeasurementFailureIndication-Extensions RNSAP-PROTOCOL-EXTENSION ::= {
  ...
}

-- *****
--
-- COMMON TRANSPORT CHANNEL RESOURCES RELEASE REQUEST
--
-- *****

CommonTransportChannelResourcesReleaseRequest ::= SEQUENCE {
  protocolIEs          ProtocolIE-Container    {{CommonTransportChannelResourcesReleaseRequest-IEs}},
  protocolExtensions  ProtocolExtensionContainer {{CommonTransportChannelResourcesReleaseRequest-Extensions}}
OPTIONAL,
  ...
}

CommonTransportChannelResourcesReleaseRequest-IEs RNSAP-PROTOCOL-IES ::= {
  { ID id-D-RNTI            CRITICALITY ignore  TYPE D-RNTI            PRESENCE mandatory },
  ...
}

CommonTransportChannelResourcesReleaseRequest-Extensions RNSAP-PROTOCOL-EXTENSION ::= {
  ...
}

-- *****

```

```

--
-- COMMON TRANSPORT CHANNEL RESOURCES REQUEST
--
-- *****

CommonTransportChannelResourcesRequest ::= SEQUENCE {
    protocolIEs          ProtocolIE-Container    {{CommonTransportChannelResourcesRequest-IEs}},
    protocolExtensions   ProtocolExtensionContainer {{CommonTransportChannelResourcesRequest-Extensions}}    OPTIONAL,
    ...
}

CommonTransportChannelResourcesRequest-IEs RNSAP-PROTOCOL-IES ::= {
    { ID id-D-RNTI          CRITICALITY reject  TYPE D-RNTI          PRESENCE mandatory } |
    { ID id-C-ID           CRITICALITY reject  TYPE C-ID           PRESENCE optional   } |
    { ID id-TransportBearerRequestIndicator CRITICALITY reject  TYPE TransportBearerRequestIndicator PRESENCE mandatory } |
    { ID id-TransportBearerID CRITICALITY reject  TYPE TransportBearerID          PRESENCE mandatory },
    ...
}

CommonTransportChannelResourcesRequest-Extensions RNSAP-PROTOCOL-EXTENSION ::= {
    { ID id-Permanent-NAS-UE-Identity          CRITICALITY ignore          EXTENSION Permanent-NAS-UE-Identity PRESENCE optional },
    ...
}

-- *****
--
-- COMMON TRANSPORT CHANNEL RESOURCES RESPONSE FDD
--
-- *****

CommonTransportChannelResourcesResponseFDD ::= SEQUENCE {
    protocolIEs          ProtocolIE-Container    {{CommonTransportChannelResourcesResponseFDD-IEs}},
    protocolExtensions   ProtocolExtensionContainer {{CommonTransportChannelResourcesResponseFDD-Extensions}}    OPTIONAL,
    ...
}

CommonTransportChannelResourcesResponseFDD-IEs RNSAP-PROTOCOL-IES ::= {
    { ID id-S-RNTI          CRITICALITY ignore  TYPE S-RNTI          PRESENCE mandatory } |
    { ID id-C-RNTI          CRITICALITY ignore  TYPE C-RNTI          PRESENCE optional   } |
    { ID id-FACH-InfoForUESelectedS-CCPCH-CTCH-ResourceRspFDD CRITICALITY ignore  TYPE FACH-InfoForUESelectedS-CCPCH-CTCH-ResourceRspFDD PRESENCE mandatory } |
    { ID id-TransportLayerAddress CRITICALITY ignore  TYPE TransportLayerAddress          PRESENCE optional } |
    { ID id-BindingID        CRITICALITY ignore  TYPE BindingID          PRESENCE optional } |
    { ID id-CriticalityDiagnostics CRITICALITY ignore  TYPE CriticalityDiagnostics          PRESENCE optional },
    ...
}

FACH-InfoForUESelectedS-CCPCH-CTCH-ResourceRspFDD ::= SEQUENCE {
    fACH-FlowControlInformation FACH-FlowControlInformation-CTCH-ResourceRspFDD,
    iE-Extensions               ProtocolExtensionContainer { {FACH-InfoForUESelectedS-CCPCH-CTCH-ResourceRspFDD-ExtIEs} } OPTIONAL,
    ...
}

FACH-InfoForUESelectedS-CCPCH-CTCH-ResourceRspFDD-ExtIEs RNSAP-PROTOCOL-EXTENSION ::= {

```



```

    ...
}

FACH-FlowControlInformation-CTCH-ResourceRspFDD ::= ProtocolIE-Single-Container {{ FACH-FlowControlInformationIEs-CTCH-ResourceRspFDD }}

FACH-FlowControlInformationIEs-CTCH-ResourceRspFDD RNSAP-PROTOCOL-IES ::= {
  { ID id-FACH-FlowControlInformation CRITICALITY ignore TYPE FACH-FlowControlInformation PRESENCE mandatory }
}

CommonTransportChannelResourcesResponseFDD-Extensions RNSAP-PROTOCOL-EXTENSION ::= {
  { ID id-C-ID CRITICALITY ignore EXTENSION C-ID PRESENCE mandatory },
  ...
}

-- *****
--
-- COMMON TRANSPORT CHANNEL RESOURCES RESPONSE TDD
--
-- *****

CommonTransportChannelResourcesResponseTDD ::= SEQUENCE {
  protocolIEs ProtocolIE-Container {{CommonTransportChannelResourcesResponseTDD-IEs}},
  protocolExtensions ProtocolExtensionContainer {{CommonTransportChannelResourcesResponseTDD-Extensions}} OPTIONAL,
  ...
}

CommonTransportChannelResourcesResponseTDD-IEs RNSAP-PROTOCOL-IES ::= {
  { ID id-S-RNTI CRITICALITY ignore TYPE S-RNTI PRESENCE mandatory } |
  { ID id-C-RNTI CRITICALITY ignore TYPE C-RNTI PRESENCE optional } |
  { ID id-FACH-InfoForUESelectedS-CCPCH-CTCH-ResourceRspTDD CRITICALITY ignore TYPE FACH-InfoForUESelectedS-CCPCH-CTCH-ResourceRspTDD
  PRESENCE mandatory } |
  { ID id-TransportLayerAddress CRITICALITY ignore TYPE TransportLayerAddress PRESENCE optional } |
  { ID id-BindingID CRITICALITY ignore TYPE BindingID PRESENCE optional } |
  { ID id-CriticalityDiagnostics CRITICALITY ignore TYPE CriticalityDiagnostics PRESENCE optional },
  ...
}

FACH-InfoForUESelectedS-CCPCH-CTCH-ResourceRspTDD ::= SEQUENCE {
  fACH-FlowControlInformation FACH-FlowControlInformation-CTCH-ResourceRspTDD,
  IE-Extensions ProtocolExtensionContainer { {FACH-InfoForUESelectedS-CCPCH-CTCH-ResourceRspTDD-ExtIEs} } OPTIONAL,
  ...
}

FACH-InfoForUESelectedS-CCPCH-CTCH-ResourceRspTDD-ExtIEs RNSAP-PROTOCOL-EXTENSION ::= {
  ...
}

FACH-FlowControlInformation-CTCH-ResourceRspTDD ::= ProtocolIE-Single-Container {{ FACH-FlowControlInformationIEs-CTCH-ResourceRspTDD }}

FACH-FlowControlInformationIEs-CTCH-ResourceRspTDD RNSAP-PROTOCOL-IES ::= {
  { ID id-FACH-FlowControlInformation CRITICALITY ignore TYPE FACH-FlowControlInformation PRESENCE mandatory }
}

CommonTransportChannelResourcesResponseTDD-Extensions RNSAP-PROTOCOL-EXTENSION ::= {

```

```

    { ID id-C-ID                CRITICALITY ignore     EXTENSION  C-ID          PRESENCE mandatory },
    ...
}

-- *****
--
-- COMMON TRANSPORT CHANNEL RESOURCES FAILURE
--
-- *****

CommonTransportChannelResourcesFailure ::= SEQUENCE {
    protocolIEs                ProtocolIE-Container   {{CommonTransportChannelResourcesFailure-IEs}},
    protocolExtensions         ProtocolExtensionContainer {{CommonTransportChannelResourcesFailure-Extensions}}    OPTIONAL,
    ...
}

CommonTransportChannelResourcesFailure-IEs RNSAP-PROTOCOL-IES ::= {
    { ID id-S-RNTI              CRITICALITY ignore     TYPE S-RNTI          PRESENCE mandatory } |
    { ID id-Cause               CRITICALITY ignore     TYPE Cause           PRESENCE mandatory } |
    { ID id-CriticalityDiagnostics CRITICALITY ignore     TYPE CriticalityDiagnostics PRESENCE optional },
    ...
}

CommonTransportChannelResourcesFailure-Extensions RNSAP-PROTOCOL-EXTENSION ::= {
    ...
}

-- *****
--
-- COMPRESSED MODE COMMAND
--
-- *****

CompressedModeCommand ::= SEQUENCE {
    protocolIEs                ProtocolIE-Container   {{CompressedModeCommand-IEs}},
    protocolExtensions         ProtocolExtensionContainer {{CompressedModeCommand-Extensions}}    OPTIONAL,
    ...
}

CompressedModeCommand-IEs RNSAP-PROTOCOL-IES ::= {
    { ID id-Active-Pattern-Sequence-Information CRITICALITY ignore     TYPE Active-Pattern-Sequence-Information PRESENCE mandatory },
    ...
}

CompressedModeCommand-Extensions RNSAP-PROTOCOL-EXTENSION ::= {
    ...
}

-- *****
--
-- ERROR INDICATION
--
-- *****

```

```

ErrorIndication ::= SEQUENCE {
    protocolIEs          ProtocolIE-Container    {{ErrorIndication-IEs}},
    protocolExtensions   ProtocolExtensionContainer {{ErrorIndication-Extensions}}    OPTIONAL,
    ...
}

ErrorIndication-IEs RNSAP-PROTOCOL-IES ::= {
    { ID id-Cause          CRITICALITY ignore TYPE Cause          PRESENCE optional } |
    { ID id-CriticalityDiagnostics CRITICALITY ignore TYPE CriticalityDiagnostics PRESENCE optional },
    ...
}

ErrorIndication-Extensions RNSAP-PROTOCOL-EXTENSION ::= {
    { ID id-S-RNTI          CRITICALITY ignore EXTENSION S-RNTI          PRESENCE optional } |
    { ID id-D-RNTI          CRITICALITY ignore EXTENSION D-RNTI          PRESENCE optional },
    ...
}

-- *****
--
-- COMMON MEASUREMENT INITIATION REQUEST
--
-- *****

CommonMeasurementInitiationRequest ::= SEQUENCE {
    protocolIEs          ProtocolIE-Container    {{CommonMeasurementInitiationRequest-IEs}},
    protocolExtensions   ProtocolExtensionContainer {{CommonMeasurementInitiationRequest-Extensions}}    OPTIONAL,
    ...
}

CommonMeasurementInitiationRequest-IEs RNSAP-PROTOCOL-IES ::= {
    { ID id-MeasurementID          CRITICALITY reject          TYPE MeasurementID          PRESENCE
    mandatory }|
    { ID id-CommonMeasurementObjectType-CM-Rqst          CRITICALITY reject          TYPE CommonMeasurementObjectType-CM-Rqst          PRESENCE
    mandatory }|
    -- This IE represents both the Common Measurement Object Type IE and the choice based on the Common Measurement Object Type
    -- as described in the tabular message format in subclause 9.1.
    { ID id-CommonMeasurementType          CRITICALITY reject          TYPE CommonMeasurementType          PRESENCE
    mandatory }|
    { ID id-MeasurementFilterCoefficient          CRITICALITY reject          TYPE MeasurementFilterCoefficient          PRESENCE optional
    }|
    { ID id-ReportCharacteristics          CRITICALITY reject          TYPE ReportCharacteristics          PRESENCE
    mandatory }|
    { ID id-SFNReportingIndicator          CRITICALITY reject          TYPE FNReportingIndicator          PRESENCE
    mandatory
    } |
    { ID id-SFN          CRITICALITY reject          TYPE SFN          PRESENCE optional
    }|
    { ID id-CommonMeasurementAccuracy          CRITICALITY reject          TYPE CommonMeasurementAccuracy          PRESENCE optional
    },
    ...
}

CommonMeasurementInitiationRequest-Extensions RNSAP-PROTOCOL-EXTENSION ::= {

```

```

}
...
}
CommonMeasurementObjectType-CM-Rqst ::= CHOICE {
    cell                Cell-CM-Rqst,
    ...
}
Cell-CM-Rqst ::= SEQUENCE {
    uC-ID                UC-ID,
    timeSlot             TimeSlot          OPTIONAL,  --3.84Mcps TDD only
    timeSlotLCR         TimeSlotLCR       OPTIONAL,  --1.28Mcps TDD only
    neighbouringCellMeasurementInformation NeighbouringCellMeasurementInfo OPTIONAL,
    -- UTRAN only
    iE-Extensions       ProtocolExtensionContainer { { CellItem-CM-Rqst-ExtIEs} } OPTIONAL,
    ...
}
NeighbouringCellMeasurementInfo ::= SEQUENCE (SIZE (1..maxNrOfMeasNCell)) OF
    CHOICE {
        neighbouringFDDCellMeasurementInformation NeighbouringFDDCellMeasurementInformation,
        neighbouringTDDCellMeasurementInformation NeighbouringTDDCellMeasurementInformation,
        ...
    }
}
CellItem-CM-Rqst-ExtIEs RNSAP-PROTOCOL-EXTENSION ::= {
    ...
}
-- *****
--
-- COMMON MEASUREMENT INITIATION RESPONSE
--
-- *****
CommonMeasurementInitiationResponse ::= SEQUENCE {
    protocolIEs          ProtocolIE-Container  {{CommonMeasurementInitiationResponse-IEs}},
    protocolExtensions   ProtocolExtensionContainer {{CommonMeasurementInitiationResponse-Extensions}} OPTIONAL,
    ...
}
CommonMeasurementInitiationResponse-IEs RNSAP-PROTOCOL-IES ::= {
    { ID      id-MeasurementID                CRITICALITY ignore          TYPE      MeasurementID          PRESENCE
    mandatory }|
    { ID      id-CommonMeasurementObjectType-CM-Rsp CRITICALITY ignore          TYPE      CommonMeasurementObjectType-CM-Rsp PRESENCE optional
    }|
    { ID      id-SFN                          CRITICALITY ignore          TYPE      SFN                          PRESENCE optional
    }|
    { ID      id-CriticalityDiagnostics        CRITICALITY ignore          TYPE      CriticalityDiagnostics        PRESENCE optional
    }|
    { ID      id-CommonMeasurementAccuracy     CRITICALITY reject          TYPE      CommonMeasurementAccuracy     PRESENCE optional
    },
    ...
}
}

```

```

CommonMeasurementInitiationResponse-Extensions RNSAP-PROTOCOL-EXTENSION ::= {
  ...
}

CommonMeasurementObjectType-CM-Rsp ::= CHOICE {
  cell                               Cell-CM-Rsp,
  ...
}

Cell-CM-Rsp ::= SEQUENCE {
  commonMeasurementValue             CommonMeasurementValue,
  iE-Extensions                      ProtocolExtensionContainer { { CellItem-CM-Rsp-ExtIEs } } OPTIONAL,
  ...
}

CellItem-CM-Rsp-ExtIEs RNSAP-PROTOCOL-EXTENSION ::= {
  ...
}

-- *****
--
-- COMMON MEASUREMENT INITIATION FAILURE
--
-- *****

CommonMeasurementInitiationFailure ::= SEQUENCE {
  protocolIEs                       ProtocolIE-Container {{CommonMeasurementInitiationFailure-IEs}},
  protocolExtensions                 ProtocolExtensionContainer {{CommonMeasurementInitiationFailure-Extensions}} OPTIONAL,
  ...
}

CommonMeasurementInitiationFailure-IEs RNSAP-PROTOCOL-IES ::= {
  { ID      id-MeasurementID          CRITICALITY  ignore          TYPE      MeasurementID      PRESENCE mandatory }|
  { ID      id-Cause                  CRITICALITY  ignore          TYPE      Cause                  PRESENCE mandatory }|
  { ID      id-CriticalityDiagnostics CRITICALITY  ignore          TYPE      CriticalityDiagnostics PRESENCE optional },
  ...
}

CommonMeasurementInitiationFailure-Extensions RNSAP-PROTOCOL-EXTENSION ::= {
  ...
}

-- *****
--
-- COMMON MEASUREMENT REPORT
--
-- *****

CommonMeasurementReport ::= SEQUENCE {
  protocolIEs                       ProtocolIE-Container {{CommonMeasurementReport-IEs}},
  protocolExtensions                 ProtocolExtensionContainer {{CommonMeasurementReport-Extensions}} OPTIONAL,
  ...
}

```

```

CommonMeasurementReport-IEs RNSAP-PROTOCOL-IES ::= {
  { ID      id-MeasurementID          CRITICALITY ignore          TYPE      MeasurementID          PRESENCE mandatory }|
  { ID      id-CommonMeasurementObjectType-CM-Rprt  CRITICALITY ignore          TYPE      CommonMeasurementObjectType-CM-Rprt  PRESENCE
  mandatory }|
  { ID      id-SFN                    CRITICALITY ignore          TYPE      SFN                    PRESENCE optional },
  ...
}

CommonMeasurementReport-Extensions RNSAP-PROTOCOL-EXTENSION ::= {
  ...
}

CommonMeasurementObjectType-CM-Rprt ::= CHOICE {
  cell                Cell-CM-Rprt,
  ...
}

Cell-CM-Rprt ::= SEQUENCE {
  commonMeasurementValueInformation CommonMeasurementValueInformation,
  iE-Extensions                ProtocolExtensionContainer {{ CellItem-CM-Rprt-ExtIEs }} OPTIONAL,
  ...
}

CellItem-CM-Rprt-ExtIEs RNSAP-PROTOCOL-EXTENSION ::= {
  ...
}

-- *****
--
-- COMMON MEASUREMENT TERMINATION REQUEST
--
-- *****

CommonMeasurementTerminationRequest ::= SEQUENCE {
  protocolIEs                ProtocolIE-Container {{CommonMeasurementTerminationRequest-IEs}},
  protocolExtensions          ProtocolExtensionContainer {{CommonMeasurementTerminationRequest-Extensions}} OPTIONAL,
  ...
}

CommonMeasurementTerminationRequest-IEs RNSAP-PROTOCOL-IES ::= {
  { ID      id-MeasurementID          CRITICALITY ignore          TYPE      MeasurementID          PRESENCE mandatory},
  ...
}

CommonMeasurementTerminationRequest-Extensions RNSAP-PROTOCOL-EXTENSION ::= {
  ...
}

-- *****
--
-- COMMON MEASUREMENT FAILURE INDICATION
--

```

```

-- *****
CommonMeasurementFailureIndication ::= SEQUENCE {
    protocolIEs          ProtocolIE-Container    {{CommonMeasurementFailureIndication-IEs}},
    protocolExtensions   ProtocolExtensionContainer {{CommonMeasurementFailureIndication-Extensions}}    OPTIONAL,
    ...
}

CommonMeasurementFailureIndication-IEs RNSAP-PROTOCOL-IES ::= {
    { ID    id-MeasurementID          CRITICALITY ignore      TYPE    MeasurementID          PRESENCE mandatory  }|
    { ID    id-Cause                  CRITICALITY ignore      TYPE    Cause                  PRESENCE mandatory  }|
    ...
}

CommonMeasurementFailureIndication-Extensions RNSAP-PROTOCOL-EXTENSION ::= {
    ...
}

-- *****
--
-- INFORMATION EXCHANGE INITIATION REQUEST
--
-- *****

InformationExchangeInitiationRequest ::= SEQUENCE {
    protocolIEs          ProtocolIE-Container    {{InformationExchangeInitiationRequest-IEs}},
    protocolExtensions   ProtocolExtensionContainer {{InformationExchangeInitiationRequest-Extensions}}    OPTIONAL,
    ...
}

InformationExchangeInitiationRequest-IEs RNSAP-PROTOCOL-IES ::= {
    { ID    id-InformationExchangeID          CRITICALITY reject      TYPE    InformationExchangeID          PRESENCE mandatory
    }|
    { ID    id-InformationExchangeObjectType-InfEx-Rqst          CRITICALITY reject      TYPE    InformationExchangeObjectType-InfEx-Rqst          PRESENCE
    mandatory }|
    -- This IE represents both the Information Exchange Object Type IE and the choice based on the Information Exchange Object Type
    -- as described in the tabular message format in subclause 9.1.
    { ID    id-InformationType          CRITICALITY reject      TYPE    InformationType          PRESENCE mandatory
    }|
    { ID    id-InformationReportCharacteristics          CRITICALITY reject      TYPE    InformationReportCharacteristics          PRESENCE mandatory
    },
    ...
}

InformationExchangeInitiationRequest-Extensions RNSAP-PROTOCOL-EXTENSION ::= {
    ...
}

InformationExchangeObjectType-InfEx-Rqst ::= CHOICE {
    cell          Cell-InfEx-Rqst,
    ...
}

Cell-InfEx-Rqst ::= SEQUENCE {

```

```

    c-ID
    iE-Extensions
    ...
}

CellItem-InfEx-Rqst-ExtIEs RNSAP-PROTOCOL-EXTENSION ::= {
    ...
}

-- *****
--
-- INFORMATION EXCHANGE INITIATION RESPONSE
--
-- *****

InformationExchangeInitiationResponse ::= SEQUENCE {
    protocolIEs          ProtocolIE-Container  {{InformationExchangeInitiationResponse-IEs}},
    protocolExtensions  ProtocolExtensionContainer  {{InformationExchangeInitiationResponse-Extensions}}  OPTIONAL,
    ...
}

InformationExchangeInitiationResponse-IEs RNSAP-PROTOCOL-IES ::= {
    { ID      id-InformationExchangeID          CRITICALITY ignore          TYPE      InformationExchangeID          PRESENCE
      mandatory  }|
    { ID      id-InformationExchangeObjectType-InfEx-Rsp  CRITICALITY ignore          TYPE      InformationExchangeObjectType-InfEx-Rsp  PRESENCE
      optional   }|
    { ID      id-CriticalityDiagnostics          CRITICALITY ignore          TYPE      CriticalityDiagnostics          PRESENCE optional
    },
    ...
}

InformationExchangeInitiationResponse-Extensions RNSAP-PROTOCOL-EXTENSION ::= {
    ...
}

InformationExchangeObjectType-InfEx-Rsp ::= CHOICE {
    cell
        Cell-InfEx-Rsp,
    ...
}

Cell-InfEx-Rsp ::= SEQUENCE {
    requestedDataValue      RequestedDataValue,
    iE-Extensions          ProtocolExtensionContainer  { { CellItem-InfEx-Rsp-ExtIEs } }  OPTIONAL,
    ...
}

CellItem-InfEx-Rsp-ExtIEs RNSAP-PROTOCOL-EXTENSION ::= {
    ...
}

-- *****

```



```

--
-- INFORMATION EXCHANGE INITIATION FAILURE
--
-- *****

InformationExchangeInitiationFailure ::= SEQUENCE {
    protocolIEs          ProtocolIE-Container    {{InformationExchangeInitiationFailure-IEs}},
    protocolExtensions   ProtocolExtensionContainer {{InformationExchangeInitiationFailure-Extensions}}    OPTIONAL,
    ...
}

InformationExchangeInitiationFailure-IEs RNSAP-PROTOCOL-IES ::= {
    { ID      id-InformationExchangeID          CRITICALITY ignore          TYPE      InformationExchangeID          PRESENCE mandatory }|
    { ID      id-Cause                          CRITICALITY ignore          TYPE      Cause                          PRESENCE mandatory }|
    { ID      id-CriticalityDiagnostics         CRITICALITY ignore          TYPE      CriticalityDiagnostics          PRESENCE optional },
    ...
}

InformationExchangeInitiationFailure-Extensions RNSAP-PROTOCOL-EXTENSION ::= {
    ...
}

-- *****
--
-- INFORMATION REPORT
--
-- *****

InformationReport ::= SEQUENCE {
    protocolIEs          ProtocolIE-Container    {{InformationReport-IEs}},
    protocolExtensions   ProtocolExtensionContainer {{InformationReport-Extensions}}    OPTIONAL,
    ...
}

InformationReport-IEs RNSAP-PROTOCOL-IES ::= {
    { ID      id-InformationExchangeID          CRITICALITY ignore          TYPE      InformationExchangeID          PRESENCE
    mandatory }|
    { ID      id-InformationExchangeObjectType-InfEx-Rprt CRITICALITY ignore          TYPE      InformationExchangeObjectType-InfEx-Rprt PRESENCE
    mandatory },
    ...
}

InformationReport-Extensions RNSAP-PROTOCOL-EXTENSION ::= {
    ...
}

InformationExchangeObjectType-InfEx-Rprt ::= CHOICE {
    cell                  Cell-InfEx-Rprt,
    ...
}

Cell-InfEx-Rprt ::= SEQUENCE {
    requestedDataValueInformation RequestedDataValueInformation,
    iE-Extensions             ProtocolExtensionContainer {{ CellItem-InfEx-Rprt-ExtIEs }}    OPTIONAL,
}

```

```

...
}
CellItem-InfEx-Rprt-ExtIEs RNSAP-PROTOCOL-EXTENSION ::= {
...
}

-- *****
--
-- INFORMATION EXCHANGE TERMINATION REQUEST
--
-- *****

InformationExchangeTerminationRequest ::= SEQUENCE {
    protocolIEs          ProtocolIE-Container    {{InformationExchangeTerminationRequest-IEs}},
    protocolExtensions   ProtocolExtensionContainer {{InformationExchangeTerminationRequest-Extensions}} OPTIONAL,
    ...
}

InformationExchangeTerminationRequest-IEs RNSAP-PROTOCOL-IES ::= {
    { ID      id-InformationExchangeID          CRITICALITY ignore          TYPE      InformationExchangeID          PRESENCE mandatory },
    ...
}

InformationExchangeTerminationRequest-Extensions RNSAP-PROTOCOL-EXTENSION ::= {
    ...
}

-- *****
--
-- INFORMATION EXCHANGE FAILURE INDICATION
--
-- *****

InformationExchangeFailureIndication ::= SEQUENCE {
    protocolIEs          ProtocolIE-Container    {{InformationExchangeFailureIndication-IEs}},
    protocolExtensions   ProtocolExtensionContainer {{InformationExchangeFailureIndication-Extensions}} OPTIONAL,
    ...
}

InformationExchangeFailureIndication-IEs RNSAP-PROTOCOL-IES ::= {
    { ID      id-InformationExchangeID          CRITICALITY ignore          TYPE      InformationExchangeID          PRESENCE mandatory } |
    { ID      id-Cause                          CRITICALITY ignore          TYPE      Cause                          PRESENCE mandatory } |
    ...
}

InformationExchangeFailureIndication-Extensions RNSAP-PROTOCOL-EXTENSION ::= {
    ...
}

-- *****

```

```

--
-- PRIVATE MESSAGE
--
-- *****
PrivateMessage ::= SEQUENCE {
    privateIEs      PrivateIE-Container  {{PrivateMessage-IEs}},
    ...
}
PrivateMessage-IEs RNSAP-PRIVATE-IES ::= {
    ...
}
END

```

9.3.4 Information Element Definitions

```

-- *****
--
-- Information Element Definitions
--
-- *****

RNSAP-IEs {
itu-t (0) identified-organization (4) etsi (0) mobileDomain (0)
umts-Access (20) modules (3) rnsap (1) version1 (1) rnsap-IEs (2) }

DEFINITIONS AUTOMATIC TAGS ::=

BEGIN

IMPORTS
    maxCodeNumComp-1,
    maxNrOfFACHs,
    maxFACHCountPlus1,
    maxIBSEG,
    maxNoOfDSCHs,
    maxNoOfDSCHs-1,
    maxNoOfUSCHs,
    maxNoTFCIGroups,
    maxNoCodeGroups,
    maxNrOfDCHs,
    maxNrOfDL-Codes,
    maxNrOfDLTs,
    maxNrOfDLTsLCR,
    maxNrOfDPCHs,
    maxNrOfDPCHsLCR,
    maxNrOfErrors,
    maxNrOfFDDNeighboursPerRNC,
    maxNrOfMACcshSDU-Length,
    maxNrOfNeighbouringRNCs,
    maxNrOfTDDNeighboursPerRNC,

```

```
maxNrOfLCRTDDNeighboursPerRNC,
maxNrOfTS,
maxNrOfULTs,
maxNrOfULTsLCR,
maxNrOfGSMNeighboursPerRNC,
maxRateMatching,
maxNrOfPoints,
maxNoOfRB,
maxNrOfTFCs,
maxNrOfTFs,
maxCTFC,
maxRNCinURA-1,
maxNrOfSCCPCHs,
maxTFCI1Combs,
maxTFCI2Combs,
maxTFCI2Combs-1,
maxTGPS,
maxTTI-Count,
maxNoGPSTypes,
maxNoSat,

id-Allowed-Rate-Information,
id-DPC-Mode-Change-SupportIndicator,
id-DSCH-Specific-FDD-Additional-List,
id-Guaranteed-Rate-Information,
id-Load-Value,
id-Load-Value-IncrDecrThres,
id-Neighbouring-GSM-CellInformation,
id-Neighbouring-UMTS-CellInformationItem,
id-neighbouring-LCR-TDD-CellInformation,
id-OnModification,
id-Received-Total-Wideband-Power-Value,
id-Received-Total-Wideband-Power-Value-IncrDecrThres,
id-SFNMeasurementThresholdInformation,
id-Transmitted-Carrier-Power-Value,
id-Transmitted-Carrier-Power-Value-IncrDecrThres,
id-TUTRANGPSMeasurementThresholdInformation,
id-UL-Timeslot-ISCP-Value,
id-UL-Timeslot-ISCP-Value-IncrDecrThres,
maxNrOfLevels,
maxNrOfMeasNCell,
maxNrOfMeasNCell-1,
id-MessageStructure,
id-EnhancedDSCHPC,
id-RestrictionStateIndicator,
id-Rx-Timing-Deviation-Value-LCR,
id-TypeOfError,
id-ExtendedGSMCellIndividualOffset
FROM RNSAP-Constants

Criticality,
ProcedureID,
ProtocolIE-ID,
TransactionID,
```

```

    TriggeringMessage
FROM RNSAP-CommonDataTypes

    ProtocolIE-Single-Container{},
    ProtocolExtensionContainer{},
    RNSAP-PROTOCOL-IES,
    RNSAP-PROTOCOL-EXTENSION
FROM RNSAP-Containers;

-- A

Active-Pattern-Sequence-Information ::= SEQUENCE {
    cmConfigurationChangeCFN          CFN,
    transmission-Gap-Pattern-Sequence-Status  Transmission-Gap-Pattern-Sequence-Status-List  OPTIONAL,
    iE-Extensions          ProtocolExtensionContainer { {Active-Pattern-Sequence-Information-ExtIEs} } OPTIONAL,
    ...
}

Active-Pattern-Sequence-Information-ExtIEs RNSAP-PROTOCOL-EXTENSION ::= {
    ...
}

AdjustmentPeriod          ::= INTEGER(1..256)
-- Unit Frame

AllocationRetentionPriority ::= SEQUENCE {
    priorityLevel          PriorityLevel,
    pre-emptionCapability  Pre-emptionCapability,
    pre-emptionVulnerability  Pre-emptionVulnerability,
    iE-Extensions          ProtocolExtensionContainer { {AllocationRetentionPriority-ExtIEs} } OPTIONAL,
    ...
}

AllocationRetentionPriority-ExtIEs RNSAP-PROTOCOL-EXTENSION ::= {
    ...
}

Allowed-Rate-Information    ::= SEQUENCE {
    allowed-UL-Rate          Allowed-Rate OPTIONAL,
    allowed-DL-Rate          Allowed-Rate OPTIONAL,
    iE-Extensions          ProtocolExtensionContainer { {Allowed-Rate-Information-ExtIEs} } OPTIONAL,
    ...
}

Allowed-Rate-Information-ExtIEs RNSAP-PROTOCOL-EXTENSION ::= {
    ...
}

Allowed-Rate          ::= INTEGER (1..maxNrOfTFs)
-- "1": TFI 0, "2": TFI 1, "3": TFI 2, ...

AllowedQueuingTime          ::= INTEGER (1..60)
-- seconds

```

```

AlphaValue ::= INTEGER (0..8)
-- Actual value = Alpha / 8

-- B

BadSatellites ::= SEQUENCE {
    badSatelliteInformation SEQUENCE (SIZE (1..maxNoSat)) OF
        SEQUENCE {
            badSAT-ID SAT-ID,
            iE-Extensions ProtocolExtensionContainer { { BadSatelliteInformation-ExtIEs} } OPTIONAL,
            ...
        },
    iE-Extensions ProtocolExtensionContainer { { BadSatellites-ExtIEs} } OPTIONAL,
    ...
}

BadSatelliteInformation-ExtIEs RNSAP-PROTOCOL-EXTENSION ::= {
    ...
}

BadSatellites-ExtIEs RNSAP-PROTOCOL-EXTENSION ::= {
    ...
}

Band-Indicator ::= ENUMERATED {
    dcs1800Band,
    pcs1900Band,
    ...
}

BCC ::= BIT STRING (SIZE (3))

BCCH-ARFCN ::= INTEGER (0..1023)

BetaCD ::= INTEGER (0..15)

BindingID ::= OCTET STRING (SIZE (1..4,...))

BLER ::= INTEGER (-63..0)
-- Step 0.1 (Range -6.3..0). It is the Log10 of the BLER

SCTD-Indicator ::= ENUMERATED {
    active,
    inactive
}

BSIC ::= SEQUENCE {
    nCC NCC,
    bCC BCC
}

BurstModeParameters ::= SEQUENCE {
    burstStart INTEGER (0..15),
    burstLength INTEGER (10..25),

```

```
    burstFreq      INTEGER (1..16),
    iE-Extensions  ProtocolExtensionContainer { { BurstModeParameters-ExtIEs} } OPTIONAL,
    ...
}

BurstModeParameters-ExtIEs RNSAP-PROTOCOL-EXTENSION ::= {
    ...
}

-- C

Cause ::= CHOICE {
    radioNetwork      CauseRadioNetwork,
    transport         CauseTransport,
    protocol          CauseProtocol,
    misc              CauseMisc,
    ...
}

CauseMisc ::= ENUMERATED {
    control-processing-overload,
    hardware-failure,
    om-intervention,
    not-enough-user-plane-processing-resources,
    unspecified,
    ...
}

CauseProtocol ::= ENUMERATED {
    transfer-syntax-error,
    abstract-syntax-error-reject,
    abstract-syntax-error-ignore-and-notify,
    message-not-compatible-with-receiver-state,
    semantic-error,
    unspecified,
    abstract-syntax-error-falsely-constructed-message,
    ...
}

CauseRadioNetwork ::= ENUMERATED {
    unknown-C-ID,
    cell-not-available,
    power-level-not-supported,
    ul-scrambling-code-already-in-use,
    dl-radio-resources-not-available,
    ul-radio-resources-not-available,
    measurement-not-supported-for-the-object,
    combining-resources-not-available,
    combining-not-supported,
    reconfiguration-not-allowed,
    requested-configuration-not-supported,
    synchronisation-failure,
    requested-tx-diversity-mode-not-supported,
    measurement-temporarily-not-available,
}
```

```

    unspecified,
    invalid-CM-settings,
    reconfiguration-CFN-not-elapsed,
    number-of-DL-codes-not-supported,
    dedicated-transport-channel-type-not-supported,
    dl-shared-channel-type-not-supported,
    ul-shared-channel-type-not-supported,
    common-transport-channel-type-not-supported,
    ul-spreading-factor-not-supported,
    dl-spreading-factor-not-supported,
    cm-not-supported,
    transaction-not-supported-by-destination-node-b,
    rl-already-activated-or-allocated,
    ...,
    number-of-UL-codes-not-supported,
    cell-reserved-for-operator-use,
    dpc-mode-change-not-supported,
    information-temporarily-not-available,
    information-provision-not-supported-for-the-object,
    dummy1,
    dummy2,
    dummy3,
    unknown-RNTI
}

CauseTransport ::= ENUMERATED {
    transport-resource-unavailable,
    unspecified,
    ...
}

C-ID ::= INTEGER (0..65535)

CCTrCH-ID ::= INTEGER (0..15)

CellIndividualOffset ::= INTEGER (-20..20)

CellParameterID ::= INTEGER (0..127,...)

CFN ::= INTEGER (0..255)

CGI ::= SEQUENCE {
    LAI SEQUENCE {
        pLMN-Identity PLMN-Identity,
        lAC LAC,
        iE-Extensions ProtocolExtensionContainer { {LAI-ExtIEs} } OPTIONAL,
        ...
    },
    cI CI,
    iE-Extensions ProtocolExtensionContainer { {CGI-ExtIEs} } OPTIONAL
}

LAI-ExtIEs RNSAP-PROTOCOL-EXTENSION ::= {
    ...
}

```



```
}
CGI-ExtIEs RNSAP-PROTOCOL-EXTENSION ::= {
    ...
}
ChannelCodingType ::= ENUMERATED {
    no-codingTDD,
    convolutional-coding,
    turbo-coding,
    ...
}
ChipOffset ::= INTEGER (0..38399)
CI ::= OCTET STRING (SIZE (2))
ClosedLoopModel-SupportIndicator ::= ENUMERATED {
    closedLoop-Model-Supported,
    closedLoop-Model-not-Supported
}
ClosedLoopMode2-SupportIndicator ::= ENUMERATED {
    closedLoop-Mode2-Supported,
    closedLoop-Mode2-not-Supported
}
Closedlooptimingadjustmentmode ::= ENUMERATED {
    adj-1-slot,
    adj-2-slot,
    ...
}
CodeNumber ::= INTEGER (0..maxCodeNumComp-1)
CodingRate ::= ENUMERATED {
    half,
    third,
    ...
}
CommonMeasurementAccuracy ::= CHOICE {
    tUTRANGPSMeasurementAccuracyClass TUTRANGPSAccuracyClass,
    ...
}
CommonMeasurementType ::= ENUMERATED {
    uTRAN-GPS-timing-of-cell-frames-for-UE-Positioning,
    sFN-SFN-observerd-time-difference,
    load,
    transmitted-carrier-power,
    received-total-wide-band-power,
    uplink-timeslot-iscp,
    ...
}
```

```

}

CommonMeasurementValue ::= CHOICE {
    tUTRANGPSMeasurementValueInformation    TUTRANGPSMeasurementValueInformation,
    sFNSFNMeasurementValueInformation       SFNSFNMeasurementValueInformation,
    loadValue                               LoadValue,
    transmittedCarrierPowerValue            INTEGER(0..100),
    receivedTotalWideBandPowerValue        INTEGER(0..621),
    uplinkTimeslotISCPValue                 UL-TimeslotISCP,
    ...
}

CommonMeasurementValueInformation ::= CHOICE {
    measurementAvailable                    CommonMeasurementAvailable,
    measurementnotAvailable                 NULL
}

CommonMeasurementAvailable ::= SEQUENCE {
    commonMeasurementValue                  CommonMeasurementValue,
    iE-Extensions                           ProtocolExtensionContainer { { CommonMeasurementAvailableItem-ExtIEs} } OPTIONAL,
    ...
}

CommonMeasurementAvailableItem-ExtIEs RNSAP-PROTOCOL-EXTENSION ::= {
    ...
}

CongestionCause ::= ENUMERATED {
    uTRAN-dynamic-resources,
    uTRAN-semistatic-resources,
    ...
}

CRC-Size ::= ENUMERATED {
    v0,
    v8,
    v12,
    v16,
    v24,
    ...
}

CriticalityDiagnostics ::= SEQUENCE {
    procedureID                             ProcedureID OPTIONAL,
    triggeringMessage                         TriggeringMessage OPTIONAL,
    procedureCriticality                      Criticality OPTIONAL,
    transactionID                            TransactionID OPTIONAL,
    iEsCriticalityDiagnostics                 CriticalityDiagnostics-IE-List OPTIONAL,
    iE-Extensions                             ProtocolExtensionContainer { {CriticalityDiagnostics-ExtIEs} } OPTIONAL,
    ...
}

CriticalityDiagnostics-ExtIEs RNSAP-PROTOCOL-EXTENSION ::= {
    ...
}

```

```

}

CriticalityDiagnostics-IE-List ::= SEQUENCE (SIZE (1..maxNrOfErrors)) OF
  SEQUENCE {
    iECriticality          Criticality,
    iE-ID                 ProtocolIE-ID,
    repetitionNumber      RepetitionNumber0      OPTIONAL,
    iE-Extensions         ProtocolExtensionContainer { {CriticalityDiagnostics-IE-List-ExtIEs} } OPTIONAL,
    ...
  }

CriticalityDiagnostics-IE-List-ExtIEs RNSAP-PROTOCOL-EXTENSION ::= {
  { ID id-MessageStructure      CRITICALITY ignore      EXTENSION MessageStructure      PRESENCE optional } |
  { ID id-TypeOfError          CRITICALITY ignore      EXTENSION TypeOfError          PRESENCE mandatory },
  ...
}

MessageStructure ::= SEQUENCE (SIZE (1..maxNrOfLevels)) OF
  SEQUENCE {
    iE-ID                 ProtocolIE-ID,
    repetitionNumber      RepetitionNumber1      OPTIONAL,
    iE-Extensions         ProtocolExtensionContainer { {MessageStructure-ExtIEs} } OPTIONAL,
    ...
  }

MessageStructure-ExtIEs RNSAP-PROTOCOL-EXTENSION ::= {
  ...
}

CN-CS-DomainIdentifier ::= SEQUENCE {
  pLMN-Identity          PLMN-Identity,
  lAC                    LAC,
  iE-Extensions         ProtocolExtensionContainer { {CN-CS-DomainIdentifier-ExtIEs} } OPTIONAL
}

CN-CS-DomainIdentifier-ExtIEs RNSAP-PROTOCOL-EXTENSION ::= {
  ...
}

CN-PS-DomainIdentifier ::= SEQUENCE {
  pLMN-Identity          PLMN-Identity,
  lAC                    LAC,
  rAC                    RAC,
  iE-Extensions         ProtocolExtensionContainer { {CN-PS-DomainIdentifier-ExtIEs} } OPTIONAL
}

CN-PS-DomainIdentifier-ExtIEs RNSAP-PROTOCOL-EXTENSION ::= {
  ...
}

CNDomainType ::= ENUMERATED {
  cs-domain,
  ps-domain,
}

```

```

    dont-care,
    ...
}
-- See in [16]

C-RNTI ::= INTEGER (0..65535)

-- D
DATA-ID ::= INTEGER (0..3)

DCH-FDD-Information ::= SEQUENCE (SIZE (1..maxNrOfDCHs)) OF DCH-FDD-InformationItem

DCH-FDD-InformationItem ::= SEQUENCE {
    payloadCRC-PresenceIndicator PayloadCRC-PresenceIndicator,
    ul-FP-Mode UL-FP-Mode,
    toAWS ToAWS,
    toAWE ToAWE,
    dCH-SpecificInformationList DCH-Specific-FDD-InformationList,
    iE-Extensions ProtocolExtensionContainer { {DCH-FDD-InformationItem-ExtIEs} } OPTIONAL,
    ...
}

DCH-FDD-InformationItem-ExtIEs RNSAP-PROTOCOL-EXTENSION ::= {
    ...
}

DCH-Specific-FDD-InformationList ::= SEQUENCE (SIZE (1..maxNrOfDCHs)) OF DCH-Specific-FDD-Item

DCH-Specific-FDD-Item ::= SEQUENCE {
    dCH-ID DCH-ID,
    trCH-SrcStatisticsDescr TrCH-SrcStatisticsDescr,
    ul-transportFormatSet TransportFormatSet,
    dl-transportFormatSet TransportFormatSet,
    ul-BLER BLER,
    dl-BLER BLER,
    allocationRetentionPriority AllocationRetentionPriority,
    frameHandlingPriority FrameHandlingPriority,
    qE-Selector QE-Selector,
    dRACControl DRACControl,
    iE-Extensions ProtocolExtensionContainer { {DCH-FDD-SpecificItem-ExtIEs} } OPTIONAL,
    ...
}

DCH-FDD-SpecificItem-ExtIEs RNSAP-PROTOCOL-EXTENSION ::= {
    { ID id-Guaranteed-Rate-Information CRITICALITY ignore EXTENSION Guaranteed-Rate-Information PRESENCE optional },
    ...
}

DCH-ID ::= INTEGER (0..255)

DCH-InformationResponse ::= SEQUENCE (SIZE (1..maxNrOfDCHs)) OF DCH-InformationResponseItem

DCH-InformationResponseItem ::= SEQUENCE {
    dCH-ID DCH-ID,

```

```

bindingID                BindingID                OPTIONAL,
transportLayerAddress    TransportLayerAddress  OPTIONAL,
iE-Extensions           ProtocolExtensionContainer { {DCH-InformationResponseItem-ExtIEs} } OPTIONAL,
...
}

DCH-InformationResponseItem-ExtIEs RNSAP-PROTOCOL-EXTENSION ::= {
  { ID id-Allowed-Rate-Information      CRITICALITY ignore  EXTENSION Allowed-Rate-Information      PRESENCE optional },
  ...
}

DCH-TDD-Information ::= SEQUENCE (SIZE (1..maxNrOfDCHs)) OF DCH-TDD-InformationItem

DCH-TDD-InformationItem ::= SEQUENCE {
  payloadCRC-PresenceIndicator      PayloadCRC-PresenceIndicator,
  ul-FP-Mode                        UL-FP-Mode,
  toAWS                             ToAWS,
  toAWE                             ToAWE,
  dCH-SpecificInformationList       DCH-Specific-TDD-InformationList,
  iE-Extensions                     ProtocolExtensionContainer { {DCH-TDD-InformationItem-ExtIEs} } OPTIONAL,
  ...
}

DCH-TDD-InformationItem-ExtIEs RNSAP-PROTOCOL-EXTENSION ::= {
  ...
}

DCH-Specific-TDD-InformationList ::= SEQUENCE (SIZE (1..maxNrOfDCHs)) OF DCH-Specific-TDD-Item

DCH-Specific-TDD-Item ::= SEQUENCE {
  dCH-ID                            DCH-ID,
  ul-cCTrCH-ID                      CCTrCH-ID, -- UL CCTrCH in which the DCH is mapped
  dl-cCTrCH-ID                      CCTrCH-ID, -- DL CCTrCH in which the DCH is mapped
  trCH-SrcStatisticsDescr           TrCH-SrcStatisticsDescr,
  ul-transportFormatSet             TransportFormatSet,
  dl-transportFormatSet             TransportFormatSet,
  ul-BLER                           BLER,
  dl-BLER                           BLER,
  allocationRetentionPriority        AllocationRetentionPriority,
  frameHandlingPriority              FrameHandlingPriority,
  qE-Selector                       QE-Selector OPTIONAL,
  -- This IE shall be present if DCH is part of set of Co-ordinated DCHs
  iE-Extensions                     ProtocolExtensionContainer { {DCH-Specific-TDD-Item-ExtIEs} } OPTIONAL,
  ...
}

DCH-Specific-TDD-Item-ExtIEs RNSAP-PROTOCOL-EXTENSION ::= {
  { ID id-Guaranteed-Rate-Information  CRITICALITY ignore  EXTENSION Guaranteed-Rate-Information  PRESENCE optional },
  ...
}

DedicatedMeasurementType ::= ENUMERATED {
  sir,
  sir-error,
}

```

```

    transmitted-code-power,
    rSCP,
    rx-timing-deviation,
    round-trip-time,
    ...,
    rx-timing-deviation-LCR
}

DedicatedMeasurementValue ::= CHOICE {
    sIR-Value          SIR-Value,
    sIR-ErrorValue    SIR-Error-Value,
    transmittedCodePowerValue  Transmitted-Code-Power-Value,
    rSCP              RSCP-Value, -- TDD only
    rxTimingDeviationValue  Rx-Timing-Deviation-Value, -- 3.84Mcps TDD only
    roundTripTime     Round-Trip-Time-Value, -- FDD only
    ...,
    extension-DedicatedMeasurementValue  Extension-DedicatedMeasurementValue
}

Extension-DedicatedMeasurementValue ::= ProtocolIE-Single-Container {{ Extension-DedicatedMeasurementValueIE }}

Extension-DedicatedMeasurementValueIE RNSAP-PROTOCOL-IES ::= {
    { ID id-Rx-Timing-Deviation-Value-LCR  CRITICALITY reject  TYPE Rx-Timing-Deviation-Value-LCR  PRESENCE mandatory },
    ...
}

DedicatedMeasurementValueInformation ::= CHOICE {
    measurementAvailable          DedicatedMeasurementAvailable,
    measurementnotAvailable       DedicatedMeasurementnotAvailable
}

DedicatedMeasurementAvailable ::= SEQUENCE {
    dedicatedmeasurementValue      DedicatedMeasurementValue,
    cFN                            CFN                            OPTIONAL,
    ie-Extensions                  ProtocolExtensionContainer { { DedicatedMeasurementAvailableItem-ExtIEs} }  OPTIONAL,
    ...
}

DedicatedMeasurementAvailableItem-ExtIEs RNSAP-PROTOCOL-EXTENSION ::= {
    ...
}

DedicatedMeasurementnotAvailable ::= NULL

DeltaSIR ::= INTEGER (0..30)
-- Step 0.1 dB, Range 0..3 dB.

DGPSCorrections ::= SEQUENCE {
    gPSTOW                          GPSTOW,
    gPS-Status-Health                GPS-Status-Health,
    satellite-DGPSCorrections-Information  SEQUENCE (SIZE (1..maxNoSat)) OF
        SEQUENCE {
            sAT-ID                    SAT-ID,
            iode-dgps                  BIT STRING (SIZE (8)),
        }
}

```

```

        uDRE                UDRE,
        pRC                 PRC,
        range-Correction-Rate Range-Correction-Rate,
        iE-Extensions       ProtocolExtensionContainer { { Satellite-DGPSCorrections-Information-ExtIEs } } OPTIONAL,
        ...
    },
    iE-Extensions           ProtocolExtensionContainer { { DGPSCorrections-ExtIEs } } OPTIONAL,
    ...
}

Satellite-DGPSCorrections-Information-ExtIEs RNSAP-PROTOCOL-EXTENSION ::= {
    ...
}

DGPSCorrections-ExtIEs RNSAP-PROTOCOL-EXTENSION ::= {
    ...
}

DGPSThreshold ::= SEQUENCE {
    pRCDeviation           PRCDeviation,
    iE-Extensions         ProtocolExtensionContainer { { DGPSThreshold-ExtIEs } } OPTIONAL,
    ...
}

DGPSThreshold-ExtIEs RNSAP-PROTOCOL-EXTENSION ::= {
    ...
}

DiversityControlField ::= ENUMERATED {
    may,
    must,
    must-not
}

DiversityMode ::= ENUMERATED {
    none,
    sTTD,
    closedLoopModel,
    closedLoopMode2,
    ...
}

DL-DPCH-SlotFormat ::= INTEGER (0..16,...)

DL-Power ::= INTEGER (-350..150)
-- Value = DL-Power / 10
-- Unit dB, Range -35dB .. +15dB, Step 0.1dB

D-RNTI ::= INTEGER (0..1048575)

D-RNTI-ReleaseIndication ::= ENUMERATED {

```

```

    release-D-RNTI,
    not-release-D-RNTI
}

DL-ScramblingCode ::= INTEGER (0..15)

DL-FrameType ::= ENUMERATED {
    typeA,
    typeB,
    ...
}

DL-Timeslot-Information ::= SEQUENCE ( SIZE (1..maxNrOfTS)) OF DL-Timeslot-InformationItem

DL-Timeslot-InformationItem ::= SEQUENCE {
    timeSlot                TimeSlot,
    midambleShiftAndBurstType MidambleShiftAndBurstType,
    tFCI-Presence           TFCI-Presence,
    dL-Code-Information      TDD-DL-Code-Information,
    iE-Extensions           ProtocolExtensionContainer { {DL-Timeslot-InformationItem-ExtIEs} } OPTIONAL,
    ...
}

DL-Timeslot-InformationItem-ExtIEs RNSAP-PROTOCOL-EXTENSION ::= {
    ...
}

DL-TimeslotLCR-Information ::= SEQUENCE (SIZE (1.. maxNrOfDLTsLCR)) OF DL-TimeslotLCR-InformationItem

DL-TimeslotLCR-InformationItem ::= SEQUENCE {
    timeSlotLCR                TimeSlotLCR,
    midambleShiftLCR           MidambleShiftLCR,
    tFCI-Presence              TFCI-Presence,
    dL-Code-LCR-Information     TDD-DL-Code-LCR-Information,
    iE-Extensions              ProtocolExtensionContainer { { DL-TimeslotLCR-InformationItem-ExtIEs} } OPTIONAL,
    ...
}

DL-TimeslotLCR-InformationItem-ExtIEs RNSAP-PROTOCOL-EXTENSION ::= {
    ...
}

DL-TimeSlot-ISCP-Info ::= SEQUENCE (SIZE (1..maxNrOfDLTs)) OF DL-TimeSlot-ISCP-InfoItem

DL-TimeSlot-ISCP-InfoItem ::= SEQUENCE {
    timeSlot                TimeSlot,
    dL-TimeslotISCP         DL-TimeslotISCP,
    iE-Extensions           ProtocolExtensionContainer { { DL-TimeSlot-ISCP-InfoItem-ExtIEs} } OPTIONAL,
    ...
}

DL-TimeSlot-ISCP-InfoItem-ExtIEs RNSAP-PROTOCOL-EXTENSION ::= {
    ...
}

```



```

DL-TimeSlot-ISCP-LCR-Information ::= SEQUENCE (SIZE (1..maxNrOfDLTsLCR)) OF DL-TimeSlot-ISCP-LCR-InfoItem

DL-TimeSlot-ISCP-LCR-InfoItem ::= SEQUENCE {
    timeSlotLCR                TimeSlotLCR,
    dL-TimeslotISCP            DL-TimeslotISCP,
    iE-Extensions              ProtocolExtensionContainer { { DL-TimeSlot-ISCP-LCR-InfoItem-ExtIEs } } OPTIONAL,
    ...
}

DL-TimeSlot-ISCP-LCR-InfoItem-ExtIEs RNSAP-PROTOCOL-EXTENSION ::= {
    ...
}

DL-TimeslotISCP                ::= INTEGER (0..91)
-- According to mapping in [24]

Downlink-Compressed-Mode-Method ::= ENUMERATED {
    puncturing,
    sFdiv2,
    higher-layer-scheduling,
    ...
}

DPC-Mode ::= ENUMERATED {
    mode0,
    mode1,
    ...
}

DPC-Mode-Change-SupportIndicator ::= ENUMERATED {
    dPC-ModeChangeSupported
}

DPCH-ID                        ::= INTEGER (0..239)

DPCHConstantValue ::= INTEGER (-10..10)
-- Unit dB, Step 1dB

DRACControl                    ::= ENUMERATED {
    requested,
    not-requested
}

DRXCycleLengthCoefficient      ::= INTEGER (3..9)
-- See in [16]

DSCH-FDD-Information ::= SEQUENCE {
    dSCH-Specific-Information    DSCH-Specific-FDD-Item,
    -- This DSCH-Specific-FDD-Item is the first DSCH-Specific-FDD-Item in DSCH-FDD-Information. If more than one DSCH-Specific-FDD-Item/s should be
    defined in a DSCH-FDD-Information, from 2nd DSCH-Specific-FDD Item, they will be included in the DSCH-Specific-FDD-Additional-List in the DSCH-FDD-
    Information-ExtIEs.
    pdSCH-RL-ID                 RL-ID,
    tFCS                         TFCS,

```

```

    iE-Extensions          ProtocolExtensionContainer { {DSCH-FDD-Information-ExtIEs} } OPTIONAL,
    ...
}

DSCH-FDD-Information-ExtIEs RNSAP-PROTOCOL-EXTENSION ::= {
  { ID id-DSCH-Specific-FDD-Additional-List          CRITICALITY reject  EXTENSION DSCH-Specific-FDD-Additional-List          PRESENCE optional } |
  { ID id-EnhancedDSCHPC                            CRITICALITY ignore    EXTENSION EnhancedDSCHPC          PRESENCE optional },
  ...
}

DSCH-RNTI ::= INTEGER (0..65535)

DSCH-Specific-FDD-Item ::= SEQUENCE {
  dsch-ID                DSCH-ID,
  trChSourceStatisticsDescriptor  TrCH-SrcStatisticsDescr,
  transportFormatSet     TransportFormatSet,
  allocationRetentionPriority  AllocationRetentionPriority,
  schedulingPriorityIndicator  SchedulingPriorityIndicator,
  bLER                   BLER,
  iE-Extensions          ProtocolExtensionContainer { {DSCH-Specific-FDD-Item-ExtIEs} } OPTIONAL,
  ...
}

DSCH-Specific-FDD-Item-ExtIEs RNSAP-PROTOCOL-EXTENSION ::= {
  ...
}

DSCH-Specific-FDD-Additional-List ::= SEQUENCE (SIZE(1..maxNoOfDSCHs-1)) OF DSCH-Specific-FDD-Item

DSCH-FDD-InformationResponse ::= SEQUENCE {
  dsch-Specific-InformationResponse  DSCH-Specific-FDD-InformationResponse,
  pdSCHCodeMapping                  PDSCHCodeMapping,
  iE-Extensions                     ProtocolExtensionContainer { { DSCH-FDD-InformationResponse-ExtIEs} } OPTIONAL,
  ...
}

DSCH-FDD-InformationResponse-ExtIEs RNSAP-PROTOCOL-EXTENSION ::= {
  ...
}

DSCH-Specific-FDD-InformationResponse ::= SEQUENCE (SIZE(1..maxNoOfDSCHs)) OF DSCH-Specific-FDD-Response-Item

DSCH-Specific-FDD-Response-Item ::= SEQUENCE {
  dsch-ID                DSCH-ID,
  dsch-FlowControlInformation  DSCH-FlowControlInformation,
  bindingID              BindingID          OPTIONAL,
  transportLayerAddress   TransportLayerAddress  OPTIONAL,
  iE-Extensions          ProtocolExtensionContainer { {DSCH-Specific-FDD-Response-Item-ExtIEs} } OPTIONAL,
  ...
}

DSCH-Specific-FDD-Response-Item-ExtIEs RNSAP-PROTOCOL-EXTENSION ::= {
  ...
}

```

```

DSCH-FlowControlInformation ::= SEQUENCE (SIZE(1..16)) OF DSCH-FlowControlItem

DSCH-FlowControlItem ::= SEQUENCE {
    dSCH-SchedulingPriority      SchedulingPriorityIndicator,
    MAC-c-sh-SDU-Lengths        MAC-c-sh-SDU-LengthList,
    iE-Extensions                ProtocolExtensionContainer { {DSCH-FlowControlItem-ExtIEs} } OPTIONAL,
    ...
}

DSCH-FlowControlItem-ExtIEs RNSAP-PROTOCOL-EXTENSION ::= {
    ...
}

DSCH-ID                        ::= INTEGER (0..255)

DSCH-TDD-Information ::= SEQUENCE (SIZE (1..maxNoOfDSCHs)) OF DSCH-TDD-InformationItem

DSCH-TDD-InformationItem ::= SEQUENCE {
    dSCH-ID                      DSCH-ID,
    dl-ccTrCHID                  CTrCH-ID, -- DL CTrCH in which the DSCH is mapped
    trChSourceStatisticsDescriptor TrCH-SrcStatisticsDescr,
    transportFormatSet           TransportFormatSet,
    allocationRetentionPriority    AllocationRetentionPriority,
    schedulingPriorityIndicator    SchedulingPriorityIndicator,
    BLER                          BLER,
    iE-Extensions                ProtocolExtensionContainer { {DSCH-TDD-InformationItem-ExtIEs} } OPTIONAL,
    ...
}

DSCH-TDD-InformationItem-ExtIEs RNSAP-PROTOCOL-EXTENSION ::= {
    ...
}

-- E

EnhancedDSCHPC ::= SEQUENCE {
    enhancedDSCHPCWnd    EnhancedDSCHPCWnd,
    enhancedDSCHPCCounter EnhancedDSCHPCCounter,
    enhancedDSCHPowerOffset EnhancedDSCHPowerOffset,
    ...
}

EnhancedDSCHPCCounter ::= INTEGER (1..50)

EnhancedDSCHPCIndicator ::= ENUMERATED {
    enhancedDSCHPCActiveInTheUE,
    enhancedDSCHPCNotActiveInTheUE
}

EnhancedDSCHPCWnd ::= INTEGER (1..10)

EnhancedDSCHPowerOffset ::= INTEGER (-15..0)

```

```
EventA ::= SEQUENCE {
    measurementTreshhold      MeasurementThreshold,
    measurementHysteresisTime MeasurementHysteresisTime      OPTIONAL,
    iE-Extensions             ProtocolExtensionContainer { {EventA-ExtIEs} } OPTIONAL,
    ...
}

EventA-ExtIEs RNSAP-PROTOCOL-EXTENSION ::= {
    ...
}

EventB ::= SEQUENCE {
    measurementTreshhold      MeasurementThreshold,
    measurementHysteresisTime MeasurementHysteresisTime      OPTIONAL,
    iE-Extensions             ProtocolExtensionContainer { {EventB-ExtIEs} } OPTIONAL,
    ...
}

EventB-ExtIEs RNSAP-PROTOCOL-EXTENSION ::= {
    ...
}

EventC ::= SEQUENCE {
    measurementIncreaseDecreaseThreshold MeasurementIncreaseDecreaseThreshold,
    measurementChangeTime      MeasurementChangeTime,
    iE-Extensions               ProtocolExtensionContainer { {EventC-ExtIEs} } OPTIONAL,
    ...
}

EventC-ExtIEs RNSAP-PROTOCOL-EXTENSION ::= {
    ...
}

EventD ::= SEQUENCE {
    measurementIncreaseDecreaseThreshold MeasurementIncreaseDecreaseThreshold,
    measurementChangeTime      MeasurementChangeTime,
    iE-Extensions               ProtocolExtensionContainer { {EventD-ExtIEs} } OPTIONAL,
    ...
}

EventD-ExtIEs RNSAP-PROTOCOL-EXTENSION ::= {
    ...
}

EventE ::= SEQUENCE {
    measurementThreshold1      MeasurementThreshold,
    measurementThreshold2      MeasurementThreshold      OPTIONAL,
    measurementHysteresisTime  MeasurementHysteresisTime      OPTIONAL,
    reportPeriodicity          ReportPeriodicity      OPTIONAL,
    iE-Extensions              ProtocolExtensionContainer { {EventE-ExtIEs} } OPTIONAL,
    ...
}
```

```

EventE-ExtIEs RNSAP-PROTOCOL-EXTENSION ::= {
    ...
}

EventF ::= SEQUENCE {
    measurementThreshold1      MeasurementThreshold,
    measurementThreshold2      MeasurementThreshold      OPTIONAL,
    measurementHysteresisTime  MeasurementHysteresisTime  OPTIONAL,
    reportPeriodicity          ReportPeriodicity          OPTIONAL,
    iE-Extensions              ProtocolExtensionContainer { {EventF-ExtIEs} } OPTIONAL,
    ...
}

EventF-ExtIEs RNSAP-PROTOCOL-EXTENSION ::= {
    ...
}

ExtendedGSMCellIndividualOffset ::= INTEGER (-50..-11|11..50)

-- F

FACH-FlowControlInformation ::= SEQUENCE (SIZE (1..16)) OF FACH-FlowControlInformationItem

FACH-FlowControlInformationItem ::= SEQUENCE {
    fACH-SchedulingPriority      SchedulingPriorityIndicator,
    mAC-c-sh-SDU-Lengths        MAC-c-sh-SDU-LengthList,
    fACH-InitialWindowSize      FACH-InitialWindowSize,
    iE-Extensions              ProtocolExtensionContainer { {FACH-FlowControlInformationItem-ExtIEs} } OPTIONAL,
    ...
}

FACH-FlowControlInformationItem-ExtIEs RNSAP-PROTOCOL-EXTENSION ::= {
    ...
}

FACH-InitialWindowSize          ::= INTEGER { unlimited(255) } (0..255)
-- Number of frames MAC-c-sh SDUs.
-- 255 = Unlimited number of FACH data frames

FACH-InformationList ::= SEQUENCE (SIZE(0.. maxNrOfFACHs)) OF FACH-InformationItem

FACH-InformationItem ::= SEQUENCE {
    transportFormatSet          TransportFormatSet,
    iE-Extensions              ProtocolExtensionContainer { { FACH-InformationItem-ExtIEs} } OPTIONAL,
    ...
}

FACH-InformationItem-ExtIEs RNSAP-PROTOCOL-EXTENSION ::= {
    ...
}

FACH-PCH-InformationList ::= SEQUENCE (SIZE(1..maxFACHCountPlus1)) OF FACH-PCH-InformationItem

FACH-PCH-InformationItem ::= SEQUENCE {

```

```

transportFormatSet      TransportFormatSet,
iE-Extensions           ProtocolExtensionContainer { { FACH-PCH-InformationItem-ExtIEs } } OPTIONAL,
...
}

FACH-PCH-InformationItem-ExtIEs RNSAP-PROTOCOL-EXTENSION ::= {
...
}

FDD-DCHs-to-Modify      ::= SEQUENCE (SIZE (1..maxNrOfDCHs)) OF FDD-DCHs-to-ModifyItem

FDD-DCHs-to-ModifyItem ::= SEQUENCE {
ul-FP-Mode              UL-FP-Mode          OPTIONAL,
toAWS                   ToAWS             OPTIONAL,
toAWE                   ToAWE             OPTIONAL,
transportBearerRequestIndicator TransportBearerRequestIndicator,
dCH-SpecificInformationList FDD-DCHs-to-ModifySpecificInformationList,
iE-Extensions           ProtocolExtensionContainer { { FDD-DCHs-to-ModifyItem-ExtIEs } } OPTIONAL,
...
}

FDD-DCHs-to-ModifyItem-ExtIEs RNSAP-PROTOCOL-EXTENSION ::= {
...
}

FDD-DCHs-to-ModifySpecificInformationList ::= SEQUENCE (SIZE (1..maxNrOfDCHs)) OF FDD-DCHs-to-ModifySpecificItem

FDD-DCHs-to-ModifySpecificItem ::= SEQUENCE {
dCH-ID                  DCH-ID,
ul-TransportformatSet   TransportFormatSet      OPTIONAL,
dl-TransportformatSet   TransportFormatSet      OPTIONAL,
allocationRetentionPriority AllocationRetentionPriority  OPTIONAL,
frameHandlingPriority   FrameHandlingPriority   OPTIONAL,
dRACControl             DRACControl           OPTIONAL,
iE-Extensions           ProtocolExtensionContainer { { FDD-DCHs-to-ModifySpecificItem-ExtIEs } } OPTIONAL,
...
}

FDD-DCHs-to-ModifySpecificItem-ExtIEs RNSAP-PROTOCOL-EXTENSION ::= {
{ ID id-Guaranteed-Rate-Information      CRITICALITY ignore EXTENSION Guaranteed-Rate-Information      PRESENCE optional },
...
}

FDD-DL-ChannelisationCodeNumber ::= INTEGER (0..511)
-- According to the mapping in [27]. The maximum value is equal to the DL spreading factor -1--

FDD-DL-CodeInformation ::= SEQUENCE (SIZE (1..maxNrOfDL-Codes)) OF FDD-DL-CodeInformationItem

FDD-DL-CodeInformationItem ::= SEQUENCE {
dl-ScramblingCode              DL-ScramblingCode,
fDD-DL-ChannelisationCodeNumber FDD-DL-ChannelisationCodeNumber,
transmission-Gap-Pattern-Sequence-ScramblingCode-Information Transmission-Gap-Pattern-Sequence-ScramblingCode-Information OPTIONAL,
iE-Extensions                   ProtocolExtensionContainer { { FDD-DL-CodeInformationItem-ExtIEs } } OPTIONAL,
...
}

```

```

}
FDD-DL-CodeInformationItem-ExtIEs RNSAP-PROTOCOL-EXTENSION ::= {
  ...
}
FDD-S-CCPCH-Offset ::= INTEGER (0..149)
FDD-TPC-DownlinkStepSize ::= ENUMERATED {
  step-size0-5,
  step-size1,
  step-size1-5,
  step-size2,
  ...
}
SchedulingPriorityIndicator ::= INTEGER { lowest(0), highest(15) } (0..15)
FirstRLS-Indicator ::= ENUMERATED {
  first-RLS,
  not-first-RLS
}
FNReportingIndicator ::= ENUMERATED {
  fN-reporting-required,
  fN-reporting-not-required
}
FPACH-Information ::= SEQUENCE {
  timeSlotLCR TimeSlotLCR,
  tDD-ChannelisationCodeLCR TDD-ChannelisationCodeLCR,
  midambleShiftLCR MidambleShiftLCR,
  wT INTEGER (1..4),
  ...
}
FrameHandlingPriority ::= INTEGER { lowest(0), highest(15) } (0..15)
FrameOffset ::= INTEGER (0..255)
-- Frames
-- G
GapLength ::= INTEGER (1..14)
-- Unit Slot
GapDuration ::= INTEGER (1..144,...)
-- Unit Frame
GA-Cell ::= SEQUENCE (SIZE (1..maxNrOfPoints)) OF
  SEQUENCE {
    cell-GAIgeographicalCoordinate GeographicalCoordinate,
    iE-Extensions ProtocolExtensionContainer { {GA-Cell-ExtIEs} } OPTIONAL,
    ...
  }

```

```

    }
GA-Cell-ExtIEs RNSAP-PROTOCOL-EXTENSION ::= {
    ...
}

GA-CellAdditionalShapes ::= CHOICE {
    pointWithUncertainty                GA-PointWithUnCertainty,
    pointWithUncertaintyEllipse         GA-PointWithUnCertaintyEllipse,
    pointWithAltitude                   GA-PointWithAltitude,
    pointWithAltitudeAndUncertaintyEllipsoid GA-PointWithAltitudeAndUncertaintyEllipsoid,
    ellipsoidArc                        GA-EllipsoidArc,
    ...
}

GA-AltitudeAndDirection ::= SEQUENCE {
    directionOfAltitude    ENUMERATED {height, depth},
    altitude                INTEGER (0..32767),
    ...
}

GA-EllipsoidArc ::= SEQUENCE {
    geographicalCoordinates    GeographicalCoordinate,
    innerRadius                INTEGER (0..65535),
    uncertaintyRadius          INTEGER (0..127),
    offsetAngle                INTEGER (0..179),
    includedAngle              INTEGER (0..179),
    confidence                 INTEGER (0..127),
    iE-Extensions              ProtocolExtensionContainer { { GA-EllipsoidArc-ExtIEs } } OPTIONAL,
    ...
}

GA-EllipsoidArc-ExtIEs RNSAP-PROTOCOL-EXTENSION ::= {
    ...
}

GA-PointWithAltitude ::= SEQUENCE {
    geographicalCoordinates    GeographicalCoordinate,
    altitudeAndDirection       GA-AltitudeAndDirection,
    iE-Extensions              ProtocolExtensionContainer { { GA-PointWithAltitude-ExtIEs } } OPTIONAL,
    ...
}

GA-PointWithAltitude-ExtIEs RNSAP-PROTOCOL-EXTENSION ::= {
    ...
}

GA-PointWithAltitudeAndUncertaintyEllipsoid ::= SEQUENCE {
    geographicalCoordinates    GeographicalCoordinate,
    altitudeAndDirection       GA-AltitudeAndDirection,
    uncertaintyEllipse         GA-UncertaintyEllipse,
    uncertaintyAltitude        INTEGER (0..127),
    confidence                 INTEGER (0..127),
    iE-Extensions              ProtocolExtensionContainer { { GA-PointWithAltitudeAndUncertaintyEllipsoid-ExtIEs } } OPTIONAL,

```



```

    ...
}
GA-PointWithAltitudeAndUncertaintyEllipsoid-ExtIEs RNSAP-PROTOCOL-EXTENSION ::= {
    ...
}
GA-PointWithUnCertaintyEllipse ::= SEQUENCE {
    geographicalCoordinates      GeographicalCoordinate,
    uncertaintyEllipse           GA-UncertaintyEllipse,
    confidence                   INTEGER (0..127),
    iE-Extensions                ProtocolExtensionContainer { { GA-PointWithUnCertaintyEllipse-ExtIEs } } OPTIONAL,
    ...
}
GA-PointWithUnCertaintyEllipse-ExtIEs RNSAP-PROTOCOL-EXTENSION ::= {
    ...
}
GA-UncertaintyEllipse ::= SEQUENCE {
    uncertaintySemi-major        INTEGER (0..127),
    uncertaintySemi-minor        INTEGER (0..127),
    orientationOfMajorAxis        INTEGER (0..179), -- The values 90..179 shall not be used.
    ...
}
GA-PointWithUnCertainty ::= SEQUENCE {
    geographicalCoordinates      GeographicalCoordinate,
    uncertaintyCode              INTEGER (0..127),
    iE-Extensions                ProtocolExtensionContainer { {GA-PointWithUnCertainty-ExtIEs} } OPTIONAL,
    ...
}
GA-PointWithUnCertainty-ExtIEs RNSAP-PROTOCOL-EXTENSION ::= {
    ...
}
GA-AccessPointPosition ::= SEQUENCE {
    geographicalCoordinate        GeographicalCoordinate,
    iE-Extensions                ProtocolExtensionContainer { {GA-AccessPoint-ExtIEs} } OPTIONAL,
    ...
}
GA-AccessPoint-ExtIEs RNSAP-PROTOCOL-EXTENSION ::= {
    ...
}
GeographicalCoordinate ::= SEQUENCE {
    latitudeSign                 ENUMERATED { north, south },
    latitude                     INTEGER (0..8388607),
    longitude                     INTEGER (-8388608..8388607),
    iE-Extensions                ProtocolExtensionContainer { {GeographicalCoordinate-ExtIEs} } OPTIONAL,
    ...
}

```

```

GeographicalCoordinate-ExtIEs RNSAP-PROTOCOL-EXTENSION ::= {
  ...
}

GPS-Almanac ::= SEQUENCE {
  wna-alm          BIT STRING (SIZE (8)),
  satellite-Almanac-Information SEQUENCE (SIZE (1..maxNoSat)) OF
    SEQUENCE {
      dATA-ID          DATA-ID,
      sAT-ID           SAT-ID,
      gps-e-alm        BIT STRING (SIZE (16)),
      gps-toa-alm      BIT STRING (SIZE (8)),
      gps-delta-I-alm  BIT STRING (SIZE (16)),
      omegadot-alm     BIT STRING (SIZE (16)),
      svhealth-alm     BIT STRING (SIZE (8)),
      gps-a-sqrt-alm   BIT STRING (SIZE (24)),
      omegazero-alm    BIT STRING (SIZE (24)),
      m-zero-alm       BIT STRING (SIZE (24)),
      gps-omega-alm    BIT STRING (SIZE (24)),
      gps-af-zero-alm  BIT STRING (SIZE (11)),
      gps-af-one-alm   BIT STRING (SIZE (11)),
      iE-Extensions    ProtocolExtensionContainer { { Satellite-Almanac-Information-ExtIEs } } OPTIONAL,
      ...
    },
  sVGlobalHealth-alm BIT STRING (SIZE (364)) OPTIONAL,
  iE-Extensions      ProtocolExtensionContainer { { GPS-Almanac-ExtIEs } } OPTIONAL,
  ...
}

Satellite-Almanac-Information-ExtIEs RNSAP-PROTOCOL-EXTENSION ::= {
  ...
}

GPS-Almanac-ExtIEs RNSAP-PROTOCOL-EXTENSION ::= {
  ...
}

GPSInformation ::= SEQUENCE (SIZE (1..maxNoGPSTypes)) OF
  SEQUENCE {
    gpsInformationItem ENUMERATED {
      GPS-NavigationModel-and-TimeRecovery,
      GPS-Ionospheric-Model,
      GPS-UTC-Model,
      GPS-Almanac,
      GPS-RealTime-Integrity,
      ...
    },
    iE-Extensions      ProtocolExtensionContainer { { GPSInformation-ExtIEs } } OPTIONAL,
    ...
  }
-- This IE shall be present if the Information Type IE indicates "GPS Information"

GPSInformation-ExtIEs RNSAP-PROTOCOL-EXTENSION ::= {

```

```

    ...
}

GPS-Ionospheric-Model ::= SEQUENCE {
    alpha-zero-ionos      BIT STRING (SIZE (8)),
    alpha-one-ionos      BIT STRING (SIZE (8)),
    alpha-two-ionos      BIT STRING (SIZE (8)),
    alpha-three-ionos    BIT STRING (SIZE (8)),
    beta-zero-ionos      BIT STRING (SIZE (8)),
    beta-one-ionos       BIT STRING (SIZE (8)),
    beta-two-ionos       BIT STRING (SIZE (8)),
    beta-three-ionos     BIT STRING (SIZE (8)),
    iE-Extensions        ProtocolExtensionContainer { { GPS-Ionospheric-Model-ExtIEs} }    OPTIONAL,
    ...
}

GPS-Ionospheric-Model-ExtIEs RNSAP-PROTOCOL-EXTENSION ::= {
    ...
}

GPS-NavigationModel-and-TimeRecovery ::= SEQUENCE (SIZE (1..maxNoSat)) OF
SEQUENCE {
    tx-tow-nav            INTEGER (0..1048575),
    sAT-ID                SAT-ID,
    tlm-message-nav      BIT STRING (SIZE (14)),
    tlm-revd-c-nav       BIT STRING (SIZE (2)),
    ho-word-nav          BIT STRING (SIZE (22)),
    w-n-nav              BIT STRING (SIZE (10)),
    ca-or-p-on-l2-nav    BIT STRING (SIZE (2)),
    user-range-accuracy-index-nav BIT STRING (SIZE (4)),
    sv-health-nav       BIT STRING (SIZE (6)),
    iodc-nav             BIT STRING (SIZE (10)),
    l2-p-dataflag-nav    BIT STRING (SIZE (1)),
    sfl-reserved-nav     BIT STRING (SIZE (87)),
    t-gd-nav            BIT STRING (SIZE (8)),
    t-oc-nav            BIT STRING (SIZE (16)),
    a-f-2-nav           BIT STRING (SIZE (8)),
    a-f-1-nav           BIT STRING (SIZE (16)),
    a-f-zero-nav        BIT STRING (SIZE (22)),
    c-rs-nav            BIT STRING (SIZE (16)),
    delta-n-nav         BIT STRING (SIZE (16)),
    m-zero-nav          BIT STRING (SIZE (32)),
    c-uc-nav            BIT STRING (SIZE (16)),
    gps-e-nav           BIT STRING (SIZE (32)),
    c-us-nav            BIT STRING (SIZE (16)),
    a-sqrt-nav          BIT STRING (SIZE (32)),
    t-oe-nav            BIT STRING (SIZE (16)),
    fit-interval-flag-nav BIT STRING (SIZE (1)),
    aodo-nav            BIT STRING (SIZE (5)),
    c-ic-nav            BIT STRING (SIZE (16)),
    omega-zero-nav      BIT STRING (SIZE (32)),
    c-is-nav            BIT STRING (SIZE (16)),
    i-zero-nav          BIT STRING (SIZE (32)),
    c-rc-nav            BIT STRING (SIZE (16)),

```

```

    gps-omega-nav          BIT STRING (SIZE (32)),
    omegadot-nav          BIT STRING (SIZE (24)),
    idot-nav              BIT STRING (SIZE (14)),
    spare-zero-fill       BIT STRING (SIZE (20)),
    iE-Extensions         ProtocolExtensionContainer { { GPS-NavigationModel-and-TimeRecoveryItem-ExtIEs } } OPTIONAL,
    ...
}

GPS-NavigationModel-and-TimeRecoveryItem-ExtIEs RNSAP-PROTOCOL-EXTENSION ::= {
    ...
}

GPS-RealTime-Integrity ::= CHOICE {
    badSatellites          BadSatellites,
    noBadSatellite        NULL
}

GPS-RX-POS ::= SEQUENCE {
    geographicalCoordinate GeographicalCoordinate,
    altitudeAndDirection  GA-AltitudeAndDirection,
    iE-Extensions         ProtocolExtensionContainer { { GPS-RX-POS-ExtIEs } } OPTIONAL,
    ...
}

GPS-RX-POS-ExtIEs RNSAP-PROTOCOL-EXTENSION ::= {
    ...
}

GPS-Status-Health ::= ENUMERATED {
    udre-1-0,
    udre-0-75,
    udre-0-5,
    udre-0-3,
    udre-0-1,
    no-data,
    invalid-data
}

GPSTOW ::= INTEGER (0..604799)

GPS-UTC-Model ::= SEQUENCE {
    a-one-utc          BIT STRING (SIZE (24)),
    a-zero-utc         BIT STRING (SIZE (32)),
    t-ot-utc           BIT STRING (SIZE (8)),
    delta-t-ls-utc     BIT STRING (SIZE (8)),
    w-n-t-utc          BIT STRING (SIZE (8)),
    w-n-lsf-utc        BIT STRING (SIZE (8)),
    dn-utc             BIT STRING (SIZE (8)),
    delta-t-lsf-utc     BIT STRING (SIZE (8)),
    iE-Extensions     ProtocolExtensionContainer { { GPS-UTC-Model-ExtIEs } } OPTIONAL,
    ...
}

GPS-UTC-Model-ExtIEs RNSAP-PROTOCOL-EXTENSION ::= {

```

```

}
...
}
Guaranteed-Rate-Information ::= SEQUENCE {
    guaranteed-UL-Rate      Guaranteed-Rate OPTIONAL,
    guaranteed-DL-Rate      Guaranteed-Rate OPTIONAL,
    iE-Extensions           ProtocolExtensionContainer { {Guaranteed-Rate-Information-ExtIEs} } OPTIONAL,
    ...
}
Guaranteed-Rate-Information-ExtIEs RNSAP-PROTOCOL-EXTENSION ::= {
    ...
}
Guaranteed-Rate      ::= INTEGER (1..maxNrOfTFs)
-- "1": TFI 0, "2": TFI 1, "3": TFI 2, ...

-- H

-- I

IB-SchedulingInformation ::= SEQUENCE {
    iB-SG-Rep              IB-SG-REP,
    iB-segmentInformationList IB-SegmentInformationList,
    iE-Extensions          ProtocolExtensionContainer { { IB-SchedulingInformation-ExtIEs } } OPTIONAL,
    ...
}
IB-SchedulingInformation-ExtIEs RNSAP-PROTOCOL-EXTENSION ::= {
    ...
}
IB-SegmentInformationList ::= SEQUENCE (SIZE(1..maxIBSEG)) OF IB-SegmentInformationItem
IB-SegmentInformationItem ::= SEQUENCE {
    iB-SG-POS              IB-SG-POS,
    iE-Extensions          ProtocolExtensionContainer { { IB-SegmentInformationItem-ExtIEs } } OPTIONAL,
    ...
}
IB-SegmentInformationItem-ExtIEs RNSAP-PROTOCOL-EXTENSION ::= {
    ...
}
IB-SG-POS      ::= INTEGER (0..4094)
-- Only even positions allowed
IB-SG-REP      ::= ENUMERATED {rep4, rep8, rep16, rep32, rep64, rep128, rep256, rep512, rep1024, rep2048, rep4096}
IMSI          ::= OCTET STRING (SIZE(3..8))

InformationAvailable ::= SEQUENCE {
    requestedDataValue      RequestedDataValue,
    iE-Extensions           ProtocolExtensionContainer { { InformationAvailable-ExtIEs } } OPTIONAL,

```

```

    ...
}

InformationAvailable-ExtIEs RNSAP-PROTOCOL-EXTENSION ::= {
    ...
}

InformationExchangeID ::= INTEGER (0..1048575)

InformationNotAvailable ::= NULL

InformationReportCharacteristics ::= CHOICE {
    onDemand          NULL,
    periodic          PeriodicInformation,
    onModification   OnModificationInformation,
    ...
}

InformationReportPeriodicity ::= CHOICE {
    min          INTEGER (1..60,...),
-- Unit min, Step lmin
    hour        INTEGER (1..24,...),
-- Unit hour, Step lhour
    ...
}

InformationThreshold ::= CHOICE {
    dGPSThreshold    DGPSThreshold,
    ...
}

InformationType ::= SEQUENCE {
    informationTypeItem    ENUMERATED {
        gA-AccessPointPositionwithAltitude,
        gA-AccessPointPosition,
        iPDLParameters,
        gPSInformation,
        dGPSCorrections,
        gPS-RX-POS,
        sFNsFN-GA-AccessPointPosition,
        ...
    },
    gPSInformation          GPSInformation          OPTIONAL,
    iE-Extensions          ProtocolExtensionContainer { { InformationType-ExtIEs } }    OPTIONAL,
    ...
}

-- The GPS Information IE shall be present if the Information Exchange Type IE indicates "GPS Information"

InformationType-ExtIEs RNSAP-PROTOCOL-EXTENSION ::= {
    ...
}

InnerLoopDLPCStatus ::= ENUMERATED {active, inactive}

```

```

IPDLParameters ::= CHOICE {
    iPDL-FDD-Parameters      IPDL-FDD-Parameters,
    iPDL-TDD-Parameters      IPDL-TDD-Parameters,
    ...
}

IPDL-FDD-Parameters ::= SEQUENCE {
    iPSpacingFDD              IPSpacingFDD,
    iPLength                  IPLength,
    iPOffset                  IPOffset,
    seed                      Seed,
    burstModeParameters      BurstModeParameters OPTIONAL,
    iE-Extensions            ProtocolExtensionContainer { { IPDL-FDD-Parameters-ExtIEs } } OPTIONAL,
    ...
}

IPDL-FDD-Parameters-ExtIEs RNSAP-PROTOCOL-EXTENSION ::= {
    ...
}

IPDL-TDD-Parameters ::= SEQUENCE {
    iPSpacingTDD              IPSpacingTDD,
    iPStart                   IPStart,
    iPSlot                     IPSlot,
    iP-P-CCPCH                IP-P-CCPCH,
    burstModeParameters      BurstModeParameters OPTIONAL,
    iE-Extensions            ProtocolExtensionContainer { { IPDL-TDD-Parameters-ExtIEs } } OPTIONAL,
    ...
}

-- The BurstModeParameters IE shall be included if the Idle Periods are arranged in Burst Mode.

IPDL-TDD-Parameters-ExtIEs RNSAP-PROTOCOL-EXTENSION ::= {
    ...
}

IPLength ::= ENUMERATED {
    ip15,
    ip110,
    ...
}

IPOffset ::= INTEGER (0..9)

IP-P-CCPCH ::= ENUMERATED {
    switchOff-1-Frame,
    switchOff-2-Frames
}

IPSlot ::= INTEGER (0..14)

IPSpacingFDD ::= ENUMERATED {
    ipsF5,

```

```
    ipsF7,
    ipsF10,
    ipsF15,
    ipsF20,
    ipsF30,
    ipsF40,
    ipsF50,
    ...
}

IPSpacingTDD ::= ENUMERATED {
    ipsT30,
    ipsT40,
    ipsT50,
    ipsT70,
    ipsT100,
    ...
}

IPStart ::= INTEGER (0..4095)

-- J
-- K
-- L

LAC                ::= OCTET STRING (SIZE (2)) --(EXCEPT ('0000'H|'FFFE'H))

LengthOfTFCI2 ::= INTEGER(1..10)

LimitedPowerIncrease ::= ENUMERATED {
    used,
    not-used
}

L3-Information      ::= BIT STRING

Load-Value-IncrDecrThres ::= INTEGER(0..100)

Load-Value ::= INTEGER(0..100)

LoadValue ::= SEQUENCE {
    uplinkLoadValue    INTEGER(0..100),
    downlinkLoadValue  INTEGER(0..100)
}

-- M

MaxNrOfUL-DPCHs      ::= INTEGER (1..6)

MAC-c-sh-SDU-Length  ::= INTEGER (1..5000)

MAC-c-sh-SDU-LengthList ::= SEQUENCE(SIZE(1..maxNrOfMACcshSDU-Length)) OF MAC-c-sh-SDU-Length

MaximumAllowedULTxPower ::= INTEGER (-50..33)
```



```

MaxNrDLPhysicalchannels ::= INTEGER (1..224)

MaxNrTimeslots ::= INTEGER (1..14)

MaxNrULPhysicalchannels ::= INTEGER (1..2)

MaxTFCIvalue ::= INTEGER (1..1023)

MeasurementFilterCoefficient ::= ENUMERATED{k0, k1, k2, k3, k4, k5, k6, k7, k8, k9, k11, k13, k15, k17, k19,...}
-- Measurement Filter Coefficient to be used for measurement

MeasurementID ::= INTEGER (0..1048575)

MinimumSpreadingFactor ::= INTEGER (1..16)

Multi-code-info ::= INTEGER (1..16)

MultipleURAsIndicator ::= ENUMERATED {
    multiple-URAs-exist,
    single-URA-exists
}

MaxAdjustmentStep ::= INTEGER(1..10)
-- Unit Slot

MeasurementChangeTime ::= INTEGER (1..6000,...)
-- The MeasurementChangeTime gives the MeasurementChangeTime
-- in number of 10 ms periods.
-- E.g. Value 6000 means 60000ms(1min)
-- Unit is ms, Step is 10 ms

MeasurementHysteresisTime ::= INTEGER (1..6000,...)
-- The MeasurementHysteresisTime gives the
-- MeasurementHysteresisTime in number of 10 ms periods.
-- E.g. Value 6000 means 60000ms(1min)
-- Unit is ms, Step is 10ms

MeasurementIncreaseDecreaseThreshold ::= CHOICE {
    sir SIR-Value-IncrDecrThres,
    sir-error SIR-Error-Value-IncrDecrThres,
    transmitted-code-power Transmitted-Code-Power-Value-IncrDecrThres,
    rscp RSCP-Value-IncrDecrThres,
    round-trip-time Round-Trip-Time-IncrDecrThres,
    ...,
    extension-MeasurementIncreaseDecreaseThreshold Extension-MeasurementIncreaseDecreaseThreshold
}

Extension-MeasurementIncreaseDecreaseThreshold ::= ProtocolIE-Single-Container {{ Extension-MeasurementIncreaseDecreaseThresholdIE }}

Extension-MeasurementIncreaseDecreaseThresholdIE RNSAP-PROTOCOL-IES ::= {
    { ID id-Load-Value-IncrDecrThres CRITICALITY reject TYPE Load-Value-IncrDecrThres PRESENCE mandatory }|
    { ID id-Transmitted-Carrier-Power-Value-IncrDecrThres CRITICALITY reject TYPE Transmitted-Carrier-Power-Value-IncrDecrThres PRESENCE
mandatory }|

```

```

    { ID id-Received-Total-Wideband-Power-Value-IncrDecrThres  CRITICALITY reject  TYPE Received-Total-Wideband-Power-Value-IncrDecrThres
      PRESENCE mandatory }|
    { ID id-UL-Timeslot-ISCP-Value-IncrDecrThres  CRITICALITY reject  TYPE UL-Timeslot-ISCP-Value-IncrDecrThres  PRESENCE mandatory }
  }
}

MeasurementThreshold ::= CHOICE {
  sir                SIR-Value,
  sir-error          SIR-Error-Value,
  transmitted-code-power  Transmitted-Code-Power-Value,
  rscp               RSCP-Value,
  rx-timing-deviation  Rx-Timing-Deviation-Value,
  round-trip-time    Round-Trip-Time-Value,
  ...,
  extension-MeasurementThreshold  Extension-MeasurementThreshold
}

Extension-MeasurementThreshold ::= ProtocolIE-Single-Container {{ Extension-MeasurementThresholdIE }}

Extension-MeasurementThresholdIE RNSAP-PROTOCOL-IES ::= {
  { ID id-TUTRANGPSMeasurementThresholdInformation  CRITICALITY reject  TYPE TUTRANGPSMeasurementThresholdInformation  PRESENCE mandatory }|
  { ID id-SFNFSNMeasurementThresholdInformation  CRITICALITY reject  TYPE SFNFSNMeasurementThresholdInformation  PRESENCE mandatory }|
  { ID id-Load-Value  CRITICALITY reject  TYPE Load-Value  PRESENCE mandatory }|
  { ID id-Transmitted-Carrier-Power-Value  CRITICALITY reject  TYPE Transmitted-Carrier-Power-Value  PRESENCE mandatory }|
  { ID id-Received-Total-Wideband-Power-Value  CRITICALITY reject  TYPE Received-Total-Wideband-Power-Value  PRESENCE mandatory }|
  { ID id-UL-Timeslot-ISCP-Value  CRITICALITY reject  TYPE UL-Timeslot-ISCP-Value  PRESENCE mandatory }|
  { ID id-Rx-Timing-Deviation-Value-LCR  CRITICALITY reject  TYPE Rx-Timing-Deviation-Value-LCR  PRESENCE mandatory }
}

MidambleConfigurationLCR ::=  ENUMERATED {v2, v4, v6, v8, v10, v12, v14, v16, ...}

MidambleConfigurationBurstType1And3 ::=  ENUMERATED {v4, v8, v16}

MidambleConfigurationBurstType2 ::=  ENUMERATED {v3, v6}

MidambleShiftAndBurstType ::=  CHOICE {
  type1                SEQUENCE {
    midambleConfigurationBurstType1And3  MidambleConfigurationBurstType1And3,
    midambleAllocationMode                CHOICE {
      defaultMidamble                    NULL,
      commonMidamble                    NULL,
      ueSpecificMidamble                MidambleShiftLong,
      ...
    },
    ...
  },
  type2                SEQUENCE {
    midambleConfigurationBurstType2      MidambleConfigurationBurstType2,
    midambleAllocationMode                CHOICE {
      defaultMidamble                    NULL,
      commonMidamble                    NULL,
      ueSpecificMidamble                MidambleShiftShort,
      ...
    },
    ...
  },
  ...
}

```

```

    },
    type3
        SEQUENCE {
            midambleConfigurationBurstType1And3 MidambleConfigurationBurstType1And3,
            midambleAllocationMode CHOICE {
                defaultMidamble NULL,
                ueSpecificMidamble MidambleShiftLong,
                ...
            },
            ...
        },
    ...
}

MidambleShiftLong ::= INTEGER (0..15)

MidambleShiftShort ::= INTEGER (0..5)

MidambleShiftLCR ::= SEQUENCE {
    midambleAllocationMode MidambleAllocationMode,
    midambleShift MidambleShiftLong OPTIONAL,
    -- The IE shall be present if the Midamble Allocation Mode IE is set to "UE specific midamble".
    midambleConfigurationLCR MidambleConfigurationLCR,
    iE-Extensions ProtocolExtensionContainer { {MidambleShiftLCR-ExtIEs} } OPTIONAL,
    ...
}

MidambleAllocationMode ::= ENUMERATED {
    defaultMidamble,
    commonMidamble,
    ueSpecificMidamble,
    ...
}

MidambleShiftLCR-ExtIEs RNSAP-PROTOCOL-EXTENSION ::= {
    ...
}

MinUL-ChannelisationCodeLength ::= ENUMERATED {
    v4,
    v8,
    v16,
    v32,
    v64,
    v128,
    v256
}

Modulation ::= ENUMERATED {
    qPSK,
    eightPSK,
    ...
}

MultiplexingPosition ::= ENUMERATED {

```

```

    fixed,
    flexible
}

-- N

NCC ::= BIT STRING (SIZE (3))

Neighbouring-UMTS-CellInformation ::= SEQUENCE (SIZE (1..maxNrOfNeighbouringRNCs)) OF ProtocolIE-Single-Container {{ Neighbouring-UMTS-CellInformationItemIE }}

Neighbouring-UMTS-CellInformationItemIE RNSAP-PROTOCOL-IES ::= {
  { ID id-Neighbouring-UMTS-CellInformationItem  CRITICALITY ignore  TYPE      Neighbouring-UMTS-CellInformationItem  PRESENCE mandatory }
}

Neighbouring-UMTS-CellInformationItem ::= SEQUENCE {
  rNC-ID                RNC-ID,
  cN-PS-DomainIdentifier  CN-PS-DomainIdentifier  OPTIONAL,
  cN-CS-DomainIdentifier  CN-CS-DomainIdentifier  OPTIONAL,
  neighbouring-FDD-CellInformation  Neighbouring-FDD-CellInformation  OPTIONAL,
  neighbouring-TDD-CellInformation  Neighbouring-TDD-CellInformation  OPTIONAL,
  iE-Extensions          ProtocolExtensionContainer { {Neighbouring-UMTS-CellInformationItem-ExtIEs} } OPTIONAL,
  ...
}

Neighbouring-UMTS-CellInformationItem-ExtIEs RNSAP-PROTOCOL-EXTENSION ::= {
  { ID id-neighbouring-LCR-TDD-CellInformation  CRITICALITY ignore  EXTENSION  Neighbouring-LCR-TDD-CellInformation  PRESENCE optional },
  ...
}

Neighbouring-FDD-CellInformation ::= SEQUENCE ( SIZE (1..maxNrOfFDDNeighboursPerRNC,...)) OF Neighbouring-FDD-CellInformationItem

Neighbouring-FDD-CellInformationItem ::= SEQUENCE {
  c-ID                C-ID,
  uARFCNforNu        UARFCN,
  uARFCNforNd        UARFCN,
  frameOffset        FrameOffset  OPTIONAL,
  primaryScramblingCode  PrimaryScramblingCode,
  primaryCPICH-Power  PrimaryCPICH-Power  OPTIONAL,
  cellIndividualOffset  CellIndividualOffset  OPTIONAL,
  txDiversityIndicator  TxDiversityIndicator,
  sTTD-SupportIndicator  STTD-SupportIndicator  OPTIONAL,
  closedLoopMode1-SupportIndicator  ClosedLoopMode1-SupportIndicator  OPTIONAL,
  closedLoopMode2-SupportIndicator  ClosedLoopMode2-SupportIndicator  OPTIONAL,
  iE-Extensions          ProtocolExtensionContainer { { Neighbouring-FDD-CellInformationItem-ExtIEs} } OPTIONAL,
  ...
}

Neighbouring-FDD-CellInformationItem-ExtIEs RNSAP-PROTOCOL-EXTENSION ::= {
  { ID id-RestrictionStateIndicator  CRITICALITY ignore  EXTENSION  RestrictionStateIndicator  PRESENCE optional }|
  { ID id-DPC-Mode-Change-SupportIndicator  CRITICALITY ignore  EXTENSION  DPC-Mode-Change-SupportIndicator  PRESENCE optional },
  ...
}

```

```

NeighbouringFDDCellMeasurementInformation ::= SEQUENCE {
    uC-ID                UC-ID,
    uARFCN               UARFCN,
    primaryScramblingCode PrimaryScramblingCode,
    iE-Extensions       ProtocolExtensionContainer { { NeighbouringFDDCellMeasurementInformationItem-ExtIEs } } OPTIONAL,
    ...
}

```

```

NeighbouringFDDCellMeasurementInformationItem-ExtIEs RNSAP-PROTOCOL-EXTENSION ::= {
    ...
}

```

```

Neighbouring-GSM-CellInformation ::= ProtocolIE-Single-Container {{ Neighbouring-GSM-CellInformationIE }}

```

```

Neighbouring-GSM-CellInformationIE RNSAP-PROTOCOL-IES ::= {
    { ID id-Neighbouring-GSM-CellInformation    CRITICALITY ignore    TYPE    Neighbouring-GSM-CellInformationIEs    PRESENCE mandatory }
}

```

```

Neighbouring-GSM-CellInformationIEs ::= SEQUENCE ( SIZE (1..maxNrOfGSMNeighboursPerRNC,...)) OF Neighbouring-GSM-CellInformationItem

```

```

Neighbouring-GSM-CellInformationItem ::= SEQUENCE {
    CGI                CGI,
    cellIndividualOffset CellIndividualOffset    OPTIONAL,
    bSIC               BSIC,
    band-Indicator     Band-Indicator,
    bCCH-ARFCN        BCCH-ARFCN,
    iE-Extensions     ProtocolExtensionContainer { { Neighbouring-GSM-CellInformationItem-ExtIEs } } OPTIONAL,
    ...
}

```

```

Neighbouring-GSM-CellInformationItem-ExtIEs RNSAP-PROTOCOL-EXTENSION ::= {
    { ID id-ExtendedGSMCellIndividualOffset    CRITICALITY ignore    EXTENSION ExtendedGSMCellIndividualOffset    PRESENCE optional },
    ...
}

```

```

Neighbouring-TDD-CellInformation ::= SEQUENCE ( SIZE (1..maxNrOfTDDNeighboursPerRNC,...)) OF Neighbouring-TDD-CellInformationItem

```

```

Neighbouring-TDD-CellInformationItem ::= SEQUENCE {
    c-ID                C-ID,
    uARFCNforNt         UARFCN,
    frameOffset         FrameOffset    OPTIONAL,
    cellParameterID    CellParameterID,
    syncCase            SyncCase,
    timeSlot            TimeSlot    OPTIONAL
    -- This IE shall be present if Sync Case = Case1 -- ,
    sCH-TimeSlot        SCH-TimeSlot    OPTIONAL
    -- This IE shall be present if Sync Case = Case2 -- ,
    sCTD-Indicator      SCTD-Indicator,
    cellIndividualOffset CellIndividualOffset    OPTIONAL,
    dPCHConstantValue   DPCHConstantValue    OPTIONAL,
    pCCPCH-Power        PCCPCH-Power    OPTIONAL,
    iE-Extensions     ProtocolExtensionContainer { { Neighbouring-TDD-CellInformationItem-ExtIEs } } OPTIONAL,
    ...
}

```

```

}

Neighbouring-TDD-CellInformationItem-ExtIEs RNSAP-PROTOCOL-EXTENSION ::= {
  { ID id-RestrictionStateIndicator          CRITICALITY ignore          EXTENSION RestrictionStateIndicator  PRESENCE optional },
  ...
}

NeighbouringTDDCellMeasurementInformation ::= SEQUENCE {
  uC-ID                UC-ID,
  uARFCN               UARFCN,
  cellParameterID     CellParameterID,
  timeSlot             TimeSlot          OPTIONAL,
  midambleShiftAndBurstType  MidambleShiftAndBurstType  OPTIONAL,
  iE-Extensions       ProtocolExtensionContainer { { NeighbouringTDDCellMeasurementInformationItem-ExtIEs } } OPTIONAL,
  ...
}

NeighbouringTDDCellMeasurementInformationItem-ExtIEs RNSAP-PROTOCOL-EXTENSION ::= {
  ...
}

Neighbouring-LCR-TDD-CellInformation ::= SEQUENCE (SIZE (1.. maxNrOfLCRTDDNeighboursPerRNC,...)) OF Neighbouring-LCR-TDD-CellInformationItem

Neighbouring-LCR-TDD-CellInformationItem ::= SEQUENCE {
  c-ID                C-ID,
  uARFCNforNt        UARFCN,
  frameOffset        FrameOffset          OPTIONAL,
  cellParameterID    CellParameterID,
  SCTD-Indicator     SCTD-Indicator,
  cellIndividualOffset  CellIndividualOffset  OPTIONAL,
  dPCHConstantValue  DPCHConstantValue  OPTIONAL,
  pCCPCH-Power       PCCPCH-Power        OPTIONAL,
  restrictionStateIndicator  RestrictionStateIndicator  OPTIONAL,
  iE-Extensions       ProtocolExtensionContainer { { Neighbouring-LCR-TDD-CellInformationItem-ExtIEs } } OPTIONAL,
  ...
}

Neighbouring-LCR-TDD-CellInformationItem-ExtIEs RNSAP-PROTOCOL-EXTENSION ::= {
  ...
}

NrOfDLchannelisationcodes ::= INTEGER (1..8)

NrOfTransportBlocks ::= INTEGER (0..512)

-- 0

OnModification ::= SEQUENCE {
  measurementThreshold  MeasurementThreshold,
  iE-Extensions         ProtocolExtensionContainer { { OnModification-ExtIEs } } OPTIONAL,
  ...
}

```

```
OnModification-ExtIEs RNSAP-PROTOCOL-EXTENSION ::= {
    ...
}

OnModificationInformation ::= SEQUENCE {
    informationThreshold      InformationThreshold OPTIONAL,
    iE-Extensions            ProtocolExtensionContainer { {OnModificationInformation-ExtIEs} } OPTIONAL,
    ...
}

OnModificationInformation-ExtIEs RNSAP-PROTOCOL-EXTENSION ::= {
    ...
}

-- P

PagingCause ::= ENUMERATED {
    terminating-conversational-call,
    terminating-streaming-call,
    terminating-interactive-call,
    terminating-background-call,
    terminating-low-priority-signalling,
    ...,
    terminating-high-priority-signalling,
    terminating-cause-unknown
}
-- See in [16]

PagingRecordType ::= ENUMERATED {
    imsi-gsm-map,
    tmsi-gsm-map,
    p-tmsi-gsm-map,
    imsi-ds-41,
    tmsi-ds-41,
    ...
}
-- See in [16]

PayloadCRC-PresenceIndicator ::= ENUMERATED {
    crc-included,
    crc-not-included
}

PCCPCH-Power ::= INTEGER (-150..400,...)
-- PCCPCH-power = power * 10
-- If power <= -15 PCCPCH shall be set to -150
-- If power >= 40 PCCPCH shall be set to 400
-- Unit dBm, Range -15dBm .. +40 dBm, Step 0.1dBm

PCH-InformationList ::= SEQUENCE (SIZE(0..1)) OF PCH-InformationItem

PCH-InformationItem ::= SEQUENCE {
    transportFormatSet      TransportFormatSet,
```

```

    iE-Extensions          ProtocolExtensionContainer { { PCH-InformationItem-ExtIEs } } OPTIONAL,
    ...
}

PCH-InformationItem-ExtIEs RNSAP-PROTOCOL-EXTENSION ::= {
    ...
}

PC-Preamble ::= INTEGER(0..7,...)

PDSCHCodeMapping ::= SEQUENCE {
    dL-ScramblingCode      DL-ScramblingCode,
    signallingMethod       PDSCHCodeMapping-SignallingMethod,
    iE-Extensions          ProtocolExtensionContainer { { PDSCHCodeMapping-ExtIEs } } OPTIONAL,
    ...
}

PDSCHCodeMapping-ExtIEs RNSAP-PROTOCOL-EXTENSION ::= {
    ...
}

PDSCHCodeMapping-SignallingMethod ::= CHOICE {
    pDSCHCodeMapping-SignallingMethod-CodeRange      PDSCHCodeMapping-SignallingMethod-CodeRange,
    pDSCHCodeMapping-SignallingMethod-TFCIRange      PDSCHCodeMapping-SignallingMethod-TFCIRange,
    pDSCHCodeMapping-SignallingMethod-Explicit      PDSCHCodeMapping-SignallingMethod-Explicit,
    ...,
    pDSCHCodeMapping-SignallingMethod-Replace      PDSCHCodeMapping-SignallingMethod-Replace
}

PDSCHCodeMapping-SignallingMethod-CodeRange ::= SEQUENCE (SIZE (1..maxNoCodeGroups)) OF
SEQUENCE {
    spreadingFactor      SpreadingFactor,
    multi-code-info      Multi-code-info,
    start-CodeNumber     CodeNumber,
    stop-CodeNumber      CodeNumber,
    iE-Extensions        ProtocolExtensionContainer { { PDSCHCodeMapping-SignallingMethod-CodeRange-ExtIEs } } OPTIONAL,
    ...
}

PDSCHCodeMapping-SignallingMethod-CodeRange-ExtIEs RNSAP-PROTOCOL-EXTENSION ::= {
    ...
}

PDSCHCodeMapping-SignallingMethod-TFCIRange ::= SEQUENCE (SIZE (1..maxNoTFCIGroups)) OF
SEQUENCE {
    maxTFCIvalue      MaxTFCIvalue,
    spreadingFactor    SpreadingFactor,
    multi-code-info    Multi-code-info,
    codeNumber         CodeNumber,
    iE-Extensions      ProtocolExtensionContainer { { PDSCHCodeMapping-SignallingMethod-TFCIRange-ExtIEs } } OPTIONAL,
    ...
}

PDSCHCodeMapping-SignallingMethod-TFCIRange-ExtIEs RNSAP-PROTOCOL-EXTENSION ::= {

```



```

}
...
}
PDSCHCodeMapping-SignallingMethod-Explicit ::= SEQUENCE (SIZE (1..maxTFCI2Combs)) OF
SEQUENCE {
    spreadingFactor          SpreadingFactor,
    multi-code-info         Multi-code-info,
    codeNumber              CodeNumber,
    iE-Extensions           ProtocolExtensionContainer { { PDSCHCodeMapping-SignallingMethod-Explicit-ExtIEs} } OPTIONAL,
    ...
}
PDSCHCodeMapping-SignallingMethod-Explicit-ExtIEs RNSAP-PROTOCOL-EXTENSION ::= {
    ...
}
PDSCHCodeMapping-SignallingMethod-Replace ::= SEQUENCE (SIZE (1..maxTFCI2Combs)) OF
SEQUENCE {
    tfci-Field2              TFCS-MaxTFCI-field2-Value,
    spreadingFactor          SpreadingFactor,
    multi-CodeInfo           Multi-code-info,
    codeNumber              CodeNumber,
    iE-Extensions           ProtocolExtensionContainer { { PDSCHCodeMapping-SignallingMethod-Replace-ExtIEs} } OPTIONAL,
    ...
}
PDSCHCodeMapping-SignallingMethod-Replace-ExtIEs RNSAP-PROTOCOL-EXTENSION ::= {
    ...
}
Periodic ::= SEQUENCE {
    reportPeriodicity        ReportPeriodicity,
    iE-Extensions           ProtocolExtensionContainer { {Periodic-ExtIEs} } OPTIONAL,
    ...
}
Periodic-ExtIEs RNSAP-PROTOCOL-EXTENSION ::= {
    ...
}
PeriodicInformation ::= SEQUENCE {
    informationReportPeriodicity InformationReportPeriodicity,
    iE-Extensions           ProtocolExtensionContainer { {PeriodicInformation-ExtIEs} } OPTIONAL,
    ...
}
PeriodicInformation-ExtIEs RNSAP-PROTOCOL-EXTENSION ::= {
    ...
}
Permanent-NAS-UE-Identity ::= CHOICE {
    imsi                    IMSI,
    ...
}

```

```
PLMN-Identity ::= OCTET STRING (SIZE(3))

PowerAdjustmentType ::= ENUMERATED {
    none,
    common,
    individual
}

PowerOffset          ::= INTEGER (0..24)

PRC ::= INTEGER (-2047..2047)
--pseudo range correction; scaling factor 0.32 meters

PRCDeviation ::= ENUMERATED {
    prcd1,
    prcd2,
    prcd5,
    prcd10,
    ...
}

Pre-emptionCapability ::= ENUMERATED {
    shall-not-trigger-pre-emption,
    may-trigger-pre-emption
}

Pre-emptionVulnerability ::= ENUMERATED {
    not-pre-emptable,
    pre-emptable
}

PredictedSFNSFNDeviationLimit ::= INTEGER (1..256)
-- Unit chip, Step 1/16 chip, Range 1/16..16 chip

PredictedTUTRANGPSDeviationLimit ::= INTEGER (1..256)
-- Unit chip, Step 1/16 chip, Range 1/16..16 chip

PrimaryCPICH-Power          ::= INTEGER (-100..500)
-- step 0.1 (Range -10.0..50.0) Unit is dBm

PrimaryCPICH-EcNo          ::= INTEGER (-30..30)

PrimaryCCPCH-RSCP          ::= INTEGER (0..91)
-- According to mapping in [14]

PrimaryScramblingCode      ::= INTEGER (0..511)

PriorityLevel               ::= INTEGER (0..15)
-- 0 = spare, 1 = highest priority, ...14 = lowest priority and 15 = no priority

PropagationDelay           ::= INTEGER (0..255)

PunctureLimit              ::= INTEGER (0..15)
```

```
-- 0: 40%; 1: 44%; ... 14: 96%; 15: 100

-- Q

QE-Selector ::= ENUMERATED {
    selected,
    non-selected
}

-- R

RAC ::= OCTET STRING (SIZE(1))

RANAP-RelocationInformation ::= BIT STRING

Range-Correction-Rate ::= INTEGER (-127..127)
-- scaling factor 0.032 m/s

RateMatchingAttribute ::= INTEGER (1..maxRateMatching)

RB-Identity ::= INTEGER (0..31)

RB-Info ::= SEQUENCE (SIZE(1..maxNoOfRB)) OF RB-Identity

Received-Total-Wideband-Power-Value ::= Received-total-wide-band-power

Received-Total-Wideband-Power-Value-IncrDecrThres ::= INTEGER(0..620)
-- Unit dB Step 0.1dB
-- e.g. value 100 means 10dB

RefTFCNumber ::= INTEGER (0..15)

RepetitionLength ::= INTEGER (1..63)

RepetitionPeriod ::= ENUMERATED {
    v1,
    v2,
    v4,
    v8,
    v16,
    v32,
    v64
}

RepetitionNumber0 ::= INTEGER (0..255)

RepetitionNumber1 ::= INTEGER (1..256)

ReportCharacteristics ::= CHOICE {
    onDemand          NULL,
    periodic          Periodic,
    eventA            EventA,
    eventB            EventB,
```

```

    eventC           EventC,
    eventD           EventD,
    eventE           EventE,
    eventF           EventF,
    ...,
    extension-ReportCharacteristics  Extension-ReportCharacteristics
}

Extension-ReportCharacteristics ::= ProtocolIE-Single-Container {{ Extension-ReportCharacteristicsIE }}

Extension-ReportCharacteristicsIE RNSAP-PROTOCOL-IES ::= {
  { ID id-OnModification  CRITICALITY reject  TYPE OnModification  PRESENCE mandatory }
}

ReportPeriodicity ::= CHOICE {
  ten-msec          INTEGER (1..6000,...),
  -- The Report Periodicity gives the reporting periodicity in number of 10 ms periods.
  -- E.g. value 6000 means 60000ms (i.e. 1min)
  -- Unit ms, Step 10ms
  min              INTEGER (1..60,...),
  -- Unit min, Step 1min
  ...
}

RequestedDataValue ::= SEQUENCE {
  gA-AccessPointPositionwithAltitude  GA-AccessPointPositionwithOptionalAltitude  OPTIONAL,
  iPDLParameters                      IPDLParameters                      OPTIONAL,
  dGPSCorrections                     DGPSCorrections                     OPTIONAL,
  gPS-NavigationModel-and-TimeRecovery GPS-NavigationModel-and-TimeRecovery  OPTIONAL,
  gPS-Ionospheric-Model               GPS-Ionospheric-Model               OPTIONAL,
  gPS-UTC-Model                       GPS-UTC-Model                       OPTIONAL,
  gPS-Almanac                         GPS-Almanac                         OPTIONAL,
  gPS-RealTime-Integrity              GPS-RealTime-Integrity              OPTIONAL,
  gPS-RX-POS                          GPS-RX-POS                          OPTIONAL,
  sFNSFN-GA-AccessPointPosition      GA-AccessPointPositionwithOptionalAltitude  OPTIONAL,
  iE-Extensions                      ProtocolExtensionContainer { { RequestedDataValue-ExtIEs} }  OPTIONAL,
  ...
}

RequestedDataValue-ExtIEs RNSAP-PROTOCOL-EXTENSION ::= {
  ...
}

RequestedDataValueInformation ::= CHOICE {
  informationAvailable      InformationAvailable,
  informationNotAvailable   InformationNotAvailable
}

RestrictionStateIndicator ::= ENUMERATED {
  cellNotResevedForOperatorUse,
  cellResevedForOperatorUse,
  ...
}

```

```

RL-ID ::= INTEGER (0..31)

RL-Set-ID ::= INTEGER (0..31)

RNC-ID ::= INTEGER (0..4095)

Round-Trip-Time-IncrDecrThres ::= INTEGER(0..32766)

Round-Trip-Time-Value ::= INTEGER(0..32767)
-- According to mapping in [23]

RSCP-Value ::= INTEGER (0..127)
-- According to mapping in [24]

RSCP-Value-IncrDecrThres ::= INTEGER (0..126)

Received-total-wide-band-power ::= INTEGER (0..621)
-- According to mapping in [23]

RxTimingDeviationForTA ::= INTEGER (0..127)
-- As specified in [5], ch. 6.2.7.6
-- For 1.28Mcps TDD this IE must be set to 0.

Rx-Timing-Deviation-Value ::= INTEGER (0..8191)
--According to mapping in [24][3.84Mcps TDD only]

Rx-Timing-Deviation-Value-LCR ::= INTEGER (0..511)
--According to mapping in [24][1.28Mcps TDD only]

-- S

SAC ::= OCTET STRING (SIZE (2))

SAI ::= SEQUENCE {
    pLMN-Identity PLMN-Identity,
    LAC LAC,
    sAC SAC,
    iE-Extensions ProtocolExtensionContainer { {SAI-ExtIEs} } OPTIONAL
}

SAI-ExtIEs RNSAP-PROTOCOL-EXTENSION ::= {
    ...
}

SAT-ID ::= INTEGER (0..63)

SCH-TimeSlot ::= INTEGER (0..6)

ScaledAdjustmentRatio ::= INTEGER(0..100)
-- AdjustmentRatio = ScaledAdjustmentRatio / 100

Secondary-CCPCH-Info ::= SEQUENCE {
    fDD-S-CCPCH-Offset FDD-S-CCPCH-Offset,
    dl-ScramblingCode DL-ScramblingCode,

```

```

    fDD-DL-ChannelisationCodeNumber      FDD-DL-ChannelisationCodeNumber,
    dl-TFCS                               TFCS,
    secondaryCCPCH-SlotFormat             SecondaryCCPCH-SlotFormat,
    tFCI-Presence                         TFCI-Presence OPTIONAL,
    -- This IE shall be present only if the Secondary CCPCH Slot Format IE is equal to any of the values from 8 to 17
    multiplexingPosition                  MultiplexingPosition,
    sTTD-Indicator                        STTD-Indicator,
    fACH-PCH-InformationList              FACH-PCH-InformationList,
    iB-schedulingInformation              IB-SchedulingInformation,
    iE-Extensions                         ProtocolExtensionContainer { { Secondary-CCPCH-Info-ExtIEs } } OPTIONAL,
    ...
}

Secondary-CCPCH-Info-ExtIEs RNSAP-PROTOCOL-EXTENSION ::= {
    ...
}

Secondary-CCPCH-Info-TDD ::= SEQUENCE {
    dl-TFCS                               TFCS,
    tFCI-Coding                           TFCI-Coding,
    secondary-CCPCH-TDD-InformationList    Secondary-CCPCH-TDD-InformationList,
    fACH-InformationList                  FACH-InformationList,
    pCH-InformationList                   PCH-InformationList,
    iE-Extensions                         ProtocolExtensionContainer { { Secondary-CCPCH-Info-TDD-ExtIEs } } OPTIONAL,
    ...
}

Secondary-CCPCH-Info-TDD-ExtIEs RNSAP-PROTOCOL-EXTENSION ::= {
    ...
}

Secondary-LCR-CCPCH-Info-TDD ::= SEQUENCE {
    dl-TFCS                               TFCS,
    tFCI-Coding                           TFCI-Coding,
    secondary-LCR-CCPCH-TDD-InformationList Secondary-LCR-CCPCH-TDD-InformationList,
    fACH-InformationList                  FACH-InformationList,
    pCH-InformationList                   PCH-InformationList,
    iE-Extensions                         ProtocolExtensionContainer { { Secondary-LCR-CCPCH-Info-TDD-ExtIEs } } OPTIONAL,
    ...
}

Secondary-LCR-CCPCH-Info-TDD-ExtIEs RNSAP-PROTOCOL-EXTENSION ::= {
    ...
}

Secondary-CCPCH-TDD-InformationList ::= SEQUENCE (SIZE(0.. maxNrOfSCCPCHs)) OF Secondary-CCPCH-TDD-InformationItem

Secondary-CCPCH-TDD-InformationItem ::= SEQUENCE {
    timeSlot                               TimeSlot,
    midambleShiftAndBurstType              MidambleShiftAndBurstType,
    tFCI-Presence                          TFCI-Presence,
    secondary-CCPCH-TDD-Code-Information  Secondary-CCPCH-TDD-Code-Information,
    tDD-PhysicalChannelOffset              TDD-PhysicalChannelOffset,
    repetitionLength                       RepetitionLength,
}

```

```

    repetitionPeriod          RepetitionPeriod,
    iE-Extensions             ProtocolExtensionContainer { { Secondary-CCPCH-TDD-InformationItem-ExtIEs} } OPTIONAL,
    ...
}

Secondary-CCPCH-TDD-InformationItem-ExtIEs RNSAP-PROTOCOL-EXTENSION ::= {
    ...
}

Secondary-LCR-CCPCH-TDD-InformationList ::= SEQUENCE (SIZE(0.. maxNrOfSCCPCHs)) OF Secondary-LCR-CCPCH-TDD-InformationItem

Secondary-LCR-CCPCH-TDD-InformationItem ::= SEQUENCE {
    timeSlotLCR                TimeSlotLCR,
    midambleShiftLCR           MidambleShiftLCR,
    tFCI-Presence              TFCI-Presence,
    secondary-LCR-CCPCH-TDD-Code-Information Secondary-LCR-CCPCH-TDD-Code-Information,
    tDD-PhysicalChannelOffset   TDD-PhysicalChannelOffset,
    repetitionLength            RepetitionLength,
    repetitionPeriod            RepetitionPeriod,
    iE-Extensions              ProtocolExtensionContainer { { Secondary-LCR-CCPCH-TDD-InformationItem-ExtIEs} } OPTIONAL,
    ...
}

Secondary-LCR-CCPCH-TDD-InformationItem-ExtIEs RNSAP-PROTOCOL-EXTENSION ::= {
    ...
}

Secondary-CCPCH-TDD-Code-Information ::= SEQUENCE ( SIZE (1..maxNrOfSCCPCHs)) OF Secondary-CCPCH-TDD-Code-InformationItem

Secondary-CCPCH-TDD-Code-InformationItem ::= SEQUENCE {
    tDD-ChannelisationCode      TDD-ChannelisationCode,
    iE-Extensions              ProtocolExtensionContainer { {Secondary-CCPCH-TDD-Code-InformationItem-ExtIEs} } OPTIONAL,
    ...
}

Secondary-CCPCH-TDD-Code-InformationItem-ExtIEs RNSAP-PROTOCOL-EXTENSION ::= {
    ...
}

Secondary-LCR-CCPCH-TDD-Code-Information ::= SEQUENCE ( SIZE (1..maxNrOfSCCPCHs)) OF Secondary-LCR-CCPCH-TDD-Code-InformationItem

Secondary-LCR-CCPCH-TDD-Code-InformationItem ::= SEQUENCE {
    tDD-ChannelisationCodeLCR    TDD-ChannelisationCodeLCR,
    s-CCPCH-TimeSlotFormat-LCR   TDD-DL-DPCH-TimeSlotFormat-LCR,
    iE-Extensions                ProtocolExtensionContainer { {Secondary-LCR-CCPCH-TDD-Code-InformationItem-ExtIEs} } OPTIONAL,
    ...
}

Secondary-LCR-CCPCH-TDD-Code-InformationItem-ExtIEs RNSAP-PROTOCOL-EXTENSION ::= {
    ...
}

SecondInterleavingMode ::= ENUMERATED {
    frame-related,

```

```

    timeslot-related,
    ...
}

Seed ::= INTEGER (0..63)

SFN ::= INTEGER (0..4095)

SFNSFN-FDD ::= INTEGER(0..614399)

SFNSFN-TDD ::= INTEGER(0..40961)

GA-AccessPointPositionwithOptionalAltitude ::= SEQUENCE {
    geographicalCoordinate      GeographicalCoordinate,
    altitudeAndDirection        GA-AltitudeAndDirection OPTIONAL,
    iE-Extensions                ProtocolExtensionContainer { { GA-AccessPointPositionwithOptionalAltitude-ExtIEs } } OPTIONAL,
    ...
}

GA-AccessPointPositionwithOptionalAltitude-ExtIEs RNSAP-PROTOCOL-EXTENSION ::= {
    ...
}

SFNSFNChangeLimit ::= INTEGER (1..256)
-- Unit chip, Step 1/16 chip, Range 1/16..16 chip

SFNSFNDriftRate ::= INTEGER (-100..100)
-- Unit chip/s, Step 1/256 chip/s, Range -100/256..+100/256 chip/s

SFNSFNDriftRateQuality ::= INTEGER (0..100)
-- Unit chip/s, Step 1/256 chip/s, Range 0..100/256 chip/s

SFNSFNMeasurementThresholdInformation ::= SEQUENCE {
    sFNSFNChangeLimit          SFNSFNChangeLimit          OPTIONAL,
    predictedSFNSFNDeviationLimit PredictedSFNSFNDeviationLimit OPTIONAL,
    iE-Extensions                ProtocolExtensionContainer { { SFNSFNMeasurementThresholdInformation-ExtIEs } } OPTIONAL,
    ...
}

SFNSFNMeasurementThresholdInformation-ExtIEs RNSAP-PROTOCOL-EXTENSION ::= {
    ...
}

SFNSFNMeasurementValueInformation ::= SEQUENCE {
    successfulNeighbouringCellSFNSFNObservedTimeDifferenceMeasurementInformation SEQUENCE (SIZE(1..maxNrOfMeasNCell)) OF
    SEQUENCE {
        uC-ID          UC-ID,
        sFNSFNValue    SFNSFNValue,
        sFNSFNQuality  SFNSFNQuality          OPTIONAL,
        sFNSFNDriftRate SFNSFNDriftRate,
        sFNSFNDriftRateQuality SFNSFNDriftRateQuality OPTIONAL,
        sFNSFNTimeStampInformation SFNSFNTimeStampInformation,
    }
}

```



```

        iE-Extensions          ProtocolExtensionContainer { {
SuccessfulNeighbouringCellSFNSFNObservedTimeDifferenceMeasurementInformationItem-ExtIEs} }    OPTIONAL,
        ...
    },
    unsuccessfulNeighbouringCellSFNSFNObservedTimeDifferenceMeasurementInformation    SEQUENCE (SIZE(0..maxNrOfMeasNCell-1)) OF
        SEQUENCE {
            uC-ID          UC-ID,
            iE-Extensions  ProtocolExtensionContainer { { UnsuccessfulNeighbouringCellSFNSFNObservedTimeDifferenceMeasurementInformationItem-
ExtIEs} }    OPTIONAL,
            ...
        },
        iE-Extensions      ProtocolExtensionContainer { { SFNSFNMeasurementValueInformationItem-ExtIEs} }    OPTIONAL,
        ...
    }

SFNSFNMeasurementValueInformationItem-ExtIEs RNSAP-PROTOCOL-EXTENSION ::= {
    ...
}

SuccessfulNeighbouringCellSFNSFNObservedTimeDifferenceMeasurementInformationItem-ExtIEs RNSAP-PROTOCOL-EXTENSION ::= {
    ...
}

UnsuccessfulNeighbouringCellSFNSFNObservedTimeDifferenceMeasurementInformationItem-ExtIEs RNSAP-PROTOCOL-EXTENSION ::= {
    ...
}

SFNSFNQuality ::= INTEGER (0..255)
-- Unit chip, Step 1/16 chip, Range 0.. 255/16 chip

SFNSFNTimeStampInformation ::= CHOICE {
    sFNSFNTimeStamp-FDD      SFN,
    sFNSFNTimeStamp-TDD      SFNSFNTimeStamp-TDD,
    ...
}

SFNSFNTimeStamp-TDD ::= SEQUENCE {
    sFN          SFN,
    timeSlot     TimeSlot,
    iE-Extensions  ProtocolExtensionContainer { { SFNSFNTimeStamp-ExtIEs}} OPTIONAL,
    ...
}

SFNSFNTimeStamp-ExtIEs RNSAP-PROTOCOL-EXTENSION ::= {
    ...
}

SFNSFNValue ::= CHOICE {

```

```
sFNSFN-FDD      SFNSFN-FDD,
sFNSFN-TDD      SFNSFN-TDD,
...
}

SIR-Error-Value      ::= INTEGER (0..125)

SIR-Error-Value-IncrDecrThres      ::= INTEGER (0..124)

SIR-Value      ::= INTEGER (0..63)
-- According to mapping in 25.215/25.225

SIR-Value-IncrDecrThres ::= INTEGER (0..62)

SecondaryCCPCH-SlotFormat      ::= INTEGER (0..17,...)
-- refer to 25.211

S-FieldLength      ::= ENUMERATED {
    v1,
    v2,
    ...
}

SpecialBurstScheduling ::= INTEGER (1..256)

SplitType ::= ENUMERATED {
    hard,
    logical
}

SpreadingFactor      ::= INTEGER (4 | 8 | 16 | 32 | 64 | 128 | 256)

S-RNTI      ::= INTEGER (0..1048575)
-- From 0 to 2^20-1

SRB-Delay ::= INTEGER(0..7,...)

SSDT-CellID ::= ENUMERATED {
    a,
    b,
    c,
    d,
    e,
    f,
    g,
    h
}

SSDT-CellID-Length ::= ENUMERATED {
    short,
    medium,
    long
}
```

```

SSDT-Indication ::= ENUMERATED {
    sSDT-active-in-the-UE,
    sSDT-not-active-in-the-UE
}

SSDT-SupportIndicator ::= ENUMERATED {
    sSDT-supported,
    sSDT-not-supported
}

STTD-Indicator ::= ENUMERATED {
    active,
    inactive
}

STTD-SupportIndicator ::= ENUMERATED {
    sTTD-Supported,
    sTTD-not-Supported
}

SyncCase ::= INTEGER (1..2,...)

SynchronisationConfiguration ::= SEQUENCE {
    n-INSYNC-IND          INTEGER (1..256),
    n-OUTSYNC-IND        INTEGER (1..256),
    t-RLFFAILURE         INTEGER (0..255),
    -- Unit seconds, Range 0s .. 25.5s, Step 0.1s
    iE-Extensions       ProtocolExtensionContainer { { SynchronisationConfiguration-ExtIEs} } OPTIONAL,
    ...
}

SynchronisationConfiguration-ExtIEs RNSAP-PROTOCOL-EXTENSION ::= {
    ...
}

SYNC-UL-ProcParameters ::= SEQUENCE {
    maxSYNC-UL-transmissions    ENUMERATED {v1, v2, v4, v8, ...},
    powerRampStep               INTEGER (0..3, ...),
    ...
}

-- T

TDD-ChannelisationCode ::= ENUMERATED {
    chCode1div1,
    chCode2div1,
    chCode2div2,
    chCode4div1,
    chCode4div2,
    chCode4div3,
    chCode4div4,
    chCode8div1,
    chCode8div2,

```

```

    chCode8div3,
    chCode8div4,
    chCode8div5,
    chCode8div6,
    chCode8div7,
    chCode8div8,
    chCode16div1,
    chCode16div2,
    chCode16div3,
    chCode16div4,
    chCode16div5,
    chCode16div6,
    chCode16div7,
    chCode16div8,
    chCode16div9,
    chCode16div10,
    chCode16div11,
    chCode16div12,
    chCode16div13,
    chCode16div14,
    chCode16div15,
    chCode16div16,
    ...
}

TDD-ChannelisationCodeLCR ::= SEQUENCE {
    tDD-ChannelisationCode      TDD-ChannelisationCode,
    modulation                  Modulation, -- Modulation options for 1.28Mcps TDD in contrast to 3.84Mcps TDD
    ...
}

TDD-DCHs-to-Modify ::= SEQUENCE (SIZE (1..maxNrOfDCHs)) OF TDD-DCHs-to-ModifyItem

TDD-DCHs-to-ModifyItem ::= SEQUENCE {
    ul-FP-Mode                  UL-FP-Mode    OPTIONAL,
    toAWS                       ToAWS       OPTIONAL,
    toAWE                        ToAWE      OPTIONAL,
    transportBearerRequestIndicator TransportBearerRequestIndicator,
    dCH-SpecificInformationList TDD-DCHs-to-ModifySpecificInformationList,
    iE-Extensions               ProtocolExtensionContainer { {TDD-DCHs-to-ModifyItem-ExtIEs} } OPTIONAL,
    ...
}

TDD-DCHs-to-ModifyItem-ExtIEs RNSAP-PROTOCOL-EXTENSION ::= {
    ...
}

TDD-DCHs-to-ModifySpecificInformationList ::= SEQUENCE (SIZE (1..maxNrOfDCHs)) OF TDD-DCHs-to-ModifySpecificItem

TDD-DCHs-to-ModifySpecificItem ::= SEQUENCE {
    dCH-ID                      DCH-ID,
    ul-CCTrCH-ID                CCTrCH-ID    OPTIONAL,
    dl-CCTrCH-ID                CCTrCH-ID    OPTIONAL,
    ul-TransportformatSet       TransportFormatSet OPTIONAL,

```

```

dl-TransportFormatSet      TransportFormatSet OPTIONAL,
allocationRetentionPriority AllocationRetentionPriority OPTIONAL,
frameHandlingPriority      FrameHandlingPriority OPTIONAL,
iE-Extensions              ProtocolExtensionContainer { {TDD-DCHs-to-ModifySpecificItem-ExtIEs} } OPTIONAL,
...
}

TDD-DCHs-to-ModifySpecificItem-ExtIEs RNSAP-PROTOCOL-EXTENSION ::= {
  { ID id-Guaranteed-Rate-Information CRITICALITY ignore EXTENSION Guaranteed-Rate-Information PRESENCE optional },
  ...
}

TDD-DL-Code-Information ::= SEQUENCE ( SIZE (1..maxNrOfDPCHs)) OF TDD-DL-Code-InformationItem

TDD-DL-Code-InformationItem ::= SEQUENCE {
  dPCH-ID          DPCH-ID,
  tDD-ChannelisationCode TDD-ChannelisationCode,
  iE-Extensions    ProtocolExtensionContainer { {TDD-DL-Code-InformationItem-ExtIEs} } OPTIONAL,
  ...
}

TDD-DL-Code-InformationItem-ExtIEs RNSAP-PROTOCOL-EXTENSION ::= {
  ...
}

TDD-DL-Code-LCR-Information ::= SEQUENCE (SIZE (1..maxNrOfDPCHsLCR)) OF TDD-DL-Code-LCR-InformationItem

TDD-DL-Code-LCR-InformationItem ::= SEQUENCE {
  dPCH-ID          DPCH-ID,
  tdd-ChannelisationCodeLCR TDD-ChannelisationCodeLCR,
  tdd-DL-DPCH-TimeSlotFormat-LCR TDD-DL-DPCH-TimeSlotFormat-LCR,
  iE-Extensions    ProtocolExtensionContainer { { TDD-DL-Code-LCR-InformationItem-ExtIEs} } OPTIONAL,
  ...
}

TDD-DL-Code-LCR-InformationItem-ExtIEs RNSAP-PROTOCOL-EXTENSION ::= {
  ...
}

TDD-DL-DPCH-TimeSlotFormat-LCR ::= CHOICE {
  qPSK          QPSK-DL-DPCH-TimeSlotFormatTDD-LCR,
  eightPSK      EightPSK-DL-DPCH-TimeSlotFormatTDD-LCR,
  ...
}

QPSK-DL-DPCH-TimeSlotFormatTDD-LCR ::= INTEGER(0..24,...)

EightPSK-DL-DPCH-TimeSlotFormatTDD-LCR ::= INTEGER(0..24,...)

TDD-DPCHOffset ::= CHOICE {
  initialOffset    INTEGER (0..255),
  noinitialOffset  INTEGER (0..63)
}

```

```

TDD-PhysicalChannelOffset ::= INTEGER (0..63)

TDD-TPC-DownlinkStepSize ::= ENUMERATED {
    step-size1,
    step-size2,
    step-size3,
    ...
}

TDD-TPC-UplinkStepSize-LCR ::= ENUMERATED {
    step-size1,
    step-size2,
    step-size3,
    ...
}

TDD-UL-Code-Information ::= SEQUENCE ( SIZE (1..maxNrOfDPCHs)) OF TDD-UL-Code-InformationItem

TDD-UL-Code-InformationItem ::= SEQUENCE {
    dPCH-ID DPCH-ID,
    tDD-ChannelisationCode TDD-ChannelisationCode,
    iE-Extensions ProtocolExtensionContainer { {TDD-UL-Code-InformationItem-ExtIEs} } OPTIONAL,
    ...
}

TDD-UL-Code-InformationItem-ExtIEs RNSAP-PROTOCOL-EXTENSION ::= {
    ...
}

TDD-UL-Code-LCR-Information ::= SEQUENCE (SIZE (1..maxNrOfDPCHsLCR)) OF TDD-UL-Code-LCR-InformationItem

TDD-UL-Code-LCR-InformationItem ::= SEQUENCE {
    dPCH-ID DPCH-ID,
    tdd-ChannelisationCodeLCR TDD-ChannelisationCodeLCR,
    tdd-UL-DPCH-TimeSlotFormat-LCR TDD-UL-DPCH-TimeSlotFormat-LCR,
    iE-Extensions ProtocolExtensionContainer { { TDD-UL-Code-LCR-InformationItem-ExtIEs} } OPTIONAL,
    ...
}

TDD-UL-Code-LCR-InformationItem-ExtIEs RNSAP-PROTOCOL-EXTENSION ::= {
    ...
}

TDD-UL-DPCH-TimeSlotFormat-LCR ::= CHOICE {
    qPSK QPSK-UL-DPCH-TimeSlotFormatTDD-LCR,
    eightPSK EightPSK-UL-DPCH-TimeSlotFormatTDD-LCR,
    ...
}

QPSK-UL-DPCH-TimeSlotFormatTDD-LCR ::= INTEGER(0..69,...)

EightPSK-UL-DPCH-TimeSlotFormatTDD-LCR ::= INTEGER(0..24,...)

TFCI-Coding ::= ENUMERATED {

```

```

    v4,
    v8,
    v16,
    v32,
    ...
}

TFCI-Presence ::= ENUMERATED {
    present,
    not-present
}

TFCI-SignallingMode ::= ENUMERATED {
    normal,
    split
}

TGD ::= INTEGER (0|15..269)
-- 0 = Undefined, only one transmission gap in the transmission gap pattern sequence

TGPRC ::= INTEGER (0..511)
-- 0 = infinity

TGPSID ::= INTEGER (1.. maxTGPS)

TGSN ::= INTEGER (0..14)

TimeSlot ::= INTEGER (0..14)

TimeSlotLCR ::= INTEGER (0..6)

TimingAdvanceApplied ::= ENUMERATED {
    yes,
    no
}

ToAWE ::= INTEGER (0..2559)

ToAWS ::= INTEGER (0..1279)

Transmission-Gap-Pattern-Sequence-Information ::= SEQUENCE (SIZE (1..maxTGPS)) OF
SEQUENCE {
    tGPSID          TGPSID,
    tGSN            TGSN,
    tGL1            GapLength,
    tGL2            GapLength OPTIONAL,
    tGD             TGD,
    tGPL1           GapDuration,
    tGPL2           GapDuration OPTIONAL,
    uL-DL-mode      UL-DL-mode,
    downlink-Compressed-Mode-Method Downlink-Compressed-Mode-Method OPTIONAL,
    -- This IE shall be present if the value of the UL/DL mode IE is "DL only" or "UL/DL"
    uplink-Compressed-Mode-Method   Uplink-Compressed-Mode-Method   OPTIONAL,

```

```

        -- This IE shall be present if the value of the UL/DL mode IE is "UL only" or "UL/DL"
        dL-FrameType      DL-FrameType,
        delta-SIR1        DeltaSIR,
        delta-SIR-after1  DeltaSIR,
        delta-SIR2        DeltaSIR  OPTIONAL,
        delta-SIR-after2  DeltaSIR  OPTIONAL,
        iE-Extensions     ProtocolExtensionContainer { {Transmission-Gap-Pattern-Sequence-Information-ExtIEs} } OPTIONAL,
        ...
    }

Transmission-Gap-Pattern-Sequence-Information-ExtIEs RNSAP-PROTOCOL-EXTENSION ::= {
    ...
}

Transmission-Gap-Pattern-Sequence-ScramblingCode-Information ::= ENUMERATED{
    code-change,
    nocode-change
}

Transmission-Gap-Pattern-Sequence-Status-List ::= SEQUENCE (SIZE (0..maxTGPS)) OF
    SEQUENCE {
        tGPSID      TGPSID,
        tGPRC       TGPRC,
        tGCFN       CFN,
        iE-Extensions ProtocolExtensionContainer { { Transmission-Gap-Pattern-Sequence-Status-List-ExtIEs } } OPTIONAL,
        ...
    }

Transmission-Gap-Pattern-Sequence-Status-List-ExtIEs RNSAP-PROTOCOL-EXTENSION ::= {
    ...
}

TransmissionTimeIntervalDynamic ::= ENUMERATED {
    msec-10,
    msec-20,
    msec-40,
    msec-80,
    ...
}

TransmissionTimeIntervalSemiStatic ::= ENUMERATED {
    msec-10,
    msec-20,
    msec-40,
    msec-80,
    dynamic,
    ...
}

TransmitDiversityIndicator ::= ENUMERATED {
    active,
    inactive
}

```



```

Transmitted-Carrier-Power-Value ::= INTEGER(0..100)
-- according to mapping in [23] and [24]

Transmitted-Carrier-Power-Value-IncrDecrThres ::= INTEGER(0..100)
-- according to mapping in [23] and [24]

TUTRANGPS ::= SEQUENCE {
    ms-part      INTEGER (0..16383),
    ls-part      INTEGER (0..4294967295)
}

TUTRANGPSChangeLimit ::= INTEGER (1..256)
-- Unit chip, Step 1/16 chip, Range 1/16..16 chip

TUTRANGPSDriftRate ::= INTEGER (-50..50)
-- Unit chip/s, Step 1/256 chip/s, Range -50/256..+50/256 chip/s

TUTRANGPSDriftRateQuality ::= INTEGER (0..50)
-- Unit chip/s, Step 1/256 chip/s, Range 0..50/256 chip/s

TUTRANGPSAccuracyClass ::= ENUMERATED {
    accuracy-class-A,
    accuracy-class-B,
    accuracy-class-C,
    ...
}

TUTRANGPSMeasurementThresholdInformation ::= SEQUENCE {
    tUTRANGPSChangeLimit          TUTRANGPSChangeLimit          OPTIONAL,
    predictedTUTRANGPSDeviationLimit PredictedTUTRANGPSDeviationLimit OPTIONAL,
    iE-Extensions                 ProtocolExtensionContainer { { TUTRANGPSMeasurementThresholdInformation-ExtIEs} } OPTIONAL,
    ...
}

TUTRANGPSMeasurementThresholdInformation-ExtIEs RNSAP-PROTOCOL-EXTENSION ::= {
    ...
}

TUTRANGPSMeasurementValueInformation ::= SEQUENCE {
    tUTRANGPS                    TUTRANGPS,
    tUTRANGPSQuality              TUTRANGPSQuality              OPTIONAL,
    tUTRANGPSDriftRate            TUTRANGPSDriftRate,
    tUTRANGPSDriftRateQuality     TUTRANGPSDriftRateQuality OPTIONAL,
    iE-Extensions                 ProtocolExtensionContainer { { TUTRANGPSMeasurementValueInformationItem-ExtIEs} } OPTIONAL,
    ...
}

TUTRANGPSMeasurementValueInformationItem-ExtIEs RNSAP-PROTOCOL-EXTENSION ::= {
    ...
}

TUTRANGPSQuality ::= INTEGER (0..255)

```

```

-- Unit chip, Step 1/16 chip, Range 0.. 255/16 chip
TransportBearerID ::= INTEGER (0..4095)

TransportBearerRequestIndicator ::= ENUMERATED {
  bearer-requested,
  bearer-not-requested,
  ...
}

TransportBlockSize ::= INTEGER (0..5000)
-- Unit is bits

TransportFormatCombination-Beta ::= CHOICE {
  signalledGainFactors SEQUENCE {
    betaC BetaCD,
    betaD BetaCD,
    refTFCNumber RefTFCNumber OPTIONAL,
    iE-Extensions ProtocolExtensionContainer { { SignalledGainFactors-ExtIEs } } OPTIONAL,
    ...
  },
  refTFCNumber RefTFCNumber,
  ...
}

SignalledGainFactors-ExtIEs RNSAP-PROTOCOL-EXTENSION ::= {
  ...
}

TFCS ::= SEQUENCE {
  tFCSvalues CHOICE {
    no-Split-in-TFCI TFCS-TFCSList,
    split-in-TFCI SEQUENCE {
      transportFormatCombination-DCH TFCS-DCHList,
      signallingMethod CHOICE {
        tFCI-Range TFCS-MappingOnDSCHList,
        explicit TFCS-DSCHList,
        ...
      },
      iE-Extensions ProtocolExtensionContainer { { Split-in-TFCI-ExtIEs } } OPTIONAL,
      ...
    },
    ...
  },
  iE-Extensions ProtocolExtensionContainer { { TFCS-ExtIEs } } OPTIONAL,
  ...
}

Split-in-TFCI-ExtIEs RNSAP-PROTOCOL-EXTENSION ::= {
  ...
}

TFCS-ExtIEs RNSAP-PROTOCOL-EXTENSION ::= {
  ...
}

```

```

}

TFCS-TFCSList ::= SEQUENCE (SIZE (1..maxNrOfTFCSs)) OF
  SEQUENCE {
    cTFC                TFCS-CTFC,
    tFC-Beta            TransportFormatCombination-Beta    OPTIONAL,
    -- The IE shall be present if the TFCS concerns a UL DPCH [FDD - or PRACH channel in FDD]
    iE-Extensions      ProtocolExtensionContainer { { TFCS-TFCSList-ExtIEs} }    OPTIONAL,
    ...
  }

TFCS-TFCSList-ExtIEs RNSAP-PROTOCOL-EXTENSION ::= {
  ...
}

TFCS-CTFC ::= CHOICE {
  ctfc2bit                INTEGER (0..3),
  ctfc4bit                INTEGER (0..15),
  ctfc6bit                INTEGER (0..63),
  ctfc8bit                INTEGER (0..255),
  ctfc12bit               INTEGER (0..4095),
  ctfc16bit               INTEGER (0..65535),
  ctfcmaxbit              INTEGER (0..maxCTFC)
}

TFCS-DCHList ::= SEQUENCE (SIZE (1..maxTFCI1Combs)) OF
  SEQUENCE {
    cTFC                TFCS-CTFC,
    iE-Extensions      ProtocolExtensionContainer { { TFCS-DCHList-ExtIEs} }    OPTIONAL,
    ...
  }

TFCS-DCHList-ExtIEs RNSAP-PROTOCOL-EXTENSION ::= {
  ...
}

TFCS-MappingOnDSCHList ::= SEQUENCE (SIZE (1..maxNoTFCIGroups)) OF
  SEQUENCE {
    maxTFCI-field2-Value  TFCS-MaxTFCI-field2-Value,
    cTFC-DSCH            TFCS-CTFC,
    iE-Extensions      ProtocolExtensionContainer { { TFCS-MappingOnDSCHList-ExtIEs} }    OPTIONAL,
    ...
  }

TFCS-MappingOnDSCHList-ExtIEs RNSAP-PROTOCOL-EXTENSION ::= {
  ...
}

TFCS-MaxTFCI-field2-Value ::= INTEGER (1..maxTFCI2Combs-1)

TFCS-DSCHList ::= SEQUENCE (SIZE (1..maxTFCI2Combs)) OF
  SEQUENCE {
    cTFC-DSCH            TFCS-CTFC,
    iE-Extensions      ProtocolExtensionContainer { { TFCS-DSCHList-ExtIEs} }    OPTIONAL,
  }

```

```

    ...
}

TFCS-DSCHList-ExtIEs RNSAP-PROTOCOL-EXTENSION ::= {
    ...
}

TransportFormatSet ::= SEQUENCE {
    dynamicParts          TransportFormatSet-DynamicPartList,
    semi-staticPart      TransportFormatSet-Semi-staticPart,
    iE-Extensions        ProtocolExtensionContainer { {TransportFormatSet-ExtIEs} } OPTIONAL,
    ...
}

TransportFormatSet-ExtIEs RNSAP-PROTOCOL-EXTENSION ::= {
    ...
}

TransportFormatSet-DynamicPartList ::= SEQUENCE (SIZE (1..maxNrOfTFs)) OF
SEQUENCE {
    nrOfTransportBlocks   NrOfTransportBlocks,
    transportBlockSize   TransportBlockSize OPTIONAL
    -- This IE shall be present if nrOfTransportBlocks is greater than 0 --,
    mode                 TransportFormatSet-ModeDP,
    iE-Extensions        ProtocolExtensionContainer { {TransportFormatSet-DynamicPartList-ExtIEs} } OPTIONAL,
    ...
}

TransportFormatSet-DynamicPartList-ExtIEs RNSAP-PROTOCOL-EXTENSION ::= {
    ...
}

TransportFormatSet-ModeDP ::= CHOICE {
    tdd                 TDD-TransportFormatSet-ModeDP,
    notApplicable      NULL,
    ...
}

TDD-TransportFormatSet-ModeDP ::= SEQUENCE {
    transmissionTimeIntervalInformation TransmissionTimeIntervalInformation OPTIONAL,
    -- This IE shall be present if the 'Transmission Time Interval' of the 'Semi-static Transport Format Information' is 'dynamic'. Otherwise it is
    absent.
    iE-Extensions        ProtocolExtensionContainer { {TDD-TransportFormatSet-ModeDP-ExtIEs} } OPTIONAL,
    ...
}

TDD-TransportFormatSet-ModeDP-ExtIEs RNSAP-PROTOCOL-EXTENSION ::= {
    ...
}

TransmissionTimeIntervalInformation ::= SEQUENCE (SIZE (1..maxTTI-Count)) OF
SEQUENCE {
    transmissionTimeInterval TransmissionTimeIntervalDynamic,
    iE-Extensions          ProtocolExtensionContainer { {TransmissionTimeIntervalInformation-ExtIEs} } OPTIONAL,
}

```

```

    }
    ...
}

TransmissionTimeIntervalInformation-ExtIEs RNSAP-PROTOCOL-EXTENSION ::= {
    ...
}

Transmitted-Code-Power-Value ::= INTEGER (0..127)
-- According to mapping in 25.215/25.225

Transmitted-Code-Power-Value-IncrDecrThres ::= INTEGER (0..112,...)

TransportFormatManagement ::= ENUMERATED {
    cell-based,
    ue-based,
    ...
}

TransportFormatSet-Semi-staticPart ::= SEQUENCE {
    transmissionTime      TransmissionTimeIntervalSemiStatic,
    channelCoding         ChannelCodingType,
    codingRate            CodingRate OPTIONAL
    -- This IE shall be present if channelCoding is 'convolutional' or 'turbo' --,
    rateMatchingAttribute RateMatchingAttribute,
    cRC-Size              CRC-Size,
    mode                  TransportFormatSet-ModeSSP,
    iE-Extensions        ProtocolExtensionContainer { {TransportFormatSet-Semi-staticPart-ExtIEs} } OPTIONAL,
    ...
}

TransportFormatSet-Semi-staticPart-ExtIEs RNSAP-PROTOCOL-EXTENSION ::= {
    ...
}

TransportFormatSet-ModeSSP ::= CHOICE {
    tdd                SecondInterleavingMode,
    notApplicable      NULL,
    ...
}

TransportLayerAddress ::= BIT STRING (SIZE(1..160, ...))

TrCH-SrcStatisticsDescr ::= ENUMERATED {
    speech,
    rRC,
    unknown,
    ...
}

TSTD-Indicator ::= ENUMERATED {
    active,
    inactive
}

```

```

TSTD-Support-Indicator ::= ENUMERATED {
    tSTD-supported,
    tSTD-not-supported
}

TxDiversityIndicator ::= ENUMERATED {
    true,
    false
}

TypeOfError ::= ENUMERATED {
    not-understood,
    missing,
    ...
}

-- U

UARFCN ::= INTEGER (0..16383,...)
-- Corresponds to: 0.0Hz..3276.6Mhz. See 25.101, 25.105

UDRE ::= ENUMERATED {
    lessThan1,
    between1-and-4,
    between4-and-8,
    over8,
    ...
}

UL-DL-mode ::= ENUMERATED {
    ul-only,
    dl-only,
    both-ul-and-dl
}

UL-Timeslot-Information ::= SEQUENCE ( SIZE (1..maxNrOfTS)) OF UL-Timeslot-InformationItem

UL-Timeslot-InformationItem ::= SEQUENCE {
    timeSlot TimeSlot,
    midambleShiftAndBurstType MidambleShiftAndBurstType,
    tFCI-Presence TFCI-Presence,
    uL-Code-Information TDD-UL-Code-Information,
    iE-Extensions ProtocolExtensionContainer { {UL-Timeslot-InformationItem-ExtIEs} } OPTIONAL,
    ...
}

UL-Timeslot-InformationItem-ExtIEs RNSAP-PROTOCOL-EXTENSION ::= {
    ...
}

UL-TimeslotLCR-Information ::= SEQUENCE (SIZE (1..maxNrOfULTsLCR)) OF UL-TimeslotLCR-InformationItem

UL-TimeslotLCR-InformationItem ::= SEQUENCE {
    timeSlotLCR TimeSlotLCR,

```

```

midambleShiftLCR                MidambleShiftLCR,
tFCI-Presence                    TFCI-Presence,
uL-Code-LCR-InformationList      TDD-UL-Code-LCR-Information,
iE-Extensions                    ProtocolExtensionContainer { { UL-TimeslotLCR-InformationItem-ExtIEs } } OPTIONAL,
...
}

UL-TimeslotLCR-InformationItem-ExtIEs RNSAP-PROTOCOL-EXTENSION ::= {
...
}

UL-TimeSlot-ISCP-Info ::= SEQUENCE (SIZE (1..maxNrOfULTs)) OF UL-TimeSlot-ISCP-InfoItem

UL-TimeSlot-ISCP-InfoItem ::= SEQUENCE {
timeSlot                TimeSlot,
uL-TimeslotISCP         UL-TimeslotISCP,
iE-Extensions           ProtocolExtensionContainer { { UL-TimeSlot-ISCP-InfoItem-ExtIEs } } OPTIONAL,
...
}

UL-TimeSlot-ISCP-InfoItem-ExtIEs RNSAP-PROTOCOL-EXTENSION ::= {
...
}

UL-TimeSlot-ISCP-LCR-Info ::= SEQUENCE (SIZE (1..maxNrOfULTsLCR)) OF UL-TimeSlot-ISCP-LCR-InfoItem

UL-TimeSlot-ISCP-LCR-InfoItem ::= SEQUENCE {
timeSlotLCR            TimeSlotLCR,
iSCP                   UL-Timeslot-ISCP-Value,
iE-Extensions          ProtocolExtensionContainer { { UL-TimeSlot-ISCP-LCR-InfoItem-ExtIEs } } OPTIONAL,
...
}

UL-TimeSlot-ISCP-LCR-InfoItem-ExtIEs RNSAP-PROTOCOL-EXTENSION ::= {
...
}

UL-Timeslot-ISCP-Value ::= UL-TimeslotISCP

UL-Timeslot-ISCP-Value-IncrDecrThres ::= INTEGER(0..126)
-- Unit dB. Step 0.5dB
-- e.g. Value 100 means 50dB

Uplink-Compressed-Mode-Method ::= ENUMERATED {
sFdiv2,
higher-layer-scheduling,
...
}

UL-SIR ::= INTEGER (-82..173)
-- The UL-SIR gives the UL-SIR in number of 0.1 dB steps.
-- E.g. Value 173 means 17.3 dB
-- Unit dB. Step 0.1 dB.

```

```

UC-ID ::= SEQUENCE {
    rNC-ID          RNC-ID,
    c-ID            C-ID,
    iE-Extensions   ProtocolExtensionContainer { {UC-ID-ExtIEs} } OPTIONAL,
    ...
}

UC-ID-ExtIEs RNSAP-PROTOCOL-EXTENSION ::= {
    ...
}

UL-DPCCH-SlotFormat ::= INTEGER (0..5,...)

UL-FP-Mode ::= ENUMERATED {
    normal,
    silent,
    ...
}

UL-PhysCH-SF-Variation ::= ENUMERATED {
    sf-variation-supported,
    sf-variation-not-supported
}

UL-ScramblingCode ::= SEQUENCE {
    ul-ScramblingCodeNumber    UL-ScramblingCodeNumber,
    ul-ScramblingCodeLength    UL-ScramblingCodeLength,
    iE-Extensions              ProtocolExtensionContainer { {UL-ScramblingCode-ExtIEs} } OPTIONAL
}

UL-ScramblingCode-ExtIEs RNSAP-PROTOCOL-EXTENSION ::= {
    ...
}

UL-ScramblingCodeLength ::= ENUMERATED {
    short,
    long
}

UL-ScramblingCodeNumber ::= INTEGER (0..16777215)

UL-TimeslotISCP ::= INTEGER (0..127)
-- According to mapping in [14]

URA-ID ::= INTEGER (0..65535)

URA-Information ::= SEQUENCE {
    uRA-ID          URA-ID,
    multipleURAsIndicator    MultipleURAsIndicator,
    rNCsWithCellsInTheAccessedURA-List    RNCsWithCellsInTheAccessedURA-List OPTIONAL,
    iE-Extensions   ProtocolExtensionContainer { {URA-Information-ExtIEs} } OPTIONAL,
    ...
}

```



```

URA-Information-ExtIEs RNSAP-PROTOCOL-EXTENSION ::= {
    ...
}

RNCsWithCellsInTheAccessedURA-List ::= SEQUENCE (SIZE (1..maxRNCinURA-1)) OF RNCsWithCellsInTheAccessedURA-Item

RNCsWithCellsInTheAccessedURA-Item ::= SEQUENCE {
    rNC-ID                RNC-ID,
    iE-Extensions        ProtocolExtensionContainer { {RNCsWithCellsInTheAccessedURA-Item-ExtIEs} } OPTIONAL,
    ...
}

RNCsWithCellsInTheAccessedURA-Item-ExtIEs RNSAP-PROTOCOL-EXTENSION ::= {
    ...
}

USCH-ID                ::= INTEGER (0..255)

USCH-Information ::= SEQUENCE (SIZE (1..maxNoOfUSCHs)) OF USCH-InformationItem

USCH-InformationItem ::= SEQUENCE {
    uSCH-ID                USCH-ID,
    ul-CCTrCH-ID          CCTrCH-ID,
    trChSourceStatisticsDescriptor TrCH-SrcStatisticsDescr,
    transportFormatSet    TransportFormatSet,
    allocationRetentionPriority AllocationRetentionPriority,
    schedulingPriorityIndicator SchedulingPriorityIndicator,
    rb-Info              RB-Info,
    iE-Extensions        ProtocolExtensionContainer { {USCH-InformationItem-ExtIEs} } OPTIONAL,
    ...
}

USCH-InformationItem-ExtIEs RNSAP-PROTOCOL-EXTENSION ::= {
    ...
}

UL-Synchronisation-Parameters-LCR ::= SEQUENCE {
    uL-Synchronisation-StepSize    UL-Synchronisation-StepSize,
    uL-Synchronisation-Frequency    UL-Synchronisation-Frequency,
    iE-Extensions                  ProtocolExtensionContainer { { UL-Synchronisation-Parameters-LCR-ExtIEs } } OPTIONAL,
    ...
}

UL-Synchronisation-Parameters-LCR-ExtIEs RNSAP-PROTOCOL-EXTENSION ::= {
    ...
}

UL-Synchronisation-StepSize ::= INTEGER (1..8)

UL-Synchronisation-Frequency ::= INTEGER (1..8)

UL-TimingAdvanceCtrl-LCR ::= SEQUENCE {
    sync-UL-codes-bitmap          BIT STRING (SIZE(8)),
    fPACH-info                    FPACH-Information,

```

```

    prxUpPCHdes                INTEGER (-120 .. -58, ...),
    syncUL-procParameter       SYNC-UL-ProcParameters,
    mMax                       INTEGER (1..32),
    ...
}

-- V
-- W
-- X
-- Y
-- Z

END

```

9.3.5 Common Definitions

```

-- *****
--
-- Common definitions
--
-- *****

RNSAP-CommonDataTypes {
itu-t (0) identified-organization (4) etsi (0) mobileDomain (0)
umts-Access (20) modules (3) rnsap (1) version1 (1) rnsap-CommonDataTypes (3) }

DEFINITIONS AUTOMATIC TAGS ::=

BEGIN

-- *****
--
-- Extension constants
--
-- *****

maxPrivateIEs                INTEGER ::= 65535
maxProtocolExtensions         INTEGER ::= 65535
maxProtocolIEs                INTEGER ::= 65535

-- *****
--
-- Common Data Types
--
-- *****

Criticality ::= ENUMERATED { reject, ignore, notify }

Presence ::= ENUMERATED { optional, conditional, mandatory }

PrivateIE-ID ::= CHOICE {
    local                INTEGER (0.. maxPrivateIEs),
    global                OBJECT IDENTIFIER
}

```

```

}
ProcedureCode ::= INTEGER (0..255)
ProcedureID ::= SEQUENCE {
    procedureCode ProcedureCode,
    ddMode        ENUMERATED { tdd, fdd, common, ... }
}
ProtocolIE-ID ::= INTEGER (0..maxProtocolIEs)
TransactionID ::= CHOICE {
    shortTransactionId INTEGER (0..127),
    longTransactionId  INTEGER (0..32767)
}
TriggeringMessage ::= ENUMERATED { initiating-message, successful-outcome, unsuccessful-outcome, outcome }
END

```

9.3.6 Constant Definitions

```

-- *****
--
-- Constant definitions
--
-- *****

RNSAP-Constants {
itu-t (0) identified-organization (4) etsi (0) mobileDomain (0)
umts-Access (20) modules (3) rnsap (1) version1 (1) rnsap-Constants (4) }

DEFINITIONS AUTOMATIC TAGS ::=

BEGIN

IMPORTS
    ProcedureCode,
    ProtocolIE-ID
FROM RNSAP-CommonDataTypes;

-- *****
--
-- Elementary Procedures
--
-- *****

id-commonTransportChannelResourcesInitialisation      ProcedureCode ::= 0
id-commonTransportChannelResourcesRelease             ProcedureCode ::= 1
id-compressedModeCommand                             ProcedureCode ::= 2
id-downlinkPowerControl                              ProcedureCode ::= 3
id-downlinkPowerTimeslotControl                      ProcedureCode ::= 4
id-downlinkSignallingTransfer                        ProcedureCode ::= 5

```

id-errorIndication	ProcedureCode ::= 6
id-dedicatedMeasurementFailure	ProcedureCode ::= 7
id-dedicatedMeasurementInitiation	ProcedureCode ::= 8
id-dedicatedMeasurementReporting	ProcedureCode ::= 9
id-dedicatedMeasurementTermination	ProcedureCode ::= 10
id-paging	ProcedureCode ::= 11
id-physicalChannelReconfiguration	ProcedureCode ::= 12
id-privateMessage	ProcedureCode ::= 13
id-radioLinkAddition	ProcedureCode ::= 14
id-radioLinkCongestion	ProcedureCode ::= 34
id-radioLinkDeletion	ProcedureCode ::= 15
id-radioLinkFailure	ProcedureCode ::= 16
id-radioLinkPreemption	ProcedureCode ::= 17
id-radioLinkRestoration	ProcedureCode ::= 18
id-radioLinkSetup	ProcedureCode ::= 19
id-relocationCommit	ProcedureCode ::= 20
id-synchronisedRadioLinkReconfigurationCancellation	ProcedureCode ::= 21
id-synchronisedRadioLinkReconfigurationCommit	ProcedureCode ::= 22
id-synchronisedRadioLinkReconfigurationPreparation	ProcedureCode ::= 23
id-unSynchronisedRadioLinkReconfiguration	ProcedureCode ::= 24
id-uplinkSignallingTransfer	ProcedureCode ::= 25
id-commonMeasurementFailure	ProcedureCode ::= 26
id-commonMeasurementInitiation	ProcedureCode ::= 27
id-commonMeasurementReporting	ProcedureCode ::= 28
id-commonMeasurementTermination	ProcedureCode ::= 29
id-informationExchangeFailure	ProcedureCode ::= 30
id-informationExchangeInitiation	ProcedureCode ::= 31
id-informationReporting	ProcedureCode ::= 32
id-informationExchangeTermination	ProcedureCode ::= 33

```
-- *****
--
-- Lists
--
-- *****
```

maxCodeNumComp-1	INTEGER ::= 255
maxRateMatching	INTEGER ::= 256
maxNoCodeGroups	INTEGER ::= 256
maxNoOfDSCHs	INTEGER ::= 10
maxNoOfDSCHsLCR	INTEGER ::= 10
maxNoOfRB	INTEGER ::= 32
maxNoOfUSCHs	INTEGER ::= 10
maxNoOfUSCHsLCR	INTEGER ::= 10
maxNoTFCIGroups	INTEGER ::= 256
maxNrOfTFCs	INTEGER ::= 1024
maxNrOfTFs	INTEGER ::= 32
maxNrOfCCTrCHs	INTEGER ::= 16
maxNrOfCCTrCHsLCR	INTEGER ::= 16
maxNrOfDCHs	INTEGER ::= 128
maxNrOfDL-Codes	INTEGER ::= 8
maxNrOfDPCHs	INTEGER ::= 240
maxNrOfDPCHsLCR	INTEGER ::= 240
maxNrOfErrors	INTEGER ::= 256

```

maxNrOfMACcshSDU-Length          INTEGER ::= 16
maxNrOfPoints                     INTEGER ::= 15
maxNrOfRLs                        INTEGER ::= 16
maxNrOfRLSets                     INTEGER ::= maxNrOfRLs
maxNrOfRLs-1                      INTEGER ::= 15 -- maxNrOfRLs - 1
maxNrOfRLs-2                      INTEGER ::= 14 -- maxNrOfRLs - 2
maxNrOfULTs                       INTEGER ::= 15
maxNrOfULTsLCR                    INTEGER ::= 6
maxNrOfDLTs                       INTEGER ::= 15
maxNrOfDLTsLCR                    INTEGER ::= 6
maxRNCinURA-1                    INTEGER ::= 15
maxTTI-Count                       INTEGER ::= 4
maxCTFC                           INTEGER ::= 16777215
maxNrOfNeighbouringRNCs           INTEGER ::= 10
maxNrOfFDDNeighboursPerRNC        INTEGER ::= 256
maxNrOfGSMNeighboursPerRNC        INTEGER ::= 256
maxNrOfTDDNeighboursPerRNC        INTEGER ::= 256
maxNrOfFACHs                       INTEGER ::= 8
maxNrOfLCRTDDNeighboursPerRNC     INTEGER ::= 256
maxFACHCountPlus1                 INTEGER ::= 10
maxIBSEG                           INTEGER ::= 16
maxNrOfSCCPCHs                    INTEGER ::= 8
maxTFCI1Combs                      INTEGER ::= 512
maxTFCI2Combs                      INTEGER ::= 1024
maxTFCI2Combs-1                   INTEGER ::= 1023
maxTGPS                            INTEGER ::= 6
maxNrOfTS                          INTEGER ::= 15
maxNrOfLevels                      INTEGER ::= 256
maxNoOfDSCHs-1                    INTEGER ::= 9
maxNrOfTsLCR                       INTEGER ::= 6
maxNoSat                           INTEGER ::= 16
maxNoGPSTypes                      INTEGER ::= 8
maxNrOfMeasNCell                   INTEGER ::= 96
maxNrOfMeasNCell-1                 INTEGER ::= 95 -- maxNrOfMeasNCell - 1

-- *****
--
-- IEs
--
-- *****

id-AllowedQueuingTime              ProtocolIE-ID ::= 4
id-Allowed-Rate-Information         ProtocolIE-ID ::= 42
id-BindingID                       ProtocolIE-ID ::= 5
id-C-ID                            ProtocolIE-ID ::= 6
id-C-RNTI                          ProtocolIE-ID ::= 7
id-CFN                             ProtocolIE-ID ::= 8
id-CN-CS-DomainIdentifier           ProtocolIE-ID ::= 9
id-CN-PS-DomainIdentifier           ProtocolIE-ID ::= 10
id-Cause                           ProtocolIE-ID ::= 11
id-CriticalityDiagnostics           ProtocolIE-ID ::= 20
id-D-RNTI                          ProtocolIE-ID ::= 21
id-D-RNTI-ReleaseIndication         ProtocolIE-ID ::= 22
id-DCHs-to-Add-FDD                 ProtocolIE-ID ::= 26

```

id-DCHs-to-Add-TDD	ProtocolIE-ID ::= 27
id-DCH-DeleteList-RL-ReconfPrepFDD	ProtocolIE-ID ::= 30
id-DCH-DeleteList-RL-ReconfPrepTDD	ProtocolIE-ID ::= 31
id-DCH-DeleteList-RL-ReconfRqstFDD	ProtocolIE-ID ::= 32
id-DCH-DeleteList-RL-ReconfRqstTDD	ProtocolIE-ID ::= 33
id-DCH-FDD-Information	ProtocolIE-ID ::= 34
id-DCH-TDD-Information	ProtocolIE-ID ::= 35
id-FDD-DCHs-to-Modify	ProtocolIE-ID ::= 39
id-TDD-DCHs-to-Modify	ProtocolIE-ID ::= 40
id-DCH-InformationResponse	ProtocolIE-ID ::= 43
id-DCH-Rate-InformationItem-RL-CongestInd	ProtocolIE-ID ::= 38
id-DL-CCTrCH-InformationAddItem-RL-ReconfPrepTDD	ProtocolIE-ID ::= 44
id-DL-CCTrCH-InformationListIE-RL-ReconfReadyTDD	ProtocolIE-ID ::= 45
id-DL-CCTrCH-InformationDeleteItem-RL-ReconfRqstTDD	ProtocolIE-ID ::= 46
id-DL-CCTrCH-InformationItem-RL-SetupRqstTDD	ProtocolIE-ID ::= 47
id-DL-CCTrCH-InformationListIE-PhyChReconfRqstTDD	ProtocolIE-ID ::= 48
id-DL-CCTrCH-InformationListIE-RL-AdditionRspTDD	ProtocolIE-ID ::= 49
id-DL-CCTrCH-InformationListIE-RL-SetupRspTDD	ProtocolIE-ID ::= 50
id-DL-CCTrCH-InformationAddList-RL-ReconfPrepTDD	ProtocolIE-ID ::= 51
id-DL-CCTrCH-InformationDeleteList-RL-ReconfRqstTDD	ProtocolIE-ID ::= 52
id-DL-CCTrCH-InformationList-RL-SetupRqstTDD	ProtocolIE-ID ::= 53
id-FDD-DL-CodeInformation	ProtocolIE-ID ::= 54
id-DL-DPCH-Information-RL-ReconfPrepFDD	ProtocolIE-ID ::= 59
id-DL-DPCH-Information-RL-SetupRqstFDD	ProtocolIE-ID ::= 60
id-DL-DPCH-Information-RL-ReconfRqstFDD	ProtocolIE-ID ::= 61
id-DL-DPCH-InformationItem-PhyChReconfRqstTDD	ProtocolIE-ID ::= 62
id-DL-DPCH-InformationItem-RL-AdditionRspTDD	ProtocolIE-ID ::= 63
id-DL-DPCH-InformationItem-RL-SetupRspTDD	ProtocolIE-ID ::= 64
id-DLReferencePower	ProtocolIE-ID ::= 67
id-DLReferencePowerList-DL-PC-Rqst	ProtocolIE-ID ::= 68
id-DL-ReferencePowerInformation-DL-PC-Rqst	ProtocolIE-ID ::= 69
id-DPC-Mode	ProtocolIE-ID ::= 12
id-DRXCycleLengthCoefficient	ProtocolIE-ID ::= 70
id-DedicatedMeasurementObjectType-DM-Rprt	ProtocolIE-ID ::= 71
id-DedicatedMeasurementObjectType-DM-Rqst	ProtocolIE-ID ::= 72
id-DedicatedMeasurementObjectType-DM-Rsp	ProtocolIE-ID ::= 73
id-DedicatedMeasurementType	ProtocolIE-ID ::= 74
id-FACH-InfoForUESelectedS-CCPCH-CTCH-ResourceRspFDD	ProtocolIE-ID ::= 82
id-FACH-InfoForUESelectedS-CCPCH-CTCH-ResourceRspTDD	ProtocolIE-ID ::= 83
id-Guaranteed-Rate-Information	ProtocolIE-ID ::= 41
id-IMSI	ProtocolIE-ID ::= 84
id-L3-Information	ProtocolIE-ID ::= 85
id-AdjustmentPeriod	ProtocolIE-ID ::= 90
id-MaxAdjustmentStep	ProtocolIE-ID ::= 91
id-MeasurementFilterCoefficient	ProtocolIE-ID ::= 92
id-MessageStructure	ProtocolIE-ID ::= 57
id-MeasurementID	ProtocolIE-ID ::= 93
id-Neighbouring-GSM-CellInformation	ProtocolIE-ID ::= 13
id-Neighbouring-UMTS-CellInformationItem	ProtocolIE-ID ::= 95
id-PagingArea-PagingRqst	ProtocolIE-ID ::= 102
id-FACH-FlowControlInformation	ProtocolIE-ID ::= 103
id-Permanent-NAS-UE-Identity	ProtocolIE-ID ::= 17
id-PowerAdjustmentType	ProtocolIE-ID ::= 107
id-RANAP-RelocationInformation	ProtocolIE-ID ::= 109

id-RL-Information-PhyChReconfRqstFDD	ProtocolIE-ID ::= 110
id-RL-Information-PhyChReconfRqstTDD	ProtocolIE-ID ::= 111
id-RL-Information-RL-AdditionRqstFDD	ProtocolIE-ID ::= 112
id-RL-Information-RL-AdditionRqstTDD	ProtocolIE-ID ::= 113
id-RL-Information-RL-DeletionRqst	ProtocolIE-ID ::= 114
id-RL-Information-RL-FailureInd	ProtocolIE-ID ::= 115
id-RL-Information-RL-ReconfPrepFDD	ProtocolIE-ID ::= 116
id-RL-Information-RL-RestoreInd	ProtocolIE-ID ::= 117
id-RL-Information-RL-SetupRqstFDD	ProtocolIE-ID ::= 118
id-RL-Information-RL-SetupRqstTDD	ProtocolIE-ID ::= 119
id-RL-InformationItem-RL-CongestInd	ProtocolIE-ID ::= 55
id-RL-InformationItem-DM-Rprt	ProtocolIE-ID ::= 120
id-RL-InformationItem-DM-Rqst	ProtocolIE-ID ::= 121
id-RL-InformationItem-DM-Rsp	ProtocolIE-ID ::= 122
id-RL-InformationItem-RL-PreemptRequiredInd	ProtocolIE-ID ::= 2
id-RL-InformationItem-RL-SetupRqstFDD	ProtocolIE-ID ::= 123
id-RL-InformationList-RL-CongestInd	ProtocolIE-ID ::= 56
id-RL-InformationList-RL-AdditionRqstFDD	ProtocolIE-ID ::= 124
id-RL-InformationList-RL-DeletionRqst	ProtocolIE-ID ::= 125
id-RL-InformationList-RL-PreemptRequiredInd	ProtocolIE-ID ::= 1
id-RL-InformationList-RL-ReconfPrepFDD	ProtocolIE-ID ::= 126
id-RL-InformationResponse-RL-AdditionRspTDD	ProtocolIE-ID ::= 127
id-RL-InformationResponse-RL-ReconfReadyTDD	ProtocolIE-ID ::= 128
id-RL-InformationResponse-RL-SetupRspTDD	ProtocolIE-ID ::= 129
id-RL-InformationResponseItem-RL-AdditionRspFDD	ProtocolIE-ID ::= 130
id-RL-InformationResponseItem-RL-ReconfReadyFDD	ProtocolIE-ID ::= 131
id-RL-InformationResponseItem-RL-ReconfRspFDD	ProtocolIE-ID ::= 132
id-RL-InformationResponseItem-RL-SetupRspFDD	ProtocolIE-ID ::= 133
id-RL-InformationResponseList-RL-AdditionRspFDD	ProtocolIE-ID ::= 134
id-RL-InformationResponseList-RL-ReconfReadyFDD	ProtocolIE-ID ::= 135
id-RL-InformationResponseList-RL-ReconfRspFDD	ProtocolIE-ID ::= 136
id-RL-InformationResponse-RL-ReconfRspTDD	ProtocolIE-ID ::= 28
id-RL-InformationResponseList-RL-SetupRspFDD	ProtocolIE-ID ::= 137
id-RL-ReconfigurationFailure-RL-ReconfFail	ProtocolIE-ID ::= 141
id-RL-Set-InformationItem-DM-Rprt	ProtocolIE-ID ::= 143
id-RL-Set-InformationItem-DM-Rqst	ProtocolIE-ID ::= 144
id-RL-Set-InformationItem-DM-Rsp	ProtocolIE-ID ::= 145
id-RL-Set-Information-RL-FailureInd	ProtocolIE-ID ::= 146
id-RL-Set-Information-RL-RestoreInd	ProtocolIE-ID ::= 147
id-ReportCharacteristics	ProtocolIE-ID ::= 152
id-Reporting-Object-RL-FailureInd	ProtocolIE-ID ::= 153
id-Reporting-Object-RL-RestoreInd	ProtocolIE-ID ::= 154
id-S-RNTI	ProtocolIE-ID ::= 155
id-SAI	ProtocolIE-ID ::= 156
id-SRNC-ID	ProtocolIE-ID ::= 157
id-SuccessfulRL-InformationResponse-RL-AdditionFailureFDD	ProtocolIE-ID ::= 159
id-SuccessfulRL-InformationResponse-RL-SetupFailureFDD	ProtocolIE-ID ::= 160
id-TransportBearerID	ProtocolIE-ID ::= 163
id-TransportBearerRequestIndicator	ProtocolIE-ID ::= 164
id-TransportLayerAddress	ProtocolIE-ID ::= 165
id-TypeOfError	ProtocolIE-ID ::= 140
id-UC-ID	ProtocolIE-ID ::= 166
id-UL-CCTrCH-AddInformation-RL-ReconfPrepTDD	ProtocolIE-ID ::= 167
id-UL-CCTrCH-InformationAddList-RL-ReconfPrepTDD	ProtocolIE-ID ::= 169

id-UL-CCTrCH-InformationItem-RL-SetupRqstTDD	ProtocolIE-ID ::= 171
id-UL-CCTrCH-InformationList-RL-SetupRqstTDD	ProtocolIE-ID ::= 172
id-UL-CCTrCH-InformationListIE-PhyChReconfRqstTDD	ProtocolIE-ID ::= 173
id-UL-CCTrCH-InformationListIE-RL-AdditionRspTDD	ProtocolIE-ID ::= 174
id-UL-CCTrCH-InformationListIE-RL-ReconfReadyTDD	ProtocolIE-ID ::= 175
id-UL-CCTrCH-InformationListIE-RL-SetupRspTDD	ProtocolIE-ID ::= 176
id-UL-DPCH-Information-RL-ReconfPrepFDD	ProtocolIE-ID ::= 177
id-UL-DPCH-Information-RL-ReconfRqstFDD	ProtocolIE-ID ::= 178
id-UL-DPCH-Information-RL-SetupRqstFDD	ProtocolIE-ID ::= 179
id-UL-DPCH-InformationItem-PhyChReconfRqstTDD	ProtocolIE-ID ::= 180
id-UL-DPCH-InformationItem-RL-AdditionRspTDD	ProtocolIE-ID ::= 181
id-UL-DPCH-InformationItem-RL-SetupRspTDD	ProtocolIE-ID ::= 182
id-UL-DPCH-InformationAddListIE-RL-ReconfReadyTDD	ProtocolIE-ID ::= 183
id-UL-SIRTarget	ProtocolIE-ID ::= 184
id-URA-Information	ProtocolIE-ID ::= 185
id-UnsuccessfulRL-InformationResponse-RL-AdditionFailureFDD	ProtocolIE-ID ::= 188
id-UnsuccessfulRL-InformationResponse-RL-SetupFailureFDD	ProtocolIE-ID ::= 189
id-UnsuccessfulRL-InformationResponse-RL-SetupFailureTDD	ProtocolIE-ID ::= 190
id-Active-Pattern-Sequence-Information	ProtocolIE-ID ::= 193
id-AdjustmentRatio	ProtocolIE-ID ::= 194
id-CauseLevel-RL-AdditionFailureFDD	ProtocolIE-ID ::= 197
id-CauseLevel-RL-AdditionFailureTDD	ProtocolIE-ID ::= 198
id-CauseLevel-RL-ReconfFailure	ProtocolIE-ID ::= 199
id-CauseLevel-RL-SetupFailureFDD	ProtocolIE-ID ::= 200
id-CauseLevel-RL-SetupFailureTDD	ProtocolIE-ID ::= 201
id-DL-CCTrCH-InformationDeleteItem-RL-ReconfPrepTDD	ProtocolIE-ID ::= 205
id-DL-CCTrCH-InformationModifyItem-RL-ReconfPrepTDD	ProtocolIE-ID ::= 206
id-DL-CCTrCH-InformationModifyItem-RL-ReconfRqstTDD	ProtocolIE-ID ::= 207
id-DL-CCTrCH-InformationDeleteList-RL-ReconfPrepTDD	ProtocolIE-ID ::= 208
id-DL-CCTrCH-InformationModifyList-RL-ReconfPrepTDD	ProtocolIE-ID ::= 209
id-DL-CCTrCH-InformationModifyList-RL-ReconfRqstTDD	ProtocolIE-ID ::= 210
id-DL-DPCH-InformationAddListIE-RL-ReconfReadyTDD	ProtocolIE-ID ::= 212
id-DL-DPCH-InformationDeleteListIE-RL-ReconfReadyTDD	ProtocolIE-ID ::= 213
id-DL-DPCH-InformationModifyListIE-RL-ReconfReadyTDD	ProtocolIE-ID ::= 214
id-DSCHs-to-Add-TDD	ProtocolIE-ID ::= 215
id-DSCHs-to-Add-FDD	ProtocolIE-ID ::= 216
id-DSCH-DeleteList-RL-ReconfPrepTDD	ProtocolIE-ID ::= 217
id-DSCH-Delete-RL-ReconfPrepFDD	ProtocolIE-ID ::= 218
id-DSCH-FDD-Information	ProtocolIE-ID ::= 219
id-DSCH-InformationListIE-RL-AdditionRspTDD	ProtocolIE-ID ::= 220
id-DSCH-InformationListIEs-RL-SetupRspTDD	ProtocolIE-ID ::= 221
id-DSCH-TDD-Information	ProtocolIE-ID ::= 222
id-DSCH-FDD-InformationResponse	ProtocolIE-ID ::= 223
id-DSCH-Information-RL-SetupRqstFDD	ProtocolIE-ID ::= 226
id-DSCH-ModifyList-RL-ReconfPrepTDD	ProtocolIE-ID ::= 227
id-DSCH-Modify-RL-ReconfPrepFDD	ProtocolIE-ID ::= 228
id-DSCH-Specific-FDD-Additional-List	ProtocolIE-ID ::= 324
id-DSCHsToBeAddedOrModified-FDD	ProtocolIE-ID ::= 229
id-DSCHsToBeAddedOrModifiedList-RL-ReconfReadyTDD	ProtocolIE-ID ::= 230
id-EnhancedDSCHPC	ProtocolIE-ID ::= 29
id-EnhancedDSCHPCIndicator	ProtocolIE-ID ::= 225
id-GA-Cell	ProtocolIE-ID ::= 232
id-GA-CellAdditionalShapes	ProtocolIE-ID ::= 3
id-SSDT-CellIDforEDSCHPC	ProtocolIE-ID ::= 246

id-Transmission-Gap-Pattern-Sequence-Information	ProtocolIE-ID ::= 255
id-UL-CCTrCH-DeleteInformation-RL-ReconfPrepTDD	ProtocolIE-ID ::= 256
id-UL-CCTrCH-ModifyInformation-RL-ReconfPrepTDD	ProtocolIE-ID ::= 257
id-UL-CCTrCH-InformationModifyItem-RL-ReconfRqstTDD	ProtocolIE-ID ::= 258
id-UL-CCTrCH-InformationDeleteList-RL-ReconfPrepTDD	ProtocolIE-ID ::= 259
id-UL-CCTrCH-InformationModifyList-RL-ReconfPrepTDD	ProtocolIE-ID ::= 260
id-UL-CCTrCH-InformationModifyList-RL-ReconfRqstTDD	ProtocolIE-ID ::= 261
id-UL-CCTrCH-InformationDeleteItem-RL-ReconfRqstTDD	ProtocolIE-ID ::= 262
id-UL-CCTrCH-InformationDeleteList-RL-ReconfRqstTDD	ProtocolIE-ID ::= 263
id-UL-DPCH-InformationDeleteListIE-RL-ReconfReadyTDD	ProtocolIE-ID ::= 264
id-UL-DPCH-InformationModifyListIE-RL-ReconfReadyTDD	ProtocolIE-ID ::= 265
id-UnsuccessfulRL-InformationResponse-RL-AdditionFailureTDD	ProtocolIE-ID ::= 266
id-USCHs-to-Add	ProtocolIE-ID ::= 267
id-USCH-DeleteList-RL-ReconfPrepTDD	ProtocolIE-ID ::= 268
id-USCH-InformationListIE-RL-AdditionRspTDD	ProtocolIE-ID ::= 269
id-USCH-InformationListIEs-RL-SetupRspTDD	ProtocolIE-ID ::= 270
id-USCH-Information	ProtocolIE-ID ::= 271
id-USCH-ModifyList-RL-ReconfPrepTDD	ProtocolIE-ID ::= 272
id-USCHToBeAddedOrModifiedList-RL-ReconfReadyTDD	ProtocolIE-ID ::= 273
id-DL-Physical-Channel-Information-RL-SetupRqstTDD	ProtocolIE-ID ::= 274
id-UL-Physical-Channel-Information-RL-SetupRqstTDD	ProtocolIE-ID ::= 275
id-ClosedLoopModel-SupportIndicator	ProtocolIE-ID ::= 276
id-ClosedLoopMode2-SupportIndicator	ProtocolIE-ID ::= 277
id-STTD-SupportIndicator	ProtocolIE-ID ::= 279
id-CFNReportingIndicator	ProtocolIE-ID ::= 14
id-CNOriginatedPage-PagingRqst	ProtocolIE-ID ::= 23
id-InnerLoopDLPCStatus	ProtocolIE-ID ::= 24
id-PropagationDelay	ProtocolIE-ID ::= 25
id-RxTimingDeviationForTA	ProtocolIE-ID ::= 36
id-timeSlot-ISCP	ProtocolIE-ID ::= 37
id-CCTrCH-InformationItem-RL-FailureInd	ProtocolIE-ID ::= 15
id-CCTrCH-InformationItem-RL-RestoreInd	ProtocolIE-ID ::= 16
id-CommonMeasurementAccuracy	ProtocolIE-ID ::= 280
id-CommonMeasurementObjectType-CM-Rprt	ProtocolIE-ID ::= 281
id-CommonMeasurementObjectType-CM-Rqst	ProtocolIE-ID ::= 282
id-CommonMeasurementObjectType-CM-Rsp	ProtocolIE-ID ::= 283
id-CommonMeasurementType	ProtocolIE-ID ::= 284
id-CongestionCause	ProtocolIE-ID ::= 18
id-SFN	ProtocolIE-ID ::= 285
id-SFNReportingIndicator	ProtocolIE-ID ::= 286
id-InformationExchangeID	ProtocolIE-ID ::= 287
id-InformationExchangeObjectType-InfEx-Rprt	ProtocolIE-ID ::= 288
id-InformationExchangeObjectType-InfEx-Rqst	ProtocolIE-ID ::= 289
id-InformationExchangeObjectType-InfEx-Rsp	ProtocolIE-ID ::= 290
id-InformationReportCharacteristics	ProtocolIE-ID ::= 291
id-InformationType	ProtocolIE-ID ::= 292
id-neighbouring-LCR-TDD-CellInformation	ProtocolIE-ID ::= 58
id-DL-Timeslot-ISCP-LCR-Information-RL-SetupRqstTDD	ProtocolIE-ID ::= 65
id-RL-LCR-InformationResponse-RL-SetupRspTDD	ProtocolIE-ID ::= 66
id-UL-CCTrCH-LCR-InformationListIE-RL-SetupRspTDD	ProtocolIE-ID ::= 75
id-UL-DPCH-LCR-InformationItem-RL-SetupRspTDD	ProtocolIE-ID ::= 76
id-DL-CCTrCH-LCR-InformationListIE-RL-SetupRspTDD	ProtocolIE-ID ::= 77
id-DL-DPCH-LCR-InformationItem-RL-SetupRspTDD	ProtocolIE-ID ::= 78
id-DSCH-LCR-InformationListIEs-RL-SetupRspTDD	ProtocolIE-ID ::= 79

id-USCH-LCR-InformationListIEs-RL-SetupRspTDD	ProtocolIE-ID ::= 80
id-DL-Timeslot-ISCP-LCR-Information-RL-AdditionRqstTDD	ProtocolIE-ID ::= 81
id-RL-LCR-InformationResponse-RL-AdditionRspTDD	ProtocolIE-ID ::= 86
id-UL-CCTrCH-LCR-InformationListIE-RL-AdditionRspTDD	ProtocolIE-ID ::= 87
id-UL-DPCH-LCR-InformationItem-RL-AdditionRspTDD	ProtocolIE-ID ::= 88
id-DL-CCTrCH-LCR-InformationListIE-RL-AdditionRspTDD	ProtocolIE-ID ::= 89
id-DL-DPCH-LCR-InformationItem-RL-AdditionRspTDD	ProtocolIE-ID ::= 94
id-DSCH-LCR-InformationListIEs-RL-AdditionRspTDD	ProtocolIE-ID ::= 96
id-USCH-LCR-InformationListIEs-RL-AdditionRspTDD	ProtocolIE-ID ::= 97
id-UL-DPCH-LCR-InformationAddListIE-RL-ReconfReadyTDD	ProtocolIE-ID ::= 98
id-UL-Timeslot-LCR-InformationModifyList-RL-ReconfReadyTDD	ProtocolIE-ID ::= 100
id-DL-DPCH-LCR-InformationAddListIE-RL-ReconfReadyTDD	ProtocolIE-ID ::= 101
id-DL-Timeslot-LCR-InformationModifyList-RL-ReconfReadyTDD	ProtocolIE-ID ::= 104
id-UL-Timeslot-LCR-InformationList-PhyChReconfRqstTDD	ProtocolIE-ID ::= 105
id-DL-Timeslot-LCR-InformationList-PhyChReconfRqstTDD	ProtocolIE-ID ::= 106
id-timeSlot-ISCP-LCR-List-DL-PC-Rqst-TDD	ProtocolIE-ID ::= 138
id-TSTD-Support-Indicator-RL-SetupRqstTDD	ProtocolIE-ID ::= 139
id-RestrictionStateIndicator	ProtocolIE-ID ::= 142
id-Load-Value	ProtocolIE-ID ::= 233
id-Load-Value-IncrDecrThres	ProtocolIE-ID ::= 234
id-OnModification	ProtocolIE-ID ::= 235
id-Received-Total-Wideband-Power-Value	ProtocolIE-ID ::= 236
id-Received-Total-Wideband-Power-Value-IncrDecrThres	ProtocolIE-ID ::= 237
id-SFNSFNMeasurementThresholdInformation	ProtocolIE-ID ::= 238
id-Transmitted-Carrier-Power-Value	ProtocolIE-ID ::= 239
id-Transmitted-Carrier-Power-Value-IncrDecrThres	ProtocolIE-ID ::= 240
id-TUTRANGPSMeasurementThresholdInformation	ProtocolIE-ID ::= 241
id-UL-Timeslot-ISCP-Value	ProtocolIE-ID ::= 242
id-UL-Timeslot-ISCP-Value-IncrDecrThres	ProtocolIE-ID ::= 243
id-Rx-Timing-Deviation-Value-LCR	ProtocolIE-ID ::= 293
id-DPC-Mode-Change-SupportIndicator	ProtocolIE-ID ::= 19
id-SplitType	ProtocolIE-ID ::= 247
id-LengthOfTFCI2	ProtocolIE-ID ::= 295
id-PrimaryCCPCH-RSCP-RL-ReconfPrepTDD	ProtocolIE-ID ::= 202
id-DL-TimeSlot-ISCP-Info-RL-ReconfPrepTDD	ProtocolIE-ID ::= 203
id-DL-Timeslot-ISCP-LCR-Information-RL-ReconfPrepTDD	ProtocolIE-ID ::= 204
id-DSCH-RNTI	ProtocolIE-ID ::= 249
id-PDSCH-RL-ID	ProtocolIE-ID ::= 323
id-TimeSlot-RL-SetupRspTDD	ProtocolIE-ID ::= 325
id-UL-Synchronisation-Parameters-LCR	ProtocolIE-ID ::= 464
id-TDD-DL-DPCH-TimeSlotFormatModifyItem-LCR-RL-ReconfReadyTDD	ProtocolIE-ID ::= 481
id-TDD-UL-DPCH-TimeSlotFormatModifyItem-LCR-RL-ReconfReadyTDD	ProtocolIE-ID ::= 482
id-TDD-TPC-UplinkStepSize-LCR-RL-SetupRqstTDD	ProtocolIE-ID ::= 483
id-UL-CCTrCH-InformationList-RL-AdditionRqstTDD	ProtocolIE-ID ::= 484
id-UL-CCTrCH-InformationItem-RL-AdditionRqstTDD	ProtocolIE-ID ::= 485
id-DL-CCTrCH-InformationList-RL-AdditionRqstTDD	ProtocolIE-ID ::= 486
id-DL-CCTrCH-InformationItem-RL-AdditionRqstTDD	ProtocolIE-ID ::= 487
id-TDD-TPC-UplinkStepSize-InformationAdd-LCR-RL-ReconfPrepTDD	ProtocolIE-ID ::= 488
id-TDD-TPC-UplinkStepSize-InformationModify-LCR-RL-ReconfPrepTDD	ProtocolIE-ID ::= 489
id-TDD-TPC-DownlinkStepSize-InformationAdd-RL-ReconfPrepTDD	ProtocolIE-ID ::= 490
id-TDD-TPC-DownlinkStepSize-InformationModify-RL-ReconfPrepTDD	ProtocolIE-ID ::= 491
id-UL-TimingAdvanceCtrl-LCR	ProtocolIE-ID ::= 492
id-ExtendedGSMCellIndividualOffset	ProtocolIE-ID ::= 514

END

9.3.7 Container Definitions

```

-- *****
--
-- Container definitions
--
-- *****

RNSAP-Containers {
itu-t (0) identified-organization (4) etsi (0) mobileDomain (0)
umts-Access (20) modules (3) rnsap (1) version1 (1) rnsap-Containers (5) }

DEFINITIONS AUTOMATIC TAGS ::=

BEGIN

-- *****
--
-- IE parameter types from other modules.
--
-- *****

IMPORTS
    maxPrivateIEs,
    maxProtocolExtensions,
    maxProtocolIEs,
    Criticality,
    Presence,
    PrivateIE-ID,
    ProtocolIE-ID
FROM RNSAP-CommonDataTypes;

-- *****
--
-- Class Definition for Protocol IEs
--
-- *****

RNSAP-PROTOCOL-IES ::= CLASS {
    &id          ProtocolIE-ID          UNIQUE,
    &criticality Criticality,
    &Value,
    &presence    Presence
}
WITH SYNTAX {
    ID          &id
    CRITICALITY &criticality
    TYPE        &Value
    PRESENCE    &presence
}

```

```
-- *****
--
-- Class Definition for Protocol IEs
--
-- *****

RNSAP-PROTOCOL-IES-PAIR ::= CLASS {
    &id          ProtocolIE-ID          UNIQUE,
    &firstCriticality    Criticality,
    &FirstValue,
    &secondCriticality    Criticality,
    &SecondValue,
    &presence          Presence
}
WITH SYNTAX {
    ID          &id
    FIRST CRITICALITY    &firstCriticality
    FIRST TYPE    &FirstValue
    SECOND CRITICALITY    &secondCriticality
    SECOND TYPE    &SecondValue
    PRESENCE          &presence
}

-- *****
--
-- Class Definition for Protocol Extensions
--
-- *****

RNSAP-PROTOCOL-EXTENSION ::= CLASS {
    &id          ProtocolIE-ID          UNIQUE,
    &criticality    Criticality,
    &Extension,
    &presence          Presence
}
WITH SYNTAX {
    ID          &id
    CRITICALITY    &criticality
    EXTENSION    &Extension
    PRESENCE          &presence
}

-- *****
--
-- Class Definition for Private IEs
--
-- *****

RNSAP-PRIVATE-IES ::= CLASS {
    &id          PrivateIE-ID,
    &criticality    Criticality,
    &Value,
    &presence          Presence
}
```

```

WITH SYNTAX {
  ID                &id
  CRITICALITY       &criticality
  TYPE              &Value
  PRESENCE          &presence
}

-- *****
--
-- Container for Protocol IEs
--
-- *****

ProtocolIE-Container {RNSAP-PROTOCOL-IES : IEsSetParam} ::=
  SEQUENCE (SIZE (0..maxProtocolIEs)) OF
  ProtocolIE-Field {{IEsSetParam}}

ProtocolIE-Single-Container {RNSAP-PROTOCOL-IES : IEsSetParam} ::=
  ProtocolIE-Field {{IEsSetParam}}

ProtocolIE-Field {RNSAP-PROTOCOL-IES : IEsSetParam} ::= SEQUENCE {
  id                RNSAP-PROTOCOL-IES.&id                ({IEsSetParam}),
  criticality       RNSAP-PROTOCOL-IES.&criticality       ({IEsSetParam}@id}),
  value            RNSAP-PROTOCOL-IES.&Value              ({IEsSetParam}@id)}
}

-- *****
--
-- Container for Protocol IE Pairs
--
-- *****

ProtocolIE-ContainerPair {RNSAP-PROTOCOL-IES-PAIR : IEsSetParam} ::=
  SEQUENCE (SIZE (0..maxProtocolIEs)) OF
  ProtocolIE-FieldPair {{IEsSetParam}}

ProtocolIE-FieldPair {RNSAP-PROTOCOL-IES-PAIR : IEsSetParam} ::= SEQUENCE {
  id                RNSAP-PROTOCOL-IES-PAIR.&id            ({IEsSetParam}),
  firstCriticality  RNSAP-PROTOCOL-IES-PAIR.&firstCriticality ({IEsSetParam}@id}),
  firstValue       RNSAP-PROTOCOL-IES-PAIR.&FirstValue     ({IEsSetParam}@id}),
  secondCriticality RNSAP-PROTOCOL-IES-PAIR.&secondCriticality ({IEsSetParam}@id}),
  secondValue      RNSAP-PROTOCOL-IES-PAIR.&SecondValue    ({IEsSetParam}@id)}
}

-- *****
--
-- Container Lists for Protocol IE Containers
--
-- *****

ProtocolIE-ContainerList {INTEGER : lowerBound, INTEGER : upperBound, RNSAP-PROTOCOL-IES : IEsSetParam} ::=
  SEQUENCE (SIZE (lowerBound..upperBound)) OF
  ProtocolIE-Container {{IEsSetParam}}

```

```

ProtocolIE-ContainerPairList {INTEGER : lowerBound, INTEGER : upperBound, RNSAP-PROTOCOL-IES-PAIR : IEsSetParam} ::=
  SEQUENCE (SIZE (lowerBound..upperBound)) OF
    ProtocolIE-ContainerPair {{IEsSetParam}}

-- *****
--
-- Container for Protocol Extensions
--
-- *****

ProtocolExtensionContainer {RNSAP-PROTOCOL-EXTENSION : ExtensionSetParam} ::=
  SEQUENCE (SIZE (1..maxProtocolExtensions)) OF
    ProtocolExtensionField {{ExtensionSetParam}}

ProtocolExtensionField {RNSAP-PROTOCOL-EXTENSION : ExtensionSetParam} ::= SEQUENCE {
  id                RNSAP-PROTOCOL-EXTENSION.&id                ({ExtensionSetParam}),
  criticality       RNSAP-PROTOCOL-EXTENSION.&criticality       ({ExtensionSetParam}@id}),
  extensionValue    RNSAP-PROTOCOL-EXTENSION.&Extension         ({ExtensionSetParam}@id)}
}

-- *****
--
-- Container for Private IEs
--
-- *****

PrivateIE-Container {RNSAP-PRIVATE-IES : IEsSetParam} ::=
  SEQUENCE (SIZE (1..maxPrivateIEs)) OF
    PrivateIE-Field {{IEsSetParam}}

PrivateIE-Field {RNSAP-PRIVATE-IES : IEsSetParam} ::= SEQUENCE {
  id                RNSAP-PRIVATE-IES.&id                ({IEsSetParam}),
  criticality       RNSAP-PRIVATE-IES.&criticality       ({IEsSetParam}@id}),
  value            RNSAP-PRIVATE-IES.&Value            ({IEsSetParam}@id)}
}

END

```

9.4 Message Transfer Syntax

RNSAP shall use the ASN.1 Basic Packed Encoding Rules (BASIC-PER) Aligned Variant as transfer syntax as specified in ref. [20].

The following encoding rules apply in addition to what has been specified in X.691 [20]:

When a bitstring value is placed in a bit-field as specified in 15.6 to 15.11 in [20], the leading bit of the bitstring value shall be placed in the leading bit of the bit-field, and the trailing bit of the bitstring value shall be placed in the trailing bit of the bit-field.

NOTE - When using the "bstring" notation, the leading bit of the bitstring value is on the left, and the trailing bit of the bitstring value is on the right. The term "leading bit" is to be interpreted as equal to the term "first bit" defined in [18].

9.5 Timers

T_{Preempt}

- Specifies the maximum time that a DRNS may wait for pre-emption of resources for establishment or reconfiguration of Radio Links.

10 Handling of Unknown, Unforeseen and Erroneous Protocol Data

10.1 General

Protocol Error cases can be divided into three classes:

1. Transfer Syntax Error;
2. Abstract Syntax Error;
3. Logical Error.

Protocol errors can occur in the following functions within a receiving node.

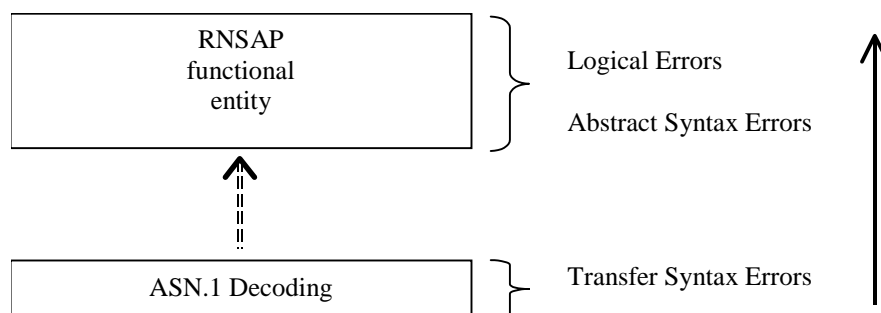

Figure 34: Protocol Errors in RNSAP

The information stated in subclauses 10.2, 10.3 and 10.4, to be included in the message used when reporting an error, is what at minimum shall be included. Other optional information elements within the message may also be included, if available. This is also valid for the case when the reporting is done with a response message. The latter is an exception to what is stated in subclause 4.1.

10.2 Transfer Syntax Error

A Transfer Syntax Error occurs when the receiver is not able to decode the received physical message. Transfer syntax errors are always detected in the process of ASN.1 decoding. If a Transfer Syntax Error occurs, the receiver should initiate Error Indication procedure with appropriate cause value for the Transfer Syntax protocol error.

Examples for Transfer Syntax Errors are:

- Violation of value ranges in ASN.1 definition of messages. e.g.: If an IE has a defined value range of 0 to 10 (ASN.1: INTEGER (0..10)), and 12 will be received, then this will be treated as a transfer syntax error;
- Violation in list element constraints. e.g.: If a list is defined as containing 1 to 10 elements, and 12 elements will be received, then this case will be handled as a transfer syntax error;
- Missing mandatory elements in ASN.1 SEQUENCE definitions (as sent by the originator of the message);
- Wrong order of elements in ASN.1 SEQUENCE definitions (as sent by the originator of the message).

10.3 Abstract Syntax Error

10.3.1 General

An Abstract Syntax Error occurs when the receiving functional RNSAP entity:

1. Receives IEs or IE groups that cannot be understood (unknown IE id);
2. Receives IEs for which the logical range is violated (e.g.: ASN.1 definition: 0 to 15, the logical range is 0 to 10 (values 11 to 15 are undefined), and 12 will be received; this case will be handled as an abstract syntax error using criticality information sent by the originator of the message);
3. Does not receive IEs or IE groups but according to the specified presence of the concerned object, the IEs or IE groups should have been present in the received message;
4. Receives IEs or IE groups that are defined to be part of that message in wrong order or with too many occurrences of the same IE or IE group;
5. receives IEs or IE groups but according to the conditional presence of the concerned object and the specified condition, the IEs or IE groups should not have been present in the received message.

Cases 1 and 2 (not comprehended IE/IE group) are handled based on received Criticality information. Case 3 (missing IE/IE group) is handled based on Criticality information and Presence information for the missing IE/IE group specified in the version of the specification used by the receiver. Case 4 (IEs or IE groups in wrong order or with too many occurrences) and Case 5 (erroneously present conditional IEs or IE groups) result in rejecting the procedure.

If an Abstract Syntax Error occurs, the receiver shall read the remaining message and shall then for each detected Abstract Syntax Error that belong to cases 1-3 act according to the Criticality Information and Presence Information for the IE/IE group due to which Abstract Syntax Error occurred in accordance with subclauses 10.3.4 and 10.3.5. The handling of cases 4 and 5 is specified in subclause 10.3.6.

10.3.2 Criticality Information

In the RNSAP messages there is criticality information set for individual IEs and/or IE groups. This criticality information instructs the receiver how to act when receiving an IE or an IE group that is not comprehended, i.e. the entire item (IE or IE group) which is not (fully or partially) comprehended shall be treated in accordance with its own criticality information as specified in subclause 10.3.4.

In addition, the criticality information is used in case of the missing IE/IE group abstract syntax error (see subclause 10.3.5).

The receiving node shall take different actions depending on the value of the Criticality Information. The three possible values of the Criticality Information for an IE/IE group are:

1. Reject IE;
2. Ignore IE and Notify Sender;
3. Ignore IE.

The following rules restrict when a receiving entity may consider an IE, an IE group or an EP not comprehended (not implemented), and when action based on criticality information is applicable:

1. IE or IE group: When one new or modified IE or IE group is implemented for one EP from a standard version, then other new or modified IEs or IE groups specified for that EP in that standard version shall be considered comprehended by a receiving entity (some may still remain unsupported).

Note that this restriction is not applicable to a sending entity for constructing messages.

2. EP: The comprehension of different EPs within a standard version or between different standard versions is not mandated. Any EP that is not supported may be considered not comprehended, even if another EP from that standard version is comprehended, and action based on criticality shall be applied.

10.3.3 Presence Information

For many IEs/IE groups which are optional according to the ASN.1 transfer syntax, RNSAP specifies separately if the presence of these IEs/IE groups is optional or mandatory with respect to RNS application by means of the presence field of the concerned object of class RNSAP-PROTOCOL-IES, RNSAP-PROTOCOL-IES-PAIR, RNSAP-PROTOCOL-EXTENSION or RNSAP-PRIVATE-IES.

The presence field of the indicated classes supports three values:

1. Optional;
2. Conditional;
3. Mandatory.

If an IE/IE group is not included in a received message and the presence of the IE/IE group is mandatory or the presence is conditional and the condition is true according to the version of the specification used by the receiver, an abstract syntax error occurs due to a missing IE/IE group.

If an IE/IE group is included in a received message and the presence of the IE/IE group is conditional and the condition is false according to the version of the specification used by the receiver, an abstract syntax error occurs due to this erroneously present conditional IE/IE group.

10.3.4 Not Comprehended IE/IE Group

10.3.4.1 Procedure ID

The receiving node shall treat the different types of received criticality information of the *Procedure ID* according to the following:

Reject IE:

- If a message is received with a *Procedure ID* marked with "*Reject IE*" which the receiving node does not comprehend, the receiving node shall reject the procedure using the Error Indication procedure.

Ignore IE and Notify Sender:

- If a message is received with a *Procedure ID* marked with "*Ignore IE and Notify Sender*" which the receiving node does not comprehend, the receiving node shall ignore the procedure and initiate the Error Indication procedure.

Ignore IE:

- If a message is received with a *Procedure ID* marked with "*Ignore IE*" which the receiving node does not comprehend, the receiving node shall ignore the procedure.

When using the Error Indication procedure to reject a procedure or to report an ignored procedure it shall include the *Procedure ID IE*, the *Triggering Message IE*, and the *Procedure Criticality IE* in the *Criticality Diagnostics IE*.

10.3.4.1A Type of Message

When the receiving node cannot decode the *Type of Message IE*, the Error Indication procedure shall be initiated with an appropriate cause value.

10.3.4.2 IEs other than the Procedure ID and Type of Message

The receiving node shall treat the different types of received criticality information of an IE/IE group other than the *Procedure ID* according to the following:

Reject IE:

- If a message *initiating* a procedure is received containing one or more IEs/IE groups marked with "*Reject IE*" which the receiving node does not comprehend; none of the functional requests of the message shall be executed. The receiving node shall reject the procedure and report the rejection of one or more IEs/IE groups using the message normally used to report unsuccessful outcome of the procedure. In case the information received in the initiating message was insufficient to determine a value for all IEs that are required to be present in the message used to report the unsuccessful outcome of the procedure, the receiving node shall instead terminate the procedure and initiate the Error Indication procedure.
- If a message *initiating* a procedure that does not have a message to report unsuccessful outcome is received containing one or more IEs/IE groups marked with "*Reject IE*" which the receiving node does not comprehend, the receiving node shall terminate the procedure and initiate the Error Indication procedure.
- If a *response* message is received containing one or more IEs/IE groups marked with "*Reject IE*", that the receiving node does not comprehend, the receiving node shall consider the procedure as unsuccessfully terminated and initiate local error handling.

Ignore IE and Notify Sender:

- If a message *initiating* a procedure is received containing one or more IEs/IE groups marked with "*Ignore IE and Notify Sender*" which the receiving node does not comprehend, the receiving node shall ignore the content of the not comprehended IEs/IE groups, continue with the procedure as if the not comprehended IEs/IE groups were not received (except for the reporting) using the understood IEs/IE groups, and report in the response message of the procedure that one or more IEs/IE groups have been ignored. In case the information received in the initiating message was insufficient to determine a value for all IEs that are required to be present in the response message, the receiving node shall instead terminate the procedure and initiate the Error Indication procedure.
- If a message *initiating* a procedure that does not have a message to report the outcome of the procedure is received containing one or more IEs/IE groups marked with "*Ignore IE and Notify Sender*" which the receiving node does not comprehend, the receiving node shall ignore the content of the not comprehended IEs/IE groups, continue with the procedure as if the not comprehended IEs/IE groups were not received (except for the reporting) using the understood IEs/IE groups, and initiate the Error Indication procedure to report that one or more IEs/IE groups have been ignored.
- If a *response* message is received containing one or more IEs/IE groups marked with "*Ignore IE and Notify Sender*" which the receiving node does not comprehend, the receiving node shall ignore the content of the not comprehended IEs/IE groups, continue with the procedure as if the not comprehended IEs/IE groups were not received (except for the reporting) using the understood IEs/IE groups and initiate the Error Indication procedure.

Ignore IE:

- If a message *initiating* a procedure is received containing one or more IEs/IE groups marked with "*Ignore IE*" which the receiving node does not comprehend, the receiving node shall ignore the content of the not comprehended IEs/IE groups and continue with the procedure as if the not comprehended IEs/IE groups were not received using the understood IEs/IE groups.
- If a *response* message is received containing one or more IEs/IE groups marked with "*Ignore IE*" which the receiving node does not comprehend, the receiving node shall ignore the content of the not comprehended IEs/IE

groups and continue with the procedure as if the not comprehended IEs/IE groups were not received using the understood IEs/IE groups.

When reporting not comprehended IEs/IE groups marked with "*Reject IE*" or "*Ignore IE and Notify Sender*" using a response message defined for the procedure, the *Information Element Criticality Diagnostics IE* shall be included in the *Criticality Diagnostics IE* for each reported IE/IE group. In the *Information Element Criticality Diagnostics IE* the *Repetition Number IE* shall be included and in addition, if the not comprehended IE/IE group is not at message hierarchy level 1 (top level; see annex C) also the *Message Structure IE* shall be included.

When reporting not comprehended IEs/IE groups marked with "*Reject IE*" or "*Ignore IE and Notify Sender*" using the Error Indication procedure, the *Procedure ID IE*, the *Triggering Message IE*, *Procedure Criticality IE*, the *Transaction ID IE*, and the *Information Element Criticality Diagnostics IE* shall be included in the *Criticality Diagnostics IE* for each reported IE/IE group. In the *Information Element Criticality Diagnostics IE* the *Repetition Number IE* shall be included and in addition, if the not comprehended IE/IE group is not at message hierarchy level 1 (top level; see annex C) also the *Message Structure IE* shall be included.

10.3.5 Missing IE or IE Group

The receiving node shall treat the missing IE/IE group according to the criticality information for the missing IE/IE group in the received message specified in the version of this specification used by the receiver:

Reject IE:

- If a received message *initiating* a procedure is missing one or more IEs/IE groups with specified criticality "*Reject IE*"; none of the functional requests of the message shall be executed. The receiving node shall reject the procedure and report the missing IEs/IE groups using the message normally used to report unsuccessful outcome of the procedure. In case the information received in the initiating message was insufficient to determine a value for all IEs that are required to be present in the message used to report the unsuccessful outcome of the procedure, the receiving node shall instead terminate the procedure and initiate the Error Indication procedure.
- If a received message *initiating* a procedure that does not have a message to report unsuccessful outcome is missing one or more IEs/IE groups with specified criticality "*Reject IE*", the receiving node shall terminate the procedure and initiate the Error Indication procedure.
- If a received *response* message is missing one or more IEs/IE groups with specified criticality "*Reject IE*", the receiving node shall consider the procedure as unsuccessfully terminated and initiate local error handling.

Ignore IE and Notify Sender:

- If a received message *initiating* a procedure is missing one or more IEs/IE groups with specified criticality "*Ignore IE and Notify Sender*", the receiving node shall ignore that those IEs are missing and continue with the procedure based on the other IEs/IE groups present in the message and report in the response message of the procedure that one or more IEs/IE groups were missing. In case the information received in the initiating message was insufficient to determine a value for all IEs that are required to be present in the response message, the receiving node shall instead terminate the procedure and initiate the Error Indication procedure.
- If a received message *initiating* a procedure that does not have a message to report the outcome of the procedure is missing one or more IEs/IE groups with specified criticality "*Ignore IE and Notify Sender*", the receiving node shall ignore that those IEs are missing and continue with the procedure based on the other IEs/IE groups present in the message and initiate the Error Indication procedure to report that one or more IEs/IE groups were missing.
- If a received *response* message is missing one or more IEs/IE groups with specified criticality "*Ignore IE and Notify Sender*", the receiving node shall ignore that those IEs are missing and continue with the procedure based on the other IEs/IE groups present in the message and initiate the Error Indication procedure to report that one or more IEs/IE groups were missing.

Ignore IE:

- If a received message *initiating* a procedure is missing one or more IEs/IE groups with specified criticality "*Ignore IE*", the receiving node shall ignore that those IEs are missing and continue with the procedure based on the other IEs/IE groups present in the message.

- If a received *response* message is missing one or more IEs/IE groups with specified criticality "*Ignore IE*", the receiving node shall ignore that those IEs/IE groups are missing and continue with the procedure based on the other IEs/IE groups present in the message.

When reporting missing IEs/IE groups with specified criticality "*Reject IE*" or "*Ignore IE and Notify Sender*" using a response message defined for the procedure, the *Information Element Criticality Diagnostics IE* shall be included in the *Criticality Diagnostics IE* for each reported IE/IE group. In the *Information Element Criticality Diagnostics IE* the *Repetition Number IE* shall be included and in addition, if the missing IE/IE group is not at message hierarchy level 1 (top level; see annex C) also the *Message Structure IE* shall be included.

When reporting missing IEs/IE groups with specified criticality "*Reject IE*" or "*Ignore IE and Notify Sender*" using the Error Indication procedure, the *Procedure ID IE*, the *Triggering Message IE*, *Procedure Criticality IE*, the *Transaction ID IE*, and the *Information Element Criticality Diagnostics IE* shall be included in the *Criticality Diagnostics IE* for each reported IE/IE group. In the *Information Element Criticality Diagnostics IE* the *Repetition Number IE* shall be included and in addition, if the missing IE/IE group is not at message hierarchy level 1 (top level; see annex C) also the *Message Structure IE* shall be included.

10.3.6 IEs or IE Groups Received In Wrong Order or With Too Many Occurrences or Erroneously Present

If a message with IEs or IE groups in wrong order or with too many occurrences is received or if IEs or IE groups with a conditional presence are present when the condition is not met (i.e. erroneously present), the receiving node shall behave according to the following:

- If a message *initiating* a procedure is received containing IEs or IE groups in wrong order or with too many occurrences or erroneously present, none of the functional requests of the message shall be executed. The receiving node shall reject the procedure and report the cause value "Abstract Syntax Error (Falsely Constructed Message)" using the message normally used to report unsuccessful outcome of the procedure. In case the information received in the initiating message was insufficient to determine a value for all IEs that are required to be present in the message used to report the unsuccessful outcome of the procedure, the receiving node shall instead terminate the procedure and initiate the Error Indication procedure.
- If a message *initiating* a procedure that does not have a message to report unsuccessful outcome is received containing IEs or IE groups in wrong order or with too many occurrences or erroneously present, the receiving node shall terminate the procedure and initiate the Error Indication procedure, and use cause value "Abstract Syntax Error (Falsely Constructed Message)".
- If a *response* message is received containing IEs or IE groups in wrong order or with too many occurrences or erroneously present, the receiving node consider the procedure as unsuccessfully terminated and initiate local error handling.

When determining the correct order only the IEs specified in the specification version used by the receiver shall be considered.

10.4 Logical Error

Logical error situations occur when a message is comprehended correctly, but the information contained within the message is not valid (i.e. semantic error), or describes a procedure which is not compatible with the state of the receiver. In these conditions, the following behaviour shall be performed (unless otherwise specified) as defined by the class of the elementary procedure, irrespective of the criticality information of the IEs/IE groups containing the erroneous values.

Class 1:

Where the logical error occurs in a request message of a class 1 procedure, and the procedure has a message to report this unsuccessful outcome, this message shall be sent with an appropriate cause value. Typical cause values are:

Protocol Causes:

1. Semantic Error;
2. Message not Compatible with Receiver State.

Where the logical error is contained in a request message of a class 1 procedure, and the procedure does not have a message to report this unsuccessful outcome, the procedure shall be terminated and the Error Indication procedure shall be initiated with an appropriate cause value. The *Procedure ID* IE, the *Triggering Message* IE and the *Transaction ID* IE within the *Criticality Diagnostics* IE shall then be included in order to identify the message containing the logical error.

Where the logical error exists in a response message of a class 1 procedure, the procedure shall be considered as unsuccessfully terminated and local error handling shall be initiated.

Class 2:

Where the logical error occurs in a message of a class 2 procedure, the procedure shall be terminated and the Error Indication procedure shall be initiated with an appropriate cause value. The *Procedure ID* IE, the *Triggering Message* IE and the *Transaction ID* IE within the *Criticality Diagnostics* IE shall then be included in order to identify the message containing the logical error.

10.5 Exceptions

The error handling for all the cases described hereafter shall take precedence over any other error handling described in the other subclauses of clause 10.

- If any type of error (Transfer Syntax Error, Abstract Syntax Error or Logical Error) is detected in the ERROR INDICATION message, it shall not trigger the Error Indication procedure in the receiving Node but local error handling.
- In case a response message or ERROR INDICATION message needs to be returned, but the information necessary to determine the receiver of that message is missing, the procedure shall be considered as unsuccessfully terminated and local error handling shall be initiated.
- If an error that terminates a procedure occurs, the returned cause value shall reflect the error that caused the termination of the procedure even if one or more abstract syntax errors with criticality 'ignore and notify' have earlier occurred within the same procedure.

Annex A (normative): Allocation and Pre-emption of Radio Links in the DRNS

A.1 Deriving Allocation Information for a Radio Link

A.1.1 Establishment of a New Radio Link

The Allocation Information for a Radio Link in the case of establishment of a new Radio Link shall be derived as follows:

- The latest received *Allocation/Retention Priority* IE for each transport channel shall be used.

Note: The *Allocation/Retention Priority* IE for a transport channel may have been received in

- a) the procedure that establishes the first Radio Link for the UE in the DRNS or
- b) a procedure adding or modifying the transport channel.

- If the *Priority Level* IE in the *Allocation/Retention Priority* IE for all transport channels that are intended to use the Radio Link is set to "no priority", the pre-emption capability of the Radio Link shall be set to "shall not trigger pre-emption".
- If the *Priority Level* IE in the *Allocation/Retention Priority* IE for one or more of the transport channels that are intended to use the Radio Link is not set to "no priority", the allocation priority and the pre-emption capability of the Radio Link shall be set according to the following:
 - The transport channels that have the *Priority Level* IE in the *Allocation/Retention Priority* IE set to "no priority" shall be excluded when setting the allocation priority and pre-emption capability of a Radio Link.
 - The allocation priority for a Radio Link shall be set to highest priority level, given by the *Priority Level* IE in the *Allocation/Retention Priority* IE, for all non excluded transport channels that are intended to use the Radio Link.
 - If all non-excluded transport channels that are intended to use a Radio Link to be established have the pre-emption capability, given by the *Pre-emption Capability* IE in the *Allocation/Retention Priority* IE, set to "shall not trigger pre-emption", the pre-emption capability of the Radio Link shall be set to "shall not trigger pre-emption".
If one or more non-excluded transport channels that are intended to use the Radio Link to be established have the value of the *Pre-emption Capability* IE in the *Allocation/Retention Priority* IE set to "may trigger pre-emption", the pre-emption capability of the Radio Link shall be set to "may trigger pre-emption".

The derived allocation priority and pre-emption capability are only valid during this allocation/retention process.

A.1.2 Modification of an Existing Radio Link

The Allocation Information for a Radio Link in the case of modification of a Radio Link (addition or modification of transport channels using the Radio Link) shall be derived as follows:

- The latest received *Allocation/Retention Priority* IE for each transport channel shall be used.

Note: The *Allocation/Retention Priority* IE for a transport channel may have been received in

- a) the procedure that establishes the first Radio Link for the UE in the DRNS,
- b) a previous procedure adding or modifying the transport channel, or
- c) the current procedure adding or modifying the transport channel.

- If the *Priority Level* IE in the *Allocation/Retention Priority* IE for all transport channels to be added or modified in the Radio Link is set to "no priority", the pre-emption capability of the Radio Link to be modified shall be set to "shall not trigger pre-emption".

- If the *Priority Level* IE in the *Allocation/Retention Priority* IE for one or more of the transport channels to be added or modified in the Radio Link is not set to "no priority", the allocation priority of and the pre-emption capability of the Radio Link to be modified shall be set according to the following:
 - The transport channels to be added or modified that have the *Priority Level* IE in the *Allocation/Retention Priority* IE set to "no priority" shall be excluded when setting the allocation priority and pre-emption capability of a Radio Link to be modified.
 - The allocation priority for a Radio Link to be modified shall be set to highest priority level, given by the *Priority Level* IE in the *Allocation/Retention Priority* IE, for all the non-excluded transport channels that are to be added or modified.
 - If all non-excluded transport channels that are to be added or modified in the Radio Link have the pre-emption capability, given by the *Pre-emption Capability* IE in the *Allocation/Retention Priority* IE, set to "shall not trigger pre-emption", the pre-emption capability of the Radio Link to be modified shall be set to "shall not trigger pre-emption".
If one or more of the non-excluded transport channels to be added or modified in the Radio Link have the value of the *Pre-emption Capability* IE in the *Allocation/Retention Priority* IE set to "may trigger pre-emption", the pre-emption capability of the Radio Link to be modified shall be set to "may trigger pre-emption".

The derived allocation priority and pre-emption capability are only valid during this allocation/retention process.

A.2 Deriving Retention Information for a Radio Link

The Retention Information for an existing Radio Link shall be derived as follows:

- The latest received *Allocation/Retention Priority* IE for each transport channel shall be used.
- Note: The *Allocation/Retention Priority* IE for a transport channel may have been received in
- a) the procedure that establishes the first Radio Link for the UE in the DRNS or
 - b) a procedure adding or modifying the transport channel.
- If the *Priority Level* IE in the *Allocation/Retention Priority* IE for one or more transport channels using the Radio Link is set to "no priority", the pre-emption vulnerability of the Radio Link shall be set to "not pre-emptable".
 - If the *Priority Level* IE in the *Allocation/Retention Priority* IE for all the transport channels using the Radio Link is not set to "no priority", the retention priority of the Radio Link and the pre-emption vulnerability of the Radio Link shall be set according to the following:
 - The retention priority for a Radio Link shall be set to highest priority level, given by the *Priority Level* IE in the *Allocation/Retention Priority* IE, for all transport channels that uses the Radio Link.
 - If all transport channels that uses the Radio Link have the pre-emption vulnerability, given by the *Pre-emption Vulnerability* IE in the *Allocation/Retention Priority* IE, set to "pre-emptable", the pre-emption vulnerability of the Radio Link shall be set to "pre-emptable".
If one or more transport channels that uses the Radio Link have the value of the *Pre-emption Vulnerability* IE in the *Allocation/Retention Priority* IE set to "not pre-emptable", the pre-emption vulnerability of the Radio Link shall be set to "not pre-emptable".

The derived retention priority and pre-emption vulnerability are valid until they are changed, or until the Radio Link is deleted. When new transport channels are added to or deleted from the Radio Link or when existing transport channels are modified with regards to the *Allocation/Retention Priority* IE, the retention information shall be derived again according to above.

A.3 The Allocation/Retention Process

The DRNS shall establish or modify the resources for a Radio Link according to:

- The value of the Allocation Information (allocation priority and pre-emption capability) of the Radio to be established or modified. The Allocation Information is derived according to clause A.1.
- The value of the Retention Information (retention priority and pre-emption vulnerability) of existing Radio Links. The Retention Information derived according to clause A.2.
- The resource situation in the DRNS.

Whilst the process and the extent of the pre-emption functionality is operator dependent, the pre-emption indicators (pre-emption capability and pre-emption vulnerability) shall be treated as follows:

- If the pre-emption capability for a Radio Link to be established or modified is set to "may trigger pre-emption" and the resource situation so requires, the DRNS may trigger the pre-emption process in clause A.4 to free resources for this allocation request.
- If the pre-emption capability for a Radio Link to be established or modified is set to "shall not trigger pre-emption", then this allocation request shall not trigger the pre-emption process in clause A.4.
- If the pre-emption vulnerability for an existing Radio Link is set to "pre-emptable", then this Radio Link shall be included in the pre-emption process in clause A.4.
- If the pre-emption vulnerability for an existing Radio Link is set to "not pre-emptable", then this Radio Link shall not be included in the pre-emption process in clause A.4.

A.4 The Pre-emption Process

The pre-emption process shall only pre-empt Radio Links with lower retention priority than the allocation priority of the Radio Link to be established or modified. The Radio Links to be pre-empted shall be selected in ascending order of the retention priority.

When the pre-emption process detects that one or more Radio Links have to be pre-empted to free resources for a Radio Link(s) to be established or modified, the DRNS shall initiate the Radio Link Pre-emption procedure for all the UE Contexts having Radio Links selected for pre-emption and start the T_{Preempt} timer.

When enough resources are freed to establish or modify the Radio Link(s) according to the request, the DRNS shall stop the T_{Preempt} timer and complete the procedure that triggered the pre-emption process in accordance with the "Successful Operation" subclause of the procedure.

If the T_{Preempt} timer expires, the DRNS shall reject the procedure that triggered the pre-emption process and complete the procedure in accordance with the "Unsuccessful Operation" subclause of the procedure.

Annex B (informative): Measurement Reporting

When the *Report Characteristics* IE is set to "Event A" (figure B.1), the Measurement Reporting procedure is initiated when the measured entity rises above the requested threshold and stays there for the requested hysteresis time. If no hysteresis time is given, the value zero shall be used for the hysteresis time.

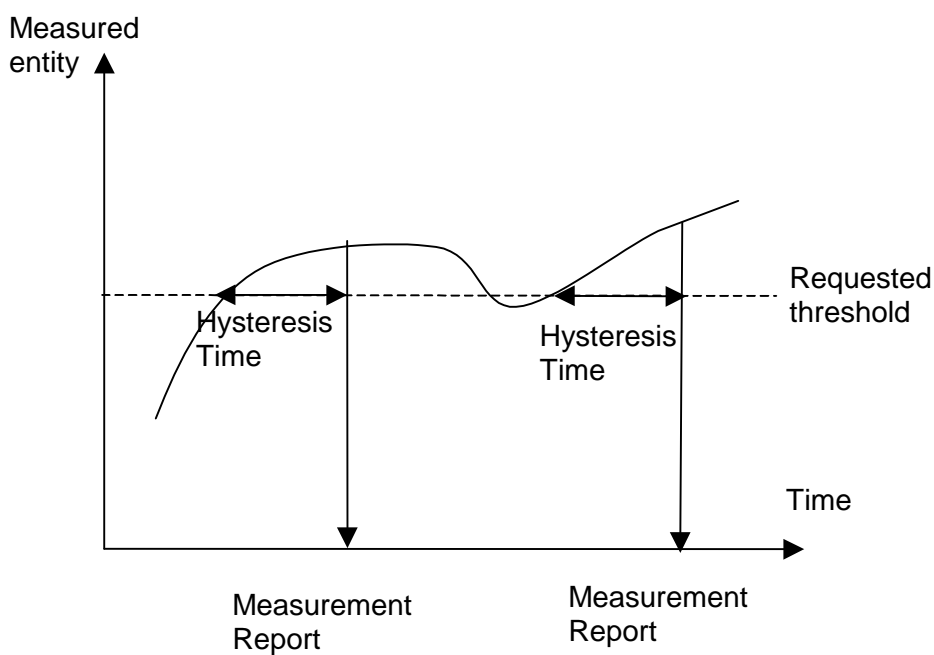

Figure B.1: Event A reporting with Hysteresis Time specified

When the *Report Characteristics* IE is set to "Event B" (figure B.2), the Measurement Reporting procedure is initiated when the measured entity falls below the requested threshold and stays there for the requested hysteresis time. If no hysteresis time is given, the value zero shall be used for the hysteresis time.

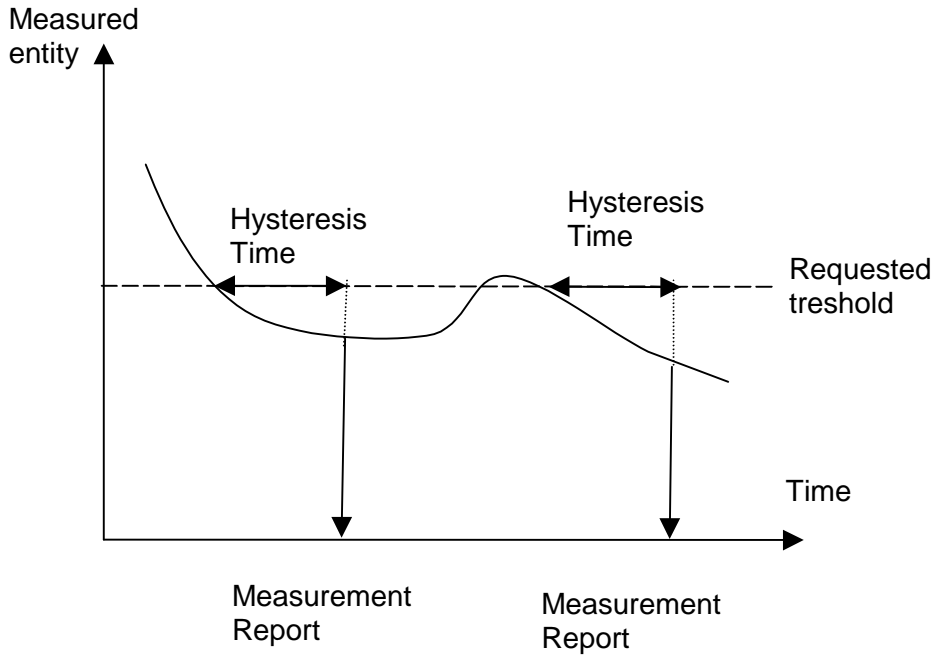

Figure B.2: Event B reporting with Hysteresis Time specified

When the *Report Characteristics* IE is set to "Event C" (figure B.3), the Measurement Reporting procedure is initiated always when the measured entity rises by an amount greater than the requested threshold within the requested time. The reporting in figure B.3 is initiated if the Rising Time T1 is less than the requested time.

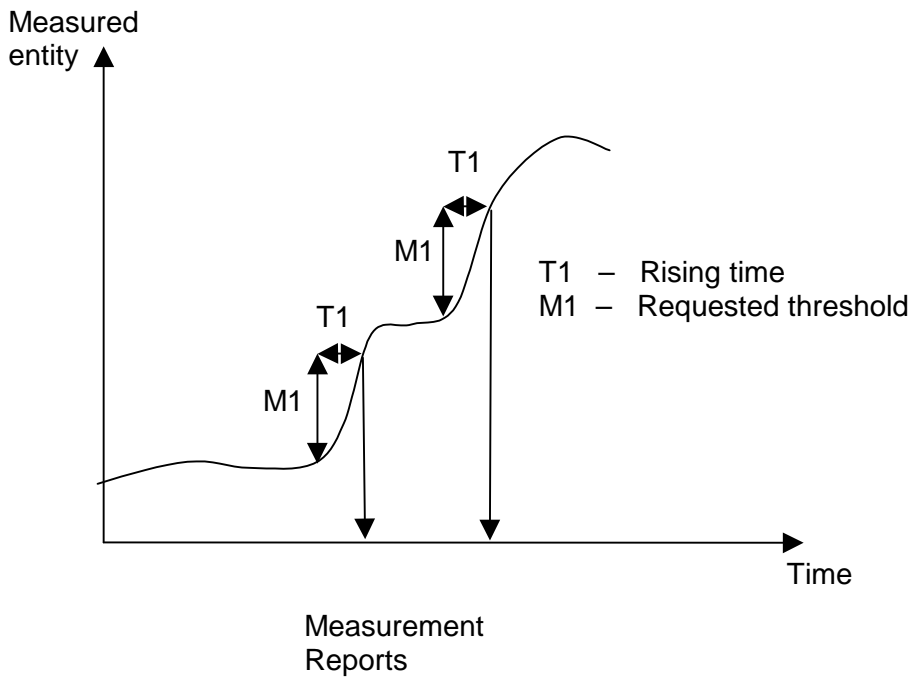

Figure B.3: Event C reporting

When the *Report Characteristics* IE is set to "Event D" (figure B.4), the Measurement Reporting procedure is initiated always when the measured entity falls by an amount greater than the requested threshold within the requested time. The reporting in figureB.4 is initiated if the Falling Time T1 is less than the requested time.

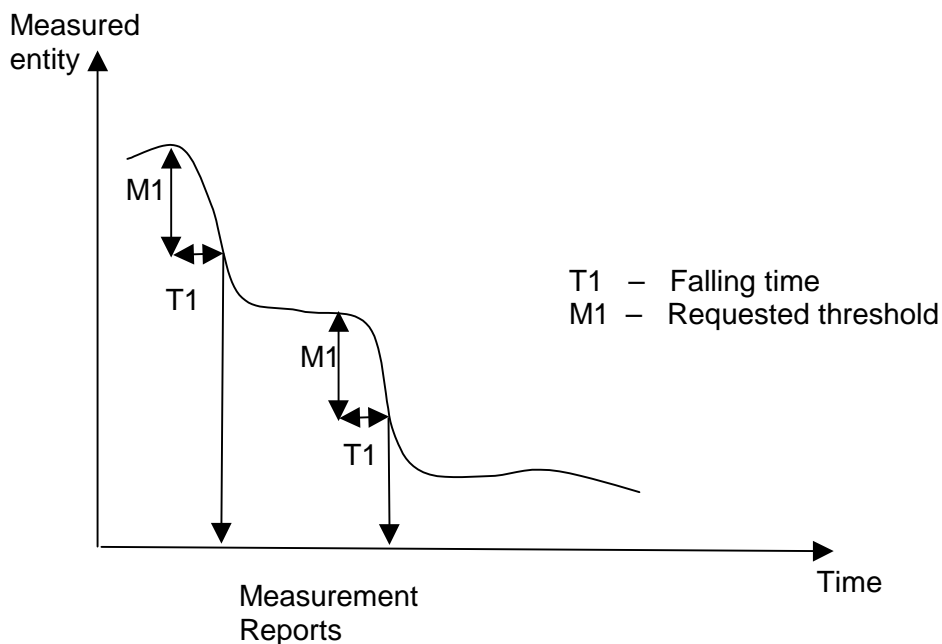

Figure B.4: Event D reporting

When the *Report Characteristics* IE is set to "Event E" (figure B.5), the Measurement Reporting procedure (Report A) is initiated always when the measured entity rises above the "Measurement Threshold 1" and stays there for the "Measurement Hysteresis Time" (T1 in figure B.5). If *Report Periodicity* IE is provided DRNS shall also initiate Measurement Reporting procedure periodically. The periodic reporting continues although the measured entity falls below the "Measurement Threshold 1" and is terminated by the Report B.

When the Report A conditions have been met and the measured entity falls below the "Measurement Threshold 2" and stays there for the "Measurement Hysteresis Time" (T1) the Measurement Reporting procedure (Report B) is initiated and the periodic reporting is terminated.

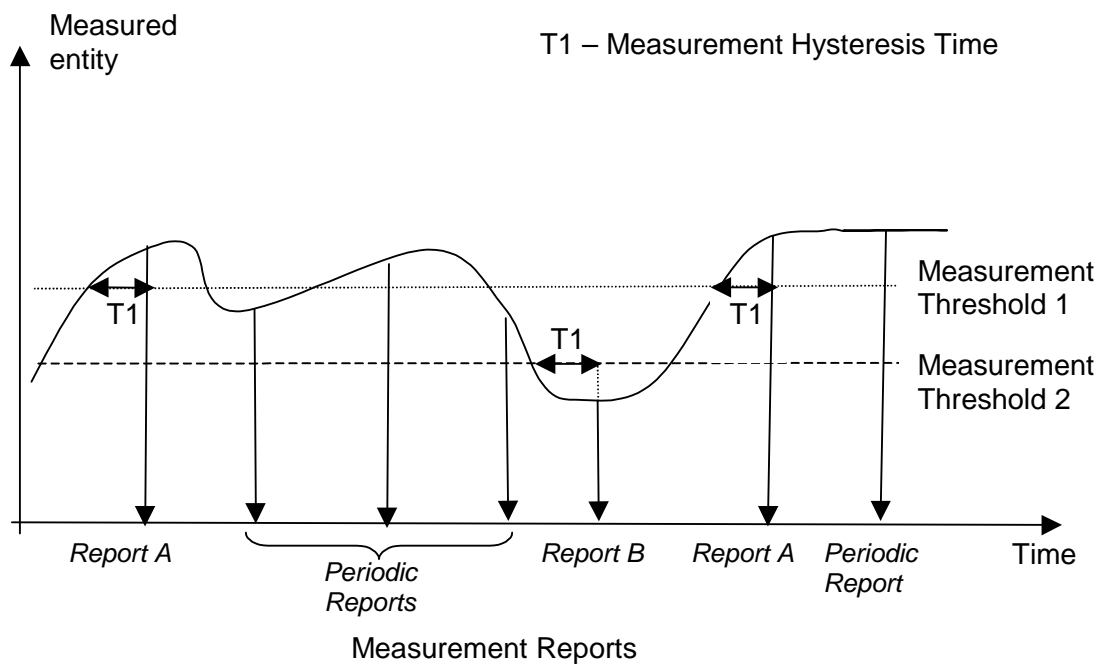

Figure B.5: Event E reporting with Hysteresis Time specified and Periodic Reporting requested

When the *Report Characteristics* IE is set to "Event F" (figure B.6), the Measurement Reporting procedure (Report A) is initiated always when the measured entity falls below the "Measurement Threshold 1" and stays there for the "Measurement Hysteresis Time" (T1 in figure B.6). If *Report Periodicity* IE is provided DRNS shall also initiate Measurement Reporting procedure periodically. The periodic reporting continues although the measured entity rises above the "Measurement Threshold 1" and is terminated by the Report B.

When the Report A conditions have been met and the measured entity rises above the "Measurement Threshold 2" and stays there for the "Measurement Hysteresis Time" (T1) Measurement Reporting procedure (Report B) is initiated and the periodic reporting is terminated.

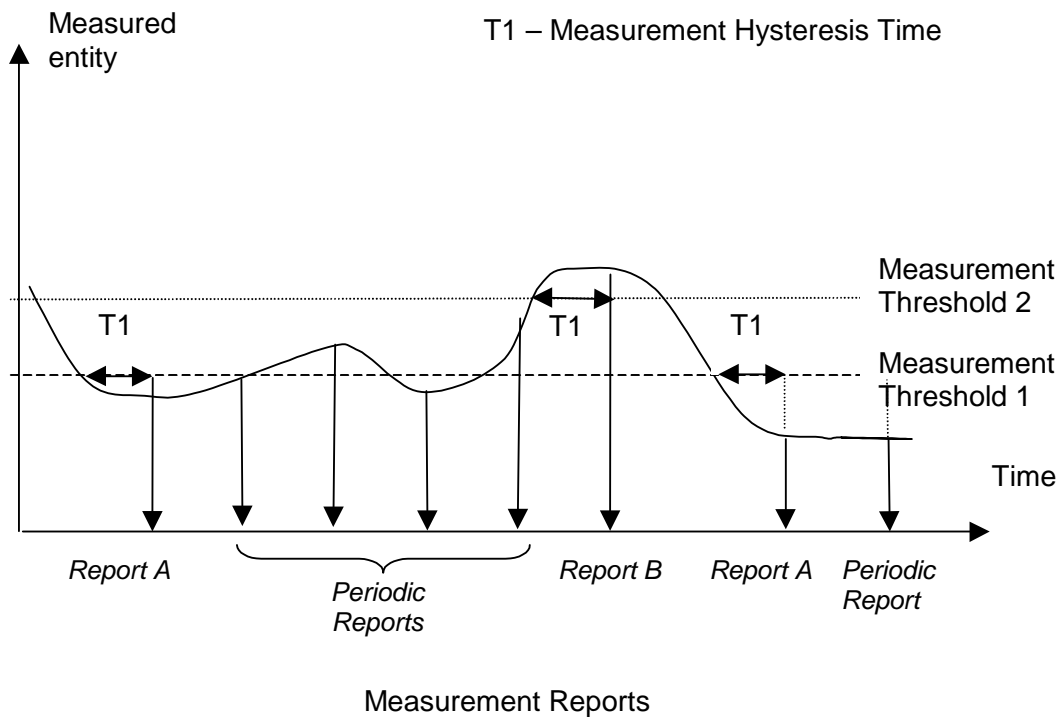

Figure B.6: Event F reporting with Hysteresis Time specified and Periodic Reporting requested

Annex C (informative): Guidelines for Usage of the Criticality Diagnostics IE

C.1 EXAMPLE MESSAGE Layout

Assume the following message format:

IE/Group Name	Presence	Range	IE Type and Reference	Semantics Description	Criticality	Assigned Criticality
Message Type	M				YES	reject
Transaction ID	M				-	
A	M				YES	reject
B	M				YES	reject
>E		1..<maxE>			EACH	ignore
>>F		1..<maxF>			-	
>>>G		0..3, ...			EACH	ignore
>>H		1..<maxH>			EACH	ignore
>>>G		0..3, ...			EACH	ignore and notify
>>G	M				YES	reject
>>J		1..<maxJ>			-	
>>>G		0..3, ...			EACH	reject
C	M				YES	reject
>K		1..<maxK>			EACH	ignore and notify
>>L		1..<maxL>			-	
>>>M	O				-	
D	M				YES	reject

Note 1. The IEs F, J, and L do not have assigned criticality. The IEs F, J, and L are consequently realised as the ASN.1 type SEQUENCE OF of "ordinary" ASN.1 type, e.g. INTEGER. On the other hand, the repeatable IEs with assigned criticality are realised as the ASN.1 type SEQUENCE OF of an IE object, e.g. Protocol IE-Single-Container.

For the corresponding ASN.1 layout, see subclause C.4.

C.2 Example on a Received EXAMPLE MESSAGE

Assume further more that a received message based on the above tabular format is according to the figure below.

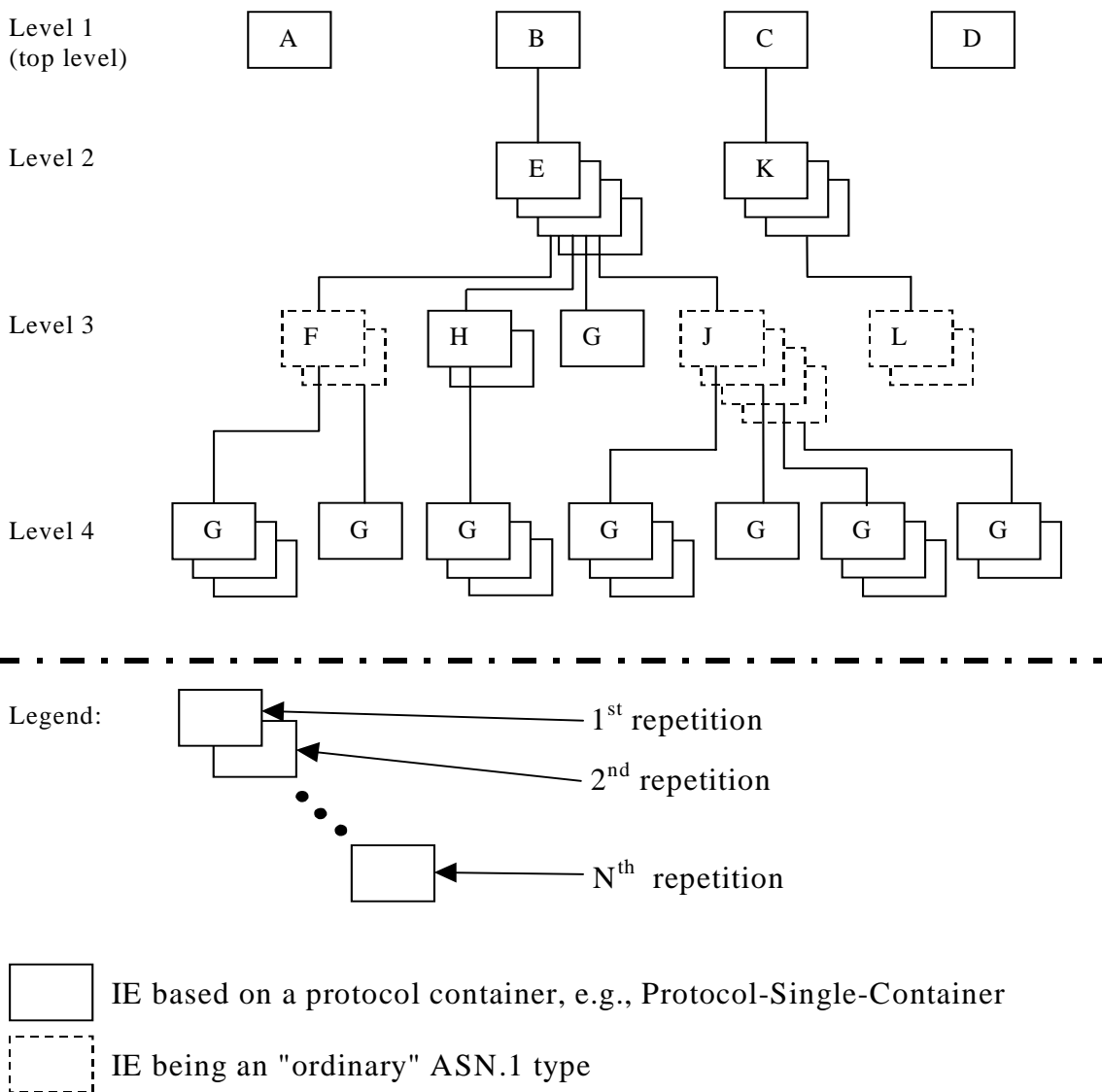
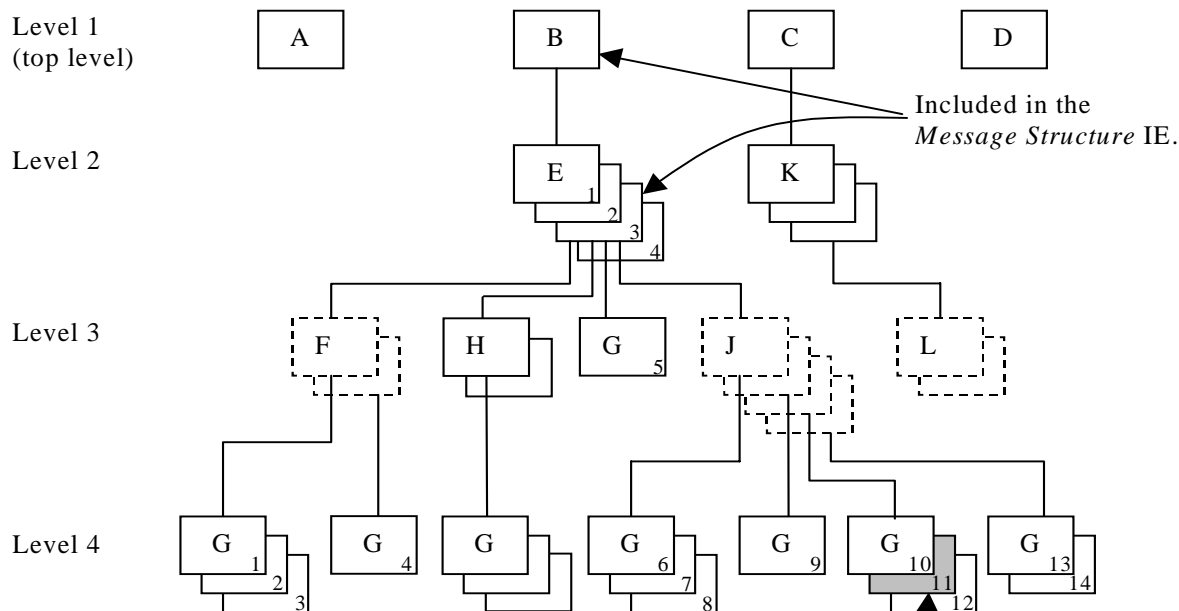

Figure C.1: Example of content of a received RNSAP message based on the EXAMPLE MESSAGE

C.3 Content of Criticality Diagnostics

C.3.1 Example 1



Included in the *Information Element Criticality Diagnostics* IE:

- a) *IE ID* IE
- b) *Repetition Number* IE

Figure C.2: Example of a received RNSAP message containing a not comprehended IE

If there is an error within the instance marked as grey in the IE G in the IE J shown in the figure C.2 above, this will be reported within the *Information Element Criticality Diagnostics* IE within the *Criticality Diagnostics* IE as follows:

IE name	Value	Comment
IE Criticality	reject	Criticality for IE on the reported level, i.e. level 4.
IE ID	id-G	IE ID from the reported level, i.e. level 4.
Repetition Number	11	Repetition number on the reported level, i.e. level 4. (Since the IE E (level 2) is the lowest level included in the <i>Message Structure</i> IE this is the eleventh occurrence of IE G within the IE E (level 2).)
Type of Error	not understood	
<i>Message Structure, first repetition</i>		
>IE ID	id-B	IE ID from level 1.
<i>Message Structure, second repetition</i>		
>IE ID	id-E	IE ID from the lowest level above the reported level, i.e. level 2.
>Repetition Number	3	Repetition number from the lowest level above the reported level, i.e. level 2.

- Note 2. The IE J on level 3 cannot be included in the *Message Structure* IE since they have no criticality of their own.
- Note 3. The repetition number of the reported IE indicates the number of repetitions of IE G received up to the detected erroneous repetition, counting all occurrences of the IE G below the same instance of the previous level with assigned criticality (instance 3 of IE E on level 2).

C.3.2 Example 2

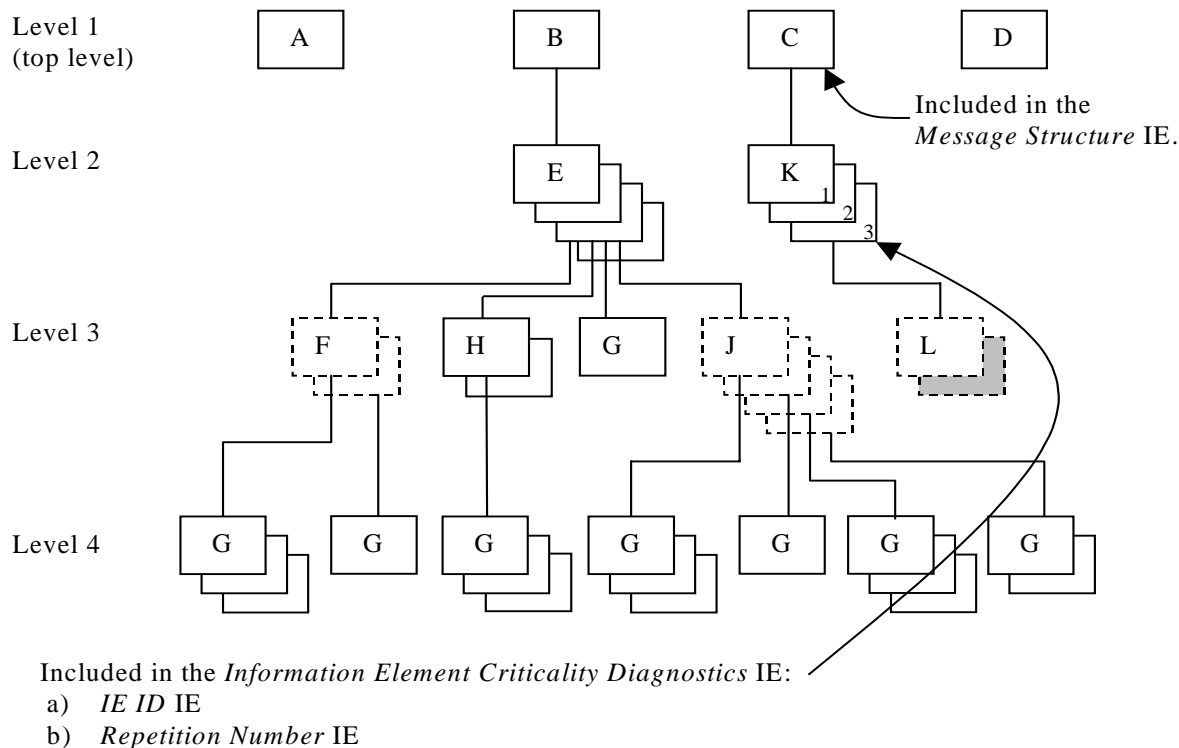

Figure C.3: Example of a received RNSAP message containing a not comprehended IE

If there is an error within the second instance (marked as grey) in the sequence (IE L in the tabular format) on level 3 below IE K in the structure shown in the figure C.3 above, this will be reported within the *Information Element Criticality Diagnostics* IE within the *Criticality Diagnostics* IE as follows:

IE name	Value	Comment
IE Criticality	ignore and notify	Criticality for IE on the reported level, i.e. level 2.
IE ID	id-K	IE ID from the reported level, i.e. level 2.
Repetition Number	3	Repetition number on the reported level, i.e. level 2.
Type of Error	not understood	
<i>Message Structure, first repetition</i>		
>IE ID	id-C	IE ID from the lowest level above the reported level, i.e. level 1.

Note 4. The IE L on level 3 cannot be reported individually included in the *Message Structure* IE since it has no criticality of its own.

C.3.3 Example 3

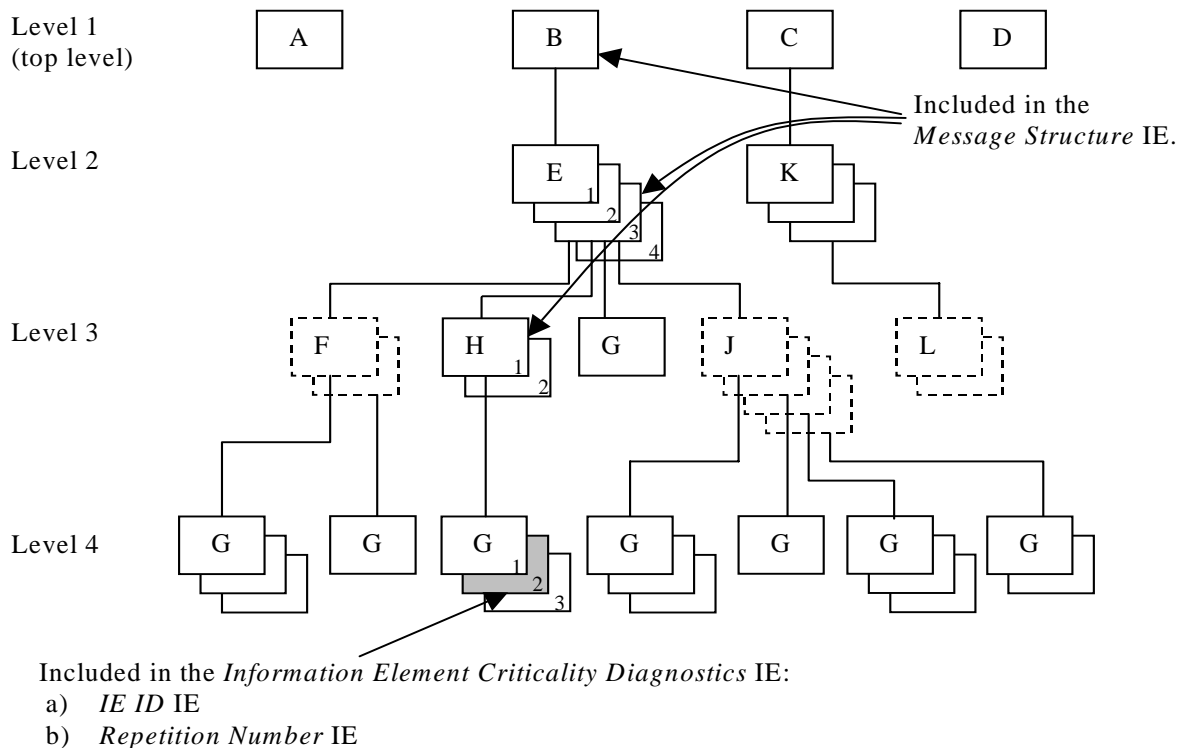

Figure C.4: Example of a received RNSAP message containing a not comprehended IE

If there is an error within the instance marked as grey in the IE G in the IE H shown in the figure C.4 above, this will be reported within the *Information Element Criticality Diagnostics* IE within the *Criticality Diagnostics* IE as follows:

IE name	Value	Comment
IE Criticality	ignore and notify	Criticality for IE on the reported level, i.e. level 4.
IE ID	id-G	IE ID from the reported level, i.e. level 4.
Repetition Number	2	Repetition number on the reported level, i.e. level 4.
Type of Error	not understood	
<i>Message Structure, first repetition</i>		
>IE ID	id-B	IE ID from level 1.
<i>Message Structure, second repetition</i>		
>IE ID	id-E	IE ID from level 2.
>Repetition Number	3	Repetition number from level 2.
<i>Message Structure, third repetition</i>		
>IE ID	id-H	IE ID from the lowest level above the reported level, i.e. level 3.
>Repetition Number	1	Repetition number from the lowest level above the reported level, i.e. level 3.

Note 5. The repetition number of level 4 indicates the number of repetitions of IE G received up to the detected erroneous repetition, counted below the same instance of the previous level with assigned criticality (instance 1 of IE H on level 3).

C.3.4 Example 4

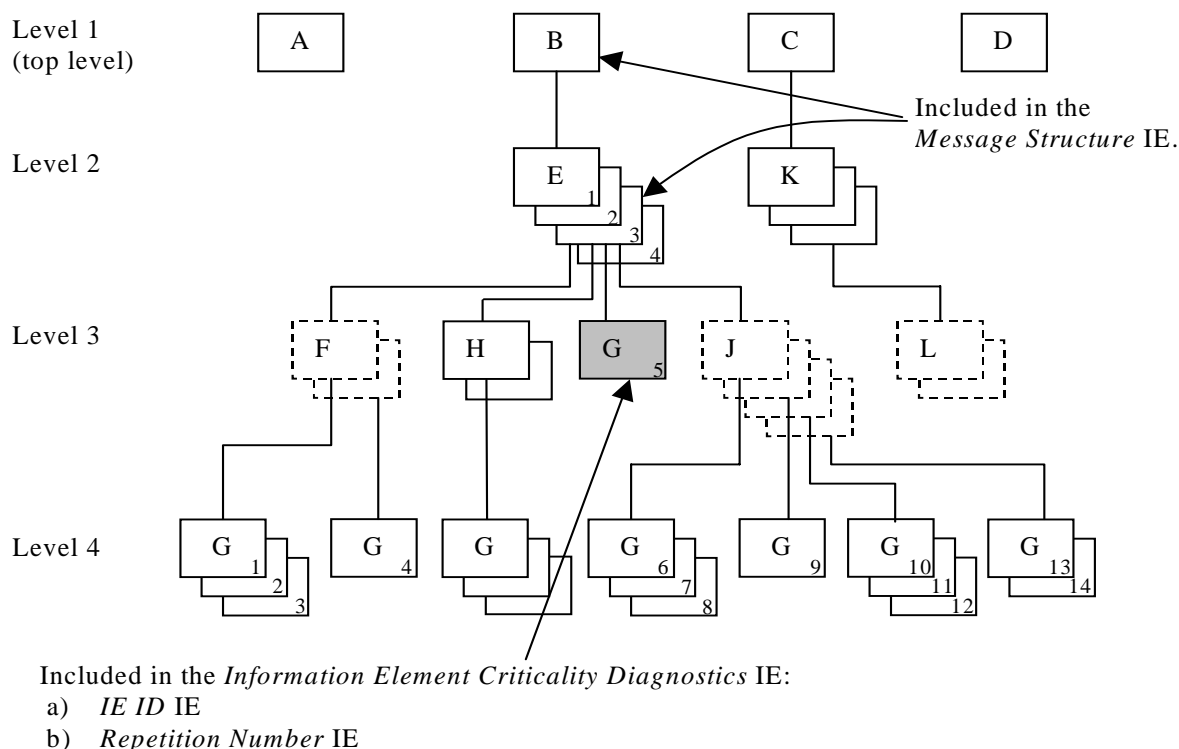

Figure C.5: Example of a received RNSAP message containing a not comprehended IE

If there is an error within the instance marked as grey in the IE G in the IE E shown in the figure C.5 above, this will be reported within the *Information Element Criticality Diagnostics* IE within the *Criticality Diagnostics* IE as follows:

IE name	Value	Comment
IE Criticality	reject	Criticality for IE on the reported level, i.e. level 3.
IE ID	id-G	IE ID from the reported level, i.e. level 3.
Repetition Number	5	Repetition number on the reported level, i.e. level 3. (Since the IE E (level 2) is the lowest level included in the <i>Message Structure</i> IE this is the fifth occurrence of IE G within the IE E (level 2)).
Type of Error	not understood	
<i>Message Structure, first repetition</i>		
>IE ID	id-B	IE ID from level 1.
<i>Message Structure, second repetition</i>		
>IE ID	id-E	IE ID from the lowest level above the reported level, i.e. level 2.
>Repetition Number	3	Repetition number from the lowest level above the reported level, i.e. level 2.

Note 6. The repetition number of the reported IE indicates the number of repetitions of IE G received up to the detected erroneous repetition, counting all occurrences of the IE G below the same instance of the previous level with assigned criticality (instance 3 of IE E on level 2).

C.3.5 Example 5

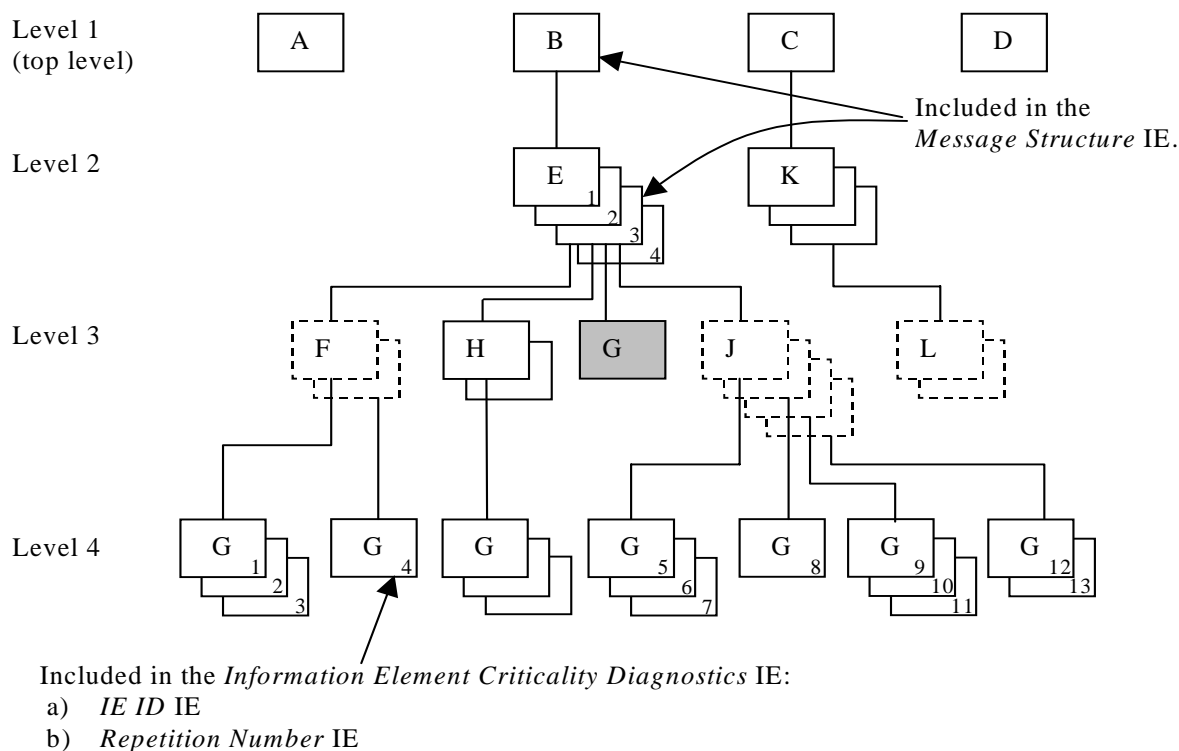

Figure C.6: Example of a received RNSAP message with a missing IE

If the instance marked as grey in the IE G in the IE E shown in the figure C.6 above, is missing this will be reported within the *Information Element Criticality Diagnostics* IE within the *Criticality Diagnostics* IE as follows:

IE name	Value	Comment
IE Criticality	reject	Criticality for IE on the reported level, i.e. level 3.
IE ID	id-G	IE ID from the reported level, i.e. level 3.
Repetition Number	4	Repetition number up to the missing IE on the reported level, i.e. level 3. (Since the IE E (level 2) is the lowest level included in the <i>Message Structure</i> IE there have been four occurrences of IE G within the IE E (level 2) up to the missing occurrence.
Type of Error	missing	
<i>Message Structure, first repetition</i>		
>IE ID	id-B	IE ID from level 1.
<i>Message Structure, second repetition</i>		
>IE ID	id-E	IE ID from the lowest level above the reported level, i.e. level 2.
>Repetition Number	3	Repetition number from the lowest level above the reported level, i.e. level 2.

Note 7. The repetition number of the reported IE indicates the number of repetitions of IE G received up to but not including the missing occurrence, counting all occurrences of the IE G below the same instance of the previous level with assigned criticality (instance 3 of IE E on level 2).

C.4 ASN.1 of EXAMPLE MESSAGE

```

ExampleMessage ::= SEQUENCE {
    ProtocolIEs          ProtocolIE-Container          {{ExampleMessage-IEs}},
    ProtocolExtensions  ProtocolExtensionContainer  {{ExampleMessage-Extensions}}  OPTIONAL,
    ...
}

ExampleMessage-IEs RNSAP-PROTOCOL-IES ::= {
    { ID id-A    CRITICALITY reject  TYPE A  PRESENCE mandatory } |
    { ID id-B    CRITICALITY reject  TYPE B  PRESENCE mandatory } |
    { ID id-C    CRITICALITY reject  TYPE C  PRESENCE mandatory } |
    { ID id-D    CRITICALITY reject  TYPE D  PRESENCE mandatory } ,
    ...
}

B ::= SEQUENCE {
    e                E-List,
    iE-Extensions   ProtocolExtensionContainer { {B-ExtIEs} }  OPTIONAL,
    ...
}

B-ExtIEs RNSAP-PROTOCOL-EXTENSION ::= {
    ...
}

E-List ::= SEQUENCE (SIZE (1..maxE)) OF ProtocolIE-Single-Container { {E-IEs} }

E-IEs RNSAP-PROTOCOL-IES ::= {
    { ID id-E    CRITICALITY ignore  TYPE E  PRESENCE mandatory }
}

E ::= SEQUENCE {
    f                F-List,
    h                H-List,
    g                G-List1,
    j                J-List,
    iE-Extensions   ProtocolExtensionContainer { {E-ExtIEs} }  OPTIONAL,
    ...
}

E-ExtIEs RNSAP-PROTOCOL-EXTENSION ::= {
    ...
}

F-List ::= SEQUENCE (SIZE (1..maxF)) OF F

F ::= SEQUENCE {
    g                G-List2 OPTIONAL,
    iE-Extensions   ProtocolExtensionContainer { {F-ExtIEs} }  OPTIONAL,
    ...
}

F-ExtIEs RNSAP-PROTOCOL-EXTENSION ::= {
    ...
}

G-List2 ::= SEQUENCE (SIZE (1..3, ...)) OF ProtocolIE-Single-Container { {G2-IEs} }

G2-IEs RNSAP-PROTOCOL-IES ::= {
    { ID id-G    CRITICALITY ignore  TYPE G  PRESENCE mandatory }
}

H-List ::= SEQUENCE (SIZE (1..maxH)) OF ProtocolIE-Single-Container { {H-IEs} }

H-IEs RNSAP-PROTOCOL-IES ::= {
    { ID id-H    CRITICALITY ignore  TYPE H  PRESENCE mandatory }
}

H ::= SEQUENCE {
    g                G-List3 OPTIONAL,
    iE-Extensions   ProtocolExtensionContainer { {H-ExtIEs} }  OPTIONAL,
    ...
}

H-ExtIEs RNSAP-PROTOCOL-EXTENSION ::= {

```

```

    ...
}
G-List3 ::= SEQUENCE (SIZE (1..3, ...)) OF ProtocolIE-Single-Container { {G3-IEs} }
G3-IEs RNSAP-PROTOCOL-IES ::= {
    { ID id-G    CRITICALITY notify  TYPE G  PRESENCE mandatory }
}
G-List1 ::= ProtocolIE-Single-Container { {G1-IEs} }
G1-IEs RNSAP-PROTOCOL-IES ::= {
    { ID id-G    CRITICALITY reject  TYPE G  PRESENCE mandatory }
}
J-List ::= SEQUENCE (SIZE (1..maxJ)) OF J
J ::= SEQUENCE {
    g                G-List4 OPTIONAL,
    iE-Extensions    ProtocolExtensionContainer { {J-ExtIEs} } OPTIONAL,
    ...
}
J-ExtIEs RNSAP-PROTOCOL-EXTENSION ::= {
    ...
}
G-List4 ::= SEQUENCE (SIZE (1..3, ...)) OF ProtocolIE-Single-Container { {G4-IEs} }
G4-IEs RNSAP-PROTOCOL-IES ::= {
    { ID id-G    CRITICALITY reject  TYPE G  PRESENCE mandatory }
}
C ::= SEQUENCE {
    k                K-List,
    iE-Extensions    ProtocolExtensionContainer { {C-ExtIEs} } OPTIONAL,
    ...
}
C-ExtIEs RNSAP-PROTOCOL-EXTENSION ::= {
    ...
}
K-List ::= SEQUENCE (SIZE (1..maxK)) OF ProtocolIE-Single-Container { {K-IEs} }
K-IEs RNSAP-PROTOCOL-IES ::= {
    { ID id-K    CRITICALITY notify  TYPE K  PRESENCE mandatory }
}
K ::= SEQUENCE {
    l                L-List,
    iE-Extensions    ProtocolExtensionContainer { {K-ExtIEs} } OPTIONAL,
    ...
}
K-ExtIEs RNSAP-PROTOCOL-EXTENSION ::= {
    ...
}
L-List ::= SEQUENCE (SIZE (1..maxL)) OF L
L ::= SEQUENCE {
    m                M OPTIONAL,
    iE-Extensions    ProtocolExtensionContainer { {L-ExtIEs} } OPTIONAL,
    ...
}
L-ExtIEs RNSAP-PROTOCOL-EXTENSION ::= {
    ...
}
ExampleMessage-Extensions RNSAP-PROTOCOL-EXTENSION ::= {
    ...
}

```

Annex D (normative): DRNS Behaviour at SRNC or RNSAP Signalling Bearer Failure

This annex describes the DRNC actions in the event of SRNC or RNSAP Signalling Bearer failure when all or some of the UE Contexts related to the SRNC need to be removed in DRNC.

D.1 Detection of SRNC or RNSAP Signalling Bearer/Connection Failure

Termination of all or some of the UE Contexts in DRNC which are related to an SRNC may be triggered due to failure of SRNC, RNSAP Signalling Bearer or the Iur signalling connection of an UE(s).

D.1.1 Termination of All UE Contexts Related to a Specific SRNC

Termination of all UE Contexts in DRNC which are related to a specific SRNC is triggered if the RNSAP Signalling Bearer failure is detected by the RNSAP according to the procedure described in the sub-clause 4.5.1.5.1 of TS 25.420. By "all" UE Contexts, it means all UEs having dedicated and/or common channel resources.

D.1.2 Termination of Specific UE Context

Termination of a specific UE Context in DRNC is triggered for an UE which has dedicated transport channel resources according to the procedure described in the sub-clause 4.5.1.5.2 of TS 25.420.

D.2 DRNC Actions at UE Context Termination

When termination of the UE Context is required, the DRNC shall remove any common and/or dedicated radio resources related to the UE Context. The DRNC shall also initiate release of the dedicated or common user plane resources that were involved in these UE Contexts. In addition, if it is possible the DRNC shall release the RRC connection.

Annex E (informative): Change History

Change history					
TSG RAN#	Version	CR	Tdoc RAN	New Version	Subject/Comment
RAN_06	-	-	RP-99755	3.0.0	Approved at TSG RAN #6 and placed under Change Control
RAN_07	3.0.0	-	RP-000100	3.1.0	Approved at TSG RAN #7
RAN_07	3.0.0	-	RP-000143	3.1.0	Approved at TSG RAN #7
RAN_07	3.0.0	-	RP-000146	3.1.0	Approved at TSG RAN #7
RAN_08	3.1.0	-	RP-000241	3.2.0	Approved at TSG RAN #8
RAN_08	3.1.0	-	RP-000242	3.2.0	Approved at TSG RAN #8
RAN_08	3.1.0	-	RP-000243	3.2.0	Approved at TSG RAN #8
RAN_08	3.1.0	-	RP-000244	3.2.0	Approved at TSG RAN #8
RAN_09	3.2.0	145-149, 151-154, 156-164, 166 167	RP-000379	3.3.0	Approved at TSG RAN #9
RAN_09	3.2.0	168 169 171 173 174 176 178-180 183-193	RP-000380	3.3.0	Approved at TSG RAN #9
RAN_09	3.2.0	194-200-	RP-000381	3.3.0	Approved at TSG RAN #9
RAN_10	3.3.0	202-219, 221-228, 230, 232-239, 241, 243-257, 259, 260, 263-265, 268-272, 274-278, 280, 281	RP-000618 RP-000619 RP-000621 RP-000696	3.4.0	Approved at TSG RAN #10
RAN_11	3.4.0	282-286, 288-293, 295-302, 304-308, 311, 313-319, 329, 332, 334-335	RP-010117 RP-010118	3.5.0	Approved at TSG RAN #11

Change history							
Date	TSG #	TSG Doc.	CR	Rev	Subject/Comment	Old	New
March 01	11	RP-010167	310		Approved at TSG RAN #11 and placed under Change Control	-	4.0.0
March 01	11	RP-010164	309				
March 01	11	RP-010159	327, 328, 336, 337		Approved at TSG RAN #11 and placed under Change Control	-	4.0.0
March 01	11	RP-010160	320, 323, 339		Approved at TSG RAN #11 and placed under Change Control	-	4.0.0
06/2001	12	RP-010378	341, 343, 345, 347, 349, 351, 353, 355, 357, 359		Approved at TSG RAN#12	4.0.0	4.1.0
06/2001	12	RP-010379	361, 363, 365, 367, 369, 378, 380, 382, 388, 390		Approved at TSG RAN#12	4.0.0	4.1.0
06/2001	12	RP-010380	399, 403, 405, 407, 409, 411, 414		Approved at TSG RAN#12	4.0.0	4.1.0
06/2001	12	RP-010394	372, 373, 374, 375, 376, 379, 380, 391, 393, 412		Approved at TSG RAN#12	4.0.0	4.1.0
09/2001	13	RP-010583	371	2	Ambiguity in CM handling	4.1.0	4.2.0
09/2001	13	RP-010583	416	1	Corrections to the DSCH Code Mapping IE	4.1.0	4.2.0
09/2001	13	RP-010583	418		Transport bearer replacement clarification	4.1.0	4.2.0
09/2001	13	RP-010583	425	1	Correction to the Error handling of the ERROR INDICATION message	4.1.0	4.2.0
09/2001	13	RP-010583	432	2	Cell Reserved for operator use	4.1.0	4.2.0
09/2001	13	RP-010583	437	1	Clarification of Abnormal Conditions/Unsuccessful Operation	4.1.0	4.2.0
09/2001	13	RP-010583	440	1	TFCS Correction for TDD	4.1.0	4.2.0
09/2001	13	RP-010583	442		Correction of a wrong implementation of CR 414	4.1.0	4.2.0
09/2001	13	RP-010583	444	1	Error handling of the Erroneously Present Conditional IEs	4.1.0	4.2.0
09/2001	13	RP-010583	446	1	Correction to Downlink Signaling Transfer	4.1.0	4.2.0
09/2001	13	RP-010584	450		Bitstrings ordering	4.1.0	4.2.0
09/2001	13	RP-010584	460		Mapping of TFCS to TFCl	4.1.0	4.2.0
09/2001	13	RP-010584	463		TDD Channelisation code range definition	4.1.0	4.2.0
09/2001	13	RP-010584	475	2	Clarification of coordinated DCHs	4.1.0	4.2.0
09/2001	13	RP-010584	466	1	Clarification on the Time Slot LCR	4.1.0	4.2.0
09/2001	13	RP-010584	468	1	Rnsap criticality	4.1.0	4.2.0
09/2001	13	RP-010584	470	1	Clarification of chapter 10	4.1.0	4.2.0
09/2001	13	RP-010584	472	1	Clarification of use of Diversity Control Indicator	4.1.0	4.2.0
09/2001	13	RP-010596	415		Clarification on the reference of the 'Neighbouring TDD Cell Information LCR'	4.1.0	4.2.0
09/2001	13	RP-010596	420	2	Allowed Combinations of Dedicated Measurement Type and the Reporting Characteristics Type	4.1.0	4.2.0
09/2001	13	RP-010596	423		Support of 8PSK modulation for LCR TDD	4.1.0	4.2.0
09/2001	13	RP-010596	430		Allowed combination of the measurement and event types	4.1.0	4.2.0
09/2001	13	RP-010596	435	1	Adding protocol container in CHOICE type IE	4.1.0	4.2.0

09/2001	13	RP-010596	438	1	Clarification of Abnormal Conditions/Unsuccessful Operation	4.1.0	4.2.0
09/2001	13	RP-010596	455	1	Correction to position reporting	4.1.0	4.2.0
09/2001	13	RP-010596	461	1	CR to 25.423 v4.1.0: RX timing deviation as dedicated measurement for 1.28Mcps TDD	4.1.0	4.2.0
12/2001	14	RP-010896	478	2	CR on Priority range	4.2.0	4.3.0
12/2001	14	RP-010855	480		Bitstrings ordering	4.2.0	4.3.0
12/2001	14	RP-010855	482		Added UTRAN modes in the Semantics Description in IEs in RNSAP messages	4.2.0	4.3.0
12/2001	14	RP-010855	484		Alignment to RAN4 spec for Transmitted Code Power Measurement	4.2.0	4.3.0
12/2001	14	RP-010855	491		Transmit Diversity for TDD	4.2.0	4.3.0
12/2001	14	RP-010855	497		Clarification for the definition of the ASN.1 constants	4.2.0	4.3.0
12/2001	14	RP-010855	504	1	Terminology Corrections	4.2.0	4.3.0
12/2001	14	RP-010855	509		Procedure Code Criticality in Error Indication	4.2.0	4.3.0
12/2001	14	RP-010855	512		Clarification for the Power Adjustment Type IE in the DL POWER CONTROL REQUEST message	4.2.0	4.3.0
12/2001	14	RP-010855	514	1	Forward Compatibility for DL Power Balancing	4.2.0	4.3.0
12/2001	14	RP-010856	516		Reconfiguration clarification	4.2.0	4.3.0
12/2001	14	RP-010856	518	2	DRNC behaviour at SRNC or RNSAP Signalling Bearer failure	4.2.0	4.3.0
12/2001	14	RP-010856	520	2	Addition of amendment to clarify the PER encoding of bitstrings	4.2.0	4.3.0
12/2001	14	RP-010856	525		Clarification on Primary CPICH Ec/No IE	4.2.0	4.3.0
12/2001	14	RP-010856	527	2	Transport Bearer replacement clarification for the DSCH case	4.2.0	4.3.0
12/2001	14	RP-010856	529		Clarification of the Transaction ID	4.2.0	4.3.0
12/2001	14	RP-010856	532		Clarification of S Field Length usage	4.2.0	4.3.0
12/2001	14	RP-010856	534		Correction the Clause 10 Error Handling	4.2.0	4.3.0
12/2001	14	RP-010856	540		Correction to Primary CPICH handling in RL Setup procedure	4.2.0	4.3.0
12/2001	14	RP-010873	486	1	Correction of drift rate resolution	4.2.0	4.3.0
12/2001	14	RP-010873	487		Cell Parameter ID IE definition for 1.28Mcps TDD	4.2.0	4.3.0
12/2001	14	RP-010873	488		Introduction of Band Indicator in GSM Neighbouring Cell Information	4.2.0	4.3.0
12/2001	14	RP-010873	489		UL SIR Target in RL Setup Request TDD	4.2.0	4.3.0
12/2001	14	RP-010873	502	2	Handling of the DPC Mode IE	4.2.0	4.3.0
12/2001	14	RP-010873	505	1	Rel-4 specific terminology corrections	4.2.0	4.3.0
12/2001	14	RP-010873	521	1	Correction to the RNSAP Congestion Indication	4.2.0	4.3.0
12/2001	14	RP-010873	530	2	SFN-SFN quality indication	4.2.0	4.3.0
12/2001	14	RP-010911	485	1	Correction to SFN-SFN Observed Time Difference Measurement report mapping	4.2.0	4.3.0
03/2002	15	RP-020169	542	3	RNSAP signalling support for flexible split	4.3.0	4.4.0
03/2002	15	RP-020169	549	1	Setting of Initial power in a new CCTrCH in TDD	4.3.0	4.4.0
03/2002	15	RP-020169	560		Clarification to measurement unit at Higher Layer Filtering.	4.3.0	4.4.0
03/2002	15	RP-020169	574	2	New UE identifier for MAC-c/sh multiplexing for DSCH	4.3.0	4.4.0
03/2002	15	RP-020169	581	1	Correction to physical channels which SCTD can be applied (Iur)	4.3.0	4.4.0
03/2002	15	RP-020181	545	1	Corrections to the Information Exchange Initiation procedure	4.3.0	4.4.0
03/2002	15	RP-020181	546	1	Correction to UE position measurements quality and threshold information	4.3.0	4.4.0
03/2002	15	RP-020181	547	1	Correction to UE position measurements change and deviation limit formulas	4.3.0	4.4.0
03/2002	15	RP-020181	552		Re-ordering of cause values	4.3.0	4.4.0
03/2002	15	RP-020181	561		Clarification to the Allowed Rate Information in RL Setup/Addition/Reconfiguration response and RL Reconfiguration Ready messages.	4.3.0	4.4.0
03/2002	15	RP-020181	562	1	Modification of the T_utan-gps length	4.3.0	4.4.0
03/2002	15	RP-020181	567		Amendment of the COMMON MEASUREMENT INITIATION	4.3.0	4.4.0
03/2002	15	RP-020181	576	2	Load Value Extension	4.3.0	4.4.0
03/2002	15	RP-020181	588		The correction on duplicated allocation of protocolIE-ID	4.3.0	4.4.0
03/2002	15	RP-020181	589		Enhanced DSCH and syntax error ASN.1 correction	4.3.0	4.4.0
03/2002	15	RP-020181	596	1	Introduction of ellipses for IPDL parameters	4.3.0	4.4.0
03/2002	15	RP-020231	586	2	Removing of channel coding option "no coding" for FDD	4.3.0	4.4.0
06/2002	16	RP-020406	591	2	Criticality Information Decoding Failure Handling	4.4.0	4.5.0
06/2002	16	RP-020406	601	1	Alignment of tabular and ASN.1 coding for DL power	4.4.0	4.5.0
06/2002	16	RP-020406	604	1	Correction to RL Restore Indication	4.4.0	4.5.0
06/2002	16	RP-020406	610		New UE identifier for Shared Channel handling for TDD DSCH/USCH	4.4.0	4.5.0
06/2002	16	RP-020406	613	1	Clarification of Cell individual offset	4.4.0	4.5.0

06/2002	16	RP-020419	617		Clarification on the Neighboring TDD Cell Measurement information	4.4.0	4.5.0
06/2002	16	RP-020406	625	1	Correction to the use of the CFN IE / SFN IE in the Measurement Initiation procedures	4.4.0	4.5.0
06/2002	16	RP-020406	631		TFCI 0 definition for TDD	4.4.0	4.5.0
06/2002	16	RP-020406	634	1	CELL_DCH to CELL_FACH TDD correction	4.4.0	4.5.0
06/2002	16	RP-020407	640	1	DSCH Information Correction	4.4.0	4.5.0
06/2002	16	RP-020419	647		Definition of quality figures for SFN-SFN and Tutan-gps measurement value information	4.4.0	4.5.0
06/2002	16	RP-020419	650	1	Clarification to the RNSAP RL Congestion procedure	4.4.0	4.5.0
06/2002	16	RP-020407	655	1	Clarification for the usage of the cause value	4.4.0	4.5.0
06/2002	16	RP-020407	672		RNSAP Tabular alignment to ASN1 and other corrections	4.4.0	4.5.0
09/2002	17	RP-020607	674		Correction of Criticality of RL set information in Dedicated Measurement initiation	4.5.0	4.6.0
09/2002	17	RP-020614	676		Rx Timing Deviation (TDD) corrections	4.5.0	4.6.0
09/2002	17	RP-020616	678		Clarification on the Common Measurement Reporting procedure	4.5.0	4.6.0
09/2002	17	RP-020607	680		Clarification to DCH Rate Control for modified DCHs	4.5.0	4.6.0
09/2002	17	RP-020612	690		WG4 Reference Corrections	4.5.0	4.6.0
09/2002	17	RP-020607	693	4	RNSAP Procedures alignment to NBAP and other corrections	4.5.0	4.6.0
09/2002	17	RP-020607	695	2	Handling of Common measurement of neighbor cell information elements	4.5.0	4.6.0
09/2002	17	RP-020589	699	1	Replacing all occurrences of $P_{SIR}(k)$ by δP_{curr} in 25.423	4.5.0	4.6.0
09/2002	17	RP-020603	704	2	Correction of the Error Indication	4.5.0	4.6.0
09/2002	17	RP-020613	706	2	Uplink Synchronisation in 1.28Mcps TDD	4.5.0	4.6.0
09/2002	17	RP-020607	715		Clarification of the DCH rate coding	4.5.0	4.6.0
09/2002	17	RP-020603	719	1	Correction to Compressed Mode in RL Addition Failure	4.5.0	4.6.0
09/2002	17	RP-020615	721		Quality Ies for UE positioning measurements	4.5.0	4.6.0
12/2002	18	RP-020758	723		Add UL SIR_target for Unsynchronized RL Reconfiguration in 1.28Mcps TDD	4.6.0	4.7.0
12/2002	18	RP-020757	725		Correction to RX Timing Deviation LCR value range	4.6.0	4.7.0
12/2002	18	RP-020759	727	2	Slot Format for 1.28Mcps TDD	4.6.0	4.7.0
12/2002	18	RP-020753	737	2	Final Corrections from RNSAP Procedure Review	4.6.0	4.7.0
12/2002	18	RP-020744	755		Correction for the DL DPDCH transmission	4.6.0	4.7.0
12/2002	18	RP-020743	762	1	DSCH-RNTI in RADIO LINK SETUP FAILURE	4.6.0	4.7.0
03/2003	19	RP-030068	766		Clarification to DL Power definition for TDD	4.7.0	4.8.0
03/2003	19	RP-030072	769	1	TPC Step Size for TDD	4.7.0	4.8.0
03/2003	19	RP-030069	771		Clarification to 2nd Interleaving Mode for TDD	4.7.0	4.8.0
03/2003	19	RP-030082	783	1	Corrections to Channelisation Code TFCI Mapping for TDD	4.7.0	4.8.0
03/2003	19	RP-030070	785		Correction for the Information Exchange Initiation procedure	4.7.0	4.8.0
03/2003	19	RP-030183	789	5	Support of Cell Individual Offset in RNSAP	4.7.0	4.8.0
03/2003	19	RP-030071	791		Midamble Configuration for Midamble Shift LCR	4.7.0	4.8.0
03/2003	19	RP-030067	795		Alignment of 'Uncertainty Ellipse' with RRC	4.7.0	4.8.0
03/2003	19	RP-030058	797	2	Uplink Timing Advance Control Parameters in LCR TDD	4.7.0	4.8.0
03/2003	19	RP-030066	802		Corrections to DCH Combining in RL SETUP and RL ADDITION	4.7.0	4.8.0
03/2003	19	RP-030058	808		Correction on CGA Additional Shapes	4.7.0	4.8.0
06/2003	20	RP-030324	823	1	Alignment of the Requested Data Value Information IE description	4.8.0	4.9.0
06/2003	20	RP-030325	825		GPS trigger condition	4.8.0	4.9.0
06/2003	20	RP-030326	841		Correction of Failure message used for logical errors	4.8.0	4.9.0
09/2003	21	RP-030443	851		Corrections to Tx Diversity	4.9.0	4.10.0
09/2003	21	RP-030444	855		'On Modification' and 'Periodic' reporting alignment for Information Exchange procedures	4.9.0	4.10.0
12/2003	22	RP-030683	892		Information Exchange Initiation behavior correction	4.10.0	4.11.0
03/2004	23	RP-040052	899		Correction of RL Congestion Indication	4.11.0	4.12.0
03/2004	23	RP-040053	923		Alignment with 23.032 correction of Included Angle for Ellipsoid Arc	4.11.0	4.12.0
03/2004	23	RP-040059	930		Correction to the threshold of Rx Timing Deviation LCR in tabular	4.11.0	4.12.0
06/2004	-	-	-	-	ASN.1 editorials	4.12.0	4.12.1

History

Document history		
V4.0.0	March 2001	Publication
V4.1.0	June 2001	Publication
V4.2.0	September 2001	Publication
V4.3.0	December 2001	Publication
V4.4.0	March 2002	Publication
V4.5.0	June 2002	Publication
V4.6.0	September 2002	Publication
V4.7.0	December 2002	Publication
V4.8.0	March 2003	Publication
V4.9.0	June 2003	Publication
V4.10.0	September 2003	Publication
V4.11.0	December 2003	Publication
V4.12.0	March 2004	Publication (Withdrawn)
V4.12.1	June 2004	Publication