

ETSI TS 125 425 V5.7.0 (2004-03)

Technical Specification

**Universal Mobile Telecommunications System (UMTS);
UTRAN Iur interface user plane protocols
for CCH data streams
(3GPP TS 25.425 version 5.7.0 Release 5)**



Reference

RTS/TSGR-0325425v570

Keywords

UMTS

ETSI

650 Route des Lucioles
F-06921 Sophia Antipolis Cedex - FRANCE

Tel.: +33 4 92 94 42 00 Fax: +33 4 93 65 47 16

Siret N° 348 623 562 00017 - NAF 742 C
Association à but non lucratif enregistrée à la
Sous-Préfecture de Grasse (06) N° 7803/88

Important notice

Individual copies of the present document can be downloaded from:

<http://www.etsi.org>

The present document may be made available in more than one electronic version or in print. In any case of existing or perceived difference in contents between such versions, the reference version is the Portable Document Format (PDF). In case of dispute, the reference shall be the printing on ETSI printers of the PDF version kept on a specific network drive within ETSI Secretariat.

Users of the present document should be aware that the document may be subject to revision or change of status. Information on the current status of this and other ETSI documents is available at

<http://portal.etsi.org/tb/status/status.asp>

If you find errors in the present document, send your comment to:

editor@etsi.org

Copyright Notification

No part may be reproduced except as authorized by written permission.
The copyright and the foregoing restriction extend to reproduction in all media.

© European Telecommunications Standards Institute 2004.
All rights reserved.

DECTTM, **PLUGTESTS**TM and **UMTS**TM are Trade Marks of ETSI registered for the benefit of its Members.
TIPHONTM and the **TIPHON logo** are Trade Marks currently being registered by ETSI for the benefit of its Members.
3GPPTM is a Trade Mark of ETSI registered for the benefit of its Members and of the 3GPP Organizational Partners.

Intellectual Property Rights

IPRs essential or potentially essential to the present document may have been declared to ETSI. The information pertaining to these essential IPRs, if any, is publicly available for **ETSI members and non-members**, and can be found in ETSI SR 000 314: "*Intellectual Property Rights (IPRs); Essential, or potentially Essential, IPRs notified to ETSI in respect of ETSI standards*", which is available from the ETSI Secretariat. Latest updates are available on the ETSI Web server (<http://webapp.etsi.org/IPR/home.asp>).

Pursuant to the ETSI IPR Policy, no investigation, including IPR searches, has been carried out by ETSI. No guarantee can be given as to the existence of other IPRs not referenced in ETSI SR 000 314 (or the updates on the ETSI Web server) which are, or may be, or may become, essential to the present document.

Foreword

This Technical Specification (TS) has been produced by ETSI 3rd Generation Partnership Project (3GPP).

The present document may refer to technical specifications or reports using their 3GPP identities, UMTS identities or GSM identities. These should be interpreted as being references to the corresponding ETSI deliverables.

The cross reference between GSM, UMTS, 3GPP and ETSI identities can be found under <http://webapp.etsi.org/key/queryform.asp>.

Contents

Intellectual Property Rights	2
Foreword.....	2
Foreword.....	5
1 Scope	6
2 References	6
3 Definitions, symbols and abbreviations	6
3.1 Definitions	6
3.2 Symbols.....	6
3.3 Abbreviations	7
3.4 Specification Notations	7
4 General Aspects.....	8
4.1 Common Transport Channel Data Streams User Plane Protocol Services.....	8
4.1.1 RACH/CPCH[FDD] Data Streams User Plane Protocol Services.....	8
4.1.2 FACH Data Streams User Plane Protocol Services	8
4.1.3 [TDD - USCH]/DSCH Data Streams User Plane Protocol Services	8
4.1.4 HS-DSCH Data Streams User Plane Protocol Services.....	9
4.2 Services expected from the Data Transport Network layer.....	9
4.3 Protocol Version.....	9
5 Common Transport Channel Data Streams User Plane Procedures.....	9
5.1 Data Transfer.....	9
5.1.1 RACH/CPCH[FDD] Data Transfer	9
5.1.2 FACH Data Transfer.....	10
5.1.3 USCH Data Transfer [TDD].....	10
5.1.4 DSCH Data Transfer.....	11
5.1.5 HS-DSCH Data Transfer	11
5.2 Flow Control	12
5.2.1 FACH Flow Control	12
5.2.2 DSCH Capacity Request.....	12
5.2.3 DSCH Capacity Allocation.....	13
5.2.4 FACH Capacity Request.....	13
5.2.5 HS-DSCH Capacity Request	14
5.2.6 HS-DSCH Capacity Allocation	14
5.3 General	15
5.3.1 DSCH / [TDD – USCH] transport bearer replacement.....	15
6 Frame Structure and Coding.....	15
6.1 General	15
6.2 Data Frame structure	16
6.2.1 RACH/CPCH[FDD] Channels	16
6.2.2 FACH Channels.....	18
6.2.3 USCH Channels [TDD]	19
6.2.4 DSCH Channels	20
6.2.4A HS-DSCH Channels	21
6.2.5 Coding of Information Elements in DATA FRAMES	21
6.2.5.1 Header CRC	21
6.2.5.2 Frame Type (FT).....	21
6.2.5.3 DRNTI	21
6.2.5.4 S-RNTI.....	22
6.2.5.5 UE-ID Type Indicator (UE-ID Type).....	22
6.2.5.6 S-CCPCH Indicator (S-CI)	22
6.2.5.7 Common Transport Channel Priority Indicator (CmCH-PI).....	22
6.2.5.8 MAC-c/sh SDU Length.....	22
6.2.5.9 NumOfSDU	22

6.2.5.10	Propagation delay [FDD]	22
6.2.5.11	Rx Timing Deviation [3.84Mcps TDD]	22
6.2.5.11A	Received SYNC UL Timing Deviation [1.28Mcps TDD]	23
6.2.5.12	User Buffer Size	23
6.2.5.13	MAC-c/sh SDU	23
6.2.5.14	Payload CRC	23
6.2.5.15	Spare Extension	23
6.2.5.16	MAC-d PDU Length	23
6.2.5.17	NumOfPDU	23
6.2.5.18	MAC-d PDU	24
6.3	Control Frame structure	24
6.3.1	Introduction	24
6.3.2	Header structure of the control frames	24
6.3.2.1	Control frame CRC	24
6.3.2.2	Frame type (FT)	24
6.3.2.3	Control Frame Type	24
6.3.3	Payload structure and information elements	25
6.3.3.1	FACH FLOW CONTROL	25
6.3.3.1.1	S-RNTI	25
6.3.3.1.2	Common Transport Channel Priority Indicator (CmCH-PI)	25
6.3.3.1.3	Credits	25
6.3.3.1.4	Spare Extension	25
6.3.3.2	DSCH CAPACITY REQUEST	26
6.3.3.2.1	Common Transport Channel Priority Indicator (CmCH-PI)	26
6.3.3.2.2	User Buffer Size	26
6.3.3.2.3	Spare Extension	26
6.3.3.3	DSCH CAPACITY ALLOCATION	26
6.3.3.3.1	Common Transport Channel Priority Indicator (CmCH-PI)	27
6.3.3.3.2	Maximum MAC-c/sh SDU Length	27
6.3.3.3.3	Credits	27
6.3.3.3.4	Interval	27
6.3.3.3.5	Repetition Period	27
6.3.3.3.6	Spare Extension	27
6.3.3.4	FACH CAPACITY REQUEST	27
6.3.3.4.1	D-RNTI	28
6.3.3.4.2	Common Transport Channel Priority Indicator (CmCH-PI)	28
6.3.3.4.3	User Buffer Size	28
6.3.3.4.4	Spare extension	28
6.3.3.5	HS-DSCH CAPACITY REQUEST	28
6.3.3.5.1	Common Transport Channel Priority Indicator (CmCH-PI)	28
6.3.3.5.2	User Buffer Size	29
6.3.3.5.3	Spare Extension	29
6.3.3.6	HS-DSCH CAPACITY ALLOCATION	29
6.3.3.6.1	Common Transport Channel Priority Indicator (CmCH-PI)	29
6.3.3.6.2	Maximum MAC-d PDU Length	29
6.3.3.6.3	HS-DSCH Credits	30
6.3.3.6.4	HS-DSCH Interval	30
6.3.3.6.5	HS-DSCH Repetition Period	30
6.3.3.6.8	Spare Extension	30
7	Handling of Unknown, Unforeseen and Erroneous Protocol Data	30
7.1	General	30
Annex A (informative): Change history		31
History		32

Foreword

This Technical Specification (TS) has been produced by the 3rd Generation Partnership Project (3GPP).

The contents of the present document are subject to continuing work within the TSG and may change following formal TSG approval. Should the TSG modify the contents of the present document, it will be re-released by the TSG with an identifying change of release date and an increase in version number as follows:

Version x.y.z

where:

- x the first digit:
 - 1 presented to TSG for information;
 - 2 presented to TSG for approval;
 - 3 or greater indicates TSG approved document under change control.
- y the second digit is incremented for all changes of substance, i.e. technical enhancements, corrections, updates, etc.
- z the third digit is incremented when editorial only changes have been incorporated in the document.

1 Scope

The present document shall provide a description of the UTRAN RNS-RNS (Iur) interface user plane protocols for Common Transport Channel data streams as agreed within the TSG-RAN working group 3.

2 References

The following documents contain provisions which, through reference in this text, constitute provisions of the present document.

- References are either specific (identified by date of publication, edition number, version number, etc.) or non-specific.
- For a specific reference, subsequent revisions do not apply.
- For a non-specific reference, the latest version applies. In the case of a reference to a 3GPP document (including a GSM document), a non-specific reference implicitly refers to the latest version of that document *in the same Release as the present document*.

- [1] ITU-T Recommendation I.361 (11/95): "B-ISDN ATM Layer Specification".
 - [2] ITU-T Recommendation I.363.2 (11/2000): "B-ISDN ATM Adaptation Layer specification: Type 2 AAL".
 - [3] ITU-T Recommendation I.366.1 (06/98): "Segmentation and Reassembly Service Specific Convergence Sublayer for the AAL type 2".
 - [4] 3GPP TS 25.427: "UTRAN Iub/Iur Interface User Plane Protocols for DCH Data Streams".
 - [5] 3GPP TS 25.401: "UTRAN overall description".
 - [6] 3GPP TR 25.990: "Vocabulary".
 - [7] 3GPP TS 25.321: "Medium Access Control (MAC) protocol specification".
 - [8] 3GPP TS 25.423: "UTRAN Iur Interface RNSAP Signalling".
 - [9] 3GPP TS 25.321: "Medium Access Control (MAC) protocol specification".
-

3 Definitions, symbols and abbreviations

3.1 Definitions

For the purposes of the present document, the terms and definitions in [5] and the following apply:

Common Transport Channel: it is defined as a transport channel that is shared by several users i.e. DSCH, USCH [TDD], CPCH [FDD], RACH, FACH

Transport Connection: service provided by the transport layer and used by Frame Protocol for the delivery of FP PDU

3.2 Symbols

No special symbols are defined in the present document.

3.3 Abbreviations

For the purposes of the present document, the following abbreviations apply:

AAL2	ATM Adaptation Layer type 2
ATM	Asynchronous Transfer Mode
CFN	Connection Frame Number
CmCH	Common Transport Channel
CPCH	Common Packet Channel
C-RNC	Controlling Radio Network Controller
CRC	Cyclic Redundancy Checksum
DCH	Dedicated Transport Channel
DL	Downlink
D-RNTI	Drift RNTI
DSCH	Downlink Shared Channel
FACH	Forward Access Channel
FP	Frame Protocol
FT	Frame Type
HS-DSCH	High Speed Downlink Shared Channel
RACH	Random Access Channel
RNC	Radio Network Controller
RNTI	Radio Network Temporary Identity
SRNC	Serving Radio Network Controller
S-RNTI	Serving RNTI
SSCS	Service Specific Convergence Sublayer
TB	Transport Block
TBS	Transport Block Set
TFI	Transport Format Indicator
ToA	Time of Arrival
TTI	Transmission Time Interval
UE	User Equipment
UL	Uplink
U-RNTI	UTRAN RNTI
USCH	Uplink Shared Channel

3.4 Specification Notations

For the purposes of the present document, the following notations apply:

- [FDD] This tagging of a word indicates that the word preceding the tag "[FDD]" applies only to FDD. This tagging of a heading indicates that the heading preceding the tag "[FDD]" and the section following the heading applies only to FDD.
- [TDD] This tagging of a word indicates that the word preceding the tag "[TDD]" applies only to TDD, including 3.84Mcps TDD and 1.28Mcps TDD. This tagging of a heading indicates that the heading preceding the tag "[TDD]" and the section following the heading applies only to TDD, including 3.84Mcps TDD and 1.28Mcps TDD.
- [3.84Mcps TDD] This tagging of a word indicates that the word preceding the tag '[3.84Mcps TDD]' applies only to 3.84Mcps TDD. This tagging of a heading indicates that the heading preceding the tag '[3.84Mcps TDD]' and the section following the heading applies only to 3.84Mcps TDD.
- [1.28Mcps TDD] This tagging of a word indicates that the word preceding the tag "[1.28Mcps TDD]" applies only to 1.28Mcps TDD. This tagging of a heading indicates that the heading preceding the tag "[1.28Mcps TDD]" and the section following the heading applies only to 1.28Mcps TDD.
- [FDD - ...] This tagging indicates that the enclosed text following the "[FDD - " applies only to FDD. Multiple sequential paragraphs applying only to FDD are enclosed separately to enable insertion of TDD specific (or common) paragraphs between the FDD specific paragraphs.

[TDD - ...]	This tagging indicates that the enclosed text following the "[TDD - " applies only to TDD including 3.84Mcps TDD and 1.28Mcps TDD. Multiple sequential paragraphs applying only to TDD are enclosed separately to enable insertion of FDD specific (or common) paragraphs between the TDD specific paragraphs.
[3.84Mcps TDD - ...]	This tagging indicates that the enclosed text following the "[3.84Mcps TDD - " applies only to 3.84Mcps TDD. Multiple sequential paragraphs applying only to 3.84Mcps TDD are enclosed separately to enable insertion of FDD and TDD specific (or common) paragraphs between the 3.84Mcps TDD specific paragraphs.
[1.28Mcps TDD - ...]	This tagging indicates that the enclosed text following the "[1.28Mcps TDD - " applies only to 1.28Mcps TDD. Multiple sequential paragraphs applying only to 1.28Mcps TDD are enclosed separately to enable insertion of FDD and TDD specific (or common) paragraphs between the 1.28Mcps TDD specific paragraphs.
Procedure	When referring to a procedure in the specification, the Procedure Name is written with the first letters in each word in upper case characters followed by the word "procedure", e.g. FACH Data Transfer procedure.
Frame	When referring to a control or data frame in the specification, the CONTROL/DATA FRAME NAME is written with all letters in upper case characters followed by the words "control/data frame", e.g. FACH FLOW CONTROL control frame.
IE	When referring to an information element (IE) in the specification, the <i>Information Element Name</i> is written with the first letters in each word in upper case characters and all letters in Italic font followed by the abbreviation "IE", e.g. <i>Credits</i> IE.
Value of an IE	When referring to the value of an information element (IE) in the specification, the "Value" is written as it is specified in subclause 6.2.5 or 6.3.3 enclosed by quotation marks, e.g. "0" or "255".

4 General Aspects

4.1 Common Transport Channel Data Streams User Plane Protocol Services

This subclause describes the services that the User Plane Protocols provide such as data transfer, flow control.

4.1.1 RACH/CPCH[FDD] Data Streams User Plane Protocol Services

RACH/CPCH[FDD] frame protocol provides the following services:

- Transport of MAC-c/sh SDUs from the DRNC to the SRNC for RACH/CPCH[FDD] common transport channels.

4.1.2 FACH Data Streams User Plane Protocol Services

FACH frame protocol provides the following services:

- Transport of MAC-c/sh SDUs from the SRNC to the DRNC for FACH common transport channel.
- Flow Control between MAC-d and MAC-c/sh.

4.1.3 [TDD - USCH]/DSCH Data Streams User Plane Protocol Services

[TDD USCH]/DSCH frame protocol provides the following services:

- Transport of MAC-c/sh SDUs between the SRNC and the DRNC for [TDD USCH] and DSCH common transport channels.
- Flow Control between MAC-d and MAC-c/sh.

4.1.4 HS-DSCH Data Streams User Plane Protocol Services

HS-DSCH frame protocol provides the following services:

- Transport of MAC-d flows between the SRNC and the DRNC for HS-DSCH common transport channels.
- Flow Control between MAC-d and CRNC HS-DSCH Flow Control.

4.2 Services expected from the Data Transport Network layer

The following services are expected from the transport layer:

- Delivery of Frame Protocol PDUs.

In sequence delivery is not required. However, frequent out-of-sequence delivery may impact the performance and should be avoided.

4.3 Protocol Version

This revision of the specification specifies version 1 of the protocols.

5 Common Transport Channel Data Streams User Plane Procedures

This clause specifies the user plane procedures for Common Transport Channels data streams. Typical related scenarios at Iur interface should be described.

For the user plane of the radio network layer there are five Common Transport Channel frame handling protocols:

1. Random Access Channel/Common Packet Channel [FDD] Frame Protocol (RACH/CPCH[FDD] FP) for transport of Iur data streams carried on RACH/CPCH[FDD] on the Uu-interface.
2. Forward Access Channel Frame Protocol (FACH FP) for transport of Iur data streams carried on FACH on the Uu-interface.
3. Downlink Shared Channel Frame Protocol (DSCH FP) for transport of Iur data streams carried on DSCH on the Uu-interface.
4. Uplink Shared Channel Frame Protocol ([TDD- USCH] FP) for transport of Iur data streams carried on USCH on the Uu-interface.
5. High Speed Downlink Shared Channel Frame Protocol (HS-DSCH FP) for transport of Iur data streams carried on HS-DSCH on the Uu-interface.

5.1 Data Transfer

5.1.1 RACH/CPCH[FDD] Data Transfer

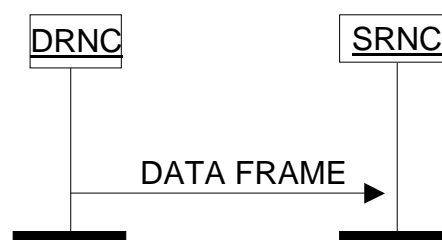

Figure 1: RACH/CPCH[FDD] Data Transfer procedure

Data received on the RACH/CPCH[FDD] transport channel is transmitted from the DRNC to the SRNC using RACH/CPCH[FDD] DATA FRAMES. The data is protected by a mandatory payload CRC. Multiple MAC-c/sh SDUs of same length may be transmitted in the same RACH/CPCH[FDD] DATA FRAME.

5.1.2 FACH Data Transfer

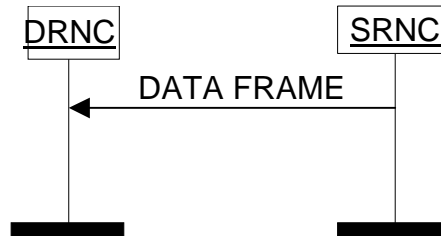

Figure 2: FACH Data Transfer procedure

Data to be transmitted on the FACH transport channel is transmitted from the SRNC to the DRNC using FACH DATA FRAMES. Multiple MAC-c/sh SDUs of same length and same priority level (CmCH-PI) may be transmitted in the same FACH DATA FRAME. Within one priority and size the MAC-c/sh SDUs shall be transmitted by the DRNS on the Uu interface in the same order as they were received from the SRNC.

The *UE-ID Type Indicator* IE indicates which UE-ID type MAC-c/sh shall include in the MAC header.

5.1.3 USCH Data Transfer [TDD]

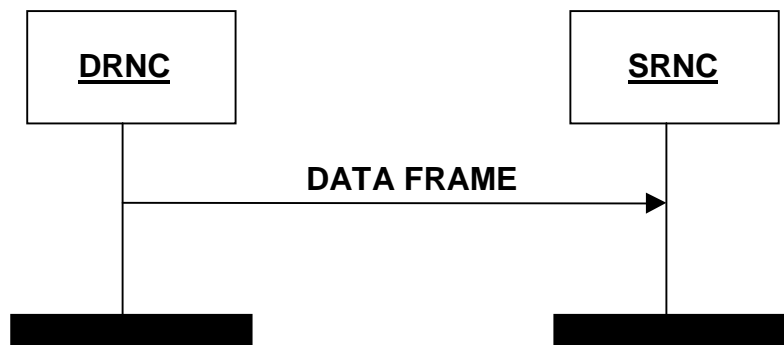

Figure 3: USCH Data Transfer procedure

Whenever there is USCH data in the DRNC, transfer is done immediately to the SRNC via the USCH Data Port using USCH DATA FRAMES.

Data received on the USCH transport channel is transmitted from the DRNC to the SRNC using USCH DATA FRAMES. The data is protected by a mandatory payload CRC. Multiple MAC-c/sh SDUs of same length may be transmitted in the same USCH DATA FRAME.

5.1.4 DSCH Data Transfer

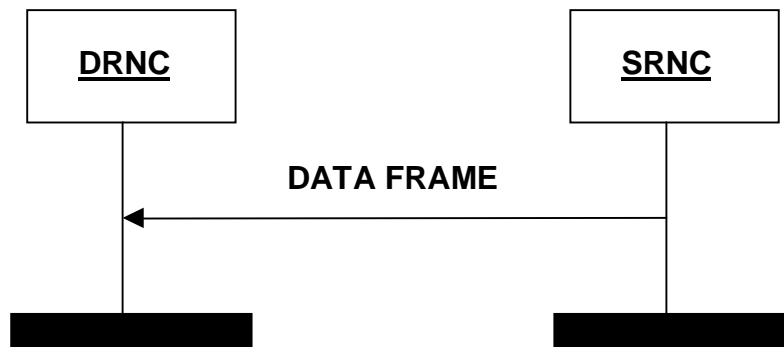

Figure 4: DSCH Data Transfer procedure

When the SRNC has been granted capacity by the DRNC via the DSCH CAPACITY ALLOCATION Control Frame or via the DSCH initial capacity allocation as described in [8] and the SRNC has data waiting to be sent, then the DSCH DATA FRAME is used to transfer the data. If the SRNC has been granted capacity by the DRNC via the DSCH initial capacity allocation as described in [8], this capacity is valid for only the first DSCH DATA FRAME transmission. When data is waiting to be transferred, and a CAPACITY ALLOCATION is received, a DATA FRAME will be transmitted immediately according to allocation received.

Multiple MAC-c/sh SDUs of same length and same priority level (CmCH-PI) may be transmitted in the same DSCH DATA FRAME.

The DSCH DATA FRAME includes a *User Buffer Size* IE to indicate the amount of data pending for the respective UE for the indicated priority level. Within one priority level and size the MAC-c/sh SDUs shall be transmitted by the DRNS on the Uu interface in the same order as they were received from the SRNC.

5.1.5 HS-DSCH Data Transfer

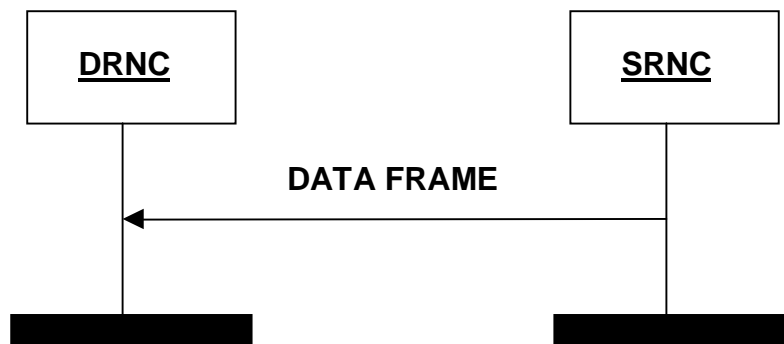

Figure 4AA: HS-DSCH Data Transfer procedure

When the SRNC has been granted capacity by the DRNC via the HS-DSCH CAPACITY ALLOCATION Control Frame or via the HS-DSCH initial capacity allocation as described in [8] and the SRNC has data waiting to be sent, then the HS-DSCH DATA FRAME is used to transfer the data. If the SRNC has been granted capacity by the DRNC via the HS-DSCH initial capacity allocation as described in [8], this capacity is valid for only the first HS-DSCH DATA FRAME transmission. When data is waiting to be transferred, and a CAPACITY ALLOCATION is received, a DATA FRAME will be transmitted immediately according to allocation received.

Multiple MAC-d PDUs of same length and same priority level (CmCH-PI) may be transmitted in one MAC-d flow in the same HS-DSCH DATA FRAME.

The HS-DSCH DATA FRAME includes a *User Buffer Size* IE to indicate the amount of data pending for the respective MAC-d flow for the indicated priority level. Within one priority level and size the MAC-d PDUs shall be transmitted by the DRNS on the Uu interface in the same order as they were received from the SRNC.

5.2 Flow Control

5.2.1 FACH Flow Control

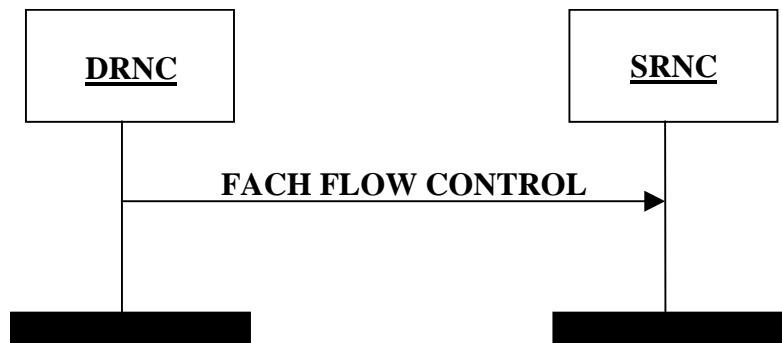

Figure 4A: FACH Flow Control procedure

The FACH Flow Control procedure is used by the DRNC to control the user data flow. It may be generated in response to a FACH Capacity Request procedure or at any other time. The *Credits* IE indicates the number of MAC-c/sh SDUs the SRNC is allowed to transmit for the UE identified by the *SRNTI* IE and the associated priority level indicated by the *Common Transport Channel Priority Indicator* IE.

The *Credits* IE indicates the total amount of credits granted. Any credits previously granted are withdrawn.

If *Credits* IE = 0 (e.g. due to congestion in the DRNC), the SRNC shall immediately stop transmission of MAC-c/sh SDUs.

Credits IE = 'unlimited' indicates that the SRNC may transmit an unlimited number of MAC-c/sh SDUs.

5.2.2 DSCH Capacity Request

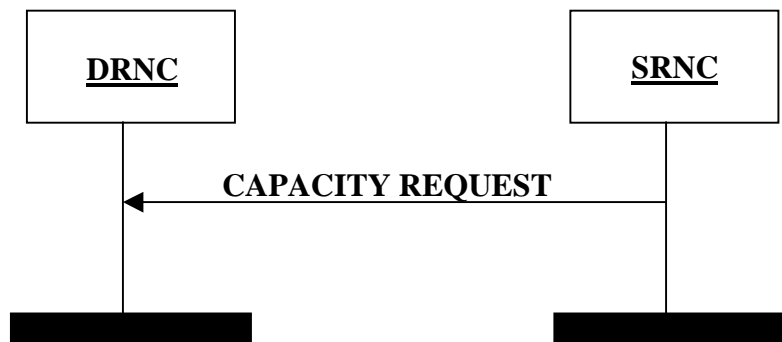

Figure 5: DSCH Capacity Request procedure

The DSCH Capacity Request procedure provides means for the SRNC to request DSCH capacity by indicating the user buffer size in the SRNC for a given priority level.

The SRNC is allowed to reissue the DSCH Capacity Request if no CAPACITY ALLOCATION has been received within an appropriate time threshold.

5.2.3 DSCH Capacity Allocation

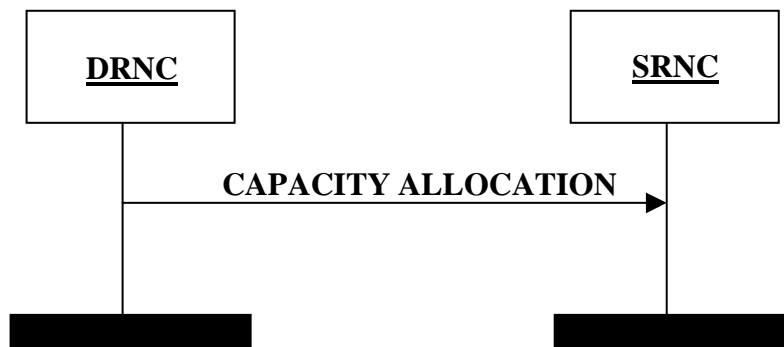

Figure 6: DSCH Capacity Allocation procedure

DSCH Capacity Allocation procedure is generated within the DRNC. It may be generated either in response to a DSCH Capacity Request or at any other time.

The DRNC may use this message to modify the capacity at any time, irrespective of the reported user buffer status.

The DSCH CAPACITY ALLOCATION frame is used by the DRNC to control the user data flow. *Credits* IE indicates the number of MAC-c/sh SDUs that the SRNC is allowed to transmit for the UE and the associated priority level indicated by the *Common Transport Channel Priority Indicator* IE.

The *Maximum MAC-c/sh SDU length*, *Credits*, *Interval* and *Repetition Period* IEs indicates the total amount of capacity granted. Any capacity previously granted is replaced.

If *Credits* IE = 0 (e.g. due to congestion in the DRNC), the SRNC shall immediately stop transmission of MAC-c/sh SDUs. If *Credits* IE = 255, the SRNC can transmit MAC-c/sh SDUs with unlimited capacity.

The IEs used in the DSCH CAPACITY ALLOCATION Control Frame are the *Common Transport Channel Priority Indicator*, *Credits*, *Maximum MAC-c/sh SDU Length*, *Interval* and the *Repetition Period*.

If the *Repetition Period* IE = 'unlimited repetition period' it indicates that the SRNC may transmit the specified number of MAC-c/sh SDUs for an unlimited period according to the bounds of *Maximum MAC-c/sh SDU Length*, *Credits* and *Interval* IEs.

5.2.4 FACH Capacity Request

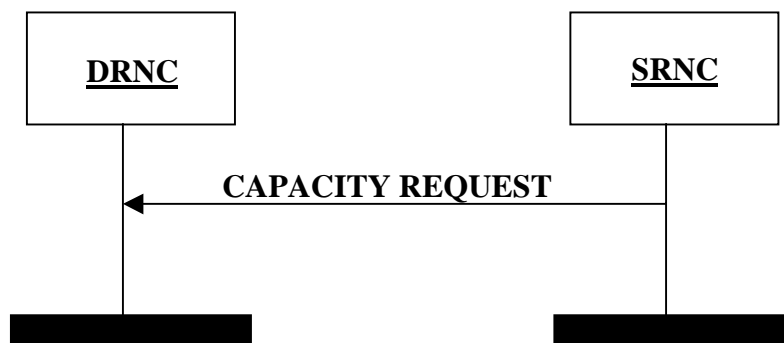

Figure 6A: FACH Capacity Request procedure

The FACH Capacity Request procedure provides the means for the SRNC to notify the DRNC about the user buffer size for a given priority level. It may be sent if no FACH FLOW CONTROL frame has been received within an appropriate time threshold, or to signal an event such as data arrival or user buffer discard.

5.2.5 HS-DSCH Capacity Request

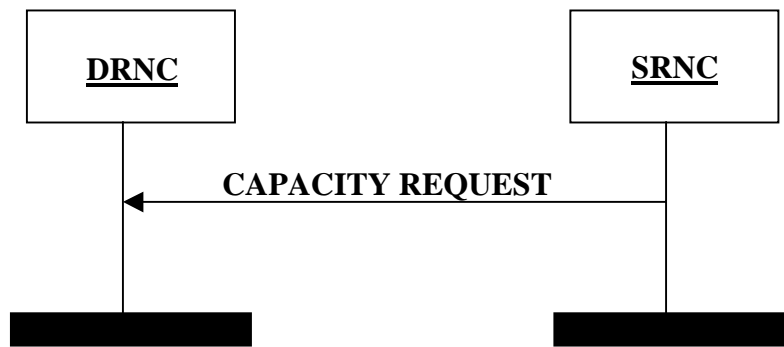

Figure 6B: HS-DSCH Capacity Request procedure

The HS-DSCH Capacity Request procedure provides means for the SRNC to request HS-DSCH capacity by indicating the user buffer size in the SRNC for a given priority level.

The SRNC is allowed to reissue the HS-DSCH Capacity Request if no CAPACITY ALLOCATION has been received within an appropriate time threshold.

5.2.6 HS-DSCH Capacity Allocation

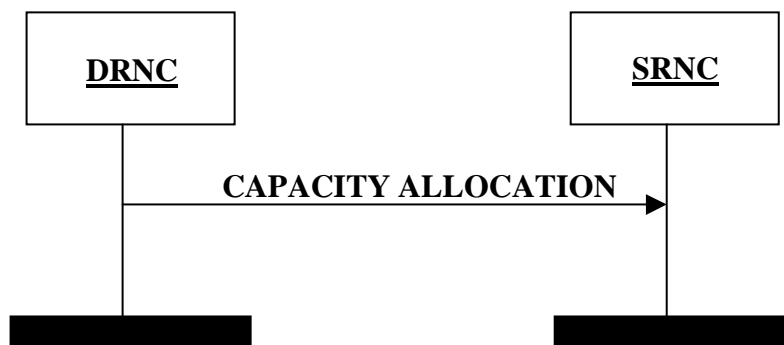

Figure 6C: HS-DSCH Capacity Allocation procedure

HS-DSCH Capacity Allocation procedure is generated within the DRNC. It may be generated either in response to a HS-DSCH Capacity Request or at any other time.

The DRNC may use this message to modify the capacity at any time, irrespective of the reported user buffer status.

The HS-DSCH CAPACITY ALLOCATION frame is used by the DRNC to control the user data flow. *HS-DSCH Credits* IE indicates the number of MAC-d PDUs that the SRNC is allowed to transmit for the MAC-d flow and the associated priority level indicated by the *Common Transport Channel Priority Indicator* IE.

The *Maximum MAC-d PDU length*, *HS-DSCH Credits*, *HS-DSCH Interval* and *HS-DSCH Repetition Period* IEs indicates the total amount of capacity granted. Any capacity previously granted is replaced.

If *HS-DSCH Credits* IE = 0 (e.g. due to congestion in the DRNC), the SRNC shall immediately stop transmission of MAC-d PDUs. If *HS-DSCH Credits* IE = 2047, the SRNC can transmit MAC-d PDUs with unlimited capacity.

The IEs used in the HS-DSCH CAPACITY ALLOCATION Control Frame are the *Common Transport Channel Priority Indicator*, *HS-DSCH Credits*, *Maximum MAC-d PDU Length*, *HS-DSCH Interval* and the *HS-DSCH Repetition Period*.

If the *Repetition Period* IE = "unlimited repetition period" it indicates that the SRNC may transmit the specified number of MAC-d PDUs for an unlimited period according to the bounds of *Maximum MAC-d PDU Length*, *HS-DSCH Credits* and *HS-DSCH Interval* IEs.

5.3 General

5.3.1 DSCH / [TDD – USCH] transport bearer replacement

As described in RNSAP [8], transport bearer replacement can be achieved for a DSCH [TDD – or USCH] by using the Synchronised Radio Link Reconfiguration Preparation procedure in combination with the Synchronised Radio Link Reconfiguration Commit procedure. In both cases the following steps can be discerned:

- 1) The new transport bearer is established after which 2 transport bearers exist in parallel.
- 2) The transport channel(s) is/are switched to the new transport bearer.
- 3) The old transport bearer is released.

In step 1), communication on the old transport bearer continues as normal.

In step 2), the moment of switching is determined as follows:

- The DSCH DATA FRAMEs [TDD – or USCH DATA FRAMEs] shall be transported on the new transport bearer from the CFN indicated in the RADIO LINK RECONFIGURATION COMMIT message.

Starting from this CFN the RNCs shall support all the applicable Common Transport Channels frame protocol procedures on the new transport bearer and no requirements exist regarding support of Common Transport Channels frame protocol procedures on the old transport bearer.

Finally in step 3), the old transport bearer is released.

6 Frame Structure and Coding

6.1 General

The general structure of a Common Transport Channel frame consists of a header and a payload. This structure is depicted in the figure 7.

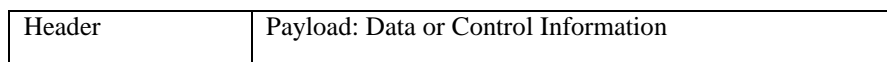

Figure 7: General Frame Structure

The header shall contain the frame type field and information related to the frame type.

There are two types of frames (indicated by the Frame Type field).

1. Data frame.
2. Control frame.

In the present document the structure of frames will be specified by using pictures similar to the following figure 8.

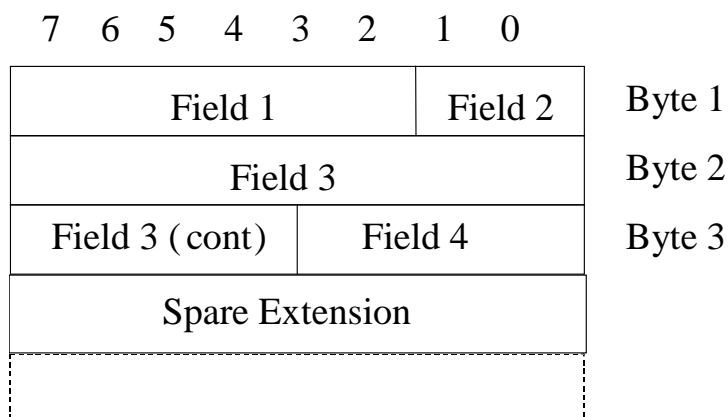

Figure 8: Example frame structure

Unless otherwise indicated, fields which consist of multiple bits within a byte will have the more significant bit located at the higher bit position (indicated above frame in figure 8). In addition, if a field spans several bytes, more significant bits will be located in lower numbered bytes (right of frame in figure 8).

On the Iur interface, the frame will be transmitted starting from the lowest numbered byte. Within each byte, the bits are sent according decreasing bit position (bit position 7 first).

The Spare Extension indicates the location where new IEs can in the future be added in a backward compatible way.

The Spare Extension shall not be used by the transmitter and shall be ignored by the receiver.

Spare bits shall be set to 0 by the transmitter and shall be ignored by the receiver.

The parameters are specified giving the value range and the step (if not 1). The coding is done as follows (unless otherwise specified):

- Lowest value (in the range) coded as a sequence of 0's;
- Highest value in the range coded as a sequence of 1's.

6.2 Data Frame structure

6.2.1 RACH/CPCH[FDD] Channels

RACH/CPCH[FDD] Iur data stream corresponds to the data stream of one specific UE. The used transport bearer for the transport of FACH/RACH or FACH/CPCH[FDD] is bi-directional.

The RACH/CPCH[FDD]/FACH FP does not facilitate multiplexing of data streams from different UEs onto the same data frame, but does allow multiple UEs to share the same transport bearer.

The RACH DATA FRAME structure is defined as common for FDD and TDD with conditional fields, and CPCH[FDD] DATA FRAME structure is defined as common for FDD only.

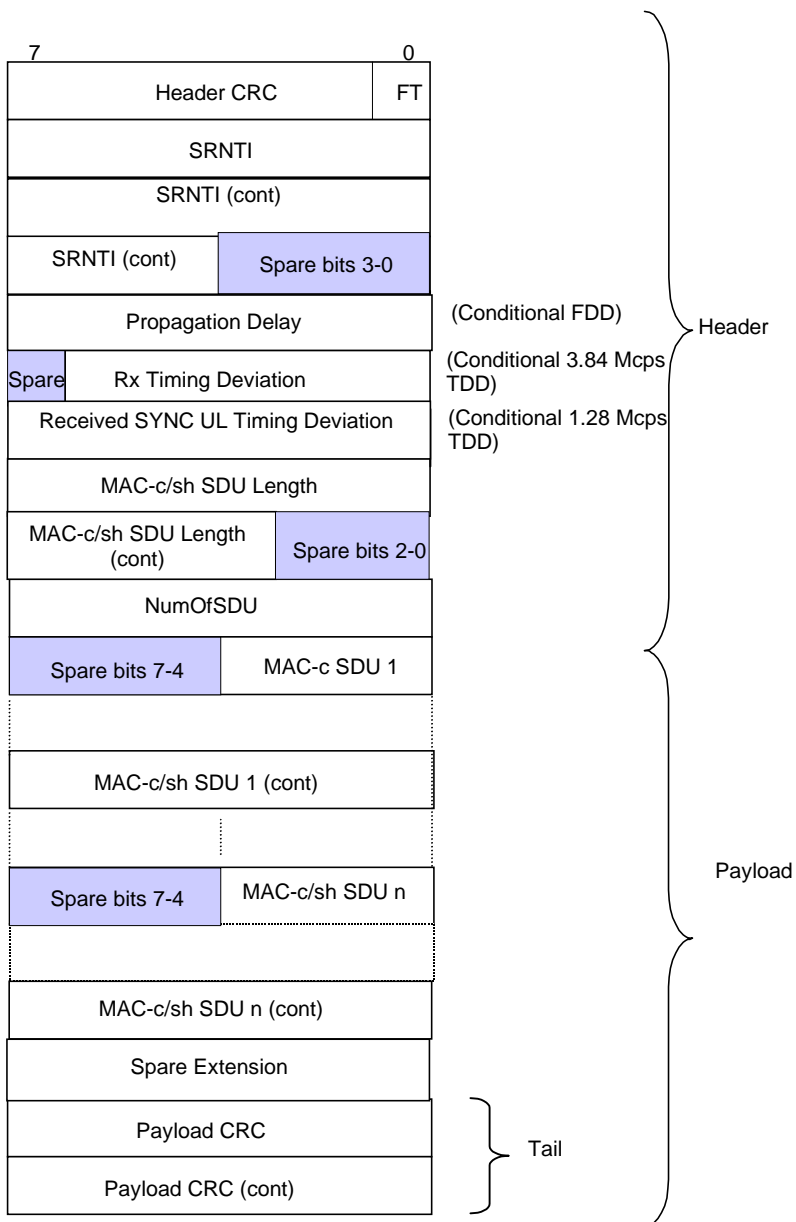

Figure 9: RACH/CPCH[FDD] DATA FRAME structure

Propagation delay is a conditional Information Element which is only present when the Cell supporting the RACH/CPCH[FDD] Transport Channel is a FDD Cell.

Rx Timing Deviation is a conditional Information Element which is only present when the Cell supporting the RACH Transport Channel is a 3.84 Mcps TDD Cell.

Received SYNC UL Timing Deviation is a conditional Information Element which is only present when the Cell supporting the RACH Transport Channel is a 1.28 Mcps TDD Cell.

6.2.2 FACH Channels

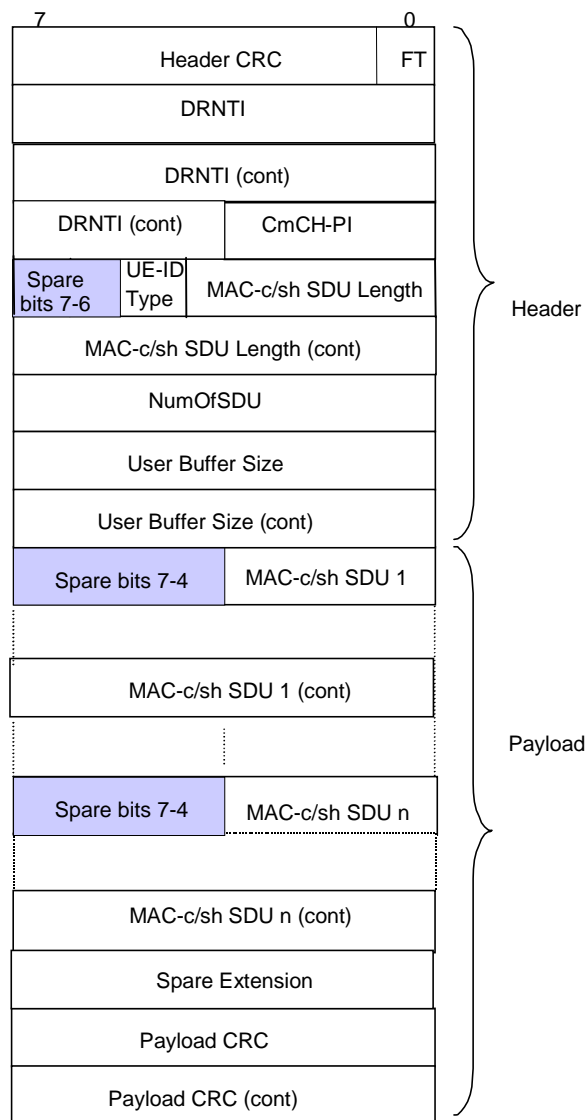

Figure 10: FACH DATA FRAME structure

6.2.3 USCH Channels [TDD]

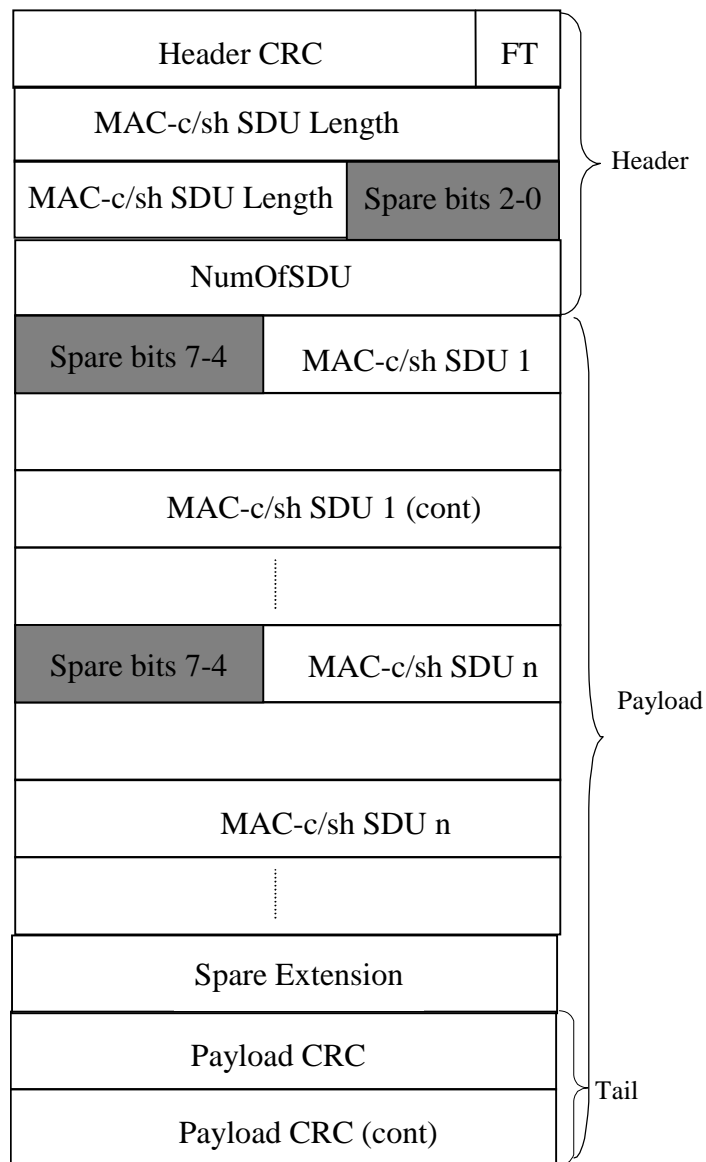

Figure 11: USCH DATA FRAME structure

6.2.4 DSCH Channels

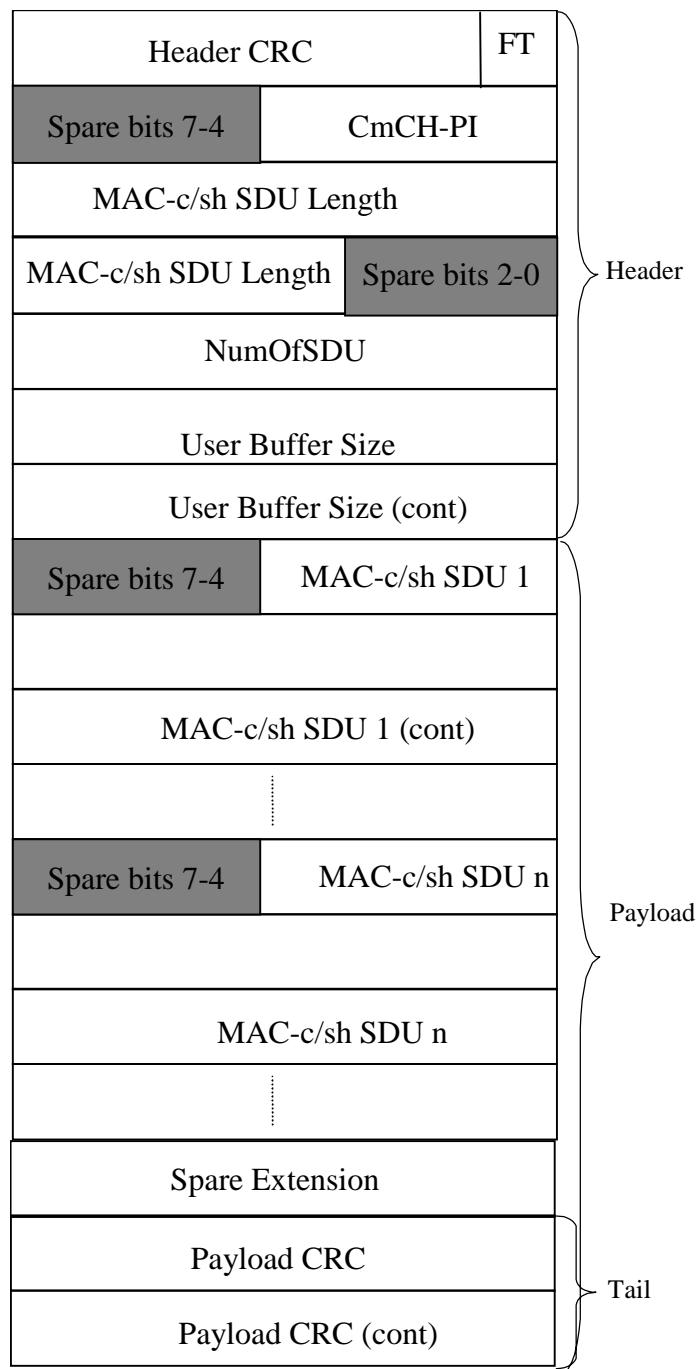

Figure 12: DSCH DATA FRAME structure

6.2.4A HS-DSCH Channels

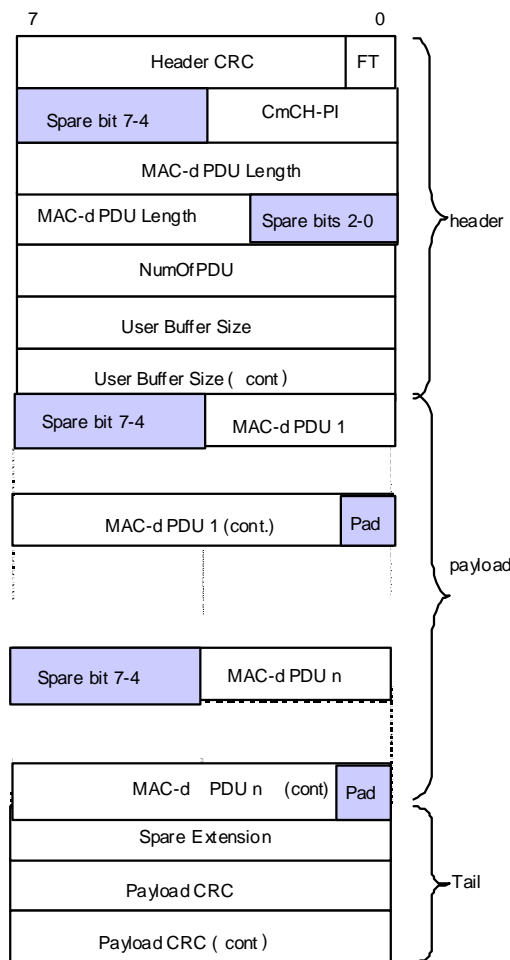

Figure 12A: HS-DSCH DATA FRAME structure

6.2.5 Coding of Information Elements in DATA FRAMES

6.2.5.1 Header CRC

Description: Cyclic Redundancy Checksum calculated on the header of a data frame with polynomial $X^7+X^6+X^2+1$. The CRC calculation shall cover all bits in the header, starting from bit 0 in the first byte (FT field) up to the end of the header.

Value range: {0-127}.

Field length: 7 bits.

6.2.5.2 Frame Type (FT)

Description: Describes if it is a control frame or a data frame.

Value range: {0=data, 1=control}.

Field Length: 1 bit.

6.2.5.3 DRNTI

Description: Identifies the UE in the DRNC.

Value range: {0-1048575}.

Field length: 20 bits.

6.2.5.4 S-RNTI

Description: S-RNTI is defined in [5]. S-RNTI is used in UL control frames to identify the UE context in the SRNC.

Value range: {0-1048575}.

Field length: 20 bits.

6.2.5.5 UE-ID Type Indicator (UE-ID Type)

Description: Indicates the UE Identifier Type to be included by MAC-c/sh in the MAC header.

Value range: {0=U-RNTI, 1=C-RNTI}.

Field Length: 1 bit.

6.2.5.6 S-CCPCH Indicator (S-CI)

Void.

6.2.5.7 Common Transport Channel Priority Indicator (CmCH-PI)

Description: CmCH-PI is the relative priority of the data frame and the SDUs included.

Value range: {0-15, where 0=lowest priority, 15=highest priority}.

Field length: 4 bits.

6.2.5.8 MAC-c/sh SDU Length

Description: The value of that field indicates the length of every MAC-c/sh SDU in the payload of the FACH, DSCH and [TDD - USCH] DATA FRAME in number of bits.

Value range: {0-5000}.

Field Length: 13 bits.

6.2.5.9 NumOfSDU

Description: Indicates the number of MAC-c/sh SDUs in the payload.

Value range: {1-255}.

Field Length: 8 bits.

6.2.5.10 Propagation delay [FDD]

Description: One-way air interface delay as measured during RACH access.

Value range: {0 - 765 chips}.

Granularity: 3 chips.

Field length: 8 bits.

6.2.5.11 Rx Timing Deviation [3.84Mcps TDD]

Description: Measured Rx Timing Deviation as a basis for timing advance.

Value range: {-256, ..., +256} chips

$$\{N*4 - 256\} \text{ chips} \leq \text{RxTiming Deviation} < \{(N+1)*4 - 256\} \text{ chips}$$

With $N = 0, 1, \dots, 127$

Granularity: 4 chips.

Field length: 7 bits.

6.2.5.11A Received SYNC UL Timing Deviation [1.28Mcps TDD]

Description: Measured Received SYNC UL Timing Deviation as a basis for propagation delay.

Value range: {0, ..., +256} chips

Granularity: 1 chip.

Field length: 8 bits.

6.2.5.12 User Buffer Size

Description: Indicates the users' buffer size (i.e. the amount of data in the buffer) in octets for a given Common Transport Channel Priority Indicator level.

Value range: {0-65535}.

Field length: 16 bits.

6.2.5.13 MAC-c/sh SDU

Description: A MAC-c/sh SDU contains the *C/T* IE field [7] of the MAC header followed by one RLC PDU. Field length: See the value of the *MAC-c/sh SDU Length* IE.

6.2.5.14 Payload CRC

Description: Cyclic Redundancy Checksum calculated on the payload of a data frame with polynomial $X^{16}+X^{15}+X^2+1$. The CRC calculation shall cover all bits in the data frame payload, starting from bit 7 in the first byte up to bit 0 in the byte before the payload CRC.

Field length: 16 bits.

6.2.5.15 Spare Extension

Description: Indicates the location where new IEs can in the future be added in a backward compatible way.

Field length: 0-32 octets.

6.2.5.16 MAC-d PDU Length

Description: The value of that field indicates the length of every MAC-d PDU in the payload of the HS-DSCH DATA FRAME in number of bits.

Value range: {0-5000}.

Field Length: 13 bits.

6.2.5.17 NumOfPDU

Description: Indicates the number of MAC-d PDUs in the payload.

Value range: {1-255}.

Field Length: 8 bits.

6.2.5.18 MAC-d PDU

Description: A MAC-d PDU contains the MAC-d PDU as defined in [9].

Field length: See the value of the *MAC-d PDU Length* IE.

6.3 Control Frame structure

6.3.1 Introduction

Control Frames are used to transport control information between SRNC and DRNC.

Figure 13 defines the Control Frame structure for common transport channels.

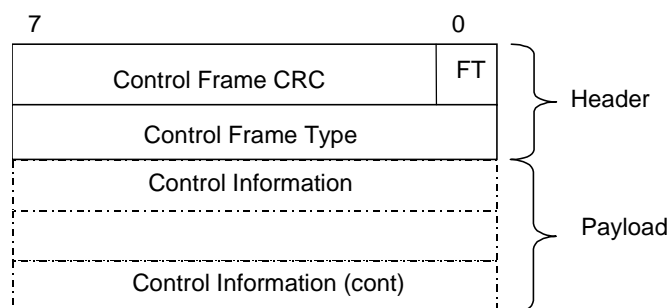

Figure 13: Iur Common Transport Channel Control Frame Format

The *Control Frame Type* IE defines the type of the control frames.

The length of the payload is variable accordingly to the control frame type.

The structure of the header and the payload of the control frames is defined in the following subclauses.

6.3.2 Header structure of the control frames

6.3.2.1 Control frame CRC

Description: Cyclic Redundancy Checksum calculated on a control frame with polynomial $X^7+X^6+X^2+1$. The CRC calculation shall cover all bits in the control frame, starting from bit 0 in the first byte (FT field) up to the end of the control frame.

Value range: {0-127}.

Field length: 7 bits.

6.3.2.2 Frame type (FT)

Refer to subclause 6.2.5.2.

6.3.2.3 Control Frame Type

Description: Indicates the type of the control information (information elements and length) contained in the payload (=type of control frame).

Value: values of the *Control Frame Type* IE parameter are defined in the table 1.

Table 1: Control Frame Type

Type of control frame	Value
FACH Flow Control	0000 0010
FACH Capacity Request	0000 0011
DSCH Capacity Request	0000 0100
DSCH Capacity Allocation	0000 0101
HS-DSCH Capacity Request	0000 1010
HS-DSCH Capacity Allocation	0000 1011

6.3.3 Payload structure and information elements

6.3.3.1 FACH FLOW CONTROL

Figure 14 shows the payload structure when the control frame is used for the above mentioned purpose. This control information is sent in the UL only.

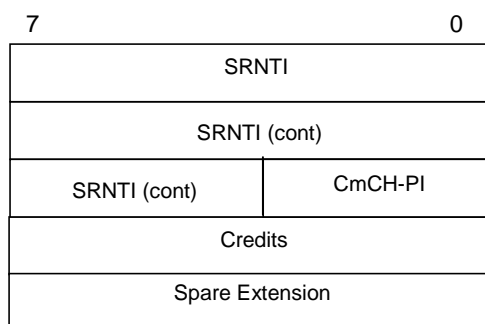
**Figure 14: FACH FLOW CONTROL payload structure**

6.3.3.1.1 S-RNTI

Refer to subclause 6.2.5.4.

6.3.3.1.2 Common Transport Channel Priority Indicator (CmCH-PI)

Refer to subclause 6.2.5.7.

6.3.3.1.3 Credits

Description: The *Credits* IE indicates the number of MAC-c/sh SDUs that a user may transmit.

Value range: {0-255, where 0=stop transmission, 255=unlimited}.

Field length: 8 bits.

6.3.3.1.4 Spare Extension

Description: Indicates the location where new IEs can in the future be added in a backward compatible way.

Field length: 0-32 octets.

6.3.3.2 DSCH CAPACITY REQUEST

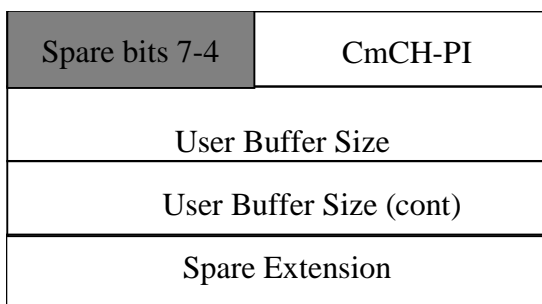

Figure 15: CAPACITY REQUEST payload structure

DSCH Capacity Request is sent for each priority group to indicate the user buffer size. The control frame is sent by the SRNC when the SRNC considers the user buffer status needs an increased buffer reporting frequency. This may be sent to signal an event, such as, data arrival or user-buffer discard. This control frame is used to improve user-buffer reporting above the level produced by the user-buffer reporting associated with the DSCH DATA FRAMES.

6.3.3.2.1 Common Transport Channel Priority Indicator (CmCH-PI)

Refer to subclause 6.2.5.7.

6.3.3.2.2 User Buffer Size

Refer to subclause 6.2.5.12.

6.3.3.2.3 Spare Extension

Refer to subclause 6.3.3.1.4.

6.3.3.3 DSCH CAPACITY ALLOCATION

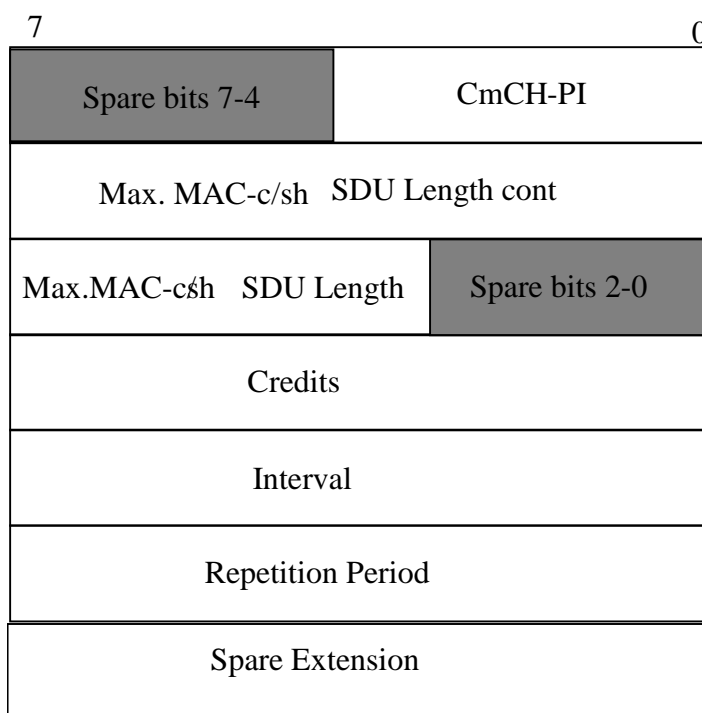

Figure 16: CAPACITY ALLOCATION payload structure

The CAPACITY ALLOCATION Control Frame describes an allocation that the SRNC may use. When the *Credits* IE has a value of 0 it signifies that there is no resources allocated for transmission and to thus stop transmission. When the *Credits* IE has a value of 255, it signifies unlimited capacity for transmission of SDUs. When the *Repetition Period* IE has a value of 0, it signifies that the allocation (*Maximum MAC-c/sh SDU Length*, *Credits* and *Interval* IEs) can be repeated without limit.

6.3.3.3.1 Common Transport Channel Priority Indicator (CmCH-PI)

Refer to subclause 6.2.5.7.

6.3.3.3.2 Maximum MAC-c/sh SDU Length

Description: The values indicated the maximum allowable SDU size. MAC-c/sh SDU contains the C/T field of the MAC header followed by one RLC PDU.

Field length: See the value of the *MAC-c/sh SDU Length* IE.

6.3.3.3.3 Credits

Description: The *Credits* IE indicates the number of MAC-c/sh SDUs that a SRNC may transmit during one Interval granted in the DSCH CAPACITY ALLOCATION Control Frame.

Value range: Refer to subclause 6.3.3.1.3.

Field Length: Refer to subclause 6.3.3.1.3.

6.3.3.3.4 Interval

Description: The value of this field indicates the time interval during which the *Credits* granted in the DSCH CAPACITY ALLOCATION Control Frame may be used. The first interval starts immediately after reception of the DSCH CAPACITY ALLOCATION control frame, subsequent intervals start immediately after the previous interval has elapsed. This value is only applied to the DSCH transport channel.

Value range: {0-2550 ms}. Value 0 shall be interpreted that none of the credits shall be used.

Granularity: 10ms.

Field Length: 8 bits.

6.3.3.3.5 Repetition Period

Description: The value of this field indicates the number of subsequent intervals that the *Credits* IE granted in the DSCH CAPACITY ALLOCATION Control Frame may be used. These values represent an integer number of Intervals (see subclause 6.3.3.3.4). This field is only applied to the DSCH transport channel.

Value range: {0-255, where 0= unlimited repetition period}.

Field Length: 8 bits.

6.3.3.3.6 Spare Extension

Refer to subclause 6.3.3.1.4.

6.3.3.4 FACH CAPACITY REQUEST

Figure 17 shows the payload structure when the control frame is used for the above mentioned purpose. This control information is sent in the DL only.

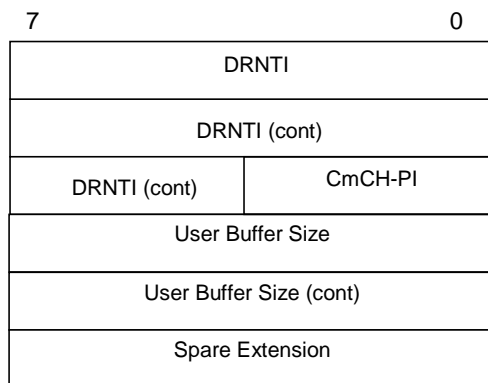

Figure 17: FACH CAPACITY REQUEST payload structure

6.3.3.4.1 D-RNTI

Refer to subclause 6.2.5.3.

6.3.3.4.2 Common Transport Channel Priority Indicator (CmCH-PI)

Refer to subclause 6.2.5.7.

6.3.3.4.3 User Buffer Size

Refer to subclause 6.2.5.12.

6.3.3.4.4 Spare extension

Refer to subclause 6.3.3.1.4.

6.3.3.5 HS-DSCH CAPACITY REQUEST

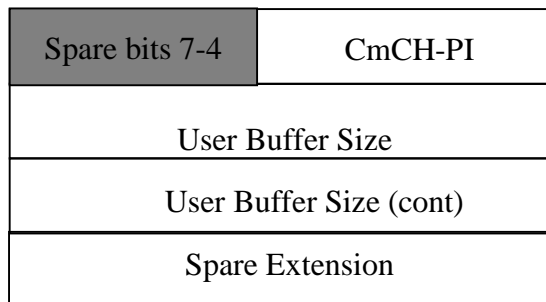

Figure 18: CAPACITY REQUEST payload structure

HS-DSCH Capacity Request is sent for each priority group to indicate the user buffer size. The control frame is sent by the HS-DSCH CAPACITY REQUEST is sent for each priority group to indicate the user buffer size. The control frame is sent by the SRNC when the SRNC considers the user buffer status needs an increased buffer reporting frequency. This may be sent to signal an event, such as, data arrival or user-buffer discard. This control frame is used to improve user-buffer reporting above the level produced by the user-buffer reporting associated with the HS-DSCH DATA FRAMEs.

6.3.3.5.1 Common Transport Channel Priority Indicator (CmCH-PI)

Description: CmCH-PI, configured via the Scheduling Priority Indicator in RNSAP [8], is the relative priority of the data frame and the SDUs included.

Value range: {0-15, where 0=lowest priority, 15=highest priority}.

Field length: 4 bits.

6.3.3.5.2 User Buffer Size

Refer to subclause 6.2.5.12.

6.3.3.5.3 Spare Extension

Refer to subclause 6.3.3.1.4.

6.3.3.6 HS-DSCH CAPACITY ALLOCATION

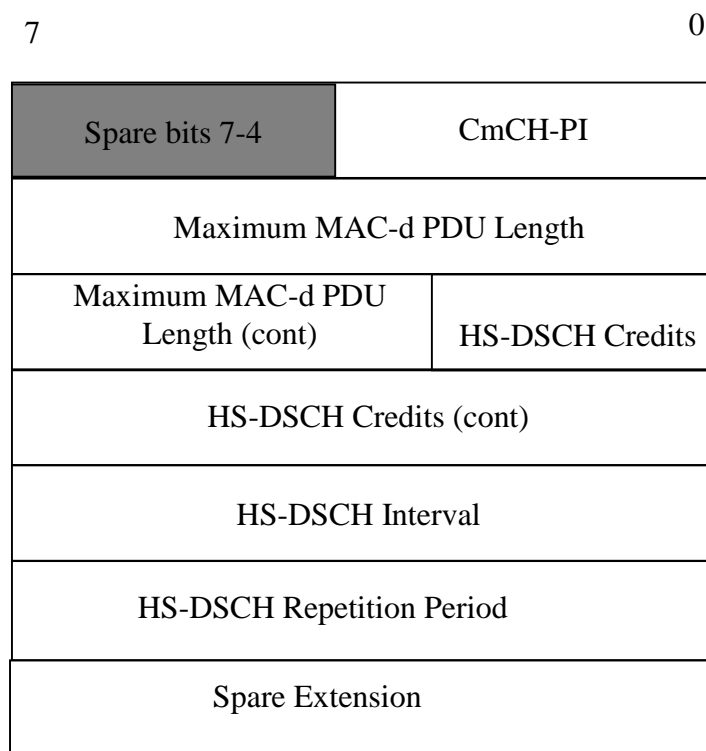

Figure 19: CAPACITY ALLOCATION payload structure

The CAPACITY ALLOCATION Control Frame describes an allocation that the SRNC may use. When the *HS-DSCH Credits* IE has a value of 0 it signifies that there is no resources allocated for transmission and to thus stop transmission. When the *HS-DSCH Credits* IE has a value of 2047, it signifies unlimited capacity for transmission of PDUs. When the *HS-DSCH Repetition Period* IE has a value of 0, it signifies that the allocation (*Maximum MAC-d PDU Length*, *HS-DSCH Credits* and *HS-DSCH Interval* IEs) can be repeated without limit.

6.3.3.6.1 Common Transport Channel Priority Indicator (CmCH-PI)

Refer to subclause 6.2.5.7.

6.3.3.6.2 Maximum MAC-d PDU Length

Description: The value indicates the maximum allowable PDU size among the MAC-d PDU sizes configured via RNSAP [8].

Value range: Refer to subclause 6.2.5.16.

Field length: Refer to subclause 6.2.5.16.

6.3.3.6.3 HS-DSCH Credits

Description: The *HS-DSCH Credits* IE indicates the number of MAC-d PDUs that a SRNC may transmit during one HS-DSCH Interval granted in the HS-DSCH CAPACITY ALLOCATION Control Frame.

Value range: {0-2047, where 0=stop transmission, 2047=unlimited}.

Field length: 11 bits.

6.3.3.6.4 HS-DSCH Interval

Description: The value of this field indicates the time interval during which the *HS-DSCH Credits* IE granted in the HS-DSCH CAPACITY ALLOCATION Control Frame may be used. The first interval starts immediately after reception of the HS-DSCH CAPACITY ALLOCATION control frame, subsequent intervals start immediately after the previous interval has elapsed. This value is only applied to the HS-DSCH transport channel.

Value range: Refer to subclause 6.3.3.3.4.

Granularity: Refer to subclause 6.3.3.3.4.

Field Length: Refer to subclause 6.3.3.3.4.

6.3.3.6.5 HS-DSCH Repetition Period

Description: The value of this field indicates the number of subsequent intervals that the *HS-DSCH Credits* IE granted in the HS-DSCH CAPACITY ALLOCATION Control Frame may be used. These values represent an integer number of Intervals (see subclause 6.3.3.6.4). This field is only applied to the HS-DSCH transport channel.

Value range: Refer to subclause 6.3.3.3.5.

Field Length: Refer to subclause 6.3.3.3.5.

6.3.3.6.8 Spare Extension

Refer to subclause 6.3.3.1.4.

7 Handling of Unknown, Unforeseen and Erroneous Protocol Data

7.1 General

A Frame Protocol frame with an unknown IE or an illegal IE value shall be ignored.

Annex A (informative): Change history

Change history					
TSG RAN#	Version	CR	Tdoc RAN	New Version	Subject/Comment
RAN_06	-	-	RP-99757	3.0.0	Approved at TSG RAN #6 and placed under Change Control
RAN_07	3.0.0	-	-	3.1.0	Approved at TSG RAN #7
RAN_08	3.1.0	-	RP-000246	3.2.0	Approved at TSG RAN #8
RAN_10	3.2.0	018 019 021	RP-000623	3.3.0	Approved at TSG RAN #10
RAN_11	3.3.0	022 024 026 028	RP-010120	3.4.0	Approved at TSG RAN #11

Change history							
Date	TSG #	TSG Doc.	CR	Rev	Subject/Comment	Old	New
March 01	11	RP-010162	025		Approved at TSG RAN #11 and placed under Change Control	-	4.0.0
March 01	11	RP-010164	023		Approved at TSG RAN #11 and placed under Change Control	-	4.0.0
09/2001	13	RP-010585	033	2	General Corrections on Common Transport Channel Data Streams	4.0.0	4.1.0
09/2001	13	RP-010597	030		Correction on RACH data frame in Iur interface	4.0.0	4.1.0
12/2001	14	RP-010858	037	1	Description of CRC	4.1.0	4.2.0
12/2001	14	RP-010858	039		Specification Notations	4.1.0	4.2.0
12/2001	14	RP-010858	041	2	Transport Bearer replacement for the DSCH	4.1.0	4.2.0
12/2001	14	RP-010858	043	1	Extension of USCH and DSCH data and control frames	4.1.0	4.2.0
02/2002	15	RP-020172	046		Transport Bearer replacement for the USCH	4.2.0	4.3.0
02/2002	15	RP-020190	044	2	HSDPA Frame Protocol-25.425	4.3.0	5.0.0
06/2002	16	RP-020422	050	1	HS-DSCH Initial credits	5.0.0	5.1.0
06/2002	16	RP-020422	051	1	Maximum number of credits	5.0.0	5.1.0
09/2002	17	RP-020620	053		DSCH Initial Credits	5.1.0	5.2.0
12/2002	18	RP-020770	055	1	Clarification for the initial capacity allocation of HS-DSCH	5.2.0	5.3.0
12/2002	18	RP-020771	057	1	Clarification for the Maximum MAC-d PDU Length	5.2.0	5.3.0
03/2003	19	RP-030075	058		Clarification for the flow control	5.3.0	5.4.0
06/2003	20	RP-030331	061	2	Correction for the HS-DSCH frame structure	5.4.0	5.5.0
06/2003	20	RP-030327	062	1	Clarification of Capacity Allocation Interval Definition	5.4.0	5.5.0
12/2003	22	RP-030682	067	1	Spare Extension in Data frame	5.5.0	5.6.0
03/2004	23	RP-040073	068		Common Transport Channel Priority Indicator for HSDPA	5.6.0	5.7.0

History

Document history		
V5.0.0	March 2002	Publication
V5.1.0	June 2002	Publication
V5.2.0	September 2002	Publication
V5.3.0	December 2002	Publication
V5.4.0	March 2003	Publication
V5.5.0	June 2003	Publication
V5.6.0	December 2003	Publication
V5.7.0	March 2004	Publication