

ETSI TS 127 007 V15.9.0 (2022-08)



**Digital cellular telecommunications system (Phase 2+) (GSM);
Universal Mobile Telecommunications System (UMTS);
LTE;
5G;
AT command set for User Equipment (UE)
(3GPP TS 27.007 version 15.9.0 Release 15)**



Reference

RTS/TSGC-0127007vf90

Keywords

5G,GSM,LTE,UMTS

ETSI

650 Route des Lucioles
F-06921 Sophia Antipolis Cedex - FRANCE

Tel.: +33 4 92 94 42 00 Fax: +33 4 93 65 47 16

Siret N° 348 623 562 00017 - APE 7112B
Association à but non lucratif enregistrée à la
Sous-Préfecture de Grasse (06) N° w061004871

Important notice

The present document can be downloaded from:

<http://www.etsi.org/standards-search>

The present document may be made available in electronic versions and/or in print. The content of any electronic and/or print versions of the present document shall not be modified without the prior written authorization of ETSI. In case of any existing or perceived difference in contents between such versions and/or in print, the prevailing version of an ETSI deliverable is the one made publicly available in PDF format at www.etsi.org/deliver.

Users of the present document should be aware that the document may be subject to revision or change of status.

Information on the current status of this and other ETSI documents is available at

<https://portal.etsi.org/TB/ETSIDeliverableStatus.aspx>

If you find errors in the present document, please send your comment to one of the following services:

<https://portal.etsi.org/People/CommitteeSupportStaff.aspx>

If you find a security vulnerability in the present document, please report it through our
Coordinated Vulnerability Disclosure Program:

<https://www.etsi.org/standards/coordinated-vulnerability-disclosure>

Notice of disclaimer & limitation of liability

The information provided in the present deliverable is directed solely to professionals who have the appropriate degree of experience to understand and interpret its content in accordance with generally accepted engineering or other professional standard and applicable regulations.

No recommendation as to products and services or vendors is made or should be implied.

No representation or warranty is made that this deliverable is technically accurate or sufficient or conforms to any law and/or governmental rule and/or regulation and further, no representation or warranty is made of merchantability or fitness for any particular purpose or against infringement of intellectual property rights.

In no event shall ETSI be held liable for loss of profits or any other incidental or consequential damages.

Any software contained in this deliverable is provided "AS IS" with no warranties, express or implied, including but not limited to, the warranties of merchantability, fitness for a particular purpose and non-infringement of intellectual property rights and ETSI shall not be held liable in any event for any damages whatsoever (including, without limitation, damages for loss of profits, business interruption, loss of information, or any other pecuniary loss) arising out of or related to the use of or inability to use the software.

Copyright Notification

No part may be reproduced or utilized in any form or by any means, electronic or mechanical, including photocopying and microfilm except as authorized by written permission of ETSI.

The content of the PDF version shall not be modified without the written authorization of ETSI.

The copyright and the foregoing restriction extend to reproduction in all media.

© ETSI 2022.
All rights reserved.

Intellectual Property Rights

Essential patents

IPRs essential or potentially essential to normative deliverables may have been declared to ETSI. The declarations pertaining to these essential IPRs, if any, are publicly available for **ETSI members and non-members**, and can be found in ETSI SR 000 314: "*Intellectual Property Rights (IPRs); Essential, or potentially Essential, IPRs notified to ETSI in respect of ETSI standards*", which is available from the ETSI Secretariat. Latest updates are available on the ETSI Web server (<https://ipr.etsi.org/>).

Pursuant to the ETSI Directives including the ETSI IPR Policy, no investigation regarding the essentiality of IPRs, including IPR searches, has been carried out by ETSI. No guarantee can be given as to the existence of other IPRs not referenced in ETSI SR 000 314 (or the updates on the ETSI Web server) which are, or may be, or may become, essential to the present document.

Trademarks

The present document may include trademarks and/or tradenames which are asserted and/or registered by their owners. ETSI claims no ownership of these except for any which are indicated as being the property of ETSI, and conveys no right to use or reproduce any trademark and/or tradename. Mention of those trademarks in the present document does not constitute an endorsement by ETSI of products, services or organizations associated with those trademarks.

DECT™, **PLUGTESTS™**, **UMTS™** and the ETSI logo are trademarks of ETSI registered for the benefit of its Members. **3GPP™** and **LTE™** are trademarks of ETSI registered for the benefit of its Members and of the 3GPP Organizational Partners. **oneM2M™** logo is a trademark of ETSI registered for the benefit of its Members and of the oneM2M Partners. **GSM®** and the GSM logo are trademarks registered and owned by the GSM Association.

Legal Notice

This Technical Specification (TS) has been produced by ETSI 3rd Generation Partnership Project (3GPP).

The present document may refer to technical specifications or reports using their 3GPP identities. These shall be interpreted as being references to the corresponding ETSI deliverables.

The cross reference between 3GPP and ETSI identities can be found under <http://webapp.etsi.org/key/queryform.asp>.

Modal verbs terminology

In the present document "**shall**", "**shall not**", "**should**", "**should not**", "**may**", "**need not**", "**will**", "**will not**", "**can**" and "**cannot**" are to be interpreted as described in clause 3.2 of the [ETSI Drafting Rules](#) (Verbal forms for the expression of provisions).

"**must**" and "**must not**" are **NOT** allowed in ETSI deliverables except when used in direct citation.

Contents

Intellectual Property Rights	2
Legal Notice	2
Modal verbs terminology.....	2
Foreword.....	10
1 Scope	11
2 References	11
3 Definitions and abbreviations.....	19
3.1 Definitions	19
3.2 Abbreviations	19
4 AT command syntax	20
4.0 General	20
4.1 Command line	20
4.2 Information responses and result codes.....	21
4.3 ITU-T Recommendation V.250 [14] TE-TA interface commands	21
5 General commands	22
5.0 General	22
5.1 Request manufacturer identification +CGMI	22
5.2 Request model identification +CGMM	23
5.3 Request revision identification +CGMR	23
5.4 Request product serial number identification +CGSN	24
5.5 Select TE character set +CSCS	25
5.6 Request international mobile subscriber identity +CIMI	26
5.7 Multiplexing mode +CMUX	27
5.8 ITU-T Recommendation V.250 [14] generic TA control commands.....	29
5.9 PCCA STD-101 [17] select wireless network +WS46.....	29
5.10 Request 5G subscription permanent identifier +CSUPI.....	31
5.11 Informative examples	31
6 Call control commands and methods	32
6.0 General	32
6.1 Select type of address +CSTA.....	32
6.2 ITU-T Recommendation V.250 [14] dial command D.....	33
6.3 Direct dialling from phonebooks.....	33
6.4 Call mode +CMOD	35
6.4A Voice call mode +CVMOD.....	35
6.5 Hangup call +CHUP.....	36
6.6 Alternating mode call control method	36
6.7 Select bearer service type +CBST	38
6.8 Radio link protocol +CRLP	40
6.9 Service reporting control +CR.....	41
6.10 Extended error report +CEER	42
6.11 Cellular result codes +CRC	43
6.12 HSCSD device parameters +CHSD	44
6.13 HSCSD transparent call configuration +CHST.....	45
6.14 HSCSD non-transparent call configuration +CHSN	46
6.15 HSCSD current call parameters +CHSC	47
6.16 HSCSD parameters report +CHSR	47
6.17 HSCSD automatic user initiated upgrading +CHSU.....	48
6.18 HSCSD non-transparent asymmetry configuration +CHSA	49
6.19 Single numbering scheme +CSNS	49
6.20 Voice hangup control +CVHU	50
6.21 CCITT V.120 [36] rate adaption protocol +CV120	51
6.22 Settings date format +CSDF.....	52

6.23	Silence command +CSIL.....	53
6.24	Settings time format +CSTF.....	54
6.25	ITU-T Recommendation V.250 [14] call control commands.....	55
6.26	ITU-T Recommendation V.250 [14] data compression commands.....	55
6.27	Initiate eCall +CECALL.....	55
6.28	eCall Notification +CECN.....	56
6.29	Informative examples.....	57
7	Network service related commands.....	58
7.0	General.....	58
7.1	Subscriber number +CNUM.....	58
7.2	Network registration +CREG.....	59
7.3	PLMN selection +COPS.....	61
7.4	Facility lock +CLCK.....	63
7.5	Change password +CPWD.....	65
7.6	Calling line identification presentation +CLIP.....	66
7.7	Calling line identification restriction +CLIR.....	67
7.8	Connected line identification presentation +COLP.....	68
7.9	Called line identification presentation +CDIP.....	69
7.10	Closed user group +CCUG.....	70
7.11	Call forwarding number and conditions +CCFC.....	71
7.12	Call waiting +CCWA.....	73
7.13	Call related supplementary services +CHLD.....	75
7.14	Call deflection +CTFR.....	75
7.15	Unstructured supplementary service data +CUSD.....	76
7.16	Advice of charge +CAOC.....	77
7.17	Supplementary service notifications +CSSN.....	78
7.18	List current calls +CLCC.....	80
7.19	Preferred PLMN list +CPOL.....	82
7.20	Selection of preferred PLMN list +CPLS.....	83
7.21	Read operator names +COPN.....	84
7.22	eMLPP priority registration and interrogation +CAEMLPP.....	84
7.23	eMLPP subscriptions +CPPS.....	85
7.24	Fast call setup conditions +CFCS.....	85
7.25	Automatic answer for eMLPP service +CAAP.....	86
7.26	User to user signalling service 1 +CUUS1.....	87
7.27	Preferred network indication +CPNET.....	88
7.28	Preferred network status +CPNSTAT.....	89
7.29	Current packet switched bearer +CPSB.....	90
7.30	Calling name identification presentation +CNAP.....	91
7.31	Connected line identification restriction status +COLR.....	92
7.32	Service specific access control restriction status +CSSAC.....	93
7.33	Network emergency (bearer) services support +CNEM.....	95
7.34	Enhanced closed user group +CECUG.....	96
7.35	Communication forwarding number and conditions with URI support +CCFCU.....	97
7.36	Message waiting indication control +CMWI.....	99
7.37	Session start and stop for MMTEL and SMSoverIP applications +CSCM.....	100
7.38	Power saving mode setting +CPSMS.....	101
7.39	Application Start and Stop indication for applications other than MMTEL and SMSoverIP +CACDC.....	102
7.40	eDRX setting +CEDRXS.....	103
7.41	eDRX read dynamic parameters +CEDRXRDP.....	105
7.42	CIoT optimization configuration +CCIOTOPT.....	105
7.43	Informative examples.....	107
8	Mobile termination control and status commands.....	108
8.0	General.....	108
8.1	Phone activity status +CPAS.....	109
8.2	Set phone functionality +CFUN.....	110
8.3	Enter PIN +CPIN.....	111
8.4	Battery charge +CBC.....	113
8.5	Signal quality +CSQ.....	113
8.6	Mobile termination control mode +CMEC.....	114

8.7	Keypad control +CKPD	115
8.8	Display control +CDIS	116
8.9	Indicator control +CIND	117
8.10	Mobile termination event reporting +CMER	118
8.11	Select phonebook memory storage +CPBS	121
8.12	Read phonebook entries +CPBR	122
8.13	Find phonebook entries +CPBF	123
8.14	Write phonebook entry +CPBW	126
8.15	Clock +CCLK	127
8.16	Alarm +CALA	128
8.17	Generic SIM access +CSIM	129
8.18	Restricted SIM access +CRSM	130
8.19	Secure control command +CSCC	131
8.20	Alert sound mode +CALM	132
8.21	Ringer sound level +CRSL	132
8.22	Vibrator mode +CVIB	133
8.23	Loudspeaker volume level +CLVL	134
8.24	Mute control +CMUT	134
8.25	Accumulated call meter +CACM	135
8.26	Accumulated call meter maximum +CAMM	135
8.27	Price per unit and currency table +CPUC	136
8.28	Call meter maximum event +CCWE	136
8.29	Power class +CPWC	137
8.30	Set language +CLAN	138
8.31	Language event +CLAE	139
8.32	Set greeting text +CSGT	139
8.33	Set voice mail number +CSVN	140
8.34	Ring melody control +CRMC	141
8.35	Ring melody playback +CRMP	142
8.36	Master reset +CMAR	142
8.37	List all available AT commands +CLAC	143
8.38	Delete alarm +CALD	143
8.39	Postpone or dismiss an alarm +CAPD	144
8.40	Automatic time zone update +CTZU	144
8.41	Time zone reporting +CTZR	145
8.42	Enter protocol mode +CPROT	146
8.43	Generic UICC logical channel access +CGLA	147
8.44	Restricted UICC logical channel access +CRLA	148
8.45	Open logical channel +CCHO	150
8.46	Close logical channel +CCHC	150
8.47	EAP authentication +CEAP	151
8.48	EAP retrieve parameters +CERP	153
8.49	UICC application discovery +CUAD	153
8.50	Mobile originated location request +CMOLR	154
8.51	Backlight +CBKLT	159
8.52	Command touch screen action +CTSA	159
8.53	Command screen orientation +CSO	161
8.54	Command screen size +CSS	163
8.54A	Command display screen boundary +CDSB	164
8.55	Positioning control +CPOS	164
8.56	Positioning reporting +CPOSR	182
8.57	Mobile terminated location request notification +CMTLR	183
8.58	Mobile terminated location request disclosure allowance +CMTLRA	185
8.59	Battery capacity +CBCAP	185
8.60	Battery connection status +CBCON	186
8.61	Battery charger status +CBCHG	187
8.62	Printing IP address format +CGPIAF	187
8.63	IMS single radio voice call continuity +CISRVCC	189
8.64	IMS network reporting +CIREP	189
8.65	Remaining PIN retries +CPINR	191
8.66	Set card slot +CSUS	192
8.67	Emergency numbers +CEN	192

8.68	Availability for voice calls with IMS +CAVIMS.....	193
8.69	Extended signal quality +CESQ.....	194
8.70	Primary notification event reporting +CPNER	197
8.71	IMS registration information +CIREG.....	198
8.72	Availability for SMS using IMS +CASIMS.....	199
8.73	Monitor of current calls +CMCCS	200
8.74	List of current calls +CLCCS	206
8.75	Supported radio accesses +CSRA	209
8.76	Circuit switched fallback +CCSFB	211
8.77	Reading coverage enhancement status +CRCES	213
8.78	Application level measurement configuration +CAPPLEVMC.....	214
8.79	Application level measurement report +CAPPLEVMR.....	215
8.80	Informative examples	215
9	Mobile termination errors.....	219
9.1	Report mobile termination error +CMEE.....	219
9.1A	Report mobile originated location request error +CMOLRE	219
9.1B	Report network error codes +CNEC	220
9.2	Mobile termination error result code +CME ERROR	222
9.2.0	General.....	222
9.2.1	General errors	222
9.2.2	CS, GPRS, UMTS, EPS and 5GS-related errors	223
9.2.2.1	Errors related to a failure to perform an attach.....	223
9.2.2.1.1	Errors for CS, GPRS and UMTS	223
9.2.2.1.2	Errors for EPS	224
9.2.2.1.3	Errors for 5GS	224
9.2.2.2	Errors related to a failure to activate a context.....	225
9.2.2.2.1	Errors for GPRS and UMTS.....	225
9.2.2.2.2	Errors for EPS	227
9.2.2.2.3	Errors for 5GS	228
9.2.2.3	Void.....	228
9.2.2.4	Void.....	228
9.2.3	VBS, VGCS and eMLPP-related errors.....	228
9.3	Mobile termination error result code +CMOLRE	229
9.3.1	General.....	229
9.3.2	Errors	229
9.4	Informative examples	229
10	Commands for packet domain.....	230
10.0	General	230
10.1	Commands specific to MTs supporting the packet domain.....	230
10.1.0	General remark about EPS bearer contexts and PDP contexts	230
10.1.0.0	General remark about 5GS PDU sessions and EPS PDN connections	232
10.1.1	Define PDP context +CGDCONT	233
10.1.2	Define secondary PDP context +CGDSCONT.....	238
10.1.3	Traffic flow template +CGTFT	240
10.1.4	Quality of service profile (requested) +CGQREQ.....	243
10.1.5	Quality of service profile (minimum acceptable) +CGQMIN	245
10.1.6	3G quality of service profile (requested) +CGEQREQ	246
10.1.7	3G quality of service profile (minimum acceptable) +CGEQMIN.....	249
10.1.8	3G quality of service profile (negotiated) +CGEQNEG	253
10.1.9	PS attach or detach +CGATT	255
10.1.10	PDP context activate or deactivate +CGACT	255
10.1.11	PDP context modify +CGCMOD	256
10.1.12	Enter data state +CGDATA	257
10.1.13	Configure local octet stream PAD parameters +CGCLOSP (Obsolete).....	259
10.1.14	Show PDP address(es) +CGPADDR.....	259
10.1.15	Automatic response to a network request for PDP context activation +CGAUTO	260
10.1.16	Manual response to a network request for PDP context activation +CGANS	261
10.1.17	GPRS mobile station class +CGCLASS.....	262
10.1.18	Configure local triple-X PAD parameters +CGCLPAD (GPRS only) (Obsolete)	263
10.1.19	Packet domain event reporting +CGEREP	263

10.1.20	GPRS network registration status +CGREG	267
10.1.21	Select service for MO SMS messages +CGSMS.....	270
10.1.22	EPS network registration status +CEREG	271
10.1.23	PDP context read dynamic parameters +CGCONTRDP	274
10.1.24	Secondary PDP context read dynamic parameters +CGSCONTRDP	277
10.1.25	Traffic flow template read dynamic parameters +CGTFTRDP.....	278
10.1.26	Define EPS quality of service +CGEQOS	280
10.1.27	EPS quality of service read dynamic parameters +CGEQOSRDP	281
10.1.28	UE modes of operation for EPS +CEMODE.....	282
10.1.29	Delete non-active PDP contexts +CGDEL	283
10.1.30	Signalling connection status +CSCON.....	284
10.1.31	Define PDP context authentication parameters +CGAUTH.....	286
10.1.32	Initial PDP context activation +CIPCA	287
10.1.33	No more PS data +CNMPSD.....	288
10.1.34	UE's usage setting for EPS and 5GS +CEUS	288
10.1.35	UE's voice domain preference E-UTRAN +CEVDP.....	289
10.1.36	UE's voice domain preference UTRAN +CVDP	289
10.1.37	UE's mobility management IMS voice termination +CMMIVT	290
10.1.38	Power preference indication for EPS and 5GS +CEPPI.....	291
10.1.39	WLAN offload assistance data +CWLANOLAD.....	291
10.1.40	WLAN offload cell measurement +CWLANOLCM.....	294
10.1.41	APN back-off timer status reporting +CABTSR	294
10.1.42	APN back-off timer read dynamic parameters +CABTRDP	296
10.1.43	Sending of originating data via the control plane +CSODCP.....	297
10.1.44	Reporting of terminating data via the control plane +CRTDCP	299
10.1.45	APN rate control +CGAPNRC	300
10.1.46	PS data off status +CPSDO	301
10.1.47	5GS network registration status +C5GREG	301
10.1.48	Bandwidth preference indication +CBPI.....	304
10.1.49	Define 5GS quality of service +C5GQOS	304
10.1.50	5GS quality of service read dynamic parameters +C5GQOSRDP	306
10.1.51	Receive UE policy +CRUEPOLICY	307
10.1.52	Send UE policy +CSUEPOLICY	308
10.1.53	5GS access selection preference for MO SMS +C5GSMS.....	308
10.1.54	Mobile initiated connection only mode +CMICO	309
10.1.55	S-NSSAI based back-off timer status reporting +CSBTSR.....	310
10.1.56	S-NSSAI based back-off timer read dynamic parameters +CSBTRDP.....	311
10.1.57	S-NSSAI and DNN based back-off timer status reporting +CSDBTSR.....	311
10.1.58	S-NSSAI and DNN based back-off timer read dynamic parameters +CSDBTRDP	313
10.1.59	5GS use of SMS over NAS +C5GUSMS	313
10.1.60	Request LADN information +CRLADN	315
10.1.61	LADN information +CLADN	315
10.1.62	5GS NSSAI setting +C5GNSSAI.....	316
10.1.63	5GS NSSAI read dynamic parameters +C5GNSSAIRDP	317
10.1.64	5GS Preferred NSSAI +C5GPNSSAI	319
10.2	Modem compatibility commands	320
10.2.0	General.....	320
10.2.1	MT originated PDP context activation.....	320
10.2.1.0	General	320
10.2.1.1	Request packet domain service 'D'	321
10.2.1.2	Request packet domain IP service 'D'	322
10.2.2	Network requested PDP context activation	323
10.2.2.0	General	323
10.2.2.1	Automatic response to a network request for PDP context activation 'S0'	323
10.2.2.2	Manual acceptance of a network request for PDP context activation 'A'	323
10.2.2.3	Manual rejection of a network request for PDP context activation 'H'	323
11	Commands for VGCS and VBS	324
11.0	General	324
11.1	Commands specific to MTs supporting the VGCS and VBS	324
11.1.1	Accept an incoming voice group or voice broadcast call +CAJOIN	324
11.1.2	Reject an incoming voice group or voice broadcast call +CAREJ	325

11.1.3	Leave an ongoing voice group or voice broadcast call +CAHLD	325
11.1.4	Talker access for voice group call +CAPTT.....	326
11.1.5	Voice group call uplink status presentation +CAULEV	326
11.1.6	List current voice group and voice broadcast calls +CALCC.....	327
11.1.7	Voice group or voice broadcast call state attribute presentation +CACSP.....	328
11.1.8	NCH support indication +CANCHEV.....	329
11.1.9	Originator to dispatcher information +COTDI.....	330
11.1.10	Short data transmission during ongoing VGCS +CEPTT.....	331
11.1.11	Group Id prefixes capability +CGIPC	332
11.2	Modem compatibility commands	332
11.2.0	General.....	332
11.2.1	Request VGCS or VBS service 'D'	332
11.2.2	Termination of an voice group or voice broadcast call 'H'.....	333
11.3.1	VGCS subscriptions and GId status +CGCS	333
11.3.2	VBS subscriptions and GId status +CBCS	334
11.4	Informative examples	335
12	Commands for USIM application toolkit.....	335
12.1	General	335
12.2	Commands specific to MTs supporting USAT	336
12.2.1	Read USAT profile +CUSATR	336
12.2.2	Write USAT profile +CUSATW	336
12.2.3	Profile download upon start-up +CUSATD.....	337
12.2.4	Activate USAT profile +CUSATA.....	339
12.2.5	Send USAT terminal response +CUSATT	340
12.2.6	Send USAT envelope command +CUSATE	341
12.3	Informative examples	341
13	Commands for enhanced support of dialling.....	343
13.1	General	343
13.2	Commands for dialling.....	344
13.2.1	Dial URI +CDU	344
13.2.2	Dial URI from phonebook +CDUP	346
13.2.3	Hangup of current calls +CHCCS.....	348
13.2.4	Define media profile +CDEFMP	349
13.2.5	Control and modify media description +CCMMD	350
13.3	Informative examples	351
14	Commands for eMBMS configuration.....	355
14.1	General	355
14.2	Commands specific to eMBMS.....	356
14.2.1	eMBMS configuration in MT +CEMBMSCFG	356
14.2.2	eMBMS status reporting in MT +CEMBMSR.....	356
14.2.3	eMBMS service configuration +CEMBMSSRV	357
14.2.4	Enter eMBMS data state +CEMBMSDATA.....	359
14.2.5	eMBMS counting procedure +CEMBMSCNT.....	359
14.2.6	eMBMS Service Area Identities +CEMBMSSAI.....	360
15	Commands for UE test functions	361
15.1	General	361
15.2	Activate test mode +CATM	361
15.3	Close UE test loop mode E +CCUTLE.....	362
15.4	UE sidelink packet counter request +CUSPCREQ	363
15.5	UTC time reset +CUTCR.....	364
15.6	Channel busy ratio request +CCBRREQ.....	364
15.7	V2X data transmission over PC5 +CV2XDTS	365
15.8	SPS assistance information request +CSPSAIR.....	366
Annex A (normative):	Summary of commands from other standards	367
Annex B (normative):	Summary of result codes	369
Annex C (informative):	Commands from TIA IS-101	372

C.1	Introduction	372
C.2	Commands	373
C.2.1	Select mode +FCLASS	373
C.2.2	Buffer threshold setting +VBT	373
C.2.3	Calling number ID presentation +VCID	374
C.2.4	Receive gain selection +VGR	374
C.2.5	Transmit gain selection +VGT	374
C.2.6	Initialise voice parameters +VIP	375
C.2.7	Inactivity timer +VIT	375
C.2.8	Line selection +VLS	375
C.2.9	Receive data state +VRX	377
C.2.10	Select compression method +VSM	377
C.2.11	DTMF and tone generation +VTS	378
C.2.12	Tone duration +VTD	378
C.2.13	Transmit data state +VTX	379
Annex D (informative):	Bibliography	380
Annex E (informative):	Mobile originated alternating voice/data call example.....	381
Annex F (informative):	Mobile terminated voice followed by data call example.....	382
Annex G (informative):	Voice call example.....	383
Annex H (informative):	Change history	384
History		393

Foreword

This Technical Specification (TS) has been produced by the 3rd Generation Partnership Project (3GPP).

The contents of the present document are subject to continuing work within the TSG and may change following formal TSG approval. Should the TSG modify the contents of the present document, it will be re-released by the TSG with an identifying change of release date and an increase in version number as follows:

Version x.y.z

where:

- x the first digit:
 - 1 presented to TSG for information;
 - 2 presented to TSG for approval;
 - 3 or greater indicates TSG approved document under change control.
- y the second digit is incremented for all changes of substance, i.e. technical enhancements, corrections, updates, etc.
- z the third digit is incremented when editorial only changes have been incorporated in the document.

1 Scope

The present document specifies a profile of AT commands and recommends that this profile be used for controlling Mobile Termination (MT) functions and network services from a Terminal Equipment (TE) through Terminal Adaptor (TA). The command prefix +C is reserved for Digital Cellular in ITU-T Recommendation V.250 [14]. The present document has also the syntax details used to construct extended commands. Commands from ITU-T Recommendation V.250 [14] and existing digital cellular standards (TIA IS-99 [15] and TIA IS-135 [16]) are used whenever applicable. Some of the new commands are defined such way that they can be easily applied to MT of other networks.

NOTE: The terms GSM and GSM/UMTS are used whenever appropriate for SIM/UICC GSM applications or GSM/UMTS bearer services or to represent specific mobile accesses covered by the present specification.

ITU-T Recommendation T.31 [11] and ITU-T Recommendation T.32 [12] fax AT commands may be used for GSM/UMTS fax transmission from TE. Short Message Service AT commands are defined in 3GPP TS 27.005 [24]. AT commands for packet systems are defined in clause 10 of this specification. The present document assumes an abstract architecture comprising a TE (e.g. a computer) and a MT interfaced by a TA (see figure 1). The span of control of the defined commands should allow handling of any physical implementation that this abstract architecture may lead to:

- TA, MT and TE as three separate entities;
- TA integrated under the MT cover, and the TE implemented as a separate entity;
- TA integrated under the TE cover, and the MT implemented as a separate entity; and
- TA and MT integrated under the TE cover as a single entity.

The commands described in the present document may be observed on the link between the TE and the TA. However, most of the commands retrieve information about the MT, not about the TA.

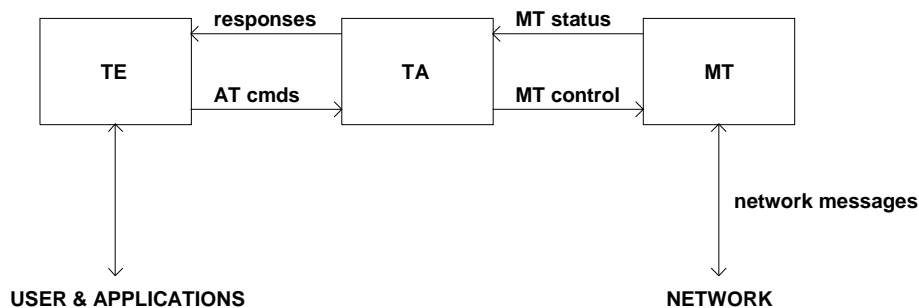

Figure 1: Setup

Interface between TE and TA is intended to operate over existing serial (ITU-T Recommendation V.24) cables, infrared link, and all link types with similar behaviour. For correct operation many of the defined commands require eight bit data and therefore it is recommended that TE-TA link is set to eight bits/ byte mode. (For infrared operation implementation, refer informative references IrDA. For embedding AT commands and data during on-line data state, refer TIA-617/ITU-T V.80.) Interface between TA and MT is dependent on the interface in the MT.

The functional blocks shown in figure 1, using AT commands, shall follow the principles described in the interactions handling framework 3GPP TS 23.227 [63].

2 References

The following documents contain provisions which, through reference in this text, constitute provisions of the present document.

- References are either specific (identified by date of publication, edition number, version number, etc.) or non-specific.

- For a specific reference, subsequent revisions do not apply.
- For a non-specific reference, the latest version applies. In the case of a reference to a 3GPP document (including a GSM document), a non-specific reference implicitly refers to the latest version of that document *in the same Release as the present document*.

- [1] 3GPP TS 22.002: "Bearer Services (BS) supported by a GSM Public Land Mobile Network (PLMN)".
- [2] 3GPP TS 22.003: "Teleservices supported by a GSM Public Land Mobile Network (PLMN)".
- [3] 3GPP TS 22.081: "Line identification supplementary services - Stage 1".
- [4] 3GPP TS 22.082: "Call Forwarding (CF) supplementary services - Stage 1".
- [5] 3GPP TS 22.083: "Call Waiting (CW) and Call Hold (HOLD) supplementary services - Stage 1".
- [6] 3GPP TS 22.088: "Call Barring (CB) supplementary services - Stage 1".
- [7] 3GPP TS 23.003: "Numbering, addressing and identification".
- [8] 3GPP TS 24.008: "Mobile Radio Interface Layer 3 specification; Core Network Protocols- Stage 3".
- [9] GSM MoU SE.13, GSM MoU Permanent Reference Document SE.13: "GSM Mobile Network Codes and Names".
- [10] ITU-T Recommendation E.212: "Identification plan for land mobile stations".
- [11] ITU-T Recommendation T.31: "Asynchronous facsimile DCE control, service class 1".
- [12] ITU-T Recommendation T.32: "Asynchronous facsimile DCE control, service class 2".
- [13] ITU-T Recommendation T.50: "International Reference Alphabet (IRA) (Formerly International Alphabet No. 5 or IA5) - Information technology - 7-bit coded character set for information exchange".
- [14] ITU-T Recommendation V.250: "Serial asynchronous automatic dialling and control".
- [15] TIA IS-99: "Data Services Option Standard for Wideband Spread Spectrum Digital Cellular System".
- [16] TIA IS-135: "800 MHz Cellular Systems, TDMA Services, Async Data and Fax".
- [17] PCCA STD-101 Data Transmission Systems and Equipment: "Serial Asynchronous Automatic Dialling and Control for Character Mode DCE on Wireless Data Services".
- [18] 3GPP TS 24.022: "Radio Link Protocol (RLP) for data and telematic services on the Mobile Station - Base Station System (MS - BSS) interface and the Base Station System - Mobile-services Switching Centre (BSS - MSC) interface".
- [19] 3GPP TS 22.030: "Man Machine Interface (MMI) of the Mobile Station (MS)".
- [20] 3GPP TS 45.008: "Radio subsystem link control".
- [21] 3GPP TS 22.085: "Closed User Group (CUG) supplementary services - Stage 1".
- [22] 3GPP TS 22.084: "MultiParty (MPTY) supplementary services - Stage 1".
- [23] 3GPP TS 22.090: "Unstructured Supplementary Service Data (USSD) - Stage 1".
- [24] 3GPP TS 27.005: "Use of Data Terminal Equipment - Data Circuit terminating Equipment (DTE - DCE) interface for Short Message Service (SMS) and Cell Broadcast Service (CBS)".
- [25] 3GPP TS 23.038: "Alphabet and language specific information".
- [26] 3GPP TS 22.024: "Description of Charge Advice Information (CAI)".

- [27] 3GPP TS 22.086: "Advice of Charge (AoC) supplementary services - Stage 1".
- [28] 3GPP TS 51.011: "Specification of the Subscriber Identity Module - Mobile Equipment (SIM-ME) interface".
- [29] 3GPP TS 22.034: "High Speed Circuit Switched Data (HSCSD) - Stage 1".
- [30] 3GPP TS 22.091: "Explicit Call Transfer (ECT) supplementary service - Stage 1".
- [31] 3GPP TS 22.072: "Call Deflection (CD) supplementary service - Stage 1".
- [32] ISO/IEC 10646: "Universal Multiple-Octet Coded Character Set (UCS)"; UCS2, 16 bit coding.
- [33] 3GPP TS 22.022: "Personalization of GSM Mobile Equipment (ME) Mobile functionality specification".
- [34] 3GPP TS 27.060: "General requirements on Mobile Stations (MS) supporting General Packet Radio Bearer Service (GPRS)".
- [35] Void.
- [36] CCITT Recommendation V.120: "Support by an ISDN of data terminal equipment with V-Series type interfaces with provision for statistical multiplexing".
- [37] Void.
- [38] 3GPP TS 45.005: "Radio transmission and reception".
- [39] 3GPP TS 29.061: "Interworking between the Public Land Mobile Network (PLMN) supporting GPRS and Packet Data Networks (PDN)".
- [40] 3GPP TS 23.081: "Line identification supplementary services - Stage 2".
- [41] 3GPP TS 27.001: "General on Terminal Adaptation Functions (TAF) for Mobile Stations (MS)".
- [42] 3GPP TS 29.007: "General requirements on interworking between the Public Land Mobile Network (PLMN) and the Integrated Services Digital Network (ISDN) or Public Switched Telephone Network (PSTN)".
- [43] Infrared Data Association; Specification of Ir Mobile Communications (IrMC).
- [44] IrDA Object Exchange Protocol.
- [45] 3GPP TS 27.010: "Terminal Equipment to User Equipment (TE-UE) multiplexer protocol User Equipment (UE)".
- [46] 3GPP TS 23.107: "Quality of Service, Concept and Architecture".
- [47] 3GPP TS 23.060: "General Packet Radio Service (GPRS) Service description; Stage 2".
- [48] Void.
- [49] 3GPP TS 43.068: "Voice Group Call service (VGCS) - Stage 2".
- [50] 3GPP TS 43.069: "Voice Broadcast Service (VBS) - Stage 2".
- [51] Void.
- [52] 3GPP TS 44.068: "Voice Group Call service (VGCS) - Stage 3".
- [53] 3GPP TS 44.069: "Voice Broadcast Service (VBS) - Stage 3".
- [54] 3GPP TS 22.067: "enhanced Multi-Level Precedence and Pre-emption service (eMLPP) - Stage 1".
- [55] 3GPP TS 42.068: "Voice Group Call service (VGCS) - Stage 1".
- [56] 3GPP TS 42.069: "Voice Broadcast Service (VBS) - Stage 1".

- [57] Void.
- [58] 3GPP TS 22.087: "User-to-User Signalling (UUS) - Stage 1".
- [59] 3GPP TS 31.102: "Characteristics of the Universal Subscriber Identity Module (USIM) Application".
- [60] ETSI TS 102 221 "Smart Cards; UICC-Terminal interface; Physical and logical characteristics (Release 1999)".
- [61] 3GPP TS 44.065: "Mobile Station (MS) – Serving GPRS Support Node (SGSN); Subnetwork Dependent Convergence Protocol (SNDCP)".
- [62] 3GPP TS 25.323: "Packet Data Convergence Protocol (PDCP)".
- [63] 3GPP TS 23.227 "Applications and User interaction in the UE-Principles and specific requirements", Release 5.
- [64] Void.
- [65] 3GPP TS 31.101: "UICC-Terminal Interface; Physical and Logical Characteristics."
- [66] ETSI TS 102 310: "Smart Cards; Extensible Authentication Protocol support in the UICC".
- [67] Void.
- [68] RFC 3748: "Extensible Authentication Protocol (EAP)".
- [69] RFC 3629: "UTF-8, a transformation format of ISO 10646".
- [70] 3GPP TS 44.318: "Generic Access (GA) to the A/Gb interface; Mobile GA interface layer 3 specification".
- [71] 3GPP TS 44.060: "General Packet Radio Service (GPRS); Mobile Station (MS) - Base Station System (BSS) interface; Radio Link Control/Medium Access Control (RLC/MAC) protocol".
- [72] 3GPP TS 25.308: "High Speed Downlink Packet Access (HSDPA): Overall Description; Stage 2".
- [73] 3GPP TS 25.319: "Enhanced Uplink; Overall Description; Stage 2".
- [74] 3GPP TS 25.331: "Radio Resource Control (RRC) protocol specification".
- [75] 3GPP TS 24.216: "Communication Continuity Management Object (MO)".
- [76] 3GPP TS 23.032: "Universal Geographical Area Description (GAD)".
- [77] 3GPP TS 25.305 "User Equipment (UE) positioning in Universal Terrestrial Radio Access Network (UTRAN); Stage 2".
- [78] IEC 61162: "Maritime navigation and radio communication equipment and systems – Digital interfaces".
- [79] 3GPP TS 44.031: "Location Services (LCS); Mobile Station (MS) - Serving Mobile Location Centre (SMLC), Radio Resource LCS Protocol (RRLP)".
- [80] 3GPP TS 49.031: "Base Station System Application Part, LCS Extension (BSSAP-LE)".
- [81] Void.
- [82] 3GPP TS 23.401: "GPRS enhancements for E-UTRAN access".
- [83] 3GPP TS 24.301: "Non-Access-Stratum (NAS) protocol for Evolved Packet System (EPS)".
- [84] Void.
- [85] 3GPP TS 23.203: "Policy and charging control architecture".

- [86] 3GPP TS 36.331: "Evolved Universal Terrestrial Radio Access (E-UTRA); Radio Resource Control (RRC); Protocol specification".
- [87] 3GPP TS 24.173: "IMS multimedia telephony communication service and supplementary services; Stage 3".
- [88] RFC 4291: "IP Version 6 Addressing Architecture".
- [89] 3GPP TS 24.229: "IP multimedia call control protocol based on Session Initiation Protocol (SIP) and Session Description Protocol (SDP)".
- [90] 3GPP TS 23.221: "Architectural requirements".
- [91] 3GPP TS 24.237: "IP Multimedia Subsystem (IMS) Service Continuity".
- [92] 3GPP TS 31.111: "Universal Subscriber Identity Module (USIM) Application Toolkit (USAT)".
- [93] 3GPP TS 22.096: "Name identification supplementary services - Stage 1".
- [94] 3GPP TS 23.096: "Name identification supplementary services - Stage 2".
- [95] 3GPP TS 25.133: "Requirements for support of radio resource management (FDD)".
- [96] 3GPP TS 25.123: "Requirements for support of radio resource management (TDD)".
- [97] 3GPP TS 36.133: "Evolved Universal Terrestrial Radio Access (E-UTRA); Requirements for support of radio resource management".
- [98] 3GPP TS 31.102: "Characteristics of the Universal Subscriber Identity Module (USIM) application".
- [99] 3GPP TS 23.040: "Technical realization of the Short Message Service (SMS)".
- [100] 3GPP TS 23.041: "Technical realization of Cell Broadcast Service (CBS)".
- [101] 3GPP TS 24.341: "Support of SMS over IP networks".
- [102] 3GPP TS 24.167: "3GPP IMS Management Object (MO); Stage 3".
- [103] IETF STD 5: "Internet Protocol".
- [104] IETF STD 51: "The Point-to-Point Protocol (PPP)".
- [105] RFC 1144: "Compressing TCP/IP Headers for Low-Speed Serial Links".
- [106] RFC 2460: "Internet Protocol, Version 6 (IPv6) Specification".
- [107] RFC 2507: "IP Header Compression".
- [108] RFC 3095: "RObust Header Compression (ROHC): Framework and four profiles: RTP, UDP, ESP, and uncompressed".
- [109] 3GPP TS 24.080: "Mobile radio interface Layer 3 supplementary service specification; Formats and coding".
- [110] 3GPP TS 29.002: "Mobile Application Part (MAP) specification".
- [111] RFC 3261: "SIP: Session Initiation Protocol".
- [112] RFC 3966: "The tel URI for Telephone Numbers".
- [113] RFC 3969: "The Internet Assigned Number Authority (IANA) Uniform Resource Identifier (URI) Parameter Registry for the Session Initiation Protocol (SIP)".
- [114] RFC 5341: "The Internet Assigned Number Authority (IANA) tel Uniform Resource Identifier (URI) Parameter Registry".

- [115] 3GPP TS 36.355: "Evolved Universal Terrestrial Radio Access (E-UTRA); LTE Positioning Protocol (LPP)".
- [116] RFC 2141: "URN Syntax".
- [117] RFC 3406: "Uniform Resource Names (URN) Namespace Definition Mechanisms".
- [118] RFC 5031: "A Uniform Resource Name (URN) for Emergency and Other Well-Known Services".
- [119] 3GPP TS 24.607: "Originating Identification Presentation (OIP) and Originating Identification Restriction (OIR) using IP Multimedia (IM) Core Network (CN) subsystem; Protocol specification".
- [120] 3GPP TS 24.608: "Terminating Identification Presentation (TIP) and Terminating Identification Restriction (TIR) using IP Multimedia (IM) Core Network (CN) subsystem; Protocol specification".
- [121] 3GPP TS 24.654: "Closed User Group (CUG) using IP Multimedia (IM) Core Network (CN) subsystem, Protocol Specification".
- [122] RFC 4715: "The Integrated Services Digital Network (ISDN) Subaddress Encoding Type for tel URI".
- [123] 3GPP TS 22.093: "Completion of Calls to Busy Subscriber (CCBS); Service description, Stage 1".
- [124] 3GPP TS 22.094: "Follow Me service description; Stage 1".
- [125] 3GPP TS 22.097: "Multiple Subscriber Profile (MSP) Phase 2; Service description; Stage 1".
- [126] 3GPP TS 22.135: "Multicall; Service description; Stage 1".
- [127] 3GPP TS 24.182: "IP Multimedia Subsystem (IMS) Customized Alerting Tones (CAT); Protocol specification".
- [128] 3GPP TS 24.183: "IP Multimedia Subsystem (IMS) Customized Ringing Signal (CRS); Protocol specification".
- [129] 3GPP TS 24.239: "Flexible Alerting (FA) using IP Multimedia (IM) Core Network (CN) subsystem; Protocol specification".
- [130] 3GPP TS 24.259: "Personal Network Management (PNM)".
- [131] 3GPP TS 24.390: "Unstructured Supplementary Service Data (USSD) using IP Multimedia (IM) Core Network (CN) subsystem IMS".
- [132] 3GPP TS 24.604: "Communication Diversion (CDIV) using IP Multimedia (IM) Core Network (CN) subsystem; Protocol specification".
- [133] 3GPP TS 24.605: "Conference (CONF) using IP Multimedia (IM) Core Network (CN) subsystem; Protocol specification".
- [134] 3GPP TS 24.606: "Message Waiting Indication (MWI) using IP Multimedia (IM) Core Network (CN) subsystem; Protocol specification".
- [135] 3GPP TS 24.610: "Communication HOLD (HOLD) using IP Multimedia (IM) Core Network (CN) subsystem; Protocol specification".
- [136] 3GPP TS 24.611: "Anonymous Communication Rejection (ACR) and Communication Barring (CB) using IP Multimedia (IM) Core Network (CN) subsystem; Protocol specification".
- [137] 3GPP TS 24.615: "Communication Waiting (CW) using IP Multimedia (IM) Core Network (CN) subsystem; Protocol Specification".
- [138] 3GPP TS 24.616: "Malicious Communication Identification (MCID) using IP Multimedia (IM) Core Network (CN) subsystem; Protocol specification".

- [139] 3GPP TS 24.629: "Explicit Communication Transfer (ECT) using IP Multimedia (IM) Core Network (CN) subsystem; Protocol specification".
- [140] 3GPP TS 24.642: "Completion of Communications to Busy Subscriber (CCBS) and Completion of Communications by No Reply (CCNR) using IP Multimedia (IM) Core Network (CN) subsystem; Protocol specification".
- [141] 3GPP TS 24.647: "Advice Of Charge (AOC) using IP Multimedia (IM) Core Network (CN) subsystem".
- [142] 3GPP TS 36.509: "Evolved Universal Terrestrial Radio Access (E-UTRA) and Evolved Packet Core (EPC); Special conformance testing functions for User Equipment (UE)".
- [143] 3GPP TS 25.102: "Multiplexing and channel coding (TDD)".
- [144] 3GPP TS 25.212: "Multiplexing and channel coding (FDD)".
- [145] 3GPP TS 36.300: "Evolved Universal Terrestrial Radio Access (E-UTRA) and Evolved Universal Terrestrial Radio Access Network (E-UTRAN); Overall description".
- [146] 3GPP TS 45.001: "Physical layer on the radio path; General description".
- [147] 3GPP TS 22.101: "Service aspects; Service principles".
- [148] 3GPP TS 24.090: "Unstructured Supplementary Service Data (USSD); Stage 3".
- [149] 3GPP TS 23.682: "Architecture Enhancements to facilitate communications with Packet Data Networks and Applications".
- [150] 3GPP TS 36.443: "Evolved Universal Terrestrial Radio Access Network (E-UTRAN); M2 Application Protocol (M2AP)".
- [151] Wi-Fi Alliance: "Hotspot 2.0 (Release 2) Technical Specification, version 1.0.0", 2014-08-08.
- [152] IEEE Std 802.11™-2012: "Information Technology- Telecommunications and information exchange between systems-Local and metropolitan area networks-Specific requirements-Part 11: Wireless LAN Medium Access Control (MAC) and Physical Layer (PHY) Specifications".
- [153] 3GPP TS 24.312: "Access Network Discovery and Selection Function (ANDSF) Management Object (MO)".
- [154] 3GPP TS 36.101: "Evolved Universal Terrestrial Radio Access (E-UTRA); User Equipment (UE) radio transmission and reception".
- [155] RFC 4122: "A Universally Unique Identifier (UUID) URN Namespace".
- [156] 3GPP TS 44.018: "GSM/EDGE Radio Resource Control (RRC) protocol".
- [157] CEN EN 15722:2015 (April 2015): "Intelligent transport systems - eSafety - ECall minimum set of data".
- [158] 3GPP TS 36.321: "Evolved Universal Terrestrial Radio Access (E-UTRA); Medium Access Control (MAC) protocol specification".
- [159] 3GPP TS 38.300: "NR; NR and NG-RAN Overall Description".
- [160] 3GPP TS 38.331: "NR; Radio Resource Control (RRC); Protocol specification".
- [161] 3GPP TS 24.501: "Access-Stratum (NAS) protocol for 5G System (5GS); Stage 3".
- [162] 3GPP TS 37.340: "Evolved Universal Terrestrial Radio Access (E-UTRA) and NR; Multi-Connectivity; Stage 2".
- [163] 3GPP TS 24.196: "Enhanced Calling Name (eCNAM)".
- [164] 3GPP TS 22.173: "IP Multimedia Core Network Subsystem (IMS) Multimedia Telephony Service and supplementary services".

- [165] 3GPP TS 23.501: "System Architecture for the 5G System; Stage 2".
- [166] 3GPP TS 36.213: "Evolved Universal Terrestrial Radio Access (E-UTRA); Physical layer procedures".
- [167] 3GPP TS 36.214: "Evolved Universal Terrestrial Radio Access (E-UTRA); Physical layer; Measurements".
- [168] 3GPP TS 24.250: "Protocol for Reliable Data Service between UE and SCEF; Stage 3".
- [169] 3GPP TS 38.133: "NR; Requirements for support of radio resource management".

3 Definitions and abbreviations

3.1 Definitions

For the purposes of the present document, the following syntactical definitions apply (refer also clause 4):

<CR>	Carriage return character, which value is specified with command S3.
<LF>	Linefeed character, which value is specified with command S4.
< . . . >	Name enclosed in angle brackets is a syntactical element. Brackets themselves do not appear in the command line.
[. . .]	Optional subparameter of a command or an optional part of TA information response is enclosed in square brackets. Brackets themselves do not appear in the command line. When subparameter is not given in <i>parameter type</i> commands, new value equals to its previous value. In <i>action type</i> commands, action should be done on the basis of the recommended default setting of the subparameter.
<u>underline</u>	Underlined defined subparameter value is the recommended default setting of this subparameter. In <i>parameter type</i> commands, this value should be used in factory settings which are configured by ITU-T Recommendation V.250 [14] command &F0. In <i>action type</i> commands, this value should be used when subparameter is not given.

3.2 Abbreviations

For the purposes of the present document, the following abbreviations apply:

5GCN	5G Core Network
5GS	5G System
AT	ATtention; this two-character abbreviation is always used to start a command line to be sent from TE to TA
ASCI	Advanced Speech Call Items, including VGCS, VBS and eMLPP
BCD	Binary Coded Decimal
BL	Bandwidth reduced Low complexity
CBR	Channel Busy Ratio
eMLPP	Enhanced Multi-Level Precedence and Pre-emption Service
ETSI	European Telecommunications Standards Institute
FTM	Frame Tunnelling Mode (refer 3GPP TS 27.001 [41] and 3GPP TS 29.007 [42])
HSCSD	High Speed Circuit Switched Data
IMEI	International Mobile station Equipment Identity
IRA	International Reference Alphabet (ITU-T Recommendation T.50 [13])
IrDA	Infrared Data Association
ISO	International Standards Organization
ITU-T	International Telecommunication Union - Telecommunications Standardization Sector
ME	Mobile Equipment
MMTEL	Multimedia Telephony
MoU	Memorandum of Understanding (GSM operator joint)
MT	Mobile Termination
MTU	Maximum Transfer Unit
NB-IoT	NarrowBand Internet of Things
NG-RAN	Next Generation Radio Access Network
NSLPI	NAS Signalling Low Priority Indication
PCCA	Portable Computer and Communications Association
PTT	Push to Talk
RDI	Restricted Digital Information
RLP	Radio Link Protocol
SIM	Subscriber Identity Module
TA	Terminal Adaptor, e.g. a GSM data card (equal to DCE; Data Circuit terminating Equipment)

TE	Terminal Equipment, e.g. a computer (equal to DTE; Data Terminal Equipment)
TIA	Telecommunications Industry Association
UDI	Unrestricted Digital Information
UE	User Equipment
UICC	Universal Integrated Circuit Card
USAT	USIM Application Toolkit
USIM	Universal Subscriber Identity Module
VBS	Voice Broadcast Service
VGCS	Voice Group Call Service

4 AT command syntax

4.0 General

This clause summarizes general aspects on AT commands and issues related to them.

TE software implementors must take into account that future versions of this specification may include additional parameters beyond what is expected in any (final or intermediate) response to an AT set command, read command or test command, and beyond what is expected in any unsolicited result code. Implementations must therefore analyse all parameters provided from the TA and discard (ignore) any parameters received following the parameters expected by the TE software.

For further information refer ITU-T Recommendation V.250 [14].

In the tables for the commands syntaxes, the possible response(s) are outlined as follows:

- the responses from ITU-T Recommendation V.250 [14] (like *OK* and *ERROR*) are normally not shown; and
- the final response *+CME ERROR* is shown when a final result code in clause 9.2 can be provided.

In certain implementations, AT commands are used as an internal interface within the physical handset, e.g. between the application and the radio interface layer 3 stack implemented on different processors. Certain AT commands transfer information in the clear that can be regarded as sensitive with regards to security or privacy. Care must be exercised in AT commands that:

- transfer passwords (e.g. *+CLCK*, *+CPWD* or *+CPBS*);
- transfer identities (e.g. *IMSI*) or details of a call (e.g. *+COLP*);
- transfer the current location of the phone (e.g. *+CMOLR*);
- reveal the *IMEI* (e.g. *+CGSN*);
- allow the TE to take unintentionally control over the *SIM-MT* interface (e.g. *+CSIM*);
- enable/disable access to commands protected by security mechanism (e.g. *+CSCC*); or
- exchange security related parameters and keys with the *UICC* (e.g. *+CEAP* and *+CERP*).

The above mentioned AT commands and parameters are examples to illustrate the concerns and is not meant to be a comprehensive list.

4.1 Command line

See figure 2 for general structure of a command line. Standardized *basic* commands are found only in ITU-T Recommendation V.250 [14]. The commands in this specification use syntax rules of *extended* commands. Every extended command has a *test command* (trailing =?) to test the existence of the command and to give information about the type of its subparameters. *Parameter type* commands also have a *read command* (trailing ?) to check the current values of subparameters. *Action type* commands do not store the values of any of their possible subparameters, and therefore do not have a read command.

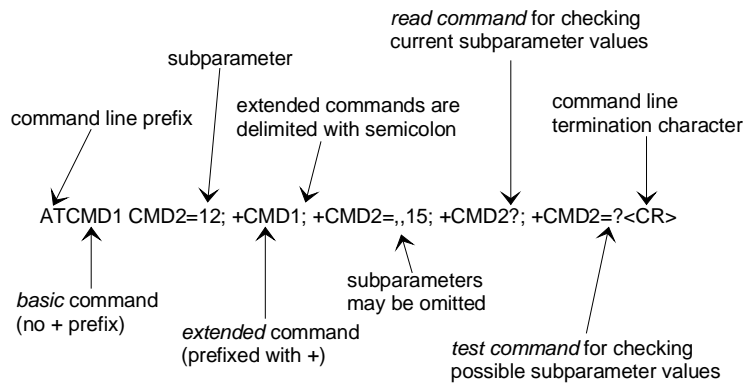

Figure 2: Basic structure of a command line

If verbose responses are enabled with command V1 and all commands in a command line has been performed successfully, result code `<CR><LF>OK<CR><LF>` is sent from the TA to the TE. If numeric responses are enabled with command V0, result code `0<CR>` is sent instead.

If verbose responses are enabled with command V1 and subparameter values of a command are not accepted by the TA (or command itself is invalid, or command cannot be performed for some reason), result code `<CR><LF>ERROR<CR><LF>` is sent to the TE and no subsequent commands in the command line are processed. If numeric responses are enabled with command V0, result code `4<CR>` is sent instead. ERROR (or 4) response may be replaced by `+CME ERROR: <err>` (refer clause 9) when command was not processed due to an error related to MT operation.

4.2 Information responses and result codes

The TA response for the example command line of figure 2 could be as shown in figure 3. Here, verbose response format is enabled with command V1. If numeric format V0 would have been used, `<CR><LF>` headers of *information responses* would have been left out and *final result code* changed to `0<CR>`.

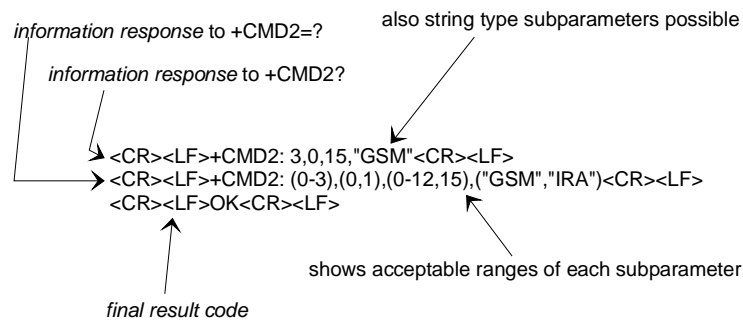

Figure 3: Response to a command line

So called *intermediate result codes* inform about progress of TA operation (e.g. connection establishment CONNECT), and so called *unsolicited result codes* indicate occurrence of an event not directly associated with issuance of a command from TE (e.g. ring indication RING).

4.3 ITU-T Recommendation V.250 [14] TE-TA interface commands

Table 1 summarizes ITU-T Recommendation V.250 [14] commands relating to command line and response formatting, and TA-TE interface operation. All are applicable to terminals specified by the present document.

Table 1: V.250 commands relating to TE-TA interface

Command	Clause	Impl.	Used in the present document
S3=[<value>]	6.2.1	mand.	command line termination character (mandatory default setting IRA 13)
S4=[<value>]	6.2.2	mand.	response formatting character (recommended default IRA 10)
S5=[<value>]	6.2.3	mand.	command line editing character (recommended default IRA 8)
E[<value>]	6.2.4	mand.	command echo (recommended default 1 i.e. TA echoes commands back)
Q[<value>]	6.2.5	mand.	result code suppression (recommended default 0 i.e. TA transmits result codes)
V[<value>]	6.2.6	mand.	TA response format (recommended default 1 i.e. verbose format)
X[<value>]	6.2.7	mand.	defines CONNECT result code format; values manufacturer specific
&C[<value>]	6.2.8	mand.	determines how ITU-T V.24 circuit 109 (or equivalent) relates to the detection of received line signal from remote end (recommended default 1 i.e. 109 operation relates to detection of received signal)
&D[<value>]	6.2.9	mand.	determines how TA responds when ITU-T V.24 circuit 108/2 (or equivalent) is changed from ON to OFF condition during online data state
+IPR=[<value>]	6.2.10	opt.	fixed TE data rate (recommended default 0 i.e. automatic detection)
+ICF=[<format>[<parity>]]	6.2.11	opt.	TE-TA character framing (recommended default 3,3 i.e. eight data bits, no parity, 1 stop bit)
+IFC=[<by_te> [<by_ta>]]	6.2.12	opt.	TE-TA local flow control (recommended default 2,2 i.e. TE uses ITU-T V.24 circuit 133 (or equivalent), and TA circuit 106 (or equivalent))
+ILRR=[<value>]	6.2.13	opt.	determines whether the used local TE-TA data rate is informed using intermediate result code +ILRR: <rate> before going online data state after call answering or originating

5 General commands

5.0 General

ITU-T Recommendation V.250 [14] includes "Generic DCE Control" commands with the prefix +G. These commands are for the identification of the TA. Four of those commands are adapted here to be the identification commands of the MT. Syntax is otherwise similar, but the prefix is +CG. TIA IS-99 [15] uses same commands for base station identification.

5.1 Request manufacturer identification +CGMI

Table 2: +CGMI action command syntax

Command	Possible response(s)
+CGMI	<manufacturer> +CME ERROR: <err>
+CGMI=?	

Description

Execution command causes the TA to return one or more lines of information text <manufacturer>, determined by the MT manufacturer, which is intended to permit the user of the TA to identify the manufacturer of the MT to which it is connected to. Typically, the text will consist of a single line containing the name of the manufacturer, but manufacturers may choose to provide more information if desired. Refer clause 9.2 for possible <err> values.

Defined values

<manufacturer>: the total number of characters, including line terminators, in the information text shall not exceed 2048 characters.

Text shall not contain the sequence 0<CR> or OK<CR>.

Implementation

Optional.

5.2 Request model identification +CGMM

Table 3: +CGMM action command syntax

Command	Possible response(s)
+CGMM	<model> +CME ERROR: <err>
+CGMM=?	

Description

Execution command causes the TA to return one or more lines of information text <model>, determined by the MT manufacturer, which is intended to permit the user of the TA to identify the specific model of the MT to which it is connected to. Typically, the text will consist of a single line containing the name of the product, but manufacturers may choose to provide more information if desired. Refer clause 9.2 for possible <err> values.

Defined values

<model>: the total number of characters, including line terminators, in the information text shall not exceed 2048 characters.

Text shall not contain the sequence 0<CR> or OK<CR>.

Implementation

Optional.

5.3 Request revision identification +CGMR

Table 4: +CGMR action command syntax

Command	Possible response(s)
+CGMR	<revision> +CME ERROR: <err>
+CGMR=?	

Description

Execution command causes the TA to return one or more lines of information text <revision>, determined by the MT manufacturer, which is intended to permit the user of the TA to identify the version, revision level or date, or other pertinent information of the MT to which it is connected to. Typically, the text will consist of a single line containing the version of the product, but manufacturers may choose to provide more information if desired. Refer clause 9.2 for possible <err> values.

Defined values

<revision>: the total number of characters, including line terminators, in the information text shall not exceed 2048 characters.

Text shall not contain the sequence 0<CR> or OK<CR>.

Implementation

Optional.

5.4 Request product serial number identification +CGSN

Table 5: +CGSN action command syntax

Command	Possible response(s)
+CGSN[=<snt>]	<p>when <snt>=0 (or omitted) and command successful: <sn></p> <p>when <snt>=1 and command successful: +CGSN: <imei></p> <p>when <snt>=2 and command successful: +CGSN: <imeisv></p> <p>when <snt>=3 and command successful: +CGSN: <svn></p> <p>+CME ERROR: <err></p>
+CGSN=?	<p>when TE supports <snt> and command successful: +CGSN: (list of supported <snt>s)</p>

Description

Execution command causes the TA to return IMEI (International Mobile station Equipment Identity number) and related information to identify the MT that the TE is connected to.

Refer clause 9.2 for possible <err> values.

Test command returns values supported as a compound value. For a TA which does not support <snt>, only OK is returned.

Defined values

<snt>: integer type indicating the serial number type that has been requested.

0 returns <sn>

1 returns the IMEI (International Mobile station Equipment Identity)

2 returns the IMEISV (International Mobile station Equipment Identity and Software Version number)

3 returns the SVN (Software Version Number)

<sn>: one or more lines of information text determined by the MT manufacturer. Typically, the text will consist of a single line containing the IMEI number of the MT, but manufacturers may choose to provide more information if desired. The total number of characters, including line terminators, in the information text shall not exceed 2048 characters. Text shall not contain the sequence 0<CR> or OK<CR>.

<imei>: string type in decimal format indicating the IMEI; refer 3GPP TS 23.003 [7], clause 6.2.1. IMEI is composed of Type Allocation Code (TAC) (8 digits), Serial Number (SNR) (6 digits) and the Check Digit (CD) (1 digit). Character set used in <imei> is as specified by command select TE character set +CSCS.

<imeisv>: string type in decimal format indicating the IMEISV; refer 3GPP TS 23.003 [7], clause 6.2.2. The 16 digits of IMEISV are composed of Type Allocation Code (TAC) (8 digits), Serial Number (SNR) (6 digits) and

the software version (SVN) (2 digits). Character set used in <imeisv> is as specified by command select TE character set +CSCS.

<svn>: string type in decimal format indicating the current SVN which is a part of IMEISV; refer 3GPP TS 23.003 [7], clause 6.2.2. This allows identifying different software versions of a given mobile. Character set used in <svn> is as specified by command select TE character set +CSCS.

NOTE: The default value <sn>=0 returns the information text <sn> with no command name prefixed. This has been done to retain backward compatibility. All other values of <sn> return the information text including command name prefix.

Informative examples

To get <sn> which returns IMEI of the MT:

```
AT+CGSN
490154203237518
OK
```

To get <imei> which returns IMEI of the MT:

```
AT+CGSN=1
+CGSN: "490154203237518"
OK
```

Implementation

Optional.

5.5 Select TE character set +CSCS

Table 6: +CSCS parameter command syntax

Command	Possible response(s)
+CSCS=[<chset>]	
+CSCS?	+CSCS: <chset>
+CSCS=?	+CSCS: (list of supported <chset>s)

Description

Set command informs TA which character set <chset> is used by the TE. TA is then able to convert character strings correctly between TE and MT character sets.

When TA-TE interface is set to 8-bit operation and used TE alphabet is 7-bit, the highest bit shall be set to zero.

NOTE: It is manufacturer specific how the internal alphabet of MT is converted to/from the TE alphabet.

Read command shows current setting and test command displays conversion schemes implemented in the TA.

Test command returns values supported as a compound value.

Defined values

<chset>: character set as a string type (conversion schemes not listed here can be defined by manufacturers).

- "GSM" GSM 7 bit default alphabet (3GPP TS 23.038 [25]); this setting causes easily software flow control (XON/XOFF) problems.
- "HEX" Character strings consist only of hexadecimal numbers from 00 to FF; e.g. "032FE6" equals three 8-bit characters with decimal values 3, 47 and 230; no conversions to the original MT character set shall be done.

If MT is using GSM 7 bit default alphabet, its characters shall be padded with 8th bit (zero) before converting them to hexadecimal numbers (i.e. no SMS-style packing of 7-bit alphabet).

"IRA"	International reference alphabet (see ITU-T Recommendation T.50 [13]).
"PCCP _{xxx} "	PC character set Code Page <i>xxx</i> .
"PCDN"	PC Danish/Norwegian character set.
"UCS2"	16-bit universal multiple-octet coded character set (see ISO/IEC10646 [32]); UCS2 character strings are converted to hexadecimal numbers from 0000 to FFFF; e.g. "004100620063" equals three 16-bit characters with decimal values 65, 98 and 99.
"UTF-8"	Octet (8-bit) lossless encoding of UCS characters (see RFC 3629 [69]); UTF-8 encodes each UCS character as a variable number of octets, where the number of octets depends on the integer value assigned to the UCS character. The input format shall be a stream of octets. It shall not be converted to hexadecimal numbers as in "HEX" or "UCS2". This character set requires an 8-bit TA – TE interface.
"8859- <i>n</i> "	ISO 8859 Latin <i>n</i> (1-6) character set.
"8859-C"	ISO 8859 Latin/Cyrillic character set.
"8859-A"	ISO 8859 Latin/Arabic character set.
"8859-G"	ISO 8859 Latin/Greek character set.
"8859-H"	ISO 8859 Latin/Hebrew character set.

Implementation

Mandatory when a command using the setting of this command is implemented.

5.6 Request international mobile subscriber identity +CIMI

Table 7: +CIMI action command syntax

Command	Possible response(s)
+CIMI	<IMSI> +CME ERROR: <err>
+CIMI=?	

Description

Execution command causes the TA to return <IMSI>, which is intended to permit the TE to identify the individual SIM card or active application in the UICC (GSM or USIM) which is attached to MT. Refer clause 9.2 for possible <err> values.

Defined values

<IMSI>: International Mobile Subscriber Identity (string without double quotes)

Implementation

Optional.

5.7 Multiplexing mode +CMUX

Table 8: +CMUX parameter command syntax

Command	Possible response(s)
+CMUX=<transparency>[,<subset>][,<port_speed>[,<N1>[,<T1>[,<N2>[,<T2>[,<T3>[,<k>]]]]]]]]	+CME ERROR: <err>
+CMUX?	+CMUX: <transparency>,[<subset>],[<port_speed>,<N1>,<T1>,<N2>,<T2>,<T3>[,<k>] +CME ERROR: <err>
+CMUX=?	+CMUX: (list of supported <transparency>s) , (list of supported <subset>s) , (list of supported <port_speed>s) , (list of supported <N1>s) , (list of supported <T1>s) , (list of supported <N2>s) , (list of supported <T2>s) , (list of supported <T3>s) , (list of supported <k>s)

Description

This command is used to enable/disable the 3GPP TS 27.010 [45] multiplexing protocol control channel. Refer clause 9.2 for possible <err> values. The AT command sets parameters for the Control Channel. If the parameters are left out, the default value is used.

Read command returns the current settings.

Test command returns the supported parameters as compound values.

It is recommended that the MT/TA/TE should autobaud to the +CMUX command up to and including an interface speed of 9600 bits/s.

The OK or +CME ERROR: <err> response is returned at the speed of the +CMUX command prior to entering <transparency>.

It is recommended that whenever the multiplexer control channel is released the MT/TA/TE should assume an interface rate of up to and including 9600 bits/s for auto bauding purposes irrespective of any previous higher speed having been selected.

If a +CMUX command is issued whilst in any multiplexer mode then that +CMUX command shall be ignored and the MT/TA shall return a +CME ERROR: <err> response.

Defined values

<transparency>: integer type (multiplexer Transparency Mechanism).

- 0 Basic option
- 1 Advanced option

<subset>: integer type. This parameter defines the way in which the multiplexer **control channel** is set up. A virtual channel may subsequently be set up differently but in the absence of any negotiation for the settings of a virtual channel, the virtual channel shall be set up according to the control channel <subset> setting.

- 0 UIH frames used only
- 1 UI frames used only
- 2 I frames used only

<port_speed> integer type (transmission rate). The default value is implementation specific.

- 1 9 600 bit/s
- 2 19 200 bit/s
- 3 38 400 bit/s
- 4 57 600 bit/s
- 5 115 200 bit/s
- 6 230 400 bits/s

<N1>: integer type (maximum frame size).

1- 32768, where the 31 is default for Basic option and 64 is default for Advanced option (see <transparency>)

<T1>: integer type (acknowledgement timer in units of ten milliseconds).

1-255, where 10 is default (100 ms)

<N2>: integer type (maximum number of re-transmissions).

0-100, where 3 is default

<T2>: integer type (response timer for the multiplexer control channel in units of ten milliseconds).

2-255, where 30 is default (300 ms)

NOTE: T2 must be longer than T1.

<T3>: integer type (wake up response timer in seconds).

1-255, where 10 is default

<k>: integer type (window size, for Advanced option with Error-Recovery Mode).

1-7, where 2 is default

Implementation

Mandatory, if 3GPP TS 27.010 [45] supported in the MT/TA.

5.8 ITU-T Recommendation V.250 [14] generic TA control commands

Table 9: V.250 generic TA control commands

Command	Clause	Impl.	Used in the present document
Z[<value>]	6.1.1	mand.	TA sets all parameters to their defaults as specified by a user memory profile or by the manufacturer, and resets TA
&F[<value>]	6.1.2	mand.	TA sets all parameters to their defaults as specified by the manufacturer
I[<value>]	6.1.3	opt.	request manufacturer specific information about the TA (software cannot use this command to determine the capabilities of a TA)
+GMI	6.1.4	mand.	request TA manufacturer identification (may equal to +CGMI)
+GMM	6.1.5	mand.	request TA model identification (may equal to +CGMM)
+GMR	6.1.6	mand.	request TA revision identification (may equal to +CGMR)
+GSN	6.1.7	opt.	request TA serial number identification (may equal to +CGSN)
+GOI	6.1.8	opt.	request ISO system global object identification of the TA (general format defined in ITU-T Recommendation X.208; encoding rules in ITU-T Recommendation X.209)
+GCAP	6.1.9	mand.	request overall capabilities of TA; the response code for a TA building on this document shall be +CGSM
+GCI=<T.35>	6.1.10	opt.	selects the country of installation for the TA using ITU-T Recommendation T.35 Annex A country codes

5.9 PCCA STD-101 [17] select wireless network +WS46

PCCA STD-101 [17] includes a command to select the cellular network (Wireless Data Service; WDS) to operate with the TA. PCCA calls this WDS-Side Stack Selection. This command may be used when TA is asked to indicate the networks in which it can operate.

Table 10: +WS46 parameter command syntax

Command	Possible response(s)
+WS46=[<n>]	
+WS46?	<n>
+WS46=?	(list of supported <n>s)

Description

Set command selects the WDS side stack <n> to be used by the TA. Read command shows current setting and test command displays side stacks implemented in the TA.

Read command (query) returns the current value of <n>.

Test command returns values supported as a compound value.

Defined values for Query

<n>: integer type

- 12 GSM Digital Cellular Systems (GERAN only)
- 22 UTRAN only
- 25 3GPP Systems (GERAN, UTRAN and E-UTRAN)
- 28 E-UTRAN only

- 29 GERAN and UTRAN
- 30 GERAN and E-UTRAN
- 31 UTRAN and E-UTRAN
- 35 GERAN, UTRAN, E-UTRAN and NG-RAN
- 36 NG-RAN only
- 37 NG-RAN and E-UTRAN
- 38 NG-RAN, E-UTRAN and UTRAN
- 39 NG-RAN, E-UTRAN and GERAN
- 40 NG-RAN and UTRAN
- 41 NG-RAN, UTRAN and GERAN
- 42 NG-RAN and GERAN

The values in <n> for Query are mutually exclusive. If one value (e.g. "25") is returned, other values shall not be returned.

Defined values for Set

<n>: integer type

- 12 3GPP System
 - 22 Not used. If received, the value shall be treated as if 12 had been received or an ERROR shall be returned.
 - 25 Not used. If received, the value shall be treated as if 12 had been received or an ERROR shall be returned.
 - 28 Not used. If received, the value shall be treated as if 12 had been received or an ERROR shall be returned.
 - 29 Not used. If received, the value shall be treated as if 12 had been received or an ERROR shall be returned.
 - 30 Not used. If received, the value shall be treated as if 12 had been received or an ERROR shall be returned.
 - 31 Not used. If received, the value shall be treated as if 12 had been received or an ERROR shall be returned.
 - 35 Not used. If received, the value shall be treated as if 12 had been received or an ERROR shall be returned.
 - 36 Not used. If received, the value shall be treated as if 12 had been received or an ERROR shall be returned.
 - 37 Not used. If received, the value shall be treated as if 12 had been received or an ERROR shall be returned.
 - 38 Not used. If received, the value shall be treated as if 12 had been received or an ERROR shall be returned.
 - 39 Not used. If received, the value shall be treated as if 12 had been received or an ERROR shall be returned.
 - 40 Not used. If received, the value shall be treated as if 12 had been received or an ERROR shall be returned.
 - 41 Not used. If received, the value shall be treated as if 12 had been received or an ERROR shall be returned.
 - 42 Not used. If received, the value shall be treated as if 12 had been received or an ERROR shall be returned.
- refer PCCA STD-101 [17] for other values.

Implementation

Mandatory in PCCA STD-101 [17], but optional in the context of this specification.

5.10 Request 5G subscription permanent identifier +CSUPI

Table 5.10-1: +CSUPI action command syntax

Command	Possible response(s)
+CSUPI	<SUPI> +CME ERROR: <err>
+CSUPI=?	

Description

Execution command causes the TA to return <SUPI>, which is intended to permit the TE to identify the individual USIM card or active application in the UICC which is attached to 5G MT. Refer clause 9.2 for possible <err> values.

Defined values

<SUPI>: 5G subscription permanent identifier (string without double quotes).

Implementation

Optional.

5.11 Informative examples

When beginning to build a communication link, a general TE application controlling a TA needs to determine the TA and the MT to which it is connected. ITU-T Recommendation V.250 [14] has seven commands for TA identification from which four are mandatory to be implemented in a TA. An example of this command sequence requesting manufacturer (+GMI), model (+GMM), revision (+GMR) and serial number (+GSN) information would be:

```
AT+GMI
Manufacturer ABC
OK
AT+GMM
GSM Ultimate Data Device
OK
AT+GMR
1.00
OK
AT+GSN
987612345-123
OK
```

The maximum lengths of the information responses are defined to be 2048 characters, but it is recommended that they are kept as simple as in the example. The serial number command is defined as optional. Another optional command is Global Object Identification command (+GOI) which should return the object identifiers of ITU-T Recommendation X.208 as numeric strings delimited by periods. The Complete Capabilities List command (+GCAP) indicates the major capability areas of the TA. The support of different areas is presented in the response of +GCAP command. Each area can be presented by the selection command name of a specific capability area (e.g. +FCLASS for fax support) or some other predefined response. For instance, a GSM TA with fax capabilities could respond as follows:

```
AT+GCAP
+GCAP: +CGSM,+FCLASS,+W
OK
```

The first supported area in the response is presented with +CGSM. It is the response text to show that some or all GSM commands of the present document are supported. Second response text (+FCLASS) informs that some fax or voice capabilities are present, and the third text (+W) about the presence of wireless commands as specified by PCCA STD-101 [17]. Command +FCLASS=? (refer e.g. ITU-T Recommendation T.31 [11] and ITU-T Recommendation T.32 [12]) can be used to query the supported fax capabilities and +WS46=? to query the wireless data services available:

```
AT+FCLASS=?;+WS46=?
0,1,2,2.0
(12)
OK
```

The TA of this example supports GSM data services, and fax service class 1 (TIA-578-A), 2 (manufacturer specific) and 2.0 (ITU-T Recommendation T.32 [12] / TIA-592).

The present document defines commands for MT identification which are similar to those for TA identification in ITU-T Recommendation V.250 [14], for an example:

```
AT+CGMI
Mobile Manufacturer XYZ
OK
AT+CGMM
GSM Phone 1234
OK
AT+CGMR
1.00
OK
AT+CGSN
123456121234561
OK
```

Manufacturer, model and version commands work similarly as for TA, except that the serial number query returns the International Mobile Station Equipment Identity (IMEI) number. IMEI is fifteen digits long and consists of a type approval code, a final assembly code, a serial number and a spare digit (refer 3GPP TS 23.003 [7]). When the TA is implemented inside MT, the responses for both TA and MT queries will most likely follow the responses of MT identification.

6 Call control commands and methods

6.0 General

This clause describes the control of calls. Normal data and fax call control is done as in ITU-T Recommendation V.250 [14], ITU-T Recommendation T.31 [11] and ITU-T Recommendation T.32 [12]. For voice call originating, refer clause "ITU-T Recommendation V.250 dial command D" and clause "Commands for enhanced support of dialling".

6.1 Select type of address +CSTA

Table 11: +CSTA parameter command syntax

Command	Possible response(s)
+CSTA=[<type>]	
+CSTA?	+CSTA: <type>
+CSTA=?	+CSTA: (list of supported <type>s)

Description

Set command selects the type of number for further dialling commands (D) according to 3GPP TS 24.008 [8].

Read command returns the current value of <type>.

Test command returns values supported as a compound value.

Defined values

<type>: type of address octet in integer format (refer 3GPP TS 24.008 [8] clause 10.5.4.7); default 145 when dialling string includes international access code character "+", otherwise 129.

Implementation

Mandatory when other than default value allowed.

6.2 ITU-T Recommendation V.250 [14] dial command D

ITU-T Recommendation V.250 [14] dial command D lists characters that may be used in a dialling string for making a call or controlling supplementary services in accordance with 3GPP TS 22.030 [19]. Their use is listed in this clause, as well as new dial modifiers are introduced. For an MT supporting AT commands only, it is mandatory to support the control of supplementary services in accordance with 3GPP TS 22.030 [19] through the dial command or through the specific supplementary service commands (+CCFC, +CLCK, etc.), where 3GPP TS 22.030 [19] identifies the supplementary services as mandatory. See also the AT commands for enhanced support of dialling as well as +CMCCS and +CLCCS.

V.250 dialling digits

1 2 3 4 5 6 7 8 9 0 * # + A B C (implementation of these characters is mandatory)

D (implementation of this character is optional, and it is ignored)

V.250 modifier characters

, (implementation of this character is mandatory, but it may be ignored)

T P (implementation of these characters is mandatory, but they are ignored)

! W @ (implementation of these characters is optional, and they are ignored)

V.250 semicolon character

When semicolon character is given after dialling digits (or modifiers), a voice call originated to the given address. TA returns to command state immediately (or after possible +COLP result code; refer clause "Connected line identification presentation +COLP"). Refer Annex G for a detailed example.

Modifier characters

> (refer clause "Direct dialling from phonebooks")

I or i (override the CLIR supplementary service subscription default value for this call; I = invocation (restrict CLI presentation) and i = suppression (allow CLI presentation); refer clause "Calling line identification restriction +CLIR").

G or g (control the CUG supplementary service information for this call; uses index and info values set with command +CCUG or +CECUG; refer clause "Closed user group +CCUG" and clause "Enhanced closed user group +CECUG").

6.3 Direct dialling from phonebooks

MT and SIM/UICC can contain phonebooks which have a phone number and an alphanumeric field for each phonebook entry location. The use of ITU-T Recommendation V.250 [14] dialling command ensures that direct dialling from MT and SIM/UICC phonebook is possible through ordinary communications software which just gives the phone number field to be filled and then use the D command to originate the call. Available memories may be queried with Select Phonebook Storage test command +CPBS=?, and location range for example with Read Phonebook Entries test command +CPBR=?.

Execute commands

1. D><str>[I][G][;] originate call to phone number which corresponding alphanumeric field is <str> (if possible, all available memories should be searched for the correct entry).

2. D>mem<n>[I][G][;] originate call to phone number in memory mem entry location <n> (available memories may be queried with Select Phonebook Storage test command +CPBS=?; mem could be e.g. ME).

3. D><n>[I][G][;] originate call to phone number in entry location <n> (it is manufacturer specific which memory storage of MT, SIM/UICC in the currently selected card slot and TA is used; command Select Phonebook Memory Storage +CPBS setting is recommended to be used).

Semicolon character shall be added when voice call is originated. CLIR and CUG per call base modifiers may also be present.

Responses

Possible error responses include +CME ERROR: <err> when error is related to MT functionality. Refer clause 9.2 for possible <err> values. Otherwise TA responses can have values defined by ITU-T Recommendation V.250 [14] and commands Service Reporting Control +CR and Connected Line Identification Presentation +COLP. Detailed error report of an unsuccessful originated call failed in the network error can be obtained with command Extended Error Report +CEER (if implemented).

Defined values

<str>: string type value, which should equal to an alphanumeric field in at least one phonebook entry in the searched memories; used character set should be the one selected with command select TE character set +CSCS.

<n>: integer type memory location should be in the range of locations available in the memory used.

Implementation

Mandatory when direct dialling is implemented. Also phonebook commands implementation is required.

6.4 Call mode +CMOD

Table 12: +CMOD parameter command syntax

Command	Possible response(s)
+CMOD=[<mode>]	
+CMOD?	+CMOD: <mode>
+CMOD=?	+CMOD: (list of supported <mode>s)

Description

Set command selects the call mode of further dialling commands (D) or for next answering command (A). Mode can be either single or alternating (in the present document, terms "alternating mode" and "alternating call" refer to all GSM/UMTS bearer and teleservices that incorporate more than one basic service (voice, data, fax) within one call). When single mode is selected the call originating and hangup procedures are similar to procedures specified in ITU-T Recommendations V.250 [14], T.31 [11] and T.32 [12]. In GSM/UMTS there can be voice followed by data (refer 3GPP TS 22.002 [1]), alternating voice/data (refer 3GPP TS 22.002 [1]) and alternating voice/fax calls (refer 3GPP TS 22.003 [2]). See following clauses for alternating call control methods.

Read command returns the current value of <mode>.

Test command returns values supported as a compound value.

NOTE: +CMOD shall be set to zero after a successfully completed alternating mode call. It shall be set to zero also after a failed answering. The power-up, factory (&F) and user resets (Z) shall also set the value to zero. This reduces the possibility that alternating mode calls are originated or answered accidentally.

Defined values

<mode>: integer type

- 0 single mode
- 1 alternating voice/fax (teleservice 61)
- 2 alternating voice/data (bearer service 61)
- 3 voice followed by data (bearer service 81)

all other values below 128 are reserved by the present document.

Implementation

Mandatory when alternating mode calls are implemented in the TA.

6.4A Voice call mode +CVMOD

Table 13: +CVMOD parameter command syntax

Command	Possible response(s)
+CVMOD=[<voice_mode>]	
+CVMOD?	+CVMOD: <voice_mode>
+CVMOD=?	+CVMOD: (list of supported <voice_mode>s)

Description

Set command selects the voice call mode for making a Mobile Originated voice call from the UE. The voice call mode can be CS_ONLY, VOIP_ONLY, CS_PREFERRED or VOIP_PREFERRED. Type of VoIP session preferred (e.g. SIP VoIP, IMS VoIP) is manufacturer specific issue.

NOTE 1: If the Call Mode is set to CS_ONLY, then the ATD command will make a call in CS mode.

If the Call Mode is set to VOIP_ONLY, then the ATD command will make a call in VoIP mode.

If the Call Mode is set to CS_PREFERRED, then the ATD command gives preference for CS based voice call.

If the Call Mode is set to VOIP_PREFERRED, then the ATD command gives preference for VoIP based voice call

NOTE 2: As an alternative to the ATD command, the command Dial URI +CDU can be used if supported.

NOTE 3: The preferences are not applicable for the emergency call.

NOTE 4: The preferences are not applicable if operator has set preferences for UE originated calls/sessions, 3GPP TS 24.216 [75] clause 5.6.

Read command returns the current value of <voice_mode>.

Test command returns the values supported by the UE as a compound value.

Defined values

<voice_mode>: integer type. The default value is manufacturer specific.

- 0 CS_ONLY
- 1 VOIP_ONLY
- 2 CS_PREFERRED
- 3 VOIP_PREFERRED

Implementation

Optional.

6.5 Hangup call +CHUP

Table 13a: +CHUP action command syntax

Command	Possible response(s)
+CHUP	
+CHUP=?	

Description

Execution command causes the TA to hangup the current call of the MT.

NOTE: The purpose of this command is not to replace the ITU-T Recommendation V.250 [14] command H, but to give an assured procedure to terminate an alternating mode call. Refer next clause.

Implementation

Mandatory when alternating mode calls implemented in the TA.

6.6 Alternating mode call control method

This clause describes the procedure to handle alternating mode calls with AT commands. Procedures are mandatory when alternating mode calls are implemented in the TA.

NOTE 1: ATH and drop DTR will not necessarily cause a hangup from voice mode. If the +CVHU is implemented the behaviour shall be controlled by its setting.

Voice followed by data call (bearer service 81)

Figure 4 shows commands to start the call, to switch from voice to data (In-Call Modification) and to hang up the call. +CMOD and +FCLASS commands indicate the current settings before dialling or answering command, not that they shall be given just before D or A command. Refer clause "Cellular result codes +CRC" for possible +CRING result code values. Refer Annex F for a detailed example.

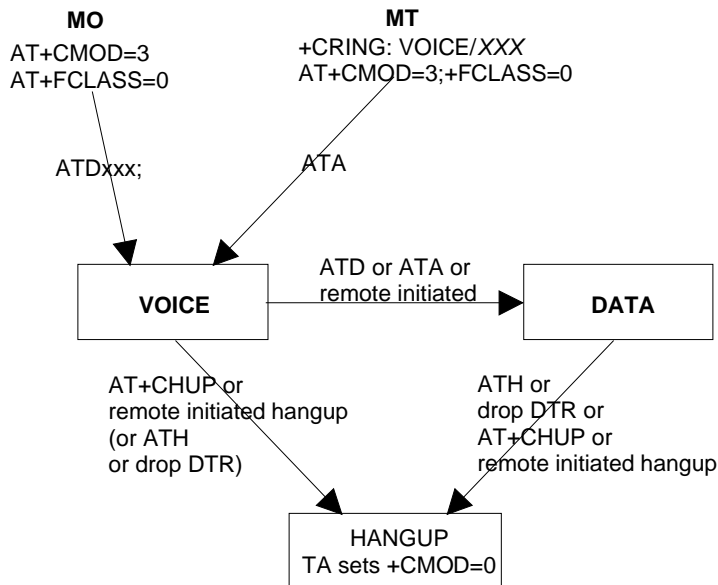

Figure 4: Voice followed by data call

Voice/ data call (bearer service number 61)

Figure 5 shows the commands to start the call, to switch between modes (In-Call Modification) and to hang up the call. +CMOD and +FCLASS commands indicate the current settings before dialling or answering command, not that they shall be given just before D or A command. Refer clause "Cellular result codes +CRC" for possible +CRING result code values. Refer Annex E for a detailed example.

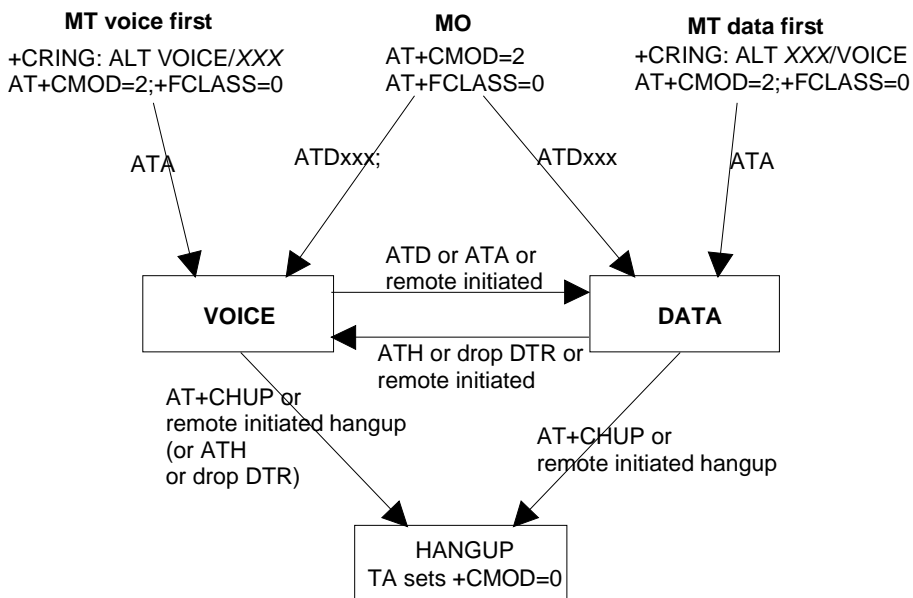

Figure 5: Alternating voice and data call

Voice/ fax call (teleservice number 61)

Figure 6 shows the commands to start the call, to switch between modes (In-Call Modification) and to hang up the call. +CMOD and +FCLASS commands indicate the current settings before dialling or answering command, not that they shall be given just before D or A command. The parameter "x" of +FCLASS command can be 1, 1.0, 2 or 2.0.

NOTE 2: The transition from fax mode to voice mode is for further study.

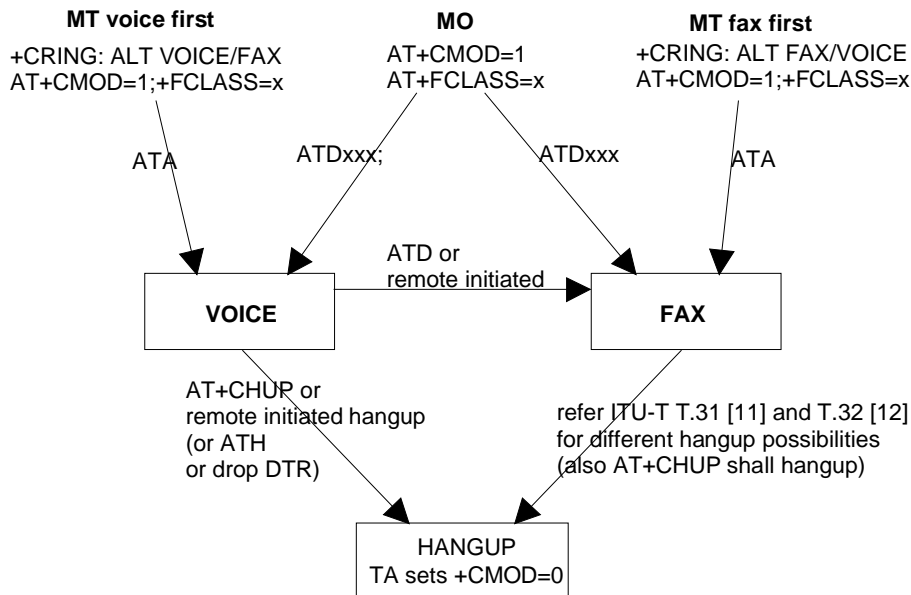

Figure 6: Alternating voice and fax call

6.7 Select bearer service type +CBST

Table 14: +CBST parameter command syntax

Command	Possible response(s)
+CBST=[<speed>[, <name>[, <ce>]]]	
+CBST?	+CBST: <speed> , <name> , <ce>
+CBST=?	+CBST: (list of supported <speed>s) , (list of supported <name>s) , (list of supported <ce>s)

Description

Set command selects the bearer service <name> with data rate <speed>, and the connection element <ce> to be used when data calls are originated (refer 3GPP TS 22.002 [1]). Values may also be used during mobile terminated data call setup, especially in case of single numbering scheme calls (refer +CSNS).

Read command returns the current parameter values.

Test command returns values supported as compound values.

Defined values

NOTE: The default values of the subparameters are manufacturer specific since they depend on the purpose of the device and data services provided by it. Not all combinations of these subparameters are supported by GSM/UMTS (refer 3GPP TS 22.002 [1]).

<speed>: integer type

- 0 autobauding (automatic selection of the speed; this setting is possible in case of 3.1 kHz modem and non-transparent service)

- 1 300 bps (V.21)
- 2 1200 bps (V.22)
- 3 1200/75 bps (V.23)
- 4 2400 bps (V.22bis)
- 5 2400 bps (V.26ter)
- 6 4800 bps (V.32)
- 7 9600 bps (V.32)
- 12 9600 bps (V.34)
- 14 14400 bps (V.34)
- 15 19200 bps (V.34)
- 16 28800 bps (V.34)
- 17 33600 bps (V.34)
- 34 1200 bps (V.120)
- 36 2400 bps (V.120)
- 38 4800 bps (V.120)
- 39 9600 bps (V.120)
- 43 14400 bps (V.120)
- 47 19200 bps (V.120)
- 48 28800 bps (V.120)
- 49 38400 bps (V.120)
- 50 48000 bps (V.120)
- 51 56000 bps (V.120)
- 65 300 bps (V.110)
- 66 1200 bps (V.110)
- 68 2400 bps (V.110 or X.31 flag stuffing)
- 70 4800 bps (V.110 or X.31 flag stuffing)
- 71 9600 bps (V.110 or X.31 flag stuffing)
- 75 14400 bps (V.110 or X.31 flag stuffing)
- 79 19200 bps (V.110 or X.31 flag stuffing)
- 80 28800 bps (V.110 or X.31 flag stuffing)
- 81 38400 bps (V.110 or X.31 flag stuffing)
- 82 48000 bps (V.110 or X.31 flag stuffing)
- 83 56000 bps (V.110 or X.31 flag stuffing; this setting can be used in conjunction with asynchronous non-transparent UDI or RDI service in order to get FTM)
- 84 64000 bps (X.31 flag stuffing; this setting can be used in conjunction with asynchronous non-transparent UDI service in order to get FTM)

- 115 56000 bps (bit transparent)
- 116 64000 bps (bit transparent)
- 120 32000 bps (PIAFS32k)
- 121 64000 bps (PIAFS64k)
- 130 28800 bps (multimedia)
- 131 32000 bps (multimedia)
- 132 33600 bps (multimedia)
- 133 56000 bps (multimedia)
- 134 64000 bps (multimedia)

all other values below 256 are reserved by the present document.

<name>: integer type

- 0 data circuit asynchronous (UDI or 3.1 kHz modem)
- 1 data circuit synchronous (UDI or 3.1 kHz modem)
- 2 PAD Access (asynchronous) (UDI)
- 3 Packet Access (synchronous) (UDI)
- 4 data circuit asynchronous (RDI)
- 5 data circuit synchronous (RDI)
- 6 PAD Access (asynchronous) (RDI)
- 7 Packet Access (synchronous) (RDI)

all other values below 128 are reserved by the present document.

<ce>: integer type

- 0 transparent
- 1 non-transparent
- 2 both, transparent preferred
- 3 both, non-transparent preferred

Implementation

Mandatory when data calls implemented.

6.8 Radio link protocol +CRLP

Table 15: +CRLP parameter command syntax

Command	Possible response(s)
+CRLP=[<iws>[,<mws>[,<T1>[,<N2>[,<ver>[,<T4>]]]]]]	
+CRLP?	+CRLP: <iws>,<mws>,<T1>,<N2>[,<ver1>[,<T4>]] [<CR><LF>+CRLP: <iws>,<mws>,<T1>,<N2>[,<ver2>[,<T4>]] [...]]

+CRLP=?	+CRLP: (list of supported <iws>s) , (list of supported <mws>s) , (list of supported <T1>s) , (list of supported <N2>s) [, <ver1> [, (list of supported <T4>s)]] [<CR><LF>+CRLP: (list of supported <iws>s) , (list of supported <mws>s) , (list of supported <T1>s) , (list of supported <N2>s) [, <ver2> [, (list of supported <T4>s)]] [. . .]]
---------	---

Description

Radio link protocol (RLP) parameters used when non-transparent data calls are originated may be altered with set command. Available command subparameters depend on the RLP versions implemented by the device (e.g. <ver> may not be available if device supports only versions 0 and 1).

NOTE 1: If radio link protocol is not used, but some other error correcting protocol (for transparent data calls), ITU-T Recommendation V.250 [14] Error Control Selection test command +ES=? may be used to indicate the presence of the protocol.

Read command returns current settings for each supported RLP version <verx>. Only RLP parameters applicable to the corresponding <verx> are returned.

Test command returns values supported as compound values. If MT/TA supports several RLP versions <verx>, the RLP parameter value ranges for each <verx> are returned on a separate line.

Defined values

<ver>, <verx>: RLP version number in integer format; when version indication is not present it shall equal 0

NOTE 2: Versions 0 and 1 share the same parameter set. Read and test commands shall return only one line for this set (where <verx> is not present).

<iws>, <mws>, <T1>, <N2>, <T4>: IWF to MS window size, MS to IWF window size, acknowledgement timer T1, retransmission attempts N2, re-sequencing period T4 in integer format (default values and value ranges depend on RLP version; refer 3GPP TS 24.022 [18]): T1 and T4 are in units of 10 ms.

Implementation

Mandatory when RLP implemented.

6.9 Service reporting control +CR

Table 16: +CR parameter command syntax

Command	Possible response(s)
+CR= [<mode>]	
+CR?	+CR: <mode>
+CR=?	+CR: (list of supported <mode>s)

Description

Set command controls whether or not intermediate result code +CR: <serv> is returned from the TA to the TE. If enabled, the intermediate result code is transmitted at the point during connect negotiation at which the TA has determined which speed and quality of service will be used, before any error control or data compression reports are transmitted, and before the intermediate result code CONNECT is transmitted.

NOTE: This command replaces ITU-T Recommendation V.250 [14] command Modulation Reporting Control +MR, which is not appropriate for use in the GSM/UMTS network. Possible error control (other than radio link protocol) and data compression reporting can be enabled with V.250 commands Error Control Reporting +ER and Data Compression Reporting +DR.

Read command returns the current value of <mode>.

Test command returns values supported as a compound value.

Defined values

<mode>: integer type

0 disables reporting

1 enables reporting

<serv>:

ASYNC asynchronous transparent

SYNC synchronous transparent

REL ASYNC asynchronous non-transparent

REL SYNC synchronous non-transparent

GPRS [<L2P>] GPRS

<L2P>: proposes a layer 2 protocol to use between the MT and the TE. It is defined in the Enter GPRS Data Mode (+CGDATA) command.

Implementation

Mandatory when data calls implemented.

6.10 Extended error report +CEER

Table 17: +CEER action command syntax

Command	Possible response(s)
+CEER	+CEER: <report>
+CEER=?	

Description

Execution command causes the TA to return one or more lines of information text <report>, determined by the MT manufacturer, which should offer the user of the TA an extended report of the reason for

- the failure in the last unsuccessful call setup (originating or answering) or in-call modification;
- the last call release;
- the last unsuccessful GPRS attach or unsuccessful PDP context activation;
- the last GPRS detach or PDP context deactivation.

Typically, the text will consist of a single line containing the cause information given by the network in textual format.

Defined values

<report>: the total number of characters, including line terminators, in the information text shall not exceed 2041 characters.

Text shall not contain the sequence 0<CR> or OK<CR>.

Implementation

Optional.

6.11 Cellular result codes +CRC

Table 18: +CRC parameter command syntax

Command	Possible response(s)
+CRC=[<mode>]	
+CRC?	+CRC: <mode>
+CRC=?	+CRC: (list of supported <mode>s)

Description

Set command controls whether or not the extended format of incoming call indication or GPRS network request for PDP context activation or notification for VBS/VGCS calls is used. When enabled, an incoming call is indicated to the TE with unsolicited result code +CRING: <type> instead of the normal RING.

Read command returns the current value of <mode>.

Test command returns values supported as a compound value.

NOTE 1: Similar command may be found in TIA IS-99 [15] and TIA IS-135 [16].

Defined values

<mode>: integer type

- 0 disables extended format
- 1 enables extended format

<type>:

ASYNC [,<priority>[,<subaddr> ,<satype>]]	asynchronous transparent
SYNC [,<priority>[,<subaddr> ,<satype>]]	synchronous transparent
REL ASYNC [,<priority>[,<subaddr> ,<satype>]]	asynchronous non-transparent
REL SYNC [,<priority>[,<subaddr> ,<satype>]]	synchronous non-transparent
FAX [,<priority>[,<subaddr> ,<satype>]]	facsimile (TS 62)
VOICE [,<priority>[,<subaddr> ,<satype>]]	normal voice (TS 11) (see NOTE 2)
VOICE/VIDEO [,<ccid>[,<priority>[,<subaddr> ,<satype>]]]	voice or video call (see NOTE 2)
VOICE/XXX [,<priority>[,<subaddr> ,<satype>]]	voice followed by data (BS 81) (XXX is ASYNC, SYNC, REL ASYNC or REL SYNC)
ALT VOICE/XXX [,<priority>[,<subaddr> ,<satype>]]	alternating voice/data, voice first (BS 61)
ALT XXX/VOICE [,<priority>[,<subaddr> ,<satype>]]	alternating voice/data, data first (BS 61)

ALT VOICE/FAX [,<priority>[,<subaddr>,<satype>]]	alternating voice/fax, voice first (TS 61)
ALT FAX/VOICE [,<priority>[,<subaddr>,<satype>]]	alternating voice/fax, fax first (TS 61)
GPRS <PDP_type> , <PDP_addr>[, [<L2P>] [, <APN>]]	GPRS network request for PDP context activation
VGC <GCA> , <GId> , <ackflag> [, <priority>]	voice group call (TS 91)
VBC <GCA> , <GId> , <ackflag> [, <priority>]	voice broadcast call (TS 92)

NOTE 2: The <type>=VOICE/VIDEO is used for voice and/or video calls. It is implementation specific whether this type will replace the <type>=VOICE or if both the types <type>=VOICE/VIDEO and <type>=VOICE are supported.

<priority>: indicates the eMLPP priority level of the incoming call by paging, notification or setup message. The priority level values are as defined in eMLPP specification 3GPP TS 22.067 [54].

<subaddr>: string type subaddress of format specified by <satype>.

<satype>: type of subaddress octet in integer format (refer 3GPP TS 24.008 [8] clause 10.5.4.8) or RFC 4715 [122] appendix A.

<ccidx>: integer type. Call identification number, see +CLCCS.

<PDP_type>, <PDP_addr> and <APN>: string types as defined in the Define PDP Context (+CGDCONT) command.

<L2P>: string type proposes a layer 2 protocol to use between the MT and the TE. It is defined in the Enter GPRS Data Mode (+CGDATA) command. If the MT is unable to announce to the TE the network's request (for example it is in V.250 online data state) the MT shall reject the request. No corresponding unsolicited result code shall be issued when the MT returns to a command state.

<GCA>: string type (consisting of digits only) is a part of the group call reference as specified in 3GPP TS 23.003 [7] and indicates group call area. See the commands +CAJOIN, +CAREJ and +CALCC.

<GId>: string type (consisting of digits only) is a part of the group call reference as specified in 3GPP TS 23.003 [7] and indicates group call identification. See the commands +CAJOIN, +CAREJ and +CALCC.

<ackflag>: integer type proposes that a predefined confirmation procedure is to be used after the call is ended. The value 1 indicates that a predefined confirmation procedure is to be used after the call is ended. The value 0 indicates that no confirmation procedure is required. See the parameter <ack_flag> of command +CALCC.

Implementation

Mandatory when data or fax circuit mode calls are implemented, or for an MT supporting AT commands only and eMLPP or VGCS or VBS is implemented.

6.12 HSCSD device parameters +CHSD

Table 19: +CHSD action command syntax

Command	Possible response(s)
+CHSD	+CHSD: <mclass> , <maxRx> , <maxTx> , <sum> , <codings> +CME ERROR: <err>
+CHSD=?	

Description

Execution command returns information about HSCSD features (refer 3GPP TS 22.034 [29]) supported by the MT/TA. Refer clause 9.2 for possible <err> values.

The return information is only applicable in GERAN.

Defined values

<mclass>: integer type; multislot class

<maxRx>: integer type; maximum number of receive timeslots that MT can use

<maxTx>: integer type; maximum number of transmit timeslots that MT can use

<sum>: integer type; total number of receive and transmit timeslots that MT can use at the same time (per TDMA frame). The following applies in a HSCSD call: $1 \leq (\text{receive slots}) + (\text{transmit slots}) \leq \text{<sum>}$

<codings>: is a sum of integers each representing a supported channel coding (e.g. value 5 indicates that 4,8k and 9,6k channel codings are supported):

1 4,8k full rate data traffic channel

4 9,6k full rate data traffic channel

8 14,4k full rate data traffic channel

16 28,8k full rate data traffic channel (only possible when 14.4k is supported)

32 32,0k full rate data traffic channel (only possible in a two-timeslot configuration)

64 43,2k full rate data traffic channel (only possible when 14.4k is supported)

Implementation

Mandatory when HSCSD implemented.

This command is only applicable to GERAN UEs.

6.13 HSCSD transparent call configuration +CHST

Table 20: +CHST parameter command syntax

Command	Possible response(s)
+CHST=[<wRx> [, <codings>]]	
+CHST?	+CHST: <wRx> , <codings>
+CHST=?	

Description

Set command controls parameters for transparent HSCSD calls in GERAN. Changing them during a call does not affect the current call.

Read command returns the current values.

NOTE: In UTRAN or E-UTRAN, values set with this command are not needed. The only applicable parameter is <SPEED>, which is set with +CBST command.

Defined values

<wRx>: integer type; wanted amount of receive timeslots. Default value 0 indicates that TA shall calculate a proper value from currently selected fixed network user rate (<speed> subparameter from +CBST command) and <codings>

<codings>: a sum of integers each representing a channel coding that is accepted for transparent HSCSD calls. Default value 0 indicates that all supported codings are accepted (refer +CHSD command for other values)

Implementation

Mandatory when transparent HSCSD implemented.

This command is only applicable to GERAN UEs.

6.14 HSCSD non-transparent call configuration +CHSN

Table 21: +CHSN parameter command syntax

Command	Possible response(s)
+CHSN=[<wAiur>[, <wRx>[, <topRx>[, <codings>]]]]	
+CHSN?	+CHSN: <wAiur> , <wRx> , <topRx> , <codings>
+CHSN=?	+CHSN: (list of supported <wAiur>s) , (list of supported <wRx>s) , (list of supported <topRx>s) , (list of supported <codings>s)

Description

Set command controls parameters for originating non-transparent HSCSD calls. Values may also be used during mobile terminated data call setup. In GERAN, changing <topRx> or <codings> value during a call does not affect the current call. In GERAN, changing of <wAiur> or <wRx> affects the current call only if <topRx> was non-zero when call was established.

Read command returns the current values.

Test command returns values supported as compound values.

Defined values

<wAiur>: integer type; wanted air interface user rate. Default value 0 indicates that TA shall calculate a proper value from currently selected fixed network user rate (<speed> subparameter from +CBST command), <codings>, and <wRx> (or <maxRx> from +CHSD command if <wRx>=0). Other values:

- 1 9600 bps
- 2 14400 bps
- 3 19200 bps
- 4 28800 bps
- 5 38400 bps
- 6 43200 bps
- 7 57600 bps

<wRx>: integer type; wanted amount of receive timeslots. Default value 0 indicates that TA shall calculate a proper value from currently selected <wAiur> and <codings>. This parameter is only applicable to GERAN UEs.

<topRx>: integer type; top value for <wRx> that user is going to request during the next established non-transparent HSCSD call. Default value 0 indicates that user is not going to change <wAiur>/<wRx> during the next call. This parameter is only applicable to GERAN UEs.

<codings>: a sum of integers each representing a channel coding that is accepted for non-transparent HSCSD calls. Default value 0 indicates that all supported codings are accepted (refer +CHSD command for other values). This parameter is only applicable to GERAN UEs.

Implementation

Mandatory when non-transparent HSCSD implemented.

6.15 HSCSD current call parameters +CHSC

Table 22: +CHSC action command syntax

Command	Possible response(s)
+CHSC	+CHSC: <rx>, <tx>, <aiur>, <coding>
+CHSC=?	

Description

Execution command returns information about current HSCSD call. If no HSCSD call is active, all parameters returned shall equal zero. If HSCSD call is active in UTRAN, all non-applicable parameters returned shall be equal to zero. (It is manufacturer specific whether non-zero information is returned in case of an active normal single-slot data call.)

Defined values

<rx>: integer type; number of receive timeslots currently in use. This parameter is only applicable to GERAN UEs.

<tx>: integer type; number of transmit timeslots currently in use. This parameter is only applicable to GERAN UEs.

<aiur>: integer type; current air interface user rate (in case of transparent service this equals fixed network user rate) (refer +CHSN command for possible values). For the two-timeslot ECSD bit transparent configuration the following additional values apply:

8 56000 bps

9 64000 bps

<coding>: is a sum of integers each representing the current channel coding (refer +CHSD command for possible values). This parameter is only applicable to GERAN UEs.

Implementation

Optional.

6.16 HSCSD parameters report +CHSR

Table 23: +CHSR parameter command syntax

Command	Possible response(s)
+CHSR=[<mode>]	
+CHSR?	+CHSR: <mode>
+CHSR=?	+CHSR: (list of supported <mode>s)

Description

Enabled command returns intermediate result code +CHSR: <type> from the TA to the TE when an HSCSD call is being set up. The result code represents the current (negotiated or renegotiated) HSCSD parameters. If enabled, the intermediate result code is transmitted at the point of the call setup negotiation where the TA has determined what type of an HSCSD connection will be used. Result code transmission is done after possible service (+CR), error control (+ER), and/or compression (+DR) reporting but before possible TE-TA rate (+ILRR) reporting and before the intermediate result code CONNECT is transmitted. The format of the intermediate result code is:

+CHSR: <rx>, <tx>, <aiur>, <coding>

For the value definitions, refer to +CHSN and +CHSC commands. For instance, for a non-transparent HSCSD call, result code '+CHSR: 2, 2, 4, 8' means that the call has two timeslots in both up- and downlink, the air interface user rate is 28800 bps, and the used channel coding TCH/F14.4.

For HSCSD in UTRAN, all non-applicable parameters returned shall be equal to zero.

Read command returns the current value of <mode>.

Test command returns the values supported by the UE as a compound value.

Defined values

<mode>: integer type

0 disables reporting

1 enables reporting

Implementation

Mandatory when HSCSD implemented.

6.17 HSCSD automatic user initiated upgrading +CHSU

Table 24: +CHSU parameter command syntax

Command	Possible response(s)
+CHSU=<mode>	
+CHSU?	+CHSU: <mode>
+CHSU=?	+CHSU: (list of supported <mode>s)

Description

Set command controls whether or not automatic user initiated service level upgrading shall be used for non-transparent HSCSD calls. "Automatic" means that, if enabled, the ME/TA shall use the UP bit in the received RLP frames to determine when to initiate user initiated service level upgrading (i.e. when to modify the +CHSN parameters <wAir> and/or <wRx> for the current call). Refer to 3GPP TS 27.001 [41] for details on the interpretation of the UP bit(s).

Read command returns the current value of <mode>.

Test command returns values supported as a compound value.

NOTE 1: The validity of the UP bit in the RLP frames depends on the result of the RLP negotiations. The UP bit shall only be used if the result of the RLP negotiations were successful with respect to the UP bit.

NOTE 2: This command is only applicable in GERAN.

Defined values

<mode>: integer type

0 disables use of UP bit for upgrading

1 enables use of UP bit for upgrading

Implementation

Optional.

This command is only applicable to GERAN UEs.

6.18 HSCSD non-transparent asymmetry configuration +CHSA

Table 25: +CHSA parameter command syntax

Command	Possible response(s)
+CHSA=<mode>	
+CHSA?	+CHSA: <mode>
+CHSA=?	+CHSA: (list of supported <mode>s)

Description

Set command controls the preferred asymmetry bias for non-transparent ECSD calls. Downlink biased asymmetry means that 8-PSK modulation is preferred downlink and GMSK modulation uplink. Uplink based asymmetry means that 8-PSK modulation is preferred uplink and GMSK downlink. Changing of <mode> affects the current call only if <toPrx> (refer +CHSN) was non-zero when call was established.

Read command returns the current value of <type>.

Test command returns values supported by the MT/TA as a compound value. The <mode> subparameter range indirectly indicates the UE Type; range (0-1) indicates UE Type A and range (0-2) indicates UE Type B.

NOTE 1: ECSD is also controlled by +CHSD, +CHSN and +CHST.

NOTE 2: This command is only applicable in GERAN.

Defined values

<mode>: integer type

- 0 No preference
- 1 Downlink biased asymmetry
- 2 Uplink biased asymmetry

Implementation

Mandatory when non-transparent ECSD is implemented.

This command is only applicable to GERAN UEs.

6.19 Single numbering scheme +CSNS

Table 26: +CSNS parameter command syntax

Command	Possible response(s)
+CSNS=[<mode>]	
+CSNS?	+CSNS: <mode>
+CSNS=?	+CSNS: (list of supported <mode>s)

Description

Set command selects the bearer or teleservice to be used when mobile terminated single numbering scheme call is established. Parameter values set with +CBST command shall be used when <mode> equals to a data service.

Read command returns the current value of <mode>.

Test command returns values supported as a compound value.

Defined values

<mode>: integer type

- 0 voice
- 1 alternating voice/fax, voice first (TS 61)
- 2 fax (TS 62)
- 3 alternating voice/data, voice first (BS 61)
- 4 data
- 5 alternating voice/fax, fax first (TS 61)
- 6 alternating voice/data, data first (BS 61)
- 7 voice followed by data (BS 81)

Implementation

Optional.

6.20 Voice hangup control +CVHU

Table 27: +CVHU parameter command syntax

Command	Possible response(s)
+CVHU=[<mode>]	
+CVHU?	+CVHU: <mode>
+CVHU=?	+CVHU: (list of supported <mode>s)

Description

Set command selects whether ATH or "drop DTR" shall cause a voice connection to be disconnected or not. By voice connection is also meant alternating mode calls that are currently in voice mode. (See clause 6.6).

Read command returns the current value of <mode>.

Test command returns values supported as a compound value.

NOTE: When <mode>=2, this command must be seen in conjunction with the ITU-T Recommendation V.250 [14] command &D. Else &D shall be ignored.

Defined values

<mode>: integer type

- 0 "Drop DTR" ignored but OK response given. ATH disconnects.
- 1 "Drop DTR" and ATH ignored but OK response given.
- 2 "Drop DTR" behaviour according to &D setting. ATH disconnects.

Implementation

Optional

6.21 CCITT V.120 [36] rate adaption protocol +CV120

Table 28: +CV120 parameter command syntax

Command	Possible response(s)
+CV120=[<rah>[,<mfm>[,<mode>[,<llineg>[,<assign>[,<negtype>]]]]]]	
+CV120?	+CV120: <rah>,<mfm>,<mode>,<llineg>,<assign>,<negtype>
+CV120=?	+CV120: (list of supported <rah>s) , (list of supported <mfm>s) , (list of supported <mode>s) , (list of supported <llineg>s) , (list of supported <assign>s) , (list of supported <negtype>s)

Description

Set command sets the values of the V.120 protocol parameters (defined in CCITT Recommendation V.120 [36]) that are carried in the GSM BC and/or LLC information elements.

Read command returns current settings for the V.120 parameters.

Test command returns values supported as compound values.

Defined values

<rah>: integer type

0 rate adaption header not included

1 rate adaption header included (mandatory for protocol sensitive modes).

<mfm>: integer type

0 multiple frame establishment not supported, only UI frames allowed

1 multiple frame establishment supported, both I and UI frames allowed.

<mode>: integer type

0 bit transparent mode of operation

1 protocol sensitive mode of operation.

<llineg>: integer type

0 no negotiation, LLI = 256 only

1 negotiation allowed.

NOTE: <negtype> indicates the connection over which the negotiation is performed.

<assign>: integer type

0 message originator is "default assignee"

1 message originator is "assignor only".

<negtype>: integer type

0 negotiation is done using logical link zero

1 negotiation is done with USER INFORMATION messages on a temporary signalling connection.

All possible modes of V.120 operation are not supported. However, in order to accommodate possible future additions, the complete set of parameters is included in the command.

The permitted values are: 1, 1 or 0, 1, 0, 0, 0.

A recommended set of default values is: 1, 1, 1, 0, 0, 0.

Implementation

Mandatory, if the MT supports V.120 interworking.

6.22 Settings date format +CSDF

Table 29: +CSDF parameter command syntax

Command	Possible response(s)
+CSDF=[[<mode>] [, <auxmode>]]	+CME ERROR: <err>
+CSDF?	+CSDF: <mode> [, <auxmode>] +CME ERROR: <err>
+CSDF=?	+CSDF: (list of supported <mode>s) [, (list of supported <auxmode>s)] +CME ERROR: <err>

Description

This command sets the date format via MMI of the date information presented to the user, which is specified by use of the <mode> parameter. The <mode> affects the date format on the phone display and doesn't affect the date format of the AT command serial interface. The command also sets the date format of the TE-TA interface, which is specified by use of the <auxmode> parameter (e.g. the <auxmode> affects the <time> of +CCLK and +CALA). If the parameter is omitted (" +CSDF=", "+CSDF=<mode>", "+CSDF= , <auxmode>"), then this sets the default value. Refer clause 9.2 for possible <err> values.

Read command returns the current settings.

Test command returns values supported as compound values.

Defined values

<mode>: integer type

NOTE 1: It is manufacturer specific which modes that are supported.

1 DD-MMM-YYYY

NOTE 2: Presentation of MMM is language dependent.

2 DD-MM-YY

3 MM/DD/YY

4 DD/MM/YY

5 DD.MM.YY

6 YYMMDD

7 YY-MM-DD

8-255 Manufacturer specific

<auxmode>: integer type

1 yy/MM/dd

2 yyyy/MM/dd

all other values are reserved by the present document.

NOTE 3: The <time> format of +CCLK and +CALA "yy/MM/dd, hh:mm:ss±zz" when <auxmode>=1 and it is "yyyy/MM/dd, hh:mm:ss±zz" when <auxmode>=2. If the MT does not support time zone information then the three last characters may be omitted (see +CCLK command).

Implementation

Optional

6.23 Silence command +CSIL

Table 30: +CSIL parameter command syntax

Command	Possible response(s)
+CSIL=[<mode>]	+CME ERROR: <err>
+CSIL?	+CSIL: <mode> +CME ERROR: <err>
+CSIL=?	+CSIL: (list of supported <mode>s) +CME ERROR: <err>

Description

Set command enables/disables the silent mode. When the phone is in silent mode, all sounds from MT are suppressed except voice. Refer clause 9.2 for possible <err> values.

Read command reads the current setting.

Test command lists the supported modes as a compound value.

Defined values

<mode>: integer type. The default value is manufacturer specific.

0 Silent mode off

1 Silent mode on

Implementation

Optional

6.24 Settings time format +CSTF

Table 31: +CSTF parameter command syntax

Command	Possible response(s)
+CSTF=[<mode>]	+CME ERROR: <err>
+CSTF?	+CSTF: <mode> +CME ERROR: <err>
+CSTF=?	+CSTF: (list of supported <mode>s) +CME ERROR: <err>

Description

Set command sets the time format of the time information presented to the user. Refer clause 9.2 for possible <err> values.

Read command reads the current setting.

Test command reads the supported <modes>s as a compound value.

Defined values

<mode>: integer type. The default value is manufacturer specific.

- 1 HH:MM (24 hour clock)
- 2 HH:MM a.m./p.m.
- 3-7 Manufacturer specific

Implementation

Optional

6.25 ITU-T Recommendation V.250 [14] call control commands

Table 32: V.250 call control commands

Command	Clause	Impl.	Used in the present document
D[<dial_string>][;]	6.3.1	mand.	originates a call
T	6.3.2	mand.	ignored (select tone dialling)
P	6.3.3	mand.	ignored (select pulse dialling)
A	6.3.5	mand.	answer a call
H[<value>]	6.3.6	mand.	hang-up a single mode call; for alternate mode call refer clause "Hangup call +CHUP" (only value equal to zero needed)
O[<value>]	6.3.7	mand.	returns TA to online data state from online command mode (only value equal to zero needed)
S0=[<value>]	6.3.8	mand.	sets the number of call indications (rings) before automatically answering the call; value equalling zero disables automatic answering and is the default
S6=[<value>]	6.3.9	mand.	ignored (pause before blind dialling)
S7=[<value>]	6.3.10	mand.	sets number of seconds to wait for completion of call answering or originating procedure before giving up and disconnecting
S8=[<value>]	6.3.11	mand.	sets number of seconds to wait when comma dial modifier encountered in dial string of D command (default is 2 seconds)
S10=[<value>]	6.3.12	mand.	sets number of tenths of seconds to wait before disconnecting after TA has indicated the absence of received line signal
L[<value>]	6.3.13	mand.	ignored (monitor speaker loudness)
M[<value>]	6.3.14	mand.	ignored (monitor speaker mode)

Implementation of commands marked as mandatory is mandatory only if call control functionality is supported.

6.26 ITU-T Recommendation V.250 [14] data compression commands

Table 33: V.250 data compression commands

Command	Clause	Impl.	Used in the present document
+DS=[<dir>[,<neg>[,<P1>[,<P2>]]]]	6.6.1	mand. when V.42bis	controls ITU-T Recommendation V.42bis data compression functions; for subparameter defaults refer 3GPP TS 24.022 [18]
+DR=[<value>]	6.6.2	mand. when V.42bis	determines whether the use of V.42bis is informed using intermediate result code +DR: <type> before going online data state after call answering or originating

6.27 Initiate eCall +CECALL

Table 6.27-1: +CECALL parameter command syntax

Command	Possible response
+CECALL=<type_of_eCall>[,<format>,<msd_data_length>,<msd_data>]	
+CECALL?	+CECALL: [<type_of_eCall>[,<format>,<msd_data_length>,<msd_data>[,<format>,<msd_data>,[...]]]

+CECALL=?	+CECALL: (list of supported <type_of_eCall>s)[, (list of supported <format>s)]
-----------	--

Description

Set command is used to trigger an eCall to the network or to provide an updated MSD to the network during an ongoing eCall. Based on the configuration selected, it can be used to either trigger a test call, a reconfiguration call, a manually initiated eCall or an automatically initiated eCall. The parameters <format>, <msd_data_length> and <msd_data> are included if the MSD is provided by the application. If the parameters are not included, the MSD is provided to the network by the MT.

Read command returns the <type_of_eCall> that is currently in progress, if any. The MT may also return the <format>s and the <msd_data>s of the eCall as provided to the network. The parameters of the response to the read command will be cleared when the eCall in progress is terminated.

Test command returns the supported values as compound values.

Defined values

<type_of_eCall>: integer type. Indicates the type of eCall.

- 0 test call
- 1 reconfiguration call eCall
- 2 manually initiated eCall
- 3 automatically initiated eCall

<format>: integer type. Indicates the format of the provided eCall MSD.

- 1 binary format

<msd_data_length>: integer type. Indicates the number of octets of the <msd_data> information element.

<msd_data>: string type. Minimum set of data, see CEN EN 15722:2015 [157]. The type of string is in the format specified by <format>. This parameter shall not be subject to conventional character conversion as per +CSCS.

Implementation

Optional.

6.28 eCall Notification +CECN

Table 6.28-1: +CECN parameter command syntax

Command	Possible response
+CECN=[<n>]	
+CECN?	+CECN: <n>
+CECN=?	+CECN: (list of supported <n>s)

Description

Set command is used to control the presentation of an unsolicited result code +CECN: <data_type> when <n>=1 and the network requests an updated MSD during an eCall. As a result of the unsolicited result code +CECN, the AT-command +CECALL can be used to provide an updated MSD for the eCall.

NOTE: The parameter <data_type>=0 is used to inform that the updated MSD will be provided to the network by the MT.

Read command returns the status of result code presentation <n>.

Test command returns the supported values as a compound value.

Defined values

<n>: integer type. Enables or disables reporting of unsolicited result code +CECN.

- 0 disable presentation of the unsolicited result code
- 1 enable presentation of the unsolicited result code

<data_type>: integer type. Indicates the type of additional data for the eCall.

- 0 updated MSD for the eCall is provided to the network by the MT
- 1 request for updated MSD

Implementation

Optional.

6.29 Informative examples

The alternating mode call handling (voice and fax, or voice and data) and the data call setup commands are defined such that the dialling command of ITU-T Recommendation V.250 [14] (D) still always originates a call. The purpose is to support all current TE applications using the dialling command as default. Fax calls are controlled following the rules of ITU-T Recommendation T.31 [11] and ITU-T Recommendation T.32 [12] standards.

An example where a voice call is originated:

```
ATD+1 812 5556731; (type of address defaults to 145, CLI presentation is restricted for this call)
OK (call setup was successful)
```

An example where a voice call is attempted from a phonebook:

```
ATD>"Doe Joe"G; (enable CUG control for this call)
+CME ERROR: 22 (entry "Doe Joe" is not found)
```

Also supplementary services can be controlled using dial command according to 3GPP TS 22.030 [19]. An example of call forwarding on no reply for telephony with the adjustment of the no reply condition timer on 25 seconds:

```
ATD**61*+1812555673*11*25#
OK (modification was successful)
```

Two new commands are created for controlling the alternating mode calls. First one, Call Mode (+CMOD), selects between single and alternating mode. Because this is a crucial command, it is defined that the value is set back to zero (single mode) after every successfully originated alternating mode call. Also on power-up and factory or user resets, the value is set to zero. The second new command, Hangup Call (+CHUP), is not a replacement of ITU-T Recommendation V.250 [14] command H, but a command which reliably disconnects the call in GSM/UMTS network. This is defined because the H command is used to switch from fax or data mode to voice mode.

The setting of GSM/UMTS bearer service (data circuit duplex asynchronous and synchronous, PAD access circuit asynchronous, or data packet duplex synchronous), is done with Select Bearer Service Type (+CBST). It chooses one of the four mentioned bearer services, the data rate of the service (or actually the modulation when modem IWFs are used), and enables or disables RLP. Command Radio Link Protocol (+CRLP) is used to set the RLP parameters in the radio path.

Service Reporting Control command (+CR) is defined similarly as the reporting of modulation, V.18, error control, and data compression which are ITU-T Recommendation V.250 [14] features used to show information about the type of the established connection before the CONNECT intermediate result code. +CR command has one subparameter which specifies whether the intermediate result code +CR: <serv> is returned or not. The result code is typically returned before any ITU-T Recommendation V.250 [14] reporting result codes. An example of setting up an asynchronous 9600 bit/s modem connection with service reporting:

```

AT+CBST=7,0,1    (asynchronous modem 9600 bit/s and RLP)
OK
AT+CR=1          (enable reporting)
OK
ATD1234567890
+CR: REL ASYNC
CONNECT 9600

```

As GSM/UMTS network offers more information about the reason of the failure in call originating and answering than normal PSTN, it is useful to add an extra command to return this information to the TE. This information should not be returned always after unsuccessful call originating or answering, because many TE applications look for just the regular NO CARRIER, BUSY, NO ANSWER and CONNECT messages. Action command Extended Error Report (+CEER) does not have any subparameters, and it returns the cause of the latest call setup failure. This information can be the textual presentation of the GSM/UMTS network failure code (refer 3GPP TS 24.008 [8] Annex H), or some other information defined by the TA manufacturer.

7 Network service related commands

7.0 General

This clause describes network related commands, which are not covered in call control clause of the present document. Commands include supplementary service handling, MSISDN query, MT and network facility locking, and network registration information query.

7.1 Subscriber number +CNUM

Table 34: +CNUM action command syntax

Command	Possible response(s)
+CNUM	+CNUM: [<alpha1>], <number1>, <type1>[, <speed>, <service>[, <itc>]] [<CR><LF>+CNUM: [<alpha2>], <number2>, <type2>[, <speed>, <service>[, <itc>]] [...]] +CME ERROR: <err>
+CNUM=?	

Description

Action command returns the MSISDNs related to the subscriber (this information can be stored in the SIM/UICC or in the MT). When storing information in the SIM/UICC, if the currently selected card slot contains a SIM card or a UICC with an active GSM application, the information is stored in the EF_{MSISDN} under DF_{Telecom}. If the currently selected card slot contains a UICC with an active USIM application, the information is stored in the EF_{MSISDN} under ADF_{USIM}. If subscriber has different MSISDN for different services, each MSISDN is returned on a separate line. Refer clause 9.2 for possible <err> values.

Defined values

<alpha>: optional alphanumeric string associated with <number>; used character set should be the one selected with command select TE character set +CSCS

<number>: string type phone number of format specified by <type>

<type>: type of address octet in integer format (refer 3GPP TS 24.008 [8] clause 10.5.4.7)

<speed>: integer type as defined in clause 6.7

<service>: integer type (service related to the phone number)

- 0 asynchronous modem
- 1 synchronous modem
- 2 PAD Access (asynchronous)
- 3 Packet Access (synchronous)
- 4 voice
- 5 fax

all other values below 128 are reserved by the present document

<itc>: integer type (information transfer capability)

- 0 3,1 kHz
- 1 UDI

Implementation

Optional.

7.2 Network registration +CREG

Table 35: +CREG parameter command syntax

Command	Possible response(s)
+CREG=[<n>]	+CME ERROR: <err>
+CREG?	+CREG: <n>,<stat>[, [<lac>] , [<ci>] , [<AcT>] [, <cause_type> , <reject_cause>]]
+CREG=?	+CREG: (list of supported <n>s)

Description

Set command controls the presentation of an unsolicited result code +CREG: <stat> when <n>=1 and there is a change in the MT's circuit mode network registration status in GERAN/UTRAN/E-UTRAN, or unsolicited result code +CREG: <stat>[, [<lac>] , [<ci>] , [<AcT>]] when <n>=2 and there is a change of the network cell in GERAN/UTRAN/E-UTRAN. The parameters <AcT>, <lac> and <ci> are sent only if available. The value <n>=3 further extends the unsolicited result code with [, <cause_type> , <reject_cause>] , when available, when the value of <stat> changes.

NOTE 1: If the MT also supports one or more of the GPRS services, EPS services or 5G services, the +CGREG command and +CGREG: result codes, the +CEREG command and +CEREG: result codes and the +C5GREG command and +C5GREG: result codes apply to the registration status and location information for those services.

Read command returns the status of result code presentation and an integer <stat> which shows whether the network has currently indicated the registration of the MT. Location information elements <lac>, <ci> and <AcT>, if available, are returned only when <n>=2 and MT is registered in the network. The parameters [, <cause_type> , <reject_cause>] , if available, are returned when <n>=3. Refer clause 9.2 for possible <err> values.

Test command returns values supported as a compound value.

Defined values

<n>: integer type

- 0 disable network registration unsolicited result code

- 1 enable network registration unsolicited result code +CREG: <stat>
- 2 enable network registration and location information unsolicited result code
+CREG: <stat>[, [<lac>], [<ci>], [<AcT>]]
- 3 enable network registration, location information and cause value information unsolicited result code
+CREG: <stat>[, [<lac>], [<ci>], [<AcT>]][, <cause_type>, <reject_cause>]]

<stat>: integer type; circuit mode registration status.

- 0 not registered, MT is not currently searching a new operator to register to
- 1 registered, home network
- 2 not registered, but MT is currently searching a new operator to register to
- 3 registration denied
- 4 unknown (e.g. out of GERAN/UTRAN/E-UTRAN coverage)
- 5 registered, roaming
- 6 registered for "SMS only", home network (applicable only when <AcT> indicates E-UTRAN)
- 7 registered for "SMS only", roaming (applicable only when <AcT> indicates E-UTRAN)
- 8 attached for emergency bearer services only (see NOTE 2) (not applicable)
- 9 registered for "CSFB not preferred", home network (applicable only when <AcT> indicates E-UTRAN)
- 10 registered for "CSFB not preferred", roaming (applicable only when <AcT> indicates E-UTRAN)

NOTE 2: 3GPP TS 24.008 [8] and 3GPP TS 24.301 [83] specify the condition when the MS is considered as attached for emergency bearer services.

<lac>: string type; two byte location area code (when <AcT> indicates value 0 to 6), or tracking area code (when <AcT> indicates value 7). In hexadecimal format (e.g. "00C3" equals 195 in decimal).

<ci>: string type; four byte GERAN/UTRAN/E-UTRAN cell ID in hexadecimal format.

<AcT>: integer type; access technology of the serving cell.

- 0 GSM
- 1 GSM Compact
- 2 UTRAN
- 3 GSM w/EGPRS (see NOTE 3)
- 4 UTRAN w/HSDPA (see NOTE 4)
- 5 UTRAN w/HSUPA (see NOTE 4)
- 6 UTRAN w/HSDPA and HSUPA (see NOTE 4)
- 7 E-UTRAN
- 8 EC-GSM-IoT (A/Gb mode) (see NOTE 5)
- 9 E-UTRAN (NB-S1 mode) (see NOTE 6)
- 10 E-UTRA connected to a 5GCN (see NOTE 7) (not applicable)
- 11 NR connected to a 5GCN (see NOTE 7) (not applicable)
- 12 NG-RAN (not applicable)

13 E-UTRA-NR dual connectivity (see NOTE 8)

NOTE 3: 3GPP TS 44.018 [156] specifies the System Information messages which give the information about whether the serving cell supports EGPRS.

NOTE 4: 3GPP TS 25.331 [74] specifies the System Information blocks which give the information about whether the serving cell supports HSDPA or HSUPA.

NOTE 5: 3GPP TS 44.018 [156] specifies the EC-SCH INFORMATION message which, if present, indicates that the serving cell supports EC-GSM-IoT.

NOTE 6: 3GPP TS 36.331 [86] specifies the System Information blocks which give the information about whether the serving cell supports NB-IoT, which corresponds to E-UTRAN (NB-S1 mode).

NOTE 7: 3GPP TS 38.331 [160] specifies the information which, if present, indicates that the serving cell is connected to a 5GCN.

NOTE 8: 3GPP TS 38.331 [160] specifies the information which, if present, indicates that the serving cell is supporting dual connectivity of E-UTRA with NR and is connected to an EPS core.

<cause_type>: integer type; indicates the type of <reject_cause>.

0 Indicates that <reject_cause> contains an MM cause value, see 3GPP TS 24.008 [8] Annex G.

1 Indicates that <reject_cause> contains a manufacturer specific cause.

<reject_cause>: integer type; contains the cause of the failed registration. The value is of type as defined by <cause_type>.

Implementation

Optional.

This command is not applicable to UEs in NG-RAN.

7.3 PLMN selection +COPS

Table 36: +COPS parameter command syntax

Command	Possible response(s)
+COPS=[<mode>[,<format>[,<oper>[,<AcT>]]]]	+CME ERROR: <err>
+COPS?	+COPS: <mode>[,<format>,<oper>[,<AcT>]] +CME ERROR: <err>
+COPS=?	+COPS: [list of supported (<stat>, long alphanumeric <oper>, short alphanumeric <oper>, numeric <oper>[,<AcT>])s][, , (list of supported <mode>s), (list of supported <format>s)] +CME ERROR: <err>

Description

Set command forces an attempt to select and register to the GSM/UMTS/EPS/5GS network operator using the SIM/USIM card installed in the currently selected card slot. <mode> is used to select whether the selection is done automatically by the MT or is forced by this command to operator <oper> (it shall be given in format <format>) to a certain access technology, indicated in <AcT>. If the selected operator is not available, no other operator shall be selected (except <mode>=4). If the selected access technology is not available, then the same operator shall be selected in other access technology. The selected operator name format shall apply to further read commands (+COPS?) also. <mode>=2 forces an attempt to deregister from the network. The selected mode affects to all further network

registration (e.g. after <mode>=2, MT shall be unregistered until <mode>=0 or 1 is selected). Refer clause 9.2 for possible <err> values. This command should be abortable when registration/deregistration attempt is made.

Read command returns the current mode, the currently selected operator and the current Access Technology. If no operator is selected, <format>, <oper> and <AcT> are omitted.

Test command returns a set of five parameters, each representing an operator present in the network. A set consists of an integer indicating the availability of the operator <stat>, long and short alphanumeric format of the name of the operator, numeric format representation of the operator and access technology. Any of the formats may be unavailable and should then be an empty field. The list of operators shall be in order: home network, networks referenced in SIM or active application in the UICC (GSM or USIM) in the following order: HPLMN selector, User controlled PLMN selector, Operator controlled PLMN selector and PLMN selector (in the SIM or GSM application), and other networks.

It is recommended (although optional) that after the operator list TA returns lists of supported <mode>s and <format>s. These lists shall be delimited from the operator list by two commas.

The access technology selected parameters, <AcT>, should only be used in terminals capable to register to more than one access technology. Selection of <AcT> does not limit the capability to cell reselections, even though an attempt is made to select an access technology, the phone may still re-select a cell in another access technology.

Defined values

<mode>: integer type

- 0 automatic (<oper> field is ignored)
- 1 manual (<oper> field shall be present, and <AcT> optionally)
- 2 deregister from network
- 3 set only <format> (for read command +COPS?), do not attempt registration/deregistration (<oper> and <AcT> fields are ignored); this value is not applicable in read command response
- 4 manual/automatic (<oper> field shall be present); if manual selection fails, automatic mode (<mode>=0) is entered

<format>: integer type

- 0 long format alphanumeric <oper>
- 1 short format alphanumeric <oper>
- 2 numeric <oper>

<oper>: string type; <format> indicates if the format is alphanumeric or numeric; long alphanumeric format can be upto 16 characters long and short format up to 8 characters (refer GSM MoU SE.13 [9]); numeric format is the Location Area Identification number (refer 3GPP TS 24.008 [8] clause 10.5.1.3) which consists of a three BCD digit country code coded as in ITU-T Recommendation E.212 [10] Annex A, plus a two BCD digit network code, which is administration specific; returned <oper> shall not be in BCD format, but in IRA characters converted from BCD; hence the number has structure: (country code digit 3)(country code digit 2)(country code digit 1)(network code digit 3)(network code digit 2)(network code digit 1)

<stat>: integer type

- 0 unknown
- 1 available
- 2 current
- 3 forbidden

<AcT>: integer type; access technology selected

- 0 GSM

- 1 GSM Compact
- 2 UTRAN
- 3 GSM w/EGPRS (see NOTE 1)
- 4 UTRAN w/HSDPA (see NOTE 2)
- 5 UTRAN w/HSUPA (see NOTE 2)
- 6 UTRAN w/HSDPA and HSUPA (see NOTE 2)
- 7 E-UTRAN
- 8 EC-GSM-IoT (A/Gb mode) (see NOTE 3)
- 9 E-UTRAN (NB-S1 mode) (see NOTE 4)
- 10 E-UTRA connected to a 5GCN (see NOTE 5)
- 11 NR connected to a 5GCN (see NOTE 5)
- 12 NG-RAN
- 13 E-UTRA-NR dual connectivity (see NOTE 6)

NOTE 1: 3GPP TS 44.018 [156] specifies the System Information messages which give the information about whether the serving cell supports EGPRS.

NOTE 2: 3GPP TS 25.331 [74] specifies the System Information blocks which give the information about whether the serving cell supports HSDPA or HSUPA.

NOTE 3: 3GPP TS 44.018 [156] specifies the EC-SCH INFORMATION message which, if present, indicates that the serving cell supports EC-GSM-IoT.

NOTE 4: 3GPP TS 36.331 [86] specifies the System Information blocks which give the information about whether the serving cell supports NB-IoT, which corresponds to E-UTRAN (NB-S1 mode).

NOTE 5: 3GPP TS 38.331 [160] specifies the information which, if present, indicates that the serving cell is connected to a 5G CN. This value is not applicable in set command.

NOTE 6: 3GPP TS 38.331 [160] specifies the information which, if present, indicates that the serving cell is supporting dual connectivity of E-UTRA with NR and is connected to an EPS core.

Implementation

Optional.

7.4 Facility lock +CLCK

Table 37: +CLCK action command syntax

Command	Possible response(s)
+CLCK=<fac>,<mode>[,<passwd>[,<class>]]	+CME ERROR: <err> when <mode>=2 and command successful: +CLCK: <status>[,<class1>] [<CR><LF>+CLCK: <status>,<class2> [...]]
+CLCK=?	+CLCK: (list of supported <fac>s) +CME ERROR: <err>

Description

Execute command is used to lock, unlock or interrogate a MT or a network facility $\langle fac \rangle$. Password is normally needed to do such actions. When querying the status of a network service ($\langle mode \rangle = 2$) the response line for 'not active' case ($\langle status \rangle = 0$) should be returned only if service is not active for any $\langle class \rangle$. Refer clause 9.2 for possible $\langle err \rangle$ values. This command should be abortable when network facilities are set or interrogated.

Call barring facilities are based on supplementary services (refer 3GPP TS 22.088 [6]). The interaction of these with other commands based on other supplementary services is described in the specification of the relevant supplementary service.

Test command returns facility values supported as a compound value.

Defined values

$\langle fac \rangle$ values reserved by the present document:

- "CS" CNTRL (lock CoNTRoL surface (e.g. phone keyboard))
- "PS" PH-SIM (lock PHone to SIM/UICC card installed in the currently selected card slot) (MT asks password when other than current SIM/UICC card inserted; MT may remember certain amount of previously used cards thus not requiring password when they are inserted)
- "PF" lock Phone to the very First inserted SIM/UICC card (also referred in the present document as PH-FSIM) (MT asks password when other than the first SIM/UICC card is inserted)
- "SC" SIM (lock SIM/UICC card installed in the currently selected card slot) (SIM/UICC asks password in MT power-up and when this lock command issued)
- "AO" BAOC (Barr All Outgoing Calls) (refer 3GPP TS 22.088 [6] clause 1)
- "OI" BOIC (Barr Outgoing International Calls) (refer 3GPP TS 22.088 [6] clause 1)
- "OX" BOIC-exHC (Barr Outgoing International Calls except to Home Country) (refer 3GPP TS 22.088 [6] clause 1)
- "AI" BAIC (Barr All Incoming Calls) (refer 3GPP TS 22.088 [6] clause 2)
- "IR" BIC-Roam (Barr Incoming Calls when Roaming outside the home country) (refer 3GPP TS 22.088 [6] clause 2)
- "NT" barr incoming calls from numbers Not stored to TA memory
- "NM" barr incoming calls from numbers Not stored to MT memory
- "NS" barr incoming calls from numbers Not stored to SIM/UICC memory
- "NA" barr incoming calls from numbers Not stored in Any memory
- "AB" All Barring services (refer 3GPP TS 22.030 [19]) (applicable only for $\langle mode \rangle = 0$)
- "AG" All outGoing barring services (refer 3GPP TS 22.030 [19]) (applicable only for $\langle mode \rangle = 0$)
- "AC" All inComing barring services (refer 3GPP TS 22.030 [19]) (applicable only for $\langle mode \rangle = 0$)
- "FD" SIM card or active application in the UICC (GSM or USIM) fixed dialling memory feature (if PIN2 authentication has not been done during the current session, PIN2 is required as $\langle passwd \rangle$)
- "PN" Network Personalization (refer 3GPP TS 22.022 [33])
- "PU" network sUbset Personalization (refer 3GPP TS 22.022 [33])
- "PP" service Provider Personalization (refer 3GPP TS 22.022 [33])
- "PC" Corporate Personalization (refer 3GPP TS 22.022 [33])

<mode>: integer type

- 0 unlock
- 1 lock
- 2 query status

<status>: integer type

- 0 not active
- 1 active

<passwd>: string type; shall be the same as password specified for the facility from the MT user interface or with command Change Password +CPWD

<classx> is a sum of integers each representing a class of information (default 7 - voice, data and fax):

- 1 voice (telephony)
- 2 data (refers to all bearer services; with <mode>=2 this may refer only to some bearer service if TA does not support values 16, 32, 64 and 128)
- 4 fax (facsimile services)
- 8 short message service
- 16 data circuit sync
- 32 data circuit async
- 64 dedicated packet access
- 128 dedicated PAD access

Implementation

The call barring supplementary service control is mandatory for MT supporting AT commands only and not supporting the control through dial command D.

7.5 Change password +CPWD

Table 38: +CPWD action command syntax

Command	Possible response(s)
+CPWD=<fac>, <oldpwd>, <newpwd>	+CME ERROR: <err>
+CPWD=?	+CPWD: list of supported (<fac>, <pwdlength>)s +CME ERROR: <err>

Description

Action command sets a new password for the facility lock function defined by command Facility Lock +CLCK. Refer clause 9.2 for possible <err> values.

Test command returns a list of pairs which present the available facilities and the maximum length of their password.

Defined values

<fac>:

"P2" SIM PIN2

refer Facility Lock +CLCK for other values

<oldpwd>, <newpwd>: string type; <oldpwd> shall be the same as password specified for the facility from the MT user interface or with command Change Password +CPWD and <newpwd> is the new password; maximum length of password can be determined with <pwdlength>

<pwdlength>: integer type maximum length of the password for the facility

Implementation

Optional.

7.6 Calling line identification presentation +CLIP

Table 39: +CLIP parameter command syntax

Command	Possible response(s)
+CLIP=[<n>]	
+CLIP?	+CLIP: <n> , <m>
+CLIP=?	+CLIP: (list of supported <n>s)

Description

This command refers to the supplementary service CLIP (Calling Line Identification Presentation) according to 3GPP TS 22.081 [3] and OIP (Originating Identification Presentation) according to 3GPP TS 24.607 [119] that enables a called subscriber to get the calling line identity (CLI) of the calling party when receiving a mobile terminated call. Set command enables or disables the presentation of the CLI at the TE. It has no effect on the execution of the supplementary service CLIP / OIP in the network.

When <n>=1, the presentation of the calling line identity at the TE is enabled and when the calling subscriber allows, the unsolicited result code

+CLIP: <number> , <type> [, <subaddr> , <satype> [, [<alpha>] [, <CLI_validity>]]] is returned after every RING (or +CRING: <type>; refer clause "Cellular result codes +CRC") result code sent from TA to TE. It is manufacturer specific if this response is used when normal voice call is answered. The unsolicited result code +CLIP does not support numbers of the SIP URI format.

When <n>=0, the presentation of the calling line identity at the TE with unsolicited result code +CLIP is disabled.

The calling line identity can also be reported in unsolicited result codes +CMCCSS<x> / +CMCCSEND, enabled with +CMCCS=3 (see AT command monitor of current calls +CMCCS). The unsolicited result codes +CMCCSS<x> / +CMCCSEND support numbers of the SIP URI format. Read command gives the status of <n>, and also triggers an interrogation of the provision status of the CLIP supplementary service according to 3GPP TS 22.081 [3] and OIP supplementary service according to 3GPP TS 24.607 [119] (given in <m>).

Read command returns the current settings.

Test command returns values supported as a compound value.

Defined values

<n>: integer type (parameter sets/shows the result code presentation status to the TE).

0 disable

1 enable

<m>: integer type (parameter shows the subscriber CLIP / OIP service status in the network).

0 CLIP / OIP not provisioned

1 CLIP / OIP provisioned

2 unknown (e.g. no network, etc.)

<number>: string type phone number of format specified by <type>.

<type>: type of address octet in integer format (refer 3GPP TS 24.008 [8] clause 10.5.4.7).

<subaddr>: string type subaddress of format specified by <satype>

<satype>: type of subaddress octet in integer format (refer 3GPP TS 24.008 [8] clause 10.5.4.8).

<alpha>: optional string type alphanumeric representation of <number> corresponding to the entry found in phonebook; used character set should be the one selected with command select TE character set +CSCS.

<CLI_validity>: integer type. This parameter can provide details why <number> does not contain a calling party BCD number (refer 3GPP TS 24.008 [8] clause 10.5.4.30).

0 CLI valid

1 CLI has been withheld by the originator (refer 3GPP TS 24.008 [8] table 10.5.135a/3GPP TS 24.008 code "Reject by user")

2 CLI is not available due to interworking problems or limitations of originating network (refer 3GPP TS 24.008 [8] table 10.5.135a/3GPP TS 24.008 code "Interaction with other service")

3 CLI is not available due to calling party being of type payphone (refer 3GPP TS 24.008 [8] table 10.5.135a/3GPP TS 24.008 code "Coin line/payphone")

4 CLI is not available due to other reasons (refer 3GPP TS 24.008 [8] table 10.5.135a/3GPP TS 24.008 code "Unavailable").

When CLI is not available (<CLI_validity>=2, <CLI_validity>=3 or <CLI_validity>=4), <number> shall be an empty string ("") and <type> value will not be significant. Nevertheless, TA may return the recommended value 128 for <type> (TON/NPI unknown in accordance with 3GPP TS 24.008 [8] clause 10.5.4.7).

When CLI has been withheld by the originator, (<CLI_validity>=1) and the CLIP is provisioned with the "override category" option (refer 3GPP TS 22.081 [3] and 3GPP TS 23.081 [40]), <number> and <type> is provided. Otherwise, TA shall return the same setting for <number> and <type> as if the CLI was not available.

Implementation

Optional.

7.7 Calling line identification restriction +CLIR

Table 40: +CLIR parameter command syntax

Command	Possible response(s)
+CLIR=[<n>]	
+CLIR?	+CLIR: <n> , <m>
+CLIR=?	+CLIR: (list of supported <n>s)

Description

This command refers to the supplementary service CLIR (Calling Line Identification Restriction) according to 3GPP TS 22.081 [3] and OIR (Originating Identification Restriction) according to 3GPP TS 24.607 [119] that allows a calling subscriber to enable or disable the presentation of the calling line identity (CLI) to the called party when originating a call.

Set command overrides the CLIR / OIR subscription (default is restricted or allowed) when temporary mode is provisioned as a default adjustment for all following outgoing calls. This adjustment can be revoked by using the

opposite command. If this command is used by a subscriber without provision of CLIR / OIR in permanent mode the network will act according to 3GPP TS 22.081 [3] and 3GPP TS 24.607 [119]).

Read command gives the default adjustment for all outgoing calls (given in <n>), and also triggers an interrogation of the provision status of the CLIR / OIR service (given in <m>).

Test command returns values supported as a compound value.

NOTE: On a per call basis CLIR / OIR functionality is explained in clauses "ITU-T Recommendation V.250 [14] dial command D" and "Dial URI +CDU".

Defined values

<n>: integer type (parameter sets the adjustment for outgoing calls).

- 0 presentation indicator is used according to the subscription of the CLIR / OIR service.
- 1 CLIR / OIR invocation
- 2 CLIR / OIR suppression

<m>: integer type (parameter shows the subscriber CLIR / OIR service status in the network).

- 0 CLIR / OIR not provisioned
- 1 CLIR / OIR provisioned in permanent mode
- 2 unknown (e.g. no network, etc.)
- 3 CLIR / OIR temporary mode presentation restricted
- 4 CLIR / OIR temporary mode presentation allowed

Implementation

Optional.

7.8 Connected line identification presentation +COLP

Table 41: +COLP parameter command syntax

Command	Possible response(s)
+COLP=[<n>]	
+COLP?	+COLP: <n>, <m>
+COLP=?	+COLP: (list of supported <n>s)

Description

This command refers to the supplementary service COLP (Connected Line Identification Presentation) according to 3GPP TS 22.081 [3] and TIP (Terminating Identification Presentation) according to 3GPP TS 24.608 [120] that enables a calling subscriber to get the connected line identity (COL) of the called party after setting up a mobile originated call. The command enables or disables the presentation of the COL at the TE. It has no effect on the execution of the supplementary service COLR / TIR in the network.

When <n>=1, the presentation of the connected line identity at the TE enabled and when the called subscriber allows the intermediate result code, +COLP: <number>, <type>[, <subaddr>, <satype> [, <alpha>]] is returned from TA to TE before any +CR or ITU-T Recommendation V.250 [14] responses. It is manufacturer specific if this response is used when normal voice call is established. The intermediate result code +COLP does not support numbers of the SIP URI format.

NOTE: If the connected line identity is available in the TE after reception of the final response to the call setup, +COLP is not returned as an intermediate result code but as an unsolicited result code.

When $\langle n \rangle = 0$, the presentation of the connected line identity at the TE is disabled.

The connected line identity can also be reported in unsolicited result codes $+CMCCSS\langle x \rangle / +CMCCSSEND$, enabled with $+CMCCS=3$ (see AT command monitor of current calls $+CMCCS$). The unsolicited result codes $+CMCCSS\langle x \rangle / +CMCCSSEND$ support numbers of the SIP URI format.

Read command gives the status of $\langle n \rangle$, and also triggers an interrogation of the provision status of the COLP supplementary service according 3GPP TS 22.081 [3] and TIP supplementary service according to 3GPP TS 24.608 [120] (given in $\langle m \rangle$).

Test command returns values supported as a compound value.

Defined values

$\langle n \rangle$: integer type (parameter sets/shows the result code presentation status to the TE).

0 disable

1 enable

$\langle m \rangle$: integer type (parameter shows the subscriber COLP service status in the network).

0 COLP / TIP not provisioned

1 COLP / TIP provisioned

2 unknown (e.g. no network, etc.)

$\langle \text{number} \rangle$, $\langle \text{type} \rangle$, $\langle \text{subaddr} \rangle$, $\langle \text{satype} \rangle$, $\langle \text{alpha} \rangle$: refer $+CLIP$.

Implementation

Optional.

7.9 Called line identification presentation +CDIP

Table 42: +CDIP parameter command syntax

Command	Possible response(s)
$+CDIP=[\langle n \rangle]$	
$+CDIP?$	$+CDIP: \langle n \rangle, \langle m \rangle$
$+CDIP=?$	$+CDIP: (\text{list of supported } \langle n \rangle\text{s})$

Description

This command related to a network service that provides "multiple called numbers (called line identifications) service" to an MT. This command enables a called subscriber to get the called line identification of the called party when receiving a mobile terminated call. Set command enables or disables the presentation of the called line identifications at the TE.

When $\langle n \rangle = 1$, the presentation of the called line identification at the TE is enabled, the unsolicited result code $+CDIP: \langle \text{number} \rangle, \langle \text{type} \rangle [, \langle \text{subaddr} \rangle, \langle \text{satype} \rangle]$ is returned after every RING (or $+CRING: \langle \text{type} \rangle$; refer clause "Cellular result codes +CRC") result code sent from TA to TE. It is manufacturer specific if this response is used when normal voice call is answered. The unsolicited result code $+CDIP$ does not support numbers of the SIP URI format.

When $\langle n \rangle = 0$, the presentation of the called line identification at the TE is disabled.

The called line identification can also be reported in unsolicited result codes $+CMCCSS\langle x \rangle / +CMCCSSEND$, enabled with $+CMCCS=3$ (see AT command monitor of current calls $+CMCCS$). The unsolicited result codes $+CMCCSS\langle x \rangle / +CMCCSSEND$ support numbers of the SIP URI format.

Read command gives the status of <n>, and also triggers an interrogation of the provision status of the "multiple called numbers" service.

Test command returns values supported as a compound value.

Defined values

<n>: integer type (parameter sets/shows the result code presentation status to the TE)

- 0 disable
- 1 enable

<m>: integer type (parameter shows the subscriber "multiple called numbers" service status in the network)

- 0 "multiple called numbers service" is not provisioned
- 1 "multiple called numbers service" is provisioned
- 2 unknown (e.g. no network, etc.)

<number>: string type phone number of format specified by <type>

<type>: type of address octet in integer format (refer 3GPP TS 24.008 [8] clause 10.5.4.7)

<subaddr>: string type subaddress of format specified by <satype>

<satype>: type of subaddress octet in integer format (refer 3GPP TS 24.008 [8] clause 10.5.4.8)

Implementation

Optional.

7.10 Closed user group +CCUG

Table 43: +CCUG parameter command syntax

Command	Possible response(s)
+CCUG=[<n>[,<index>[,<info>]]]	
+CCUG?	+CCUG: <n>,<index>,<info>
+CCUG=?	

Description

This command allows control of the Closed User Group supplementary service (refer 3GPP TS 22.085 [21]). Set command enables the served subscriber to select a CUG index, to suppress the Outgoing Access (OA), and to suppress the preferential CUG.

Set command with <n>=1 enables to control the CUG information on the air interface as a default adjustment for all following outgoing calls. The interaction of this command with other commands based on other supplementary services is described in the specification of the relevant supplementary service.

NOTE: On a per call basis CUG functionality is explained in clause "ITU-T Recommendation V.250 [14] dial command D".

Read command returns the current settings.

Defined values

<n>: integer type

- 0 disable CUG temporary mode
- 1 enable CUG temporary mode

<index>: integer type

0...9 CUG index

10 no index (preferred CUG taken from subscriber data)

<info>: integer type

0 no information

1 suppress OA

2 suppress preferential CUG

3 suppress OA and preferential CUG

Implementation

Optional. This command is superfluous when the command +CECUG is supported.

7.11 Call forwarding number and conditions +CCFC

Table 44: +CCFC action command syntax

Command	Possible response(s)
+CCFC=<reason>, <mode>[, <number>[, <type>[, <class>[, <subaddr>[, <satype>[, <time>]]]]]	+CME ERROR: <err> when <mode>=2 and command successful: +CCFC: <status>, <class1>[, <number>, <type>[, <subaddr>, <satype>[, <time>]]] [<CR><LF>+CCFC: <status>, <class2>[, <number>, <type>[, <subaddr>, <satype>[, <time>]]] [...]]
+CCFC=?	+CCFC: (list of supported <reason>s)

Description

This command allows control of the call forwarding supplementary service according to 3GPP TS 22.082 [4]. Registration, erasure, activation, deactivation, and status query are supported. When querying the status of a network service (<mode>=2) the response line for 'not active' case (<status>=0) should be returned only if service is not active for any <class>. Refer clause 9.2 for possible <err> values.

Test command returns reason values supported as a compound value.

NOTE: This command cannot be used with URIs. For communication forwarding control with URI support see AT command call forwarding number and conditions with URI support +CCFCU.

Defined values

<reason>: integer type

0 unconditional

1 mobile busy

2 no reply

3 not reachable

4 all call forwarding (refer 3GPP TS 22.030 [19])

5 all conditional call forwarding (refer 3GPP TS 22.030 [19])

<mode>: integer type

- 0 disable
- 1 enable
- 2 query status
- 3 registration
- 4 erasure

<number>: string type phone number of forwarding address in format specified by <type>

<type>: type of address octet in integer format (refer 3GPP TS 24.008 [8] clause 10.5.4.7); default 145 when dialling string includes international access code character "+", otherwise 129

<subaddr>: string type subaddress of format specified by <satype>

<satype>: type of subaddress octet in integer format (refer 3GPP TS 24.008 [8] clause 10.5.4.8); default 128

<classx> is a sum of integers each representing a class of information (default 7 - voice, data and fax):

- 1 voice (telephony)
- 2 data (refers to all bearer services; with <mode>=2 this may refer only to some bearer service if TA does not support values 16, 32, 64 and 128)
- 4 fax (facsimile services)
- 8 short message service
- 16 data circuit sync
- 32 data circuit async
- 64 dedicated packet access
- 128 dedicated PAD access

<time>: integer type

- 1...30 when "no reply", "all call forwarding" or "all conditional call forwarding" is enabled or queried, this gives the time in seconds to wait before call is forwarded, default value 20

<status>: integer type

- 0 not active
- 1 active

Implementation

Mandatory for MT supporting AT commands only and not supporting the control through dial command D.

7.12 Call waiting +CCWA

Table 45: +CCWA parameter command syntax

Command	Possible response(s)
+CCWA=[<n>[,<mode>[,<class>]]]	+CME ERROR: <err> when <mode>=2 and command successful +CCWA: <status>,<class1> [<CR><LF>+CCWA: <status>,<class2> [...]]
+CCWA?	+CCWA: <n>
+CCWA=?	+CCWA: (list of supported <n>s)

Description

This command allows control of the supplementary service Call Waiting according to 3GPP TS 22.083 [5] and Communication Waiting according to 3GPP TS 24.607 [137]. Activation, deactivation and status query are supported. When querying the status of a network service (<mode>=2) the response line for 'not active' case (<status>=0) should be returned only if service is not active for any <class>. Refer clause 9.2 for possible <err> values.

Parameter <n> is used to disable/enable the presentation of an unsolicited result code +CCWA: <number> ,<type> ,<class> , [<alpha>] [, <CLI_validity> [, <subaddr> , <satype> [, <priority>]]] to the TE when call waiting service is enabled. The unsolicited result code +CCWA does not support numbers of the SIP URI format.

The call waiting information can also be reported in unsolicited result codes +CMCCSS<x> / +CMCCSSEND, enabled with +CMCCS=3 (see AT command monitor of current calls +CMCCS). The unsolicited result codes +CMCCSS<x> / +CMCCSSEND support numbers of the SIP URI format.

Command should be abortable when network is interrogated.

Read command returns the current value of <n>.

Test command returns values supported as a compound value.

Defined values

<n>: integer type (sets/shows the result code presentation status to the TE).

- 0 disable
- 1 enable

<mode>: integer type (when <mode> parameter is not given, network is not interrogated).

- 0 disable
- 1 enable
- 2 query status

<classx>: is a sum of integers each representing a class of information (default 7 - voice, data and fax).

- 1 voice (telephony)
- 2 data (refers to all bearer services; with <mode>=2 this may refer only to some bearer service if TA does not support values 16, 32, 64 and 128)
- 4 fax (facsimile services)
- 8 short message service

- 16 data circuit sync
- 32 data circuit async
- 64 dedicated packet access
- 128 dedicated PAD access

<status>: integer type

- 0 not active
- 1 active

<number>: string type phone number of calling address in format specified by <type>.

<type>: type of address octet in integer format (refer 3GPP TS 24.008 [8] clause 10.5.4.7).

<alpha>: optional string type alphanumeric representation of <number> corresponding to the entry found in phonebook; used character set should be the one selected with command select TE character set +CSCS.

<CLI_validity>: integer type. This parameter can provide details why <number> does not contain a calling party BCD number (refer 3GPP TS 24.008 [8] clause 10.5.4.30).

- 0 CLI valid
- 1 CLI has been withheld by the originator (refer 3GPP TS 24.008 [8] table 10.5.135a/3GPP TS 24.008 code "Reject by user")
- 2 CLI is not available due to interworking problems or limitations of originating network (refer 3GPP TS 24.008 [8] table 10.5.135a/3GPP TS 24.008 code "Interaction with other service")
- 3 CLI is not available due to calling party being of type payphone (refer 3GPP TS 24.008 [8] table 10.5.135a/3GPP TS 24.008 code "Coin line/payphone")
- 4 CLI is not available due to other reasons (refer 3GPP TS 24.008 [8] table 10.5.135a/3GPP TS 24.008 code "Unavailable")

When CLI is not available (<CLI_validity>=2, <CLI_validity>=3 or <CLI_validity>=4), <number> shall be an empty string ("") and <type> value will not be significant. Nevertheless, TA may return the recommended value 128 for <type> ((TON/NPI unknown in accordance with 3GPP TS 24.008 [8] clause 10.5.4.7).

When CLI has been withheld by the originator, (<CLI_validity>=1) and the CLIP is provisioned with the "override category" option (refer 3GPP TS 22.081 [3] and 3GPP TS 23.081 [40]), <number> and <type> is provided. Otherwise, TA shall return the same setting for <number> and <type> as if the CLI was not available.

<subaddr>: string type subaddress of format specified by <satype>.

<satype>: type of subaddress octet in integer format (refer 3GPP TS 24.008 [8] clause 10.5.4.8).

<priority>: optional digit type parameter indicating that the eMLPP priority level of the incoming call. The priority level values are as defined in eMLPP specification 3GPP TS 22.067 [54].

Implementation

Optional.

7.13 Call related supplementary services +CHLD

Table 46: +CHLD action command syntax

Command	Possible response(s)
+CHLD=<n>	+CME ERROR: <err>
+CHLD=?	+CHLD: (list of supported <n>s)

Description

This command allows the control of the following call related services:

- a call can be temporarily disconnected from the MT but the connection is retained by the network;
- multiparty conversation (conference calls);
- the served subscriber who has two calls (one held and the other either active or alerting) can connect the other parties and release the served subscriber's own connection.

Calls can be put on hold, recovered, released, added to conversation, and transferred similarly as defined in 3GPP TS 22.030 [19]. Refer clause 9.2 for possible <err> values.

This is based on the supplementary services HOLD (Call Hold; refer 3GPP TS 22.083 [5] clause 2 and 3GPP TS 24.610 [135]), MPTY / CONF (MultiParty; refer 3GPP TS 22.084 [22] and Conference; refer 3GPP TS 24.605 [133]) and ECT (Explicit Call Transfer; refer 3GPP TS 22.091 [30] and 3GPP TS 24.629 [139]).

NOTE 1: In the CS-domain, Call Hold, MultiParty and Explicit Call Transfer are only applicable to teleservice 11.

Test command returns a list of operations which are supported. The call number required by some operations shall be denoted by "x" (e.g. +CHLD: (0 , 1 , 1x , 2 , 2x , 3)).

Defined values

<n>: integer type; equals to numbers entered before SEND button in 3GPP TS 22.030 [19] clause 6.5.5.1.

NOTE 2: The "directory number" case shall be handled with dial command D, and the END case with hangup command H (or +CHUP). The 4*"directory number" case is handled with +CTFR command.

Implementation

Optional.

7.14 Call deflection +CTFR

Table 47: +CTFR action command syntax

Command	Possible response(s)
+CTFR=<number>[, <type>[, <subaddr>[, <satype>]]]	+CME ERROR: <err>
+CTFR=?	

Description

This refers to a service that causes an incoming alerting call to be forwarded to a specified number. Action command does this. Refer clause 9.2 for possible <err> values.

This is based on the supplementary service CD (Call Deflection; refer 3GPP TS 22.072 [31]). The interaction of this command with other commands based on other supplementary services is described in the specification of the relevant supplementary service.

NOTE 1: Call Deflection is only applicable to teleservice 11.

NOTE 2: This command cannot be used with URIs. For communication forwarding control with URI support see AT command call forwarding number and conditions with URI support +CCFCU.

Defined values

<number>: string type phone number of format specified by <type>

<type>: type of address octet in integer format (refer 3GPP TS 24.008 [8] clause 10.5.4.7); default 145 when dialling string includes international access code character "+", otherwise 129

<subaddr>: string type subaddress of format specified by <satype>

<satype>: type of subaddress octet in integer format (refer 3GPP TS 24.008 [8] clause 10.5.4.8); default 128

Implementation

Optional.

7.15 Unstructured supplementary service data +CUSD

Table 48: +CUSD parameter command syntax

Command	Possible response(s)
+CUSD=[<n>[, <str>[, <dc>]]]	+CME ERROR: <err>
+CUSD?	+CUSD: <n>
+CUSD=?	+CUSD: (list of supported <n>s)

Description

This command allows control of the Unstructured Supplementary Service Data (USSD) according to 3GPP TS 22.090 [23], 3GPP TS 24.090 [148] and 3GPP TS 24.390 [131]. Both network and mobile initiated operations are supported. Parameter <n> is used to disable/enable the presentation of an unsolicited result code. The value <n>=2 is used to cancel an ongoing USSD session. For an USSD response from the network, or a network initiated operation, the format is: +CUSD: <m>[, <str>, <dc>].

NOTE 1: If the MT supports USSD according to 3GPP TS 24.090 [148] and USSD according to 3GPP TS 24.390 [131] then the MT decides which to invoke. The decision is out of scope of this specification.

When <str> is given, a mobile initiated USSD-string or a response USSD-string to a network initiated operation is sent to the network. The response USSD-string from the network is returned in a subsequent unsolicited +CUSD result code. Refer clause 9.2 for possible <err> values.

NOTE 2: In case of successful mobile initiated operation, TA implemented according to a version prior to 6 of this standard, waits the USSD response from the network and sends it to the TE before the final result code. This will block the AT command interface for the period of the operation. Such TA does not support <n> value 2.

The interaction of this command with other commands based on other supplementary services is described in the specification of the relevant supplementary service.

Read command returns the current value of <n>.

Test command returns values supported as a compound value.

Defined values

<n>: integer type (sets/shows the result code presentation status to the TE).

0 disable the result code presentation to the TE

1 enable the result code presentation to the TE

- 2 cancel session (not applicable to read command response)

<str>: string type USSD-string (when <str> parameter is not given, network is not interrogated):

- if <dcs> indicates that 3GPP TS 23.038 [25] 7 bit default alphabet is used:
 - if TE character set other than "HEX" (refer command select TE character set +CSCS): MT/TA converts GSM alphabet into current TE character set according to rules of 3GPP TS 27.005 [24] Annex A
 - if TE character set is "HEX": MT/TA converts each 7-bit character of GSM alphabet into two IRA character long hexadecimal number (e.g. character Π (GSM 23) is presented as 17 (IRA 49 and 55))
- if <dcs> indicates that 8-bit data coding scheme is used: MT/TA converts each 8-bit octet into two IRA character long hexadecimal number (e.g. octet with integer value 42 is presented to TE as two characters 2A (IRA 50 and 65))
- if <dcs> indicates that 16-bit data coding scheme (UCS2) is used: MT/TA splits the 16 bits into two 8-bit octets. Each of those octets are converted as per the 8-bit data coding scheme, with the most significant octet first (e.g. decimal value 4906 is presented to TE as four characters 132A (IRA 49, 51, 50 and 65))

<dcs>: integer type (shows Cell Broadcast Data Coding Scheme, see 3GPP TS 23.038 [25]). Default value is 0.

<m>: integer type (shows the USSD response from the network or the network initiated operation).

- 0 no further user action required (network initiated USSD-Notify, or no further information needed after mobile initiated operation)
- 1 further user action required (network initiated USSD-Request, or further information needed after mobile initiated operation)
- 2 USSD terminated by network
- 3 other local client has responded
- 4 operation not supported
- 5 network time out

Implementation

Optional.

7.16 Advice of charge +CAOC

Table 49: +CAOC parameter command syntax

Command	Possible response(s)
+CAOC [= <mode>]	[+CAOC: <ccm>] +CME ERROR: <err>
+CAOC?	+CAOC: <mode>
+CAOC=?	+CAOC: (list of supported <mode>s)

Description

This refers to Advice of Charge supplementary service (3GPP TS 22.024 [26] and 3GPP TS 22.086 [27]) that enables subscriber to get information about the cost of calls. With <mode>=0, the execute command returns the current call meter value from the MT.

The command also includes the possibility to enable/disable reporting of the CCM information with unsolicited result code +CCCM: <ccm>. When enabled, this unsolicited result code is sent when the CCM value changes, but not more frequently than at every 10 seconds.

Refer clause 9.2 for possible <err> values.

NOTE: Advice of Charge values stored in the SIM card or in the active application in the UICC (GSM or USIM) (ACM, ACMmax, PUCT) can be accessed with generic or restricted SIM access command (+CSIM or +CRSM)). Those values can be more readily accessed with commands +CACM, +CAMP and +CPUC .

Read command indicates whether the unsolicited reporting is activated or not.

Test command returns the supported mode values as a compound value.

Defined values

<mode>: integer type

- 0 query CCM value
- 1 deactivate the unsolicited reporting of CCM value
- 2 activate the unsolicited reporting of CCM value

<ccm>: string type; three bytes of the current call meter value in hexadecimal format (e.g. "00001E" indicates decimal value 30); value is in home units and bytes are similarly coded as ACMmax value in the SIM card or in the active application in the UICC (GSM or USIM)

Implementation

Optional.

7.17 Supplementary service notifications +CSSN

Table 50: +CSSN parameter command syntax

Command	Possible response(s)
+CSSN=[<n> [, <m>]]	
+CSSN?	+CSSN: <n> , <m>
+CSSN=?	+CSSN: (list of supported <n>s) , (list of supported <m>s)

Description

This command refers to supplementary service related network initiated notifications. The set command enables/disables the presentation of notification result codes from TA to TE.

When <n>=1 and a supplementary service notification is received after a mobile originated call setup, intermediate result code +CSSI: <code1>[, [<index>] [, <SS_code>]] is sent to TE before any other MO call setup result codes presented in the present document or in ITU-T Recommendation V.250 [14]. When several different <code1>s are received from the network, each of them shall have its own +CSSI result code.

NOTE: If the supplementary service notification is available in the TE after reception of the final response to the call setup, +CSSI is not returned as an intermediate result code but as an unsolicited result code.

When <m>=1 and a supplementary service notification is received during a mobile terminated call setup or during a call, or when a forward check supplementary service notification is received, unsolicited result code +CSSU: <code2>[, <index>[, [<number>] , [<type>] [, [<subaddr>] , [<satype>]]] [, <SS_code>]] is sent to TE. In case of MT call setup, result code is sent after every +CLIP result code (refer command Calling line identification presentation +CLIP) and when several different <code2>s are received from the network, each of them shall have its own +CSSU result code. <code2>=5 does not reflect any supplementary service, and the parameter <SS_code> will not be provided.

The supplementary service notification can also be reported in unsolicited result codes +CMCCSS<x> / +CMCCSEND, enabled with +CMCCS=3 (see AT command monitor of current calls +CMCCS). The unsolicited result codes +CMCCSS<x> / +CMCCSEND support numbers of the SIP URI format.

Read command returns the current settings.

Test command returns values supported as a compound value.

Defined values

<n>: integer type (parameter sets/shows the +CSSI intermediate result code presentation status to the TE)

- 0 disable
- 1 enable

<m>: integer type (parameter sets/shows the +CSSU unsolicited result code presentation status to the TE)

- 0 disable
- 1 enable

<code1>: integer type (it is manufacturer specific, which of these codes are supported)

- 0 unconditional call forwarding is active
- 1 some of the conditional call forwardings are active
- 2 call has been forwarded
- 3 call is waiting
- 4 this is a CUG call (also <index> present)
- 5 outgoing calls are barred
- 6 incoming calls are barred
- 7 CLIR suppression rejected
- 8 call has been deflected

<index>: integer type (refer Closed user group +CCUG command)

<SS_code>: integer type used to present the code identifying a single supplementary service (see 3GPP TS 24.080 [109] and 3GPP TS 29.002 [110] clause 17.7.5)

<code2>: integer type (it is manufacturer specific, which of these codes are supported)

- 0 this is a forwarded call (MT call setup)
- 1 this is a CUG call (also <index> present) (MT call setup)
- 2 call has been put on hold (during a voice call)
- 3 call has been retrieved (during a voice call)
- 4 multiparty call entered (during a voice call)
- 5 call on hold has been released (this is not a SS notification) (during a voice call)
- 6 forward check SS message received (can be received whenever)
- 7 call is being connected (alerting) with the remote party in alerting state in explicit call transfer operation (during a voice call)
- 8 call has been connected with the other remote party in explicit call transfer operation (also number and subaddress parameters may be present) (during a voice call or MT call setup)
- 9 this is a deflected call (MT call setup)
- 10 additional incoming call forwarded

<number>: string type phone number of format specified by <type>

<type>: type of address octet in integer format (refer 3GPP TS 24.008 [8] clause 10.5.4.7)

<subaddr>: string type subaddress of format specified by <satype>

<satype>: type of subaddress octet in integer format (refer 3GPP TS 24.008 [8] clause 10.5.4.8)

Implementation

Optional.

7.18 List current calls +CLCC

Table 51: +CLCC action command syntax

Command	Possible response(s)
+CLCC	[+CLCC: <ccid1>, <dir>, <stat>, <mode>, <empty>[, <number> , <type>[, <alpha>[, <priority>[, <CLI validity>]]]] [<CR><LF>+CLCC: <ccid2>, <dir>, <stat>, <mode>, <empty>[, <number>, <type>[, <alpha>[, <priority>[, <CLI validity>]]]] [...]]] +CME ERROR: <err>
+CLCC=?	

Description

Returns list of current calls of MT. If command succeeds but no calls are available, no information response is sent to TE. Refer clause 9.2 for possible <err> values. See also AT command +CLCCS.

Defined values

<ccidx>: integer type. Call identification number as described in 3GPP TS 22.030 [19] clause 6.5.5.1. This number can be used in +CHLD command operations. Value range is from 1 to N. N, the maximum number of simultaneous call control processes is implementation specific.

<dir>: integer type

- 0 mobile originated (MO) call
- 1 mobile terminated (MT) call

<stat>: integer type (state of the call)

- 0 active
- 1 held
- 2 dialing (MO call)
- 3 alerting (MO call)
- 4 incoming (MT call)
- 5 waiting (MT call)

<mode>: integer type (bearer/teleservice)

- 0 voice
- 1 data

- 2 fax
- 3 voice followed by data, voice mode
- 4 alternating voice/data, voice mode
- 5 alternating voice/fax, voice mode
- 6 voice followed by data, data mode
- 7 alternating voice/data, data mode
- 8 alternating voice/fax, fax mode
- 9 unknown

<empty>: integer type

- 0 call is not one of multiparty (conference) call parties
- 1 call is one of multiparty (conference) call parties

<number>: string type phone number in format specified by <type>.

<type>: type of address octet in integer format (refer 3GPP TS 24.008 [8] clause 10.5.4.7).

<alpha>: string type alphanumeric representation of <number> corresponding to the entry found in phonebook; used character set should be the one selected with command select TE character set +CSCS.

<priority>: integer type parameter indicating the eMLPP priority level of the call, values specified in 3GPP TS 22.067 [54].

<CLI validity>: integer type. This parameter can provide details why <number> does not contain a calling party BCD number (refer 3GPP TS 24.008 [8] clause 10.5.4.30). The parameter is not present for MO call types.

- 0 CLI valid
- 1 CLI has been withheld by the originator (refer 3GPP TS 24.008 [8] table 10.5.135a/3GPP TS 24.008 code "Reject by user")
- 2 CLI is not available due to interworking problems or limitations of originating network (refer 3GPP TS 24.008 [8] table 10.5.135a/3GPP TS 24.008 code "Interaction with other service")
- 3 CLI is not available due to calling party being of type payphone (refer 3GPP TS 24.008 [8] table 10.5.135a/3GPP TS 24.008 code "Coin line/payphone")
- 4 CLI is not available due to other reasons (refer 3GPP TS 24.008 [8] table 10.5.135a/3GPP TS 24.008 code "Unavailable")

When CLI is not available (<CLI validity>=2, <CLI validity>=3 or <CLI validity>=4), <number> shall be an empty string ("") and <type> value will not be significant. Nevertheless, TA may return the recommended value 128 for <type> (TON/NPI unknown in accordance with 3GPP TS 24.008 [8] clause 10.5.4.7).

When CLI has been withheld by the originator, (<CLI validity>=1) and the CLIP is provisioned with the "override category" option (refer 3GPP TS 22.081 [3] and 3GPP TS 23.081 [40]), <number> and <type> is provided. Otherwise, TA shall return the same setting for <number> and <type> as if the CLI was not available.

Implementation

Optional. Recommended when +CHLD command is implemented.

When +CDU is supported and SIP URIs are used in the MT, the AT command +CLCC is fully replaced by +CLCCS.

7.19 Preferred PLMN list +CPOL

Table 52: +CPOL parameter command syntax

Command	Possible response(s)
+CPOL=[<index>][,<format>][,<oper>[,<GSM_Act>,<GSM_Compact_Act>,<UTRAN_Act>,<E-UTRAN_Act>,<NG-RAN_Act>]]]	+CME ERROR: <err>
+CPOL?	+CPOL: <index1>,<format>,<oper1>[,<GSM_Act1>,<GSM_Compact_Act1>,<UTRAN_Act1>,<E-UTRAN_Act1>,<NG-RAN_Act1>] [<CR><LF>+CPOL: <index2>,<format>,<oper2>[,<GSM_Act2>,<GSM_Compact_Act2>,<UTRAN_Act2>,<E-UTRAN_Act2>,<NG-RAN_Act2>]] [...]] +CME ERROR: <err>
+CPOL=?	+CPOL: (list of supported <index>s) , (list of supported <format>s) +CME ERROR: <err>

Description

This command is used to edit the PLMN selector with Access Technology lists in the SIM card or active application in the UICC (GSM or USIM).

Execute command writes an entry in the SIM/USIM list of preferred PLMNs, previously selected by the command +CPLS. If no list has been previously selected, the User controlled PLMN selector with Access Technology, EF_{PLMNwAcT}, is the one accessed by default. If <index> is given but <oper> is left out, entry is deleted. If <oper> is given but <index> is left out, <oper> is put in the next free location. If only <format> is given, the format of the <oper> in the read command is changed. The Access Technology selection parameters, <GSM_Act>, <GSM_Compact_Act>, <UTRAN_Act>, <E-UTRAN_Act> and <NG-RAN_Act> are required when writing User controlled PLMN selector with Access Technology, EF_{PLMNwAcT}, Operator controlled PLMN selector with Access Technology EF_{OPLMNwAcT} and HPLMN selector with Access Technology EF_{HPLMNwAcT}, see 3GPP TS 31.102 [59]. Refer clause 9.2 for possible <err> values.

NOTE 1: MT can also update the User controlled PLMN selector with Access Technology, EF_{PLMNwAcT}, automatically when new networks are selected.

NOTE 2: The Operator controlled PLMN selector with Access Technology EF_{OPLMNwAcT}, can only be written if the write access condition in the SIM/USIM has been previously verified.

Read command returns all used entries from the SIM/USIM list of preferred PLMNs, previously selected by the command +CPLS, with the Access Technologies for each PLMN in the list.

Test command returns the whole index range supported by the SIM as compound values.

Defined values

<indexn>: integer type; the order number of operator in the SIM/USIM preferred operator list

<format>: integer type

0 long format alphanumeric <oper>

1 short format alphanumeric <oper>

2 numeric <oper>

<opern>: string type; <format> indicates if the format is alphanumeric or numeric (see +COPS)

<GSM_AcTn>: integer type; GSM access technology:

0 access technology not selected

1 access technology selected

<GSM_Compact_AcTn>: integer type; GSM compact access technology

0 access technology not selected

1 access technology selected

<UTRAN_AcTn>: integer type; UTRAN access technology

0 access technology not selected

1 access technology selected

<E-UTRAN_AcTn>: integer type; E-UTRAN access technology

0 access technology not selected

1 access technology selected

<NG-RAN_AcTn>: integer type; NG-RAN access technology

0 access technology not selected

1 access technology selected

Implementation

Optional.

7.20 Selection of preferred PLMN list +CPLS

Table 53: +CPLS parameter command syntax

Command	Possible response(s)
+CPLS=[<list>]	+CME ERROR: <err>
+CPLS?	+CPLS: <list> +CME ERROR: <err>
+CPLS=?	+CPLS: (list of supported <list>s) +CME ERROR: <err>

Description

This command is used to select one PLMN selector with Access Technology list in the SIM card or active application in the UICC (GSM or USIM), that is used by +CPOB command.

Execute command selects a list in the SIM/USIM. Refer clause 9.2 for possible <err> values.

Read command returns the selected PLMN selector list from the SIM/USIM.

Test command returns the whole index range supported lists by the SIM/USIM as a compound value.

Defined values

<list>: integer type

- 0 User controlled PLMN selector with Access Technology EF_{PLMNwAcT}, if not found in the SIM/UICC then PLMN preferred list EF_{PLMNsel} (this file is only available in SIM card or GSM application selected in UICC)
- 1 Operator controlled PLMN selector with Access Technology EF_{OPLMNwAcT}
- 2 HPLMN selector with Access Technology EF_{HPLMNwAcT}

Implementation

Optional.

7.21 Read operator names +COPN

Table 54: +COPN action command syntax

Command	Possible response(s)
+COPN	+COPN: <numeric1>, <alpha1> [<CR><LF>+COPN: <numeric2>, <alpha2> [...]] +CME ERROR: <err>
+COPN=?	

Description

Execute command returns the list of operator names from the MT. Each operator code <numericn> that has an alphanumeric equivalent <alphan> in the MT memory shall be returned. Refer clause 9.2 for possible <err> values.

Defined values

<numericn>: string type; operator in numeric format (see +COPS)

<alphan>: string type; operator in long alphanumeric format (see +COPS)

Implementation

Optional.

7.22 eMLPP priority registration and interrogation +CAEMLPP

Table 55: +CAEMLPP parameter command syntax

Command	Possible Response(s)
+CAEMLPP=<priority>	+CME ERROR: <err>
+CAEMLPP?	+CAEMLPP: <default_priority>, <max_priority> +CME ERROR: <err>
+CAEMLPP=?	

Description

The execute command is used to change the default priority level of the user in the network. The requested priority level is checked against the eMLPP subscription of the user stored on the SIM card or in the active application in the UICC (GSM or USIM) EF_{eMLPP}. If the user doesn't have subscription for the requested priority level an ERROR or +CME ERROR result code is returned. Refer clause 9.2 for possible <err> values.

The read command triggers an interrogation of the provision of the maximum priority level which the service subscriber is allowed to use and default priority level activated by the user.

If the service is not provisioned, a result code including the SS-Status (?) parameter is returned.

Defined values

<priority>: integer type parameter which identifies the default priority level to be activated in the network, values specified in 3GPP TS 22.067 [54]

<default_priority>: integer type parameter which identifies the default priority level which is activated in the network, values specified in 3GPP TS 22.067 [54]

<max_priority>: integer type parameter which identifies the maximum priority level for which the service subscriber has a subscription in the network, values specified in 3GPP TS 22.067 [54]

Implementation

Mandatory for an MT supporting AT commands only and supplementary service eMLPP is implemented.

7.23 eMLPP subscriptions +CPPS

Table 56: +CPPS action command syntax

Command	Possible response(s)
+CPPS	[+CPPS: <priority>[,<priority> [...]]] +CME ERROR: <err>
+CPPS=?	

Description

This command returns all eMLPP priority subscriptions of the user stored on the SIM card or in the active application in the UICC (GSM or USIM) EF_{eMLPP}. If no explicit priority level subscription is stored on the SIM card or in the active application in the UICC (GSM or USIM) EF_{eMLPP} the result code OK is returned. Refer clause 9.2 for possible <err> values.

Defined values

<priority>: integer type, eMLPP subscription to priority level {0,1,...,4} as defined in 3GPP TS 22.067 [54].

Implementation

Mandatory for a MT supporting AT commands only and eMLPP is implemented.

7.24 Fast call setup conditions +CFCS

Table 57: +CFCS parameter command syntax

Command	Possible response(s)
+CFCS=<priority>,<status>	+CME ERROR: <err>
+CFCS?	[+CFCS: <priority>[,<priority> [...]]] +CME ERROR: <err>
+CFCS=?	+CFCS: (list of supported <priority>,<status>s)

Description

The set command is used to edit the status of the priority level for fast call set-up stored on the SIM card or in the active application in the UICC (GSM or USIM) EF_{eMLPP}. If the user has no subscription to the priority level status he wants to edit, an ERROR or +CME ERROR result code is returned. Refer clause 9.2 for possible <err> values.

The read command returns all enabled priority levels for fast call set-up stored on the SIM card or in the active application in the UICC (GSM or USIM) EF_{eMLPP}. If no priority level is enabled for fast call set-up, the result code OK is returned.

Test command returns the values supported by the UE.

Defined values

<priority>: integer type, eMLPP fast call set-up priority level {0,1,...,4} as defined in 3GPP TS 22.067 [54]

<status>: integer type

0 disable <priority> for fast call set-up

1 enable <priority> for fast call set-up

Implementation

Mandatory for a MT supporting AT commands only and eMLPP is implemented.

7.25 Automatic answer for eMLPP service +CAAP

Table 58: +CAAP parameter command syntax

Command	Possible response(s)
+CAAP=<priority>,<status>	+CME ERROR: <err>
+CAAP?	[+CAAP: <priority>[,<priority> [...]]] +CME ERROR: <err>
+CAAP=?	+CAAP: (list of supported <priority>,<status>s)

Description

The set command is used to edit the status of the priority level for automatic answering for eMLPP stored on the SIM card or in the active application in the UICC (GSM or USIM) EF_{AAeM}. If the user has no subscription to the priority level status he wants to edit, an ERROR or +CME ERROR result code is returned. Refer clause 9.2 for possible <err> values.

The read command returns all enabled priority levels for automatic answering for eMLPP stored on the SIM card or in the active application in the UICC (GSM or USIM) EF_{AAeM}. If no priority level is enabled for automatic answering for eMLPP, the result code OK is returned.

Test command returns the values supported by the UE.

Defined values

<priority>: eMLPP automatic answer priority level value {A,B,0,1,...,4} as defined in 3GPP TS 22.067 [54]

<status>: integer type

0 disable eMLPP <priority> for automatic answering

1 enable eMLPP <priority> for automatic answering

Implementation

Mandatory for a MT supporting AT commands only and eMLPP is implemented.

7.26 User to user signalling service 1 +CUUS1

Table 59: +CUUS1 parameter command syntax

Command	Possible response(s)
+CUUS1=[<n>[,<m>[,<message>[,<UUIE>[,<message>[,<UUIE>[,...]]]]]]]]	+CME ERROR: <err>
+CUUS1?	+CUUS1: <n> ,<m>[,<message> ,<UUIE>[,<message> ,<UUIE>[,...]]]
+CUUS1=?	+CUUS1: (list of supported <n>s) , (list of supported <m>s) , (list of supported <message>s) , (list of supported <messageI>s) , (list of supported <messageU>s)

Description

This command allows control of the User-to-User Signalling Supplementary Service 1 (UUS1) according to 3GPP TS 22.087 [58].

Parameters <message> and <UUIE> are used to activate/deactivate the implicit request of the User-to-User Signalling Supplementary Service 1.

When <message> and <UUIE> are both present the string specified in <UUIE> is included as the value part of the User-to-User Information Element (as defined in 3GPP TS 24.008 [8]) into all subsequent messages of type <message>. If parameter <message> is present but parameter <UUIE> is not present then the User-to-User Information Element shall not be present in subsequent messages of type <message>.

Parameters <n> and <m> are used to enable/disable the presentation of incoming User-to-User Information Elements.

When <n>=1 and a User-to-User Information is received after a mobile originated call setup or after hanging up a call, intermediate result code +CUUS1I: <messageI> ,<UUIE> is sent to the TE.

When <m>=1 and a User-to-User Information is received during a mobile terminated call setup or during a remote party call hangup, unsolicited result code +CUUS1U: <messageU> ,<UUIE> is sent to the TE.

Refer clause 9.2 for possible <err> values.

Test command returns values supported as compound values.

Defined values

<n>: integer type (parameter sets/shows the +CUUS1I result code presentation status in the TA).

0 disable.

1 enable.

<m>: integer type (parameter sets/shows the +CUUS1U result code presentation status in the TA).

0 disable.

1 enable.

<message>: integer type (type of message containing the outgoing User-to-User Information Element).

0 ANY

1 SETUP

2 ALERT

3 CONNECT

- 4 DISCONNECT
- 5 RELEASE
- 6 RELEASE_COMPLETE

<messageI>: integer type (type of message containing the intermediate User-to-User Information Element).

- 0 ANY
- 1 ALERT
- 2 PROGRESS
- 3 CONNECT (sent after +COLP if enabled)
- 4 RELEASE

<messageU>: integer type (type of message containing the unsolicited User-to-User Information Element).

- 0 ANY
- 1 SETUP (returned after +CLIP if presented, otherwise after every RING or +CRING)
- 2 DISCONNECT
- 3 RELEASE_COMPLETE

<UUIE>: the User-user Information Element (as defined in 3GPP TS 24.008 [8]) in hexadecimal character format (for hexadecimal format, refer +CSCS).

NOTE: If the TA does not distinguish the type of message containing the User-to-user Information Element, it can use the value for ANY message.

Implementation

Optional.

7.27 Preferred network indication +CPNET

Table 59A: +CPNET parameter command syntax

Command	Possible response(s)
+CPNET=[<Pref_net>]	
+CPNET?	+CPNET: <Pref_net>
+CPNET=?	+CPNET: (list of supported <Pref_net>s)

Description

This command indicates whether the terminal has preference <Pref_net> for GERAN/UTRAN/E-UTRAN/NG-RAN or GAN, see 3GPP TS 44.318 [70].

Read command returns the current preference for GERAN/UTRAN/E-UTRAN/NG-RAN or GAN.

Test command returns the parameter indicating preference <Pref_net> for GERAN/UTRAN/E-UTRAN/NG-RAN or GAN as a compound value.

Defined values

<Pref_net>: integer type; indicates the preference for GERAN/UTRAN/E-UTRAN/NG-RAN or GAN.

- 0 GERAN/UTRAN/E-UTRAN/NG-RAN shall be used. The terminal uses GERAN/UTRAN/E-UTRAN/NG-RAN coverage only.

- 1 GAN shall be used. The terminal used GAN coverage only.
- 2 GERAN/UTRAN/E-UTRAN/NG-RAN preferred. The terminal prefers to stay in GERAN/UTRAN/E-UTRAN/NG-RAN rather than GAN.
- 3 GAN preferred. The terminal prefers to stay in GAN rather than GERAN/UTRAN/E-UTRAN/NG-RAN.

NOTE: Usage of value 0 or 1 will prevent the terminal from changing between GERAN/UTRAN/E-UTRAN/NG-RAN and GAN. E.g. setting `<Pref_net>` to 1 indicates that only GAN will be used, and prevents the terminal from using available GERAN/UTRAN/E-UTRAN/NG-RAN coverage.

Implementation

Optional.

7.28 Preferred network status +CPNSTAT

Table 59B: +CPNSTAT parameter command syntax

Command	Possible response(s)
+CPNSTAT=[<n>]	
+CPNSTAT?	+CPNSTAT: <n> , <stat>
+CPNSTAT=?	+CPNSTAT: (list of supported <n>s)

Description

Set command controls the presentation of an unsolicited result code +CPNSTAT: <stat> when <n>=1 and there is a change in the preferred network indication status.

Read command returns the status of result code presentation <n> and an integer <stat> which shows whether the terminal is in GERAN/UTRAN/E-UTRAN/NG-RAN or GAN, see 3GPP TS 44.318 [70].

NOTE: Further details about registration status are available using commands +CREG (see clause 7.2), +CGREG (see clause 10.1.19), +CEREG (see clause 10.1.21) and +CNRREG (see clause 10.1.47).

Test command returns the list of supported unsolicited result codes as a compound value.

Defined values

<n>: integer type

0 disable preferred network indication unsolicited result code.

1 enable preferred network indication unsolicited result code +CPNSTAT: <stat>.

<stat>: integer type; preferred network indication status.

0 Requested network not available.

1 GERAN/UTRAN/E-UTRAN/NG-RAN used.

2 GAN used.

Implementation

Optional.

7.29 Current packet switched bearer +CPSB

Table 59C: +CPSB parameter command syntax

Command	Possible response(s)
+CPSB=[<n>]	+CME ERROR: <err>
+CPSB?	+CPSB: <n>[, <cid> , <curr_bearer>] [<CR><LF>+CPSB: <n> , <cid> , <curr_bearer> [. . .]] +CME ERROR: <err>
+CPSB=?	+CPSB: (list of supported <n>s)

Description

Set command controls the presentation of an unsolicited result code +CPSB: <cid> , <curr_bearer> when <n>=1 and the <cid> corresponds to a PDP context in the PDP-ACTIVE state, to an EPS bearer context in the BEARER CONTEXT ACTIVE state or to a 5GS QoS flow of a PDU session in the PDU SESSION ACTIVE state and there is a change in the current value of <curr_bearer> due to the reception of a control or signalling message from the network as specified in 3GPP TS 44.060 [71], 3GPP TS 25.331 [74], 3GPP TS 36.331 [86] or 3GPP TS 38.331 [160].

Read command returns the current status of the unsolicited result code presentation <n>. The parameters <cid> and <curr_bearer> are returned for each defined context when <n>=1 for <cid>s that correspond to a PDP context in the PDP-ACTIVE state, to an EPS bearer context in the BEARER CONTEXT ACTIVE state or to a 5GS QoS flow of a PDU session in the PDU SESSION ACTIVE state.

Refer clause 9.2 for possible <err> values.

Test command returns the list of supported <n>s as a compound value.

Defined values

<n>: integer type

- 0 disable the presentation of the unsolicited result code
- 1 enable the presentation of the unsolicited result code
+CPSB: <cid> , <curr_bearer>

<cid>: A numeric parameter which specifies a particular PDP context, an EPS bearer context or a 5GS QoS flow. The <cid> parameter is local to the TE-MT interface and identifies only those PDP contexts, EPS bearer contexts or 5GS QoS flows which have been setup via AT command (see the +CGDCONT and +CGDSCONT commands).

<curr_bearer>: integer type; the current packet switched bearer which is established between the UE and network.

- 0 There is currently no packet switched bearer between the UE and the network (e.g. RAB is released in UMTS or the TBF is released in GSM). This would mean that there is no bearer associated to the PDP context referred to by the <cid> parameter and hence no data transfer is currently occurring on that particular PDP context. This result code covers the case where the PDP context is active but there is no bearer associated with it.
- 1 GPRS. (See 3GPP TS 44.060 [71] for definition of GPRS TBF Mode)
- 2 EGPRS. (See 3GPP TS 44.060 [71] for definition of EGPRS TBF Mode)
- 3 Non-HSUPA in uplink and non-HSDPA in downlink. (See NOTE 1 to NOTE 3)
- 4 HSUPA in uplink and non-HSDPA in downlink. (See NOTE 1 to NOTE 4)

- 5 Non-HSUPA in uplink and HSDPA in downlink. (See NOTE 1 to NOTE 4)
- 6 HSUPA in uplink and HSDPA in downlink. (See NOTE 1 to NOTE 4)
- 7 EPS (See NOTE 5)
- 8 5GS (See NOTE 6)

NOTE 1: The term "non-HSDPA" means a non-HSDPA UMTS bearer. 3GPP TS 25.331 [74] specifies the criterion to be satisfied in order for a downlink UMTS RAB to be termed as HSDPA. If those criterion are not met, then the downlink UMTS RAB would be termed as "non-HSDPA" by this AT command.

NOTE 2: The term "non-HSUPA" means a non-HSUPA UMTS bearer. 3GPP TS 25.331 [74] specifies the criterion to be satisfied in order for an uplink UMTS RAB to be termed as HSUPA (or Enhanced uplink DCH). If those criterion are not met, then the uplink UMTS RAB would be termed as "non-HSUPA" by this AT command.

NOTE 3: The terms "non-HSDPA", "non-HSUPA" indicate R99 to pre- HSDPA or pre-HSUPA UMTS bearers. They do not imply GPRS or EGPRS bearers.

NOTE 4: See 3GPP TS 25.308 [72] for HSDPA and 3GPP TS 25.319 [73] for HSUPA.

NOTE 5: The term "EPS" means an EPS bearer (see 3GPP TS 36.331 [86]).

NOTE 6: The term "5GS" means a 5GS QoS flow (see 3GPP TS 38.331 [160]).

Implementation

Optional.

7.30 Calling name identification presentation +CNAP

Table 59D: +CNAP parameter command syntax

Command	Possible response(s)
+CNAP=[<n>]	
+CNAP?	+CNAP: <n> , <m>
+CNAP=?	+CNAP: (list of supported <n>s)

Description

This command refers to the supplementary service CNAP (Calling Name Presentation) according to 3GPP TS 22.096 [93] that enables a called subscriber to get a calling name indication (CNI) of the calling party when receiving a mobile terminated call. Set command enables or disables the presentation of the CNI at the TE. It has no effect on the execution of the supplementary service CNAP in the network.

When <n>=1, the presentation of the calling name indication at the TE is enabled and CNI is provided the unsolicited result code, +CNAP: <name>[, <CNI_validity>] is returned after every RING (or +CRING: <type>; refer clause "Cellular result codes +CRC") result code sent from TA to TE. It is manufacturer specific if this response is used when normal voice call is answered.

The calling name indication can also be reported in unsolicited result codes +CMCCSS<x> / +CMCCSSSEND, enabled with +CMCCS=3 (see AT command monitor of current calls +CMCCS). The unsolicited result codes +CMCCSS<x> / +CMCCSSSEND support numbers of the SIP URI format.

Read command gives the status of <n>, and also triggers an interrogation of the provision status of the CNAP service according 3GPP TS 22.096 [93] (given in <m>).

Test command returns values supported as a compound value.

Defined values

<n>: integer type (parameter sets/shows the result code presentation status to the TE)

0 disable

1 enable

<m>: integer type (parameter shows the subscriber CNAP service status in the network)

0 CNAP not provisioned

1 CNAP provisioned

2 unknown (e.g. no network, etc.)

<name>: string type, up to 80 characters long string containing the calling name

<CNI_validity>: integer type

0 CNI valid

1 CNI has been withheld by the originator.

2 CNI is not available due to interworking problems or limitations of originating network.

When CNI is not available (<CNI_validity>=2), <name> shall be an empty string ("").

When CNI has been withheld by the originator, (<CNI_validity>=1) and the CNAP is provisioned with the "override category" option (refer 3GPP TS 22.096 [93] and 3GPP TS 23.096 [94]), <name> is provided.

Otherwise, TA shall return the same setting for <name> as if the CNI was not available.

Implementation

Optional.

7.31 Connected line identification restriction status +COLR

Table 59E: +COLR action command syntax

Command	Possible response(s)
+COLR	+COLR: <m>
+COLR=?	

Description

This command refers to the supplementary service COLR (Connected Line Identification Restriction) according to 3GPP TS 22.081 [3] and supplementary service TIR (Terminating Identification Restriction) according to 3GPP TS 24.608 [120] that enables a called subscriber to restrict the possibility of presentation of connected line identity (COL) to the calling party after receiving a mobile terminated call. The command displays the status of the COL presentation in the network. It has no effect on the execution of the supplementary services COLR / TIR in the network.

The command triggers an interrogation of the activation status of the COLR supplementary service according to 3GPP TS 22.081 [3] and the TIR supplementary service according to 3GPP TS 24.608 [120] (given in <m>).

Activation, deactivation, registration and erasure of the supplementary service COLR / TIR are not applicable.

Defined values

<m>: integer type (parameter shows the subscriber COLR / TIR service status in the network).

0 COLR / TIR not provisioned

1 COLR / TIR provisioned

2 unknown (e.g. no network, etc.)

Implementation

Optional.

7.32 Service specific access control restriction status +CSSAC**Table 7.32-1: +CSSAC action command syntax**

Command	Possible response(s)
+CSSAC	+CSSAC: <BFVoice>,<BFVideo>,<BTVoice>,<BTVideo>
+CSSAC=?	

Description

This command refers to SSAC (Service Specific Access Control) related information which is used by MMTEL application (see 3GPP TS 24.173 [87]). The command provides the current status of the parameters for SSAC, <BFVoice>,<BFVideo>,<BTVoice> and <BTVideo>. The AT command has no effect on the execution of SSAC.

Defined values

<BFVoice> integer type; parameter shows the barring factor for MMTEL voice. <BFVoice> is mapped to the BarringFactorForMMTEL-Voice as in table 7.32-2.

Table 7.32-2: Value of BFVoice and its interpretation by MMTEL application

<BFVoice>	BarringFactorForMMTEL-Voice as specified in 3GPP TS 24.173 [87]
0	0
1	0,05
2	0,1
3	0,15
4	0,2
5	0,25
6	0,3
7	0,4
8	0,5
9	0,6
10	0,7
11	0,75
12	0,8
13	0,85
14	0,9
15	0,95
16	1

<BFVideo> integer type; parameter shows the barring factor for MMTEL video. <BFVideo> is mapped to the BarringFactorForMMTEL-Video as in table 7.32-3.

Table 7.32-3: Value of BFVideo and its interpretation by MMTEL application

<BFVideo>	BarringFactorForMMTEL-Video as specified in 3GPP TS 24.173 [87]
0	0
1	0,05
2	0,1
3	0,15
4	0,2
5	0,25
6	0,3
7	0,4
8	0,5
9	0,6
10	0,7
11	0,75
12	0,8
13	0,85
14	0,9
15	0,95
16	1

<BTVoice> integer type; parameter shows the barring timer for MMTEL voice. <BTVoice> is mapped to the BarringTimeForMMTEL-Voice as in table 7.32-4.

Table 7.32-4: Value of BTVoice and its interpretation by MMTEL application

<BTVoice>	BarringTimeForMMTEL-Voice as specified in 3GPP TS 24.173 [87]
0	0
1	4
2	8
3	16
4	32
5	64
6	128
7	256
8	512

<BTVideo> integer type; parameter shows the barring timer for MMTEL video. <BTVideo> is mapped to the BarringTimeForMMTEL-Video as in table 7.32-5.

Table 7.32-5: Value of BTVideo and its interpretation by MMTEL application

<BTVideo>	BarringTimeForMMTEL-Video as specified in 3GPP TS 24.173 [87]
0	0
1	4
2	8
3	16
4	32
5	64
6	128
7	256
8	512

Implementation

Optional.

This command is only applicable to UEs in E-UTRAN.

7.33 Network emergency (bearer) services support +CNEM

Table 7.33-1: +CNEM parameter command syntax

Command	Possible response(s)
+CNEM=[<reporting>]	+CME ERROR: <err>
+CNEM?	+CNEM: <reporting>[,<emb_Iu_supp>[,<emb_S1_supp>[,<ems_5G_supp>,<emf_5G_supp>]]]
+CNEM=?	+CNEM: (list of supported <reporting>s)

Description

Set command enables reporting of changes in the emergency (bearer) services support indicators and emergency services fallback indicator with the unsolicited result code +CNEMIU: <emb_Iu_supp> according to the network feature support information element, see 3GPP TS 24.008 [8] clause 10.5.5.23, the unsolicited result code +CNEMS1: <emb_S1_supp> according to the EPS network feature support information element, see 3GPP TS 24.301 [83] clause 9.9.3.12A, and the unsolicited result code +CNEM5G: <ems_5G_supp> , <emf_5G_supp> according to the 5GS network feature support information element, see 3GPP TS 24.501 [161] clause 9.11.3.5. Refer clause 9.2 for possible <err> values.

Read command returns current command setting and if enabled, the settings of the emergency bearer services support indicator in Iu mode and the emergency bearer services support indicator in S1 mode for the network where the UE is attached. The read command also returns the emergency services support indicator in 5G and the emergency services fallback indicator in 5G for the network where the UE is registered.

Test command returns values supported as a compound value.

Defined values

<reporting>: integer type

- 0 Reporting not enabled
- 1 Reporting enabled

<emb_Iu_supp>: integer type. Emergency bearer services support indicator for Iu mode (See NOTE).

- 0 Emergency bearer services in Iu mode and A/Gb mode not supported
- 1 Emergency bearer services supported in Iu mode, but not supported in A/Gb mode

<emb_S1_supp>: integer type. Emergency bearer services support indicator for S1 mode (See NOTE).

- 0 Emergency bearer services in S1 mode not supported
- 1 Emergency bearer services in S1 mode supported

<ems_5G_supp>: integer type. Emergency services support indicator for 5G (See NOTE).

- 0 Emergency services in 5G not supported
- 1 Emergency services supported in NR connected to 5GC only
- 2 Emergency services supported in E-UTRA connected to 5GC only
- 3 Emergency services supported in NR connected to 5GC and E-UTRA connected to 5GC

<emf_5G_supp>: integer type. Emergency services fallback indicator for 5G (See NOTE).

- 0 Emergency services fallback in 5G not supported
- 1 Emergency services fallback supported in NR connected to 5GC only

- 2 Emergency services fallback supported in E-UTRA connected to 5GC only
- 3 Emergency services fallback supported in NR connected to 5GC and E-UTRA connected to 5GC

NOTE: The indicators `<emb_Iu_supp>`, `<emb_S1_supp>`, `<ems_5G_supp>` and `<emf_5G_supp>` are only set to supported when explicitly signalled from the network. When an emergency (bearer) services support indicator is not signalled from the network or if no network is available, this is interpreted as "Emergency (bearer) services not supported". When the emergency services fallback indicator is not signalled from the network or if no network is available, this is interpreted as "Emergency services fallback in 5G not supported".

Implementation

Optional.

7.34 Enhanced closed user group +CECUG

Table 7.34-1: +CECUG parameter command syntax

Command	Possible response(s)
<code>+CECUG=<n>,[<CUG_pointer>[,<CUG_index>,<CUG_info>]]</code>	
<code>+CECUG?</code>	<code>[+CECUG: <n>,<CUG_pointer>,<CUG_index>,<CUG_info></code> <code>[<CR><LF>+CECUG: <n>,<CUG_pointer>,<CUG_index>,<CUG_info></code> <code>[...]]]</code>
<code>+CECUG=?</code>	<code>+CECUG: (list of supported <n>s) , (range of supported <CUG_pointer>s)</code>

Description

This command allows control of the Closed User Group supplementary service (refer 3GPP TS 22.085 [21] and 3GPP TS 24.654 [121]). Set command enables the served subscriber to create a number of `<CUG_pointer>s` that each define a `<CUG_index>` and a `<CUG_info>` to define how the preferential CUG and the Outgoing Access (OA) is handled for outgoing calls.

Set command with `<n>=0` disable settings in the MT and use the subscribed settings, while `<n>=1` enables to control the CUG information on the air interface as adjustments for outgoing calls according to the settings defined by the parameters `<CUG_pointer>s`, `<CUG_index>` and `<CUG_info>`. For calls initiated using the dial command D, the dial string modifiers 'G' or 'g' can not indicate a `<CUG_pointer>` and the `<CUG_index>` and `<CUG_info>` as defined for `<CUG_pointer>=1` shall be used.

NOTE 1: On a per call basis CUG functionality is explained in the clauses "ITU-T Recommendation V.250 [14] dial command D" and "Dial URI +CDU".

A special form of the set command, `+CECUG=<n>,<CUG_pointer>` causes the value of `<CUG_index>` and `<CUG_info>` for the CUG pointer `<CUG_pointer>` to become undefined. The set command, `+CECUG=0` that can be used to disable the CUG temporary mode will not make previously defined CUG pointers and the corresponding defined `<CUG_index>` and `<CUG_info>` undefined.

The read command returns the current settings for each defined CUG pointer.

The test command returns values supported as compound values.

Defined values

`<n>`: integer type. This parameter sets CUG activation on a per call basis.

0 disable CUG temporary mode. All calls initiated using the dial command D or +CDU use the subscribed CUG settings. The parameters <CUG_index> and <CUG_info> are ignored at call initiation. For calls initiated using the dial command D, the dial string modifiers 'G' or 'g' have no effect (see clause "ITU T Recommendation V.250 [14] dial command D"). For calls initiated using +CDU, the parameter <CUG_pointer> has no effect (see clause "Dial URI +CDU").

- 1 enable CUG temporary mode. Values for <CUG_index> and <CUG_info> are applied for:
- all calls initiated using the dial command D where the dial modifier 'G' or 'g' (see clause "ITU T Recommendation V.250 [14] dial command D") is present as part of the dial string.
 - all calls initiated using +CDU where parameter <CUG_pointer> is set to 1 (see clause "Dial URI +CDU")

If 'G' or 'g' is not applied (for the dial command D) or <CUG_pointer> is set to 0 (for +CDU) <CUG_index> and <CUG_info> are ignored. In that case only the subscribed CUG settings apply.

<CUG_pointer>: integer type. A numeric parameter which specifies a particular set of CUG data. The <CUG_pointer> is local to the TE-MT interface and identifies a particular <CUG_index> and <CUG_info> which indicates per call basis changes provided to the supplementary service closed user group. The range of permitted values is from 1-n. The maximum value of n is implementation specific.

NOTE 2: 3GPP TS 22.085 [21] indicates that each individual subscriber can be a member of a maximum of 10 CUGs.

<CUG_index>: string type. The parameter sets the CUG index for this <CUG_pointer>.

- "0" ... "32767" CUG index
- "" no CUG index, indicated by empty string. Preferential CUG taken from subscriber data.

<CUG_info>: integer type. The parameter sets the CUG information for this <CUG_pointer>.

- 0 no information
- 1 suppress OA
- 2 suppress preferential CUG
- 3 suppress OA and preferential CUG

Implementation

Optional. This command can replace the command +CCUG.

7.35 Communication forwarding number and conditions with URI support +CCFCU

Table 7.35-1: +CCFCU action command syntax

Command	Possible response(s)
+CCFCU=<reason>, <mode>[, <numbertype>, <ton>, <number>[, <class>, <ruleset>[, <subaddr>[, <satype>[, <time>]]]]]	+CME ERROR: <err> when <mode>=2 and command successful: +CCFCU: <status>, <class1>[, <numbertype>, <ton>, <number>[, <subaddr>, <satype>[, <time>]]] [<CR><LF>+CCFCU: <status>, <class2>[, <number>, <type>[, <subaddr>, <satype>[, <time>]]] [...]]
+CCFCU=?	+CCFCU: (list of supported <reason>s)

Description

The command allows control of the communication forwarding supplementary service according to 3GPP TS 22.072 [31], 3GPP TS 22.082 [4] and 3GPP TS 24.604 [132]. This command is an extended version of AT commands +CCFC and +CTFR which also supports numbers of the SIP URI format. Registration, erasure, activation, deactivation, and status query are supported. When querying the status of a network service (<mode>=2) the response line for 'not active' case (<status>=0) should be returned only if service is not active for any <class>.

Test command returns reason values supported as a compound value.

Defined values

<reason>: integer type

- 0 communication forwarding unconditional – CFU, refer 3GPP TS 22.082 [4] and 3GPP TS 24.604 [132]
- 1 communication forwarding on busy user – CFB, refer 3GPP TS 22.082 [4] and 3GPP TS 24.604 [132]
- 2 communication forwarding on no reply – CFNR, refer 3GPP TS 22.082 [4] and 3GPP TS 24.604 [132]
- 3 communication forwarding on subscriber not reachable – CFNRc, refer 3GPP TS 22.082 [4] and 3GPP TS 24.604 [132]
- 4 all call forwarding (refer to "all CF" in 3GPP TS 22.030 [19])
- 5 all conditional call forwarding (refer to "all conditional CF" in 3GPP TS 22.030 [19])
- 6 communication deflection – CD, refer 3GPP TS 22.072 [31] and 3GPP TS 24.604 [132]
- 7 communication forwarding on not logged-in – CFNL, refer 3GPP TS 24.604 [132]

<mode>: integer type

- 0 disable
- 1 enable
- 2 query status
- 3 registration
- 4 erasure

<numbertype>: integer type. Indicating type of information in parameter <number>.

- 0 No valid information in parameter <number>. <number> shall then be set to empty string ("").
- 1 Number in <number> according to URI including the prefix specifying the URI type (see command +CDU). Parameter <ton> has no relevant information and is set to zero.
- 2 Number in <number> according to one of the formats supported by 3GPP TS 24.008 [8] clause 10.5.4.7)

<ton>: type of number in integer format (refer 3GPP TS 24.008 [8] clause 10.5.4.7). The parameter is also set to zero when it has no meaningful content, e.g. when <numbertype>=1.

<number>: string type phone number in format specified by <numbertype>. The used character set should be the one selected with command select TE character set +CSCS. When no number is available, <number> shall be set to empty string ("").

<subaddr>: string type subaddress of format specified by <satype>.

<satype>: type of subaddress octet in integer format (refer 3GPP TS 24.008 [8] clause 10.5.4.8); default 128.

<classx> is a sum of integers each representing a class of information (default 7 - voice, data and fax):

- 0 communication forwarding without differentiation on class of information

- 1 voice (telephony)
- 2 data (refers to all bearer services; with <mode>=2 this may refer only to some bearer service if TA does not support values 16, 32, 64 and 128)
- 4 fax (facsimile services)
- 8 short message service
- 16 data circuit sync
- 32 data circuit async
- 64 dedicated packet access
- 128 dedicated PAD access

<ruleset>: string type ruleset value of XML element of communication diversion XML document (refer 3GPP TS 24.604 [132]). If XML ruleset values are not supported or intended to be used, the parameter shall be set to an empty string ("").

<time>: integer type

- 1...30 when "no reply", "all call forwarding" or "all conditional call forwarding" is enabled or queried, this gives the time in seconds to wait before call is forwarded, default value 20.

<status>: integer type

- 0 not active
- 1 active

Implementation

Optional.

7.36 Message waiting indication control +CMWI

Table 7.36-1: +CMWI parameter command syntax

Command	Possible response(s)
+CMWI=[<state>[,<expiry_time>]]	+CME ERROR: <err>
+CMWI?	+CMWI: <state>[,<expiry_time>]
+CMWI=?	+CMWI: (list of supported <state>s) , (maximum <expiry_time>)

Description

The command allows to control the message waiting indication service according to 3GPP TS 24.606 [134].

The set command invokes the service for a certain <expiry_time> or deactivates the service. Refer clause 9.2 for possible <err> values.

When the message waiting indication service is activated the unsolicited result code +CMWN: <mw_notification> is provided to indicate waiting messages.

The read command returns the message waiting indication service state and the time remaining for the service to be active if available.

Test command returns values supported as compound values. <expiry_time>s are supported from 0 to (maximum <expiry_time>) in seconds.

Defined values

<state>: integer type. Indicates the state of the message waiting indication service.

0 not active

1 active

<expiry_time>: integer type. Indicates the time in seconds after which the message waiting indication service will become inactive. The range of permitted values is from 0 to (2**32)-1. The default value is implementation specific.

<mw_notification>: string type. Indicates waiting message information in application/simple-message-summary MIME type format according to 3GPP TS 24.606 [134].

Implementation

Optional.

7.37 Session start and stop for MMTEL and SMSoverIP applications +CSCM

Table 7.37-1: +CSCM action command syntax

Command	Possible response(s)
+CSCM=<application>,<start-end_indication>	+CME ERROR: <err>
+CSCM=?	+CSCM: (list of supported <application>s), (list of supported <start-end_indication>s)

Description

This command allows the MMTEL and SMS over IP applications to provide start and stop indications to the MT, for MMTEL voice, MMTEL video or SMSoverIP sessions, in support of

- SCM (smart congestion mitigation) in E-UTRAN; and
- ACDC (Application specific Congestion control for Data Communications) in E-UTRAN and UTRAN.

The set command allows the:

- MMTEL application to provide an indication to the MT when an originating multimedia telephony session for voice communication is started or ended according to the conditions in 3GPP TS 24.173 [87]).
- MMTEL application to provide an indication to the MT when an originating multimedia telephony session for video communication is started or ended according to the conditions in 3GPP TS 24.173 [87]).
- SMS over IP application to provide an indication to the MT when an originating SMS over IP is started or ended according to the conditions in 3GPP TS 24.341 [101].

Refer clause 9.2 for possible <err> values.

The test command returns the supported values as compound values.

Defined values

<application>: integer type. Type of application.

0 MMTEL voice

1 MMTEL video

2 SMS over IP

<start-end_indication>: integer type. Indication of the start or the end of the session as indicated by <application>.

- 1 Start indication
- 2 End indication

Implementation

Optional.

For SCM, this command is only applicable to UEs in E-UTRAN.

For ACDC, this command is only applicable to UEs in UTRAN and E-UTRAN.

7.38 Power saving mode setting +CPSMS

Table 7.38-1: +CPSMS parameter command syntax

Command	Possible response(s)
+CPSMS=[<mode>[,<Requested_Periodic-RAU>[,<Requested_GPRS-READY-timer>[,<Requested_Periodic-TAU>[,<Requested_Active-Time>]]]]]	+CME ERROR: <err>
+CPSMS?	+CPSMS: <mode>[,<Requested_Periodic-RAU>], [<Requested_GPRS-READY-timer>], [<Requested_Periodic-TAU>], [<Requested_Active-Time>]
+CPSMS=?	+CPSMS: (list of supported <mode>s), (list of supported <Requested_Periodic-RAU>s), (list of supported <Requested_GPRS-READY-timer>s), (list of supported <Requested_Periodic-TAU>s), (list of supported <Requested_Active-Time>s)

Description

The set command controls the setting of the UE's power saving mode (PSM) parameters. The command controls whether the UE wants to apply PSM or not, as well as the requested extended periodic RAU value and the requested GPRS READY timer value in GERAN/UTRAN, the requested extended periodic TAU value in E-UTRAN and the requested Active Time value. See the unsolicited result codes provided by commands +CGREG for the Active Time value, the extended periodic RAU value and the GPRS READY timer value that are allocated to the UE by the network in GERAN/UTRAN and +CEREG for the Active Time value and the extended periodic TAU value that are allocated to the UE by the network in E-UTRAN.

A special form of the command can be given as +CPSMS=2. In this form, the use of PSM will be disabled and data for all parameters in the command +CPSMS will be removed or, if available, set to the manufacturer specific default values.

Refer clause 9.2 for possible <err> values.

The read command returns the current parameter values.

The test command returns the supported <mode>s and the value ranges for the requested extended periodic RAU value and the requested GPRS READY timer value in GERAN/UTRAN, the requested extended periodic TAU value in E-UTRAN and the requested Active Time value as compound values.

Defined values

<mode>: integer type. Indication to disable or enable the use of PSM in the UE.

- 0 Disable the use of PSM
- 1 Enable the use of PSM
- 2 Disable the use of PSM and discard all parameters for PSM or, if available, reset to the manufacturer specific default values.

<Requested_Periodic-RAU>: string type; one byte in an 8 bit format. Requested extended periodic RAU value (T3312) to be allocated to the UE in GERAN/UTRAN. The requested extended periodic RAU value is coded as one byte (octet 3) of the GPRS Timer 3 information element coded as bit format (e.g. "01000111" equals 70 hours). For the coding and the value range, see the GPRS Timer 3 IE in 3GPP TS 24.008 [8] Table 10.5.163a/3GPP TS 24.008. See also 3GPP TS 23.682 [149] and 3GPP TS 23.060 [47]. The default value, if available, is manufacturer specific.

<Requested_GPRS-READY-timer>: string type; one byte in an 8 bit format. Requested GPRS READY timer value (T3314) to be allocated to the UE in GERAN/UTRAN. The requested GPRS READY timer value is coded as one byte (octet 2) of the GPRS Timer information element coded as bit format (e.g. "01000011" equals 3 decihours or 18 minutes). For the coding and the value range, see the GPRS Timer IE in 3GPP TS 24.008 [8] Table 10.5.172/3GPP TS 24.008. See also 3GPP TS 23.060 [47]. The default value, if available, is manufacturer specific.

<Requested_Periodic-TAU>: string type; one byte in an 8 bit format. Requested extended periodic TAU value (T3412) to be allocated to the UE in E-UTRAN. The requested extended periodic TAU value is coded as one byte (octet 3) of the GPRS Timer 3 information element coded as bit format (e.g. "01000111" equals 70 hours). For the coding and the value range, see the GPRS Timer 3 IE in 3GPP TS 24.008 [8] Table 10.5.163a/3GPP TS 24.008. See also 3GPP TS 23.682 [149] and 3GPP TS 23.401 [82]. The default value, if available, is manufacturer specific.

<Requested_Active-Time>: string type; one byte in an 8 bit format. Requested Active Time value (T3324) to be allocated to the UE. The requested Active Time value is coded as one byte (octet 3) of the GPRS Timer 2 information element coded as bit format (e.g. "00100100" equals 4 minutes). For the coding and the value range, see the GPRS Timer 2 IE in 3GPP TS 24.008 [8] Table 10.5.163/3GPP TS 24.008. See also 3GPP TS 23.682 [149], 3GPP TS 23.060 [47] and 3GPP TS 23.401 [82]. The default value, if available, is manufacturer specific.

Implementation

Optional.

This command is not applicable to UEs in NG-RAN in this release of the specification.

7.39 Application Start and Stop indication for applications other than MMTEL and SMSoverIP +CACDC

Table 7.39-1: +CACDC action command syntax

Command	Possible response(s)
+CACDC=<OSid>,<OSappid>,<start-stop-indication>	+CME ERROR: <err>
+CACDC=?	+CACDC: (list of supported <OSid>,<OSappid> pairs) , (list of supported <start-stop-indication>s)

Description

This command allows the operating system on the TE to provide start and stop indications other than MMTEL and SMSoverIP to the MT for a particular application in support of ACDC. Each application is identified by an application identity which consists of two parts:

<OSid> an operating system identifier. This identifier identifies the operating system.

<OSappid> an OS specific application identifier. This identifier is associated with a given application and uniquely identifies the application within the UE for a given operating system.

The supported <OSid>s and <OSappid>s are manufacturer specific.

Refer clause 9.2 for possible <err> values.

The test command returns the supported values as compound values.

Defined values

<OSid>: string type. Operating system identifier. The format of the OS ID is a Universally Unique Identifier (UUID) as specified in RFC 4122 [155].

<OSappid>: string type. A string containing the OS specific application identifier. The format of the OS specific application identifier is manufacturer specific.

<start-stop-indication>: integer type. Indication to start sending data and the indication to stop sending data, for the application identified by <OSid> and <OSappid>.

0 indication to start sending data

1 indication to stop sending data

Implementation

Optional.

This command is only applicable to UEs in UTRAN and E-UTRAN.

7.40 eDRX setting +CEDRXS

Table 7.40-1: +CEDRXS parameter command syntax

Command	Possible response(s)
+CEDRXS=[<mode> , [, <AcT-type> [, <Requested_eDRX_value>]]	+CME ERROR: <err>
+CEDRXS?	[+CEDRXS: <AcT-type> , <Requested_eDRX_value> [<CR><LF>+CEDRXS: <AcT-type> , <Requested_eDRX_value> [...]]]
+CEDRXS=?	+CEDRXS: (list of supported <mode>s) , (list of supported <AcT-type>s) , (list of supported <Requested_eDRX_value>s)

Description

The set command controls the setting of the UEs eDRX parameters. The command controls whether the UE wants to apply eDRX or not, as well as the requested eDRX value for each specified type of access technology.

The set command also controls the presentation of an unsolicited result code +CEDRXP: <AcT-type> [, <Requested_eDRX_value> [, <NW-provided_eDRX_value> [, <Paging_time_window>]]] when <n>=2 and there is a change in the eDRX parameters provided by the network.

A special form of the command can be given as +CEDRXS=3. In this form, eDRX will be disabled and data for all parameters in the command +CEDRXS will be removed or, if available, set to the manufacturer specific default values.

Refer clause 9.2 for possible <err> values.

The read command returns the current settings for each defined value of <AcT-type>.

The test command returns the supported <mode>s and the value ranges for the access technology and the requested eDRX value as compound values.

Defined values

<mode>: integer type, indicates to disable or enable the use of eDRX in the UE. This parameter is applicable to all specified types of access technology, i.e. the most recent setting of <mode> will take effect for all specified values of <AcT>.

- 0 Disable the use of eDRX
- 1 Enable the use of eDRX
- 2 Enable the use of eDRX and enable the unsolicited result code
+CEDRXP: <AcT-type>[, <Requested_eDRX_value>[, <NW-provided_eDRX_value>[, <Paging_time_window>]]]
- 3 Disable the use of eDRX and discard all parameters for eDRX or, if available, reset to the manufacturer specific default values.

<AcT-type>: integer type, indicates the type of access technology. This AT-command is used to specify the relationship between the type of access technology and the requested eDRX value.

- 0 Access technology is not using eDRX. This parameter value is only used in the unsolicited result code.
- 1 EC-GSM-IoT (A/Gb mode)
- 2 GSM (A/Gb mode)
- 3 UTRAN (Iu mode)
- 4 E-UTRAN (WB-S1 mode)
- 5 E-UTRAN (NB-S1 mode)

<Requested_eDRX_value>: string type; half a byte in a 4 bit format. The eDRX value refers to bit 4 to 1 of octet 3 of the Extended DRX parameters information element (see clause 10.5.5.32 of 3GPP TS 24.008 [8]). For the coding and the value range, see Extended DRX parameters information element in 3GPP TS 24.008 [8] Table 10.5.5.32/3GPP TS 24.008. The default value, if available, is manufacturer specific.

<NW-provided_eDRX_value>: string type; half a byte in a 4 bit format. The eDRX value refers to bit 4 to 1 of octet 3 of the Extended DRX parameters information element (see clause 10.5.5.32 of 3GPP TS 24.008 [8]). For the coding and the value range, see Extended DRX parameters information element in 3GPP TS 24.008 [8] Table 10.5.5.32/3GPP TS 24.008.

<Paging_time_window>: string type; half a byte in a 4 bit format. The paging time window refers to bit 8 to 5 of octet 3 of the Extended DRX parameters information element (see clause 10.5.5.32 of 3GPP TS 24.008 [8]). For the coding and the value range, see the Extended DRX parameters information element in 3GPP TS 24.008 [8] Table 10.5.5.32/3GPP TS 24.008.

Implementation

Optional.

7.41 eDRX read dynamic parameters +CEDRXRDP

Table 7.41-1: +CEDRXRDP action command syntax

Command	Possible response(s)
+CEDRXRDP	+CEDRXRDP: <AcT-type>[, <Requested_eDRX_value>[, <NW-provided_eDRX_value>[, <Paging_time_window>]]]
+CEDRXRDP=?	

Description

The execution command returns <AcT-type> and <Requested_eDRX_value>, <NW-provided_eDRX_value> and <Paging_time_window> if eDRX is used for the cell that the MS is currently registered to.

If the cell that the MS is currently registered to is not using eDRX, AcT-type=0 is returned.

Defined values

<AcT-type>: integer type, indicates the type of access technology. This AT-command is used to specify the relationship between the type of access technology and the requested eDRX value.

- 0 Access technology is not using eDRX
- 1 EC-GSM-IoT (A/Gb mode)
- 2 GSM (A/Gb mode)
- 3 UTRAN (Iu mode)
- 4 E-UTRAN (WB-S1 mode)
- 5 E-UTRAN (NB-S1 mode)

<Requested_eDRX_value>: string type; half a byte in a 4 bit format. The eDRX value refers to bit 4 to 1 of octet 3 of the Extended DRX parameters information element (see clause 10.5.5.32 of 3GPP TS 24.008 [8]). For the coding and the value range, see Extended DRX parameters information element in 3GPP TS 24.008 [8] Table 10.5.5.32/3GPP TS 24.008.

<NW-provided_eDRX_value>: string type; half a byte in a 4 bit format. The eDRX value refers to bit 4 to 1 of octet 3 of the Extended DRX parameters information element (see clause 10.5.5.32 of 3GPP TS 24.008 [8]). For the coding and the value range, see Extended DRX parameters information element in 3GPP TS 24.008 [8] Table 10.5.5.32/3GPP TS 24.008.

<Paging_time_window>: string type; half a byte in a 4 bit format. The paging time window refers to bit 8 to 5 of octet 3 of the Extended DRX parameters information element (see clause 10.5.5.32 of 3GPP TS 24.008 [8]). For the coding and the value range, see the Extended DRX parameters information element in 3GPP TS 24.008 [8] Table 10.5.5.32/3GPP TS 24.008.

Implementation

Optional.

7.42 CloT optimization configuration +CCIOTOPT

Table 7.42-1: CIOPT parameter command syntax

Command	Possible Response(s)
+CCIOTOPT=[<n>[, <supported_UE_opt>[, <preferred_UE_opt>]]]	+CME ERROR: <err>

+CCIOTOPT?	+CCIOTOPT : <n> , <supported_UE_opt> , <preferred_UE_opt>
+CCIOTOPT=?	+CCIOTOPT: (list of supported <n>s) , (list of supported <supported_UE_opt>s) , (list of supported <preferred_UE_opt>s)

Description

The set command controls which CIoT EPS optimizations the UE indicates as supported and preferred in the ATTACH REQUEST and TRACKING AREA UPDATE REQUEST messages. The command also allows reporting of the CIoT EPS optimizations that are supported by the network. A UE supporting CIoT functionality may support control plane CIoT EPS optimization or user plane CIoT EPS optimization or both (see 3GPP TS 24.301 [83], clause 9.9.3.34). Based on the application characteristics the UE may prefer to be registered for control plane CIoT EPS optimization or for user plane CIoT EPS optimization (see 3GPP TS 24.301 [83], clause 9.9.3.0B). Further the network may support control plane CIoT EPS optimization or user plane CIoT EPS optimization or both (see 3GPP TS 24.301 [83], clause 9.9.3.12A).

The set command is used also to control the unsolicited result code +CCIOTOPTI. An unsolicited result code +CCIOTOPTI : <supported_Network_opt> is used to indicate the supported CIoT EPS optimizations by the network.

Refer clause 9.2 for possible <err> values.

The read command returns the current settings for supported and preferred CIoT EPS optimizations and the current status of unsolicited result code +CCIOTOPTI.

The test command returns values supported as compound values.

Defined values

<n>: integer type. Enables or disables reporting of unsolicited result code +CCIOTOPTI.

- 0 Disable reporting.
- 1 Enable reporting.
- 3 Disable reporting and reset the parameters for CIoT EPS optimization to the default values.

<supported_UE_opt>: integer type; indicates the UE's support for CIoT EPS optimizations.

- 0 No support.
- 1 Support for control plane CIoT EPS optimization.
- 2 Support for user plane CIoT EPS optimization.
- 3 Support for both control plane CIoT EPS optimization and user plane CIoT EPS optimization.

<preferred_UE_opt>: integer type; indicates the UE's preference for CIoT EPS optimizations.

- 0 No preference.
- 1 Preference for control plane CIoT EPS optimization.
- 2 Preference for user plane CIoT EPS optimization.

<supported_Network_opt>: integer type; indicates the Network support for CIoT EPS optimizations.

- 0 No support.
- 1 Support for control plane CIoT EPS optimization.
- 2 Support for user plane CIoT EPS optimization.

- 3 Support for both control plane CIoT EPS optimization and user plane CIoT EPS optimization.

Implementation

Optional.

7.43 Informative examples

This clause includes all the GSM/UMTS supplementary service related commands, additional commands to lock MT and SIM/UICC capabilities, and commands to check the network registration status.

An example where MSISDNs of a MT are queried, calls are forwarded to different numbers when mobile is busy (CFB) or when it does not answer (CFNRy). The status of CFNRy is read:

```
AT+CNUM
+CNUM: , "+358501234567" , 145 , , 4      (voice number)
OK
AT+CCFC=1 , 1 , "931123456"              (enable CFB)
OK
AT+CCFC=2 , 1 , "921654321"              (enable CFNRy)
OK
AT+CCFC=1 , 2                             (query CFNRy)
+CCFC: 1 , 7 , "+35821654321" , 145 , , 20 (forward after 20 seconds)
OK
```

An example of Call Waiting (+CCWA), Call Related Supplementary Services (+CHLD), and Connected Line Identification Presentation (+COLP) usage:

```
AT+CCWA=1 , 1 ; +COLP=1                  (enable call waiting and COLP result codes)
OK
ATD9311234567 ;                          (originate a voice call)
+COLP: " +358311234567 " , 145
OK
...conversation...
+CCWA: " +358317654321 " , 145 (another call is waiting)
AT+CHLD=2                                  (put first call on hold and answer the second one)
OK
...conversation...
AT+CHLD=1                                  (release the second (active) call and recover the first (held) call)
OK
ATH                                         (release the first call)
OK
```

Call barring supplementary services are combined in one command, Facility Lock (+CLCK), which is also used to restrict MT and SIM/UICC functionality. Some of the facilities require a password when enabled or disabled. An additional command, Change Password (+CPWD), is defined for changing the password of different barring and restriction facilities. An example where locking status of outgoing international calls is interrogated and then barred, and the password of the SIM/UICC card lock (Personal Identity Number, PIN) is changed:

```
AT+CLCK="OI" , 2
+CLCK: 0 , 7
OK
AT+CLCK="OI" , 1 , "1234"
OK
AT+CPWD="SC" , "4321" , "1234"
OK
```

Operator Selection (+COPS) command is used for querying the status of all GSM/UMTS operators detected in the area, and switching between operators.

Following example illustrates a network selection sequence in Finland. Two operators are found, the status of Tele is unknown and Radiolinja is currently selected. Read command shows that automatic selection mode is on and that Radiolinja is selected. Then an attempt is made to access Tele, but it is denied (shown by +CME ERROR).

```
AT+COPS=?
+COPS: ( 2 , "RADIOLINJA" , "RL" , "24405" ) , ( 0 , "TELE" , "TELE" , "24491" )
OK
AT+COPS?
+COPS: 0 , 0 , "RADIOLINJA"
OK
```

```
AT+COPS=1,0,"TELE"
+CME ERROR: 3
```

When a terminal wanders between countries (i.e. networks), an application may follow this e.g. with the following scenario:

```
AT+CREG=1                (enable +CREG: <stat> unsolicited result code)
OK
AT+CREG?
+CREG: 1,1              (MT is registered in home PLMN)
OK
AT+COPS=3,2;+COPS?;+COPS=3,0;+COPS?
+COPS: 0,2,"24405"      (get the country...
+COPS: 0,0,"RADIOLINJA" ...and operator name)
OK
...user wanders to another PLMN...
+CREG: 2                (deregistered, roaming ongoing)
+CREG: 5                (registered again, not home PLMN)
AT+COPS=3,2;+COPS?;+COPS=3,0;+COPS?
+COPS: 0,2,"24001"      (get the country...
+COPS: 0,0,"TELIA MOBITEL" ...and operator name)
OK
...user loses connection, no other PLMNs around...
+CREG: 0
```

An example of eMLPP Supplementary Service usage for a ptp voice call:

```
ATD*752#+436644101453;  (originate a voice call with the priority level 2, see for priority level definitions GSM 02.30)
OK                        (call setup was successful)
```

8 Mobile termination control and status commands

8.0 General

This clause includes commands for MT power, keypad, touch screen, display and indicator handling. Also commands for selecting, reading and writing of phonebooks, and setting real-time clock facilities are specified. Two commands are specified for accessing SIM/UICC database records in a general way.

Figure 7 illustrates the effect of these commands. Command Phone Activity Status +CPAS indicates the current general activity status of the MT. Command Set Phone Functionality +CFUN is used to set the MT to different power consumption states. Command Enter PIN +CPIN is used to enter MT passwords which are needed before any other functionality of the MT can be used (e.g. SIM PIN, PUK). Commands Generic SIM Access +CSIM and Restricted SIM Access +CRSM can be used to access all data in SIM/UICC. Commands Battery Charge +CBC and Signal Quality +CSQ are same as in TIA IS-135 [16] and they are used to query the battery charge of the MT and the current RSSI of the MT. Command Mobile Termination Control Mode +CMEC is used to select the controlling unit of MT keypad, display touch screen, and indicators. Controlling commands for the TE are Keypad Emulation +CKPD, Display Control +CDIS, Touch Screen Emulation +CTSA, and Indicator Control +CIND. If corresponding event reporting is enabled with command Mobile Termination Event Reporting +CMER, +CKEV is the result code of a keypad event, +CDEV is the result code of a display event, +CTEV is the result code of a touch screen event, +COEV is the result code of a display orientation event, and +CIEV is the result code of an indicator event. Phonebook commands are Select Phonebook Memory Storage +CPBS, Read Phonebook Entries +CPBR, Find Phonebook Entries +CPBF and Write Phonebook Entry +CPBW. Additional command Clock +CCLK can be used to control the real-time clock of the MT if available. Command Alarm +CALA sets possible alarm clock facilities of the MT.

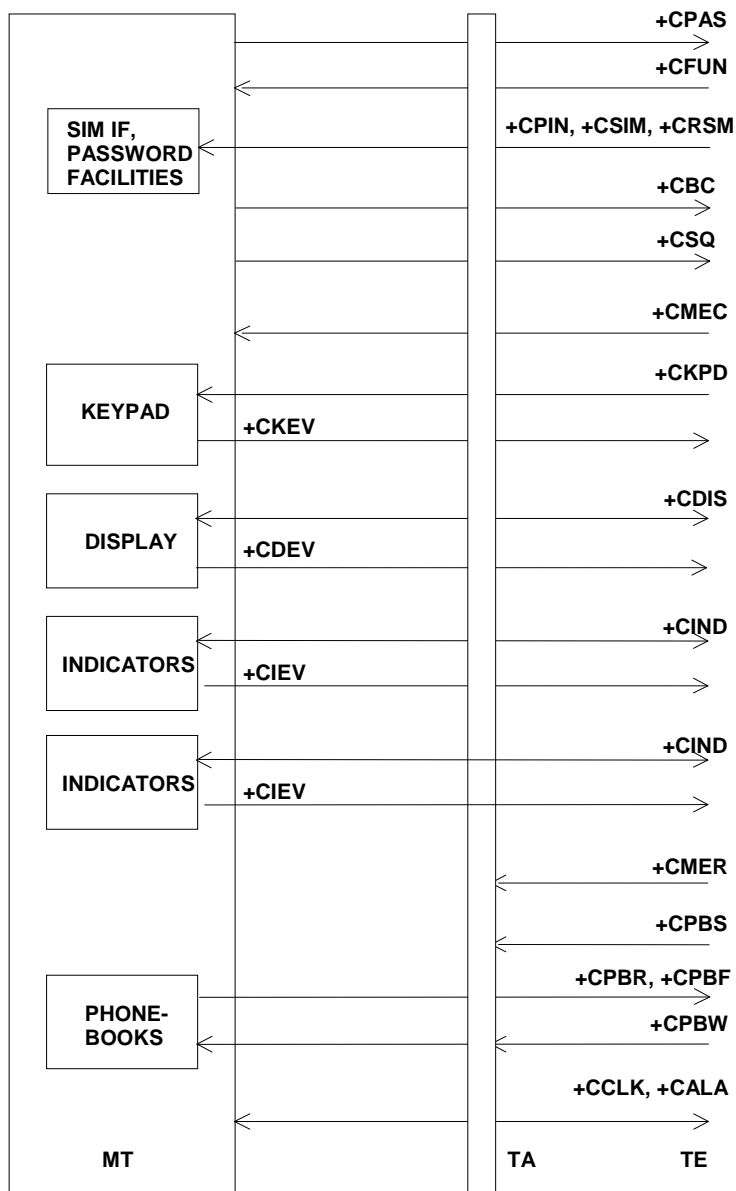

Figure 7: Mobile termination control and status commands

8.1 Phone activity status +CPAS

Table 60: +CPAS action command syntax

Command	Possible response(s)
+CPAS	+CPAS: <pas> +CME ERROR: <err>
+CPAS=?	+CPAS: (list of supported <pas>s) +CME ERROR: <err>

Description

Execution command returns the activity status `<pas>` of the MT. It can be used to interrogate the MT before requesting action from the phone. Refer clause 9.2 for possible `<err>` values.

Test command returns values supported by the MT as a compound value.

Defined values

`<pas>`: integer type

- 0 ready (MT allows commands from TA/TE)
- 1 unavailable (MT does not allow commands from TA/TE)
- 2 unknown (MT is not guaranteed to respond to instructions)
- 3 ringing (MT is ready for commands from TA/TE, but the ringer is active)
- 4 call in progress (MT is ready for commands from TA/TE, but a call is in progress)
- 5 asleep (MT is unable to process commands from TA/TE because it is in a low functionality state)

all other values below 128 are reserved by the present document.

Implementation

Mandatory when MT can be operated from TE (refer clause "Mobile termination control mode +CMEC").

8.2 Set phone functionality +CFUN

Table 61: +CFUN parameter command syntax

Command	Possible response(s)
+CFUN=[<code><fun></code> [, <code><rst></code>]]	+CME ERROR: <code><err></code>
+CFUN?	+CFUN: <code><fun></code> +CME ERROR: <code><err></code>
+CFUN=?	+CFUN: (list of supported <code><fun></code> s) , (list of supported <code><rst></code> s) +CME ERROR: <code><err></code>

Description

Set command selects the level of functionality `<fun>` in the MT. Level "full functionality" is where the highest level of power is drawn. "Minimum functionality" is where minimum power is drawn. Level of functionality between these may also be specified by manufacturers. When supported by manufacturers, MT resetting with `<rst>` parameter may be utilized. Refer clause 9.2 for possible `<err>` values.

NOTE 1: It is manufacturer specific if this command affects network registration. Command Operator Selection +COPS is used to force registration/deregistration.

Read command returns the current setting of `<fun>`.

Test command returns values supported by the MT as compound values.

Defined values

`<fun>`: integer type

- 0 minimum functionality
- 1 full functionality. Enable (turn on) the transmit and receive RF circuits for all supported radio access technologies. For MTs supporting +CSRA, this equals the RATs indicated by the response of

+CSRA=? . Current +CSRA setting is ignored. It is not required that the MT transmit and receive RF circuits are in a disabled state for this setting to have effect.

- 2 disable (turn off) MT transmit RF circuits only
- 3 disable (turn off) MT receive RF circuits only
- 4 disable (turn off) both MT transmit and receive RF circuits
- 5...127 reserved for manufacturers as intermediate states between full and minimum functionality
- 128 Full functionality with radio access support according to the setting of +CSRA. Enables (turns on) the transmit and receive RF circuits if not already enabled. This <fun> setting is applicable for MTs supporting +CSRA.
- 129 Prepare for shutdown. This setting has its prime use when some of the MT's resources (e.g. file system) are located on a tightly integrated TE (host). The MT will execute pending actions resulting in "permanent" changes, e.g. execute pending file system operations. The MT will also make an orderly network detach. After this action and +CFUN has returned OK, the MT can be shut down with <fun>=0, or by other means. After setting <fun>=129, only <fun>=0 is valid. All other values will make +CFUN return ERROR.

<rst>: integer type

- 0 do not reset the MT before setting it to <fun> power level

NOTE 2: This shall be always default when <rst> is not given.

- 1 reset the MT before setting it to <fun> power level

Implementation

Optional. When <fun>=128, is supported, +CSRA is required.

8.3 Enter PIN +CPIN

Table 62: +CPIN parameter command syntax

Command	Possible response(s)
+CPIN=<pin>[,<newpin>]	+CME ERROR: <err>
+CPIN?	+CPIN: <code> +CME ERROR: <err>
+CPIN=?	

Description

Set command sends to the MT a password which is necessary before it can be operated (SIM PIN, SIM PUK, PH-SIM PIN, etc.). If the PIN is to be entered twice, the TA shall automatically repeat the PIN. If no PIN request is pending, no action is taken towards MT and an error message, +CME ERROR, is returned to TE. Refer clause 9.2 for possible <err> values.

NOTE 1: SIM PIN, SIM PUK, PH-SIM PIN, PH-FSIM PIN, PH-FSIM PUK, SIM PIN2 and SIM PUK2 refer to the PIN of the selected application on the UICC. For example, in an UTRAN context, the selected application on the currently selected UICC should be a USIM and the SIM PIN then represents the PIN of the selected USIM. See 3GPP TS 31.101 [65] for further details on application selection on the UICC.

If the PIN required is SIM PUK or SIM PUK2, the second pin is required. This second pin, <newpin>, is used to replace the old pin in the SIM.

NOTE 2: Commands which interact with MT that are accepted when MT is pending SIM PIN, SIM PUK, or PH-SIM are: +CGMI, +CGMM, +CGMR, +CGSN, D112; (emergency call), +CPAS, +CFUN, +CPIN, +CPINR, +CDIS (read and test command only), and +CIND (read and test command only). It is implementation specific whether additional commands can be accepted when MT is pending SIM PIN, SIM PUK, or PH-SIM.

Read command returns an alphanumeric string indicating whether some password is required or not.

Defined values

<pin>, <newpin>: string type values

<code> values reserved by the present document:

READY	MT is not pending for any password
SIM PIN	MT is waiting SIM PIN to be given
SIM PUK	MT is waiting SIM PUK to be given
PH-SIM PIN	MT is waiting phone-to-SIM card password to be given
PH-FSIM PIN	MT is waiting phone-to-very first SIM card password to be given
PH-FSIM PUK	MT is waiting phone-to-very first SIM card unblocking password to be given
SIM PIN2	MT is waiting SIM PIN2 to be given (this <code> is recommended to be returned only when the last executed command resulted in PIN2 authentication failure (i.e. +CME ERROR: 17); if PIN2 is not entered right after the failure, it is recommended that MT does not block its operation)
SIM PUK2	MT is waiting SIM PUK2 to be given (this <code> is recommended to be returned only when the last executed command resulted in PUK2 authentication failure (i.e. +CME ERROR: 18); if PUK2 and new PIN2 are not entered right after the failure, it is recommended that MT does not block its operation)
PH-NET PIN	MT is waiting network personalization password to be given
PH-NET PUK	MT is waiting network personalization unblocking password to be given
PH-NETSUB PIN	MT is waiting network subset personalization password to be given
PH-NETSUB PUK	MT is waiting network subset personalization unblocking password to be given
PH-SP PIN	MT is waiting service provider personalization password to be given
PH-SP PUK	MT is waiting service provider personalization unblocking password to be given
PH-CORP PIN	MT is waiting corporate personalization password to be given
PH-CORP PUK	MT is waiting corporate personalization unblocking password to be given

Implementation

Mandatory for MT not supporting the +CKPD command and supporting AT commands only.

8.4 Battery charge +CBC

Table 63: +CBC action command syntax

Command	Possible response(s)
+CBC	+CBC: <bc^s>, <bc^l> +CME ERROR: <err>
+CBC=?	+CBC: (list of supported <bc^s>s), (list of supported <bc^l>s)

Description

Execution command returns battery connection status <bc^s> and battery charge level <bc^l> of the MT. Refer clause 9.2 for possible <err> values.

Test command returns values supported as compound values.

Defined values

<bc^s>: integer type

- 0 MT is powered by the battery
- 1 MT has a battery connected, but is not powered by it
- 2 MT does not have a battery connected
- 3 Recognized power fault, calls inhibited

<bc^l>: integer type

- 0 battery is exhausted, or MT does not have a battery connected
- 1...100 battery has 1-100 percent of capacity remaining

Implementation

Optional.

8.5 Signal quality +CSQ

Table 64: +CSQ action command syntax

Command	Possible response(s)
+CSQ	+CSQ: <rssi>, <ber> +CME ERROR: <err>
+CSQ=?	+CSQ: (list of supported <rssi>s), (list of supported <ber>s)

Description

Execution command returns received signal strength indication <rssi> and channel bit error rate <ber> from the MT. Refer clause 9.2 for possible <err> values.

Test command returns values supported as compound values.

Defined values

<rssi>: integer type

- 0 -113 dBm or less

- 1 -111 dBm
- 2...30 -109... -53 dBm
- 31 -51 dBm or greater
- 99 not known or not detectable

<ber>: integer type; channel bit error rate (in percent)

- 0...7 as RXQUAL values in the table in 3GPP TS 45.008 [20] clause 8.2.4
- 99 not known or not detectable

Implementation

Optional.

8.6 Mobile termination control mode +CMEC

Table 65: +CMEC parameter command syntax

Command	Possible response(s)
+CMEC=[<keyp>[,<disp>[,<ind>[,<tscrn>]]]]	+CME ERROR: <err>
+CMEC?	+CMEC: <keyp>, <disp>, <ind>, <tscrn>
+CMEC=?	+CMEC: (list of supported <keyp>s), (list of supported <disp>s), (list of supported <ind>s), (list of supported <tscrn>s)

Description

Set command selects the equipment, which operates MT keypad, writes to MT display and sets MT indicators. If operation mode is not allowed by the MT, +CME ERROR: <err> is returned. Refer clause 9.2 for possible <err> values.

Read command returns the current settings.

Test command returns the modes supported as compound values.

Defined values

<keyp>: integer type

- 0 MT can be operated only through its keypad (execute command of +CKPD cannot be used)
- 1 MT can be operated only from TE (with command +CKPD)
- 2 MT can be operated from both MT keypad and TE

<disp>: integer type

- 0 only MT can write to its display (command +CDIS can only be used to read the display)
- 1 only TE can write to MT display (with command +CDIS)
- 2 MT display can be written by both MT and TE

<ind>: integer type

- 0 only MT can set the status of its indicators (command +CIND can only be used to read the indicators)
- 1 only TE can set the status of MT indicators (with command +CIND)

- 2 MT indicators can be set by both MT and TE

<tscrn>: integer type

- 0 only MT can set the status of its indicators (execute command of +CTSA cannot be used)
- 1 only TE can set the status of MT indicators (with command +CTSA)
- 2 MT indicators can be set by both MT and TE

Implementation

Mandatory when any of keypad, display or indicator or touch screen commands is implemented.

8.7 Keypad control +CKPD

Table 66: +CKPD action command syntax

Command	Possible response(s)
+CKPD=<keys>[, <time>[, <pause>]]	+CME ERROR: <err>
+CKPD=?	

Description

Execution command emulates MT keypad by giving each keystroke as a character in a string <keys>. <time>*0.1 seconds is the time to stroke each key and <pause>*0.1 seconds is the length of pause between two strokes. If emulating fails in an MT error, +CME ERROR: <err> is returned. Refer clause 9.2 for possible <err> values. This command should be accepted (OK returned) before actually starting to press the keys. Thus unsolicited result codes of key pressings and display events can be returned (refer clause "Mobile termination event reporting +CMER").

Defined values

<keys>: string of characters representing keys as listed in the following table 67 (based on PCCA STD-101 [17] Annex I table I-3). Colon character (IRA 58) followed by one character can be used to indicate a manufacturer specific key not listed here. All characters from a semicolon character (IRA 59) to the next single semicolon character are treated as alpha entries and are not converted to key equivalents. All semicolon characters inside alpha entries should be duplicated in the TE and stripped to one before entering to the MT. Pause character (IRA 87 or 119) can be used to pause between key pressings for a time specified by <pause>. All IRA values not listed here are reserved.

Table 67: Character codes

Char	IRA (dec)	Comment (+ some known key symbols)
#	35	hash (number sign)
%	37	percent sign (P)
*	42	star (*)
0... 9	48... 57	number keys
:	58	escape character for manufacturer specific keys
;	59	escape character for string entering
<	60	left arrow
>	62	right arrow
@	64	alpha key (α/ABC)
A/a	65/97	channel A (A)
B/b	66/98	channel B (B)
C/c	67/99	clear display (C/CLR)
D/d	68/100	volume down
E/e	69/101	connection end (END)
F/f	70/102	function (FCN)

Char	IRA (dec)	Comment (+ some known key symbols)
L/l	76/108	phone lock (LOCK)
M/m	77/109	menu (MENU)
P/p	80/112	power (PWR)
Q/q	81/113	quiet/mute (MUTE)
R/r	82/114	recall last number (R/RCL/MR)
S/s	83/115	connection start (SEND)
T/t	84/116	store/ memory (STO/M/M+)
U/u	85/117	volume up
V/v	86/118	down arrow
W/w	87/119	pause character
X/x	88/120	auxiliary (AUX)
Y/y	89/121	delete last character (C)
[91	soft key 1
]	93	soft key 2
^	94	up arrow

<time>, <pause>: integer type

0...255 0... 25.5 seconds (default values are manufacturer specific, but should be so long that a normal MT can handle keystrokes correctly)

Implementation

Mandatory for MT not supporting the +CPIN command and supporting AT commands only.

8.8 Display control +CDIS

Table 68: +CDIS parameter command syntax

Command	Possible response(s)
+CDIS=[<text>[,<text>[,...]]]	+CME ERROR: <err>
+CDIS?	+CDIS: <text>[,<text>[,...]] +CME ERROR: <err>
+CDIS=?	+CDIS: <length>[,<length>[,...]] +CME ERROR: <err>

Description

Set command is used to write the contents of MT text type display elements. An element can consist of one character or several characters. The order of element parameters <text> should follow the rule: first is the element in upper left corner, second is the next element to the right and so on. The last element is the element in lower right corner. The number of elements is MT specific. If MT does not allow writing to its display or MT is not currently reachable, +CME ERROR: <err> is returned. Refer clause 9.2 for possible <err> values. If certain element is not writable, setting of it should be ignored. If element parameter is empty field, element shall remain in the previous value.

NOTE 1: This command cannot be used to write to a display which sum of element lengths exceed the length of the command line buffer of the TA.

Read command returns the contents of MT display elements. If <text> field is empty (not empty string), MT does not allow the reading of corresponding element. If MT is not currently reachable, +CME ERROR: <err> is returned. Refer clause 9.2 for possible <err> values.

Test command returns maximum length of each display element. If MT does not offer the length of elements, <length> fields should be empty. If MT is not currently reachable, +CME ERROR: <err> is returned. Refer clause 9.2 for possible <err> values.

NOTE 2: MT manufacturer should offer the order and maximum length of elements.

Defined values

<text>: string type parameter using character set specified by command select TE character set +CSCS

<length>: integer type parameter giving the maximum length of corresponding <text> parameter

Implementation

Optional.

8.9 Indicator control +CIND

Table 69: +CIND parameter command syntax

Command	Possible response(s)
+CIND=[<ind>[,<ind>[,...]]]	+CME ERROR: <err>
+CIND?	+CIND: <ind>[,<ind>[,...]] +CME ERROR: <err>
+CIND=?	+CIND: (<descr>, (list of supported <ind>s))[, (<descr>, (list of supported <ind>s))[,...]] +CME ERROR: <err>

Description

Set command is used to set the values of MT indicators. <ind> value 0 means that the indicator is off (or in state which can be identified as "off"-state), 1 means that indicator is on (or in a state which is more substantial than "off"-state), 2 is more substantial than 1, and so on. If the indicator is a simple on/off style element, it has values 0 and 1. The number of elements is MT specific. If MT does not allow setting of indicators or MT is not currently reachable, +CME ERROR: <err> is returned. Refer clause 9.2 for possible <err> values. If certain indicator is not writable, setting of it should be ignored. If parameter is empty field, indicator shall remain in the previous value.

Read command returns the status of MT indicators. If MT is not currently reachable, +CME ERROR: <err> is returned. Refer clause 9.2 for possible <err> values.

Test command returns pairs, where string value <descr> is a maximum 16 character description of the indicator and compound value is the allowed values for the indicator. If MT is not currently reachable, +CME ERROR: <err> is returned. Refer clause 9.2 for possible <err> values.

NOTE: MT manufacturer should offer the description of supported indicators not listed here and their value ranges and default values.

Defined values

<ind>: integer type value, which shall be in range of corresponding <descr>

<descr> values reserved by the present document and their <ind> ranges:

"battchg" battery charge level (0-5)

"signal" signal quality (0-5)

"service" service availability (0-1)

"sounder"	sounder activity (0-1)
"message"	message received (0-1)
"call"	call in progress (0-1)
"vox"	transmit activated by voice activity (0-1)
"roam"	roaming indicator (0-1)
"smsfull"	a short message memory storage in the MT has become full and a short message has been rejected (2), has become full (1), or memory locations are available (0); i.e. the range is (0-2)
"inputstatus"	keypad/touch screen status (0-1)

Implementation

Optional.

8.10 Mobile termination event reporting +CMER

Table 70: +CMER parameter command syntax

Command	Possible response(s)
+CMER=[<mode>[,<keyp>[,<disp>[,<ind>[,<bfr>[,<tscrn>][,<orientation>]]]]]]	+CME ERROR: <err>
+CMER?	+CMER: <mode> , <keyp> , <disp> , <ind> , <bfr> , <tscrn> , <orientation>
+CMER=?	+CMER: (list of supported <mode>s) , (list of supported <keyp>s) , (list of supported <disp>s) , (list of supported <ind>s) , (list of supported <bfr>s) , (list of supported <tscrn>s) , (list of supported <orientation>s)

Description

Set command enables or disables sending of unsolicited result codes from TA to TE in the case of key pressings, display changes, and indicator state changes. <mode> controls the processing of unsolicited result codes specified within this command. <bfr> controls the effect on buffered codes when <mode> 1, 2 or 3 is entered. If setting is not supported by the MT, +CME ERROR: <err> is returned. Refer clause 9.2 for possible <err> values.

Read command returns the current settings.

Test command returns the modes supported as compound values.

Defined values

<mode>: integer type

- 0 buffer unsolicited result codes in the TA; if TA result code buffer is full, codes can be buffered in some other place or the oldest ones can be discarded
- 1 discard unsolicited result codes when TA-TE link is reserved (e.g. in on-line data mode); otherwise forward them directly to the TE
- 2 buffer unsolicited result codes in the TA when TA-TE link is reserved (e.g. in on-line data mode) and flush them to the TE after reservation; otherwise forward them directly to the TE
- 3 forward unsolicited result codes directly to the TE; TA-TE link specific inband technique used to embed result codes and data when TA is in on-line data mode

<keyp>: integer type

0 no keypad event reporting

- 1 keypad event reporting using unsolicited result code +CKEV: <key> , <press>. <key> indicates the key (refer IRA values defined in table 67 in clause "Keypad control +CKPD") and <press> if the key is pressed or released (1 for pressing and 0 for releasing). Only those key pressings, which are not caused by +CKPD shall be indicated by the TA to the TE.

NOTE 1: When this mode is enabled, corresponding result codes of all keys currently pressed are flushed to the TA regardless of <bfr> setting.

- 2 keypad event reporting using unsolicited result code +CKEV: <key> , <press>. All key pressings shall be directed from TA to TE.

NOTE 2: When this mode is enabled, corresponding result codes of all keys currently pressed are flushed to the TA regardless of <bfr> setting.

<disp>: integer type

0 no display event reporting

- 1 display event reporting using unsolicited result code +CDEV: <elem> , <text>. <elem> indicates the element order number (as specified for +CDIS) and <text> is the new value of text element. Only those display events, which are not caused by +CDIS shall be indicated by the TA to the TE. Character set used in <text> is as specified by command select TE character set +CSCS
- 2 display event reporting using unsolicited result code +CDEV: <elem> , <text>. All display events shall be directed from TA to TE. Character set used in <text> is as specified by command Select TE Character Set +CSCS

<ind>: integer type

0 no indicator event reporting

- 1 indicator event reporting using unsolicited result code +CIEV: <ind> , <value>. <ind> indicates the indicator order number (as specified for +CIND) and <value> is the new value of indicator. Only those indicator events, which are not caused by +CIND shall be indicated by the TA to the TE
- 2 indicator event reporting using unsolicited result code +CIEV: <ind> , <value>. All indicator events shall be directed from TA to TE

<bfr>: integer type

0 TA buffer of unsolicited result codes defined within this command is cleared when <mode> 1...3 is entered

- 1 TA buffer of unsolicited result codes defined within this command is flushed to the TE when <mode> 1...3 is entered (OK response shall be given before flushing the codes)

<tscrn>: integer type

0 no touch screen event reporting

- 1 touch screen event reporting using unsolicited result code +CTEV: <action> , <x> , <y>. The <x> , <y> parameters indicate the x, y coordinates on the touch screen device (as specified for +CTSA), and <action> indicates the action performed on the screen (0 for screen released, 1 for screen depressed, 2 for single tap, and 3 for double tap). Only those touch screen events, which are not caused by +CTSA shall be indicated by the TA to the TE.

NOTE 3: When this mode is enabled, corresponding result codes of all touch screen actions are flushed to the TA regardless of <bfr> setting.

- 2 touch screen event reporting using unsolicited result code +CTEV: <action> , <x> , <y>. All touch screen events shall be directed from the TA to the TE.

NOTE 4: When this mode is enabled, corresponding result codes of all touch screen actions are flushed to the TA regardless of <bfr> setting.

- 3 Verbose mode. Touch screen event reporting using unsolicited result code +CTEV: <action>, <x>, <y>. This is a special mode where intermediate depressed result codes (+CTEV: 1, <x>, <y>) are generated for each new <x>, <y> coordinate detected while a user is dragging a touch to a new location. All other touch screen actions shall be directed from the TA to the TE normally. Only those touch screen events which are not caused by +CTSA shall be indicated by the TA to the TE.

NOTE 5: When this mode is enabled, corresponding result codes of all touch screen actions are flushed to the TA regardless of <bfr> setting.

- 4 enhanced touch screen event reporting using unsolicited result code +CTEV: <action>, <x>, <y>, <id>[, <duration>]. The <x>, <y> parameters indicate the x, y coordinates on the touch screen device (as specified for +CTSA), the <duration> parameter indicates the duration of the touch (as specified for +CTSA) and, the <id> identifies any simultaneous touch (as specified for +CTSA). Only those touch screen events, which are not caused by +CTSA shall be indicated by the TA to the TE. The <action> parameter indicates the action performed on the screen, if the <duration> parameter is:
 - 0, it is valid for the <action> parameter to indicate 0 for screen released, 1 for screen depressed, 2 for single tap, and 3 for double tap;
 - a positive, non-zero integer, it is valid for the <action> parameter to indicate 0 for screen released.

NOTE 6: When this mode is enabled, corresponding result codes of all touch screen actions are flushed to the TA regardless of <bfr> setting.

- 5 enhanced touch screen event reporting using unsolicited result code +CTEV: <action>, <x>, <y>, <id>[, <duration>]. See description of <tscrn> set to 4 for the valid for the <action> parameter. All touch screen events shall be directed from the TA to the TE.

NOTE 7: When this mode is enabled, corresponding result codes of all touch screen actions are flushed to the TA regardless of <bfr> setting.

- 6 Verbose mode. enhanced touch screen event reporting using unsolicited result code +CTEV: <action>, <x>, <y>, <id>[, <duration>]. This is a special mode where intermediate depressed result codes (+CTEV: 1, <x>, <y>, <id>[, <duration>]) are generated for each new <x>, <y> coordinate detected while a user is dragging a touch to a new location. All other touch screen actions shall be directed from the TA to the TE normally. See description of <tscrn> set to 4 for the valid for the <action> parameter. Only those touch screen events which are not caused by +CTSA shall be indicated by the TA to the TE.

NOTE 8: When this mode is enabled, corresponding result codes of all touch screen actions are flushed to the TA regardless of <bfr> setting.

<orientation>: integer type: Parameter to enable display orientation event reporting from the TA to the TE, using unsolicited result code +COEV: <CurrentTopSide>. The <CurrentTopSide> parameter indicates the top of the ME's screen (as specified for +CSO).

- 0 No display orientation event reporting.
- 1 Only those display orientation events, which are not caused by +CSO shall be indicated.
- 2 All display orientation events shall be indicated.

Implementation

Mandatory when any of the keypad, display, or indicator, or touch screen result codes is implemented.

8.11 Select phonebook memory storage +CPBS

Table 71: +CPBS parameter command syntax

Command	Possible response(s)
+CPBS=<storage>[,<password>]	+CME ERROR: <err>
+CPBS?	+CPBS: <storage>[,<used>,<total>] +CME ERROR: <err>
+CPBS=?	+CPBS: (list of supported <storage>s)

Description

Set command selects phonebook memory storage <storage>, which is used by other phonebook commands. If setting fails in an MT error, +CME ERROR: <err> is returned. Refer clause 9.2 for possible <err> values.

Read command returns currently selected memory, and when supported by manufacturer, number of used locations and total number of locations in the memory.

Test command returns supported storages as a compound value.

Defined values

<storage> values reserved by the present document:

- "DC" MT dialled calls list (+CPBW may not be applicable for this storage)
- "EN" SIM/USIM (or MT) emergency number (+CPBW is not be applicable for this storage)
- "FD" SIM/USIM fixdialling-phonebook. In the currently selected card slot, if a SIM card is present or if a UICC with an active GSM application is present, the information in EF_{FDN} under DF_{Telecom} is selected. If a UICC with an active USIM application is present, the information in EF_{FDN} under ADF_{USIM} is selected.
- "LD" SIM/UICC last-dialling-phonebook
- "MC" MT missed (unanswered received) calls list (+CPBW may not be applicable for this storage)
- "ME" MT phonebook
- "MT" combined MT and SIM/USIM phonebook
- "ON" SIM (or MT) own numbers (MSISDNs) list (reading of this storage may be available through +CNUM also). When storing information in the SIM/UICC, if a SIM card is present or if a UICC with an active GSM application is present, the information in EF_{MSISDN} under DF_{Telecom} is selected. If a UICC with an active USIM application is present, the information in EF_{MSISDN} under ADF_{USIM} is selected.
- "RC" MT received calls list (+CPBW may not be applicable for this storage)
- "SM" SIM/UICC phonebook. In the currently selected card slot, if a SIM card is present or if a UICC with an active GSM application is present, the EF_{ADN} under DF_{Telecom} is selected. If a UICC with an active USIM application is present, the global phonebook, DF_{PHONEBOOK} under DF_{Telecom} is selected.
- "TA" TA phonebook
- "AP" Selected application phonebook. In the currently selected card slot, if a UICC with an active USIM application is present, the application phonebook, DF_{PHONEBOOK} under ADF_{USIM} is selected.

<password>: string type value representing the PIN2-code required when selecting PIN2-code locked <storage>s above, e.g. "FD" or the hidden key to be verified in order to access to the hidden phonebook entries in the UICC/USIM or any other phonebook with hidden entries.

If the combined phonebook is selected, "MT", the <password> will correspond to the hidden key of the USIM phonebook.

<used>: integer type value indicating the number of used locations in selected memory.

<total>: integer type value indicating the total number of locations in selected memory.

Implementation

Mandatory when phonebook read, find or write command, or direct dialling (refer clause "Direct dialling from phonebooks") is implemented.

8.12 Read phonebook entries +CPBR

Table 72: +CPBR action command syntax

Command	Possible response(s)
+CPBR=<index1>[,<index2>]	<p>[+CPBR: <index1>,<number>,<type>,<text>[,<hidden>][,<group>][,<adnumber>][,<adtype>][,<secondtext>][,<email>][,<sip_uri>][,<tel_uri>]]</p> <p>[...]</p> <p>[<CR><LF>+CPBR: <index2>,<number>,<type>,<text>[,<hidden>][,<group>][,<adnumber>][,<adtype>][,<secondtext>][,<email>][,<sip_uri>][,<tel_uri>]]</p> <p>+CME ERROR: <err></p>
+CPBR=?	<p>+CPBR: (list of supported <index>s), [<nlength>], [<tlength>], [<glength>], [<slength>], [<elength>], [<siplength>], [<tellength>]</p> <p>+CME ERROR: <err></p>

Description

Execution command returns phonebook entries in location number range <index1>... <index2> from the current phonebook memory storage selected with +CPBS. If <index2> is left out, only location <index1> is returned. Entry fields returned are location number <indexn>, phone number stored there <number> (of format <type>), text <text> associated with the number, if the selected phonebook supports hidden entries, <hidden> indicating if the entry is hidden, <group> indicating a group the entry may belong to, <adnumber> an additional number (of format <adtype>), <secondtext> a second text field associated with the number, <email> an email field, <sip_uri> SIP number and <tel_uri> TEL number. If all queried locations are empty (but available), no information text lines may be returned. If listing fails in an MT error, +CME ERROR: <err> is returned. Refer clause 9.2 for possible <err> values.

Test command returns location range supported by the current storage as a compound value and the maximum lengths of <number>, <text>, <group>, <secondtext>, <email>, <sip_uri> and <tel_uri> fields. In case of (U)SIM storage, the lengths may not be available. If MT is not currently reachable, +CME ERROR: <err> is returned. Refer clause 9.2 for possible <err> values.

Defined values

<index1>, <index2>, <index>: integer type values in the range of location numbers of phonebook memory

<number>: string type phone number of format <type>

<type>: type of address octet in integer format (refer 3GPP TS 24.008 [8] clause 10.5.4.7)

<text>: string type field of maximum length <tlength>; character set as specified by command select TE character set +CSCS

<group>: string type field of maximum length <glength>; character set as specified by command select TE character set +CSCS

<adnumber>: string type phone number of format <adtype>

<adtype>: type of address octet in integer format (refer 3GPP TS 24.008 [8] clause 10.5.4.7)

<secondtext>: string type field of maximum length <slength>; character set as specified by command select TE character set +CSCS

<email>: string type field of maximum length <elength>; character set as specified by command select TE character set +CSCS

<sip_uri>: string type field of maximum length <siplength>; character set as specified by command select TE character set +CSCS

<tel_uri>: string type phone number of maximum length <tellength>; character set as specified by command select TE character set +CSCS

<nlength>: integer type value indicating the maximum length of field <number>

<tlength>: integer type value indicating the maximum length of field <text>

<glength>: integer type value indicating the maximum length of field <group>

<slength>: integer type value indicating the maximum length of field <secondtext>

<elength>: integer type value indicating the maximum length of field <email>

<siplength>: integer type value indicating the maximum length of field <sip_uri>

<tellength>: integer type value indicating the maximum length of field <tel_uri>

<hidden>: integer type value indicates if the entry is hidden or not

0: phonebook entry not hidden

1: phonebook entry hidden

Implementation

Optional.

8.13 Find phonebook entries +CPBF

Table 73: +CPBF action command syntax

Command	Possible response(s)
+CPBF=<findtext>	<p>[+CPBF: <index1>,<number>,<type>,<text>[,<hidden>][,<group>][,<adnumber>][,<adtype>][,<secondtext>][,<email>][,<sip_uri>][,<tel_uri>]]</p> <p>[<CR><LF>+CPBF: <index2>,<number>,<type>,<text>[,<hidden>][,<group>][,<adnumber>][,<adtype>][,<secondtext>][,<email>][,<sip_uri>][,<tel_uri>]]</p> <p>[...]]</p> <p>+CME ERROR: <err></p>
+CPBF=?	<p>+CPBF: [<nlength>],[<tlength>],[<glength>],[<slength>],[<elength>],[<siplength>],[<tellength>]]</p> <p>+CME ERROR: <err></p>

Description

Execution command returns phonebook entries (from the current phonebook memory storage selected with +CPBS) which alphanumeric field start with string <findtext>. Entry fields returned are location number <indexn>, phone number stored there <number> (of format <type>), text <text> associated with the number, if the selected phonebook supports hidden entries, <hidden> indicating if the entry is hidden, <group> indicating a group the entry may belong to, <adnumber> an additional number (of format <adtype>), <secondtext> a second text field associated with the number, <email> an email field, <sip_uri> SIP number and <tel_uri> TEL number. If listing fails in an MT error, +CME ERROR: <err> is returned. Refer clause 9.2 for possible <err> values.

Test command returns the maximum lengths of <number>, <text>, <group>, <secondtext>, <email>, <sip_uri> and <tel_uri> fields. In case of (U)SIM storage, the lengths may not be available. If MT is not currently reachable, +CME ERROR: <err> is returned. Refer clause 9.2 for possible <err> values.

Defined values

- <index1>, <index2>: integer type values in the range of location numbers of phonebook memory
- <number>: string type phone number of format <type>
- <type>: type of address octet in integer format (refer 3GPP TS 24.008 [8] clause 10.5.4.7)
- <group>: string type field of maximum length <glength>; character set as specified by command select TE character set +CSCS
- <adnumber>: string type phone number of format <adtype>
- <adtype>: type of address octet in integer format (refer 3GPP TS 24.008 [8] clause 10.5.4.7)
- <secondtext>: string type field of maximum length <slength>; character set as specified by command select TE character set +CSCS
- <email>: string type field of maximum length <elength>; character set as specified by command select TE character set +CSCS
- <findtext>, <text>: string type field of maximum length <tlength>; character set as specified by command select TE character set +CSCS
- <sip_uri>: string type field of maximum length <siplength>; character set as specified by command select TE character set +CSCS
- <tel_uri>: string type phone number of maximum length <tellength>; character set as specified by command select TE character set +CSCS
- <nlength>: integer type value indicating the maximum length of field <number>
- <tlength>: integer type value indicating the maximum length of field <text>
- <glength>: integer type value indicating the maximum length of field <group>
- <slength>: integer type value indicating the maximum length of field <secondtext>
- <elength>: integer type value indicating the maximum length of field <email>
- <siplength>: integer type value indicating the maximum length of field <sip_uri>
- <tellength>: integer type value indicating the maximum length of field <tel_uri>
- <hidden>: integer type value indicates if the entry is hidden or not
 - 0: phonebook entry not hidden
 - 1: phonebook entry hidden

Implementation

Optional.

8.14 Write phonebook entry +CPBW

Table 74: +CPBW parameter command syntax

Command	Possible response(s)
+CPBW=[<index>][,<number>[,<type>[,<text>[,<group>[,<adnumber>[,<adtype>[,<secondtext>[,<email>[,<sip_uri>[,<tel_uri>[,<hidden>]]]]]]]]]]]	+CPBW: <written_index> +CME ERROR: <err>
+CPBW?	+CPBW: <written_index>
+CPBW=?	+CPBW: (list of supported <index>s), [<nlength>], (list of supported <type>s), [<tlength>], [<glength>], [<slength>], [<elength>], [<siplength>], [<tellength>] +CME ERROR: <err>

Description

Execution command writes phonebook entry in location number <index> in the current phonebook memory storage selected with +CPBS. Entry fields written are phone number <number> (in the format <type>), text <text> associated with the number, if the selected phonebook supports hidden entries, <hidden> parameter, which indicates if the entry is hidden or not, <group> indicating a group the entry may belong to, <adnumber> an additional number (of format <adtype>), <secondtext> a second text field associated with the number, <email> an email field, <sip_uri> SIP number and <tel_uri> TEL number. If all those fields are omitted, the phonebook entry is deleted. If <index> is left out, but <number> is given, the entry is written to the first free location in the phonebook (the implementation of this feature is manufacturer specific). For successful writes where <index> is not given, the intermediate result code +CPBW: <written_index> may be provided to indicate the location the entry was written to. If writing fails in an MT error, +CME ERROR: <err> is returned. Refer clause 9.2 for possible <err> values.

Read command returns the last <written_index> value, or -1 if information about previous value is not available.

NOTE: Changing the current phonebook memory storage with +CPBS to another storage invalidates the last <written_index> value.

Test command returns location range supported by the current storage and types of address as compound values, the maximum length of <number> field, supported number formats of the storage, the maximum length of <text> field, the maximum length of <group>, the maximum length of <secondtext>, the maximum length of <email>, the maximum length of <sip_uri> and the maximum length of <tel_uri>. In case of SIM storage, the lengths may not be available. If MT is not currently reachable, +CME ERROR: <err> is returned. Refer clause 9.2 for possible <err> values. If storage does not offer format information, the format list should be empty parenthesis.

Defined values

<index>: integer type values in the range of location numbers of phonebook memory

<number>: string type phone number of format <type>

<type>: type of address octet in integer format (refer 3GPP TS 24.008 [8] clause 10.5.4.7) ; default 145 when dialling string includes international access code character "+", otherwise 129

<text>: string type field of maximum length <tlength>; character set as specified by command select TE character set +CSCS

<group>: string type field of maximum length <glength>; character set as specified by command select TE character set +CSCS

<adnumber>: string type phone number of format <adtype>

<adtype>: type of address octet in integer format (refer 3GPP TS 24.008 [8] clause 10.5.4.7)

<secondtext>: string type field of maximum length <slength>; character set as specified by command select TE character set +CSCS

<email>: string type field of maximum length <elength>; character set as specified by command select TE character set +CSCS

<sip_uri>: string type field of maximum length <siplength>; character set as specified by command select TE character set +CSCS

<tel_uri>: string type phone number of maximum length <tellength>; character set as specified by command select TE character set +CSCS

<nlength>: integer type value indicating the maximum length of field <number>

<tlength>: integer type value indicating the maximum length of field <text>

<glength>: integer type value indicating the maximum length of field <group>

<slength>: integer type value indicating the maximum length of field <secondtext>

<elength>: integer type value indicating the maximum length of field <email>

<siplength>: integer type value indicating the maximum length of field <sip_uri>

<tellength>: integer type value indicating the maximum length of field <tel_uri>

<hidden>: integer type value indicates if the entry is hidden or not

0: phonebook entry not hidden

1: phonebook entry hidden

<written_index>: integer type value indicating the last location number <index> of the written phonebook entry

Implementation

Optional.

8.15 Clock +CCLK

Table 75: +CCLK parameter command syntax

Command	Possible response(s)
+CCLK=<time>	+CME ERROR: <err>
+CCLK?	+CCLK: <time> +CME ERROR: <err>
+CCLK=?	

Description

Set command sets the real-time clock of the MT. If setting fails in an MT error, +CME ERROR: <err> is returned. Refer clause 9.2 for possible <err> values.

Read command returns the current setting of the clock.

Defined values

<time>: string type value; format is "yy/MM/dd,hh:mm:ss±zz", where characters indicate year (two last digits), month, day, hour, minutes, seconds and time zone (indicates the difference, expressed in quarters of an hour, between the local time and GMT; range -96...+96). E.g. 6th of May 1994, 22:10:00 GMT+2 hours equals to "94/05/06,22:10:00+08"

NOTE: If MT does not support time zone information then the three last characters of <time> are not returned by +CCLK?. The format of <time> is specified by use of the +CSDF command.

Implementation

Optional.

8.16 Alarm +CALA

Table 76: +CALA parameter command syntax

Command	Possible response(s)
+CALA=<time>[,<n>[,<type>[,<text>[,<recurr>[,<silent>]]]]]	+CME ERROR: <err>
+CALA?	[+CALA: <time>,<n1>,<type>,[<text>],[<recurr>],<silent>] [<CR><LF>+CALA: <time>,<n2>,<type>,[<text>],[<recurr>],<silent>] [...]] +CME ERROR: <err>
+CALA=?	+CALA: (list of supported <n>s) , (list of supported <type>s) , <tlength> , <rlength> , (list of supported <silent>s) +CME ERROR: <err>

Description

Set command sets an alarm time in the MT. There can be an array of different types of alarms, and each alarm may cause different text to be displayed in the MT display. If setting fails in an MT error, +CME ERROR: <err> is returned. Refer clause 9.2 for possible <err> values.

To set up a recurrent alarm for one or more days in the week, the <recurr>-parameter may be used.

When an alarm is timed out and executed, the unsolicited result code +CALV: <n> is always returned, even if the alarm is set up to be silent.

Read command returns the list of current active alarm settings in the MT.

Test command returns supported array index values, alarm types, and maximum length of the text to be displayed as compound values.

Defined values

<time>: refer +CCLK, +CSDF

NOTE: If the <recurr>-parameter is used, the <time>-parameter must not contain a date.

<n>, <n1>, <n2>: integer type value indicating the index of the alarm; default is manufacturer specific.

<type>: integer type value indicating the type of the alarm (e.g. sound, volume, LED); values and default are manufacturer specific.

<text>: string type value indicating the text to be displayed when alarm time is reached; maximum length <length>; values and default are manufacturer specific.

<length>: integer type value indicating the maximum length of <text>.

<recurr>: string type value indicating day of week for the alarm in one of the following formats (values and default are manufacturer specific):

"<1..7>[, <1..7>[...]]" Sets a recurrent alarm for one or more days in the week. The digits 1 to 7 corresponds to the days in the week, Monday (1), ..., Sunday (7).

Example: The string "1, 2, 3, 4, 5" is used to set an alarm for all weekdays.

"0" Sets a recurrent alarm for all days in the week.

<rlength>: integer type value indicating the maximum length of <recurr>.

<silent>: Integer type value indicating if the alarm is silent or not. The default value is manufacturer specific.

0 the alarm will not be silent

1 the alarm will be silent and the only result from the alarm is the unsolicited result code +CALV

Implementation

Optional.

8.17 Generic SIM access +CSIM

Table 77: +CSIM action command syntax

Command	Possible response(s)
+CSIM=<length>,<command>	+CSIM: <length>,<response> +CME ERROR: <err>
+CSIM=?	

Description

Set command transmits to the MT the <command> it then shall send as it is to the SIM. In the same manner, the SIM <response> shall be sent back by the MT to the TA as it is. Refer clause 9.2 for possible <err> values.

This command allows a direct control of the SIM that is installed in the currently selected card slot, by a distant application on the TE. The TE shall then take care of processing SIM information within the frame specified by GSM/UMTS.

NOTE: Compared to Restricted SIM Access command +CRSM, the definition of +CSIM allows TE to take more control over the SIM-MT interface. The locking and unlocking of the interface may be done by a special <command> value or automatically by TA/MT (by interpreting <command> parameter). In case that TE application does not use the unlock command (or does not send a <command> causing automatic unlock) in a certain timeout value, MT may release the locking.

Defined values

<length>: integer type; length of the characters that are sent to TE in <command> or <response> (two times the actual length of the command or response)

<command>: command passed on by the MT to the SIM in the format as described in 3GPP TS 51.011 [28] (hexadecimal character format; refer +CSCS)

<response>: response to the command passed on by the SIM to the MT in the format as described in 3GPP TS 51.011 [28] (hexadecimal character format; refer +CSCS)

Implementation

Optional.

8.18 Restricted SIM access +CRSM**Table 78: +CRSM action command syntax**

Command	Possible response(s)
+CRSM=<command>[,<fileid>[,<P1> ,<P2> ,<P3>[,<data>[,<pathid>]]]]	+CRSM: <sw1> ,<sw2>[,<response>] +CME ERROR: <err>
+CRSM=?	

Description

By using this command instead of Generic SIM Access +CSIM TE application has easier but more limited access to the SIM database. Set command transmits to the MT the SIM <command> and its required parameters. If a SIM installed in the currently selected card slot, the MT handles internally all SIM-MT interface locking and file selection routines. As response to the command, MT sends the actual SIM information parameters and response data. MT error result code +CME ERROR may be returned when the command cannot be passed to the SIM, but failure in the execution of the command in the SIM is reported in <sw1> and <sw2> parameters. Refer clause 9.2 for possible <err> values.

Coordination of command requests to SIM and the ones issued by GSM/UMTS application inside the MT is implementation dependent. However the TE should be aware of the precedence of the GSM/UMTS application commands to the TE commands.

Defined values

<command>: (command passed on by the MT to the SIM; refer 3GPP TS 51.011 [28]):

- 176 READ BINARY
- 178 READ RECORD
- 192 GET RESPONSE
- 214 UPDATE BINARY
- 220 UPDATE RECORD
- 242 STATUS
- 203 RETRIEVE DATA
- 219 SET DATA

all other values are reserved

NOTE 1: The MT internally executes all commands necessary for selecting the desired file, before performing the actual command.

<fileid>: integer type; this is the identifier of a elementary datafile on SIM. Mandatory for every command except STATUS.

NOTE 2: The range of valid file identifiers depends on the actual SIM and is defined in 3GPP TS 51.011 [28]. Optional files may not be present at all.

<P1>, <P2>, <P3>: integer type; parameters passed on by the MT to the SIM. These parameters are mandatory for every command, except GET RESPONSE and STATUS. The values are described in 3GPP TS 51.011 [28].

<data>: information which shall be written to the SIM (hexadecimal character format; refer +CSCS).

<pathid>: string type; contains the path of an elementary file on the SIM/UICC in hexadecimal format as defined in ETSI TS 102 221 [60] (e.g. "7F205F70" in SIM and UICC case). The <pathid> shall only be used in the mode "select by path from MF" as defined in ETSI TS 102 221 [60].

NOTE 3: Since valid elementary file identifiers may not be unique over all valid dedicated file identifiers the <pathid> indicates the targeted UICC/SIM directory path in case of ambiguous file identifiers. For earlier versions of this specification or if <pathid> is omitted, it could be implementation specific which one will be selected.

<sw1>, <sw2>: integer type; information from the SIM about the execution of the actual command. These parameters are delivered to the TE in both cases, on successful or failed execution of the command.

<response>: response of a successful completion of the command previously issued (hexadecimal character format; refer +CSCS). STATUS and GET RESPONSE return data, which gives information about the current elementary datafield. This information includes the type of file and its size (refer 3GPP TS 51.011 [28]). After READ BINARY, READ RECORD or RETRIEVE DATA command the requested data will be returned. <response> is not returned after a successful UPDATE BINARY, UPDATE RECORD or SET DATA command.

Implementation

Optional.

8.19 Secure control command +CSCC

Table 79: +CSCC parameter command syntax

Command	Possible response(s)
+CSCC=<mode>[, <cmd_set>[, <token>]]	+CSCC: <challenge> +CME ERROR: <err>
+CSCC?	+CSCC: <mode> , <cmd_set1> [<CR><LF>+CSCC: <mode> , <cmd_set2> [...]] +CME ERROR: <err>
+CSCC=?	+CSCC: (list of supported <mode>s) , (list of supported <cmd_set>s)

Description

This command is used to enable/disable access to commands protected by security mechanism. This enables/disables access to command sets designated as "secure" such as programming of MT. Refer clause 9.2 for possible <err> values.

The TE asks for a <challenge> with <mode>=1 and one specific command set (<cmd_set>), the MT replies with the <challenge>, which should be inserted into the identification algorithm in both entities (TE and MT). The algorithm output <token> is sent to the MT with <mode>=2 to enable the specified command set. <mode>=3 is used to disable the command set.

The read command returns the status (<mode> 2 or 3) of each supported command set.

Test command returns the values supported as compound values.

Defined values

<mode>: integer type

- 1 request challenge token to enable access to specified command set
- 2 enable access to specified command set (<token> required)

3 disable access to specified command set

<cmd_set>, <cmd_set1>, <cmd_set2>:

0 MT/TA code re-programming command set.

other values below 128 are reserved by the present document.

<token>: string type; a variable length bit string represented with IRA characters 0 - 9 and A - F, each character representing a nibble; e.g. bit string "0110 1100 1001 1010" is represented by the IRA string "6C9A". The length of the required bit string varies depending on the value of <cmd_set>.

<challenge>: same format as token

Implementation

Optional.

8.20 Alert sound mode +CALM

Table 80: +CALM parameter command syntax

Command	Possible response(s)
+CALM=[<mode>]	+CME ERROR: <err>
+CALM?	+CALM: <mode> +CME ERROR: <err>
+CALM=?	+CALM: (list of supported <mode>s) +CME ERROR: <err>

Description

This command is used to select the general alert sound mode of the MT. Refer clause 9.2 for possible <err> values.

Read command returns the current value of <mode>.

Test command returns supported values as a compound value.

Defined values

<mode>: integer type

- 0 normal mode
- 1 silent mode (all sounds from MT are prevented)
- 2... manufacturer specific

Implementation

Optional.

8.21 Ringer sound level +CRSL

Table 81: +CRSL parameter command syntax

Command	Possible response(s)
+CRSL=<level>	+CME ERROR: <err>

+CRSL?	+CRSL: <level> +CME ERROR: <err>
+CRSL=?	+CRSL: (list of supported <level>s) +CME ERROR: <err>

Description

This command is used to select the incoming call ringer sound level of the MT. Refer clause 9.2 for possible <err> values.

Read command returns the current value of <level>.

Test command returns supported values as a compound value.

Defined values

<level>: integer type value with manufacturer specific range (smallest value represents the lowest sound level)

Implementation

Optional.

8.22 Vibrator mode +CVIB

Table 82: +CVIB parameter command syntax

Command	Possible response(s)
+CVIB=[<mode>]	+CME ERROR: <err>
+CVIB?	+CVIB: <mode> +CME ERROR: <err>
+CVIB=?	+CVIB: (list of supported <mode>s) +CME ERROR: <err>

Description

This command is used to enable and disable the vibrator alert feature of the MT. It is manufacturer specific how this interacts with +CALM command. Refer clause 9.2 for possible <err> values.

Read command returns the current value of <mode>.

Test command returns supported values as a compound value.

Defined values

<mode>: integer type

0 disable

1 enable

...15 reserved by the present document

16... manufacturer specific

Implementation

Optional.

8.23 Loudspeaker volume level +CLVL

Table 83: +CLVL parameter command syntax

Command	Possible response(s)
+CLVL=<level>	+CME ERROR: <err>
+CLVL?	+CLVL: <level> +CME ERROR: <err>
+CLVL=?	+CLVL: (list of supported <level>s) +CME ERROR: <err>

Description

This command is used to select the volume of the internal loudspeaker of the MT. Refer clause 9.2 for possible <err> values.

Read command returns the current value of <level>.

Test command returns supported values as a compound value.

Defined values

<level>: integer type value with manufacturer specific range (smallest value represents the lowest sound level)

Implementation

Optional.

8.24 Mute control +CMUT

Table 84: +CMUT parameter command syntax

Command	Possible response(s)
+CMUT=[<n>]	+CME ERROR: <err>
+CMUT?	+CMUT: <n> +CME ERROR: <err>
+CMUT=?	+CMUT: (list of supported <n>s)

Description

This command is used to enable and disable the uplink voice muting during a voice call. Refer clause 9.2 for possible <err> values.

Read command returns the current value of <n>.

Test command returns supported values as a compound value.

Defined values

<n>: integer type

0 mute off

1 mute on

Implementation

Optional.

8.25 Accumulated call meter +CACM

Table 85: +CACM parameter command syntax

Command	Possible response(s)
+CACM=[<passwd>]	+CME ERROR: <err>
+CACM?	+CACM: <acm> +CME ERROR: <err>
+CACM=?	

Description

Set command resets the Advice of Charge related accumulated call meter value in SIM card or in the active application in the UICC (GSM or USIM) file EF_{ACM}. ACM contains the total number of home units for both the current and preceding calls. SIM PIN2 is usually required to reset the value. If setting fails in an MT error, +CME ERROR: <err> is returned. Refer clause 9.2 for possible <err> values.

Read command returns the current value of ACM.

Defined values

<passwd>: string type; SIM PIN2

<acm>: string type; accumulated call meter value similarly coded as <ccm> under +CAOC

Implementation

Optional.

8.26 Accumulated call meter maximum +CAMM

Table 86: +CAMM parameter command syntax

Command	Possible response(s)
+CAMM=[<acmmax> [, <passwd>]]	+CME ERROR: <err>
+CAMM?	+CAMM: <acmmax> +CME ERROR: <err>
+CAMM=?	

Description

Set command sets the Advice of Charge related accumulated call meter maximum value in SIM card or in the active application in the UICC (GSM or USIM) file EF_{ACMmax}. ACMmax contains the maximum number of home units allowed to be consumed by the subscriber. When ACM (refer +CACM) reaches ACMmax calls are prohibited (see also 3GPP TS 22.024 [26]). SIM PIN2 is usually required to set the value. If setting fails in an MT error, +CME ERROR: <err> is returned. Refer clause 9.2 for possible <err> values.

Read command returns the current value of ACMmax.

Defined values

<acmmax>: string type; accumulated call meter maximum value similarly coded as <ccm> under +CAOC; value zero disables ACMmax feature

<passwd>: string type; SIM PIN2

Implementation

Optional.

8.27 Price per unit and currency table +CPUC**Table 87: +CPUC parameter command syntax**

Command	Possible response(s)
+CPUC=<currency>,<ppu>[,<passwd>]	+CME ERROR: <err>
+CPUC?	+CPUC: <currency>,<ppu> +CME ERROR: <err>
+CPUC=?	

Description

Set command sets the parameters of Advice of Charge related price per unit and currency table in SIM card or in the active application in the UICC (GSM or USIM) file EF_{PUCT}. PUCT information can be used to convert the home units (as used in +CAOC, +CACM and +CAMP) into currency units. SIM PIN2 is usually required to set the parameters. If setting fails in an MT error, +CME ERROR: <err> is returned. Refer clause 9.2 for possible <err> values.

Read command returns the current parameters of PUCT.

Defined values

<currency>: string type; three-character currency code (e.g. "GBP", "DEM"); character set as specified by command select TE character set +CSCS

<ppu>: string type; price per unit; dot is used as a decimal separator (e.g. "2.66")

<passwd>: string type; SIM PIN2

Implementation

Optional.

8.28 Call meter maximum event +CCWE**Table 88: +CCWE parameter command syntax**

Command	Possible response(s)
+CCWE=[<mode>]	+CME ERROR: <err>
+CCWE?	+CCWE: <mode> +CME ERROR: <err>
+CCWE=?	+CCWE: (list of supported <mode>s) +CME ERROR: <err>

Description

Shortly before the ACM (Accumulated Call Meter) maximum value is reached, an unsolicited result code +CCWV will be sent, if enabled by this command. The warning is issued approximately when 30 seconds call time remains. It is also issued when starting a call if less than 30 s call time remains. If setting fails in an MT error, +CME ERROR: <err> is returned. Refer clause 9.2 for possible <err> values.

Read command returns the current setting.

Test command returns supported settings as a compound value.

Defined values

<mode>: integer type

- 0 Disable the call meter warning event
- 1 Enable the call meter warning event

Implementation

Optional.

8.29 Power class +CPWC

Table 89: +CPWC parameter command syntax

Command	Possible response(s)
+CPWC=[<class>[,<band>]]	+CME ERROR: <err>
+CPWC?	+CPWC: <curr_class1>,<def_class1>, <band1>[,<curr_class2>,<def_class2>, <band2>[...]] +CME ERROR: <err>
+CPWC=?	+CPWC: list of supported (<band> , (list of <class>s)) pairs +CME ERROR: <err>

Description

This command is used to set the preferred MT power class for each GSM frequency band supported. The interaction of this setting with the selected bearer service (+CBST and HSCSD commands) is manufacturer specific (for example, selecting a multislot operation might reduce the power class automatically). If setting fails in an MT error, +CME ERROR: <err> is returned. Refer clause 9.2 for possible <err> values.

Read command returns the currently selected output power class and default output power class for each supported frequency band (as defined by MT manufacturer). Parameter <band1> and its associated power class parameters refer to the currently used frequency band.

Example: +CPWC: 2,1,1,5,4,0 indicates a dual-band MT currently using band GSM1800, for which the power class is currently set to 2, the default being class 1, and for which the currently set power class value for GSM900 is class 5 the default being class 4.

Test command returns supported bands and their power classes as compound values.

Example: +CPWC: (0,(0,4,5)),(1,(0-2)) indicates a dual-band handheld MT.

Defined values

<class>,<curr_classn>s,<def_classn>s: integer type

- 0 default (not applicable to <curr_class>s or <def_classn>s)
- 1... MT output power class as in 3GPP TS 45.005 [38]

<band>,<bandn>s:

- 0 GSM900
- 1 GSM1800

- 2 reserved for GSM1900
- 3 GSM 400

Implementation

Optional.

8.30 Set language +CLAN

Table 90: +CLAN parameter command syntax

Command	Possible response(s)
+CLAN=<code>	+CME ERROR: <err>
+CLAN?	+CLAN: <code> +CME ERROR: <err>
+CLAN=?	+CLAN: (list of supported <code>s) +CME ERROR: <err>

Description

This command sets the language in the MT. The set-command must confirm the selected language with the MMI-module in the MT. If setting fails, a MT error, +CME ERROR: <err> is returned. Refer clause 9.2 for possible <err> values.

The <code>-parameter is a two-letter abbreviation of the language. The language codes, as defined in ISO 639, consists of two characters, e.g. "sv", "en" etc.

The complete set of language codes to be used are manufacturer specific and should all be possible to use with the command. Some examples are described under <code>. For a complete list see ISO 639.

The read command gives the current language as output. If the language has been set to "AUTO", the read command returns the current language set from the currently selected SIM-card /UICC. Hence, the "AUTO"-code is never returned by the read-command.

Test command returns supported <code>s as a compound value.

Defined values

<code>: (not all language codes are present in this list)

"AUTO"	Read language from SIM-card /UICC. "Auto" is not returned by the read-command.
"sw"	Swedish
"fi"	Finnish
"da"	Danish
"no"	Norwegian
"de"	German
"fr"	French
"es"	Spanish
"it"	Italian
"en"	English

Implementation

Optional.

8.31 Language event +CLAE

Table 91: +CLAE parameter command syntax

Command	Possible response(s)
+CLAE=[<mode>]	+CME ERROR: <err>
+CLAE?	+CLAE: <mode> +CME ERROR: <err>
+CLAE=?	+CLAE: (list of supported <mode>s) +CME ERROR: <err>

Description

This command is used to enable/disable unsolicited result code +CLAV: <code>. If <mode>=1, +CLAV: <code> is sent from the MT when the language in the MT is changed. If setting fails, a MT error, +CME ERROR: <err> is returned. Refer clause 9.2 for possible <err> values.

Read command returns the current status for <mode>.

Test command returns supported <mode>s as a compound value.

Defined values

<mode>: integer type

0 Disable unsolicited result code +CLAV

1 Enable unsolicited result code +CLAV

<code>: For description see +CLAN.

Implementation

Optional.

8.32 Set greeting text +CSGT

Table 92: +CSGT parameter command syntax

Command	Possible response(s)
+CSGT=<mode>[,<text>]	+CME ERROR: <err>
+CSGT?	+CSGT: <text> ,<mode> +CME ERROR: <err>
+CSGT=?	+CSGT: (list of supported <mode>s) ,<text> +CME ERROR: <err>

Description

This command sets and activates the greeting text in the MT. The greeting text is shown in the MT display when the MT is turned on. The command can also be used to deactivate a text. If setting fails in an MT error, +CME ERROR: <err> is returned. Refer clause 9.2 for possible <err> values.

The read command queries the current <text> and the status of the <mode> parameter

Test command returns supported <mode>s as a compound value and the maximum number of characters in <text>.

Example: +CSGT: (0-1),20

Defined values

<mode>: integer type

0 Turn off greeting text

1 Turn on greeting text

<text>: string type. A manufacturer specific free text that can be displayed. The text can not include <CR>.

<mode>: integer type. Maximum number of characters in <text>.

Implementation

Optional.

8.33 Set voice mail number +CSVM

Table 93: +CSVM parameter command syntax

Command	Possible response(s)
+CSVM=<mode> [, <number> [, <type>]]	+CME ERROR: <err>
+CSVM?	+CSVM: <mode> , <number> , <type> +CME ERROR: <err>
+CSVM=?	+CSVM: (list of supported <mode>s) , (list of supported <type>s) +CME ERROR: <err>

Description

The number to the voice mail server is set with this command. The parameters <number> and <type> can be left out if the parameter <mode> is set to 0. If setting fails, an MT error, +CME ERROR: <err> is returned. Refer clause 9.2 for possible <err> values.

Read command returns the currently selected voice mail number and the status (i.e. enabled/disabled).

Test command returns supported <mode>s and <type>s as compound values.

Defined values

<mode>: integer type

0 Disable the voice mail number.

1 Enable the voice mail number.

<number>: string type; Character string <0..9,+>

<type>: integer type; Type of address octet in integer format (refer 3GPP TS 24.008 [8] clause 10.5.4.7); default 145 when dialling string includes international access code character "+", otherwise 129.

129	ISDN / telephony numbering plan, national / international unknown
145	ISDN / telephony numbering plan, international number
161	ISDN / telephony numbering plan, national number
128 - 255	Other values refer 3GPP TS 24.008 [8] clause 10.5.4.7

Implementation

Optional.

8.34 Ring melody control +CRMC

Table 94: +CRMC parameter command syntax

Command	Possible response(s)
+CRMC=<index>,<volume>[, [<call type>][,<profile>]]	+CME ERROR: <err>
+CRMC?	+CRMC: <index>,<volume>[, [<call type1>][,<profile1>]] [<CR><LF>+CRMC: <index>,<volume>[, [all type2>][,<profile1>]][...]] [<CR><LF>+CRMC: <index>,<volume>[, [all type1>][,<profile2>]]] [<CR><LF>+CRMC: <index>,<volume>[, [all type2>][,<profile2>]][...]] +CME ERROR: <err>
+CRMC=?	+CRMC: (list of supported <index>s) , (list of supported <volume>s) [, [(list of supported <call type>s)] [, (list of supported <profile>s)]] +CME ERROR: <err>

Description

Write command causes the MT to set a specific ring melody and volume for the selected call type and profile. The default values for the optional parameters are defined by the manufacturer.

Read command queries the settings for the ring melody. If call types and profiles are available, the corresponding ring melodies are listed. Starting with call type1 and profile1 the ring melody settings for each available profile and call type is issued.

Test command returns the list of supported indexes, volumes, call types and profiles as compound values.

Refer clause 9.2 for possible <err> values.

Defined values

<index>: integer type; manufacturer specific number to identify a certain ring melody

<volume>: integer type value with manufacturer specific range (smallest value represents the lowest sound level)

<call type>x>: integer type; manufacturer specific number for a call type

<profile>x>: integer type; manufacturer specific number for a profile

Implementation

Optional.

8.35 Ring melody playback +CRMP

Table 95: +CRMP action command syntax

Command	Possible response(s)
+CRMP=<call type>[,<volume>[,<type>,<index>]]	+CME ERROR: <err>
+CRMP=?	+CRMP: (list of supported <call type>s) , (list of supported <volume>s) , (<type0>) , (list of supported <index>s) [<CR><LF>+CRMP: (list of supported <call type>s) , (list of supported <volume>s) , (<type1>) , (list of supported <index>s)] +CME ERROR: <err>

Description

Execution command causes the MT to playback a specific ring type. The default values for the optional parameters are the current selected in the MT.

Test command returns the supported call types, volumes, types and indexes as compound values. The manufacturer defined and the user defined values are returned on separate lines.

Refer clause 9.2 for possible <err> values.

Defined values

<call type>: integer type; manufacturer specific

<volume>: integer type value with manufacturer specific range (smallest value represents the lowest sound level)

<type>: integer type

0 Manufacturer defined

1 User defined

<index>: integer type

Implementation

Optional.

8.36 Master reset +CMAR

Table 96: +CMAR action command syntax

Command	Possible response(s)
+CMAR=<phone lock code>	+CME ERROR: <err>
+CMAR=?	+CME ERROR: <err>

Description

This command requests the MT to reset user data. The user data in the phone will be reset to default values. If setting fails, a MT error, `+CME ERROR: <err>`, is returned. Refer clause 9.2 for possible `<err>` values.

If the MT is locked and this command is used, then the MT will be unlocked after the master reset.

Test command returns OK.

Defined values

`<phone lock code>` string type; Security code (Phone Lock code) must be verified before performing the master reset.

Implementation

Optional.

8.37 List all available AT commands +CLAC

Table 97: +CLAC action command syntax

Command	Possible response(s)
+CLAC	<AT Command1> [<CR><LF><AT Command2> [...]] <code>+CME ERROR: <err></code>
+CLAC=?	<code>+CME ERROR: <err></code>

Description

Execution command causes the MT to return one or more lines of AT Commands. Refer clause 9.2 for possible `<err>` values.

NOTE: This command only returns the AT commands that are available for the user.

Defined values

`<AT Command>`: Defines the AT command including the prefix AT. Text shall not contain the sequence `0<CR>` or `OK<CR>`

Implementation

Optional.

8.38 Delete alarm +CALD

Table 98: +CALD action command syntax

Command	Possible response(s)
+CALD=<n>	<code>+CME ERROR: <err></code>
+CALD=?	<code>+CALD: (list of supported <n>s)</code> <code>+CME ERROR: <err></code>

Description

Action command deletes an alarm in the MT. If the command fails in an MT error, `+CME ERROR: <err>` is returned. Refer clause 9.2 for possible `<err>` values.

Test command returns supported array index values as a compound value.

Defined values

<n>: integer type value indicating the index of the alarm; default is manufacturer specific

Implementation

Optional.

8.39 Postpone or dismiss an alarm +CAPD

Table 99: +CAPD action command syntax

Command	Possible response(s)
+CAPD[=<sec>]	+CME ERROR: <err>
+CAPD=?	+CAPD: (list of supported <sec>s) +CME ERROR: <err>
NOTE: The syntax of the AT Set Command is corrected to be according to ITU-T Recommendation V.250 [14]. Older versions of the specification specify incorrect syntax +CAPD=[<sec>].	

Description

Set command postpones or dismisses a currently active alarm. If the command fails in an MT error, +CME ERROR: <err> is returned. Refer clause 9.2 for possible <err> values.

Test command returns supported <sec>-parameter values as a compound value.

Defined values

<sec>: integer type value indicating the number of seconds to postpone the alarm. If <sec> is set to 0 (default), the alarm is dismissed.

Implementation

Optional.

8.40 Automatic time zone update +CTZU

Table 100: +CTZU parameter command syntax

Command	Possible response(s)
+CTZU=[<onoff>]	+CME ERROR: <err>
+CTZU?	+CTZU: <onoff> +CME ERROR: <err>
+CTZU=?	+CTZU: (list of supported <onoff>s) +CME ERROR: <err>

Description

Set command enables and disables automatic time zone update via NITZ. If setting fails in an MT error, +CME ERROR: <err> is returned. Refer clause 9.2 for possible <err> values.

Read command returns the current settings in the MT.

Test command returns supported on- and off-values as a compound value.

Defined values

<onoff>: integer type value indicating

- 0 Disable automatic time zone update via NITZ.
- 1 Enable automatic time zone update via NITZ.

Implementation

Optional.

8.41 Time zone reporting +CTZR

Table 101: +CTZR parameter command syntax

Command	Possible response(s)
+CTZR=[<reporting>]	+CME ERROR: <err>
+CTZR?	+CTZR:<reporting> +CME ERROR: <err>
+CTZR=?	+CTZR: (list of supported <reporting>s) +CME ERROR: <err>

Description

This set command controls the time zone change event reporting. If reporting is enabled the MT returns the unsolicited result code +CTZV: <tz>, +CTZE: <tz>, <dst>, [<time>], or +CTZEU: <tz>, <dst>, [<utime>] whenever the time zone is changed. The MT also provides the time zone upon network registration if provided by the network. If setting fails in an MT error, +CME ERROR: <err> is returned. Refer clause 9.2 for possible <err> values.

Read command returns the current reporting settings in the MT.

Test command returns supported <reporting>-values as a compound value.

NOTE: The Time Zone reporting is not affected by the Automatic Time Zone setting command, +CTZU.

Defined values

<reporting>: integer type value indicating:

- 0 disable time zone change event reporting.
- 1 Enable time zone change event reporting by unsolicited result code +CTZV: <tz>.
- 2 Enable extended time zone and local time reporting by unsolicited result code +CTZE: <tz>, <dst>, [<time>].
- 3 Enable extended time zone and universal time reporting by unsolicited result code +CTZEU: <tz>, <dst>, [<utime>].

<tz>: string type value representing the sum of the local time zone (difference between the local time and GMT expressed in quarters of an hour) plus daylight saving time. The format is "+zz", expressed as a fixed width, two digit integer with the range -48 ... +56. To maintain a fixed width, numbers in the range -9 ... +9 are expressed with a leading zero, e.g. "-09", "+00" and "+09".

<dst>: integer type value indicating whether <tz> includes daylight savings adjustment;

0 <tz> includes no adjustment for Daylight Saving Time

1 <tz> includes +1 hour (equals 4 quarters in <tz>) adjustment for daylight saving time

2 <tz> includes +2 hours (equals 8 quarters in <tz>) adjustment for daylight saving time

<time>: string type value representing the local time. The format is "YYYY/MM/DD, hh:mm:ss", expressed as integers representing year (YYYY), month (MM), date (DD), hour (hh), minute (mm) and second (ss). The local time can be derived by the MT from information provided by the network at the time of delivering time zone information and will be present in the unsolicited result code for extended time zone and local time reporting if the universal time is provided by the network.

<utime>: string type value representing the universal time. The format is "YYYY/MM/DD, hh:mm:ss", expressed as integers representing year (YYYY), month (MM), date (DD), hour (hh), minute (mm) and second (ss). The universal time can be provided by the network at the time of delivering time zone information and will be present in the unsolicited result code for extended time zone and universal time reporting if provided by the network.

Implementation

Optional.

8.42 Enter protocol mode+CPROT

Table 102: +CPROT action command syntax

Command	Possible response(s)
+CPROT=<proto>[,<version>[,<lsap1>[,...[<lsapN>]]]]	CONNECT NO CARRIER OK ERROR +CME ERROR: <err>
+CPROT=?	+CPROT: <proto1>[,(list of supported <version>s)[,(list of supported <lsap1>s)[,...[,(list of supported <lsapN>s)]]] [<CR><LF>+CPROT: <proto2>[,(list of supported <version>s)[,(list of supported <lsap1>s)[,...[,(list of supported <lsapN>s)]]] [...]]

Description

Set command informs TA that TE wants to establish a peer-to-peer protocol <proto> or upper layer connection (indicating by the <lsap>s setting) with the MT on the link from which the command was received. This command can be used in case the link between TE and MT does not provide itself such a mechanism.

If MT has succeeded in establishing a logical link between application protocols and external interface, it will send CONNECT message to the TE. Otherwise, the NO CARRIER response will be returned.

If the CONNECT response is received, TE can start sending <proto> or upper layer frames.

The connection shall always return for <proto> mode when the protocol session is ended. When the MT receives a disconnect request from its peer entity, it will process it and send OK response to the TE indicating its capability for receiving new AT commands. Since <proto> or upper layers can be accessed in other ways, TA must have pre-knowledge of the fact that connection is initiated with AT+CPROT command. This means that switch to <proto> mode must include some sort of notification to the protocol entity.

This command can be aborted by sending a <proto> or upper layer disconnection frame. In that case, MT will return in command mode by sending the OK response.

Refer clause 9.2 for possible <err> values.

Test command returns values supported as compound values.

Defined values

<proto>: integer type

- 0 OBEX (refer IrDA Object Exchange Protocol [44]).
- ...15 reserved by the present document
- 16... manufacturer specific

<version>: version number of <proto>: string type

<lsap1>: integer type; defines a level of service or application protocol on the top of <proto> layer. It may refer to services or protocols defined in other standards development organizations (SDOs).

- 1 IrMC level 1 (Minimum Level) Only .(refer [43] clause 2.9.4)
- 2 IrMC level 1 and 2 (Minimum and Access Levels) Only. .(refer [43] clause 2.9.4)
- 4 IrMC level 1, 2 and 3 (Minimum, Access, Index Levels) Only- implies static index support. .(refer [43] clause 2.9.4)
- 8 IrMC level 1, 2 and 4 (Minimum, Access and Sync Levels) Only-implies unique index support. .(refer [43] clause 2.9.4)
- 10 IrMC level 1, 2, 3 and 4 (Minimum, Access, Index and Sync Levels)-implies support of static and unique index. .(refer [43] clause 2.9.4)
- ...15 reserved by the present document
- 16... manufacturer specific

<lsap2>...<lsapN>: integer type

In case <lsapN> , <lsapN+1> received in the +CPROT command identifies protocol layers, the protocol identified by N+1 shall be on the top of the protocol identified by N on a framework point of view.

- 0...15 reserved by the present document
- 16... manufacturer specific

Implementation

Optional.

8.43 Generic UICC logical channel access +CGLA

Table 103: +CGLA action command syntax

Command	Possible response(s)
+CGLA=<sessionid>,<length> ,<command>	+CGLA: <length>,<response> +CME ERROR: <err>
+CGLA=?	

Description

Set command transmits to the MT the <command> it then shall send as it is to the selected UICC. In the same manner the UICC <response> shall be sent back by the MT to the TA as it is. Refer clause 9.2 for possible <err> values.

This command allows a direct control of the currently selected UICC by a distant application on the TE. The TE shall then take care of processing UICC information within the frame specified by GSM/UMTS.

Although Generic UICC Logical Channel Access command +CGLA allows TE to take control over the UICC-MT interface, there are some functions of the UICC-MT interface that logically do not need to be accessed from outside the TA/MT. Moreover, for security reason the GSM network authentication should not be handled outside the TA/MT. Therefore it shall not be allowed to execute a Run GSM Algorithm command or an Authenticate command in GSM context from the TE using +CGLA at all time whether the +CGLA is locked or unlocked. This shall not forbid the TE to send Authenticate commands in other security contexts (e.g. EAP security context).

For example, the TA/MT shall forbid the transfer of the Authenticate command to a USIM application when parameters P2 = 0 (GSM security context). See 3GPP TS 31.102 [59] for USIM authenticate command definition.

NOTE: Compared to Restricted UICC Access command +CRLA, the definition of +CGLA allows TE to take more control over the UICC-MT interface. The locking and unlocking of the interface may be done by a special <command> value or automatically by TA/MT (by interpreting <command> parameter). In case that TE application does not use the unlock command (or does not send a <command> causing automatic unlock) in a certain timeout value, MT may release the locking.

Defined values

<sessionid>: integer type; this is the identifier of the session to be used in order to send the APDU commands to the UICC. It is mandatory in order to send commands to the UICC when targeting applications on the smart card using a logical channel other than the default channel (channel "0").

<length>: integer type; length of the characters that are sent to TE in <command> or <response> (two times the actual length of the command or response).

<command>: command passed on by the MT to the UICC in the format as described in 3GPP TS 31.101 [65] (hexadecimal character format; refer +CSCS).

<response>: response to the command passed on by the UICC to the MT in the format as described in 3GPP TS 31.101 [65] (hexadecimal character format; refer +CSCS).

Implementation

Optional.

8.44 Restricted UICC logical channel access +CRLA

Table 104: +CRLA action command syntax

Command	Possible response(s)
+CRLA=<sessionid>,<command>[,<fileid>[,<P1>,<P2>,<P3>[,<data>[,<pathid>]]]]	+CRLA: <sw1>,<sw2>[,<response>] +CME ERROR: <err>
+CRLA=?	

Description

By using this command instead of Generic UICC Access +CGLA TE application has easier but more limited access to the UICC database. Set command transmits to the MT the UICC <command> and its required parameters. MT handles internally, for the selected UICC, all UICC-MT interface locking and file selection routines. As response to the command, MT sends the actual UICC information parameters and response data. MT error result code +CME ERROR may be returned when the command cannot be passed to the UICC, but failure in the execution of the command in the UICC is reported in <sw1> and <sw2> parameters. Refer clause 9.2 for possible <err> values.

Coordination of command requests to UICC and the ones issued by GSM/UMTS application inside the MT is implementation dependent. However the TE should be aware of the precedence of the GSM/UMTS application commands to the TE commands.

Defined values

<sessionid>: integer type; this is the identifier of the session to be used in order to send the APDU commands to the UICC. It is mandatory in order to send commands to the UICC when targeting applications on the smart card using a logical channel other than the default channel (channel "0").

<command>: (command passed on by the MT to the UICC; refer 3GPP TS 31.101 [65]):

176 READ BINARY

178 READ RECORD

192 GET RESPONSE

214 UPDATE BINARY

220 UPDATE RECORD

242 STATUS

203 RETRIEVE DATA

219 SET DATA

all other values are reserved

NOTE 1: The MT internally executes all commands necessary for selecting the desired file, before performing the actual command.

<fileid>: integer type; this is the identifier of an elementary datafile on UICC. Mandatory for every command except STATUS.

NOTE 2: The range of valid file identifiers depends on the actual UICC and is defined in 3GPP TS 31.101 [65]. Optional files may not be present at all.

<P1>, <P2>, <P3>: integer type; parameters passed on by the MT to the UICC. These parameters are mandatory for every command, except GET RESPONSE and STATUS. The values are described in 3GPP TS 31.101 [65].

<data>: information which shall be written to the SIM (hexadecimal character format; refer +CSCS).

<pathid>: string type; contains the path of an elementary file on the UICC in hexadecimal format (e.g. "5F704F30" for DF_{SoLSA}/EF_{SAI}). The <pathid> shall only be used in the mode "select by path from current DF" as defined in ETSI TS 102 221 [60].

<sw1>, <sw2>: integer type; information from the UICC about the execution of the actual command. These parameters are delivered to the TE in both cases, on successful or failed execution of the command.

<response>: response of a successful completion of the command previously issued (hexadecimal character format; refer +CSCS). STATUS and GET RESPONSE return data, which gives information about the current elementary datafield. This information includes the type of file and its size (refer 3GPP TS 31.101 [65]). After READ BINARY, READ RECORD or RETRIEVE DATA command the requested data will be returned.

<response> is not returned after a successful UPDATE BINARY, UPDATE RECORD or SET DATA command.

Implementation

Optional.

8.45 Open logical channel +CCHO

Table 105: +CCHO action command syntax

Command	Possible response(s)
+CCHO=<dfname>	<sessionid> +CME ERROR: <err>
+CCHO=?	

Description

Execution of the command causes the MT to return <sessionid> to allow the TE to identify a channel that is being allocated by the currently selected UICC, which is attached to ME. The currently selected UICC will open a new logical channel; select the application identified by the <dfname> received with this command and return a session Id as the response. The ME shall restrict the communication between the TE and the UICC to this logical channel.

This <sessionid> is to be used when sending commands with Restricted UICC Logical Channel access +CRLA or Generic UICC Logical Channel access +CGLA commands.

NOTE: The logical channel number is contained in the CLASS byte of an APDU command, thus implicitly contained in all APDU commands sent to a UICC. In this case it will be up to the MT to manage the logical channel part of the APDU CLASS byte and to ensure that the chosen logical channel is relevant to the <sessionid> indicated in the AT command. See 3GPP TS 31.101 [65] for further information on logical channels in APDU commands protocol.

Refer clause 9.2 for possible <err> values.

Defined values

<dfname>: all selectable applications in the UICC are referenced by a DF name coded on 1 to 16 bytes

<sessionid>: integer type; a session Id to be used in order to target a specific application on the smart card (e.g. (U)SIM, WIM, ISIM) using logical channels mechanism

See 3GPP TS 31.101 [65] for more information about defined values.

Implementation

Optional.

8.46 Close logical channel +CCHC

Table 106: +CCHC action command syntax

Command	Possible response(s)
+CCHC=<sessionid>	+CCHC +CME ERROR: <err>
+CCHC=?	

Description

This command asks the ME to close a communication session with the active UICC. The ME shall close the previously opened logical channel. The TE will no longer be able to send commands on this logical channel. The UICC will close the logical channel when receiving this command. Refer clause 9.2 for possible `<err>` values.

Defined values

`<sessionid>`: integer type; a session Id to be used in order to target a specific application on the smart card (e.g. (U)SIM, WIM, ISIM) using logical channels mechanism

Implementation

Optional.

8.47 EAP authentication +CEAP

Table 107: +CEAP action command syntax

Command	Possible response(s)
+CEAP=<dfname>,<EAPMethod>,<EAP packet data> [,<DFeap>]	+CEAP: <EAPsessionid>,<EAP packet response> +CME ERROR: <err>
+CEAP=?	

Description

This command allows a TE to exchange EAP packets with the UICC or the ME.

Prior to the execution of this command, the TE shall retrieve the available AIDs using the +CUAD command. The TE shall select one appropriate AID to be addressed. Selection may include asking the user, and considering EAP methods supported by the AIDs. The TE shall set the `<dfname>` value using the selected AID and shall set the `<EAPMethod>` value to the requested EAP method. The TE may set the `<DFeap>` value to the directory file identifier that is applicable to the `<EAPMethod>`; which is derived from the discretionary data returned by +CUAD. The parameter is mandatory for EAP terminated in UICC.

If the targeted application on the UICC does support the requested EAP method, the MT shall use the value provided in `<DFeap>`, and it shall transmit the `<EAP packet data>` to the UICC application using the Authenticate APDU command as defined in ETSI TS 102 310 [66]. The appropriate DF_{EAP} in the ADF must be selected prior to the submission of an EAP Authenticate command with the `<EAP packet data>`. Then the EAP Response data sent by the UICC application in its response to the Authenticate command shall be provided to the TE in `<EAP packet response>`.

If the targeted application on the UICC does not support the requested EAP method and if the MT does support this method then the `<EAP packet data>` shall be handled by the MT. During the handling of the EAP method, the MT shall run the authentication algorithm on the SIM or USIM, respectively.

Also the MT has to allocate an `<EAPsessionid>` in order to identify an EAP session and its corresponding keys and parameters.

If neither the MT nor the appropriate UICC application support the requested EAP method, the MT shall respond with `CME ERROR: 49` (EAP method not supported).

Refer clause 9.2 for possible `<err>` values.

Defined values

`<dfname>`: string type in hexadecimal character format. All selectable applications are represented in the UICC by an AID coded on 1 to 16 bytes.

<EAPMethod>: string type in hexadecimal character format. This is the EAP Method Type as defined in RFC 3748 [68] in 1 byte format or 8 bytes expanded format. The value range for 1 byte format and for 8 bytes expanded format is defined in RFC 3748 [68].

<EAP packet data>: string type in hexadecimal character format. This is the EAP packet data in hexadecimal character as defined in ETSI TS 102 310 [66].

<DFeap>: string type in hexadecimal character format. Contains the DF(EAP) associated with the specified <EAPMethod> on the SIM/UICC as defined in ETSI TS 102 310 [66] (e.g. "6D34").

<EAPsessionid>: integer type. This is the identifier of the EAP session to be used in order to retrieve the EAP parameters with EAP Retrieve Parameters +CERP command. Value range is from 1 to 4294967295.

<EAP packet response>: string type in hexadecimal character format. Defined in ETSI TS 102 310 [66].

Implementation

Optional.

8.48 EAP retrieve parameters +CERP

Table 108: +CERP action command syntax

Command	Possible response(s)
+CERP=<EAPsessionid> , <EAPparameter>	+CERP: <EAP parameter response> +CME ERROR: <err>
+CERP=?	

Description

This command allows a TE to retrieve EAP session parameters / derived keys after a run of the +CEAP command. If the EAP session is handled by the UICC then the MT shall return the content of the elementary file corresponding to the indicated <EAPparameter>. Those EFs are defined in ETSI TS 102 310 [66].

If the MT handles the EAP session then the MT shall return the corresponding parameter encoded as defined for EAP files, see ETSI TS 102 310 [66].

For example, the keys shall be retrieved in the TLV format described in ETSI TS 102 310 [66].

If neither the MT nor the appropriate UICC application can provide the requested information (e.g. because the requested EAP session ID does not exist), the MT shall respond with CME ERROR: 50 (Incorrect parameters).

Refer clause 9.2 for possible <err> values.

Defined values

<EAPparameter>: integer type.

- 1 Keys
- 2 Status
- 3 Identity
- 4 Pseudonym

<EAPsessionid>: integer type; this is the identifier of the EAP session to be used in order to retrieve the EAP parameters corresponding to an active EAP session. Value range is from 1 to 4294967295.

<EAP parameter response>: string type in hexadecimal character format. The format of the parameter is defined in ETSI TS 102 310 [66]. The <EAP parameter response> depends on the value of the <EAPparameter>.

Implementation

Optional.

8.49 UICC application discovery +CUAD

Table 109: +CUAD action command syntax

Command	Possible response(s)
+CUAD[=<option>]	+CUAD: <response>[,<active_application>[,<AID>]] +CME ERROR: <err>
+CUAD=?	+CUAD: (list of supported <option>s)

+CMOLR=?	+CMOLR: (list of supported <enable>s) , (list of supported <method>s) , (list of supported <hor-acc-set>s) , (list of supported <hor-acc>s) , (list of supported <ver-req>s) , (list of supported <ver-acc-set>s) , (list of supported <ver-acc>s) , (list of supported <vel-req>s) , (list of supported <rep-mode>s) , (list of supported <timeout>s) , (list of supported <interval>s) , (list of supported <shape-rep>s) , (list of supported <plane>s) , (list of supported <NMEA-rep>s) , (list of supported <third-party-address>s)
----------	---

Description

Set command initiates a mobile originated location request (MO-LR). The parameter <enable> enables or disables positioning and reporting by unsolicited result codes. Reporting can be performed in the format of GAD shapes <location_parameters> or in the format of NMEA strings <NMEA-string> or both. The unsolicited result codes that can be provided are +CMOLRG: <location_parameters> and/or +CMOLRN: <NMEA-string>.

The method to use for positioning is decided by the parameter <method>. The parameters <hor-acc-set>, <hor-acc>, <ver-req>, <ver-acc-set>, <ver-acc> and <vel-req> indicate accuracy for the MO-LR. The parameter <timeout> indicates how long the MS will wait for a report before an unsolicited result code is provided. A single report or periodic reports can be requested by the parameter <rep-mode>. If periodic reports are requested, the time interval between the reports is specified by the parameter <interval>. If GAD shapes are requested, the GAD shapes that will be accepted in the unsolicited result code +CMOLRG: <location_parameters> are defined by the parameter <shape-rep>. The parameter <plane> specifies the signalling to use for MO-LR. The parameter <NMEA-rep> indicates possible restrictions in supported NMEA strings that will be accepted in the unsolicited result code +CMOLRN: <NMEA-string>. The parameter <third-party-address> is used to specify the address when reporting to a third party is specified. Additional information about positioning can be found in 3GPP TS 25.305 [77]. If positioning-data cannot be provided at a timeout, the unsolicited result +CMOLRE is provided. Refer clause 9.2 and clause 9.3 for possible <err> values.

Read command returns the current settings of the parameters <enable>, <method>, <hor-acc-set>, <hor-acc>, <ver-req>, <ver-acc-set>, <ver-acc>, <vel-req>, <rep-mode>, <timeout>, <interval>, <shape-rep>, <plane>, <NMEA-rep> and <third-party-address>. The parameters <hor-acc>, <ver-acc-set>, <ver-acc> and <plane> are only applicable in certain configurations. The parameter <interval> is only applicable if periodic reporting is specified. The parameter <NMEA-rep> is only applicable if reporting is specified by NMEA strings. The parameter <third-party-address> is only applicable if reporting to third party is specified.

Test command returns the supported values and ranges.

Defined values

<enable>: integer type. Enables and disables reporting location as a result of a MO-LR. Only one <method> can be enabled at any given time.

0 Disables reporting and positioning.

1 Enables reporting of NMEA strings by unsolicited result code +CMOLRN: <NMEA-string>. Lack of data at each timeout is indicated by an unsolicited result code +CMOLRE.

2 Enables reporting of GAD shapes by unsolicited result code +CMOLRG: <location_parameters>. Lack of data at each timeout is indicated by an unsolicited result code +CMOLRE.

3 Enables reporting of NMEA strings and GAD shapes by unsolicited result codes +CMOLRG: <location_parameters> and +CMOLRN: <NMEA-string>. Lack of data at each timeout is indicated by an unsolicited result code +CMOLRE.

NOTE 1: The string of <location_parameters> intended for +CMOLR can be split into multiple unsolicited result codes e.g. in order to prevent that the string in the unsolicited result code becomes too long. How to split the string is implementation specific.

<method>: integer type. Method for MO-LR. The default value is implementation specific.

- 0 Unassisted GPS. Autonomous GPS only, no use of assistance data.
- 1 Assisted GPS (see NOTE 2).
- 2 Assisted GANSS (see NOTE 2).
- 3 Assisted GPS and GANSS (see NOTE 2).
- 4 Basic self location (the network determines the position technology).
- 5 Transfer to third party. This method makes the parameters <shape-rep> and <NMEA-rep> irrelevant (any values are accepted and disregarded). The third party address is given in the parameter <third-party-address> (see NOTE 3).
- 6 Retrieval from third party. This method is to get the position estimate of the third party. The third party address is given in the parameter <third-party-address>.

NOTE 2: For the methods that require assistance data, the assistance data obtained from the network is used for a UE-based GPS location procedure.

NOTE 3: Lack of data at each timeout is not indicated by an unsolicited result code +CMOLRE if reporting to third party is specified.

<hor-acc-set>: integer type.

- 0 Horizontal accuracy not set/specified.
- 1 Horizontal accuracy set in parameter <hor-acc>.

<hor-acc>: integer type. Requested accuracy as horizontal uncertainty exponent (refer to 3GPP TS 23.032 [76] clause 6.2). The value range is 0-127. The default value is implementation specific.

<ver-req>: integer type.

- 0 Vertical coordinate (altitude) is not requested, 2D location fix is acceptable. The parameters <ver-acc-set> and <ver-acc> do not apply.
- 1 Vertical coordinate (altitude) is requested, 3D location fix is required.

<ver-acc-set>: integer type.

- 0 Vertical accuracy not set/specified.
- 1 Vertical accuracy set/specified in parameter <ver-acc>.

<ver-acc>: integer type. Requested accuracy as vertical uncertainty exponent (refer to 3GPP TS 23.032 [76] clause 6.4). The value range is 0-127. The default value is implementation specific.

<vel-req>: integer type. Requested velocity type (refer to 3GPP TS 23.032 [76] clause 8.6).

- 0 Velocity not requested.
- 1 Horizontal velocity requested.
- 2 Horizontal velocity and vertical velocity requested.
- 3 Horizontal velocity with uncertainty requested.
- 4 Horizontal velocity with uncertainty and vertical velocity with uncertainty requested.

<rep-mode>: integer type. Reporting mode. The default value is implementation specific.

- 0 Single report, the timeout for the MO-LR response request is specified by <timeout>.
- 1 Periodic reporting, the timeout for each MO-LR response request is specified by <timeout> and the interval between each MO-LR is specified by <interval>.

<timeout>: integer type. Indicates how long the MS will wait for a response after a MO-LR. The value range is in seconds from 1 to 65535. The default value is implementation specific.

<interval>: integer type. The parameter is applicable to periodic reporting only. Determine the interval between periodic MO-LRs. The value range is in seconds from 1 to 65535, and must be greater than or equal to <timeout>. The default value is implementation specific.

<shape-rep>: integer type. This parameter is a sum of integers each representing a certain GAD shape that will be accepted in the unsolicited result code +CMOLRG: <location_parameters>. Note that only one GAD shape is present per unsolicited result code. The default value is implementation specific.

- 1 Ellipsoid point.
- 2 Ellipsoid point with uncertainty circle.
- 4 Ellipsoid point with uncertainty ellipse.
- 8 Polygon.
- 16 Ellipsoid point with altitude.
- 32 Ellipsoid point with altitude and uncertainty ellipsoid.
- 64 Ellipsoid arc.

<plane>: integer type. The parameter specifies whether the control plane or SUPL will be used for MO-LR.

- 0 Control plane.
- 1 Secure user plane (SUPL).

<NMEA-rep>: string type. The supported NMEA strings that will be accepted in the unsolicited result code +CMOLRN: <NMEA-string> are specified as a comma separated values inside one string. If the parameter is omitted or an empty string is given, no restrictions apply and all NMEA strings are supported. The default value is that all strings are supported.

Example of NMEA strings: "\$GPRMC,\$GPGSA,\$GPGSV"

<third-party-address>: string type. The parameter is applicable to reporting to third party only, and specifies the address to the third party. This parameter has to be specified when <method> value is set to 5 or 6.

<location_parameters>: string type in UTF-8. This parameter provides XML-formatted strings of GAD-shape positioning data as defined in table 8.50-2. This parameter shall not be subject to conventional character conversion as per +CSCS. The XML according to the DTD in table 8.50-2 may be provided in one or multiple unsolicited result codes.

Table 8.50-2: XML DTD for <location_parameters>

```
<?xml version="1.0" ?>
<!DOCTYPE location_parameters [
<!ELEMENT location_parameters (time?,direction?,shape_data,velocity_data?)>
  <!ELEMENT time (#PCDATA)>
  <!ELEMENT direction (#PCDATA)>
  <!ELEMENT shape_data
(ellipsoid_point|ellipsoid_point_uncert_circle|ellipsoid_point_uncert_ellipse|po
lygon|ellipsoid_point_alt|ellipsoid_point_alt_uncertellipse|ellips_arc)>
  <!ELEMENT ellipsoid_point (coordinate)>
```

```

        <!ELEMENT coordinate (latitude,longitude)>
        <!ELEMENT latitude (north,degrees)>
            <!ELEMENT north (#PCDATA)>
            <!ELEMENT degrees (#PCDATA)>
            <!ELEMENT longitude (#PCDATA)>
        <!ELEMENT ellipsoid_point_uncert_circle (coordinate,uncert_circle)>
            <!ELEMENT uncert_circle (#PCDATA)>
        <!ELEMENT ellipsoid_point_uncert_ellipse (coordinate,uncert_ellipse)>
            <!ELEMENT uncert_ellipse
(uncert_semi_major,uncert_semi_minor,orient_major,confidence)>
            <!ELEMENT uncert_semi_major (#PCDATA)>
            <!ELEMENT uncert_semi_minor (#PCDATA)>
            <!ELEMENT orient_major (#PCDATA)>
            <!ELEMENT confidence (#PCDATA)>
        <!ELEMENT polygon (coordinate+)>
        <!ELEMENT ellipsoid_point_alt (coordinate,altitude)>
            <!ELEMENT altitude (height_above_surface,height)>
            <!ELEMENT height_above_surface (#PCDATA)>
            <!ELEMENT height (#PCDATA)>
        <!ELEMENT ellipsoid_point_alt_uncertellipse
(coordinate,altitude,uncert_semi_major,uncert_semi_minor,orient_major,confidence
,uncert_alt)>
            <!ELEMENT uncert_alt (#PCDATA)>
        <!ELEMENT ellips_arc
(coordinate,inner_rad,uncert_rad,offset_angle,included_angle,confidence)>
            <!ELEMENT inner_rad (#PCDATA)>
            <!ELEMENT uncert_rad (#PCDATA)>
            <!ELEMENT offset_angle (#PCDATA)>
            <!ELEMENT included_angle (#PCDATA)>
        <!ELEMENT velocity_data
(hor_velocity?,vert_velocity?,vert_velocity_direction?,hor_uncert?,vert_uncert?)
>
            <!ELEMENT hor_velocity (#PCDATA)>
            <!ELEMENT vert_velocity (#PCDATA)>
            <!ELEMENT vert_velocity_direction (#PCDATA)>
            <!ELEMENT hor_uncert (#PCDATA)>
            <!ELEMENT vert_uncert (#PCDATA)>
    ]>

```

<NMEA-string>: string type in UTF-8. This parameter provides an NMEA-string as defined in IEC 61162 [78]. This parameter shall not be subject to conventional character conversion as per +CSCS.

Example:+CMOLRN: "\$GPRMC,235947.000,V,0000.0000,N,00000.0000,E,, ,041299,,*1D<CR><LF>&"

Implementation

Optional.

8.51 Backlight +CBKLT

Table 8.51-1: +CBKLT parameter command syntax

Command	Possible response(s)
+CBKLT=[<state>[,<duration>]]	+CME ERROR: <err>
+CBKLT?	+CBKLT: <state>[,<duration>] +CME ERROR: <err>
+CBKLT=?	+CBKLT: (list of supported <state>s) +CME ERROR: <err>

Description

This command is used to enable or disable the backlight of the MT's main display. The backlight can be enabled indefinitely or the duration shall be indicated as a specified period of time (in seconds). Refer clause 9.2 for possible <err> values.

Read command returns the current state and duration (in seconds) if applicable.

Test command returns supported values as a compound value.

Defined values

<state>: integer type

- 0 disable
- 1 enable for the duration specified
- 2 enable indefinitely
- 3 enable for a short duration specified by the UE manufacturer

<duration>: integer type. The range (if seconds) is manufacturer specific.

xxxx in seconds

Implementation

Optional.

8.52 Command touch screen action +CTSA

Table 8.52-1: +CTSA action command syntax

Command	Possible response(s)
+CTSA=<action>,<x>,<y>,<id> [,<duration>]	+CME ERROR: <err>
+CTSA=?	+CTSA: (list of supported <action>s)

Description:

This command is used to emulate a touch screen action on the mobile equipment (ME). If emulation fails with an ME error, +CME ERROR: <err> is returned. Refer clause 9.2 for possible <err> values.

This command should be accepted (OK returned) before actually emulating the touch screen action.

Test command returns the list of supported actions for the mobile equipment.

The top left corner of the touch screen is defined as the 0, 0 point, see figure 8.52-1. This coordinate does not change regardless of the display mode (portrait or landscape). All coordinate values are non-negative integers.

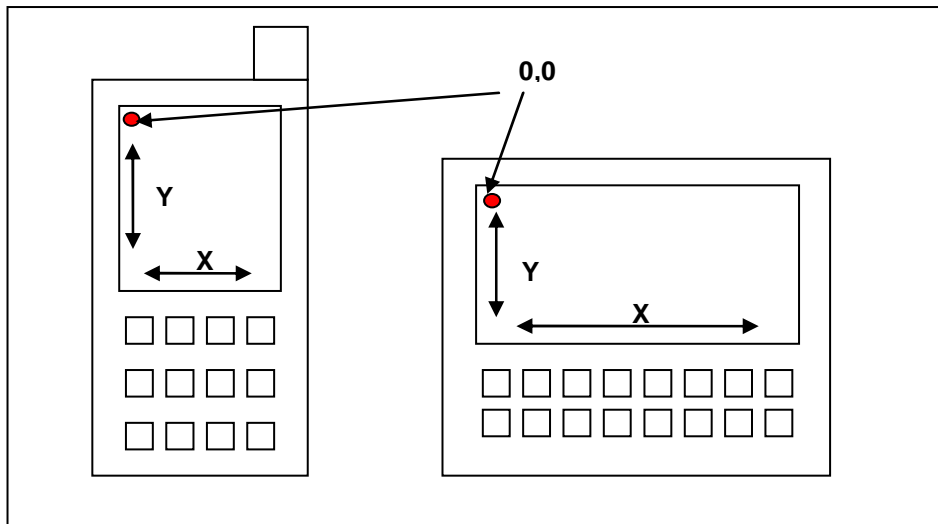

Figure 8.52-1: ME screen outline

Defined values

<action>: integer type

- 0 Release. Emulates the user releasing the touch screen at the <x>, <y> coordinates.
- 1 Depress. Emulates the user depressing the touch screen at location <x>, <y>.

NOTE 1: Consecutive Depress actions will emulate dragging a stylus on the touch device to the new location.

- 2 Single Tap. Emulates the user performing a single tap action at the <x>, <y> location. The timing required to emulate a single tap shall be handled by the mobile equipment.
- 3 Double Tap. Emulates the user performing a double tap action at the <x>, <y> location. The timing required to emulate a double tap shall be handled by the mobile equipment.

<x>: integer type. The horizontal x coordinate location of the action performed on the touch screen.

<y>: integer type. The vertical y coordinate location of the action performed on the touch screen.

<id>: integer type. A positive integer value. If *id* is a non-zero integer value *N*, then it represents, or correlates with, the *N*th simultaneous touch action performed on the touch screen. If *id* is 0 then the touch screen action is an initial touch screen action or the touch screen action is correlated with the initial touch action.

NOTE 2: The number of possible simultaneous touch actions is implementation specific.

<duration>: integer type (the value range is in milliseconds from 1 to 65535). Emulates the user releasing the touch screen at the <x>, <y> coordinates after *duration* milliseconds. If the value is set to 0, then a duration is not indicated.

Examples:

Table 8.52-2: Examples of syntax for various user actions

User Action	Syntax	Description
Depress	AT+CTSA=1,25,45	This will emulate a user pressing down on the ME touch screen at the 25, 45 coordinates.
Release	AT+CTSA=0,25,45	This will emulate a user releasing the touch screen at the 25, 45 coordinates.
Single Tap	AT+CTSA=2,25,45	This will emulate a user single tapping the touch screen at the 25, 45 coordinates.
Double Tap	AT+CTSA=3,25,45	This will emulate a user double tapping the touch screen at the 25, 45 coordinates.
Drag	AT+CTSA=1,10,10; +CTSA=0,50,50	This will emulate a user touching at 10,10, dragging to 50,50, and releasing.
Draw	AT+CTSA=1,10,10; +CTSA=1,50,50; +CTSA=0,100,100	This will emulate a user touching at 10,10, then dragging to 50,50, then dragging to 100,100 and finally releasing the touch screen at 100,100.
Multi Touch	AT+CTSA=1,10,10,0; +CTSA=1,50,50,1; +CTSA=0,60,60,1; +CTSA=0,100,100,0	This will emulate a user initiating a first gesture touching at 10,10, then simultaneously initiating a second gesture at 50,50, then dragging the second gesture from 50, 50 to 60,60. The user releases the second gesture at 60. 60 while simultaneously dragging the first gesture from 10,10 to 100,100 and finally releasing the touch screen at 100,100.
Long Depress	AT+CTSA=1,10,10,0; +CTSA=0,10,10,0,3000	This will emulate a user touching at coordinates 10,10, and releasing the touch screen at coordinates 10, 10, after 3 seconds.

Implementation

Optional.

8.53 Command screen orientation +CSO

Table 8.53-1: +CSO parameter command syntax

Command	Possible response(s)
+CSO=<orientation>[,<Current TopSide>]	+CME ERROR: <err>
+CSO?	+CSO: <orientation>[,<Current TopSide>] +CME ERROR: <err>
+CSO=?	+CSO: (list of supported <orientation>s) +CME ERROR: <err>

Description

This command is used to set or read back the orientation of the screen on the mobile equipment (ME). The ME may override the setting via a key press or touch screen action. In addition to setting portrait mode and landscape mode, the command is used by the TE to set a reference orientation for the screen on the ME. The physical orientation of the ME shall not override this command. If emulation fails with an ME error, +CME ERROR: <err> is returned. Refer clause 9.2 for possible <err> values.

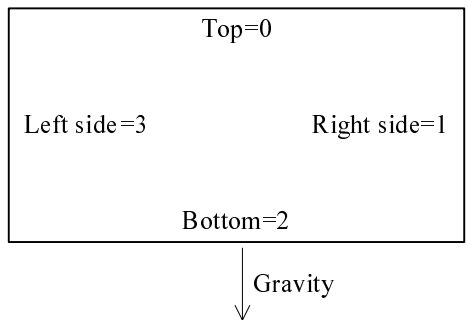

Figure 8.53-1: Labelled ME sides when the ME is in the normal operating mode

This command should be accepted (OK returned) before actually performing the action.

Read command returns the current settings.

Test command returns the list of supported orientations for the mobile equipment as a compound value.

Defined values

<orientation>: integer type

- 0 Portrait. The device is in portrait mode.
- 1 Landscape. The device is in landscape mode.
- 2 Any. The top of the ME's screen is identified by <CurrentTopSide> parameter, identifying a side of the screen of the ME.

<CurrentTopSide>: integer type, representing the label of the side that is the top of the screen. The default value is manufacturer specific.

- 0 Top. The ME is in the normal operating mode (see figure 8.53-1).
- 1 Right side. The side labelled right side is the side that is the top of the screen.
- 2 Bottom. The side labelled bottom is the side that is the top of the screen.
- 3 Left side. The side labelled left side is the side that is the top of the screen.

Examples:

Table 8.53-2: Examples of syntax for various actions

Action	Syntax	Description
Get Orientation	AT+CSO?	This will return the current orientation of the screen device.
Set Orientation	AT+CSO=0	This will set the current orientation of the screen device to portrait.
Set Orientation	AT+CSO=2, 3	The right side is the current top side (e.g. the top can be determined relative to gravitational forces) and identifies the TE's reference orientation for the screen on the device.

Implementation

Optional.

8.54 Command screen size +CSS

Table 8.54-1: +CSS action command syntax

Command	Possible response(s)
+CSS	+CSS: <Max_X> , <Max_Y> +CME ERROR: <err>
+CSS=?	

Description

The execution of this command will get the size (in pixels) of the ME's (touch) screen.

The x-axis and y-axis will be based on a single normal operating mode of the ME, see figure 8.54-1. The 0,0 point will always be located at the top left corner of the screen in the normal operating mode. Changing the ME's mode from e.g. portrait mode to landscape mode does not change the physical location of 0,0 or how the x and y axes are interpreted.

If emulation fails with an ME error, +CME ERROR: <err> is returned. Refer clause 9.2 for possible <err> values. This command should be accepted (OK returned) before returning the screen size of the device.

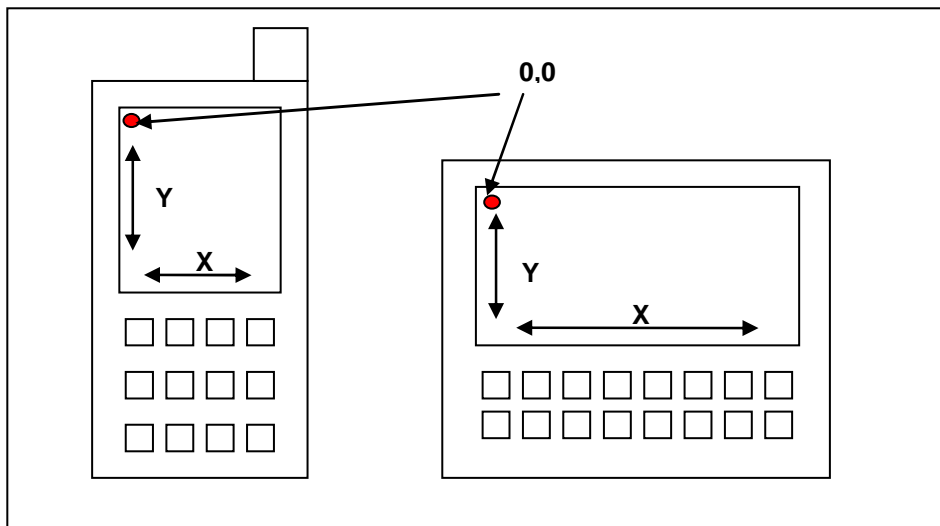

Figure 8.54-1: ME screen outline

Defined values

<Max_X>: integer type. Must be a positive integer representing the maximum width of the screen.

<Max_Y>: integer type. Must be a positive integer representing the maximum height of the screen

Implementation

Optional.

8.54A Command display screen boundary +CDSB

Table 8.54A-1: +CDSB action command syntax

Command	Possible response(s)
+CDSB	+CDSB: <Top_Left_X>, <Top_Left_Y>, <Bottom_Right_X>, <Bottom_Right_Y>[, <Width_of_the_Boundary>] +CME ERROR: <err>
+CDSB=?	

Description

The execution of this command will identify the boundary between a display area and a non-display area of the ME's (touch) screen. If the display area of the (touch) screen is the same size as the (touch) screen, the values <Top_Left_X>, <Top_Left_Y> are set to 0, and the values <Bottom_Right_X>, <Bottom_Right_Y> match the values returned by the command +CSS (see clause 8.54).

As in clause 8.54, the x-axis and y-axis will be based on a single normal operating mode of the ME.

If emulation fails with an ME error, +CME ERROR: <err> is returned. Refer clause 9.2 for possible <err> values.

Defined values

<Top_Left_X>: integer type. Must be a positive integer representing the top left pixel X coordinate of the boundary.

<Top_Left_Y>: integer type. Must be a positive integer representing the top left pixel Y coordinate of the boundary.

<Bottom_Right_X>: integer type. Must be a positive integer representing the bottom right pixel X coordinate of the boundary.

<Bottom_Right_Y>: integer type. Must be a positive integer representing the bottom right pixel Y coordinate of the boundary.

<Width_of_the_Boundary>: integer type (the value range is in pixels, and starts at 1. The maximum value is implementation specific). Representing the width of the boundary, by default the width is 1 pixel. If the integer value is positive, the boundary is part of the display area of the ME's (touch) screen. If the integer value is negative, the boundary is part of the non-display area of the ME's (touch) screen.

Implementation

Optional.

8.55 Positioning control +CPOS

Table 8.55-1: +CPOS Action Command Syntax

Command	Possible response(s)
+CPOS<CR> text is entered <ctrl-Z/ESC>	+CME ERROR: <err>
+CPOS=?	

Description

Execution command causes the TE to enter a transparent mode for sending XML formatted data according to table 8.55-2: XML DTD for <pos>.

Subsequent to +CPOS:

- the TA shall send a two character sequence <CR><LF> after command line is terminated with <CR>. Then text can be entered from TE to ME/TA.
- the echoing of entered characters back from the TA is controlled by V.25ter echo command E.
- sending may be cancelled by giving <ESC> character (IRA 27).
- <ctrl-z> (IRA 26) shall be used to indicate the ending of the message body.

Refer clause 9.2 for possible <err> values.

Defined events

<location>: string type in UTF-8. This parameter provides an XML-formatted string of GAD-shape positioning data similar to what is defined in table 8.55-3. This parameter shall not be subject to conventional character conversion as per +CSCS.

<assist_data>: string type in UTF-8. This parameter provides an XML-formatted string of assistance data as defined in table 8.55-5. This parameter shall not be subject to conventional character conversion as per +CSCS.

<GPS_meas>: string type in UTF-8. This parameter provides an XML-formatted string of GPS measurement data as defined in table 8.55-10. This parameter shall not be subject to conventional character conversion as per +CSCS.

<GNSS_meas>: string type in UTF-8. This parameter provides an XML-formatted string of GPS measurement data as defined in table 8.55-11 for LPP procedures and GANSS procedures in RRLP and RRC. This parameter shall not be subject to conventional character conversion as per +CSCS.

<GPS_assist_req>: string type in UTF-8. This parameter provides an XML-formatted string for requesting GPS assistance data as defined in table 8.55-12. This parameter shall not be subject to conventional character conversion as per +CSCS.

<Strobe>: string type in UTF-8. This parameter provides an XML-formatted string for triggering the generation of strobe as defined in table 8.55-25. This parameter shall not be subject to conventional character conversion as per +CSCS.

<GNSS_assist_req>: string type in UTF-8. This parameter provides an XML-formatted string for requesting GNSS assistance data as defined in table 8.55-15. This parameter shall not be subject to conventional character conversion as per +CSCS.

<capability_req> string type in UTF-8. This parameter provides an XML-formatted string for requesting capability data as defined in table 8.55-4. This parameter shall not be subject to conventional character conversion as per +CSCS.

<msg>: string type in UTF-8. This parameter provides an XML-formatted string for communicating simple messages as defined in table 8.55-13. This parameter shall not be subject to conventional character conversion as per +CSCS.

<pos_err>: string type in UTF-8. This parameter provides an XML-formatted string of positioning error parameters as defined in table 8.55-14. This parameter shall not be subject to conventional character conversion as per +CSCS.

<reset_assist_data>: string type in UTF-8. This parameter provides an XML-formatted string for resetting GNSS/OTDOA/Sensor/TBS assistance data as defined in table 8.55-22. This parameter shall not be subject to conventional character conversion as per +CSCS.

<OTDOA_ECID_req>: string type in UTF-8. This parameter provides an XML-formatted string for aborting/requesting location information for OTDOA/ECID method types as defined in table 8.55-23. This parameter shall not be subject to conventional character conversion as per +CSCS.

NOTE 1: An XML-formatted string intended for +CPOS can be split e.g. in order to prevent that the string becomes too long. Where to split an XML-formatted string is implementation specific.

<GNSS_provided_location_information>: string type in UTF-8. This parameter provides an XML-formatted string of GAD-shape positioning data as defined in table 8.55-19. This parameter shall not be subject to conventional character conversion as per +CSCS.

<Add_pos_req>: string type in UTF-8. This parameter provides an XML-formatted string for aborting/requesting location information for Additional Positioning method types (Bluetooth/Sensor/TBS/WLAN) as defined in table 8.55-2. This parameter shall not be subject to conventional character conversion as per +CSCS.

Table 8.55-2: XML DTD for <pos>

```
<?xml version="1.0" ?>
<!DOCTYPE pos[
<!ELEMENT pos
(location|GNSS_provided_location_information|assist_data|pos_meas|pos_meas_req|GPS_meas|OTDOA_ECID_req|Add_pos_req|OTDOA_meas|ECID_meas|GNSS_meas|Bluetooth_meas|Sensor_meas|TBS_meas|WLAN_meas|GPS_assist_req|GNSS_assist_req|OTDOA_assist_req|Sensor_assist_req|TBS_assist_req|capability_req|capabilities|msg|pos_err|reset_assist_data|Strobe)>
  <!ATTLIST pos protocol (RRLP|RRC|LPP) #IMPLIED
  transaction_id CDATA #IMPLIED>
]>
```

NOTE 2: The XML DTD for 'pos' is the top-level definition of all positioning events, containing elements going in both directions between the MS and the network. The subelements of 'pos' are superset definitions of the positioning events. A variable amount of these elements can be sent. Sent elements must follow the rules for the XML, e.g. elements postfixed by '?' can occur zero or more times. The total delivery must be a complete specification. Sub-elements cannot be delivered without being preceded with an element reference from the above level.

Table 8.55-3: XML DTD for <location>

```
<!ELEMENT location (location_parameters,time_of_fix?,time_assistance?)>
<!ELEMENT time_of_fix (#PCDATA)>
<!ELEMENT time_assistance (GPS_time,(GSM_time|WCDMA_time|LTE_time)?,TimeUnc?)>
```

NOTE 3: The element 'location_parameters' provides one or more XML-formatted strings of GAD-shape positioning data as defined in table 8.50-2.

NOTE 3a: The elements 'time_of_fix' of 'location' and 'time' of 'location_parameters' (see Table 8.50-2) are both for holding time-stamp of the location information. Due to this, the parameter 'time_of_fix' can be omitted when 'time' is present or vice versa.

Table 8.55-4: XML DTD for <capability_req>, <capabilities>

```
<!ELEMENT capability_req EMPTY>

<!ELEMENT capabilities
(GPS_method?,GNSS_method*,GPS_aid?,GNSS_aid?,OTDOA_capability?,ECID_capability?,Bluetooth_capability?,Sensor_capability?,TBS_capability?,WLAN_capability?)>
  <!ELEMENT GPS_Method (MSA_sup?,MSB_sup?,Standalone_sup?)>
    <!ELEMENT MSA_sup EMPTY>
      <!ATTLIST MSA_sup fta_sup CDATA "000"> <!-- as LPP fta-MeasSupport -->
    <!ELEMENT MSB_sup EMPTY>
      <!ATTLIST MSB_sup fta_sup CDATA "000"
      velocity_sup (true|false) "false">
    <!ELEMENT Standalone_sup EMPTY>
      <!ATTLIST Standalone_sup fta_sup CDATA "000"
      <!-- as LPP fta-MeasSupport -->
      velocity_sup (true|false) "false">
  <!ELEMENT GNSS_Method (MSA_sup?,MSB_sup?,Standalone_sup?)>
```

```

<!ATTLIST GNSS_Method supported_signal
(GPS_L1|GPS_L1C|GPS_L2C|GPS_L5|SBAS_L1|GLO_G1|GLO_G2|GLO_G3|BDS_B1I) "GPS_L1">
<!ELEMENT GPS_aid
(almanac_sup?,UTC_model_sup?,ionospheric_sup?,nav_model_sup?,DGPS_sup?,ref_loc_sup?,ref_time_sup?,ac
quisition_sup?,rt_integr_sup?)>
<!ELEMENT almanac_sup EMPTY>
<!ELEMENT UTC_model_sup EMPTY>
<!ELEMENT ionospheric_sup EMPTY>
<!ELEMENT nav_model_sup EMPTY>
<!ELEMENT DGPS_sup EMPTY>
<!ELEMENT ref_loc_sup EMPTY>
<!ELEMENT ref_time_sup EMPTY>
<!ELEMENT acquisition_sup EMPTY>
<!ELEMENT rt_integr_sup EMPTY>
<!ELEMENT GNSS_aid (ionospheric_sup?,ref_loc_sup?,ref_time_sup?,earth_orient_sup?,GNSS_aid_for_on
e_gnss*)>
<!ELEMENT earth_orient_sup EMPTY>
<!ELEMENT GNSS_aid_for_one_gnss
(orbit_sup*,clock_sup*,acquisition_sup?,rt_integr_sup?,GNSS_auxiliary_info_sup?,GNSS_databitassistan
ce_sup?,GNSS_almanac_sup?,GNSS.UTC_model_sup?,BDS_grid_model_sup?)>
<!ATTLIST GNSS_aid_for_one_gnss
gnss_id (SBAS|MGPS|QZSS|Glonass|GPS|BDS) #IMPLIED
sbas_id (WASS|EGNOS|MSAS|GAGAN) #IMPLIED>
<!ELEMENT orbit_sup EMPTY>
<!ATTLIST orbit_sup model (2|3|4|5|6) #REQUIRED>
<!-- 2=GPS NAV, 3=GPS CNAV, 4=Glonass, 5=SBAS, 6=BDS -->
<!ELEMENT clock_sup EMPTY>
<!ATTLIST clock_sup model (2|3|4|5|6) #REQUIRED>
<!ELEMENT GNSS_auxiliary_info_sup EMPTY>
<!ELEMENT GNSS_databitassistance_sup EMPTY>
<!ELEMENT GNSS_almanac_sup (almanac_model)>
<!ELEMENT almanac_model (#PCDATA)> <!-- Integer corresponds to bit string 1-8 where bit
at position if set, means particular almanac model is supported -bit6 set means BDS almanac model is
supported. -->
<!ELEMENT GNSS.UTC_model_sup (utc_model)>
<!ELEMENT utc_model (#PCDATA)> <!-- Integer corresponds to bit string 1-8 where bit at
position if set, means particular UTC model is supported -bit4 set means BDS UTC model is supported
-->
<!ELEMENT BDS_grid_model_sup EMPTY>
<!ELEMENT OTDOA_capability (otdoa_mode,supported_band_list_EUTRA,interFreqRSTDmeasurement-r10?)>
<!ELEMENT otdoa_mode #PCDATA> <!-- Integer corresponds to bit string 1-8 where bit at
position if set, means particular OTDOA mode is supported
bit0 -ue-assisted supported -->
<!ELEMENT supported_band_list_EUTRA (band_EUTRA+)>
<!ELEMENT band_EUTRA (#PCDATA)> <!-- 1..64 -->
<!ELEMENT interFreqRSTDmeasurement-r10 EMPTY>
<!ELEMENT ECID_capability (ECID_measSupported)>
<!ELEMENT ECID_measSupported (#PCDATA)> <!-- Integer corresponds to bit string 1-8 where bit
at position if set, means particular ECID mode is supported bit0-rsrp Supported,bit1-rsrq
Supported,bit2-ueRxTx Supported -->
<!ELEMENT Bluetooth_capability (bluetooth_modes,bluetooth_meas_sup)>
<!ELEMENT bluetooth_modes #PCDATA> <!-- Integer corresponds to bit string 1-8 where bit at
position if set, means particular bluetooth mode is supported bit0-standalone, bit1-ue-assisted
supported -->
<!ELEMENT bluetooth_meas_sup #PCDATA> <!-- Integer corresponds to bit string 1-8 where bit
at position if set, means particular bluetooth measurement is supported bit0-rssi -->
<!ELEMENT Sensor_capability (sensor_modes,sensor_databitassistance_sup)>
<!ELEMENT sensor_modes #PCDATA> <!-- Integer corresponds to bit string 1-8 where bit at
position if set, means particular Sensor mode is supported bit0-standalone, bit1-ue-assisted bit2-
ue-based supported -->
<!ELEMENT sensor_databitassistance_sup EMPTY>
<!ELEMENT TBS_capability (tbs_modes,tbs_databitassistance_sup)>
<!ELEMENT tbs_modes #PCDATA> <!-- Integer corresponds to bit string 1-8 where bit at
position if set, means particular TBS mode is supported bit0-standalone, bit1-ue-assisted bit2-ue-
based supported -->
<!ELEMENT tbs_databitassistance_sup (mbs_acq,mbs_almanac)>
<!ELEMENT mbs_acq #PCDATA> <!-- boolean -->
<!ELEMENT mbs_almanac #PCDATA> <!-- boolean -->
<!ELEMENT WLAN_capability (wlan_modes,wlan_meas_sup)>
<!ELEMENT wlan_modes #PCDATA> <!-- Integer corresponds to bit string 1-8 where bit at
position if set, means particular WLAN mode is supported bit0-standalone, bit1-ue-assisted -->
<!ELEMENT wlan_meas_sup #PCDATA> <!-- Integer corresponds to bit string 1-8 where bit at
position if set, means particular WLAN measurement is supported bit0-rssi, bit1-rtt -->

```

NOTE 3b: For elements 'OTDOA_capability' and 'ECID_capability', refer to 3GPP TS 36.355 [115] (clause 6.5.1.7) and (clause 6.5.3.4) respectively. Additionally, for elements 'Bluetooth_capability', 'Sensor_capability', 'TBS_capability' and 'WLAN_capability', refer to 3GPP TS 36.355 [115].

Table 8.55-5: XML DTD for <assist_data>

```

<!ELEMENT assist_data
(GPS_assist?,GNSS_assist?,msr_assist_data?,system_info_assist_data?,more_assist_data?,ext_container?,
rel198_assist_data_ext?,rel5_assist_data_ext?,rel7_assist_data_ext?,OTDOA_assist_data?,GNSS_loc_serv
er_err?,OTDOA_loc_server_err?,Sensor_assist_data?,TBS_assist_data?,Sensor_loc_server_err?,TBS_loc_se
rver_err?)>
  <!ELEMENT GPS_assist
(status_health?,BTS_clock_drift?,ref_time*,location_parameters?,DGPS_corrections?,nav_model_elem*,io
nospheric_model?,UTC_model?,almanac?,acqu_assist*,GPS_rt_integrity?)>
    <!ELEMENT status_health (#PCDATA)>
    <!ELEMENT BTS_clock_drift (#PCDATA)>
    <!ELEMENT ref_time (GPS_time),(GSM_time|WCDMA_time|LTE_time)?,TimeUnc?,GPS_TOW_assist*)>
      <!ELEMENT GPS_time (GPS_TOW_msec,GPS_week)>
        <!ELEMENT GPS_TOW_msec (#PCDATA)>
        <!ELEMENT GPS_week (#PCDATA)>
      <!ELEMENT GPS_TOW_assist (sat_id,tlm_word,anti_sp,alert,tlm_res)>
        <!ELEMENT sat_id (#PCDATA)>
        <!ELEMENT tlm_word (#PCDATA)>
        <!ELEMENT anti_sp (#PCDATA)>
        <!ELEMENT alert (#PCDATA)>
        <!ELEMENT tlm_res (#PCDATA)>
      <!ELEMENT DGPS_corrections (sat_id,iode,UDRE,PRC,RRC,delta_PRC2?,delta_RRC2?)>
        <!ELEMENT iode (#PCDATA)>
        <!ELEMENT UDRE (#PCDATA)>
        <!ELEMENT PRC (#PCDATA)>
        <!ELEMENT RRC (#PCDATA)>
        <!ELEMENT delta_PRC2 (#PCDATA)>
        <!ELEMENT delta_RRC2 (#PCDATA)>
      <!ELEMENT nav_model_elem (sat_id,sat_status,ephem_and_clock?)>
        <!ELEMENT sat_status EMPTY>
        <!-- ATTLIST sat_status literal (NS_NN-U|ES_NN-U|NS_NN|ES_SN|REVD) #REQUIRED -->
        <!ELEMENT ephem_and_clock
(12_code,ura,sv_health,iodc,l2p_flag,esr1,esr2,esr3,esr4,tgd,toc,af2,af1,af0,crs,delta_n,m0,cuc,ecc,
cus,power_half,toe,fit_flag,aoda,cic,omega0,cis,i0,crc,omega,omega_dot,idot,derived?)>
          <!ELEMENT 12_code (#PCDATA)>
          <!ELEMENT ura (#PCDATA)>
          <!ELEMENT sv_health (#PCDATA)>
          <!ELEMENT iodc (#PCDATA)>
          <!ELEMENT l2p_flag (#PCDATA)>
          <!ELEMENT esr1 (#PCDATA)>
          <!ELEMENT esr2 (#PCDATA)>
          <!ELEMENT esr3 (#PCDATA)>
          <!ELEMENT esr4 (#PCDATA)>
          <!ELEMENT tgd (#PCDATA)>
          <!ELEMENT toc (#PCDATA)>
          <!ELEMENT af2 (#PCDATA)>
          <!ELEMENT af1 (#PCDATA)>
          <!ELEMENT af0 (#PCDATA)>
          <!ELEMENT crs (#PCDATA)>
          <!ELEMENT delta_n (#PCDATA)>
          <!ELEMENT m0 (#PCDATA)>
          <!ELEMENT cuc (#PCDATA)>
          <!ELEMENT ecc (#PCDATA)>
          <!ELEMENT cus (#PCDATA)>
          <!ELEMENT power_half (#PCDATA)>
          <!ELEMENT toe (#PCDATA)>
          <!ELEMENT fit_flag (#PCDATA)>
          <!ELEMENT aoda (#PCDATA)>
          <!ELEMENT cic (#PCDATA)>
          <!ELEMENT omega0 (#PCDATA)>
          <!ELEMENT cis (#PCDATA)>
          <!ELEMENT i0 (#PCDATA)>
          <!ELEMENT crc (#PCDATA)>
          <!ELEMENT omega (#PCDATA)>
          <!ELEMENT omega_dot (#PCDATA)>
          <!ELEMENT idot (#PCDATA)>
          <!-- data derived locally, e.g from EE -->
          <!-- ELEMENT ionospheric_model (alfa0,alfa1,alfa2,alfa3,beta0,beta1,beta2,beta3) -->
            <!ELEMENT alfa0 (#PCDATA)>
            <!ELEMENT alfa1 (#PCDATA)>

```

```

<!ELEMENT alfa2 (#PCDATA)>
<!ELEMENT alfa3 (#PCDATA)>
<!ELEMENT beta0 (#PCDATA)>
<!ELEMENT beta1 (#PCDATA)>
<!ELEMENT beta2 (#PCDATA)>
<!ELEMENT beta3 (#PCDATA)>
<!ELEMENT UTC_model (a1,a0,tot,wnt,dtls,wlnsf,dn,dtlsf)>
  <!ELEMENT a1 (#PCDATA)>
  <!ELEMENT a0 (#PCDATA)>
  <!ELEMENT tot (#PCDATA)>
  <!ELEMENT wnt (#PCDATA)>
  <!ELEMENT dtls (#PCDATA)>
  <!ELEMENT wlnsf (#PCDATA)>
  <!ELEMENT dn (#PCDATA)>
  <!ELEMENT dtlsf (#PCDATA)>
<!ELEMENT almanac (wna,alm_elem*)>
  <!ELEMENT wna (#PCDATA)>
  <!ELEMENT alm_elem
(data_id?,sat_id,alm_ecc,alm_toa,alm_ksii,alm_omega_dot,alm_sv_health,alm_power_half,alm_omega0,alm_
omega,alm_m0,alm_af0,alm_af1)>
  <!ELEMENT data_id (#PCDATA)>
  <!ELEMENT alm_ecc (#PCDATA)>
  <!ELEMENT alm_toa (#PCDATA)>
  <!ELEMENT alm_ksii (#PCDATA)>
  <!ELEMENT alm_omega_dot (#PCDATA)>
  <!ELEMENT alm_sv_health (#PCDATA)>
  <!ELEMENT alm_power_half (#PCDATA)>
  <!ELEMENT alm_omega0 (#PCDATA)>
  <!ELEMENT alm_omega (#PCDATA)>
  <!ELEMENT alm_m0 (#PCDATA)>
  <!ELEMENT alm_af0 (#PCDATA)>
  <!ELEMENT alm_af1 (#PCDATA)>
  <!ELEMENT GPS_rt_integrity (bad_satellite_set)>
    <!ELEMENT bad_satellite_set (sat_id+) <!-- 1..16 -->
<!ELEMENT msr_assist_data EMPTY>
<!ELEMENT system_info_assist_data EMPTY>
<!ELEMENT more_assist_data EMPTY>
<!ELEMENT ext_container EMPTY>
<!ELEMENT rel98_assist_data_ext EMPTY>
<!ELEMENT rel5_assist_data_ext EMPTY>
<!ELEMENT rel7_assist_data_ext EMPTY>
<!ELEMENT OTDOA_assist_data (OTDOA_ref_cell_info,OTDOA_neighbour_cell_info_list)>
  <!ELEMENT OTDOA_ref_cell_info
(phys_cell_id,cell_global_id,earfcn_ref?,antenna_port_conf?,cp_length,prs_info?)>
  <!ELEMENT phys_cell_id (#PCDATA) <!-- 0..503 -->
  <!ELEMENT cell_global_id (plmn_identity,cell_identity)>
    <!ELEMENT plmn_identity (mcc,mnc)>
      <!ELEMENT mcc (#PCDATA)>
      <!ELEMENT mnc (#PCDATA)>
    <!ELEMENT cell_identity #PCDATA> <!-- 32-bit extended UTRAN cell ID; in case the cell
ID is shorter, the most significant bits are set to 0. -->
  <!ELEMENT earfcn_ref (#PCDATA) <!-- 0..65535 -->
  <!ELEMENT antenna_port_conf EMPTY>
    <!ATTLIST antenna_port_conf ports(ports1-or-2|ports4) "ports1-or-2">
  <!ELEMENT cp_length EMPTY>
    <!ATTLIST cp_length literal(normal|extended) #REQUIRED>
  <!ELEMENT prs_info (prs_bandwidth,prs_conf_index,num_dl_frames,prs_muting_info_r9?)>
    <!ELEMENT prs_bandwidth EMPTY>
      <!ATTLIST prs_bandwidth literal(n6|n15|n25|n50|n75|n100)>
    <!ELEMENT prs_conf_index (#PCDATA) <!-- 0..4095 -->
    <!ELEMENT num_dl_frames EMPTY>
      <!ATTLIST num_dl_frames literal(sf-1|sf-2|sf-4|sf-6)#REQUIRED>
    <!ELEMENT prs_muting_info_r9 muting_info>
      <!ATTLIST prs_muting_info_r9 literal(po2-r9|po4-r9|po8-r9|po16-r9) #REQUIRED>
    <!ELEMENT muting_info (#PCDATA)>
  <!ELEMENT OTDOA_neighbour_cell_info_list (OTDOA_neighbour_freq_info)+>
    <!ELEMENT OTDOA_neighbour_freq_info (OTDOA_neighbour_cell_info_element)+>
    <!ELEMENT OTDOA_neighbour_cell_info_element
(phys_cell_id,cell_global_id?,earfcn?,cp_length?,prs_info?,antenna_port_conf?,slot_number_offset?,pr
s_subframe_offset?,expected_RSTD,expected_RSTD_uncertainty)>
      <!ELEMENT phys_cell_id (#PCDATA) <!-- 0..503 -->
      <!ELEMENT cell_global_id (#PCDATA)>
      <!ELEMENT earfcn (#PCDATA) <!-- 0..65535 -->
      <!ELEMENT cp_length EMPTY>
        <!ATTLIST cp_length literal(normal|extended) #REQUIRED>
      <!ELEMENT prs_info (prs_bandwidth,prs_conf_index,num_dl_frames,prs_muting_info_r9?)>
        <!ELEMENT prs_bandwidth EMPTY>
          <!ATTLIST prs_bandwidth literal(n6|n15|n25|n50|n75|n100)>

```

```

        <!ELEMENT prs_conf_index (#PCDATA)> <!-- 0..4095 -->
        <!ELEMENT num_dl_frames EMPTY>
        <!ATTLIST num_dl_frames literal(sf-1|sf-2|sf-4|sf-6)#REQUIRED>
        <!ELEMENT prs_muting_info_r9 muting_info>
        <!ATTLIST prs_muting_info_r9 literal(po2-r9|po4-r9|po8-r9|po16-r9) #REQUIRED>
        <!ELEMENT muting_info (#PCDATA)>
        <!ELEMENT antenna_port_conf EMPTY>
        <!ATTLIST antenna_port_conf ports(ports1-or-2|ports4) "ports1-or-2">
        <!ELEMENT slot_number_offset (#PCDATA)> <!-- 0..19 -->
        <!ELEMENT prs_subframe_offset (#PCDATA)> <!-- 0..1279 -->
        <!ELEMENT expected_RSTD (#PCDATA)> <!-- 0..16383 -->
        <!ELEMENT expected_RSTD_uncertainty (#PCDATA)> <!-- 0..1023 -->
        <!ELEMENT GNSS_loc_server_err_EMPTY>
        <!ATTLIST GNSS_loc_server_err literal (undefined_error|
        undelivered_assistance_data_not_supported|
        undelivered_assistance_data_supported_but_currently_not_available|undelivered_assistance_data_is_partly_not_supported_and_partly_not_available) #REQUIRED>
        <!ELEMENT OTDOA_loc_server_err_EMPTY>
        <!ATTLIST OTDOA_loc_server_err literal (undefined_error|assistance_data_not_supported|
        assistance_data_supported_but_currently_not_available) #REQUIRED>
        <!ELEMENT Sensor_assist_data (ref_pressure?,ref_position?,ref_temperature?)>
        <!ELEMENT ref_pressure (#PCDATA)> <!-- -20000..10000 -->
        <!ELEMENT ref_position (ellipsoid_point_alt_uncertellipse)>
        <!ELEMENT ref_temperature (#PCDATA)> <!-- -64..63 -->
        <!ELEMENT TBS_assist_data (almanac?,acqu_assist?)>
        <!ELEMENT almanac (trans_id,trans_lat,trans_long,trans_alt,time_correct?)>
        <!ELEMENT trans_id (#PCDATA)> <!-- 0..32767 -->
        <!ELEMENT trans_lat (#PCDATA)>
        <!ELEMENT trans_long (#PCDATA)>
        <!ELEMENT trans_alt (#PCDATA)>
        <!ELEMENT time_correct (#PCDATA)> <!-- 0..25 -->
        <!ELEMENT acqu_assist (trans_id?,mbs_config?,pn_code?,freq?)>
        <!ELEMENT trans_id (#PCDATA)> <!-- 0..32767 -->
        <!ELEMENT mbs_config EMPTY>
        <!ATTLIST mbs_config literal(tb1|tb2|tb3|tb4)>
        <!ELEMENT pn_code (#PCDATA)> <!-- 1..128 -->
        <!ELEMENT freq (#PCDATA)> <!-- 919750000..927250000 -->
        <!ELEMENT Sensor_loc_server_err_EMPTY>
        <!ATTLIST Sensor_loc_server_err literal (undefined_error|assistance_data_not_supported|
        assistance_data_supported_but_currently_not_available) #REQUIRED>
        <!ELEMENT TBS_loc_server_err_EMPTY>
        <!ATTLIST TBS_loc_server_err literal (undefined_error|assistance_data_not_supported|
        assistance_data_supported_but_currently_not_available) #REQUIRED>

```

NOTE 4: For the elements and the value ranges of assistance data information delivered from the network, refer to 3GPP TS 25.331 [74] (clause 10.3.7.90), 3GPP TS 36.355 [115] (clause 6.5.1) and 3GPP TS 44.031 [79] (clause A.4.2.4). The value ranges of the relevant parameters are described in the ASN.1 syntax.

NOTE 5: For the element 'location_parameters', see table 8.50-2. In the context of this XML, the 'location_parameters' will describe a reference location.

NOTE 6: The elements ext_container, rel98_assist_data_ext, rel5_assist_data_ext and rel7_assist_data_ext are deprecated.

Table 8.55-6: XML DTD for <GSM_time>, <WCDMA_time>, <LTE_time>, <TimeUnc>

```

<!ELEMENT GSM_time (frame_number,frame_number_msb,time_slot_number,bit_number,BCCH_carrier?,BSIC?)>
  <!ELEMENT frame_number (#PCDATA)>
  <!ELEMENT frame_number_msb (#PCDATA)>
  <!ELEMENT time_slot_number (#PCDATA)>
  <!ELEMENT bit_number (#PCDATA)>
  <!ELEMENT BCCH_carrier (#PCDATA)>
  <!ELEMENT BSIC (#PCDATA)>

<!ELEMENT WCDMA_time (cell_timing_chips,(FDD_CPICH|TDD_cell_id|SFN),SFN_TOW_Unc?)>
  <!ELEMENT cell_timing_chips (#PCDATA)>
  <!ELEMENT FDD_CPICH (#PCDATA)>
  <!ELEMENT TDD_cell_id (#PCDATA)>
  <!ELEMENT SFN (#PCDATA)>
  <!ELEMENT SFN_TOW_Unc (#PCDATA)> <!-- Integer 0..1 0- Uncertainty less than 10 ms, 1-
  Uncertainty more than 10 ms -->

<!ELEMENT LTE_time (secFromFrameStructStart,fractSecFromFrameStructStart,
frameDrift?,physCellId,cellGlobalIdEUTRA?,earfcn,TimeUnc)>

```

```

<!ELEMENT secFromFrameStructStart (#PCDATA)> <!-- 0..12533 -->
<!ELEMENT fractSecFromFrameStructStart (#PCDATA)> <!-- 0..3999999 -->
<!ELEMENT frameDrift (#PCDATA)> <!-- -64..63 -->
<!ELEMENT physCellId (#PCDATA)>
<!ELEMENT cellGlobalIdEUTRA (#PCDATA)>
<!ELEMENT earfcn (#PCDATA)>

<!ELEMENT TimeUnc EMPTY>
<!-- ATTLLIST TimeUnc
Value CDATA "127"
units (s|ms|us|rrlp_k|rrc_k|lpp_k) "rrc_k">

```

Table 8.55-7: XML DTD for <acqu_assist>

```

<!ELEMENT acqu_assist (tow_msec,sat_info*,confidence_r10?)>
  <!ELEMENT tow_msec (#PCDATA)>
  <!ELEMENT sat_info
(sat_id,dopl0,dopl_extra?,code_ph,code_ph_int,GPS_bitno,srch_w,az_el?,doppler_uncertainty_ext_r10?)>
    <!ELEMENT dopl0 (#PCDATA)>
      <!-- ATTLLIST dopl0 units (rrlp|rrc|lpp|Hz|mps) "rrlp">
      <!-- rrlp gps is 2.5 Hz -->
      <!-- rrc gps is 2.5 Hz -->
      <!-- lpp gnss is 0.5 m/s -->
    <!ELEMENT dopl_extra (dopl1,dopl1_uncert)>
      <!ELEMENT dopl1 (#PCDATA)>
        <!-- ATTLLIST dopl1 units (rrlp|rrc|lpp) "rrlp">
        <!-- rrlp is 1/42 Hz/s -->
        <!-- rrc is 0.023 Hz/s -->
        <!-- lpp is 1/210 m/s/s -->
      <!ELEMENT dopl1_uncert EMPTY>
        <!-- ATTLLIST dopl1_uncert literal (hz12-5|hz25|hz50|hz100|hz200) #REQUIRED>
    <!ELEMENT code_ph (#PCDATA)>
      <!-- ATTLLIST code_ph units (chips|ms) "chips">
      <!-- chips used for GPS in RRLP and RRC, ms used for LPP -->
    <!ELEMENT code_ph_int (#PCDATA)>
    <!ELEMENT GPS_bitno (#PCDATA)>
    <!ELEMENT srch_w (#PCDATA)>
    <!ELEMENT az_el (az,elev)>
      <!ELEMENT az (#PCDATA)>
        <!-- ATTLLIST az_el units (rrlp|lpp|degree) "rrlp">
        <!-- rrlp and rrc have units of 11.25 degree -->
        <!-- lpp has units of 0.703125 degrees -->
      <!ELEMENT elev (#PCDATA)>
    <!ELEMENT doppler_uncertainty_ext_r10>
      <!-- ATTLLIST doppler_uncertainty_ext_r10 (d60|d80|d100|d120|no_information) #IMPLIED>
    <!ELEMENT confidence_r10 (#PCDATA)> <!-- 0..100 -->

```

NOTE 7: Units of mps, lpp and ms are used with GNSS procedures.

Table 8.55-8: XML DTD for <pos_meas>

```

<!ELEMENT pos_meas (meas_abort|RRLP_meas|RRC_meas)>
  <!ELEMENT meas_abort EMPTY>
  <!ELEMENT RRLP_meas (RRLP_pos_instruct)>
    <!ELEMENT RRLP_pos_instruct (RRLP_method_type,RRLP_method,resp_time_seconds,mult_sets)>
      <!ELEMENT RRLP_method_type
(ms_assisted|ms_assisted_no_accuracy|ms_based|ms_based_pref|ms_assisted_pref)>
        <!ELEMENT ms_assisted (method_accuracy)>
          <!ELEMENT method_accuracy (#PCDATA)>
        <!ELEMENT ms_assisted_no_accuracy EMPTY>
        <!ELEMENT ms_based (method_accuracy)>
        <!ELEMENT ms_based_pref (method_accuracy)>
        <!ELEMENT ms_assisted_pref (method_accuracy)>
      <!ELEMENT RRLP_method EMPTY>
        <!-- ATTLLIST RRLP_method literal (gps) #REQUIRED>
      <!ELEMENT resp_time_seconds (#PCDATA)>
      <!ELEMENT mult_sets EMPTY>
        <!-- ATTLLIST mult_sets literal (multiple|one) #REQUIRED>
    <!ELEMENT RRC_meas (rep_quant,rep_crit)>
      <!ELEMENT rep_quant (RRC_method_type,RRC_method,hor_acc?,vert_acc?)>
        <!-- ATTLLIST rep_quant
gps_timing_of_cell_wanted (true|false) "false"
addl_assist_data_req (true|false) #REQUIRED>
      <!ELEMENT RRC_method_type EMPTY>

```

```

        <!-- ATTLIST RRC_method_type literal (ue_assisted|ue_based|ue_based_pref|ue_assisted_pref)
#REQUIRED>
        <!-- ELEMENT RRC_method EMPTY>
        <!-- ATTLIST RRC_method literal (otdoa|gps|otdoaOrGPS|cellID) #REQUIRED>
        <!-- ELEMENT hor_acc (#PCDATA)>
        <!-- ELEMENT vert_acc (#PCDATA)>
        <!-- ELEMENT rep_crit (no_rep|event_rep_crit|period_rep_crit)>
        <!-- ELEMENT no_rep EMPTY>
        <!-- ELEMENT event_rep_crit (event_par*)>
        <!-- ELEMENT event_par (rep_amount,meas_interval,event_specific_info?)>
        <!-- ATTLIST event_par report_first_fix (true|false) #REQUIRED>
        <!-- ELEMENT rep_amount EMPTY>
        <!-- ATTLIST rep_amount literal (ra1|ra2|ra4|ra8|ra16|ra32|ra64|ra-Infinity)
#REQUIRED>
        <!-- ELEMENT meas_interval EMPTY>
        <!-- ATTLIST meas_interval literal (e5|e15|e60|e300|e900|e1800|e3600|e7200)
#REQUIRED>
        <!-- ELEMENT event_specific_info (tr_pos_chg|tr_SFN_SFN_chg|tr_SFN_GPS_TOW)>
        <!-- ELEMENT tr_pos_chg EMPTY>
        <!-- ATTLIST tr_pos_chg literal
(pc10|pc20|pc30|pc40|pc50|pc100|pc200|pc300|pc500|pc1000|pc2000|pc5000|pc10000|pc20000|pc50000|pc100
000) #REQUIRED>
        <!-- ELEMENT tr_SFN_SFN_chg EMPTY>
        <!-- ATTLIST tr_SFN_SFN_chg literal (c0-25|c0-
5|c1|c2|c3|c4|c5|c10|c20|c50|c100|c200|c500|c1000|c2000|c5000) #REQUIRED>
        <!-- ELEMENT tr_SFN_GPS_TOW EMPTY>
        <!-- ATTLIST tr_SFN_GPS_TOW literal (ms1|ms2|ms3|ms5|ms10|ms20|ms50|ms100)
#REQUIRED>
        <!-- ELEMENT period_rep_crit EMPTY>
        <!-- ATTLIST period_rep_crit rep_amount (ra1|ra2|ra4|ra8|ra16|ra32|ra64|ra-Infinity) "ra-
Infinity">
        <!-- ATTLIST period_rep_crit rep_interval_long (ril0|ril0-25|ril0-
5|ril1|ril2|ril3|ril4|ril6|ril8|ril12|ril16|ril20|ril24|ril28|ril32|ril64) #REQUIRED>

```

NOTE 8: For the elements and the value ranges of position measurements data, refer to 3GPP TS 25.331 [74] (clause 10.3.7.100) and 3GPP TS 44.031 [79] (clause A.2). The value ranges of the relevant parameters are described in the ASN.1 syntax.

Table 8.55-9: XML DTD for <pos_meas_req>

```

<!-- Alternative to pos_meas, supports RRLP, RRC and LPP -->
<!-- ELEMENT pos_meas_req (abort|(req_info,qos,loc_coordinate_types?))>
  <!-- ATTLIST pos_meas_req aid_req_allowed (yes|no) #IMPLIED> <!-- Present for RRC and LPP
procedures -->
  <!-- ELEMENT abort EMPTY>
  <!-- ELEMENT req_info (GNSS_allowed_methods?)>
    <!-- ATTLIST req_info loc_info_type (loc_req|meas_req|loc_pref|MSB_req|MSA_req|MSB_pref|MSA_pref)
"loc_req"
    velocity_req (true|false) "false"
    time_req (true|false) "false"
    multiple_sets (yes|no) "no"
    additional_info (yes|no) "no" <!-- lpp only --> <!-- MSB synonomous with loc_req -->
    <!-- ELEMENT GNSS_allowed_methods
(gps_method?,sbas_method?,qzss_method?,glonass_method?,BDS_method?)>
      <!-- ELEMENT gps_method EMPTY>
      <!-- ELEMENT sbas_method EMPTY>
      <!-- ELEMENT qzss_method EMPTY>
      <!-- ELEMENT glonass_method EMPTY>
      <!-- ELEMENT BDS_method EMPTY>
    <!-- ELEMENT qos (response_time?,(reporting_interval,amount)?,hacc?,vacc?)>
    <!-- The presence of reporting_interval implies a periodic procedure -->
    <!-- The absence of reporting_interval implies a one-shot procedure -->
    <!-- ELEMENT response_time(time,responseTimeEarlyFix-r12?)>
      <!-- ELEMENT time (#PCDATA)> <!-- 1..128 -->
      <!-- ELEMENT responseTimeEarlyFix-r12(#PCDATA)> <!-- 1..128,value of responseTimeEarlyFix-r12
should be less than time -->
    <!-- ELEMENT reporting_interval EMPTY>
    <!-- ATTLIST reporting_interval
ri_exp (ril1|ril2|ril3|ril4|ril6|ril8|ril12|ril16|ril20|ril24|ril28|ril32|ril64) "ril20" >
  <!-- ELEMENT amount EMPTY>
  <!-- ATTLIST amount amount (ra1|ra2|ra4|ra8|ra16|ra32|ra64|ra-Infinity) "ra-Infinity">
  <!-- ELEMENT hacc EMPTY>
  <!-- ATTLIST hacc
    accuracy_k CDATA #IMPLIED
    confidence CDATA #IMPLIED>

```

```

<!ELEMENT vacc EMPTY>
  <!ATTLIST vacc
    accuracy_k CDATA #IMPLIED
    confidence CDATA #IMPLIED>
<ELEMENT loc_coordinate_types(#PCDATA)>
  <!-- Integer corresponds to bit string 1-8 where bit at position if set, means location co-
  ordinate type is supported bit0-ellipsoidPoint supported,bit1-ellipsoidPointWithUncertaintyCircle
  supported,bit2-ellipsoidPointWithUncertaintyEllipse supported,bit3-polygon
  supported,bit4ellipsoidPointWithAltitude
  supported,bit5ellipsoidPointWithAltitudeAndUncertaintyEllipsoid supported,bit6-ellipsoidArc
  supported -->

```

Table 8.55-10: XML DTD for <GPS_meas>

```

<!ELEMENT GPS_meas (ref_time_only,meas_params*)>
  <!ELEMENT ref_time_only (tow_msec)>
  <!ELEMENT meas_params (sat_id,carr2_noise,dopl,whole_chips,fract_chips,multi_path,psr_rms_err)>
    <!ELEMENT carr2_noise (#PCDATA)>
    <!ELEMENT dopl (#PCDATA)>
    <!ELEMENT whole_chips (#PCDATA)>
    <!ELEMENT fract_chips (#PCDATA)>
    <!ELEMENT multi_path EMPTY>
      <!ATTLIST multi_path literal (not_measured|low|medium|high) #REQUIRED>
    <!ELEMENT psr_rms_err (#PCDATA)>

```

NOTE 9: For the elements and the value ranges of GPS measurement data, refer to 3GPP TS 25.331 [74] (clause 10.3.7.93) and 3GPP TS 44.031 [79] (clause A.3.2.5). The value ranges of the relevant parameters are described in the ASN.1 syntax.

Table 8.55-11: XML DTD for <GNSS_meas>

```

<!ELEMENT GNSS_meas ( GNSS_meas_for_one_gnss+,TOD_ms|ref_time_only,earlyFixReport-r12?)>
  <!ELEMENT GNSS_meas_for_one_gnss (GNSS_sgn_meas_element+)>
  <!ATTLIST GNSS_meas_for_one_gnss gnss_id GPS|SBAS|QZSS|Galileo|Glonass|BDS "GPS">
  <!ELEMENT GNSS_sgn_meas_element (code_phase_ambiguity?, GNSS_sat_meas_element+)>
    <!ATTLIST GNSS_sgn_meas_element measured_signal (GPS_L1|GPS_L1C|GPS_L2C|GPS_L5|SBAS_L1|GLO_G1|
    GLO_G2|GLO_G3|BDS_B11) "GPS_L1">
    <!ELEMENT code_phase_ambiguity (#PCDATA)> <!-- 0..127 -->
    <!ELEMENT GNSS_sat_meas_element
    (sat_id,carr2_noise,doppler_mps?,code_phase_ms?,integer_code_phase?,multi_path,psr_rms_err,adr?,whol
    e_chips?,fract_chips?,carrier_quality_ind?)>
    <!ELEMENT doppler_mps (#PCDATA)> <!-- m/s Range -32768..32767 -->
    <!ELEMENT code_phase_ms (#PCDATA)> <!-- ms Range 0..2097151 -->
    <!ELEMENT integer_code_phase (#PCDATA)>
    <!ELEMENT adr (#PCDATA)>
    <!ELEMENT carrier_quality_ind (#PCDATA)> <!-- 0..3 -->
    <!ELEMENT TOD_ms (gnss_TOD_msec,gnss_TOD_frac?,gnss_TOD_unc?) >
    <!ATTLIST TOD_ms gnss_time_id (GPS|Glonass|QZSS|BDS) "GPS">
  <!ELEMENT earlyFixReport-r12 EMPTY>

```

NOTE 10: 'GNSS_meas' is used for reporting measurements results for GNSS procedures i.e. procedures where: 'GNSS_allowed_methods', 'GNSS_assist' was received or where 'acqu_assist' uses units of ms.

NOTE 10a: 'ref_time_only' shall be provided by the TE for gnss_id="GPS", refer to 3GPP TS 25.331 [74] (clause 10.3.7.93) and 3GPP TS 44.031 [79] (clause A.3). Usage of the element 'GNSS_meas' in 'GNSS_provided_location_information' can be omitted as 'GNSS_meas' is already present in 'pos'.

NOTE 10b: 'whole_chips' and 'fract_chips' to be provided for gnss_id="GPS"

Table 8.55-12: XML DTD for <GPS_assist_req>

```

<!ELEMENT GPS_assist_req (nav_addl_data?)>
  <!ATTLIST GPS_assist_req
    alm_req (true|false) "false"
    UTC_model_req (true|false) "false"
    ion_req (true|false) "false"

```

```

nav_model_req (true|false) "false"
DGPS_corr_req (true|false) "false"
ref_loc_req (true|false) "false"
ref_time_req (true|false) "false"
aqu_assist_req (true|false) "false"
rt_integr_req (true|false) "false">
<!ELEMENT nav_addl_data (GPS_week,GPS_toe,ttoe_limit,addl_req_sat*)>
  <!ELEMENT GPS_toe (#PCDATA)>
  <!ELEMENT ttoe_limit (#PCDATA)>
  <!ELEMENT addl_req_sat (sat_id,iode)>

```

NOTE 11: For requesting assistance data, refer to 3GPP TS 25.331 [74] (clause 10.3.7.88a) and 3GPP TS 49.031 [80] (clause 10.10).

Table 8.55-13: XML DTD for <msg>

```

<!ELEMENT msg EMPTY>
  <!ATTLIST msg status (assist_data_delivered|abort_confirm) #REQUIRED>

```

NOTE 12: 'assist_data_delivered' can be used as an indication of completion of provision of assistance data.

NOTE 12a: 'abort_confirm' can be used as an indication for positioning abort confirmation.

Table 8.55-14: XML DTD for <pos_err>

```

<!ELEMENT pos_err (err_reason,GPS_assist_req?,ECID_meas_error_cause?,GNSS_assist_req?)>
  <!ELEMENT err_reason EMPTY>
  <!ATTLIST err_reason literal
(undefined_error|not_enough_gps_satellites|gps_assist_data_missing|gnss_assist_data_missing|not_enough_gnss_satellites|OTDOA_undefined|OTDOA_assistance_data_missing|OTDOA_unable_to_measure_referencecell|OTDOA_unable_to_measure_any_neighbourcell|OTDOA_attempted_but_unable_to_measure_some_neighbourcells|ECID_undefined|ECID_requested_measurement_not_available|ECID_not_all_requested_measurements_possible|Bluetooth_undefined|Bluetooth_not_all_requested_measurements_possible|Sensor_undefined|TBS_undefined|TBS_not_enough_MBS_beacons|WLAN_undefined|WLAN_not_all_requested_measurements_possible)
#REQUIRED>
  <!ELEMENT ECID_meas_error_cause (#PCDATA)> <!-- Integer corresponds to bit string 1-8 where bit at position represents ECID error cause. Only applicable, when value of err_reason = "ECID_not_all_requested_measurements_possible" bit0-rsrpMeasurementNotPossible, bit1-rsrqMeasurementNotPossible, bit2-ueRxTxMeasurementNotPossible -->

```

NOTE 13: For reporting positioning error, refer to 3GPP TS 25.331 [74] (clause 10.3.7.87) and 3GPP TS 44.031 [79] (clause A.3.2.6).

NOTE 13a: For reporting GNSS related positioning errors, refer to 3GPP TS 36.355 [115] (clause 6.5.2.12) for LPP, 3GPP TS 25.331 [74] (clause 10.3.7.87) for RRC and 3GPP TS 44.031 [79] (clause A.3.2.6) for RRLP.

NOTE 13b: For reporting OTDOA and ECID errors, refer to 3GPP TS 36.355 [115] (clause 6.5.1.9) for OTDOA specific errors and 3GPP TS 36.355 [115] (clause 6.5.3.6) for ECID specific errors.

NOTE 13c: For reporting Bluetooth, Sensor, TBS and WLAN errors, refer to 3GPP TS 36.355 [115] for specific errors.

Table 8.55-15: XML DTD for <GNSS_assist>, <GNSS_assist_req>

```

<!ELEMENT GNSS_assist
(GNSS_ref_time?,GNSS_ref_location?,GNSS_ref_measurement_assist?,GNSS_ionospheric_model?,GNSS_earth_orient_param?,GNSS_additional_ion_model?,GNSS_time_model,GNSS_nav_model?,GNSS_integrity?,acqu_assist*,GNSS_databitassistance?,GNSS_almanac?,GNSS_UTC_model?,BDS-GridModel-r12?,GNSS_auxiliary_info?)>
  <!ATTLIST GNSS_assist
gnss_id (SBAS|MGNOS|QZSS|Glonass|GPS|BDS) #IMPLIED
sbas_id (WASS|EGNOS|MSAS|GAGAN) #IMPLIED>
<!ELEMENT GNSS_ref_time (GNSS_day,GNSS_TOD_s,notification_leap_sec?,GNSS_TOD_frac_ms?,TimeUnc?)>
  <!ATTLIST GNSS_ref_time gnss_time_id (GPS|Glonass|QZSS|BDS) #REQUIRED>
  <!ELEMENT GNSS_day (#PCDATA)>
  <!ELEMENT GNSS_TOD_s (#PCDATA)> <!-- 0..86399 seconds -->
  <!ELEMENT GNSS_TOD_frac_ms (#PCDATA)> <!-- 0..999 milli-seconds -->

```

```

<!-- TOD Uncertainty presented in TimeUnc -->
<!ELEMENT notification_leap_sec (#PCDATA) > <!-- hex LPP only -->
<!ELEMENT GNSS_ref_location (location_parameters)>
<!ELEMENT GNSS_ref_measurement_assist (acqu_assist)>
<!ELEMENT GNSS_ionospheric_model (gnss_ion_ai0,gnss_ion_ai1,gnss_ion_ai2,gnss_ion_flags?)>
  <!ELEMENT gnss_ion_ai0 (#PCDATA)> <!-- range 0..4095 -->
  <!ELEMENT gnss_ion_ai1 (#PCDATA)> <!-- range 0..4095 -->
  <!ELEMENT gnss_ion_ai2 (#PCDATA)> <!-- range 0..4095 -->
  <!ELEMENT gnss_ion_flags EMPTY>
  <!ATTLIST gnss_ion_flags
    storm_flag1 (0|1) "0"
    storm_flag2 (0|1) "0"
    storm_flag3 (0|1) "0"
    storm_flag4 (0|1) "0"
    storm_flag5 (0|1) "0">
<!ELEMENT GNSS_earth_orient_param
(gnss_eop_teop,gnss_eop_pmX,gnss_eop_pmX_d,gnss_eop_pmY,gnss_eop_pmY_d,gnss_eop_deltaUT1,gnss_eop_deltaUT1_d)>
  <!ELEMENT gnss_eop_teop (#PCDATA)> <!-- range 0..65535 -->
  <!ELEMENT gnss_eop_pmX (#PCDATA)> <!-- range -1048576..1048575 -->
  <!ELEMENT gnss_eop_pmX_d (#PCDATA)> <!-- range -16384..16383 -->
  <!ELEMENT gnss_eop_pmY (#PCDATA)> <!-- range -1048576..1048575 -->
  <!ELEMENT gnss_eop_pmY_d (#PCDATA)> <!-- range -16384..16383 -->
  <!ELEMENT gnss_eop_deltaUT1 (#PCDATA)> <!-- range -1073741824..1073741823 -->
  <!ELEMENT gnss_eop_deltaUT1_d (#PCDATA)> <!-- range -262144..262143 -->
<!ELEMENT GNSS_additional_ion_model (ionospheric_model)>
  <!ATTLIST GNSS_additional_ion_model
    ion_model_data_id (00|11|01) "00"> <!-- from rrlp 11=QZSS 00=other 01=BDS -->
<!ELEMENT GNSS_time_model (tme_ref_time,tme_A0,tme_A1?,tme_A2?,tme_week?)>
  <!ATTLIST GNSS_time_model gnss_time_id (GPS|Glonass|QZSS|BDS)#REQUIRED>
  <!ELEMENT tme_ref_time (#PCDATA)> <!-- sec scale 2**4 -->
  <!ELEMENT tme_A0 (#PCDATA)> <!--sec scale 2**35 -->
  <!ELEMENT tme_A1 (#PCDATA)> <!-- sec/sec scale 2**51 -->
  <!ELEMENT tme_A2 (#PCDATA)> <!-- sec/sec sec scale 2**68 -->
  <!ELEMENT tme_week (#PCDATA)> <!-- 0..8191 -->
<!ELEMENT GNSS_nav_model (GNSS_satellite+)>
  <!ATTLIST GNSS_nav_model
    non_broadcast_ind_flag (0|1) "0">
<!ELEMENT GNSS_satellite (sat_id,nms_health,nms_iod,
((nms_clock_nav,nms_orbit_nav)|
(nms_clock_cnav,nms_orbit_cnav)|
(nms_clock_glonass,nms_orbit_glonass)|
(nms_clock_sbas,nms_orbit_sbas)|
(nms_clock_bds,nms_orbit_bds)))>
  <!ELEMENT nms_health (#PCDATA)> <!-- in hexadecimal -->
  <!ELEMENT nms_iod (#PCDATA)> <!-- includes iod_msb -->
<!ELEMENT GNSS_integrity (bad_signal*)>
  <!ELEMENT bad_signal (sat_id,GNSS_signal?)>
  <!ELEMENT GNSS_signal (#PCDATA)>
<!ELEMENT GNSS_databitassistance (gnss-TOD,gnss-TODfrac?,gnss-DataBitsSatList+)>
<!ELEMENT gnss-TOD (#PCDATA)> <!-- 0..3599 -->
  <!ELEMENT gnss-TODfrac (#PCDATA)> <!-- 0..99 -->
  <!ELEMENT gnss-DataBitsSatList(sat_id,gnss-DataBitsSgnList+)>
  <!ATTLIST gnss-DataBitsSatList signal_id
(GPS_L1|GPS_L1C|GPS_L2C|GPS_L5|SBAS_L1|GLO_G1|GLO_G2|GLO_G3|BDS_B1I) "GPS_L1">
  <!ELEMENT gnss-DataBitsSgnList (GNSS_databits)> <>
  <!ELEMENT GNSS_databits (#PCDATA)> <!-- 1..1024 -->
  <!ELEMENT GNSS_almanac(week_number?,toa,ioda?,completeAlmanacProvided,gnss-AlmanacList+)>
  <!ELEMENT week_number (#PCDATA)> <!-- 0..255 -->
  <!ELEMENT toa (#PCDATA)> <!-- 0..255 -->
  <!ELEMENT ioda(#PCDATA)> <!-- 0..3 -->
  <!ELEMENT completeAlmanacProvided (#PCDATA)>
  <!ELEMENT gnss-AlmanacList(keplerianBDS-Almanac-r12)>
  <!ELEMENT keplerianBDS-Almanac-r12(sat_id,bdsAlmToa-r12?,bdsAlmSqrtA-r12,bdsAlmE-r12,bdsAlmW-r12,bdsAlmM0-r12,bdsAlmOmega0-r12,bdsAlmOmegaDot-r12,bdsAlmDeltaI-r12,bdsAlmA0-r12,bdsAlmA1-r12,bdsSvHealth-r12?)>
  <!ELEMENT bdsAlmToa-r12 (#PCDATA)> <!-- 0..256 -->
  <!ELEMENT bdsAlmSqrtA-r12 (#PCDATA)> <!-- 0..16777215 -->
  <!ELEMENT bdsAlmE-r12 (#PCDATA)> <!-- 0..131071 -->
  <!ELEMENT bdsAlmW-r12 (#PCDATA)> <!-- -8388608..8388607 -->
  <!ELEMENT bdsAlmM0-r12 (#PCDATA)> <!-- -8388608..8388607 -->
  <!ELEMENT bdsAlmOmega0-r12(#PCDATA)> <!-- -8388608..8388607 -->
  <!ELEMENT bdsAlmOmegaDot-r12 (#PCDATA)> <!-- -65536..65535 -->
  <!ELEMENT bdsAlmDeltaI-r12 (#PCDATA)> <!-- -32768..32767 -->
  <!ELEMENT bdsAlmA0-r12 (#PCDATA)> <!-- -1024..1023 -->
  <!ELEMENT bdsAlmA1-r12 (#PCDATA)> <!-- -1024..1023 -->
  <!ELEMENT bdsSvHealth-r12(#PCDATA)> <!-- 0..3599 -->

```



```

<!ELEMENT GNSS.UTC_model (utcModel5-r12)>
  <!ELEMENT utcModel5-r12 (utcA0-r12,utcA1-r12,utcDeltaTls-r12,utcWNlsf-r12,utcDN-r12,utcDeltaTlsf-r12)>
    <!ELEMENT utcA0-r12 (#PCDATA)> <!-- -2147483648..2147483647 -->
    <!ELEMENT utcA1-r12 (#PCDATA)> <!-- -8388608..8388607 -->
    <!ELEMENT utcDeltaTls-r12 (#PCDATA)> <!-- -128..127 -->
    <!ELEMENT utcWNlsf-r12 (#PCDATA)> <!-- 0..255 -->
    <!ELEMENT utcDN-r12(#PCDATA)> <!-- 0..255 -->
    <!ELEMENT utcDeltaTlsf-r12 (#PCDATA)> <!-- -128..127 -->

<!ELEMENT BDS-GridModel-r12(bds-RefTime-r12,gridIonList-r12+)>
  <!ELEMENT bds-RefTime-r12 (#PCDATA)> <!-- 0..3599 -->
  <!ELEMENT gridIonList-r12 (igp-ID-r12,dt-r12,givei-r12)>
    <!ELEMENT igp-ID-r12 (#PCDATA)> <!-- 1..320 -->
    <!ELEMENT dt-r12 (#PCDATA)> <!-- 0..511 -->
    <!ELEMENT givei-r12 (#PCDATA)> <!-- 0..15 -->
<!ELEMENT GNSS_auxiliary_info (GNSS_id_glonass)>
  <!ELEMENT GNSS_id_glonass (GNSS_id_glonass_sat_element+)>
    <!ELEMENT GNSS_id_glonass_sat_element (sat_id,GNSS_signal_id,channel_number?)> <!-- sat_id 0..63 -->
      <!ELEMENT GNSS_signal_id (#PCDATA)>
<!-- Integer corresponds to bit string 1-8 where bit at position if set, means particular signal is addressed; a zero-value at the particular bit position means the signal is not addressed -
-->
    <!ELEMENT channel_number (#PCDATA)> <!-- -7..13 -->

<!ELEMENT GNSS_assist_req (GNSS_assist_req_per_gnss*)>
  <!-- common assist req -->
  <!ELEMENT GNSS_ref_time_req EMPTY>
    <!ATTLIST GNSS_ref_time_req
      time_req_pref (SBAS|MGPS|QZSS|Glonass|GPS) #IMPLIED
      tow_req (false|true) "false"
      leap_sec_req (false|true) #IMPLIED>
  <!ELEMENT GNSS_ref_loc_req EMPTY>
  <!ELEMENT GNSS_ion_model_req EMPTY>
  <!ELEMENT GNSS_earth_orient_req EMPTY>

  <!-- generic req -->
  <!ELEMENT GNSS_assist_req_per_gnss
(GNSS_time_model_req?,GNSS_navigation_model_req?,GNSS_integrity_req?,GNSS_acquisition_req?,GNSS_auxiliary_info_req?,GNSS_databitassistance_req?,GNSS_Almanac_req?,GNSS_UTC_model_req?,BDS_grid_model_req_r12?)>
    <!ATTLIST GNSS_assist_req_per_gnss
      gnss_id (SBAS|MGPS|QZSS|Glonass|GPS) #REQUIRED
      sbas_id (WASS|EGNOS|MSAS|GAGAN) #IMPLIED>
  <!ELEMENT GNSS_time_model_req EMPTY>
  <!-- For LPP gnss-TO-IDsReq is derived from gnss_id -->
    <!ATTLIST GNSS_time_model_req delta_T_req (false|true) #IMPLIED>
  <!ELEMENT GNSS_navigation_model_req (stored_nav_list?,requested_nav_list?) >
    <!ELEMENT stored_nav_list
(snl_week_or_day,snl_toe,snl_toe_limit,stored_sat_list_element*,requested_nav_list?)>
      <!ELEMENT snl_week_or_day (#PCDATA)>
      <!ELEMENT snl_toe (#PCDATA)>
      <!ELEMENT snl_toe_limit (#PCDATA)>
      <!ELEMENT stored_sat_list_element EMPTY>
        <!ATTLIST stored_sat_list_element
          stored_id CDATA #REQUIRED
          stored_iod CDATA #REQUIRED
          stored_clock_model (2|3|4|5|6) #IMPLIED
          stored_orbit_model (2|3|4|5|6) #IMPLIED>
      <!ELEMENT requested_nav_list (requested_nav_list_info*)>
        <!ELEMENT requested_nav_list_info EMPTY>
          <!ATTLIST requested_nav_list_info
            requested_sv CDATA "00000000ffffffff"
            requested_clock_model (2|3|4|5|6) #IMPLIED
            requested_orbit_model (2|3|4|5|6) #IMPLIED
            requested_add_nav_param (false|true) #IMPLIED>
          <!-- requested_sv is a bit string in hexadecimal, needed for LPP -->
        <!ELEMENT GNSS_integrity_req EMPTY>
        <!ELEMENT GNSS_acquisition_req EMPTY>
          <!ATTLIST GNSS_acquisition_req signal
(GPS_L1|GPS_L1C|GPS_L2C|GPS_L5|SBAS_L1|GLO_G1|GLO_G2|GLO_G3|BDS_B1I) "GPS_L1">
        <!ELEMENT GNSS_databitassistance_req
(gnss_TOD_req,gnss_TOD_frag?,databit_interval,databit_reqsat_list+)>
          <!ATTLIST GNSS_databitassistance_req signal
(GPS_L1|GPS_L1C|GPS_L2C|GPS_L5|SBAS_L1|GLO_G1|GLO_G2|GLO_G3|BDS_B1I) "GPS_L1">
          confidence_support (yes|no) #IMPLIED
          doppler_uncertainty_ext_support(yes|no) #IMPLIED>

```

```

<!ELEMENT GNSS_auxiliary_info_req EMPTY>
<!ELEMENT gnss_TOD_req (#PCDATA)> <!-- 0..3599 -->
<!ELEMENT gnss_TOD_fraq (#PCDATA)> <!-- 0..599 -->
<!ELEMENT databit_interval (#PCDATA)> <!-- 0..15 -->
<!ELEMENT databit_reqsat_list (sat_id)> <!-- sat_id 0..63 -->
<!ELEMENT GNSS_Almanac_req >
<!ATTLIST GNSS_Almanac_req model (7)#IMPLIED>
<!ELEMENT GNSS_UTC_model_req >
<!ATTLIST GNSS_UTC_model_req model (5)#IMPLIED>
<!ELEMENT BDS_grid_model_req_r12 EMPTY>

```

NOTE 14:GNSS_assist is used for assistance data received via an RRLP ASN.1 GANSSAssistanceSet element (refer to 3GPP TS 44.031 [79]), via an RRC GANSS assistance data element (refer to 3GPP TS 25.331 [74] clause 10.3.7.90b) or via LPP.

NOTE 14a: The element 'GNSS_ref_measurement_assist' of 'GNSS_assist' and 'acqu_assist' of 'GNSS_assist', both hold 'acqu_assist' data. Therefore 'GNSS_ref_measurement_assist' can be omitted when 'acqu_assist' is present or vice versa.

Table 8.55-16: XML DTD for <nms_clock_nav>, <nms_orbit_nav>, <nms_clock_cnav>, <nms_orbit_cnav>

```

<!ELEMENT nms_clock_nav (nav_Toc,nav_af2,nav_af1,nav_af0,nav_Tgd)>
  <!ELEMENT nav_Toc (#PCDATA)> <!-- 0..37799 -->
  <!ELEMENT nav_af2 (#PCDATA)> <!-- -128..127 -->
  <!ELEMENT nav_af1 (#PCDATA)> <!-- -32768..32767 -->
  <!ELEMENT nav_af0 (#PCDATA)> <!-- -2097152..2097151 -->
  <!ELEMENT nav_Tgd (#PCDATA)> <!-- -128..127 -->

<!ELEMENT nms_orbit_nav
(nav_URA,nav_FitFlag,nav_Toe,nav_Omega,nav_DeltaN,nav_M0,nav_OmegaA_d,nav_E,nav_I_d,nav_APowerHalf,nav_I0,nav_OmegaA0,nav_Crs,nav_Cis,nav_Cus,nav_Crc,nav_Cic,nav_Cuc,(nav_CodeOnL2,nav_L2Pflag,nav_sf1_1,nav_sf1_2,nav_sf1_3,nav_sf1_4,nav_AODA?))>
  <!ELEMENT nav_URA (#PCDATA)> <!-- 0..15 -->
  <!ELEMENT nav_FitFlag (#PCDATA)> <!-- 0..1 -->
  <!ELEMENT nav_Toe (#PCDATA)> <!-- 0..37799 -->
  <!ELEMENT nav_Omega (#PCDATA)> <!-- -2147483648..2147483647 -->
  <!ELEMENT nav_DeltaN (#PCDATA)> <!-- -32768..32767 -->
  <!ELEMENT nav_M0 (#PCDATA)> <!-- -2147483648..2147483647 -->
  <!ELEMENT nav_OmegaA_d (#PCDATA)> <!-- -8388608..8388607 -->
  <!ELEMENT nav_E (#PCDATA)> <!-- 0..4294967295 -->
  <!ELEMENT nav_I_d (#PCDATA)> <!-- -8192..8191 -->
  <!ELEMENT nav_APowerHalf (#PCDATA)> <!-- 0..4294967295 -->
  <!ELEMENT nav_I0 (#PCDATA)> <!-- -2147483648..2147483647 -->
  <!ELEMENT nav_OmegaA0 (#PCDATA)> <!-- -2147483648..2147483647 -->
  <!ELEMENT nav_Crs (#PCDATA)> <!-- -32768..32767 -->
  <!ELEMENT nav_Cis (#PCDATA)> <!-- -32768..32767 -->
  <!ELEMENT nav_Cus (#PCDATA)> <!-- -32768..32767 -->
  <!ELEMENT nav_Crc (#PCDATA)> <!-- -32768..32767 -->
  <!ELEMENT nav_Cic (#PCDATA)> <!-- -32768..32767 -->
  <!ELEMENT nav_Cuc (#PCDATA)> <!-- -32768..32767 -->
  <!ELEMENT nav_CodeOnL2 (#PCDATA)> <!-- 0..3 -->
  <!ELEMENT nav_L2Pflag (#PCDATA)> <!-- 0..1 -->
  <!ELEMENT nav_sf1_1 (#PCDATA)> <!-- 0..8388607 -->
  <!ELEMENT nav_sf1_2 (#PCDATA)> <!-- 0..16777215 -->
  <!ELEMENT nav_sf1_3 (#PCDATA)> <!-- 0..16777215 -->
  <!ELEMENT nav_sf1_4 (#PCDATA)> <!-- 0..65535 -->
  <!ELEMENT nav_AODA (#PCDATA)> <!-- 0..31 -->

<!ELEMENT nms_clock_cnav
(cnav_Toc,cnav_Top,cnav_URA0,cnav_URA1,cnav_URA2,cnav_Af2,cnav_Af1,cnav_Af0,cnav_Tgd,cnav_ISC11cp?,cnav_ISC11cd?,cnav_ISC11ca?,cnav_ISC12c?,cnav_ISC15i5?,cnav_ISC15q5?)>
  <!ELEMENT cnav_Toc (#PCDATA)> <!-- 0..2015 -->
  <!ELEMENT cnav_Top (#PCDATA)> <!-- 0..2015 -->
  <!ELEMENT cnav_URA0 (#PCDATA)> <!-- -16..15 -->
  <!ELEMENT cnav_URA1 (#PCDATA)> <!-- 0..7 -->
  <!ELEMENT cnav_URA2 (#PCDATA)> <!-- 0..7 -->
  <!ELEMENT cnav_Af2 (#PCDATA)> <!-- -512..511 -->
  <!ELEMENT cnav_Af1 (#PCDATA)> <!-- -524288..524287 -->
  <!ELEMENT cnav_Af0 (#PCDATA)> <!-- -33554432..33554431 -->
  <!ELEMENT cnav_Tgd (#PCDATA)> <!-- -4096..4095 -->
  <!ELEMENT cnav_ISC11cp (#PCDATA)> <!-- -4096..4095 -->
  <!ELEMENT cnav_ISC11cd (#PCDATA)> <!-- -4096..4095 -->

```

```

<!ELEMENT cnav_ISCl1ca (#PCDATA)> <!-- -4096..4095 -->
<!ELEMENT cnav_ISCl2c (#PCDATA)> <!-- -4096..4095 -->
<!ELEMENT cnav_ISCl5i5 (#PCDATA)> <!-- -4096..4095 -->
<!ELEMENT cnav_ISCl5q5 (#PCDATA)> <!-- -4096..4095 -->

<!ELEMENT nms_orbit_cnav
(cnav_Top,cnav_URAIindex,cnav_DeltaA,cnav_Adot,cnav_DeltaNo,cnav_DeltaNoDot,cnav_Mo,cnav_E,cnav_Omega
,cnav_OMEGA0,cnav_DeltaOmegaDot,cnav_Io,cnav_IoDot,cnav_Cis,cnav_Cic,cnav_Crs,cnav_Crc,cnav_Cus,cnav
_Cuc)>
<!ELEMENT cnav_URAIindex (#PCDATA)> <!-- -16..15 -->
<!ELEMENT cnav_DeltaA (#PCDATA)> <!-- -33554432..33554431 -->
<!ELEMENT cnav_Adot (#PCDATA)> <!-- -16777216..16777215 -->
<!ELEMENT cnav_DeltaNo (#PCDATA)> <!-- -65536..65535 -->
<!ELEMENT cnav_DeltaNoDot (#PCDATA)> <!-- -4194304..4194303 -->
<!ELEMENT cnav_Mo (#PCDATA)> <!-- -4294967296..4294967295 -->
<!ELEMENT cnav_E (#PCDATA)> <!-- 0..8589934591 -->
<!ELEMENT cnav_Omega (#PCDATA)> <!-- -4294967296..4294967295 -->
<!ELEMENT cnav_OMEGA0 (#PCDATA)> <!-- -4294967296..4294967295 -->
<!ELEMENT cnav_DeltaOmegaDot (#PCDATA)> <!-- -65536..65535 -->
<!ELEMENT cnav_Io (#PCDATA)> <!-- -4294967296..4294967295 -->
<!ELEMENT cnav_IoDot (#PCDATA)> <!-- -16384..16383 -->
<!ELEMENT cnav_Cis (#PCDATA)> <!-- -32768..32767 -->
<!ELEMENT cnav_Cic (#PCDATA)> <!-- -32768..32767 -->
<!ELEMENT cnav_Crs (#PCDATA)> <!-- -8388608..8388607 -->
<!ELEMENT cnav_Crc (#PCDATA)> <!-- -8388608..8388607 -->
<!ELEMENT cnav_Cus (#PCDATA)> <!-- -1048576..1048575 -->
<!ELEMENT cnav_Cuc (#PCDATA)> <!-- -1048576..1048575 -->

```

Table 8.55-17: XML DTD for <nms_orbit_glonass>, <nms_clock_glonass>

```

<!ELEMENT nms_orbit_glonass
(glo_En,glo_P1,glo_P2,glo_M,glo_X,glo_X_d,glo_X_dd,glo_Y,glo_Y_d,glo_Y_dd,glo_Z_d,glo_Z_dd)>
<!ELEMENT glo_En (#PCDATA)> <!-- 0..31 -->
<!ELEMENT glo_P1 (#PCDATA)> <!-- hex -->
<!ELEMENT glo_P2 (#PCDATA)> <!-- 0..1 -->
<!ELEMENT glo_M (#PCDATA)> <!-- 0..3 -->
<!ELEMENT glo_X (#PCDATA)> <!-- -67108864..67108863 -->
<!ELEMENT glo_X_d (#PCDATA)> <!-- -8388608..8388607 -->
<!ELEMENT glo_X_dd (#PCDATA)> <!-- -16..15 -->
<!ELEMENT glo_Y (#PCDATA)> <!-- -67108864..67108863 -->
<!ELEMENT glo_Y_d (#PCDATA)> <!-- -8388608..8388607 -->
<!ELEMENT glo_Y_dd (#PCDATA)> <!-- -16..15 -->
<!ELEMENT glo_Z (#PCDATA)> <!-- -67108864..67108863 -->
<!ELEMENT glo_Z_d (#PCDATA)> <!-- -8388608..8388607 -->
<!ELEMENT glo_Z_dd (#PCDATA)> <!-- -16..15 -->

<!ELEMENT nms_clock_glonass (glo_Tau,glo_Gamma,glo_DeltaTau)>
<!ELEMENT glo_Tau (#PCDATA)> <!-- -2097152..2097151 -->
<!ELEMENT glo_Gamma (#PCDATA)> <!-- -1024..1023 -->
<!ELEMENT glo_DeltaTau (#PCDATA)> <!-- -16..15 -->

```

Table 8.55-18: XML DTD for <nms_clock_sbas>, <nms_orbit_sbas>

```

<!ELEMENT nms_clock_sbas (sbas_To,sbas_Agfo,sbas_Agfl)> <!-- model 4 -->
<!ELEMENT sbas_To (#PCDATA)>
<!ELEMENT sbas_Agfo (#PCDATA)>
<!ELEMENT sbas_Agfl (#PCDATA)>

<!ELEMENT nms_orbit_sbas
(sbas_To,sbas_accuracy,sbas_Xg,sbas_Yg,sbas_Zg,sbas_Xg_d,sbas_Yg_d,sbas_Zg_d,sbas_Xg_dd,sbas_Yg_dd,s
bas_Zg_dd)> <!-- model 4 -->
<!ELEMENT sbas_accuracy (#PCDATA)> <!-- hex -->
<!ELEMENT sbas_Xg (#PCDATA)>
<!ELEMENT sbas_Yg (#PCDATA)>
<!ELEMENT sbas_Zg (#PCDATA)>
<!ELEMENT sbas_Xg_d (#PCDATA)>
<!ELEMENT sbas_Yg_d (#PCDATA)>
<!ELEMENT sbas_Zg_d (#PCDATA)>
<!ELEMENT sbas_Xg_dd (#PCDATA)>
<!ELEMENT sbas_Yg_dd (#PCDATA)>
<!ELEMENT sbas_Zg_dd (#PCDATA)>

```

Table 8.55-19: XML DTD for <GNSS_provided_location_information>

```

<!ELEMENT GNSS_provided_location_information
(GNSS_meas*|(agnss_list,GNSS_meas_ref_time,locationparameters,earlyFixReport-r12?))>
  <!ELEMENT agnss_list (#PCDATA) <!-- Integer corresponds to bit string 1-8 where bit at position
if set, means particular GNSS id is supported bit0-GPS,bit1-sbas,bit2-qzss,bit3-galileo,bit4-
glonass,bit5-bds -->
  <!ELEMENT GNSS_meas_ref_time (gnss_TOD_msec,gnss_TOD_frac?,gnss_TOD_unc?)>
  <!ATTLIST GNSS_meas_ref_time time_id(SBAS|MGPS|QZSS|Glonass|GPS|BDS) #IMPLIED>
  <!ELEMENT gnss_TOD_msec (#PCDATA)> <!-- 0..3599999 -->
  <!ELEMENT gnss_TOD_frac (#PCDATA)> <!-- 0..39999 -->
  <!ELEMENT gnss_TOD_unc (#PCDATA)> <!-- 0..127 -->

```

NOTE 15:GNSS_provide_location_information is used for reporting location information for GNSS procedures i.e. procedures where GNSS_allowed_methods or GNSS_assist is received. This element matches the ASN.1 element GANSSLocationInfo for RRLP procedures; UE positioning measured results information element for RRC or ASN.1 A-GNSS-ProvideLocationInformation for LPP.

NOTE 15a: Both in 'pos_meas' and 'pos_meas_req', either MS-Based or MS-Assisted positioning can be specified requiring either 'location_parameters' or 'GNSS_meas' elements respectively.

Table 8.55-20: XML DTD for <OTDOA_meas>

```

<!ELEMENT OTDOA_meas
(system_frame_number,phys_cell_id_ref,cell_global_id_ref?,earfcn_ref?,ref_quality?,neighbour_meas_list,earlyFixReport-r12?)>
  <!ELEMENT system_frame_number (#PCDATA)>
  <!ELEMENT phys_cell_id_ref (#PCDATA)> <!-- 0..503 -->
  <!ELEMENT cell_global_id_ref (mcc,mnc,cell_id)>
  <!ELEMENT mcc (#PCDATA)>
  <!ELEMENT mnc (#PCDATA)>
  <!ELEMENT cell_id (#PCDATA)>
  <!ELEMENT earfcn_ref (#PCDATA)> <!-- 0..65535 -->
  <!ELEMENT ref_quality (OTDOA_meas_quality)>
  <!ELEMENT neighbour_meas_list (neighbour_meas_element)+>
  <!ELEMENT neighbour_meas_element
(phys_cell_id_neighbour,cell_global_id_neighbour?,earfcn_neighbour?,rstd,rstd_quality)>
  <!ELEMENT phys_cell_id_neighbour (#PCDATA)>
  <!ELEMENT cell_global_id_neighbour (mcc,mnc,cell_identity)>
  <!ELEMENT mcc (#PCDATA)>
  <!ELEMENT mnc (#PCDATA)>
  <!ELEMENT cell_identity (#PCDATA)>
  <!ELEMENT earfcn_neighbour (#PCDATA)> <!-- 0..65535 -->
  <!ELEMENT rstd (#PCDATA)> <!-- 0..12711 -->
  <!ELEMENT rstd_quality (OTDOA_meas_quality)>
  <!ELEMENT OTDOA_meas_quality (err_resolution,err_value,err_num_samples?)>
  <!ELEMENT err_resolution (#PCDATA)>
  <!ELEMENT err_value (#PCDATA)>
  <!ELEMENT err_num_samples (#PCDATA)>

```

NOTE 16:For the elements and the value ranges of OTDOA measurements refer to 3GPP TS 36.355 [115] (clause 6.5.1). The value ranges of relevant parameters are described in the ASN.1 syntax.

Table 8.55-21: XML DTD for <OTDOA_assist_req>

```

<!ELEMENT OTDOA_assist_req (phys_cell_id)>
  <!ELEMENT phys_cell_id (#PCDATA)> <!-- 0..503 -->

```

Table 8.55-22: XML DTD for <reset_assist_data>

```

<!ELEMENT reset_assist_data EMPTY> <!-- Reset UE positioning stored AGNSS/OTDOA/Sensor/TBS
assistance data -->

```

NOTE 17:For resetting UE positioning stored AGNSS assistance data refer to 3GPP TS 36.509 [142] (clause 6.9).

Table 8.55-23: XML DTD for <OTDOA_ECID_req>

```

<!ELEMENT OTDOA_ECID_req (abort|request_location_info)>
  <!ELEMENT abort EMPTY>
    <!ATTLIST abort abort_otdoa_meas_req (true|false) "false"
      abort_ecid_meas_req (true|false) "false"> <!-- Session ID will be provided in Transaction ID
under root element <pos> -->
  <!ELEMENT request_location_info
(OTDOA_req_loc_info?,ECID_req_loc_info?,(response_time|periodic_reporting|triggered_reporting?))>
<!-- triggered_reporting for ECID_req_loc_info only -->
  <!ATTLIST request_location_info emergency_call_indicator (true|false) "false">
  <!ELEMENT OTDOA_req_loc_info EMPTY>
    <!ATTLIST OTDOA_req_loc_info assistance_available (true|false) #REQUIRED>
  <!ELEMENT ECID_req_loc_info EMPTY>
    <!ATTLIST ECID_req_loc_info
      rs_rp_req (true|false) "false"
      rs_rq_req (true|false) "false"
      ue_rx_tx_req (true|false) "false">
  <!ELEMENT response_time(time,earlyFixReport-r12?)>
  <!ELEMENT periodic_reporting(rep_amount,rep_interval)>
    <!ELEMENT rep_amount EMPTY>
      <!ATTLIST rep_amount literal (ra1|ra2|ra4|ra8|ra16|ra32|ra64|ra-Infinity) #REQUIRED>
    <!ELEMENT rep_interval EMPTY>
      <!ATTLIST rep_interval literal (ri1|ri2|ri4|ri8|ri16|ri32|ri64)>
  <!ELEMENT triggered_reporting(rep_duration)>
    <!ATTLIST triggered_reporting cell_change (true|false) #REQUIRED>
  <!ELEMENT rep_duration #PCDATA> <!-- 0..255 -->

```

NOTE 18: 'emergency_call_indicator' indicates whether the OTDOA and/or ECID location request is due to an Emergency Call.

Table 8.55-24: XML DTD for <ECID_meas>

```

<!ELEMENT ECID_meas (primary_cell_measured_results?,measured_result_list)>
  <!ELEMENT primary_cell_measured_results (measured_result_element)>
    <!ELEMENT measured_result_element
(phys_cell_id,cell_global_id?,earfcn_eutra,sfn?,rsrp_result?,rsrq_result?,ue_rxtx_time_diff?)>
    <!ELEMENT phys_cell_id (#PCDATA)> <!-- 0..503 -->
    <!ELEMENT cell_global_id (mcc,mnc,cell_id)>
      <!ELEMENT mcc (#PCDATA)>
      <!ELEMENT mnc (#PCDATA)>
      <!ELEMENT cell_id (#PCDATA)>
    <!ELEMENT earfcn_eutra (#PCDATA)> <!-- 0..262143 -->
    <!ELEMENT sfn (#PCDATA)>
    <!ELEMENT rsrp_result (#PCDATA)> <!-- 0..97 -->
    <!ELEMENT rsrq_result (#PCDATA)> <!-- 0..34 -->
    <!ELEMENT ue_rxtx_time_diff (#PCDATA)> <!--0..4095 -->
  <!ELEMENT measured_result_list (measured_result_element+)> <!-- 1..32 -->

```

Table 8.55-25: XML DTD for <Strobe>

```

<!ELEMENT Strobe (#PCDATA)> <!-- Triggers the generation of a strobe -->

```

Table 8.55-26: XML DTD for <nms_clock_bds>

```

<!ELEMENT nms_clock_bds (bdsToc-r12,bdsA0-r12,bdsA1-r12,bdsA2-r12,bdsTgd1-r12)>
  <!ELEMENT bdsToc-r12 (#PCDATA)> <!-- 0..131071 -->
  <!ELEMENT bdsA0-r12 (#PCDATA)> <!-- -8388608..8388607 -->
  <!ELEMENT bdsA1-r12 (#PCDATA)> <!-- -2097152..2097151 -->
  <!ELEMENT bdsA2-r12 (#PCDATA)> <!-- -1024..1023 -->
  <!ELEMENT bdsTgd1-r12 (#PCDATA)> <!-- -512..511-->

```

Table 8.55-27: XML DTD for <nms_orbit_bds>

```

<!ELEMENT nms_orbit_bds(bdsURAI-r12,bdsToe-r12,bdsAPowerHalf-r12,bdsE-r12,bdsW-r12,bdsDeltaN-
r12,bdsM0-r12,bdsOmega0-r12,bdsOmegaDot-r12,bdsI0-r12, bdsIDot-r12,bdsCuc-r12,bdsCus-r12,bdsCrc-
r12,bdsCrs-r12,bdsCic-r12,bdsCis-r12)>
  <!ELEMENT bdsURAI-r12 (#PCDATA)> <!-- 0..15 -->
  <!ELEMENT bdsToe-r12 (#PCDATA)> <!-- 0..131071 -->

```

```

<!ELEMENT bdsAPowerHalf-r12 (#PCDATA)> <!-- 0..4294967295 -->
<!ELEMENT bdsE-r12 (#PCDATA)> <!-- 0..4294967295 -->
<!ELEMENT bdsW-r12 (#PCDATA)> <!-- -2147483648..2147483647 -->
<!ELEMENT bdsDeltaN-r12 (#PCDATA)> <!-- (-32768..32767 -->
<!ELEMENT bdsM0-r12 (#PCDATA)> <!-- -2147483648..2147483647 -->
<!ELEMENT bdsOmega0-r12 (#PCDATA)> <!-- -2147483648..2147483647 -->
<!ELEMENT bdsOmegaDot-r12 (#PCDATA)> <!-- -8388608..8388607 -->
<!ELEMENT bdsI0-r12 (#PCDATA)> <!-- -2147483648..2147483647 -->
<!ELEMENT bdsIDot-r12 (#PCDATA)> <!-- -8192..8191 -->
<!ELEMENT bdsCuc-r12 (#PCDATA)> <!-- -131072..131071 -->
<!ELEMENT bdsCus-r12 (#PCDATA)> <!-- -131072..131071 -->
<!ELEMENT bdsCrc-r12 (#PCDATA)> <!-- -131072..131071 -->
<!ELEMENT bdsCrs-r12 (#PCDATA)> <!-- -131072..131071 -->
<!ELEMENT bdsCic-r12 (#PCDATA)> <!-- -131072..131071 -->
<!ELEMENT bdsCis-r12 (#PCDATA)> <!-- -131072..131071 -->

```

Table 8.55-28: XML DTD for <Bluetooth_meas>

```

<!ELEMENT Bluetooth_meas (meas_ref_time?,bt_meas?)>
  <!ELEMENT meas_ref_time (#PCDATA)> <!-- ASN.1 data type UTCTime -->
  <!ELEMENT bt_meas (bt_addr,rssi?)>
    <!ELEMENT bt_addr (#PCDATA)>
    <!ELEMENT rssi (#PCDATA)>

```

NOTE 19: For the elements and the value ranges of Bluetooth measurements refer to 3GPP TS 36.355 [115] (clause 6.5.7). The value ranges of relevant parameters are described in the ASN.1 syntax.

Table 8.55-29: XML DTD for <Sensor_meas>

```

<!ELEMENT Sensor_meas (meas_ref_time?,unc_baro_pressure?,uncertainty?)>
  <!ELEMENT meas_ref_time (#PCDATA)> <!-- ASN.1 data type UTCTime -->
  <!ELEMENT unc_baro_pressure (#PCDATA)> <!-- 30000..115000 -->
  <!ELEMENT uncertainty (range,confidence)>
    <!ELEMENT range (#PCDATA)> <!-- 0..1000 -->
    <!ELEMENT confidence (#PCDATA)> <!-- 1..100 -->

```

NOTE 20: For the elements and the value ranges of Sensor measurements refer to 3GPP TS 36.355 [115] (clause 6.5.5). The value ranges of relevant parameters are described in the ASN.1 syntax.

Table 8.55-30: XML DTD for <Sensor_assist_req>

```

<!ELEMENT Sensor_assist_req EMPTY>

```

Table 8.55-31: XML DTD for <TBS_meas>

```

<!ELEMENT TBS_meas (meas_ref_time?,mbs_meas_list?)>
  <!ELEMENT meas_ref_time (#PCDATA)> <!-- ASN.1 data type UTCTime -->
  <!ELEMENT mbs_meas_list (trans_ID,code_phase,code_phase_rms_error)>
    <!ELEMENT trans_ID (#PCDATA)> <!-- 0..32767 -->
    <!ELEMENT code_phase (#PCDATA)> <!-- 0..2097151 -->
    <!ELEMENT code_phase_rms_error (#PCDATA)> <!-- 0..63 -->

```

NOTE 21: For the elements and the value ranges of TBS measurements refer to 3GPP TS 36.355 [115] (clause 6.5.4). The value ranges of relevant parameters are described in the ASN.1 syntax.

Table 8.55-32: XML DTD for <TBS_assist_req>

```

<!ELEMENT TBS_assist_req (mbs_almanac_assist_req,mbs_acqu_assist_req)>
  <!ELEMENT mbs_almanac_assist_req EMPTY>
  <!ELEMENT mbs_acqu_assist_req EMPTY>

```

Table 8.55-33: XML DTD for <WLAN_meas>

```

<!ELEMENT WLAN_meas (meas_ref_time?,wlan_meas_list?)>
  <!ELEMENT meas_ref_time (#PCDATA) <!-- ASN.1 data type UTCTime -->
  <!ELEMENT wlan_meas_list (wlan_AP_ID,rssi?,rtt?,ap_ch_freq?,serving_flag?)>
    <!ELEMENT wlan_AP_ID (#PCDATA)>
    <!ELEMENT rssi (#PCDATA)>
    <!ELEMENT rtt (#PCDATA)>
    <!ELEMENT ap_ch_freq (#PCDATA)>
    <!ELEMENT serving_flag (true|false)>

```

NOTE 22:For the elements and the value ranges of WLAN measurements refer to 3GPP TS 36.355 [115] (clause 6.5.6). The value ranges of relevant parameters are described in the ASN.1 syntax.

Implementation

Optional.

8.56 Positioning reporting +CPOSR

Table 8.56-1: +CPOSR parameter command syntax

Command	Possible response(s)
+CPOSR=[<mode>]	
+CPOSR?	+CPOSR: <mode>
+CPOSR=?	+CPOSR: (list of supported <mode>s)

Description

Set command enables or disables the sending of unsolicited result codes. The XML-formatted string may be sent as one or more unsolicited result codes. Each part of the XML-formatted string is sent as one unsolicited result code, prefixed with +CPOSR.

NOTE: An XML-formatted string intended for +CPOSR can be split e.g. in order to prevent that the string becomes too long. Where to split an XML-formatted string is implementation specific. The characters <CR><LF>, <+CPOSR> and space(s) are ignored when re-constructing an XML-formatted string.

Example: +CPOSR: <One line of positioning data sent on XML format>.

Read command returns the current mode.

Test command returns the supported values as a compound value.

Defined values

<mode>: integer type

0 disables reporting

1 enables reporting

Defined events

<pos_meas>: string type in UTF-8. This parameter provides an XML-formatted string of position measurements data request as defined in table 8.55-8. This parameter shall not be subject to conventional character conversion as per +CSCS.

<pos_meas_req>: string type in UTF-8. This parameter provides an XML-formatted string of position measurements request data as defined in table 8.55-9. This is an alternative to <pos_meas>. This parameter shall not be subject to conventional character conversion as per +CSCS.

- <OTDOA_meas>: string type in UTF-8. This parameter provides an XML-formatted string of OTDOA measurement data as defined in table 8.55-20. This parameter shall not be subject to conventional character conversion as per +CSCS.
- <ECID_meas>: string type in UTF-8. This parameter provides an XML-formatted string of ECID measurement data as defined in table 8.55-24. This parameter shall not be subject to conventional character conversion as per +CSCS.
- <OTDOA_assist_req>: string type in UTF-8. This parameter provides an XML-formatted string for requesting OTDOA assistance data as defined in table 8.55-21. This parameter shall not be subject to conventional character conversion as per +CSCS.
- <capabilities>: string type in UTF-8. This parameter provides an XML-formatted string for providing capability data as defined in table 8.55-4. This parameter shall not be subject to conventional character conversion as per +CSCS.
- <msg>: string type in UTF-8. This parameter provides an XML-formatted string for communicating simple messages as defined in table 8.55-13. This parameter shall not be subject to conventional character conversion as per +CSCS.
- <pos_err>: string type in UTF-8. This parameter provides an XML-formatted string of positioning error parameters as defined in table 8.55-14. This parameter shall not be subject to conventional character conversion as per +CSCS.
- <reset_assist_data>: string type in UTF-8. This parameter provides an XML-formatted string for resetting GNSS/OTDOA/Sensor/TBS assistance data as defined in table 8.55-22. This parameter shall not be subject to conventional character conversion as per +CSCS.
- <Bluetooth_meas>: string type in UTF-8. This parameter provides an XML-formatted string of Bluetooth measurement data as defined in table 8.55-28. This parameter shall not be subject to conventional character conversion as per +CSCS.
- <Sensor_meas>: string type in UTF-8. This parameter provides an XML-formatted string of Sensor measurement data as defined in table 8.55-29. This parameter shall not be subject to conventional character conversion as per +CSCS.
- <Sensor_assist_req>: string type in UTF-8. This parameter provides an XML-formatted string for requesting Sensor assistance data as defined in table 8.55-30. This parameter shall not be subject to conventional character conversion as per +CSCS.
- <TBS_meas>: string type in UTF-8. This parameter provides an XML-formatted string of TBS measurement data as defined in table 8.55-31. This parameter shall not be subject to conventional character conversion as per +CSCS.
- <TBS_assist_req>: string type in UTF-8. This parameter provides an XML-formatted string for requesting TBS assistance data as defined in table 8.55-32. This parameter shall not be subject to conventional character conversion as per +CSCS.
- <WLAN_meas>: string type in UTF-8. This parameter provides an XML-formatted string of WLAN measurement data as defined in table 8.55-33. This parameter shall not be subject to conventional character conversion as per +CSCS.

Implementation

Optional.

8.57 Mobile terminated location request notification +CMTLR

Table 8.57-1: +CMTLR parameter command syntax

Command	Possible response(s)
+CMTLR=[<subscribe>]	

+CMTLR?	+CMTLR: <subscribe>
+CMTLR=?	+CMTLR: (list of supported <subscribe> values)

Description

Set command enables Mobile Terminated Location Request (MT-LR) notifications to the TE. The parameter <subscribe> enables or disables notification by an unsolicited result code. It is possible to enable notification of MT-LR performed over the control plane or over SUPL or both. Relevant location request parameters are provided in the unsolicited result code +CMTLR: <handle-id>, <notification-type>, <location-type>, [<client-external-id>], [<client-name>][, <plane>].

This unsolicited result code is reported upon arrival of a Mobile Terminated Location Request. In order to differentiate multiple requests, every request is given a different <handle-id>. This ID is used when allowing or denying location disclosure with +CMTLRA.

Read command returns the current value of <subscribe>.

Test command returns the supported values as a compound value.

Defined values

<subscribe>: integer type. Enables and disables the subscription for MT-LR notifications.

- 0 Disables reporting and positioning.
- 1 Subscribe for notifications of MT-LR over control plane.
- 2 Subscribe for notifications of MT-LR over SUPL.
- 3 Subscribe for notifications of MT-LR over control plane and SUPL.

<handle-id>: integer type. ID associated with each MT-LR used to distinguish specific request in case of multiple requests. The value range is 0-255.

<notification-type>: integer type. Information about the user's privacy.

- 0 The subscription may stipulate that positioning the user by a third party is allowed and the network may choose to inform the user as a matter of courtesy.
- 1 Locating the user is permitted if the user ignores the notification.
- 2 Locating the user is forbidden if the user ignores the notification.

<location-type>: integer type. Indicates what type of the location is requested.

- 0 The current location.
- 1 The current or last known location.
- 2 The initial location.

<client-external-id>: string type. Indicates the external client where the location information is sent to (if required).

<client-name>: string type. Contains the string identifying the external client requesting the user's location.

<plane>: integer type. The parameter specifies whether the MT-LR came over control plane or SUPL.

- 0 Control plane.
- 1 Secure user plane (SUPL).

Implementation

Optional.

8.58 Mobile terminated location request disclosure allowance +CMTLRA

Table 8.58-1: +CMTLRA parameter command syntax

Command	Possible response(s)
+CMTLRA=<allow>,<handle_id>	
+CMTLRA?	+CMTLRA: <allow>,<handle_id>
+CMTLRA=?	+CMTLRA: (list of supported <allow> values)

Description

Set command allows or disallows disclosure of the location to the TE as a result of MT-LR by the parameter <allow>.

Read command returns the current values.

Test command returns the supported values.

Defined values

<allow>: integer type. Enables and disables the allowance for location disclosure.

- 0 Location disclosure allowed.
- 1 Location disclosure not allowed.

<handle-id>: integer type. ID associated with each MT-LR used to distinguish specific request in case of multiple requests. The value is given in +CMTLR. The value range is 0-255.

Implementation

Optional.

8.59 Battery capacity +CBCAP

Table 8.59-1: CBCAP parameter command syntax

Command	Possible response(s)
+CBCAP=[<reporting>[,<reporting_interval>]]	
+CBCAP?	+CBCAP: <reporting>,<reporting_interval>,<bcl>
+CBCAP=?	+CBCAP: (list of supported <reporting>s) , (list of supported <reporting_interval>s)

Description

Set command enables reporting upon change in battery capacity level, with unsolicited result code +CBCAP: <bcl>. Consecutive reports never show same value of <bcl>.

Read command returns the status of result code presentation and the current battery capacity level.

Test command returns values supported as compound values.

Defined values

<reporting>: integer type. Enables and disables reporting of changes in the battery capacity level.

- 0 Disable reporting
- 1 Enable reporting

<reporting_interval>: integer type. Sets the reporting interval of the battery capacity level (in percentages). The default value is manufacturer specific.

1...100 Amount that the remaining battery capacity must change before reporting.

<bcl>: integer type. Gives the remaining relative battery capacity level (in percentages).

0 The battery is exhausted or ME does not have a battery connected

1...100 remaining battery capacity level (in percentages). The provided values are dependant on the parameter <reporting_interval>. A value of 5 for parameter <reporting_interval>, means that the following values of <bcl> are applicable: 0, 5, 10, 15, ... , 90, 95, 100.

NOTE: 100% capacity is always reported, even if <reporting_interval> is set to a value where no integer multiple equals 100.

Implementation

Optional.

8.60 Battery connection status +CBCON

Table 8.60-1: +CBCON parameter command syntax

Command	Possible response(s)
+CBCON=[<reporting>]	
+CBCON?	+CBCON: <reporting>, <bcs>
+CBCON=?	+CBCON: (list of supported <reporting>s)

Description

Set command enables reporting upon change in battery connection status, with unsolicited result code +CBCON: <bcs>.

Read command returns the status of result code presentation and the current battery status.

Test command returns values supported as a compound value.

Defined values

<reporting>: integer type. Enables and disables reporting of changes in the battery connection status.

0 disable reporting

1 enable reporting

<bcs>: integer type. Indicates the battery status.

0 ME is powered by the battery

1 ME has a battery connected, but is not powered by it

2 ME does not have a battery connected

3 Recognized power fault, calls inhibited

Implementation

Optional.

8.61 Battery charger status +CBCHG

Table 8.61-1: +CBCHG parameter command syntax

Command	Possible response(s)
+CBCHG=[<reporting>]	
+CBCHG?	+CBCHG: <reporting>, <chg_status>
+CBCHG=?	+CBCHG: (list of supported <reporting>s)

Description

Set command enables reporting upon change in battery charger status, with unsolicited result code +CBCHG: <chg_status>.

Read command returns the status of result code presentation and the current battery charger status.

Test command returns values supported as a compound value.

Defined values

<reporting>: integer type. Enables and disables reporting of changes in the battery charger status.

0 disable reporting

1 enable reporting

<chg_status>: integer type. Indicates type of battery charger status.

0 no charger connected

1 charger connected, normal type charger

2 charger connected, USB type charger

Implementation

Optional.

8.62 Printing IP address format +CGPIAF

Table 8.62-1: +CGPIAF parameter command syntax

Command	Possible response(s)
+CGPIAF=[<IPv6_AddressFormat>[, <IPv6_SubnetNotation>[, <IPv6_LeadingZeros>[, <IPv6_CompressZeros>]]]	
+CGPIAF?	+CGPIAF: <IPv6_AddressFormat>, <IPv6_SubnetNotation>, <IPv6_LeadingZeros>, <IPv6_CompressZeros>
+CGPIAF=?	+CGPIAF: (list of supported <IPv6_AddressFormat>s), (list of supported <IPv6_SubnetNotation>s), (list of supported <IPv6_LeadingZeros>s), (list of supported <IPv6_CompressZeros>s)

Description

Set command decides what format to print IPV6 address parameters of other AT commands. See RFC 4291 [88] for details of the IPv6 address format.

The +CGPIAF parameters <IPv6_AddressFormat>, <IPv6_SubnetNotation>, <IPv6_LeadingZeros> and <IPv6_CompressedZeros> affect the following commands and parameters:

- a) in +CGTFT and +CGTFTTRDP, the <remote address and subnet mask>;
- b) in +CGDCONT, the <PDP_addr>;
- c) in +CGPADDR, the <PDP_addr_1> and <PDP_addr_2>;
- d) in +CGCONTRDP, the <local address and subnet mask>, <DNS_prim_addr>, <DNS_sec_addr>, <P_CSCF_prim_addr> and <P_CSCF_sec_addr>; and
- e) in +CRC, the <PDP_addr> of unsolicited result code +CRING: GPRS <PDP_type>, <PDP_addr> [, [<L2P>] [, <APN>]] .

Read command returns the current command parameter settings.

Test command returns values supported as compound values.

Defined values

<IPv6_AddressFormat>: integer type, decides the IPv6 address format. Relevant for all AT command parameters that can hold an IPv6 address.

- 0 Use IPv4-like dot-notation. IP address, and subnetwork mask if applicable, are dot-separated.

Example: For <remote address and subnet mask>:
 "32.1.13.184.0.0.205.48.0.0.0.0.0.0.0.0.0.0.255.255.255.255.255.255.240.0.0.0.0.0.0.0"
 For other IP address parameters:
 "32.1.13.184.0.0.205.48.0.0.0.0.0.0.0"

- 1 Use IPv6-like colon-notation. IP address, and subnetwork mask if applicable and when given explicitly, are separated by a space.

Example: For <remote address and subnet mask>:
 "2001:0DB8:0000:CD30:0000:0000:0000:0000 FFFF:FFFF:FFFF:FFF0:0000:0000:0000:0000"
 For other IP address parameters:
 "2001:0DB8:0000:CD30:0000:0000:0000:0000"

<IPv6_SubnetNotation>: integer type, decides the subnet-notation for <remote address and subnet mask>. Setting does not apply if <IPv6_AddressFormat>=0.

- 0 Both IP Address and subnet mask are stated explicitly, separated by a space.

Example: "2001:0DB8:0000:CD30:0000:0000:0000:0000 FFFF:FFFF:FFFF:FFF0:0000:0000:0000:0000"

- 1 The printout format is applying / (forward slash) subnet-prefix Classless Inter-Domain Routing (CIDR) notation.

Example: "2001:0DB8:0000:CD30:0000:0000:0000:0000/60"

<IPv6_LeadingZeros>: integer type, decides whether leading zeros are omitted or not. Setting does not apply if <IPv6_AddressFormat>=0.

- 0 Leading zeros are omitted.

Example: "2001:DB8:0:CD30:0:0:0:0"

- 1 Leading zeros are included.

Example: "2001:0DB8:0000:CD30:0000:0000:0000:0000"

<IPv6_CompressZeros>: integer type, decides whether 1-n instances of 16-bit zero-values are replaced by only ':'. This applies only once. Setting does not apply if <IPv6_AddressFormat>=0.

- 0 No zero compression.

Example: "2001:DB8:0:CD30:0:0:0:0"

- 1 Use zero compression.

Example: "2001:DB8:0:CD30:."

Implementation

Optional.

8.63 IMS single radio voice call continuity +CISRVCC

Table 8.63-1: +CISRVCC parameter command syntax

Command	Possible response(s)
+CISRVCC=[<uesrvcc>]	+CME ERROR: <err>
+CISRVCC?	+CISRVCC: <uesrvcc>
+CISRVCC=?	+CISRVCC: (list of supported <uesrvcc>s)

Description

SRVCC provides the ability to have a seamless handover of a voice call between the PS domain and the CS domain for calls that are anchored in IMS, when the UE is capable of transmitting/receiving on only one of those access networks (PS or CS) at a given time, see 3GPP TS 23.221 [90] clause 7.2a, annex A.1 and annex A.2

Set command informs MT about the SRVCC Support. MT normally updates the network when changing this parameter. Refer clause 9.2 for possible <err> values.

Read command returns the status of the MT stored SRVCC Support.

Test command returns supported values as a compound value.

Defined values

<uesrvcc>: integer type. SRVCC support status

0 The UE does not have SRVCC support

1 The UE has SRVCC support

Implementation

Optional.

8.64 IMS network reporting +CIREP

Table 8.64-1: +CIREP parameter command syntax

Command	Possible response(s)
+CIREP=[<reporting>]	
+CIREP?	+CIREP: <reporting>, <nwimsvops>, <nwimsvops_n3gpp>
+CIREP=?	+CIREP: (list of supported <reporting>s)

Description

Set command enables or disables reporting of PS to CS Single Radio Voice Call Continuity (SRVCC), PS to CS Single Radio Video Call Continuity (vSRVCC) handover information and CS to PS Single Radio Voice Call Continuity (see 3GPP TS 24.237 [91]), of IMS Voice Over PS sessions (IMSVOPS) indicator information and of IMS Voice Over PS sessions over non-3GPP (IMSVOPS-N3GPP) indicator information, by the following unsolicited result codes:

+CIREPI: <nwimsvops>, <nwimsvops_n3gpp> IMS Voice Over PS sessions (IMSVOPS) supported indication and IMS Voice Over PS sessions over non-3GPP (IMSVOPS-N3GPP) supported indication from the network.

+CIREPH: <srvcch> Provides PS to CS SRVCC, PS to CS vSRVCC and CS to PS SRVCC handover information.

Read command returns the status of result code presentation and the IMSVOPS supported indication.

Test command returns supported values as a compound value.

Defined values

<reporting>: integer type. Enables or disables reporting of changes in the IMSVOPS and the IMSVOPS-N3GPP supported indications received from the network and reporting of PS to CS SRVCC, PS to CS vSRVCC and CS to PS SRVCC handover information.

0 Disable reporting

1 Enable reporting

<nwimsvops>: integer type. Gives the last IMS Voice Over PS sessions (IMSVOPS) supported indication received from network.

0 IMSVOPS support indication is not received from network, or is negative.

1 IMSVOPS support indication as received from network is positive.

<nwimsvops_n3gpp>: integer type. Gives the last IMS Voice Over PS sessions over non-3GPP (IMSVOPS-N3GPP) supported indication received from network.

0 IMSVOPS-N3GPP support indication is not received from network, or is negative.

1 IMSVOPS-N3GPP support indication as received from network is positive.

<srvcch>: integer type. PS to CS SRVCC, PS to CS vSRVCC and CS to PS SRVCC handover information.

0 PS to CS SRVCC handover has started in the CS domain ("Handover Command" indicating PS to CS SRVCC received).

1 PS to CS SRVCC handover successful ("Handover Complete" sent).

2 PS to CS SRVCC or PS to CS vSRVCC handover cancelled ("Handover Failure" sent).

3 PS to CS SRVCC or PS to CS vSRVCC handover, general non-specific failure.

4 PS to CS vSRVCC handover has started in the CS domain ("Handover Command" indicating vSRVCC received).

5 PS to CS vSRVCC handover successful ("Handover Complete" sent).

6 CS to PS SRVCC handover has started in the PS domain ("Handover Command" indicating CS to PS SRVCC received).

7 CS to PS SRVCC handover cancelled ("Handover Failure" sent).

8 CS to PS SRVCC handover, general non-specific failure.

9 CS to PS SRVCC handover successful ("Handover Complete" sent).

NOTE 1: Value 3 and 8, general non-specific failure, might be used e.g. in the case of handover cancellation as specified in 3GPP TS 24.301 [83] clause 6.6.2.

NOTE 2: The naming of SRVCC and vSRVCC handover information values is different from the naming of corresponding NAS session management notifications.

Implementation

Optional.

8.65 Remaining PIN retries +CPINR

Table 8.65-1: +CPINR action command syntax

Command	Possible response(s)
+CPINR[=<sel_code>]	+CME ERROR: <err>
+CPINR=?	

Description

Execution command cause the MT to return the number of remaining PIN retries for the MT passwords with intermediate result code +CPINR: <code>, <retries>[, <default_retries>] for standard PINs and +CPINRE: <ext_code>, <retries>[, <default_retries>] for manufacturer specific PINs. One line with one intermediate result code is returned for every <code> or <ext_code> selected by <sel_code>.

When execution command is issued without the optional parameter <sel_code>, intermediate result codes are returned for all <code>s and <ext_code>s.

In the intermediate result codes, the parameter <default_retries> is an optional (manufacturer specific) parameter, per <code> and <ext_code>.

Refer clause 9.2 for possible <err> values.

Defined values

<retries>: integer type. Number of remaining retries per PIN.

<default_retries>: integer type. Number of default/initial retries per PIN.

<code>: Type of PIN. All values listed under the description of the AT+CPIN command, <code> parameter, except 'READY'.

<ext_code>: Extended, manufacturer specific codes.

<sel_code>: String type. Same values as for the <code> and <ext_code> parameters. These values are strings and shall be indicated within double quotes. It is optional to support wildcard match by '*', meaning match any (sub-)string.

Example: AT+CPINR="SIM*" will return the lines:

```
+CPINR: SIM PIN,<retries>,<default_retries>
+CPINR: SIM PUK,<retries>,<default_retries>
+CPINR: SIM PIN2,<retries>,<default_retries>
+CPINR: SIM PUK2,<retries>,<default_retries>
```

Example: AT+CPINR="*SIM*" will additionally return the lines:

```
+CPINR: PH-SIM PIN,<retries>,<default_retries>
+CPINR: PH-FSIM PIN,<retries>,<default_retries>
+CPINR: PH-FSIM PUK,<retries>,<default_retries>
```

Implementation

Optional.

8.66 Set card slot +CSUS

Table 8.66-1: +CSUS parameter command syntax

Command	Possible response(s)
+CSUS=[<card slot>]	+CME ERROR: <err>
+CSUS?	+CSUS: <card slot>
+CSUS=?	+CSUS: (number of supported <card slot>s)

Description

When a MT is equipped with multiple card slots, the set command directs the MT to select the SIM/UICC card installed in the indicated card slot in all future actions that require the use of SIM/UICC.

If this command is issued when a SIM/UICC is active, +CME ERROR is returned. Refer to clause 9.2 for possible <err> values.

Read command returns the currently selected card slot.

Test command returns the number of card slots in the MT as a compound value.

The numbering of card slots is implementation dependent.

Defined values

<card slot>: integer type.

- 0 the SIM/UICC card installed in card slot 0
- 1 the SIM/UICC card installed in card slot 1
- 2 the SIM/UICC card installed in card slot 2
- 3 the SIM/UICC card installed in card slot 3

Implementation

Optional.

8.67 Emergency numbers +CEN

Table 8.67-1: +CEN parameter command syntax

Command	Possible response(s)
+CEN=[<reporting>]	
+CEN?	+CEN1: <reporting> [, <mcc> , <mnc>] <CR><LF> [+CEN2: <cat> , <number> [<CR><LF>+CEN2: <cat> , <number> [...]]] [<CR><LF>+CEN3: <validity> <CR><LF> [+CEN4: <number-ext> , <sub-services> [<CR><LF>+CEN4: <number-ext> , <sub-services> [...]]]]]
+CEN=?	+CEN: (list of supported <reporting>s)

Description

This command allows for reading and dynamical reporting of local emergency numbers and categories or emergency service URNs as received from the network in the Emergency Number List IE (see 3GPP TS 24.008 [8]) and the

Extended Emergency Number List IE (see 3GPP TS 24.301 [83]). The emergency numbers are not necessarily received for the same <mcc> and <mnc> as currently registered to.

Read command returns one line of intermediate result code +CEN1: <reporting>, <mcc>, <mnc> with the current <reporting> setting and the Mobile Country Code <mcc> and Mobile Network Code <mnc>. Then follows zero or more occurrences of the local emergency number received in the Emergency Number List IE with intermediate result code +CEN2: <cat>, <number>. This is followed by one line of intermediate result code +CEN3: <validity> with the current <validity> setting. This is followed by zero or more occurrences of the local emergency number received in the Extended Emergency Number List IE and an associated sub-service with intermediate result code +CEN4: <number-ext>, <sub-service>.

Set command enables reporting of local emergency numbers received from the network with unsolicited result codes equal to the intermediate result codes of the read form of the command.

Test command returns values supported as a compound value.

Defined values

<reporting>: integer type. Enables and disables reporting of local emergency numbers received from the network.

- 0 Disable reporting
- 1 Enable reporting

<mcc>: integer type. A three-digit value indicating mobile country code as defined in ITU-T Recommendation E.212 [10] Annex A.

<mnc>: integer type. A three-digit value indicating the mobile network code.

<cat>: integer type. A bitmap indicating the Emergency Service Category Value according to 3GPP TS 24.008 [8] table 10.5.135d.

<number>: String type. Representing a local emergency number from the list received in the Emergency Number List IE in 3GPP TS 24.008 [8] clause 10.5.3.13. The <number> is encoded with one digit per character and is applicable to the country indicated by <mcc>.

<validity>: integer type. Indicated validity of the local emergency number associated sub-service from the list received in the Extended Emergency Number List IE in 3GPP TS 24.301 [83] clause 9.9.3.37A.

- 0 Extended Local Emergency Numbers List is valid in the country of the PLMN from which this IE is received
- 1 Extended Local Emergency Numbers List is valid only in the PLMN from which this IE is received

<number-ext>: String type. Representing a local emergency number from the list received in the Extended Emergency Number List IE in 3GPP TS 24.301 [83] clause 9.9.3.37A. The <number-ext> is encoded with one digit per character and is applicable to the country indicated by <mcc>.

<sub-service>: String type. Representing an associated sub-service to the <number-ext>. The <sub-service> is encoded in the GSM 7 bit default alphabet and is applicable to the country indicated by <mcc> or to the PLMN indicated by the <mcc> and <mnc>. This parameter shall not be subject to conventional character conversion as per +CSCS.

Implementation

Optional.

8.68 Availability for voice calls with IMS +CAVIMS

Table 8.68-1: +CAVIMS parameter command syntax

Command	Possible response(s)
+CAVIMS=[<state>]	

+CAVIMS?	+CAVIMS: <state>
+CAVIMS=?	+CAVIMS: (list of supported <state>s)

Description

Set command informs the MT whether the UE is currently available for voice calls with the IMS (see 3GPP TS 24.229 [89]). The information can be used by the MT to determine "IMS voice not available" as defined in 3GPP TS 24.301 [83] and 3GPP TS 24.501 [161], and for mobility management for IMS voice termination, see 3GPP TS 24.008 [20].

Read command returns the UEs IMS voice call availability status stored in the MT.

Test command returns supported values as a compound value.

Defined values

<state>: integer type. The UEs IMS voice call availability status.

- 0 Voice calls with the IMS are not available
- 1 Voice calls with the IMS are available

Implementation

Optional.

8.69 Extended signal quality +CESQ

Table 8.69-1: +CESQ action command syntax

Command	Possible response(s)
+CESQ	+CESQ: <rxlev>, <ber>, <rscp>, <ecno>, <rsrq>, <rsrp>, <ss_rsrq>, <ss_rsrp>, <ss_sinr> +CME ERROR: <err>
+CESQ=?	+CESQ: (list of supported <rxlev>s), (list of supported <ber>s), (list of supported <rscp>s), (list of supported <ecno>s), (list of supported <rsrq>s), (list of supported <rsrp>s), (list of supported <ss_rsrq>s), (list of supported <ss_rsrp>s), (list of supported <ss_sinr>s)

Description

Execution command returns received signal quality parameters. If the current serving cell is not a GERAN cell, <rxlev> and <ber> are set to value 99. If the current serving cell is not a UTRA FDD or UTRA TDD cell, <rscp> is set to 255. If the current serving cell is not a UTRA FDD cell, <ecno> is set to 255. If the current serving cell is not an E-UTRA cell, <rsrq> and <rsrp> are set to 255. If the current serving cell is not an NR cell, <ss_rsrq>, <ss_rsrp> and <ss_sinr> are set to 255.

Refer clause 9.2 for possible <err> values.

Test command returns values supported as compound values.

Defined values

<rxlev>: integer type, received signal strength level (see 3GPP TS 45.008 [20] clause 8.1.4).

- 0 rssi < -110 dBm
- 1 -110 dBm ≤ rssi < -109 dBm

2	$-109 \text{ dBm} \leq \text{rssi} < -108 \text{ dBm}$
:	:
61	$-50 \text{ dBm} \leq \text{rssi} < -49 \text{ dBm}$
62	$-49 \text{ dBm} \leq \text{rssi} < -48 \text{ dBm}$
63	$-48 \text{ dBm} \leq \text{rssi}$
99	not known or not detectable

<ber>: integer type; channel bit error rate (in percent).

0...7	as RXQUAL values in the table in 3GPP TS 45.008 [20] clause 8.2.4
99	not known or not detectable

<rscp>: integer type, received signal code power (see 3GPP TS 25.133 [95] clause 9.1.1.3 and 3GPP TS 25.123 [96] clause 9.1.1.1.3).

0	$\text{rscp} < -120 \text{ dBm}$
1	$-120 \text{ dBm} \leq \text{rscp} < -119 \text{ dBm}$
2	$-119 \text{ dBm} \leq \text{rscp} < -118 \text{ dBm}$
:	:
94	$-27 \text{ dBm} \leq \text{rscp} < -26 \text{ dBm}$
95	$-26 \text{ dBm} \leq \text{rscp} < -25 \text{ dBm}$
96 -	$25 \text{ dBm} \leq \text{rscp}$
255	not known or not detectable

<ecno>: integer type, ratio of the received energy per PN chip to the total received power spectral density (see 3GPP TS 25.133 [95] clause).

0	$\text{Ec/Io} < -24 \text{ dB}$
1	$-24 \text{ dB} \leq \text{Ec/Io} < -23.5 \text{ dB}$
2	$-23.5 \text{ dB} \leq \text{Ec/Io} < -23 \text{ dB}$
:	:
47	$-1 \text{ dB} \leq \text{Ec/Io} < -0.5 \text{ dB}$
48	$-0.5 \text{ dB} \leq \text{Ec/Io} < 0 \text{ dB}$
49	$0 \text{ dB} \leq \text{Ec/Io}$
255	not known or not detectable

<rsrq>: integer type, reference signal received quality (see 3GPP TS 36.133 [96] clause 9.1.7).

0	$\text{rsrq} < -19.5 \text{ dB}$
1	$-19.5 \text{ dB} \leq \text{rsrq} < -19 \text{ dB}$
2	$-19 \text{ dB} \leq \text{rsrq} < -18.5 \text{ dB}$
:	:
32	$-4 \text{ dB} \leq \text{rsrq} < -3.5 \text{ dB}$

33 $-3.5 \text{ dB} \leq \text{rsrq} < -3 \text{ dB}$

34 $-3 \text{ dB} \leq \text{rsrq}$

255 not known or not detectable

<rsrp>: integer type, reference signal received power (see 3GPP TS 36.133 [96] clause 9.1.4).

0 $\text{rsrp} < -140 \text{ dBm}$

1 $-140 \text{ dBm} \leq \text{rsrp} < -139 \text{ dBm}$

2 $-139 \text{ dBm} \leq \text{rsrp} < -138 \text{ dBm}$

: : :

95 $-46 \text{ dBm} \leq \text{rsrp} < -45 \text{ dBm}$

96 $-45 \text{ dBm} \leq \text{rsrp} < -44 \text{ dBm}$

97 $-44 \text{ dBm} \leq \text{rsrp}$

255 not known or not detectable

<ss_rsrq>: integer type, synchronization signal based reference signal received quality (see 3GPP TS 38.133 [169] clause 10.1.11).

0 $\text{ss_rsrq} < -43 \text{ dB}$

1 $-43 \text{ dB} \leq \text{ss_rsrq} < -42.5 \text{ dB}$

2 $-42.5 \text{ dB} \leq \text{ss_rsrq} < -42 \text{ dB}$

: : :

124 $18.5 \text{ dB} \leq \text{ss_rsrq} < 19 \text{ dB}$

125 $19 \text{ dB} \leq \text{ss_rsrq} < 19.5 \text{ dB}$

126 $19.5 \text{ dB} \leq \text{ss_rsrq} < 20 \text{ dB}$

255 not known or not detectable

<ss_rsrp>: integer type, synchronization signal based reference signal received power (see 3GPP TS 38.133 [169] clause 10.1.6).

0 $\text{ss_rsrp} < -156 \text{ dBm}$

1 $-156 \text{ dBm} \leq \text{ss_rsrp} < -155 \text{ dBm}$

2 $-155 \text{ dBm} \leq \text{ss_rsrp} < -154 \text{ dBm}$

: : :

125 $-32 \text{ dBm} \leq \text{ss_rsrp} < -31 \text{ dBm}$

126 $-31 \text{ dBm} \leq \text{ss_rsrp}$

255 not known or not detectable

<ss_sinr>: integer type, synchronization signal based signal to noise and interference ratio (see 3GPP TS 38.133 [169] clause 10.1.16).

0 $\text{ss_sinr} < -23 \text{ dB}$

1 $-23 \text{ dB} \leq \text{ss_sinr} < -22.5 \text{ dB}$

2	$-22.5 \text{ dB} \leq \text{ss_sinnr} < -22 \text{ dB}$
:	:
125	$39 \text{ dB} \leq \text{ss_sinnr} < 39.5 \text{ dBm}$
126	$39.5 \text{ dB} \leq \text{ss_sinnr} < 40 \text{ dB}$
127	$40 \text{ dB} \leq \text{ss_sinnr}$
255	not known or not detectable

Implementation

Optional.

8.70 Primary notification event reporting +CPNER

Table 8.70-1: +CPNER parameter command syntax

Command	Possible response(s)
+CPNER=[<reporting>]	+CME ERROR: <err>
+CPNER?	+CPNER:<reporting> +CME ERROR: <err>
+CPNER=?	+CPNER: (list of supported <reporting>s) +CME ERROR: <err>

Description

Set command enables and disables reporting of primary notification events when received from the network with unsolicited result code +CPNERU: <message_identifier>, <serial_number>, <warning_type>. Primary notification events are used for public warning systems like ETWS (Earthquake and Tsunami Warning Systems).

When <reporting>=1, duplicate primary notifications will be discarded by the UE.

NOTE 1: The notification is considered a duplicate of the previous if it has equal <message_identifier> and <serial_number> and arrives from the same PLMN. A primary notification message stored to detect duplication is cleared automatically after three hours of not receiving any message.

Read command returns the current settings.

Test command returns supported values as a compound value.

Refer clause 9.2 for possible <err> values.

Defined values

<reporting>: integer type, controlling reporting of primary notification events

0 Disable primary notification events.

1 Enable reporting of primary notification events without security information, unsolicited result code +CPNERU: <message_identifier>, <serial_number>, <warning_type>.

NOTE 2: Provision of information for the digital signature authentication is referred to as "reporting of primary notification events with security information" in 3GPP TS 25.331 [74], 3GPP TS 36.331 [86]) and 3GPP TS 23.041 [100]. This functionality is not fully implemented in this release, hence is not supported.

<message_identifier>: string type in hexadecimal character format. The parameter contains the message identifier (2 bytes) of the primary notification. For UTRAN see 3GPP TS 25.331 [74] clause 10.3.8.4.ea, for GERAN see 3GPP TS 23.041 [100] clause 9.4.1.3.2, for E-UTRAN see 3GPP TS 36.331 [86] clause 6.3.1 *SystemInformationBlockType10*, and for NG-RAN see 3GPP TS 38.331 [160] clause 6.3.1 *SystemInformationBlockType6*.

<serial_number>: string type in hexadecimal character format. The parameter contains the serial number (2 bytes) of the primary notification. For UTRAN see 3GPP TS 25.331 [74] clause 10.3.8.4.ea, for GERAN see 3GPP TS 23.041 [100] clause 9.4.1.3.2, for E-UTRAN see 3GPP TS 36.331 [86] clause 6.3.1 *SystemInformationBlockType10*, and for NG-RAN see 3GPP TS 38.331 [160] clause 6.3.1 clause 6.3.1 *SystemInformationBlockType6*.

<warning_type>: string type in hexadecimal character format. The parameter contains the warning type (2 bytes) of the primary notification. For UTRAN see 3GPP TS 25.331 [74] clause 10.3.8.4.ea, for GERAN see 3GPP TS 23.041 [100] clause 9.4.1.3.2, for E-UTRAN see 3GPP TS 36.331 [86] clause 6.3.1 *SystemInformationBlockType10*, and for NG-RAN see 3GPP TS 38.331 [160] clause 6.3.1 *SystemInformationBlockType6*.

Implementation

Optional.

8.71 IMS registration information +CIREG

Table 8.71-1: +CIREG parameter command syntax

Command	Possible response(s)
+CIREG=[<n>]	+CME ERROR: <err>
+CIREG?	+CIREG: <n>, <reg_info>[, <ext_info>]
+CIREG=?	+CIREG: (list of supported <n>s)

Description

The set command controls the presentation of an unsolicited result code +CIREGU: <reg_info>[, <ext_info>] when there is a change in the MT's IMS registration information. Refer clause 9.2 for possible <err> values.

The read command returns <n>, that shows whether reporting is enabled or disabled, <reg_info> that shows whether one or more of the public user identities are registered and optionally <ext_info>, that shows the status of the MT's IMS capabilities. For <ext_info>, all relevant values are always summarized and reported as a complete set of IMS capabilities in the unsolicited result code.

The test command returns the supported values for <n> as a compound value.

Defined values

<n>: integer type. Enables or disables reporting of changes in the MT's IMS registration information.

0 disable reporting.

1 enable reporting (parameter <reg_info>).

2 enable extended reporting (parameters <reg_info> and <ext_info>).

<reg_info>: integer type. Indicates the IMS registration status. The UE is seen as registered as long as one or more of its public user identities are registered with any of its contact addresses, see 3GPP TS 24.229 [89].

0 not registered.

1 registered.

<ext_info>: numeric value in hexadecimal format. The value range is from 1 to FFFFFFFF. It is a sum of hexadecimal values, each representing a particular IMS capability of the MT. The MT can have IMS capabilities not covered by the below list. This parameter is not present if the IMS registration status is "not registered".

- 1 RTP-based transfer of voice according to MMTEL, see 3GPP TS 24.173 [87]. This functionality can not be indicated if the UE is not available for voice over PS, see 3GPP TS 24.229 [89].
- 2 RTP-based transfer of text according to MMTEL, see 3GPP TS 24.173 [87].
- 4 SMS using IMS functionality, see 3GPP TS 24.341 [101].
- 8 RTP-based transfer of video according to MMTEL, see 3GPP TS 24.173 [87].

The hexadecimal values 10, 20, 40 ... 80000 are reserved by the present document.

Example: The parameter <ext_info>=5 means that both RTP-based transfer of voice according to MMTEL and SMS using IMS functionality can be used.

Implementation

Optional.

8.72 Availability for SMS using IMS +CASIMS

Table 8.72-1: +CASIMS parameter command syntax

Command	Possible response(s)
+CASIMS=[<state>]	
+CASIMS?	+CASIMS: <state>
+CASIMS=?	+CASIMS: (list of supported <state>s)

Description

Set command informs the MT whether the UE is currently available for SMS using IMS (see 3GPP TS 24.229 [89]). The information can be used by the MT to determine the need to remain attached for non-EPS services, as defined in 3GPP TS 24.301 [83].

Read command returns the UE's SMS using IMS availability status, as stored in the MT.

Test command returns supported values as a compound value.

Defined values

<state>: integer type. The UE's SMS using IMS availability status.

0 SMS using IMS is not available

1 SMS using IMS is available

Implementation

Optional.

This command is only applicable to UEs in GERAN, UTRAN and E-UTRAN.

8.73 Monitor of current calls +CMCCS

Table 8.73-1: +CMCCS parameter command syntax

Command	Possible response(s)
+CMCCS=[<n>]	when <n>=1 and command successful: +CMCCS: (list of supported <x>s)
+CMCCS?	+CMCCS: <n>
+CMCCS=?	+CMCCS: (list of supported <n>s)

Description

This command activates or deactivates a call monitoring function in the ME. When this function is activated in the ME, the ME informs about events for calls with unsolicited result codes.

The purpose of the call monitoring function is to:

- 1) gather relevant information for the detected calls in a TE; and
- 2) make it possible for the TE to display call state information for ongoing calls.

The unsolicited result code +CMCCSI is used for basic call information.

+CMCCSI: <ccid>, <dir>, <neg_status_present>, <neg_status>, <SDP_md>, <cs_mode>, <ccs_tatus>, <empty>, <numbertype>, <ton>, <number>, <exittype>, <exitcause>

The unsolicited result code +CMCCSI is provided when <n>=2. For an originating call, the parameters <numbertype>, <ton> and <number> in +CMCCSI provide the number (line identity) information which has been dialled with +CDU or ATD. For a terminating call, the parameters <numbertype>, <ton> and <number> in +CMCCSI provide the number (line identity) information of the calling user.

The unsolicited result codes +CMCCSS<x> / +CMCCSSSEND are used for supplementary service related information.

```
+CMCCSS1: <ccid>, <dir>, <service>
[+CMCCSS2: <numbertype>, <ton>, <number>]
[+CMCCSS3: <CLI_validity>]
[+CMCCSS4: <name>]
[+CMCCSS5: <subaddr>, <satype>]
[+CMCCSS6: <priority>]
[+CMCCSS7: <CUG_index>]
[+CMCCSS8: <eCNAM_meta>]
+CMCCSSSEND
```

The unsolicited result codes +CMCCSS<x> / +CMCCSSSEND are used for supplementary service related information and are reported when <n>=3. For every supplementary service related event, the unsolicited result codes +CMCCSS<x> shall be given in consecutive order, and the sequence of unsolicited result codes shall be terminated by +CMCCSSSEND. It is manufacturer specific when and if this additional service reporting will be issued. Whenever a service event is to be reported using these unsolicited result codes, the codes +CMCCSS1 and +CMCCSSSEND are mandatory. +CMCCSS1 contains essential information that is always needed (for example <ccid>) and +CMCCSSSEND indicates the end of this particular set of unsolicited result codes. The other unsolicited result codes (+CMCCSS2 to +CMCCSSn) are optional, intended to provide information related to a given service. E.g. for the supplementary service CNAP, the unsolicited result code +CMCCSS4 (containing <name>) may be issued. It is implementation specific which of the unsolicited result codes +CMCCSS<x> / +CMCCSSSEND that are supported and provided to the TE. The unsolicited result codes should be provided to the TE as soon as the information is available in the ME. The parameters <numbertype>, <ton> and <number> in +CMCCSS2 are, if applicable, normally the line identity information that is related to the parameter <service>.

NOTE 1: For situations where ringing is applicable, the unsolicited result codes +CMCCSS<x> / +CMCCSSSEND are typically returned after the first RING (or +CRING: <type>; refer clause "Cellular result codes +CRC") result code sent from TA to TE.

A subset of the information provided by the call monitoring function can be provided by the command +CLCCS.

When the unsolicited result code +CMCCSI report that the <ccstatus>=1 (Idle), the call identification number is reset and the call identification number <ccidx> can be used by new calls. The logic for reuse of the parameter <ccidx> is implementation specific.

Read command returns the current value of <n>.

Test command returns the values supported as a compound value.

Defined values

<n>: integer type

- 0 The call monitoring function is disabled
- 1 List the unsolicited result codes +CMCCSS<x> that are supported by the TE. The supported values for <x> are reported as a compound value, e.g. a TE supporting +CMCCSS1, +CMCCSS2 and +CMCCSS5 will report +CMCCS: (1,2,5) or +CMCCS: (1-2,5)
- 2 The call monitoring function is enabled for basic call information (unsolicited result code +CMCCSI)
- 3 The call monitoring function is enabled for basic call information and supplementary service information (unsolicited result codes +CMCCSI and +CMCCSS<x> / +CMCCSSSEND)

<x>: integer type. <x> is the suffix in the unsolicited result codes +CMCCSS<x>.

<ccidx>: integer type. Call identification number as described in 3GPP TS 22.030 [19] clause 6.5.5.1. This number can be used in +CHLD command operations. Value range is from 1 to N. N, the maximum number of simultaneous call control processes is implementation specific. The call identification number must not be reused until the unsolicited result code +CMCCSI has indicated that the <ccstatus>=1 (Idle).

<dir>: integer type

- 0 mobile originated (MO) call
- 1 mobile terminated (MT) call

<neg_status_present>: integer type. Indicates whether parameter <neg_status> has any valid information.

- 0 No valid information in parameter <neg_status>. Parameter <neg_status> is set to zero.
- 1 Valid information in parameter <neg_status>.

<neg_status>: integer type as defined in the +CCMMD command.

- 0 The parameter <neg_status> has no valid content. Parameter <SDP_md> is set to an empty string ("").
- 1 The <SDP_md> parameter describes the active media in the call.
- 2 The <SDP_md> parameter describes a proposed but not yet active new set of media for the call.
- 3 A proposed new set of media for the call was accepted by the remote party. The <SDP_md> parameter describes the accepted media by the remote party. The accepted media can be same as proposed new set of media or a subset of proposed media.
- 4 A proposed new set of media for the call was rejected by the remote party. The <SDP_md> parameter will be set to an empty string ("").

<SDP_md>: string type represented with IRA characters. Media description as per the +CDEFMP command. This parameter shall not be subject to conventional character conversion as per +CSCS. This parameter will be an empty string ("") if the call has no multimedia content.

<cs_mode>: integer type (bearer/teleservice). Applicable to CS calls only.

- 0 no relevant information about bearer/teleservice
- 1 voice
- 2 data
- 3 fax
- 4 voice followed by data, voice mode
- 5 alternating voice/data, voice mode
- 6 alternating voice/fax, voice mode
- 7 voice followed by data, data mode
- 8 alternating voice/data, data mode
- 9 alternating voice/fax, fax mode
- 255 unknown

<ccstatus>: integer type Indicating the state of the call.

- 1 Idle
- 2 Calling (MO); the call setup has been started
- 3 Connecting (MO); the call is in progress
- 4 Alerting (MO); an alert indication has been received
- 5 Alerting (MT); an alert indication has been sent
- 6 Active; the connection is established
- 7 Released; an outgoing (MO) call is released.
- 8 Released; an incoming (MT) call is released
- 9 User busy
- 10 User determined user busy
- 11 Call waiting (MO)
- 12 Call waiting (MT)

13 Call hold (MO)

14 Call hold (MT)

<empty>: integer type

0 call is not one of multiparty (conference) call parties

1 call is one of multiparty (conference) call parties

<numbertype>: integer type. Indicating type of information in parameter <number>.

0 No valid information in parameter <number>. <number> shall then be set to empty string ("").

1 Number in <number> according to URI including the prefix specifying the URI type (see command +CDU). Parameter <ton> has no relevant information and is set to zero.

2 Number in <number> according to one of the formats supported by 3GPP TS 24.008 [8] clause 10.5.4.7)

<ton>: type of number in integer format (refer 3GPP TS 24.008 [8] clause 10.5.4.7). The parameter is also set to zero when it has no meaningful content, e.g. when <numbertype>=1.

<number>: string type phone number in format specified by <numbertype>. The used character set should be the one selected with command select TE character set +CSCS. When no number is available, <number> shall be set to empty string ("").

<exittype>: integer type. Indicating type of information in parameter <exitcause>.

0 No valid information in parameter <exitcause>

1 Cause in <exitcause> according to 3GPP TS 24.008 [8], Annex H

2 Cause in <exitcause> according to 3GPP TS 24.229 [89], Annex A.2.1.4.1

<exitcause>: integer type. Additional information provided if relevant. If there is no relevant cause to report, or if <exittype>=0 the exitcause is set to 0 (<exitcause>=0).

<service>: integer type. Indication of the indicated (supplementary) service. It is vendor specific which of the services that are provided. The related unsolicited result codes +CMCCSS<x> are provided as applicable for a given <service>, e.g. the +CMCCSS5: <subaddr>, <satype> can be omitted when it is not relevant for the service, but can also be omitted if this information is not provided for a relevant service or if a vendor does not support parameters <subaddr> and <satype>.

0 No service

1 Originating identification presentation – CLIP / OIP, refer 3GPP TS 22.081 [3] and 3GPP TS 24.607 [119]
CLIP / OIP specific information can be provided in:

+CMCCSI (in parameters <numbertype>, <ton> and <number>)

Additional CLIP / OIP specific information can be provided in:

+CMCCSS1 (in parameter <service>)

+CMCCSS3 (in parameter <CLI_validity>, typically used when no <number> is available)

+CMCCSS5 (in parameters <subaddr> and <satype>, when applicable)

2 Originating identification restriction – CLIR / OIR, refer 3GPP TS 22.081 [3] and 3GPP TS 24.607 [119]

3 Terminating identification presentation – COLP / TIP, refer 3GPP TS 22.081 [3] and 3GPP TS 24.608 [120]
COLP / TIP specific information can be provided in:

+CMCCSI (in parameters <numbertype>, <ton> and <number>)

Additional COLP / TIP specific information can be provided in:

+CMCCSS1 (in parameter <service>)

+CMCCSS5 (in parameters <subaddr> and <satype>, when applicable)

4 Terminating identification restriction – COLR / TIR, refer 3GPP TS 22.081 [3] and 3GPP TS 24.608 [120]

5 Called line presentation – CDIP

Additional CDIP specific information can be provided in:

+CMCCSS1 (in parameter <service>)

+CMCCSS2 (in parameters <numbertype>, <ton> and <number>)

+CMCCSS5 (in parameters <subaddr> and <satype>, when applicable)

NOTE 2: The command +CDIP does not explicitly specify what "multiple called numbers" it is intended to support. +CMCCS can therefore not be more specific. The CDIP service in +CMCCS is therefore intended for manufacturers who already have chosen a manufacturer specific way to support +CDIP and needs to extend or replace +CDIP with support for SIP URIs. For manufacturers who do not already support the command +CDIP, the usage of the CDIP service in +CMCCS is deprecated.

6 Calling name presentation – CNAP, refer 3GPP TS 22.096 [93]

Additional CNAP specific information can be provided in:

+CMCCSS1 (in parameter <service>)

+CMCCSS4 (in parameter <name>)

7 Communication deflection – CD, refer 3GPP TS 22.072 [31] and 3GPP TS 24.604 [132]

8 Communication forwarding unconditional – CFU, refer 3GPP TS 22.082 [4] and 3GPP TS 24.604 [132]

9 Communication forwarding on busy user – CFB, refer 3GPP TS 22.082 [4] and 3GPP TS 24.604 [132]

10 Communication forwarding on no reply – CFNR, refer 3GPP TS 22.082 [4] and 3GPP TS 24.604 [132]

11 Communication forwarding on subscriber not reachable – CFNRc, refer 3GPP TS 22.082 [4] and 3GPP TS 24.604 [132]

12 Communication forwarding on not logged-in – CFNL, refer 3GPP TS 24.604 [132]

13 Communication diversion notification – CDIVN, refer 3GPP TS 24.604 [132]

14 Communication waiting – CW, refer 3GPP TS 22.083 [5] and 3GPP TS 24.615 [137]

Additional CW specific information can be provided in:

+CMCCSS1 (in parameter <service>)

+CMCCSS6 (in parameter <priority>)

15 Communication hold – HOLD, refer 3GPP TS 22.083 [5] and 3GPP TS 24.610 [135]

16 Conference – MPTY / CONF, refer 3GPP TS 22.084 [22] and 3GPP TS 24.605 [133]

17 Explicit communication transfer – ECT, refer 3GPP TS 22.091 [30] and 3GPP TS 24.629 [139]

18 Completion of communications to busy subscriber – CCBS, refer 3GPP TS 22.093 [123] and 3GPP TS 24.642 [140]

19 Completion of communications by no reply – CCNR, refer 3GPP TS 24.642 [140]

20 Communication barring of all outgoing calls – BAOC, refer 3GPP TS 22.088 [6] and 3GPP TS 24.611 [136]

21 Communication barring of all international outgoing calls except those directed to the home PLMN country – BOIC-exHC, refer 3GPP TS 22.088 [6] and 3GPP TS 24.611 [136]

22 Communication barring of all incoming calls – BAIC, refer 3GPP TS 22.088 [6] and 3GPP TS 24.611 [136]

23 Communication barring of incoming calls when roaming outside the home PLMN country – BIC-Roam, refer 3GPP TS 22.088 [6] and 3GPP TS 24.611 [136]

24 All barring services, refer 3GPP TS 22.030 [19]

25 All outgoing barring services, refer 3GPP TS 22.030 [19]

26 All incoming barring services, refer 3GPP TS 22.030 [19]

27 Anonymous communication rejection – ACR, refer 3GPP TS 22.088 [6] and 3GPP TS 24.611 [136]

- 28 Advice of charge – AOC, refer 3GPP TS 22.085 [21] and 3GPP TS 24.654 [121]
- 29 Message waiting indication – MWI, refer 3GPP TS 24.606 [134]
- 30 Malicious communication identification, all outgoing calls – MCID, refer 3GPP TS 24.616 [138]
- 31 Unstructured supplementary service data – USSD, refer 3GPP TS 22.090 [23] and 3GPP TS 24.390 [131]
- 32 Customized alerting tones – CAT, refer 3GPP TS 24.182 [127]
- 33 Customized ringing signal – CRS, refer 3GPP TS 24.183 [128]
- 34 Flexible alerting – FA, refer 3GPP TS 24.239 [129]
- 35 Personal network management – PNM, refer 3GPP TS 24.259 [130]
- 36 User-to-user signalling service 1 – UUS 1, refer 3GPP TS 22.087 [58] and 3GPP TS 24.229 [89]
- 37 User-to-user signalling service 2 – UUS 2, refer 3GPP TS 22.087 [58]
- 38 User-to-user signalling service 3 – UUS 3, refer 3GPP TS 22.087 [58]
- 39 All user-to-user signalling services, refer 3GPP TS 22.087 [58]
- 40 Follow me – FM, refer 3GPP TS 22.094 [124]
- 41 Multiple subscriber profile – MSP, refer 3GPP TS 22.097 [125]
- 42 Multicall – MC, refer 3GPP TS 22.135 [126]
- 43 enhanced multi-level precedence and pre-emption service – eMLPP, refer 3GPP TS 22.067 [54]
- 44 Closed user group – CUG, refer 3GPP TS 22.085 [21] and 3GPP TS 24.654 [121]
 Additional CUG specific information can be provided in:
 +CMCCSS1 (in parameter <service>)
 +CMCCSS7 (in parameter <CUG_index>)
- 45 enhanced calling name – eCNAM, refer to 3GPP TS 24.196 [163] and 3GPP TS 22.173 [164].
 eCNAM specific information can be provided in:
 +CMCCSS1 (in parameter <service>)
 Additional eCNAM specific information can be provided in:
 +CMCCSS4 (in parameter <name>)
 +CMCCSS8 (in parameter <eCNAM_meta>, when available)

256 - 511 Reserved for vendor specific services

<CLI_validity>: integer type. This parameter can provide details why <number> does not contain a calling party BCD number (refer 3GPP TS 24.008 [8] clause 10.5.4.30). The parameter is not relevant for MO call types.

0 CLI valid

1 CLI has been withheld by the originator (refer 3GPP TS 24.008 [8] table 10.5.135a/3GPP TS 24.008 code "Reject by user")

2 CLI is not available due to interworking problems or limitations of originating network (refer 3GPP TS 24.008 [8] table 10.5.135a/3GPP TS 24.008 code "Interaction with other service")

3 CLI is not available due to calling party being of type payphone (refer 3GPP TS 24.008 [8] table 10.5.135a/3GPP TS 24.008 code "Coin line/payphone")

4 CLI is not available due to other reasons (refer 3GPP TS 24.008 [8] table 10.5.135a/3GPP TS 24.008 code "Unavailable")

When CLI is not available (<CLI_validity>=2, <CLI_validity>=3 or <CLI_validity>=4), <number> shall be an empty string ("") and <ton> value will not be significant. The parameter

<numbertype> will be set to 0. Nevertheless, TA may return the recommended value 128 for <ton> (TON/NPI unknown in accordance with 3GPP TS 24.008 [8] clause 10.5.4.7).

When CLI has been withheld by the originator, (<CLI validity>=1) and the CLIP is provisioned with the "override category" option (refer 3GPP TS 22.081 [3] and 3GPP TS 23.081 [40]), <number> and <ton> is provided. Otherwise, TA shall return the same setting for <number> and <type> as if the CLI was not available. The parameter <numbertype> shall be set as applicable.

<name>: string type up to 80 characters long string containing the calling name.

<subaddr>: string type subaddress of format specified by <satype>.

<satype>: type of subaddress octet in integer format (refer 3GPP TS 24.008 [8] clause 10.5.4.8) or RFC 4715 [122] appendix A.

<priority>: integer type indicating the eMLPP priority level of the call, values specified in 3GPP TS 22.067 [54].

<CUG_index>: string type. The parameter sets the CUG index for this <CUG_pointer>.

"0" ... "32767" CUG index

"" no CUG index, indicated by empty string. Preferential CUG taken from subscriber data.

<eCNAM_meta>: string type up to 1000 characters long. The string contains additional information about the caller (such as language, location or results of analytics and verification of the caller – refer to 3GPP TS 24.196 [158] clause 4.5.3.3 about additional information in Call-Info header fields).

NOTE 3: The eCNAM metadata can also include graphics (e.g., logos and symbols). Manufacturer specific commands are needed to upload such information.

Implementation

Optional.

8.74 List of current calls +CLCCS

Table 8.74-1: +CLCCS action command syntax

Command	Possible response(s)
+CLCCS[=<ccidx>]	<pre>[+CLCCS: <ccid1>,<dir>,<neg_status_present>,<neg_status> ,<SDP_md>,<cs_mode>,<ccstatus>,<empty>,[,<numbertype>,<ton> ,<number>[,<priority_present>,<priority>[,<CLI_validity_present>,<CLI_validity>]]] [<CR><LF>+CLCCS: <ccid2>,<dir>,<neg_status_present>,<neg_status> ,<SDP_md>,<cs_mode>,<ccstatus>,<empty>,[,<numbertype>,<ton> ,<number>[,<priority_present>,<priority>[,<CLI_validity_present>,<CLI_validity>]]] [...]]] +CME ERROR: <err></pre>
+CLCCS=?	

Description

Returns a list of current calls controlled by the MT for which the <ccidx> is allocated. The information returned is a subset of the information provided by the call monitoring function, see +CMCCS and its unsolicited result codes +CMCCSI and +CMCCSS<x> / +CMCCSSEND. For an originating call, the parameters <numbertype>, <ton> and <number> provide the number (line identity) information which has been dialled with +CDU or ATD. For a terminating call, the parameters <numbertype>, <ton> and <number> provide the number (line identity)

information of the calling user. If no particular <ccid> is included in the request, data for all allocated <ccid> are returned. If the command succeeds but no <ccid> is allocated, no information response is sent to the TE. Refer clause 9.2 for possible <err> values.

Defined values

<ccid>: integer type. Call identification number (see 3GPP TS 22.030 [19] clause 6.5.5.1). This number can be used in +CHLD command operations. Value range is from 1 to N. N, the maximum number of simultaneous call control processes is implementation specific.

NOTE 1: The restrictions and limitations of the call identification number as described in 3GPP TS 22.030 [19] clause 6.5.5.1 and 3GPP TS 22.084 [22] do not apply.

NOTE 2: When +CMCCS is supported, the call identification number is not reset until the unsolicited result code +CMCCSI has indicated that the <ccstatus>=1 (Idle).

<dir>: integer type

- 0 mobile originated (MO) call
- 1 mobile terminated (MT) call

<neg_status_present>: integer type. Indicates whether parameter <neg_status> has any valid information.

- 0 No valid information in parameter <neg_status>. Parameter <neg_status> is set to zero.
- 1 Valid information in parameter <neg_status>.

<neg_status>: integer type as defined in the +CCMMD command.

- 0 The parameter <neg_status> has no valid content. Parameter <SDP_md> is set to an empty string ("").
- 1 The <SDP_md> parameter describes the active media in the call.
- 2 The <SDP_md> parameter describes a proposed but not yet active new set of media for the call.
- 3 A proposed new set of media for the call was accepted by the remote party. The <SDP_md> parameter describes the active media in the call (if any).
- 4 A proposed new set of media for the call was rejected by the remote party. The <SDP_md> parameter describes the active media in the call (if any).

<SDP_md>: string type represented with IRA characters. SDP media description as per the +CDEFMP command. This parameter shall not be subject to conventional character conversion as per +CSCS. This parameter will be an empty string ("") if the call has no multimedia content.

<cs_mode>: integer type (bearer/teleservice)

- 0 no relevant information about bearer/teleservice
- 1 voice
- 2 data
- 3 fax
- 4 voice followed by data, voice mode
- 5 alternating voice/data, voice mode
- 6 alternating voice/fax, voice mode
- 7 voice followed by data, data mode
- 8 alternating voice/data, data mode

9 alternating voice/fax, fax mode

255 unknown

<ccstatus>: integer type. Indicating the state of the call.

- 1 Idle
- 2 Calling (MO); the call setup has been started
- 3 Connecting (MO); the call is in progress
- 4 Alerting (MO); an alert indication has been received
- 5 Alerting (MT); an alert indication has been sent
- 6 Active; the connection is established
- 7 Released; an outgoing (MO) call is released.
- 8 Released; an incoming (MT) call is released
- 9 User Busy
- 10 User Determined User Busy
- 11 Call Waiting (MO)
- 12 Call Waiting (MT)
- 13 Call Hold (MO)
- 14 Call Hold (MT)

<mpty>: integer type

- 0 call is not one of multiparty (conference) call parties
- 1 call is one of multiparty (conference) call parties

<numbertype>: integer type. Indicating type of information in parameter <number>.

- 0 No valid information in parameter <number>
- 1 Number in <number> according to URI including the prefix specifying the URI type (see command +CDU). Parameter <ton> has no relevant information and is set to zero.
- 2 Number in <number> according to one of the formats supported by 3GPP TS 24.008 [8] clause 10.5.4.7)

<ton>: type of number in integer format (refer 3GPP TS 24.008 [8] clause 10.5.4.7). The parameter is also set to zero when it has no meaningful content, e.g. when <numbertype>=1.

<number>: string type phone number in format specified by <numbertype>. This parameter shall not be subject to conventional character conversion as per +CSCS.

<priority_present>: integer type. Indicates whether parameter <priority> has any valid information.

- 0 No valid information in parameter <priority>. Parameter <priority> is set to zero.
- 1 Valid information in parameter <priority>.

<priority>: integer type parameter indicating the eMLPP priority level of the call, values specified in 3GPP TS 22.067 [54].

<CLI_validity_present>: integer type. Indicates whether parameter <CLI_validity> has any valid information.

- 0 No valid information in parameter <CLI_validity>. Parameter <priority> is set to zero.
- 1 Valid information in parameter <CLI_validity>.

<CLI_validity>: integer type. This parameter can provide details why <number> does not contain a calling party BCD number (refer 3GPP TS 24.008 [8] clause 10.5.4.30). The parameter is not relevant for MO call types.

- 0 CLI valid
- 1 CLI has been withheld by the originator (refer 3GPP TS 24.008 [8] table 10.5.135a/3GPP TS 24.008 code "Reject by user")
- 2 CLI is not available due to interworking problems or limitations of originating network (refer 3GPP TS 24.008 [8] table 10.5.135a/3GPP TS 24.008 code "Interaction with other service")
- 3 CLI is not available due to calling party being of type payphone (refer 3GPP TS 24.008 [8] table 10.5.135a/3GPP TS 24.008 code "Coin line/payphone")
- 4 CLI is not available due to other reasons (refer 3GPP TS 24.008 [8] table 10.5.135a/3GPP TS 24.008 code "Unavailable")

When CLI is not available (<CLI_validity>=2, <CLI_validity>=3 or <CLI_validity>=4), <number> shall be an empty string ("") and <type> value will not be significant. The parameter <numbertype> will be set to 0. Nevertheless, TA may return the recommended value 128 for <ton> (TON/NPI unknown in accordance with 3GPP TS 24.008 [8] clause 10.5.4.7).

When CLI has been withheld by the originator, (<CLI_validity>=1) and the CLIP is provisioned with the "override category" option (refer 3GPP TS 22.081 [3] and 3GPP TS 23.081 [40]), <number> and <type> is provided. Otherwise, TA shall return the same setting for <number> and <type> as if the CLI was not available. The parameter <numbertype> shall be set as applicable.

Implementation

Optional. Recommended when +CHLD command is implement.

This command supports all types of numbers (including SIP URIs) and can replace +CLCC.

8.75 Supported radio accesses +CSRA

Table 8.75-1: +CSRA parameter command syntax

Command	Possible response(s)
+CSRA=<GERAN-TDMA>, <UTRAN-FDD>, <UTRAN-TDD-LCR>, <UTRAN-TDD-HCR>, <UTRAN-TDD-VHCR>, <E-UTRAN-FDD>, <E-UTRAN-TDD>, <NR-FDD>, <NR-TDD>	+CME ERROR: <err>
+CSRA?	+CSRAC: <GERAN-TDMA>, <UTRAN-FDD>, <UTRAN-TDD-LCR>, <UTRAN-TDD-HCR>, <UTRAN-TDD-VHCR>, <E-UTRAN-FDD>, <E-UTRAN-TDD>, <NR-FDD>, <NR-TDD> <CR><LF>+CSRAA: <GERAN-TDMA>, <UTRAN-FDD>, <UTRAN-TDD-LCR>, <UTRAN-TDD-HCR>, <UTRAN-TDD-VHCR>, <E-UTRAN-FDD>, <E-UTRAN-TDD>, <NR-FDD>, <NR-TDD> +CME ERROR: <err>

+CSRA=?	+CSRA: (indication of supported <GERAN-TDMA>s) , (indication of supported <UTRAN-FDD> s) , (indication of supported <UTRAN-TDD-LCR> s) , (indication of supported <UTRAN-TDD-HCR> s) , (indication of supported <UTRAN-TDD-VHCR> s) , (indication of supported <E-UTRAN-FDD> s) , (indication of supported <E-UTRAN-TDD> s , (indication of supported <NR-FDD> s) , (indication of supported <NR-TDD> s)) +CME ERROR: <err>
---------	--

Description

Set command is used to configure the availability of the radio accesses inherently supported by the MT. E.g. in a GSM-only environment, other radio access technologies could be disabled to reduce power-consumption. Settings are persistent over a power-cycle. It is not supported to set all parameters to indicate "Radio access is disabled", this will cause the MT to return ERROR. +CSRA only configures the requested parameters; no change in the transmit and receive RF circuits takes place by using +CSRA. The actual execution of the configuration is obtained by using +CFUN=128.

Read command returns two lines of information text with two distinct prefixes:

- a line prefixed with +CSRAC: displaying the currently configured +CSRA settings. These values are not activated until +CFUN=128 is executed, and this line does therefore not necessarily reflect the RATs currently activated on the radio interface; and
- a line prefixed with +CSRAA: displaying the RATs currently active on the radio interface.

Read command returns the current settings in the MT.

Refer clause 9.2 for possible <err> values.

Test command returns values supported by the MT as compound values. The returned values do not reflect network capabilities.

Defined values

<GERAN-TDMA>: integer type. Indicates usage of radio access of type GERAN TDMA, see 3GPP TS 45.001 [146]. The initial value is manufacturer specific.

- 0 Radio access is disabled
- 1 Radio access is enabled

<UTRAN-FDD>: integer type. Indicates usage of radio access of type UTRAN FDD, see 3GPP TS 25.212 [144]. The initial value is manufacturer specific.

- 0 Radio access is disabled
- 1 Radio access is enabled

<UTRAN-TDD-LCR>: integer type. Indicates usage of radio access of type UTRAN 1.28 Mcps TDD low chip rate (TD-SCDMA), see 3GPP TS 25.102 [143]. The initial value is manufacturer specific.

- 0 Radio access is disabled
- 1 Radio access is enabled

<UTRAN-TDD-HCR>: integer type. Indicates usage of radio access of type UTRAN 3.84 Mcps TDD high chip rate, see 3GPP TS 25.102 [143]. The initial value is manufacturer specific.

- 0 Radio access is disabled
- 1 Radio access is enabled

<UTRAN-TDD-VHCR>: integer type. Indicates usage of radio access of type UTRAN 7.68 Mcps TDD very high chip rate, see 3GPP TS 25.102 [143]. The initial value is manufacturer specific.

0 Radio access is disabled

1 Radio access is enabled

<E-UTRAN-FDD>: integer type. Indicates usage of radio access of type E-UTRAN FDD, see 3GPP TS 36.300 [145]. The initial value is manufacturer specific.

0 Radio access is disabled

1 Radio access is enabled

<E-UTRAN-TDD>: integer type. Indicates usage of radio access of type E-UTRAN TDD, see 3GPP TS 36.300 [145]. The initial value is manufacturer specific.

0 Radio access is disabled

1 Radio access is enabled

<NR-FDD>: integer type. Indicates usage of radio access of type NR-FDD, see 3GPP TS 38.300 [159]. The initial value is manufacturer specific.

0 Radio access is disabled

1 Radio access is enabled

<NR-TDD>: integer type. Indicates usage of radio access of type NR-TDD, see 3GPP TS 38.300 [159]. The initial value is manufacturer specific.

0 Radio access is disabled

1 Radio access is enabled

Implementation

Optional. Mandatory when +CFUN supports <fun>=128.

8.76 Circuit switched fallback +CCSFB

Table 8.76-1: +CCSFB parameter command syntax

Command	Possible response(s)
+CCSFB=[<n>]	+CME ERROR: <err>
+CCSFB?	+CCSFB: <n>
+CCSFB=?	+CCSFB: (list of supported <n>s)

Description

The set command is used to control circuit switched fallback (CSFB) operation. Reporting of CSFB related CS paging requests can be switched on or off. After reporting the command can be used to accept or reject the CSFB call. The command can also be used to control automatic acceptance/rejection of CSFB calls. Refer clause 9.2 for possible <err> values.

CS paging requests are reported with unsolicited result code +CCSFBU in the format:

```
+CCSFBU: <numbertype>, <ton>, <number>[ , <ss_code>[ , <lcs_indicator>[ , <lcs_client_id
entity>]]]
```

NOTE 1: The command +CCSFB applies to connected mode. It does not apply to idle mode.

Read command returns the current value of <n>.

Test command returns values supported as a compound value.

Defined values

<n>: integer type.

- 0 disable reporting of CSFB related CS paging requests and disable automatic acceptance/rejection of CSFB calls.
- 1 enable reporting of CSFB related CS paging requests and disable automatic acceptance/rejection of CSFB calls.
- 2 enable reporting of CSFB related CS paging requests and enable automatic acceptance of CSFB calls.
- 3 enable reporting of CSFB related CS paging requests and enable automatic rejection of CSFB calls.
- 4 disable reporting of CSFB related CS paging requests and enable automatic acceptance of CSFB calls.
- 5 disable reporting of CSFB related CS paging requests and enable automatic rejection of CSFB calls.
- 6 accept CSFB call. This value can be used only after having received the unsolicited result code +CCSFBU when automatic acceptance/rejection of CSFB calls has been disabled.
- 7 reject CSFB call. This value can be used only after having received the unsolicited result code +CCSFBU when automatic acceptance/rejection of CSFB calls has been disabled.

NOTE 2: The values <n>=6 and <n>=7 will not be reported by +CCSFBU as these values are not associated with any MT state.

<number>: integer type. Indicating type of information in parameter <number>.

- 0 No valid information in parameter <number>. <number> shall then be set to empty string ("").
- 1 Number in <number> according to URI including the prefix specifying the URI type (see command +CDU). Parameter <ton> has no relevant information and is set to zero.
- 2 Number in <number> according to one of the formats supported by 3GPP TS 24.008 [8] clause 10.5.4.7.

NOTE 3: In +CCSFBU, the parameter <number> can have value 2 only.

<ton>: type of number in integer format (refer 3GPP TS 24.008 [8] clause 10.5.4.7). The parameter is also set to zero when it has no meaningful content, e.g. when <number>=1.

<number>: string type phone number in format specified by <number>. The used character set should be the one selected with command select TE character set +CSCS. When no number is available, <number> shall be set to empty string ("").

<ss_code>: integer type. SS code (refer 3GPP TS 24.301 [83] clause 9.9.3.39).

<lcs_indicator>: integer type. LCS indicator value (refer 3GPP TS 24.301 [83] clause 9.9.3.40).

<lcs_client_identity>: string type. LCS client identity information in hexadecimal format (refer 3GPP TS 24.301 [83] clause 9.9.3.41).

Implementation

Optional.

8.77 Reading coverage enhancement status +CRCES

Table 8.77-1: +CRCES action command syntax

Command	Possible Response(s)
+CRCES	+CRCES: <Act>, <CE_level>, <CC>
+CRCES=?	

Description

This command returns the coverage enhancement status of the MT. The terminal can consider the coverage enhancement status prior to deciding to transmit data (see e.g. clause 10.1.43). Depending on the coverage enhancement status the terminal can refrain from transmitting data.

The coverage enhancement status is only provided by the MT if the access technology of the serving cell is E-UTRAN, EC-GSM-IoT or E-UTRAN (NB-S1 mode). If the access technology of the serving cell is different, <Act>=0 is indicated.

Defined values

<Act>: integer type; access technology of the serving cell.

- 0 Serving cell has no coverage enhancement
- 1 E-UTRAN
- 2 EC-GSM-IoT (A/Gb mode) (see NOTE 1)
- 3 E-UTRAN (NB-S1 mode) (see NOTE 2)

NOTE 1: 3GPP TS 44.018 [156] specifies the EC-SCH INFORMATION message which, if present, indicates that the serving cell supports EC-GSM-IoT.

NOTE 2: 3GPP TS 36.331 [86] specifies the System Information blocks which give the information about whether the serving cell supports NB-IoT, which corresponds to E-UTRAN (NB-S1 mode).

<CE_level>: integer type; Coverage Enhancement (CE) level of the MT in the serving cell. Applicable only if <Act>=1 (E-UTRAN) or <Act>=3 (E-UTRAN (NB-S1 mode)). The Coverage Enhancement levels are defined and specified in 3GPP TS 36.331 [86].

- 0 No Coverage Enhancement in the serving cell
- 1 Coverage Enhancement level 0
- 2 Coverage Enhancement level 1
- 3 Coverage Enhancement level 2
- 4 Coverage Enhancement level 3

<CC>: integer type; Coverage Class (CC) of the MT in the serving cell. Applicable only if <Act>=2 (EC-GSM-IoT). The Coverage Classes are defined and specified in 3GPP TS 43.064 [13].

- 0 No Coverage Class in the serving cell
- 1 Coverage Class 1
- 2 Coverage Class 2
- 3 Coverage Class 3
- 4 Coverage Class 4
- 5 Coverage Class 5

Implementation

Optional.

8.78 Application level measurement configuration +CAPPLEVMC

Table 8.78-1: +CAPPLEVMC parameter command syntax

Command	Possible response(s)
+CAPPLEVMC=[<n>]	+CME ERROR: <err>
+CAPPLEVMC?	+CAPPLEVMC: <n>
+CAPPLEVMC=?	+CAPPLEVMC: (list of supported <n>s)

Description

This command allows control of the application level measurement configuration according to 3GPP TS 25.331 [74] and 3GPP TS 36.331 [86]. The set command controls the presentation of the unsolicited result code +CAPPLEVMC: <app-meas_service_type>, <start-stop_reporting>[, <app-meas_config_file_length>, <app-meas_config-file>] providing data for the configuration. Refer clause 9.2 for possible <err> values.

Read command returns the current value of <n>.

Test command returns values supported as a compound value.

Defined values

<n>: integer type. Disable and enable presentation of the unsolicited result code +CAPPLEVMC to the TE.

- 0 Disable presentation of the unsolicited result code
- 1 Enable presentation of the unsolicited result code

<app-meas_service_type>: integer type. Contains the indication of what application that is target for the application level measurement configuration.

- 1 QoE measurement collection for streaming services
- 2 QoE measurement collection for MTSI services

<start-stop_reporting>: integer type. Indicates the start and stop of the application level measurement reporting for the application indicated by the <app-meas_service_type>.

- 0 start the application level measurement reporting
- 1 stop the application level measurement reporting

<app-meas_config_file_length>: integer type. Indicates the number of octets of the <app-meas_config-file> parameter.

<app-meas_config-file>: string of octets. Contains the application level measurement configuration file for the application indicated by the <app-meas_service_type>. The parameter shall not be subject to conventional character conversion as per +CSCS.

Implementation

Optional.

8.79 Application level measurement report +CAPPLEVMR

Table 8.79-1: +CAPPLEVMR action command syntax

Command	Possible response(s)
+CAPPLEVMR=<app-meas_service_type>,<app-meas_report_length>,<app-meas_report>	+CME ERROR: <err>
+CAPPLEVMR=?	

Description

This command allows the MT to provide the application level measurement report according to 3GPP TS 25.331 [74] and 3GPP TS 36.331 [86]. Refer clause 9.2 for possible <err> values.

Defined values

<app_meas_service_type>: integer type. Contains the indication of what application that is providing the application level measurement report.

- 1 QoE measurement collection for streaming services
- 2 QoE measurement collection for MTSI services

<app-meas_report_length>: integer type. Indicates the number of octets of the <app-meas_report> parameter.

<app-meas_report>: string of octets. Contains the application level measurement configuration file for the application indicated by the <app-meas_service_type>. The parameter shall not be subject to conventional character conversion as per +CSCS.

Implementation

Optional.

8.80 Informative examples

Phone Activity Status (+CPAS) is a general command used to detect the presence of the MT, if there is an incoming call, or if there is a call in progress. This command is normally used before trying to operate the MT from the TE. Note that the activity status can change at any time after the execution of +CPAS, and hence the returned value can be obsolete. Detachment of the MT from the TA is indicated with a special final result code that indicates all errors related to the operation of the MT. Result code is +CME ERROR: <err>, where <err> is an integer or verbose value giving useful information about the reason for the command failure (refer clause "Mobile termination error result code +CME ERROR").

Set Phone Functionality (+CFUN) can be used to reset the MT or set the power consumption level of the MT by disabling certain parts of the MT (e.g. the transmit and receive RF circuits). Mobile Termination Control Mode (+CMEC) is a command which manages access sharing between the MT and the TE to operate the user interface of the MT. It has four subparameters which describe the access to keypad, display, indicators, and touch screen. Each subparameter has values for restricting the operation of the corresponding user interface part only to the MT or only to the TE, or to give the access for both of them.

Keypad Control command (+CKPD) is used to operate the keypad of the MT. Here lies the problem of different keypad types between manufacturers, and also between their MT models. The keypresses are sent to the MT as a string type subparameter of this command. Each character in that string represents a key which will be logically pressed. A special character (colon) followed by any character can be used by manufacturers (or TE application programmers) to represent a key which is not defined in this profile. An escape character (semicolon) for direct string entering is also defined. All text between single semicolon characters is treated as an alphanumeric entry and is not converted to keypressings. All semicolon characters inside the text is duplicated in the TE and stripped back to one before entering them to the MT. Command has also optional second and third parameters which can be used to alter the time to strike each key, and the pause to wait between keystrokes (in tenths of a second). A special pause character (W or w) can be added in the string type subparameter for an extra pause of the same length as given by the third subparameter. In the following example

alphanumeric mode is entered and a person predefined in the MT phonebook, "Ilkka", is called; each key is struck for half a second and pauses between strokes are a tenth of a second:

```
AT+CKPD="@:Ilkka:S",5,1
OK
```

Display Control command (+CDIS) is used both for writing to the display text fields and for reading the current status of the fields. Mobile Termination usually has a character set of its own, so the TA will do a conversion between the TE and the MT character sets. TE can have several character sets and the TA must be informed of the character set in use before starting to write or read the display. Character set is set with general command select TE character set +CSCS. The +CDIS=? query command is a way to get information about the length of the fields. In the following example an MT is first queried about the supported conversions and the lengths of the fields. The response shows there are three ten character long and two six character long fields. Then the TE character set is set to be IRA and the current status of the display is read. The last command writes the text "Hello, I'm writing to display" in the three fields, and keeps the contents of the two other fields same (the last two commas could also be left out).

```
AT+CSCS=?;+CDIS=?
+CSCS: ("IRA","PCCP850","8859-1")
+CDIS: 10,10,10,6,6
OK
AT+CSCS="IRA"
OK
AT+CDIS?
+CDIS: "RADIOLINJA","","","Menu","Memory"
OK
AT+CDIS="IRA","Hello, I'm","writing to","display",,
OK
```

The writing is possible only when it is permitted by the Mobile Termination Control Mode command (and by the manufacturer). If a certain field is not writable (but is readable), writing to it is ignored. The order of the text fields is determined by manufacturers and follow the rule: first field is in the upper left corner, second in the next field to the right, and so on, until to the last field in the lower right corner.

Touch screen action Control command (+CTSA) is used to operate the touch screen of the MT. The x, y coordinates of the phone are fixed even if the device's orientation is changed. In the following example commands are sent to the MT to emulate a user drawing on the ME's touch screen; it is relevant that the gesture starts from the top of the touch screen. A gesture is emulated, starting at location 10,10 in a non-display area of the ME's (touch) screen, then dragged to 50,50 (during which the gesture crosses the boundary between the non-display area and a display area), then dragged to 100,100 and finally the touch screen is released at location 100,100.

```
AT+CSO=?                obtain the touch screen orientation
+CSO=2,0
AT+CSS=?                obtain the touch screen size
+CSS=200,600
AT+CDSB=?              determine if a boundary between the non-display area and a display area exists, and its location
+CDSB=20,20,180,580
AT+CTSA=1,10,10        start emulating a gesture
AT+CTSA=1,50,50        emulate that the gesture crosses the boundary between non-display area and a display area
+CTSA=0,100,100       end emulating the gesture
```

Indicators can be handled with Indicator Control command (+CIND). Its query command returns a short description (abbreviation) of the purpose of the indicators and the supported values for each indicator. The setting and reading is done similarly as with Display Control command. In the following example the indicators of a phone are queried, their current value is read, and the value of message indicator is tried to set (but it is forbidden):

```
AT+CIND=?
+CIND: ("memory",(0-2)),("call",(0,1)),("data",(0,1)),("roam",(0,1)),
("alpha",(0,1)),("message",(0,1)),("index1",(0-11)),("index2",(0-11)),
("index3",(0-11)),("signal",(0-5)),("service",(0,1)),("sel1",(0,1)),
("sel2",(0,1)),("sel3",(0,1)),("battchg",(0-5))
OK
AT+CIND?
+CIND: 1,0,0,0,0,1,0,0,0,3,1,0,0,0,5
OK
AT+CIND=,,,,,0
+CME ERROR: 10
```

The subparameter order in the command is defined by the query command order, not by the actual display order. The zero value of an indicator means that it is off (or in state which can be identified as "off"-state), value one means that

the indicator is on (or in a state which is more substantial than "off"-state), value two is more substantial than one, and so on.

To this point, only operating through the TE is covered. But when MT can be operated also through its keypad, or touch screen, or there are changes in the status of the display elements, the information about these actions is given to the TE also. This can be solved only with unsolicited result codes which return keypad, display text and indicator, and touch screen events. Each event group has a result code of its own: +CKEV returns the key code and if the key pressed (1) or released (0), +CDEV returns the display text field running number (as specified by command +CDIS) and the new status of the field, and +CIEV returns the running number of the indicator (refer +CIND) and the new value of it, and +CTEV returns the location of the action performed on the touch screen. In the following example number key 1 is pressed, updated on the display, released, and signal strength changes its state to five, the touch screen is pressed at coordinates 10,10, and it is released at the same coordinates, 3 seconds after initially pressing the screen:

```
+CKEV: 49,1
+CDEV: 1,"1"
+CKEV: 49,0
+CIND: 10,5
+CTEV: 1,10,10,0;
+CTEV: 0,10,10,0,3000
```

Mobile Termination Event Reporting command (+CMER) has been specified for the purpose of controlling the sending of these unsolicited result codes to the TE. Four ways are provided to handle the buffering of the result codes (see figure 8). The first is to buffer them always. The second possibility is to discard them when in on-line data mode and otherwise forward them directly to the TE. The third possibility is to buffer them in data mode and otherwise forward them to the TE. The last possibility is to send them always to the TE (some inband technique - e.g. V.80 - is used in data mode to send the result codes within the data). This is the first subparameter of +CMER command. Next three subparameters are used to enable or disable each of the keypad, text field and indicator result codes. Sending codes can be enabled either so that only events generated from the MT user interface are returned, or so that also events caused by Keypad, Display and Indicator Control commands are returned. The fifth subparameter controls the flushing of the buffer when the value of the first subparameter is changed to a value from one to three.

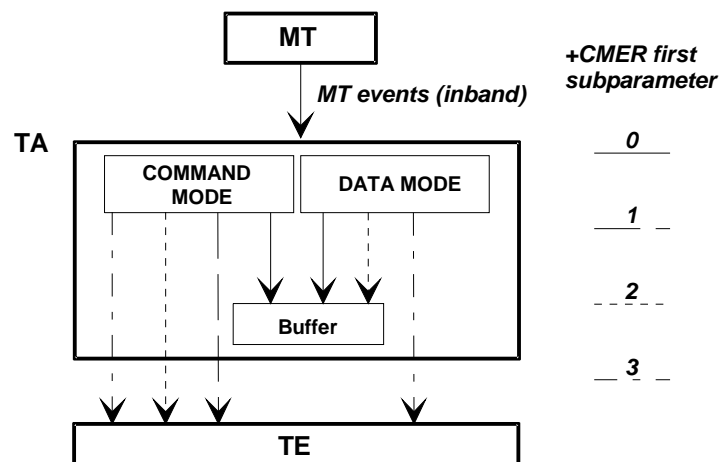

Figure 8: Mobile termination event reporting

An example of complete setup of the TA where TE takes the control of keypad, but does not want to write to display nor control the indicators (in the start MT is powered off):

```
AT+CMEE=2;+CREG=1          (use verbose <err> values; report registration)
OK
AT+CPAS                     (query MT status)
+CPAS: 5                    (MT is asleep)
OK
AT+CFUN=1                   (set MT to full functionality state)
+CME ERROR: SIM PIN required (SIM requests PIN)
AT+CPIN="1234"
+CME ERROR: incorrect password (user entered wrong PIN)
AT+CPIN="4321"
OK                           (correct PIN)
AT+COPS=0,0                 (ask for automatic operator selection and registration)
OK
+CREG: 1                    (registered in the network)
```

```

AT+COPS?
+COPS: 0,0,"RADIOLINJA"          (get the operator name)
OK
AT+CMEC=1,0,0                    (take over the keypad, leave display to MT)
OK
AT+CDIS=?;+CIND=?                (query display text and indicator formats)
+CDIS: 10,10,10,6,6
+CIND: ("memory",(0-2)),("call",(0,1)),("data",(0,1)),("roam",(0,1)),
("alpha",(0,1)),("message",(0,1)),("index1",(0-11)),("index2",(0-11)),
("index3",(0-11)),("signal",(0-5)),("service",(0,1)),("sel1",(0,1)),
("sel2",(0,1)),("sel3",(0,1)),("battchg",(0-5))
OK
AT+CSCS="IRA"                    (set TE character set for display text results)
OK
AT+CMER=1,0,2,2,0                (return display text and indicator result codes when
OK                               in command state, in data mode discard them)
AT+CDIS?;+CIND?                  (read current state of display texts and indicators)
+CDIS: "","","" 12345,"Menu","Memory" (user had pressed number buttons before
+CIND: 1,0,0,0,0,1,0,0,0,3,1,0,0,0,5   TE took control with +CMEC)
OK
AT+CKPD="C",20                   (clear main display text '12345' by holding the
OK                               'clear' button down two seconds)
+CDEV: 3,"1234"                  (first only one character deleted)
+CDEV: 3,""                      (while holding continues, whole display is cleared)
+CDEV: 1,"RADIOLINJA"           (operator name comes to the display)

```

The start of the previous example could go as follows when MT has already been powered on but is waiting for the PIN:

```

AT+CMEE=2;+CREG=1                (use verbose <err> values; report registration)
OK
AT+CPAS                           (query MT status)
+CPAS: 0                            (MT is ready to receive commands)
OK
AT+CPIN?                           (is MT asking passwords?)
+CPIN: SIM PIN                       (yes, SIM PIN required)
AT+CPIN="4321"
OK                                   (correct PIN)

```

One of the most regular operations done through the MT user interface is phonebook control. To lessen the workload of the TE, some direct commands for phonebook reading and writing are practical. Command Select Phonebook Memory Storage +CPBS query version returns supported phonebook memories, read version returns current settings, and set version selects the memory. For GSM, the normal storages are SIM, MT and TA.

Read Phonebook Entries (+CPBR) can be used to read either one or many phonebook locations at the same time. A regular phonebook entry consists of three elements: memory index number, the phone number and its alphanumeric equivalent given by the user. Query version of this returns supported index values of the selected memory, and the maximum lengths of the number and alphanumeric elements. The query version of the Write Phonebook Entry command (+CPBW) is similar, but the action version sets or clears an entry in the phonebook. Find Phonebook Entries (+CPBF) can be used to search alphanumeric entries starting with specific string. An example where the whole phonebook of the MT is read, index number four is cleared, and number three is written:

```

AT+CPBS=?
+CPBS: ("ME","SM")                (MT and SIM have phonebooks)
OK
AT+CPBS="ME"                       (select MT memory)
OK
AT+CPBR=?                           (read index range and element lengths)
+CPBR: (1-99),30,30
OK
AT+CPBR=1,99                        (read all entries but only the ones set are returned)
+CPBR: 1,"931123456",129,"Ilkka"
+CPBR: 2,"9501234567",129,""
+CPBR: 4,"901234567",129,"Hesari"
OK
AT+CPBW=4;+CPBW=3,"921123456",,"TS" (clear index 4 and write index 3)
OK

```

Circuit switched fallback (+CCSFB) can be used to control circuit switched fallback operation. Reporting of CSFB related CS paging requests can be switched on or off by +CCSFB=1 and +CCSFB=0. CSFB related CS paging requests are reported with unsolicited result code +CCSFBU. CSFB calls can be automatically accepted or rejected by +CCSFB=2, +CCSFB=3, +CCSFB=4 and +CCSFB=5. CSFB calls can be manually accepted or rejected by

+CCSFB=6 and +CCSFB=7. In the example the ME interrogates the current CSFB settings, enables reporting and accepts a CSFB call:

```
AT+CCSFB=?
+CCSFB: 0                (reporting and automatic acceptance/rejection disabled)
OK
AT+CCSFB=1              (enable reporting)
OK
+CCSFBU: 2,1,12345678,17 (incoming CSFB paging request with clip supplementary service)
AT+CCSFB=6              (accept CSFB call)
OK
```

9 Mobile termination errors

9.1 Report mobile termination error +CMEE

Table 110: +CMEE parameter command syntax

Command	Possible response(s)
+CMEE=[<n>]	
+CMEE?	+CMEE: <n>
+CMEE=?	+CMEE: (list of supported <n>s)

Description

Set command disables or enables the use of final result code +CME ERROR: <err> as an indication of an error relating to the functionality of the MT. When enabled, MT related errors cause +CME ERROR: <err> final result code instead of the regular ERROR final result code. ERROR is returned normally when error is related to syntax, invalid parameters, or TA functionality.

Read command returns the current setting of <n>.

Test command returns values supported as a compound value.

Defined values

<n>: integer type.

- 0 disable +CME ERROR: <err> result code and use ERROR instead
- 1 enable +CME ERROR: <err> result code and use numeric <err> values (refer clause 9.2)
- 2 enable +CME ERROR: <err> result code and use verbose <err> values (refer clause 9.2)

Implementation

Mandatory for <n> values 0 and 1.

9.1A Report mobile originated location request error +CMOLRE

Table 9.1A-1: +CMOLRE parameter command syntax

Command	Possible response(s)
+CMOLRE=[<n>]	
+CMOLRE?	+CMOLRE: <n>
+CMOLRE=?	+CMOLRE: (list of supported <n>s)

Description

Set command disables or enables the verbose format of unsolicited result code +CMOLRE: <err> as an indication of an error relating to the functionality for the mobile originated location request (MO-LR) error reporting format. When enabled, MT related verbose error cause is given.

Read command returns the current setting of <n>.

Test command returns values supported as a compound value.

Defined values

<n>: integer type.

0 disable. This will give +CMOLRE: <err> result code with numeric <err> values (refer clause 9.3)

1 enable. This will give +CMOLRE: <err> result code with verbose <err> values (refer clause 9.3)

Implementation

Optional.

9.1B Report network error codes +CNEC

Table 9.1B-1: +CNEC parameter command syntax

Command	Possible response(s)
+CNEC=[<n>]	
+CNEC?	+CNEC: <n>
+CNEC=?	+CNEC: (list of supported <n>s)

Description

The command activates or deactivates unsolicited reporting of error codes sent by the network. When activated, based on the setting of <n>, the ME will report CS mobility management, GPRS mobility management, GPRS session management, EPS mobility management and EPS session management related error codes sent by the network. The following unsolicited result codes can be reported:

- +CNEC_MM: <error_code> CS Mobility Management
- +CNEC_GMM: <error_code> GPRS Mobility Management
- +CNEC_GSM: <error_code>[, <cid>] GPRS Session Management
- +CNEC_EMM: <error_code>[, <cid>] EPS Mobility Management
- +CNEC_ESM: <error_code>[, <cid>] EPS Session Management
- +CNEC_5GMM: <error_code>[, <cid>] 5GS Mobility Management
- +CNEC_5GSM: <error_code>[, <cid>] 5GS Session Management

The parameter <n> is specified as a sum of integers, each representing the category of error codes that the MT is interested in receiving.

The read command returns the current setting of <n>.

Test command returns the supported values as a compound value.

Parameters

<n>: integer type. The parameter is a sum of integers each representing a certain category of error codes. The value consists of the sum of the individual values for <n> for the required unsolicited result codes.

- 0 Disable unsolicited error reporting
- 1 Enable unsolicited result code +CNEC_MM to report CS mobility management errors coded as specified in 3GPP TS 24.008 [8] Table 10.5.95/3GPP TS 24.008
- 2 Enable unsolicited result code +CNEC_GMM to report GPRS mobility management errors coded as specified in 3GPP TS 24.008 [8] Table 10.5.147/3GPP TS 24.008
- 4 Enable unsolicited result code +CNEC_GSM to report GPRS session management errors coded as specified in 3GPP TS 24.008 [8] Table 10.5.157/3GPP TS 24.008
- 8 Enable unsolicited result code +CNEC_EMM to report EPS mobility management errors coded as specified in 3GPP TS 24.301 [83] Table 9.9.3.9.1
- 16 Enable unsolicited result code +CNEC_ESM to report EPS session management errors coded as specified in 3GPP TS 24.301 [83] Table 9.9.4.4.1
- 32 Enable unsolicited result code +CNEC_5GMM to report 5GS mobility management errors coded as specified in 3GPP TS 24.501 [161] Table 9.11.3.2.1
- 64 Enable unsolicited result code +CNEC_5GSM to report 5GS session management errors coded as specified in 3GPP TS 24.501 [161] Table 9.11.4.2.1

NOTE: The sequence of entering +CNEC=1, followed by +CNEC=4 does not yield the same result as +CNEC=5, as +CNEC=4 overwrites the previous setting.

Example: If the MT wants to receive only CS mobility management errors, then <n>=1 must be specified.

AT+CNEC=1

If the MT wants to receive CS mobility management errors and GPRS session management errors, then <n>=5 must be specified (1 for enabling CS mobility management error and 4 for enabling GPRS session management error).

AT+CNEC=5

To enable reporting of all error codes, then <n>=127 must be specified (equals 1+2+4+8+16+32+64).

AT+CNEC=127

<error_code>: integer type. Error codes as appropriate according to:

3GPP TS 24.008 [8] Table 10.5.95/3GPP TS 24.008 for CS mobility management errors codes

3GPP TS 24.008 [8] Table 10.5.147/3GPP TS 24.008 for GPRS mobility management errors codes

3GPP TS 24.008 [8] Table 10.5.157/3GPP TS 24.008 for GPRS session management errors codes

3GPP TS 24.301 [83] Table 9.9.3.9.1 for EPS mobility management errors codes

3GPP TS 24.301 [83] Table 9.9.4.4.1 for EPS session management errors codes

3GPP TS 24.501 [161] Table 9.11.3.2.1 for 5GS mobility management errors codes

3GPP TS 24.501 [161] Table 9.11.4.2.1 for 5GS session management errors codes

<cid>: integer type. Specifies a particular PDP context definition.

Implementation

Optional.

9.2 Mobile termination error result code +CME ERROR

9.2.0 General

The operation of +CME ERROR: <err> final result code is similar to the regular ERROR result code: if +CME ERROR: <err> is the result code for any of the commands in a command line, none of the following commands in the same command line is executed (neither ERROR nor OK result code shall be returned as a result of a completed command line execution). The format of <err> can be either numeric or verbose. This is set with command +CMEE (refer clause 9.1).

NOTE: ITU-T Recommendation V.250 [14] command V does not affect the format of this result code.

<err> values (numeric format followed by verbose format):

All values below 256 are reserved.

Values in the range 0 - 100 are reserved for general errors.

Values in the range 101 - 150 are reserved for use by CS, GPRS, EPS and 5GS.

Values in the range 151 - 170 are reserved for use by VBS/VGCS and eMLPP.

Values in the range 171 - 256 can be used by GPRS, EPS and 5GS.

9.2.1 General errors

Numeric Text

0	phone failure
1	no connection to phone
2	phone-adaptor link reserved
3	operation not allowed
4	operation not supported
5	PH-SIM PIN required
6	PH-FSIM PIN required
7	PH-FSIM PUK required
10	SIM not inserted (See NOTE 1)
11	SIM PIN required
12	SIM PUK required
13	SIM failure (See NOTE 1)
14	SIM busy (See NOTE 1)
15	SIM wrong (See NOTE 1)
16	incorrect password
17	SIM PIN2 required
18	SIM PUK2 required
20	memory full
21	invalid index
22	not found
23	memory failure
24	text string too long
25	invalid characters in text string
26	dial string too long
27	invalid characters in dial string
30	no network service
31	network timeout
32	network not allowed - emergency calls only
40	network personalization PIN required
41	network personalization PUK required
42	network subset personalization PIN required
43	network subset personalization PUK required
44	service provider personalization PIN required

45	service provider personalization PUK required
46	corporate personalization PIN required
47	corporate personalization PUK required
48	hidden key required (See NOTE 2)
49	EAP method not supported
50	Incorrect parameters
51	command implemented but currently disabled
52	command aborted by user
53	not attached to network due to MT functionality restrictions
54	modem not allowed - MT restricted to emergency calls only
55	operation not allowed because of MT functionality restrictions
56	fixed dial number only allowed - called number is not a fixed dial number (refer 3GPP TS 22.101 [147])
57	temporarily out of service due to other MT usage
58	language/alphabet not supported
59	unexpected data value
60	system failure
61	data missing
62	call barred
63	message waiting indication subscription failure
100	unknown

NOTE 1: This error code is also applicable to UICC.

NOTE 2: This key is required when accessing hidden phonebook entries.

9.2.2 CS, GPRS, UMTS, EPS and 5GS-related errors

9.2.2.1 Errors related to a failure to perform an attach

9.2.2.1.1 Errors for CS, GPRS and UMTS

Numeric	Text
102	IMSI unknown in HLR (#2) NOTE 2
103	Illegal MS (#3)
104	IMSI unknown in VLR (#4) NOTE 2
105	IMEI not accepted (#5) NOTE 2
106	Illegal ME (#6)
107	GPRS services not allowed (#7)
108	GPRS services and non-GPRS services not allowed (#8)
109	MS identity cannot be derived by the network (#9) NOTE 2
110	Implicitly detached (#10) NOTE 2
111	PLMN not allowed (#11)
112	Location area not allowed (#12)
113	Roaming not allowed in this location area (#13)
114	GPRS services not allowed in this PLMN (#14)
115	No Suitable Cells In Location Area (#15)
116	MSC temporarily not reachable (#16) NOTE 2
117	Network failure (#17) NOTE 2
122	Congestion (#22)
125	Not authorized for this CSG (#25)
132	Service option not supported (#32) NOTE 2
133	Requested service option not subscribed (#33) NOTE 2
134	Service option temporarily out of order (#34) NOTE 2
138	Call cannot be identified (#38) NOTE 2
148	Unspecified GPRS error NOTE 2
150	Invalid mobile class
172	Semantically incorrect message (#95)
173	Invalid mandatory information (#96)
174	Message type non-existent or not implemented (#97)
175	Conditional IE error (#100)

176	Protocol error, unspecified (#111)
183	SMS provided via GPRS in this routing area (#28) NOTE 2
185	No PDP context activated (#40) NOTE 2
186	Message not compatible with protocol state (#101) NOTE 2
187	Recovery on timer expiry (#102) NOTE 2
208	Message type not compatible with protocol state (#98) NOTE 2
209	Information element non-existent or not implemented (#99) NOTE 2

NOTE 1: Values in parentheses are 3GPP TS 24.008 [8] cause codes.

NOTE 2: This error code was given a numeric value in 3GPP Rel-15, but was introduced in an earlier release.

9.2.2.1.2 Errors for EPS

Numeric	Text
102	IMSI unknown in HSS (#2) NOTE 2
103	Illegal UE (#3)
105	IMEI not accepted (#5) NOTE 2
106	Illegal ME (#6)
107	EPS services not allowed (#7)
108	EPS services and non-EPS services not allowed (#8)
109	UE identity cannot be derived by the network (#9) NOTE 2
110	Implicitly detached (#10) NOTE 2
111	PLMN not allowed (#11)
112	Tracking area not allowed (#12)
113	Roaming not allowed in this tracking area (#13)
114	EPS services not allowed in this PLMN (#14)
115	No suitable cells in tracking area (#15)
116	MSC temporarily not reachable (#16) NOTE 2
117	Network failure (#17) NOTE 2
118	CS domain not available (#18)
119	ESM failure (#19)
122	Congestion (#22)
125	Not authorized for this CSG (#25)
139	CS service temporarily not available (#39) NOTE 2
172	Semantically incorrect message (#95)
173	Invalid mandatory information (#96)
174	Message type non-existent or not implemented (#97)
175	Conditional IE error (#100)
176	Protocol error, unspecified (#111)
185	No EPS bearer context activated (#40) NOTE 2
186	Message not compatible with protocol state (#101) NOTE 2
189	Requested service option not authorized in this PLMN (#35) NOTE 2
204	Severe network failure (#42) NOTE 2
208	Message type not compatible with protocol state (#98) NOTE 2
209	Information element non-existent or not implemented (#99) NOTE 2

NOTE 1: Values in parentheses are 3GPP TS 24.301 [83] cause codes.

NOTE 2: This error code was given a numeric value in 3GPP Rel-15, but was introduced in an earlier release.

9.2.2.1.3 Errors for 5GS

Numeric	Text
103	Illegal UE (#3)
105	PEI not accepted (#5)
106	Illegal ME (#6)
107	5GS services not allowed (#7)
109	UE identity cannot be derived by the network (#9)
110	Implicitly deregistered (#10)
111	PLMN not allowed (#11)

112	Tracking area not allowed (#12)
113	Roaming not allowed in this tracking area (#13)
115	No suitable cells in tracking area (#15)
122	Congestion (#22)
172	Semantically incorrect message (#95)
173	Invalid mandatory information (#96)
174	Message type non-existent or not implemented (#97)
175	Conditional IE error (#100)
176	Protocol error, unspecified (#111)
178	Maximum number of PDU sessions reached (#65)
186	Message not compatible with protocol state (#101)
205	Insufficient resources for specific slice and DNN (#67)
207	Insufficient resources for specific slice (#69)
208	Message type not compatible with protocol state (#98)
209	Information element non-existent or not implemented (#99)
210	N1 mode not allowed (#27)
211	Restricted service area (#28)
212	LADN not available (#43)
214	ngKSI already in use (#71)
215	Payload was not forwarded (#90)
216	Non-3GPP access to 5GCN not allowed (#72)
217	Serving network not authorized (#73)
218	DNN not supported or not subscribed in the slice (#91)
219	Insufficient user-plane resources for the PDU session (#92)

NOTE: Values in parentheses are 3GPP TS 24.501 [161] cause codes.

9.2.2.2 Errors related to a failure to activate a context

9.2.2.2.1 Errors for GPRS and UMTS

Numeric	Text
124	MBMS bearer capabilities insufficient for the service (#24) NOTE 2
126	Insufficient resources (#26)
127	Missing or unknown APN (#27)
128	Unknown PDP address or PDP type (#28)
129	User authentication or authorization failed (#29)
130	Activation rejected by GGSN, Serving GW or PDN GW (#30)
131	Activation rejected, unspecified (#31)
132	Service option not supported (#32)
133	Requested service option not subscribed (#33)
134	Service option temporarily out of order (#34)
135	NSAPI already used (#35) NOTE 2
136	Regular deactivation (#36) NOTE 2
140	Feature not supported (#40)
141	Semantic error in the TFT operation (#41)
142	Syntactical error in the TFT operation (#42)
143	Unknown PDP context (#43)
144	Semantic errors in packet filter(s) (#44)
145	Syntactical errors in packet filter(s) (#45)
146	PDP context without TFT already activated (#46)
147	Multicast group membership time-out (#47) NOTE 2
148	Unspecified GPRS error
149	PDP authentication failure
150	Invalid mobile class
172	Semantically incorrect message (#95) NOTE 2
173	Invalid mandatory information (#96) NOTE 2
174	Message type non-existent or not implemented (#97) NOTE 2
175	Conditional IE error (#100) NOTE 2
176	Protocol error, unspecified (#111) NOTE 2

177	Operator determined barring (#8)
178	Maximum number of PDP contexts reached (#65)
179	Requested APN not supported in current RAT and PLMN combination (#66)
180	Request rejected, bearer control mode violation (#48)
182	User data transmission via control plane is congested
186	Message not compatible with protocol state (#101) NOTE 2
188	Invalid transaction identifier value (#81) NOTE 2
190	Network failure (#38) NOTE 2
191	Reactivation requested (#39) NOTE 2
192	PDP type IPv4 only allowed (#50) NOTE 2
193	PDP type IPv6 only allowed (#51) NOTE 2
194	Single address bearers only allowed (#52) NOTE 2
195	Collision with network initiated request (#56) NOTE 2
196	PDP type IPv4v6 only allowed (#57) NOTE 2
197	PDP type non IP only allowed (#58) NOTE 2
198	Bearer handling not supported (#60) NOTE 2
199	APN restriction value incompatible with active PDP context (#112) NOTE 2
200	Multiple accesses to a PDN connection not allowed (#113) NOTE 2
208	Message type not compatible with protocol state (#98) NOTE 2
209	Information element non-existent or not implemented (#99) NOTE 2

NOTE 1: Values in parentheses are 3GPP TS 24.008 [8] cause codes.

NOTE 2: This error code was given a numeric value in 3GPP Rel-15, but was introduced in an earlier release.

9.2.2.2.2 Errors for EPS

Numeric	Text
126	Insufficient resources (#26)
127	Missing or unknown APN (#27)
128	Unknown PDN type (#28)
129	User authentication or authorization failed (#29)
130	Activation rejected by Serving GW or PDN GW (#30)
131	Request rejected, unspecified (#31)
132	Service option not supported (#32)
133	Requested service option not subscribed (#33)
134	Service option temporarily out of order (#34)
135	PTI already in use (#35)
136	Regular deactivation (#36) NOTE 2
137	EPS QoS not accepted (#37) NOTE 2
141	Semantic error in the TFT operation (#41)
142	Syntactical error in the TFT operation (#42)
143	Invalid EPS bearer identity (#43)
144	Semantic errors in packet filter(s) (#44)
145	Syntactical errors in packet filter(s) (#45)
171	Last PDN disconnection not allowed (#49) NOTE 3
172	Semantically incorrect message (#95) NOTE 2
173	Invalid mandatory information (#96) NOTE 2
174	Message type non-existent or not implemented (#97) NOTE 2
175	Conditional IE error (#100) NOTE 2
176	Protocol error, unspecified (#111) NOTE 2
177	Operator determined barring (#8)
178	Maximum number of EPS bearers reached (#65)
179	Requested APN not supported in current RAT and PLMN combination (#66)
181	unsupported QCI value (#59)
184	Invalid PTI value (#81)
186	Message not compatible with protocol state (#101) NOTE 2
190	Network failure (#38) NOTE 2
191	Reactivation requested (#39) NOTE 2
192	PDN type IPv4 only allowed (#50) NOTE 2
193	PDN type IPv6 only allowed (#51) NOTE 2
194	Single address bearers only allowed (#52) NOTE 2
195	Collision with network initiated request (#56) NOTE 2
196	PDN type IPv4v6 only allowed (#57) NOTE 2
197	PDN type non IP only allowed (#58) NOTE 2
198	Bearer handling not supported (#60) NOTE 2
199	APN restriction value incompatible with active PDP context (#112) NOTE 2
200	Multiple accesses to a PDN connection not allowed (#113) NOTE 2
201	ESM information not received (#53) NOTE 2
202	PDN connection does not exist (#54) NOTE 2
203	Multiple PDN connections for a given APN not allowed (#55) NOTE 2
208	Message type not compatible with protocol state (#98) NOTE 2
209	Information element non-existent or not implemented (#99) NOTE 2

NOTE 1: Values in parentheses are 3GPP TS 24.301 [83] cause codes.

NOTE 2: This error code was given a numeric value in 3GPP Rel-15, but was introduced in an earlier release.

NOTE 3: The numeric error code for "Last PDN disconnection not allowed (#49)" is returned when the MT detects an attempt to disconnect the last PDN or the network returns a response message with cause value #49. The numeric error code was changed to 171 in 3GPP Rel-11.

9.2.2.2.3 Errors for 5GS

Numeric	Text
126	Insufficient resources (#26)
127	Missing or unknown DNN (#27)
128	Unknown PDU session type (#28)
129	User authentication or authorization failed (#29)
131	Request rejected, unspecified (#31)
132	Service option not supported (#32)
133	Requested service option not subscribed (#33)
135	PTI already in use (#35)
136	Regular deactivation (#36)
141	Semantic error in the TFT operation (#41)
142	Syntactical error in the TFT operation (#42)
143	Invalid PDU session identity (#43)
144	Semantic errors in packet filter(s) (#44)
145	Syntactical errors in packet filter(s) (#45)
172	Semantically incorrect message (#95)
173	Invalid mandatory information (#96)
174	Message type non-existent or not implemented (#97)
175	Conditional IE error (#100)
176	Protocol error, unspecified (#111)
177	Operator determined barring (#8)
184	Invalid PTI value (#81)
186	Message not compatible with protocol state (#101)
190	Network failure (#38)
191	Reactivation requested (#39)
192	PDU session type IPv4 only allowed (#50)
193	PDU session type IPv6 only allowed (#51)
202	PDU session does not exist (#54)
205	Insufficient resources for specific slice and DNN (#67)
206	Not supported SSC mode (#68)
207	Insufficient resources for specific slice (#69)
208	Message type not compatible with protocol state (#98)
209	Information element non-existent or not implemented (#99)
213	Missing or unknown DNN in a slice (#70)
220	Out of LADN service area (#46)
221	PTI mismatch (#47)
222	Maximum data rate per UE for user-plane integrity protection is too low (#82)
223	Semantic error in the QoS operation (#83)
224	Syntactical error in the QoS operation (#84)
225	Invalid mapped EPS bearer identity (#85)

NOTE: Values in parentheses are 3GPP TS 24.501 [161] cause codes.

9.2.2.3 Void

9.2.2.4 Void

9.2.3 VBS, VGCS and eMLPP-related errors

Numeric	Text
151	VBS/VGCS not supported by the network
152	No service subscription on SIM
153	No subscription for group ID
154	Group Id not activated on SIM
155	No matching notification
156	VBS/VGCS call already present
157	Congestion

158	Network failure
159	Uplink busy
160	No access rights for SIM file
161	No subscription for priority
162	operation not applicable or not possible
163	Group Id prefixes not supported
164	Group Id prefixes not usable for VBS
165	Group Id prefix value invalid

Implementation

Mandatory for numeric format codes applicable to implemented command set.

9.3 Mobile termination error result code +CMOLRE

9.3.1 General

The operation of +CMOLRE: <err> unsolicited result code is similar to the regular ERROR result code. The format of <err> can be either numeric or verbose. This is set with command +CMOLRE (refer clause 9.1a).

<err> values (numeric format followed by verbose format):

9.3.2 Errors

Numeric	Text
0	Method not supported
1	Additional assistance data required
2	Not enough satellites
3	UE busy (See NOTE)
4	Network error
5	Failed to open internet connection, too many connections
6	Failed to open internet connection, too many users
7	Failure due to handover
8	Internet connection failure
9	Memory error
255	Unknown error

NOTE: Error code 3 (UE busy) indicates there is already one ongoing positioning session and the UE does not support multiple simultaneous sessions

9.4 Informative examples

An example of TA responses with all three +CMEE values when MT manufacturer identification is requested but MT is not connected to the TA:

```

AT+CMEE=0    (+CME ERROR shall not be used)
OK
AT+CGMI
ERROR
AT+CMEE=1    (use numeric <err>)
OK
AT+CGMI
+CME ERROR: 1
AT+CMEE=2    (use verbose <err>)
OK
AT+CGMI
+CME ERROR: no connection to phone

```

10 Commands for packet domain

10.0 General

This clause defines commands that a TE can use to control a MT supporting packet switched services.

Packet Domain MTs vary widely in functionality. At one extreme, an advanced MT can support multiple PDP types, and use multiple external networks and QoS profiles. At the other extreme, an MT can support only a single PDP type using a single external network, and rely on the HLR to contain the PDP context definition.

A comprehensive set of Packet Domain-specific commands is defined in clause 10.1 to provide the flexibility needed by the more complex MT. The commands are designed to be expandable to accommodate new PDP types and interface protocols, merely by defining new values for many of the parameters. Multiple contexts can be activated if the interface link-layer protocol is able to support them. The commands use the extended information and error message capabilities described in this specification.

For MTs of intermediate complexity, most commands have simplified forms where certain parameters can be omitted.

For certain simple MTs, and for backwards compatibility with existing communications software as defined in 3GPP TS 23.060 [47], it is possible to control access to the Packet Domain using existing modem-compatible commands. A special dial-string syntax is defined for use with the D command. This "modem compatible" mode of operation is described in clause 10.2.

A discussion on the interaction of the AT commands, Packet Domain Management and Packet Data Protocols, together with examples of command sequences for some applications can be found in 3GPP TS 23.060 [47] and 3GPP TS 27.060 [34].

10.1 Commands specific to MTs supporting the packet domain

10.1.0 General remark about EPS bearer contexts and PDP contexts

According to 3GPP TS 23.401 [82], there is a 1 to 1 mapping between active EPS bearer context and active PDP context:

- An active default EPS bearer context is associated with an active non secondary PDP context.
- An active dedicated EPS bearer context is associated with an active secondary PDP context.

In consequence to the implicit logical relation between EPS PDN connection and its associated Default EPS Bearer, hereafter a same non secondary PDP context identifier <p_cid> can be used to refer either an EPS PDN connection context or its associated Default EPS Bearer context.

As dedicated EPS bearer contexts are activated by the network, the network can then activate a new dedicated EPS bearer or modify an existing one to fulfil the request. For bearer resources activated by the network a context identifier is allocated by the MT/TA.

For easy reading the term PDP context is used for PDP contexts in UMTS/GPRS as well as PDN/default EPS bearers and traffic flows in EPS.

The feature "initial PDP context" may be supported and is a manufacturer specific option. For this option, the context with <cid>=0 (context number 0) is defined upon startup and does not need to be created with the +CGDCONT command. The initial PDP context has particular manufacturer specific default settings disassociated with any other default settings of +CGDCONT. When in E-UTRAN or according to the AT-command +CIPCA in GERAN and UTRAN, the initial PDP context is automatically activated by the MT following a successful registration to the network. If all active contexts are deactivated, the initial PDP context can be (re)established. This is manufacturer specific and depends on the current RAT as well as how the active contexts are deactivated.

NOTE 1: Care must be taken to secure that repetitive PDP context activations / deactivations are not performed and that PDP contexts are not activated in situations where it is a determined choice by the terminal or the network to discontinue connectivity. Examples of such deliberate discontinuation of connectivity are the AT-commands +CGATT=0 or +CGACT=0, receipt of a detach request from the network with "re-attach not required" or when all PDP contexts are deactivated by the network.

**Table 10.1.0-1: AT commands/results applicable for EPS
(equivalence between PDP context / PDN Connection or Default EPS Bearer)**

AT commands	Comments
+CGDCONT	Used to define PDN connection for EPS.
+CGACT	Used to activate a bearer resource for EPS.
+CGCONTRDP	Used to show dynamically allocated PDN parameters.
+CGEV: xxx . . .	Used to indicate EPS bearers operations status.

**Table 10.1.0-2: AT commands/results applicable for EPS
(equivalence between PDP context / EPS Bearer Resources)**

AT commands	Comments
+CGACT	Used to activate a modification of a PDP context or EPS bearer resource.
+CGDSCONT	Used to define EPS Bearer Resource for a specific PDN for EPS.
+CGSCONTRDP	Used to show dynamically allocated EPS Bearer Resource parameters.
+CGCMOD	Used to request a modification of a PDP context or EPS Bearer Resource.
+CGTFT	Used to define a Traffic Flow Template for a PDP context or a Traffic Flow Aggregate for an EPS bearer resource.
+CGTFTTRDP	Used to show the network assigned Traffic Flow Template for an EPS bearer resource.
+CGEQOS	Used to define the EPS bearer resource Quality of Service parameter. In UMTS/GPRS mode this would hold a mapping function to the UMTS/GPRS QoS parameters.
+CGEQOSRDP	Used to show the network assigned EPS QoS parameters for an EPS bearer resource. In UMTS/GPRS mode this would hold a mapping function to the UMTS/GPRS QoS parameters.
+CGEV: xxx . . .	Used to indicate EPS PDN connection and bearer resources operations status

Table 10.1.0-3: AT commands applicable for EPS

AT commands	Comments
+CGATT	Used to attach/detach the MT from the Packet Domain service.

NOTE 2: The above is not a complete list of AT commands for EPS but only those applicable to PDN connections and EPS bearer resources.

10.1.00 General remark about 5GS PDU sessions and EPS PDN connections

According to 3GPP TS 23.501 [165] and 3GPP TS 24.501 [161] there exists a one to one mapping between a 5GS PDU session and an EPS PDN connection. A 5GS PDU session is a set of QoS flows consisting of one QoS flow of the default QoS rule and optionally one or more QoS flows of non-default QoS rule. A PDN connection is set of EPS bearer contexts and consists of at least one default EPS bearer context and optionally one or more dedicated EPS bearer contexts. A PDU session can be mapped to one default EPS bearer context and zero or more dedicated bearer EPS bearer contexts. An EPS bearer context can be mapped to one or more QoS flows. The mapping between a QoS flow and an EPS bearer context is not always one to one.

Table 10.1.00-1: AT commands/results applicable for 5GS PDU session (equivalence between PDU Session / PDN Connection)

AT commands	Comments
+CGDCONT	Used to define a 5GS PDU session
+CGACT	Used to activate a 5GS PDU session.
+CGCMOD	Used to modify a 5GS PDU session
+CGCONTRDP	Used to show dynamically allocated 5GS PDU session parameters.
+CGEV: xxx . . .	Used to indicate 5GS PDU session operations status.

Table 10.1.00-2: AT commands/results applicable for 5GS QoS flow (equivalence between QoS flow / EPS bearer resources)

AT commands	Comments
+CGDSCONT	Used to define a 5GS QoS flow
+CGSCONTRDP	Used to show dynamically allocated 5GS QoS flow parameters
+CGTFT	Used to define QoS rules for a 5GS QoS flow
+CGTFTTRDP	Used to show the network assigned QoS rules for a 5GS QoS flow
+C5GQOS	Used to define QoS flows of a 5GS PDU session
+C5GQOSRDP	Used to show the dynamically allocated QoS flows corresponding to a 5GS PDU session.

+CGDCONT=?	+CGDCONT: (range of supported <cid>s), <PDP_type>, , , (list of supported <d_comp>s), (list of supported <h_comp>s), (list of supported <IPv4AddrAlloc>s), (list of supported <request_type>s), (list of supported <P-CSCF_discovery>s), (list of supported <IM_CN_Signalling_Flag_Ind>s), (list of supported <NSLPI>s), (list of supported <securePCO>s), (list of supported <IPv4_MTU_discovery>s), (list of supported <Local_Addr_Ind>s), (list of supported <Non-IP_MTU_discovery>s), (list of supported <Reliable_Data_Service>s), (list of supported <SSC_mode>s), , (list of supported <Pref_access_type>s), (list of supported <RQoS_ind>s), (list of supported <MH6-PDU>s), (list of supported <Always-on_req>s) [<CR><LF>+CGDCONT: (range of supported <cid>s), <PDP_type>, , , (list of supported <d_comp>s), (list of supported <h_comp>s), (list of supported <IPv4AddrAlloc>s), (list of supported <request_type>s), (list of supported <P-CSCF_discovery>s), (list of supported <IM_CN_Signalling_Flag_Ind>s), (list of supported <NSLPI>s), (list of supported <securePCO>s), (list of supported <IPv4_MTU_discovery>s), (list of supported <Local_Addr_Ind>s), (list of supported <Non-IP_MTU_discovery>s), (list of supported <Reliable_Data_Service>s), (list of supported <SSC_mode>s), , (list of supported <Pref_access_type>s), (list of supported <RQoS_ind>s), (list of supported <MH6-PDU>s), (list of supported <Always-on_req>s), (range of supported <old-cid>s) [. . .]
------------	--

Description

The set command specifies PDP context parameter values for a PDP context identified by the (local) context identification parameter, <cid> and also allows the TE to specify whether security protected transmission of ESM information is requested, because the PCO can include information that requires ciphering. There can be other reasons for the UE to use security protected transmission of ESM information, e.g. if the UE needs to transfer an APN. The number of PDP contexts that may be in a defined state at the same time is given by the range returned by the test command.

For EPS the PDN connection and its associated EPS default bearer is identified herewith.

For 5GS the PDU session and its associated QoS flow of the default QoS rule is identified herewith.

A special form of the set command, +CGDCONT=<cid> causes the values for context number <cid> to become undefined.

If the initial PDP context is supported, the context with <cid>=0 is automatically defined at startup, see clause 10.1.0. As all other contexts, the parameters for <cid>=0 can be modified with +CGDCONT. If the initial PDP context is supported, +CGDCONT=0 resets context number 0 to its particular default settings.

The read command returns the current settings for each defined context.

The test command returns values supported as compound values. If the MT supports several PDP types, <PDP_type>, the parameter value ranges for each <PDP_type> are returned on a separate line.

Defined values

<cid>: integer type; specifies a particular PDP context definition. The parameter is local to the TE-MT interface and is used in other PDP context-related commands. The range of permitted values (minimum value = 1 or if the initial PDP context is supported (see clause 10.1.0), minimum value = 0) is returned by the test form of the command.

NOTE 1: The <cid>s for network-initiated PDP contexts will have values outside the ranges indicated for the <cid> in the test form of the commands +CGDCONT and +CGDSCONT.

<PDP_type>: string type; specifies the type of packet data protocol. The default value is manufacturer specific.

X.25	ITU-T/CCITT X.25 layer 3 (Obsolete)
IP	Internet Protocol (IETF STD 5 [103])
IPV6	Internet Protocol, version 6 (see RFC 2460 [106])
IPV4V6	Virtual <PDP_type> introduced to handle dual IP stack UE capability. (See 3GPP TS 24.301 [83])
OSPIH	Internet Hosted Octect Stream Protocol (Obsolete)
PPP	Point to Point Protocol (IETF STD 51 [104])
Non-IP	Transfer of Non-IP data to external packet data network (see 3GPP TS 23.401 [82])
Ethernet	Ethernet protocol (IEEE 802.3)
Unstructured	Transfer of Unstructured data to the Data Network via N6 (see 3GPP TS 23.501 [165])

NOTE 2: Only IP, IPV6, IPV4V6 and Non-IP values are supported for EPS services. Only IP, IPV6, IPV4V6, Ethernet and Unstructured values are supported for 5GS service.

<APN>: string type; a logical name that is used to select the GGSN or the external packet data network.

If the value is null or omitted, then the subscription value will be requested.

<PDP_addr>: string type; identifies the MT in the address space applicable to the PDP.

When +CGPIAF is supported, its settings can influence the format of this parameter returned with the read form of +CGDCONT.

NOTE 3: The value of this parameter is ignored with the set command. The parameter is included in the set command for backwards compatibility reasons only.

<d_comp>: integer type; controls PDP data compression (applicable for SNDCP only) (refer 3GPP TS 44.065 [61]).

- 0 off
- 1 on (manufacturer preferred compression)
- 2 V.42bis
- 3 V.44

<h_comp>: integer type; controls PDP header compression (refer 3GPP TS 44.065 [61] and 3GPP TS 25.323 [62]).

- 0 off
- 1 on (manufacturer preferred compression)
- 2 RFC 1144 [105] (applicable for SNDCP only)

3 RFC 2507 [107]

4 RFC 3095 [108] (applicable for PDCP only)

<IPv4AddrAlloc>: integer type; controls how the MT/TA requests to get the IPv4 address information.

0 IPv4 address allocation through NAS signalling

1 IPv4 address allocated through DHCP

<request_type>: integer type; indicates the type of PDP context activation request for the PDP context, see 3GPP TS 24.501 [161] (clause 6.4.1), 3GPP TS 24.301 [83] (clause 6.5.1.2) and 3GPP TS 24.008 [8] (clause 10.5.6.17). If the initial PDP context is supported (see clause 10.1.0) it is not allowed to assign <cid>=0 for emergency (bearer) services. According to 3GPP TS 24.008 [8] (clause 4.2.4.2.2 and clause 4.2.5.1.4) and 3GPP TS 24.301 [83] (clause 5.2.2.3.3 and clause 5.2.3.2.2), a separate PDP context must be established for emergency (bearer) services.

NOTE 4: If the PDP context for emergency (bearer) services is the only activated context, only emergency calls are allowed, see 3GPP TS 23.401 [82] clause 4.3.12.9.

0 PDP context is for new PDP context establishment or for handover from a non-3GPP access network (how the MT decides whether the PDP context is for new PDP context establishment or for handover is implementation specific)

1 PDP context is for emergency (bearer) services

2 PDP context is for new PDP context establishment

3 PDP context is for handover from a non-3GPP access network

4 PDP context is for handover of emergency (bearer) services from a non-3GPP access network

NOTE 5: A PDP context established for handover of emergency (bearer) services from a non-3GPP access network has the same status as a PDP context for emergency (bearer) services.

<P-CSCF_discovery>: integer type; influences how the MT/TA requests to get the P-CSCF address, see 3GPP TS 24.229 [89] annex B and annex L.

0 Preference of P-CSCF address discovery not influenced by +CGDCONT

1 Preference of P-CSCF address discovery through NAS signalling

2 Preference of P-CSCF address discovery through DHCP

<IM_CN_Signalling_Flag_Ind>: integer type; indicates to the network whether the PDP context is for IM CN subsystem-related signalling only or not.

0 UE indicates that the PDP context is not for IM CN subsystem-related signalling only

1 UE indicates that the PDP context is for IM CN subsystem-related signalling only

<NSLPI>: integer type; indicates the NAS signalling priority requested for this PDP context:

0 indicates that this PDP context is to be activated with the value for the low priority indicator configured in the MT.

1 indicates that this PDP context is to be activated with the value for the low priority indicator set to "MS is not configured for NAS signalling low priority".

NOTE 6: The MT utilises the provide NSLPI information as specified in 3GPP TS 24.301 [83] and 3GPP TS 24.008 [8].

<securePCO>: integer type. Specifies if security protected transmission of PCO is requested or not (applicable for EPS only, see 3GPP TS 23.401 [82] clause 6.5.1.2).

0 Security protected transmission of PCO is not requested

- 1 Security protected transmission of PCO is requested

<IPv4_MTU_discovery>: integer type; influences how the MT/TA requests to get the IPv4 MTU size, see 3GPP TS 24.008 [8] clause 10.5.6.3.

- 0 Preference of IPv4 MTU size discovery not influenced by +CGDCONT

- 1 Preference of IPv4 MTU size discovery through NAS signalling

<Local_Addr_Ind>: integer type; indicates to the network whether or not the MS supports local IP address in TFTs (see 3GPP TS 24.301 [83] and 3GPP TS 24.008 [8] clause 10.5.6.3).

- 0 indicates that the MS does not support local IP address in TFTs

- 1 indicates that the MS supports local IP address in TFTs

<Non-IP_MTU_discovery>: integer type; influences how the MT/TA requests to get the Non-IP MTU size, see 3GPP TS 24.008 [8] clause 10.5.6.3.

- 0 Preference of Non-IP MTU size discovery not influenced by +CGDCONT

- 1 Preference of Non-IP MTU size discovery through NAS signalling

<Reliable_Data_Service>: integer type; indicates whether the UE is using Reliable Data Service for a PDN connection or not, see 3GPP TS 24.301 [83] and 3GPP TS 24.008 [8] clause 10.5.6.3.

- 0 Reliable Data Service is not being used for the PDN connection

- 1 Reliable Data Service is being used for the PDN connection

<SSC_mode>: integer type; indicates the session and service continuity (SSC) mode for the PDU session in 5GS, see 3GPP TS 23.501 [165].

- 0 indicates that the PDU session is associated with SSC mode 1

- 1 indicates that the PDU session is associated with SSC mode 2

- 2 indicates that the PDU session is associated with SSC mode 3

<S-NSSAI>: string type in hexadecimal character format. Dependent of the form, the string can be separated by dot(s) and semicolon(s). The S-NSSAI is associated with the PDU session for identifying a network slice in 5GS, see 3GPP TS 23.501 [165] and 3GPP TS 24.501 [161]. For the format and the encoding of S-NSSAI, see also 3GPP TS 23.003 [7]. This parameter shall not be subject to conventional character conversion as per +CSCS. The <S-NSSAI> has one of the forms:

sst	only slice/service type (SST) is present
sst;mapped_sst	SST and mapped configured SST are present
sst.sd	SST and slice differentiator (SD) are present
sst.sd;mapped_sst	SST, SD and mapped configured SST are present
sst.sd;mapped_sst.mapped_sd	SST, SD, mapped configured SST and mapped configured SD are present

<Pref_access_type>: integer type; indicates the preferred access type for the PDU session in 5GS, see 3GPP TS 23.501 [165] and 3GPP TS 24.501 [161].

- 0 indicates that the preferred access type is 3GPP access

- 1 indicates that the preferred access type is non-3GPP access

<RQoS_ind>: integer type; indicates whether the UE supports reflective QoS for the PDU session, see 3GPP TS 23.501 [165] and 3GPP TS 24.501 [161].

- 0 indicates that reflective QoS is not supported for the PDU session

- 1 indicates that reflective QoS is supported for the PDU session

<MH6-PDU>: integer type; indicates whether the UE supports IPv6 multi-homing for the PDU session, see 3GPP TS 23.501 [165] and 3GPP TS 24.501 [161].

0 indicates that IPv6 multi-homing is not supported for the PDU session

1 indicates that IPv6 multi-homing is supported for the PDU session

<Always-on_req>: integer type; indicates whether the UE requests to establish the PDU session as an always-on PDU session, see 3GPP TS 24.501 [161].

0 always-on PDU session is not requested

1 always-on PDU session is requested

<old-cid>: integer type; indicates the context identifier of the QoS flow of the default QoS rule of the SSC mode 2 or SSC mode 3 PDU session where the network requests relocation of the PDU session anchor.

Implementation

Mandatory unless only a single subscribed context is supported.

10.1.2 Define secondary PDP context +CGDSCONT

Table 112: +CGDSCONT parameter command syntax

Command	Possible response(s)
+CGDSCONT=[<cid>,<p_cid>[,<d_comp>[,<h_comp>[,<IM_CN_Signalling_Flag_Ind>]]]]	
+CGDSCONT?	[+CGDSCONT: <cid>,<p_cid>,<d_comp>,<h_comp>,<IM_CN_Signalling_Flag_Ind>] [<CR><LF>+CGDSCONT: <cid>,<p_cid>,<d_comp>,<h_comp>,<IM_CN_Signalling_Flag_Ind> [...]]
+CGDSCONT=?	+CGDSCONT: (range of supported <cid>s), (list of <p_cid>s for active primary contexts), (list of supported <d_comp>s), (list of supported <h_comp>s), (list of supported <IM_CN_Signalling_Flag_Ind>s)

Description

The set command specifies PDP context parameter values for a Secondary PDP context identified by the (local) context identification parameter, <cid>. The number of PDP contexts that may be in a defined state at the same time is given by the range returned by the test command.

In EPS the command is used to define traffic flows.

In 5GS the command is used to define QoS flows of non-default QoS rule.

A special form of the set command, +CGDSCONT=<cid> causes the values for context number <cid> to become undefined.

NOTE: If the initial PDP context is supported, the context with <cid>=0 is automatically defined at startup, see clause 10.1.0.

The read command returns the current settings for each defined context.

The test command returns values supported as compound values.

Defined values

<cid>: integer type; which specifies a particular PDP context definition. The parameter is local to the TE-MT interface and is used in other PDP context-related commands. The range of permitted values (minimum value = 1) is returned by the test form of the command.

NOTE: The <cid>s for network-initiated PDP contexts will have values outside the ranges indicated for the <cid> in the test form of the commands +CGDCONT and +CGDSCONT.

<p_cid>: integer type; specifies a particular PDP context definition which has been specified by use of the +CGDCONT command. The parameter is local to the TE-MT interface. The list of permitted values is returned by the test form of the command.

<d_comp>: integer type; controls PDP data compression (applicable for SNDCP only) (refer 3GPP TS 44.065 [61]).

- 0 off
- 1 on (manufacturer preferred compression)
- 2 V.42bis
- 3 V.44

<h_comp>: integer type; controls PDP header compression (refer 3GPP TS 44.065 [61] and 3GPP TS 25.323 [62]).

- 0 off
- 1 on (manufacturer preferred compression)
- 2 RFC 1144 [105] (applicable for SNDCP only)
- 3 RFC 2507 [107]
- 4 RFC 3095 [108] (applicable for PDCP only)

<IM_CN_Signalling_Flag_Ind>: integer type; indicates to the network whether the PDP context is for IM CN subsystem-related signalling only or not.

- 0 UE indicates that the PDP context is not for IM CN subsystem-related signalling only
- 1 UE indicates that the PDP context is for IM CN subsystem-related signalling only

Implementation

Optional.

10.1.3 Traffic flow template +CGTFT

Table 113: +CGTFT parameter command syntax

Command	Possible Response(s)
<pre>+CGTFT=[<cid>,[<packet filter identifier>,<evaluation precedence index>[,<remote address and subnet mask>[,<protocol number (ipv4) / next header (ipv6)>[,<local port range>[,<remote port range>[,<ipsec security parameter index (spi)>[,<type of service (tos) (ipv4) and mask / traffic class (ipv6) and mask>[,<flow label (ipv6)>[,<direction>[,<local address and subnet mask>[,<QRI>[,<traffic_segregation>]]]]]]]]]]]]]</pre>	<pre>+CME ERROR: <err></pre>
<pre>+CGTFT?</pre>	<pre>[+CGTFT: <cid>,<packet filter identifier>,<evaluation precedence index>,<remote address and subnet mask>,<protocol number (ipv4) / next header (ipv6)>,<local port range>,<remote port range>,<ipsec security parameter index (spi)>,<type of service (tos) (ipv4) and mask / traffic class (ipv6) and mask>,<flow label (ipv6)>,<direction>,<local address and subnet mask>,<QRI>,<traffic_segregation>] [<CR><LF>+CGTFT: <cid>,<packet filter identifier>,<evaluation precedence index>,<remote address and subnet mask>,<protocol number (ipv4) / next header (ipv6)>,<local port range>,<remote port range>,<ipsec security parameter index (spi)>,<type of service (tos) (ipv4) and mask / traffic class (ipv6) and mask>,<flow label (ipv6)>,<direction>,<local address and subnet mask>,<QRI>,<traffic_segregation> [...]]</pre>

Command	Possible Response(s)
+CGTFT=?	<p>+CGTFT: <PDP_type>, (list of supported <packet filter identifier>s), (list of supported <evaluation precedence index>s), (list of supported <remote address and subnet mask>s), (list of supported <protocol number (ipv4) / next header (ipv6)>s), (list of supported <local port range>s), (list of supported <remote port range>s), (list of supported <ipsec security parameter index (spi)>s), (list of supported <type of service (tos) (ipv4) and mask / traffic class (ipv6) and mask>s), (list of supported <flow label (ipv6)>s), (list of supported <direction>s), (list of supported <local address and subnet mask>s), (range of supported <QRI>s), (list of supported <traffic_segregation>s)</p> <p>[<CR><LF>+CGTFT: <PDP_type>, (list of supported <packet filter identifier>s), (list of supported <evaluation precedence index>s), (list of supported <remote address and subnet mask>s), (list of supported <protocol number (ipv4) / next header (ipv6)>s), (list of supported <local port range>s), (list of supported <remote port range>s), (list of supported <ipsec security parameter index (spi)>s), (list of supported <type of service (tos) (ipv4) and mask / traffic class (ipv6) and mask>s), (list of supported <flow label (ipv6)>s), (list of supported <direction>s), (list of supported <local address and subnet mask>s), (range of supported <QRI>s), (list of supported <traffic_segregation>s)</p> <p>[...]</p>

Description

This command allows the TE to specify a Packet Filter - PF for a Traffic Flow Template - TFT that is used in the GGSN and in the Packet GW for routing of packets onto different QoS flows towards the TE. The concept is further described in the 3GPP TS 23.060 [47], 3GPP TS 23.501 [165] and 3GPP TS 24.501 [161]. A TFT consists of from one and up to 16 Packet Filters, each identified by a unique <packet filter identifier>. A Packet Filter also has an <evaluation precedence index> that is unique within all TFTs associated with all PDP contexts that are associated with the same PDP address.

The set command specifies a Packet Filter that is to be added to the TFT stored in the MT and used for the context identified by the (local) context identification parameter, <cid>. The specified TFT will be stored in the GGSN, the Packet GW and UPF only at activation or MS-initiated modification of the related context. Since this is the same parameter that is used in the +CGDCONT and +CGDSCONT commands, the +CGTFT command is effectively an extension to these commands. The Packet Filters consist of a number of parameters, each of which may be set to a separate value.

A special form of the set command, +CGTFT=<cid> causes all of the Packet Filters in the TFT for context number <cid> to become undefined. At any time there may exist only one PDP context with no associated TFT amongst all PDP contexts associated to one PDP address. At an attempt to delete a TFT, which would violate this rule, an ERROR or

+CME ERROR response is returned. Extended error responses are enabled by the +CMEE command. Refer clause 9.2 for possible <err> values.

The read command returns the current settings for all Packet Filters for each defined context.

The test command returns values supported as compound values. If the MT supports several PDP types, the parameter value ranges for each PDP type are returned on a separate line. TFTs shall be used for PDP-type IP and PPP only. For PDP-type PPP a TFT is applicable only when IP traffic is carried over PPP. If PPP carries header-compressed IP packets, then a TFT cannot be used.

Defined values

<cid>: integer type. Specifies a particular PDP context definition (see the +CGDCONT and +CGDSCONT commands).

<PDP_type>: string type. Specifies the type of packet data protocol (see the +CGDCONT command).

For the following parameters, see also 3GPP TS 23.060 [47], 3GPP TS 23.501 [165] and 3GPP TS 24.501 [161]:

<packet filter identifier>: integer type. Value range is from 1 to 16.

<evaluation precedence index>: integer type. The value range is from 0 to 255.

<remote address and subnet mask>: string type. The string is given as dot-separated numeric (0-255) parameters on the form:
 "a1.a2.a3.a4.m1.m2.m3.m4" for IPv4 or
 "a1.a2.a3.a4.a5.a6.a7.a8.a9.a10.a11.a12.a13.a14.a15.a16.m1.m2.m3.m4.m5.m6.m7.m8.m9.m10.m11.m12.m13.m14.m15.m16", for IPv6.

When +CGPIAF is supported, its settings can influence the format of this parameter returned with the read form of +CGTFT.

<protocol number (ipv4) / next header (ipv6)>: integer type. Value range is from 0 to 255.

<local port range>: string type. The string is given as dot-separated numeric (0-65535) parameters on the form "f.t".

<remote port range>: string type. The string is given as dot-separated numeric (0-65535) parameters on the form "f.t".

<ipsec security parameter index (spi)>: numeric value in hexadecimal format. The value range is from 00000000 to FFFFFFFF.

<type of service (tos) (ipv4) and mask / traffic class (ipv6) and mask>: string type. The string is given as dot-separated numeric (0-255) parameters on the form "t.m".

<flow label (ipv6)>: numeric value in hexadecimal format. The value range is from 00000 to FFFFF. Valid for IPv6 only.

<direction>: integer type. Specifies the transmission direction in which the packet filter shall be applied.

0 Pre-Release 7 TFT filter (see 3GPP TS 24.008 [8], table 10.5.162)

1 Uplink

2 Downlink

3 Bidirectional (Up & Downlink)

<local address and subnet mask>: string type. The string is given as dot-separated numeric (0-255) parameters on the form:

"a1.a2.a3.a4.m1.m2.m3.m4" for IPv4 or

"a1.a2.a3.a4.a5.a6.a7.a8.a9.a10.a11.a12.a13.a14.a15.a16.m1.m2.m3.m4.m5.m6.m7.m8.m9.m10.m11.m12.m13.m14.m15.m16", for IPv6.

When +CGPIAF is supported, its settings can influence the format of this parameter returned with the read form of +CGTFT.

<QRI>: integer type. Identifies the QoS rule, see 3GPP TS 23.501 [165] and 3GPP TS 24.501 [161].

<traffic_segregation>: integer type; indicates to the network whether traffic segregation is requested or not, see 3GPP TS 24.501 [161].

0 traffic segregation is not requested

1 traffic segregation is requested

Some of the above listed attributes may coexist in a Packet Filter while others mutually exclude each other, the possible combinations are shown in 3GPP TS 23.060 [47], 3GPP TS 23.501 [165] and 3GPP TS 24.501 [161].

Implementation

Optional.

10.1.4 Quality of service profile (requested) +CGQREQ

Table 114: +CGQREQ parameter command syntax

Command	Possible Response(s)
+CGQREQ=[<cid>[,<precedence>[,<delay>[,<reliability>[,<peak>[,<mean>]]]]]]	
+CGQREQ?	[+CGQREQ: <cid>,<precedence>,<delay>,<reliability>,<peak>,<mean>] [<CR><LF>+CGQREQ: <cid>,<precedence>,<delay>,<reliability>,<peak>,<mean> [...]]
+CGQREQ=?	+CGQREQ: <PDP_type> , (list of supported <precedence>s) , (list of supported <delay>s) , (list of supported <reliability>s) , (list of supported <peak>s) , (list of supported <mean>s) [<CR><LF>+CGQREQ: <PDP_type> , (list of supported <precedence>s) , (list of supported <delay>s) , (list of supported <reliability>s) , (list of supported <peak>s) , (list of supported <mean>s) [...]]

Description

This command allows the TE to specify a Quality of Service Profile that is used when the MT activates a PDP context.

The set command specifies a profile for the context identified by the (local) context identification parameter, <cid>. Since this is the same parameter that is used in the +CGDCONT and +CGDSCONT commands, the +CGQREQ command is effectively an extension to these commands. The QoS profile consists of a number of parameters, each of which may be set to a separate value.

A special form of the set command, +CGQREQ=<cid> causes the requested profile for context number <cid> to become undefined.

The read command returns the current settings for each defined context.

The test command returns values supported as compound values. If the MT supports several PDP types, the parameter value ranges for each PDP type are returned on a separate line.

Defined values

<cid>: integer type; specifies a particular PDP context definition (see the +CGDCONT and +CGDSCONT commands).

<PDP_type>: string type; specifies the type of packet data protocol (see the +CGDCONT command).

The following parameters are defined in 3GPP TS 23.107 [46]:

<precedence>: integer type; specifies the precedence class

<delay>: integer type; specifies the delay class

<reliability>: integer type; specifies the reliability class

<peak>: integer type; specifies the peak throughput class

<mean>: integer type; specifies the mean throughput class

If a value is omitted for a particular class then the value is considered to be unspecified.

Implementation

Optional. If the command is not implemented then all the values are considered to be unspecified.

10.1.5 Quality of service profile (minimum acceptable) +CGQMIN

Table 115: +CGQMIN parameter command syntax

Command	Possible Response(s)
+CGQMIN=[<cid>[,<precedence>[,<delay>[,<reliability>[,<peak>[,<mean>]]]]]]	
+CGQMIN?	[+CGQMIN: <cid>,<precedence>,<delay>,<reliability>,<peak>,<mean>] [<CR><LF>+CGQMIN: <cid>,<precedence>,<delay>,<reliability>,<peak>,<mean> [...]]
+CGQMIN=?	+CGQMIN: <PDP_type>,(list of supported <precedence>s),(list of supported <delay>s),(list of supported <reliability>s),(list of supported <peak>s),(list of supported <mean>s) [<CR><LF>+CGQMIN: <PDP_type>,(list of supported <precedence>s),(list of supported <delay>s),(list of supported <reliability>s),(list of supported <peak>s),(list of supported <mean>s) [...]]

Description

This command allows the TE to specify a minimum acceptable profile which is checked by the MT against the negotiated profile when the PDP context is activated.

The set command specifies a profile for the context identified by the (local) context identification parameter, <cid>. Since this is the same parameter that is used in the +CGDCONT and +CGDSCONT commands, the +CGQMIN command is effectively an extension to these commands. The QoS profile consists of a number of parameters, each of which may be set to a separate value.

A special form of the set command, +CGQMIN=<cid> causes the minimum acceptable profile for context number <cid> to become undefined. In this case no check is made against the negotiated profile.

The read command returns the current settings for each defined context.

The test command returns values supported as compound values. If the MT supports several PDP types, the parameter value ranges for each PDP type are returned on a separate line.

Defined values

<cid>: integer type; specifies a particular PDP context definition (see the +CGDCONT and +CGDSCONT commands).

<PDP_type>: string type; specifies the type of packet data protocol (see the +CGDCONT command).

The following parameters are defined in 3GPP TS 23.107 [46]:

<precedence>: integer type; specifies the precedence class

<delay>: integer type; specifies the delay class

<reliability>: integer type; specifies the reliability class

<peak>: integer type; specifies the peak throughput class

<mean>: integer type; specifies the mean throughput class

Command	Possible Response(s)
	<p>[<CR><LF>+CGEQREQ: <PDP_type>, (list of supported <Traffic class>s), (list of supported <Maximum bitrate UL>s), (list of supported <Maximum bitrate DL>s), (list of supported <Guaranteed bitrate UL>s), (list of supported <Guaranteed bitrate DL>s), (list of supported <Delivery order>s), (list of supported <Maximum SDU size>s), (list of supported <SDU error ratio>s), (list of supported <Residual bit error ratio>s), (list of supported <Delivery of erroneous SDUs>s), (list of supported <Transfer delay>s), (list of supported <Traffic handling priority>s), (list of supported <Source statistics descriptor>s), (list of supported <Signalling indication>s)</p> <p>[...]]</p>

Description

This command allows the TE to specify a UMTS Quality of Service Profile that is used when the MT activates a PDP context.

The set command specifies a profile for the context identified by the (local) context identification parameter, <cid>. The specified profile will be stored in the MT and sent to the network only at activation or MS-initiated modification of the related context. Since this is the same parameter that is used in the +CGDCONT and +CGDSCONT commands, the +CGEQREQ command is effectively an extension to these commands. The QoS profile consists of a number of parameters, each of which may be set to a separate value.

A special form of the set command, +CGEQREQ=<cid> causes the requested profile for context number <cid> to become undefined.

The read command returns the current settings for each defined context.

The test command returns values supported as compound values. If the MT supports several PDP types, the parameter value ranges for each PDP type are returned on a separate line.

Defined values

<cid>: integer type; specifies a particular PDP context definition (see +CGDCONT and +CGDSCONT commands).

<PDP_type>: string type; specifies the type of packet data protocol (see the +CGDCONT command).

For the following parameters, see also 3GPP TS 23.107 [46].

<Traffic class>: integer type; indicates the type of application for which the UMTS bearer service is optimised (refer 3GPP TS 24.008 [8] clause 10.5.6.5).

- 0 conversational
- 1 streaming
- 2 interactive
- 3 background
- 4 subscribed value

If the Traffic class is specified as conversational or streaming, then the Guaranteed and Maximum bitrate parameters should also be provided.

- <Maximum bitrate UL>: integer type; indicates the maximum number of kbits/s delivered to UMTS (up-link traffic) at a SAP. As an example a bitrate of 32kbit/s would be specified as '32' (e.g. AT+CGEQREQ=..., 32, ...). This parameter should be provided if the Traffic class is specified as conversational or streaming (refer 3GPP TS 24.008 [8] clause 10.5.6.5).
- <Maximum bitrate DL>: integer type; indicates the maximum number of kbits/s delivered by UMTS (down-link traffic) at a SAP. As an example a bitrate of 32kbit/s would be specified as '32' (e.g. AT+CGEQREQ=..., 32, ...). If the parameter is set to '0' the subscribed value will be requested. This parameter should be provided if the Traffic class is specified as conversational or streaming (refer 3GPP TS 24.008 [8] clause 10.5.6.5).
- <Guaranteed bitrate UL>: integer type; indicates the guaranteed number of kbits/s delivered to UMTS (up-link traffic) at a SAP (provided that there is data to deliver). As an example a bitrate of 32kbit/s would be specified as '32' (e.g. AT+CGEQREQ=..., 32, ...). If the parameter is set to '0' the subscribed value will be requested. This parameter should be provided if the Traffic class is specified as conversational or streaming (refer 3GPP TS 24.008 [8] clause 10.5.6.5).
- <Guaranteed bitrate DL>: integer type; indicates the guaranteed number of kbits/s delivered by UMTS (down-link traffic) at a SAP (provided that there is data to deliver). As an example a bitrate of 32kbit/s would be specified as '32' (e.g. AT+CGEQREQ=..., 32, ...). If the parameter is set to '0' the subscribed value will be requested. This parameter should be provided if the Traffic class is specified as conversational or streaming (refer 3GPP TS 24.008 [8] clause 10.5.6.5).
- <Delivery order>: integer type; indicates whether the UMTS bearer shall provide in-sequence SDU delivery or not (refer 3GPP TS 24.008 [8] clause 10.5.6.5).
- 0 no
 - 1 yes
 - 2 subscribed value
- <Maximum SDU size>: integer type; (1,2,3,...) indicates the maximum allowed SDU size in octets. If the parameter is set to '0' the subscribed value will be requested (refer 3GPP TS 24.008 [8] clause 10.5.6.5).
- <SDU error ratio>: string type; indicates the target value for the fraction of SDUs lost or detected as erroneous. SDU error ratio is defined only for conforming traffic. The value is specified as 'mEe'. As an example a target SDU error ratio of $5 \cdot 10^{-3}$ would be specified as "5E3" (e.g. AT+CGEQREQ=..., "5E3", ...). "0E0" means subscribed value (refer 3GPP TS 24.008 [8] clause 10.5.6.5).
- <Residual bit error ratio>: string type; indicates the target value for the undetected bit error ratio in the delivered SDUs. If no error detection is requested, Residual bit error ratio indicates the bit error ratio in the delivered SDUs. The value is specified as "mEe". As an example a target residual bit error ratio of $5 \cdot 10^{-3}$ would be specified as "5E3" (e.g. AT+CGEQREQ=..., "5E3", ...). "0E0" means subscribed value (refer 3GPP TS 24.008 [8] clause 10.5.6.5).
- <Delivery of erroneous SDUs>: integer type; indicates whether SDUs detected as erroneous shall be delivered or not (refer 3GPP TS 24.008 [8] clause 10.5.6.5).
- 0 no
 - 1 yes
 - 2 no detect
 - 3 subscribed value
- <Transfer delay>: integer type; (0,1,2,...) indicates the targeted time between request to transfer an SDU at one SAP to its delivery at the other SAP, in milliseconds. If the parameter is set to '0' the subscribed value will be requested (refer 3GPP TS 24.008 [8] clause 10.5.6.5).
- <Traffic handling priority>: integer type; (1,2,3,...) specifies the relative importance for handling of all SDUs belonging to the UMTS bearer compared to the SDUs of other bearers. If the parameter is set to '0' the subscribed value will be requested (refer 3GPP TS 24.008 [8] clause 10.5.6.5).

Command	Possible Response(s)
	[...]
+CGEQMIN=?	<p>+CGEQMIN: <PDP_type>, (list of supported <Traffic class>s), (list of supported <Maximum bitrate UL>s), (list of supported <Maximum bitrate DL>s), (list of supported <Guaranteed bitrate UL>s), (list of supported <Guaranteed bitrate DL>s), (list of supported <Delivery order>s), (list of supported <Maximum SDU size>s), (list of supported <SDU error ratio>s), (list of supported <Residual bit error ratio>s), (list of supported <Delivery of erroneous SDUs>s), (list of supported <Transfer delay>s), (list of supported <Traffic handling priority>s), (list of supported <Source statistics descriptor>s), (list of supported <Signalling indication>s)</p> <p>[<CR><LF>+CGEQMIN: <PDP_type>, (list of supported <Traffic class>s), (list of supported <Maximum bitrate UL>s), (list of supported <Maximum bitrate DL>s), (list of supported <Guaranteed bitrate UL>s), (list of supported <Guaranteed bitrate DL>s), (list of supported <Delivery order>s), (list of supported <Maximum SDU size>s), (list of supported <SDU error ratio>s), (list of supported <Residual bit error ratio>s), (list of supported <Delivery of erroneous SDUs>s), (list of supported <Transfer delay>s), (list of supported <Traffic handling priority>s), (list of supported <Source statistics descriptor>s), (list of supported <Signalling indication>s)</p> <p>[...]</p>

Description

This command allows the TE to specify a minimum acceptable profile, which is checked by the MT against the negotiated profile returned in the PDP context establishment and PDP context modification procedures.

The set command specifies a profile for the context identified by the (local) context identification parameter, <cid>. The specified profile will be stored in the MT and checked against the negotiated profile only at activation or MS-initiated modification of the related context. Since this is the same parameter that is used in the +CGDCONT and +CGDSCONT commands, the +CGEQMIN command is effectively an extension to these commands. The QoS profile consists of a number of parameters, each of which may be set to a separate value.

A special form of the set command, +CGEQMIN=<cid> causes the minimum acceptable profile for context number <cid> to become undefined. In this case no check is made against the negotiated profile.

The read command returns the current settings for each defined context.

The test command returns values supported as compound values. If the MT supports several PDP types, the parameter value ranges for each PDP type are returned on a separate line.

Defined values

<cid>: integer type; specifies a particular PDP context definition (see +CGDCONT and +CGDSCONT commands).

<PDP_type>: string type; specifies the type of packet data protocol (see the +CGDCONT command).

For the following parameters, see also 3GPP TS 23.107 [46].

<Traffic class>: integer type; indicates the type of application for which the UMTS bearer service is optimised (refer 3GPP TS 24.008 [8] clause 10.5.6.5).

- 0 conversational
- 1 streaming
- 2 interactive
- 3 background

<Maximum bitrate UL>: integer type; indicates the maximum number of kbits/s delivered to UMTS (up-link traffic) at a SAP. As an example a bitrate of 32kbit/s would be specified as '32' (e.g. AT+CGEQMIN=..., 32, ...) (refer 3GPP TS 24.008 [8] clause 10.5.6.5).

<Maximum bitrate DL>: integer type; indicates the maximum number of kbits/s delivered by UMTS (down-link traffic) at a SAP. As an example a bitrate of 32kbit/s would be specified as '32' (e.g. AT+CGEQMIN=..., 32, ...) (refer 3GPP TS 24.008 [8] clause 10.5.6.5).

<Guaranteed bitrate UL>: integer type; indicates the guaranteed number of kbits/s delivered to UMTS (up-link traffic) at a SAP (provided that there is data to deliver). As an example a bitrate of 32kbit/s would be specified as '32' (e.g. AT+CGEQMIN=..., 32, ...) (refer 3GPP TS 24.008 [8] clause 10.5.6.5).

<Guaranteed bitrate DL>: integer type; indicates the guaranteed number of kbits/s delivered by UMTS (down-link traffic) at a SAP (provided that there is data to deliver). As an example a bitrate of 32kbit/s would be specified as '32' (e.g. AT+CGEQMIN=..., 32, ...) (refer 3GPP TS 24.008 [8] clause 10.5.6.5).

<Delivery order>: integer type; indicates whether the UMTS bearer shall provide in-sequence SDU delivery or not (refer 3GPP TS 24.008 [8] clause 10.5.6.5).

- 0 no
- 1 yes

<Maximum SDU size>: integer type; (1,2,3,...) indicates the maximum allowed SDU size in octets (refer 3GPP TS 24.008 [8] clause 10.5.6.5).

<SDU error ratio>: string type; indicates the target value for the fraction of SDUs lost or detected as erroneous. SDU error ratio is defined only for conforming traffic. The value is specified as "mEe". As an example a target SDU error ratio of $5 \cdot 10^{-3}$ would be specified as "5E3" (e.g. AT+CGEQMIN=..., "5E3", ...) (refer 3GPP TS 24.008 [8] clause 10.5.6.5).

<Residual bit error ratio>: string type; indicates the target value for the undetected bit error ratio in the delivered SDUs. If no error detection is requested, Residual bit error ratio indicates the bit error ratio in the delivered SDUs. The value is specified as "mEe". As an example a target residual bit error ratio of $5 \cdot 10^{-3}$ would be specified as "5E3" (e.g. AT+CGEQMIN=..., "5E3", ...) (refer 3GPP TS 24.008 [8] clause 10.5.6.5).

<Delivery of erroneous SDUs>: integer type; indicates whether SDUs detected as erroneous shall be delivered or not (refer 3GPP TS 24.008 [8] clause 10.5.6.5).

- 0 no
- 1 yes
- 2 no detect

<Transfer delay>: integer type; (0,1,2,...) indicates the targeted time between request to transfer an SDU at one SAP to its delivery at the other SAP, in milliseconds (refer 3GPP TS 24.008 [8] clause 10.5.6.5).

<Traffic handling priority>: integer type; (1,2,3,...) specifies the relative importance for handling of all SDUs belonging to the UMTS bearer compared to the SDUs of other bearers (refer 3GPP TS 24.008 [8] clause 10.5.6.5).

<Source Statistics Descriptor>: integer type; specifies characteristics of the source of the submitted SDUs for a PDP context. This parameter should be provided if the Traffic class is specified as conversational or streaming (refer 3GPP TS 24.008 [8] clause 10.5.6.5).

0 Characteristics of SDUs is unknown

1 Characteristics of SDUs corresponds to a speech source

<Signalling Indication>: integer type; indicates signalling content of submitted SDUs for a PDP context. This parameter should be provided if the Traffic class is specified as interactive (refer 3GPP TS 24.008 [8] clause 10.5.6.5).

0 PDP context is not optimized for signalling

1 PDP context is optimized for signalling

If a value is omitted for a particular class then the value is considered to be unspecified.

Implementation

Optional. If the command is not implemented then no check is made against the negotiated profile.

10.1.8 3G quality of service profile (negotiated) +CGEQNEG

Table 118: +CGEQNEG action command syntax

Command	Possible Response(s)
+CGEQNEG[=<cid>[,<cid>[,...]]]	<pre>[+CGEQNEG: <cid>,<Traffic class>,<Maximum bitrate UL>,<Maximum bitrate DL>,<Guaranteed bitrate UL>,<Guaranteed bitrate DL>,<Delivery order>,<Maximum SDU size>,<SDU error ratio>,<Residual bit error ratio>,<Delivery of erroneous SDUs>,<Transfer delay>,<Traffic handling priority>] [<CR><LF>+CGEQNEG: <cid>,<Traffic class>,<Maximum bitrate UL>,<Maximum bitrate DL>,<Guaranteed bitrate UL>,<Guaranteed bitrate DL>,<Delivery order>,<Maximum SDU size>,<SDU error ratio>,<Residual bit error ratio>,<Delivery of erroneous SDUs>,<Transfer delay>,<Traffic handling priority> [...]]</pre>
+CGEQNEG=?	+CGEQNEG: (list of <cid>s associated with active contexts)
<p>NOTE: The syntax of the AT Set Command is corrected to be according to ITU-T Recommendation V.250 [14]. Older versions of the specification specify incorrect syntax +CGEQNEG=[<cid>[,<cid>[,...]]].</p>	

Description

This command allows the TE to retrieve the negotiated QoS profiles returned in the PDP context establishment procedure.

The execution command returns the negotiated QoS profile for the specified context identifiers, <cid>s. The QoS profile consists of a number of parameters, each of which may have a separate value.

If the parameter <cid> is omitted, the relevant information for all established PDP contexts are returned.

The test command returns a list of <cid>s associated with active contexts.

Defined values

<cid>: integer type; specifies a particular PDP context definition (see +CGDCONT and +CGDSCONT commands).

For the following parameters, see also 3GPP TS 23.107 [46].

<Traffic class>: integer type; indicates the type of application for which the UMTS bearer service is optimised (refer 3GPP TS 24.008 [8] clause 10.5.6.5).

- 0 conversational
- 1 streaming
- 2 interactive
- 3 background

- <Maximum bitrate UL>: integer type; indicates the maximum number of kbits/s delivered to UMTS (up-link traffic) at a SAP. As an example a bitrate of 32kbit/s would be specified as '32' (e.g. +CGEQNEG:..., 32, ...) (refer 3GPP TS 24.008 [8] clause 10.5.6.5).
- <Maximum bitrate DL>: integer type; indicates the maximum number of kbits/s delivered by UMTS (down-link traffic) at a SAP. As an example a bitrate of 32kbit/s would be specified as '32' (e.g. +CGEQNEG:..., 32, ...) (refer 3GPP TS 24.008 [8] clause 10.5.6.5).
- <Guaranteed bitrate UL>: integer type; indicates the guaranteed number of kbits/s delivered to UMTS (up-link traffic) at a SAP (provided that there is data to deliver). As an example a bitrate of 32kbit/s would be specified as '32' (e.g. +CGEQNEG:..., 32, ...) (refer 3GPP TS 24.008 [8] clause 10.5.6.5).
- <Guaranteed bitrate DL>: integer type; indicates the guaranteed number of kbits/s delivered by UMTS (down-link traffic) at a SAP (provided that there is data to deliver). As an example a bitrate of 32kbit/s would be specified as '32' (e.g. +CGEQNEG:..., 32, ...) (refer 3GPP TS 24.008 [8] clause 10.5.6.5).
- <Delivery order>: integer type; indicates whether the UMTS bearer shall provide in-sequence SDU delivery or not (refer 3GPP TS 24.008 [8] clause 10.5.6.5).
- 0 no
- 1 yes
- <Maximum SDU size>: integer type; (1,2,3,...) indicates the maximum allowed SDU size in octets (refer 3GPP TS 24.008 [8] clause 10.5.6.5).
- <SDU error ratio>: string type; indicates the target value for the fraction of SDUs lost or detected as erroneous. SDU error ratio is defined only for conforming traffic. The value is specified as "mEe". As an example a target SDU error ratio of $5 \cdot 10^{-3}$ would be specified as "5E3" (e.g. +CGEQNEG:..., "5E3", ...) (refer 3GPP TS 24.008 [8] clause 10.5.6.5).
- <Residual bit error ratio>: string type; indicates the target value for the undetected bit error ratio in the delivered SDUs. If no error detection is requested, Residual bit error ratio indicates the bit error ratio in the delivered SDUs. The value is specified as "mEe". As an example a target residual bit error ratio of $5 \cdot 10^{-3}$ would be specified as "5E3" (e.g. +CGEQNEG:..., "5E3", ...) (refer 3GPP TS 24.008 [8] clause 10.5.6.5).
- <Delivery of erroneous SDUs>: integer type; indicates whether SDUs detected as erroneous shall be delivered or not (refer 3GPP TS 24.008 [8] clause 10.5.6.5).
- 0 no
- 1 yes
- 2 no detect
- <Transfer delay>: integer type; (0,1,2,...) indicates the targeted time between request to transfer an SDU at one SAP to its delivery at the other SAP, in milliseconds (refer 3GPP TS 24.008 [8] clause 10.5.6.5).
- <Traffic handling priority>: integer type; (1,2,3,...) specifies the relative importance for handling of all SDUs belonging to the UMTS bearer compared to the SDUs of other bearers (refer 3GPP TS 24.008 [8] clause 10.5.6.5).

If a value is omitted for a particular class then the value is considered to be unspecified.

Implementation

Optional.

10.1.9 PS attach or detach +CGATT

Table 119: +CGATT parameter command syntax

Command	Possible Response(s)
+CGATT=<state>	+CME ERROR: <err>
+CGATT?	+CGATT: <state>
+CGATT=?	+CGATT: (list of supported <state>s)

Description

The execution command is used to attach the MT to, or detach the MT from, the Packet Domain service. After the command has completed, the MT remains in V.250 command state. If the MT is already in the requested state, the command is ignored and the OK response is returned. If the requested state cannot be achieved, an ERROR or +CME ERROR response is returned. Extended error responses are enabled by the +CMEE command. Refer clause 9.2 for possible <err> values.

NOTE 1: If the initial PDP context is supported, the context with <cid>=0 is automatically defined at startup, see clause 10.1.0.

Any active PDP contexts will be automatically deactivated when the attachment state changes to detached.

The read command returns the current Packet Domain service state.

The test command is used for requesting information on the supported Packet Domain service states.

NOTE 2: This command has the characteristics of both the V.250 action and parameter commands. Hence it has the read form in addition to the execution/set and test forms.

Defined values

<state>: integer type; indicates the state of PS attachment

0 detached

1 attached

Implementation

Optional.

10.1.10 PDP context activate or deactivate +CGACT

Table 120: +CGACT parameter command syntax

Command	Possible Response(s)
+CGACT=[<state>[,<cid>[,<cid>[,...]]]]	+CME ERROR: <err>
+CGACT?	[+CGACT: <cid>,<state>] [<CR><LF>+CGACT: <cid>,<state>] [...]
+CGACT=?	+CGACT: (list of supported <state>s)

Description

The execution command is used to activate or deactivate the specified PDP context (s). After the command has completed, the MT remains in V.250 command state. If any PDP context is already in the requested state, the state for that context remains unchanged. If the requested state for any specified context cannot be achieved, an ERROR or +CME

ERROR response is returned. Extended error responses are enabled by the +CMEE command. If the MT is not PS attached when the activation form of the command is executed, the MT first performs a PS attach and then attempts to activate the specified contexts. If the attach fails then the MT responds with ERROR or, if extended error responses are enabled, with the appropriate failure-to-attach error message. Refer clause 9.2 for possible <err> values.

For EPS, if an attempt is made to disconnect the last PDN connection, then the MT responds with ERROR or, if extended error responses are enabled, a +CME ERROR.

NOTE: If the initial PDP context is supported, the context with <cid>=0 is automatically defined at startup, see clause 10.1.0.

For EPS, the activation request for an EPS bearer resource will be answered by the network by either an EPS dedicated bearer activation or EPS bearer modification request. The request must be accepted by the MT before the PDP context can be set in to established state.

For 5GS, the command is used to request or delete the specified QoS flow. The request for a specific QoS flow will be answered by the network by a PDU session establishment accept message or a PDU session modification command message. The PDU session establishment accept message or a PDU session modification command message must be accepted by the MT before the QoS flow can be set to active state.

If no <cid>s are specified the activation form of the command activates all defined non-emergency contexts.

If no <cid>s are specified the deactivation form of the command deactivates all active contexts.

The read command returns the current activation states for all the defined PDP contexts.

The test command is used for requesting information on the supported PDP context activation states.

NOTE. This command has the characteristics of both the V.250 action and parameter commands. Hence it has the read form in addition to the execution/set and test forms.

Defined values

<state>: integer type; indicates the state of PDP context activation. The default value is manufacturer specific.

0 deactivated

1 activated

<cid>: integer type; specifies a particular PDP context definition (see the +CGDCONT and +CGDSCONT commands).

Implementation

Optional.

10.1.11 PDP context modify +CGCMOD

Table 121: +CGCMOD action command syntax

Command	Possible Response(s)
+CGCMOD[=<cid>[,<cid>[,...]]]	+CME ERROR: <err>
+CGCMOD=?	+CGCMOD: (list of <cid>s associated with active contexts)
NOTE: The syntax of the AT Set Command is corrected to be according to ITU-T Recommendation V.250 [14]. Older versions of the specification specify incorrect syntax +CGCMOD=[<cid>[,<cid>[,...]]].	

Description

The execution command is used to modify the specified PDP context (s) with respect to QoS profiles and TFTs. After the command has completed, the MT returns to V.250 online data state. If the requested modification for any specified context cannot be achieved, an ERROR or +CME ERROR response is returned. Extended error responses are enabled by the +CMEE command. Refer clause 9.2 for possible <err> values.

For EPS, the modification request for an EPS bearer resource will be answered by the network by an EPS bearer modification request. The request must be accepted by the MT before the PDP context is effectively changed.

For 5GS, the command is used to modify the specified QoS flow. The modification request for a QoS flow resource will be answered by the network by a PDU session modification command. The command must be accepted by the MT before the QoS flow is effectively changed.

If no <cid>s are specified the activation form of the command modifies all active contexts.

The test command returns a list of <cid>s associated with active contexts.

Defined values

<cid>: integer type; specifies a particular PDP context definition (see the +CGDCONT and +CGDSCONT commands).

Implementation

Optional.

10.1.12 Enter data state +CGDATA

Table 122: +CGDATA action command syntax

Command	Possible Response(s)
+CGDATA[=<L2P>[,<cid>[,<cid>[,...]]]]	CONNECT ERROR <i>+CME ERROR: <err></i>
+CGDATA=?	+CGDATA: (list of supported <L2P>s)
NOTE:	The syntax of the AT Set Command is corrected to be according to ITU-T Recommendation V.250 [14]. Older versions of the specification specify incorrect syntax +CGDATA=[<L2P>[,<cid>[,<cid>[,...]]]].

Description

The execution command causes the MT to perform whatever actions are necessary to establish communication between the TE and the network using one or more Packet Domain PDP types. This may include performing a PS attach and one or more PDP context activations. If the <L2P> parameter value is unacceptable to the MT, the MT shall return an ERROR or +CME ERROR response. Refer clause 9.2 for possible <err> values. Otherwise, the MT issues the intermediate result code CONNECT and enters V.250 online data state.

NOTE: If the initial PDP context is supported, the context with <cid>=0 is automatically defined at startup, see clause 10.1.0.

Commands following +CGDATA command in the AT command line shall not be processed by the MT.

The detailed behaviour after the online data state has been entered is dependent on the PDP type. It is described briefly in 3GPP TS 27.060 [34] and in more detail in 3GPP TS 29.061 [39] and the specifications for the relevant PDPs. PS attachment and PDP context activation procedures may take place prior to or during the PDP startup if they have not already been performed using the +CGATT and +CGACT commands.

If context activation takes place during the PDP startup, one or more <cid>s may be specified in order to provide the information needed for the context activation request(s).

During each PDP startup procedure the MT may have access to some or all of the following information -

The MT may have a priori knowledge, for example, it may implement only one PDP type.

The command may have provided an <L2P> parameter value.

The TE may provide a PDP type and/or PDP address to the MT during in the PDP startup procedure.

If any of this information is in conflict, the command will fail.

Any PDP type and/or PDP address present in the above information shall be compared with the PDP type and/or PDP address in any context definitions specified in the command in the order in which their <cid>s appear. For a context definition to match:

The PDP type must match exactly.

The PDP addresses are considered to match if they are identical or if either or both addresses are unspecified. For example, a PPP NCP request specifying PDP type = IP and no PDP address would cause the MT to search through the specified context definitions for one with PDP type = IP and any PDP address.

The context shall be activated using the matched value for PDP type and a static PDP address if available, together with the other information found in the PDP context definition. If a static PDP address is not available then a dynamic address is requested.

If no <cid> is given or if there is no matching context definition, the MT shall attempt to activate the context with whatever information is available to the MT. The other context parameters shall be set to their default values.

If the activation is successful, data transfer may proceed.

After data transfer is complete, and the layer 2 protocol termination procedure has completed successfully, the V.250 command state is re-entered and the MT returns the final result code OK.

In the event of an erroneous termination or a failure to start up, the V.250 command state is re-entered and the MT returns the final result code NO CARRIER or, if enabled, +CME ERROR. Refer clause 9.2 for possible <err> values. Attach, activate and other errors may be reported.

The test command is used for requesting information on the supported layer 2 protocols.

This command may be used in both normal and modem compatibility modes.

Defined values

<L2P>: string type; indicates the layer 2 protocol to be used between the TE and MT

NULL	none, for PDP type OSP:IHOSS (Obsolete)
PPP	Point-to-point protocol for a PDP such as IP
PAD	character stream for X.25 character (triple X PAD) mode (Obsolete)
X25	X.25 L2 (LAPB) for X.25 packet mode (Obsolete)
M-xxxx	manufacturer-specific protocol (xxxx is an alphanumeric string)

If the value is omitted, the layer 2 protocol is unspecified. Other values are reserved and will result in an ERROR response.

<cid>: integer type; specifies a particular PDP context definition (see the +CGDCONT and +CGDSCONT commands).

Implementation

Optional if the D (dial) command can be used to specify Packet Domain operation.

10.1.13 Configure local octet stream PAD parameters +CGCLOSP (Obsolete)

10.1.14 Show PDP address(es) +CGPADDR

Table 123: +CGPADDR action command syntax

Command	Possible response(s)
+CGPADDR[=<cid>[,<cid>[,...]]]	[+CGPADDR: <cid>[,<PDP_addr_1>[,<PDP_addr_2>]]] [<CR><LF>+CGPADDR: <cid>[,<PDP_addr_1>[,<PDP_addr_2>]] [...]]
+CGPADDR=?	+CGPADDR: (list of defined <cid>s)
NOTE:	The syntax of the AT Set Command is corrected to be according to ITU-T Recommendation V.250 [14]. Older versions of the specification specify incorrect syntax +CGPADDR=[,<cid>[,<cid>[,...]]].

Description

The execution command returns a list of PDP addresses for the specified context identifiers. If no <cid> is specified, the addresses for all defined contexts are returned.

The test command returns a list of defined <cid>s.

Defined values

<cid>: integer type; specifies a particular PDP context definition (see the +CGDCONT and +CGDSCONT commands).

<PDP_addr_1> and <PDP_addr_2>: each is a string type that identifies the MT in the address space applicable to the PDP. The address may be static or dynamic. For a static address, it will be the one set by the +CGDCONT and +CGDSCONT commands when the context was defined. For a dynamic address it will be the one assigned during the last PDP context activation that used the context definition referred to by <cid>. Both <PDP_addr_1> and <PDP_addr_2> are omitted if none is available. Both <PDP_addr_1> and <PDP_addr_2> are included when both IPv4 and IPv6 addresses are assigned, with <PDP_addr_1> containing the IPv4 address and <PDP_addr_2> containing the IPv6 address.

The string is given as dot-separated numeric (0-255) parameter of the form:

a1.a2.a3.a4 for IPv4 and

a1.a2.a3.a4.a5.a6.a7.a8.a9.a10.a11.a12.a13.a14.a15.a16 for IPv6.

When +CGPIAF is supported, its settings can influence the format of the IPv6 address in parameter <PDP_addr_1> or <PDP_addr_2> returned with the execute form of +CGPADDR.

NOTE: In dual-stack terminals (<PDP_type> IPV4V6), the IPv6 address will be provided in <PDP_addr_2>. For terminals with a single IPv6 stack (<PDP_type> IPV6) or due to backwards compatibility, the IPv6 address can be provided in parameter <PDP_addr_1>.

Implementation

Optional.

10.1.15 Automatic response to a network request for PDP context activation +CGAUTO

Table 124: +CGAUTO parameter command syntax

Command	Possible response(s)
+CGAUTO=[<n>]	+CME ERROR: <err>
+CGAUTO?	+CGAUTO: <n>
+CGAUTO=?	+CGAUTO: (list of supported <n>s)

Description

The set command disables or enables an automatic positive or negative response (auto-answer) to the receipt of a NW-initiated Request PDP Context Activation message, NW-initiated Request EPS Bearer Activation/ Modification Request messages and a NW-initiated PDU Session Modification Command message. It also provides control over the use of the V.250 basic commands 'S0', 'A' and 'H' for handling network requests for PDP context activation. The setting does not affect the issuing of the unsolicited result code RING or +CRING.

When the +CGAUTO=0 command is received for GERAN, UTRAN or E-UTRAN RATs, the MT shall not perform a PS detach if it is attached. Subsequently, when the MT announces a network request for PDP context activation by issuing the unsolicited result code RING or +CRING, the TE may manually accept or reject the request by issuing the +CGANS command or may simply ignore the network request.

When the +CGAUTO=1 command is received for GERAN, UTRAN or E-UTRAN RATs, the MT shall attempt to perform a PS attach if it is not already attached. Failure will result in ERROR or, if enabled, +CME ERROR being returned to the TE. Refer clause 9.2 for possible <err> values. Subsequently, when the MT announces a network request for PDP context activation by issuing the unsolicited result code RING or +CRING to the TE, this is followed by the intermediate result code CONNECT. The MT then enters V.250 online data state and follows the same procedure as it would after having received a +CGANS=1 with no <L2P> or <cid> values specified.

The read command returns the current value of <n>.

The test command returns the values of <n> supported by the MT as a compound value.

Defined values

<n>: integer type

- 0 turn off automatic response for Packet Domain only
- 1 turn on automatic response for Packet Domain only
- 2 modem compatibility mode, Packet Domain only
- 3 modem compatibility mode, Packet Domain and circuit switched calls
- 4 turn on automatic negative response for Packet Domain only

For <n>=0 Packet Domain network requests are manually accepted or rejected by the +CGANS command.

For <n>=1 Packet Domain network requests are automatically accepted according to the description above.

For <n>=2, automatic acceptance of Packet Domain network requests is controlled by the 'S0' command. Manual control uses the 'A' and 'H' commands, respectively, to accept and reject Packet Domain requests. (+CGANS may also be used.) Incoming circuit switched calls can be neither manually nor automatically answered.

For <n>=3, automatic acceptance of both Packet Domain network requests and incoming circuit switched calls is controlled by the 'S0' command. Manual control uses the 'A' and 'H' commands, respectively, to accept and reject Packet Domain requests. (+CGANS may also be used.) Circuit switched calls are handled as described elsewhere in this specification.

For <n>=4, Packet Domain network requests are automatically rejected.

Implementation

Optional. If not implemented, the MT shall behave according to the case of $\langle n \rangle = 3$.

10.1.16 Manual response to a network request for PDP context activation +CGANS

Table 125: +CGANS action command syntax

Command	Possible response(s)
+CGANS [= <response> , [<L2P> , [<cid>]]]	+CME ERROR: <err>
+CGANS=?	+CGANS: (list of supported <response>s) , (list of supported <L2P>s)
NOTE:	The syntax of the AT Set Command is corrected to be according to ITU-T Recommendation V.250 [14]. Older versions of the specification specify incorrect syntax +CGANS=[<response> , [<L2P> , [<cid>]]]

Description

The execution command requests the MT to respond to a network request for Packet Domain PDP context activation which has been signalled to the TE by the RING, +CRING or +CGEV unsolicited result code. The <response> parameter allows the TE to accept or reject the request.

If <response> is 0, the request is rejected and the MT returns OK to the TE.

If <response> is 1, the following procedure is followed by the MT.

Commands following the +CGANS command in the AT command line shall not be processed by the MT.

If the <L2P> parameter value is unacceptable to the MT, the MT shall return an ERROR or +CME ERROR response. Refer clause 9.2 for possible <err> values. Otherwise, the MT issues the intermediate result code CONNECT and enters V.250 online data state.

The detailed behaviour after the online data state has been entered is dependent on the PDP type. It is described briefly in 3GPP TS 27.060 [34] and in more detail in 3GPP TS 29.061 [39] and the specifications for the relevant PDPs. PDP context activation procedures shall take place prior to or during the PDP startup.

One or more <cid>s may be specified in order to provide the values needed for the context activation request.

During the PDP startup procedure the MT has the PDP type and the PDP address provided by the network in the Request PDP Context Activation message. The MT may also have some or all of the following information:

The MT may have a priori knowledge, for example, it may implement only one PDP type.

The command may have provided an <L2P> parameter value.

The TE may provide one or both of PDP type and PDP address to the MT in the PDP startup.

If any of this information is in conflict, the command will fail.

If one or more <cid> is given then an attempt shall be made to identify an appropriate context definition by matching the PDP type and PDP address in the network request with the PDP type and PDP address in each of the specified context definitions (in the order in which their <cid>s appear in the command) as follows:

The PDP type must match exactly.

The PDP addresses are considered to match if they are identical or if the address in the context definition is unspecified.

The context shall be activated using the values for PDP type and PDP address provided by the network, together with the other information found in the PDP context definition. An APN may or may not be required, depending on the application.

If no <cid> is given or if there is no matching context definition, the MT will attempt to activate the context using the values for PDP type and PDP address provided by the network, together with any other relevant information known to the MT. The other context parameters will be set to their default values.

If the activation is successful, data transfer may proceed.

After data transfer is complete, and the layer 2 protocol termination procedure has completed successfully, the V.250 command state is re-entered and the MT returns the final result code OK.

In the event of an erroneous termination or a failure to startup, the V.250 command state is re-entered and the MT returns the final result code NO CARRIER or, if enabled, +CME ERROR. Refer clause 9.2 for possible <err> values. Attach, activate and other errors may be reported. It is also an error to issue the +CGANS command when there is no outstanding network request.

NOTE: This is not the same as if the MT issues a +CGDATA (or +CGACT) command after receiving a +CRING unsolicited result code. A +CGDATA (or +CGACT) does not command the MT to acknowledge the network request but rather to make a new request for context activation. The network request would be ignored.

The test command returns the values of <response> and <L2P> supported by the MT as compound values.

This command may be used in both normal and modem compatibility modes.

Defined values

<response>: integer type; specifies how the request should be responded to.

- 0 reject the request
- 1 accept and request that the PDP context be activated

If <response> is omitted it is assumed to be 0.

<L2P>: string type; indicates the layer 2 protocol to be used (see +CGDATA command).

<cid>: integer type; specifies a particular PDP context definition (see the +CGDCONT and +CGDSCONT commands).

Implementation

Optional.

10.1.17 GPRS mobile station class +CGCLASS

Table 126: +CGCLASS parameter command syntax

Command	Possible Response(s)
+CGCLASS=[<class>]	+CME ERROR: <err>
+CGCLASS?	+CGCLASS: <class>
+CGCLASS=?	+CGCLASS: (list of supported <class>s)

Description

The set command is used to set the MT to operate according to the specified mode of operation, see 3GPP TS 23.060 [47]. If the requested mode of operation is not supported, an `ERROR` or `+CME ERROR` response is returned. Extended error responses are enabled by the `+CMEE` command. Refer clause 9.2 for possible `<err>` values.

The read command returns the mode of operation set by the TE, independent of the current serving cell capability and independent of the current serving cell Access Technology. If no value has been set by the TE previously, the return value shall be the highest mode of operation that can be supported by the MT.

The test command is used for requesting information on the supported MT modes of operation as a compound value.

Defined values

`<class>`: string type; indicates the mode of operation. The default value is manufacturer specific.

- A Class-A mode of operation (A/Gb mode), or CS/PS mode of operation (Iu mode) (highest mode of operation)
- B Class-B mode of operation (A/Gb mode), or CS/PS mode of operation (Iu mode)
- CG Class-C mode of operation in PS only mode (A/Gb mode), or PS mode of operation (Iu mode)
- CC Class-C mode of operation in CS only mode (A/Gb mode), or CS (Iu mode) (lowest mode of operation)

NOTE: `<class>` A means that the MT would operate simultaneous PS and CS service
`<class>` B means that the MT would operate PS and CS services but not simultaneously in A/Gb mode
`<class>` CG means that the MT would only operate PS services
`<class>` CC means that the MT would only operate CS services

If the MT is attached to the PS domain when the set command is issued with a `<class>=CC` specified, a PS detach shall be performed by the MT.

Implementation

Optional.

10.1.18 Configure local triple-X PAD parameters +CGCLPAD (GPRS only) (Obsolete)

10.1.19 Packet domain event reporting +CGEREP

Table 127: +CGEREP parameter command syntax

Command	Possible response(s)
<code>+CGEREP=[<mode>[, <bfr>]]</code>	<code>+CME ERROR: <err></code>
<code>+CGEREP?</code>	<code>+CGEREP: <mode>, <bfr></code>
<code>+CGEREP=?</code>	<code>+CGEREP: (list of supported <mode>s) , (list of supported <bfr>s)</code>

Description

Set command enables or disables sending of unsolicited result codes, `+CGEV: XXX` from MT to TE in the case of certain events occurring in the Packet Domain MT or the network. `<mode>` controls the processing of unsolicited result codes specified within this command. `<bfr>` controls the effect on buffered codes when `<mode>` 1 or 2 is entered. If a setting is not supported by the MT, `ERROR` or `+CME ERROR:` is returned. Refer clause 9.2 for possible `<err>` values.

Read command returns the current mode and buffer settings.

Test command returns the modes and buffer settings supported by the MT as compound values.

Defined values

<mode>: integer type

- 0 buffer unsolicited result codes in the MT; if MT result code buffer is full, the oldest ones can be discarded. No codes are forwarded to the TE.
- 1 discard unsolicited result codes when MT-TE link is reserved (e.g. in on-line data mode); otherwise forward them directly to the TE
- 2 buffer unsolicited result codes in the MT when MT-TE link is reserved (e.g. in on-line data mode) and flush them to the TE when MT-TE link becomes available; otherwise forward them directly to the TE

<bfr>: integer type

- 0 MT buffer of unsolicited result codes defined within this command is cleared when <mode> 1 or 2 is entered
- 1 MT buffer of unsolicited result codes defined within this command is flushed to the TE when <mode> 1 or 2 is entered (OK response shall be given before flushing the codes)

Defined events

The events are valid for all accesses unless explicitly mentioned.

For network attachment, the following unsolicited result codes and the corresponding events are defined:

+CGEV: NW DETACH

The network has forced a PS detach. This implies that all active contexts have been deactivated. These are not reported separately.

+CGEV: ME DETACH

The mobile termination has forced a PS detach. This implies that all active contexts have been deactivated. These are not reported separately.

For MT class, the following unsolicited result codes and the corresponding events are defined:

+CGEV: NW CLASS <class>

The network has forced a change of MT class. The highest available class is reported (see +CGCLASS). The format of the parameter <class> is found in command +CGCLASS.

+CGEV: ME CLASS <class>

The mobile termination has forced a change of MT class. The highest available class is reported (see +CGCLASS). The format of the parameter <class> is found in command +CGCLASS.

For PDP context activation, the following unsolicited result codes and the corresponding events are defined:

+CGEV: NW PDN ACT <cid>[, <WLAN_Offload>]

The network has activated a context. The context represents a Primary PDP context. The <cid> for this context is provided to the TE. The format of the parameter <cid> is found in command +CGDCONT.

<WLAN_Offload>: integer type. An integer that indicates whether traffic can be offloaded using the specified PDN connection via a WLAN or not. This refers to bit 1 (E-UTRAN offload acceptability value) and bit 2 (UTRAN offload acceptability value) in the WLAN offload acceptability IE as specified in 3GPP TS 24.008 [8] clause 10.5.6.20.

- 0 offloading the traffic of the PDN connection via a WLAN when in S1 mode or when in Iu mode is not acceptable.
- 1 offloading the traffic of the PDN connection via a WLAN when in S1 mode is acceptable, but not acceptable in Iu mode.

- 2 offloading the traffic of the PDN connection via a WLAN when in Iu mode is acceptable, but not acceptable in S1 mode.
- 3 offloading the traffic of the PDN connection via a WLAN when in S1 mode or when in Iu mode is acceptable.

NOTE 1: This event is not applicable for EPS and 5GS.

+CGEV: ME PDN ACT <cid>[, <reason>[, <cid_other>[, <WLAN_Offload>[, <SSC>[, <old-cid>]]]]]

The mobile termination has activated a context. The context represents a PDN connection or a Primary PDP context. The <cid> for this context is provided to the TE. This event is sent either in result of explicit context activation request (+CGACT), or in result of implicit context activation request associated to attach request (+CGATT=1). The format of the parameter <cid> is found in command +CGDCONT. The format of the parameter <WLAN_Offload> is defined above.

<reason>: integer type; indicates the reason why the context activation request for PDP type IPv4v6 was not granted. This parameter is only included if the requested PDP type associated with <cid> is IPv4v6, and the PDP type assigned by the network for <cid> is either IPv4 or IPv6.

- 0 IPv4 only allowed
- 1 IPv6 only allowed
- 2 single address bearers only allowed.
- 3 single address bearers only allowed and MT initiated context activation for a second address type bearer was not successful.

<cid_other>: integer type; indicates the context identifier allocated by MT for an MT initiated context of a second address type. MT shall only include this parameter if <reason> parameter indicates single address bearers only allowed, and MT supports MT initiated context activation of a second address type without additional commands from TE, and MT has activated the PDN connection or PDP context associated with <cid_other>.

<SSC>: integer type; indicates whether the established PDU session is requested by the network for SSC mode 2 or SSC mode 3 PDU session anchor relocation as specified in 3GPP TS 23.501 [165] and 3GPP TS 24.501 [161].

- 1 the established PDU session is requested by the network for SSC mode 2 PDU session anchor relocation.
- 2 the established PDU session is requested by the network for SSC mode 3 PDU session anchor relocation.

<old-cid>: integer type; indicates the context identifier of the QoS flow of the default QoS rule of the SSC mode 2 or SSC mode 3 PDU session where the network requests relocation of the PDU session anchor.

NOTE 1A: For legacy TEs supporting MT initiated context activation without TE requests, there is also a subsequent event +CGEV: ME PDN ACT <cid_other> returned to TE.

+CGEV: NW ACT <p_cid>, <cid>, <event_type>[, <WLAN_Offload>]

The network has activated a context. The <cid> for this context is provided to the TE in addition to the associated primary <p_cid>. The format of the parameters <p_cid> and <cid> are found in command +CGDSCONT. The format of the parameter <WLAN_Offload> is defined above.

<event_type>: integer type; indicates whether this is an informational event or whether the TE has to acknowledge it.

- 0 Informational event
- 1 Information request: Acknowledgement required. The acknowledgement can be accept or reject, see +CGANS.

+CGEV: ME ACT <p_cid>, <cid>, <event_type>[,<WLAN_Offload>]

The network has responded to an ME initiated context activation. The <cid> for this context is provided to the TE in addition to the associated primary <p_cid>. The format of the parameters <p_cid> and <cid> are found in command +CGDSCONT. The format of the parameters <event_type> and <WLAN_Offload> are defined above.

For PDP context deactivation, the following unsolicited result codes and the corresponding events are defined:

+CGEV: NW DEACT <PDP_type>, <PDP_addr>, [<cid>]

The network has forced a context deactivation. The <cid> that was used to activate the context is provided if known to the MT. The format of the parameters <PDP_type>, <PDP_addr> and <cid> are found in command +CGDCONT.

+CGEV: ME DEACT <PDP_type>, <PDP_addr>, [<cid>]

The mobile termination has forced a context deactivation. The <cid> that was used to activate the context is provided if known to the MT. The format of the parameters <PDP_type>, <PDP_addr> and <cid> are found in command +CGDCONT.

+CGEV: NW PDN DEACT <cid>[,<WLAN_Offload>[,<SSC>]]

The network has deactivated a context. The context represents a PDN connection or a Primary PDP context. The associated <cid> for this context is provided to the TE. The format of the parameter <cid> is found in command +CGDCONT. The format of the parameters <WLAN_Offload> and <SSC> are defined above.

NOTE 2: Occurrence of this event replaces usage of the event

+CGEV: NW DEACT <PDP_type>, <PDP_addr>, [<cid>].

+CGEV: ME PDN DEACT <cid>

The mobile termination has deactivated a context. The context represents a PDN connection or a Primary PDP context. The <cid> for this context is provided to the TE. The format of the parameter <cid> is found in command +CGDCONT.

NOTE 3: Occurrence of this event replaces usage of the event

+CGEV: ME DEACT <PDP_type>, <PDP_addr>, [<cid>].

+CGEV: NW DEACT <p_cid>, <cid>, <event_type>[,<WLAN_Offload>]

The network has deactivated a context. The <cid> for this context is provided to the TE in addition to the associated primary <p_cid>. The format of the parameters <p_cid> and <cid> are found in command +CGDSCONT. The format of the parameters <event_type> and <WLAN_Offload> are defined above.

NOTE 4: Occurrence of this event replaces usage of the event

+CGEV: NW DEACT <PDP_type>, <PDP_addr>, [<cid>].

+CGEV: ME DEACT <p_cid>, <cid>, <event_type>

The network has responded to an ME initiated context deactivation request. The associated <cid> is provided to the TE in addition to the associated primary <p_cid>. The format of the parameters <p_cid> and <cid> are found in command +CGDSCONT. The format of the parameter <event_type> is defined above.

NOTE 5: Occurrence of this event replaces usage of the event

+CGEV: ME DEACT <PDP_type>, <PDP_addr>, [<cid>].

For PDP context modification, the following unsolicited result codes and the corresponding events are defined:

+CGEV: NW MODIFY <cid>, <change_reason>, <event_type>[,<WLAN_Offload>[,<PDU-lifetime>]]

The network has modified a context. The associated <cid> is provided to the TE in addition to the <change_reason> and <event_type>. The format of the parameter <cid> is found in command

+CGDCONT or +CGDSCONT. The format of the parameters <change_reason>, <event_type>, and <WLAN_Offload> are defined above.

<change_reason>: integer type; a bitmap that indicates what kind of change occurred. The <change_reason> value is determined by summing all the applicable bits. For example if both the values of QoS changed (Bit 2) and WLAN_Offload changed (Bit 3) have changed, then the <change_reason> value is 6.

NOTE 5A: The WLAN offload value will change when bit 1 or bit 2 or both of the indicators in the WLAN offload acceptability IE change, see the parameter <WLAN_Offload> defined above.

Bit 1 TFT changed

Bit 2 Qos changed

Bit 3 WLAN Offload changed

Bit 4 Relocation of PDU session anchor requested

<PDU-lifetime>: integer type; indicates the PDU session address lifetime value in seconds for relocation of SSC mode 3 PDU session anchor, see 3GPP TS 23.501 [165] and 3GPP TS 24.501 [161].

+CGEV: ME MODIFY <cid>, <change_reason>, <event_type>[, <WLAN_Offload>]

The mobile termination has modified a context. The associated <cid> is provided to the TE in addition to the <change_reason> and <event_type>. The format of the parameter <cid> is found in command +CGDCONT or +CGDSCONT. The format of the parameters <change_reason>, <event_type> and <WLAN_Offload> are defined above.

For other PDP context handling, the following unsolicited result codes and the corresponding events are defined:

+CGEV: REJECT <PDP_type>, <PDP_addr>

A network request for context activation occurred when the MT was unable to report it to the TE with a +CRING unsolicited result code and was automatically rejected. The format of the parameters <PDP_type> and <PDP_addr> are found in command +CGDCONT.

NOTE 6: This event is not applicable for EPS and 5GS.

+CGEV: NW REACT <PDP_type>, <PDP_addr>, [<cid>]

The network has requested a context reactivation. The <cid> that was used to reactivate the context is provided if known to the MT. The format of the parameters <PDP_type>, <PDP_addr> and <cid> are found in command +CGDCONT.

NOTE 7: This event is not applicable for EPS and 5GS.

Implementation

Optional.

10.1.20 GPRS network registration status +CGREG

Table 128: +CGREG parameter command syntax

Command	Possible response(s)
+CGREG=[<n>]	+CME ERROR: <err>

+CGREG?	<p>when <n>=0, 1, 2 or 3 and command successful: +CGREG: <n>, <stat>[, [<i><lac></i>], [<i><ci></i>], [<i><AcT></i>], [<i><rac></i>]][, [<i><cause_type></i>], [<i><reject_cause></i>]]</p> <p>when <n>=4 or 5 and command successful: +CGREG: <n>, <stat>[, [<i><lac></i>], [<i><ci></i>], [<i><AcT></i>], [<i><rac></i>]][, [<i><cause_type></i>], [<i><reject_cause></i>]][, [<i><Active-Time></i>], [<i><Periodic-RAU></i>], [<i><GPRS-READY-timer></i>]]]]</p>
+CGREG=?	+CGREG: (list of supported <n>s)

Description

The set command controls the presentation of an unsolicited result code +CGREG: <stat> when <n>=1 and there is a change in the MT's GPRS network registration status in GERAN/UTRAN, or unsolicited result code +CGREG: <stat>[, [*<lac>*], [*<ci>*], [*<AcT>*], [*<rac>*]] when <n>=2 and there is a change of the network cell in GERAN/UTRAN. The parameters <AcT>, <lac>, <rac> and <ci> are provided only if available. The value <n>=3 further extends the unsolicited result code with [, <cause_type>, <reject_cause>], when available, when the value of <stat> changes.

If the UE wants to apply PSM for reducing its power consumption, see +CPSMS command and 3GPP TS 23.682 [149], the set command controls the presentation of an unsolicited result code +CGREG: <stat>[, [*<lac>*], [*<ci>*], [*<AcT>*], [*<rac>*]][, [*<cause_type>*], [*<reject_cause>*]][, [*<Active-Time>*], [*<Periodic-RAU>*], [*<GPRS-READY-timer>*]]]]. When <n>=4 the unsolicited result code will provide the UE with additional information for the Active Time value, the extended periodic RAU value and the GPRS READY timer value if there is a change of the network cell in GERAN/UTRAN. The value <n>=5 further enhances the unsolicited result code with <cause_type> and <reject_cause> when the value of <stat> changes. The parameters <AcT>, <lac>, <rac>, <ci>, <cause_type>, <reject_cause>, <Active-Time>, <Periodic-RAU> and <GPRS-READY-timer> are provided only if available.

Refer clause 9.2 for possible <err> values.

NOTE 1: If the GPRS MT also supports one or more of the circuit mode services in GERAN/UTRAN, EPS services in E-UTRAN or 5G services in NG-RAN, the +CREG command and +CREG: result codes, the +CEREG command and +CEREG: result codes and the +C5GREG command and +C5GREG: result codes apply to the registration status and location information for those services.

The read command returns the status of result code presentation and an integer <stat> which shows whether the network has currently indicated the registration of the MT. Location information elements <lac>, <ci>, <AcT> and <rac>, if available, are returned only when <n>=2 and MT is registered in the network. The parameters [, <cause_type>, <reject_cause>], if available, are returned when <n>=3.

Test command returns values supported as a compound value.

Defined values

<n>: integer type

- 0 disable network registration unsolicited result code
- 1 enable network registration unsolicited result code +CGREG: <stat>
- 2 enable network registration and location information unsolicited result code +CGREG: <stat>[, [*<lac>*], [*<ci>*], [*<AcT>*], [*<rac>*]]
- 3 enable network registration, location information and GMM cause value information unsolicited result code +CGREG: <stat>[, [*<lac>*], [*<ci>*], [*<AcT>*], [*<rac>*]][, [*<cause_type>*], [*<reject_cause>*]]
- 4 For a UE that wants to apply PSM, enable network registration and location information unsolicited result code +CGREG: <stat>[, [*<lac>*], [*<ci>*], [*<AcT>*], [*<rac>*]][, [, [*<Active-Time>*], [*<Periodic-RAU>*], [*<GPRS-READY-timer>*]]]]

- 5 For a UE that wants to apply PSM, enable network registration, location information and GMM cause value information unsolicited result code
 +CGREG: <stat>[, [<lac>], [<ci>], [<AcT>], [<rac>][, [<cause_type>], [<reject_cause>][, [<Active-Time>], [<Periodic-RAU>], [<GPRS-READY-timer>]]]]

<stat>: integer type; indicates the GPRS registration status.

- 0 not registered, MT is not currently searching an operator to register to
- 1 registered, home network
- 2 not registered, but MT is currently trying to attach or searching an operator to register to
- 3 registration denied
- 4 unknown (e.g. out of GERAN/UTRAN coverage)
- 5 registered, roaming
- 6 registered for "SMS only", home network (not applicable)
- 7 registered for "SMS only", roaming (not applicable)
- 8 attached for emergency bearer services only (see NOTE 2) (applicable only when <AcT> indicates 2,4,5,6)
- 9 registered for "CSFB not preferred", home network (not applicable)
- 10 registered for "CSFB not preferred", roaming (not applicable)

NOTE 2: 3GPP TS 24.008 [8] and 3GPP TS 24.301 [83] specify the condition when the MS is considered as attached for emergency bearer services.

<lac>: string type; two byte location area code in hexadecimal format (e.g. "00C3" equals 195 in decimal).

<ci>: string type; four byte GERAN/UTRAN cell ID in hexadecimal format.

<AcT>: integer type; indicates the access technology of the serving cell.

- 0 GSM
- 1 GSM Compact
- 2 UTRAN
- 3 GSM w/EGPRS (see NOTE 3)
- 4 UTRAN w/HSDPA (see NOTE 4)
- 5 UTRAN w/HSUPA (see NOTE 4)
- 6 UTRAN w/HSDPA and HSUPA (see NOTE 4)
- 7 E-UTRAN (not applicable)
- 8 EC-GSM-IoT (A/Gb mode) (see NOTE 5)
- 9 E-UTRAN (NB-S1 mode) (see NOTE 6) (not applicable)
- 10 E-UTRA connected to a 5GCN (see NOTE 7) (not applicable)
- 11 NR connected to a 5GCN (see NOTE 7) (not applicable)
- 12 NG-RAN (not applicable)
- 13 E-UTRA-NR dual connectivity (see NOTE 8) (not applicable)

NOTE 3: 3GPP TS 44.018 [156] specifies the System Information messages which give the information about whether the serving cell supports EGPRS.

NOTE 4: 3GPP TS 25.331 [74] specifies the System Information blocks which give the information about whether the serving cell supports HSDPA or HSUPA.

NOTE 5: 3GPP TS 44.018 [156] specifies the EC-SCH INFORMATION message which, if present, indicates that the serving cell supports EC-GSM-IoT.

NOTE 6: 3GPP TS 36.331 [86] specifies the System Information blocks which give the information about whether the serving cell supports NB-IoT, which corresponds to E-UTRAN (NB-S1 mode).

NOTE 7: 3GPP TS 38.331 [160] specifies the information which, if present, indicates that the serving cell is connected to a 5GCN.

NOTE 8: 3GPP TS 38.331 [160] specifies the information which, if present, indicates that the serving cell is supporting dual connectivity of E-UTRA with NR and is connected to an EPS core.

<rac>: string type; one byte routing area code in hexadecimal format.

<cause_type>: integer type; indicates the type of <reject_cause>.

0 Indicates that <reject_cause> contains a GMM cause value, see 3GPP TS 24.008 [8] Annex G.

1 Indicates that <reject_cause> contains a manufacturer-specific cause.

<reject_cause>: integer type; contains the cause of the failed registration. The value is of type as defined by <cause_type>.

<Active-Time>: string type; one byte in an 8 bit format. Indicates the Active Time value (T3324) allocated to the UE in GERAN/UTRAN. The Active Time value is coded as one byte (octet 3) of the GPRS Timer 2 information element coded as bit format (e.g. "00100100" equals 4 minutes). For the coding and the value range, see the GPRS Timer 2 IE in 3GPP TS 24.008 [8] Table 10.5.163/3GPP TS 24.008. See also 3GPP TS 23.682 [149] and 3GPP TS 23.060 [47].

<Periodic-RAU>: string type; one byte in an 8 bit format. Indicates the extended periodic RAU value (T3312) allocated to the UE in GERAN/UTRAN. The extended periodic RAU value is coded as one byte (octet 3) of the GPRS Timer 3 information element coded as bit format (e.g. "01000111" equals 70 hours). For the coding and the value range, see the GPRS Timer 3 IE in 3GPP TS 24.008 [8] Table 10.5.163a/3GPP TS 24.008. See also 3GPP TS 23.682 [149] and 3GPP TS 23.060 [47].

<GPRS-READY-timer>: string type; one byte in an 8 bit format. Indicates the GPRS READY timer value (T3314) allocated to the UE in GERAN/UTRAN. The GPRS READY timer value is coded as one byte (octet 2) of the GPRS Timer information element coded as bit format (e.g. "01000011" equals 3 decihours or 18 minutes). For the coding and the value range, see the GPRS Timer IE in 3GPP TS 24.008 [8] Table 10.5.172/3GPP TS 24.008. See also 3GPP TS 23.060 [47].

Implementation

Optional.

This command is not applicable to UEs in E-UTRAN or NG-RAN.

10.1.21 Select service for MO SMS messages +CGSMS

Table 129: +CGSMS parameter command syntax

Command	Possible Response(s)
+CGSMS=[<service>]	
+CGSMS?	+CGSMS: <service>
+CGSMS=?	+CGSMS: (list of currently available <service>s)

Description

The set command is used to specify the service or service preference that the MT will use to send MO SMS messages.

The read command returns the currently selected service or service preference.

The test command is used for requesting information on the currently available services and service preferences as a compound value.

Defined values

<service>: integer type; indicates the service or service preference to be used. The default value is manufacturer specific.

- 0 Packet Domain
- 1 circuit switched
- 2 Packet Domain preferred (use circuit switched if GPRS not available)
- 3 circuit switched preferred (use Packet Domain if circuit switched not available)

Implementation

Optional.

This command is not applicable to UEs in E-UTRAN or NG-RAN.

10.1.22 EPS network registration status +CEREG

Table 10.1.22-1: +CEREG parameter command syntax

Command	Possible response(s)
+CEREG=[<n>]	+CME ERROR: <err>
+CEREG?	<p>when <n>=0, 1, 2 or 3 and command successful: +CEREG: <n>, <stat>[, [<tac>], [<ci>], [<Act>] [, <cause_type> , <reject_cause>]]]</p> <p>when <n>=4 or 5 and command successful: +CEREG: <n>, <stat>[, [<tac>], [<ci>], [<Act>] [[, [<cause_type>], [<reject_cause>]] [, [<Active-Time>], [<Periodic-TAU>]]]]]</p>
+CEREG=?	+CEREG: (list of supported <n>s)

Description

The set command controls the presentation of an unsolicited result code +CEREG: <stat> when <n>=1 and there is a change in the MT's EPS network registration status in E-UTRAN, or unsolicited result code +CEREG: <stat>[, [<tac>], [<ci>], [<Act>]] when <n>=2 and there is a change of the network cell in E-UTRAN. The parameters <Act>, <tac> and <ci> are provided only if available. The value <n>=3 further extends the unsolicited result code with [, <cause_type> , <reject_cause>] , when available, when the value of <stat> changes.

If the UE wants to apply PSM for reducing its power consumption, see +CPSMS command and 3GPP TS 23.682 [149], the set command controls the presentation of an unsolicited result code +CEREG: <stat>[, [<tac>], [<ci>], [<Act>] [[, [<cause_type>], [<reject_cause>]] [, [<Active-Time>], [<Periodic-TAU>]]]] . When <n>=4 the unsolicited result code will provide the UE with additional information for the Active Time value and the extended periodic TAU value if there is a change of the network cell in E-UTRAN. The value <n>=5 further enhances the unsolicited result code with <cause_type> and <reject_cause> when the value of <stat> changes. The parameters <Act>, <tac>, <ci>, <cause_type>, <reject_cause>, <Active-Time> and <Periodic-TAU> are provided only if available.

Refer clause 9.2 for possible <err> values.

NOTE 1: If the EPS MT in GERAN/UTRAN/E-UTRAN also supports one or more of the circuit mode services, GPRS services or 5G services, the +CREG command and +CREG: result codes, the +CGREG command and +CGREG: result codes and the +C5GREG command and +C5GREG: result codes apply to the registration status and location information for those services.

The read command returns the status of result code presentation and an integer <stat> which shows whether the network has currently indicated the registration of the MT. Location information elements <tac>, <ci> and <AcT>, if available, are returned only when <n>=2 and MT is registered in the network. The parameters [, <cause_type> , <reject_cause>], if available, are returned when <n>=3.

Test command returns values supported as a compound value.

Defined values

<n>: integer type

- 0 disable network registration unsolicited result code
- 1 enable network registration unsolicited result code +CREG: <stat>
- 2 enable network registration and location information unsolicited result code +CREG: <stat>[, [<tac>], [<ci>], [<AcT>]]
- 3 enable network registration, location information and EMM cause value information unsolicited result code +CREG: <stat>[, [<tac>], [<ci>], [<AcT>] [, <cause_type> , <reject_cause>]]
- 4 For a UE that wants to apply PSM, enable network registration and location information unsolicited result code +CREG: <stat>[, [<tac>], [<ci>], [<AcT>] [, [<Active-Time>], [<Periodic-TAU>]]]
- 5 For a UE that wants to apply PSM, enable network registration, location information and EMM cause value information unsolicited result code +CREG: <stat>[, [<tac>], [<ci>], [<AcT>] [, [<cause_type>], [<reject_cause>] [, [<Active-Time>], [<Periodic-TAU>]]]

<stat>: integer type; indicates the EPS registration status.

- 0 not registered, MT is not currently searching an operator to register to
- 1 registered, home network
- 2 not registered, but MT is currently trying to attach or searching an operator to register to
- 3 registration denied
- 4 unknown (e.g. out of E-UTRAN coverage)
- 5 registered, roaming
- 6 registered for "SMS only", home network (not applicable)
- 7 registered for "SMS only", roaming (not applicable)
- 8 attached for emergency bearer services only (See NOTE 2)
- 9 registered for "CSFB not preferred", home network (not applicable)
- 10 registered for "CSFB not preferred", roaming (not applicable)

NOTE 2: 3GPP TS 24.008 [8] and 3GPP TS 24.301 [83] specify the condition when the MS is considered as attached for emergency bearer services.

<tac>: string type; two byte tracking area code in hexadecimal format (e.g. "00C3" equals 195 in decimal).

<ci>: string type; four byte E-UTRAN cell ID in hexadecimal format.

<AcT>: integer type; indicates the access technology of the serving cell.

- 0 GSM (not applicable)
- 1 GSM Compact (not applicable)
- 2 UTRAN (not applicable)
- 3 GSM w/EGPRS (see NOTE 3) (not applicable)
- 4 UTRAN w/HSDPA (see NOTE 4) (not applicable)
- 5 UTRAN w/HSUPA (see NOTE 4) (not applicable)
- 6 UTRAN w/HSDPA and HSUPA (see NOTE 4) (not applicable)
- 7 E-UTRAN
- 8 EC-GSM-IoT (A/Gb mode) (see NOTE 5) (not applicable)
- 9 E-UTRAN (NB-S1 mode) (see NOTE 6)
- 10 E-UTRA connected to a 5GCN (see NOTE 7) (not applicable)
- 11 NR connected to a 5G CN (see NOTE 7) (not applicable)
- 12 NG-RAN (not applicable)
- 13 E-UTRA-NR dual connectivity (see NOTE 8)

NOTE 3: 3GPP TS 44.018 [156] specifies the System Information messages which give the information about whether the serving cell supports EGPRS.

NOTE 4: 3GPP TS 25.331 [74] specifies the System Information blocks which give the information about whether the serving cell supports HSDPA or HSUPA.

NOTE 5: 3GPP TS 44.018 [156] specifies the EC-SCH INFORMATION message which, if present, indicates that the serving cell supports EC-GSM-IoT.

NOTE 6: 3GPP TS 36.331 [86] specifies the System Information blocks which give the information about whether the serving cell supports NB-IoT, which corresponds to E-UTRAN (NB-S1 mode).

NOTE 7: 3GPP TS 38.331 [160] specifies the information which, if present, indicates that the serving cell is connected to a 5GCN.

NOTE 8: 3GPP TS 38.331 [160] specifies the information which, if present, indicates that the serving cell is supporting dual connectivity of E-UTRA with NR and is connected to an EPS core.

<cause_type>: integer type; indicates the type of <reject_cause>.

- 0 Indicates that <reject_cause> contains an EMM cause value, see 3GPP TS 24.301 [83] Annex A.
- 1 Indicates that <reject_cause> contains a manufacturer-specific cause.

<reject_cause>: integer type; contains the cause of the failed registration. The value is of type as defined by <cause_type>.

<Active-Time>: string type; one byte in an 8 bit format. Indicates the Active Time value (T3324) allocated to the UE in E-UTRAN. The Active Time value is coded as one byte (octet 3) of the GPRS Timer 2 information element coded as bit format (e.g. "00100100" equals 4 minutes). For the coding and the value range, see the GPRS Timer 2 IE in 3GPP TS 24.008 [8] Table 10.5.163/3GPP TS 24.008. See also 3GPP TS 23.682 [149] and 3GPP TS 23.401 [82].

<Periodic-TAU>: string type; one byte in an 8 bit format. Indicates the extended periodic TAU value (T3412) allocated to the UE in E-UTRAN. The extended periodic TAU value is coded as one byte (octet 3) of the GPRS Timer 3 information element coded as bit format (e.g. "01000111" equals 70 hours). For the coding and the

If the MT indicates more than two IP addresses of P-CSCF servers or more than two IP addresses of DNS servers, multiple lines of information per <cid> will be returned.

If the MT has dual stack capabilities, at least one pair of lines with information is returned per <cid>. First one line with the IPv4 parameters followed by one line with the IPv6 parameters. If this MT with dual stack capabilities indicates more than two IP addresses of P-CSCF servers or more than two IP addresses of DNS servers, multiple of such pairs of lines are returned.

NOTE: If the MT doesn't have all the IP addresses to be included in a line, e.g. in case the UE received four IP addresses of DNS servers and two IP addresses of P-CSCF servers, the parameter value representing an IP address that can not be populated is set to an empty string or an absent string.

If the parameter <cid> is omitted, the relevant information for all active non secondary PDP contexts is returned.

The test command returns a list of <cid>s associated with active non secondary contexts.

Defined values

<cid>: integer type; specifies a particular non secondary PDP context definition. The parameter is local to the TE-MT interface and is used in other PDP context-related commands (see the +CGDCONT and +CGDSCONT commands).

<bearer_id>: integer type; identifies the bearer, i.e. the EPS bearer and the NSAPI.

<apn>: string type; a logical name that was used to select the GGSN or the external packet data network.

<local_addr and subnet_mask>: string type; shows the IP address and subnet mask of the MT. The string is given as dot-separated numeric (0-255) parameters on the form:

"a1.a2.a3.a4.m1.m2.m3.m4" for IPv4 or

"a1.a2.a3.a4.a5.a6.a7.a8.a9.a10.a11.a12.a13.a14.a15.a16.m1.m2.m3.m4.m5.m6.m7.m8.m9.m10.m11.m12.m13.m14.m15.m16" for IPv6.

When +CGPIAF is supported, its settings can influence the format of this parameter returned with the execute form of +CGCONTRDP.

<gw_addr>: string type; shows the Gateway Address of the MT. The string is given as dot-separated numeric (0-255) parameters.

When +CGPIAF is supported, its settings can influence the format of this parameter returned with the execute form of +CGCONTRDP.

<DNS_prim_addr>: string type; shows the IP address of the primary DNS server.

When +CGPIAF is supported, its settings can influence the format of this parameter returned with the execute form of +CGCONTRDP.

<DNS_sec_addr>: string type; shows the IP address of the secondary DNS server.

When +CGPIAF is supported, its settings can influence the format of this parameter returned with the execute form of +CGCONTRDP.

<P_CSCF_prim_addr>: string type; shows the IP address of the primary P-CSCF server.

When +CGPIAF is supported, its settings can influence the format of this parameter returned with the execute form of +CGCONTRDP.

<P_CSCF_sec_addr>: string type; shows the IP address of the secondary P-CSCF server.

When +CGPIAF is supported, its settings can influence the format of this parameter returned with the execute form of +CGCONTRDP.

<IM_CN_Signalling_Flag>: integer type; shows whether the PDP context is for IM CN subsystem-related signalling only or not.

- 0 PDP context is not for IM CN subsystem-related signalling only
- 1 PDP context is for IM CN subsystem-related signalling only

<LIPA_indication>: integer type; indicates that the PDP context provides connectivity using a LIPA PDN connection. This parameter cannot be set by the TE.

- 0 indication not received that the PDP context provides connectivity using a LIPA PDN connection
- 1 indication received that the PDP context provides connectivity using a LIPA PDN connection

<IPv4_MTU>: integer type; shows the IPv4 MTU size in octets.

<WLAN_Offload>: integer type; indicates whether traffic can be offloaded using the specified PDN connection via a WLAN or not. This refers to bits 1 and 2 of the WLAN offload acceptability IE as specified in 3GPP TS 24.008 [8] clause 10.5.6.20.

- 0 offloading the traffic of the PDN connection via a WLAN when in S1 mode or when in Iu mode is not acceptable.
- 1 offloading the traffic of the PDN connection via a WLAN when in S1 mode is acceptable, but not acceptable in Iu mode.
- 2 offloading the traffic of the PDN connection via a WLAN when in Iu mode is acceptable, but not acceptable in S1 mode.
- 3 offloading the traffic of the PDN connection via a WLAN when in S1 mode or when in Iu mode is acceptable.

<Local_Addr_Ind>: integer type; indicates whether or not the MS and the network support local IP address in TFTs (see 3GPP TS 24.301 [83] and 3GPP TS 24.008 [8] clause 10.5.6.3).

- 0 indicates that the MS or the network or both do not support local IP address in TFTs
- 1 indicates that the MS and the network support local IP address in TFTs

<Non-IP_MTU>: integer type; shows the Non-IP MTU size in octets.

<Serving_PLMN_rate_control_value>: integer type; indicates the maximum number of uplink messages the UE is allowed to send in a 6 minute interval. This refers to octet 3 to 4 of the Serving PLMN rate control IE as specified in 3GPP TS 24.301 [8] clause 9.9.4.28.

<Reliable_Data_Service>: integer type; indicates whether the UE is using Reliable Data Service for a PDN connection or not, see 3GPP TS 24.301 [83] and 3GPP TS 24.008 [8] clause 10.5.6.3.

- 0 Reliable Data Service is not being used for the PDN connection
- 1 Reliable Data Service is being used for the PDN connection

<PS_Data_Off_Support>: integer type; indicates whether the network supports PS data off or not, see 3GPP TS 24.301 [83] clause 6.3.10 and 3GPP TS 24.501 [161] clause 6.2.10.

- 0 indicates that the network does not support PS data off
- 1 indicates that the network supports PS data off

<PDU_session_id>: integer type; identifies the PDU session, see 3GPP TS 24.501 [161].

<QFI>: integer type; identifies the QoS flow, see 3GPP TS 24.501 [161].

<SSC_mode>: integer type; indicates the session and service continuity (SSC) mode for the PDU session in 5GS, see 3GPP TS 23.501 [165].

- 0 indicates that the PDU session is associated with SSC mode 1
- 1 indicates that the PDU session is associated with SSC mode 2

2 indicates that the PDU session is associated with SSC mode 3

<S-NSSAI>: string type in hexadecimal format. Dependent of the form, the string can be separated by dot(s) and semicolon(s). The S-NSSAI is associated with the PDU session for identifying a network slice in 5GS, see 3GPP TS 23.501 [165] and 3GPP TS 24.501 [161]. Refer parameter <S-NSSAI> in clause 10.1.1. This parameter shall not be subject to conventional character conversion as per +CSCS.

<Access_type>: integer type; indicates the access type over which the PDU session is established in 5GS, see 3GPP TS 23.501 [165] and 3GPP TS 24.501 [161].

0 indicates that the preferred access type is 3GPP access

1 indicates that the preferred access type is non-3GPP access

<RQ_timer>: integer type; indicates the timer for reflective QoS, see 3GPP TS 23.501 [165] and 3GPP TS 24.501 [161].

<Always-on_ind>: integer type; indicates whether the PDU session is an always-on PDU session, see 3GPP TS 24.501 [161].

0 indicates that the PDU session is not an always-on PDU session

1 indicates that the PDU session is an always-on PDU session

Implementation

Optional.

10.1.24 Secondary PDP context read dynamic parameters +CGSCONTRDP

Table 10.1.24-1: +CGSCONTRDP action command syntax

Command	Possible response(s)
+CGSCONTRDP[=<cid>]	[+CGSCONTRDP: <cid>,<p_cid>,<bearer_id>[,<IM_CN_Signalling_Flag>[,<WLAN_Offload>[,<PDU_session_id>,<QFI>]]]] [<CR><LF>+CGSCONTRDP: <cid>,<p_cid>,<bearer_id>[,<IM_CN_Signalling_Flag>[,<WLAN_Offload>[,<PDU_session_id>,<QFI>]]] [...]]
+CGSCONTRDP=?	+CGSCONTRDP: (list of <cid>s associated with active contexts)
NOTE:	The syntax of the AT Set Command is corrected to be according to ITU-T Recommendation V.250 [14]. Older versions of the specification specify incorrect syntax +CGSCONTRDP=[<cid>]

Description

The execution command returns <p_cid>,<bearer_id>,<IM_CN_Signalling_Flag>,<WLAN_Offload>,<PDU_session_id> and <QFI> for an active secondary PDP context or a QoS flow of non-default QoS rule with the context identifier <cid>.

If the parameter <cid> is omitted, the <cid>,<p_cid>,<bearer_id>,<IM_CN_Signalling_Flag>,<WLAN_Offload>,<PDU_session_id> and <QFI> are returned for all active secondary PDP contexts or all QoS flows of non-default QoS rule.

In EPS, the Traffic Flow parameters are returned.

NOTE: Parameters for UE initiated and network initiated PDP contexts are returned.

The test command returns a list of <cid>s associated with active secondary PDP contexts.

Defined values

<cid>: integer type; specifies a particular active secondary PDP context or Traffic Flows definition. The parameter is local to the TE-MT interface and is used in other PDP context-related commands (see the +CGDCONT and +CGDSCONT commands).

<p_cid>: integer type; specifies a particular PDP context definition or default EPS context Identifier which has been specified by use of the +CGDCONT command. The parameter is local to the TE-MT interface (see the +CGDSCONT command).

<bearer_id>: integer type; identifies the bearer, EPS Bearer and NSAPI.

<IM_CN_Signalling_Flag>: integer type; shows whether the PDP context is for IM CN subsystem-related signalling only or not.

0 PDP context is not for IM CN subsystem-related signalling only

1 PDP context is for IM CN subsystem-related signalling only

<WLAN_Offload>: integer type. An integer that indicates whether traffic can be offloaded using the specified PDN connection via a WLAN or not. This refers to bits 1 and 2 of the WLAN offload acceptability IE as specified in 3GPP TS 24.008 [8] clause 10.5.6.20.

0 offloading the traffic of the PDN connection via a WLAN when in S1 mode or when in Iu mode is not acceptable.

1 offloading the traffic of the PDN connection via a WLAN when in S1 mode is acceptable, but not acceptable in Iu mode.

2 offloading the traffic of the PDN connection via a WLAN when in Iu mode is acceptable, but not acceptable in S1 mode.

3 offloading the traffic of the PDN connection via a WLAN when in S1 mode or when in Iu mode is acceptable.

<PDU_session_id>: integer type; identifies the PDU session, see 3GPP TS 24.501 [161].

<QFI>: integer type; identifies the QoS flow, see 3GPP TS 24.501 [161].

Implementation

Optional.

10.1.25 Traffic flow template read dynamic parameters +CGTFTRDP**Table 10.1.25-1: +CGTFTRDP action command syntax**

Command	Possible Response(s)
+CGTFTRDP[=<cid>]	<pre>[+CGTFTRDP: <cid>,<packet filter identifier>,<evaluation precedence index>,<remote address and subnet mask>,<protocol number (ipv4) / next header (ipv6)>,<local port range>,<remote port range>,<ipsec security parameter index (spi)>,<type of service (tos) (ipv4) and mask / traffic class (ipv6) and mask>,<flow label (ipv6)>,<direction>,<NW packet filter Identifier>,<local address and subnet mask>,<QRI>] [<CR><LF>+CGTFTRDP: <cid>,<packet filter identifier>,<evaluation precedence index>,<remote address and subnet mask>,<protocol number (ipv4) / next header (ipv6)>,<local port range>,<remote port range>,<ipsec security parameter index (spi)>,<type of service (tos) (ipv4) and mask /</pre>

Command	Possible Response(s)
	traffic class (ipv6) and mask>,<flow label (ipv6)>,<direction>,<NW packet filter Identifier>,<local address and subnetmask>,<QRI> [...]]
+CGTFTRDP=?	+CGTFTRDP: (list of <cid>s associated with active contexts)
NOTE:	The syntax of the AT Set Command is corrected to be according to ITU-T Recommendation V.250 [14]. Older versions of the specification specify incorrect syntax +CGTFTRDP=[<cid>]

Description

The execution command returns the relevant information about Traffic Flow Template for an active secondary or non secondary PDP context specified by <cid> together with the additional network assigned values when established by the network. If the parameter <cid> is omitted, the Traffic Flow Templates for all active secondary and non secondary PDP contexts are returned.

Parameters of both network and MT/TA initiated PDP contexts will be returned.

The test command returns a list of <cid>s associated with active secondary and non secondary contexts.

Defined values

<cid>: integer type; Specifies a particular secondary or non secondary PDP context definition or Traffic Flows definition (see +CGDCONT and +CGDSCONT commands).

For the following parameters, see also 3GPP TS 23.060 [47], 3GPP TS 23.501 [165] and 3GPP TS 24.501 [161].

<packet filter identifier>: integer type. The value range is from 1 to 16.

<evaluation precedence index>: integer type. The value range is from 0 to 255.

<remote address and subnet mask>: string type. The string is given as dot-separated numeric (0-255) parameters on the form:
"a1.a2.a3.a4.m1.m2.m3.m4" for IPv4 or
"a1.a2.a3.a4.a5.a6.a7.a8.a9.a10.a11.a12.a13.a14.a15.a16.m1.m2.m3.m4.m5.m6.m7.m8.m9.m10.m11.m12.m13.m14.m15.m16" for IPv6.

When +CGPIAF is supported, its settings can influence the format of this parameter returned with the execute form of +CGTFTRDP.

<protocol number (ipv4) / next header (ipv6)>: integer type. The value range is from 0 to 255.

<local port range>: string type. The string is given as dot-separated numeric (0-65535) parameters on the form "f.t".

<remote port range>: string type. The string is given as dot-separated numeric (0-65535) parameters on the form "f.t".

<ipsec security parameter index (spi)>: numeric value in hexadecimal format. The value range is from 00000000 to FFFFFFFF.

<type of service (tos) (ipv4) and mask / traffic class (ipv6) and mask>: string type. The string is given as dot-separated numeric (0-255) parameters on the form "t.m".

<flow label (ipv6)>: numeric value in hexadecimal format. The value range is from 00000 to FFFFF. Valid for IPv6 only.

<direction> integer type. Specifies the transmission direction in which the Packet Filter shall be applied.

0 Pre Release 7 TFT Filter (see 3GPP TS 24.008 [8], table 10.5.162)

- 1 Uplink
- 2 Downlink
- 3 Bidirectional (Used for Uplink and Downlink)

<NW packet filter Identifier> integer type. The value range is from 1 to 16. In EPS the value is assigned by the network when established

<local address and subnet mask>: string type. The string is given as dot-separated numeric (0-255) parameters on the form:
 "a1.a2.a3.a4.m1.m2.m3.m4" for IPv4 or
 "a1.a2.a3.a4.a5.a6.a7.a8.a9.a10.a11.a12.a13.a14.a15.a16.m1.m2.m3.m4.m5.m6.m7.m8.m9.m10.m11.m12.m13.m14.m15.m16", for IPv6.

When +CGPIAF is supported, its settings can influence the format of this parameter returned with the read form of +CGTFTRDP.

<QRI>: integer type. Identifies the QoS rule, see 3GPP TS 23.501 [165] and 3GPP TS 24.501 [161].

NOTE: Some of the above listed attributes can coexist in a Packet Filter while others mutually exclude each other. The possible combinations are shown in 3GPP TS 23.060 [47], 3GPP TS 23.501 [165] and 3GPP TS 24.501 [161].

Implementation

Optional.

10.1.26 Define EPS quality of service +CGEQOS

Table 10.1.26-1: +CGEQOS parameter command syntax

Command	Possible Response(s)
+CGEQOS=[<cid>[, <QCI>[, <DL_GBR> , <UL_GBR>] [, <DL_MBR> , <UL_MBR>]]]	+CME ERROR: <err>
+CGEQOS?	[+CGEQOS: <cid> , <QCI> , [<DL_GBR> , <UL_GBR>] , [<DL_MBR> , <UL_MBR>]] [<CR><LF>+CGEQOS: <cid> , <QCI> , [<DL_GBR> , <UL_GBR>] , [<DL_MBR> , <UL_MBR>]] [...]
+CGEQOS=?	+CGEQOS: (range of supported <cid>s) , (list of supported <QCI>s) , (list of supported <DL_GBR>s) , (list of supported <UL_GBR>s) , (list of supported <DL_MBR>s) , (list of supported <UL_MBR>s)

Description

The set command allows the TE to specify the EPS Quality of Service parameters <cid>, <QCI>, [<DL_GBR> and <UL_GBR>] and [<DL_MBR> and <UL_MBR>] for a PDP context or Traffic Flows (see 3GPP TS 24.301 [83] and 3GPP TS 23.203 [85]). When in UMTS/GPRS the MT applies a mapping function to UMTS/GPRS Quality of Service. Refer clause 9.2 for possible <err> values.

A special form of the set command, +CGEQOS= <cid> causes the values for context number <cid> to become undefined.

The read command returns the current settings for each defined QoS.

The test command returns the ranges of the supported parameters as compound values.

Defined values

<cid>: integer type; specifies a particular EPS Traffic Flows definition and a PDP Context definition (see the +CGDCONT and +CGDSCONT commands).

<QCI>: integer type; specifies a class of EPS QoS (see 3GPP TS 23.203 [85] and 3GPP TS 24.301 [83]).

0	QCI is selected by network
[1 – 4]	value range for guaranteed bit rate Traffic Flows
75	value for guaranteed bit rate Traffic Flows
[82 – 85]	value range for guaranteed bit rate Traffic Flows
[5 – 9]	value range for non-guaranteed bit rate Traffic Flows
79	value for non-guaranteed bit rate Traffic Flows
[128 – 254]	value range for Operator-specific QCIs

The QCI values 65, 66, 67, 69 and 70 are not allowed to be requested by the UE. If the TE requests a QCI parameter 65, 66, 67, 69 or 70, the MT responds with result code +CME ERROR: 181 (unsupported QCI value).

<DL_GBR>: integer type; indicates DL GBR in case of GBR QCI. The value is in kbit/s. This parameter is omitted for a non-GBR QCI (see 3GPP TS 24.301 [83]).

<UL_GBR>: integer type; indicates UL GBR in case of GBR QCI. The value is in kbit/s. This parameter is omitted for a non-GBR QCI (see 3GPP TS 24.301 [83]).

<DL_MBR>: integer type; indicates DL MBR in case of GBR QCI. The value is in kbit/s. This parameter is omitted for a non-GBR QCI (see 3GPP TS 24.301 [83]).

<UL_MBR>: integer type; indicates UL MBR in case of GBR QCI. The value is in kbit/s. This parameter is omitted for a non-GBR QCI (see 3GPP TS 24.301 [83]).

Implementation

Optional.

10.1.27 EPS quality of service read dynamic parameters +CGEQOSRDP

Table 10.1.27-1: +CGEQOSRDP action command syntax

Command	Possible Response(s)
+CGEQOSRDP[=<cid>]	[+CGEQOSRDP: <cid>,<QCI>,[<DL_GBR>,<UL_GBR>] ,[<DL_MBR>,<UL_MBR>][,<DL_AMBR>,<UL_AMBR>]] [<CR><LF>+CGEQOSRDP: <cid>,<QCI>,[<DL_GBR>,<UL_GBR>] ,[<DL_MBR>,<UL_MBR>][,<DL_AMBR>,<UL_AMBR>]] [...]]
+CGEQOSRDP=?	+CGEQOSRDP: (list of <cid>s associated with active contexts)
NOTE:	The syntax of the AT Set Command is corrected to be according to ITU-T Recommendation V.250 [14]. Older versions of the specification specify incorrect syntax +CGEQOSRDP=[<cid>]

Description

The execution command returns the Quality of Service parameters <QCI>, [<DL_GBR> and <UL_GBR>] and [<DL_MBR> and <UL_MBR>] of the active secondary or non secondary PDP context associated to the provided context identifier <cid>.

If the parameter <cid> is omitted, the Quality of Service parameters for all secondary and non secondary active PDP contexts are returned.

The test command returns a list of <cid>s associated with secondary or non secondary active PDP contexts.

Parameters of both network and MT/TA initiated PDP contexts will be returned.

Defined values

<cid>: integer type; specifies a particular Traffic Flows definition and a PDP Context definition (see the +CGDCONT and +CGDSCONT commands).

<QCI>: integer type; specifies a class of EPS QoS (see 3GPP TS 23.203 [85] and 3GPP TS 24.301 [83]).

0	QCI is selected by network
[1 – 4]	value range for guaranteed bit rate Traffic Flows
65, 66, 67, 75	values for guaranteed bit rate Traffic Flows
[82 – 85]	value range for guaranteed bit rate Traffic Flows
[5 – 9]	value range for non-guaranteed bit rate Traffic Flows
69, 70, 79	values for non-guaranteed bit rate Traffic Flows
[128 – 254]	value range for Operator-specific QCIs

<DL_GBR>: integer type; indicates DL GBR in case of GBR QCI. The value is in kbit/s. This parameter is omitted for a non-GBR QCI (see 3GPP TS 24.301 [83]).

<UL_GBR>: integer type; indicates UL GBR in case of GBR QCI. The value is in kbit/s. This parameter is omitted for a non-GBR QCI (see 3GPP TS 24.301 [83]).

<DL_MBR>: integer type; indicates DL MBR in case of GBR QCI. The value is in kbit/s. This parameter is omitted for a non-GBR QCI (see 3GPP TS 24.301 [83]).

<UL_MBR>: integer type; indicates UL MBR in case of GBR QCI. The value is in kbit/s. This parameter is omitted for a non-GBR QCI (see 3GPP TS 24.301 [83]).

<DL_AMBR>: integer type; indicates DL APN aggregate MBR (see 3GPP TS 24.301 [83]). The value is in kbit/s.

<UL_AMBR>: integer type; indicates UL APN aggregate MBR (see 3GPP TS 24.301 [83]). The value is in kbit/s.

NOTE: If multiple lines in a response belong to the same PDN connection they contain the same <DL_AMBR> <UL_AMBR> values.

Implementation

Optional.

10.1.28 UE modes of operation for EPS +CEMODE

Table 10.1.28-1: +CEMODE parameter command syntax

Command	Possible Response(s)
+CEMODE=[<mode>]	+CME ERROR: <err>

+CEMODE?	+CEMODE: <mode>
+CEMODE=?	+CEMODE: (list of supported <mode>s)

Description

The set command is used to set the MT to operate according to the specified mode of operation for EPS, see 3GPP TS 24.301 [83]. If the requested mode of operation is not supported, an `ERROR` or `+CME ERROR` response is returned. Extended error responses are enabled by the `+CMEE` command. Refer clause 9.2 for possible `<err>` values.

The read command returns the mode of operation set by the TE, independent of the current serving cell capability and independent of the current serving cell Access Technology.

The test command is used for requesting information on the supported MT modes of operation as a compound value.

Defined values

`<mode>`: integer type; indicates the mode of operation. The default value is manufacturer specific.

- 0 PS mode 2 of operation
- 1 CS/PS mode 1 of operation
- 2 CS/PS mode 2 of operation
- 3 PS mode 1 of operation

NOTE: the definition for UE modes of operation can be found in 3GPP TS 24.301 [83]

Implementation

Optional.

10.1.29 Delete non-active PDP contexts +CGDEL

Table 10.1.29-1: +CGDEL action command syntax

Command	Possible Response(s)
+CGDEL[=<cid>]	[+CGDEL: <cid>[,<cid>[,...]]] <i>+CME ERROR: <err></i>
+CGDEL=?	

Description

The execution command `+CGDEL=<cid>` removes the indicated PDP context and removes all associated data related to the indicated PDP contexts that are not activated. The AT command will not delete or remove information for activated PDP contexts. The removed PDP context is listed by the `+CGDEL: <cid>` intermediate result code. If the initial PDP context is supported (see clause 10.1.0), `+CGDEL=0` will return `ERROR` and the context will not be removed.

If `<cid>` points to a primary PDP context, the PDP context will be deleted together with all linked secondary PDP contexts if none of the PDP contexts are activated.

If `<cid>` points to a secondary PDP context, the PDP context will be deleted if it is not activated.

A special form of the command can be given as `+CGDEL` (with the `=<cid>` omitted). In this form, all primary PDP contexts that are not activated or have any activated secondary PDP contexts will be removed and all secondary PDP contexts that are not activated will be removed. The associated data of all the deleted PDP contexts will be removed, and the removed PDP context are listed by the `+CGDEL: <cid>[,<cid>[,...]]` intermediate result code.

Activated PDP contexts will not cause this form of the command to return `ERROR` or `+CME ERROR`. Refer clause 9.2 for possible `<err>` values.

If the initial PDP context is supported (see clause 10.1.0), `+CGDEL` (with the `=<cid>` omitted) will not cause the initial PDP context to be removed or cause `+CGDEL` to return `ERROR`.

NOTE: `+CGDEL` will remove associated PDP context data that can be set by the AT commands `+CGDCONT`, `+CGDSCONT`, `+CGTFT`, `+CGQREQ`, `+CGQMIN`, `+CGEQREQ`, `+CGEQMIN`, `+CGEQOS`, `+CGAUTH` and `+C5GQOS`.

For an attempt to delete PDP context(s) which would violate these rules, a `+CME ERROR` response is returned. Refer clause 9.2 for possible `<err>` values.

Defined values

`<cid>`: integer type; specifies a particular PDP context definition (see the `+CGDCONT` and `+CGDSCONT` commands).

Implementation

Optional.

10.1.30 Signalling connection status +CSCON

Table 10.1.30-1: +CSCON parameter command syntax

Command	Possible response(s)
<code>+CSCON=[<n>]</code>	<code>+CME ERROR: <err></code>
<code>+CSCON?</code>	<code>+CSCON: <n>, <mode>[, <state>[, <access>]]</code> <code>[<CR><LF>+CSCON: <n>, <mode>[, <state>[, <access>[, <coreNetwork>]]]</code> <code>[...]</code> <code>+CME ERROR: <err></code>
<code>+CSCON=?</code>	<code>+CSCON: (list of supported <n>s)</code>

Description

The set command controls the presentation of an unsolicited result code `+CSCON`. If `<n>=1`, `+CSCON: <mode>` is sent from the MT when the connection mode of the MT is changed. If `<n>=2` and there is a state within the current mode, `+CSCON: <mode>[, <state>]` is sent from the MT when the connection mode or state information of the MT is changed. If `<n>=3`, `+CSCON: <mode>[, <state>[, <access>]]` is sent from the MT when the connection mode, state or access information of the MT is changed. If `<n>=4`, `+CSCON: <mode>[, <state>[, <access>[, <coreNetwork>]]]` is sent from the MT. If setting fails, an MT error, `+CME ERROR: <err>` is returned. Refer clause 9.2 for possible `<err>` values.

When the MT is in UTRAN, E-UTRAN or NG-RAN, the `<mode>` refers to idle when no PS signalling connection between UE and network is setup and to connected mode when a PS signalling connection between UE and network is setup. When the UE is in GERAN, the mode refers to idle when the MT is in either the IDLE state or the STANDBY state and to connected mode when the MT is in READY state.

The `<state>` indicates the state of the MT when the MT is in GERAN, UTRAN connected mode, E-UTRAN or NG-RAN.

The `<access>` indicates the current radio access type of the MT when the MT is in GERAN, UTRAN, E-UTRAN or NG-RAN.

The `<coreNetwork>` indicates the core network type the MT is connected to when the MT is in E-UTRAN or NG-RAN.

The read command returns the status of result code presentation and an integer <mode> which shows whether the MT is currently in idle mode or connected mode. State information <state> is returned only when <n>=2. Radio access type information <access> is returned only when <n>=3. Core network type information <coreNetwork> is returned only when <n>=4. For Multi-RAT Dual Connectivity (MR-DC) architecture (see 3GPP TS 37.340 [162]), information is presented for the master RAT followed by optionally, information for each of the secondary RATs on a separate line.

Test command returns supported values as a compound value.

Defined values

<n>: integer type

- 0 disable unsolicited result code
- 1 enable unsolicited result code +CSCON: <mode>
- 2 enable unsolicited result code +CSCON: <mode>[,<state>]
- 3 enable unsolicited result code +CSCON: <mode>[,<state>[,<access>]]
- 4 enable unsolicited result code +CSCON: <mode>[,<state>[,<access>[,<coreNetwork>]]]

<mode>: integer type; indicates the signalling connection status

- 0 idle
- 1 connected

<state>: integer type; indicates the CS or PS state while in GERAN and the RRC state information if the MT is in connected mode while in UTRAN, E-UTRAN and NG-RAN.

- 0 UTRAN URA_PCH state
- 1 UTRAN Cell_PCH state
- 2 UTRAN Cell_FACH state
- 3 UTRAN Cell_DCH state
- 4 GERAN CS connected state
- 5 GERAN PS connected state
- 6 GERAN CS and PS connected state
- 7 E-UTRAN connected state
- 8 NG-RAN connected state
- 9 NG-RAN inactive state (see 3GPP TS 38.331 [160]).

<access>: integer type; indicates the current radio access type.

- 0 Indicates usage of radio access of type GERAN, see 3GPP TS 45.001 [146].
- 1 Indicates usage of radio access of type UTRAN TDD, see 3GPP TS 25.212 [144].
- 2 Indicates usage of radio access of type UTRAN FDD, see 3GPP TS 25.212 [144].
- 3 Indicates usage of radio access of type E-UTRA TDD, see 3GPP TS 36.300 [145].
- 4 Indicates usage of radio access of type E-UTRA FDD, see 3GPP TS 36.300 [145].
- 5 Indicates usage of radio access of type NR, see 3GPP TS 38.300 [159].

<coreNetwork>: integer type; indicates the core network type the UE is connected to.

- 0 Indicates MT is connected to EPC, see 3GPP TS 23.401 [82].
- 1 Indicates MT is connected to 5GCN, see 3GPP TS 23.501 [165].

Implementation

Optional.

10.1.31 Define PDP context authentication parameters +CGAUTH

Table 10.1.31-1: +CGAUTH parameter command syntax

Command	Possible response(s)
+CGAUTH=<cid>[,<auth_prot>[,<userid>[,<password>]]]	+CME ERROR: <err>
+CGAUTH?	[+CGAUTH: <cid>,<auth_prot>,<userid>,<password>] [<CR><LF>+CGAUTH: <cid>,<auth_prot>,<userid>,<password>] [...]]
+CGAUTH=?	+CGAUTH: (range of supported <cid>s), (list of supported <auth_prot>s), (range of supported <userid>s), (range of supported <password>s)

Description

Set command allows the TE to specify authentication parameters for a PDP context identified by the (local) context identification parameter <cid> used during the PDP context activation and the PDP context modification procedures. Since the <cid> is the same parameter that is used in the +CGDCONT and +CGDSCONT commands, +CGAUTH is effectively as an extension to these commands. Refer clause 9.2 for possible <err> values.

A special form of the set command, +CGAUTH=<cid> causes the authentication parameters for context number <cid> to become undefined.

The read command returns the current settings for each defined context.

The test command returns values supported as compound values.

Defined values

<cid>: integer type. Specifies a particular PDP context definition (see the +CGDCONT and +CGDSCONT commands).

<auth_prot>: integer type. Authentication protocol used for this PDP context.

- 0 None. Used to indicate that no authentication protocol is used for this PDP context. Username and password are removed if previously specified.

1 PAP

2 CHAP

<userid>: String type. User name for access to the IP network.

<password>: String type. Password for access to the IP network.

Implementation

Optional.

10.1.32 Initial PDP context activation +CIPCA

Table 10.1.32-1: +CIPCA parameter command syntax

Command	Possible response(s)
+CIPCA=[<n>[, <AttachWithoutPDN>]]	
+CIPCA?	+CIPCA: <n>[, <AttachWithoutPDN>]
+CIPCA=?	+CIPCA: (list of supported <n>s) , (list of supported <AttachWithoutPDN>s)

Description

The set command controls whether an initial PDP context (see clause 10.1.0) shall be established automatically following an attach procedure when the UE is attached to GERAN or UTRAN RATs and whether the UE is attached to E-UTRAN with or without a PDN connection.

For 5GS, the command controls whether an initial PDU session shall be established automatically following initial registration.

For <n>≠0, deactivating the last (active) PDP context can lead to a (re)establishment of the initial PDP context. Changing setting of <n> from 0 to 1 will cause an immediate attempt to (re)establish the initial PDP context if no PDP context is active. Changing <n> from 0 to 2 will if not roaming cause an immediate attempt to (re)establish the initial PDP context if no other PDP context is active. The value of <n>=3 applies to E-UTRAN or NG-RAN RATs and does not change the setting of PDP context activation in GERAN or UTRAN RATs. Changing <n> will never cause a PDP context deactivation.

For <AttachWithoutPDN>=1, the EPS Attach is performed without a PDN connection.

NOTE: For this command, the term roaming corresponds to being registered to a VPLMN which is not equivalent to HPLMN or EHPLMN.

The read command returns the current setting of the command.

The test command returns values supported as a compound value.

Defined values

<n>: integer type. Activation of PDP context upon attach.

- 0 Do not activate
- 1 Always activate
- 2 Activate when not roaming
- 3 No change in current setting

<AttachWithoutPDN>: integer type. EPS Attach with or without PDN connection.

- 0 EPS Attach with PDN connection
- 1 EPS Attach without PDN connection

Implementation

Optional.

10.1.33 No more PS data +CNMPSD

Table 10.1.33-1: +CNMPSD action command syntax

Command	Possible Response(s)
+CNMPSD	
+CNMPSD=?	

Description

This command indicates that no application is expected to exchange data.

When in UTRAN, if further conditions defined in 3GPP TS 25.331 [74] are met, this can cause transmission of a SIGNALLING CONNECTION RELEASE INDICATION message with the cause "UE Requested PS Data session end".

When in E-UTRAN or E-UTRA connected to a 5GCN (see NOTE 2), if further conditions defined in 3GPP TS 36.331 [86] are met, this can cause transmission of a UEAssistanceInformation message with powerPrefIndication set to "lowPowerConsumption" to the network. For BL UEs or NB-IoT UEs, if further conditions defined in 3GPP TS 36.321 [158] and 3GPP TS 36.331 [86] are met, this can cause triggering of the Release Assistance Indication.

NOTE 1: See clause 10.1.38 for a command applicable to an MT using E-UTRAN, where the MT has a preference for a configuration that is not optimized for power saving.

NOTE 2: E-UTRA can be connected to EPC, 5GCN or both.

This command may be used in both normal and modem compatibility modes.

Implementation

Optional.

This command is not applicable to UEs camped on NR in this release of the specification.

10.1.34 UE's usage setting for EPS and 5GS +CEUS

Table 10.1.34-1: +CEUS parameter command syntax

Command	Possible Response(s)
+CEUS=[<setting>]	
+CEUS?	+CEUS: <setting>
+CEUS=?	+CEUS: (list of supported <setting>s)

Description

The set command is used to set the MT to operate according to the specified UE's usage setting for EPS (see 3GPP TS 24.301 [83]) and 5GS (see 3GPP TS 24.501 [161]). A UE that supports both S1 mode and N1 mode has a single UE's usage setting which applies to both EPS and 5GS.

The read command returns the usage setting set by the TE.

The test command is used for requesting information on the supported MT setting(s) as a compound value.

Defined values

<setting>: integer type; indicates the usage setting of the UE. The default value is manufacturer specific.

0 voice centric

- 1 data centric

NOTE: The definition for UE's usage setting can be found in 3GPP TS 24.301 [83].

Implementation

Optional.

10.1.35 UE's voice domain preference E-UTRAN +CEVDP

Table 10.1.35-1: +CEVDP parameter command syntax

Command	Possible Response(s)
+CEVDP=[<setting>]	
+CEVDP?	+CEVDP: <setting>
+CEVDP=?	+CEVDP: (list of supported <setting>s)

Description

The set command is used to set the MT to operate according to the specified voice domain preference for E-UTRAN.

The read command returns the setting, independent of the current serving cell capability and independent of the current serving cell's access technology.

Test command returns supported values as a compound value.

Defined values

<setting>: integer type; indicates the voice domain preference of the UE. The default value is manufacturer specific.

- 1 CS Voice only
- 2 CS Voice preferred, IMS PS Voice as secondary
- 3 IMS PS Voice preferred, CS Voice as secondary
- 4 IMS PS Voice only

NOTE: The definition for the UE's voice domain preference for E-UTRAN can be found in 3GPP TS 24.167 [102], clause 5.27.

Implementation

Optional.

10.1.36 UE's voice domain preference UTRAN +CVDP

Table 10.1.36-1: +CVDP parameter command syntax

Command	Possible Response(s)
+CVDP=[<setting>]	
+CVDP?	+CVDP: <setting>
+CVDP=?	+CVDP: (list of supported <setting>s)

Description

The set command is used to set the MT to operate according to the specified voice domain preference for UTRAN.

The read command returns the setting, independent of the current serving cell capability and independent of the current serving cell's access technology.

Test command returns supported values as a compound value.

Defined values

<setting>: integer type; indicates the voice domain preference of the UE. The default value is manufacturer specific.

- 1 CS Voice only
- 2 CS Voice preferred, IMS PS Voice as secondary
- 3 IMS PS Voice preferred, CS Voice as secondary

NOTE: The definition for the UE's voice domain preference for UTRAN can be found in 3GPP TS 24.167 [102], clause 5.30.

Implementation

Optional.

10.1.37 UE's mobility management IMS voice termination +CMMIVT

Table 10.1.QT3-1: +CMMIVT parameter command syntax

Command	Possible Response(s)
+CMMIVT=[<setting>]	
+CMMIVT?	+CMMIVT: <setting>
+CMMIVT=?	+CMMIVT: (list of supported <setting>s)

Description

The set command is used to set the MT to perform additional procedures as specified in 3GPP TS 24.008 [8] and 3GPP TS 24.301 [83] to support terminating access domain selection by the network.

The read command returns the setting, independent of the current serving cell capability and independent of the current serving cell's access technology.

Test command returns supported values as a compound value.

Defined values

<setting>: integer type; indicates the mobility management IMS voice termination preference of the UE. The default value is manufacturer specific.

- 1 Mobility Management for IMS Voice Termination disabled
- 2 Mobility Management for IMS Voice Termination enabled

NOTE: The definition of the UE's mobility management IMS voice termination values can be found in 3GPP TS 24.167 [102], clause 5.31.

Implementation

Optional.

This command is only applicable to UEs in GERAN, UTRAN and E-UTRAN.

10.1.38 Power preference indication for EPS and 5GS +CEPPI

Table 10.1.38-1: +CEPPI action command syntax

Command	Possible Response(s)
+CEPPI=<power preference>	
+CEPPI=?	+CEPPI: (list of supported <power preference>s)

Description

This command indicates whether the MT prefers a configuration primarily optimised for power saving or not.

When in E-UTRAN or E-UTRA connected to a 5GCN (see NOTE), if further conditions defined in 3GPP TS 36.331 [86] are met, this can cause transmission of a UEAssistanceInformation message with powerPrefIndication set to <power preference> to the network.

NOTE: E-UTRA can be connected to EPC, 5GCN or both.

Test command returns the values supported as a compound value.

Defined values

<power preference>: integer type; indicates the power consumption preference of the MT.

- 0 normal
- 1 low power consumption

Implementation

Optional.

This command is not applicable to UEs camped on NR in this release of the specification.

10.1.39 WLAN offload assistance data +CWLANOLAD

Table 10.1.39-1: +CWLANOLAD parameter command syntax

Command	Possible response(s)
+CWLANOLAD=[<n>]	+CME ERROR: <err>
+CWLANOLAD?	+CWLANOLAD: <n>[,<threshRSCP>Low,<threshRSCP>High[,<threshEcno>Low,<threshEcno>High[,<threshRSRQ>Low,<threshRSRQ>High[,<threshChUtil>Low,<threshChUtil>High[,<threshBackhRateDL>Low,<threshBackhRateDL>High[,<threshBackhRateUL>Low,<threshBackhRateUL>High[,<threshBeaconRSSI>Low,<threshBeaconRSSI>High[,<opi>[,<tSteering>[,<WLANIdentifierListLength>[,<ssid_1>,<bssid_1>,<hssid_1>][,<ssid_2>,<bssid_2>,<hssid_2>][,...]]]]]]]]]]]]]]

+CWLANOLAD=?	+CWLANOLAD: (list of supported <n>s), (list of supported <threshRSCPLow>s), (list of supported <threshRSCPHigh>s), (list of supported <threshEcnoLow>s), (list of supported <threshEcnoHigh>s), (list of supported <threshRSRPLow>s), (list of supported <threshRSRPHigh>s), (list of supported <threshRSRQLow>s), (list of supported <threshRSRQHigh>s), (list of supported <threshChUtilLow>s), (list of supported <threshChUtilHigh>s), (list of supported <threshBackhRateDLLow>s), (list of supported <threshBackhRateDLHigh>s), (list of supported <threshBackhRateULLow>s), (list of supported <threshBackhRateULHigh>s), (list of supported <threshBeaconRSSILow>s), (list of supported <threshBeaconRSSIHigh>s), (list of supported <tSteering>s), (list of supported <WLANIdentifierListLength>s)
--------------	---

Description

Set command enables or disables the WLAN offload assistance data reporting. If reporting is enabled by <n>=1, the MT returns the following unsolicited result code from MT to TE whenever the WLAN offload assistance data changes at the MT:

```
+CWLANOLADI: [,<threshRSCPLow>,<threshRSCPHigh>[,<threshEcnoLow>,<threshEcnoHigh>[,<threshRSRPLow>,<threshRSRPHigh>[,<threshRSRQLow>,<threshRSRQHigh>[,<threshChUtilLow>,<threshChUtilHigh>[,<threshBackhRateDLLow>,<threshBackhRateDLHigh>[,<threshBackhRateULLow>,<threshBackhRateULHigh>[,<threshBeaconRSSILow>,<threshBeaconRSSIHigh>[,<opi>[,<tSteering>[,<WLANIdentifierListLength>[,<ssid_1>,<bssid_1>,<hessid_1>][,<ssid_2>,<bssid_2>,<hessid_2>][, ... ]]]]]]]]]]]]]]]]]]]]
```

Refer IE *WLAN-OffloadConfig* in 3GPP TS 36.331 [86] clause 6.3.6.

If a setting is not supported by the MT, +CME ERROR: <err> is returned. Refer clause 9.2 for possible <err> values.

Read command returns the current status of <n> and the WLAN offload assistance data currently available at the MT.

Test command returns the values supported by MT as compound values.

Defined values

<n>: integer type

0 disable WLAN offload assistance data unsolicited result code

1 enable WLAN offload assistance data unsolicited result code +CWLANOLADI

<threshRSCPLow>: integer type; indicates the threshold for received signal code power for offloading traffic from UTRAN to WLAN. Refer parameter <rscp> in clause 8.69.

<threshRSCPHigh>: integer type; indicates the threshold for received signal code power for offloading traffic from WLAN to UTRAN. Refer parameter <rscp> in clause 8.69.

<threshEcnoLow>: integer type; indicates the threshold for ratio of the received energy per PN chip to the total received power spectral density for offloading traffic from UTRAN to WLAN. Refer parameter <ecno> in clause 8.69.

<threshEcnoHigh>: integer type; indicates the threshold for ratio of the received energy per PN chip to the total received power spectral density for offloading traffic from WLAN to UTRAN. Refer parameter <ecno> in clause 8.69.

- <threshRSRPLow>: integer type; indicates the threshold for reference signal received power for offloading traffic from E-UTRAN to WLAN. Refer parameter <rsrp> in clause 8.69.
- <threshRSRPHigh>: integer type; indicates the threshold for reference signal received power for offloading traffic from WLAN to E-UTRAN. Refer parameter <rsrp> in clause 8.69.
- <threshRSRQLow>: integer type; indicates the threshold for reference signal received quality for offloading traffic from E-UTRAN to WLAN. Refer parameter <rsrq> in clause 8.69.
- <threshRSRQHigh>: integer type; indicates the threshold for reference signal received quality for offloading traffic from WLAN to E-UTRAN. Refer parameter <rsrq> in clause 8.69.
- <threshChUtilLow>: integer type; indicates the low threshold value of WLAN channel utilization (BSS load).obtained from 802.11 (Beacon or Probe Response) signalling, see IEEE 802.11 [152].
- <threshChUtilHigh>: integer type; indicates the high threshold value of WLAN channel utilization (BSS load) obtained from 802.11 (Beacon or Probe Response) signalling, see IEEE 802.11 [152].
- <threshBackhRateDLLow>: integer type; indicates the low threshold value of backhaul available downlink bandwidth for traffic offloading to UTRAN or E-UTRAN, see Hotspot 2.0 (Release 2) Technical Specification [151].
- <threshBackhRateDLHigh>: integer type; indicates the high threshold value of backhaul available downlink bandwidth for traffic offloading to WLAN, see Hotspot 2.0 (Release 2) Technical Specification [151].
- <threshBackhRateULLow>: integer type; indicates the low threshold value of backhaul available uplink bandwidth for traffic offloading to UTRAN or E-UTRAN, see Hotspot 2.0 (Release 2) Technical Specification [151].
- <threshBackhRateDLHigh>: integer type; indicates the high threshold value of backhaul available uplink bandwidth for traffic offloading to WLAN. Refer to Hotspot 2.0 (Release 2) Technical Specification [151].
- <threshBeaconRSSILow>: integer type; indicates the low threshold value of beacon RSSI used for traffic offloading to UTRAN or E-UTRAN see IEEE 802.11 [152].
- <threshBeaconRSSIHigh>: integer type; indicates the high threshold value of beacon RSSI used for traffic offloading to WLAN, see IEEE 802.11 [152].
- <opi>: integer type; A 16-bit integer formatted as a bitmap that specifies the Offload Preference Indicator, see 3GPP TS 24.312 [153]
- <tSteering>: integer type; indicates the timer value in seconds during which the rules should be fulfilled before starting traffic offloading between E-UTRAN and WLAN.
- <WLANIdentifierListLength>: integer type; indicates the number of entries in WLAN identifier list which is a tuple consisting of the <ssid>, the <bssid> and the <hessid> identifiers. If an identifier is not present for a tuple, it will be indicated as an empty string.
- <ssid>: string type; indicates the 802.11 Service Set Identifier (SSID), see IEEE 802.11 [152].
- <bssid>: string type; indicates the 802.11 Basic Service Set Identifier (BSSID), see IEEE 802.11 [152].
- <hessid>: string type; indicates the 802.11 Homogenous Extended Service Set Identifier (HESSID), see IEEE 802.11 [152].

Implementation

Optional.

10.1.40 WLAN offload cell measurement +CWLANOLCM

Table 10.1.40-1: +CWLANOLCM parameter command syntax

Command	Possible response(s)
+CWLANOLCM=[<n>]	+CME ERROR: <err>
+CWLANOLCM?	+CWLANOLCM: <n>, <rscp>, <ecno>, <rsrp>, <rsrq>
+CWLANOLCM=?	+CWLANOLCM: (list of supported <n>s), (list of supported <rscp>s), (list of supported <ecno>s), (list of supported <rsrp>s), (list of supported <rsrq>s)

Description

Set command enables or disables the indication for WLAN offloading based on the thresholds for cell measurement parameters. If reporting is enabled by <n>=1, the MT returns the following unsolicited result code from MT to TE whenever the cell measurement parameters meet the criteria for WLAN offloading based on configured thresholds:

+CWLANOLCMI: <rscp>, <ecno>, <rsrp>, <rsrq>

If a setting is not supported by the MT, +CME ERROR: <err> is returned. Refer clause 9.2 for possible <err> values.

Read command returns the current status of result code presentation and the measurements from the current primary serving cell at the MT.

Test command returns the values supported by MT as compound values.

Defined values

<n>: integer type

0 disable WLAN offload cell measurement unsolicited result code

1 enable WLAN offload cell measurement unsolicited result code +CWLANOLCMI

<rscp>: integer type; indicates the received signal code power. Refer parameter <rscp> in clause 8.69.

<ecno>: integer type; indicates the ratio of the received energy per PN chip to the total received power spectral density. Refer parameter <ecno> in clause 8.69.

<rsrp>: integer type; indicates the reference signal received power. Refer parameter <rsrp> in clause 8.69.

<rsrq>: integer type; indicates the reference signal received quality. Refer parameter <rsrq> in clause 8.69.

Implementation

Optional.

10.1.41 APN back-off timer status reporting +CABTSR

Table 10.1.41-1: +CABTSR parameter command syntax

Command	Possible response(s)
+CABTSR=[<n>]	+CME ERROR: <err>
+CABTSR?	+CABTSR: <n>
+CABTSR=?	+CABTSR: (list of supported <n>s)

Description

Set command controls the presentation of unsolicited result code

+CABTSRI: <apn>, <event_type>[, <residual_backoff_time>, <re-attempt_rat_indicator>, <re-attempt_eplmn_indicator>, <NSLPI>[, <procedure>]] reporting the APN back-off timer parameter values from MT to TE if the back-off timer is started, stopped, deactivated or expires. Refer clause 9.2 for possible <err> values.

Read command returns the current APN back-off timer unsolicited result code settings in the MT.

Test command returns values supported as a compound value.

Defined values

<n>: integer type.

- 0 Disable presentation of the unsolicited result code +CABTSRI.
- 1 Enable presentation of the unsolicited result code +CABTSRI.

<apn>: string type. A logical name that was used to select the GGSN or the external packet data network.

<event_type>: integer type. Indicates the event happened to the back-off timer.

- 0 The back-off timer is started.
- 1 The back-off timer is stopped.
- 2 The back-off timer is expired.
- 3 The back-off timer is deactivated.

<residual_backoff_time>: integer type. Indicates the remaining back-off time associated with the <apn> in seconds. When the back-off timer is deactivated, the parameter <residual_backoff_time> is omitted.

<re-attempt_rat_indicator>: integer type. Indicates whether the UE is allowed to re-attempt the corresponding session management procedure for the same APN after inter-system change.

- 0 Re-attempt the session management procedure after inter-system change is allowed.
- 1 Re-attempt the session management procedure after inter-system change is not allowed.

<re-attempt_eplmn_indicator>: integer type. Indicates whether the UE is allowed to re-attempt the corresponding session management procedure for the same APN in an equivalent PLMN.

- 0 Re-attempt the session management procedure in an equivalent PLMN is allowed.
- 1 Re-attempt the session management procedure in an equivalent PLMN is not allowed.

<NSLPI>: integer type. Indicates the NAS signalling priority requested for this PDN connection.

- 0 Indicates that this PDN connection was activated with the value for NAS signalling low priority indicator set to "MS is configured for NAS signalling low priority".
- 1 Indicates that this PDN connection was activated with the value for NAS signalling low priority indicator set to "MS is not configured for NAS signalling low priority".

<procedure>: integer type. Indicates the procedure(s) for which the back-off timer applies. When <procedure>=0 the information returned is associated with timer T3396. For all other values of <procedure> the information returned is associated with the back-off timer as specified in 3GPP TS 24.008 [8], 3GPP TS 24.301 [83] or 3GPP TS 24.501 [161] for the various session management procedures. When the parameter <procedure> is omitted, the back-off timer is deactivated.

- 0 All procedures.
- 1 PDN connectivity procedure as specified in 3GPP TS 24.301 [83], clause 6.5.1.
- 2 Bearer resource allocation procedure as specified in 3GPP TS 24.301 [83], clause 6.5.3.

- 3 Bearer modification procedure as specified in 3GPP TS 24.301 [83], clause 6.5.4.
- 4 PDP context activation procedure as specified in 3GPP TS 24.008 [8], clause 6.1.3.1.
- 5 Secondary PDP context activation procedure as specified in 3GPP TS 24.008 [8], clause 6.1.3.2.
- 6 PDP context modification procedure as specified in 3GPP TS 24.008 [8], clause 6.1.3.3.
- 7 PDU session establishment procedure (see 3GPP TS 24.501 [161], clause 6.4.1) and PDU session modification procedure (see 3GPP TS 24.501 [161], clause 6.4.2).

Implementation

Optional.

10.1.42 APN back-off timer read dynamic parameters +CABTRDP

Table 10.1.42-1: +CABTRDP action command syntax

Command	Possible response(s)
+CABTRDP [=<apn>]	[+CABTRDP: <apn>[, <residual_backoff_time>][, <re-attempt_rat_indicator>[, <re-attempt_eplmn_indicator>[, <NSLPI>[, <procedure>]]]]] [<CR><LF>+CABTRDP :<apn>[, <residual_backoff_time>][, <re-attempt_rat_indicator>[, <re-attempt_eplmn_indicator>[, <NSLPI>[, <procedure>]]]]] [...]]
+CABTRDP=?	

Description

The execution command returns the relevant information in the MT for the APN back-off timer parameter values <residual_backoff_time>, <re-attempt_rat_indicator>, <re-attempt_eplmn_indicator>, <NSLPI> and <procedure> for an <apn> if the back-off timer is running.

If the parameter <apn> is omitted, the relevant information for all APNs associated with running session management back-off timers is returned.

Defined values

<apn>: string type. A logical name that was used to select the GGSN or the external packet data network. When <apn> indicates an empty string (""), the following parameters are associated with no APN as specified in 3GPP TS 24.301 [83].

<residual_backoff_time>: integer type. Indicates the remaining back-off time associated with the <apn> in seconds. When the parameter <residual_backoff_time> is omitted, the back-off timer is deactivated.

<re-attempt_rat_indicator>: integer type. Indicates whether the UE is allowed to re-attempt the corresponding session management procedure for the same APN after inter-system change.

0 Re-attempt the session management procedure after inter-system change is allowed.

1 Re-attempt the session management procedure after inter-system change is not allowed.

<re-attempt_eplmn_indicator>: integer type. Indicates whether the UE is allowed to re-attempt the corresponding session management procedure for the same APN in an equivalent PLMN.

0 Re-attempt the session management procedure in an equivalent PLMN is allowed.

1 Re-attempt the session management procedure in an equivalent PLMN is not allowed.

<NSLPI>: integer type. Indicates the NAS signalling priority requested for this PDN connection.

- 0 Indicates that this PDN connection was activated with the value for NAS signalling low priority indicator set to "MS is configured for NAS signalling low priority".
- 1 Indicates that this PDN connection was activated with the value for NAS signalling low priority indicator set to "MS is not configured for NAS signalling low priority".

<procedure>: integer type. Indicates the procedure(s) for which the back-off timer applies. When <procedure>=0 the information returned is associated with timer T3396. For all other values of <procedure> the information returned is associated with the back-off timer as specified in 3GPP TS 24.008 [8], 3GPP TS 24.301 [83] or 3GPP TS 24.501 [161] for the various session management procedures.

- 0 All procedures.
- 1 PDN connectivity procedure as specified in 3GPP TS 24.301 [83], clause 6.5.1.
- 2 Bearer resource allocation procedure as specified in 3GPP TS 24.301 [83], clause 6.5.3.
- 3 Bearer modification procedure as specified in 3GPP TS 24.301 [83], clause 6.5.4.
- 4 PDP context activation procedure as specified in 3GPP TS 24.008 [8], clause 6.1.3.1.
- 5 Secondary PDP context activation procedure as specified in 3GPP TS 24.008 [8], clause 6.1.3.2.
- 6 PDP context modification procedure as specified in 3GPP TS 24.008 [8], clause 6.1.3.3.
- 7 PDU session establishment procedure (see 3GPP TS 24.501 [161], clause 6.4.1) and PDU session modification procedure (see 3GPP TS 24.501 [161], clause 6.4.2).

Implementation

Optional.

10.1.43 Sending of originating data via the control plane +CSODCP

Table 10.1.43-1: +CSODCP action command syntax

Command	Possible Response(s)
+CSODCP=<cid>,<cpdata_length>,<cpdata>[,<RAI>[,<type_of_user_data>[,<sourcePort>[,<destinationPort>[,<ackRequest>]]]]]	+CME ERROR: <err>
+CSODCP=?	+CSODCP: (range of supported <cid>s) ,(maximum number of octets of user data indicated by <cpdata_length>),(list of supported <RAI>s) ,(list of supported <type_of_user_data>s) ,(list of supported <sourcePort>s) ,(list of supported <destinationPort>s) ,(list of supported <ackRequest>s)

Description

The set command is used by the TE to transmit data over control plane to network via MT. Context identifier <cid> is used to link the data to particular context.

This command optionally indicates that the application on the MT expects that the exchange of data:

- will be completed with this uplink data transfer; or
- will be completed with the next received downlink data.

This command also optionally indicates whether or not the data to be transmitted is an exception data.

If the UE is using Reliable Data Service to transmit data, then this command optionally also indicates the source port number used by the originator, the destination port number to be used by the receiver and whether the originator is soliciting an acknowledgement from the receiver as defined in 3GPP TS 24.250 [168].

This command causes transmission of an ESM DATA TRANSPORT message, as defined in 3GPP TS 24.301 [83].

Refer clause 9.2 for possible <err> values.

Test command returns range of supported <cid>s, the maximum number of bytes of user data indicated by <cpdata_length>, supported <RAI>s, supported <type_of_user_data>s, supported <sourcePort>s, supported <destinationPort>s and supported <ackRequest>s as compound values.

Defined values

<cid>: integer type. A numeric parameter which specifies a particular PDP context or EPS bearer context definition. The <cid> parameter is local to the TE-MT interface and identifies the PDP or EPS bearer contexts which have been setup via AT command (see the +CGDCONT and +CGDSCONT commands).

<cpdata_length>: integer type. Indicates the number of octets of the <cpdata> information element. When there is no data to transmit, the value shall be set to zero.

<cpdata>: string of octets. Contains the user data container contents (refer 3GPP TS 24.301 [83] clause 9.9.4.24). When there is no data to transmit, the <cpdata> shall be an empty string (""). This parameter shall not be subject to conventional character conversion as per +CSCS. The coding format of the user data container and the maximum length of <cpdata> are implementation specific.

<RAI>: integer type. Indicates the value of the release assistance indication, refer 3GPP TS 24.301 [83] clause 9.9.4.25.

0 No information available.

1 The MT expects that exchange of data will be completed with the transmission of the ESM DATA TRANSPORT message.

2 The MT expects that exchange of data will be completed with the receipt of an ESM DATA TRANSPORT message.

<type_of_user_data>: integer type. Indicates whether the user data that is transmitted is regular or exceptional.

0 Regular data.

1 Exception data.

<sourcePort>: integer type. Indicates the source port number on the originator entity (refer 3GPP TS 24.250 [168] clause 5.2.4).

<destinationPort>: integer type. Indicates the destination port number on the receiver entity (refer 3GPP TS 24.250 [168] clause 5.2.5).

<ackRequest>: integer type. Indicates whether the originator entity is soliciting an acknowledgement from the receiver entity (refer 3GPP TS 24.250 [168] clause 5.3.1).

0 No acknowledgement is requested

1 Acknowledgement is requested.

Implementation

Optional.

10.1.44 Reporting of terminating data via the control plane +CRTDCP

Table 10.1.44-1: +CRTDCP parameter command syntax

Command	Possible response(s)
+CRTDCP=[<reporting>]	+CME ERROR: <err>
+CRTDCP?	+CRTDCP: <reporting>
+CRTDCP=?	+CRTDCP: (list of supported <reporting>s) , (range of supported <cid>s) , (maximum number of octets of user data indicated by <cpdata_length>) , (list of supported <sourcePort>s) , (list of supported <destinationPort>s)

Description

The set command is used to enable and disable reporting of data from the network to the MT that is transmitted via the control plane in downlink direction. If <reporting>=1, the MT returns the unsolicited result code +CRTDCP: <cid>, <cpdata_length>, <cpdata> when data is received from the network. If <reporting>=2, the MT returns the unsolicited result code +CRTDCP: <cid>, <cpdata_length>, <cpdata>, <sourcePort>, <destinationPort> when data is received from the network using the Reliable Data Service as defined in 3GPP TS 24.250 [168]. Refer clause 9.2 for possible <err> values.

Read command returns the current settings.

Test command returns supported values as compound values.

Defined values

<reporting>: integer type, controlling reporting of mobile terminated control plane data events

- 0 Disable reporting of MT control plane data.
- 1 Enable reporting of MT control plane data by the unsolicited result code +CRTDCP: <cid>, <cpdata_length>, <cpdata>.
- 2 Enable reporting of MT control plane data by the unsolicited result code +CRTDCP: <cid>, <cpdata_length>, <cpdata>, <sourcePort>, <destinationPort>.

<cid>: integer type. A numeric parameter which specifies a particular PDP context or EPS bearer context definition. The <cid> parameter is local to the TE-MT interface and identifies the PDP or EPS bearer contexts which have been setup via AT command (see the +CGDCONT and +CGDSCONT commands).

<cpdata_length>: integer type. Indicates the number of octets of the <cpdata> information element. When there is no data to transmit, the value shall be set to zero.

<cpdata>: string of octets. Contains the user data container contents (refer 3GPP TS 24.301 [83] clause 9.9.4.24). When there is no data to transmit, the <cpdata> shall be an empty string (""). This parameter shall not be subject to conventional character conversion as per +CSCS. The coding format of the user data container and the maximum length of <cpdata> are implementation specific.

<sourcePort>: integer type. Indicates the source port number on the originator entity (refer 3GPP TS 24.250 [168] clause 5.2.4).

<destinationPort>: integer type. Indicates the destination port number on the receiver entity (refer 3GPP TS 24.250 [168] clause 5.2.5).

Implementation

Optional.

10.1.45 APN rate control +CGAPNRC

Table 10.1.45-1: +CGAPNRC action command syntax

Command	Possible Response(s)
+CGAPNRC[=<cid>]	<pre>[+CGAPNRC: <cid>[,<Additional_exception_reports>[,<Uplink_time_unit>[,<Maximum_uplink_rate>]]] [<CR><LF>+CGAPNRC: <cid>[,<Additional_exception_reports>[,<Uplink_time_unit>[,<Maximum_uplink_rate>]]] [...]]]</pre>
+CGAPNRC=?	+CGAPNRC: (list of <cid>s associated with active contexts)

Description

This execution command returns the APN rate control parameters (see 3GPP TS 24.008 [8]) associated to the provided context identifier <cid>.

If the parameter <cid> is omitted, the APN rate control parameters for all active PDP contexts are returned.

The test command returns a list of <cid>s associated with secondary and non secondary active PDP contexts.

Defined values

<cid>: integer type; specifies a particular PDP context definition (see the +CGDCONT and +CGDSCONT commands).

<Additional_exception_reports>: integer type; indicates whether or not additional exception reports are allowed to be sent when the maximum uplink rate is reached. This refers to bit 4 of octet 1 of the APN rate control parameters IE as specified in 3GPP TS 24.008 [8] clause 10.5.6.3.2.

0 Additional_exception_reports at maximum rate reached are not allowed to be sent.

1 Additional_exception_reports at maximum rate reached are allowed to be sent.

<Uplink_time_unit>: integer type; specifies the time unit to be used for the maximum uplink rate. This refers to bits 1 to 3 of octet 1 of the APN rate control parameters IE as specified in 3GPP TS 24.008 [8] clause 10.5.6.3.2.

0 unrestricted

1 minute

2 hour

3 day

4 week

<Maximum_uplink_rate>: integer type; specifies the maximum number of messages the UE is restricted to send per uplink time unit. This refers to octet 2 to 4 of the APN rate control parameters IE as specified in 3GPP TS 24.008 [8] clause 10.5.6.3.2.

Implementation

Optional.

10.1.46 PS data off status +CPSDO

Table 10.1.46-1: +CPSDO parameter command syntax

Command	Possible response(s)
+CPSDO=[<PS_Data_Off_Status >]	+CME ERROR: <err>
+CPSDO?	+CPSDO: <PS_Data_Off_Status>
+CPSDO=?	+CPSDO: (list of supported <PS_Data_Off_Status>s)

Description

The set command enables the UE to specify the PS data off UE status to the network during attach, UE-requested PDN connectivity, and UE-requested bearer modification procedure (see 3GPP TS 24.301 [83], clause 6.3.10 and clauses 5.5.1, 6.5.1, and 6.5.4). The PS data off UE status may be activated or deactivated.

Refer clause 9.2 for possible <err> values.

The read command returns the current settings for PS data off UE status.

The test command returns values supported as a compound value.

Defined values

<PS_Data_Off_Status>: integer type; indicates the PS data off UE status, see 3GPP TS 24.301 [83], clause 6.3.10.

0 indicates to the network that PS data off UE status is deactivated

1 indicates to the network that PS data off UE status is activated

Implementation

Optional.

10.1.47 5GS network registration status +C5GREG

Table 10.1.47-1: +C5GREG parameter command syntax

Command	Possible response(s)
+C5GREG=[<n>]	+CME ERROR: <err>
+C5GREG?	when <n>=0, 1, 2 or 3 and command successful: +C5GREG: <n>, <stat>[, [<tac>], [<ci>], [<AcT>] [, [<Allowed_NSSAI_length>], [<Allowed_NSSAI>] [, <cause_type> , <reject_cause>]]
+C5GREG=?	+C5GREG: (list of supported <n>s)

Description

The set command controls the presentation of an unsolicited result code +C5GREG: <stat> when <n>=1 and there is a change in the MT's network registration status in 5GS, or unsolicited result code +C5GREG: <stat>[, [<tac>], [<ci>], [<AcT>], [<Allowed_NSSAI_length>], [<Allowed_NSSAI>]] when <n>=2 and there is a change of the network cell in 5GS or the network provided an Allowed NSSAI. The parameters <AcT>, <tac>, <ci>, <Allowed_NSSAI_length> and <Allowed_NSSAI> are provided only if available. The value <n>=3 further extends the unsolicited result code with [, <cause_type> , <reject_cause>], when available, when the value of <stat> changes.

Refer clause 9.2 for possible <err> values.

NOTE 1: If the 5G MT in GERAN/UTRAN/E-UTRAN also supports one or more of the circuit mode services, GPRS services or EPS services, the +CREG command and +CREG: result codes, the +CGREG command and +CGREG: result codes and the +CEREG command and +CEREG: result codes apply to the registration status and location information for those services.

The read command returns the status of result code presentation and an integer <stat> which shows whether the network has currently indicated the registration of the MT. Location information elements <tac>, <ci> and <AcT>, and parameters <Allowed_NSSAI_length>, <Allowed_NSSAI>, if available, are returned only when <n>=2 and MT is registered in the network. The parameters [, <cause_type>, <reject_cause>], if available, are returned when <n>=3.

Test command returns values supported as a compound value.

Defined values

<n>: integer type

- 0 disable network registration unsolicited result code
- 1 enable network registration unsolicited result code +C5GREG: <stat>
- 2 enable network registration and location information unsolicited result code
+C5GREG: <stat>[, [<tac>], [<ci>], [<AcT>], [<Allowed_NSSAI_length>], [<Allowed_NSSAI>]]
- 3 enable network registration, location information and 5GMM cause value information unsolicited result code
+C5GREG: <stat>[, [<tac>], [<ci>], [<AcT>], [<Allowed_NSSAI_length>], [<Allowed_NSSAI>] [, <cause_type>, <reject_cause>]]

<stat>: integer type; indicates the NR registration status.

- 0 not registered, MT is not currently searching an operator to register to
- 1 registered, home network
- 2 not registered, but MT is currently trying to attach or searching an operator to register to
- 3 registration denied
- 4 unknown (e.g. out of NR coverage)
- 5 registered, roaming
- 6 registered for "SMS only", home network (not applicable)
- 7 registered for "SMS only", roaming (not applicable)
- 8 registered for emergency services only (See NOTE 2)
- 9 registered for "CSFB not preferred", home network (not applicable)
- 10 registered for "CSFB not preferred", roaming (not applicable)

NOTE 2: 3GPP TS 24.501 [161] specify the condition when the MS is considered as registered for emergency services.

<tac>: string type; three byte tracking area code in hexadecimal format (e.g. "0000C3" equals 195 in decimal).

<ci>: string type; five byte NR cell ID in hexadecimal format.

<Allowed_NSSAI_length>: integer type; indicates the number of octets of the <Allowed_NSSAI> information element.

<Allowed_NSSAI>: string type in hexadecimal format. Dependent of the form, the string can be separated by dot(s), semicolon(s) and colon(s). This parameter indicates the list of allowed S-NSSAIs received from the network. The <Allowed_NSSAI> is coded as a list of <S-NSSAI>s separated by colons. Refer parameter <S-

NSSAI> in clause 10.1.1. This parameter shall not be subject to conventional character conversion as per +CSCS.

<AcT>: integer type; indicates the access technology of the serving cell.

- 0 GSM (not applicable)
- 1 GSM Compact (not applicable)
- 2 UTRAN (not applicable)
- 3 GSM w/EGPRS (see NOTE 3) (not applicable)
- 4 UTRAN w/HSDPA (see NOTE 4) (not applicable)
- 5 UTRAN w/HSUPA (see NOTE 4) (not applicable)
- 6 UTRAN w/HSDPA and HSUPA (see NOTE 4) (not applicable)
- 7 E-UTRAN (not applicable)
- 8 EC-GSM-IoT (A/Gb mode) (see NOTE 5) (not applicable)
- 9 E-UTRAN (NB-S1 mode) (see NOTE 6) (not applicable)
- 10 E-UTRA connected to a 5GCN (see NOTE 7)
- 11 NR connected to a 5GCN (see NOTE 7)
- 12 NG-RAN (not applicable)
- 13 E-UTRA-NR dual connectivity (see NOTE 9) (not applicable)

NOTE 3: 3GPP TS 44.018 [156] specifies the System Information messages which give the information about whether the serving cell supports EGPRS.

NOTE 4: 3GPP TS 25.331 [74] specifies the System Information blocks which give the information about whether the serving cell supports HSDPA or HSUPA.

NOTE 5: 3GPP TS 44.018 [156] specifies the EC-SCH INFORMATION message which, if present, indicates that the serving cell supports EC-GSM-IoT.

NOTE 6: 3GPP TS 36.331 [86] specifies the System Information blocks which give the information about whether the serving cell supports NB-IoT, which corresponds to E-UTRAN (NB-S1 mode).

NOTE 7: 3GPP TS 38.331 [160] specifies the information which, if present, indicates that the serving cell is connected to a 5GCN.

NOTE 8: 3GPP TS 38.331 [160] specifies the information which, if present, indicates that the serving cell is supporting dual connectivity of E-UTRA with NR and is connected to an EPS core.

<cause_type>: integer type; indicates the type of <reject_cause>.

- 0 Indicates that <reject_cause> contains an EMM cause value, see 3GPP TS 24.301 [83] Annex A.
- 1 Indicates that <reject_cause> contains a manufacturer-specific cause.

<reject_cause>: integer type; contains the cause of the failed registration. The value is of type as defined by <cause_type>.

Implementation

Optional. This command is only applicable to UEs supporting 5GS.

10.1.48 Bandwidth preference indication +CBPI

Table 10.1.48-1: +CBPI action command syntax

Command	Possible Response(s)
+CBPI[=<uplink_bandwidth_preference> [,<downlink_bandwidth_preference>]]	+CME ERROR: <err>
+CBPI=?	+CBPI: (list of supported <uplink_bandwidth_preference>s) , (list of supported <downlink_bandwidth_preference>s)

Description

This command indicates to the MT the frequency bandwidth preference for uplink or for downlink.

For BL UEs or for UEs operating in coverage enhancement mode. If further conditions defined in 3GPP TS 36.331 [86] are met, this may cause transmission to the network of a UEAssistanceInformation message with *bw-Preference* set to <uplink_bandwidth_preference> and <downlink_bandwidth_preference>.

Test command returns the values supported as compound values.

Refer clause 9.2 for possible <err> values.

Defined values

<uplink_bandwidth_preference>: integer type; indicates the TE's preference on configuration on maximum Physical Uplink Shared Channel bandwidth.

- 0 no preference indicated by the TE
- 1 CE mode usage in 1.4MHz
- 2 CE mode usage in 5MHz

<downlink_bandwidth_preference>: integer type; indicates the TE's preference on configuration on maximum Physical Downlink Shared Channel bandwidth.

- 0 no preference indicated by the TE
- 1 CE mode usage in 1.4MHz
- 2 CE mode usage in 5MHz
- 3 CE mode usage in 20MHz (normal coverage)

Implementation

Optional.

10.1.49 Define 5GS quality of service +C5GQOS

Table 10.1.49-1: +C5GQOS parameter command syntax

Command	Possible Response(s)
+C5GQOS=[<cid>[,<5QI>[,<DL_GFBR> ,<UL_GFBR> [,<DL_MFBR> ,<UL_MFBR>]]]]	+CME ERROR: <err>
+C5GQOS?	[+C5GQOS: <cid> ,<5QI>[,<DL_GFBR> ,<UL_GFBR> [,<DL_MFBR> ,<UL_MFBR>]]] [<CR><LF>+C5GQOS: <cid> ,<5QI> , [<DL_GFBR> ,<UL_GFBR> [,<DL_MFBR> ,<UL_MFBR>]]]

Command	Possible Response(s)
	[. . .]
+C5GQOS=?	+C5GQOS: (range of supported <cid>s) , (list of supported <5QI>s) , (list of supported <DL_GFBR>s) , (list of supported <UL_GFBR>s) , (list of supported <DL_MFBR>s) , (list of supported <UL_MFBR>s)

Description

The set command allows the TE to specify the 5GS Quality of Service parameters <cid>, <5QI>, [<DL_GFBR> and <UL_GFBR>] and [<DL_MFBR> and <UL_MFBR>] for a QoS flow (see 3GPP TS 23.501 [165] and 3GPP TS 24.501 [161]). Refer clause 9.2 for possible <err> values.

A special form of the set command, +C5GQOS= <cid> causes the values for context number <cid> to become undefined.

The read command returns the current settings for each defined QoS.

The test command returns the ranges of the supported parameters as compound values.

Defined values

<cid>: integer type; specifies a particular QoS flow definition, EPS Traffic Flows definition and a PDP Context definition (see the +CGDCONT and +CGDSCONT commands).

<5QI>: integer type; specifies a class of 5GS QoS (see 3GPP TS 23.501 [165] and 3GPP TS 24.501 [161]).

0	5QI is selected by network
[1 – 4]	value range for guaranteed bit rate QoS flows
65, 66, 67, 75	values for guaranteed bit rate QoS flows
[5 – 9]	value range for non-guaranteed bit rate QoS flows
69, 70, 79, 80	values for non-guaranteed bit rate QoS flows
[82 – 85]	value range for delay critical guaranteed bit rate QoS flows
[128 – 254]	value range for Operator-specific 5QIs

<DL_GFBR>: integer type; indicates DL GFBR in case of GBR 5QI. The value is in kbit/s. This parameter is omitted for a non-GBR 5QI (see 3GPP TS 24.501 [161]).

<UL_GFBR>: integer type; indicates UL GFBR in case of GBR 5QI. The value is in kbit/s. This parameter is omitted for a non-GBR 5QI (see 3GPP TS 24.501 [161]).

<DL_MFBR>: integer type; indicates DL MFBR in case of GBR 5QI. The value is in kbit/s. This parameter is omitted for a non-GBR 5QI (see 3GPP TS 24.501 [161]).

<UL_MFBR>: integer type; indicates UL MFBR in case of GBR 5QI. The value is in kbit/s. This parameter is omitted for a non-GBR 5QI (see 3GPP TS 24.501 [161]).

Implementation

Optional.

10.1.50 5GS quality of service read dynamic parameters +C5GQOSRDP

Table 10.1.50-1: +C5GQOSRDP action command syntax

Command	Possible Response(s)
+C5GQOSRDP[=<cid>]	<pre>[+C5GQOSRDP: <cid>,<5QI>[,<DL_GFBR>,<UL_GFBR> >[,<DL_MFBR>,<UL_MFBR>[,<DL_SAMBR>,<UL_SAMBR> >[,<Averaging_window>]]]]] [<CR><LF>+C5GQOSRDP: <cid>,<5QI>[,<DL_GFBR>,< UL_GBR>[,<DL_MFBR>,<UL_MFBR>[,<DL_SAMBR>,<U L_SAMBR>[,<Averaging_window>]]]]] [...]]</pre>
+C5GQOSRDP=?	+C5GQOSRDP: (list of <cid>s associated with QoS flows)

Description

The execution command returns the Quality of Service parameters <5QI>, [<DL_GFBR> and <UL_GFBR>], [<DL_MFBR> and <UL_MFBR>], [<DL_SAMBR> and <UL_SAMBR>] and <Averaging_window> of the QoS flow associated to the provided context identifier <cid>.

If the parameter <cid> is omitted, the Quality of Service parameters for all QoS flows are returned.

The test command returns a list of <cid>s associated with all QoS flows.

Parameters of both network and MT/TA initiated QoS flows will be returned.

Defined values

<cid>: integer type; specifies a particular QoS flow definition, Traffic Flows definition and a PDP Context definition (see the +CGDCONT and +CGDSCONT commands).

<5QI>: integer type; specifies a class of 5GS QoS (see 3GPP TS 23.501 [165] and 3GPP TS 24.501 [161]).

0	5QI is selected by network
[1 – 4]	value range for guaranteed bit rate QoS flows
65, 66, 67, 75	values for guaranteed bit rate QoS flows
[5 – 9]	value range for non-guaranteed bit rate QoS flows
69, 70, 79, 80	values for non-guaranteed bit rate QoS flows
[82 – 85]	value range for delay critical guaranteed bit rate QoS flows
[128 – 254]	value range for Operator-specific 5QIs

<DL_GFBR>: integer type; indicates DL GFBR in case of GBR 5QI. The value is in kbit/s. This parameter is omitted for a non-GBR 5QI (see 3GPP TS 24.501 [161]).

<UL_GFBR>: integer type; indicates UL GFBR in case of GBR 5QI. The value is in kbit/s. This parameter is omitted for a non-GBR 5QI (see 3GPP TS 24.501 [161]).

<DL_MFBR>: integer type; indicates DL MFBR in case of GBR 5QI. The value is in kbit/s. This parameter is omitted for a non-GBR 5QI (see 3GPP TS 24.501 [161]).

<UL_MFBR>: integer type; indicates UL MFBR in case of GBR 5QI. The value is in kbit/s. This parameter is omitted for a non-GBR 5QI (see 3GPP TS 24.501 [161]).

<UL_SAMBR>: integer type; indicates the UL session AMBR (see 3GPP TS 24.501 [161]). The value is in kbit/s.

<DL_SAMBR>: integer type; indicates the DL session AMBR (see 3GPP TS 24.501 [161]). The value is in kbit/s.

<Averaging_window>: integer type; indicates the averaging window (see 3GPP TS 24.501 [161]). The value is in milliseconds.

Implementation

Optional.

10.1.51 Receive UE policy +CRUEPOLICY

Table 10.1.51-1: +CRUEPOLICY parameter command syntax

Command	Possible response(s)
+CRUEPOLICY=[<reporting>]	
+CRUEPOLICY?	+CRUEPOLICY: <reporting>[,<UE_policy_section_management_list_length>,<UE_policy_section_management_list>]
+CRUEPOLICY=?	+CRUEPOLICY: (list of supported <reporting>s)

Description

The set command controls the presentation of policy information to the TE by an unsolicited result code +CRUEPOLICYU: <UE_policy_section_management_list_length>,<UE_policy_section_management_list> when policy information is received from the network.

Read command returns <reporting> which indicates whether reporting of policy information is enabled or disabled. When reporting is enabled, the parameters <UE_policy_section_management_list_length> and <UE_policy_section_management_list> indicates the most recently received policy information at the MT. When reporting is disabled, no policy information is provided.

Test command returns values supported as a compound value.

Defined values

<reporting>: integer type. Enables and disables reporting of policy information received from the network.

0 Disable reporting

1 Enable reporting

<UE_policy_section_management_list_length>: integer type; indicates the number of octets of the <UE_policy_section_management_list> information element.

<UE_policy_section_management_list>: string type; coded as the value part of the UE policy section management list information element in 3GPP TS 24.501 [161] clause D.6.2, table D.6.2.1. This parameter shall not be subject to conventional character conversion as per +CSCS.

Implementation

Optional.

10.1.52 Send UE policy +CSUEPOLICY

Table 10.1.52-1: +CSUEPOLICY action command syntax

Command	Possible response(s)
+CSUEPOLICY=<message_type>[,<UE_policy_information_length>,<UE_policy_information>[,<UE_policy_classmark>]]	+CME ERROR: <err>
+CSUEPOLICY=?	

Description

Execution command allows the TE to send the UE policy section management result or the UPSI list and UE policy classmark to the MT.

The UE policy information information element contains the UE policy section management result or the UPSI list as specified in 3GPP TS 24.501 [161] clause D.6.3 and clause D.6.4.

Refer clause 9.2 for possible <err> values.

Defined values

<message_type>: integer type. Indicates which type of message the MT is requested to send.

- 0 MANAGE UE POLICY COMPLETE
- 1 MANAGE UE POLICY COMMAND REJECT
- 2 UE STATE INDICATION

<UE_policy_information_length>: integer type; only present if <message_type>=1 or <message_type>=2. It indicates the number of octets of the <UE_policy_information> information element.

<UE_policy_information>: string type; only present if <message_type>=1 or <message_type>=2. If <message_type>=1, it is coded as the value part of the UE policy section management result information element in 3GPP TS 24.501 [161] clause D.6.3, table D.6.3.1. If <message_type>=2, it is coded as the value part of the UPSI list information element in 3GPP TS 24.501 [161] clause D.6.4, table D.6.4.1. This parameter shall not be subject to conventional character conversion as per +CSCS.

<UE_policy_classmark>: string type; one byte in an 8 bit format; only present if <message_type>=2. It is coded as octet 3 of the UE policy classmark information element in 3GPP TS 24.501 [161] clause D.6.5, table D.6.5.1. This parameter shall not be subject to conventional character conversion as per +CSCS.

Implementation

Optional.

10.1.53 5GS access selection preference for MO SMS +C5GSMS

Table 10.1.53-1: +C5GSMS parameter command syntax

Command	Possible Response(s)
+C5GSMS=[<access_pref>]	
+C5GSMS?	+C5GSMS: <access_pref>
+C5GSMS=?	+C5GSMS: (list of currently supported <access_pref>s)

Description

The set command is used to specify the access preference that the MT will use to send MO SMS over NAS messages in 5GS.

The read command returns the currently selected access preference.

The test command returns the supported access preferences as a compound value.

Defined values

<access_pref>: integer type; indicates the access preference to use to send MO SMS over NAS messages.

0 3GPP access preferred, non-3GPP access is used if 3GPP access is not available

1 non-3GPP access preferred, 3GPP access is used if non-3GPP access is not available

Implementation

Optional.

10.1.54 Mobile initiated connection only mode +CMICO

Table 10.1.54-1: +CMICO parameter command syntax

Command	Possible response(s)
+CMICO=[<n> [, <Requested_MICO_Mode>]]	+CME ERROR: <err> when <n>=2 and command successful +CMICO: <Current_MICO_Mode> [, <RAAI>]
+CMICO?	+CMICO: <n> , <Requested_MICO_Mode> [, <Current_MICO_Mode> [, <RAAI>]]
+CMICO=?	+CMICO: (list of supported <n>s) , (list of supported <Requested_MICO_Mode>s)

Description

The set command controls the presentation of unsolicited result code

+CMICO: <Current_MICO_Mode> [, <RAAI>] when <n>=1 and there is a change in the current MICO mode.

When <n>=2, a special form of the set command enables the UE to request the use of MICO mode from the network or re-negotiate the use of MICO mode from the network during the registration procedure (see 3GPP TS 24.501 [161], clause 5.3.6 and clause 5.5.1).

Refer clause 9.2 for possible <err> values.

The command should be abortable when <n>=2, when the use of MICO mode is requested or re-negotiated from the network.

The read command returns the current settings of <n> and <Requested_MICO_Mode>. The command also returns the current values of <Current_MICO_Mode> and <RAAI> if available (see 3GPP TS 24.501 [161] clause 9.11.3.31).

The test command returns values supported as compound values.

Defined values

<n>: integer type

0 disable unsolicited result code +CMICO: <Current_MICO_Mode> [, <RAAI>]

1 enable unsolicited result code +CMICO: <Current_MICO_Mode> [, <RAAI>]

2 MICO mode is requested or re-negotiated from the network. There will be no change in the current setting of <n>, enabling or disabling of unsolicited result code +CMICO: <Current_MICO_Mode> [, <RAAI>]

<Requested_MICO_Mode>: integer type; indicates the requested MICO mode, see 3GPP TS 24.501 [161], clause 5.5.1.

0 triggers the UE to request stopping the use of MICO mode

1 triggers the UE to request the use of MICO mode

<Current_MICO_Mode>: integer type; indicates the current MICO mode, see 3GPP TS 24.501 [161], clause 5.3.6.

0 indicates that the use of MICO mode is not allowed by the network

1 indicates that the use of MICO mode is allowed by the network

<RAAI>: integer type; only present when <Current_MICO_Mode>=1. Indicates the registration area allocation indication, see 3GPP TS 24.501 [161] clause 9.11.3.31.

0 indicates to the UE that all PLMN registration areas are not allocated

1 indicates to the UE that all PLMN registration areas are allocated

Implementation

Optional.

10.1.55 S-NSSAI based back-off timer status reporting +CSBTSR

Table 10.1.55-1: +CSBTSR parameter command syntax

Command	Possible response(s)
+CSBTSR=[<n>]	+CME ERROR: <err>
+CSBTSR?	+CSBTSR: <n>
+CSBTSR=?	+CSBTSR: (list of supported <n>s)

Description

Set command controls the presentation of unsolicited result code +CSBTSRI: <S-NSSAI>, <event_type> [, <S-NSSAI_backoff_time>] reporting the S-NSSAI based back-off timer parameter values from MT to TE if the back-off timer is started, stopped, deactivated or expires. Refer clause 9.2 for possible <err> values.

Read command returns the current S-NSSAI based back-off timer unsolicited result code settings in the MT.

Test command returns values supported as a compound value.

Defined values

<n>: integer type.

0 Disable presentation of the unsolicited result code +CSBTSRI.

1 Enable presentation of the unsolicited result code +CSBTSRI.

<S-NSSAI>: string type in hexadecimal format. Dependent of the form, the string can be separated by dot(s) and semicolon(s). The S-NSSAI is associated with the back-off timer for identifying a network slice in 5GS, see 3GPP TS 23.501 [165] and 3GPP TS 24.501 [161]. Refer parameter <S-NSSAI> in clause 10.1.1. This parameter shall not be subject to conventional character conversion as per +CSCS.

<event_type>: integer type. Indicates the event happened to the back-off timer.

0 The back-off timer is started.

1 The back-off timer is stopped.

2 The back-off timer is expired.

3 The back-off timer is deactivated.

<S-NSSAI_backoff_time>: integer type; indicates the remaining back-off time associated with the <S-NSSAI> in seconds. When the back-off timer is deactivated, the parameter <S-NSSAI_backoff_time> is omitted.

Implementation

Optional.

10.1.56 S-NSSAI based back-off timer read dynamic parameters +CSBTRDP

Table 10.1.56-1: +CSBTRDP action command syntax

Command	Possible response(s)
+CSBTRDP [=<S-NSSAI>]	[+CSBTRDP: <S-NSSAI>[, <S-NSSAI_backoff_time>] [<CR><LF>+CSBTRDP: <S-NSSAI>[, <S-NSSAI_backoff_time>] [...]]]
+CSBTRDP=?	

Description

The execution command returns the relevant information in the MT for the S-NSSAI based back-off timer parameter value <S-NSSAI_backoff_time> for an <S-NSSAI> if the back-off timer is running.

If the parameter <S-NSSAI> in the execution command is omitted, the relevant information for all S-NSSAIs associated with running back-off timers are returned.

Defined values

<S-NSSAI>: string type in hexadecimal format. Dependent of the form, the string can be separated by dot(s) and semicolon(s). The S-NSSAI is associated with the back-off timer for identifying a network slice in 5GS, see 3GPP TS 23.501 [165] and 3GPP TS 24.501 [161]. When <S-NSSAI> indicates an empty string (""), the following parameter is associated with no S-NSSAI as specified in 3GPP TS 24.501 [161]. Refer parameter <S-NSSAI> in clause 10.1.1. This parameter shall not be subject to conventional character conversion as per +CSCS.

<S-NSSAI_backoff_time>: integer type; indicates the remaining back-off time associated with the <S-NSSAI> in seconds. When the back-off timer is deactivated, the parameter <S-NSSAI_backoff_time> is omitted.

Implementation

Optional.

10.1.57 S-NSSAI and DNN based back-off timer status reporting +CSDBTSR

Table 10.1.57-1: +CSDBTSR parameter command syntax

Command	Possible response(s)
+CSDBTSR=[<n>]	+CME ERROR: <err>
+CSDBTSR?	+CSDBTSR: <n>
+CSDBTSR=?	+CSDBTSR: (list of supported <n>s)

Description

Set command controls the presentation of unsolicited result code +CSDBTSRI: <S-NSSAI>, <DNN>, <event_type>[, <S-NSSAI_DNN_backoff_time>] reporting the S-NSSAI and DNN based back-off timer parameter values from MT to TE if the back-off timer is started, stopped, deactivated or expires. Refer clause 9.2 for possible <err> values.

Read command returns the current S-NSSAI and DNN based back-off timer unsolicited result code settings in the MT.

Test command returns values supported as a compound value.

Defined values

<n>: integer type.

- 0 Disable presentation of the unsolicited result code +CSDBTSRI.
- 1 Enable presentation of the unsolicited result code +CSDBTSRI.

<S-NSSAI>: string type in hexadecimal format. Dependent of the form, the string can be separated by dot(s) and semicolon(s). The S-NSSAI is associated with the back-off timer for identifying a network slice in 5GS, see 3GPP TS 23.501 [165] and 3GPP TS 24.501 [161]. Refer parameter <S-NSSAI> in clause 10.1.1. This parameter shall not be subject to conventional character conversion as per +CSCS.

<DNN>: string type; indicates the DNN associated with the back-off timer for identifying a data network in 5GS, see 3GPP TS 23.501 [165] and 3GPP TS 24.501 [161]. This parameter shall not be subject to conventional character conversion as per +CSCS.

<event_type>: integer type. Indicates the event happened to the back-off timer.

- 0 The back-off timer is started.
- 1 The back-off timer is stopped.
- 2 The back-off timer is expired.
- 3 The back-off timer is deactivated.

<S-NSSAI_DNN_backoff_time>: integer type; indicates the remaining back-off time associated with the <S-NSSAI> and <DNN> in seconds. When the back-off timer is deactivated, the parameter <S-NSSAI_DNN_backoff_time> is omitted.

Implementation

Optional.

10.1.58 S-NSSAI and DNN based back-off timer read dynamic parameters +CSDBTRDP

Table 10.1.58-1: +CSDBTRDP action command syntax

Command	Possible response(s)
+CSDBTRDP [= <S-NSSAI> , <DNN>]	[+CSDBTRDP: <S-NSSAI> , <DNN> [, <S-NSSAI_DNN_backoff_time>] [<CR><LF>+CSDBTRDP: <S-NSSAI> , <DNN> [, <S-NSSAI_DNN_backoff_time>] [...]]
+CSDBTRDP=?	

Description

The execution command returns the relevant information in the MT for the S-NSSAI and DNN based back-off timer parameter value <S-NSSAI_DNN_backoff_time> for the <S-NSSAI> and <DNN> combination if the back-off timer is running.

If the parameter <S-NSSAI> in the execution command is omitted, the DNN specific information for all S-NSSAIs associated with running back-off timers are returned.

If the parameter <DNN> in the execution command is omitted, the S-NSSAI specific information for all DNNs associated with running back-off timers are returned.

If both the parameters <S-NSSAI> and <DNN> are omitted, the relevant information for all S-NSSAI and DNN combinations associated with running back-off timers are returned.

Defined values

<S-NSSAI>: string type in hexadecimal format. Dependent of the form, the string can be separated by dot(s) and semicolon(s). The S-NSSAI is associated with the back-off timer for identifying a network slice in 5GS, see 3GPP TS 23.501 [165] and 3GPP TS 24.501 [161]. When <S-NSSAI> indicates an empty string (""), the parameter <S-NSSAI_DNN_backoff_time> in the response is associated with no S-NSSAI as specified in 3GPP TS 24.501 [161]. Refer parameter <S-NSSAI> in clause 10.1.1. This parameter shall not be subject to conventional character conversion as per +CSCS.

<DNN>: string type; indicates the DNN associated with the back-off timer for identifying a data network in 5GS, see 3GPP TS 23.501 [165] and 3GPP TS 24.501 [161]. When <DNN> indicates an empty string (""), the parameter <S-NSSAI_DNN_backoff_time> in the response is associated with no DNN as specified in 3GPP TS 24.501 [161]. This parameter shall not be subject to conventional character conversion as per +CSCS.

<S-NSSAI_DNN_backoff_time>: integer type; indicates the remaining back-off time associated with the <S-NSSAI> and <DNN> combination in seconds. When the back-off timer is deactivated, the parameter <S-NSSAI_DNN_backoff_time> is omitted.

Implementation

Optional.

10.1.59 5GS use of SMS over NAS +C5GUSMS

Table 10.1.59-1: +C5GUSMS parameter command syntax

Command	Possible Response(s)
+C5GUSMS=[<n>[,<sms_requested>]]	+CME ERROR: <err>
+C5GUSMS?	+C5GUSMS: <sms_available>,<sms_allowed>
+C5GUSMS=?	+C5GUSMS: (list of supported <n>s) , (list of supported <sms_requested>s)

Description

The set command enables the UE to request the use of SMS over NAS in 5GS or to request stopping the use of SMS over NAS in 5GS. Additionally, the set command controls the presentation of the unsolicited result code +C5GUSMS: <sms_available>,<sms_allowed> when <n>=2 and SMS over NAS in 5GS allowed status information or SMS over NAS in 5GS availability status information is received from the network, for the UE (see 3GPP TS 24.501 [161] clauses 5.4.4.3, 5.5.1.2.4 and 5.5.1.3.4).

Refer to clause 9.2 for possible <err> values.

The read command returns the current SMS over NAS in 5GS availability status for the UE and the current SMS over NAS in 5GS allowed status for the UE.

The test command returns the values supported as compound values.

Defined values

<n>: integer type

- 0 no change in current setting of <n>
- 1 disable unsolicited result code +C5GUSMS <sms_available>,<sms_allowed>
- 2 enable unsolicited result code +C5GUSMS: <sms_available>,<sms_allowed>

<sms_requested>: integer type; indicates the UE's request for SMS over NAS in 5GS.

0 triggers the UE to request the use of SMS over NAS in 5GS

1 triggers the UE to request stopping the use of SMS over NAS in 5GS

<sms_available>: integer type; indicates the current SMS over NAS in 5GS availability status for the UE in the network.

0 indicates that the SMS over NAS in 5GS availability status for the UE is unknown

1 indicates that SMS over NAS in 5GS is not available in the network for the UE (see 3GPP TS 24.501 [161] clause 5.4.4.3)

2 indicates that SMS over NAS in 5GS is available in the network for the UE (see 3GPP TS 24.501 [161] clause 5.4.4.3)

<sms_allowed>: integer type; indicates the current SMS over NAS in 5GS allowed status for UE in the network.

0 indicates that SMS over NAS in 5GS allowed status for the UE is unknown

1 indicates that the UE is not allowed by the network to use SMS over NAS in 5GS (see 3GPP TS 24.501 [161] clauses 5.4.4.3, 5.5.1.2.4 and 5.5.1.3.4)

2 indicates that the UE is allowed by the network to use SMS over NAS in 5GS (see 3GPP TS 24.501 [161] clauses 5.5.1.2.4 and 5.5.1.3.4)

Implementation

Optional.

10.1.60 Request LADN information +CRLADN

Table 10.1.60-1: +CRLADN action command syntax

Command	Possible response(s)
+CRLADN[=<ladn_dnn>[, <ladn_dnn>[, ...]]]	+CME ERROR: <err> +CRLADN: <ladn_information_length>, <ladn_information>
+CRLADN=?	

Description

The execution command enables the TE to request LADN information from the network for the specified LADN DNN(s). If the parameter <ladn_dnn> in the execution command is omitted, it indicates a request to the network for LADN information for all LADN(s) available in the current registration area. If <ladn_information_length> has a value of zero and <ladn_information> consists of an empty string, no LADN information is stored on the MT.

The command should be abortable as the LADN information is provided by the network.

Refer clause 9.2 for possible <err> values.

Defined values

<ladn_dnn>: string type; included when the TE wants to request LADN information for specific LADN DNN(s). The <ladn_dnn> is encoded as the value part of the DNN information element in 3GPP TS 24.501 [161], clause 9.11.2.1A. This parameter shall not be subject to conventional character conversion as per +CSCS.

<ladn_information_length>: integer type; indicates the number of octets of the <ladn_information> information element.

If the value is zero, no LADN information is stored on the MT.

<ladn_information>: string type; indicates the LADN information for one or more LADNs, where each LADN consists of a DNN and a tracking area identity list. The <ladn_information> is encoded as the value part of the LADN information information element in 3GPP TS 24.501 [161], clause 9.11.3.30, where each DNN is encoded as the value part of the DNN information element in 3GPP TS 24.501 [161], clause 9.11.2.1A, and each tracking area identity list is encoded as the length and the value part of the 5GS Tracking area identity list information element as specified in clause 9.11.3.9. This parameter shall not be subject to conventional character conversion as per +CSCS.

If the value is an empty string (""), no LADN information is stored on the MT.

Implementation

Optional.

10.1.61 LADN information +CLADN

Table 10.1.61-1: +CLADN parameter command syntax

Command	Possible response(s)
+CLADN=[<n>]	+CME ERROR: <err>
+CLADN?	+CLADN: <n>, <ladn_information_length>, <ladn_information>
+CLADN=?	+CLADN: (list of supported <n>s)

Description

The set command controls the presentation of LADN information to the TE by an unsolicited result code +CLADNU: <ladn_information_length>, <ladn_information> when there is a change in the LADN information stored at the MT. For each LADN, the LADN information consists of a DNN and a tracking identity list, as specified in 3GPP TS 24.501 [161], clause 9.11.3.30. If <ladn_information_length> has a value of zero and <ladn_information> consists of an empty string, no LADN information is stored on the MT.

Read command returns <n> which indicates whether reporting of LADN information is enabled or disabled. The read command also returns the current values of <ladn_information_length> and <ladn_information> if available.

Test command returns values supported as a compound value.

Defined values

<n>: integer type.

0 disable unsolicited result code

+CLADNU: <ladn_information_length>, <ladn_information>

1 enable unsolicited result code +CLADNU: <ladn_information_length>, <ladn_information>

<ladn_information_length>: integer type; indicates the number of octets of the <ladn_information> information element.

If the value is zero, no LADN information is stored on the MT.

<ladn_information>: string type; indicates the LADN information for one or more LADNs, where each LADN consists of a DNN and a tracking area identity list. The <ladn_information> is encoded as the value part of the LADN information information element in 3GPP TS 24.501 [161], clause 9.11.3.30, where each DNN is encoded as the value part of the DNN information element in 3GPP TS 24.501 [161], clause 9.11.2.1A, and each tracking area identity list is encoded as the length and the value part of the 5GS Tracking area identity list information element as specified in clause 9.11.3.9. This parameter shall not be subject to conventional character conversion as per +CSCS.

If the value is an empty string (""), no LADN information is stored on the MT.

Implementation

Optional.

10.1.62 5GS NSSAI setting +C5GNSSAI**Table 10.1.62-1: +C5GNSSAI parameter command syntax**

Command	Possible Response(s)
+C5GNSSAI=<default_configured_nssai_length>,<default_configured_nssai>	+CME ERROR: <err>
+C5GNSSAI?	+C5GNSSAI: [<default_configured_nssai_length>,<default_configured_nssai>]
+C5GNSSAI=?	+C5GNSSAI: (range of supported <default_configured_nssai_length>s), (range of supported <default_configured_nssai>s)

Description

The set command enables updating the default configured NSSAI stored at the MT (see 3GPP TS 24.501 [161] clause 4.6.2.2). If <default_configured_nssai_length> has a value of zero and <default_configured_nssai> consists of an empty string, the default configured NSSAI stored at the MT, if any, shall be deleted by the MT. If the MT has previously received a default configured NSSAI from the network via NAS signalling as specified in 3GPP TS 24.501 [161], the default configured NSSAI stored at the MT is not updated and an error message, +CME ERROR, is returned to TE. Refer clause 9.2 for possible <err> values.

The read command returns the current parameter values.

The test command returns the values supported as compound values.

Defined values

<default_configured_nssai_length>: integer type; indicates the length in octets of the default configured NSSAI to be stored at the MT.

If the value is zero, no default configured NSSAI is stored at the MT.

<default_configured_nssai>: string type in hexadecimal format. Dependent of the form, the string can be separated by dot(s), semicolon(s) and colon(s). This parameter indicates the list of S-NSSAIs included in the default configured NSSAI to be stored by the MT. The <default_configured_nssai> is coded as a list of <S-NSSAI>s separated by colons. Refer parameter <S-NSSAI> in clause 10.1.1. This parameter shall not be subject to conventional character conversion as per +CSCS.

If the value is an empty string (""), no default configured NSSAI is stored at the MT.

Implementation

Optional.

10.1.63 5GS NSSAI read dynamic parameters +C5GNSSAIRDP**Table 10.1.63-1: +C5GNSSAIRDP action command syntax**

Command	Possible Response(s)
+C5GNSSAIRDP[=<nssai_type>[,<plmn_id>]]	[+C5GNSSAIRDP: [<default_configured_nssai_length>,<default_configured_nssai>[,<rejected_nssai_3gpp_1

Command	Possible Response(s)
	<p>ength>, <rejected_nssai_3gpp>[, <rejected_nssai_non3gpp_length>, <rejected_nssai_non3gpp>]]]</p> <p>[<CR><LF>+C5GNSSAIRDP: <plmn_id>[, <configured_nssai_length>, <configured_nssai>[, <allowed_nssai_3gpp_length>, <allowed_nssai_3gpp>, <allowed_nssai_non3gpp_length>, <allowed_nssai_non3gpp>]]]</p> <p>[<CR><LF>+C5GNSSAIRDP: <plmn_id>[, <configured_nssai_length>, <configured_nssai>[, <allowed_nssai_3gpp_length>, <allowed_nssai_3gpp>, <allowed_nssai_non3gpp_length>, <allowed_nssai_non3gpp>]]]</p> <p>[...]]]]</p>
+C5GNSSAIRDP=?	+C5GNSSAIRDP: (list of supported <nssai_type>s) , (range of supported <plmn_id>s)

Description

The execution command returns the default configured NSSAI, rejected NSSAI for 3GPP access and rejected NSSAI for non-3GPP access stored at the MT, if any, as well as the configured NSSAI, allowed NSSAI for 3GPP access and allowed NSSAI for non-3GPP access stored at the MT, if any for the PLMN identified by <plmn_id>.

If the parameter <plmn_id> is omitted, the NSSAIs for all PLMNs for which the MT has stored NSSAI information are returned.

The test command returns the values supported as compound values.

Defined values

<nssai_type>: integer type; specifies the type of NSSAI to be returned.

- 0 return stored default configured NSSAI only
- 1 return stored default configured NSSAI and rejected NSSAI(s)
- 2 return stored default configured NSSAI, rejected NSSAI(s) and configured NSSAI(s)
- 3 return stored default configured NSSAI, rejected NSSAI(s), configured NSSAI(s) and allowed NSSAI(s)

<plmn_id>: string type; indicates the MCC and MNC of the PLMN to which the NSSAI information applies. For the format and the encoding of the MCC and MNC, see 3GPP TS 23.003 [7]. This parameter shall not be subject to conventional character conversion as per +CSCS.

<default_configured_nssai_length>: integer type; indicates the length in octets of the default configured NSSAI stored at the MT.

<default_configured_nssai>: string type in hexadecimal format. Dependent of the form, the string can be separated by dot(s), semicolon(s) and colon(s). This parameter indicates the list of S-NSSAIs included in the default configured NSSAI stored at the MT for the PLMN. The <default_configured_nssai> is coded as a list of <S-NSSAI>s separated by colons. Refer parameter <S-NSSAI> in clause 10.1.1. This parameter shall not be subject to conventional character conversion as per +CSCS.

<rejected_nssai_3gpp_length>: integer type; indicates the length in octets of the rejected NSSAI associated with 3GPP access stored at the MT for the serving PLMN.

<rejected_nssai_3gpp>: string type in hexadecimal format. Dependent of the form, the string can be separated by dot(s), colon(s) and hash(es). This parameter indicates the list of rejected S-NSSAIs associated with 3GPP access stored at the MT for the serving PLMN. The <rejected_nssai_3gpp> is coded as a list of rejected S-NSSAIs separated by colon. For the format and the encoding of S-NSSAI, see also 3GPP TS 23.003 [7]. This parameter shall not be subject to conventional character conversion as per +CSCS.

The rejected S-NSSAI has one of the forms:

sst#cause only slice/service type (SST) and reject cause are present
sst.sd#cause SST and slice differentiator (SD) and reject cause are present

where cause is a cause value is according to 3GPP TS 24.501 [161] table 9.11.3.46.1.

<rejected_nssai_non3gpp_length>: integer type; indicates the length in octets of the rejected NSSAI associated with non-3GPP access stored at the MT for the serving PLMN.

<rejected_nssai_non3gpp>: string type in hexadecimal format. Dependent of the form, the string can be separated by dot(s), colon(s) and hash(es). This parameter indicates the list of rejected S-NSSAIs associated with non-3GPP access stored at the MT for the serving PLMN. The <rejected_nssai_non3gpp> is coded as a list of rejected S-NSSAIs separated by colon. For the format and the encoding of S-NSSAI, see also 3GPP TS 23.003 [7]. This parameter shall not be subject to conventional character conversion as per +CSCS. The rejected S-NSSAI has one of the forms:

sst#cause only slice/service type (SST) and reject cause are present
sst.sd#cause SST and slice differentiator (SD) and reject cause are present

where cause is a cause value is according to 3GPP TS 24.501 [161] table 9.11.3.46.1.

<configured_nssai_length>: integer type; indicates the length in octets of the configured NSSAI stored at the MT for the PLMN identified by <plmn_id>.

<configured_nssai>: string type in hexadecimal format. Dependent of the form, the string can be separated by dot(s), semicolon(s) and colon(s). This parameter indicates the list of configured S-NSSAIs stored at the MT for the PLMN identified by <plmn_id>. The <configured_nssai> is coded as a list of <S-NSSAI>s separated by colons. Refer parameter <S-NSSAI> in clause 10.1.1. This parameter shall not be subject to conventional character conversion as per +CSCS.

<allowed_nssai_3gpp_length>: integer type; indicates the length in octets of the allowed NSSAI associated with 3GPP access stored at the MT for the PLMN identified by <plmn_id>.

<allowed_nssai_3gpp>: string type in hexadecimal format. Dependent of the form, the string can be separated by dot(s), semicolon(s) and colon(s). This parameter indicates the list of allowed S-NSSAIs associated with 3GPP access stored at the MT for the PLMN identified by <plmn_id>. The <allowed_nssai_3gpp> is coded as a list of <S-NSSAI>s separated by colons. Refer parameter <S-NSSAI> in clause 10.1.1. This parameter shall not be subject to conventional character conversion as per +CSCS.

<allowed_nssai_non3gpp_length>: integer type; indicates the length in octets of the allowed NSSAI associated with non-3GPP access stored at the MT for the PLMN identified by <plmn_id>.

<allowed_nssai_non3gpp>: string type in hexadecimal format. Dependent of the form, the string can be separated by dot(s), semicolon(s) and colon(s). This parameter indicates the list of allowed S-NSSAIs associated with non-3GPP access stored at the MT for the PLMN identified by <plmn_id>. The <allowed_nssai_non3gpp> is coded as a list of <S-NSSAI>s separated by colons. Refer parameter <S-NSSAI> in clause 10.1.1. This parameter shall not be subject to conventional character conversion as per +CSCS.

Implementation

Optional.

10.1.64 5GS Preferred NSSAI +C5GPNSSAI

Table 10.1.64-1: +C5GPNSSAI parameter command syntax

Command	Possible Response(s)
+C5GPNSSAI=[<Preferred_NSSAI_3gpp_length>,[<Preferred_NSSAI_3gpp>]	+CME ERROR: <err>

], [<Preferred_NSSAI_non3gpp_length>], [<Preferred_NSSAI_non3gpp>]]	
+C5GPNSSAI?	+C5GPNSSAI: <Preferred_NSSAI_3gpp_length>, <Preferred_NSSAI_3gpp>, <Preferred_NSSAI_non3gpp_length>, <Preferred_NSSAI_non3gpp>
+C5GPNSSAI=?	+C5GPNSSAI: (range of supported <Preferred_NSSAI_3gpp_length>s), (range of supported <Preferred_NSSAI_non3gpp_length>s)

Description

The set command specifies the preferred NSSAI as a list of S-NSSAIs matching the preference of the TE. The preferred NSSAI is coded as a list of HPLMN values of S-NSSAIs. Its content is independent of the selected or registered PLMNs. MT takes the preferred NSSAI into account when selecting the requested NSSAI.

NOTE: It is the MT responsibility to ensure that the Requested NSSAI IE sent to the network during 5GS registration is set according to the rules in 3GPP TS 24.501 [161]. MT takes into account the configured NSSAI for the current PLMN, the allowed NSSAI for the current PLMN and access type, and the rejected NSSAI for the current PLMN or rejected NSSAI for the current PLMN and registration area combination.

Refer to clause 9.2 for possible <err> values.

A special form of the set command can be given as +C5GPNSSAI= without any parameters. In this form, no preferred NSSAI for 3GPP access and no preferred NSSAI for non-3GPP access are stored in the MT.

The read command returns the current values.

The test command returns the values supported as compound values.

Defined values

<Preferred_NSSAI_3gpp_length>: integer type; indicates the length in octets of the <Preferred_NSSAI_3gpp> to be stored in the MT.

If the value is zero, no preferred NSSAI for 3GPP access is stored in the MT.

<Preferred_NSSAI_3gpp>: string type in hexadecimal format. Dependent of the form, the string can be separated by dot(s), semicolon(s) and colon(s). This parameter indicates the list of preferred S-NSSAIs for 3GPP access. The <Preferred_NSSAI_3gpp> is coded as a list of S-NSSAIs separated by colons. The TE includes the HPLMN values of the S-NSSAIs; therefore, no mapped S-NSSAIs are included. Refer parameter <S-NSSAI> in clause 10.1.1. This parameter shall not be subject to conventional character conversion as per +CSCS.

If the value is an empty string (""), no preferred NSSAI for 3GPP access is stored in the MT.

<Preferred_NSSAI_non3gpp_length>: integer type; indicates the length in octets of the <Preferred_NSSAI_non3gpp> to be stored in the MT.

If the value is zero, no preferred NSSAI for non-3GPP access is stored in the MT.

<Preferred_NSSAI_non3gpp>: string type in hexadecimal format. Dependent of the form, the string can be separated by dot(s), semicolon(s) and colon(s). This parameter indicates the list of preferred S-NSSAIs for non-3GPP access. The <Preferred_NSSAI_non3gpp> is coded as a list of S-NSSAIs separated by colons. The TE includes the HPLMN values of the S-NSSAIs; therefore, no mapped S-NSSAIs are included. Refer parameter <S-NSSAI> in clause 10.1.1. This parameter shall not be subject to conventional character conversion as per +CSCS.

Implementation

Optional.

10.2 Modem compatibility commands

10.2.0 General

This clause describes how existing AT commands, designed for use with a modem, may be used to control a Packet Domain MT. This is to provide backwards compatibility with existing communications software. For new applications it is recommended that the Packet Domain-specific commands, described in previous clauses, be used.

10.2.1 MT originated PDP context activation

10.2.1.0 General

In this mode of operation, the MT behaves like an originating modem and accepts the normal V.250 commands associated with placing and clearing a call. If Packet Domain-specific configuration commands are required, they may be sent to the MT as part of the modem initialization commands.

10.2.1.1 Request packet domain service 'D'

Table 130: D command syntax

Command	Possible Response(s)
D* <code><GPRS_SC></code> [* [<code><called_address></code>] [* [<code><L2P></code>] [* [<code><cid></code> [, <code><cid></code> [, ...]]]]]]#	CONNECT ERROR

Description

This command causes the MT to perform whatever actions are necessary to establish communication between the TE and the external PDN.

The V.250 'D' (Dial) command causes the MT to enter the V.250 online data state and, with the TE, to start the specified layer 2 protocol. The MT shall return CONNECT to confirm acceptance of the command prior to entering the V.250 online data state. No further commands may follow on the AT command line.

The detailed behaviour after the online data state has been entered is dependent on the PDP type. It is described briefly in clause 9 (for IP) of 3GPP TS 27.060 [34]. PS attachment and PDP context activation procedures may take place prior to or during the PDP startup if they have not already been performed using the +CGATT and +CGACT commands.

When the layer 2 protocol has terminated, either as a result of an orderly shut down of the PDP or an error, the MT shall enter V.250 command state and return the NO CARRIER final result code.

If `<called_address>` is supported and provided, the MT shall automatically set up a virtual call to the specified address after the PDP context has been activated.

If `<L2P>` and `<cid>` are supported, their usage shall be the same as in the +CGDATA command. The +CGDCONT, +CGQREQ, etc. commands may be used in the modem initialization AT command string to set values for for PDP type, APN, QoS etc..

If `<L2P>` is not supported or is supported but omitted, the MT shall use a layer 2 protocol appropriate to the PDP type.

If `<cid>` is not supported or is supported but omitted, the MT shall attempt to activate the context using:

- (a) any information provided by the TE during the PDP startup procedure, e.g. the TE may provide a PDP type and/or PDP address to the MT;
- (b) a priori knowledge, e.g. the MT may implement only one PDP type; or
- (c) using the 'Empty PDP type' (3GPP TS 24.008 [8]). (No PDP address or APN shall be sent in this case and only one PDP context subscription record shall be present in the HLR for this subscriber.)

This command may be used in both normal and modem compatibility modes.

NOTE: The dial string conforms to the syntax specified in 3GPP TS 22.030 [19].

Defined values

<GPRS_SC>: (GPRS Service Code) a string of digits (value 99) which identifies a request to use the Packet Domain service.

<called_address>: a string that identifies the called party in the address space applicable to the PDP. For communications software that does not support arbitrary characters in the dial string, a numeric equivalent may be used. Also, the character comma ',' may be used as a substitute for the character period '.'.

<L2P>: a string which indicates the layer 2 protocol to be used (see +CGDATA command). For communications software that does not support arbitrary characters in the dial string, the following numeric equivalents shall be used:

0	NULL (Obsolete)
1	PPP
2	PAD (Obsolete)
3	X25 (Obsolete)
9yyyy	M-xxxx

Other values are reserved and will result in an ERROR response

<cid>: a string of digits which specifies a particular PDP context definition (see the +CGDCONT and +CGDSCONT commands).

Implementation

Optional if the +CGDATA command is supported. If the D command is provided, then support for <called_address>, <L2P> and <cid> are optional. If they are not supported but values are provided by the TE, the values shall be ignored and this shall not constitute an error.

10.2.1.2 Request packet domain IP service 'D'

Table 131: D command syntax

Command	Possible Response(s)
D* <GPRS_SC_IP>[* <cid>[, <cid>[, ...]]]#	CONNECT ERROR

Description

This command causes the MT to perform whatever actions are necessary to establish communication between the TE and the external PDN.

The V.250 'D' (Dial) command causes the MT to enter the V.250 online data state and, with the TE, to start the specified layer 2 protocol. The MT shall return CONNECT to confirm acceptance of the command prior to entering the V.250 online data state. No further commands may follow on the AT command line.

The detailed behaviour after the online data state has been entered is described briefly in clause 9, for IP, of 3GPP TS 27.060 [34]. GPRS attachment and PDP context activation procedures may take place prior to or during the PDP startup if they have not already been performed using the +CGATT and +CGACT commands.

When the layer 2 protocol has terminated, either as a result of an orderly shut down of the PDP or an error, the MT shall enter V.250 command state and return the NO CARRIER final result code.

If <cid> is supported, its usage shall be the same as in the +CGDATA command. The +CGDCONT, +CGQREQ, etc. commands may be used in the modem initialization AT command string to set values for PDP type, APN, QoS etc.

If <cid> is not supported or is supported but omitted, the MT shall attempt to activate the context using:

- (a) any information provided by the TE during the PDP startup procedure, e.g. the TE may provide a PDP type and/or PDP address to the MT;
- (b) a priori knowledge, e.g. the MT may implement only one PDP type; or
- (c) using the 'Empty PDP type' (3GPP TS 24.008 [8]). (No PDP address or APN shall be sent in this case and only one PDP context subscription record shall be present in the HLR for this subscriber.)

This command may be used in both normal and modem compatibility modes.

NOTE. The dial string conforms to the syntax specified in 3GPP TS 22.030 [19].

Defined values

<GPRS_SC_IP>: (GPRS Service Code for IP) a string of digits (value 98) which identifies a request to use the GPRS with IP (PDP types IP and PPP).

<cid>: a string of digits which specifies a particular PDP context definition (see +CGDCONT command).

Implementation

Optional if the +CGDATA command is supported. If the D command is provided, then support for <cid> is optional. If it is not supported but a value is provided by the TE, the value shall be ignored and this shall not constitute an error.

10.2.2 Network requested PDP context activation

10.2.2.0 General

In this mode of operation, the MT behaves like an answering modem and accepts the normal V.250 commands associated with answering a call. If Packet Domain-specific configuration commands are required, they may be sent to the MT as part of the modem initialization commands.

The +CGAUTO command is used to select modem compatibility mode.

10.2.2.1 Automatic response to a network request for PDP context activation 'S0'

The V.250 'S0=n' (Automatic answer) command may be used to turn off (n=0) and on (n>0) the automatic response to a network request for a PDP context activation.

When the 'S0=n' (n>0) command is received, the MT shall attempt to perform a PS attach if it is not already attached. Failure will result in ERROR being returned to the TE. Subsequently, the MT will announce a network request for PDP context activation by issuing the unsolicited result code RING to the TE, followed by the intermediate result code CONNECT. The MT then enters V.250 online data state and follows the same procedure as it would after having received a +CGANS=1 with no <L2P> or <cid> values specified.

NOTE: The 'S0=n' (n=0) command does not perform an automatic PS detach.

Implementation

Optional.

10.2.2.2 Manual acceptance of a network request for PDP context activation 'A'

The V.250 'A' (Answer) command may be used to accept a network request for a PDP context activation announced by the unsolicited result code RING. The MT responds with CONNECT, enters V.250 online data state and follows the same procedure as it would after having received a +CGANS=1 with no <L2P> or <cid> values specified. It is an error to issue the 'A' command when there is no outstanding network request.

Implementation

Optional.

10.2.2.3 Manual rejection of a network request for PDP context activation 'H'

The V.250 'H' or 'H0' (On-hook) command may be used to reject a network request for PDP context activation announced by the unsolicited result code RING. The MT responds with OK. It is an error to issue the 'H' command when there is no outstanding network request.

NOTE: This is an extension to the usage of the 'H' command that is described in ITU-T Recommendation V.250 [14].

Implementation

Optional.

11 Commands for VGCS and VBS**11.0 General**

This clause defines commands that a TE may use to control a VGCS or VBS supporting MT. The requirements for the VGCS and VBS are included in the following specifications:

- Voice Group Call service (VGCS): 3GPP TS 42.068 [55], 3GPP TS 43.068 [49] and 3GPP TS 44.068 [52];
- Voice Broadcast Service (VBS): 3GPP TS 42.069 [56], 3GPP TS 43.069 [50] and 3GPP TS 44.069 [53].

It is anticipated that VGCS or VBS supporting MTs will vary widely in functionality.

A comprehensive set of VGCS and VBS-specific commands is defined in clause 11.1 to provide the flexibility needed by the more complex MT. The commands use the extended information and error message capabilities described in this specification.

For the simplest MTs, and for backwards compatibility with existing communications software, it is possible to control access to the VGCS and VBS using existing modem-compatible commands. A special dial-string syntax is defined for use with the D command. This "modem compatible" mode of operation is described in clause 11.2.

11.1 Commands specific to MTs supporting the VGCS and VBS**11.1.1 Accept an incoming voice group or voice broadcast call +CAJOIN**

Table 132: +CAJOIN action command syntax

Command	Possible Response(s)
+CAJOIN=<service>,<GId>,<GCA>	+CME ERROR: <err>
+CAJOIN=?	

Description

The execute command accepts an incoming or ongoing voice group or voice broadcast call. Refer clause 9.2 for possible <err> values.

See command +CALCC to get a list of current voice group or voice broadcast calls.

Defined values

<GId>: string of digits that specifies the group identification for the incoming voice group or voice broadcast call.

<GCA>: string of digits that specifies the group call area identification for the incoming voice group or voice broadcast call.

<service>: integer type (tele-service)

17 voice group call

18 voice broadcast call

Implementation

Mandatory for a MT supporting AT commands only and VGCS or VBS is implemented.

11.1.2 Reject an incoming voice group or voice broadcast call +CAREJ

Table 133: +CAREJ action command syntax

Command	Possible Response(s)
+CAREJ=<service>, <GId>, <GCA>	+CME ERROR: <err>
+CAREJ=?	

Description

The execute command rejects an incoming voice group or voice broadcast call indicated by RING or +CRING, the command is applicable as long as the indication is pending. Refer clause 9.2 for possible <err> values.

If the call is once rejected the RING or +CRING indication is not repeated to TE although the call is still running and notifications for the call are received.

See command +CALCC to get a list of current voice group or voice broadcast calls.

Defined values

<GId>: string of digits that specifies the group identification for the incoming voice group or voice broadcast call.

<GCA>: string of digits that specifies the group call area identification for the incoming voice group or voice broadcast call.

<service>: integer type (tele-service)

17 voice group call

18 voice broadcast call

Implementation

Mandatory for a MT supporting AT commands only and VGCS or VBS is implemented.

11.1.3 Leave an ongoing voice group or voice broadcast call +CAHLD

Table 134: +CAHLD action command syntax

Command	Possible Response(s)
+CAHLD	+CME ERROR: <err>
+CAHLD=?	

Description

The execute command forces the MT to leave the active voice group or voice broadcast call without terminating it. The command is only applicable if the MT is in group receive mode. The MT returns to idle mode. Refer clause 9.2 for possible <err> values.

Implementation

Mandatory for a MT supporting AT commands only and VGCS or VBS is implemented.

11.1.4 Talker access for voice group call +CAPTT

Table 135: +CAPTT parameter command syntax

Command	Possible Response(s)
+CAPTT=[<mode>[,<time>]]	+CME ERROR: <err>
+CAPTT?	+CAPTT: <mode> +CME ERROR: <err>
+CAPTT=?	+CAPTT: (list of supported <mode>s) , (list of supported <time>s)

Description

The execute command emulates the Push To Talk function for VGCS talker access. If the parameter <mode> is set to value "0" i.e. "RELEASED" the PTT key is assumed to be released immediately. If the parameter <mode> is set to value "1" i.e. "PUSHED" the PTT key is assumed to be pushed immediately for the period of <time> in seconds. If the command execution is repeated before the <time> expires the PTT timer will be loaded with the new <time> value and the PTT key remains "PUSHED" for the period of new <time> in seconds.

If the parameter <mode> is set to value "2" i.e. "PUSHED" the PTT key is assumed to be pushed immediately for an infinite period of time and can be released by <mode> value 0. For <mode>=0 if the parameter <time> is issued it is ignored.

If the PTT timer expires after <time> seconds during <mode> "PUSHED" an unsolicited result code +CAPTT: 0 is issued to the TE.

Refer clause 9.2 for possible <err> values.

The read command returns the current <mode>.

The test command returns values supported as compound values.

Defined values

<mode>: integer type.

- 0 status of the PTT key is RELEASED
- 1 status of the PTT key is PUSHED for a limited time by <time> in seconds
- 2 status of the PTT key is PUSHED for an infinite time

<time>: integer type.

- 3..255 this gives the time in seconds to wait before the PTT key is released, default value 10

Implementation

Mandatory for a MT supporting AT commands only and VGCS is implemented.

11.1.5 Voice group call uplink status presentation +CAULEV

Table 136: +CAULEV parameter command syntax

Command	Possible Response(s)
+CAULEV=[<mode>]	+CME ERROR: <err>
+CAULEV?	+CAULEV: <mode>,[<status>] +CME ERROR: <err>
+CAULEV=?	+CAULEV: (list of supported <mode>s)

Description

The set command enables or disables the presentation of uplink access status for an active VGCS call. When enabled the unsolicited result code +CAULEV: <status> is returned from MT to TE whenever the call uplink status changes.

Refer clause 9.2 for possible <err> values.

Read command returns the current uplink <status> and the selected <mode>.

The test command returns values supported as a compound value.

Defined values

<mode>: integer type; status of unsolicited result code presentation.

0 disabled

1 enabled

<status>: integer type; network uplink access status.

0 uplink free

1 uplink busy

Implementation

Mandatory for a MT supporting AT commands only and VGCS is implemented.

11.1.6 List current voice group and voice broadcast calls +CALCC

Table 137: +CALCC action command syntax

Command	Possible response(s)
+CALCC=<mode>	[+CALCC: <GId>,<GCA>,<service>,<stat>,<dir>,<ack_flag>[,<priority>]] [<CR><LF>+CALCC: <GId>,<GCA>,<service>,<stat>,<dir>,<ack_flag>[,<priority>]] [...] +CME ERROR: <err>
+CALCC=?	+CALCC: (list of supported <mode>s)

Description

The set command returns for <mode>=1 the active voice group or voice broadcast call and for <mode>=0 a list of all current running voice group and voice broadcast calls for which the user has a subscription and the GId is activated on

the SIM. If the command succeeds but no calls are available, OK response is returned. Refer clause 9.2 for possible <err> values.

Test command returns the values supported as a compound value.

Defined values

<mode>: integer type.

0 return a list of all current running voice group and voice broadcast calls for which the user has a subscription and the Gid is activated on the SIM

1 return the active voice group or voice broadcast call

<Gid>: string of digits that specifies the group identification of the voice group or voice broadcast call.

<GCA>: string of digits that specifies the group call area of the voice group or voice broadcast call.

<service>: integer type (tele-service).

17 voice group call

18 voice broadcast call

<stat>: integer type (state of the call).

0 active, i.e. user participating at the call as talker or listener

1 held, the call is running but put to background, notifications ignored

2 incoming (MT call), the user doesn't respond to notifications of this call yet

<dir>: integer type (direction of the call).

0 mobile originated (MO) call, the user is the originator of the call

1 mobile terminated (MT) call, the user is not the originator of the call

<ack_flag>: integer type; proposes that a predefined confirmation procedure is to be used after the call is ended.

0 confirmation procedure is not required

1 confirmation procedure is required

<priority>: integer type; identifies the priority level of the voice group or voice broadcast call. The values are specified in 3GPP TS 22.067 [54].

Implementation

Optional. Recommended for an MT supporting AT commands only and VGCS or VBS is implemented.

11.1.7 Voice group or voice broadcast call state attribute presentation +CACSP

Table 138: +CACSP parameter command syntax

Command	Possible Response(s)
+CACSP=[<mode>]	+CME ERROR: <err>
+CACSP?	+CACSP: <mode>[, <da> , <ua> , <comm> , <oi>] +CME ERROR: <err>
+CACSP=?	+CACSP: (list of supported <mode>s)

Description

The set command enables or disables the presentation of unsolicited result code +CACSP: <da>, <ua>, <comm>, <oi> from MT to TE if the call control state attributes of the active voice group or voice broadcast call changes.

Read command returns the current call control state attributes <da>, <ua>, <comm>, <oi> and selected <mode>.

Refer clause 9.2 for possible <err> values.

The test command returns values supported as a compound value.

Defined values

<mode>: integer type; status of unsolicited result code presentation

0 disabled

1 enabled

<da>: integer type. User connection in the downlink

0 not attached

1 attached

<ua>: integer type. User connection in the uplink

0 not attached

1 attached

<comm>: integer type. The MT assumes that communication with its peer entity is

0 not enabled in both directions

1 enabled in both directions

<oi>: integer type. The MT assumes to be

0 not the originator of the call

1 the originator of the call

Implementation

Optional. Recommended for a MT supporting AT commands only and VGCS or VBS is implemented.

11.1.8 NCH support indication +CANCHEV

Table 139: +CANCHEV parameter command syntax

Command	Possible Response(s)
+CANCHEV=[<mode>]	+CME ERROR: <err>
+CANCHEV?	+CANCHEV: <status>, <mode> +CME ERROR: <err>
+CANCHEV=?	+CANCHEV: (list of supported <mode>s)

Description

The set command enables or disables the presentation of unsolicited result code +CANCHEV: <status> from MT to TE if the status of the network NCH support information changes.

Read command returns in parameter <status> the network NCH support information in the selected cell and the selected <mode>.

Refer clause 9.2 for possible <err> values.

The test command returns values supported as a compound value.

Defined values

<mode>: integer type; status of unsolicited result code presentation

0 disabled

1 enabled

<status>: integer type; network NCH support information

0 NCH not available

1 NCH available

Implementation

Optional. Recommended for a MT supporting AT commands only and VGCS or VBS is implemented.

11.1.9 Originator to dispatcher information +COTDI

Table 140: +COTDI parameter command syntax

Command	Possible response(s)
+COTDI=<message>[,<OTDIE>[,<message>[,<OTDIE>]]]	+CME ERROR: <err>
+COTDI?	[+COTDI: <message> ,<OTDIE>[,<message> ,<OTDIE>]]
+COTDI=?	+COTDI: (list of supported <message>s)

Description

This command allows control of the Originator-to-Dispatcher Information and Compressed Originator-to-Dispatcher Information according to 3GPP TS 44.068 [52] and 3GPP TS 44.069 [53].

When <message> and <OTDIE> are both present the string specified in <OTDIE> is included in the corresponding group or broadcast control <message> as the value part of the Originator-to-Dispatcher Information Element or Compressed Originator-to-Dispatcher Information Element (as defined in 3GPP TS 44.068 [52] and 3GPP TS 44.069 [53]) into all subsequent messages of type <message>. If parameter <message> is present but parameter <OTDIE> is not present then the Originator-to-Dispatcher Information Element shall not be present in subsequent messages of type <message>. Refer clause 9.2 for possible <err> values.

The read command returns the content of <message> and of <OTDIE>. If no <OTDIE> is available, no information text shall be returned.

Test command returns values supported as a compound value.

Defined values

<message>: integer type

0 SETUP message containing the outgoing Originator-to-Dispatcher Information Element

1 IMMEDIATE SETUP 2 message containing the outgoing Compressed Originator-to-Dispatcher Information Element

<OTDIE>: the Originator-to-Dispatcher Information Element or Compressed Originator-to-Dispatcher Information Element (as defined in 3GPP TS 44.068 [52] and 3GPP TS 44.069 [53]) in hexadecimal character format (for hexadecimal format, refer +CSCS).

Implementation

Optional.

11.1.10 Short data transmission during ongoing VGCS +CEPTT

Table 141: +CEPTT action command syntax

Command	Possible response(s)
+CEPTT=<mode>, <data>, <dataid>, <dist-param>	+CME ERROR: <err>
+CEPTT=?	+CEPTT: (list of supported <mode>s), (list of supported <dataid>s), (list of supported <dist-param>s)

Description

The execute command emulates the Short Data Transmission during ongoing VGCS according to 3GPP TS 42.068 [55] and 3GPP TS 43.068 [49].

The application indicator <mode> is used to identify whether the application data is an application-specific data or is a confirmation. The data identifier <dataid> is to provide a sequence number of the sending of application data. The value of the data identifier <dataid> is dependent on the value of the application indicator <mode>. If the application indicator <mode> indicates sending application data to the network, the data identifier <dataid> contains a number from the range between 0 and 15 which is generated by the mobile station. If the application indicator <mode> indicates sending confirmation of the reception of the application data, the data identifier <dataid> shall contain the data identifier which was received in the data identity sent by the previous sender. The distribution parameter <dist-param> contains information to which participants shall be transferred the short data.

The response CEPTT string from the network to the other participants is returned in a subsequent unsolicited result code +CEPTT: <mode>, <data>, <dataid>, <dist-param> [, <number>].

Refer clause 9.2 for possible <err> values.

Test command returns values supported as compound values.

Defined values

<mode>: integer type.

- 0 sending of application-specific data
- 1 confirmation of receiving application-specific data

<data>: 9 bytes application-specific data in hexadecimal character format (for hexadecimal character format, refer +CSCS).

<dataid>: integer type, a number from the range between 0 and 15.

<dist-param>: integer type, a number from the range between 1 and 7.

- 1 data shall be distributed only to network application
- 2 data shall be distributed only to dispatchers
- 3 data shall be distributed to network application and to dispatchers
- 4 data shall be distributed to talkers and listeners

- 5 data shall be distributed to talkers and listeners and to network application
- 6 data shall be distributed to talkers and listeners and to dispatchers
- 7 data shall be distributed to network application, to talkers and listeners and to dispatchers

<mode>: integer type.

Implementation

Optional.

11.1.11 Group Id prefixes capability +CGIPC

Table 11.1.11-1: +CGIPC action command syntax

Command	Possible Response(s)
+CGIPC	+CGIPC: <status> +CME ERROR: <err>
+CGIPC=?	

Description

Execution command returns the MT Group Id prefix management capability, according to 3GPP TS 43.068 [49]. Refer clause 9.2 for possible <err> values.

Defined values

<status>: integer type, value

- 0 MT is not able to manage Group Id prefixes
- 1 MT is able to manage Group Id prefixes

Implementation

Optional.

11.2 Modem compatibility commands

11.2.0 General

This clause describes how existing AT commands, designed for use with a modem, may be used to control a VGCS or VBS supporting MT. This is to provide backwards compatibility with existing communications software.

11.2.1 Request VGCS or VBS service 'D'

Table 141a: D command syntax

Command	Possible Response(s)
D* <SC ₁ > [* <SC ₂ > [* <SC ₃ >]] # <Gid> ;	+CME ERROR: <err>

Description

This Dial command extension is a service request application according to 3GPP TS 22.030 [19]. No further commands may follow on the AT command line.

Responses

When the call has terminated, either as a result of an orderly termination or an error, the MT shall return the NO_CARRIER final result code.

Possible error responses include +CME_ERROR: <err> when error is related to MT functionality. The requested service, GId and priority level are checked against the subscriptions of the user and the status of the GId stored on the SIM. In case if no subscription is available for this service, GId or priority level or the GId is deactivated an ERROR or +CME_ERROR result code is returned. The requested Group Id prefix is not checked against subscription. The Group Id prefixes are not stored in the SIM/USIM card. If Service Code for Group Id prefix is used, but is not managed by MT, an ERROR or +CME_ERROR result code is returned. See +CME_ERROR extensions for VGCS, VBS and eMLPP in clause 9.2.3.

Detailed error report of an unsuccessful originated call can be obtained with command Extended Error Report +CEER (if implemented).

NOTE 1: The dial string conforms to the syntax specified in 3GPP TS 22.030 [19].

Defined values

<SC₁>: Service Code is a string of digits which identifies a request to use.

17 Voice Group Call Service

18 Voice Broadcast Service

<SC₂>: Service Code is a string of digits which identifies a request to use eMLPP priority. Service Code values for different priority levels are specified in 3GPP TS 22.030 [19].

<GId>: a string of digits that specifies the group identification of a called party as specified in 3GPP TS 43.068 [49].

<SC₃>: a digit that specifies a Group Id prefix as specified in 3GPP TS 43.068 [49].

NOTE 2: <SC₃> is only applicable when <SC₁> defines Voice Group Call Service.

Implementation

Mandatory for a MT supporting AT commands only and VGCS or VBS is implemented.

11.2.2 Termination of an voice group or voice broadcast call 'H'

The V.250 'H' or 'H0' (On-hook) command may be used to terminate an ongoing voice group or voice broadcast call. The MT responds with OK. It is an error to issue the 'H' command when there is no outstanding network request.

It is an error to issue the 'H' command if the user is in group receive mode or the user is not the originator of the call and a ERROR or +CME_ERROR result code is returned to the TE. Refer clause 9.2 for possible <err> values.

NOTE: This is an extension to the usage of the 'H' command that is described in ITU-T Recommendation V.250 [14].

Implementation

Mandatory for a MT supporting AT commands only and VGCS or VBS is implemented.

11.3 SIM commands supporting the VGCS and VBS

11.3.1 VGCS subscriptions and GId status +CGCS

Table 142: +CGCS parameter command syntax

Command	Possible response(s)
+CGCS=<GId>, <status>	+CME_ERROR: <err>

+CGCS?	+CGCS: <GId>,<status> [<CR><LF>+CGCS: <GId>,<status> [...]] +CME ERROR: <err>
+CGCS=?	+CGCS: (list of supported <GId>s) ,(list of supported <status>s)

Description

This command works with SIM Card and when the GSM Application is selected in UICC. Function with USIM is for further study. The set command is used to edit the status of the GId EF_{VGCS} on the SIM.

The read command returns all subscribed GIDs in EF_{VGCS} and their status in EF_{VGCS} from the SIM.

Refer clause 9.2 for possible <err> values.

The test command returns the values supported by the UE as compound values.

Defined values

<GId> integer type, group Id as specified in 3GPP TS 22.030 [19]

<status>: integer type, value

0 deactivated

1 activated

Implementation

Mandatory for a MT supporting AT commands only and supporting VGCS.

11.3.2 VBS subscriptions and GId status +CBCS

Table 143: +CBCS parameter command syntax

Command	Possible response(s)
+CBCS=<GId>,<status>	+CME ERROR: <err>
+CBCS?	+CBCS: <GId>,<status> [<CR><LF>+CBCS: <GId>,<status> [...]] +CME ERROR: <err>
+CBCS=?	+CBCS: (list of supported <GId>s) ,(list of supported <status>s)

Description

This command works with SIM Card and when the GSM Application is selected in UICC. Function with USIM is for further study. The set command is used to edit the status of the GId EF_{VBS} on the SIM.

The read command returns all subscribed GIDs in EF_{VBS} and their status in EF_{VBS} from the SIM.

Refer clause 9.2 for possible <err> values.

The test command returns the values supported by the UE as compound values.

Defined values

<GId> integer type, group Id as specified in 3GPP TS 22.030 [19]

<status>: integer type, value

0 deactivated

1 activated

Implementation

Mandatory for a MT supporting AT commands only and supporting VBS.

11.4 Informative examples

As supplementary services may be invoked and controlled using dial command according to 3GPP TS 22.030 [19].

Examples of voice group call service request usage:

```

ATD*17*753#500;           (originate voice group call with the priority level 3)
OK                         (voice group call setup was successful)

ATD*17*750*3#299;        (originate voice group call for Group Id 299, with Group Id prefix 3 and priority level 0)
OK                         (voice group call setup was successful)

ATD*17**6#599;           (originate voice group call for Group Id 599, with Group Id prefix 6 and default priority selected by the
OK                         network)
                           (voice group call setup was successful)
    
```

12 Commands for USIM application toolkit

12.1 General

If a UICC connected to an MT uses USIM Application Toolkit (USAT), some USAT features can be provided by the MT itself, whereas other features can be implemented in the TE. This applies especially to MTs with limited capabilities, where the user interface could be provided by the TE.

If there are multiple entities inside the TE providing USAT services, for the purpose of this specification, the TE is visible as one entity handling AT commands and responses on the interface to the TA/MT, see figure 12.1-1.

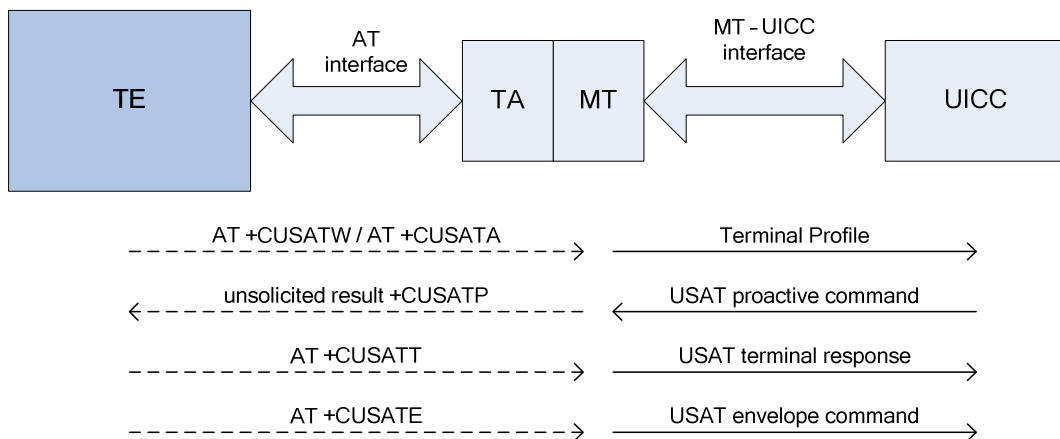

Figure 12.1-1: Overview of the interfaces between TE, TA/MT and UICC for USAT

The AT commands for definition of the USAT profiles and transmission of USAT proactive commands, USAT terminal responses and USAT envelope commands between the TE and UICC are specified in the subsequent clauses.

Compared to APDUs, where the MT is the initiator, USAT defines logic where the UICC is the initiator of the USAT proactive commands and the MT sends responses to these commands. Due to that, USAT proactive commands are sent in unsolicited result codes, whereas the associated responses are transported in subsequent AT commands.

12.2 Commands specific to MTs supporting USAT

12.2.1 Read USAT profile +CUSATR

Table 12.2.1-1: +CUSATR action command syntax

Command	Possible response(s)
+CUSATR[=<profile_storage>]	[+CUSATR: <profile_storage>,<profile>] [<CR><LF>+CUSATR: <profile_storage>,<profile> [...]] +CME ERROR: <err>
+CUSATR=?	+CUSATR: (list of supported <profile_storage>s)

Execution command +CUSATR=<profile_storage> returns the profile specified by <profile_storage>. Execution command issued without parameter; +CUSATR, returns all profiles.

Test command returns values supported as a compound value.

Refer clause 9.2 for possible <err> values.

Defined values

<profile_storage>: integer type.

- 0 TE profile that can be set with +CUSATW.
- 1 MT profile that can be set with +CUSATW.
- 2 MT default profile that reflects the inherent, default supported facilities of the MT.
- 3 UICC profile that reflects the currently active UICC profile that was sent to the UICC in the last TERMINAL PROFILE command.
- 4 UICC EF_{UST}. The elementary file that indicates services available in the USIM.
- 5 List of MT only facilities (facilities that are not allowed to be assigned to the TE, see 3GPP TS 31.111 [92]).

<profile>: string type in hexadecimal character format. The profile describing the supported facilities of the referenced <profile_storage> as specified for the Terminal Profile in 3GPP TS 31.111 [92] or for the related EF in 3GPP TS 31.102 [59].

Implementation

Optional.

12.2.2 Write USAT profile +CUSATW

Table 12.2.2-1: +CUSATW action command syntax

Command	Possible response(s)
+CUSATW[=<profile_storage>[,<profile_storage>],<profile_storage>]	+CUSATW: <profile_storage>,<conflict_profile> +CME ERROR: <err>

+CUSATW=?	+CUSATW: (list of supported <profile_storage>s)
-----------	---

Description

Execution command without parameters resets stored TE and MT profiles to their default values. Adding parameter <profile_storage> to the AT command resets only the referred storage to its default value. Execution command issued with accompanied parameter <profile>, stores the given <profile> to non-volatile memory in the MT.

Upon an attempt to store or reset a profile that conflicts with an already stored profile or the list of MT only facilities, the operation fails and the profile referred to by command parameter <profile_storage> remains unchanged. The MT responds with +CUSATW: <profile_storage>, <conflict_profile> where <profile_storage> refers the conflicting profile followed by the final result code +CME ERROR: 3 (Operation not allowed). If there is a conflict with the MT only facilities, <profile_storage> is set to 5; otherwise <profile_storage> indicates the profile already stored for the TE or for the MT. The rules for detecting conflicts are defined in 3GPP TS 31.111 [92].

Successful execution of the command does not result in any information response.

Test command returns supported values as a compound value.

Refer clause 9.2 for possible <err> values.

Defined values

<profile_storage>: integer type.

- 0 TE. Refers profile storage for the facilities supported by the TE. Default value is a blank profile with all bits set to zero. This value is applicable both in the execution command and in the information response.
- 1 MT. Refers profile storage for the facilities to be supported by MT, which can be a subset of the default MT facilities. The TE can choose to register a subset of the MT default profile, typically omitting facilities also supported by the TE profile. Default value is the MT default profile. This value is applicable both in the execution command and in the information response.
- 5 Refers to a conflict between the TE profile and the list of MT only facilities. This value is not applicable in the execution command.

<profile>: string type in hexadecimal character format. The profile describing the supported USAT facilities of the referenced <profile_storage> as specified for the Terminal Profile in 3GPP TS 31.111 [92].

<conflict_profile>: string type in hexadecimal character format. A bitwise AND of two profiles, showing the conflicts, that is, USAT facilities supported by both profiles. See description of Terminal Profile in 3GPP TS 31.111 [92].

Implementation

Optional.

12.2.3 Profile download upon start-up +CUSATD

Table 12.2.3-1: +CUSATD parameter command syntax

Command	Possible response(s)
+CUSATD=[<download> [, <reporting>]]	+CME ERROR: <err>
+CUSATD?	+CUSATD: <download>, <reporting>
+CUSATD=?	+CUSATD: (list of supported <download>s) , (list of supported <reporting>s)

Description

This command determines if, and optionally which profile should be downloaded to the UICC automatically upon start-up. If, prior to a restart/start-up, the +CUSATD settings have not been altered, then the default settings determine the behaviour upon start-up. However, if the parameters of +CUSATD has been set to other than default and then a restart is performed (e.g. by +CFUN), these values determine the behaviour. This is true for one restart only after altering +CUSATD parameters as they are always reset to default at the end of the next UICC start-up (i.e. when the USIM initialisation as specified in 3GPP TS 31.102 [98] has been completed).

The command without parameters resets the parameters to their default values.

The command can only be used if the UICC is already in active state (<UICC_state> 4, e.g. upon +CUSATA) or in download completed state (<UICC_state> 2) and the UICC does not support the "Additional TERMINAL PROFILE after UICC activation" feature (see 3GPP TS 31.111 [92]). In all other cases the command responds with +CME ERROR: 14 (SIM busy).

+CUSATD=<download>, 1 also enables the unsolicited result code +CUSATS: <UICC_state>. The MT uses this unsolicited result code to indicate that a profile download is performed (setting +CUSATD=0, 1 or +CUSATD=1, 1) or that it is ready for profile download (setting +CUSATD=2, 1). In both cases, the MT also indicates the end of UICC start-up by the unsolicited result code +CUSATS: 4. If the UICC is awaiting PIN verification during start-up, this is also reported.

When using +CUSATD=1, the +CUSATA=1 command has to be used to enable TE profile facility handling after restart. In the time between profile download and issuance of +CUSATA=1, the UICC may already attempt to issue proactive commands. The MT will not send these to the TE, but rather give the UICC the response "terminal currently unable to process command" autonomously. The UICC may implement only a limited number of retries, which can potentially leave USAT in an unwanted state if the +CUSATA=1 command arrives late.

NOTE: Care has to be taken when using +CUSATD=2. If no +CUSATA=2 or +CUSATA=3 is sent during start-up, USAT is also blocked for the MT.

Test command returns supported values as compound values.

Refer clause 9.2 for possible <err> values.

Defined values

<download>: integer type. Parameter decides when/if to perform a profile download to UICC and which profile to download. The default value is implementation specific.

- 0 Download MT default profile automatically during next start-up.
- 1 Download the combined TE and MT profile (merger of the profiles written by +CUSATW) automatically during next start-up. The rules for merging profiles are defined in 3GPP TS 31.111 [92].
- 2 Halt next UICC start-up when ready for profile download. Profile to download will be selected and download will be triggered by +CUSATA.

<reporting>: integer type. Parameter enables unsolicited result code +CUSATS: <UICC_state> to notify the TE about a new state during start-up.

- 0 Disable +CUSATS, i.e. no notification.
- 1 Enable +CUSATS, i.e. notify TE.

<UICC_state>: integer type. Parameter reports that the UICC entered a new state during start-up or that the UICC ended startup and entered active state.

- 0 UICC start-up in progress, before profile download.
- 1 UICC start-up halted and ready for profile download. This state is reached if +CUSATD=2 was issued before restart. UICC start-up will continue upon +CUSATA=2 or +CUSATA=3.
- 2 Profile download completed, UICC startup continuing.
- 3 UICC awaiting PIN verification.

4 UICC active.

Implementation

Optional.

12.2.4 Activate USAT profile +CUSATA

Table 12.2.4-1: +CUSATA action command syntax

Command	Possible response(s)
+CUSATA[=<activation>]	+CUSATA: <UICC_state>[,<additional_profile_support>] +CME ERROR: <err>
+CUSATA=?	+CUSATA: (list of supported <activation>s)

Description

Execution command +CUSATA retrieves the current UICC state or downloads a profile to the UICC and/or activates handling of the TE profile facilities.

A positive result upon a +CUSATA=1 or +CUSATA=3 command (also) enables TE profile facility handling via unsolicited result codes +CUSATP: <proactive_command> and +CUSATEND. The MT uses the unsolicited result code +CUSATP: <proactive_command> to forward to the TE proactive commands issued by the UICC. The unsolicited result code +CUSATEND is issued by the MT when the UICC indicates that the proactive command session is terminated, i.e. in response to a USAT terminal response, the UICC indicates that no other USAT proactive command is pending. Lastly, terminal responses to the proactive commands can now be issued with +CUSATT=<terminal_response> and envelope commands can be issued with +CUSATE=<envelope_command>.

If the action requested by the +CUSATA command can not be performed, the information response +CUSATA: <UICC_state>[,<additional_profile_support>] is returned with appropriate values, followed by the final result code +CME ERROR: 4 (Operation not supported) in case the UICC does not support USAT at all, or the final result code +CME ERROR: 3 (Operation not allowed) in all other cases.

If the UICC is already in active state and the UICC does not support the "Additional TERMINAL PROFILE after UICC activation" feature (see 3GPP TS 31.111 [92]), the TE has the option to perform a reset of the UICC or use +CFUN to get back to an initial non-active UICC state. The +CUSATD command can be used to set profile handling upon the next restart.

All USAT proactive commands that the MT does not process itself and all terminal responses from the TE are transparently forwarded by the MT. The routing mechanism for USAT commands supported by both entities is specified in 3GPP TS 31.111 [92].

Test command returns values supported as a compound value.

Refer clause 9.2 for possible <err> values.

Defined values

<activation>: integer type.

- 0 Return status information only, in information response:
+CUSATA: <UICC_state>[,<additional_profile_support>].
- 1 Enable TE profile facility handling only, no profile download. This action can only be used if the combined TE and MT profile was downloaded during start-up (setting +CUSATD=1).
- 2 Download MT default profile.

- 3 Download the combined TE and MT profile (merger of the profiles written by +CUSATW) and enable TE profile facility handling. The rules for merging profiles are defined in 3GPP TS 31.111 [92].

<UICC_state>: integer type. Parameter reports that the UICC entered a new state during start-up or that the UICC ended startup and entered active state.

- 0 UICC start-up in progress, before profile download.
- 1 UICC start-up halted and ready for profile download. This state is reached if +CUSATD=2 was issued before restart. UICC start-up will continue upon +CUSATA=2 or +CUSATA=3.
- 2 Profile download completed, UICC startup continuing.
- 3 UICC awaiting PIN verification.
- 4 UICC active.

<additional_profile_support>: integer type. Indicates whether the UICC supports the "Additional TERMINAL PROFILE after UICC activation" feature (see 3GPP TS 31.111 [92]). The value may not be available during early phases of start-up.

- 0 No support.
- 1 Supported.

<proactive_command>: string type in hexadecimal character format. Proactive command as defined in 3GPP TS 31.111 [92], consisting of the full BER-TLV data object.

Implementation

Optional.

12.2.5 Send USAT terminal response +CUSATT

Table 12.2.5-1: +CUSATT action command syntax

Command	Possible response(s)
+CUSATT=<terminal_response>	+CME ERROR: <err>
+CUSATT=?	

Description

Execution command sends a USAT terminal response to the MT as an answer to a preceding USAT proactive command sent from the UICC with unsolicited result code +CUSATP: <proactive_command> (see +CUSATA command description).

Refer clause 9.2 for possible <err> values.

Defined values

<terminal_response>: string type in hexadecimal character format. Terminal response to a proactive command as defined in 3GPP TS 31.111 [92], consisting of the full BER-TLV data object.

Implementation

Optional.

12.2.6 Send USAT envelope command +CUSATE

Table 12.2.6-1: +CUSATE action command syntax

Command	Possible response(s)
+CUSATE=<envelope_command>	+CUSATE: <envelope_response>[,<busy>] [<CR><LF>+CUSATE2: <sw1> ,<sw2>] +CME ERROR: <err>
+CUSATE=?	

Description

Execution command allows the TE to send a USAT envelope command to the MT. If the UICC provides response data to the command or indicates that USAT is busy, the information response

+CUSATE: <envelope_response>[,<busy>] is returned. A second line of information response +CUSATE2: <sw1> ,<sw2> may be provided if the MT presents the status words provided by the UICC.

Refer clause 9.2 for possible <err> values.

Defined values

<envelope_command>: string type in hexadecimal character format. Envelope command as defined in 3GPP TS 31.111 [92], consisting of the full BER-TLV data object.

<envelope_response>: string type in hexadecimal character format. Response to the envelope command as defined in 3GPP TS 31.111 [92], consisting of the full BER-TLV data object. An empty string is provided if the UICC does not have any response data to provide.

<busy>: integer type.

- 0 UICC indicated normal ending of the command.
- 1 UICC responded with USAT is busy, no retry by the MT.
- 2 UICC responded with USAT is busy even after one or more retries by the MT.

<sw1>: integer type. Status word information from the envelope response returned by the UICC as defined in ETSI TS 102 221 [60], clause 10.2. The parameter can be delivered to the TE both in the case of successful and failed execution of the envelope command.

<sw2>: integer type. For description see <sw1>.

Implementation

Optional.

12.3 Informative examples

These examples provide a sequence of interactions where USAT commands and responses are transmitted in AT commands. As it would make the examples unreadable, USAT data is not given in its hexadecimal representation (which is found in 3GPP TS 31.111 [92]), but in abstract textual form. For readability, only a subset of USAT facilities typically provided in a profile is given in the examples. Resulting or triggering actions on the MT-UICC interface are also indicated in the examples.

First, the TE reads the MT default profile:

```
AT+CUSATR=2
+CUSATR: 2,<PLAY TONE, SET UP MENU, DISPLAY TEXT, EVENT MENU SELECTION, ...>
OK
```

The TE removes some USAT facilities in the MT by writing a new MT profile, which contains those facilities that are to be handled by the MT:

```
AT+CUSATW=1,<PLAY TONE, ...>
OK
```

Now the TE tries to write a TE profile that conflicts with the MT profile. The MT responds with the conflict information and rejects the command.

```
AT+CUSATW=0,<PLAY TONE, SET UP MENU, DISPLAY TEXT, EVENT MENU SELECTION, ...>
+CUSATW: 1,<PLAY TONE>
+CME ERROR: 3
```

The next attempt to write a TE profile is successful and the TE activates the profiles.

```
AT+CUSATW=0,<SET UP MENU, DISPLAY TEXT, EVENT MENU SELECTION, ...>
OK
AT+CUSATA=3
  MT -> UICC: TERMINAL PROFILE
  UICC -> ME: proactive command pending
OK
```

The UICC sends a SET UP MENU proactive command, resulting in the command being transferred to the TE and the latter confirming it with a terminal response; thereafter the proactive session ends.

```
  UICC -> MT: SET UP MENU
+CUSATP: <SET UP MENU>
AT+CUSATT=<OK>
  MT -> UICC: TERMINAL RESPONSE: OK
  UICC -> ME: no proactive command pending
OK
+CUSATEND
```

A selection by the subscriber in the menu results in an ENVELOPE being sent to the MT and forwarded to the UICC. The UICC responds with the next proactive command DISPLAY TEXT. After the terminal response, the proactive session ends.

```
AT+CUSATE=<MENU SELECTION, item=1>
  MT -> UICC: ENVELOPE(MENU SELECTION, item=1)
  UICC -> ME: proactive command pending
OK
  UICC -> MT: DISPLAY TEXT
+CUSATP: <DISPLAY TEXT>
AT+CUSATT=<OK>
  MT -> UICC: TERMINAL RESPONSE: OK
  UICC -> ME: no proactive command pending
OK
+CUSATEND
```

The TE defines UICC profile download options. The definition is effective for the next UICC start-up.

```
AT+CUSATD=1,1
OK
```

The UICC restarts. The MT reports the start-up. During start-up the profile download definition cannot be altered and the MT responds error code 14 (SIM busy).

```
+CUSATS: 0
AT+CUSATD=2,1
+CME ERROR: 14
```

The UICC is awaiting PIN verification. During PIN verification the profile download definition cannot be altered and the MT responds error code 14 (SIM busy).

```
+CUSATS: 3
AT+CUSATD=2,1
+CME ERROR: 14
```

The UICC becomes active and the profile download definition can be changed.

```
+CUSATS: 4
AT+CUSATD=2,1
OK
```

The TE enables the downloaded profile.

```
AT+CUSATA=1
```

OK

The TE reads the TE profile:

```
AT+CUSATR=0
+CUSATR: 0,<PLAY TONE, SET UP MENU, DISPLAY TEXT, EVENT MENU SELECTION, ...>
OK
```

Now the TE tries to write a MT profile that conflicts with the TE profile. The MT responds with the conflict information and rejects the command.

```
AT+CUSATW=1,<DISPLAY TEXT, ...>
+CUSATW: 0,<DISPLAY TEXT>
+CME ERROR: 3
```

The next attempt to write a MT profile is successful.

```
AT+CUSATW=1,<SET UP MENU, EVENT MENU SELECTION, ...>
OK
```

The TE reads the List of MT only facilities:

```
AT+CUSATR=5
+CUSATR: 5,<POLL INTERVAL, POLLING OFF, PROVIDE LOCAL INFORMATION (NMR), ...>
OK
```

Now the TE tries to write a TE profile that conflicts with the MT only facilities. The MT responds with the conflict information and rejects the command.

```
AT+CUSATW=0,<POLL INTERVAL, ...>
+CUSATW: 5,<POLL INTERVAL>
+CME ERROR: 3
```

The next attempt to write a TE profile is successful.

```
AT+CUSATW=0,<SET UP MENU, DISPLAY TEXT, EVENT MENU SELECTION, ...>
OK
```

13 Commands for enhanced support of dialling

13.1 General

This clause defines commands that a TE may use when dialling. These commands can be used instead of ATD that does not support dialling of URIs.

Clause 13.2 defines commands for dialling (direct dialling and dialling from phonebook) as well as hangup of these calls.

Clause 13.3 contains relevant examples.

13.2 Commands for dialling

13.2.1 Dial URI +CDU

Table 13.2.1-1: +CDU action command syntax

Command	Possible response(s)
+CDU=<action>[,<URI>[,<client>[,<mpidx>[,<CLIR_OIR>[,<CUG_pointer>[,<type_of_call>]]]]]]]	<p>+CME ERROR: <err></p> <p>when <action>=0 and command successful:</p> <p>[+CDUT: <URI_scheme>[,<client>] [<CR><LF>+CDUT: <URI_scheme>[,<client>]] [...]]</p> <p>when <action>=1 and command successful:</p> <p>[+CDU: <ccidx>]</p> <p>when <action>=1 and command unsuccessful:</p> <p>[+CDUI: <cause>]</p>
+CDU=?	+CDU: (list of supported <URI_scheme>s)

Description

Execution command can be used to dial a URI (with <action>=1) for initiating communication using the specified communication client with the specified media profile. With <action>=0 the command can query which clients are supported for the URI types supported.

When the command is used to query the supported URI types (i.e. <action>=0), the URI types are provided by +CDUT: <URI_scheme>. When the command is used to dial a URI (i.e. <action>=1) and the dialling succeeds the command is terminated by +CDU: <ccidx> and OK. The parameters <CLIR_OIR> and <CUG_pointer> are used to set the per call basis values of the supplementary services CLIR / OIR and CUG.

The unsolicited result code +CDUU: <ccidx>, <code> can be subsequently provided to give further basic information about the call as it progresses. The value of the <ccidx> is kept until the call is released. See command +CMCCS and unsolicited result code +CMCCSI for provision of additional information about the call setup.

If "Call control by USIM" see 3GPP TS 31.111 [92] clause 4.5 is activated by the USIM, it is the responsibility of the communication client to perform any required call control verification according to the procedures defined in 3GPP TS 31.111 [92] clause 7.3 prior to the execution of the call setup.

When call control by USIM is applicable, the communication client shall perform the call control (for example by using the Commands for USIM application toolkit, see clause 12) and act upon the result of the call control as follows:

- if call control by USIM performs no modifications to the call request, the call setup shall be executed without any changes to the data;
- if call control by USIM modifies the call request, the call setup shall be executed using the modified data as provided by the call control;
- if call control by USIM modifies the call request to a different service, the appropriate AT command(s) for that service shall be executed; and
- if call control by USIM rejects the call request, the call setup shall not be executed.

If the attempt to dial does not succeed, the command is terminated by `ERROR / CME ERROR` or `+CDUI: <cause>` and `OK`. Refer clause 9.2 for possible `<err>` values.

Test command returns values supported as a compound value.

Defined values

`<action>`: integer type

- 0 Query supported communication clients for the supported URI types. Execution command `+CDU=0` returns a line of intermediate result code `+CDUT: <URI_scheme>[, <client>]` for every supported `<URI_scheme>`.
- 1 Dial `<URI>` using the indicated communication client with the indicated media profile.

`<URI>`: string type. URI including the prefix specifying the URI type. The URI may include URI parameters. The used character set should be the one selected with command `select TE` character set `+CSCS`.

`<CLIR_OIR>`: integer type. Indicates per call basis changes provided to the supplementary service CLIR / OIR. See `+CLIR` for further information of the related parameters.

- 0 No per call based changes to CLIR / OIR, the settings with `+CLIR` apply
- 1 Restrict the CLI presentation for the current call (CLIR / OIR invocation)
- 2 Allow CLI presentation for the current call (CLIR / OIR suppression)

`<CUG_pointer>`: integer type. Indicates per call basis changes provided to the supplementary service closed user group. See `+CECUG` for further information of the related parameters.

- 0 No per call basis changes to CUG
- 1-n Indicates the CUG index to use for this call. The CUG index and corresponding values used as set with command `+CECUG` (enable CUG temporary mode). The maximum value of n is implementation specific.

NOTE 1: 3GPP TS 22.085 [21] indicates that each individual subscriber can be a member of a maximum of 10 CUGs.

`<type_of_call>`: integer type. Indicates type of call on per call basis.

- 0 Normal call
- 1 Dual radio voice call continuity call.

`<URI_scheme>`: string type represented with IRA characters. Parameter identifies supported URI scheme. This parameter shall not be subject to conventional character conversion as per `+CSCS`.

- "sip" Internet Assigned Number Authority (IANA) registry as per RFC 3969 [113], used with Session Initiation Protocol (SIP), see RFC 3261 [111].
- "tel" Internet Assigned Number Authority (IANA) registry as per RFC 5341 [114], used with SIP, see RFC 3966 [112].
- "urn" Internet Assigned Number Authority (IANA) registry according to RFC 2141 [116], only used with SIP in combination with a suitable uniform resource name (URN) namespace.

NOTE 2: The URN namespace "service" listed in the Internet Assigned Number Authority (IANA) registry according to RFC 3406 [117] is an example of a namespace that can be used in SIP in combination with the URI scheme "urn". Not all top-level service labels listed in the Internet Assigned Number Authority (IANA) registry according to RFC 5031 [118] need to be supported in combination with the URN namespace "service".

`<client>`: integer type. Communication client indication. The default value is implementation specific.

- 1 MMTel. The UE procedures in 3GPP TS 24.173 [87] apply.

128 – 255 Reserved for vendor specific communication clients.

<mpidx>: integer type. Media profile identification number. The parameter is local to the TE-MT interface. The range of permitted values (minimum value = 1) is returned by the test form of the command +CDEFMP. When +CDU is used for dialling (i.e. with <action>=1) this number can be provided to point to a particular media profile. The provided media profile identification number is the number being returned by +CDEFMP when defining the media profile. Usage and value of a default media profile is implementation specific.

<ccidx>: integer type. Call identification number as described in 3GPP TS 22.030 [19] clause 6.5.5.1. This number can be used in +CHLD command operations. Value range is from 1 to N. N, the maximum number of simultaneous call control processes is implementation specific.

NOTE 3: When +CMCCS is supported, the call identification number is not reset until the unsolicited result code +CMCCSI has indicated that the <ccstatus>=1 (Idle).

<code>: string type represented with IRA characters. Cause codes giving main call state information. Intermediate call status responses can be reported using the unsolicited result code +CMCCSI (see command +CMCCS). This parameter shall not be subject to conventional character conversion as per +CSCS.

"BUSY"	Busy signal detected
"ANSWERED"	Remote party has answered and the connection between A and B has been established
"NO ANSWER"	Connection completion timeout
"CONNECTION TERMINATED"	The connection is terminated from either the remote party or the network, or the attempt to establish the call setup is unsuccessful

NOTE 4: The cause code "CONNECTION TERMINATED" also covers all other situations where a call is unsuccessfully terminated. Examples of this are all types of network congestion or lack of radio coverage.

<cause>: integer type. Reason code providing further details why the call setup fails in the terminal before signalling towards the network is initiated.

- 0 Outgoing call attempt rejected by (U)SIM/ME, unspecified
- 1 Outgoing call attempt rejected by barring services in the SIM/ME

Implementation

Optional.

13.2.2 Dial URI from phonebook +CDUP

Table 13.2.2-1: +CDUP action command syntax

Command	Possible response(s)
+CDUP=<pb_field>,<str>[,<client>[,<mpidx>[,<storage>]]]	+CME ERROR: <err> when command successful: [+CDUP: <ccidx>]
+CDUP=?	

Description

Execution command dials a URI for initiating communication using the specified communication client with the specified media profile by referencing either the alphanumeric phonebook field, or the index or entry-number in the phonebook. Supported clients URI schemes are those returned with +CDU=0. If parameter <storage> is not

included, the relevant phonebook is specified by the current +CPBS setting. If the referenced URI is not found, OK is returned and nothing is dialled.

+CDUP=0 , <str> originates a call to the first URI found in the selected phonebook which has a partial or full match to <str>. The mechanism to search for the first match through a phonebook is implementation specific. Upon no match in the selected phonebook, it is manufacturer specific if and what further phonebook memories are searched.

+CDUP=1 , <str> originates a call to the URI in memory location <str>, where <str> must contain a decimal number. The index or entry-number in the phonebook is expressed by <str>.

How the string of digits or the index or entry-number is associated with entries is implementation specific.

The command is terminated by +CDUP: <ccidx> and OK or ERROR / CME ERROR. Refer clause 9.2 for possible <err> values.

Defined values

<pb_field>: integer type

- 0 Refers alphanumeric field of the phonebook. <str> may contain valid characters for alphanumeric field of the selected phonebook.
- 1 Refers index or entry-number in the phonebook.

<str>: string type. Valid characters are governed by <pb_field>.

<storage>: string type. Supported values are the same as that supported for <storage> of +CPBS.

<client>: integer type. Communication client indication.

- 1 MMTel. The UE procedures in 3GPP TS 24.173 [87] apply.
- 128 – 255 Reserved for vendor specific communication clients.

<mpidx>: integer type. Media profile identification number. The parameter is local to the TE-MT interface. The range of permitted values (minimum value = 1) is returned by the test form of the command +CDEFMP. The provided media profile identification number is the number being returned by +CDEFMP when defining the media profile. Usage and value of a default media profile is implementation specific.

<ccidx>: integer type. Call identification number as described in 3GPP TS 22.030 [19] clause 6.5.5.1. This number can be used in +CHLD command operations. Value range is from 1 to N. N, the maximum number of simultaneous call control processes is implementation specific.

Implementation

Optional.

13.2.3 Hangup of current calls +CHCCS

Table 13.2.3-1: +CHCCS action command syntax

Command	Possible response(s)
+CHCCS=<ccid>[,<cause>]	<p>+CME ERROR: <err></p> <p>when <ccid>=value>0 is inserted and command successful:</p> <p>[+CHCCSI: <ccid>]</p> <p>when <ccid>=0 is inserted and command successful:</p> <p>[+CHCCSI: <ccid> [<CR><LF>+CHCCSI: <ccid>] [...]]</p>
+CHCS=?	

Description

Execution command causes the TA to initiate hangup and subsequently perform call clearing of the call for which a <ccid> was provided when the call was detected in the MT. The parameter <cause> can be added to indicate particular information on the cause for call clearing. Setting the parameter <cause> to values 2 or 3 is typically relevant for call clearing before a call has been established (e.g. an incoming or waiting call). The parameter <cause> is ignored by the lower layers if it is not according to the signalling procedures in question.

A special form of the execution command, +CHCCS=0, causes the TA to initiate hangup and subsequently perform call clearing of all calls for which a <ccid> was provided when the call was detected in the MT. The parameter <cause> will be ignored if <ccid>=0.

The information text +CHCCSI: <ccid> is provided for each call where a successful hangup is initiated as result of the +CHCCS. If no hangup is initiated, no information text is provided before OK is returned.

NOTE 1: The command +CHCCS=0 will initiate hangup of all calls with a <ccid>. This also applies to calls on hold and call waiting calls.

Refer clause 9.2 for possible <err> values.

Defined values

<ccid>: integer type. Call identification number as described in 3GPP TS 22.030 [19] clause 6.5.5.1. This number can be used in +CHLD command operations. Value range is from 1 to N. N, the maximum number of simultaneous call control processes is implementation specific.

NOTE 2: When +CMCCS is supported, the call identification number is not reset until the unsolicited result code +CMCCSI has indicated that the <ccstatus>=1 (Idle).

<cause>: integer type. Proposed cause value for call clearing.

- 0 No particular cause indicated
- 1 Cause "Normal call clearing" (value 16), see 3GPP TS 24.008 [8] table 10.5.123 or BYE request, see RFC 3261 [111] clause 15.1
- 2 Cause "Call rejected" (value 21), see 3GPP TS 24.008 [8] table 10.5.123 or "488 Not Acceptable Here", see RFC 3261 [111] clause 21.4.26
- 3 Cause "User busy" (value 17), see 3GPP TS 24.008 [8] table 10.5.123 or "486 Busy Here", see RFC 3261 [111] clause 21.4.24

Implementation

Mandatory when +CDU is implemented in the TA.

13.2.4 Define media profile +CDEFMP

Table 13.2.4-1: +CDEFMP parameter command syntax

Command	Possible response(s)
+CDEFMP=[<mpidx>][,<SDP_md>]	+CME ERROR: <err> When no <mpidx> but <SDP_md> provided and command successful: [+CDEFMP: <mpidx>]
+CDEFMP?	[+CDEFMP: <mpidx>,<SDP_md> [<CR><LF>+CDEFMP: <mpidx>,<SDP_md> [...]]]
+CDEFMP=?	+CDEFMP: (range of supported <mpidx>s)

Description

A media profile is identified by its media profile identification number. A media profile defines an SDP media description to be used in SDP offers and SDP answers. Media profiles can be used with +CDU and +CDUP when dialling URIs.

The set command specifies the SDP media description for a media profile identified by the (local) media profile identification number, <mpidx>. When no <mpidx> value is provided then a new SDP media description is defined and the media profile's identification number is returned by the command's response. When an <mpidx> value is provided, the definition of the SDP media description identified by the media profile identification number <mpidx> is replaced with the SDP media description provided by the command.

A special form of the set command, +CDEFMP=<mpidx> causes the SDP media description for the indicated media profile to become undefined. Further, +CDEFMP= causes the SDP media description for all defined media profiles to become undefined.

The read command returns a list of all defined media profiles.

The test command returns values supported as a compound value.

Refer clause 9.2 for possible <err> values.

Defined values

<mpidx>: integer type. Media profile identification number. The parameter is local to the TE-MT interface. The range of permitted values (minimum value = 1) is returned by the test form of the command. The MT shall use the indicated SDP media description for the <mpidx> in the initial SDP offer for a call setup.

<SDP_md>: string type represented with IRA characters. SDP media description including media level SDP lines. This parameter shall not be subject to conventional character conversion as per +CSCS.

This parameter can contain the following types of SDP lines: SDP m-lines, SDP a-lines and partial SDP m-lines.

The communication client in the MT shall take into account SDP a-line rtpmap and fmtp attributes when negotiating media. Which other attributes in media level SDP a-lines are taken into account by the communication client is implementation specific.

Partial SDP m-lines include nothing but a media type.

For every media either an SDP m-line or a partial SDP m-line must be provided.

SDP m-lines indicate that the described media is encoded/decoded outside the MT.

Partial SDP m-lines indicate that the described media is encoded/decoded by the MT. When negotiating media the MT adds payload information to the partial SDP m-line.

The communication client in the MT shall use the provided SDP line information when negotiating media. The communication client shall add other SDP lines required for negotiating media.

Informative examples

The MT handles encoding and decoding of audio media, and the TE supports two types of video media, as described by the following SDP lines:

```
m=audio
m=video 99 98
a=rtpmap:99 H264/90000
a=fmtp:99 profile-level-id=4D4033
a=rtpmap:98 MP4V-ES/90000
a=fmtp:98 profile-level-id=1
```

To indicate its support for both audio and video media for an incoming or outgoing call, the TE uses the following <SDP_md>:

```
"m=audio\0D\0Aa=video 99 98\0D\0Aa=rtpmap:99 H264/90000\0D\0Aa=fmtp:99 profile-level-id=4D4033\0D\0Aa=rtpmap:98 MP4V-ES/90000\0D\0Aa=fmtp:98 profile-level-id=1"
```

The TE intends to offer a file transfer over MSRP, as described by the following SDP lines:

```
m=message 7654 TCP/MSRP *
i=This is my latest picture
a=sendonly
a=accept-types:message/cpim
a=accept-wrapped-types:*
a=path:msrp://atlanta.example.com:7654/jshA7we;tcp
a=file-selector:name:"My cool picture.jpg" type:image/jpeg
```

When proposing the MSRP file transfer to the remote party, the TE uses the following <SDP_md>:

```
"m=message 7654 TCP/MSRP *\0D\0Aa=sendonly\0D\0Aa=accept-types:message/cpim\0D\0Aa=accept-wrapped-types:*\0D\0Aa=path:msrp://atlanta.example.com:7654/jshA7we;tcp\0D\0Aa=file-selector:name:\22My cool picture.jpg\22 type:image/jpeg"
```

NOTE: The SDP i-line is not provided as part of the <SDP_md> value.

Implementation

Optional.

13.2.5 Control and modify media description +CCMMD

Table 13.2.5-1: +CCMMD parameter command syntax

Command	Possible response(s)
+CCMMD=<ccid>,<neg_status>[,<SDP_md>]	
+CCMMD?	
+CCMMD=?	

Description

This command allows control of the media used in a multimedia call. The command can be used to initiate modification of the media of an ongoing call, to accept, modify or reject incoming changes in media or to accept, modify or reject the media for an incoming call. Supported media types are typically audio, video and messaging (MSRP).

When <ccidx> matches the index of an ongoing call, the TA/MT will attempt to add or remove media to the call by triggering an SDP renegotiation over the SIP protocol.

When <neg_status>=1, the set command requests an unconditional change the media of the call to that described by <SDP_md>.

When <neg_status>=2, the set command proposes a change of media to that described by <SDP_md>, to which the remote party has to respond before the media of the call is changed. The response from the remote party will be indicated in a +CMCCSI unsolicited result code. If the remote party accepts the change of media, the <neg_status> value in +CMCCSI will be set to 3. If the remote party rejects the change of media, <neg_status> will be set to 4. In both cases the <SDP_md> value in +CMCCSI will describe the currently active media of the call (if any).

If the remote party unconditionally changes the media of the call, this will be indicated in a +CMCCSI unsolicited result code, with <neg_status>=1 and <SDP_md> containing the updated (and now active) media description.

If the remote party proposes to change the media of an ongoing call, this will be indicated in a +CMCCSI unsolicited result code, with <neg_status>=2. The set command is used to respond to the proposal, either by accepting it by setting <neg_status>=3, by rejecting it by setting <neg_status>=4, or indicate that a subset of the incoming proposal is accepted by setting the <neg_status>=3 along with the <SDP_md> containing the subset of the incoming proposal is acceptable.

When the MT receives an incoming call from a remote party, the +CMCCSI unsolicited result code will be sent to the TE with <neg_status>=2. This proposed media for the new call is either accepted, modified or rejected as described above.

Defined values

<ccidx>: integer type. Call identification number as defined in the +CMCCS and +CLCCS commands.

<neg_status>: integer type

- 1 The <SDP_md> parameter describes the desired set of media for the call.
- 2 The <SDP_md> parameter describes a proposal for a new set of media for the call.
- 3 Accept the most recently received media proposal. The <SDP_md> parameter describes the accepted media for the call.
- 4 Reject the most recently received media proposal.

<SDP_md>: string type represented with IRA characters. Media description as per the +CDEFMP command. This parameter shall not be subject to conventional character conversion as per +CSCS.

Implementation

Optional.

13.3 Informative examples

Below is an example where a voice call originated with +CDU is placed to a tel-URI. This example outlines how the call is initiated by the AT command +CDU, and how the unsolicited result code +CDUU is used to indicate how the call-setup progress until it is terminated. Both successful and unsuccessful outcome of a call attempt is shown in the example.

```
AT+CDU=1, "tel:+47-123-45678"
+CDU: 2
OK
```

```
(Voice call initiated)
(Call initiated, call identification number 2 provided)
(Call initiation successful)
```

(Call setup progress, unsolicited result codes appear as appropriate)

(If call is answered by the remote party)
(Remote party has answered)

+CDUU: 2, "ANSWERED"

(If remote party does not answer)
(Connection completion timeout)

+CDUU: 2, "NO ANSWER"

(If remote party is busy)
(Busy signal detected)

+CDUU: 2, "BUSY"

(If call is terminated from remote party)
(Connection terminated from remote party)

+CDUU: 2, "CONNECTION TERMINATED"

(If call is terminated from calling party)
(Connection with call identification number 2 terminated from calling party)

AT+CHCCS=2
+CHCCSI: 2
OK

Below is an example where a multimedia-call (voice) originated with +CDU is placed to a SIP-URI. This example outlines how the call is initiated by the AT command +CDU, and how the unsolicited result codes +CDUU and +CMCCSI are used to indicate how the call-setup progress until it is terminated. A precondition for this example is that the basic event for the call monitoring function is successfully enabled with +CMCCS=2.

AT+CDU=1, "sip:veronica@university.org" (Multimedia-call (voice) initiated)
+CDU: 4 (Call initiated, call identification number 4 provided)
OK (Call initiation successful)

(+CDUU and +CMCCSI appear as appropriate)

+CMCCSI: 4,0,0,0,"",0,2,0,1,0,"sip:veronica@university.org",0,0 (Call setup is started)
+CMCCSI: 4,0,0,0,"",0,3,0,1,0,"sip:veronica@university.org",0,0 (Call is in progress)
+CMCCSI: 4,0,0,0,"",0,4,0,1,0,"sip:veronica@university.org",0,0 (Alert indication received)

CDUU: 4, "ANSWERED" (Remote party answered)

+CMCCSI: 4,0,0,0,"",0,6,0,1,0,"sip:veronica@university.org",0,0 (Connection established)

AT+CHCCS=4 (Connection with call identification number 4 terminated)
+CHCCSI: 4
OK

+CMCCSI: 4,0,0,0,"",0,7,0,1,0,"sip:veronica@university.org",2,200 (Outgoing connection released)
+CMCCSI: 4,0,0,0,"",0,0,0,1,0,"sip:veronica@university.org",0,0 (Idle)

Below is an example where a multimedia-call originated with +CDU is placed to a SIP-URI. This example outlines how the call is initiated by the AT command +CDU, and how the unsolicited result codes +CDUU and +CMCCSI are used to indicate how the call-setup progresses until it is terminated. A precondition for this example is that the basic event for the call monitoring function is successfully enabled with +CMCCS=2. This example illustrates the use of the +CDEFMP and +CCMMD commands to define and control the types of media that are used in the call.

AT+CDEFMP=, "m=audio" (Media profile defined, offering only audio)
+CDEFMP=3 (Media profile index number 3 provided)
OK

AT+CDU=1, "sip:veronica@university.org",1,3 (Multimedia-call initiated, using media profile number 3)
+CDU: 5 (Call initiated, call identification number 5 provided)
OK (Call initiation successful)

(+CDUU and +CMCCSI appear as appropriate)

+CMCCSI: 5,0,0,0,"",0,2,0,1,0,"sip:veronica@university.org",0,0 (Call setup is started)
+CMCCSI: 5,0,0,0,"",0,3,0,1,0,"sip:veronica@university.org",0,0 (Call is in progress)
+CMCCSI: 5,0,0,1,"m=audio",0,4,0,1,0,"sip:veronica@university.org",0,0 (Alert indication received and played back)
+CMCCSI: 5,0,1,3,"m=audio",0,4,0,1,0,"sip:veronica@university.org",0,0 (Remote party accepted the proposal for audio media)

+CDUU: 5, "ANSWERED" (Remote party answered)

+CMCCSI: 5,0,1,1,"m=audio",0,6,0,1,0,"sip:veronica@university.org",0,0
(Connection established, audio media is active)

+CMCCSI: 5,0,1,2,"m=audio\0D\0Am=video 99 98\0D\0Aa=rtpmap:99 H264/90000\0D\0Aa=fmtp:99 profile-level-id=4D4033\0D\0Aa=rtpmap:98 MP4V-ES/90000\0D\0Aa=fmtp:98 profile-level-id=1",0,6,0,1,0,"sip:veronica@university.org",0,0
(Remote party proposed adding video to the call, offering two different formats)

AT+CCMDC=5,3,"m=audio\0D\0Am=video 99 98\0D\0Aa=rtpmap:99 H264/90000\0D\0Aa=fmtp:99 profile-level-id=4D4033\0D\0Aa=rtpmap:98 MP4V-ES/90000\0D\0Aa=fmtp:98 profile-level-id=1"
(Proposal accepted, indicating support for both formats offered)

OK

+CMCCSI: 5,0,1,1,"m=audio\0D\0Am=video 99\0D\0Aa=rtpmap:99 H264/90000\0D\0Aa=fmtp:99 profile-level-id=4D4033",0,6,0,1,0,"sip:veronica@university.org",0,0
(Call media changed to audio and video on a format selected by the TE)

AT+CCMDC=5,1,"m=audio" (Video media removed, unconditionally)

OK

+CMCCSI: 5,0,1,1,"m=audio",0,6,0,1,0,"sip:veronica@university.org",0,0
(Call media changed to audio only)

AT+CHCCS=5 (Connection with call identification number 5 terminated)

+CHCCSI: 5

OK

+CMCCSI: 5,0,0,0,"",0,7,0,1,0,"sip:veronica@university.org",2,200 (Outgoing connection released)

+CMCCSI: 5,0,0,0,"",0,1,0,1,0,"sip:veronica@university.org",0,0 (Idle)

Below is an example where an incoming multimedia-call is received, but the initially offered media audio+video is accepted as audio+video-recv-only, which is subset of the initial offer. A precondition for this example is that the basic event for the call monitoring function is successfully enabled with +CMCCS=2. The terms "<audio>", "<audio+video>" and "<audio+video-recv-only>" are used to illustrate respective SDP media descriptions of audio, audio+video and audio+video-recv-only in the example.

RING (Ringing call)

+CMCCSI: 3,1,1,2,"<audio+video>",0,5,0,1,0,"sip:archie@university.org",0,0
(Incoming ringing call with call identification number 3 and a proposal for audio+video media)

AT+CCMMD=3,3," <audio+video-recv-only>" (Media proposal accepted as audio+video-recv-only)

OK

ATA (Call answered)

OK

+CMCCSI: 3,1,1,1,"< Audio+video-recv-only >",0,6,0,1,0,"sip:archie@university.org",0,0
(Active call established with audio media)

Below is an example where a multimedia-call originated with +CDU is placed to a SIP-URI. In this example, the remote party proposes to add video to the call, the local UE accepts the incoming proposal as audio+video-recv-only. A precondition for this example is that the basic event for the call monitoring function is successfully enabled with +CMCCS=2. The terms "<audio>", "<audio+video>" and "<audio+video-recv-only>" are used to illustrate respective SDP media descriptions of audio, audio+video and audio+video-recv-only in the example.

AT+CDEFMP="m=audio" (Media profile defined, offering only audio)

+CDEFMP=3 (Media profile index number 3 provided)

OK

AT+CDU=1,"sip:veronica@university.org",1,3 (Multimedia-call initiated, using media profile number 3)

+CDU: 5 (Call initiated, call identification number 5 provided)

OK (Call initiation successful)

(+CDUU and +CMCCSI appear as appropriate)

+CMCCSI: 5,0,0,0,"",0,2,0,1,0,"sip:veronica@university.org",0,0 (Call setup is started)

+CMCCSI: 5,0,0,0,"",0,3,0,1,0,"sip:veronica@university.org",0,0 (Call is in progress)

+CMCCSI: 5,0,0,1,"m=audio",0,4,0,1,0,"sip:veronica@university.org",0,0
(Alert indication received and played back)

+CMCCSI: 5,0,1,3,"m=audio",0,4,0,1,0,"sip:veronica@university.org",0,0
(Remote party accepted the proposal for audio media)

+CDUU: 5,"ANSWERED"
(Remote party answered)

+CMCCSI: 5,0,1,2,"m=audio",0,6,0,1,0,"sip:veronica@university.org",0,0
(Connection established, audio media is active)

+CMCCSI: 5,0,1,2,"<audio+video>",0,5,0,1,0,"sip:archie@university.org",0,0
(Remote party propose to add video to the call)

AT+CCMDC=5,3,"<audio+video-recv-only>"
OK
(Proposal accepted as audio and video (recv-only))

+CMCCSI: 5,0,1,1,"<audio+video-recv-only>",0,6,0,1,0,"sip:veronica@university.org",0,0
(Call media changed to audio and video-recv-only)

Below is an example where a multimedia-call originated with +CDU is placed to a SIP-URI. In this example, the remote party rejects the proposed media and makes a counterproposal, which is then accepted by the originating party before the call is established. A precondition for this example is that the basic event for the call monitoring function is successfully enabled with +CMCCS=2. The terms "<audio>" and "<audio+video>" are used to illustrate respective SDP media descriptions of audio and audio+video in the example.

AT+CDEFMP=,"<audio+video>"
+CDEFMP=4
OK
(Media profile defined, offering both audio and video)
(Media profile index number 4 provided)

AT+CDU=1,"sip:veronica@university.org",1,4
+CDU: 6
OK
(Multimedia-call initiated, using media profile number 4)
(Call initiated, call identification number 6 provided)
(Call initiation successful)

(+CDUU and +CMCCSI appear as appropriate)

+CMCCSI: 6,0,0,0,"",0,2,0,1,0,"sip:veronica@university.org",0,0
(Call setup is started)

+CMCCSI: 6,0,0,0,"",0,3,0,1,0,"sip:veronica@university.org",0,0
(Call is in progress)

+CMCCSI: 6,0,0,1,"<audio>",0,4,0,1,0,"sip:veronica@university.org",0,0
(Alert indication received and played back)

+CMCCSI: 6,0,1,4,"",0,4,0,1,0,"sip:veronica@university.org",0,0
(Remote party rejected the proposal for audio+video media)

+CMCCSI: 6,0,1,2,"<audio>",0,4,0,1,0,"sip:veronica@university.org",0,0
(Remote party proposed audio-only media for the call)

AT+CCMMD=6,3,"<audio>"
OK
(Proposal accepted)

+CDUU: 6,"ANSWERED"
(Remote party answered the call)

+CMCCSI: 6,0,1,1,"<audio>",0,6,0,1,0,"sip:veronica@university.org",0,0
(Connection established, audio media is active)

Below is the same scenario as above from the terminating party's perspective. An incoming multimedia-call is received, but the initially offered media is rejected and a successful counterproposal is made. A precondition for this example is that the basic event for the call monitoring function is successfully enabled with +CMCCS=2. The terms "<audio>" and "<audio+video>" are used to illustrate respective SDP media descriptions of audio and audio+video in the example.

RING
(Ringing call)

+CMCCSI: 3,1,1,2,"<audio+video>",0,5,0,1,0,"sip:archie@university.org",0,0
(Incoming ringing call with call identification number 3 and a proposal for audio+video media)

AT+CCMMD=3,4
OK
(Media proposal rejected)

AT+CCMMD=3,2,"<audio>"
OK
(Audio-only media for the call proposed)

+CMCCSI: 3,1,1,3,"<audio>",0,5,0,1,0,"sip:archie@university.org",0,0
(Originating party accepted the proposed, and now active, audio media)

ATA (Call answered)
 OK
 +CMCCSI: 3,1,1,1,"<audio>",0,6,0,1,0,"sip:archie@university.org",0,0 (Active call established with audio media)

Below is an example where a multimedia-call originated with +CDU is placed to a SIP-URI. In this example, both the proposed media and the call is rejected by the remote party. A precondition for this example is that the basic event for the call monitoring function is successfully enabled with +CMCCS=2. The terms "<audio>" and "<audio+video>" are used to illustrate SDP media description of audio and audio+video in the example.

AT+CDEFMP=,"<audio+video>" (Media profile defined, offering both audio and video)
 +CDEFMP=5 (Media profile index number 5 provided)
 OK
 AT+CDU=1,"sip:veronica@university.org",1,5 (Multimedia-call initiated, using media profile number 5)
 +CDU: 7 (Call initiated, call identification number 7 provided)
 OK (Call initiation successful)
 (+CDUU and +CMCCSI appear as appropriate)
 +CMCCSI: 7,0,0,0,"",0,2,0,1,0,"sip:veronica@university.org",0,0 (Call setup is started)
 +CMCCSI: 7,0,0,0,"",0,3,0,1,0,"sip:veronica@university.org",0,0 (Call is in progress)
 +CMCCSI: 7,0,0,1,"<audio>",0,4,0,1,0,"sip:veronica@university.org",0,0 (Alert indication received and played back)
 +CMCCSI: 7,0,1,4,"",0,4,0,1,0,"sip:veronica@university.org",0,0 (Remote party rejected the proposal for audio+video media)
 +CDUU: 7,"CONNECTION TERMINATED" (Remote party rejected the call)
 +CMCCSI: 7,0,0,0,"",0,7,0,1,0,"sip:veronica@university.org",2,488 (Outgoing connection released)
 +CMCCSI: 7,0,0,0,"",0,1,0,1,0,"sip:veronica@university.org",0,0 (Idle)

Below is the same scenario as above from the terminating party's perspective. An incoming multimedia-call is received, but both the initially offered media and the call are rejected. A precondition for this example is that the basic event for the call monitoring function is successfully enabled with +CMCCS=2. The term "<audio+video>" is used to illustrate SDP media description of audio+video in the example.

RING (Ringing call)
 +CMCCSI: 4,1,1,2,"<audio+video>",0,5,0,1,0,"sip:archie@university.org",0,0 (Incoming ringing call with call identification number 4 and a proposal for audio+video media)
 AT+CCMMD=4,4 (Media proposal rejected)
 OK
 AT+CHCCS=4,2 (Connection with identification number 4 rejected)
 +CHCCSI: 4
 OK
 +CMCCSI: 4,0,0,0,"",0,8,0,1,0,"sip:veronica@university.org",2,488 (Incoming connection released)
 +CMCCSI: 4,0,0,0,"",0,1,0,1,0,"sip:veronica@university.org",0,0 (Idle)

14 Commands for eMBMS configuration

14.1 General

This clause defines AT commands that a TE may use to control MT supporting evolved Multimedia Broadcast Multicast Service (eMBMS). eMBMS is a unidirectional point-to-multipoint service in which data is transmitted from a single source entity to a group of users in a specific area. eMBMS services are transmitted on the same carrier frequencies used by mobile operators to provide other typical services such as voice calls and internet. There are various types of eMBMS services that can be provided to the end user such as Mobile TV, streaming, file download, etc.

eMBMS information is sent over SystemInformationBlockType13 information element (SIB-13) according to 3GPP TS 36.331 [86] clause 6.3.1. Information on eMBMS parameters can be found in 3GPP TS 36.443 [150] and 3GPP TS 29.061 [39].

A comprehensive set of eMBMS-specific commands is defined to provide the flexibility needed by the more complex MT. The commands are designed to be expandable to accommodate new eMBMS feature options and interface protocols, merely by defining new values for many of the parameters. The commands use the extended information and error message capabilities described in this specification.

The +CEMBMSCFG command enables or disables the eMBMS support in the MT. Once the eMBMS service is enabled then the status of the eMBMS session can be received by enabling the URC using the +CEMBMSR command. The +CEMBMSR command also provides information about the TMGI and eMBMS session being used by the MT. The +CEMBMSDATA command can be used by the MT to configure the data channel to use for receiving eMBMS services. The +CEMBMSSRV command is used to configure and activate the eMBMS service for a specific TMGI and listen for any service change indications. The +CEMBMSCNT command can be used to set the list of TMGIs from which the MT can receive eMBMS services.

14.2 Commands specific to eMBMS

14.2.1 eMBMS configuration in MT +CEMBMSCFG

Table 14.2.1-1: +CEMBMSCFG parameter command syntax

Command	Possible response(s)
+CEMBMSCFG=<setup_cfg>	+CME ERROR: <err>
+CEMBMSCFG?	+CEMBMSCFG: <setup_cfg>
+CEMBMSCFG=?	+CEMBMSCFG: (list of supported <setup_cfg>s)

Description

Set command enables and disables the eMBMS support.

When eMBMS is enabled the MT reads the SystemInformationBlockType13 information element (SIB-13) according to 3GPP TS 36.331 [86] clause 6.3.1.

If this command is issued when eMBMS is not active, +CME ERROR is returned. Refer to clause 9.2 for possible <err> values.

Read command returns the current eMBMS configuration settings in the MT.

Test command returns values supported as a compound value.

Defined values

<setup_cfg>: integer type; specifies if eMBMS support is to be enabled or disabled in the MT.

0 disable eMBMS support in MT. When eMBMS support is disabled MT is not receiving or consuming any eMBMS service nor monitoring any Multicast Control Channel

1 enable eMBMS support in MT

Implementation

Optional

14.2.2 eMBMS status reporting in MT +CEMBMSR

Table 14.2.2-1: +CEMBMSR parameter command syntax

Command	Possible response(s)
+CEMBMSR=[<n>]	
+CEMBMSR?	+CEMBMSR: <n>
+CEMBMSR=?	+CEMBMSR: (list of supported <n>s)

Description

Set command controls the presentation of unsolicited result code +CEMBMSRI: <session_status>, <tmgi>, <embms_session_id>[, <tmgi>, <embms_session_id> [...]] reporting eMBMS session parameter values. The eMBMS session parameter values are reported only if the eMBMS service is enabled using the +CEMBMSCFG command. Set command does not trigger a request in the MT to read the SystemInformationBlockType13 information element (SIB-13) information.

Read command returns the current eMBMS unsolicited result code settings in the MT.

Test command returns values supported as a compound value.

Defined values

<n>: integer type

0 disable presentation of the unsolicited result code

1 enable presentation of the unsolicited result code

+CEMBMSRI: <session_status>, <tmgi>, <embms_session_id>[, <tmgi>, <embms_session_id> [...]]

<session_status>: integer type; if eMBMS support is enabled, this parameter indicates whether an eMBMS session is activated or deactivated. When the eMBMS session is activated, +CEMBMSDATA command can be used to enter into data state.

0 eMBMS session is deactivated. When eMBMS session is deactivated MT is not receiving or consuming any eMBMS service but the MT is monitoring Multicast Control Channels

1 eMBMS session is activated

<tmgi>: string type in hex format; value is the Temporary Mobile Group Identity allocated to a particular eMBMS bearer service. Refer 3GPP TS 24.008 [8], clause 10.5.6.13.

<embms_session_id>: integer type; value is the eMBMS Session Identity, which together with TMGI identifies a specific eMBMS session. Refer 3GPP TS 29.061 [39], clause 17.7.11.

Implementation

Optional

14.2.3 eMBMS service configuration +CEMBMSSRV

Table 14.2.3-1: +CEMBMSSRV parameter command syntax

Command	Possible response(s)
+CEMBMSSRV=[<n>[, <embms_service>[, <tmgi>]]]	[+CEMBMSSRV: <service_type>, <no_services_info>, <tmgi>[, <embms_session_id>[, <tmgi>[, <embms_session_id> [...]]]] [<CR><LF>[+CEMBMSSRV: <service_type>, <no_services_info>, <tmgi>[, <embms_session_id>[, <tmgi>[, <embms_session_id> [...]]]]] [...]]]] +CME ERROR:<err>
+CEMBMSSRV?	+CEMBMSSRV: <n>

+CEMBSSRV=?	+CEMBSSRV: (list of supported <n>s) , (list of supported <embms_service>s)
-------------	--

Set command is used for querying and listening for service change indications and to control the presentation of following unsolicited service result code in the terminal

+CEMBSSRVI: <service_type>, <no_services_info>, <tmgi>[, <embms_session_id>[, <tmgi> >[, <embms_session_id>[...]]]] reporting eMBMS service information TMGI and eMBMS Session Identity.

If this command is issued when eMBMS is not active, +CME ERROR is returned. Refer to clause 9.2 for possible <err> values.

Read command returns the result code settings of the terminal.

Test command returns values supported as a compound value.

Defined values

<n>: integer type; provides an option to control the unsolicited presentation on TE/MT.

- 0 disable eMBMS unsolicited result code
- 1 enable eMBMS unsolicited result code

<embms_service>: integer type; provides an option to query and configure eMBMS services. The MT should use the value 4 as the default value.

- 0 query eMBMS services available for use by the MT
- 1 query eMBMS services being used by the MT
- 2 configure eMBMS service for use by the MT
- 3 deconfigure eMBMS service for use by the MT
- 4 keep current configuration of eMBMS services used by the MT

<service_type>: integer type; indicates whether the eMBMS service is available for use or is being used by the mobile

- 0 eMBMS service available for use by the MT
- 1 eMBMS service being used by the MT

<no_services_info>: integer type; number of eMBMS services for which information is reported for a particular <service_type>

<tmgi>: string type in hex format; value is the Temporary Mobile Group Identity allocated to a particular eMBMS bearer service. Refer 3GPP TS 24.008 [8], clause 10.5.6.13.

<embms_session_id>: integer type; value is the optional MBMS Session Identity, which together with TMGI identifies a specific MBMS session. Refer 3GPP TS 29.061 [39], clause 17.7.11.

Implementation

Optional

14.2.4 Enter eMBMS data state +CEMBMSDATA

Table 14.2.4-1: +CEMBMSDATA parameter command syntax

Command	Possible response(s)
+CEMBMSDATA=<embms_session_id> [,<tmgi>]	+CME ERROR: <err>
+CEMBMSDATA=?	

Description

Set command is used to enter eMBMS data state by configuring the channel for data transfer for the specified eMBMS session. MT does not process any further AT commands after entering the eMBMS data state. The MT exits the eMBMS data state once the eMBMS data transfer is complete or the eMBMS session becomes inactive.

If this command is issued when <embms_session_id> or <tmgi> fail to identify an existing eMBMS session, +CME ERROR is returned. Refer to clause 9.2 for possible <err> values.

If this command is issued when eMBMS is not active, +CME ERROR is returned. Refer to clause 9.2 for possible <err> values.

Defined values

<embms_session_id>: integer type; value is the eMBMS Session Identity, which together with TMGI identifies a specific eMBMS session. Refer 3GPP TS 29.061 [39], clause 17.7.11.

<tmgi>: string type in hex format; value is the Temporary Mobile Group Identity allocated to a particular eMBMS bearer service. Refer 3GPP TS 24.008 [8], clause 10.5.6.13.

Implementation

Optional

14.2.5 eMBMS counting procedure +CEMBMSCNT

Table 14.2.5-1: +CEMBMSCNT parameter command syntax

Command	Possible response(s)
CEMBMSCNT=<tmgi> [,<tmgi> [,...]]	+CME ERROR: <err>
CEMBMSCNT?	+CEMBMSCNT: <tmgi> [,<tmgi> [,...]]
CEMBMSCNT=?	

Description

Set command is used to set the list of TMGIs for which the user is interested in receiving eMBMS services. Refer to 3GPP TS 36.331 [86] clause 5.8.4.1 for MBMS Counting Procedure.

If this command is issued when eMBMS is not active, +CME ERROR is returned. Refer to clause 9.2 for possible <err> values.

Read command is used to get the list of TMGI's from which the user is interested in receiving eMBMS services.

Defined values

<tmgi>: string type in hex format; value is the Temporary Mobile Group Identity allocated to a particular eMBMS bearer service. Refer 3GPP TS 24.008 [8], clause 10.5.6.13.

Implementation

Optional

14.2.6 eMBMS Service Area Identities +CEMBMSSAI

Table 14.2.6-1: +CEMBMSSAI parameter command syntax

Command	Possible response(s)
+CEMBMSSAI=[<n>[,<embms_priority_flag>[,<earfcn_cnt>[,<earfcn>[,<earfcn>[,...]]]]][,<sai_cnt>[,<sai>[,<sai>[,...]]]]	+CME ERROR: <err>
+CEMBMSSAI?	+CEMBMSSAI: USERDEF <n>,<embms_priority_flag>,<earfcn_cnt>[,<earfcn>[,<earfcn>[,...]]] +CEMBMSSAI: FCNT <embms_priority_flag>,<inter_frequency_cnt> +CEMBMSSAI: INTER <earfcn>,<sai_cnt>[,<sai>[,<sai>[,...]]] +CEMBMSSAI: INTRA <sai_cnt>,<sai>[,<sai>[,...]]
+CEMBMSSAI=?	+CEMBMSSAI: (list of supported <n>s) , (list of supported <embms_priority_flag>s)

Set command sets the priority of eMBMS reception over unicast reception, the eMBMS frequencies the user is interested to receive and the SAIs corresponding to neighbor frequencies. When <n=1>, unsolicited result codes report the SAI of the current and the neighboring carrier frequencies provided by the network through SystemInformationBlockType15 (SIB-15) according to 3GPP TS 36.331 [86] clause 6.3.1.

The unsolicited result code +CEMBMSSAI: FCNT <embms_priority_flag>,<inter_frequency_cnt> reports the priority of eMBMS reception over unicast reception and the number of neighboring frequencies that provide eMBMS services.

The unsolicited result code +CEMBMSSAI: INTER <earfcn>,<sai_cnt>[,<sai>[,<sai>[,...]] reports the SAI in the neighboring frequencies.

The unsolicited result code +CEMBMSSAI: INTRA <sai_cnt>,<sai>[,<sai>[,...]] reports the SAI in the current frequency.

If this command is issued when eMBMS is not active, +CME ERROR is returned. Refer clause 9.2 for possible <err> values.

Read command returns the current settings of <n> and <embms_priority_flag> in the MT.

Test command returns values supported as compound values.

Defined values

<n>: integer type; provides an option to control the unsolicited presentation on TE/MT.

0 disable eMBMS unsolicited result code

1 enable eMBMS unsolicited result code

<embms_priority_flag>: integer type; indicates the priority of eMBMS reception over unicast reception.

0 the unicast reception shall have priority over eMBMS reception

1 the eMBMS reception shall have priority over unicast reception

<earfcn>: integer type; indicates the eMBMS frequency the user is interested to receive. It's the carrier frequency of the LTE cell designated by the EUTRA Absolute Radio Frequency Channel Number (EARFCN), valid range: 0...0xFFFF (refer 3GPP TS 36.101 [154], clause 5.7.3).

<earfcn_cnt>: integer type; indicates the count of <earfcn> reported. The maximum possible value is 32.

<inter_frequency_cnt>: integer type; indicates the number of inter frequencies that will be set or reported.

<sai>: integer type; indicates the SAI in corresponding downlink carrier frequencies.

<sai_cnt>: integer type; indicates the count of <sai> being set or reported. The maximum value is 128.

Implementation

Optional.

15 Commands for UE test functions

15.1 General

This clause defines AT commands that a TE can use to control MT test loop function for UE test loop and UTC time reset as specified in 3GPP TS 36.509 [142].

The UE test loop function provides access to isolated functions of the UE via the radio interface without introducing new physical interfaces just for the reason of conformance testing. The UE test loop function is activated by transmitting the appropriate TC message to the UE. The +CATM command activates and deactivates the UE test mode procedure and sets the UE into test loop mode. The +CCUTLE command opens and closes the UE test loop mode E function in the UE for either transmitting or receiving of V2X communication packets. Only UE test loop mode E is supported by AT commands.

The +CUSPCREQ command requests the UE to report the counter of successful reception of sidelink PSCCH transport blocks, STCH PDCP SDU packets and PSSCH transport blocks.

The +CUTCRCR command resets the UTC time previously calculated from GNSS in the UE.

The +CCBRREQ command requests the UE to report the channel busy ratio (CBR).

The +CV2XDTS command triggers the UE to start or stop sending V2X data over PC5.

The +CSPSAIR command requests the UE to send UEAssistanceInformation message to request SPS grant from eNB.

15.2 Activate test mode +CATM

Table 15.2-1: +CATM parameter command syntax

Command	Possible response(s)
+CATM=[<status>[, <test_loop_mode>]]	+CME ERROR: <err>
+CATM?	+CATM: <status>[, <test_loop_mode>]
+CATM=?	+CATM: (list of supported <status>s) , (list of supported <test_loop_mode>s)

Description

The set command is used to activate or deactivate the UE test mode according to UE test mode procedures as defined in 3GPP TS 36.509 [142] clause 5.3.2 and clause 5.3.3. When <status>=1, the set command activates the UE test mode and sets the UE in test loop mode. The parameter <test_loop_mode> must be included to indicate the UE test loop mode. When <status>=0, the set command deactivates the UE test mode. Refer clause 9.2 for possible <err> values.

NOTE: Only UE test loop mode E is supported by AT commands.

The read command returns the current UE test mode activation and UE test loop mode statuses.

The test command returns values supported as compound values.

Defined values

<status>: integer type. Indicates the state of UE test mode.

0 deactivated

1 activated

<test_loop_mode>: integer type. Indicates the UE test loop mode.

1 UE test loop mode E

Implementation

Optional.

15.3 Close UE test loop mode E +CCUTLE

Table 15.3-1: +CCUTLE parameter command syntax

Command	Possible response(s)
+CCUTLE=<status>[,<direction>[,<format>,<length>,<monitor_list>]]	+CME ERROR: <err>
+CCUTLE?	+CCUTLE: <status>[,<direction>[,<format>,<length>,<monitor_list>]]
+CCUTLE=?	+CCUTLE: (list of supported <status>s), (list of supported <direction>s), (list of supported <format>s) (maximum supported <length>)

Description

The set command is used to close or open the UE test loop mode E according to UE test loop procedures as defined in 3GPP TS 36.509 [142] clause 5.4.2, clause 5.4.4c and clause 5.4.5. The AT command is only applicable when test mode is activated, see clause 15.2. The <status> indicates whether the UE test loop mode E is closed or opened. If <status>=0, the parameters <direction>, <format>, <length> and <monitor_list> are as required provided to configure UE test loop mode E.

The UE test loop mode E provides means for either transmitting or receiving of V2X communication packets, and the <direction> indicates the direction of communication under test. For communication receive operation, <direction>=0 and the UE test loop mode E provides counting of successfully received STCH PDCP SDUs, PSCCH transport blocks and PSSCH transport blocks. The parameters <format>, <length> and <monitor_list> must be provided. For communication transmit operation, <direction>=1 and the UE test loop mode E provides trigger for transmission of IP packets for V2X communication message on STCH. The parameters <format>, <length> and <monitor_list> are not used and ignored if received. All parameters are discarded when <status>=1 or when the UE test mode is deactivated.

The read command returns the current settings.

The test command returns values supported as compound values.

Defined values

<status>: integer type. Indicates the state of UE test loop E.

0 closed

1 opened

<direction>: integer type. Indicates the direction of communication under test.

- 0 communication receive
- 1 communication transmit

<format>: integer type. Indicates the format of the <monitor_list> parameter.

- 1 binary format

<length>: integer type. Indicates the number of 24 bit Destination Layer-2 IDs in the parameter <monitor_list>.

<monitor_list>: string of octets. This parameter contains all 24 bit Destination Layer-2 IDs to monitor for V2X communication. The type of string is in the format as specified by <format>. The number of 24 bit Destination Layer-2 IDs is given by <length>. The parameter shall not be subject to conventional character conversion as per +CSCS.

Implementation

Optional.

15.4 UE sidelink packet counter request +CUSPCREQ

Table 15.4-1: +CUSPCREQ action command syntax

Command	Possible response(s)
+CUSPCREQ	+CUSPCREQ: [<type1>,<format>,<length1>,<counter1>],[<type2>,<format>,<length2>,<counter2>],[<type3>,<format>,<length3>,<counter3>] +CME ERROR: <err>
+CUSPCREQ=?	

Description

The set command is used to request the UE to report the counter of successful reception of sidelink PSCCH transport blocks, STCH PDCP SDU packets and PSSCH transport blocks according to the ProSe Packet Counter reporting procedure as defined in 3GPP TS 36.509 [142] clause 5.7. The AT command is only applicable when test mode is activated, see clause 15.2. Refer clause 9.2 for possible <err> values.

Defined values

<type1>: integer type. Indicates the type of V2X communication.

- 1 PSCCH transport blocks

<type2>: integer type. Indicates the type of V2X communication.

- 1 STCH PDCP SDU packets

<type3>: integer type. Indicates the type of V2X communication.

- 1 PSSCH transport blocks

<format>: integer type. Indicates the format of the requested packet counter.

- 1 binary format

<length1>: integer type. Indicates the number of octets of the <counter1> information element.

<length2>: integer type. Indicates the number of octets of the <counter2> information element.

<length3>: integer type. Indicates the number of octets of the <counter3> information element.

<counter1>: string of octets. Indicates the counter value of <type1>, PSCCH transport blocks. The type of string is in the format as specified by <format>. The parameter shall not be subject to conventional character conversion as per +CSCS.

<counter2>: string of octets. Indicates the counter value of <type2>, STCH PDCP SDU packets. The type of string is in the format as specified by <format>. The parameter shall not be subject to conventional character conversion as per +CSCS.

<counter3>: string of octets. Indicates the counter value of <type3>, PSSCH transport blocks. The type of string is in the format as specified by <format>. The parameter shall not be subject to conventional character conversion as per +CSCS.

Implementation

Optional.

15.5 UTC time reset +CUTCR

Table 15.5-1: +CUTCR action command syntax

Command	Possible response(s)
+CUTCR	+CME ERROR: <err>
+CUTCR=?	

Description

The set command is used to reset the current UTC time that has been calculated from GNSS in the UE as defined in 3GPP TS 36.509 [142] clause 5.5.3. This allows the UE to rapidly re-acquire GNSS and calculate a new value of UTC time. The UE can optionally retain the information that may aid rapid re-acquisition of GNSS and the calculation of a new value of UTC time. The AT command is only applicable when test mode is activated, see clause 15.2. Refer clause 9.2 for possible <err> values.

NOTE: This command does not affect functionality provided by other AT commands defined in clauses other than clause 15.

Defined values

None.

Implementation

Optional.

15.6 Channel busy ratio request +CCBRREQ

Table 15.6-1: +CCBRREQ action command syntax

Command	Possible response(s)
+CCBRREQ	+CCBRREQ: <cbr-pssch> [, <cbr-pscch>] +CME ERROR: <err>
+CCBRREQ=?	

Description

The set command is used to request the UE to report the Channel busy ratio (CBR) for V2X communication over PC5 measured as specified in 3GPP TS 36.214 [167] clause 5.1.30. The AT command is only applicable when test mode is activated, see clause 15.2. Refer clause 9.2 for possible <err> values.

Defined values

<cbrr-pssch>: integer type. Indicates the CBR measured on the PSSCH for V2X communication over PC5. Value 0 corresponds to CBR=0.0, value 1 corresponds to CBR=0.01, value 2 corresponds to CBR=0.02 and so on.

<cbrr-pscch>: integer type. Indicates the CBR measured on the PSCCH. Value 0 corresponds to CBR=0.0, value 1 corresponds to CBR=0.01, value 2 corresponds to CBR=0.02 and so on. This parameter is only returned by the UE if the PSSCH and the PSCCH are transmitted in non-adjacent resource blocks as specified in 3GPP TS 36.214 [167] clause 5.1.30.

Implementation

Optional.

15.7 V2X data transmission over PC5 +CV2XDTS

Table 15.7-1: +CV2XDTS parameter command syntax

Command	Possible response(s)
+CV2XDTS=<action>[,<data_size>,<periodicity>]	+CME ERROR: <err>
+CV2XDTS?	+CV2XDTS: <action>[,<data_size>,<periodicity>]
+CV2XDTS=?	+CV2XDTS: (list of supported <action>s)[,(maximum supported <data_size>),(minimum supported <periodicity>)]

Description

The set command is used to trigger the UE to start or stop sending V2X data over PC5 as defined in 3GPP TS 36.213 [166] clause 14. The AT command is only applicable when test mode is activated, see clause 15.2.

The <action> indicates whether the UE shall start or stop sending data. If <action>=1, the parameters <data_size> and <periodicity> must be provided. All parameters are discarded when <action>=0 or when the UE test mode is deactivated.

The read command returns the current settings.

The test command returns values supported as compound values.

Defined values

<action>: integer type. Indicates whether the UE shall start or stop sending V2X data over PC5.

- 0 stop sending data
- 1 start sending data

<data_size>: integer type. Indicates how many bytes of data the UE shall send over PC5.

NOTE: The data sent by the UE consists of a random bit string. How it is generated is up to UE implementation.

<periodicity>: integer type. Indicates with which periodicity, in milliseconds, the UE shall transmit the number of bytes indicated in <data_size>.

Implementation

Optional.

15.8 SPS assistance information request +CSPSAIR**Table 15.8-1: +CSPSAIR action command syntax**

Command	Possible Response(s)
+CSPSAIR=<interface>	+CME ERROR: <err>
+CSPSAIR=?	+CSPSAIR: (list of supported <interface>s)

Description

The set command is used to request the UE to send the UEAssistanceInformation message to request SPS grant from eNB as specified in 3GPP TS 36.331 [86] clause 5.6.10.2. The set command is only applicable when test mode is activated, see clause 15.2. When <interface>=0, the UE shall send the UEAssistanceInformation message to request UL SPS grant for V2X communication over LTE-Uu from eNB. When <interface>=1, the UE shall send the UEAssistanceInformation message to request SL SPS grant for V2X communication over PC5 from eNB.

Refer clause 9.2 for possible <err> values.

Test command returns the values supported as a compound value.

Defined values

<interface>: integer type. Indicates the interface type for which UE requests SPS grant from eNB.

0 request UL SPS grant for V2X communication over LTE-Uu from eNB

1 request SL SPS grant for V2X communication over PC5 from eNB

Implementation

Optional.

Annex A (normative): Summary of commands from other standards

Summary of ITU-T Recommendation V.250 [14] commands applicable to the present document:

Table A.1: V.250 commands applicable to the present document

Name	V.250 clause	Description	Clauses in the present document
&C	6.2.8	Circuit 109 (Received line signal detector) Behaviour	4.3
&D	6.2.9	Circuit 108 (Data terminal ready) Behaviour	4.3
&F	6.1.2	Set to Factory-defined Configuration	5.8/ 3
+DR	6.6.2	Data Compression Reporting	6.20
+DS	6.6.1	Data Compression	6.20
+GCAP	6.1.9	Request Complete Capabilities List	5.8
+GCI	6.1.10	Country of Installation	5.8
+GMI	6.1.4	Request Manufacturer Identification	5.8/ 5.1
+GMM	6.1.5	Request Model Identification	5.8/ 5.2
+GMR	6.1.6	Request Revision Identification	5.8/ 5.3
+GOI	6.1.8	Request Global Object Identification	5.8
+GSN	6.1.7	Request Product Serial Number Identification	5.8/ 5.4
+ICF	6.2.11	DTE-DCE Character Framing	4.3
+IFC	6.2.12	DTE-DCE Local Flow Control	4.3
+ILRR	6.2.13	DTE-DCE Local Rate Reporting	4.3
+IPR	6.2.10	Fixed DTE Rate	4.3
A	6.3.5	Answer	6.19/ 6.6
D	6.3.1	Dial	6.1-6.4/ 6.6
E	6.2.4	Command Echo	4.3
H	6.3.6	Hook Control	6.19/ 6.5/ 6.6
I	6.1.3	Request Identification Information	5.8
L	6.3.13	Monitor Speaker Loudness	6.19
M	6.3.14	Monitor Speaker Mode	6.19
O	6.3.7	Return to Online Data State	6.19
P	6.3.3	Select Pulse Dialling	6.19
Q	6.2.5	Result Code Suppression	4.3
S0	6.3.8	Automatic Answer	6.19
S10	6.3.12	Automatic Disconnect Delay	6.19
S3	6.2.1	Command Line Termination Character	4.3
S4	6.2.2	Response Formatting Character	4.3
S5	6.2.3	Command Line Editing Character	4.3
S6	6.3.9	Pause Before Blind Dialling	6.19
S7	6.3.10	Connection Completion Timeout	6.19
S8	6.3.11	Comma Dial Modifier Time	6.19
T	6.3.2	Select Tone Dialling	6.19
V	6.2.6	DCE Response Format	4.3/ 3/ 4.1/ 4.2
X	6.2.7	Result Code Selection and Call Progress Monitoring Control	4.3
Z	6.1.1	Reset To Default Configuration	5.8

The use of ITU-T Recommendation V.42 error control protocol is not specified in the present document, but if a manufacturer chooses to implement it over transparent data service, +E prefixed commands of ITU-T Recommendation V.250 [14] shall be used.

ITU-T Recommendation T.31 [11] and ITU-T Recommendation T.32 [12] may be used as facsimile TA-TE protocols without deletions or additions to the command set.

TIA IS-99 [15] commands referenced in the present document:

Table A.2: TIA IS-99 commands in the present document

Command	IS-99 clause	Description	Clause in the present document
+CBC	5.6.5	Battery Charge	8.4
+CGMI	5.6.10	Request Manufacturer Identification	5.1
+CGMM	5.6.10	Request Model Identification	5.2
+CGMR	5.6.10	Request Revision Identification	5.3
+CGSN	5.6.10	Request Product Serial Number Identification	5.4
+CRC	5.6.7	Cellular Result Codes	6.11

TIA IS-135 [16] commands referenced in the present document:

Table A.3: TIA IS-135 commands in the present document

Command	IS-135 clause	Description	Clause in the present document
+CBC	4.1.24	Battery Charge	8.4
+CRC	4.1.29	Cellular Result Codes	6.11
+CSQ	4.1.31	Signal Quality	8.5

PCCA STD-101 [17] commands referenced in the present document:

Table A.4: PCCA STD-101 commands in the present document

Command	STD-101 clause	Description	Clause in the present document
+WS46	5.2.4.6	WDS-side Stack Selection	5.9

Annex B (normative): Summary of result codes

ITU-T Recommendation V.250 [14] result codes which can be used in the present document and result codes defined in the present document:

Table B.1: Result codes

Verbose result code (V.250 command V1 set)	Numeric (V0 set)	Type	Description
+C5GUSMS	as verbose	unsolicited	refer clause 10.1.59
+CABTSRI	as verbose	unsolicited	refer clause 10.1.41
+CACSP	as verbose	unsolicited	refer clause 11.1.7
+CALV	as verbose	unsolicited	refer clause 8.16
+CANCHEV	as verbose	unsolicited	refer clause 11.1.8
+CAPPLEVMC	as verbose	unsolicited	refer clause 8.78
+CAPTT	as verbose	unsolicited	refer clause 11.1.4
+CAULEV	as verbose	unsolicited	refer clause 11.1.5
+CBCAP	as verbose	unsolicited	refer clause 8.59
+CBCHG	as verbose	unsolicited	refer clause 8.61
+CBCON	as verbose	unsolicited	refer clause 8.60
+CCCM	as verbose	unsolicited	refer clause 7.16
+CCSFBU	as verbose	unsolicited	refer clause 8.76
+CCWA	as verbose	unsolicited	refer clause 7.12
+CCWV	as verbose	unsolicited	refer clause 8.28
+CDEV	as verbose	unsolicited	refer clause 8.10
+CDIP	as verbose	unsolicited	refer clause 7.9
+CDUT	as verbose	intermediate	refer clause 13.2.1
+CDUU	as verbose	unsolicited	refer clause 13.2.1
+CECN	as verbose	unsolicited	refer clause 6.28
+CEDRXSP	as verbose	unsolicited	refer clause 7.40
+CEMBMSRI	as verbose	unsolicited	refer clause 14.2.2
+CEMBMSAII	as verbose	unsolicited	refer clause 14.2.6
+CEMBMSRVI	as verbose	unsolicited	refer clause 14.2.3
+CEN1	as verbose	intermediate unsolicited	refer clause 8.67
+CEN2	as verbose	intermediate unsolicited	refer clause 8.67
+CEN3	as verbose	intermediate unsolicited	refer clause 8.67
+CEN4	as verbose	intermediate unsolicited	refer clause 8.67
+CEPTT	as verbose	unsolicited	refer clause 11.1.10
+CEREG	as verbose	unsolicited	refer clause 10.1.22
+CPBW	as verbose	intermediate	refer clause 8.14
+CPNERU	as verbose	unsolicited	refer clause 8.70
+CGDEL	as verbose	intermediate	refer clause 10.1.29
+CGEV	as verbose	unsolicited	refer clause 10.1.19
+CGREG	as verbose	unsolicited	refer clause 10.1.20
+CHSR	as verbose	intermediate	refer clause 6.16
+CIEV	as verbose	unsolicited	refer clause 8.10
+CCIOTOPTI	as verbose	unsolicited	refer clause 7.42
+CIREGU	as verbose	unsolicited	refer clause 8.71
+CIREPH	as verbose	unsolicited	refer clause 8.64

+CIREPI	as verbose	unsolicited	refer clause 8.64
+CKEV	as verbose	unsolicited	refer clause 8.10
+CLADNU	as verbose	unsolicited	refer clause 10.1.61
+CLAV	as verbose	unsolicited	refer clause 8.31
+CLIP	as verbose	unsolicited	refer clause 7.6
+CMCCSI	as verbose	unsolicited	refer clause 8.73
+CMCCSS<x>	as verbose	unsolicited	refer clause 8.73
+CMCCSEND	as verbose	unsolicited	refer clause 8.73
+CME ERROR	as verbose	final	refer clause 9.2.0
+CMICO	as verbose	unsolicited	refer clause 10.1.55
+CMOLRE	as verbose	unsolicited	refer clause 9.3.1
+CMOLRG	as verbose	unsolicited	refer clause 8.50
+CMOLRN	as verbose	unsolicited	refer clause 8.50
+CMTLR	as verbose	unsolicited	refer clause 8.57
+CRTDCP	as verbose	unsolicited	refer clause 10.1.44
+CMWN	as verbose	unsolicited	refer clause 7.36
+CNAP	as verbose	intermediate unsolicited	refer clause 7.30
+CNEC_MM	as verbose	unsolicited	refer clause 9.1b
+CNEC_GMM	as verbose	unsolicited	refer clause 9.1b
+CNEC_GSM	as verbose	unsolicited	refer clause 9.1b
+CNEC_EMM	as verbose	unsolicited	refer clause 9.1b
+CNEC_ESM	as verbose	unsolicited	refer clause 9.1b
+CNEMIU	as verbose	unsolicited	refer clause 7.33
+CNEMS1	as verbose	unsolicited	refer clause 7.33
+CNEM5G	as verbose	unsolicited	refer clause 7.33
+CNRREG	as verbose	unsolicited	refer clause 10.1.47
+COEV	as verbose	unsolicited	refer clause 8.10
+COLP	as verbose	intermediate unsolicited	refer clause 7.8
+CPINR	as verbose	intermediate	refer clause 8.65
+CPINRE	as verbose	intermediate	refer clause 8.65
+CPOSR	as verbose	unsolicited	refer clause 8.56
+CPNERU	as verbose	unsolicited	refer clause 8.70
+CPNSTAT	as verbose	unsolicited	refer clause 7.28
+CPSB	as verbose	unsolicited	refer clause 7.29
+CR	as verbose	intermediate	refer clause 6.9
+CREG	as verbose	unsolicited	refer clause 7.2
+CRING	as verbose	unsolicited	refer clause 6.11
+CRTDCP	as verbose	unsolicited	refer clause 10.1.44
+CRUEPOLICYU	as verbose	unsolicited	refer clause 10.1.51
+CSBTSRI	as verbose	unsolicited	refer clause 10.1.56
+CSCON	as verbose	unsolicited	refer clause 10.1.30
+CSDBTSRI	as verbose	unsolicited	refer clause 10.1.58
+CSSI	as verbose	intermediate	refer clause 7.17
+CSSU	as verbose	unsolicited	refer clause 7.17
+CTEV	as verbose	unsolicited	refer clause 8.10
+CTZE	as verbose	unsolicited	refer clause 8.41
+CTZEU	as verbose	unsolicited	refer clause 8.41
+CTZV	as verbose	unsolicited	refer clause 8.41
+CUSATEND	as verbose	unsolicited	refer clause 12.2.4
+CUSATP	as verbose	unsolicited	refer clause 12.2.4
+CUSATS	as verbose	unsolicited	refer clause 12.2.3

+CUSD	as verbose	unsolicited	refer clause 7.15
+CUUS1I	as verbose	intermediate	refer clause 7.26
+CUUS1U	as verbose	unsolicited	refer clause 7.26
+CWLANOLADI	as verbose	unsolicited	refer clause 10.1.39
+CWLANOLCMI	as verbose	unsolicited	refer clause 10.1.40
+DR	as verbose	intermediate	refer clause 6.26
+ILRR	as verbose	intermediate	refer clause 4.3
BUSY	7	final	busy signal detected
CONNECT	1	intermediate	connection has been established
CONNECT <text>	manufacturer specific	intermediate	as CONNECT but manufacturer specific <text> gives additional information (e.g. connection data rate)
ERROR	4	final	command not accepted
NO ANSWER	8	final	connection completion timeout
NO CARRIER	3	final	connection terminated
NO DIALTONE	6	final	no dialtone detected
OK	0	final	acknowledges execution of a command line
RING	2	unsolicited	incoming call signal from network
NOTE: From v6.2.0 onwards, ATV0 numeric result codes 5, 6, 7 for NO DIALTONE, BUSY and NO ANSWER respectively, have been replaced by numeric result codes 6, 7, 8 respectively, to be aligned with the values listed in ITU-T Recommendation V.250 [14] (previously V.25ter).			

NOTE: The table B.1 is as an overview of the result codes, hence the complete syntax of the result codes is not shown.

Annex C (informative): Commands from TIA IS-101

C.1 Introduction

The "Voice Control Interim Standard for Asynchronous DCE", TIA IS-101, contains some commands that are useful when passing audio "data" (that is, data which represents audio information) between the computer and the TA.

Some of the following clauses describe commands from IS-101 which are central to this TA application. However, with the exception of necessary extensions, these descriptions are not intended to replace the definitions found in IS-101. Other novel commands from the interim standard are not included because they are peripheral to TA operation.

NOTE 1: IS-101 also uses ITU-T Recommendation V.250 [14] AT commands, but these are not mentioned here.

The standard specifies the following modes:

- command mode, where there is no transfer of audio "data" between the TA and the computer. In command mode, the computer is neither sending audio data to the TA nor receiving audio data from the TA.
- transmit mode, where audio "data" is being transferred from the computer to the TA. No audio "data" is transferred from the TA to the computer in this state. A transition back to command mode occurs when an embedded command indicates "end of play" or "flush data", or an inactivity timer times out.
- receive mode, where audio "data" is being transferred from the TA to the computer. No audio "data" is transferred from the computer to the TA in this state. A transition back to command mode occurs when any command is sent from the computer, or an inactivity timer times out. During the receive mode, the TA embeds result codes into the audio "data". These result codes indicate permanent events such as "silence detected", "busy detected", and so on.

Strictly, the standard specifies another mode (translation), but this is not directly of interest here.

NOTE 2: The TA "knows" the type of an incoming call (whether it is voice, data, fax, whatever), and certain POTS events cannot occur. Hence some standard result codes for indication of events and discrimination of call type are unnecessary.

There are three possible levels of service:

- a TA supporting level A performs the following operations and detects the following events: audio transmit, audio receive, DTMF detection, DTMF generation and single tone generation. The following indications are supported:

Event	Description	Handset state
3	ring	idle
4	DTMF received	idle
5	receive buffer overrun	receive
6	unsolicited fax request	idle
8	phone on/off hook	idle
9	presumed hangup	receive
10	presumed end of message	receive
18	ringback	idle
19	busy	idle
23	playback buffer underrun	transmit

25 fax or data request acknowledged idle

- a TA supporting level B performs the operations and events of level A, and also supports DTMF detection while in the transmit state.
- a TA supporting level C performs the operations and events of level B, and also supports double DTMF tone generation.

Since DTMF detection and generation cannot be guaranteed over current digital networks, it follows that none of the three levels of service can be supported.

C.2 Commands

C.2.1 Select mode +FCLASS

This command puts the TA into a particular mode of operation (data, fax, voice etc.). This causes the TA to process information in a manner suitable for that type of information (rather than for other types of information). The values and meanings of parameter <n> are specified in the following table.

<n>	Mode
0	data
1	fax class 1 (TIA-578-A)
1.0	fax class 1 (ITU-T Recommendation T.31 [11])
2	fax (manufacturer specific)
2.0	fax class 2 (ITU-T Recommendation T.32 [12] and TIA-592)
3..7	reserved for other fax modes
8	voice
9..15	reserved for other voice modes
16..79	reserved
80	VoiceView (Radish)
81..255	reserved

Table C.1: +FCLASS parameter command syntax

Command	Return
+FCLASS=<n>	
+FCLASS?	<n>
+FCLASS=?	(list of supported <n>s)

Voice mode is of particular interest here, and has an additional result code +VCON. Specifically, +VCON indicates that the TA is entering the voice command mode and there is a voice connection to at least one audio input or output. This presupposes that some mechanism has previously initiated a connection to that audio I/O.

C.2.2 Buffer threshold setting +VBT

This refers to integers <lo> and <hi> that indicate levels within the TA transmit buffer at which flow control is asserted and deasserted. The buffer is used for averaging out the irregular timing of data from the computer, so that the data becomes synchronous and may be sent to some audio device.

Table C.2: +VBT parameter command syntax

Command	Return
+VBT=<lo>,<hi>	
+VBT?	<lo>,<hi>
+VBT=?	(list of supported <lo>s) , (list of supported <hi>s) , (buffer size)

C.2.3 Calling number ID presentation +VCID

The command refers to an integer that allows a called party to enable or disable (<n>=0) the reporting of the ID of calling parties, and specifies the method of presentation of the ID. This is basically the same as the supplementary service CLIP (Calling Line Identification Presentation). The presentation may be either formatted (<n>=1) or unformatted (<n>=2):

- Formatted presentation: data items are reported in the form of <tag>=<value> pairs.

<tag>	<value>
DATE	MMDD (month, day)
TIME	HHMM (hour, minute)
NMBR	calling number or P or O (P = number is private, O = number is unavailable)
NAME	subscription listing name
MESG	data from other (unknown) tags

- Unformatted presentation: the data is presented in ASCII hex as printable numbers.

Table C.3: +VCID parameter command syntax

Command	Return
+VCID=<n>	
+VCID?	<n>
+VCID=?	(0-2)

C.2.4 Receive gain selection +VGR

This refers to the amplification by the TA of audio samples sent from the TA to the computer. The command operates on an integer <n>, range 0...255. Values larger than 128 indicate a larger gain than nominal. Values less than 128 indicate a smaller gain than nominal. The entire range of 0...255 does not have to be provided. A value of zero implies the use of automatic gain control by the TA.

Table C.4: +VGR parameter command syntax

Command	Return
+VGR=<n>	
+VGR?	<n>
+VGR=?	(list of supported <n>s)

C.2.5 Transmit gain selection +VGT

This refers to the amplification by the TA of audio samples sent from the computer to the TA. The command operates on an integer <n>, range 0...255. Values larger than 128 indicate a larger gain than nominal. Values less than 128

indicate a smaller gain than nominal. The entire range of 0...255 does not have to be provided. A value of zero implies the uses of automatic gain control by the TA.

Table C.5: +VGT parameter command syntax

Command	Return
+VGT=<n>	
+VGT?	<n>
+VGT=?	(list of supported <n>s)

C.2.6 Initialise voice parameters +VIP

This recalls manufacturer determined settings <n> of voice parameters. The command is write only. The effect of the command is manufacturer specific.

Table C.6: +VIP action command syntax

Command	Return
+VIP=<n>	
+VIP=?	(list of supported <n>s)

C.2.7 Inactivity timer +VIT

This refers to the value of the inactivity timer in the TA. It is used to monitor activity on the connection between the computer and the TA when the computer is in "transmit" mode and sending audio data to the TA. When the connection has been inactive for the time set by this command, the TA leaves "transmit" mode and reverts to command mode. An integer <n> different than zero implies a time of <n>/10 seconds. A value of zero disables the timer.

Table C.7: +VIT parameter command syntax

Command	Return
+VIT=<n>	
+VIT?	<n>
+VIT=?	(list of supported <n>s)

C.2.8 Line selection +VLS

This determines the selection of sources and destinations of audio samples. An integer is used to label a particular combination of sources and destinations. The integer is defined in an entry in IS-101 which assumes as a model a TA, a local phone and a phone line. Two additional "manufacturer specific" configurations (16,17) are defined.

- label=0: this is the idle state - the phone is not connected to the radio network and no audio paths are used.
- label=1: the phone is connected to the radio network and no audio paths involving the internal microphone or internal loudspeaker are selected. This allows the computer to transmit audio data over the radio transmitter by selecting "transmit mode":

Table C.8: +VLS label 1a

	loudspeaker	computer i/p	transmit stage
microphone -->			
computer o/p -->			*
receiver stage -->			

This also allows the computer to receive audio data from the radio receiver by selecting "receive mode":

Table C.9: +VLS label 1b

	loudspeaker	computer i/p	transmit stage
microphone -->			
computer o/p -->			
receiver stage -->		*	

- label=4: the phone is not connected to the radio network but there is an audio path to the internal speaker. This allows the computer to play sound by selecting "transmit mode".

Table C.10: +VLS label 4

	loudspeaker	computer i/p	transmit stage
microphone -->			
computer o/p -->	*		
receiver stage -->			

- label=6: the phone is not connected to the radio network but there is an audio path to the internal microphone. This allows the computer to record sound by selecting "receive mode".

Table C.11: +VLS label 6

	loudspeaker	computer i/p	transmit stage
microphone -->		*	
computer o/p -->			
receiver stage -->			

- label=7: the phone is connected to the radio network. The internal microphone is connected to the radio transmitter. The radio receiver is connected to the internal loudspeaker. This allows the computer to enable normal phone operation (a human holding a conversation) by selecting command mode.

Table C.12: +VLS label 7

	loudspeaker	computer i/p	transmit stage
microphone -->			*
computer o/p -->			
receiver stage -->	*		

Table C.13: +VLS parameter command syntax

Command	Return
+VLS=<n>	+VCON
+VLS?	<n>
+VLS=?	<i>complex; refer IS-101</i>

+VCON is returned if an audio path is established or if a connection is made to the radio network.

Manufacturer specific extension (reserved as such by IS-101)

- label=16: the phone is connected to the radio network. There is a path to the internal microphone, which is also connected to the radio transmitter. There is a path to the radio receiver, which is also connected to the internal loudspeaker. This allows the computer to record the sum of transmitted and received audio by selecting "receive mode".

Table C.14: +VLS label 16

	loudspeaker	computer i/p	transmit stage
microphone -->		*	*
computer o/p -->			
receiver stage -->	*	*	

- label=17: the phone is connected to the radio system and there is a path to the internal loudspeaker and to the radio transmitter. This allows the computer to simultaneously play sound and send audio over the radio by selecting "transmit mode".

Table C.15: +VLS label 17

	loudspeaker	computer i/p	transmit stage
microphone -->			
computer o/p -->	*		*
receiver stage -->			

C.2.9 Receive data state +VRX

This action command causes the TA to get audio data from a source determined by the +VLS command, and send it to the computer. Once the datastream has started, any result codes will be embedded in the data and shielded using the normal <DLE> methods. The receive process is terminated when the computer sends any command to the TA, or by time-out of the inactivity timer. The command is write only.

Table C.16: +VRX action command syntax

Command	Return
+VRX	CONNECT

C.2.10 Select compression method +VSM

This selects the voice compression method <n1>, the voice sampling rate <n2>, the silence compression sensitivity <n3>, and a parameter related to silence expansion <n4>. There are several choices of compression method. IS-101 does not specify methods, but here is a list of some usual compression methods:

Name	Communications system
GSM/full-rate	GSM
GSM/half-rate	GSM
ADPCM/G.721	DECT, CT2
ADPCM/G.723	DECT, CT2
ADPCM/G.726	DECT, CT2
ADPCM/G.727	DECT, CT2
SIGNED PCM	POTS

Table C.17: +VSM parameter command syntax

Command	Return
+VSM=<n1>, <n2>, <n3>, <n4>	
+VSM?	<n1>, <n2>, <n3>, <n4>
+VSM=?	<i>complex; refer IS-101</i>

NOTE: A value of $\langle n3 \rangle = 0$ implies no silence compression sensitivity. A value of $\langle n4 \rangle = 0$ implies no silence expansion.

C.2.11 DTMF and tone generation +VTS

This command allows the transmission of DTMF tones and arbitrary tones (see NOTE 1). These tones may be used (for example) when announcing the start of a recording period. The command is write only. In this profile of commands, this command does not operate in data or fax modes of operation (+FCLASS=0,1,2-7).

NOTE 1: D is used only for dialling.

The string parameter of the command consists of combinations of the following separated by commas:

1. $\langle \text{DTMF} \rangle$. A single ASCII character in the set 0-9, #, *, A-D. This is interpreted as a single ASCII character whose duration is set by the +VTD command.

NOTE 2: In GSM this operates only in voice mode.

2. $[\langle \text{tone1} \rangle, \langle \text{tone2} \rangle, \langle \text{duration} \rangle]$. This is interpreted as a dual tone of frequencies $\langle \text{tone1} \rangle$ and $\langle \text{tone2} \rangle$, lasting for a time $\langle \text{duration} \rangle$ (in 10 ms multiples).

NOTE 3: This does not operate in GSM.

3. $\{ \langle \text{DTMF} \rangle, \langle \text{duration} \rangle \}$. This is interpreted as a DTMF tone of different duration from that mandated by the +VTD command.

NOTE 4: In GSM this operates only in voice mode.

Table C.18: +VTS action command syntax

Command	Return
+VTS= <i>as above</i>	
+VTS=?	(list of supported $\langle \text{tone1} \rangle$ s) , (list of supported $\langle \text{tone2} \rangle$ s) , (list of supported $\langle \text{duration} \rangle$ s)

C.2.12 Tone duration +VTD

This refers to an integer $\langle n \rangle$ that defines the length of tones emitted as a result of the +VTS command. This does not affect the D command. A value different than zero causes a tone of duration $\langle n \rangle / 10$ seconds. The value zero causes a "manufacturer specific" value.

Table C.19: +VTD parameter command syntax

Command	Return
+VTD= $\langle n \rangle$	
+VTD?	$\langle n \rangle$
+VTD=?	(list of supported $\langle n \rangle$ s)

NOTE: In GSM/UMTS the value of tone duration is preset and cannot be altered.

C.2.13 Transmit data state +VTX

This action command causes the TA to receive audio data from the computer and send it to a destination determined by the +VLS command. Once the audio datastream has started, commands to the TA shall be embedded in the data stream, and shielded using the normal <DLE> methods. The transmit process is terminated by the use of embedded commands or by the time-out of an inactivity timer. It is recommended that the TA has a buffer to allow the TA to convert potentially bursty data from the computer into synchronous data for "transmission". The command is write only.

Table C.20: +VTX action command syntax

Command	Return
+VTX	CONNECT

Annex D (informative): Bibliography

Informative references:

- 1) IrDA Serial Infrared Physical Layer Specification.
IrDA Serial Infrared MAC and Link Protocol.
IrDA Serial Infrared Link Access Protocol.
- 2) PCCA STD-101 Annex I: Data Transmission Systems and Equipment - Serial Asynchronous Automatic Dialling and Control for Character Mode DCE on Wireless Data Services - Annex I: Command Extensions for Analog Cellular Data Modems.
- 3) TIA IS-101 Facsimile Digital Interfaces - Voice Control Interim Standard for Asynchronous DCE.
- 4) TIA-578-A Facsimile Digital Interfaces - Asynchronous Facsimile DCE Control Standard, Service Class 1.
- 5) TIA-592 Facsimile Digital Interfaces - Asynchronous Facsimile DCE Control Standard, Service Class 2.
- 6) TIA-617 Data Transmission Systems and Equipment - In-Band DCE Control.
- 7) ITU-T Recommendation V.80: In-band DCE control and synchronous data modes for asynchronous DTE.

Annex E (informative): Mobile originated alternating voice/data call example

Figure E.1 illustrates the possible transitions in MO BS 61 call. Responses and result codes generated by TA are in bold face. In this example, data part of the call is asynchronous non-transparent 9600 bps service.

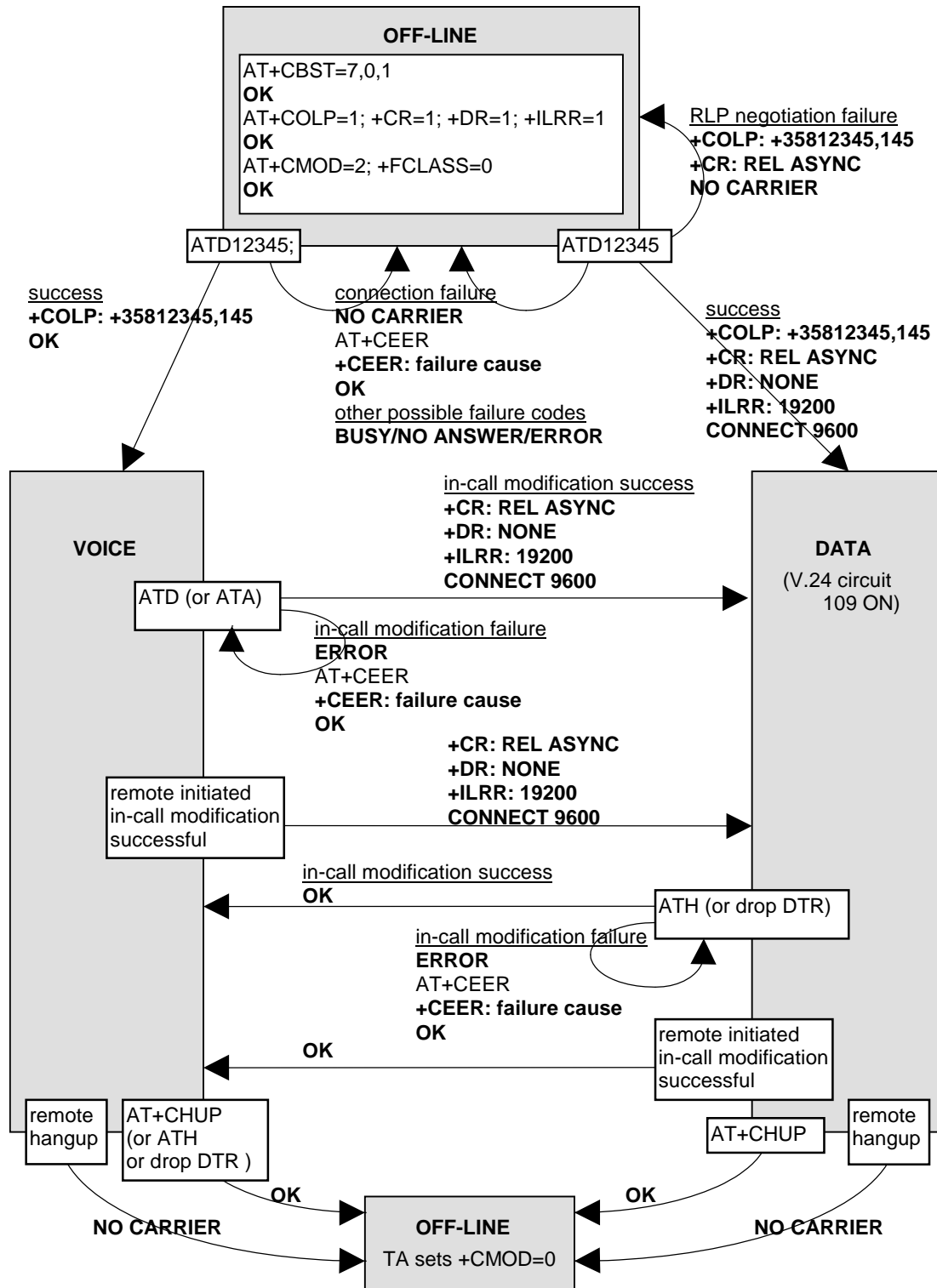

Figure E.1: MO BS 61 call

Annex F (informative): Mobile terminated voice followed by data call example

Figure F.1 illustrates the possible transitions in MT BS 81 call. Responses and result codes generated by TA are in bold face. In this example, data part of the call is asynchronous non-transparent 9600 bps service.

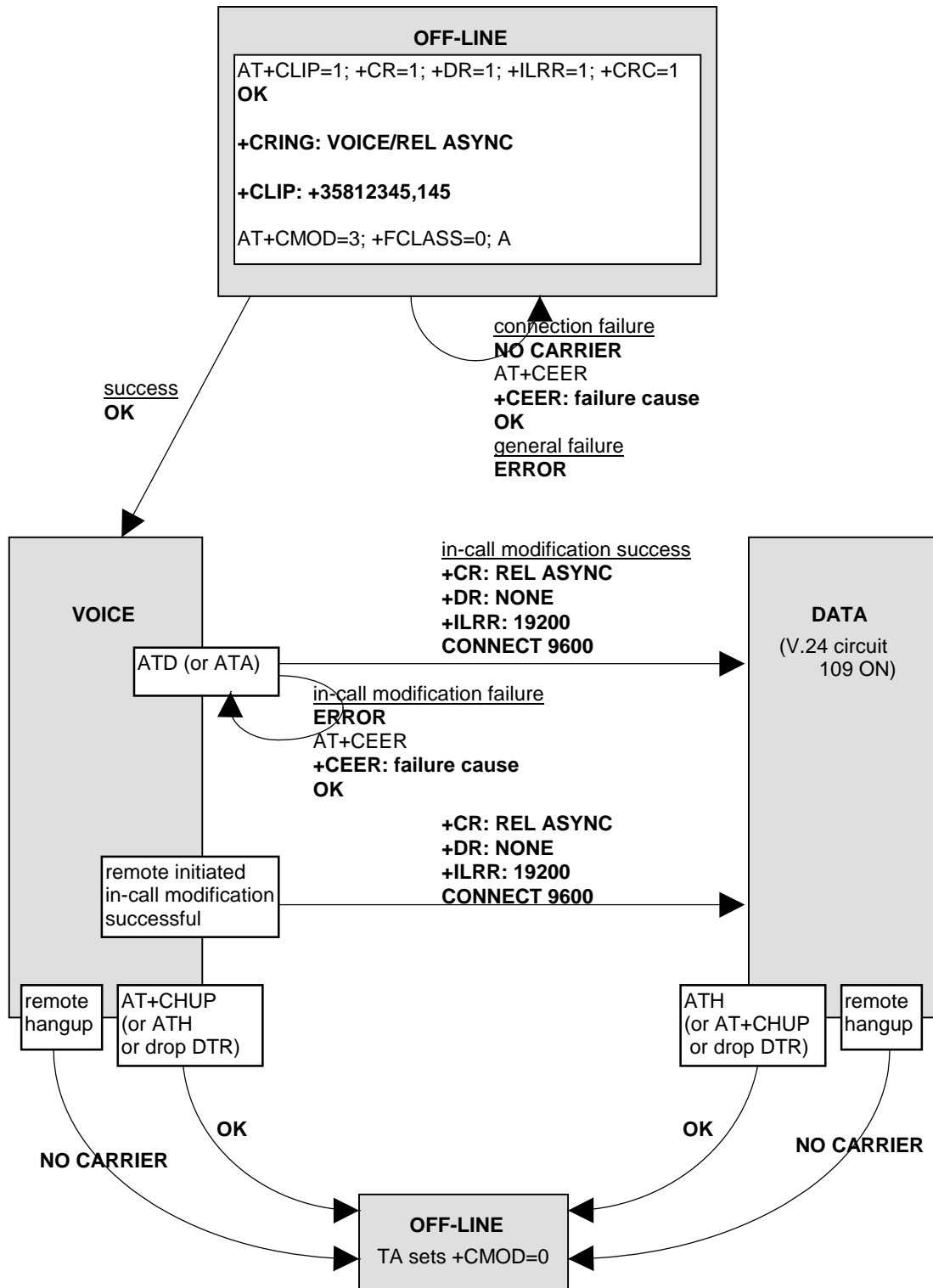

Figure F.1: MT BS 81 call

Annex G (informative): Voice call example

Figure G.1 illustrates the possible transitions in both MT and MO TS 11 calls. Responses and result codes generated by TA are in bold face.

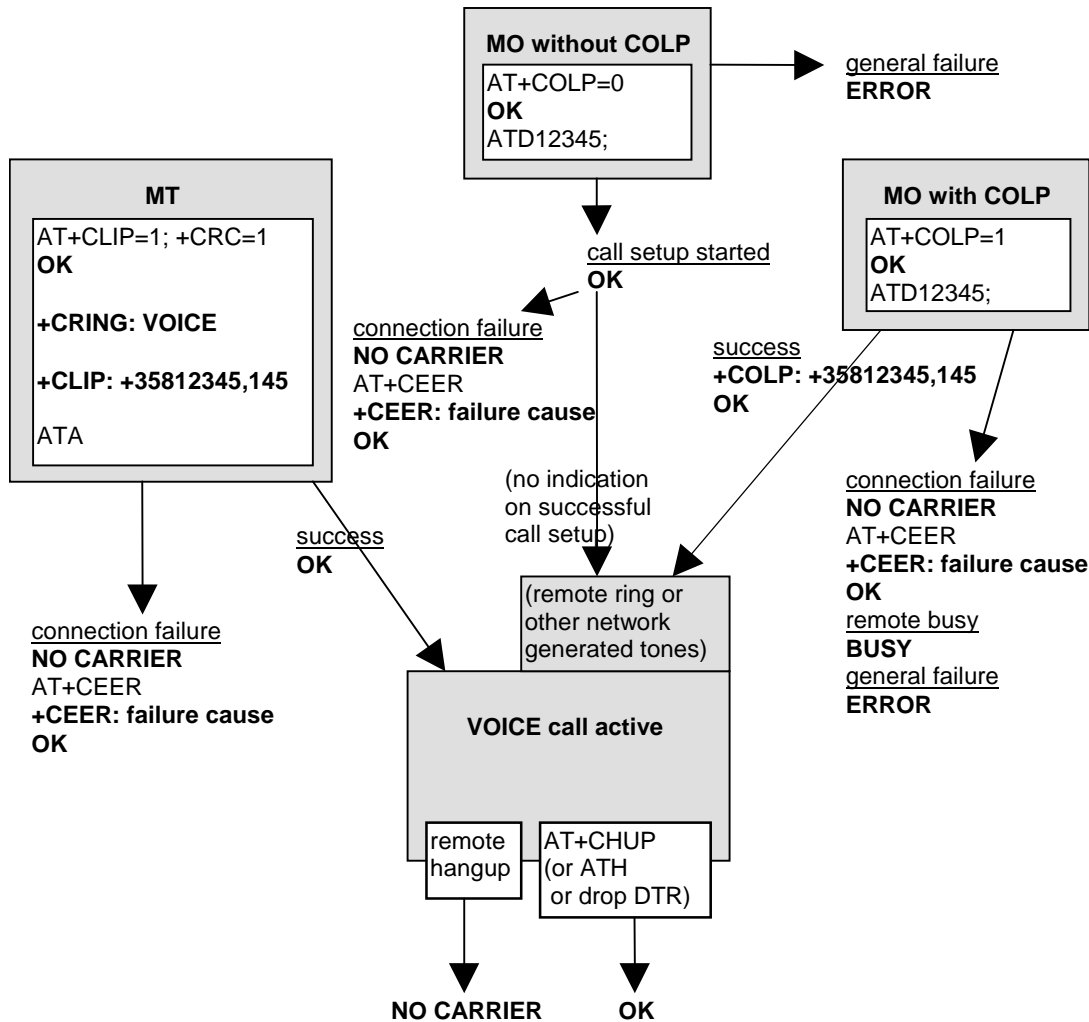

Figure G.1: TS 11 calls

Annex H (informative): Change history

TSG	TDoc	CR	R E V	PH	CAT	SUBJECT	WORKITEM	NEW _VERS
T#4	TP-99118	New				Creation of 3GPP 27.007 v3.0.0 out of GSM 07.07 v7.2.0		3.0.0
T#4	TP-99124	001		R99	A	Additional result codes for +CLIP+CCWA	TEI	3.1.0
T#4	TP-99124	002		R99	B	ECSD additions	EDGE	3.1.0
T#4	TP-99124	003		R99	B	ECSD asymmetry (new command +CHSA)	EDGE	3.1.0
T#4	TP-99146	004		R99	A	Syntax error in +CHSN command	TEI	3.1.0
T#4	TP-99146	005		R99	A	Moving AT commands to 07.07 for 07.60 handover to SMG3 / 3GPP TSG CN WG3	GPRS	3.1.0
T#5	TP-99177	006		R99	D	ECSD AT command correction	EDGE	3.2.0
T#5	TP-99177	007		R99	B	Alarm functionality	TEI	3.2.0
T#5	TP-99177	008		R99	B	Phonebook storage	TEI	3.2.0
T#5	TP-99177	009		R99	B	Time Zone	TEI	3.2.0
T#5	TP-99177	010		R99	B	Additional result code for +CSSN	TEI	3.2.0
T#5	TP-99177	011		R99	B	New command for setting of Date format	TEI	3.2.0
T#5	TP-99177	012		R99	B	New command for Silent mode	TEI	3.2.0
T#5	TP-99177	013		R99	B	New command for setting of Time format	TEI	3.2.0
T#5	TP-99177	014		R99	B	GSM 400 Spectrum update	GSM 400	3.2.0
T#5	TP-99177	015		R99	A	AT command - Request GPRS service 'D'	GPRS	3.2.0
T#6	TP-99237	016		R99	F	Clarification to result codes for +CLIP+CCWA	TEI	3.3.0
T#6	TP-99237	017		R99	B	AT command for Frame Tunnelling Mode (FTM)	Frame Tunnelling Mode	3.3.0
T#6	TP-99237	018		R99	B	New AT command for application protocols activation	TEI	3.3.0
T#6	TP-99237	022		R99	B	Add new AT command (+CDIP) to inform the called line identification	TEI	3.3.0
T#6	TP-99237	020		R99	C	Packet Domain ATD command syntax	GPRS	3.3.0
T#6	TP-99237	021		R99	B	Additional parameter for +CBST	TEI	3.3.0
T#6	TP-99237	019		R99	B	AT-commands for Enhanced QoS Support management	Enhanced QoS Support in GPRS	3.3.0
T#7	TP-000024	024		R99	F	Deletion of the AT+CPROT? read command	TEI	3.4.0
T#7	TP-000024	025		R99	F	Adaptations for UMTS	TEI	3.4.0
T#7	TP-000024	026		R99	D	References to ASCII Specifications	ASCII	3.4.0
T#7	TP-000024	027		R99	D	Abbreviations related to ASCII	ASCII	3.4.0
T#7	TP-000024	028		R99	B	Priority indication in +CLCC, List Current Calls	ASCII	3.4.0
T#7	TP-000024	029		R99	B	Indication of priority, sub-address, sub-address type and TS 91/TS92 in +CRC, Cellular Result Codes	ASCII	3.4.0
T#7	TP-000024	030		R99	B	Commands for ASCII	ASCII	3.4.0
T#7	TP-000024	031		R99	B	Commands for eMLPP	eMLPP	3.4.0
T#7	TP-000024	032		R99	B	Example for usage of priority	eMLPP	3.4.0
T#8	TP-000073	033		R99	B	+CSDF,+CCLK and +CALA(4 digits for year field)	TEI	3.5.0
T#8	TP-000073	034		R99	F	APN presentation	TEI	3.5.0
T#8	TP-000073	035		R99	F	+CAJOIN also serves to join an ongoing group or a broadcast call	ASCII	3.5.0
T#8	TP-000073	036		R99	F	+CAULEV, the uplink status presentation in a Voice Group Call	ASCII	3.5.0
T#8	TP-000073	037		R99	F	CME ERROR extensions for ASCII Commands	ASCII	3.5.0
T#8	TP-000073	038		R99	F	Correction of the description of the +CRC	ASCII	3.5.0
T#8	TP-000073	039		R99	F	Definition of the abbreviation of MT	ASCII	3.5.0
T#8	TP-000073	040		R99	F	Packet Domain QoS AT-commands	TEI	3.5.0
T#9	TP-000143	041		R99	F	TE software implementations must take account of extra parameters	TEI	3.6.0
T#9	TP-000143	042		R99	F	APN presentation	TEI	3.6.0
T#9	TP-000144	043		R00	B	Introduction of a new AT command +CUUS1 to manage User-to-User Information element	ASCII	4.0.0
T#9	TP-000144	044		R00	B	Indication of priority and/or sub-address in the unsolicited result code CCWA	ASCII	4.0.0
T#9	TP-000144	045		R00	B	eMLPP SIM Commands	ASCII	4.0.0
T#9	TP-000144	046		R00	B	VBS, VGCS SIM Commands	ASCII	4.0.0
T#9	TP-000144	047		R00	A	Extension of dial command for VBS and VGCS	ASCII	4.0.0
T#9	TP-000144	048		R00	A	Introduction of a new AT command +COTDI to manage Originator-to-dispatcher information element	ASCII	4.0.0
T#11	TP-010028	053		Rel-4	A	Clarification of the specification to incorporate UICC/USIM references	TI-ATC	4.1.0
T#11	TP-010028	054		Rel-4	F	Update the AT command, +CPBS, that select the phonebooks in the SIM/UICC	TI-ATC	4.1.0
T#11	TP-010028	055		Rel-4	F	Correction of GSM references	TI-ATC	4.1.0

T#11	TP-010028	056		Rel-4	F	Update the AT commands that access the PLMN preferred list in the SIM/UICC	TI-ATC	4.1.0
T#11	TP-010028	057		Rel-4	F	Update of phonebook AT commands, +CBBS,+CPBR, +CPBF and +CPBW, to access the hidden phonebook entries	TI-ATC	4.1.0
T#11	TP-010028	058		Rel-4	A	Addition of explicit subscribed value to QoS command	TI-ATC	4.1.0
T#11	TP-010028	059		Rel-4	A	Corresponding GMM states for +CGREG command	TI-ATC	4.1.0
T#11	TP-010028	060		Rel-4	F	Definition of "class C in GPRS and circuit switched alternate mode"	TI-ATC	4.1.0
T#12	TP-010127	061		Rel-4	A	Aligning command AT+CSNS with changes introduced to single numbering scheme	TEI4	4.2.0
T#12	TP-010127	064		Rel-4	A	Inclusion of multimedia values to command AT+CBST	TEI4	4.2.0
T#12	TP-010127	066		Rel-4	A	Modification to Request Packet Domain service 'D' command	TEI4	4.2.0
T#12	TP-010127	068		Rel-4	A	Inclusion of IPv6 and removal of X.25 and OSPH <PDP_type> values	TEI4	4.2.0
T#14	TP-010269	070	1	Rel-4	A	Obsolete +CGCLOSP and corrections due to IHOSS and OSP removal	TI-ATC	4.3.0
T#14	TP-010269	072		Rel-4	A	Obsolete +CGCLPAD and corrections due to X.25 removal	TI-ATC	4.3.0
T#14	TP-010269	074		Rel-4	A	Clarifications to AT commands used with circuit switched data	TI-ATC	4.3.0
T#14	TP-010269	076		Rel-4	A	Correction in the +CGACT command explanation	TI-ATC	4.3.0
T#14	TP-010269	077		Rel-4	F	Correction of chapter heading and references	TI-ATC	4.3.0
T#14	TP-010269	079		Rel-4	A	Different compression algorithms in AT commands +CGDCONT and +CGDSCONT	TI-ATC	4.3.0
T#14	TP-010269	080		Rel-5	B	New AT command +CRMC (Ring Melody Control)	TEI5	5.0.0
T#14	TP-010269	081		Rel-5	B	Added reference to 23.227	TEI5	5.0.0
T#15	TP-020014	084		Rel-5	A	Alignment of UE architecture with 23.101	TEI5	5.1.0
T#16	TP-020103	085		Rel-6	B	Enhancement of AT command +CIND to indicate SMS rejection	TEI6	6.0.0
T#17	TP-020272	089		Rel-6	A	Clarification in the behaviour of AT+W46	TEI6	6.1.0
T#19	TP-030067	097	1	Rel-6	A	Clarification in the behaviour of AT+CGCLASS	TEI6	6.2.0
T#19	TP-030037	101		Rel-6	A	Correction ATV0 result codes	TEI6	6.2.0
T#19	TP-030071	105	1	Rel-6	A	Correction of AT+WS46 parameter values	TEI6	6.2.0
T#19	TP-030037	109		Rel-6	A	AT +CGEQREQ - Required Parameters for Streaming / Conversational Traffic Class	TEI6	6.2.0
T#20	TP-030113	110		Rel-6	F	Correction of references	TEI6	6.3.0
T#21	TP-030212	111		Rel-6	A	Adding reference to 24.008 for the 3G QoS AT-commands	TEI5	6.4.0
T#24	TP-040134	116	1	Rel-6	C	Updating error codes description to support UICC	TEI6	6.5.0
T#25	TP-040170	117		Rel-6	F	Correction to AT command +CHSN	HSCSD	6.6.0
T#25	TP-040170	118		Rel-6	B	Support of logical channels in AT commands	TEI6	6.6.0
T#26	TP-040225	120		Rel-6	A	Additional parameter for AT command +CRSM (Restricted SIM access)	TEI5	6.7.0
T#26	TP-040225	122		Rel-6	A	Corrections to AcTs of PLMN Selection	TEI5	6.7.0
T#26	TP-040225	123		Rel-6	C	Improve security in UICC generic access command +CGLA	TEI6	6.7.0
T#26	TP-040225	124		Rel-6	B	Support of EAP authentication command	TEI6	6.7.0
T#26	TP-040225	125		Rel-6	F	Correction of file identification in +CRLA command	TEI6	6.7.0
T#26	TP-040225	126		Rel-6	B	UICC Application Discovery Command +CUAD	TEI6	6.7.0
T#26	TP-040225	127		Rel-6	F	Clarification on the use of PIN with (U)SIM	TEI6	6.7.0
T#26	TP-040225	128		Rel-6	D	Editorial modifications to +CGLA and +CRLA commands	TEI6	6.7.0
T#26	TP-040225	129		Rel-6	B	Add RETRIEVE DATA and SET DATA APDU commands in +CRSM and +CRLA AT commands	TEI6	6.7.0
T#26	TP-040225	130		Rel-6	B	Extension of read, write and find phonebook entry commands for 3G phonebooks	TEI6	6.7.0
T#27	TP-050012	131		Rel-6	F	Align time zone range of AT+CCLK (CLOCK)	TEI	6.8.0
T#27	TP-050012	132		Rel-6	A	Illogical response in +CGDSCONT test command (REL 6)	TEI5	6.8.0
CT#31	CP-060126	137		Rel-7	F	QoS additions for the AT commands +CGEQREQ and +CGEQMIN	TEI7	7.0.0
CT#32	CP-060276	0138		Rel-7	F	Access technology added to AT commands +CREG and +CGREG	TEI7	7.1.0
CT#32	CP-060276	0139		Rel-7	F	Enhancement of parameter CI in AT commands +CREG and +CGREG	TEI7	7.1.0
CT#33	CP-060506	0140	1	Rel-7	F	Support for UTF-8 in AT-command +CSCS	TEI7	7.2.0
CT#35	CP-070155	0141	2	Rel-7	B	Addition of preferred network in AT command	TEI7	7.3.0
CT#36	CP-070371	0147	-	Rel-7	A	Extension of AT-command +CEAP	TEI6	7.4.0
CT#36	CP-070458	0145	1	Rel-7	A	Correction for AT-commands +CEAP, +CERP and +CUAD	TEI6	7.4.0
CT#36	CP-070395	0144	3	Rel-8	B	Introduction of the new AT command AT+CPSB	TEI8	8.0.0
CT#36	CP-070395	0148	2	Rel-8	B	Extension of parameter <Act> to include HSDPA- & HSUPA-capability	TEI8	8.0.0
CT#37	CP-070604	0149	3	Rel-8	C	Extension for AT-commands +CPBW, +CPBF and +CPBR	TEI8	8.1.0
CT#37	CP-070604	0150	3	Rel-8	B	AT-command +CVMOD to set the voice call preference	TEI8	8.1.0
CT#38	CP-070815	0152	2	Rel-8	B	AT-commands for location handling	TEI8	8.2.0
CT#39	CP-080136	0153		Rel-8	F	Corrections to +CMOLRG	TEI8	8.3.0
CT#40	CP-080361	0156		Rel-8	B	AT command for enabling/disabling the backlight	TEI8	8.4.0
CT#40	CP-080351	0158	1	Rel-8	B	TCRT: Short Data Transmission during ongoing VGCS	EVA	8.4.0
						Editorial change: sub clauses 8.51 and 8.52 swapped		8.4.1
CT#41	CP-080536	0159	1	Rel-8	B	Adding and extending AT-commands to support touch screen functions	TEI8	8.5.0
CT#41	CP-080536	0160	1	Rel-8	B	Setting of display resolution and screen orientation for touch screen functions	TEI8	8.5.0
CT#41	CP-080536	0161	1	Rel-8	C	AT Backlight command. CBKLT Default setting	TEI8	8.5.0
CT#42	CP-080873	0162	3	Rel-8	F	Corrections to +CMOLRG	TEI8	8.6.0

CT#42	CP-0808873	0163	3	Rel-8	B	AT-Commands for positioning assistance	TEI8	8.6.0
CT#42	CP-080866	0164	1	Rel-8	B	Introduction of new RAT-type for SAE	SAES	8.6.0
CT#42	CP-080866	0165	2	Rel-8	B	Additional AT commands for LTE/SAE	SAES	8.6.0
CT#42	CP-080872	0167		Rel-8	A	Restoring default value for TE character set	TEI7	8.6.0
CT#42	CP-080872	0168	2	Rel-8	A	Introduction of RAC to CGREG	TEI7	8.6.0
CT#43	CP-090159	0170	1	Rel-8	F	Correction of AT-Commands for positioning	TEI8	8.7.0
CT#43	CP-090130	0171	1	Rel-8	F	Support of dedicated bearer related AT command	SAES	8.7.0
CT#43	CP-090153	0172		Rel-8	B	AT-command for UE modes of operation in SAE	SAES-CSFB	8.7.0
CT#43	CP-090159	0174	1	Rel-8	F	Corrections for +CGCLASS	TEI8	8.7.0
CT#43				Rel-8		Editorial cleanup by MCC		8.7.0
CT#44	CP-090413	0178	1	Rel-8	F	Adding E-UTRAN to the Current Packet Switched Bearer AT command	SAES	8.8.0
CT#44	CP-090391	0177	2	Rel-8	F	Common AT Command Set for EPS and UMTS/GPRS for the PS Domain	SAES	8.8.0
CT#44	CP-090430	0175	1	Rel-9	B	AT command for CNAP (Calling Name Presentation)	TEI9	9.0.0
CT#44	CP-090430	0176	2	Rel-9	B	AT command for COLR (Connected Line Identification Restriction Status)	TEI9	9.0.0
CT#45	CP-090679	0181		Rel-9	A	Corrections of AT-command for originated location request	TEI8	9.1.0
CT#45	CP-090679	0183		Rel-9	A	Origin for assist_data is corrected	TEI8	9.1.0
CT#45	CP-090682	0184		Rel-9	B	"non-GPS" enhancements of AT-command for originated location request	TEI9	9.1.0
CT#45	CP-090682	0185		Rel-9	F	Corrections to UCS2 coding of +CUSD	TEI9	9.1.0
CT#45	CP-090682	0186	1	Rel-9	B	New AT-commands for mobile terminated location request and disclosure	TEI9	9.1.0
CT#45	CP-090655	0188	1	Rel-9	A	Correct alignment of notes for +CEREG	SAES	9.1.0
CT#45	CP-090682	0189		Rel-9	B	Addition of intermediate result code for +CPBW	TEI9	9.1.0
CT#45	CP-090682	0190		Rel-9	B	New AT-commands for administration of battery	TEI9	9.1.0
CT#45	CP-090674	0192	1	Rel-9	A	Corrections to +CEMODE	SAES-CSFB,SAES	9.1.0
CT#46	CP-090920	0196		Rel-9	A	Correction of direction of data for +CPOS	TEI8	9.2.0
CT#46	CP-090922	0197	1	Rel-9	F	Correction of usage of underscore (default values) for 27.007	TEI9	9.2.0
CT#46	CP-090900	0200	1	Rel-9	A	Correction of outstanding Editor's note on +WS46	SAES	9.2.0
CT#47	CP-100135	0209	2	Rel-9	D	Correction of minor drafting rule issues for TS 27.007	TEI9	9.3.0
CT#47	CP-100102	0207		Rel-9	A	Removal of [,<pd1>[...[.pdN]]] in +CGDCONT	TEI	9.3.0
CT#47	CP-100135	0208		Rel-9	F	Clarification of parameter type for +CCHO and +CCHC	TEI9	9.3.0
CT#47	CP-100131	0211		Rel-9	A	Incorrect indication of AT commands as parameter commands	TEI8, SAES	9.3.0
CT#47	CP-100135	0212	1	Rel-9	B	+CGDEL – AT-command for deletion of non-active PDP contexts and associated parameters	TEI9	9.3.0
CT#47	CP-100135	0214		Rel-9	A	Incorrect name for test command version of +CGTFTRDP	SAES	9.3.0
CT#47	CP-100107	0216		Rel-9	A	Correction of the packet domain event reporting +CGEV	SAES	9.3.0
CT#47	CP-100135	0217		Rel-9	F	The value range of <cid> for network initiated PDP contexts is clarified	TEI9	9.3.0
CT#47	CP-100145	0218	1	Rel-9	B	Addition of new AT-Command related to SSAC	SSAC	9.3.0
CT#47	CP-100144	0219	1	Rel-9	F	Correction of AT command for emergency bearer services	IMS_EMER_G PRS_EPS	9.3.0
CT#47				Rel-9		Editorial cleanup by MCC		9.3.0
CT#48	CP-100339	0221		Rel-9	A	Correction of unsolicited result codes for packet domain event reporting	SAES	9.4.0
CT#48	CP-100339	0223		Rel-9	A	+CGCONTRDP, alignment of with +CGTFT and +CGTFTRDP	SAES	9.4.0
CT#48	CP-100339	0228	1	Rel-9	A	Description of handling a request to disconnect when only connected to a single PDN	SAES	9.4.0
CT#48	CP-100339	0230	1	Rel-9	A	Support for +CGPADDR returning both IPv4 and IPv6 addresses	SAES	9.4.0
CT#48	CP-100339	0232	1	Rel-9	A	Clarification of relationship between CREG, CEREG and CGREG	SAES	9.4.0
CT#48	CP-100355	0234		Rel-9	F	Removal of remaining [,<pd1>[...[.pdN]]] in +CGDCONT	TEI9	9.4.0
CT#48	CP-100355	0238		Rel-9	F	Addition of missing parameter in +CNAP	TEI9	9.4.0
CT#48	CP-100371	0226		Rel-10	B	Support of compressed IPv6 format in AT-commands	TEI10	10.0.0
CT#48	CP-100369	0224	2	Rel-10	B	Control of P-CSCF address discovery	AT_IMS	10.0.0
CT#48	CP-100369	0225	1	Rel-10	B	+CISRVCC and +CIREP, new AT-commands for support of SRVCC	AT_IMS	10.0.0
CT#48	CP-100369	0233	1	Rel-10	B	Control of IM CN Subsystem Signalling Flag	AT_IMS	10.0.0
CT#49	CP-100520	0240	1	Rel-10	F	Alignment of table headers with AT-command names	TEI10	10.1.0
CT#49	CP-100492	0243	2	Rel-10	A	AT commands for eCall	eData	10.1.0
CT#49	CP-100485	0248	1	Rel-10	A	Clarification of Act parameter in CREG, CGREG and CEREG	SAES	10.1.0
CT#49	CP-100571	0249	4	Rel-10	B	USAT over AT	AT_UICC	10.1.0
CT#49	CP-100518	0250		Rel-10	F	Clarification to +COPS.	TEI10	10.1.0
CT#49	CP-100520	0251	1	Rel-10	B	AT command for remaining PIN retries for MT passwords, +CPINR	TEI10	10.1.0
CT#49	CP-100520	0252	2	Rel-10	B	AT command for supporting multiple cards installed in a ME	TEI10	10.1.0
CT#49	CP-100520	0253	1	Rel-10	B	AT command for Emergency Numbers +CEN	TEI10	10.1.0
CT#50	CP-100763	0254	2	Rel-10	B	TC-RT: Introduction of group IDs with prefix	TEI10	10.2.0
CT#50	CP-100742	0256	1	Rel-10	A	Correction of Table 8.58-1 for +CMTLRA	TEI9	10.2.0
CT#50	CP-100763	0257		Rel-10	F	Correction of terminology for result codes and alignment of Annex B	TEI10	10.2.0
CT#50	CP-100757	0258	1	Rel-10	B	Examples of AT-commands for USAT	AT_UICC	10.2.0
CT#50	CP-100757	0259	1	Rel-10	C	Multiple corrections to AT-commands for USAT	AT_UICC	10.2.0

CT#50	CP-100757	0260	2	Rel-10	F	Removal of editor's note on security mechanism for AT-commands for USAT	AT_UICC	10.2.0
CT#50	CP-100747	0262	2	Rel-10	A	+CGDCONT syntax	IMS_EMER_G PRS_EPS	10.2.0
CT#50	CP-100763	0263	1	Rel-10	F	+CGEV for IP address types	TEI10	10.2.0
CT#50	CP-100763	0265		Rel-10	F	Correction of references for +CNAP	TEI10	10.2.0
CT#50	CP-100763	0266		Rel-10	F	Correction of action versus parameter commands	TEI10	10.2.0
CT#50	CP-100763	0267	1	Rel-10		Correction of print of the IP address format	TEI10	10.2.0
CT#50	CP-100763	0268	1	Rel-10	B	New AT-command for Network Emergency Bearer Services Support +CNEM	TEI10	10.2.0
CT#50	CP-100763	0270	3	Rel-10		AT command for creating connection status event	TEI10	10.2.0
CT#51	CP-110197	0271	1	Rel-10	B	Enhancement of +CPOS and +CPOSR for LPP, capability request and velocity request, GLONASS and SBAS	TEI10	10.3.0
CT#51	CP-110197	0272		Rel-10	B	Enhancement and alignment of +CLIP, +CCWA and +CLCC when CLI is not available	TEI10	10.3.0
CT#51	CP-110197	0273	1	Rel-10	F	Support of AT commands for voice	TEI10	10.3.0
CT#51	CP-110188	0274	1	Rel-10	F	Correction of USAT profile activation	AT_UICC	10.3.0
CT#51	CP-110188	0275	1	Rel-10	B	Detection of currently active SIM or USIM	AT_UICC	10.3.0
CT#51	CP-110188	0277	1	Rel-10	C	Modification of default profiles and write response	AT_UICC	10.3.0
CT#51	CP-110188	0278	1	Rel-10	F	Correction of USAT event response	AT_UICC	10.3.0
CT#51	CP-110197	0279	1	Rel-10	F	Clarification of relationship between CREG, CERE and CGREG. Introduction of registration for EPS and non-EPS services for 'SMS only' in CREG.	TEI10	10.3.0
CT#51	CP-110186	0280	1	Rel-10	B	+CAVIMS, availability for voice calls with the IMS	AT_IMS	10.3.0
CT#51	CP-110197	0281		Rel-10	B	Addition of registration status to CREG,CGREG, CERE command for emergency attached UE	TEI10	10.3.0
CT#51	CP-110197	0282	2	Rel-10	B	+CESQ, new AT-command on extended signal quality	TEI10	10.3.0
CT#52	CP-110454	0286		Rel-10	A	+CGDATA, correction of syntax	TEI8	10.4.0
CT#52	CP-110461	0287	1	Rel-10	F	Cleanups for WI AT_UICC	AT_UICC	10.4.0
CT#52	CP-110466	0291	1	Rel-10	F	CREG, CERE and CGREG: clarification for 'out of coverage'	TEI10	10.4.0
CT#53	CP-110669	0292	2	Rel-10	F	Clarifying the indication of availability for voice calls in the IMS and in the PS	AT_IMS	10.5.0
CT#53	CP-110695	0288	4	Rel-11	B	+CGAUTH, new AT-command for definition of PDP context authentication parameters	TEI11	11.0.0
CT#53	CP-110695	0293	3	Rel-11	B	Enhancements to Event Reporting due to CBS primary notifications	TEI11	11.0.0
CT#53	CP-110695	0294	1	Rel-11	C	Enhancing touch screen actions and events	TEI11	11.0.0
CT#53	CP-110695	0295	1	Rel-11	C	Enhancing supported orientations by AT command +CSO	TEI11	11.0.0
CT#53	CP-110695	0296	1	Rel-11	C	Enhancing the assumption that touch screen size is equal to display screen size	TEI11	11.0.0
CT#54	CP-110875	0298		Rel-11	A	Corrections to +VIP	TEI10	11.1.0
CT#54	CP-110865	0303		Rel-11	A	+CMOLR: Third Party Address should be specified when Method value set to 5	TEI9	11.1.0
CT#54	CP-110882	0304	1	Rel-11	C	Add support for display orientation event reporting	TEI11	11.1.0
CT#54	CP-110864	0308		Rel-11	A	Correcting syntax of +CMER	TEI8	11.1.0
CT#54	CP-110882	0309	1	Rel-11	B	Introduction of a default PDP context (cid=0)	TEI11	11.1.0
CT#54	CP-110881	0310	1	Rel-11	B	IMS registration information, +CIREG	TEI11	11.1.0
CT#54	CP-110882	0311		Rel-11	F	Corrections to +CGCONTRDP and +CGSCONTRDP	TEI11	11.1.0
CT#54	CP-110882	0312		Rel-11	F	Addition of missing brackets to make responses optional	TEI11	11.1.0
CT#54	CP-110882	0313		Rel-11	F	Correction to +CRLP	TEI11	11.1.0
CT#54	CP-110864	0317	1	Rel-11	A	Corrections to +CGCONTRDP	TEI8	11.1.0
CT#54	CP-110882	0318		Rel-11	B	No More PS Data, +CNMPD	TEI11	11.1.0
CT#54	CP-110882	0319	2	Rel-11	B	Setting UE Usage Setting, +CEUS	TEI11	11.1.0
CT#54	CP-110882	0320	1	Rel-11	C	Modifying +CGCONTRDP to indicate that connectivity is provided by a LIPA PDN connection	TEI11	11.1.0
CT#55	CP-120113	0322		Rel-11	A	+CESQ=?, removal of non-existing parameter <rep>	TEI10	11.2.0
CT#55	CP-120113	0324	1	Rel-11	A	+CESQ, alignment of parameters with value ranges in 3GPP TSs	TEI10	11.2.0
CT#55	CP-120113	0326		Rel-11	A	Correction of +CSUS	TEI10	11.2.0
CT#55	CP-120125	0327	1	Rel-11	F	Correction of action command syntax according to V.250	TEI11	11.2.0
CT#55	CP-120125	0328		Rel-11	F	Usage of AT-commands in insecure scenarios	TEI11	11.2.0
CT#55	CP-120125	0329		Rel-11	F	Correction of AT-command +CALCC	TEI11	11.2.0
CT#55	CP-120125	0330		Rel-11	F	Response to test version of AT- commands shall not be optional	TEI11	11.2.0
CT#55	CP-120125	0331	1	Rel-11	C	+CREG, +CGREG and +CERE, addition of cause values	TEI11	11.2.0
CT#55	CP-120125	0332		Rel-11	F	Indication of optional parameter in AT-command syntax	TEI11	11.2.0
CT#55	CP-120124	0333	1	Rel-11	F	Clarification of SRVCC handover information in +CIREPH AT command	TEI11	11.2.0
CT#55	CP-120125	0335		Rel-11	F	Alignment of descriptions for context parameters	TEI11	11.2.0
CT#55	CP-120125	0337	2	Rel-11	B	Setting configuration values specified in TS 24.167, +CEVDP, +CVDP, +CMMIVT	TEI11	11.2.0
CT#55	CP-120125	0338	1	Rel-11	B	Adding +CASIMS: SMS using IMS support indication	TEI11	11.2.0
CT#55	CP-120125	0340		Rel-11	F	Correct +CREG reported status	TEI11	11.2.0
CT#55	CP-120125	0342		Rel-11	F	Corrections to CPNER parameters	TEI11	11.2.0
CT#56	CP-120309	0343	1	Rel-11	F	Alignment of response codes	TEI11	11.3.0

CT#56				Rel-11	F	Removal of editor's note for security aspects of public warning systems in Rel-11	TEI11	11.3.0
CT#56	CP-120309	0344		Rel-11	F	Response to +CNEM=? is missing	TEI11	11.3.0
CT#56	CP-120309	0346		Rel-11	F	Correction of value range for <QC>	TEI11	11.3.0
CT#56	CP-120309	0347	1	Rel-11	B	<SS_code> added to result codes +CSSI and +CSSU	TEI11	11.3.0
CT#56	CP-120309	0348		Rel-11	F	Update of AT command +CMUX	TEI11	11.3.0
CT#56	CP-120313	0349	2	Rel-11	F	Modifications to UR code for SRVCC due to introduction of vSRVCC	vSRVCC-CT	11.3.0
CT#56	CP-120309	0354	2	Rel-11	F	Correction of TFT description	TEI11	11.3.0
CT#56	CP-120325	0355	3	Rel-11	B	AT commands for URI dialling	ATURI	11.3.0
CT#56	CP-120309	0356		Rel-11	F	Correction of response to +CPSB?	TEI11	11.3.0
CT#57	CP-120584	0357	2	Rel-11	B	+CPOS and +CPOSR, enhancementst for OTDOA	TEI11	11.4.0
CT#57	CP-120604	0359	1	Rel-11	B	Completion of basic dialup scenaros with +CDU	ATURI	11.4.0
CT#57	CP-120584	0360		Rel-11	F	Clarification of time-information elements of +CPOS	TEI11	11.4.0
CT#57	CP-120604	0362	1	Rel-11	B	Service URNs in AT commands	ATURI	11.4.0
CT#58	CP-120794	0364	1	Rel-11	F	Parameters missing for response to +CUSATE	TEI11	11.5.0
CT#58	CP-120813	0365	3	Rel-11	B	Addition of per-call based SS-parameters to +CDU	ATURI	11.5.0
CT#58	CP-120813	0366	3	Rel-11	F	Completion of AT command for hangup	ATURI	11.5.0
CT#58	CP-120813	0367	3	Rel-11	B	Further refinement of the call monitoring command and its responses	ATURI	11.5.0
CT#58	CP-120794	0368	1	Rel-11	F	Inclusion of APN aggregate maximum bit rate in +CGEQSRDP	TEI11	11.5.0
CT#58	CP-120814	0369	7	Rel-11	B	Communication service indication in AT commands	ATURI	11.5.0
CT#58	CP-120794	0370		Rel-11	B	New method introduced for +CMOLRE	TEI11	11.5.0
CT#58	CP-120794	0371	1	Rel-11	F	+CGCONTRDP: support providing more or less than 2 IP addresses	TEI11	11.5.0
CT#58	CP-120861	0373	3	Rel-11	B	Extension of +CPOSR	TEI11	11.5.0
CT#58	CP-120794	0374	1	Rel-11	B	Time of day inclusion for +CPOS	TEI11	11.5.0
CT#58	CP-120794	0376	1	Rel-11	F	DTD corrections for +CPOS and +CPOSR	TEI11	11.5.0
CT#58	CP-120813	0377	2	Rel-11	B	ATURI editor's notes	ATURI	11.5.0
CT#58	CP-120795	0379	2	Rel-11	F	+CEPPI: Power Preference Indication for EPS	TEI11	11.5.0
CT#58	CP-120806	0380	2	Rel-11	F	AT command support for rSRVCC handover	rSRVCC-CT	11.5.0
CT#59				Rel-11		Enabling upper layers to deal with GPRS, EPS, VBS / VGCS and eMLPP related errors	TEI11	11.6.0
CT#59	CP-130115	0378	3		F			
CT#59	CP-130120	0381	2	Rel-11	B	Completion of presentation-related supplementary services wrt SIP-URIs	ATURI	11.6.0
CT#59	CP-130120	0382	1	Rel-11	B	Completion of mid-call related SSs for SIP-URIs	ATURI	11.6.0
CT#59	CP-130120	0383		Rel-11	F	Corrections to +CECUG	ATURI	11.6.0
CT#59	CP-130120	0386	3	Rel-11	B	SDP in media profiles	ATURI	11.6.0
CT#59	CP-130120	0388	1	Rel-11	F	Renaming of 'voice client'	ATURI	11.6.0
CT#59	CP-130120	0390	1	Rel-11	B	Update of media during a call	ATURI	11.6.0
CT#59	CP-130129	0384	1	Rel-12	F	Clarification to PDP context for emergency services	TEI12	12.0.0
CT#59	CP-130129	0385		Rel-12	B	New AT command - Report network error codes +CNEC	TEI12	12.0.0
CT#60	CP-130234	0394	1	Rel-12	A	Corrections of +CSSAC	SSAC	12.1.0
CT#60	CP-130264	0395		Rel-12	B	Enhancement of +CGSN	TEI12	12.1.0
CT#60	CP-130264	0396	4	Rel-12	B	Supported radio accesses, +CSRA	TEI12	12.1.0
CT#60	CP-130264	0398	1	Rel-12	F	Correction to media for SIP-URI	TEI12	12.1.0
CT#60	CP-130264	0400	1	Rel-12	C	MSRP as media for SIP-URI	TEI12	12.1.0
CT#60	CP-130264	0401	1	Rel-12	F	Minor correction for +CUSATW	TEI12	12.1.0
CT#60	CP-130264	0402	2	Rel-12	B	AT command for Circuit Switched Fallback Support	TEI12	12.1.0
CT#60	CP-130254	0405	1	Rel-12	A	Removal of Editors note for ATURI	ATURI	12.1.0
CT#60	CP-130254	0407	1	Rel-12	A	Missing optionality for UR-code +CMCCSS7: <CUG_index>	ATURI, TEI11	12.1.0
CT#60	CP-130264	0408		Rel-12	F	Alignments and corrections of descriptions and parameters	TEI12	12.1.0
CT#60	CP-130254	0410	2	Rel-12	A	Call Forwarding URI support	ATURI	12.1.0
CT#60	CP-130264	0411	1	Rel-12	B	General error extensions to +CMEE	TEI12	12.1.0
CT#61	CP-130510	0413		Rel-12	F	+CCSFB informative example correction	TEI12	12.2.0
CT#61	CP-130502	0415	1	Rel-12	A	+CDEFMP error response	ATURI	12.2.0
CT#61	CP-130510	0416		Rel-12	B	+CPOS and +CPOSR Enhancements for LTE ECID and OTDOA	TEI12	12.2.0
CT#62	CP-130762	0417	1	Rel-12	B	+CGDCONT handover indication	TEI12	12.3.0
CT#62	CP-130762	0418	2	Rel-12	B	New AT command to control message waiting indication	TEI12	12.3.0
CT#62	CP-130762	0419	2	Rel-12	F	Update of +CNMPD AT command	TEI12	12.3.0
CT#62	CP-130762	0420	1	Rel-12	F	Update of +CCFC AT command	TEI12	12.3.0
CT#62	CP-130762	0421	1	Rel-12	B	USSI support for +CUSD	TEI12	12.3.0
CT#62	CP-130762	0422	1	Rel-12	C	MS initiated PDP Context Activation without PDP address	TEI12	12.3.0
CT#63	CP-140059	0423	1	Rel-12	F	+CCFCU time conditions	TEI12, ATURI	12.4.0
CT#63				Rel-12		+CGDCONT - missing parameters for NAS signalling low priority indications and EAB	TEI12, SIMTC-RAN_OC	12.4.0
CT#63	CP-140144	0425	2		F			
CT#63	CP-140144	0426	1	Rel-12	F	Update of AT commands accepted when MT is pending SIM PIN, SIM PUK, or PH-SIM	TEI12	12.4.0
CT#64	CP-140331	0428	1	Rel-12	F	Multiple PDP context activation using +CGACT	TEI12	12.5.0
CT#64	CP-140331	0429	1	Rel-12	F	+CUSATD and +CUSATA alignment	TEI12	12.5.0
CT#64	CP-140331	0430	2	Rel-12	F	Clarifications for +CUSATD	TEI12	12.5.0
CT#64	CP-140331	0432	1	Rel-12	F	Message waiting indication subscription failure error code	TEI12	12.5.0
CT#64				Rel-12			TEI12, SIMTC-RAN_OC	12.5.0
CT#64	CP-140331	0434			F	Removal of redundant "EAB override" in +CGDCONT		
CT#65				Rel-12		Corrupted fonts fixed by MCC		12.6.0

CT#65	CP-140662	0435		Rel-12	B	AT commands in support of ACB-skip	SCM_LTE-CT	12.6.0
CT#65	CP-140664	0436		Rel-12	F	Remove support of CDIVN from +CCFCU	TEI12	12.6.0
CT#65	CP-140664	0437	1	Rel-12	F	+CPOS Modifications for OTDOA and ECID	TEI12	12.6.0
CT#66				Rel-12		Misalignment of +CMWI between the AT-command syntax in the table and the parameter description	TEI12	12.7.0
	CP-140836	0438	1		F			
CT#66	CP-140836	0439		Rel-12	F	Alignment of parameter description in +CCSFB	TEI12	12.7.0
CT#66				Rel-12		Misalignment of +CSCM between the AT-command syntax in the table and the parameter description	SCM_LTE-CT	12.7.0
	CP-140855	0440			F			
CT#66				Rel-12		Updates to +CGDCONT to allow security protected transmission of ESM information	TEI12	12.7.0
	CP-140836	0441	3		F			
CT#66	CP-140836	0442	4	Rel-12	F	Clean split of 'Defined Events' between CPOS and +CPOSR	TEI12	12.7.0
CT#66	CP-140836	0443		Rel-12	F	Correction of ECID measurements parameters in +CPOS	TEI12	12.7.0
CT#66	CP-140836	0444		Rel-12	F	Modification of <Strobe> element usage in +CPOS	TEI12	12.7.0
CT#66	CP-140836	0446	1	Rel-12	F	AT command update for Extended TFT	TEI12	12.7.0
CT#66				Rel-12			MTCe-UEPCOP-CT	12.7.0
	CP-140843	0447	2		B	Addition of AT-commands for UE Power Saving Mode		
CT#66	CP-140850	0448		Rel-12	F	Alignment of value range for QCI	GCSE_LTE-CT	12.7.0
CT#66	CP-140836	0449		Rel-12	F	Corrections to +CUSATW AT Command	TEI12	12.7.0
CT#67				Rel-12		BeiDou System (BDS) support in +CPOS and +CPOSR positioning commands	TEI12	12.8.0
	CP-150064	0456	1		F			
CT#67	CP-150083	0457	2	Rel-13	B	+CEMBMSCFG: AT command for eMBMS Configuration	TEI13	13.0.0
CT#67	CP-150083	0458	2	Rel-13	B	+CEMBMSR: AT command for eMBMS Status Reporting	TEI13	13.0.0
CT#67	CP-150083	0459	2	Rel-13	B	+CEMBMSSRV: AT command for eMBMS Service Configuration	TEI13	13.0.0
CT#67	CP-150083	0460	3	Rel-13	B	+CEMBMSDATA: AT command for eMBMS Data State	TEI13	13.0.0
CT#67	CP-150083	0461	3	Rel-13	B	+CEMBMSCNT: AT command for eMBMS Counting Procedure	TEI13	13.0.0
CT#67	CP-150083	0462	2	Rel-13	B	Enhance +CGCONTRDP for MTU size indication	TEI13	13.0.0
CT#67	CP-150083	0463	2	Rel-13	B	Enhance +CGDCONT for MTU size discovery configuration	TEI13	13.0.0
CT#68	CP-150329	0469		Rel-13	C	AT Command +CTZR: enhancement to extended time zone reporting	TEI13	13.1.0
CT#68				Rel-13		GNSS related corrections in CPOS and +CPOSR positioning commands	TEI12	13.1.0
	CP-150310	0471			A			
CT#68	CP-150329	0472	1	Rel-13	B	Support for WLAN Offload Indication	TEI13	13.1.0
CT#68	CP-150310	0473	1	Rel-13	A	Type correction for +CGDCONT	TEI12	13.1.0
CT#69	CP-150529	0476	2	Rel-13	B	Update to +CSCON AT command	TEI13	13.2.0
CT#69				Rel-13		Missing parameter definitions and support for 'Early Position Fix' in +CPOS	TEI12	13.2.0
	CP-150511	0478	1		A			
CT#69	CP-150529	0479	1	Rel-13	B	New AT command for WLAN Offload Assistance Data	TEI13	13.2.0
CT#69	CP-150529	0480	1	Rel-13	B	New AT command for WLAN Offload based on cell measurements	TEI13	13.2.0
CT#70				Rel-13		AT command in support of Application-specific congestion control for data communication (ACDC)	ACDC-CT	13.3.0
	CP-150719	0464	3		C			
CT#70				Rel-13		MS support of Local address in TFT indicator for +CGDCONT and +CGCONTRDP	TEI13	13.3.0
	CP-150710	0481	1		F			
CT#70				Rel-13		+CEMBMSSAI: AT command to determine available eMBMS Service Area Identities	TEI13	13.3.0
	CP-150710	0482	1		B			
CT#70				Rel-13		AT Command +CGEQOS (Define EPS quality of service): correction of value range for CQI	GCSE_LTE-CT	13.3.0
	CP-150694	0484	2		A			
CT#71	CP-160085	0485	1	Rel-13	F	ToD related corrections for +CPOS and +CPOSR commands	TEI13	13.4.0
CT#72				Rel-13		Correction of indicator for support of Local address in TFT for +CGCONTRDP	TEI13	13.5.0
	CP-160318	0486	1		F			
CT#72	CP-160307	0487	1	Rel-13	F	Correction to +CSCM in support of ACDC	ACDC-CT	13.5.0
CT#72	CP-160331	0488	2	Rel-14	B	+CABTSR: AT command for SM back-off timer status reporting	TEI14	14.0.0
CT#72	CP-160331	0489	2	Rel-14	B	+CABTRDP: AT command for SM back-off timer query	TEI14	14.0.0

Change history							
Date	Meeting	TDoc	CR	Rev	Cat	Subject/Comment	New version
2016-09	CT#73	CP-160589	0491	3	B	Transport of Data via the Control Plane, +CTDCP	14.1.0
2016-09	CT#73	CP-160511	0492	1	B	AT Command for Non-IP Link MTU of non-IP connection	14.1.0
2016-12	CT#74	CP-160737	0493		B	AT Command for rate control	14.2.0
2016-12	CT#74	CP-160737	0494	3	B	Adding NB-IoT and EC-GSM-IoT as new access technologies	14.2.0
2016-12	CT#74	CP-160737	0495	2	C	Correction to MO data via control plane AT-command	14.2.0
2016-12	CT#74	CP-160737	0469		B	Mobile terminated CP data reporting +CRTDCP	14.2.0
2016-12	CT#74	CP-160737	0498	1	B	AT Command for EPS Attach without PDN Connection	14.2.0
2016-12	CT#74	CP-160754	0499	1	F	New QCI values for V2X services	14.2.0
2016-12	CT#74	CP-160737	0500	1	B	AT Command for eDRX setting	14.2.0
2016-12	CT#74	CP-160798	0501		B	Indication of access transfer of PDN for emergency bearer services from non-3GPP access network	14.2.0
2016-12	CT#74	CP-160753	0502		F	Corrections and improvements for +CPSMS	14.2.0
2016-12	CT#74	CP-160753	0503		F	Alignment of +CEPPI with other AT-commands	14.2.0
2016-12	CT#74	CP-160753	0504	1	F	AT commands for indoor positioning	14.2.0
2016-12	CT#74	CP-160737	0505	2	B	CIOT Optimization Configuration	14.2.0
2017-03	CT#75	CP-170136	0490	4	B	AT command for DRVCC indication	14.3.0
2017-03	CT#75	CP-170126	0506	3	F	Addition of cid in +CSODCP and +CRTDCP and editor's note removal	14.3.0
2017-03	CT#75	CP-170136	0507	5	F	+CECALL changes for provision of MSD for eCall and eCall Notification +CECN	14.3.0
2017-03	CT#75	CP-170126	0509	3	B	+CRCES: read coverage (enhancement) status	14.3.0
2017-06	CT#76	CP-171071	0510		F	+CRCES: Fixing syntax error	14.4.0
2017-06	CT#76	CP-171073	0511		F	CP Data path congestion AT CMD error response	14.4.0
2017-06	CT#76	CP-171069	0513	1	A	Addition of TMGI in +CEMBMSDATA	14.4.0
2017-09	CT#77	CP-172114	0514	1	F	Using a single +CCMMD to accept a subset of incoming proposed set of media	14.5.0
2017-09	CT#77	CP-172114	0515	1	F	Updates to +CABTRDP AT command	14.5.0
2017-09	CT#77	CP-172114	0516	1	F	Updates to +CABTSR AT command	14.5.0
2017-09	CT#77	CP-172110	0518	3	B	Addition of AT commands for V2X UE conformance test	14.5.0
2017-12	CT#78	CP-173067	0521	1	F	Clarifications on +CABTSR & +CABTRDP	14.6.0
2017-12	CT#78	CP-173056	0522	3	F	Clarifications on commands for UE test loop function	14.6.0
2017-12	CT#78	CP-173067	0523	3	F	Update to +CGDCONT and +CGCONTRDP for Reliable Data Service	14.6.0
2017-12	CT#78	CP-173069	0519	1	B	Preparation for the 5G access	15.0.0
2017-12	CT#78	CP-173079	0520		F	Misalignment between running text and Annex B for result codes	15.0.0
2017-12	CT#78	CP-173081	0524	1	B	AT-commands for application level measurement reporting	15.0.0
2017-12	CT#78	CP-173069	0525		B	Enhancements to +WS46 for the 5G-system	15.0.0
2018-03	CT#79	CP-180062	0527		A	Corrections to UE test commands +CATM and +CCUTLE	15.1.0
2018-03	CT#79	CP-180065	0529		A	Corrections to test form of +CABTRDP	15.1.0
2018-03	CT#79	CP-180089	0534	1	F	Correct description of +CNMPSD	15.1.0
2018-03	CT#79	CP-180092	0535	1	B	Enhancement to +CNMPSD for BL UEs and NB-IoT UEs	15.1.0
2018-03	CT#79	CP-180065	0537		A	Corrections to +CGDCONT for Reliable Data Service	15.1.0
2018-03	CT#79	CP-180089	0538	2	B	Support for PS Data Off in AT Commands	15.1.0
2018-03	CT#79	CP-180089	0539		F	Update to +CEMBSSAI to include Frequency and Service area identity	15.1.0
2018-03	CT#79	CP-180076	0540	2	B	Support for 5G in AT-commands +CPNET and +CSRA	15.1.0
2018-03	CT#79	CP-180076	0541		B	Support for 5G in AT-command +CPOL	15.1.0
2018-03	CT#79	CP-180076	0542	1	B	5G in AT-command for preferred network status	15.1.0
2018-03	CT#79	CP-180076	0543	3	B	5G in AT-commands for network registration and PLMN selection	15.1.0
2018-03	CT#79	CP-180060	0547		A	Correction to read command of +CEREG when <n>=4 and <n>=5	15.1.0
2018-03	CT#79	CP-180113	0549	3	A	Addition of AT command for V2X UTC time reset for UE conformance test	15.1.0
2018-03	CT#79	CP-180076	0550		B	Applicability of service specific access control restriction status, +CSSAC, for 5G	15.1.0
2018-03	CT#79	CP-180089	0551		F	Fix reference to 3GPP TS 23.227	15.1.0
2018-03	CT#79	CP-180089	0552	1	F	Fix "unsolicited result code" confusion	15.1.0
2018-03	CT#79	CP-180076	0553		B	Applicability for Session start and stop for MMTEL and SMSoverIP applications, +CSCM, for 5G	15.1.0
2018-03	CT#79	CP-180076	0554		B	Applicability for Application Start and Stop indication for applications other than MMTEL and SMSoverIP, +CACDC, for 5G	15.1.0
2018-06	CT#80	CP-181050	0556		A	Update of +CUSPCREQ AT command	15.2.0
2018-06	CT#80	CP-181076	0557		F	Clarification in use of <SDP_md> in +CMCCS	15.2.0
2018-06	CT#80	CP-181076	0558		F	Corrections to +CEMBSSAI	15.2.0
2018-06	CT#80	CP-181076	0559		F	Support of +CDU in +CVMOD	15.2.0
2018-06	CT#80	CP-181076	0560		F	CME ERROR is misspelt in +CAEMLPP	15.2.0
2018-06	CT#80	CP-181058	0561	3	B	Inclusion of error codes for 5G, and update of error codes for CS, GPRS and EPS	15.2.0
2018-06	CT#80	CP-181057	0562	1	F	Corrections to AT-commands on network registration	15.2.0
2018-06	CT#80	CP-181057	0563		F	Support of +CNEM in 5G	15.2.0

2018-06	CT#80	CP-181058	0565	1	B	Removal of Editor's Notes for 5G on commands for alignment between 5GS and EPS	15.2.0
2018-06	CT#80	CP-181057	0566		B	Extend +CSCON for 5G and Multi-RAT Dual Connectivity	15.2.0
2018-06	CT#80	CP-181061	0567	1	B	[+CBPI] Bandwidth Preference indication for BL UEs and UEs in coverage enhancement mode	15.2.0
2018-06	CT#80	CP-181062	0568	1	B	AT commands for Enhanced Calling Name (eCNAM)	15.2.0
2018-06	CT#80	CP-181058	0569	1	F	Clarification to registration commands for 5GS	15.2.0
2018-06	CT#80	CP-181058	0570	2	B	AT+CSUPI	15.2.0
2018-06	CT#80	CP-181058	0571	2	B	Support for 5G in AT-commands +CGDCONT	15.2.0
2018-06	CT#80	CP-181057	0572	1	B	Support for 5G in AT-commands +CGCONTRDP and +CGSCONTRDP	15.2.0
2018-06	CT#80	CP-181058	0573	2	B	Support for 5G in AT-commands +CGTFT and +CGTFTTRDP	15.2.0
2018-06	CT#80	CP-181058	0574	2	B	AT-commands +CG5QOS and +CG5QOSRDP for 5G QoS	15.2.0
2018-09	CT#81	CP-182144	0575		B	Inclusion and alignment of error codes for GPRS, UMTS, EPS and 5G	15.3.0
2018-09	CT#81	CP-182144	0576		F	Removal of TBDs and editor's notes in registration and PLMN selection commands	15.3.0
2018-09	CT#81	CP-182144	0577	2	B	AT command for UE policy delivery	15.3.0
2018-09	CT#81	CP-182144	0578	1	B	AT Command for Allowed NSSAI	15.3.0
2018-09	CT#81	CP-182144	0579		B	+CGSMS not applicable to UE in E-UTRAN or NG-RAN	15.3.0
2018-09	CT#81	CP-182144	0580	1	B	New AT command to set access selection preferences for MO SMS over NAS in 5GS	15.3.0
2018-09	CT#81	CP-182232	0582	3	A	Addition of new AT commands +CCBRREQ and +CV2XDTS for V2X testing	15.3.0
2018-09	CT#81	CP-182144	0583	3	F	General remark about 5GS PDU Sessions and EPS PDN Connections	15.3.0
2018-09	CT#81	CP-182144	0584	2	F	AT Command to enable MICO mode	15.3.0
2018-09	CT#81	CP-182144	0585	3	F	Adding RRC Inactive and CN type in CSCON	15.3.0
2018-09	CT#81	CP-182144	0586		F	Correction to AT+CSCON when MT connected to NR	15.3.0
2018-09	CT#81	CP-182144	0587		B	AT-commands for IMS in 5G	15.3.0
2018-09	CT#81	CP-182144	0588		B	AT-command for primary notification event reporting in 5G	15.3.0
2018-09	CT#81	CP-182159	0589		B	Completion of AT-commands for application level measurement reporting	15.3.0
2018-09	CT#81	CP-182144	0590		F	Extend +CGTFT test command for QRI	15.3.0
2018-09	CT#81	CP-182144	0591		F	Correction to +CG5QOS and +CG5QOSRDP	15.3.0
2018-09	CT#81	CP-182148	0592		B	New QCI for MCVideo	15.3.0
2018-09	CT#81	CP-182144	0593	1	F	Extend +CGDCONT for always-on PDU session	15.3.0
2018-09	CT#81	CP-182120	0595	1	A	Addition of new AT command +CSPSAIR for V2X testing	15.3.0
2018-09	CT#81	CP-182146	0596		F	+CBPI: fix syntax	15.3.0
2018-09	CT#81	CP-182144	0597	1	F	Update +CNEM to include support for emergency services fallback	15.3.0
2018-09	CT#81	CP-182158	0598	1	F	Adding support for RDS port numbers and Acknowledgement	15.3.0
2018-09	CT#81	CP-182144	0599		B	AT commands +CSBTSR and +CSBTRDP for supporting S-NSSAI based backoff timer report	15.3.0
2018-09	CT#81	CP-182144	0600		B	AT commands +CSDBTSR and +CSDBTRDP for supporting S-NSSAI and DNN based backoff timer report	15.3.0
2018-09	CT#81	CP-182122	0602		A	Correction on +CABTSR and +CABTRDP	15.3.0
2018-12	CT#82	CP-183043	0564	3	B	Addition of the extended emergency number list in AT-command +CEN	15.4.0
2018-12	CT#82	CP-183043	0603		B	Alignment of error codes with TS 24.501	15.4.0
2018-12	CT#82	CP-183043	0604	2	F	Correcting +CNMPD for 5G	15.4.0
2018-12	CT#82	CP-183043	0605	2	F	Correcting +CPSMS for 5G	15.4.0
2018-12	CT#82	CP-183043	0606	2	F	Correcting +CEPPI for 5G	15.4.0
2018-12	CT#82	CP-183075	0608		A	Update of description of AT command +CUSPCREQ	15.4.0
2018-12	CT#82	CP-183043	0609	1	F	Resolving Editor Note regarding NR cell connected to EPS core	15.4.0
2018-12	CT#82	CP-183043	0610	1	B	Update +CGDCONT and +CGCONTRDP to support always-on PDU session	15.4.0
2018-12	CT#82	CP-183043	0611	1	F	Definition of S-NSSAI parameter format	15.4.0
2018-12	CT#82	CP-183043	0612		F	Removal of the EN on "New AT-command(s) for 5G UE settings like e.g. voice, data & power"	15.4.0
2018-12	CT#82	CP-183043	0613		F	Assignment of values for +WS46	15.4.0
2018-12	CT#82	CP-183043	0614		F	Removal of the EN on "Delete non-active PDP contexts"	15.4.0
2018-12	CT#82	CP-183043	0615	1	F	Removal of editor's notes on eMBMS and 5G	15.4.0
2018-12	CT#82	CP-183043	0616	1	F	Removal of editor's note for +CAVIMS and 5G	15.4.0
2018-12	CT#82	CP-183043	0617	2	F	Updates to TS 24.501 clause references	15.4.0
2018-12	CT#82	CP-183043	0618	1	F	Corrections to +CMICO	15.4.0
2018-12	CT#82	CP-183043	0619	1	F	New AT command to use SMS over NAS +C5GUSMS	15.4.0
2018-12	CT#82	CP-183043	0622	1	F	Definition of Allowed_NSSAI parameter format	15.4.0
2019-03	CT#83	CP-190091	0620	6	F	New AT Command to request LADN information from the network +CRLADN	15.5.0
2019-03	CT#83	CP-190091	0621	5	F	New AT Command for enabling reporting of LADN information from the MT +CLADN	15.5.0
2019-03	CT#83	CP-190091	0624		F	Alignment of error codes with TS 24.501 v15.2.0	15.5.0

2019-03	CT#83	CP-190091	0625	6	F	New AT command for supporting UE requested NSSAI	15.5.0
2019-03	CT#83	CP-190091	0626	2	F	Inclusion of 5G in +CPBS	15.5.0
2019-03	CT#83	CP-190100	0627		F	Update of the general clause for AT-commands for the PS-domain	15.5.0
2019-03	CT#83	CP-190091	0628	4	F	New AT commands for network slicing	15.5.0
2019-03	CT#83	CP-190091	0630		F	Corrections to +CMICO command	15.5.0
2019-03	CT#83	CP-190091	0632	1	F	Support for Traffic Segregation	15.5.0
2019-03	CT#83	CP-190091	0633		F	Correction on the general remark about 5GS	15.5.0
2019-03	CT#83	CP-190091	0634	1	F	Support for 5G NR signal quality indicator	15.5.0
2019-03	CT#83	CP-190091	0635		F	Corrections for access technology connectivity to core network in +CEREG	15.5.0
2019-03	CT#83	CP-190091	0636	1	F	Resolve Editor's Note in +CGACT	15.5.0
2019-03	CT#83	CP-190091	0637		F	Resolve Editor's Note in +CGAUTO	15.5.0
2019-03	CT#83	CP-190091	0638	1	F	Resolve Editor's Note in +CGCMOD	15.5.0
2019-03	CT#83	CP-190091	0639		F	Resolve Editor's Note in +CIPCA	15.5.0
2019-03	CT#83	CP-190100	0641	1	F	Addition of missing QCLs and 5QCLs	15.5.0
2019-03	CT#83	CP-190091	0642		F	Removal of text on applicability to 5GS	15.5.0
2019-03	CT#83	CP-190091	0643		F	Alignment on description of NSSAI	15.5.0
2019-06	CT#84	CP-191125	0644		F	Correction of numeric error code values	15.6.0
2019-06	CT#84	CP-191125	0646		F	Alignment of error codes with TS 24.501 v15.3.0	15.6.0
2019-06	CT#84	CP-191125	0648		F	Correction of parameter name <MICO_Mode>	15.6.0
2019-06	CT#84	CP-191125	0654		F	Correction to access technology selected in +COPS	15.6.0
2019-06	CT#84	CP-191125	0657	1	F	Correction to AT-command +CIREPI to support non-3GPP VoPS indication	15.6.0
2019-06	CT#84	CP-191125	0659	1	F	Removal of editor's note for +CABTSR and +CABTRDP	15.6.0
2019-09	CT#85	CP-192045	0671	1	F	Support for SSC mode 2 and SSC mode 3	15.7.0
2020-06	CT#88e	CP-201352	0695	4	F	Removing the ENs for the enhancement to 5G Location Service	15.8.0
2022-06	CT#96	CP-221196	0773	-	F	Removal of remaining Editor's Notes for WI 5GS_Ph1	15.9.0

History

Document history		
V15.2.0	June 2018	Publication
V15.3.0	October 2018	Publication
V15.4.0	April 2019	Publication
V15.5.0	April 2019	Publication
V15.6.0	July 2019	Publication
V15.7.0	October 2019	Publication
V15.8.0	August 2020	Publication
V15.9.0	August 2022	Publication