

ETSI TS 128 533 V16.7.0 (2021-04)



**5G;  
Management and orchestration;  
Architecture framework  
(3GPP TS 28.533 version 16.7.0 Release 16)**



---

Reference

RTS/TSGS-0528533vg70

---

Keywords

5G

**ETSI**

650 Route des Lucioles  
F-06921 Sophia Antipolis Cedex - FRANCE

Tel.: +33 4 92 94 42 00 Fax: +33 4 93 65 47 16

Siret N° 348 623 562 00017 - APE 7112B  
Association à but non lucratif enregistrée à la  
Sous-Préfecture de Grasse (06) N° w061004871

---

**Important notice**

The present document can be downloaded from:

<http://www.etsi.org/standards-search>

The present document may be made available in electronic versions and/or in print. The content of any electronic and/or print versions of the present document shall not be modified without the prior written authorization of ETSI. In case of any existing or perceived difference in contents between such versions and/or in print, the prevailing version of an ETSI deliverable is the one made publicly available in PDF format at [www.etsi.org/deliver](http://www.etsi.org/deliver).

Users of the present document should be aware that the document may be subject to revision or change of status.

Information on the current status of this and other ETSI documents is available at

<https://portal.etsi.org/TB/ETSIDeliverableStatus.aspx>

If you find errors in the present document, please send your comment to one of the following services:

<https://portal.etsi.org/People/CommitteeSupportStaff.aspx>

---

**Notice of disclaimer & limitation of liability**

The information provided in the present deliverable is directed solely to professionals who have the appropriate degree of experience to understand and interpret its content in accordance with generally accepted engineering or other professional standard and applicable regulations.

No recommendation as to products and services or vendors is made or should be implied.

No representation or warranty is made that this deliverable is technically accurate or sufficient or conforms to any law and/or governmental rule and/or regulation and further, no representation or warranty is made of merchantability or fitness for any particular purpose or against infringement of intellectual property rights.

In no event shall ETSI be held liable for loss of profits or any other incidental or consequential damages.

Any software contained in this deliverable is provided "AS IS" with no warranties, express or implied, including but not limited to, the warranties of merchantability, fitness for a particular purpose and non-infringement of intellectual property rights and ETSI shall not be held liable in any event for any damages whatsoever (including, without limitation, damages for loss of profits, business interruption, loss of information, or any other pecuniary loss) arising out of or related to the use of or inability to use the software.

---

**Copyright Notification**

No part may be reproduced or utilized in any form or by any means, electronic or mechanical, including photocopying and microfilm except as authorized by written permission of ETSI.

The content of the PDF version shall not be modified without the written authorization of ETSI.

The copyright and the foregoing restriction extend to reproduction in all media.

© ETSI 2021.  
All rights reserved.

---

# Intellectual Property Rights

## Essential patents

IPRs essential or potentially essential to normative deliverables may have been declared to ETSI. The declarations pertaining to these essential IPRs, if any, are publicly available for **ETSI members and non-members**, and can be found in ETSI SR 000 314: "*Intellectual Property Rights (IPRs); Essential, or potentially Essential, IPRs notified to ETSI in respect of ETSI standards*", which is available from the ETSI Secretariat. Latest updates are available on the ETSI Web server (<https://ipr.etsi.org/>).

Pursuant to the ETSI Directives including the ETSI IPR Policy, no investigation regarding the essentiality of IPRs, including IPR searches, has been carried out by ETSI. No guarantee can be given as to the existence of other IPRs not referenced in ETSI SR 000 314 (or the updates on the ETSI Web server) which are, or may be, or may become, essential to the present document.

## Trademarks

The present document may include trademarks and/or tradenames which are asserted and/or registered by their owners. ETSI claims no ownership of these except for any which are indicated as being the property of ETSI, and conveys no right to use or reproduce any trademark and/or tradename. Mention of those trademarks in the present document does not constitute an endorsement by ETSI of products, services or organizations associated with those trademarks.

**DECT™**, **PLUGTESTS™**, **UMTS™** and the ETSI logo are trademarks of ETSI registered for the benefit of its Members. **3GPP™** and **LTE™** are trademarks of ETSI registered for the benefit of its Members and of the 3GPP Organizational Partners. **oneM2M™** logo is a trademark of ETSI registered for the benefit of its Members and of the oneM2M Partners. **GSM®** and the GSM logo are trademarks registered and owned by the GSM Association.

---

# Legal Notice

This Technical Specification (TS) has been produced by ETSI 3rd Generation Partnership Project (3GPP).

The present document may refer to technical specifications or reports using their 3GPP identities. These shall be interpreted as being references to the corresponding ETSI deliverables.

The cross reference between 3GPP and ETSI identities can be found under <http://webapp.etsi.org/key/queryform.asp>.

---

# Modal verbs terminology

In the present document "**shall**", "**shall not**", "**should**", "**should not**", "**may**", "**need not**", "**will**", "**will not**", "**can**" and "**cannot**" are to be interpreted as described in clause 3.2 of the [ETSI Drafting Rules](#) (Verbal forms for the expression of provisions).

"**must**" and "**must not**" are **NOT** allowed in ETSI deliverables except when used in direct citation.

# Contents

Intellectual Property Rights .....	2
Legal Notice .....	2
Modal verbs terminology.....	2
Foreword.....	5
Introduction .....	5
1 Scope .....	6
2 References .....	6
3 Definitions and abbreviations.....	7
3.1 Definitions .....	7
3.2 Abbreviations .....	8
4 Service Based Management Architecture (SBMA) .....	8
4.1 Management Services (MnS) .....	8
4.2 MnS components.....	9
4.2.1 Introduction.....	9
4.2.2 MnS component type A .....	9
4.2.3 Management information.....	9
4.2.3.1 MnS component type B.....	9
4.2.3.2 MnS component type C.....	9
4.2.4 MnS producer profile.....	9
4.3 Combination of MnS components.....	9
4.4 Management capability exposure governance.....	10
4.5 Management Function (MnF) concept .....	11
4.6 Management data analytics capability.....	13
4.7 Management service discovery .....	14
4.7.1 Introduction.....	14
4.7.2 MnS data.....	14
4.7.3 MnS discovery service.....	14
4.8 Management capability support in multiple tenant environment .....	14
5 Architecture reference model .....	14
5.1 General concepts .....	14
5.1.1 Management service producers, consumers and exposure.....	14
5.1.2 Interactions between management service producer and management service consumer .....	16
5.2 Management interactions with NFV MANO .....	17
5.3 Management service deployment based on ZSM framework.....	17
5.4 Management interactions with NWDAF.....	18
6 Use cases and requirements.....	19
6.1 Use cases .....	19
6.1.1 MnS query .....	19
6.2 Requirements.....	19
6.2.1 Requirements for MnS discovery service .....	19
<b>Annex A (informative): Example of deployment model with utilization of management services .....</b>	<b>20</b>
A.1 Utilization of Management services in network and subnet layers.....	20
A.2 Utilization of management services in network function management. ....	20
A.3 Utilization of management services by Exposure Governance Management Function (EGMF) .....	21
A.4 Utilization of interface to NFV-MANO by the producer of management services .....	22
A.5 Management Data Analytics Service (MDAS) .....	23

A.6	Utilization of management services in functional management architecture.....	24
A.7	Utilization of management data analytics services .....	25
A.8	An example of deployment scenario for network and network slice .....	25
A.9	Deployment examples of ONAP platform consuming 3GPP MnS(s) .....	27
A.9.1	Integration with ONAP DCAE collection framework utilizing 3GPP MnS(s) .....	27
A.9.2	Integration with ONAP controller utilizing 3GPP MnS(s) .....	27
<b>Annex B (normative):</b>	<b>Solutions for management of 5G network and network slicing.....</b>	<b>28</b>
<b>Annex C (informative):</b>	<b>Example of mapping Management Services (MnS) to pre-Rel-15 management framework .....</b>	<b>29</b>
<b>Annex D (informative):</b>	<b>Change history .....</b>	<b>30</b>
History .....		31

---

# Foreword

This Technical Specification has been produced by the 3rd Generation Partnership Project (3GPP).

The contents of the present document are subject to continuing work within the TSG and may change following formal TSG approval. Should the TSG modify the contents of the present document, it will be re-released by the TSG with an identifying change of release date and an increase in version number as follows:

Version x.y.z

where:

- x the first digit:
  - 1 presented to TSG for information;
  - 2 presented to TSG for approval;
  - 3 or greater indicates TSG approved document under change control.
- y the second digit is incremented for all changes of substance, i.e. technical enhancements, corrections, updates, etc.
- z the third digit is incremented when editorial only changes have been incorporated in the document.

---

# Introduction

The management of the 3GPP network is provided by management services. The service based architecture and interfaces support various management services of vastly different requirements on network configuration, network performance, and network fault supervision. The 3GPP network management architecture evolves supporting operators' design and management of their service oriented networks.

---

# 1 Scope

The present document defines the network management and orchestration architecture for 3GPP networks including network slicing. The use cases and requirements are specified in TS 28.530 [3].

---

# 2 References

The following documents contain provisions which, through reference in this text, constitute provisions of the present document.

- References are either specific (identified by date of publication, edition number, version number, etc.) or non-specific.
- For a specific reference, subsequent revisions do not apply.
- For a non-specific reference, the latest version applies. In the case of a reference to a 3GPP document (including a GSM document), a non-specific reference implicitly refers to the latest version of that document *in the same Release as the present document*.

- [1] 3GPP TR 21.905: "Vocabulary for 3GPP Specifications".
- [2] 3GPP TS 32.101: "Telecommunication management; Principles and high level requirements".
- [3] 3GPP TS 28.530: "Management and orchestration of networks and network slicing; Concepts, use cases and requirements".
- [4] 3GPP TS 28.541: "Management and orchestration of 5G networks; Network Resource Model (NRM); Stage 2 and stage 3".
- [5] 3GPP TS 28.552: "Management and orchestration of 5G networks; Performance measurements and assurance data".
- [6] 3GPP TS 28.554: "Management and orchestration of 5G networks; 5G End to end Key Performance Indicators (KPI)".
- [7] 3GPP TS 32.425: "Telecommunication management; Performance Management (PM); Performance measurements Evolved Universal Terrestrial Radio Access Network (E-UTRAN)".
- [8] 3GPP TS 28.531: "Management and orchestration of 5G networks; Provisioning; Stage 1".
- [9] 3GPP TS 28.532: "Management and orchestration; Management services".
- [10] 3GPP TS 28.500: "Telecommunication management; Management concept, architecture and requirements for mobile networks that include virtualized network functions"
- [11] 3GPP TS 28.510; "Telecommunication management; Configuration Management (CM) for mobile networks that include virtualized network functions; Requirements".
- [12] 3GPP TS 28.511; "Telecommunication management; Configuration Management (CM) for mobile networks that include virtualized network functions; Procedures".
- [13] 3GPP TS 28.512; "Telecommunication management; Configuration Management (CM) for mobile networks that include virtualized network functions; Stage 2".
- [14] 3GPP TS 28.513: "Telecommunication management; Configuration Management (CM) for mobile networks that include virtualized network functions; Stage 3".
- [15] 3GPP TS 28.515; "Telecommunication management; Fault Management (FM) for mobile networks that include virtualized network functions; Requirements".
- [16] 3GPP TS 28.516: "Telecommunication management; Fault Management (FM) for mobile networks that include virtualized network functions; Procedures".

- [17] 3GPP TS 28.517: "Telecommunication management; Fault Management (FM) for mobile networks that include virtualized network functions; Stage 2".
- [18] 3GPP TS 28.518: "Telecommunication management; Fault Management (FM) for mobile networks that include virtualized network functions; Stage 3".
- [19] 3GPP TS 28.520: "Telecommunication management; Performance Management (PM) for mobile networks that include virtualized network functions; Requirements".
- [20] 3GPP TS 28.521: "Telecommunication management; Performance Management (PM) for mobile networks that include virtualized network functions; Procedures".
- [21] 3GPP TS 28.522: "Telecommunication management; Performance Management (PM) for mobile networks that include virtualized network functions; Stage 2".
- [22] 3GPP TS 28.523: "Telecommunication management; Performance Management (PM) for mobile networks that include virtualized network functions; Stage 3".
- [23] 3GPP TS 28.525: "Telecommunication management; Life Cycle Management (LCM) for mobile networks that include virtualized network functions; Requirements".
- [24] 3GPP TS 28.526: "Telecommunication management; Life Cycle Management (LCM) for mobile networks that include virtualized network functions; Procedures".
- [25] 3GPP TS 28.527: "Telecommunication management; Life Cycle Management (LCM) for mobile networks that include virtualized network functions; Stage 2".
- [26] 3GPP TS 28.528: "Telecommunication management; Life Cycle Management (LCM) for mobile networks that include virtualized network functions; Stage 3".
- [27] ETSI GS NFV 003: "Network Functions Virtualisation (NFV); Terminology for Main Concepts in NFV V1.3.1 (2018-01)".
- [28] 3GPP TS 28.545: "Management and orchestration; Fault Supervision (FS)".
- [29] ETSI GS ZSM 002: "Zero-touch Network and Service Management (ZSM); Reference Architecture V.1.1 (2019-08)".
- [30] 3GPP TS 23.288: "Architecture enhancements for 5G System (5GS) to support network data analytics services".
- [31] 3GPP TS 23.501: "System Architecture for the 5G system".
- [32] 3GPP TS 28.622: "Telecommunication management; Generic Network Resource Model (NRM) Integration Reference Point (IRP); Information Service (IS)".

---

## 3 Definitions and abbreviations

### 3.1 Definitions

For the purposes of the present document, the terms and definitions given in 3GPP TR 21.905 [1] and the following apply. A term defined in the present document takes precedence over the definition of the same term, if any, in 3GPP TR 21.905 [1] or NFV-MANO [27].

**Exposure governance management function:** Management Function entity with the role of management service exposure governance.

**Management Service (MnS):** set of offered management capabilities.

**Management Function (MnF):** logical entity playing the roles of Management Service consumer and/or Management Service producer.

**Network Function (NF):** defined in TS 23.501[31].



NOTE: In 3GPP NRM, the Network Functions are modeled using ManagedFunction IOCs (e.g. AMFFunction) and its sub-classes.

## 3.2 Abbreviations

For the purposes of the present document, the abbreviations given in 3GPP TR 21.905 [1], TS 28.530 [3], in NFV-MANO [27] and the following apply. An abbreviation defined in the present document takes precedence over the definition of the same abbreviation, if any, in 3GPP TR 21.905 [1].

CM	Configuration Management
LCM	Lifecycle Management
MDAS	Management Data Analytics Service
MnF	Management Function
MnS	Management Service
NF	Network Function
NFV-MANO	Network Functions Virtualisation Management and Orchestration
PM	Performance Management
SBMA	Service Based Management Architecture

---

# 4 Service Based Management Architecture (SBMA)

## 4.1 Management Services (MnS)

The fundamental building block of the Service Based Management Architecture (SBMA) is the Management Service (MnS). A MnS is a set of offered capabilities for management and orchestration of network and services. The entity producing an MnS is called MnS producer. The entity consuming an MnS is called MnS consumer. An MnS provided by an MnS producer can be consumed by any entity with appropriate authorisation and authentication.

An MnS producer offers its services via a standardized service interface composed of individually specified MnS components.

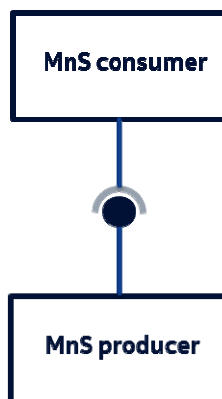

Figure 4.1.1: MnS producer and MnS consumer

## 4.2 MnS components

### 4.2.1 Introduction

A MnS is specified using different independent components. A concrete MnS is composed of at least two of these components. Three different component types are defined, called MnS component type A, MnS component type B and MnS component type C. These components are defined in the following clauses.

### 4.2.2 MnS component type A

The MnS component type A is a group of management operations and/or notifications that is agnostic with regard to the entities managed. The operations and notifications as such are hence not involving any information related to the managed network. These operations and notifications are called generic or network agnostic.

For example, operations for creating, reading, updating and deleting managed object instances, where the managed object instance to be manipulated is specified only in the signature of the operation, are generic.

### 4.2.3 Management information

#### 4.2.3.1 MnS component type B

MnS component type B refers to management information represented by information models representing the managed entities. A MnS component type B is also called Network Resource Model (NRM).

MnS component type B examples are:

- 1) Network resource models as defined in TS 28.622 [32].
- 2) Network resource models as defined in TS 28.541 [4]

#### 4.2.3.2 MnS component type C

MnS component type C is performance information of the managed entity and fault information of the managed entity.

The following are examples of Management service component type C:

1. Alarm information as defined in TS 28.532 [9] and TS 28.545 [28].
2. Performance data as defined in TS 28.552 [5], TS 28.554 [6] and TS 32.425 [7].

### 4.2.4 MnS producer profile

A MnS producer is described by a set of meta data called MnS producer profile. The profile holds information about the supported MnS components and their version numbers. This may include also information about support of optional features. For example, a read operation on a complete subtree of managed object instances may support applying filters on the scoped set of objects as optional feature. In this case the MnS profile should include the information if filtering is supported.

## 4.3 Combination of MnS components

A MnS is composed by a MnS component type A and

- a MnS component type B, or
- a MnS component type B and a MnS component type C.

The instances of management services carry information about specified management service components in the metadata attributes. Figure 4.3.1 illustrates examples of management service instances with various management service components of type A, type B and type C:

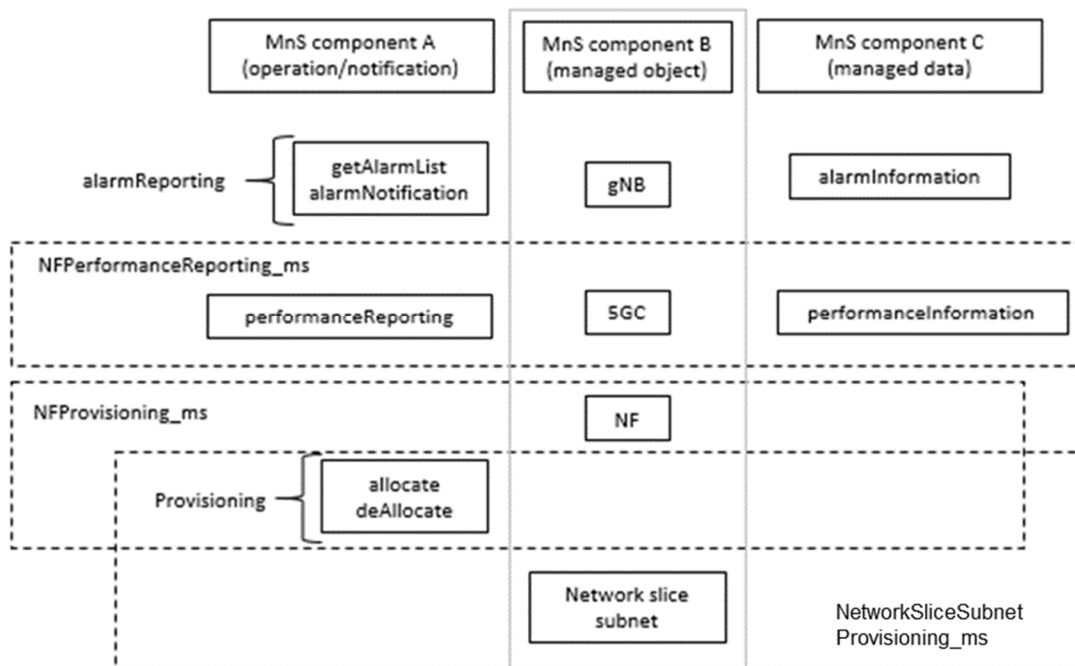

Figure 4.3.1: Example of Management Service and component type A, B and C

## 4.4 Management capability exposure governance

As precondition for Management Service exposure governance offer, producer of management capability exposure governance should have access to:

An association between information about specified management service components and instances of management services.

NOTE: The detail creation of an association is left for implementation and out of scope of 3GPP standardization.

Management capability exposure governance provides exposure governance on basic elements of management function service based interface:

- 1) Management service component type A
- 2) Management service component type B
- 3) Management service component type C

As described in Figure 4.4.1 left hand part, when there is a Management Service A exposure without exposure governance, Management Service A Consumer (e.g. 3<sup>rd</sup> party) can access all management capability offered by Management Service A Producer.

As described in Figure 4.4.1 right hand part, when Management Service A is exposed with applied exposure governance it becomes Management Service A'. Management Service A' Consumer can access Management Service A' after following steps:

- Management Service A, exposed by Management Service A Producer, is consumed by Management Service A Consumer;

- Management Service B, exposed by Management Service B Producer, is consumed by Management Service B Consumer (e.g. operator) who is authorized to access offered management capabilities exposure governance(s);
- Management Service B Consumer (e.g. operator) request a specified exposure governance on Management Service A;
- Management Service A' Producer produces Management Service A' based on applied exposure governance on consumed Management Service A.

NOTE: The Management Service A Consumer, the Management Service A' Producer and Management Service B Producer can be represented as a single Management Function e.g. a single MnF).

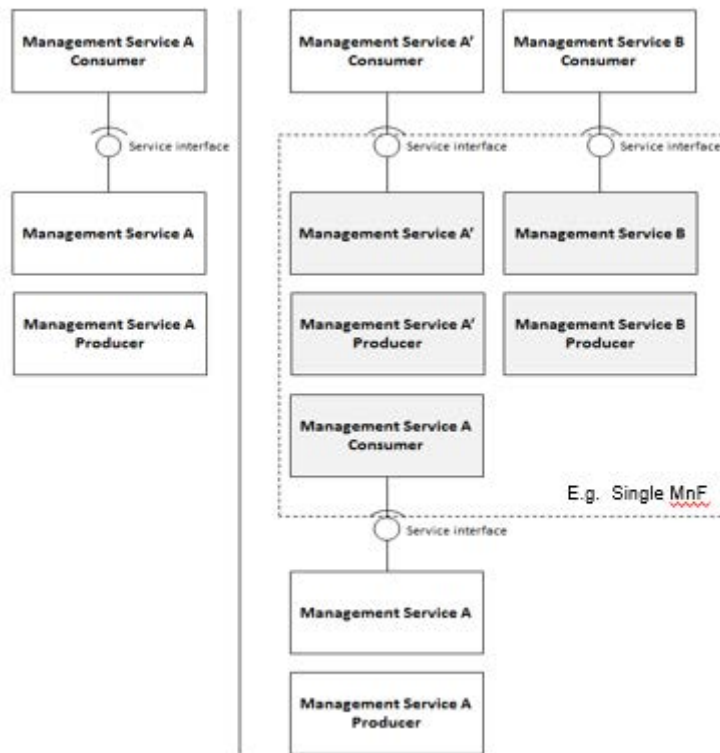
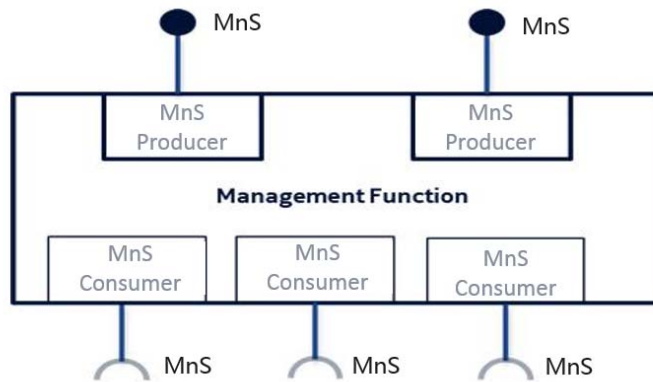

Figure 4.4.1: Management capability exposure governance applied on exposed Management Service A

## 4.5 Management Function (MnF) concept

A Management Function (MnF) is a logical entity playing the roles of MnS consumer and/or MnS producer.

A Management Service produced by MnF may have multiple consumers. The MnF may consume multiple Management Services from one or multiple Management Service producers. An example of a MnF playing both roles (Management Service producer and consumer) illustrated in the figure 4.5.1 below.



**Figure 4.5.1: Example of Management Function and Management Services**

Management Function can be deployed as a separate entity or embedded in Network Function to provide MnS(s). Following figure 4.5.2 shows an example (on the left) which MnF deployed as a separate entity to provide MnS(s) and another example (on the right) which MnF is embedded in Network Function to provide MnS(s):

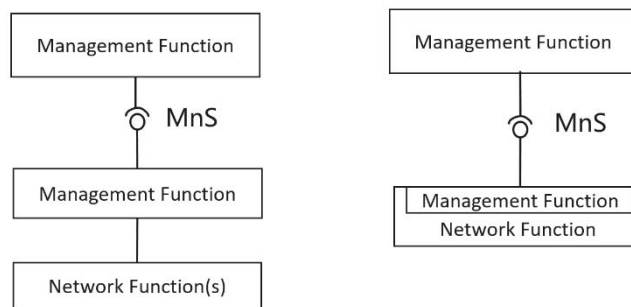

**Figure 4.5.2 Examples of MnS deployment scenario**

Management Functions may interact by consuming Management Services produced by other Management Functions. The figure 4.6.2 below illustrates multiple scenarios:

- MnF1 produces Management Service MnS-a;
- MnF2 consumes Management Service MnS-a produced by MnF1 and produces Management Services MnS-b and MnS-c;
- MnF3 produces Management Service MnS-c;
- MnF4 consumes Management Service MnS-b produced by the MnF2;
- MnF5 consumes Management Services MnS-c produced by the MnF2 and MnF3, and in turn produces the same Management Service MnS-c. The behaviour of MnF5 may be seen as aggregation of Management Services MnS-c.

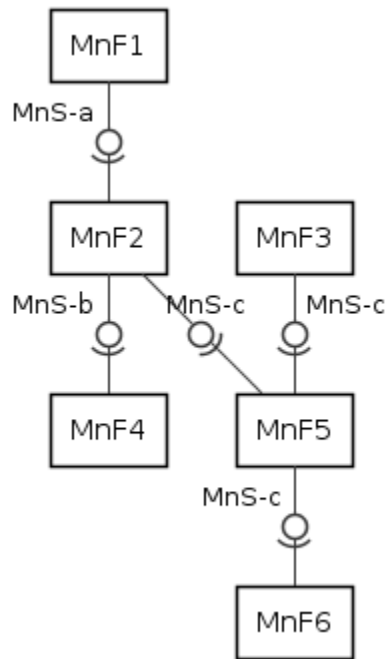
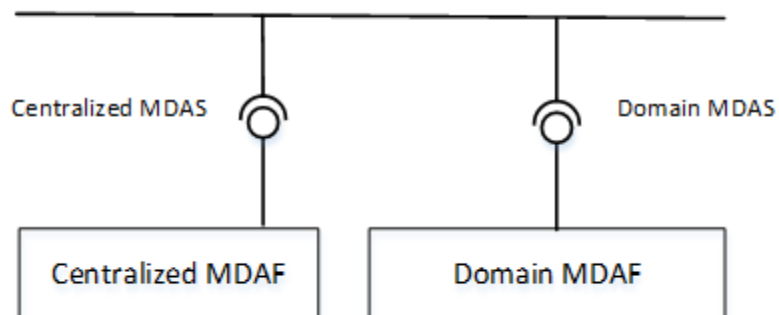

**Figure 4.5.2: An example of interactions between Management Functions**

NOTE: The specification of a MnF is out of scope of the present document.

## 4.6 Management data analytics capability

Mobile networks have the capability to support a wide variety of services and requirements. This, along with increasing flexibility of the network may present management and operational challenges and complexities. The management system can therefore benefit from management data analytics services for improving networks performance and efficiency to accommodate and support the diversity of services and requirements. The management data analytics utilize the network management data collected from the network (including e.g. service, slicing and/or network functions related data) and make the corresponding analytics based on the collected information. For example, the information provided by PM data analytics services can be used to optimize network performance, and the information provided by FM data analytics services can be used to predict and prevent failures of the network. MDAS can be deployed at different levels, for example, at a domain level (e.g. RAN, CN, network slice subnet) and/or in a centralized manner (e.g. at a PLMN level).



**Figure 4.6.1: Service based architecture for management data analytics**

## 4.7 Management service discovery

### 4.7.1 Introduction

The MnS consumer in an operator's management system need to discover the availability of MnS instances provided by other MnS producer(s). In order to enable the MnS instances to be discovered by MnS consumer, the MnS needs to be discoverable to the operator's management system when the MnS instance become operative.

### 4.7.2 MnS data

The MnS data includes the information of MnS instance used for MnS discovery.

### 4.7.3 MnS discovery service

The MnS discovery service enables MnS consumer to discover management capabilities of MnS instances provided by MnS producer(s). The MnS consumer sends a MnS query request to MnS discover service producer to discover MnS instances and receives response with the MnS data of MnS instances which satisfy the request.

The MnS discovery service is illustrated in Table 4.7.3-1.

**Table 4.7.3-1: MnS discovery service**

MnS name	MnS component type A (operations and notifications)	MnS component type B (information model)
MnS discovery service	Operations: - MnSQuery operation	MnS data

## 4.8 Management capability support in multiple tenant environment

In 3GPP management system, tenant represents a group of MnS consumers associated with the management capabilities they are allowed to access and consume. The 3GPP management system provides multi-tenancy support, by associating different tenants with different sets of management capabilities. Every tenant may be authorized to access and consume those MnSs that the operator makes available to this tenant based on SLA.

## 5 Architecture reference model

### 5.1 General concepts

#### 5.1.1 Management service producers, consumers and exposure

The management services for a mobile network with or without network slicing may be produced by any entity. For example, it can be a Network Functions (NF), or network management functions. The entity may provide (produce) such management services as, for example, the performance management services, configuration management services and fault supervision services.

The management services can be consumed by another entity, which may in turn produce (expose) the service to other entities. Figure 5.1.1-1 shows an example of the management service X which is initially produced by the entity A which is an NF, then consumed by another entity B which is a network management function. Then entity B in turn exposes it to the entity C.

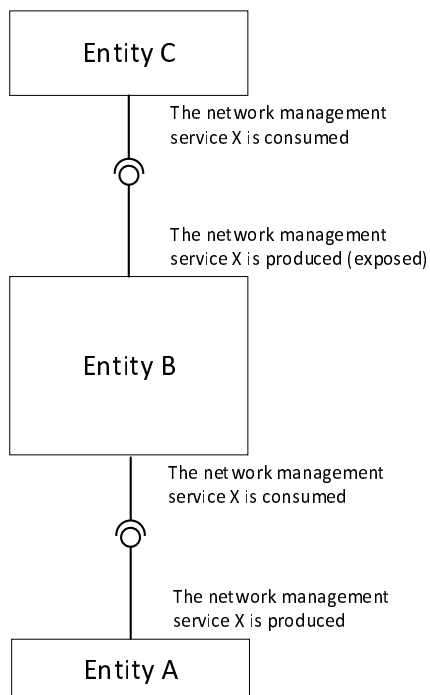

**Figure 5.1.1-1. Example of producers and consumers of the management service**

Figure 5.1.1-2 shows another example of the management service X which is produced by the entity A which is a NF, then entity B processes the information and produce management service Y and exposes it to the entity C.

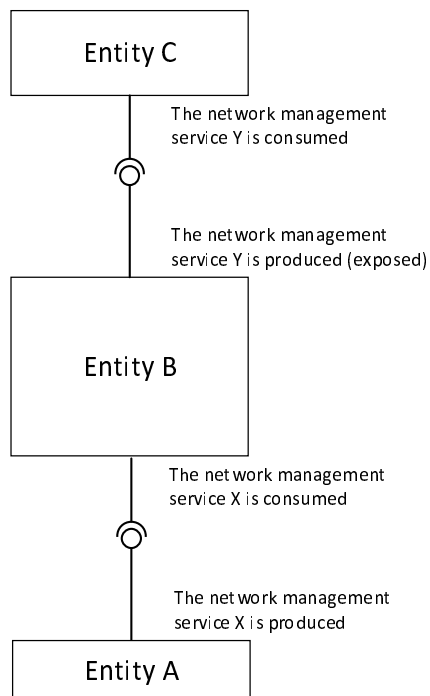

**Figure 5.1.1-2. Example of producers and consumers of management services**



### 5.1.2 Interactions between management service producer and management service consumer

The interactions between the management service producer and management service consumer follows one of the three following paradigms:

- "Request-response": A management service producer is requested by a management service consumer to invoke an operation, which either performs an action or provides information or both. The management service producer provides response based on the request by management service consumer.

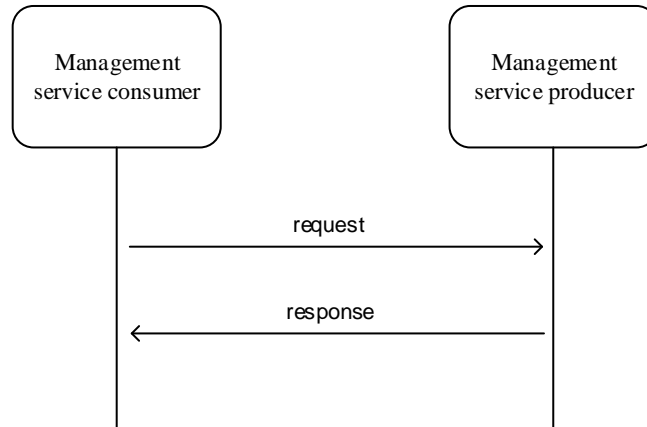

**Figure 5.1.1.1: Request-response communication paradigm**

- "Subscribe-notify": A management service consumer requests a management service producer to establish a subscription to receive network events via notifications, under the filter constraint specified in this operation.

Subscriptions can be created also by other means than by using such operation.

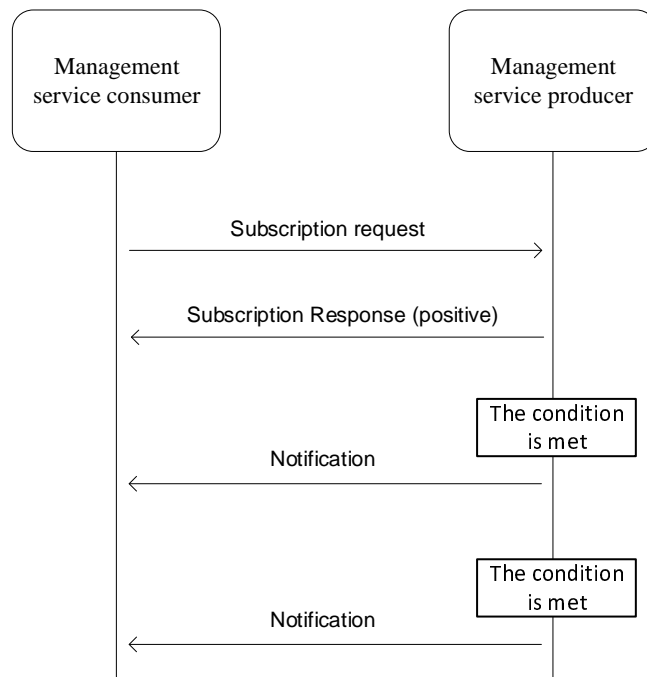

**Figure 5.1.1.2: Subscribe-notify communication paradigm**

NOTE: Example of a common aspect applicable to all management services is the use of notifications. For a management service to use notifications the management service consumer needs a subscription to notifications it is interested in. The management service consumer requests the creation of a subscription by sending a subscribe operation to the management service producer. To cancel a subscription the consumer sends an unsubscribe operation to the producer.

- "Connect-streaming": A management producer is provided with the address the management service consumer. The management service producer requests to establish a connection with the management service consumer for management data streaming. The management service producer sends the management data, when they are ready, by streaming to the management service consumer over the established connection.

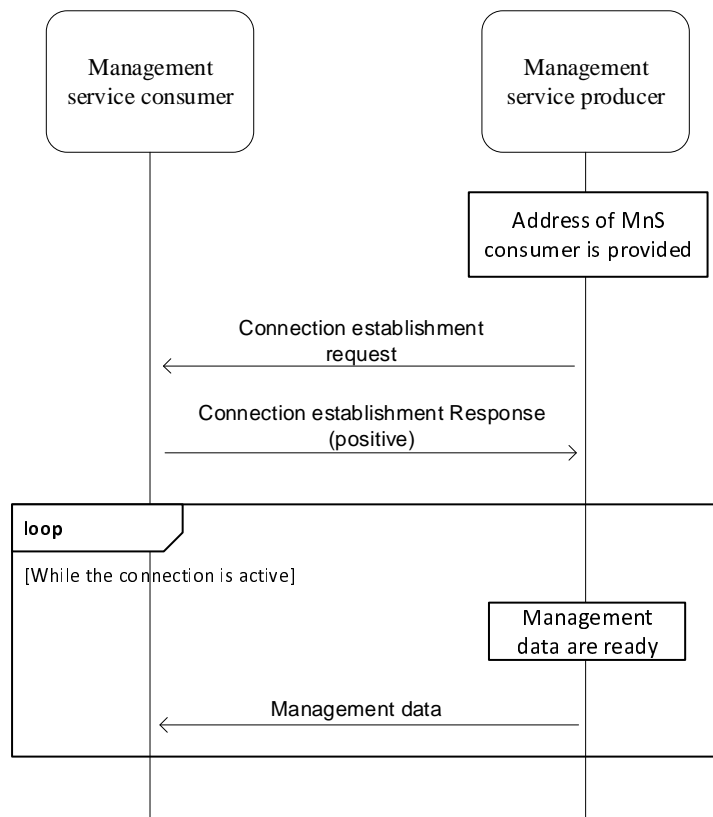

Figure 5.1.1.3: Connect-streaming communication paradigm

## 5.2 Management interactions with NFV MANO

3GPP management system shall be capable to consume NFV MANO interface (e.g. Os-Ma-nfvo, Ve-Vnfm-em and Ve-Vnfm-vnf reference points).

Producer of management services can consume management interfaces provided by NFV MANO for following purposes:

- Network service LCM.
- VNF LCM, PM, FM, CM on resources supporting VNF.

## 5.3 Management service deployment based on ZSM framework

ZSM framework reference architecture is described in ETSI GS ZSM 002 [29]. The ZSM framework reference architecture defines a set of architectural building blocks that collectively enable construction of more complex management services and management functions using a consistent set of composition and interoperation patterns. So it

is important to show the 3GPP Management Service deployment based on ZSM Framework. Figure 5.3-1 shows an example of 3GPP Management Service deployment based on ZSM framework reference architecture. In this example:

- 3GPP Cross Management Domain (A bundle of Cross Domain MnFs) provides a set of MnS(s) for Cross Domain Network (including Network Slice) and consumes MnSs provided by the RAN Management Domain and the CN Management Domain. 3GPP Cross Management Domain can implement close loop (s) within the domain. 3GPP Cross Management Domain is a part of E2E Service Management Domain in ETSI ZSM Framework.
- RAN Management Domain (A bundle of RAN MnFs) provides a set of MnS(s) for the RAN SubNetwork and NF. RAN Management Domain can implement close loop(s) within the domain. RAN Management Domain is a Management Domain in ETSI ZSM Framework.
- CN Management Domain (A bundle of CN MnFs) provides a set of MnS(s) for the CN SubNetwork and NF. CN Management Domain can implement close loop(s) within the domain. CN Management Domain is a Management Domain in ETSI ZSM Framework.
- A 3GPP Management Framework Consumer (e.g. vertical OT system, BSS) can consume MnS(s) provided by the 3GPP Cross Management Domain, RAN Management Domain, CN Management Domain. 3GPP Management Framework Consumer is a ZSM framework consumer in ETSI ZSM Framework.

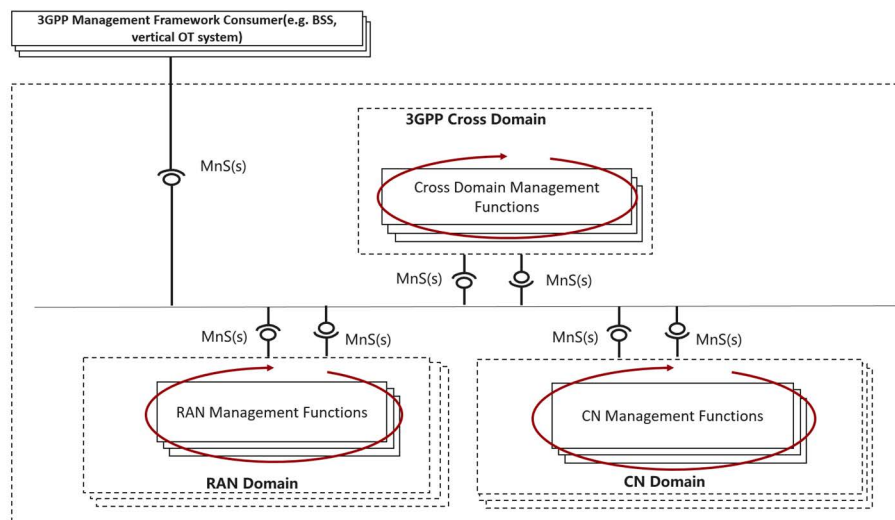

**Figure 5.3-1: An example of Management Service deployment framework.**

The closed control loop SLS assurance (COSLA) is an example of the closed loop in ZSM framework. COSLA can be deployed at domain level or cross domain level. A domain COSLA provides domain specific assurance, e.g. closed control loop assurance in a RAN management domain, CN management domain. A cross domain COSLA can provide a part of end-to-end SLS assurance service, e.g. to assure the service experience in 3GPP cross management domain.

## 5.4 Management interactions with NWDAF

3GPP management system interacts with NWDAF in a coordinated way. 3GPP management system takes the responsibility of management from the network-wide view, addresses the slow control loop with broad management scope. NWDAF is a 5GC NF as specified in TS 23.288 [30].

## 6 Use cases and requirements

### 6.1 Use cases

#### 6.1.1 MnS query

Use case stage	Evolution/Specification	<<Uses>> Related use
<b>Goal</b>	Enable MnS discovery service consumer to obtain the available MnS instance(s).	
<b>Actors and Roles</b>	MnS discovery service consumer	
<b>Telecom resources</b>	MnS discovery service producer	
<b>Assumptions</b>	MnS discovery service consumer is authorized to obtain the available MnS instance(s) from MnS discovery service producer.	
<b>Pre-conditions</b>	Information of MnS instance(s) is existed in MnS discovery service producer.	
<b>Begins when</b>	MnS discovery service consumer wants to obtain the available MnS instance(s).	
<b>Step 1 (M)</b>	MnS discovery service consumer sends a request to MnS discovery service producer to obtain the available MnS instances with MnS requirements (e.g. MnS type (e.g. provisioning MnS, fault supervision MnS, performance assurance MnS), requirement description for MnS components (e.g. class name and/or instance information of the managedObject)).	
<b>Step 2 (M)</b>	MnS discovery service producer decides the available MnS instance(s) to satisfy the received MnS requirements.	
<b>Step 3 (M)</b>	MnS discovery service producer sends the available MnS instance with some information (e.g. MnS Id, MnS component information, MnS producer information) to MnS discovery service consumer.	
<b>Ends when</b>	All the steps identified above are successfully completed.	
<b>Exceptions</b>	One of the mandatory steps fails.	
<b>Post-conditions</b>	MnS discovery service consumer has obtained the the available MnS instance(s) and be ready to use this MnS instance.	
<b>Traceability</b>	REQ-MnSD-FUN-X	

### 6.2 Requirements

#### 6.2.1 Requirements for MnS discovery service

**REQ-MnSD-FUN-X** The MnS discovery service producer shall have the capability allowing its authorized consumer to obtain the available MnS instance(s).

## Annex A (informative): Example of deployment model with utilization of management services

### A.1 Utilization of Management services in network and subnet layers

To deploy a management and orchestration system for the mobile network including network slice(s), the management system can follow the network and network slice management model, subnetwork and network slice subnet management model, and network function management model. As an example, management models are shown in Figure A.1.1, management services in each management model.

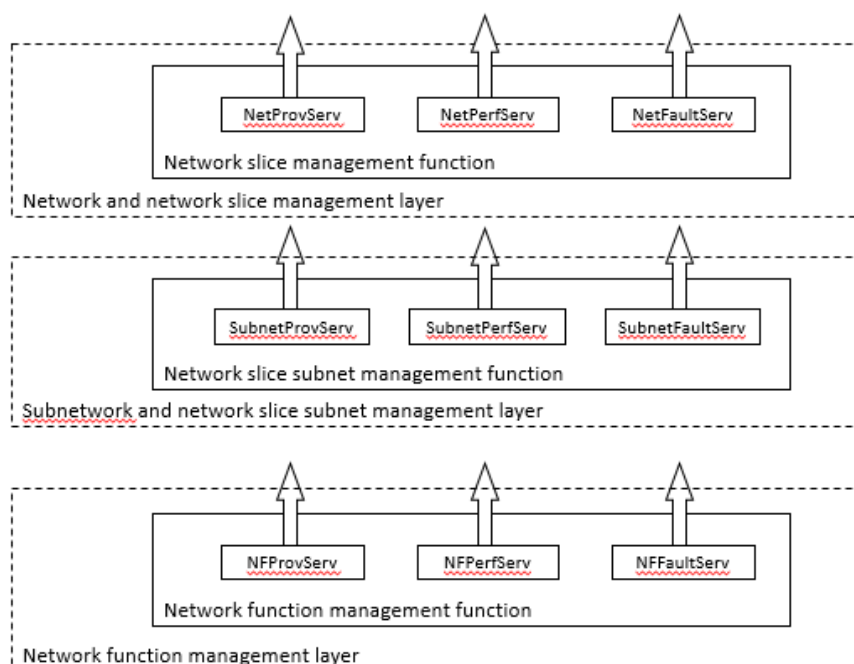

Figure A.1.1: Example management layers in layered management model

### A.2 Utilization of management services in network function management.

This subclause describes the network function management model in the example of management services deployment. In case that a deployment requires management service in NF management model, management services in NF management model can provide specific management capability for NFs to authorized management service consumer through service based interface.

NF management function is an execution entity to provide NF Management services in NF management model. NF Management function (NFMF) may manage more than one network functions.

NF management function for multiple managed network functions as shown in Figure A.2.1 provides:

- Management services exposure; and
- Data governance for management service exposure.

NOTE 1: One example of a management object with multiple management services is NF pooling design. Another example of a management object with this multiple NF management services is 5G Core control plane.

NOTE 2: NF management function can behave as consumer to ETSI ISG NFV MANO interfaces (e.g. Ve-Vnfm-em interface exposed by VNFM).

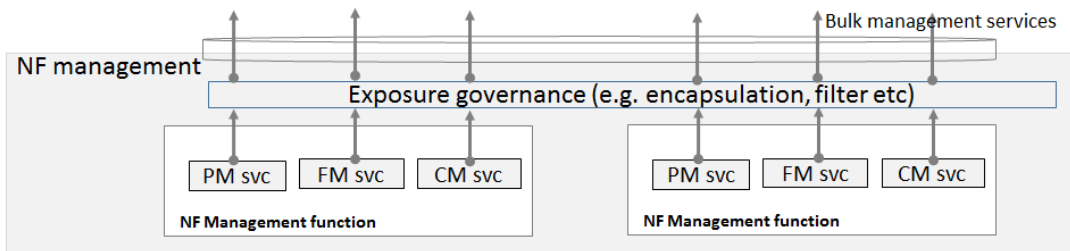

**Figure A.2.1: Example NF management function layer structure**

As shown in Figure A.2.1, an example of NF management function model structure is given. Exposure governance management function (EGMF) shown in Figure A.2.1 is management function in network function model with the role of management service exposure governance (i.e. abstraction, simplification, filtering, etc.). When multiple NF management services are exposed to network management, the particular group of multiple NF management services can be represented by a set of NF management services. This set of NF management services are exposed as a bulk NF management service, by NF management function. Additional management service abstraction may be needed based on NF management services because of lack of trust relationship between management service producer/consumer cannot address management services to build a global view of subnet or meaningful management purposes.

## A.3 Utilization of management services by Exposure Governance Management Function (EGMF)

Exposure Governance Management Function (EGMF) offers following management capability (Figure A.3.1):

- Exposure governance

NOTE: Details of EGMF management capability exposure governance is FFS.

In Figure A.3.1, EGMF produces exposure governance management capability that operators can apply on Management Function (MnF) 1 MnS for exposing different derivation of MnF 1 MnS to:

- MnF 2 (e.g. from another Operator) and
- 3<sup>rd</sup> party (e.g. from vertical industry).

NOTE: Exposure governance can be controlled by a policy for different type of MnF 1 MnS consumers (e.g. other operator, other management system, 3rd party, other administrative domain, etc.)

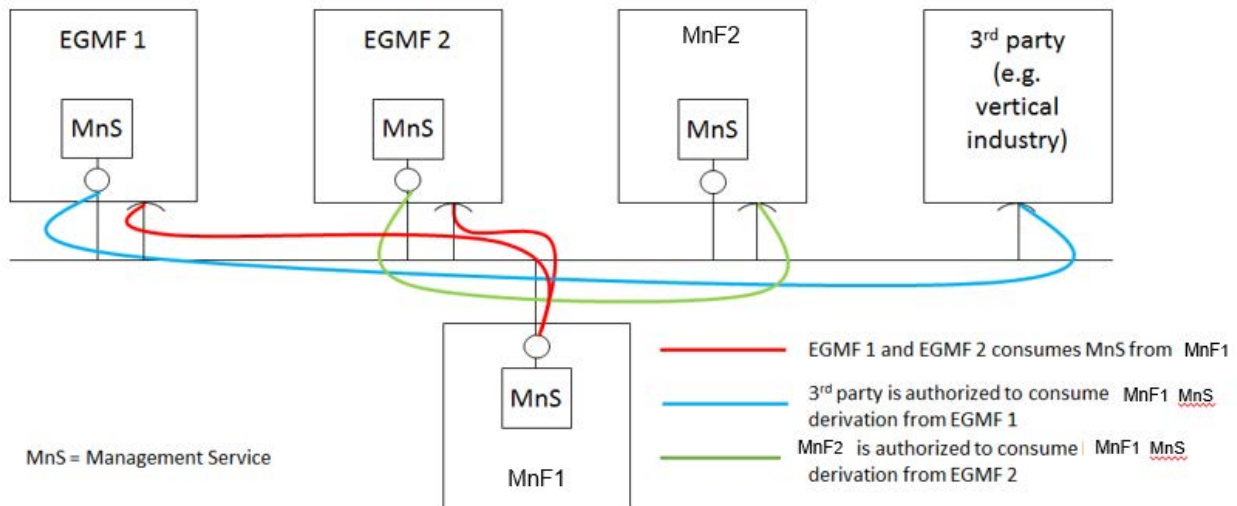

**Figure A.3.1: MnF-1 Management Service (MnS) exposed through Exposure Governance Management Function 1 (EGMF 1) and through Exposure Governance Management Function 2 (EGMF 2)**

## A.4 Utilization of interface to NFV-MANO by the producer of management services

In this deployment scenario the producers of the network slice subnet related management services and NF related management services are also consuming the management interfaces provided by the NFV-MANO:

- VNF PM, FM and LCM
- Network service PM, FM and LCM

These interfaces are provided via the Os-Ma-nfvo and the Ve-Vnfm-em reference points as specified in the following specifications:

- Configuration Management (CM): TS 28.510 [11], TS 28.511 [12], TS 28.512 [13], TS 28.513 [14],
- Fault Management (FM): TS 28.515 [15], TS 28.516 [16], TS 28.517 [17], TS 28.518 [18],
- Performance Management (PM): TS 28.520[19], TS 28.521 [21], TS 28.522 [22], TS 28.523 [23],
- Life Cycle Management (LCM): TS 28.525[24], TS 28.526 [25], TS 28.527 [26], TS 28.528 [27].

In this deployment scenario:

- the entity denoted as NSSMF, is capable of consuming the VNF LCM and network service LCM related services provided by the NFV-MANO (NFVO). Same entity is also a producer of the network slice subnet related management services.
- the entity denoted as NFMF (NF Management Function), is capable of application level management of VNFs and PNFs and is a producer of the NF Provisioning service that includes Configuration Management (CM), Fault Management (FM) and Performance Management. Same entity is consumer of the NF Provisioning service produced by VNFs and PNFs.

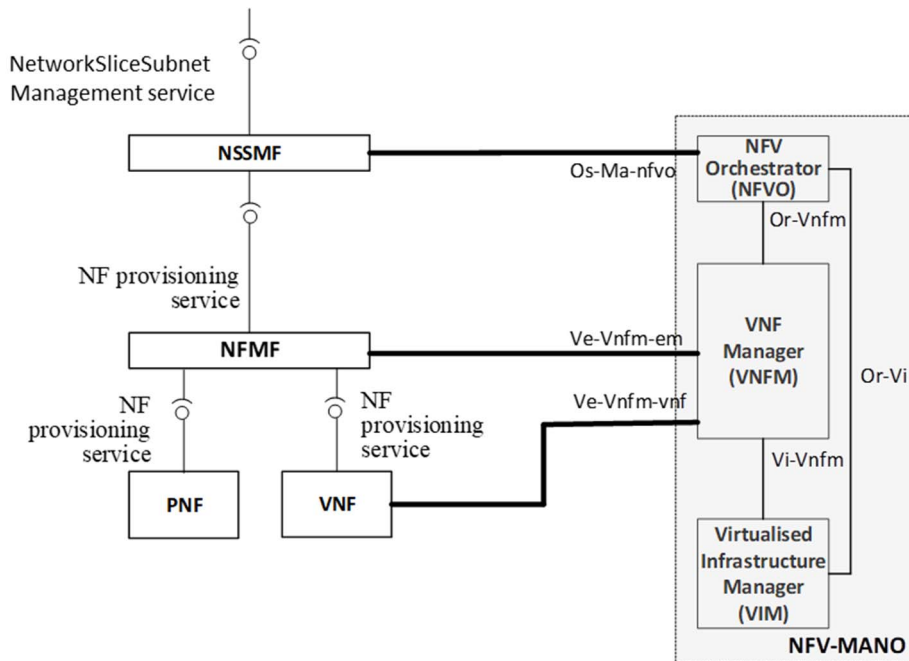

**Figure A.4.1 The deployment scenario for network slice subnet management with interface to NFV-MANO**

The use case Network slice subnet instance creation in the clause 5.1.2 of the TS 28.531 [8] shows example of interaction between:

- the consumer of the network slice subnet related management services (e.g. network slice subnet provisioning service) and the NSSMF as the producer of the network slice subnet related management services.
- the NSSMF and the NFMF.

and also, the interaction between:

- the NSSMF and the NFV-MANO,
- the NFMF and the NFV-MANO.

NOTE: Figure A.4.1 shows an example of a deployment scenario, not all scenarios are captured by this figure.

## A.5 Management Data Analytics Service (MDAS)

A management data analytics service (MDAS) provides data analytics of different network related parameters including for example load level and/or resource utilisation. For example, the MDAS for a network function (NF) can collect the NF's load related performance data, e.g. resource usage status of the NF. The analysis of the collected data may provide forecast of resource usage information in a predefined future time. This analysis may also recommend appropriate actions e.g. scaling of resources, admission control, load balancing of traffic, etc.

A MDAS for a NetworkSliceSubnet provides network slice subnet related data analytics. The service may consume the corresponding MDAS of its constituent NFs'. The MDAS for a network slice subnet may further classify or shape the data in different useful categories and analyse them for different network slice subnet management needs (e.g. scaling, admission control of the constituent NFs etc.). If a network slice subnet is composed of multiple other network slice subnets, the MDAS for a network slice subnet acts as a consumer of MDAS of the constituent network slice subnets for further analysis e.g. resource usage prediction, failure prediction for a network slice subnet, etc.

A MDAS for a NetworkSlice instance provides network slice related data analytics. The service may consume the corresponding MDAS of its constituent network slice subnet(s). The network slice MDAS may further classify or shape



the data in different useful categories according to different customer needs, e.g. slice load, constituent network slice subnet load, communication service loads. This data can be used for further analysis e.g. resource usage prediction, failure prediction for an network slice, etc.

## A.6 Utilization of management services in functional management architecture

The management services for a mobile network including network slicing may be produced by a set of functional blocks. This annex shows an example of such deployment scenario where functional blocks (such as NSMF, NSSMF, NFMF and CSMF) are producing and consuming various management services.

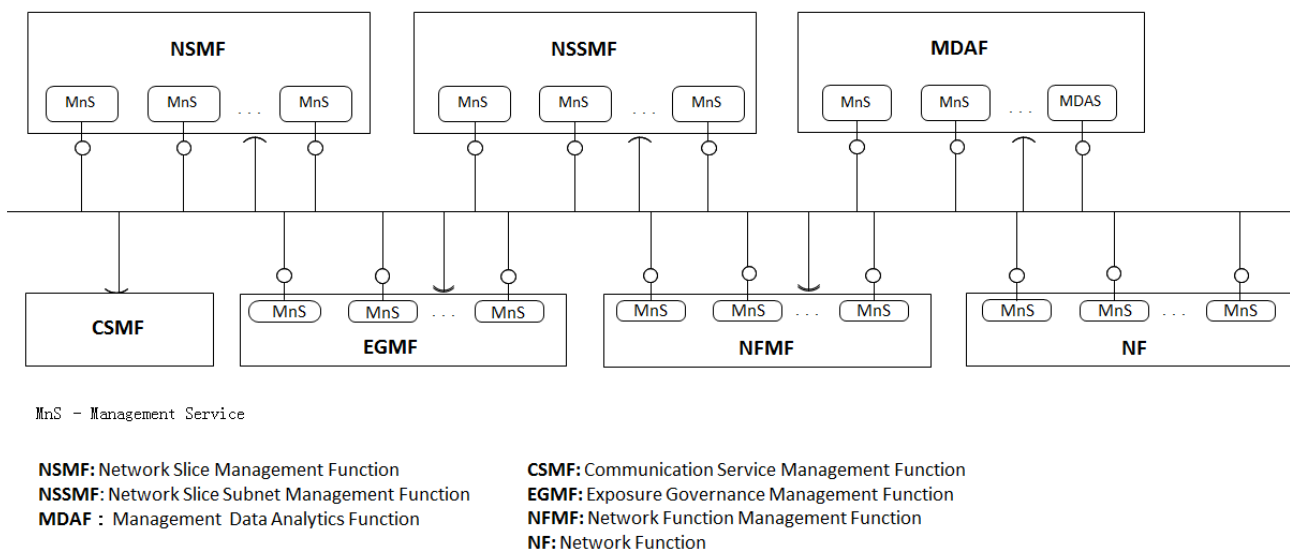

**Figure A.6.1: Example of functional management architecture**

In this deployment example:

- NFMF (Network Function Management Function) provides the management services for managing one or more NF(s) and may consume some management services produced by other functional blocks.
- The NF provides some management services, for example the NF performance management services, NF configuration management services and NF fault supervision services.
- NSSMF provides the management services for one or more network slice subnets and may consume some management services produced by other functional blocks.
- NSMF provides the management services for one or more network slices and may consume some management services produced by other functional blocks.
- MDAF provides the Management Data Analytics Service for one or more NF, network slice subnet and/or network slice, and may consume some management services produced by other functional blocks.
- CSMF consumes the management service(s) provided by the other functional blocks. This deployment example does not illustrate what management services the CSMF consumes.
- EGMF provides management service(s) with applied exposure governance and a management service with management capability exposure governance to one or more management service consumers and may consume some management services produced by other functional blocks.

- One functional block may consume the management service(s) provided by another functional block, depending on the management scope of the functional block(s). The scope may be expressed in the terms of Management Service Components (see clause 4.3).

## A.7 Utilization of management data analytics services

A management data analytics service (MDAS) provides data analytics for the network. MDAS can be deployed at different levels, for example, at domain level (e.g. RAN, CN, network slice subnet) or in a centralized manner (e.g. in a PLMN level). A domain-level MDAS provides domain specific analytics, e.g. resource usage prediction in a CN or failure prediction in a network slice subnet, etc. A centralized MDAS can provide end-to-end or cross-domain analytics service, e.g. resource usage or failure prediction in an network slice, optimal CN node placement for ensuring lowest latency in the connected RAN, etc. Figure A.7.1 illustrates an example of deployment model of the MDAS:

- Domain MDAF produces Domain MDAS
- Domain MDAS is consumed by the Centralized MDAF and the other authorized MDAS Consumers (for example, infrastructure manager, network manager, network slice manager, network slice subnet manger, other 3rd party OSS, etc.)
- Centralized MDAF produces Centralized MDAS
- Centralized MDAS is consumed by different authorized MDAS Consumers

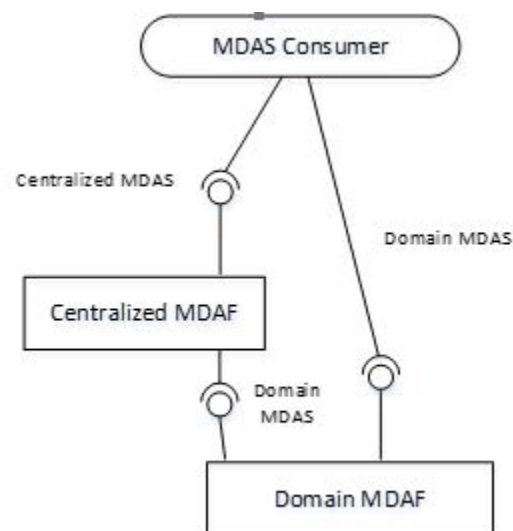
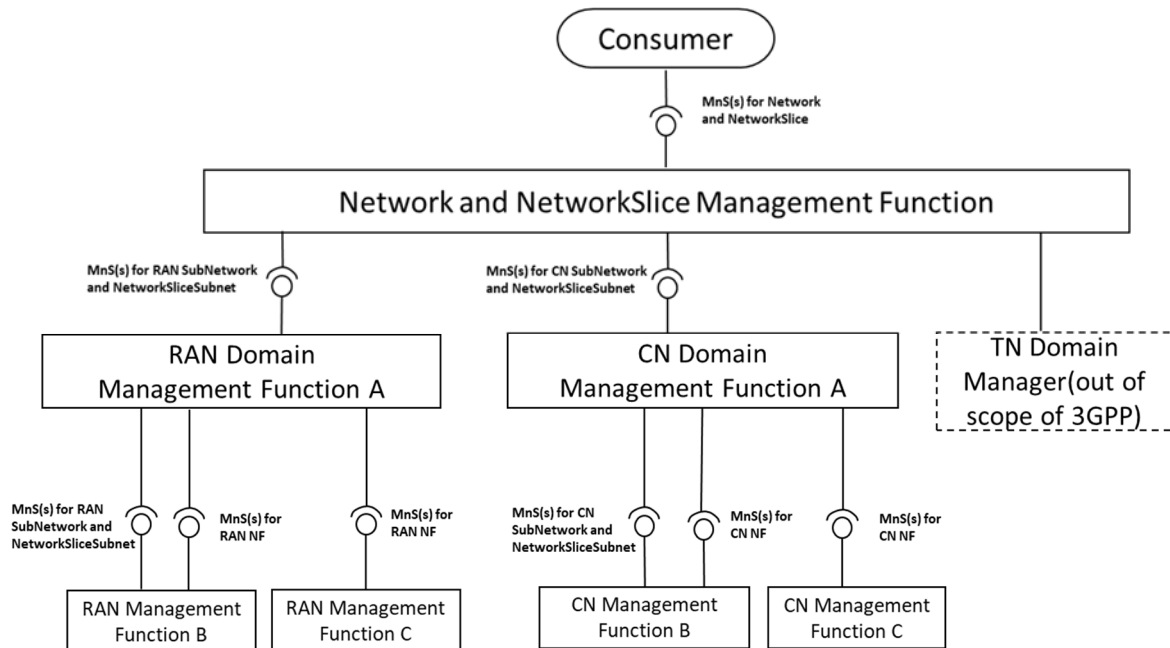

Figure A.7.1: MDAS provided at different levels

## A.8 An example of deployment scenario for network and network slice

This annex shows an example of deployment scenario for management of a mobile network including network slicing.



**Figure A.8.1: An example of deployment scenario for management of a mobile network including network slicing**

In this deployment scenario:

- Network and Network Slice Management Function provides the management services for network or network slice which includes RAN part, CN part and TN part to the Consumer. Network and NetworkSlice Management Function consumes management services for RAN SubNetwork or network slice subnet produced by RAN Management Function, management services for CN SubNetwork or NSSI produced by CN Management Function and interface produced by TN Manager.
- RAN Management Function provides the management services for a RAN SubNetwork or network slice subnet and/or management services for RAN NF(s). RAN Management Function may consume management service for RAN SubNetwork or network slice subnet and management services for RAN NF. In this scenario, the following RAN Management Function(s) are described:
  - RAN Management Function A provides the management services for RAN SubNetwork or network slice subnet to Network and Network Slice Management Function. RAN Management Function A consumes the management services for RAN network slice subnet(s) and management services for RAN NF produced by RAN Management Function B, and management services for RAN NF produced by RAN Management Function C.
  - RAN Management Function B provides the management services for RAN network slice subnet and management services for RAN NF to RAN Management Function A.
  - RAN Management Function C provides the management services for RAN NF to RAN Management Function A.
- CN Management Function provides the management services for a CN network slice subnet and/or management services for CN NF. CN Management Function may consume management service for CN network slice subnet and management services for CN NF. In this scenario, the following CN Management Function(s) are described:
  - CN Management Function A provides the management services for CN network slice subnet to Network and Network Slice Management Function. CN A consumes the management services for CN network slice subnet and management services for CN NF produced by CN Management Function B and management services for CN NFs produced by CN Management Function C.
  - CN Management Function B provides the management services for CN network slice subnet and management services for CN NF to RAN Management Function A.
  - CN Management Function C provides the management services for CN NF to CN Management Function A.

## A.9 Deployment examples of ONAP platform consuming 3GPP MnS(s)

### A.9.1 Integration with ONAP DCAE collection framework utilizing 3GPP MnS(s)

Figure A.9.1 shows an example of integration with ONAP DCAE utilizing the management services provided by 3GPP Data Report MnS Producer. In this example, the 3GPP MnS(s) Consumer which uses the ONAP DCAE Collection Framework, utilizes the management services (i.e., Performance Data File Report MnS, Performance Data Streaming MnS, Fault Supervision Data Report MnS) provided by 3GPP Management Service(s) Producer.

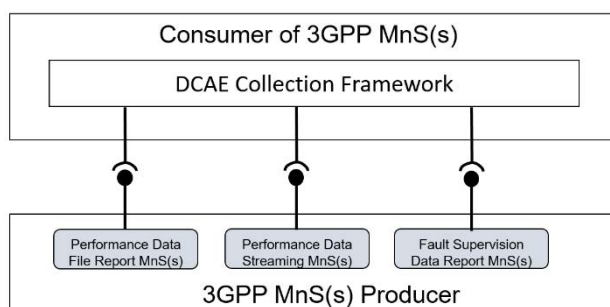

**Figure A.9.1: An example of integration with ONAP DCAE Collection Framework utilizing the management services provided by 3GPP Data Report MnS(s) Producer**

### A.9.2 Integration with ONAP controller utilizing 3GPP MnS(s)

Figure A.9.2 shows an example of integration with ONAP Controller (e.g. APPC) utilizing provisioning management services provided by 3GPP Management Service Producer. In this example, the 3GPP MnS(s) Consumer which uses ONAP Controller may utilize the provisioning management services (e.g. configuration management related provisioning management service components) as follows provided by 3GPP Management Service Producer.

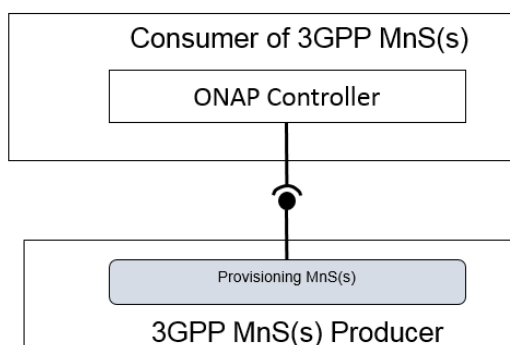

**Figure A.9.2: An example of integration with ONAP Controller utilizing the management services provided by 3GPP MnS(s) Producer**

# Annex B (normative): Solutions for management of 5G network and network slicing

Figure B.1 shows the two solutions for managing the mobile network including network slicing:

Solution1: Management with combination of existing interface IRP where applicable and 5G management information (Management service component type B and Management service component type C).

Solution2: Management with using the management services (Management service component type A, Management service component type B and Management service component type C).

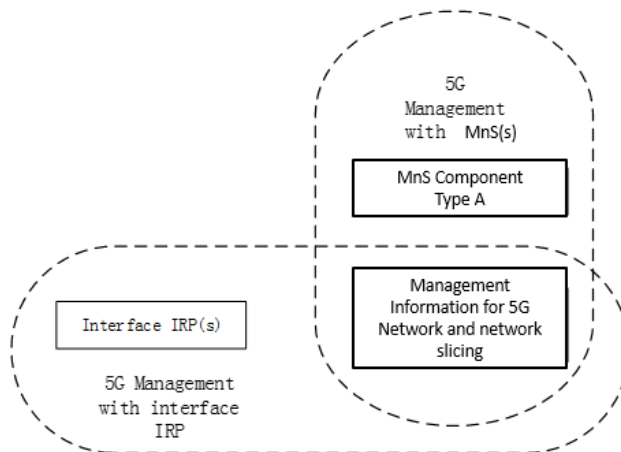

**Figure B.1: Two solutions for managing a 5G network including network slicing**

## Annex C (informative): Example of mapping Management Services (MnS) to pre-Rel-15 management framework

Figure C.1 depicts an example of management service consumer and producer interaction shown in the context of the 3GPP pre-Rel-15 management reference model [10] where Integration Reference Point (IRP) information services are replaced by the management services. One or more management service producers are provided by a management function that applies to a network resource model representing the managed network.

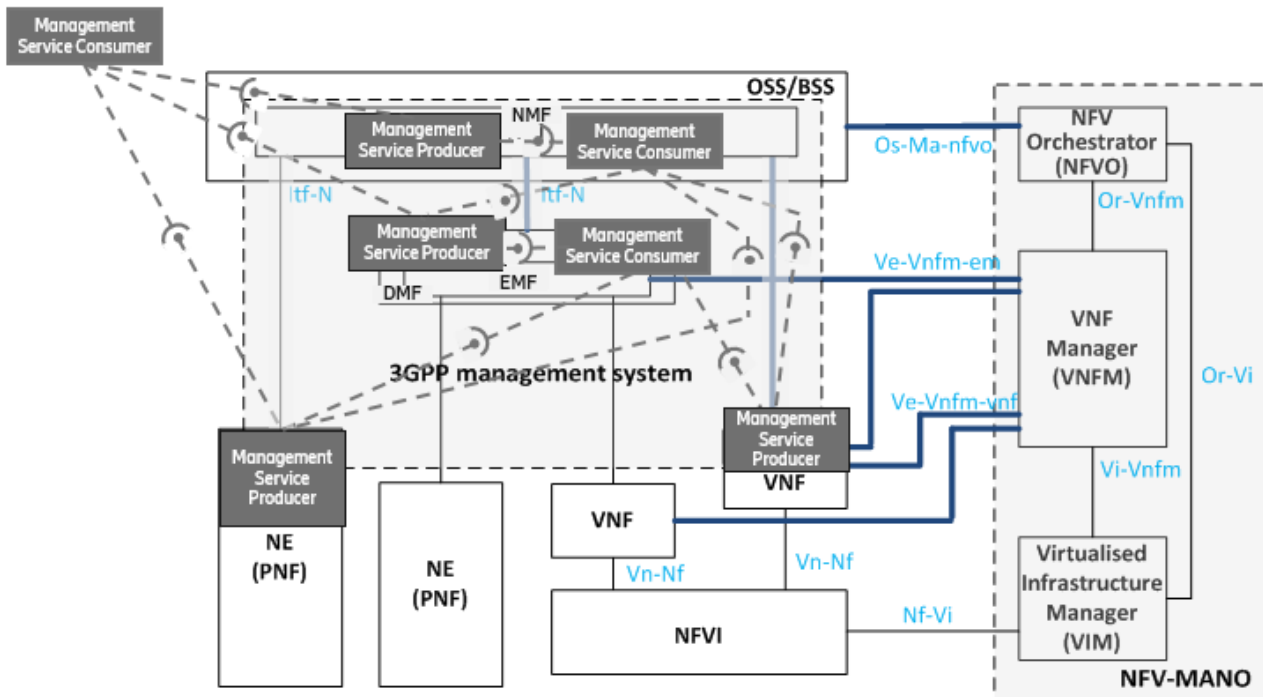

Figure C.1: Example of Management service producer and consumer interaction mapped into the pre-Rel-15 management reference model [10]

## Annex D (informative): Change history

Change history							
Date	Meeting	TDoc	CR	Rev	Cat	Subject/Comment	New version
2018-09	SA#81					Upgrade to change control version	15.0.0
2018-12	SA#82	SP-181042	0001	1	F	Add management service discovery	15.1.0
2018-12	SA#82	SP-181042	0003	1	F	Update reference to TS 28.532	15.1.0
2018-12	SA#82	SP-181042	0004	2	F	Replace MF with management function	15.1.0
2018-12	SA#82	SP-181042	0005	-	F	Implement MnS naming agreement	15.1.0
2018-12	SA#82	SP-181042	0008	1	F	Add usecase and requirements for MnS Query	15.1.0
2019-06	SA#84	SP-190372	0015	1	B	Add examples of ONAP utilizing the MnSs provided by 3GPP MnS Producer	16.0.0
2019-09	SA#85	SP-190742	0026	1	A	Add description of MnS provided by NF	16.1.0
2019-09	SA#85	SP-190750	0028	2	B	Add 3GPP Management Service deployment based on ZSM Framework	16.1.0
2019-09	SA#85	SP-190742	0031	3	A	Add management coordination with NWDAF	16.1.0
2019-12	SA#86	SP-191219	0039	2	A	Update of Management service description and diagram	16.2.0
2019-12	SA#86	SP-191171	0044	1	B	Add description for management capability support in multiple tenant environment	16.2.0
2019-12	SA#86	SP-191219	0047	2	A	Correction on example of MnS deployment scenario in clause 4.5	16.2.0
2019-12	SA#86	SP-191159	0049	-	F	Some correction on the reference in Clause 5.3	16.2.0
2019-12	SA#86	SP-191152	0051	1	B	Introduce a MnS profile	16.2.0
2019-12	SA#86	SP-191219	0053	1	A	Clarify numerous definitions	16.2.0
2020-03	SA#87E	SP-200227	0056	1	A	Add the missing paradigm of interaction between MnS producer and MnS consumer	16.3.0
2020-03	SA#87E	SP-200180	0057	1	F	Update Clause 5.3 Management service deployment based on ZSM framework	16.3.0
2020-03	SA#87E	SP-200227	0064	2	A	Update of Management service description and diagram	16.3.0
2020-06	SA#88-e	SP-200497	0068	-	B	Add clarifications to description of tenant concept	16.4.0
2020-09	SA#89e	SP-200724	0072	1	F	Add missing definition	16.5.0
2020-09	SA#89e					Adding missing definition due that were missed in CR implementation	16.5.1
2020-12	SA#90e	SP-201050	0073	1	F	Cleanup based on refined slice definition	16.6.0
2020-12	SA#90e	SP-201050	0074	-	F	Add abbreviation reference	16.6.0
2020-12	SA#90e	SP-201056	0075	1	F	Add example of closed loop SLS assurance	16.6.0
2020-12	SA#90e	SP-201088	0076	-	F	Correct inconsistent terminology	16.6.0
2021-03	SA#91e	SP-210145	0077	-	A	Fix errors in Exposure Governance descriptions	16.7.0

---

# History

<b>Document history</b>		
V16.4.0	August 2020	Publication
V16.5.1	November 2020	Publication
V16.6.0	January 2021	Publication
V16.7.0	April 2021	Publication