



**Universal Mobile Telecommunications System (UMTS);  
LTE;  
5G;  
Telecommunication management;  
Generic Network Resource Model (NRM)  
Integration Reference Point (IRP);  
Information Service (IS)  
(3GPP TS 28.622 version 17.1.1 Release 17)**





---

**Reference**

---

RTS/TSGS-0528622vh11

---

---

**Keywords**

---

5G,LTE,UMTS

---

**ETSI**

---

650 Route des Lucioles  
F-06921 Sophia Antipolis Cedex - FRANCE

---

Tel.: +33 4 92 94 42 00 Fax: +33 4 93 65 47 16

Siret N° 348 623 562 00017 - APE 7112B  
Association à but non lucratif enregistrée à la  
Sous-Préfecture de Grasse (06) N° w061004871

---

**Important notice**

---

The present document can be downloaded from:

<http://www.etsi.org/standards-search>

The present document may be made available in electronic versions and/or in print. The content of any electronic and/or print versions of the present document shall not be modified without the prior written authorization of ETSI. In case of any existing or perceived difference in contents between such versions and/or in print, the prevailing version of an ETSI deliverable is the one made publicly available in PDF format at [www.etsi.org/deliver](http://www.etsi.org/deliver).

Users of the present document should be aware that the document may be subject to revision or change of status.

Information on the current status of this and other ETSI documents is available at

<https://portal.etsi.org/TB/ETSIDeliverableStatus.aspx>

If you find errors in the present document, please send your comment to one of the following services:

<https://portal.etsi.org/People/CommitteeSupportStaff.aspx>

If you find a security vulnerability in the present document, please report it through our  
Coordinated Vulnerability Disclosure Program:

<https://www.etsi.org/standards/coordinated-vulnerability-disclosure>

---

**Notice of disclaimer & limitation of liability**

---

The information provided in the present deliverable is directed solely to professionals who have the appropriate degree of experience to understand and interpret its content in accordance with generally accepted engineering or other professional standard and applicable regulations.

No recommendation as to products and services or vendors is made or should be implied.

No representation or warranty is made that this deliverable is technically accurate or sufficient or conforms to any law and/or governmental rule and/or regulation and further, no representation or warranty is made of merchantability or fitness for any particular purpose or against infringement of intellectual property rights.

In no event shall ETSI be held liable for loss of profits or any other incidental or consequential damages.

Any software contained in this deliverable is provided "AS IS" with no warranties, express or implied, including but not limited to, the warranties of merchantability, fitness for a particular purpose and non-infringement of intellectual property rights and ETSI shall not be held liable in any event for any damages whatsoever (including, without limitation, damages for loss of profits, business interruption, loss of information, or any other pecuniary loss) arising out of or related to the use of or inability to use the software.

---

**Copyright Notification**

---

No part may be reproduced or utilized in any form or by any means, electronic or mechanical, including photocopying and microfilm except as authorized by written permission of ETSI.

The content of the PDF version shall not be modified without the written authorization of ETSI.

The copyright and the foregoing restriction extend to reproduction in all media.

© ETSI 2022.  
All rights reserved.



---

# Intellectual Property Rights

## Essential patents

IPRs essential or potentially essential to normative deliverables may have been declared to ETSI. The declarations pertaining to these essential IPRs, if any, are publicly available for **ETSI members and non-members**, and can be found in ETSI SR 000 314: *"Intellectual Property Rights (IPRs); Essential, or potentially Essential, IPRs notified to ETSI in respect of ETSI standards"*, which is available from the ETSI Secretariat. Latest updates are available on the ETSI Web server (<https://ipr.etsi.org/>).

Pursuant to the ETSI Directives including the ETSI IPR Policy, no investigation regarding the essentiality of IPRs, including IPR searches, has been carried out by ETSI. No guarantee can be given as to the existence of other IPRs not referenced in ETSI SR 000 314 (or the updates on the ETSI Web server) which are, or may be, or may become, essential to the present document.

## Trademarks

The present document may include trademarks and/or tradenames which are asserted and/or registered by their owners. ETSI claims no ownership of these except for any which are indicated as being the property of ETSI, and conveys no right to use or reproduce any trademark and/or tradename. Mention of those trademarks in the present document does not constitute an endorsement by ETSI of products, services or organizations associated with those trademarks.

**DECT™**, **PLUGTESTS™**, **UMTS™** and the ETSI logo are trademarks of ETSI registered for the benefit of its Members. **3GPP™** and **LTE™** are trademarks of ETSI registered for the benefit of its Members and of the 3GPP Organizational Partners. **oneM2M™** logo is a trademark of ETSI registered for the benefit of its Members and of the oneM2M Partners. **GSM®** and the GSM logo are trademarks registered and owned by the GSM Association.

---

# Legal Notice

This Technical Specification (TS) has been produced by ETSI 3rd Generation Partnership Project (3GPP).

The present document may refer to technical specifications or reports using their 3GPP identities. These shall be interpreted as being references to the corresponding ETSI deliverables.

The cross reference between 3GPP and ETSI identities can be found under <http://webapp.etsi.org/key/queryform.asp>.

---

# Modal verbs terminology

In the present document "**shall**", "**shall not**", "**should**", "**should not**", "**may**", "**need not**", "**will**", "**will not**", "**can**" and "**cannot**" are to be interpreted as described in clause 3.2 of the [ETSI Drafting Rules](#) (Verbal forms for the expression of provisions).

"**must**" and "**must not**" are **NOT** allowed in ETSI deliverables except when used in direct citation.



# Contents

Intellectual Property Rights .....	2
Legal Notice .....	2
Modal verbs terminology.....	2
Foreword.....	7
Introduction .....	7
1 Scope .....	8
2 References .....	8
3 Definitions and abbreviations.....	10
3.1 Definitions .....	10
3.2 Abbreviations .....	11
4 Model .....	12
4.1 Imported information entities and local labels .....	12
4.2 Class diagrams.....	12
4.2.1 Relationships.....	12
4.2.2 Inheritance .....	16
4.3 Class definitions .....	19
4.3.1 Any .....	19
4.3.1.1 Definition .....	19
4.3.1.2 Attributes.....	19
4.3.1.3 Attribute constraints .....	19
4.3.1.4 Notifications.....	19
4.3.2 IRPAgent .....	19
4.3.2.1 Definition .....	19
4.3.2.2 Attributes.....	20
4.3.2.3 Attribute constraints .....	20
4.3.2.4 Notifications.....	20
4.3.2a MnsAgent .....	20
4.3.2a.1 Definition .....	20
4.3.2a.2 Attributes.....	20
4.3.2a.3 Attribute constraints .....	21
4.3.2a.4 Notifications.....	21
4.3.3 ManagedElement .....	21
4.3.3.1 Definition .....	21
4.3.3.2 Attributes.....	21
4.3.3.3 Attribute constraints .....	22
4.3.3.4 Notifications.....	22
4.3.4 ManagedFunction .....	22
4.3.4.1 Definition .....	22
4.3.4.2 Attributes.....	22
4.3.4.3 Attribute constraints .....	22
4.3.4.4 Notifications.....	22
4.3.5 ManagementNode.....	23
4.3.5.1 Definition .....	23
4.3.5.2 Attributes.....	23
4.3.5.3 Attribute constraints .....	23
4.3.5.4 Notifications.....	23
4.3.6 MeContext.....	23
4.3.6.1 Definition .....	23
4.3.6.2 Attributes.....	24
4.3.6.3 Attribute constraints .....	24
4.3.6.4 Notifications.....	24
4.3.7 SubNetwork .....	24



4.3.7.1	Definition .....	24
4.3.7.2	Attributes.....	24
4.3.7.3	Attribute constraints .....	24
4.3.7.4	Notifications.....	24
4.3.8	TopX.....	25
4.3.8.1	Definition .....	25
4.3.8.2	Attributes.....	25
4.3.8.3	Attribute constraints .....	25
4.3.8.4	Notifications.....	25
4.3.9	VsDataContainer .....	25
4.3.9.1	Definition .....	25
4.3.9.2	Attributes.....	25
4.3.9.3	Attribute constraints .....	25
4.3.9.4	Notifications.....	25
4.3.10	Link.....	25
4.3.10.1	Definition .....	25
4.3.10.2	Attributes.....	26
4.3.10.3	Attribute constraints .....	26
4.3.10.4	Notifications.....	26
4.3.11	EP_RP .....	26
4.3.11.1	Definition .....	26
4.3.11.2	Attributes.....	26
4.3.11.3	Attribute constraints .....	26
4.3.11.4	Notifications.....	27
4.3.12	Void.....	27
4.3.13	Void.....	27
4.3.14	Void.....	27
4.3.15	Void.....	27
4.3.16	ThresholdMonitor .....	27
4.3.16.1	Definition .....	27
4.3.16.2	Attributes.....	28
4.3.16.3	Attribute constraints .....	28
4.3.16.4	Notifications.....	28
4.3.17	ManagedNFService .....	28
4.3.17.1	Definition .....	28
4.3.17.2	Attributes.....	28
4.3.17.3	Attribute constraints .....	28
4.3.17.4	Notifications.....	29
4.3.18	Operation <<dataType>>.....	29
4.3.18.1	Definition .....	29
4.3.18.2	Attributes.....	29
4.3.18.3	Attribute constraints .....	29
4.3.18.4	Notifications.....	29
4.3.19	SAP <<dataType>> .....	29
4.3.19.1	Definition .....	29
4.3.19.2	Attributes.....	29
4.3.19.3	Attribute constraints .....	29
4.3.19.4	Notifications.....	29
4.3.20	ManagedEntity <<ProxyClass>> .....	29
4.3.20.1	Definition .....	29
4.3.20.2	Attributes.....	30
4.3.20.3	Attribute constraints .....	30
4.3.20.4	Notifications.....	30
4.3.21	HeartbeatControl .....	30
4.3.21.1	Definition .....	30
4.3.21.2	Attributes.....	30
4.3.21.3	Attribute constraints .....	31
4.3.21.4	Notifications.....	31
4.3.22	NtfSubscriptionControl.....	31
4.3.22.1	Definition .....	31
4.3.22.2	Attributes.....	31



4.3.22.3	Attribute constraints .....	32
4.3.22.4	Notifications .....	32
4.3.23	Scope <<dataType>> .....	32
4.3.23.1	Definition .....	32
4.3.23.2	Attributes .....	32
4.3.23.3	Attribute constraints .....	32
4.3.23.4	Notifications .....	32
4.3.24	Void .....	32
4.3.25	Void .....	32
4.3.26	AlarmList .....	32
4.3.26.1	Definition .....	32
4.3.26.2	Attributes .....	33
4.3.26.3	Attribute constraints .....	33
4.3.26.4	Notifications .....	33
4.3.27	AlarmRecord <<dataType>> .....	33
4.3.27.1	Definition .....	33
4.3.27.2	Attributes .....	34
4.3.27.3	Attribute constraints .....	34
4.3.27.4	Notifications .....	34
4.3.28	Void .....	35
4.3.29	Top .....	35
4.3.29.1	Definition .....	35
4.3.29.2	Attributes .....	35
4.3.29.3	Attribute constraints .....	35
4.3.29.4	Notifications .....	35
4.3.30	TraceJob .....	35
4.3.30.1	Definition .....	35
4.3.30.2	Attributes .....	38
4.3.30.3	Attribute constraints .....	39
4.3.30.4	Notifications .....	42
4.3.31	PerfMetricJob .....	42
4.3.31.1	Definition .....	42
4.3.31.2	Attributes .....	43
4.3.31.3	Attribute constraints .....	43
4.3.31.4	Notifications .....	43
4.3.32	SupportedPerfMetricGroup <<dataType>> .....	43
4.3.32.1	Definition .....	43
4.3.32.2	Attributes .....	44
4.3.32.3	Attribute constraints .....	44
4.3.32.4	Notifications .....	44
4.3.33	ReportingCtrl <<choice>> .....	44
4.3.33.1	Definition .....	44
4.3.33.2	Attributes .....	44
4.3.33.3	Attribute constraints .....	44
4.3.33.4	Notifications .....	45
4.3.34	ThresholdInfo <<dataType>> .....	45
4.3.34.1	Definition .....	45
4.3.34.2	Attributes .....	45
4.3.34.3	Attribute constraints .....	45
4.3.34.4	Notifications .....	45
4.3.35	TraceReference <<dataType>> .....	45
4.3.35.1	Definition .....	45
4.3.35.2	Attributes .....	45
4.3.36	AreaConfig <<dataType>> .....	45
4.3.36.1	Definition .....	45
4.3.36.2	Attributes .....	45
4.3.37	FreqInfo <<dataType>> .....	46
4.3.37.1	Definition .....	46
4.3.37.2	Attributes .....	46
4.3.38	AreaScope <<dataType>> .....	46
4.3.38.1	Definition .....	46



4.3.38.2	Attributes.....	46
4.3.39	Tai <<dataType>> .....	46
4.3.39.1	Definition .....	46
4.3.39.2	Attributes.....	46
4.3.40	MbsfnArea <<dataType>> .....	47
4.3.40.1	Definition .....	47
4.3.40.2	Attributes.....	47
4.3.41	MnsRegistry.....	47
4.3.41.1	Definition .....	47
4.3.41.2	Attributes.....	47
4.3.41.3	Attribute constraints .....	47
4.3.41.4	Notifications.....	47
4.3.42	MnsInfo .....	47
4.3.42.1	Definition .....	47
4.3.42.2	Attributes.....	47
4.3.43	ProcessMonitor <<DataType>> .....	48
4.3.43.1	Definition .....	48
4.3.43.2	Attributes.....	49
4.3.44	Files .....	49
4.3.44.1	Definition .....	49
4.3.44.2	Attributes.....	49
4.3.44.3	Attribute constraints .....	50
4.3.44.4	Notifications.....	50
4.3.45	File .....	50
4.3.45.1	Definition .....	50
4.3.45.2	Attributes.....	51
4.3.45.3	Attribute constraints .....	51
4.3.45.4	Notifications.....	51
4.3.46	FileDownloadJob.....	51
4.3.46.1	Definition .....	51
4.3.46.2	Attributes.....	52
4.3.46.3	Attribute constraints .....	52
4.3.46.4	Notifications.....	52
4.3.42.3	Attribute constraints .....	52
4.3.42.4	Notifications.....	53
4.4	Attribute definitions .....	54
4.4.1	Attribute properties .....	54
4.4.2	Constraints .....	75
4.5	Common notifications .....	75
4.5.1	Alarm notifications .....	75
4.5.2	Configuration notifications .....	76
4.5.3	Threshold Crossing notifications .....	76
<b>Annex A (informative):</b>	<b>Alternate class diagram.....</b>	<b>77</b>
<b>Annex B (informative):</b>	<b>Change history .....</b>	<b>78</b>
History .....		81



---

# Foreword

This Technical Specification has been produced by the 3<sup>rd</sup> Generation Partnership Project (3GPP).

The contents of the present document are subject to continuing work within the TSG and may change following formal TSG approval. Should the TSG modify the contents of the present document, it will be re-released by the TSG with an identifying change of release date and an increase in version number as follows:

Version x.y.z

where:

- x the first digit:
  - 1 presented to TSG for information;
  - 2 presented to TSG for approval;
  - 3 or greater indicates TSG approved document under change control.
- y the second digit is incremented for all changes of substance, i.e. technical enhancements, corrections, updates, etc.
- z the third digit is incremented when editorial only changes have been incorporated in the document.

---

# Introduction

The present document is part of a TS-family covering the 3<sup>rd</sup> Generation Partnership Project; Technical Specification Group Services and System Aspects; Telecommunication management; as identified below:

28.621 Generic Network Resource Model (NRM) Integration Reference Point (IRP); Requirements;

**28.622 Generic Network Resource Model (NRM) Integration Reference Point (IRP); Information Service (IS)**  
;

28.623 Generic Network Resource Model (NRM) Integration Reference Point (IRP); Solution Set (SS) definitions.

The interface Itf-N, defined in 3GPP TS 32.102 [2], is built up by a number of Integration Reference Points (IRPs) and a related Name Convention, which realise the functional capabilities over this interface. The basic structure of the IRPs is defined in 3GPP TS 32.150 [4].

The present document is part of a set that has been developed for converged management solutions.

The present document is part of a set that is used for management and orchestration of 5G networks and network slicing.



---

# 1 Scope

The present document specifies the Generic network resource information that can be communicated between an IRPAgent and an IRPManager in the deployment scenarios using IRP framework as defined in TS 32.102 [2], or between an MnS producer and MnS consumer in deployment scenarios using the Service Based Management Architecture (SBMA) as defined in TS 28.533 [32], for telecommunication network management purposes, including management of converged networks and networks that include virtualized network functions.

This document specifies the semantics of information object class attributes and relations visible across the reference point in a protocol and technology neutral way. It does not define their syntax and encoding.

This document supports the Federated Network Information Model (FNIM) concept described in [8] in that the relevant Information Object Class (IOC)s defined in this specification are directly or indirectly inherited from those specified in the Umbrella Information Model (UIM) of [9].

---

# 2 References

The following documents contain provisions which, through reference in this text, constitute provisions of the present document.

- References are either specific (identified by date of publication, edition number, version number, etc.) or non-specific.
- For a specific reference, subsequent revisions do not apply.
- For a non-specific reference, the latest version applies. In the case of a reference to a 3GPP document (including a GSM document), a non-specific reference implicitly refers to the latest version of that document *in the same Release as the present document*.

- [1] 3GPP TS 32.101: "Telecommunication management; Principles and high level requirements".
- [2] 3GPP TS 32.102: "Telecommunication management; Architecture".
- [3] 3GPP TS 32.302: "Telecommunication management; Configuration Management (CM); Notification Integration Reference Point (IRP): Information Service (IS)".
- [4] 3GPP TS 32.150: "Telecommunication management; Integration Reference Point (IRP) Concept and Definitions".
- [5] 3GPP TS 23.003: "Technical Specification Group Core Network and Terminals; Numbering, addressing and identification".
- [6] 3GPP TS 32.532: "Telecommunication management; Software Management Integration Reference Point (IRP); Information Service (IS)".
- [7] ITU-T Recommendation X.710 (1991): "Common Management Information Service Definition for CCITT Applications".
- [8] TS 32.107: "Telecommunication management; Fixed Mobile Convergence (FMC) Federated Network Information Model (FNIM)".
- [9] TS 28.620: "Telecommunication management; Fixed Mobile Convergence (FMC) Federated Network Information Model (FNIM) Umbrella Information Model (UIM)".
- [10] TS 32.156: "Telecommunication management; Fixed Mobile Convergence (FMC) Model Repertoire".
- [11] 3GPP TS 32.111-2: "Telecommunication management; Fault Management; Part 2: Alarm Integration Reference Point (IRP): Information Service (IS)".
- [12] 3GPP TS 32.662: "Telecommunication management; Configuration Management (CM); Kernel CM Information Service (IS)".



- [13] 3GPP TS 32.300: "Telecommunication management; Configuration Management (CM); Name convention for Managed Objects".
- [14] 3GPP TS 32.600: "Telecommunication management; Configuration Management (CM); Concept and high-level requirements".
- [15] ETSI GS NFV 003 V1.1.1: "Network Functions Virtualisation (NFV); Terminology for Main Concepts in NFV".
- [16] ETSI GS NFV-IFA 008 v2.1.1: "Network Functions Virtualisation (NFV); Management and Orchestration; Ve-Vnfm reference point - Interface and Information Model Specification".
- [17] ETSI GS NFV-IFA 015 v2.1.2: "Network Functions Virtualisation (NFV); Management and Orchestration; Report on NFV Information Model".
- [18] ETSI ES 202 336-12 V1.1.1: "Environmental Engineering (EE); Monitoring and control interface for infrastructure equipment (power, cooling and building environment systems used in telecommunication networks); Part 12: ICT equipment power, energy and environmental parameters monitoring information model".
- [19] ITU-T Recommendation X.731: "Information technology - Open Systems Interconnection - Systems Management: State management function".
- [20] 3GPP TS 28.552: "Management and orchestration; 5G performance measurements".
- [21] 3GPP TS 28.625: "State Management Data Definition Integration Reference Point (IRP); Information Service (IS) ".
- [22] 3GPP TS 23.501: "System Architecture for the 5G System".
- [23] 3GPP TS 23.502: "Procedures for the 5G System; Stage 2".
- [24] IETF RFC 791: "Internet Protocol".
- [25] IETF RFC 2373: "IP Version 6 Addressing Architecture".
- [26] 3GPP TR 21.905: "Vocabulary for 3GPP Specifications".
- [27] 3GPP TS 28.532: "Management and orchestration; Generic management services".
- [28] 3GPP TS 28.554: "Management and orchestration; 5G end to end Key Performance Indicators (KPI)".
- [29] 3GPP TS 32.421: "Telecommunication management; Subscriber and equipment trace; Trace concepts and requirements".
- [30] 3GPP TS 32.422: "Telecommunication management; Subscriber and equipment trace; Trace control and configuration management".
- [31] ITU-T Recommendation X.733 (02/92): "Information technology - Open Systems Interconnection - Systems Management: Alarm reporting function".
- [32] 3GPP TS 28.533: "Management and orchestration; Architecture framework".
- [33] 3GPP TS 38.300: "NR; NR and NG-RAN Overall Description; Stage 2".
- [34] 3GPP TS 38.413: "NG-RAN; NG Application Protocol (NGAP)".
- [35] 3GPP TS 38.104: "NR; Base Station (BS) radio transmission and reception".
- [36] 3GPP TS 38.321: "NR; Medium Access Control (MAC) protocol specification".
- [37] 3GPP TS 36.321: "Evolved Universal Terrestrial Radio Access (E-UTRA); Medium Access Control (MAC) protocol specification".
- [38] 3GPP TS 38.331: "NR; Radio Resource Control (RRC); Protocol specification".



- [39] 3GPP TS 36.331: "Evolved Universal Terrestrial Radio Access (E-UTRA); Radio Resource Control (RRC); Protocol specification".
- [40] 3GPP TS 25.321: "Medium Access Control (MAC) protocol specification".
- [41] 3GPP TS 25.331: "Radio Resource Control (RRC); Protocol specification".
- [42] 3GPP TS 38.304: "NR; User Equipment (UE) procedures in Idle mode and RRC Inactive state".
- [43] 3GPP TS 37.320: "Universal Terrestrial Radio Access (UTRA) and Evolved Universal Terrestrial Radio Access (E-UTRA); Radio measurement collection for Minimization of Drive Tests (MDT); Overall description; Stage 2".
- [44] 3GPP TS 28.705: "Telecommunication management; IP Multimedia Subsystem (IMS) Network Resource Model (NRM) Integration Reference Point (IRP); Information Service (IS)".
- [45] 3GPP TS 28.702: "Telecommunication management; Core Network (CN) Network Resource Model (NRM) Integration Reference Point (IRP); Information Service (IS)".
- [46] 3GPP TS 28.652: "Telecommunication management; Universal Terrestrial Radio Access Network (UTRAN) Network Resource Model (NRM) Integration Reference Point (IRP); Information Service (IS)".
- [47] 3GPP TS 28.708: "Telecommunication management; Evolved Packet Core (EPC) Network Resource Model (NRM) Integration Reference Point (IRP); Information Service (IS)".
- [48] 3GPP TS 28.541: "Management and orchestration; 5G Network Resource Model (NRM); Stage 2 and stage 3".
- [49] IETF RFC 8089: "The "file" URI Scheme".

---

## 3 Definitions and abbreviations

### 3.1 Definitions

For the purposes of the present document, the following terms and definitions apply. For terms and definitions not found here, please refer to 3GPP TS 32.101 [1], 3GPP TS 32.102 [2], 3GPP TS 32.150 [4] and 3GPP TS 32.600 [14].

**Association:** In general, it is used to model relationships between Managed Objects. Associations can be implemented in several ways, such as:

- 1) name bindings,
- 2) reference attributes, and
- 3) association objects.

This IRP stipulates that name containment associations shall be expressed through name bindings, but it does not stipulate the implementation for other types of associations as a general rule. These are specified as separate entities in the object models (UML diagrams). Currently however, all (non-containment) associations are modelled by means of reference attributes of the participating MOs.

**Information Object Class (IOC):** An IOC represents the management aspect of a network resource. It describes the information that can be passed/used in management interfaces. Their representations are technology agnostic software objects. IOC has attributes that represents the various properties of the class of objects. See the term "attribute" defined in [10]. Furthermore, IOC can support operations providing network management services invocable on demand for that class of objects. An IOC may support notifications that report event occurrences relevant for that class of objects. It is modelled using the stereotype "Class" in the UML meta-model. See TS 32.156 [10] for additional information on IOC.

**Managed Object (MO):** A MO is an instance of a Managed Object Class (MOC) representing the management aspects of a network resource. Its representation is a technology specific software object. It is sometimes called MO instance (MOI). The MOC is a class of such technology specific software objects. An MOC is the same as an IOC except that



the former is defined in technology specific terms and the latter is defined in technology agnostic terms. MOCs are used/defined in SS level specifications. IOC are used/defined in IS level specifications.

**Management Information Base (MIB):** A MIB is an instance of an NRM and has some values on the defined attributes and associations specific for that instance. In the context of the present document, an MIB consists of:

- 1) a Name space (describing the MO containment hierarchy in the MIB through Distinguished Names),
- 2) a number of Managed Objects with their attributes and
- 3) a number of Associations between these MOs. Also note that TMN (ITU-T Recommendation X.710 [7]) defines a concept of a Management Information Tree (also known as a Naming Tree) that corresponds to the name space (containment hierarchy) portion of this MIB definition. Figure 3.1 depicts the relationships between a Name space and a number of participating MOs (the shown association is of a non-containment type)

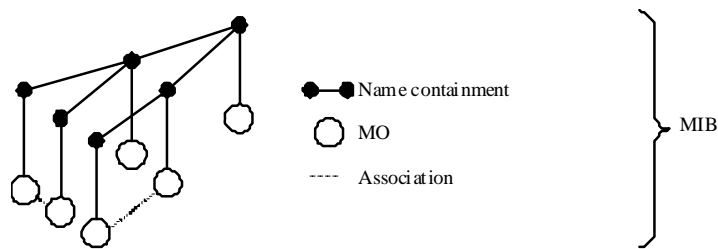

**Figure 3.1: Relationships between a Name space and a number of participating MOs**

**Name space:** A name space is a collection of names. The IRP name convention (see 3GPP TS 32.300 [13]) restricts the name space to a hierarchical containment structure, including its simplest form - the one-level, flat name space. All Managed Objects in a MIB are included in the corresponding name space and the MIB/name space shall only support a strict hierarchical containment structure (with one root object). A Managed Object that contains another is said to be the superior (parent); the contained Managed Object is referred to as the subordinate (child). The parent of all MOs in a single name space is called a Local Root. The ultimate parent of all MOs of all managed systems is called the Global Root.

**Network resource:** discrete entity represented by an Information Object Class (IOC) for the purpose of network and service management.

NOTE: A network resource may represent intelligence, information, hardware and software of a telecommunication network.

**Network Resource Model (NRM):** A collection of IOCs, inclusive of their associations, attributes and operations, representing a set of network resources under management.

## 3.2 Abbreviations

For the purposes of the present document, the abbreviations given in 3GPP TR 21.905 [26] and the following apply. An abbreviation defined in the present document takes precedence over the definition of the same abbreviation, if any, in 3GPP TR 21.905 [26].

DN	Distinguished Name (see 3GPP TS 32.300 [13])
IOC	Information Object Class
MO	Managed Object
MOC	Managed Object Class
MOI	Managed Object Instance
NFVI	Network Functions Virtualisation Infrastructure (NFVI): Defined in ETSI GS NFV 003 [15].
RDN	Relative Distinguished Name (see 3GPP TS 32.300 [13])
SS	Solution Set
VNF	Virtualised Network Function



## 4 Model

### 4.1 Imported information entities and local labels

Label reference	Local label
3GPP TS 28.532 [27], notification, notifyMOICreation	notifyMOICreation
3GPP TS 28.532 [27], notification, notifyMOIDeletion	notifyMOIDeletion
3GPP TS 28.532 [27], notification, notifyMOIAttributeValueChanges	notifyMOIAttributeValueChanges
3GPP TS 28.532 [27], notification, notifyMOIChanges	notifyMOIChanges
3GPP TS 28.532 [27], notification, notifyNewAlarm	notifyNewAlarm
3GPP TS 28.532 [27], notification, notifyClearedAlarm	notifyClearedAlarm
3GPP TS 28.532 [27], notification, notifyChangedAlarm	notifyChangedAlarm
3GPP TS 28.532 [27], notification, notifyChangedAlarmGeneral	notifyChangedAlarmGeneral
3GPP TS 28.532 [27], notification, notifyCorrelatedNotificationChanged	notifyCorrelatedNotificationChanged
3GPP TS 28.532 [27], notification, notifyAckStateChanged	notifyAckStateChanged
3GPP TS 28.532 [27], notification, notifyComments	notifyComments
3GPP TS 28.532 [27], notification, notifyPotentialFaultyAlarmlist	notifyPotentialFaultyAlarmList
3GPP TS 28.532 [27], notification, notifyAlarmlistRebuilt	notifyAlarmListRebuilt
3GPP TS 28.532 [27], notification, notifyFileReady	notifyFileReady
3GPP TS 28.532 [27], notification, notifyFilePreparationError	notifyFilePreparationError
3GPP TS 28.532 [27], SupportIOC, AlarmInformation	AlarmRecord
3GPP TS 28.620 [9], IOC, <i>Domain_</i>	<i>Domain_</i>
3GPP TS 28.620 [9], IOC, <i>ManagedElement_</i>	<i>ManagedElement_</i>
3GPP TS 28.620 [9], IOC, <i>Function_</i>	<i>Function_</i>
3GPP TS 28.620 [9], IOC, <i>ManagementSystem_</i>	<i>ManagementSystem_</i>
3GPP TS 28.620 [9], IOC, <i>TopologicalLink_</i>	<i>TopologicalLink_</i>
3GPP TS 28.620 [9], IOC, <i>Top_</i>	<i>Top_</i>

### 4.2 Class diagrams

#### 4.2.1 Relationships

This clause depicts the set of classes (e.g. IOCs) that encapsulates the information relevant for this IRP. This clause provides the overview of the relationships of relevant classes in UML. Subsequent clauses provide more detailed specification of various aspects of these classes.

The following figure shows the containment/naming hierarchy and the associations of the classes defined in the present document. See Annex A of a class diagram that combines this figure with Figure 1 of [2], the class diagram of UIM.



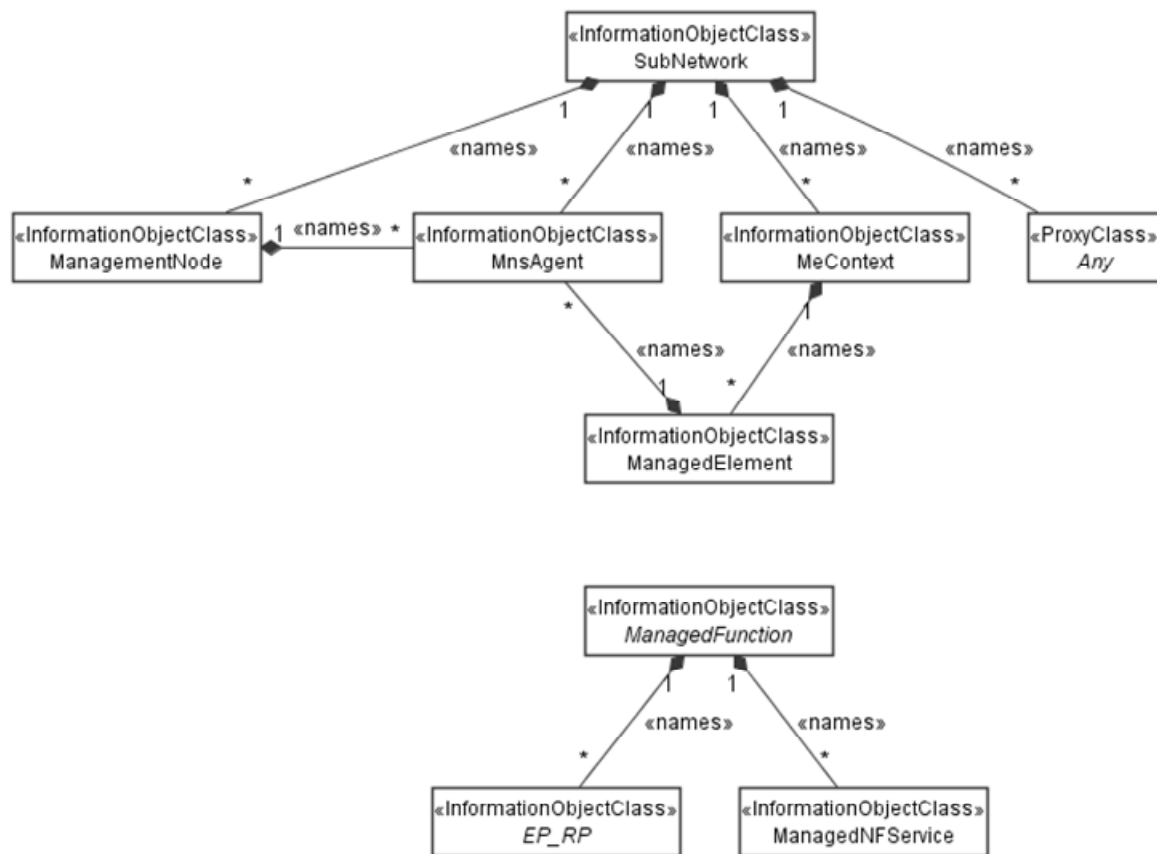

NOTE 1: ManagedElement may be contained either

- in a SubNetwork (since *SubNetwork* inherits from *Domain\_* and *ManagedElement* inherits from *ManagedElement\_* and *Domain\_* name-contained *ManagedElement\_* as observed in the figure of Annex A) or
- in a MeContext instance as observed by the above figure or in the figure of Annex A.

This either-or relation cannot be shown by using an {xor} constraint in the above figure. ManagedElement may also have no parent instance at all.

NOTE 2: Void

NOTE 3: If the configuration contains several instances of SubNetwork, exactly one SubNetwork instance shall directly or indirectly contain all the other SubNetwork instances.

NOTE 4: The SubNetwork instance not contained in any other instance of SubNetwork is referred to as "the root SubNetwork instance".

NOTE 5: ManagementNode shall be contained in the root SubNetwork instance.

NOTE 6: If contained in a SubNetwork instance, MnsAgent shall be contained in the root SubNetwork instance.

NOTE 7: For a clarification on the choice of containment of the IRPAgent (since it has three possible parents), see the definition of MnsAgent.

NOTE 8: The MnsAgent shall be replaced by the IRPAgent in deployments using the IRP framework as defined in TS 32.102 [2].

**Figure 4.2.1-1: NRM fragment**

Each Managed Object is identified with a Distinguished Name (DN) according to 3GPP TS 32.300 [13] that expresses its containment hierarchy. As an example, the DN of a ManagedElement instance could have a format like:

SubNetwork=Sweden,MeContext=MEC-Gbg-1,ManagedElement=RNC-Gbg-1.





NOTE 8: Void  
NOTE 9: Void

Figure 4.2.1-2: Vendor specific data container NRM fragment

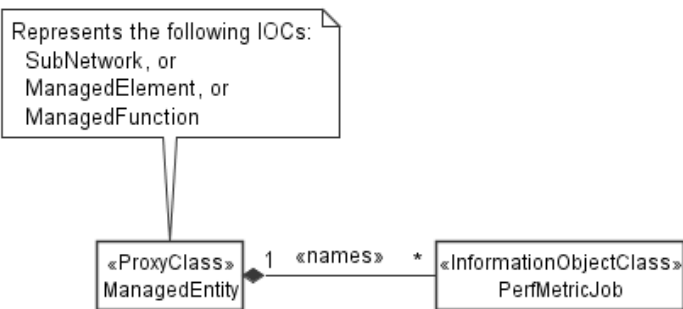

Figure 4.2.1-3: PM control NRM fragment

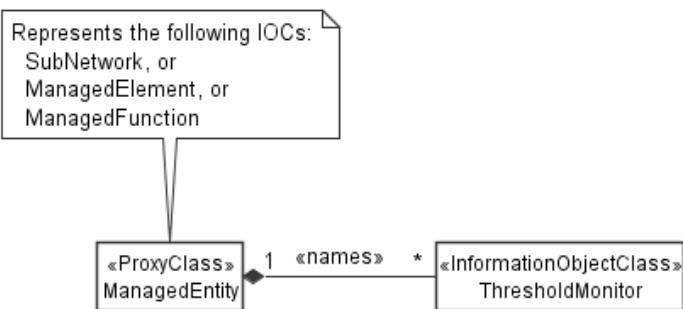

Figure 4.2.1-4: Threshold monitoring control NRM fragment



Figure 4.2.1-5: Notification subscription and heartbeat notification control NRM fragment



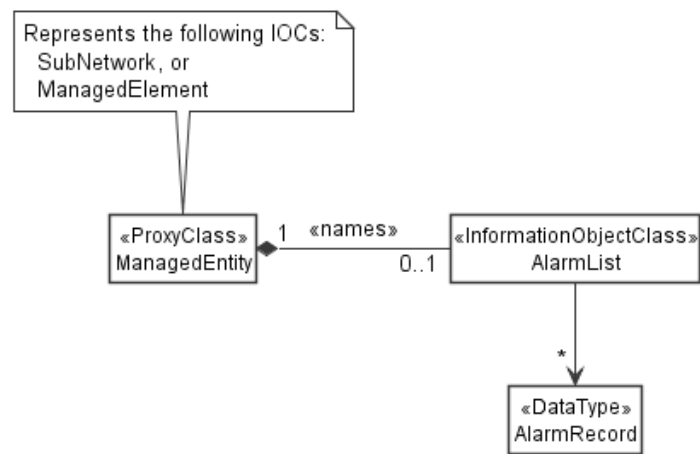

Figure 4.2.1-6: FM control NRM fragment

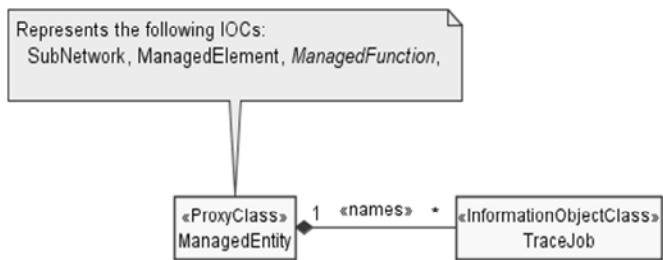

Figure 4.2.1-7: Trace control NRM fragment

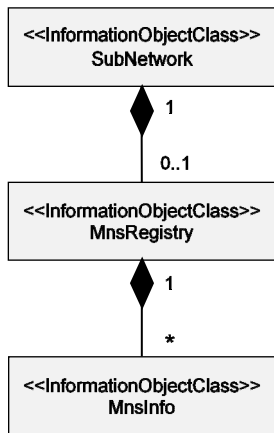

Figure 4.2.1-8: MnS Registry NRM fragment



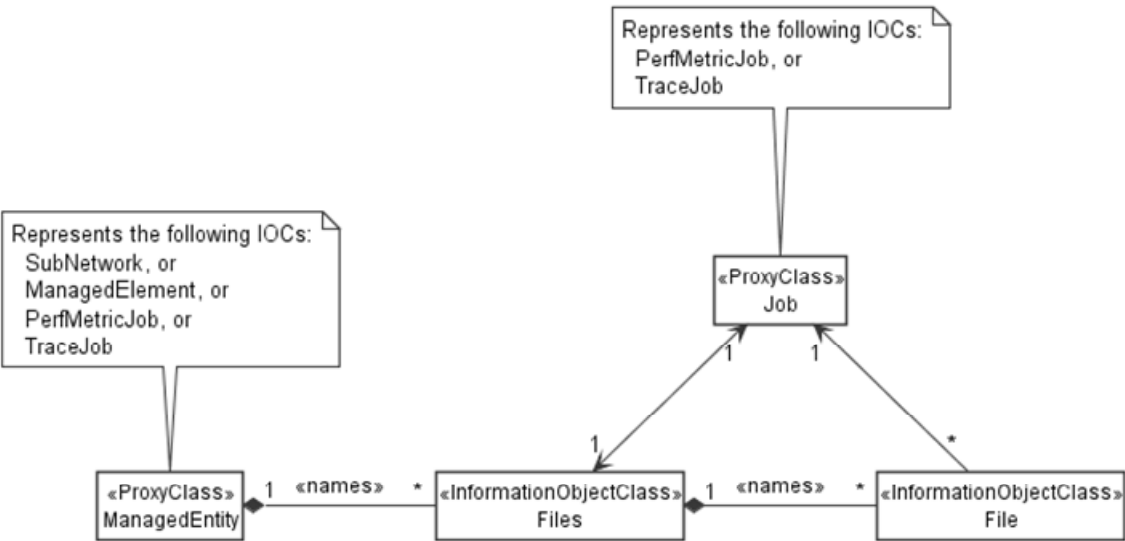

Figure 4.2.1-9: File retrieval NRM fragment

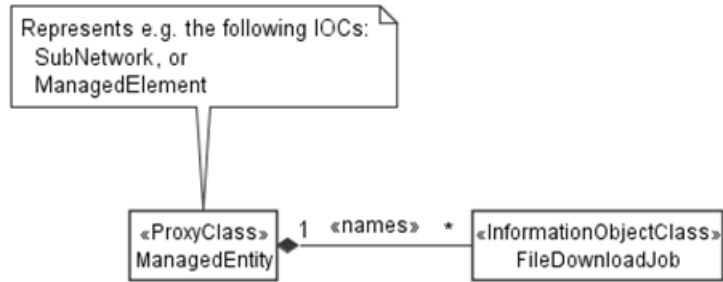

Figure 4.2.1-10: File download NRM fragment

4.2.2 Inheritance

This clause depicts the inheritance relationships.



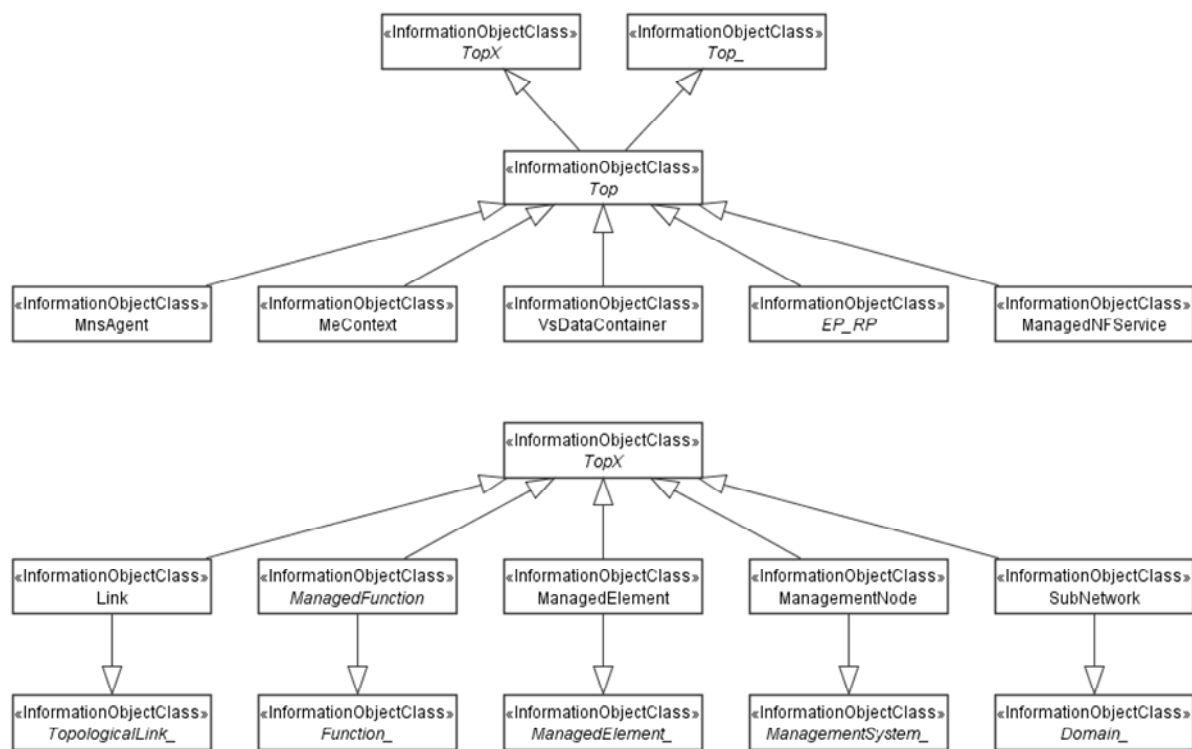

Figure 4.2.2-1: NRM fragment

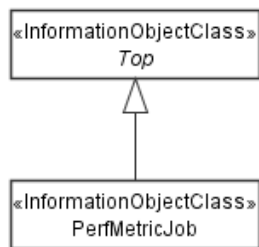

Figure 4.2.2-2: PM control NRM fragment

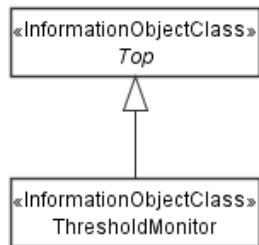

Figure 4.2.2-3: Threshold monitoring control NRM fragment



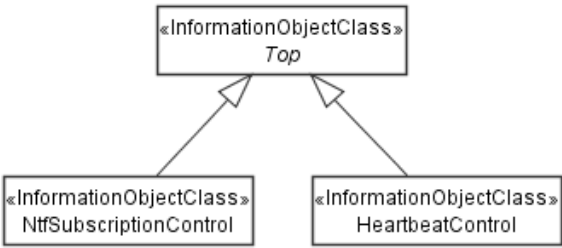

Figure 4.2.2-4: Notification subscription and heartbeat notification control NRM fragment

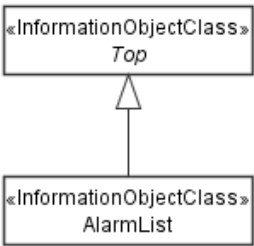

Figure 4.2.2-5: FM control NRM fragment

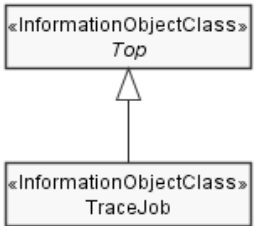

Figure 4.2.2-6: Trace control NRM fragment

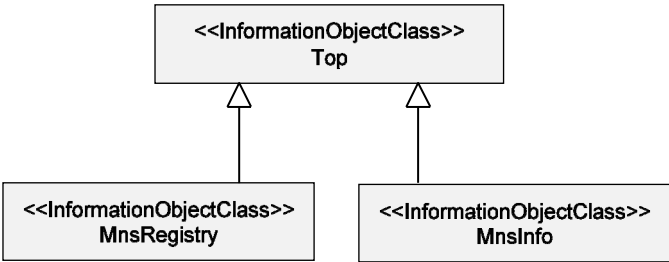

Figure 4.2.2-7: MnS Registry NRM fragment



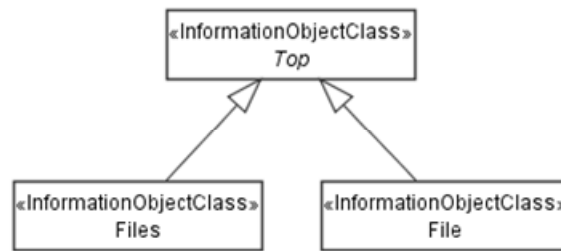

Figure 4.2.2-8: File retrieval NRM fragment

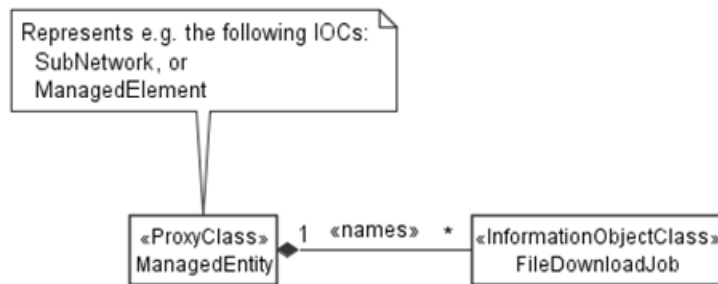

Figure 4.2.1-9: File download NRM fragment

## 4.3 Class definitions

### 4.3.1 Any

#### 4.3.1.1 Definition

This class represents the classes (e.g. IOC) that are not defined in this specification but are or will be defined in other IRP specification(s).

#### 4.3.1.2 Attributes

None

#### 4.3.1.3 Attribute constraints

None

#### 4.3.1.4 Notifications

This class does not support any notification.

### 4.3.2 IRPAgent

#### 4.3.2.1 Definition

This IOC represents the functionality of an IRPAgent. It shall be present. For a definition of IRPAgent, see 3GPP TS 32.102 [2].

The IRPAgent will be contained under an IOC as follows (only one of the options shall be used):

- 1) ManagementNode, if the configuration contains a ManagementNode;



- 2) SubNetwork, if the configuration contains a SubNetwork and no ManagementNode;
- 3) ManagedElement, if the configuration contains no ManagementNode or SubNetwork.

The IRPAgent shall be used only in deployments using the IRP framework as defined in TS 32.102 [2]. The MnsAgent shall not be used in these deployments.

#### 4.3.2.2 Attributes

The IRPAgent IOC includes the attributes inherited from Top IOC (defined in clause 4.3.29) and the following attributes:

Attribute Name	S	isReadable	isWritable	isInvariant	isNotifiable
systemDN	M	T	F	F	T

#### 4.3.2.3 Attribute constraints

None

#### 4.3.2.4 Notifications

The common notifications defined in clause 4.5 are valid for this IOC, without exceptions or additions.

### 4.3.2a MnsAgent

#### 4.3.2a.1 Definition

The MnsAgent represents the MnS producers, incl. the supporting hardware and software, available for a certain management scope that is related to the object name-containing the MnS Agent.

The MnsAgent can be name-contained under an IOC as follows (only one of the options shall be used):

- 1) ManagementNode, if the configuration contains a ManagementNode;
- 2) SubNetwork, if the configuration contains a SubNetwork and no ManagementNode;
- 3) ManagedElement, if the configuration contains no ManagementNode or SubNetwork.

In case the MnsAgent is name-contained under a ManagementNode, the management scope is the complete management scope of the ManagementNode or a subset thereof.

In case the MnsAgent is name-contained under a SubNetwork, the management scope is the complete SubNetwork or a subset thereof.

In case the MnsAgent is name-contained under a ManagedElement, the management scope is the complete ManagedElement or a subset thereof.

The MnsAgent shall be used only in deployments using the Service Based Management Architecture (SBMA) as defined in TS 28.533 [32]. The IRPAgent shall not be used in these deployments.

#### 4.3.2a.2 Attributes

The MnsAgent IOC includes the attributes inherited from Top\_ IOC (defined in TS 28.620 [9]), attributes inherited from Top IOC (defined in clause 4.3.8) and the following attributes:

Attribute Name	S	isReadable	isWritable	isInvariant	isNotifiable
systemDN	M	T	F	F	T



### 4.3.2a.3 Attribute constraints

None.

### 4.3.2a.4 Notifications

The common notifications defined in clause 4.5 are valid for this IOC, without exceptions or additions.

## 4.3.3 ManagedElement

### 4.3.3.1 Definition

This IOC represents telecommunications equipment or TMN entities within the telecommunications network providing support and/or service to the subscriber.

A ManagedElement IOC is used to represent a Network Element defined in TS 32.101[1] including virtualization or non-virtualization scenario. ManagementElement instance is used for communicating with a manager (directly or indirectly) over one or more management interfaces for the purpose of being monitored and/or controlled.

ManagedElement may or may not additionally perform element management functionality. A ManagedElement contains equipment that may or may not be geographically distributed.

A telecommunication equipment has software and hardware components. The ManagedElement IOC described above represents the following two cases:

- In the case when the software component is designed to run on dedicated hardware component, the ManagedElement IOC description includes both software and hardware component.
- In the case when the software is designed to run on ETSI NFV defined NFVI [15], the ManagedElement IOC description would exclude the NFVI component supporting the above mentioned subject software.

A ManagedElement may be contained in either a SubNetwork or in a MeContext instance. A ManagedElement may also exist stand-alone with no parent at all.

The relation of ManagedElement IOC and ManagedFunction IOC can be described as following:

- A ManagedElement instance may have 1..1 containment relationship to a ManagedFunction instance. In this case, the ManagedElement IOC may be used to represent a NE with single ManagedFunction functionality. For example, a ManagedElement is used to represent the 3GPP defined RNC node.
- A ManagedElement instances may have 1..N containment relationship to multiple ManagedFunction IOC instances. In this case, the ManagedElement IOC may be used to represent a NE with combined ManagedFunction functionality (as indicated by the managedElementType attribute and the contained instances of different ManagedFunction IOCs). For example, a ManagedElement is used to represent the combined functionality of 3GPP defined gNBCUCPFunction, gNBCUUPFunction and gNBDFFunction.

NOTE: For some specific functional IOCs a 1..N containment relationship is permitted. The specific functional entities are identified in the NRMs that define subclasses of ManagedFunction.

### 4.3.3.2 Attributes

The ManagedElement IOC includes the attributes inherited from ManagedElement\_ IOC (defined in TS 28.620 [9]), attributes inherited from TopX IOC (defined in clause 4.3.8) and the following attributes:

Attribute Name	S	isReadable	isWritable	isInvariant	isNotifiable
vendorName	M	T	F	F	T
userDefinedState	M	T	T	F	T
swVersion	M	T	F	F	T
priorityLabel	O	T	T	F	T
supportedPerfMetricGroups	O	T	F	F	T



#### 4.3.3.3 Attribute constraints

Attribute constraints for `dnPrefix`: The attribute `dnPrefix` shall be supported if an instance of `ManagedElement` is the local root instance of the MIB. Otherwise the attribute shall be absent or carry no information.

#### 4.3.3.4 Notifications

The common notifications defined in clause 4.5 are valid for this IOC. In addition, the following set of notifications is also valid.

Name	S	Notes
<code>notifyFileReady</code>	M	--
<code>notifyFilePreparationError</code>	M	--
<code>notifyDownloadNESwStatusChanged</code>	M	--
<code>notifyInstallNESwStatusChanged</code>	O	--
<code>notifyActivateNESwStatusChanged</code>	M	--

### 4.3.4 *ManagedFunction*

#### 4.3.4.1 Definition

This IOC is provided for sub-classing only. It provides attribute(s) that are common to functional IOCs. Note that a `ManagedElement` may contain several managed functions, a managed function may contain other managed functions as specified for the specific subclass.. The `ManagedFunction` may be extended in the future if more common characteristics to functional objects are identified.

This IOC can represent a telecommunication function either realized by software running on dedicated hardware or realized by software running on NFVI. Each `ManagedFunction` instance communicates with a manager (directly or indirectly) over one or more management interfaces exposed via its containing ME instance.

#### 4.3.4.2 Attributes

The `ManagedFunction` IOC includes the attributes inherited from `Function_` IOC (defined in TS 28.620 [9]), attributes inherited from `TopX` IOC (defined in clause 4.3.8) and the following attributes:

Attribute Name	S	isReadable	isWritable	isInvariant	isNotifiable
<code>vnfParametersList</code>	CM	T	T	F	T
<code>peeParametersList</code>	CM	T	T	F	T
<code>priorityLabel</code>	O	T	T	F	T
<code>supportedPerfMetricGroups</code>	O	T	F	F	T

#### 4.3.4.3 Attribute constraints

Name	Definition
<code>vnfParametersList</code> Support Qualifier	Condition: The <code>ManagedFunction</code> instance is realized by one or more VNF instance(s). Otherwise this attribute shall be absent.
<code>peeParametersList</code> Support Qualifier	Condition: The control and monitoring of PEE parameters is supported by the <code>ManagedFunction</code> or sub-class instance.

#### 4.3.4.4 Notifications

There is no notification defined.



## 4.3.5 ManagementNode

### 4.3.5.1 Definition

This IOC represents a telecommunications management system (EM) within the TMN that contains functionality for managing a number of ManagedElements (MEs). The management system communicates with the MEs directly or indirectly over one or more interfaces for the purpose of monitoring and/or controlling these MEs.

This class has similar characteristics as the ManagedElement. The main difference between these two classes is that the ManagementNode has a special association to the managed elements that it is responsible for managing.

### 4.3.5.2 Attributes

The ManagementNode IOC includes the attributes inherited from ManagementSystem\_IOC (defined in TS 28.620 [9]), attributes inherited from TopX IOC (defined in clause 4.3.8) and the following attributes:

Attribute Name	S	isReadable	isWritable	isInvariant	isNotifiable
vendorName	M	T	F	F	T
userDefinedState	M	T	T	F	T
locationName	M	T	F	F	T
swVersion	M	T	F	F	T

### 4.3.5.3 Attribute constraints

None

### 4.3.5.4 Notifications

The common notifications defined in clause 4.5 are valid for this IOC. In addition, the following set of notifications is also valid.

Name	S	Notes
notifyFileReady	M	--
notifyFilePreparationError	M	--

## 4.3.6 MeContext

### 4.3.6.1 Definition

This IOC is introduced for naming purposes. It may support creation of unique DNs in scenarios when some MEs have the same RDNs due to the fact that they have been manufacturer pre-configured.

If some MEs have the same RDNs (for the above mentioned reason) and they are contained in the same SubNetwork instance, some measure shall be taken in order to assure the global uniqueness of DNs for all IOC instances under those MEs. One way could be to set different dnPrefix for those NEs, but that would require either that:

- all LDNs or DNs are locally modified using the new dnPrefix for the upper portion of the DNs, or
- a mapping (translation) of the old LDNs or DNs to the new DNs every time they are used externally, e.g. in alarm notifications.

As both the two alternatives above may involve unacceptable drawbacks (as the old RDNs for the MEs then would have to be changed or mapped to new values), using MeContext offers a new alternative to resolve the DN creation. Using MeContext as part of the naming tree (and thus the DN) means that the dnPrefix, including a unique MeContext for each ME, may be directly concatenated with the LDNs, without any need to change or map the existing ME RDNs to new values.

MeContext have 0..N instances. It may exist even if no SubNetwork exists. Every instance of MeContext contains exactly one ManagedElement during steady-state operations.



### 4.3.6.2 Attributes

The MeContext IOC includes the attributes inherited from Top IOC (defined in clause 4.3.29) and the following attributes:

Attribute Name	S	isReadable	isWritable	isInvariant	isNotifiable
dnPrefix	CM	T	F	F	T

### 4.3.6.3 Attribute constraints

Name	Definition
dnPrefix Support Qualifier	Condition: The instance of MeContext is the local root instance of the MIB. Otherwise the attribute shall be absent or carry no information.

### 4.3.6.4 Notifications

The common notifications defined in clause 4.5 are valid for this IOC, without exceptions or additions.

## 4.3.7 SubNetwork

### 4.3.7.1 Definition

This IOC represents a set of managed entities. There may be zero or more instances of a SubNetwork. It shall be present if either a ManagementNode or multiple ManagedElements are present (i.e. ManagementNode and multiple ManagedElement instances shall have SubNetwork as parent).

The SubNetwork instance not contained in any other instance of SubNetwork is referred to as the "root" SubNetwork instance.

### 4.3.7.2 Attributes

The SubNetwork IOC includes the attributes inherited from Domain\_ IOC (defined in TS 28.620 [9]), attributes inherited from TopX IOC (defined in clause 4.3.8) and the following attributes:

Attribute Name	S	isReadable	isWritable	isInvariant	isNotifiable
setOfMcc	CM	T	F	F	T
priorityLabel	O	T	T	F	T
supportedPerfMetricGroups	O	T	F	F	T

### 4.3.7.3 Attribute constraints

Name	Definition
dnPrefix (inherited from Domain_) Support Qualifier	Condition: The instance of SubNetwork is the local root instance of the MIB. Otherwise the attribute shall be absent or carry no information.
setOfMcc Support Qualifier	Condition: There is more than one value in setOfMcc of the SubNetwork ; otherwise the support is optional.

### 4.3.7.4 Notifications

The common notifications defined in clause 4.5 are valid for this IOC, without exceptions or additions



## 4.3.8 TopX

### 4.3.8.1 Definition

This IOC is provided for sub-classing only. All information object classes defined in all TS that claim to be conformant to 32.102 [2] shall inherit from TopX.

### 4.3.8.2 Attributes

Attribute Name	S	isReadable	isWritable	isInvariant	isNotifiable
objectClass	M	T	T	T	T
objectInstance	M	T	T	T	T

### 4.3.8.3 Attribute constraints

None

### 4.3.8.4 Notifications

There is no notification defined.

## 4.3.9 VsDataContainer

### 4.3.9.1 Definition

The VsDataContainer is a container for vendor specific data. The VsDataContainer is contained by Top and hence optionally name-contained by ech IOC.

### 4.3.9.2 Attributes

The VsDataContainer IOC includes the attributes inherited from Top IOC (defined in clause 4.3.29) and the following attributes:

Attribute Name	S	isReadable	isWritable	isInvariant	isNotifiable
vsDataType	M	T	F	F	O
vsData	M	T	O	F	O
vsDataFormatVersion	M	T	F	F	O

### 4.3.9.3 Attribute constraints

None

### 4.3.9.4 Notifications

Support for notification on the change of attribute value is vendor-specific.

## 4.3.10 Link

### 4.3.10.1 Definition

This IOC is provided for sub-classing only. This IOC represents a communication link or reference point between two network entities. The Link IOC does not indicate whether the represented communication link or reference point is a physical or logical entity.



For the subclasses of Link, the following rules apply:

- 1) The subclass names shall have the form “Link\_<X>\_<Y>”, where <X> is a string that represents the IOC at one end of the association related to the particular Link subclass, and <Y> is a string that represents the IOC at the other end of the association. For the order of the two strings, <X> shall come alphabetically before <Y>.
- 2) In case <X> and <Y> are YyyFunction IOCs (inheriting from ManagedFunction and on first level below ManagedElement), the <X> and <Y> strings shall have the same form as the legal values of the managedElementType attribute (see clause 4.5.1), e.g. “Auc”. Otherwise <X> and <Y> shall be the full IOC names.

Thus, two valid examples of Link subclass names would be: Link\_As\_Cscf and Link\_Mrfc\_Mrfp.

#### 4.3.10.2 Attributes

The Link IOC includes the attributes inherited from TopologicalLink\_ (defined in TS 28.620 [9]), attributes inherited from TopX IOC (defined in clause 4.3.8) and the following attributes:

Attribute Name	S	isReadable	isWritable	isInvariant	isNotifiable
userLabel	M	T	T	F	T
linkType	O	T	F	F	T
protocolVersion	O	T	F	F	T

#### 4.3.10.3 Attribute constraints

Name	Definition
aEnd and zEnd (inherited from <i>TopologicalLink_</i> ) Support Qualifier	Condition: The property multiplicity is 1.

#### 4.3.10.4 Notifications

The common notifications defined in subclause 4.5 are valid for this IOC, without exceptions or additions

### 4.3.11 EP\_RP

#### 4.3.11.1 Definition

This IOC is provided for sub-classing only. This IOC represents an end point of a link used across a reference point between two network entities.

For naming the subclasses of EP\_RP, the following rules shall apply:

- The name of the subclassed IOC shall have the form “EP\_<rp>”, where <rp> is a string that represents the name of the reference point.

Thus, two valid examples of EP\_RP subclassed IOC names would be: EP\_S1 and EP\_X2.

#### 4.3.11.2 Attributes

The EP\_RP IOC includes the attributes inherited from Top IOC (defined in clause 4.3.29) and the following attributes:

Attribute Name	S	isReadable	isWritable	isInvariant	isNotifiable
farEndEntity	O	T	F	F	T
userLabel	O	T	T	F	T
supportedPerfMetricGroups	O	T	F	F	T

#### 4.3.11.3 Attribute constraints

None



#### 4.3.11.4 Notifications

This class does not support any notification.

#### 4.3.12 Void

#### 4.3.13 Void

#### 4.3.14 Void

#### 4.3.15 Void

### 4.3.16 ThresholdMonitor

#### 4.3.16.1 Definition

This IOC represents a threshold monitor for performance metrics. It can be name-contained by `SubNetwork`, `ManagedElement`, or `ManagedFunction`. A threshold monitor checks for threshold crossings of performance metric values and generates a notification when that happens.

To activate threshold monitoring, a MnS consumer needs to create a `ThresholdMonitor` instance on the MnS producer. For ultimate deactivation of threshold monitoring, the MnS consumer should delete the monitor to free up resources on the MnS producer.

For temporary suspension of threshold monitoring, the MnS consumer can manipulate the value of the administrative state attribute. The MnS producer may disable threshold monitoring as well, for example in overload situations. This situation is indicated by the MnS producer with setting the operational state attribute to disabled. When monitoring is resumed the operational state is set again to enabled.

All object instances below and including the instance name-containing the `ThresholdMonitor` (base object instance) are scoped for performance metric production. Performance metrics are monitored only on those object instances whose object class matches the object class associated to the performance metrics to be monitored.

The optional attributes `objectInstances` and `rootObjectInstances` allow to restrict the scope. When the attribute `objectInstances` is present, only the object instances identified by this attribute are scoped. When the attribute `rootObjectInstances` is present, then the subtrees whose root objects are identified by this attribute are scoped. Both attributes may be present at the same time meaning the total scope is equal to the sum of both scopes. Object instances may be scoped by both the `objectInstances` and `rootObjectInstances` attributes. This shall not be considered as an error by the MnS producer.

Multiple thresholds can be defined for multiple performance metric sets in a single monitor using `thresholdInfoList`. The attribute `monitorGranularityPeriod` defines the granularity period to be applied.

A threshold is defined using the attributes `thresholdValue`, `thresholdDirection` and `hysteresis`.

When `hysteresis` is absent or carries no information, a threshold is triggered when the `thresholdValue` is reached or crossed. When `hysteresis` is present, two threshold values are specified for the threshold as follows: A high threshold value equal to the threshold value plus the hysteresis value, and a low threshold value equal to the threshold value minus the hysteresis value. When the monitored performance metric increases, the threshold is triggered when the high threshold value is reached or crossed. When the monitored performance metric decreases, the threshold is triggered when the low threshold value is reached or crossed. The hysteresis ensures that the performance metric value can oscillate around a comparison value without triggering each time the threshold when the threshold value is crossed.

Using the `thresholdDirection` attribute a threshold can be configured in such a manner that it is triggered only when the monitored performance metric is going up or down upon reaching or crossing the threshold.



A `ThresholdMonitor` creation request shall be rejected, if the performance metrics requested to be monitored, the requested granularity period, or the requested combination thereof is not supported by the MnS producer. A creation request may fail, when the performance metrics requested to be monitored are not produced by a `PerfMetricJob`.

Creation and deletion of `ThresholdMonitor` instances by MnS consumers is optional; when not supported, `ThresholdMonitor` instances may be created and deleted by the system or be pre-installed.

#### 4.3.16.2 Attributes

The `ThresholdMonitor` IOC includes attributes inherited from Top IOC (defined in clause 4.3.29) and the following attributes:

Attribute name	S	isReadable	isWritable	isInvariant	isNotifiable
administrativeState	M	T	T	F	T
operationalState	M	T	F	F	T
thresholdInfoList	M	T	T	F	T
monitorGranularityPeriod	M	T	T	F	T
objectInstances	O	T	T	F	F
rootObjectInstances	O	T	T	F	F

#### 4.3.16.3 Attribute constraints

None.

#### 4.3.16.4 Notifications

The common notifications defined in clause 4.5 are valid for this IOC.

### 4.3.17 ManagedNFService

#### 4.3.17.1 Definition

A `ManagedNFService` represents a Network Function (NF) service as defined in clause 7 of 3GPP TS 23.501[22].

#### 4.3.17.2 Attributes

The `ManagedNFService` IOC includes attributes inherited from Top IOC (defined in clause 4.3.29) and the following attributes:

Attribute Name	S	isReadable	isWritable	isInvariant	isNotifiable
administrativeState	M	T	T	F	T
operationalState	M	T	F	T	T
userLabel	O	T	T	F	T
nFServiceType	M	T	F	T	F
sAP	M	T	T	F	T
operations	M	T	T	F	T
usageState	M	T	F	T	T
registrationState	CM	T	F	F	T

#### 4.3.17.3 Attribute constraints

Attribute constraint for `registrationState`: The attribute `registrationState` should be supported by instance of a `ManagedNFService` if the service is designed for being published and discovered by other NFs, and need to be registered to a repository function. E.g. Authentication service provided by AUSF should include this attribute. NF management services provided by NRF don't include this attribute.



#### 4.3.17.4 Notifications

The common notifications defined in clause 4.5 are valid for this IOC, without exceptions or additions

### 4.3.18 Operation <<dataType>>

#### 4.3.18.1 Definition

This data type represents an Operation. An Operation is comprised of a name, an allowedNFType and an operationSemantics (See TS 23.502 [23]).

#### 4.3.18.2 Attributes

Attribute Name	S	isReadable	isWritable	isInvariant	isNotifiable
name	M	T	F	T	F
allowedNFTypes	M	T	T	F	T
operationSemantics	M	T	F	T	T

#### 4.3.18.3 Attribute constraints

None

#### 4.3.18.4 Notifications

The subclause 4.5 of the <<IOC>> using this <<dataType>> as one of its attributes, shall be applicable.

### 4.3.19 SAP <<dataType>>

#### 4.3.19.1 Definition

This data type represents the access point of a managed NF service which is comprised of a host and a port.

#### 4.3.19.2 Attributes

Attribute Name	S	isReadable	isWritable	isInvariant	isNotifiable
host	M	T	T	F	T
port	M	T	T	F	T

#### 4.3.19.3 Attribute constraints

None

#### 4.3.19.4 Notifications

The subclause 4.5 of the <<IOC>> using this <<dataType>> as one of its attributes, shall be applicable.

### 4.3.20 ManagedEntity <<ProxyClass>>

#### 4.3.20.1 Definition

This <<ProxyClass>> represents one or multiple IOCs. The IOCs the <<ProxyClass>> represents are defined where the <<ProxyClass>> is used.



#### 4.3.20.2 Attributes

See respective IOCs.

#### 4.3.20.3 Attribute constraints

See respective IOCs.

#### 4.3.20.4 Notifications

See respective IOCs.

### 4.3.21 HeartbeatControl

#### 4.3.21.1 Definition

MnS consumers (i.e. notification recipients) use heartbeat notifications to monitor the communication channels between them and data report MnS producers emitting notifications such as `notifyNewAlarm` and `notifyFileReady`.

A `HeartbeatControl` instance allows controlling the emission of heartbeat notifications by MnS producers. The recipients of heartbeat notifications are specified by the `notificationRecipientAddress` attribute of the `NtfSubscriptionControl` instance name containing the `HeartbeatControl` instance.

Note that the MnS consumer managing the `HeartbeatControl` instance and the MnS consumer receiving the heartbeat notifications may not be the same.

As a pre-condition for the emission of heartbeat notifications, a `HeartbeatControl` instance needs to be created. Creation of an instance with an initial non-zero value of the `heartbeatNtfPeriod` attribute triggers an immediate heartbeat notification emission. Creation of an instance with an initial zero value of the `heartbeatPeriod` attribute does not trigger an emission of a heartbeat notification. Deletion of an instance does not trigger an emission of a heartbeat notification.

Once the instance is created, heartbeat notifications are emitted with a periodicity defined by the value of the `heartbeatNtfPeriod` attribute. No heartbeat notifications are emitted if the value is equal to zero. Setting a zero value to a non zero value, or a non zero value to a different non zero value, triggers an immediate heartbeat notification, that is the base for the new heartbeat period. Setting a non zero value to a zero value stops emitting heartbeats immediately; no final heartbeat notification is sent.

The attribute `triggerHeartbeatNtf` allows MnS consumers to trigger the emission of an immediate additional heartbeat notification. The emission of heartbeat notifications according to the heartbeat period is not impacted by this additional notification.

Creation and deletion of `HeartbeatControl` instances by MnS Consumers is optional; when not supported, the `HeartbeatControl` instances may be created and deleted by the system or be pre-installed.

The emission of heartbeat notifications is fully controlled by `HeartbeatControl` instances. Subscription for heartbeat notifications is not supported by `NtfSubscriptionControl`.

#### 4.3.21.2 Attributes

The `HeartbeatControl` IOC includes attributes inherited from Top IOC (defined in clause 4.3.29) and the following attributes:

Attribute Name	S	isReadable	isWritable	isInvariant	isNotifiable
<code>heartbeatNtfPeriod</code>	M	T	T	F	T
<code>triggerHeartbeatNtf</code>	M	F	T	F	F



### 4.3.21.3 Attribute constraints

None.

### 4.3.21.4 Notifications

The common notifications defined in clause 4.5 are valid for this IOC. In addition, the following set of notifications is also valid.

Name	S	Notes
notifyHeartbeat	M	--

## 4.3.22 NtfSubscriptionControl

### 4.3.22.1 Definition

`NtfSubscriptionControl` represents a notification subscription of a notification recipient. It can be name-contained by `SubNetwork` or `ManagedElement`.

The `scope` attribute is used to select managed object instances included in the subscription. The base object instance of the scope (see clause 4.3.23) is the object instance name-containing the `NtfSubscriptionControl` instance. When the `scope` attribute is absent, all objects below and including the base object are scoped. The notifications related to the selected managed object instances are candidates to be sent to the address specified by the `notificationRecipientAddress` attribute.

The `notificationType` attribute and `notificationFilter` attribute allow MnS consumers to control which candidate notifications are sent to the `notificationRecipientAddress`.

If the `notificationType` attribute is present, its value identifies the notification types that are candidates to be sent to the `notificationRecipientAddress`. If the `notificationType` attribute is absent, notifications of all types are candidates to be sent to `notificationRecipientAddress`.

If supported, the `notificationFilter` attribute defines a filter that is applied to the set of candidate notifications. The filter is applicable to all parameters of a notification. Only candidate notifications that pass the filter criteria are sent to the `notificationRecipientAddress`. If the `notificationFilter` attribute is absent, all candidate notifications are sent to the `notificationRecipientAddress`.

To receive notifications, a MnS consumer has to create a `NtfSubscriptionControl` instance on the MnS producer. A MnS consumer can create a subscription for another MnS consumer since it is not required the `notificationRecipientAddress` be his own address.

When a MnS consumer does not wish to receive notifications any more the MnS consumer shall delete the corresponding `NtfSubscriptionControl` instance.

When a subscription is created and the notification scope includes the created subscription object and the subscribed notification types include notifications reporting object creation (`notifyMOICreation` or `notifyMOIChanges`), the first notification sent related to the new subscription shall report the creation of the `NtfSubscriptionControl` instance. Likewise, when a subscription is deleted and the notification scope includes the deleted subscription object and the subscribed notification types include notifications reporting object deletion (`notifyMOIDeletion` or `notifyMOIChanges`), the last notification sent related to the subscription shall report the deletion of the `NtfSubscriptionControl` instance.

Creation and deletion of `NtfSubscriptionControl` instances by MnS consumers is optional; when not supported, the `NtfSubscriptionControl` instances may be created and deleted by the system or be pre-installed.

### 4.3.22.2 Attributes

The `NtfSubscriptionControl` IOC includes attributes inherited from Top IOC (defined in clause 4.3.29) and the following attributes:



Attribute Name	S	isReadable	isWritable	isInvariant	isNotifiable
notificationRecipientAddress	M	T	T	F	T
notificationTypes	O	T	T	F	T
scope	O	T	T	F	T
notificationFilter	O	T	T	F	T

#### 4.3.22.3 Attribute constraints

None.

#### 4.3.22.4 Notifications

The common notifications defined in clause 4.5 are valid for this IOC, without exceptions or additions.

### 4.3.23 Scope <<dataType>>

#### 4.3.23.1 Definition

This <<dataType>> defines a scope for selecting managed object instances below and including a base managed object instance. The scope is specified with the scope type and a scope level attributes. The specification of the base object instance is not part of this <<dataType>> and needs to be specified by other means.

#### 4.3.23.2 Attributes

Attribute Name	S	isReadable	isWritable	isInvariant	isNotifiable
scopeType	M	T	T	F	T
scopeLevel	O	T	T	F	T

#### 4.3.23.3 Attribute constraints

None.

#### 4.3.23.4 Notifications

The subclause 4.5 of the <<IOC>> using this <<dataType>> as one of its attributes, shall be applicable.

### 4.3.24 Void

### 4.3.25 Void

### 4.3.26 AlarmList

#### 4.3.26.1 Definition

The AlarmList represents the capability to store and manage alarm records. It can be name-contained by SubNetwork and ManagedElement. The management scope of an AlarmList is defined by all descendant objects of the base managed object, which is the object name-containing the AlarmList, and the base object itself.

AlarmList instances are created by the system or are pre-installed. They cannot be created nor deleted by MnS consumers.

An instance of SubNetwork or ManagedElement has at most one name-contained instance of AlarmList.



When the alarm list is locked or disabled, the existing alarm records are not updated, and new alarm records are not added to the alarm list.

#### 4.3.26.2 Attributes

The AlarmList IOC includes attributes inherited from Top IOC (defined in clause 4.3.29) and the following attributes:

Attribute Name	S	isReadable	isWritable	isInvariant	isNotifiable
administrativeState	M	T	T	F	T
operationalState	M	T	F	F	T
numOfAlarmRecords	M	T	F	F	F
lastModification	M	T	F	F	F
alarmRecords	M	T	T	F	F

#### 4.3.26.3 Attribute constraints

None

#### 4.3.26.4 Notifications

The common notifications defined in clause 4.5 are valid for this IOC, without exceptions or additions.

### 4.3.27 AlarmRecord <<dataType>>

#### 4.3.27.1 Definition

An AlarmRecord contains alarm information of an alarmed object instance. A new record is created in the alarm list when an alarmed object instance generates an alarm and no alarm record exists with the same values for objectInstance, alarmType, probableCause and specificProblem. When a new record is created the MnS producer creates an alarmId, that unambiguously identifies an alarm record in the AlarmList.

Alarm records are maintained only for active alarms. Inactive alarms are automatically deleted by the MnS producer from the AlarmList. Active alarms are alarms whose

- a) perceivedSeverity is not "CLEARED", or whose
- b) perceivedSeverity is "CLEARED" and its ackState is not "ACKNOWLEDDED".



### 4.3.27.2 Attributes

The attributes are defined in clause 11.2.2.1.5.1 of TS 28.532 [27]. Many of them are based on definitions in ITU-T X.733 [31].

Attribute name	S	isReadable	isWritable	isInvariant	isNotifiable
alarmId	M	T	F	T	F
objectInstance	M	T	F	T	F
notificationId	M	T	F	T	F
alarmRaisedTime	M	T	F	F	F (note 5)
alarmChangedTime	O	T	F	F	F (note 6)
alarmClearedTime	M	T	F	F	F (note 7)
alarmType	M	T	F	T	F
probableCause	M	T	F	T	F
specificProblem	O	T	F	T	F
perceivedSeverity	M	T	T (note 4)	F	F (note 6)
backedUpStatus	O	T	F	F	F
backUpObject	O	T	F	F	F
trendIndication	O	T	F	F	F
thresholdInfo	O	T	F	F	F
stateChangeDefinition	O	T	F	F	F
monitoredAttributes	O	T	F	F	F
proposedRepairActions	O	T	F	F	F
additionalText	O	T	F	F	F
additionalInformation	O (see note 3)	T	F	F	F
rootCauseIndicator	O	T	F	F	F
ackTime	M	T	F	F	F
ackUserId	M	T	T (see note 8)	F	F
ackSystemId	O	T	T (see note 8)	F	F
ackState	M	T	T (see note 8)	F	F
clearUserId	O (see note 1)	T	T	F	F
clearSystemId	O (see note 1)	T	T	F	F
serviceUser	O (see note 2)	T	F	F	F
serviceProvider	O (see note 2)	T	F	F	F
securityAlarmDetector	O (see note 2)	T	F	F	F
NOTE 1: These attributes and qualifiers are applicable only if producer supports consumer to set perceivedSeverity to CLEARED.					
NOTE 2: These attributes are supported if the producer emits notifyNewAlarm that carries security alarm information.					
NOTE 3: This attribute is supported to carry vendor specific information.					
NOTE 4: This isWritable property is True only if producer supports consumer to set perceivedSeverity to CLEARED					
NOTE 5: Emit notifyNewAlarm.					
NOTE 6: Emit notifyChangedAlarm					
NOTE 7: Emit notifyClearedAlarm					
NOTE 8: This isWritable property is True only if producer supports the consumer to acknowledge alarms.					

### 4.3.27.3 Attribute constraints

None.

### 4.3.27.4 Notifications

See subclause 4.5.1.



### 4.3.28 Void

### 4.3.29 *Top*

#### 4.3.29.1 Definition

This IOC is provided for sub-classing only. All information object classes defined in all TS that claim to be conformant to 32.102 [2] and support the Federated Network Information Model (FNIM) concept shall inherit from *Top*.

#### 4.3.29.2 Attributes

This IOC includes attributes inherited from *TopX* IOC (defined in clause 4.3.8) and the attributes inherited from *Top\_* IOC (defined in TS 28.620 [9]).

#### 4.3.29.3 Attribute constraints

None

#### 4.3.29.4 Notifications

There is no notification defined.

### 4.3.30 *TraceJob*

#### 4.3.30.1 Definition

A *TraceJob* instance represents the Trace Control and Configuration parameters of a particular Trace Job (see TS 32.421 [29] and TS 32.422 [30] for details). It can be name-contained by *SubNetwork*, *ManagedElement*, *ManagedFunction*.

To activate Trace Jobs, a MnS consumer has to create *TraceJob* object instances on the MnS producer. A MnS consumer can activate a Trace Job for another MnS consumer since it is not required the value of *tjTraceCollectionEntityAddress* or *tjStreamingTraceConsumerUri* to be his own.

For the details of Trace Job activation see clauses 4.1.1.1.2 and 4.1.2.1.2 of TS 32.422 [30].

When a MnS consumer wishes to deactivate a Trace Job, the MnS consumer shall delete the corresponding *TraceJob* instance. For details of management Trace Job deactivation see clauses 4.1.3.8 to 4.1.3.11 and 4.1.4.10 to 4.1.4.13 of TS 32.422 [30].

The attribute *tjTraceReference* specifies a globally unique ID and identifies a Trace session. One Trace Session may be activated to multiple Network Elements.

The attribute *tjTraceRecordSessionReference* identifies a Trace Recording Session within a Trace Session. Two different trace sessions could e.g. be caused by two different trigger events.

The *jobId* attribute presents the job identifier of a *TraceJob* instance. The *jobId* can be used to associate multiple *TraceJob* instances. For example, it is possible to configure the same *jobId* value for multiple *TraceJob* instances required to produce the data (e.g. RSRP values of M1 and RLF reports) for a specific network analysis.

The attribute *tjTraceReportingFormat* defines the method for reporting the produced measurements. The selectable options are file-based or stream-based reporting. In case of file-based reporting the attribute *tjTraceCollectionEntityAddress* is used to specify the IP address to which the trace records shall be transferred, while in case of stream-based reporting the attribute *tjStreamingTraceConsumerUri* specifies the streaming target.

The mandatory attribute *tjTraceTarget* determines the target object of the *TraceJob*. Dependent on the network element to which the Trace Session is activated different types of the target object are possible. The attribute



tjPLMNTarget defines the PLMN for which sessions shall be selected in the Trace Session in case of management based activation when several PLMNs are supported in the RAN.

The attribute tjJobType specifies the kind of data to collect. Dependent on the selected type various parameters shall be available. The attributes tjJobType, tjTraceReference, tjTraceRecordSessionReference, tjTraceCollectionEntityAddress, tjTraceTarget and tjTraceReportingFormat are mandatory for all job types. If streaming reporting is selected for tjTraceReportingFormat, tjStreamingTraceConsumerURI shall be present additionally. The attribute tjPLMNTarget shall be present if trace activation method is management based.

For the different job types the attributes are differentiated as follows:

- In case of TRACE\_ONLY additionally the following attributes shall be available: tjListOfNeTypes, tjTraceDepth, and tjTriggeringEvent.

For this case the optional attribute tjListOfInterfaces allows to specify the interfaces to be recorded.

- In case of IMMEDIATE\_MDT\_ONLY additionally the following attributes shall be available:
  - tjMDTAnonymizationOfData,
  - tjMDTListOfMeasurements,
  - tjMDTCollectionPeriodRrmUmts (conditional for M4 and M5 in UMTS),
  - tjMDTMeasurementPeriodUMTS (conditional for M6 and M7 in UMTS),
  - tjMDTCollectionPeriodRrmLte (conditional for M3 in LTE),
  - tjMDTMeasurementPeriodLTE (conditional for M4 and M5 in LTE),
  - tjMDTCollectionPeriodM6Lte (conditional for M6 in LTE),
  - tjMDTCollectionPeriodM7Lte (conditional for M7 in LTE),
  - tjMDTCollectionPeriodRrmNR (conditional for M4 and M5 in NR),
  - tjMDTCollectionPeriodM6NR (conditional for M6 in NR),
  - tjMDTCollectionPeriodM7NR (conditional for M7 in NR),
  - tjMDTBeamLevelMeasurement (conditional for M1 in NR),
  - tjMDTReportInterval (conditional for M1 in LTE or NR and M1/M2 in UMTS),
  - tjMDTReportAmount (conditional for M1 in LTE or NR and M1/M2 in UMTS),
  - tjMDTReportingTrigger (conditional for M1 in LTE or NR and M1/M2 in UMTS),
  - tjMDTEventThreshold (conditional for A2 event reporting or A2 event triggered periodic reporting),
  - tjMDTMeasurementQuantity (conditional for 1F event reporting).

For this case the optional attribute tjMDTAreaScope allows to specify the area in terms of cells or Tracking Area/Routing Area/Location area where the MDT data collection shall take place and the optional attributes tjMDTPositioningMethod, tjMDTSensorInformation allow to specify the positioning methods to use or the sensor information to include.

- In case of IMMEDIATE\_MDT\_AND\_TRACE both additional attributes of TRACE\_ONLY and IMMEDIATE\_MDT\_ONLY shall apply.
- In case of LOGGED\_MDT\_ONLY additionally the following attributes shall be available: tjMDTAnonymizationOfData, tjMDTTraceCollectionEntityID, tjMDTLoggingInterval, tjMDTLoggingDuration, tjMDTReportType, tjMDTEventListForTriggeredMeasurements.

For this case the optional attribute tjMDTAreaScope allows to specify the area in terms of cells or Tracking Area/Routing Area/Location area where the MDT data collection shall take place, the optional attribute tjMDTPLMNList allows to specify the PLMNs where measurement collection, status indication and log reporting is allowed, the optional attribute tjMDTAreaConfigurationForNeighCell allows to specify the area for which UE is requested to perform measurements logging for neighbour cells which have list of frequencies and the optional attribute tjMDTSensorInformation allows to specify the sensor information to include.

- In case of RLF\_REPORT\_ONLY and RCEF\_REPORT\_ONLY the optional attribute tjMDTAreaScope allows to specify the eNB or list of eNBs or gNB or list of gNBs where the reports should be collected.



- In case of LOGGED\_MBSFN\_MDT additionally the following attributes shall be available:  
tjMDTAnonymizationOfData, tjMDTLoggingInterval, tjMDTLoggingDuration,  
tjMDTMBSFNAreaList.

Reporting of measurements and messages can be periodical, event triggered or event triggered periodic depending on the selected job type.

- For trace the reporting is event based, where the triggering event is configured with attribute tjTriggeringEvent. For each triggering event the first and last message (start/stop triggering event) to record are specified.
- For immediate MDT, the reporting is dependent on the configured measurements:
  - For measurement M1 in LTE or NR, it is possible to select between periodical, event triggered, event triggered periodic reporting or reporting according to all configured RRM event triggers. For M1 and M2 measurement in UMTS, it is possible to select between periodical, event triggered reporting or reporting according to all configured RRM event triggers. Parameter tjMDTReportingTrigger determines which of the reporting methods is selected and in case of event triggered or event-triggered periodic, which is the decisive event type. For periodical reporting, parameters tjMDTReportInterval and tjMDTReportAmount determine the interval between two successive reports and the number of reports. This means the periodical reporting terminates after tjMDTReportAmount reports have been sent as long as tjMDTReportAmount is configured with a value different from infinity. For event-triggered periodic reporting, these two parameters apply in addition to parameter tjMDTEventThreshold which determines the threshold of the event. In this case up to tjMDTReportAmount reports are sent with a periodicity of tjMDTReportInterval after the entering condition is fulfilled. The reporting is stopped, if the leaving condition is fulfilled and is restarted if the configured event reoccurs. For event based reporting, there is only one report sent after the event occurs. The parameters to configure are tjMDTReportingTrigger and tjMDTEventThreshold. In case of UMTS and if event reporting, additionally parameter tjMDTMeasurementQuantity is necessary in order to determine for which measurement(s) the event threshold is applicable. Parameter tjMDTBeamLevelMeasurement determines whether beam level measurements shall be included in case of NR.
  - For measurement M2 in LTE or NR, reporting is according to RRM configuration, see TS 38.321 [36], TS 36.321 [37] and TS 38.331 [38], TS 36.331 [39]. For measurement M4 in UMTS, reporting is either according to RRM configuration, see TS 25.321 [40] and TS 25.331 [41] or periodic or event triggered periodic using parameter tjMDTCollectionPeriodRrmUmts and tjMDTM4ThresholdUmts.
  - For measurement M3 in UMTS, the reporting is done upon availability, see TS 37.320 [43].
  - For measurements M4, M5, M6 and M7 in NR, for measurements M3, M4, M5, M6 and M7 in LTE and for measurements M5, M6 and M7 in UMTS periodical reporting is applied. The configurable parameter is the interval between two measurements (tjMDTCollectionPeriodRrmNR, tjMDTCollectionPeriodM6NR, tjMDTCollectionPeriodM7NR, tjMDTCollectionPeriodRrmLte, tjMDTMeasurementPeriodLTE, tjMDTCollectionPeriodM6Lte, tjMDTCollectionPeriodM7Lte, tjMDTCollectionPeriodRrmUmts, tjMDTMeasurementPeriodUMTS). If no collection period is configured for M5 in UMTS, all available measurements are logged according to RRM configuration.
- For logged MDT in UMTS and LTE, the reporting is periodical. Parameter tjMDTLoggingInterval determines the interval between the reports and parameter tjMDTLoggingDuration determines how long the configuration is valid meaning after this duration has passed no further reports are sent. In NR, the reporting can be periodical or event based, determined by parameter tjMDTReportType. For periodical reporting the same parameters as in LTE and UMTS apply. For event based reporting, parameter tjMDTEventListForTriggeredMeasurement configures the event type, namely 'out of coverage' or 'L1 event'. In case 'L1 event' is selected as event type, the logging is performed according to parameter tjMDTLoggingInterval at regular intervals only when the conditions indicated by tjMDTLoggingEventThreshold, tjMDTLoggingHysteresis, tjMDTLoggingTimeToTrigger (defining the thresholds, hysteresis and time to trigger) are met and if UE is 'camped normally' state (TS 38.331 [38], TS 38.304 [42]). In case 'out of coverage' is selected as event type, the logging is performed according to parameter tjMDTLoggingInterval at regular intervals only when the UE is in 'any cell selection' state.



Furthermore, logging is performed immediately upon transition from the ‘any cell selection’ state to the ‘camped normally’ state ( TS 38.331 [38], TS 38.304 [42]).

Creation and deletion of TraceJob instances by MnS consumers is optional; when not supported, the TraceJob instances may be created and deleted by the system or be pre-installed.

#### 4.3.30.2 Attributes

The TraceJob IOC includes attributes inherited from Top IOC (defined in clause 4.3.29) and the following attributes:

Attribute Name	S	isReadable	isWritable	isInvariant	isNotifiable
tjJobType	M	T	T	F	T
tjListOfInterfaces	CO	T	T	F	T
tjListOfNeTypes	CM	T	T	F	T
tjPLMNTarget	CM	T	T	F	T
tjStreamingTraceConsumerURI	CM	T	T	F	T
tjTraceCollectionEntityAddress	CM	T	T	F	T
tjTraceDepth	CM	T	T	F	T
tjTraceReference	M	T	T	F	T
tjTraceRecordSessionReference	M	T	T	F	T
jobId	OM	T	T	T	T
tjTraceReportingFormat	M	T	T	F	T
tjTraceTarget	M	T	T	F	T
tjTriggeringEvent	CM	T	T	F	T
tjMDTAnonymizationOfData	CM	T	T	F	T
tjMDTAreaConfigurationForNeighCell	CO	T	T	F	T
tjMDTAreaScope	CO	T	T	F	T
tjMDTCollectionPeriodRrmLte	CM	T	T	F	T
tjMDTCollectionPeriodM6Lte	CM	T	T	F	T
tjMDTCollectionPeriodM7Lte	CM	T	T	F	T
tjMDTCollectionPeriodRrmUmts	CM	T	T	F	T
tjMDTCollectionPeriodRrmNR	CM	T	T	F	T
tjMDTCollectionPeriodM6NR	CM	T	T	F	T
tjMDTCollectionPeriodM7NR	CM	T	T	F	T
tjMDTBeamLevelMeasurement	CM	T	T	F	T
tjMDTEventListForTriggeredMeasurement	CM	T	T	F	T
tjMDTEventThreshold	CM	T	T	F	T
tjMDTListOfMeasurements	CM	T	T	F	T
tjMDTLoggingDuration	CM	T	T	F	T
tjMDTLoggingInterval	CM	T	T	F	T
tjMDTLoggingEventThreshold	CM	T	T	F	T
tjMDTLoggedHysteresis	CM	T	T	F	T
tjMDTLoggedTimeToTrigger	CM	T	T	F	T
tjMDTMBSFNAreaList	CM	T	T	F	T
tjMDTMeasurementPeriodLTE	CM	T	T	F	T
tjMDTMeasurementPeriodUMTS	CM	T	T	F	T
tjMDTMeasurementQuantity	CM	T	T	F	T
tjMDTM4ThresholdUmts	CO	T	T	F	T
tjMDTPLMNList	CO	T	T	F	T
tjMDTPositioningMethod	CO	T	T	F	T
tjMDTReportAmount	CM	T	T	F	T
tjMDTReportingTrigger	CM	T	T	F	T
tjMDTReportInterval	CM	T	T	F	T
tjMDTReportType	CM	T	T	F	T
tjMDTSensorInformation	CO	T	T	F	T
tjMDTTraceCollectionEntityID	CM	T	T	F	T



#### 4.3.30.3 Attribute constraints



Name	Definition
tjListOfInterfaces (support qualifier)	This attribute shall be present when <code>tjJobType</code> includes Trace.
tjListOfNeTypes (support qualifier)	This attribute shall be present only for Trace with Signalling Based Activation
tjPLMNTarget (support qualifier)	This attribute shall be present for management based activation when several PLMNs are supported in the RAN.
tjStreamingTraceConsumerURI (support qualifier)	This attribute shall be present if streaming trace data reporting is supported and <code>tjTraceReportingFormat</code> set to "streaming".
tjTraceCollectionEntityAddress (support qualifier)	This attribute shall be present if file based trace data reporting is supported and <code>tjTraceReportingFormat</code> set to "file based" or when <code>tjJobType</code> is set to Logged MDT or Logged MBSFN MDT.
tjTraceDepth (support qualifier)	This attribute shall be present when <code>tjJobType</code> includes Trace.
tjTriggeringEvent (support qualifier)	This attribute shall be present when <code>tjJobType</code> includes Trace.
tjMDTAnonymizationOfData (support qualifier)	This attribute shall be present only if MDT is supported and the <code>tjMDTAreaScope</code> attribute is present. This attribute is only applicable for management based activation.
tjMDTAreaConfigurationForNeighCell (support qualifier)	This attribute shall be present only if NR MDT is supported and the <code>tjJobType</code> attribute is set to Logged MDT.
tjMDTAreaScope (support qualifier)	This attribute shall be present if MDT is supported.
tjMDTCollectionPeriodRrmLte (support qualifier)	This attribute shall be present only if MDT is supported and the <code>tjJobType</code> attribute is set to Immediate MDT or combine Trace and Immediate MDT and the <code>tjMDTListOfMeasurements</code> attribute has any of M2, M3 measurement set in case of LTE.
tjMDTCollectionPeriodRrmUmts (support qualifier)	This attribute shall be present only if MDT is supported and the <code>tjJobType</code> attribute is set to Immediate MDT or combine Trace and Immediate MDT and the <code>tjMDTListOfMeasurements</code> attribute has any of M3, M4, M5 measurement set in case of UMTS.
tjMDTEventListForTriggeredMeasurement (support qualifier)	This attribute shall be present only if NR MDT is supported and the <code>tjJobType</code> attribute is set to Logged MDT.
tjMDTEventThreshold (support qualifier)	This attribute shall be present only if MDT is supported and the <code>tjJobType</code> attribute is set to Immediate MDT and the <code>tjMDTReportingTrigger</code> attribute is configured for A2EventReporting in LTE and NR or 1f/1IEventReporting in UMTS.
tjMDTListOfMeasurements (support qualifier)	This attribute shall be present only if MDT is supported and the <code>tjJobType</code> attribute is set to Immediate MDT.
tjMDTLoggingDuration (support qualifier)	This attribute shall be present only if MDT is supported and the <code>tjJobType</code> attribute is set to Logged MDT or Logged MBSFN MDT.
tjMDTLoggingInterval (support qualifier)	This attribute shall be present only if MDT is supported and the <code>tjJobType</code> attribute is set to Logged MDT or Logged MBSFN MDT.
tjMDTLoggingEventThreshold (support qualifier)	This attribute shall be present only if NR MDT is supported and the <code>tjJobType</code> attribute is set to Logged MDT.
tjMDTLoggedHysteresis (support qualifier)	This attribute shall be present only if NR MDT is supported and the <code>tjJobType</code> attribute is set to Logged MDT.
tjMDTLoggedTimeToTrigger (support qualifier)	This attribute shall be present only if NR MDT is supported and the <code>tjJobType</code> attribute is set to Logged MDT.
tjMDTMBSFNAreaList (support qualifier)	This attribute shall be present only if Logged MBSFN MDT is supported and the <code>tjJobType</code> attribute is set to Logged MBSFN MDT. This is applicable only for eUTRAN.
tjMDTMeasurementPeriodLTE (support qualifier)	This attribute shall be present only if MDT is supported and the <code>tjJobType</code> attribute is set to Immediate MDT or combine Trace and Immediate MDT and the <code>tjMDTListOfMeasurements</code> attribute for LTE has either M4 or M5 measurement set.



tjMDTCollectionPeriodM6Lte (support qualifier)	This attribute shall be present only if MDT is supported and the tjJobType attribute is set to Immediate MDT or combine Trace and Immediate MDT and the tjMDTListOfMeasurements attribute for LTE has M6 measurement set.
tjMDTCollectionPeriodM7Lte (support qualifier)	This attribute shall be present only if MDT is supported and the tjJobType attribute is set to Immediate MDT or combine Trace and Immediate MDT and the tjMDTListOfMeasurements attribute for LTE has M7 measurement set.
tjMDTMeasurementPeriodUMTS (support qualifier)	This attribute shall be present only if MDT is supported and the tjJobType attribute is set to Immediate MDT or combine Trace and Immediate MDT and the tjMDTListOfMeasurements attribute for UMTS has M6 or M7 measurements set.
tjMDTCollectionPeriodRrmNR (support qualifier)	This attribute shall be present only if MDT is supported and the tjJobType attribute is set to Immediate MDT or combine Trace and Immediate MDT and the tjMDTListOfMeasurements attribute has any of M4, M5 measurement set in case of NR.
tjMDTCollectionPeriodM6NR (support qualifier)	This attribute shall be present only if MDT is supported and the tjJobType attribute is set to Immediate MDT or combine Trace and Immediate MDT and the tjMDTListOfMeasurements attribute has M6 measurement set in case of NR.
tjMDTCollectionPeriodM7NR (support qualifier)	This attribute shall be present only if MDT is supported and the tjJobType attribute is set to Immediate MDT or combine Trace and Immediate MDT and the tjMDTListOfMeasurements attribute has any of M7 measurement set in case of NR.
beamLevelMeasurement (support qualifier)	This attribute shall be present only if MDT is supported and the tjJobType attribute is set to Immediate MDT or combine Trace and Immediate MDT and the tjMDTListOfMeasurements attribute has M1 measurement set in case of NR.
tjMDTMeasurementQuantity (support qualifier)	This attribute shall be present only if MDT is supported and the tjJobType attribute is set to Immediate MDT or combined Trace and Immediate MDT and the tjMDTReportingTrigger parameter is set to event 1F.
tjMDTM4ThresholdUmts (support qualifier)	This attribute shall be present only if MDT is supported and the tjJobType attribute is set to Immediate MDT or combined Trace and Immediate MDT and the tjMDTListOfMeasurements attribute has M4 measurement set in case of UMTS.
tjMDTPLMNList (support qualifier)	This attribute shall be present only if MDT is supported, several PLMNs are supported in the RAN and the tjJobType attribute is set to Logged MDT.
tjMDTPositioningMethod (support qualifier)	This attribute shall be present only if MDT is supported and the tjJobType attribute is set to Immediate MDT or combine Trace and Immediate MDT.
tjMDTReportAmount (support qualifier)	This attribute shall be present only if MDT is supported and the tjJobType attribute is set to Immediate MDT and the tjMDTReportingTrigger attribute is configured for periodic measurements or event triggered periodic measurements.
tjMDTReportingTrigger (support qualifier)	This attribute shall be present only if MDT is supported and the tjJobType attribute is set to Immediate MDT and the tjMDTListOfMeasurements attribute is configured for M1 (for UMTS, LTE and NR) or M2 (only for UMTS).
tjMDTReportInterval (support qualifier)	This attribute shall be present only if MDT is supported and the tjJobType attribute is set to Immediate MDT, the tjMDTListOfMeasurements attribute is configured for M1 (for UMTS, LTE and NR) or M2 (only for UMTS) and the tjMDTReportingTrigger is configured for periodic measurements or event triggered periodic measurements.
tjMDTReportType (support qualifier)	This attribute shall be present only if NR MDT is supported and the tjJobType attribute is set to Logged MDT.



tjMDTSensorInformation (support qualifier)	This attribute shall be present only if NR MDT is supported.
tjMDTTraceCollectionEntityID (support qualifier)	This attribute shall be present only if MDT is supported and the tjJobType attribute is set to Logged MDT.

#### 4.3.30.4 Notifications

The common notifications defined in clause 4.5 are valid for this IOC, without exceptions.

### 4.3.31 PerfMetricJob

#### 4.3.31.1 Definition

This IOC represents a performance metric production job. It can be name-contained by SubNetwork, ManagedElement, or ManagedFunction.

To activate the production of the specified performance metrics, a MnS consumer needs to create a PerfMetricJob instance on the MnS producer. For ultimate deactivation of metric production, the MnS consumer should delete the job to free up resources on the MnS producer.

For temporary suspension of metric production, the MnS consumer can manipulate the value of the administrative state attribute. The MnS producer may disable metric production as well, for example in overload situations. This situation is indicated by the MnS producer with setting the operational state attribute to disabled. When production is resumed the operational state is set back to enabled.

The jobId attribute can be used to associate metrics from multiple PerfMetricJob instances. The jobId can be included when reporting performance metrics to allow a MnS consumer to associate received metrics for the same purpose. For example, it is possible to configure the same jobId value for multiple PerfMetricJob instances required to produce the measurements for a specific KPI.

The attribute performanceMetrics defines the performance metrics to be produced and the attribute granularityPeriod defines the granularity period to be applied.

All object instances below and including the instance name-containing the PerfMetricJob (base object instance) are scoped for performance metric production. Performance metrics are produced only on those object instances whose object class matches the object class associated to the performance metrics to be produced.

The optional attributes objectInstances and rootObjectInstances allow to restrict the scope. When the attribute objectInstances is present, only the object instances identified by this attribute are scoped. When the attribute rootObjectInstances is present, then the subtrees whose root objects are identified by this attribute are scoped. Both attributes may be present at the same time meaning the total scope is equal to the sum of both scopes. Object instances may be scoped by both the objectInstances and rootObjectInstances attributes. This shall not be considered as an error by the MnS producer.

When the performance metric requires performance metric production on multiple managed objects, which is for example the case for KPIs, the MnS consumer needs to ensure all required objects are scoped. Otherwise a PerfMetricJob creation request shall fail.

The attribute reportingCtrl specifies the method and associated control parameters for reporting the produced measurements to MnS consumers. Three methods are available: file-based reporting with selection of the file location by the MnS producer, file-based reporting with selection of the file location by the MnS consumer and stream-based reporting.

For file-based reporting, all performance metrics that are produced related to a "PerfMetricJob" instance for a reporting period shall be stored in a single reporting file.

When the administrative state is set to "UNLOCKED" after the creation of a "PerfMetricJob" the first granularity period shall start. When the administrative state is set to "LOCKED" or the operational state to "DISABLED", the ongoing reporting period shall be aborted, for streaming the ongoing granularity period. When the administrative state is set back to "UNLOCKED" or the operational state to "ENABLED" a new reporting period shall start, in case of streaming a new granularity period.



Changes of all other configurable attributes shall take effect only at the beginning of the next reporting period, for streaming at the beginning of the next granularity period.

When the "PerfMetricJob" is deleted, the ongoing reporting period shall be aborted, for streaming the ongoing granularity period.

A PerfMetricJob creation request shall be rejected, if the requested performance metrics, the requested granularity period, the requested reporting method, or the requested combination thereof is not supported by the MnS producer.

Creation and deletion of PerfMetricJob instances by MnS consumers is optional; when not supported, PerfMetricJob instances may be created and deleted by the system or be pre-installed.

When the file retrieval NRM fragment is supported by the MnS producer, the "\_linkToFiles" attribute shall be supported, for details on the usage of this attribute see the definition of the file retrieval NRM fragment.

#### 4.3.31.2 Attributes

The PerfMetricJob IOC includes attributes inherited from Top IOC (defined in clause 4.3.29) and the following attributes:

Attribute name	S	isReadable	isWritable	isInvariant	isNotifiable
administrativeState	M	T	T	F	T
operationalState	M	T	F	F	T
jobId	M	T	T	T	T
performanceMetrics	M	T	T	F	T
granularityPeriod	M	T	T	F	T
objectInstances	O	T	T	F	T
rootObjectInstances	O	T	T	F	T
reportingCtrl	M	T	T	F	T
_linkToFiles	CO	T	F	T	F

#### 4.3.31.3 Attribute constraints

Name	Definition
_linkToFiles	This attribute should be supported, when the MnS producer supports the file retrieval NRM fragment.

#### 4.3.31.4 Notifications

The common notifications defined in clause 4.5 are valid for this IOC. In addition, the following set of notifications is also valid.

Name	S	Notes
notifyFileReady	M	--
notifyFilePreparationError	M	--

### 4.3.32 SupportedPerfMetricGroup <<dataType>>

#### 4.3.32.1 Definition

This <<dataType>> captures a group of supported performance metrics, and associated (production and monitoring) granularity periods and reporting methods that are supported for the specified performance metric group.



#### 4.3.32.2 Attributes

Attribute name	S	isReadable	isWritable	isInvariant	isNotifiable
performanceMetrics	M	T	F	F	T
granularityPeriods	M	T	F	F	T
reportingMethods	M	T	F	F	T
monitorGranularityPeriods	M	T	F	F	T

#### 4.3.32.3 Attribute constraints

None

#### 4.3.32.4 Notifications

Not applicable.

### 4.3.33 ReportingCtrl <<choice>>

#### 4.3.33.1 Definition

This <<choice>> defines the method for reporting collected performance metrics to MnS consumers as well as the parameters for configuring the reporting function. It is a choice between the control parameter required for the reporting methods, whose presence selects the reporting method as follows:

When only the `fileReportingPeriod` attribute is present, the MnS producer shall store files on the MnS producer at a location selected by the MnS producer and, on condition that an appropriate subscription is in place, inform the MnS consumer about the availability of new files and the file location using the `notifyFileReady` notification. In case the preparation of a file fails, "notifyFilePreparationError" shall be sent instead.

When only the `fileReportingPeriod` and `fileLocation` attributes are present, the MnS producer shall store the files on a MnS consumer, that can be any entity such as a file server, at the location specified by `fileLocation`. No notification is emitted by the MnS producer.

When only the `streamTarget` attribute is present, the MnS producer shall stream the data to the location specified by `streamTarget`.

For the file-based reporting methods the `fileReportingPeriod` attribute specifies the time window during which collected measurements are stored into the same file before the file is closed and a new file is opened.

#### 4.3.33.2 Attributes

Attribute name	S	isReadable	isWritable	isInvariant	isNotifiable
CHOICE_1.1 <code>fileReportingPeriod</code>	CM	T	T	F	T
CHOICE_2.1 <code>fileReportingPeriod</code>	CM	T	T	F	T
CHOICE_2.2 <code>fileLocation</code>	CM	T	T	F	T
CHOICE_3.1 <code>streamTarget</code>	CM	T	T	F	T

#### 4.3.33.3 Attribute constraints

Name	Definition
CHOICE_1.1 <code>fileReportingPeriod</code>	This attribute shall be supported, when the MnS producer supports file based reporting and storing files on the MnS producer.
CHOICE_2.1 <code>fileReportingPeriod</code> CHOICE_2.2 <code>fileLocation</code>	These attributes shall be supported, when MnS producer supports file based reporting and storing files on a MnS consumer.
CHOICE_3.1 <code>streamTarget</code>	This attribute shall be supported, when the MnS producer supports stream-based reporting.



#### 4.3.33.4 Notifications

The subclause 4.5 of the <<IOC>> using this <<dataType>> as one of its attributes, shall be applicable.

### 4.3.34 ThresholdInfo <<dataType>>

#### 4.3.34.1 Definition

This data type defines a single threshold level.

#### 4.3.34.2 Attributes

Attribute name	S	isReadable	isWritable	isInvariant	isNotifiable
performanceMetrics	M	T	T	F	T
thresholdDirection	M	T	T	F	T
thresholdValue	M	T	T	F	T
hysteresis	O	T	T	F	T

#### 4.3.34.3 Attribute constraints

None

#### 4.3.34.4 Notifications

The subclause 4.5 of the <<IOC>> using this <<dataType>> as one of its attributes, shall be applicable.

### 4.3.35 TraceReference <<dataType>>

#### 4.3.35.1 Definition

This <<dataType>> defines a globally unique identifier, which uniquely identifies the Trace Session that is created by the TraceJob. It is composed of the MCC, MNC (resulting in PLMN identifier) and the trace identifier.

#### 4.3.35.2 Attributes

Attribute name	S	isReadable	isWritable	isInvariant	isNotifiable
mcc	M	T	T	T	N/A
mnc	M	T	T	T	N/A
traceId	M	T	T	T	N/A

### 4.3.36 AreaConfig <<dataType>>

#### 4.3.36.1 Definition

This <<dataType>> defines the area for which measurement logging should be performed. It is described by a list of cells and a list of frequencies.

#### 4.3.36.2 Attributes

Attribute name	S	isReadable	isWritable	isInvariant	isNotifiable
freqInfo	M	T	T	F	T
pciList	M	T	T	F	T



### 4.3.37 FreqInfo <<dataType>>

#### 4.3.37.1 Definition

This <<dataType>> defines the RF reference frequency and the frequency operating bands used in a cell for a given direction (UL or DL) in FDD or for both UL and DL directions in TDD.

#### 4.3.37.2 Attributes

Attribute name	S	isReadable	isWritable	isInvariant	isNotifiable
arfcn	M	T	T	F	T
freqBands	M	T	T	F	T

### 4.3.38 AreaScope <<dataType>>

#### 4.3.38.1 Definition

This <<dataType>> defines the area scope of MDT.

The Area Scope parameter in LTE and NR is either:

- list of Cells, identified by E-UTRAN-CGI or NG-RAN CGI. Maximum 32 CGI can be defined.
- list of Tracking Area, identified by TAC. Maximum of 8 TAC can be defined.
- list of Tracking Area Identity, identified by TAC with associated plmn-Identity perTAC-List containing the PLMN identity for each TAC. Maximum of 8 TAI can be defined.

#### 4.3.38.2 Attributes

Attribute name	S	isReadable	isWritable	isInvariant	isNotifiable
choice					
> eutraCellIdList	O	T	T	F	T
> nrCellIdList	O	T	T	F	T
> tacList	O	T	T	F	T
> taiList	O	T	T	F	T

### 4.3.39 Tai <<dataType>>

#### 4.3.39.1 Definition

This <<dataType>> defines a Tracking Area Identity (TAI) as specified in clause 28.6 of TS 23.003 [5], clause 8.2 of TS 38.300 [33] and clause 9.3.3.11 of TS 38.413 [34]. It is composed of the PLMN identifier (PLMN-Id, which is composed of the MCC and MNC) and the Tracking Area Code (TAC).

#### 4.3.39.2 Attributes

Attribute name	S	isReadable	isWritable	isInvariant	isNotifiable
mcc	M	T	T	T	N/A
mnc	M	T	T	T	N/A
tac	M	T	T	T	N/A



## 4.3.40 MbsfnArea <<dataType>>

### 4.3.40.1 Definition

This <<dataType>> defines a MBSFN area. It is composed of the MBSFN Area identifier and the carrier frequency (EARFCN).

### 4.3.40.2 Attributes

Attribute name	S	isReadable	isWritable	isInvariant	isNotifiable
mbsfnAreald	M	T	T	F	T
earfcn	M	T	T	F	T

## 4.3.41 MnsRegistry

### 4.3.41.1 Definition

This IOC is a container for MnsInfo IOC-s. It can be contained only by SubNetwork IOC. A SubNetwork IOC can contain only one instance of MnsRegistry.

The IOC is instantiated by the system.

### 4.3.41.2 Attributes

The MnsRegistry IOC includes the attributes inherited from Top IOC (defined in clause 4.3.29).

### 4.3.41.3 Attribute constraints

None.

### 4.3.41.4 Notifications

None.

## 4.3.42 MnsInfo

### 4.3.42.1 Definition

This IOC represents an available Management Service (MnS) and provides the data required to support its discovery. It is name-contained by MnsRegistry.

This information is used by the consumer to discover the producers of specific Management Services and to derive the addresses of the Management Service.

Attributes mnsLabel, mnsType, and mnsVersion are used to describe the Management Service.

Attribute mnsAddress is used to provide addressing information for the Management Service operations.

Attribute mnsScope is used to provide information about the management scope of the Management Service. The management scope is defined as the set of managed object instances that can be accessed using the Management Service.

### 4.3.42.2 Attributes

The MnsInfo IOC includes the attributes inherited from Top IOC (defined in clause 4.3.29) and the following attributes:



Attribute name	S	isReadable	isWritable	isInvariant	isNotifiable
mnsLabel	M	T	F	F	T
mnsType	M	T	F	F	T
mnsVersion	M	T	F	F	T
mnsAddress	M	T	F	F	T
mnsScope	M	T	F	F	T

### 4.3.43 ProcessMonitor <<DataType>>

#### 4.3.43.1 Definition

This data type provides attributes to monitor the progress of processes with specific purpose and limited lifetime running on MnS producers. It may be used as data type for dedicated progress monitor attributes when specifying the management representation of these processes. The attributes in this clause are defined in a generic way. For some attributes specialisations may be provided when specifying a concrete process representation.

If a management operation on some IOCs triggers an associated asynchronous process (whose progress shall be monitored), this should also result in creating an attribute named "processMonitor" (of type "ProcessMonitor") in these IOC(s). The processMonitor attribute may be accompanied by use-case specific additional data items.

The progress of the process is described by the "status" and "progressPercentage" attributes. Additional textual qualifications for the "status" attribute may be provided by the "progressStateInfo" and "resultStateInfo" attributes.

When the process is instantiated, the "status" is set to "NOT\_RUNNING" and the "progressPercentage" to "0". The MnS producer decides when to start executing the process and to transition into the "RUNNING" state. This time is captured in the "startTime" attribute. Alternatively, the process may start to execute directly upon its instantiation. One alternative must be selected when using this data type.

During the "RUNNING" state the "progressPercentage" attribute may be repeatedly updated. The exact semantic of this attribute is subject to further specialisation. The "progressInfo" attribute may be used to provide additional textual information in the "NOT\_RUNNING", "CANCELLING" and "RUNNING" states. Further specialisation of "progressStateInfo" may be provided where this data type is used.

Upon successful completion of the process, the "status" attribute is set to "FINISHED", the "progressPercentage" to 100%. The time is captured in the "endTime" attribute. Additional textual information may be provided in the "resultStateInfo" attribute. The type of "resultStateInfo" in this data type definition is "String". Further specialisation of "resultStateInfo" may be provided where this data type is used.

In case the process fails to complete successfully, the "status" attribute is set to "FAILED" or "PARTIALLY\_FAILED", the current value of "progressPercentage" is frozen, and the time captured in "endTime". The "resultStateInfo" specifies the reason for the failure. Specific failure reasons may be specified where the data type defined in this clause is used. The exact semantic of failure may be subject for further specialisation as well.

In case the process is cancelled, the "status" attribute is first set to "CANCELLING" and when the process is really cancelled then to "CANCELLED". The transition to "CANCELLED" is captured in the "endTime" attribute. The value of "progressPercentage" is frozen. Additional textual information may be provided in the "resultStateInfo" attribute.

The "resultStateInfo" attribute is provided only for additional textual qualification of the states "FINISHED", "FAILED", "PARTIALLY\_FAILED" or "CANCELLED". It shall not be used for making the outcome, that the process may produce in case of success, available.

The process may have to be completed within a certain time after its creation, for example because required data may not be available any more after a certain time, or the process outcome is needed until a certain time and when not provided by this time is not needed any more. The time until the MnS producer automatically cancels the process is indicated by the "timer" attribute.



#### 4.3.43.2 Attributes

Attribute name	S	isReadable	isWritable	isInvariant	isNotifiable
id	M	T	F	F	T
status	M	T	F	F	T
progressPercentage	O	T	F	F	T
progressStateInfo	O	T	F	F	T
resultStateInfo	O	T	F	F	T
startTime	O	T	F	F	T
endTime	O	T	F	F	T
timer	O	T	T	F	F

#### 4.3.44 Files

##### 4.3.44.1 Definition

This IOC represents a collection of files. It can be name-contained by "SubNetwork", "ManagedElement", "PerfMetricJob" or "TraceJob". The "Files" object name-contains "File" objects, that represent the files of the collection. File collections allow to structure related files under a common root.

Instances of "Files" are created by MnS producers. They shall be created at latest when the first file of the collection becomes available for retrieval by MnS consumers.

The attributes of "Files" represent properties of the file collection and not properties of individual files.

When the file retrieval NRM fragment is used together with a data collection job ("PerfMetricJob" or "TraceJob") the following provisions shall apply:

- The "Files" object shall be created at the same time as the object representing the data collection job.
- The attributes "jobRef" and "jobId" shall be supported and present in a "Files" instance. They shall identify the job that the files in the file collection relate to.
- A "Files" instance shall contain files related to one and only one job.
- The files produced by one job shall be contained in one and only one "Files" instance.
- The job object shall support an attribute with a link to the created "Files" instance ("\_linkToFiles").
- The attribute "\_linkToFiles" shall be returned in the job creation response, if the stage 3 protocol supports returning attributes in an object creation response.
- The MnS producer decides where to name-contain the "Files" instance related to a job.

The attribute "\_linkToFiles" allows a MnS consumer to create simple and targeted subscriptions for "notifyFileReady", "notifyFilePreparationError" and "notifyFileDeletion", or "notifyMOICreation", "notifyFilePreparationError" and "notifyFileDeletion" related to "File" instances created or deleted under the "Files" instance of a specific job. The subscription needs to scope simply objects one level below the "Files" object.

In addition, the attribute "\_linkToFiles" allows for simple deployments not relying on notifications for reporting the availability of new files, where the MnS consumer polls regularly for new files under "Files".

##### 4.3.44.2 Attributes

Attribute name	S	isReadable	isWritable	isInvariant	isNotifiable
numberOfFiles	M	T	F	F	F
<b>Attributes related to roles</b>					
jobRef	CM	T	F	T	F
jobId	CM	T	F	T	F



#### 4.3.44.3 Attribute constraints

Name	Definition
jobRef Support Qualifier	Condition: This attribute shall be supported when "PerfMetricJob" or "TraceJob" are supported.
jobId Support Qualifier	Condition: This attribute shall be supported when "PerfMetricJob" or "TraceJob" are supported.

#### 4.3.44.4 Notifications

The common notifications defined in clause 4.5 are valid for this IOC, without exceptions or additions.

### 4.3.45 File

#### 4.3.45.1 Definition

This IOC represents a file. It is name-contained by "Files".

When a file becomes available on a MnS producer for retrieval by a MnS consumer, the MnS producer shall create a "File" instance representing that file.

The time of creation shall be captured by the MnS producer in the "fileReadyTime" attribute. The MnS producer shall keep the file at least until the time specified by "fileExpirationTime". After that time the MnS producer may delete the "File" instance. The "fileExpirationTime" is determined by the MnS producer based on considerations such as available storage space or file retention policies.

The attributes "fileSize", "fileCompression", "fileDataType" and "fileFormat" describe the file properties.

The "fileLocation" attribute indicates the address where the file can be retrieved. The address includes the file transfer protocol (schema). Allowed file transfer protocols are "sftp", "ftpes" and "https".

The value of "fileLocation" can be identical to or different from the address of the "File" instance. The attribute "fileContent" is provided for retrieving the actual file content. When identifying in the Read request a "File" instance and specifying only the "fileContent" attribute be returned, then only the file content shall be returned in the response. Note, as usual, multiple attributes can be specified to be returned, so that the file content together with some or all file meta data attributes can be returned in response to a single request.

In case the "fileLocation" specifies a location different than the "File" object location, then the attribute "fileContent" cannot be used for retrieving the file content. For example, the "File" object location may be given by

"https://companyA.com/ManagedElement=1/Files=1/File=1

and the value of the "fileLocation" attribute by

"sftp://companyA.com/datastore/fileName.xml"

In this case the file needs to be retrieved using "sftp" from "sftp://companyA.com/datastore/fileName.xml". Attempts to read the "fileContent" attribute shall return an error.

When the file retrieval NRM fragment is used together with a data collection job ("PerfMetricJob" or "TraceJob") the following provisions shall apply:

- The attributes "jobRef" and "jobId" shall be supported and present. They shall identify the job that the file is related to.

The attributes "jobRef" and "jobId" allow to set notification filters in the subscription in such a way that only "notifyMOICreation" and "notifyMOIDeletion" notifications are sent to subscribed MnS consumers if the created or deleted "File" instance represents data related to jobs the subscribed MnS consumer created or is interested in.

Upon creation of a "File" instance, a notification of type "notifyMOICreation" shall be emitted to subscribed MnS consumers as usual. For the case that the file contains performance metric data ("fileDataType" is "PERFORMANCE") the MnS producer shall emit either a notification of type "notifyMOICreation" or of type "notifyFileReady". The MnS consumer selects the notification type he wishes to receive with the subscription created on the MnS producer.



The "objectClass" and "objectInstance" parameters in the notification header of "notifyFileReady" shall identify the new "File" instance, instead of the related "PerfMetricJob", "TraceJob", "ManagedElement" or "ManagementNode" as described in 3GPP TS 28.532 [27], clause 11.6.1.1.1 for the case that "notifyFileReady" is used as part of the file data reporting MnS.

The notification "notifyFilePreparationError" shall be supported as well by the "File" object. It shall be sent when an error occurs during the preparation of the file. No "notifyFileReady" or "notifMOICreation" shall be sent in that case. The "objectClass" and "objectInstance" parameters of the notification header shall identify the new "File" instance representing the corrupted file, instead of the related "PerfMetricJob", "TraceJob", "ManagedElement" or "ManagementNode" as described in 3GPP TS 28.532 [27], clause 11.6.1.1.1 for the case that "notifyFilePreparationError" is used as part of the file data reporting MnS. When the file is not created at all or deleted, the "objectClass" and "objectInstance" parameters of the notification header are populated as described in 3GPP TS 28.532 [27], clause 11.6.1.1.1. Note that to receive "notifyFilePreparationError" in that case the notification subscription needs to include these objects in its scope.

#### 4.3.45.2 Attributes

Attribute name	S	isReadable	isWritable	isInvariant	isNotifyable
fileLocation	M	T	F	T	F
fileCompression	M	T	F	T	F
fileSize	O	T	F	T	F
fileDataType	O	T	F	T	F
fileFormat	O	T	F	T	F
fileReadyTime	O	T	F	T	F
fileExpirationTime	O	T	F	T	F
fileContent	M	T	F	T	F
<b>Attributes related to roles</b>					
jobRef	CM	T	F	T	F
jobId	CM	T	F	T	F

#### 4.3.45.3 Attribute constraints

Name	Definition
jobRef Support Qualifier	Condition: This attribute shall be supported when "PerfMetricJob" or "TraceJob" are supported.
jobId Support Qualifier	Condition: This attribute shall be supported when "PerfMetricJob" or "TraceJob" are supported.

#### 4.3.45.4 Notifications

The common notifications defined in clause 4.5 are valid for this IOC. In addition, the following set of notifications is also valid.

Name	S	Notes
notifyFileReady	M	
notifyFilePreparationError	M	

### 4.3.46 FileDownloadJob

#### 4.3.46.1 Definition

The "FileDownloadJob" represents a job on a MnS producer that downloads a file to the MnS producer. It can be name-contained by "ManagedElement" or "SubNetwork".

A "FileDownloadJob" is created by a MnS consumer to request that the MnS producer download a file from a specified location. The creation request contains the information required by the MnS producer to download the file, namely the attribute "fileLocation".



The creation request may contain as well a "notificationRecipientAddress". If present, this attribute instructs the MnS producer to create, on behalf of the MnS consumer, a subscription for attribute value change notifications of the new "FileDownloadJob" (implicit notification subscription). In case the MnS producer supports the notification type "notifyMOIChanges", the created subscription shall be for this type, otherwise for "notifyMOIAttributeValueChanges". The MnS consumer needs to be prepared to receive either of them. The "notificationRecipientAddress" attribute of the created "NtfSubscriptionControl" object shall be set to the value of the "notificationRecipientAddress" in the "FileDownloadJob" creation request.

The "jobMonitor" attribute represents the status of a file download job and includes information the MnS consumer can use to monitor the progress and result of the file download job. The data type of this attribute is "ProcessMonitor". The following specialisations are provided for this data type for the file download job:

- The "status" attribute values are "NOT\_STARTED", "RUNNING", "CANCELLING", "FINISHED", "FAILED" and "CANCELLED". The values "SUSPENDED" and "PARTIALLY\_FAILED" are not used.
- The MnS consumer can set the value of the "timer" attribute to specify the time by which the file download is expected to complete, i.e. to indicate how long the file is available for download. If the timer expires before the MnS producer has finished the job the "status" is set to "FAILED" and "resultStateInfo" is set to "TIMER\_EXPIRED".
- The "progressPercentage" attribute indicates how much percent of the file is already downloaded as measured by downloaded bytes from total file size in bytes.
- No specialisations are provided for the "progressStateInfo" attribute. Vendor specific information may be provided though.
- For the case that the "status" is equal to "FAILED" the "resultStateInfo" attribute shall indicate one of the following failure reasons: "UNKNOWN", "NO\_STORAGE", "LOW\_MEMROY", "NO\_CONNECTION\_TO\_REMOTE\_SERVER", "FILE\_NOT\_AVAILABLE", "DNS\_CANNOT\_BE\_RESOLVED", "TIMER\_EXPIRED", "OTHER".
- For the case that the "status" is equal to "FINISHED" or "CANCELLED" no specialisations are provided for the "resultStateInfo" attribute. Vendor specific information may be provided though.

Once the job is complete with "jobStatus" equal to "FINISHED", "CANCELLED", or "FAILED" the MnS consumer shall delete the "FileDownloadJob". The MnS producer may also delete the "FileDownloadJob".

#### 4.3.46.2 Attributes

Attribute name	S	isReadable	isWritable	isInvariant	isNotifiable
fileLocation	M	T	T	T	F
notificationRecipientAddress	O	T	T	T	F
cancelJob	M	T	T	F	T
jobMonitor	M	T	T	F	T

#### 4.3.46.3 Attribute constraints

None.

#### 4.3.46.4 Notifications

The common notifications defined in clause 4.5 are valid for this IOC, without exceptions or additions.

#### 4.3.42.3 Attribute constraints

None.



#### 4.3.42.4 Notifications

The configuration notifications defined in clause 4.5.2 are valid for this IOC.



## 4.4 Attribute definitions

### 4.4.1 Attribute properties

The following table defines the properties of attributes specified in the present document.



Attribute Name	Documentation and Allowed Values	Properties
numberOfFiles	Number of files in a file collection.  allowedValues: NA	Type: Integer multiplicity: 1 isOrdered: N/A isUnique: N/A defaultValue: None isNullable: False
fileLocation	Location of the file incl. the file transfer protocol, and the file name for the case the file content cannot be retrieved by reading the "fileContent" attribute.  The allowed file transfer protocols are: - sftp - ftpes - https  Examples: "sftp://companyA.com/datastore/fileName.xml", "https://companyA.com/ManagedElement=1/Files=1/File=1"  allowedValues: NA	Type: String multiplicity: 1 isOrdered: N/A isUnique: N/A defaultValue: None isNullable: False
fileCompression	Name of the algorithm used for compressing the file. An empty or absent "fileCompression" parameter indicates the file is not compressed. The MnS producer selects the compression algorithm. It is encouraged to use popular algorithms such as GZIP.  allowedValues: N/A	Type: String multiplicity: 1 isOrdered: N/A isUnique: N/A defaultValue: None isNullable: False
fileSize	Size of the file.  Unit is byte.  allowedValues: non-negative integers	Type: Integer multiplicity: 1 isOrdered: N/A isUnique: N/A defaultValue: None isNullable: False
fileDataType	Type of the management data stored in the file.  AllowedValues : - "PERFORMANCE" - "TRACE" - "ANALYTICS" - "PROPRIETARY"  The value "PERFORMANCE" refers to measurements and KPIs.	Type: ENUM multiplicity: 1 isOrdered: N/A isUnique: N/A defaultValue: None isNullable: False
fileFormat	Identifier of the XML or ASN.1 schema (incl. its version) used to produce the file content.  allowedValues: N/A	Type: String multiplicity: 1 isOrdered: N/A isUnique: N/A defaultValue: None isNullable: False
fileReadyTime	Date and time, when the file was closed (the last time) and made available on the MnS producer. The file content will not be changed anymore.  allowedValues: N/A	Type: DateTime multiplicity: 1 isOrdered: N/A isUnique: N/A defaultValue: None isNullable: False
fileExpirationTime	Date and time after which the file may be deleted.  allowedValues: N/A	Type: DateTime multiplicity: 1 isOrdered: N/A isUnique: N/A defaultValue: None isNullable: False
fileContent	File content.  allowedValues: N/A	Type: String multiplicity: 1 isOrdered: N/A isUnique: N/A defaultValue: None isNullable: False



Attribute Name	Documentation and Allowed Values	Properties
jobMonitor	Provides monitoring for the file download job. The data type of this attribute is the "ProcessMonitor" as defined in clause 4.3.43 with the specialisations defined in clause 4.3.44.1.  allowedValues: N/A	Type: JobMonitor multiplicity: 1 isOrdered: N/A isUnique: N/A defaultValue: None isNullable: False
cancelJob	Setting this attribute to "TRUE" cancels the file download job. As specified in the definition of "ProcessMonitor", cancellation is possible in the "NOT_STARTED" and "RUNNING" state. Setting the attribute to "FALSE" has no observable result.  allowedValues: TRUE, FALSE	Type: ENUM multiplicity: 0..1 isOrdered: N/A isUnique: N/A defaultValue: FALSE isNullable: False
FileDownloadJob.jobMonitor.resultStateInfo	Provides the following specialisation for the "resultStateInfo" attribute of the "ProcessMonitor" data type for the "FileDownloadJob".  In the event the file download fails, and the "status" is equal to "FAILED", it provides the reason for the failure.  allowedValues for "status" = "FAILED": - NULL - UNKNOWN - NO_STORAGE - LOW_MEMORY - NO_CONNECTION_TO_REMOTE_SERVER - FILE_NOT_AVAILABLE - DNS_CANNOT_BE_RESOLVED - TIMER_EXPIRED - OTHER  The allowed values for "FINISHED" or "CANCELLED" are vendor specific.	Type: String multiplicity: 0..1 isOrdered: N/A isUnique: N/A defaultValue: None isNullable: False
heartbeatNtfPeriod	Periodicity of the heartbeat notification emission. The value of zero has the special meaning of stopping the heartbeat notification emission.  Unit is in seconds.  AllowedValues: non-negative integers	type: Integer multiplicity: 1 isOrdered: N/A isUnique: N/A defaultValue: 0 isNullable: False
triggerHeartbeatNtf	Setting this attribute to TRUE triggers an immediate additional heartbeat notification emission. Setting the value to FALSE has no observable result.  The periodicity of notifyHeartbeat emission is not changed.  AllowedValues: TRUE, FALSE	type: ENUM multiplicity: 1 isOrdered: N/A isUnique: N/A defaultValue: FALSE isNullable: False
notificationRecipientAddress	Address of the notification recipient.  allowedValues: N/A	type: String multiplicity: 1 isOrdered: N/A isUnique: N/A defaultValue: None isNullable: False



Attribute Name	Documentation and Allowed Values	Properties
notificationTypes	<p>Notification types of notifications that are candidates for being forwarding to the notification recipient. If this attribute is absent, notifications of all types are candidates for being forwarding to the notification recipient.</p> <p>If the <code>notificationFilter</code> attribute is absent, all candidate notifications are forwarded to the notification recipient, otherwise the candidate notifications are discriminated by the filter specified by the <code>notificationFilter</code> attribute.</p> <p>Below is a list of <code>notificationType</code> values that are defined in 3GPP specifications. If the <code>notificationType</code> itself is supported by the system, it shall be supported in the <code>NtfSubscriptionControl.notificationTypes</code> attribute as well. Other <code>notificationTypes</code> defined by SDOs or enterprises may also be supported.</p> <p>AllowedValues:</p> <ul style="list-style-type: none"> <li>- <code>notifyMOICreation</code></li> <li>- <code>notifyMOIDeletion</code></li> <li>- <code>notifyMOIAttributeValueChanges</code></li> <li>- <code>notifyMOIChanges</code></li> <li>- <code>notifyEvent</code></li> <li>- <code>notifyNewAlarm</code></li> <li>- <code>notifyChangedAlarm</code></li> <li>- <code>notifyAckStateChanged</code></li> <li>- <code>notifyComments</code></li> <li>- <code>notifyCorrelatedNotificationChanged</code></li> <li>- <code>notifyChangedAlarmGeneral</code></li> <li>- <code>notifyClearedAlarm</code></li> <li>- <code>notifyAlarmListRebuilt</code></li> <li>- <code>notifyPotentialFaultyAlarmList</code></li> <li>- <code>notifyFileReady</code></li> <li>- <code>notifyFilePreparationError</code></li> <li>- <code>notifyThresholdCrossing</code></li> </ul>	<p>type: ENUM</p> <p>multiplicity: *</p> <p>isOrdered: False</p> <p>isUnique: True</p> <p>defaultValue: None</p> <p>isNullable: False</p>
notificationFilter	<p>Filter to be applied to candidate notifications identified by the <code>notificationTypes</code> attribute. Only notifications that pass the filter criteria are forwarded to the notification recipient. All other notifications are discarded.</p> <p>The filter can be applied to any field of a notification.</p> <p>allowedValues: N/A</p>	<p>type: String</p> <p>multiplicity: 0..1</p> <p>isOrdered: N/A</p> <p>isUnique: N/A</p> <p>defaultValue: None</p> <p>isNullable: False</p>
scope	<p>Scopes the managed object instances included in the notification subscription. If this attribute is absent, all objects below and including the base object are scoped.</p> <p>allowedValues: N/A</p>	<p>type: Scope</p> <p>multiplicity: 0..1</p> <p>isOrdered: N/A</p> <p>isUnique: N/A</p> <p>defaultValue: None</p> <p>isNullable: False</p>



Attribute Name	Documentation and Allowed Values	Properties
scopeType	<p>If the optional <code>scopeLevel</code> attribute is not supported or absent, allowed values of <code>scopeType</code> are <code>BASE_ONLY</code> and <code>BASE_ALL</code>.</p> <p>The value <code>BASE_ONLY</code> indicates only the base object is selected.</p> <p>The value <code>BASE_ALL</code> indicates the base object and all of its subordinate objects (incl. the leaf objects) are selected.</p> <p>If the <code>scopeLevel</code> attribute is supported and present, allowed values of <code>scopeType</code> are <code>BASE_NTH_LEVEL</code> and <code>BASE_SUBTREE</code>.</p> <p>The value <code>BASE_NTH_LEVEL</code> indicates all objects on the level, which is specified by the <code>scopeLevel</code> attribute, below the base object are selected. The base object is at <code>scopeLevel</code> zero.</p> <p>The value <code>BASE_SUBTREE</code> indicates the base object and all subordinate objects down to and including the objects on the level, which is specified by the <code>scopeLevel</code> attribute, are selected. The base object is at <code>scopeLevel</code> zero.</p> <p>allowedValues: N/A</p>	<p>type: ENUM</p> <p>multiplicity: 1</p> <p>isOrdered: N/A</p> <p>isUnique: N/A</p> <p>defaultValue: None</p> <p>isNullable: False</p>
scopeLevel	<p>See definition of <code>scopeType</code> attribute.</p> <p>allowedValues: N/A</p>	<p>type: Integer</p> <p>multiplicity: 1</p> <p>isOrdered: N/A</p> <p>isUnique: N/A</p> <p>defaultValue: None</p> <p>isNullable: False</p>
farEndEntity	<p>The value of this attribute shall be the Distinguished Name of the far end network entity to which the reference point is related. As an example, with <code>EP_Iucs</code>, if the instance of <code>EP_Iucs</code> is contained by one <code>RncFunction</code> instance, the <code>farEndEntity</code> is the Distinguished Name of the <code>MscServerFunction</code> instance to which this <code>Iucs</code> reference point is related.</p> <p>allowedValues: N/A</p>	<p>type: DN</p> <p>multiplicity: 0..1</p> <p>isOrdered: N/A</p> <p>isUnique: N/A</p> <p>defaultValue: None</p> <p>isNullable: False</p>
linkType	<p>This attribute defines the type of the link.</p> <p>allowedValues: Signalling, Bearer, OAM&amp;P, Other or multiple combinations of this type.</p>	<p>type: String</p> <p>multiplicity: 0..*</p> <p>isOrdered: False</p> <p>isUnique: True</p> <p>defaultValue: No</p> <p>isNullable: False</p>
locationName	<p>The physical location of this entity (e.g. an address).</p> <p>allowedValues: N/A</p>	<p>type: String</p> <p>multiplicity: 0..1</p> <p>isOrdered: N/A</p> <p>isUnique: N/A</p> <p>defaultValue: None</p> <p>isNullable: False</p>
monitorGranularityPeriod	<p>Granularity period used to monitor measurements for threshold crossings. The period is defined in seconds.</p> <p>See Note 5</p> <p>allowedValues: Integer with a minimum value of 1</p>	<p>type: Integer</p> <p>multiplicity: 1</p> <p>isOrdered: N/A</p> <p>isUnique: True</p> <p>defaultValue: None</p> <p>isNullable: False</p>
monitorGranularityPeriods	<p>Granularity periods supported for the monitoring of associated measurement types for thresholds. The period is defined in seconds.</p> <p>allowedValues: Integer with a minimum value of 1</p>	<p>type: Integer</p> <p>multiplicity: *</p> <p>isOrdered: False</p> <p>isUnique: True</p> <p>defaultValue: None</p> <p>isNullable: False</p>



Attribute Name	Documentation and Allowed Values	Properties
thresholdInfoList	List of threshold infos.	type: ThresholdInfo multiplicity: 1..* isOrdered: False isUnique: True defaultValue: None isNullable: False
thresholdValue	Value against which the monitored performance metric is compared at a threshold level in case the hysteresis is zero.  allowedValues: float or integer	type: Union multiplicity: 1 isOrdered: NA isUnique: NA defaultValue: None isNullable: False
hysteresis	Hysteresis of a threshold. If this attribute is present the monitored performance metric is not compared against the threshold value as specified by the <code>thresholdValue</code> attribute but against a high and low threshold value given by  $\text{highThresholdValue} = \text{thresholdValue} + \text{hysteresis}$ $\text{lowThresholdValue} = \text{thresholdValue} - \text{hysteresis}$  When going up, the threshold is triggered when the performance metric reaches or crosses the high threshold value. When going down, the threshold is triggered when the performance metric reaches or crosses the low threshold value.  A hysteresis may be present only when the monitored performance metric is not of type counter that can go up only. If present for a performance metric of type counter, it shall be ignored.  allowedValues: non-negative float or integer	type: Union multiplicity: 0..1 isOrdered: NA isUnique: NA defaultValue: None isNullable: False
thresholdDirection	Direction of a threshold indicating the direction for which a threshold crossing triggers a threshold.  When the threshold direction is configured to "UP", the associated threshold is triggered only when the performance metric value is going up upon reaching or crossing the threshold value. The threshold is not triggered, when the performance metric is going down upon reaching or crossing the threshold value.  Vice versa, when the threshold direction is configured to "DOWN", the associated threshold is triggered only when the performance metric is going down upon reaching or crossing the threshold value. The threshold is not triggered, when the performance metric is going up upon reaching or crossing the threshold value.  When the threshold direction is set to "UP_AND_DOWN" the threshold is active in both directions.  In case a threshold with hysteresis is configured, the threshold direction attribute shall be set to "UP_AND_DOWN".  allowedValues: - UP - DOWN - UP_AND_DOWN	type: ENUM multiplicity: 1 isOrdered: NA isUnique: NA defaultValue: None isNullable: False
objectClass	Class of a managed object instance.  allowedValues: N/A	type: String multiplicity: 1 isOrdered: N/A isUnique: N/A defaultValue: None isNullable: False



Attribute Name	Documentation and Allowed Values	Properties
objectInstance	Managed object instance identified by its DN.  allowedValues: N/A	type: String multiplicity: 1 isOrdered: N/A isUnique: N/A defaultValue: None isNullable: False
objectInstances	List of managed object instances. Each object instance is identified by its DN.  allowedValues: N/A	type: Dn multiplicity: * isOrdered: False isUnique: True defaultValue: None isNullable: False



<p>peeParametersList</p>	<p>This attribute contains the parameter list for the control and monitoring of power, energy and environmental parameters of ManagedFunction instance(s). This list contains the following parameters:</p> <ul style="list-style-type: none"> <li>- siteIdentification</li> <li>- siteLatitude (optional)</li> <li>- siteLongitude (optional)</li> <li>- siteAltitude (optional)</li> <li>- siteDescription</li> <li>- equipmentType</li> <li>- environmentType</li> <li>- powerInterface</li> </ul> <p>siteIdentification: The identification of the site where the ManagedFunction resides.</p> <p>allowedValues: N/A</p> <p>siteLatitude: The latitude of the site where the ManagedFunction instance resides, based on World Geodetic System (1984 version) global reference frame (WGS 84). Positive values correspond to the northern hemisphere. This attribute is optional for BTSFunction, RNCFunction, GNBDUFunction and NRSectorCarrier instance(s).</p> <p>allowedValues: -90.0000 to +90.0000</p> <p>siteLongitude: The longitude of the site where the ManagedFunction instance resides, based on World Geodetic System (1984 version) global reference frame (WGS 84). Positive values correspond to degrees east of 0 degrees longitude. This attribute is optional for BTSFunction, RNCFunction, GNBDUFunction and NRSectorCarrier instance(s).</p> <p>allowedValues: -180.0000 to +180.0000</p> <p>siteAltitude: The altitude of the site where the ManagedFunction instance resides, in unit of meter. This attribute is optional for BTSFunction, RNCFunction, GNBDUFunction and NRSectorCarrier instance(s).</p> <p>siteDescription: An operator defined description of the site where the ManagedFunction instance resides.</p> <p>allowedValues: N/A</p> <p>equipmentType: The type of equipment where the managedFunction instance resides.</p> <p>allowedValues: see clause 4.4.1 of ETSI ES 202 336-12 [18].</p> <p>environmentType: The type of environment where the managedFunction instance resides.</p> <p>allowedValues: see clause 4.4.1 of ETSI ES 202 336-12 [18].</p> <p>powerInterface: The type of power.</p> <p>allowedValues: see clause 4.4.1 of ETSI ES 202 336-12 [18].</p>	<p>type: String multiplicity: 0..* isOrdered: False isUnique: True defaultValue: None isNullable: True</p>
--------------------------	---	--



Attribute Name	Documentation and Allowed Values	Properties
priorityLabel	This is a label that consumer would assign a value on a concrete instance of the managed object. The management system takes the value of this attribute into account. The effect of this attribute value to the subject managed entity is not standardized	type: Integer multiplicity: 1 isOrdered: N/A isUnique: N/A defaultValue: None isNullable: False
protocolVersion	Versions(s) and additional descriptive information for the protocol(s) used for the associated communication link. Syntax and semantic is not specified.  allowedValues: N/A	type: String multiplicity: * isOrdered: False isUnique: True defaultValue: None isNullable: False
setOfMcc	Set of Mobile Country Code (MCC). The MCC uniquely identifies the country of domicile of the mobile subscriber. MCC is part of the IMSI (TS 23.003 [5])  This list contains all the MCC values in subordinate object instances to this <i>SubNetwork</i> instance.  allowedValues: See clause 2.3 of TS 23.003 [5] for MCC allocation principles.	type: Integer multiplicity: 1..* isOrdered: False isUnique: True defaultValue: No default value isNullable: False
swVersion	The software version of the <i>ManagementNode</i> or <i>ManagedElement</i> (this is used for determining which version of the vendor specific information is valid for the <i>ManagementNode</i> or <i>ManagedElement</i> ).  allowedValues: N/A	type: String multiplicity: 0..1 isOrdered: N/A isUnique: N/A defaultValue: None isNullable: False
systemDN	Distinguished Name (DN) of a <i>IRPAgent</i> or a <i>MnSAgent</i> .  allowedValues: N/A	type: DN multiplicity: 0..1 isOrdered: N/A isUnique: N/A defaultValue: None isNullable: False
userDefinedState	An operator defined state for operator specific usage.  allowedValues: N/A	type: String multiplicity: 0..1 isOrdered: N/A isUnique: N/A defaultValue: None isNullable: False
userLabel	A user-friendly (and user assignable) name of this object.  allowedValues: N/A	type: String multiplicity: 0..1 isOrdered: N/A isUnique: N/A defaultValue: None isNullable: False
vendorName	The name of the vendor.  allowedValues: N/A	type: String multiplicity: 0..1 isOrdered: N/A isUnique: N/A defaultValue: None isNullable: False



Attribute Name	Documentation and Allowed Values	Properties
vnfParametersList	<p>This attribute contains the parameter set of the VNF instance(s) corresponding to an NE. Each entry in the list contains:</p> <ul style="list-style-type: none"> <li>- vnfInstanceId</li> <li>- vnfdId (optional)</li> <li>- flavourId (optional)</li> <li>- autoScalable (optional)</li> </ul> <p>vnfInstanceId: VNF instance identifier (vnfInstanceId, see section 9.4.2 of [16] and section B2.4.2.1.2.3 of [17]).</p> <p>See Note 1.</p> <p>vnfdId: Identifier of the VNFD on which the VNF instance is based, see section 9.4.2 of [16]. This attribute is optional. Note: the value of this attribute is identical to that of the same attribute in clause 9.4.2 of ETSI GS NFV-IFA 008 [16].</p> <p>flavourId: Identifier of the VNF Deployment Flavour applied to this VNF instance, see section 9.4.3 of [16]. This attribute is optional. Note: the value of this attribute is identical to that of the same attribute in clause 9.4.3 of ETSI GS NFV-IFA 008 [16].</p> <p>autoScalable: Indicator of whether the auto-scaling of this VNF instance is enabled or disabled. The type is Boolean. This attribute is optional.</p> <p>See Note2.</p> <p>The presence of this attribute indicates that the ManagedFunction represented by the MOI is a virtualized function.</p> <p>See Note 3.</p> <p>allowedValues: N/A</p> <p>A string length of zero for vnfInstanceId means the VNF instance(s) corresponding to the MOI does not exist (e.g. has not been instantiated yet, has already been terminated).</p>	<p>type: String</p> <p>multiplicity: *</p> <p>isOrdered: False</p> <p>isUnique: True</p> <p>defaultValue: None</p> <p>isNullable: True</p>
vsData	<p>Vendor specific attributes of the type vsDataType. The attribute definitions including constraints (value ranges, data types, etc.) are specified in a vendor specific data format file.</p> <p>allowedValues: --</p>	<p>type: --</p> <p>multiplicity: --</p> <p>isOrdered: --</p> <p>isUnique: --</p> <p>defaultValue: --</p> <p>isNullable: False</p>
vsDataFormatVersion	<p>Name of the data format file, including version.</p> <p>allowedValues: N/A</p>	<p>type: String</p> <p>multiplicity: 1</p> <p>isOrdered: N/A</p> <p>isUnique: N/A</p> <p>defaultValue: None</p> <p>isNullable: False</p>
vsDataType	<p>Type of vendor specific data contained by this instance, e.g. relation specific algorithm parameters, cell specific parameters for power control or re-selection or a timer. The type itself is also vendor specific.</p> <p>allowedValues: N/A</p>	<p>type: String</p> <p>multiplicity: 1</p> <p>isOrdered: N/A</p> <p>isUnique: N/A</p> <p>defaultValue: None</p> <p>isNullable: False</p>



Attribute Name	Documentation and Allowed Values	Properties
supportedPerfMetricGroups	A set of performance metric groups. When this attribute is contained in a managed object it may define performance metrics for this object and all descendant objects.  allowedValues: N/A	type: SupportedPerfMetricGroup multiplicity: * isOrdered: False isUnique: True defaultValue: None allowedValues: N/A isNullable: False
performanceMetrics	List of performance metrics.  Performance metrics include measurements defined in TS 28.552 [20] and KPIs defined in TS 28.554 [28]. Performance metrics can also be specified by other SDOs, or be vendor specific. Performance metrics are identified with their names.  For measurements defined in TS 28.552 [20] the name is constructed as follows: <ul style="list-style-type: none"> <li>- "family.measurementName.subcounter" for measurement types with subcounters</li> <li>- "family.measurementName" for measurement types without subcounters</li> <li>- "family" for measurement families</li> </ul> For KPIs defined in TS 28.554 [28] the name is defined in the KPI definitions template as the component designated with e).  A name can also identify a vendor specific performance metric or a group of vendor specific performance metrics.  allowedValues: N/A	type: String multiplicity: * isOrdered: False isUnique: True defaultValue: None isNullable: False
rootObjectInstances	List of object instances. Each object instance is identified by its DN and designates the root of a subtree that contains the root object and all descendant objects.	type: Dn multiplicity: * isOrdered: False isUnique: True defaultValue: None isNullable: False
reportingMethods	List of reporting methods for performance metrics  allowedValues: <ul style="list-style-type: none"> <li>- "FILE_BASED_LOC_SET_BY_PRODUCER",</li> <li>- "FILE_BASED_LOC_SET_BY_CONSUMER",</li> <li>- "STREAM_BASED"</li> </ul>	type: ENUM multiplicity: * isOrdered: False isUnique: True defaultValue: None isNullable: False
nFServiceType	The parameter defines the type of the managed NF service instance  allowedValues: See clause 7.2 of TS 23.501[22]	type: ENUM multiplicity: 1 isOrdered: N/A isUnique: True defaultValue: None isNullable: False
operations	This parameter defines set of operations supported by the managed NF service instance.  allowedValues: See TS 23.502[23] for supporting operations	type: Operation multiplicity: 1..* isOrdered: False isUnique: True defaultValue: No default value isNullable: False
Operation.name	This parameter defines the name of the operation of the managed NF service instance.  allowedValues: N/A	type: String multiplicity: 1 isOrdered: False isUnique: False defaultValue: None isNullable: True



Attribute Name	Documentation and Allowed Values	Properties
allowedNFTypes	This parameter identifies the type of network functions allowed to access the operation of the managed NF service instance.  allowedValues: See TS 23.501[22] for NF types	type: ENUM multiplicity: 1..* isOrdered: False isUnique: True defaultValue: None isNullable: False
operationSemantics	This parameter identifies the semantics type of the operation. See TS 23.502[23]  allowedValues: "Request/Response", "Subscribe/Notify".	type: ENUM multiplicity: 1 isOrdered: N/A isUnique: N/A defaultValue: None isNullable: False
sAP	This parameter specifies the service access point of the managed NF service instance.  allowedValues: N/A	type: SAP multiplicity: 1 isOrdered: N/A isUnique: N/A defaultValue: None isNullable: False
host	This parameter specifies the host address of the managed NF service instance. It can be FQDN (See TS 23.003 [5]) or an IPv4 address (See RFC 791 [24]) or an IPv6 address (See RFC 2373 [25]).  allowedValues: N/A	type: String multiplicity: 1 isOrdered: False isUnique: N/A defaultValue: None isNullable: False
port	This parameter specifies the transport port of the managed NF service instance.  allowedValues: 1 - 65535	type: Integer multiplicity: 1 isOrdered: False isUnique: False defaultValue: None isNullable: False
usageState	Usage state of a managed object instance. It describes whether the resource is actively in use at a specific instant, and if so, whether or not it has spare capacity for additional users at that instant.  allowedValues: "IDLE", "ACTIVE", "BUSY". The meaning of these values is as defined in 3GPP TS 28.625 [21] and ITU-T X.731 [19].	type: ENUM multiplicity: 1 isOrdered: N/A isUnique: N/A defaultValue: None isNullable: False
registrationState	This parameter defines the registration status of the managed NF service instance.  allowedValues: "Registered", "Deregistered".	type: ENUM multiplicity: 1 isOrdered: N/A isUnique: N/A defaultValue: Deregistered isNullable: False
jobRef	Object instance of the "PerfMetricJob" or "TraceJob" that produced the file.  allowedValues: NA	Type: Dn multiplicity: 0..* isOrdered: N/A isUnique: N/A defaultValue: None isNullable: False
jobId	Identifier of a PerfMetricJob job or a TraceJob.	type: String multiplicity: 0..1 isOrdered: N/A isUnique: N/A defaultValue: None isNullable: False
granularityPeriod	Granularity period used to produce measurements. The period is defined in seconds.  See Note 4.  allowedValues: Integer with a minimum value of 1	type: Integer multiplicity: 1 isOrdered: N/A isUnique: N/A defaultValue: None isNullable: False



Attribute Name	Documentation and Allowed Values	Properties
granularityPeriods	Granularity periods supported for the production of associated measurement types. The period is defined in seconds.  allowedValues: Integer with a minimum value of 1	type: Integer multiplicity: * isOrdered: False isUnique: False defaultValue: None isNullable: False
reportingCtrl	Selecting the reporting method and defining associated control parameters.	type: ReportingCtrl multiplicity: 1 isOrdered: N/A isUnique: N/A defaultValue: None isNullable: False
fileReportingPeriod	For the file-based reporting method this is the time window during which collected measurements are stored into the same file before the file is closed and a new file is opened. The period is defined in minutes.  allowedValues: Multiples of granularityPeriod	type: Integer multiplicity: 1 isOrdered: N/A isUnique: N/A defaultValue: None isNullable: False
_linkToFiles	Link to a "Files" object.  allowedValues: N/A	type: String multiplicity: 1 isOrdered: N/A isUnique: N/A defaultValue: None isNullable: False
fileLocation	The location of a file.  allowedValues: File URI [See RFC 8089 [49]].	type: String multiplicity: 1 isOrdered: N/A isUnique: N/A defaultValue: None isNullable: True
streamTarget	The stream target for the stream-based reporting method.  allowedValues: N/A	type: String multiplicity: 1 isOrdered: N/A isUnique: N/A defaultValue: None isNullable: True
administrativeState	Administrative state of a managed object instance. The administrative state describes the permission to use or prohibition against using the object instance. The administrative state is set by the MnS consumer.  allowedValues: LOCKED, UNLOCKED.	type: ENUM multiplicity: 1 isOrdered: N/A isUnique: N/A defaultValue: LOCKED isNullable: False
operationalState	Operational state of managed object instance. The operational state describes if an object instance is operable ("ENABLED") or inoperable ("DISABLED"). This state is set by the object instance or the MnS producer and is hence READ-ONLY.  allowedValues: ENABLED, DISABLED.	type: ENUM multiplicity: 1 isOrdered: N/A isUnique: N/A defaultValue: DISABLED isNullable: False
alarmRecords	List of alarm records  allowedValues: N/A	type: AlarmRecord multiplicity: * isOrdered: N/A isUnique: True defaultValue: None isNullable: True
numOfAlarmRecords	Number of alarm records in the AlarmList.  allowedValues: 0 to x where x is vendor specific.	type: integer multiplicity: 1 isOrdered: N/A isUnique: N/A defaultValue: None isNullable: False
lastModification	Time an alarm record was modified the last time  allowedValues: N/A	type: DateTime multiplicity: 1 isOrdered: N/A isUnique: N/A defaultValue: None isNullable: False



Attribute Name	Documentation and Allowed Values	Properties
tjJobType	It specifies the MDT mode and it specifies also whether the TraceJob represents only MDT, Logged MBSFN MDT, Trace or a combined Trace and MDT job. The attribute is applicable for Trace, MDT, RCEF and RLF reporting. See the clause 5.9a of TS 32.422 [30] for additional details on the allowed values.	type: ENUM multiplicity: 1 isOrdered: N/A isUnique: N/A defaultValue: TRACE_ONLY isNullable: False
tjListOfInterfaces	It specifies the interfaces that need to be traced. The attribute is applicable only for Trace. In case this attribute is not used, it carries a null semantic. See the clause 5.5 of TS 32.422 [30] for additional details on the allowed values.	type: ENUM multiplicity: 1..* isOrdered: N/A isUnique: N/A defaultValue: No isNullable: True
tjListOfNeTypes	It specifies the network element types where the trace should be activated. The attribute is applicable only for Trace with Signalling Based Trace activation. In case this attribute is not used, it carries a null semantic. See the clause 5.4 of TS 32.422 [30] for additional details on the allowed values.	type: ENUM multiplicity: 1..* isOrdered: N/A isUnique: N/A defaultValue: No isNullable: True
tjPLMNTarget	It specifies which PLMN that the subscriber of the session to be recorded uses as selected PLMN. PLMN Target might differ from the PLMN specified in the Trace Reference. See the clause 5.9b of 3GPP TS 32.422 [30] for additional details on the allowed values.	type: PlmnId multiplicity: 1 isOrdered: N/A isUnique: True defaultValue: No isNullable: True
tjStreamingTraceConsumerURL	It specifies the Uniform Resource Identifier (URI) of the Streaming Trace data reporting MnS consumer (a.k.a. streaming target). See the clause 5.9 c of TS 32.422 [30] for additional details on the allowed values.	type: String multiplicity: 1 isOrdered: N/A isUnique: N/A defaultValue: No isNullable: True
tjTraceCollectionEntityAddress	It specifies the address of the Trace Collection Entity when the attribute tjTraceReportingFormat is configured for the file-based reporting. The attribute is applicable for both Trace and MDT. See the clause 5.9 of TS 32.422 [30] for additional details on the allowed values.	type: IPAddress multiplicity: 1 isOrdered: N/A isUnique: N/A defaultValue: No isNullable: True
tjTraceDepth	It specifies the trace depth. The attribute is applicable only for Trace. In case this attribute is not used, it carries a null semantic. See the clause 5.3 of 3GPP TS 32.422 [30] for additional details on the allowed values.	type: ENUM multiplicity: 1 isOrdered: N/A isUnique: N/A defaultValue: MAXIMUM isNullable: True
tjTraceReference	A globally unique identifier, which uniquely identifies the Trace Session that is created by the TraceJob. In case of shared network, it is the MCC and MNC of the Participating Operator that request the trace session that shall be provided. The attribute is applicable for both Trace and MDT. See the clause 5.6 of 3GPP TS 32.422 [30] for additional details on the allowed values.	type: TraceReference multiplicity: 1 isOrdered: N/A isUnique: True defaultValue: None isNullable: False
tjTraceRecordSessionReference	An identifier, which identifies the Trace Recording Session. The attribute is applicable for both Trace and MDT. See the clause 5.7 of 3GPP TS 32.422 [30] for additional details on the allowed values.	type: String multiplicity: 1 isOrdered: N/A isUnique: True defaultValue: None isNullable: False
tjTraceReportingFormat	It specifies the trace reporting format - streaming trace reporting or file-based trace reporting. See the clause 5.11 of 3GPP TS 32.422 [30] for additional details on the allowed values.	type: ENUM multiplicity: 1 isOrdered: N/A isUnique: N/A defaultValue: FILE isNullable: False



Attribute Name	Documentation and Allowed Values	Properties
tjTraceTarget	<p>It specifies the target object of the Trace and MDT. The attribute is applicable for both Trace and MDT. This attribute includes the ID type of the target as an enumeration and the ID value(s).</p> <p>The <code>tjTraceTarget</code> shall be "PUBLIC_ID" in case of a Management Based Activation is done to an SCSCFFunction (Serving Call Session Control Function) or PCSCFFunction (Proxy Call Session Control Function) (TS 28.705[44]). The <code>tjTraceTarget</code> shall be "UTRAN_CELL" only in case of the UTRAN cell traffic trace function.</p> <p>The <code>tjTraceTarget</code> shall be "E-UTRAN_CELL" only in case of E-UTRAN cell traffic trace function.</p> <p>The <code>tjTraceTarget</code> shall be "NG-RAN_CELL" only in case of NR cell traffic trace function.</p> <p>The <code>tjTraceTarget</code> shall be either "IMSI", "IMEI" or "IMEISV" if the Trace Session is activated to any of the following ManagedEntity(ies):</p> <ul style="list-style-type: none"> <li>- HSSFunction (Home Subscriber Server) (TS 28.705 [44])</li> <li>- MscServerFunction (Mobile Switching Centre Server) (TS 28.702 [45])</li> <li>- SgsnFunction (Serving GPRS Support Node) (TS 28.702[45])</li> <li>- GgsnFunction (Gateway GPRS Support Node) (TS 28.702[45])</li> <li>- BmcsFunction (Broadcast Multicast Service Centre) (TS 28.702[45])</li> <li>- RncFunction (Radio Network Controller) (TS 28.652[46])</li> <li>- MmeFunction (Mobility Management Entity) (TS 28.708[47])</li> <li>- ServingGWFunction (Serving Gateway) (TS 28.708[47])</li> <li>- PGWFunction (PDN Gateway) (TS 28.708[47]).</li> </ul> <p>The <code>tjTraceTarget</code> shall be either "SUPI" or "IMEISV" if the Trace Session is activated to any of the following ManagedEntity(ies) (TS 28.541[48]):</p> <ul style="list-style-type: none"> <li>- AFFunction</li> <li>- AMFFunction</li> <li>- AUSFunction</li> <li>- NEFFunction</li> <li>- NRFFunction</li> <li>- NSSFFunction</li> <li>- PCFFunction</li> <li>- SMFFunction</li> <li>- UPFFunction</li> <li>- UDMFunction</li> </ul> <p>In case of signalling based MDT, the <code>tjTraceTarget</code> attribute shall be able to carry "PUBLIC_ID", "IMSI", "IMEI", "IMEISV" or "SUPI".</p> <p>In case of management based Immediate MDT, the <code>tjTraceTarget</code> attribute shall be null value.</p> <p>In case of management based Logged MDT, the <code>tjTraceTarget</code> attribute shall carry an "eNB" or a "gNB" or an "RNC". The Logged MDT should be initiated on the specified eNB/gNB/RNC in <code>tjTraceTarget</code>.</p> <p>In case of RLF reporting, or RCEF reporting, the <code>tjTraceTarget</code> attribute shall be null value.</p>	<p>type: String</p> <p>multiplicity: 1</p> <p>isOrdered: N/A</p> <p>isUnique: N/A</p> <p>defaultValue: No</p> <p>isNullable: True</p>
tjTriggeringEvent	<p>It specifies the triggering event parameter of the trace session. The attribute is applicable only for Trace. In case this attribute is not used, it carries a null semantic.</p> <p>See the clause 5.1 of 3GPP TS 32.422 [30] for additional details on the allowed values.</p>	<p>type: ENUM</p> <p>multiplicity: 1</p> <p>isOrdered: N/A</p> <p>isUnique: N/A</p> <p>defaultValue: No</p> <p>isNullable: True</p>



Attribute Name	Documentation and Allowed Values	Properties
tjMDTAnonymizationOfData	It specifies the level of anonymization for management based MDT. See the clause 5.10.12 of 3GPP TS 32.422 [30] for additional details on the allowed values.	type: ENUM multiplicity: 1 isOrdered: N/A isUnique: N/A defaultValue: NO_IDENTITY isNullable: True
tjMDTAreaConfigurationForNeighbourCell	It specifies the area for which UE is requested to perform measurement logging for neighbour cells which have list of frequencies. If it is not configured, the UE shall perform measurement logging for all the neighbour cells. Applicable only to NR Logged MDT. See the clause 5.10.26 of 3GPP TS 32.422 [30] for additional details on the allowed values.	type: AreaConfig multiplicity: 1..* isOrdered: N/A isUnique: N/A defaultValue: No isNullable: True
tjMDTAreaScope	It specifies MDT area scope when activates an MDT job. For RLF and RCEF reporting it specifies the eNB/gNB or list of eNBs/gNBs where the RLF or RCEF reports should be collected.  List of cells/TA/LA/RA for signalling based MDT or management based Logged MDT.  List of cells for management based Immediate MDT.  Cell, TA, LA, RA are mutually exclusive. One or list of eNBs/gNBs for RLF and RCEF reporting  See the clause 5.10.2 of 3GPP TS 32.422 [30] for additional details on the allowed values.	type: AreaScope multiplicity: 1..* isOrdered: N/A isUnique: N/A defaultValue: No isNullable: True
tjMDTCollectionPeriodRrmLte	It specifies the collection period for collecting RRM configured measurement samples for M3 in LTE. The attribute is applicable only for Immediate MDT. In case this attribute is not used, it carries a null semantic. See the clause 5.10.20 of 3GPP TS 32.422 [30] for additional details on the allowed values.	type: ENUM multiplicity: 1 isOrdered: N/A isUnique: N/A defaultValue: No isNullable: True
tjMDTCollectionPeriodRrmUmts	It specifies the collection period for collecting RRM configured measurement samples for M3, M4, M5 in UMTS. The attribute is applicable only for Immediate MDT. In case this attribute is not used, it carries a null semantic. See the clause 5.10.21 of 3GPP TS 32.422 [30] for additional details on the allowed values.	type: ENUM multiplicity: 1 isOrdered: N/A isUnique: N/A defaultValue: No isNullable: True
tjMDTEventListForTriggeredMeasurement	It specifies event types for event triggered measurement in the case of logged NR MDT. Each trace session may configure at most one event. The UE shall perform logging of measurements only upon certain condition being fulfilled: - Out of coverage. - A2 event. See the clause 5.10.28 of 3GPP TS 32.422 [30] for additional details on the allowed values.	type: ENUM multiplicity: 1 isOrdered: N/A isUnique: N/A defaultValue: No isNullable: True
tjMDTEventThreshold	It specifies the threshold which should trigger the reporting in case A2 event reporting in LTE and NR or 1F/1I event in UMTS. The attribute is applicable only for Immediate MDT and when tjMDTReportingTrigger is configured for A2 event in LTE and NR or 1F event or 1I event in UMTS. In case this attribute is not used, it carries a null semantic. See the clauses 5.10.7 and 5.10.7a of 3GPP TS 32.422 [30] for additional details on the allowed values.	type: Integer multiplicity: 1 isOrdered: N/A isUnique: N/A defaultValue: No isNullable: True
tjMDTListOfMeasurements	It specifies the UE measurements that shall be collected in an Immediate MDT job. The attribute is applicable only for Immediate MDT. In case this attribute is not used, it carries a null semantic. See the clause 5.10.3 of 3GPP TS 32.422 [30] for additional details on the allowed values.	type: ENUM multiplicity: 1 isOrdered: N/A isUnique: N/A defaultValue: No isNullable: True
tjMDTLoggingDuration	It specifies how long the MDT configuration is valid at the UE in case of Logged MDT. The attribute is applicable only for Logged MDT and Logged MBSFN MDT. In case this attribute is not used, it carries a null semantic. See the clause 5.10.9 of 3GPP TS 32.422 [30] for additional details on the allowed values.	type: ENUM multiplicity: 1 isOrdered: N/A isUnique: N/A defaultValue: No isNullable: True



Attribute Name	Documentation and Allowed Values	Properties
tjMDTLoggingInterval	It specifies the periodicity for Logged MDT. The attribute is applicable only for Logged MDT and Logged MBSFN MDT. In case this attribute is not Sused, it carries a null semantic. See the clause 5.10.8 of 3GPP TS 32.422 [30] for additional details on the allowed values.	type: ENUM multiplicity: 1 isOrdered: N/A isUnique: N/A defaultValue: No isNullable: True
tjMDTLoggingEventThreshold	It specifies the threshold which should trigger the reporting in case of event based reporting of logged NR MDT. The attribute is applicable only for Logged MDT and when tjMDTReportType is configured for event triggered reporting and when tjMDTEventListForTriggeredMeasurement is configured for L1 event. In case this attribute is not used, it carries a null semantic. See the clause 5.10.36 of TS 32.422 [30] for additional details on the allowed values.	type: Integer multiplicity: 1 isOrdered: N/A isUnique: N/A defaultValue: No isNullable: True
tjMDTLoggedHysteresis	It specifies the hysteresis used within the entry and leave condition of the L1 event based reporting of logged NR MDT. The attribute is applicable only for Logged MDT, when tjMDTReportType is configured for event triggered reporting and when tjMDTEventListForTriggeredMeasurement is configured for L1 event. In case this attribute is not used, it carries a null semantic. See the clause 5.10.37 of TS 32.422 [30] for additional details on the allowed values.	type: Integer multiplicity: 1 isOrdered: N/A isUnique: N/A defaultValue: No isNullable: True
tjMDTLoggedTimeToTrigger	It specifies the threshold which should trigger the reporting in case of event based reporting of logged NR MDT. The attribute is applicable only for Logged MDT, when tjMDTReportType is configured for event triggered reporting and when tjMDTEventListForTriggeredMeasurement is configured for L1 event. In case this attribute is not used, it carries a null semantic. See the clauses 5.10.38 of TS 32.422 [30] for additional details on the allowed values.	type: ENUM multiplicity: 1 isOrdered: N/A isUnique: N/A defaultValue: No isNullable: True
tjMDTMBSFNAreaList	The MBSFN Area consists of a MBSFN Area ID and Carrier Frequency (EARFCN). The target MBSFN area List can have up to 8 entries. This parameter is applicable only if the job type is Logged MBSFN MDT. See the clause 5.10.25 of TS 32.422 [30] for additional details on the allowed values.	type: MbsfnArea multiplicity: 1..8 isOrdered: N/A isUnique: N/A defaultValue: No isNullable: True
tjMDTMeasurementPeriodLTE	It specifies the collection period for the Data Volume (M4) and Scheduled IP throughput measurements (M5) for LTE MDT taken by the eNB. The attribute is applicable only for Immediate MDT. In case this attribute is not used, it carries a null semantic. See the clause 5.10.23 of TS 32.422 [30] for additional details on the allowed values.	type: ENUM multiplicity: 1 isOrdered: N/A isUnique: N/A defaultValue: No isNullable: True
tjMDTCollectionPeriodM6Lte	It specifies the collection period for the Packet Delay measurement (M6) for MDT taken by the eNB. The attribute is applicable only for Immediate MDT. In case this attribute is not used, it carries a null semantic. See the clause 5.10.32 of TS 32.422 [30] for additional details on the allowed values.	type: ENUM multiplicity: 1 isOrdered: N/A isUnique: N/A defaultValue: No isNullable: True
tjMDTCollectionPeriodM7Lte	It specifies the collection period for the Packet Loss Rate measurement (M7) for LTE MDT taken by the eNB. The attribute is applicable only for Immediate MDT. In case this attribute is not used, it carries a null semantic. See the clause 5.10.33 of TS 32.422 [30] for additional details on the allowed values.	type: ENUM multiplicity: 1 isOrdered: N/A isUnique: N/A defaultValue: No isNullable: True
tjMDTMeasurementPeriodUMTS	It specifies the collection period for the Data Volume (M6) and Throughput measurements (M7) for UMTS MDT taken by RNC. The attribute is applicable only for Immediate MDT. In case this attribute is not used, it carries a null semantic. See the clause 5.10.22 of TS 32.422 [30] for additional details on the allowed values.	type: ENUM multiplicity: 1 isOrdered: N/A isUnique: N/A defaultValue: No isNullable: True



Attribute Name	Documentation and Allowed Values	Properties
tjMDTCollectionPeriodRrmNR	It specifies the collection period for collecting RRM configured measurement samples for M4, M5 in NR. The attribute is applicable only for Immediate MDT. In case this attribute is not used, it carries a null semantic. See the clause 5.10.30 of TS 32.422 [30] for additional details on the allowed values.	type: ENUM multiplicity: 1 isOrdered: N/A isUnique: N/A defaultValue: No isNullable: True
tjMDTCollectionPeriodM6NR	It specifies the collection period for the Packet Delay measurement (M6) for NR MDT taken by the gNB. The attribute is applicable only for Immediate MDT. In case this attribute is not used, it carries a null semantic. See the clause 5.10.34 of TS 32.422 [30] for additional details on the allowed values.	type: ENUM multiplicity: 1 isOrdered: N/A isUnique: N/A defaultValue: No isNullable: True
tjMDTCollectionPeriodM7NR	It specifies the collection period for the Packet Loss Rate measurement (M7) for NR MDT taken by the gNB. The attribute is applicable only for Immediate MDT. In case this attribute is not used, it carries a null semantic. See the clause 5.10.35 of TS 32.422 [30] for additional details on the allowed values.	type: ENUM multiplicity: 1 isOrdered: N/A isUnique: N/A defaultValue: No isNullable: True
tjMDTBeamLevelMeasurement	This indicates whether the NR M1 beam level measurements shall be included or not. See the clause 5.10.40 of TS 32.422 [30] for additional details.  The default value is "FALSE".  allowedValues: TRUE, FALSE	type: Boolean multiplicity: 1 isOrdered: N/A isUnique: N/A defaultValue: FALSE isNullable: False
tjMDTM4ThresholdUmts	It specifies the threshold which should trigger the reporting in case of event-triggered periodic reporting for M4 (UE power headroom measurement) in UMTS. In case this attribute is not used, it carries a null semantic. See the clause 5.10.39 of TS 32.422 [30] for additional details on the allowed values.	type: Integer multiplicity: 1 isOrdered: N/A isUnique: N/A defaultValue: No isNullable: True
tjMDTMeasurementQuantity	It specifies the measurements that are collected in an MDT job for a UMTS MDT configured for event triggered reporting. See the clause 5.10.15 of TS 32.422 [30] for additional details on the allowed values.	type: ENUM multiplicity: 1 isOrdered: N/A isUnique: N/A defaultValue: No isNullable: True
tjMDTPLMNList	It indicates the PLMNs where measurement collection, status indication and log reporting are allowed. See the clause 5.10.24 of TS 32.422 [30] for additional details on the allowed values.	type: PlmnId multiplicity: 1..16 isOrdered: N/A isUnique: N/A defaultValue: No isNullable: True
tjMDTPositioningMethod	It specifies what positioning method should be used in the MDT job. See the clause 5.10.19 of TS 32.422 [30] for additional details on the allowed values.	type: Integer multiplicity: 1 isOrdered: N/A isUnique: N/A defaultValue: No isNullable: True
tjMDTReportAmount	It specifies the number of measurement reports that shall be taken for periodic reporting while the UE is in connected. The attribute is applicable only for Immediate MDT and when tjMDTReportingTrigger is configured for periodical measurements. In case this attribute is not used, it carries a null semantic. See the clause 5.10.6 of TS 32.422 [30] for additional details on the allowed values.	type: ENUM multiplicity: 1 isOrdered: N/A isUnique: N/A defaultValue: No isNullable: True
tjMDTReportingTrigger	It specifies whether periodic or event based measurements should be collected. The attribute is applicable only for Immediate MDT and when the tjMDTListOfMeasurements is configured for M1 (for UMTS, LTE and NR) or M2 (only for UMTS). In case this attribute is not used, it carries a null semantic. See the clause 5.10.4 of TS 32.422 [30] for additional details on the allowed values.	type: ENUM multiplicity: 1 isOrdered: N/A isUnique: N/A defaultValue: No isNullable: True



Attribute Name	Documentation and Allowed Values	Properties
tjMDTReportInterval	It specifies the interval between the periodical measurements that shall be taken when the UE is in connected mode. The attribute is applicable only for Immediate MDT and when tjMDTReportingTrigger is configured for periodical measurements. In case this attribute is not used, it carries a null semantic. See the clause 5.10.5 of TS 32.422 [30] for additional details on the allowed values.	type: ENUM multiplicity: 1 isOrdered: N/A isUnique: N/A defaultValue: No isNullable: True
tjMDTReportType	It specifies report type for logged NR MDT as: - periodical. - event triggered. See the clause 5.10.27 of TS 32.422 [30] for additional details on the allowed values.	type: ENUM multiplicity: 1 isOrdered: N/A isUnique: N/A defaultValue: No isNullable: True
tjMDTSensorInformation	It specifies which sensor information shall be included in logged NR MDT and immediate NR MDT measurement if they are available. The following sensor measurement can be included or excluded for the UE: - Barometric pressure. - UE speed. - UE orientation. See the clause 5.10.29 of 3GPP TS 32.422 [30] for additional details on the allowed values.	type: ENUM multiplicity: 1..* isOrdered: N/A isUnique: N/A defaultValue: No isNullable: True
tjMDTTraceCollectionEntityID	It specifies the TCE Id which is sent to the UE in Logged MDT. See the clause 5.10.11 of 3GPP TS 32.422 [30] for additional details on the allowed values.	type: Integer multiplicity: 1 isOrdered: N/A isUnique: N/A defaultValue: No isNullable: True
mcc	Mobile Country Code  allowedValues: As defined by the data type	type: Mcc multiplicity: 1 isOrdered: N/A isUnique: N/A defaultValue: No value isNullable: False
mnc	Mobile Network  allowedValues: As defined by the data type	type: Mnc multiplicity: 1 isOrdered: N/A isUnique: N/A defaultValue: No value isNullable: False
traceld	An identifier, which identifies the Trace (together with MCC and MNC). This is a 3 byte Octet String.  See the clause 5.6 of 3GPP TS 32.422 [30] for additional details on the allowed values.	type: String multiplicity: 1 isOrdered: N/A isUnique: N/A defaultValue: No value isNullable: False
freqInfo	It specifies the carrier frequency and bands used in a cell.	type: FreqInfo multiplicity: 1 isOrdered: N/A isUnique: N/A defaultValue: No value isNullable: False
arfcn	RF Reference Frequency as defined in TS 38.104 [35], clause 5.4.2.1. The frequency provided identifies the absolute frequency position of the reference resource block (Common RB 0) of the carrier. Its lowest subcarrier is also known as Point A.  allowedValues: 0, 1, ...,3279165	type: Integer multiplicity: 1 isOrdered: N/A isUnique: N/A defaultValue: No value isNullable: False
freqBands	List of NR frequency operating bands. Primary NR Operating Band as defined in TS 38.104 [35], clause 5.4.2.3. The value 1 corresponds to n1, value 2 corresponds to NR operating band n2, etc.  allowedValues: 1, 2, ...,1024	type: Integer multiplicity: 1..* isOrdered: N/A isUnique: N/A defaultValue: No value isNullable: False



Attribute Name	Documentation and Allowed Values	Properties
pciList	List of neighbour cells subject for MDT scope. allowedValues: 0, 1, ...,1007	type: Integer multiplicity: 1..32 isOrdered: N/A isUnique: N/A defaultValue: No value isNullable: False
tac	Tracking Area Code allowedValues: As defined by the data type	type: Tac multiplicity: 1 isOrdered: N/A isUnique: N/A defaultValue: No value isNullable: False
eutraCellIdList	List of E-UTRAN cells identified by E-UTRAN-CGI allowedValues: As defined by the data type	type: EutraCellId multiplicity: 1..32 isOrdered: False isUnique: True defaultValue: No value isNullable: False
nrCellIdList	List of NR cells identified by NG-RAN CGI allowedValues: As defined by the data type	type: NrCellId multiplicity: 1..32 isOrdered: False isUnique: True defaultValue: No value isNullable: False
tacList	Tracking Area Code list allowedValues: As defined by the data type	type: Tac multiplicity: 1..8 isOrdered: False isUnique: True defaultValue: No value isNullable: False
taIList	Tracking Area Identity list allowedValues: As defined by the data type	type: Tai multiplicity: 1..8 isOrdered: False isUnique: True defaultValue: No value isNullable: False
mbsfnAreald	MBSFN Area Identifier AllowedValues: 1, 2, ...	type: Integer multiplicity: 1 isOrdered: N/A isUnique: N/A defaultValue: No value isNullable: False
earfcn	Carrier Frequency AllowedValues: 1, 2, ...	type: Integer multiplicity: 1 isOrdered: N/A isUnique: N/A defaultValue: No value isNullable: False
mnsLabel	Human-readable name of management service.	type: String multiplicity: 1 isOrdered: N/A isUnique: N/A defaultValue: None isNullable: False
mnsType	Type of management service. allowedValues: ProvMnS, FaultSupervisionMnS, StreamingDataReportingMnS, FileDataReportingMnS	type: ENUM multiplicity: 1 isOrdered: N/A isUnique: N/A defaultValue: None isNullable: False
mnsVersion	Version of management service.	type: String multiplicity: 1 isOrdered: N/A isUnique: N/A defaultValue: None isNullable: False



Attribute Name	Documentation and Allowed Values	Properties
mnsAddress	Addressing information for Management Service operations.	type: String multiplicity: 1 isOrdered: N/A isUnique: N/A defaultValue: None isNullable: False
ProcessMonitor.id	Id of the process. It is unique within a single multivalue attribute of type ProcessMonitor.	Type: String multiplicity: 1 isOrdered: N/A isUnique: True defaultValue: None isNullable: False
ProcessMonitor.status	This attribute represents the status of the associated process, whether it fails, succeeds etc. It does not represent the returned values of a successfully finished process.  allowedValues: - NOT_STARTED - RUNNING - CANCELLING - FINISHED - FAILED - PARTIALLY_FAILED - CANCELLED	Type: ENUM multiplicity: 1 isOrdered: N/A isUnique: N/A defaultValue: None isNullable: False
ProcessMonitor.progressPercentage	Progress of the process as percentage.  Allowed values: integer between 0 and 100	Type: Integer multiplicity: 0..1 isOrdered: N/A isUnique: N/A defaultValue: None isNullable: False
ProcessMonitor.progressStateInfo	Additional textual qualification of the states "NOT_STARTED", "CANCELLING" and "RUNNING".  For specific processes, specific well-defined strings (e.g. string patterns or enums) may be defined as a specialisation.  allowedValues: N/A	Type: String multiplicity: 0..* isOrdered: True isUnique: False defaultValue: None isNullable: False
ProcessMonitor.resultStateInfo	Additional textual qualification of the states "FINISHED", "FAILED", "PARTIALLY_FAILED" and "CANCELLED". For example, in the "FAILED" or "PARTIALLY_FAILED" state this attribute may be used to provide error reasons.  This attribute shall not be used to make the outcome of the process available for retrieval, if any. For this purpose, dedicated attributes shall be specified when specifying the representation of a specific process.  For specific processes, specific well-defined strings (e.g. string patterns or enums) may be defined as a specialisation.  allowedValues: N/A	Type: String multiplicity: 0..1 isOrdered: N/A isUnique: N/A defaultValue: None isNullable: False
ProcessMonitor.startTime	Start time of the associated process, i.e. the time when the status changed from "NOT_STARTED" to "RUNNING".  allowedValues: N/A	Type: DateTime multiplicity: 0.. 1 isOrdered: N/A isUnique: N/A defaultValue: None isNullable: False
ProcessMonitor.endTime	Date and time when status changed to SUCCESS, CANCELLED, FAILED or PARTIALLY_FAILED. If the time is in the future, it is the estimated time the process will end.  allowedValues: N/A	Type: DateTime multiplicity: 0.. 1 isOrdered: N/A isUnique: N/A defaultValue: None isNullable: False



Attribute Name	Documentation and Allowed Values	Properties
<u>ProcessMonitor.timer</u>	Time until the associated process is automatically cancelled. If set, the system decreases the timer with time. When it reaches zero the cancellation of the associated process is initiated by the MnS_Producer. If not set, there is no time limit for the process. Once the timer is set, the consumer can not change it anymore. If the consumer has not set the timer the MnS Producer may set it. Unit is minutes.  allowedValues: Positive integers	Type: Integer multiplicity: 0.. 1 isOrdered: N/A isUnique: N/A defaultValue: None isNullable: False
mnsScope	This attribute list contains the DNs of the managed object instances that can be accessed using the Management Service. If a complete SubNetwork can be accessed using the Management Service, this attribute may contain the DN of the SubNetwork instead of the DNs of the individual managed entities within the SubNetwork.	type: DN multiplicity: 1..* isOrdered: False isUnique: True defaultValue: None isNullable: False
NOTE 1: The value of this attribute is identical to that of the same attribute in clause 9.4.2 of ETSI GS NFV-IFA 008 [16].		
NOTE 2: The value of this attribute is identical to that of the attribute isAutoscaleEnabled included in vnfConfigurableProperty in clause 9.4.2 of ETSI GS NFV-IFA 008 [16].		
NOTE 3: The presence of the attribute vnfParametersList, whose vnfInstanceId with a string length of zero, in createMO operation can trigger the instantiation of the related VNF/VNFC instances.		
NOTE 4: The GP defines the measurement data production rate. The supported rates are dependent on the capacity of the producer involved (e.g. the processing power of the producer, the complexity of the measurement type involved etc) and therefore, it cannot be standardized for all producers involved. The supported GPs reflects the agreement between producer and the consumer involved.		
NOTE 5: The monitoring granularity period defines the measurements monitoring period. The supported monitoring periods are dependent on the capacity of the producer involved (e.g. the processing power of the producer, the complexity of the measurement type involved etc) and therefore, it cannot be standardized for all producers involved. The supported monitoring GPs reflect the agreement between producer and the consumer involved.		
NOTE 6: The supported threshold levels are dependent on the capacity of the producer involved (e.g. the processing power of the producer, number of measurements being measured by the producer at the time, the complexity of the measurement type involved etc) and therefore, it cannot be standardized for all producers involved. The supported levels can only reflect the negotiated agreement between producer and the consumer involved.		

#### 4.4.2 Constraints

None

### 4.5 Common notifications

#### 4.5.1 Alarm notifications

This clause presents a list of notifications, defined in [27], that a MnS consumer can receive. The notification header attribute `objectClass/objectInstance`, defined in [3], captures the DN of an instance of an IOC defined in the present document.



Name	S	Notes
notifyNewAlarm	M	
notifyClearedAlarm	M	
notifyChangedAlarm	O	
notifyChangedAlarmGeneral	O	
notifyCorrelatedNotificationChanged	O	
notifyAckStateChanged	O	
notifyComments	O	
notifyPotentialFaultyAlarmList	O	
notifyAlarmListRebuilt	M	

## 4.5.2 Configuration notifications

This clause presents a list of notifications, defined in [27], that a MnS consumer can receive. The notification header attribute `objectClass/objectInstance`, defined in [3], captures the DN of an instance of an IOC defined in the present document.

Name	S	Notes
notifyMOIObjectCreation	O	
notifyMOIObjectDeletion	O	
notifyMOIAttributeValueChanges	O	
notifyMOIChanges	O	
notifyEvent	O	

## 4.5.3 Threshold Crossing notifications

This clause presents a list of notifications, defined in [27], that a MnS consumer can receive. The notification header attribute `objectClass/objectInstance`, defined in [3], captures the DN of an instance of an IOC defined in the present document.

Name	S	Notes
notifyThresholdCrossing	M	



## Annex A (informative): Alternate class diagram

This class diagram combines the Figure 4.2.1-1 of this document with Figure 1 of [9], the class diagram of UIM.

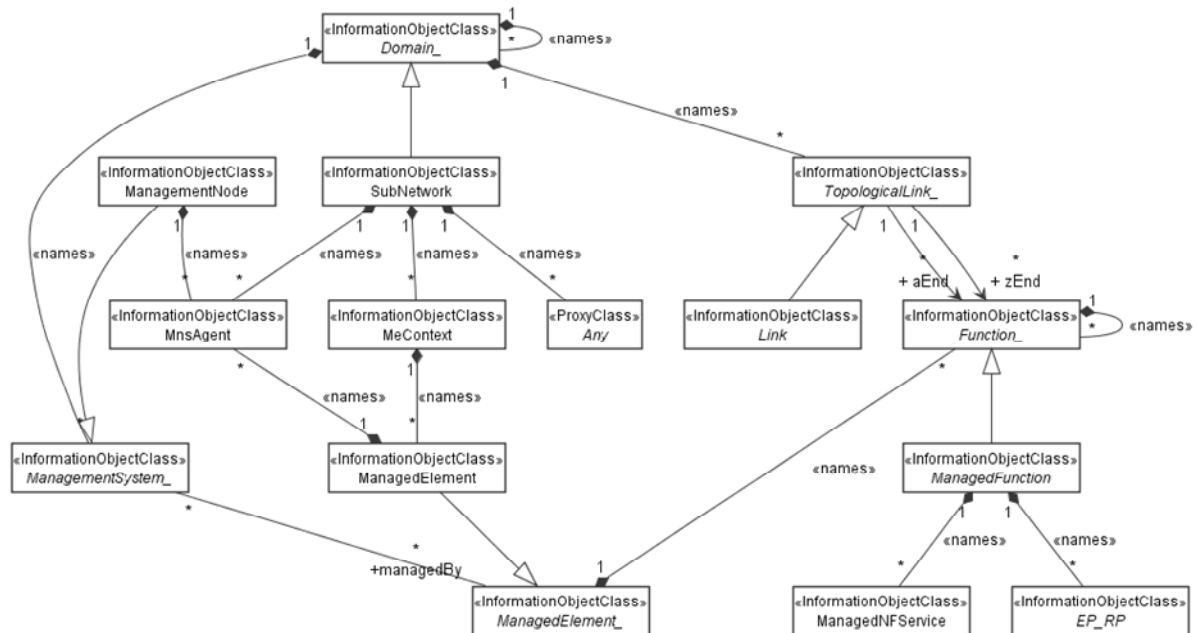

Figure A-1: Alternate class diagram



---

## Annex B (informative): Change history

Change history							
Date	TSG #	TSG Doc.	CR	Rev	Subject/Comment	Old	New
2012-12					New version after approval	2.0.0	11.0.0
2012-02					MCC update of TOC	11.0.0	11.0.1
2014-06	SA#64	SP-140332	001	-	Correction of reference	11.0.1	11.1.0
		SP-140358	002	-	Remove the feature support statements		
2014-09	SA#65				Upgrade to Rel-12	11.1.0	12.0.0
2015-12	SA#70	SP-150691	005	1	Add missing id attribute for 28.622	12.0.0	12.1.0
2016-01					Upgrade to Rel-13 (MCC)	12.1.0	13.0.0



Change history							
Date	Meeting	TDoc	CR	Rev	Cat	Subject/Comment	New version
2016-12	SA#74	SP-160853	0010	-	A	Clarification on the need to show VsDataContainer self-containing itself several times	13.1.0
2017-03	SA#75	SP-170139	0012	2	A	Clarify notification triggered by VsDataContainer change	13.2.0
2017-03	SA#75	SP-170143	0015	1	B	Modify definitions of ME and MF to support virtualized network element	14.0.0
2017-03	SA#75	SP-170142	0016	3	B	Adding an attribute for ManagedFunction to support management of virtualized NE	14.0.0
2017-06	SA#76	SP-170510	0019	2	B	Add VNFInfo related attributes in IOC ManagedFunction	14.1.0
2018-01	SA#78	SP-170969	0021	-	F	Missing note in table of Attribute Properties	14.2.0
2018-03	SA#79	SP-180060	0022	-	B	Add new attribute peeParametersList to IOC ManagedFunction	15.0.0
2018-06	SA#80	SP-180421	0024	1	B	Remove references to ltf-N	15.1.0
2018-12	SA#82	SP-181156	0027	-	F	Add the missing NRM fragment supporting network performance management	15.2.0
2018-12	SA#82	SP-181042	0028	1	F	Replace MF with ManagedFunction	15.2.0
2018-12	SA#82	SP-181042	0029	1	F	Update NRM root IOCs to support slice priority	15.2.0
2019-06	SA#84	SP-190371	0031	2	B	Add IOCs for threshold monitoring control	16.0.0
2019-06	SA#84	SP-190373	0033	2	B	Update generic NRM Information Service to support Managed NF Service Object	16.0.0
2019-09	SA#85	SP-190744	0038	2	A	Update class definition with inheritance information	16.1.0
2019-09	SA#85	SP-190744	0043	1	A	Correct PMControl (Add report period attribute and disambiguate the delivery method attributes)	16.1.0
2019-09	SA#85	SP-190751	0044	-	A	Correct NR definition to avoid misalignment with RAN2 and add NRM definition	16.1.0
2019-09	SA#85	SP-190744	0046	1	A	Correct definitions of granularity period.	16.1.0
2019-09	SA#85					Correction in implementation of CR0043	16.1.1
2019-12	SA#86	SP-191158	0057	2	A	Correct definition of network resource	16.2.0
2019-12	SA#86	SP-191173	0059	-	A	Add measurementsList attribute into related IOCs	16.2.0
2019-12	SA#86	SP-191166	0062	2	B	Add heartbeat control NRM fragment	16.2.0
2019-12	SA#86	SP-191166	0063	2	B	Add notification subscription control fragment	16.2.0
2020-03	SA#87E	SP-200169	0066	-	B	Add configurable FM.	16.3.0
2020-03	SA#87E	SP-200163	0069	1	B	Add configurable KPI control NRM	16.3.0
2020-03	SA#87E	SP-200169	0071	1	F	Correct definition of HeartbeatControl and attribute NotificationType	16.3.0
2020-07	SA#88-e	SP-200489	0074	1	F	Add TOP_ as parent IOC	16.4.0
2020-07	SA#88-e	SP-200489	0075	1	F	Update concept of ME and MF	16.4.0
2020-07	SA#88-e	SP-200489	0076	-	F	Update the attribute priorityLabel for several IOCs	16.4.0
2020-07	SA#88-e	SP-200489	0077	-	F	Updated MF description with nested clarification	16.4.0
2020-07	SA#88-e	SP-200483	0078	1	B	Add trace control NRM fragment stage 2	16.4.0
2020-07	SA#88-e	SP-200484	0080	1	D	Fix inconsistent formatting	16.4.0
2020-07	SA#88-e	SP-200490	0083	1	F	Combine class diagrams of subscription and heartbeat NRM control fragments (stage 2)	16.4.0
2020-07	SA#88-e	SP-200490	0084	1	F	Update PM control fragment (stage 2)	16.4.0
2020-07	SA#88-e	SP-200490	0085	-	F	Clarify usage of the VsDataContainer (stage 2)	16.4.0
2020-07	SA#88-e	SP-200490	0086	1	F	Update FM control fragment (stage 2)	16.4.0
2020-09	SA#89e	SP-200729	0087	1	F	Correct ThresholdMonitor definition (stage 2)	16.5.0
2020-09	SA#89e	SP-200729	0088	-	F	Correct HeartbeatControl definition and some other smaller issues (stage 2)	16.5.0
2020-09	SA#90e	SP-201063	0089	1	F	Add new MDT specific parameter collection period for NR aligning with 32.422	16.6.0
2020-09	SA#90e	SP-201057	0090	1	F	Remove thresholdLevel attribute from ThresholdMonitor (stage 2)	16.6.0
2020-09	SA#90e	SP-201057	0091	1	F	Update the perfMetricJobGroupId attribute	16.6.0
2020-09	SA#90e	SP-201057	0092	-	F	Remove value handling from the granularityPeriod description.	16.6.0
2020-09	SA#90e	SP-201088	0093	-	F	Correct the attributes description of the IOCs inherited from Top and Top_	16.6.0
2020-09	SA#90e	SP-201063	0094		F	Correct 5G trace parameter for trace control	16.6.0
2020-09	SA#90e	SP-201089	0095	-	F	Update notifyThresholdCrossing to be a common notification.	16.6.0
2021-03	SA#91e	SP-210150	0097	-	F	Correct notification support table for ManagedElement and ManagementNode	16.7.0
2021-03	SA#91e	SP-210153	0099	1	F	Correction of attribute properties and IOC inheritance description	16.7.0
2021-04	SA#91e					Editorial cleanup with the help of the Rapporteur	16.7.1
2021-06	SA#92e	SP-210406	0096	3	F	Replace legacy IRPAgent with MnsAgent (stage 2)	16.8.0
2021-06	SA#92e	SP-210397	0100	1	F	Addition, adaptation and cleanup of Trace/MDT related parameters (stage2)	16.8.0
2021-06	SA#92e	SP-210416	0102	-	F	Align different (abbreviated) names for support qualifier to S	16.8.0
2021-06	SA#92e	SP-210406	0103	1	F	Clarify a subscription is required for notifyFileReady	16.8.0
2021-06	SA#92e	SP-210406	0104	1	F	Clarify definition of PerfMetricJob	16.8.0
2021-06	SA#92e	SP-210406	0105	-	F	Clarify the notification filter applies to all parameters of a notification	16.8.0
2021-06	SA#92e	SP-210406	0106	-	F	Correct common notifications table	16.8.0



2021-06	SA#92e					Editorial fix on tables and fonts	16.8.1
2021-09	SA#93e	SP-210879	0110	1	A	Correction for vnfParametersList	16.9.0
2021-09	SA#93e	SP-210885	0111	1	F	Add missing MnsAgent to class and inheritance diagrams	16.9.0
2021-09	SA#93e	SP-210871	0112	-	F	Add missing notification type "notifyClearedAlarm" to the attribute "notificationTypes"	16.9.0
2021-09	SA#93e	SP-210871	0113	1	F	Fix the issue caused by the updated NetworkSliceSubnet inheritance relationship	16.9.0
2021-09	SA#93e	SP-210865	0115	-	F	Correction and clarification of reporting in TraceJob (stage2)	16.9.0
2021-09	SA#93e	SP-210865	0116	-	F	Adaptation and cleanup of Trace/MDT related parameters (stage2)	16.9.0
2021-12	SA#94e	SP-211458	0121	-	F	Introduce missing references	16.10.0
2021-12	SA#94e	SP-211478	0124	-	A	Update Scope to be applicable for SBMA	16.10.0
2021-12	SA#94e	SP-211475	0125	1	F	Clarify behavior of NtfSubscriptionControl	16.10.0
2021-12	SA#94e	SP-211467	0122	-	B	Add support for MnS Discovery	17.0.0
2022-03	SA#95e	SP-220168	0126	1	C	Asynchronous operation NRM additions	17.1.0
2022-03	SA#95e	SP-220179	0127	1	A	Alarm Record changes	17.1.0
2022-03	SA#95e	SP-220179	0128	1	A	Notification Subscription changes	17.1.0
2022-03	SA#95e	SP-220177	0131	1	B	Enhance NRM with geographical information supporting MDA	17.1.0
2022-03	SA#95e	SP-220163	0133	1	B	Add support for discovery of managed entities	17.1.0
2022-03	SA#95e	SP-220183	0134	1	B	Add attribute to configure an identifier of a TraceJob	17.1.0
2022-03	SA#95e	SP-220171	0141	-	B	Add parameter to configure beam level measurements in NR MDT	17.1.0
2022-03	SA#95e	SP-220183	0147	-	B	Add stage2 definition for file management	17.1.0
2022-03	SA#95e					Adding a missing parenthesis in clause 4.4.1 (misimplemented CR)	17.1.1



---

# History

Document history		
V17.1.1	May 2022	Publication