

# ETSI TS 128 628 V15.1.0 (2019-05)



**Universal Mobile Telecommunications System (UMTS);  
LTE;  
Telecommunication management;  
Self-Organizing Networks (SON)  
Policy Network Resource Model (NRM)  
Integration Reference Point (IRP);  
Information Service (IS)  
(3GPP TS 28.628 version 15.1.0 Release 15)**



---

Reference

RTS/TSGS-0528628v10

---

Keywords

LTE,UMTS

**ETSI**

650 Route des Lucioles  
F-06921 Sophia Antipolis Cedex - FRANCE

Tel.: +33 4 92 94 42 00 Fax: +33 4 93 65 47 16

Siret N° 348 623 562 00017 - NAF 742 C  
Association à but non lucratif enregistrée à la  
Sous-Préfecture de Grasse (06) N° 7803/88

---

**Important notice**

The present document can be downloaded from:

<http://www.etsi.org/standards-search>

The present document may be made available in electronic versions and/or in print. The content of any electronic and/or print versions of the present document shall not be modified without the prior written authorization of ETSI. In case of any existing or perceived difference in contents between such versions and/or in print, the prevailing version of an ETSI deliverable is the one made publicly available in PDF format at [www.etsi.org/deliver](http://www.etsi.org/deliver).

Users of the present document should be aware that the document may be subject to revision or change of status.

Information on the current status of this and other ETSI documents is available at

<https://portal.etsi.org/TB/ETSIDeliverableStatus.aspx>

If you find errors in the present document, please send your comment to one of the following services:

<https://portal.etsi.org/People/CommiteeSupportStaff.aspx>

---

**Copyright Notification**

No part may be reproduced or utilized in any form or by any means, electronic or mechanical, including photocopying and microfilm except as authorized by written permission of ETSI.

The content of the PDF version shall not be modified without the written authorization of ETSI.

The copyright and the foregoing restriction extend to reproduction in all media.

© ETSI 2019.

All rights reserved.

**DECT™**, **PLUGTESTS™**, **UMTS™** and the ETSI logo are trademarks of ETSI registered for the benefit of its Members.

**3GPP™** and **LTE™** are trademarks of ETSI registered for the benefit of its Members and of the 3GPP Organizational Partners.

**oneM2M™** logo is a trademark of ETSI registered for the benefit of its Members and of the oneM2M Partners.

**GSM®** and the GSM logo are trademarks registered and owned by the GSM Association.

---

# Intellectual Property Rights

## Essential patents

IPRs essential or potentially essential to normative deliverables may have been declared to ETSI. The information pertaining to these essential IPRs, if any, is publicly available for **ETSI members and non-members**, and can be found in ETSI SR 000 314: *"Intellectual Property Rights (IPRs); Essential, or potentially Essential, IPRs notified to ETSI in respect of ETSI standards"*, which is available from the ETSI Secretariat. Latest updates are available on the ETSI Web server (<https://ipr.etsi.org/>).

Pursuant to the ETSI IPR Policy, no investigation, including IPR searches, has been carried out by ETSI. No guarantee can be given as to the existence of other IPRs not referenced in ETSI SR 000 314 (or the updates on the ETSI Web server) which are, or may be, or may become, essential to the present document.

## Trademarks

The present document may include trademarks and/or tradenames which are asserted and/or registered by their owners. ETSI claims no ownership of these except for any which are indicated as being the property of ETSI, and conveys no right to use or reproduce any trademark and/or tradename. Mention of those trademarks in the present document does not constitute an endorsement by ETSI of products, services or organizations associated with those trademarks.

---

# Foreword

This Technical Specification (TS) has been produced by ETSI 3rd Generation Partnership Project (3GPP).

The present document may refer to technical specifications or reports using their 3GPP identities, UMTS identities or GSM identities. These should be interpreted as being references to the corresponding ETSI deliverables.

The cross reference between GSM, UMTS, 3GPP and ETSI identities can be found under <http://webapp.etsi.org/key/queryform.asp>.

---

# Modal verbs terminology

In the present document "**shall**", "**shall not**", "**should**", "**should not**", "**may**", "**need not**", "**will**", "**will not**", "**can**" and "**cannot**" are to be interpreted as described in clause 3.2 of the [ETSI Drafting Rules](#) (Verbal forms for the expression of provisions).

"**must**" and "**must not**" are **NOT** allowed in ETSI deliverables except when used in direct citation.

# Contents

Intellectual Property Rights .....	2
Foreword.....	2
Modal verbs terminology.....	2
Foreword.....	6
Introduction .....	6
1 Scope .....	7
2 References .....	7
3 Definitions and abbreviations.....	8
3.1 Definitions .....	8
3.2 Abbreviations .....	8
4 SON Policy and optimization function definitions .....	9
4.1 Monitoring and management operations for self-optimization .....	9
4.1.1 Monitoring and management function.....	9
4.1.1.1 Usage of Itf-N .....	9
4.2 Load balancing optimization function.....	9
4.2.1 Objective and targets .....	9
4.2.2 Parameters To Be Optimized .....	10
4.2.3 Optimization method .....	10
4.2.3.1 Problem detection .....	10
4.2.3.2 Problem solution .....	10
4.2.4 Architecture .....	11
4.2.4.1 Definition of logical functions .....	11
4.2.4.2 Location of logical functions.....	11
4.2.5 PM .....	11
4.3 Handover (HO) parameter optimization function.....	12
4.3.1 Objective and targets .....	12
4.3.2 Parameters To Be Optimized .....	12
4.3.3 Optimization method .....	13
4.3.3.1 Problem detection .....	13
4.3.3.2 Problem solution .....	13
4.3.4 Architecture .....	13
4.3.4.1 Definition of logical functions .....	13
4.3.4.2 Location of logical functions.....	14
4.3.5 PM .....	14
4.4 Interference control function .....	15
4.5 Capacity and coverage optimization function .....	15
4.5.4 Architecture .....	16
4.5.4.1 Definition of logical functions .....	16
4.5.4.2 Location of logical functions.....	16
4.5.6 MDT measurements.....	20
4.6 RACH Optimization Function.....	20
4.6.1 Objective and targets .....	20
4.6.2 Parameters to be optimized.....	20
4.6.3 Optimization method .....	21
4.6.3.1 Problem detection .....	21
4.6.3.2 Problem solution .....	21
4.6.4 PM .....	21
4.7 SON coordination.....	21
4.7.1 Introduction.....	21
4.7.2 Coordination between SON functions below Itf-N and non-SON CM operations over itf-N .....	22
4.7.2.1 Description .....	22
4.7.2.2 Prevention.....	22
4.7.2.3 Resolution.....	22
4.7.3 Coordination between different SON functions.....	22

4.7.3.0	General .....	22
4.7.3.1	Coordination between Cell Outage Compensation and Energy Saving Management .....	23
4.7.3.1.1	Description .....	23
4.7.3.1.2	Prevention.....	23
4.7.3.1.3	Resolution.....	23
4.7.3.2	Coordination among Cell Outage Compensation, Capacity and Coverage Optimization, and Energy Saving Management .....	23
4.7.3.2.1	Description .....	23
4.7.3.2.2	Prevention.....	24
4.7.3.2.3	Resolution.....	24
4.7.3.3	Coordination between Cell Outage Compensation and Automatic Neighbour Relation .....	24
4.7.3.3.1	Description .....	24
4.7.3.3.2	Prevention.....	24
4.7.3.3.3	Resolution.....	24
4.7.3.4	Coordination between HandOver parameter Optimization and Load Balancing Optimization .....	25
4.7.3.4.1	Description .....	25
4.7.3.4.2	Prevention.....	25
4.7.3.4.3	Resolution.....	25
4.7.4	General SON coordination solutions .....	25
4.7.4.1	Overview .....	25
4.7.4.2	Conflict prevention.....	26
4.7.4.3	Conflict resolution.....	27
4.8	SON for AAS management .....	27
4.8.1	Objective and targets .....	27
4.8.2	Parameters to be optimized.....	28
4.8.3	Optimization method .....	28
4.8.3.1	Problem detection .....	28
4.8.3.2	Problem solution .....	28
4.8.4	Architecture .....	28
4.8.4.1	Definition of logical functions .....	28
4.8.4.2	Location of logical functions.....	28
4.8.5	PM .....	29
5	Model .....	31
5.1	Imported information entities and local labels .....	31
5.2	Class diagrams.....	31
5.2.1	Relationships.....	31
5.2.2	Inheritance .....	37
5.3	Class definitions .....	39
5.3.1	SONTargets .....	39
5.3.1.1	Definition .....	39
5.3.1.2	Attributes.....	39
5.3.1.3	Attribute constraints .....	40
5.3.1.4	Notifications.....	40
5.3.2	SONControl .....	40
5.3.2.1	Definition .....	40
5.3.2.2	Attributes.....	40
5.3.2.3	Attribute constraints .....	40
5.3.2.4	Notifications.....	40
5.3.3	ESPolicies .....	41
5.3.3.1	Definition .....	41
5.3.3.2	Attributes.....	41
5.3.3.3	Attribute constraints .....	41
5.3.3.4	Notifications.....	41
5.3.4	EUtranCellSON .....	41
5.3.4.1	Definition .....	41
5.3.4.2	Attributes.....	41
5.3.4.3	Attribute constraints .....	41
5.3.4.4	Notifications.....	42
5.3.5	EnergySavingProperties.....	42
5.3.5.1	Definition .....	42
5.3.5.2	Attributes.....	42

5.3.5.3	Attribute constraints .....	42
5.3.5.4	Notifications .....	42
5.3.6	IOC SONFuncInfo .....	42
5.3.6.1	Definition .....	42
5.3.6.2	Attributes .....	43
5.3.6.3	Attribute constraints .....	43
5.3.6.4	Notifications .....	43
5.3.7	IOC SONCoordinationPolicies .....	43
5.3.7.1	Definition .....	43
5.3.7.2	Attributes .....	43
5.3.7.3	Attribute constraints .....	43
5.3.7.4	Notifications .....	43
5.3.8	interRatEsPolicies .....	44
5.3.8.1	Definition .....	44
5.3.8.2	Attributes .....	44
5.3.8.3	Attribute constraints .....	44
5.3.8.4	Notifications .....	44
5.4	Attribute definitions .....	45
5.4.1	Attribute properties .....	45
5.4.2	Constraints .....	57
5.5	Common notifications .....	57
5.5.2	Configuration notifications .....	57
<b>Annex A (informative): Target Achievement Evaluation .....</b>		<b>58</b>
<b>Annex B (informative): Examples of how to use general SON coordination solutions .....</b>		<b>59</b>
B.1	Coordination of COC and CCO using priority of SON functions .....	59
B.2	Coordination of COC, CCO and ES using priority of SON functions .....	59
B.3	Coordination of COC, CCO and ES based on the cell state .....	60
<b>Annex C (informative): State diagram for Distributed and EM-centralized Energy Saving Management .....</b>		<b>61</b>
<b>Annex D (informative): Change history .....</b>		<b>64</b>
History .....		65

---

# Foreword

This Technical Specification has been produced by the 3<sup>rd</sup> Generation Partnership Project (3GPP).

The contents of the present document are subject to continuing work within the TSG and may change following formal TSG approval. Should the TSG modify the contents of the present document, it will be re-released by the TSG with an identifying change of release date and an increase in version number as follows:

Version x.y.z

where:

- x the first digit:
  - 1 presented to TSG for information;
  - 2 presented to TSG for approval;
  - 3 or greater indicates TSG approved document under change control.
- y the second digit is incremented for all changes of substance, i.e. technical enhancements, corrections, updates, etc.
- z the third digit is incremented when editorial only changes have been incorporated in the document.

---

# Introduction

The present document is part of a TS-family covering the 3<sup>rd</sup> Generation Partnership Project Technical Specification Group Services and System Aspects, Telecommunication management; as identified below:

28.627: Self-Organizing Networks (SON) Policy Network Resource Model (NRM) Integration Reference Point (IRP); Requirements

**28.628: Self-Organizing Networks (SON) Policy Network Resource Model (NRM) Integration Reference Point (IRP); Information Service (IS)**

28.629: Self-Organizing Networks (SON) Policy Network Resource Model (NRM) Integration Reference Point (IRP); Solution Set (SS) definitions

---

# 1 Scope

The present document is part of an Integration Reference Point (IRP) named Self Organizing Networks (SON) Policy Network Resource Model (NRM) IRP, through which an IRP Agent can communicate management information to one or several IRP Managers concerning SON policies. The SON policy NRM IRP comprises a set of specifications defining Requirements, a protocol neutral Information Service and one or more Solution Set(s).

The present document specifies the protocol neutral SON policy NRM IRP: Information Service (IS).

In order to access the information defined by this NRM, an Interface IRP such as the "Basic CM IRP" is needed (3GPP TS 32.602 [11]). However, which Interface IRP is applicable is outside the scope of the present document.

The present document also contains stage 2 descriptions for those functionalities for the Self-Optimization OAM, SON coordination and Energy Saving Management.

---

# 2 References

The following documents contain provisions which, through reference in this text, constitute provisions of the present document.

- References are either specific (identified by date of publication, edition number, version number, etc.) or non-specific.
- For a specific reference, subsequent revisions do not apply.
- For a non-specific reference, the latest version applies. In the case of a reference to a 3GPP document (including a GSM document), a non-specific reference implicitly refers to the latest version of that document *in the same Release as the present document*.

- [1] 3GPP TS 32.101: "Telecommunication management; Principles and high level requirements".
- [2] 3GPP TS 32.102: "Telecommunication management; Architecture".
- [3] 3GPP TS 32.150: "Telecommunication management; Integration Reference Point (IRP) Concept and definitions".
- [4] 3GPP TR 21.905: "Vocabulary for 3GPP Specifications".
- [5] 3GPP TS 28.627: "Telecommunication management; Self-Organizing Networks (SON) Policy Network Resource Model (NRM) Integration Reference Point (IRP): Requirements".
- [6] 3GPP TS 36.331: "Technical Specification Group Radio Access Network; Evolved Universal Terrestrial Radio Access (E-UTRA); Radio Resource Control (RRC); Protocol specification".
- [7] 3GPP TS 36.423: "Technical Specification Group Radio Access Network; Evolved Universal Terrestrial Radio Access Network (E-UTRAN); X2 Application Protocol (X2AP)".
- [8] 3GPP TS 32.425: "Technical Specification Group Services and System Aspects; Telecommunication management; Performance Management (PM); Performance measurements; Evolved Universal Terrestrial Radio Access Network (E-UTRAN)".
- [9] 3GPP TS 28.622: "Telecommunication management; Configuration Management (CM); Generic network resources Integration Reference Point (IRP): Network Resource Model (NRM)".
- [10] 3GPP TS 28.658: "Telecommunication management; Configuration Management (CM); Evolved Universal Terrestrial Radio Access Network (E-UTRAN) network resources Integration Reference Point (IRP): Network Resource Model (NRM)".
- [11] 3GPP TS 32.602: "Telecommunication management; Configuration Management (CM); Basic CM Integration Reference Point (IRP) Information Service (IS)".
- [12] 3GPP TS 36.413: "Technical Specification Group Radio Access Network; Evolved Universal Terrestrial Radio Access Network (E-UTRAN); S1 Application Protocol (S1AP)".



- [13] 3GPP TS 36.314: "Evolved Universal Terrestrial Radio Access (E-UTRA); Layer 2 - Measurements".
- [14] 3GPP TS 36.300: " Evolved Universal Terrestrial Radio Access (E-UTRA) and Evolved Universal Terrestrial Radio Access Network (E-UTRAN); Overall description; Stage 2 ".
- [15] 3GPP TS 37.320: "Universal Terrestrial Radio Access (UTRA) and Evolved Universal Terrestrial Radio Access (E-UTRA); Radio measurement collection for Minimization of Drive Tests (MDT); Overall description; Stage 2".
- [16] 3GPP TS 32.302: "Telecommunication management; Configuration Management (CM); Notification Integration Reference Point (IRP): Information Service (IS)".
- [17] 3GPP TS 32.662: "Telecommunication management; Configuration Management (CM); Kernel CM Information Service (IS)".
- [18] Void .
- [19] 3GPP TS 25.413: "UTRAN Iu interface RANAP signalling".
- [20] 3GPP TS 48.008: "Mobile Switching Centre-Base Station System (MSC-BSS) interface; Layer 3 specification".
- [21] 3GPP TS 32.405: "Telecommunication management; Performance Management (PM); Performance measurements; Universal Terrestrial Radio Access Network (UTRAN)".
- [22] 3GPP TS 32.422: "Telecommunication management; Subscriber and equipment trace; Trace control and configuration management".
- [23] 3GPP TS 32.423: "Telecommunication management; Subscriber and equipment trace; Trace data definition and management".
- [24] 3GPP TS 36.133: "Evolved Universal Terrestrial Radio Access (E-UTRA); Requirements for support of radio resource management".

---

## 3 Definitions and abbreviations

### 3.1 Definitions

For the purposes of the present document, the terms and definitions given in TS 32.101 [1], TS 32.102 [2], TS 32.150 [3] and TR 21.905 [4] and the following apply. A term defined in the present document takes precedence over the definition of the same term, if any, in TS 28.627 [5], TS 32.101 [1], TS 32.102 [2] and TR 21.905 [4], in that order.

**Target:** See 3GPP TS 28.627 [5].

**Trigger condition:** See 3GPP TS 28.627 [5].

**Hand-Over parameter Optimisation:** See clause 4.3 of this document and Mobility Robustness Optimisation (MRO) are synonyms (see TS 36.300 [14]).

### 3.2 Abbreviations

For the purposes of the present document, the abbreviations given in TR 21.905 [4], TS 28.627 [5] and the following apply. An abbreviation defined in the present document takes precedence over the definition of the same abbreviation, if any, in TR 21.905 [4] and TS 28.627 [5].

AAS	Active Antenna System
AoA	Angle of Arrival
CAC	Composite Available Capacity
CCO	Capacity and Coverage Optimization
CDF	Cumulative Distribution Function
COC	Cell Outage Compensation
CQI	Channel Quality Indicator

EM	Element Manager
eNodeB, eNB	evolved NodeB
ESM	Energy Saving Management
E-UTRAN	Evolved Universal Terrestrial Radio Access Network
GNSS	Global Navigation Satellite System
HO	Handover
HOO	HandOver parameter Optimization
ICIC	Inter Cell Interference Coordination
IOC	Information Object Class
LB	Load Balancing
LBO	Load Balancing Optimization
MDT	Minimization of Drive Tests
MRO	Mobility Robustness Optimisation
NM	Network Manager
NRM	Network Resource Model
OAM	Operation Administration Maintenance
PM	Performance Measurement
RACH	Random Access Channel
RLF	Radio Link Failure
RO	RACH Optimization
RSCP	Received Signal Code Power
RSRP	Reference Signal Received Power
RSRQ	Reference Signal Received Quality
RTWP	Received Total Wideband Power
SON	Self Organizing Networks
TA	Timing Advance
UE	User Equipment

---

## 4 SON Policy and optimization function definitions

### 4.1 Monitoring and management operations for self-optimization

#### 4.1.1 Monitoring and management function

##### 4.1.1.1 Usage of Itf-N

For specifically defined Itf-N NRM Interface see clause 5.

### 4.2 Load balancing optimization function

#### 4.2.1 Objective and targets

The objective of LB Optimization is to cope with undesired traffic load distribution and to minimize the number of handovers and redirections needed to achieve the load balancing. One of the following targets or the combination of the following targets shall be used. The specific target value or values shall be configured by operators. Operators should assign weights for targets being used.

Targets drawn from the following table can be configured for LBO:

Target Name	Definition	Legal Values
RRC connection establishments failure rate related to load	The number of Failed RRC connection establishments related to load/ The total number of Attempted RRC connection establishments.  The target is met if the actual rate is smaller than the target value.	Integer [0..100] in unit percentage
E-RAB setup failure rate related to load	The number of E-RAB setup failure related to load/ The total number of attempted E-RAB setup  For E-RAB setup failure related to load, the causes "Reduce load in serving cell" and "Radio resources not available" defined in TS 36.413 [12] could be used.  The target is met if the actual rate is smaller than the target value.	Integer [0..100] in unit percentage
RRC Connection Abnormal Release Rate Related to Load	The number of abnormal RRC connection release related to load/ The total number of RRC connection release.  The target is met if the actual rate is smaller than the target value.	Integer [0..100] in unit percentage
E-RAB Abnormal Release Rate Related to Load	The number of E-RAB abnormal release related to load/ The total number of E-RAB release  For E-RAB setup failure related to load, the causes "Reduce load in serving cell" and "Radio resources not available" defined in TS 36.413 [12] could be used.  The target is met if the actual rate is smaller than the target value.	Integer [0..100] in unit percentage
Rate of failures related to handover	(the number of failure events related to handover) / (the total number of handover events)  The target is met if the actual rate is smaller than the target value.	Integer [0..100] in unit percentage

For the following targets out of the above table, the target values depend on the composite available capacity range in the cell and are defined separately for uplink and downlink. For these tuples can be configured, indicating the capacity ranges together with the target value valid in that range.

RRC connection establishments failure rate related to load,

E-RAB setup failure rate related to load,

RRC Connection Abnormal Release Rate Related to Load,

E-RAB Abnormal Release Rate Related to Load

For the following targets shall be identical with the corresponding targets defined in Handover Optimization.

Rate of failures related to handover

## 4.2.2 Parameters To Be Optimized

To reach load optimization target, LBO may optimize some mobility settings (HO and/or idle mobility configuration) defined in TS 36.331 [6].

### 4.2.3 Optimization method

#### 4.2.3.1 Problem detection

The problem detection is out of scope of this specification.

#### 4.2.3.2 Problem solution

The problem solution is out of scope of this specification.

## 4.2.4 Architecture

### 4.2.4.1 Definition of logical functions

**LB Monitor Function:** This function is used for monitoring the load balance optimization (e.g. Monitoring related performance counters or alarms).

**LB Policy control function:** This function is used for configuring the load balance optimization policies.

### 4.2.4.2 Location of logical functions

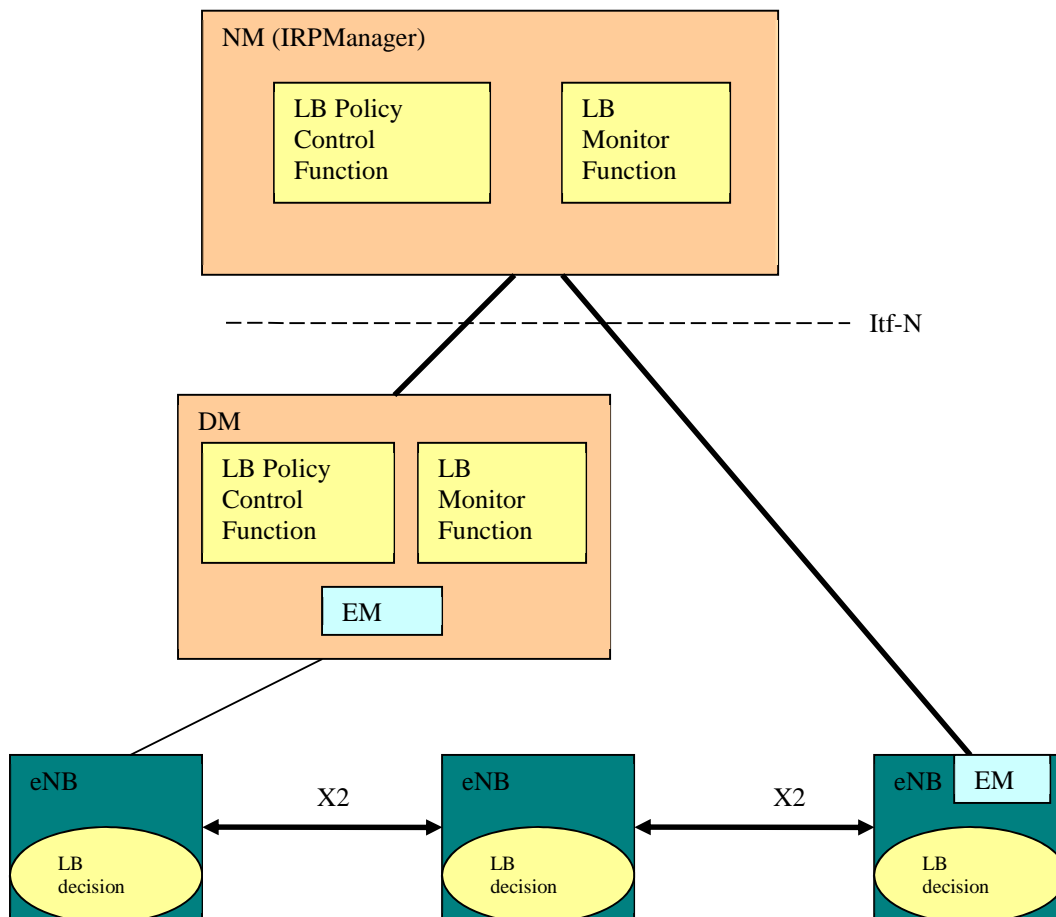

For Load Balancing, the SON LB decision algorithm is located in eNB. The detailed SON functionalities in eNB are out of scope of this specification.

## 4.2.5 PM

IRPManager may collect Load balancing related performance measurements. Performance Measurements related with Load balancing are captured in the table below:

Performance measurement name	Description	Related targets
The number of Failed RRC connection establishments related to load	Refer to 3GPP TS 32.425 [8] Failed RRC connection establishments	RRC connection establishments failure rate related to load
The total number of Attempted RRC connection establishments	Refer to 3GPP TS 32.425 [8] Attempted RRC connection establishments	RRC connection establishments failure rate related to load
The number of E-RAB setup failure related to load	Refer to 3GPP TS 32.425 [8] Number of initial SAE Bearers failed to setup	E-RAB setup failure rate related to load
The total number of attempted E-RAB setup	Refer to 3GPP TS 32.425 [8] Number of initial SAE Bearers attempted to setup	E-RAB setup failure rate related to load
The number of abnormal RRC connection release related to load	Number of UE CONTEXT Release Request initiated by eNodeB	RRC Connection Abnormal Release Rate Related to Load
The total number of RRC connection release	Number of Successful UE Context Release	RRC Connection Abnormal Release Rate Related to Load
The number of E-RAB abnormal release related to load	Refer to 3GPP TS 32.425 [8] Number of SAE Bearers requested to release initiated by eNodeB per cause	E-RAB Abnormal Release Rate Related to Load
The total number of E-RAB release	Refer to 3GPP TS 32.425 [8] Number of SAE Bearers successfully released	E-RAB Abnormal Release Rate Related to Load
the number of failure events related to handover	Refer to 4.3.5	Rate of failures related to handover
the total number of handover events	Refer to 4.3.5	Rate of failures related to handover

NOTE: The monitoring of performance measurements will make use of existing PM IRP.

## 4.3 Handover (HO) parameter optimization function

### 4.3.1 Objective and targets

For intra-LTE, one of the following targets or the combination of the following targets shall be used. The specific target value shall be configured by operators. Operators should assign weights for targets being used.

Target Name	Definition	Legal Values
Rate of failures related to handover	(the number of failure events related to handover) / (the total number of handover events)  The target is met if the actual rate is smaller than the target value.	Integer [0..100] in unit percentage

The objective of minimizing the number of unnecessary handovers shall always be pursued in case the other target/s configured by the operator is/are achieved. This objective may not need configuration of a target value.

### 4.3.2 Parameters To Be Optimized

The tables below summarise the handover parameters in TS 36.331 [6].

**Table 4.3.2-1. Handover parameters that may be optimized for intra-frequency and inter-frequency handovers**

Event	Summary	Tunable parameters
A3	Neighbour becomes offset better than serving	Ofn, Ofs, Ocn, Ocs, Hys, Off, timeToTrigger
A4	Neighbour becomes better than threshold	Ofn, Ocn, Hys, Thresh, Off, timeToTrigger
A5	Serving becomes worse than threshold1 and neighbour becomes better than threshold2	Ofn, Ocn, Hys, Thresh1, Thresh2, Off, timeToTrigger

**Table 4.3.2-2. Handover parameters that may be optimised for inter RAT handover**

Event	Summary	Tunable parameters
B1	Inter RAT Neighbour becomes better than threshold	Ofn, Hys, Thresh, timeToTrigger
B2	Serving becomes worse than threshold1 and inter RAT neighbour becomes better than threshold2	Ofn, Hys, Thresh1, Thresh2, timeToTrigger

### 4.3.3 Optimization method

#### 4.3.3.1 Problem detection

HO Parameter Optimization Function shall focus on detecting the problem scenarios described in TS 28.627 [5]; namely: too early handovers, too late handovers and inefficient use of NW resources due to HOs. For more information about these scenarios see TS 28.627 [5] section 6.1.3.

The following inputs may be used for the identification of the problem scenarios:

- Event capture and analysis
- UE measurements
- Performance measurements

In event capture and analysis, the eNodeB exploits event information associated with a UE context, such as evidence of previous handovers (UE History, see TS 36.423 [7]) and HO failure details (such as in which cell the handover failed and where the UE re-established the connection).

UE measurements are sent within UE measurement reports and they may indicate whether HOs are too early or too late.

HO-related performance measurements (PMs) collected at the source and / or target eNB can be useful in detecting HO-related issues on the cell level. Since the impact of incorrect HO parameter setting will also be on the cell-level, PMs can provide useful information that can be used to detect and resolve HO-related issues due to incorrect parameter settings.

#### 4.3.3.2 Problem solution

HO Parameter Optimization Function will aim at optimizing the HO parameters listed in Section 4.3.2 in such way to mitigate the problem scenarios discussed in Section 4.3.3.1. The optimization algorithms will not be specified. The exact set of HO parameters that may be adjusted by the algorithms is dictated by the choice of triggered HO measurements made by the RRM entity in an eNodeB.

### 4.3.4 Architecture

#### 4.3.4.1 Definition of logical functions

**HO Parameter Optimization Monitor Function:** This function is used for monitoring the handover parameter optimization (e.g. monitoring related performance counters or alarms).

**HO Parameter Optimization Policy Control Function:** This function is used for configuring the handover parameter optimization policies.

### 4.3.4.2 Location of logical functions

For HandOver (HO) parameter optimization there are several options for the location of the SON algorithm:

1. The SON algorithm is located in the eNB(s).
2. The SON algorithm is located in the EM, the parameter changes are executed in the eNBs.

An example for the first option is shown in figure 4.3.4.2:

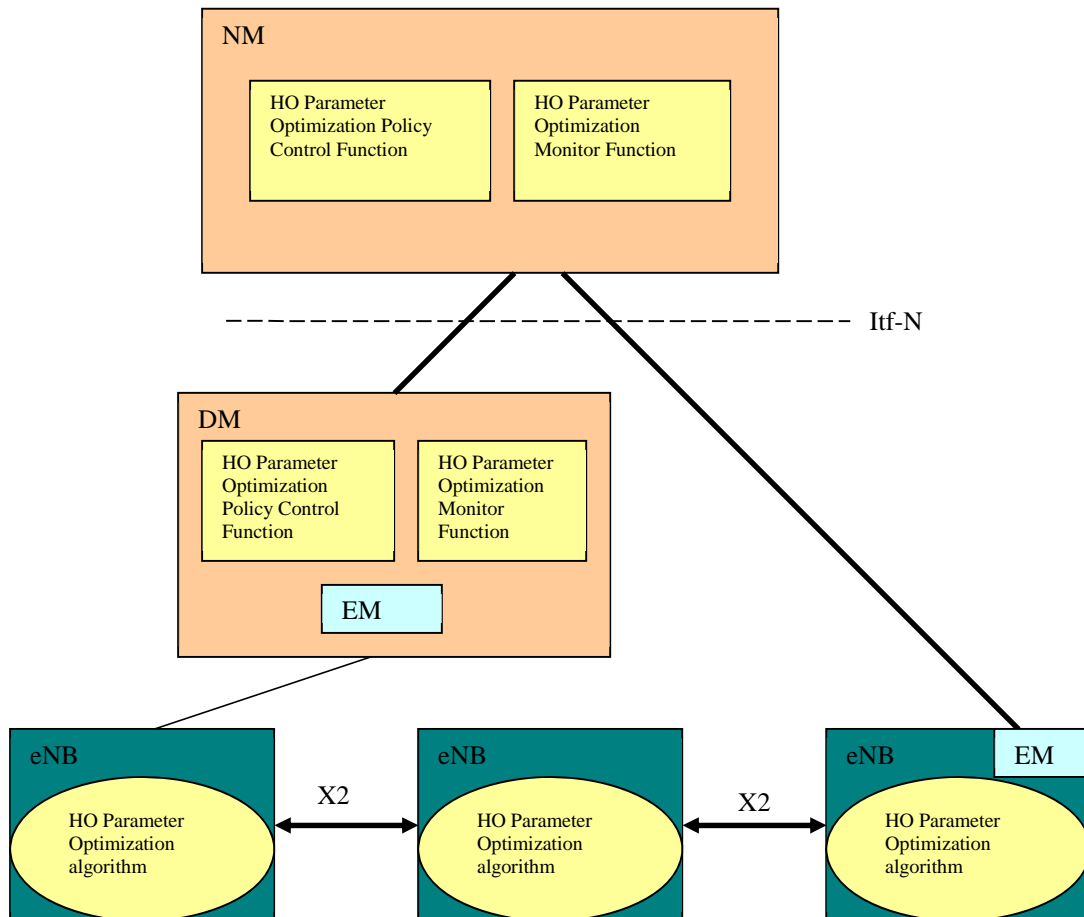

**Figure 4.3.4.2: Example when the SON algorithm is located in the eNB(s)**

The detailed SON functionalities in eNB are out of scope of this specification.

### 4.3.5 PM

IRPManager shall collect HO-related performance measurements from the source and / or target eNB which can be useful in detecting HO-related issues on the cell level. The following input can be used for the identification of the problem scenarios specified:

The number of RLF event happened within an interval after handover success.

The number of unnecessary handovers to another RAT without RLF.

Performance Measurements related to handover failure are captured in the table below.

The Performance Measurements are for outgoing handovers. Further, they should be available on a cell relation basis.

Performance measurement name	Description	Related targets
Number of handover events	Includes successful handovers plus all identified failures	Rate of failures related to handover
Number of HO failures	All failure cases	Rate of failures related to handover
Number of too early HO failures	Too early HO failure cases	Rate of failures related to handover
Number of too late HO failures	Too late HO failure cases	Rate of failures related to handover
Number of HO failures to wrong cell	HO failures to wrong cell	Rate of failures related to handover
Number of unnecessary HOs to another RAT	Unnecessary HOs to each of different RATs	

NOTE: The monitoring of performance measurements will make use of existing PM IRP.

## 4.4 Interference control function

## 4.5 Capacity and coverage optimization function

### 4.5.1 Objective and targets

The objective of capacity and coverage optimization is to provide optimal coverage and capacity for the radio network. A tradeoff between capacity and coverage needs to be considered.

The detailed target(s) FFS.

### 4.5.2 Parameters to be optimized

To reach capacity and coverage optimization targets, the following parameters may be optimized:

- Downlink transmit power
- Antenna tilt
- Antenna azimuth

### 4.5.3 Optimization method

#### 4.5.3.1 Problem detection

The main symptoms of capacity and coverage optimization problems (see TS 37.320 [15]) are:

**Coverage hole:** A coverage hole is an area where the pilot signal strength is below a threshold which is required by a UE to access the network, or the SINRs of both serving and neighbor cells is below a level needed to maintain the basic service. Coverage holes are usually caused by physical obstructions such as new buildings, hills, or by unsuitable antenna parameters, or just inadequate RF planning. UEs around coverage hole will suffer from call drop and radio link failure. Typical phenomenon of coverage hole is either HO failure happens frequently and cannot be optimized by HO parameter optimization or call drop happens frequently and cannot be rescued by RRC re-establishment.

**Weak coverage:** Weak coverage occurs when the pilot signal strength or the SNR (or SINR) of serving cell is below the level needed to maintain a planned performance requirement (e.g. cell edge bit-rate).

**Pilot pollution:** In areas where coverage of different cells overlap a lot, interference levels are high, power levels are high, energy consumption is high and cell performance may be low. Typically in this situation UEs may experience high SNR to more than one cell and high interference levels.

**Overshoot coverage:** Overshoot occurs when coverage of a cell reaches far beyond what is planned. It can occur as an “island” of coverage in the interior of another cell, which may not be a direct neighbor. Reasons for overshoot may be reflections in buildings or across open water, lakes etc. UEs in this area may suffer call drops or high interference.



**DL and UL channel coverage mismatch:** DL channel coverage is larger than UL channel coverage is one typical scenario of DL and UL channel coverage mismatch. The UE will suffer UL problems when it moves into the mismatch area.

In a realistic network, these symptoms may be tolerated to a certain level. These symptoms may indicate a real problem when combined with other factors such as frequency of symptoms, duration of symptoms, or affected population.

The following inputs may be used for the identification of the problem scenarios:

- UE measurements
- Performance measurements
- Alarms, other monitoring information e.g. trace data

UE measurements are sent within UE measurement reports and they may indicate the capacity and coverage problem.

Capacity and coverage related performance measurements collected at the source and / or target eNB can be useful in detecting capacity and coverage related issues on the cell level. Minimizing Driver Test (MDT) or HO-related performance measurements may be used also in detecting capacity and coverage related issues on the cell level.

Alarms, other monitoring information e.g. trace data can be correlated to get an unambiguous indication of capacity and coverage problem.

#### 4.5.3.2 Problem solution

Capacity and coverage optimization function will aim at optimizing the parameters listed in Section 4.5.2 in such way to mitigate the problem scenarios discussed in Section 4.5.3.1.

### 4.5.4 Architecture

#### 4.5.4.1 Definition of logical functions

**CCO Monitor Function:** This function is used for monitoring the capacity and coverage optimization (e.g. monitoring related performance counters, UE measurements or alarms).

**CCO Policy Control Function:** This function is used for configuring the capacity and coverage optimization policies.

#### 4.5.4.2 Location of logical functions

For capacity and coverage optimization (CCO), there are several options for the location of the centralized CCO SON algorithm:

- 1) The CCO SON algorithm is located in the DM. The capacity and coverage optimization decision is made by the DM centralized CCO algorithm.
- 2) The CCO SON algorithm is located in the NM. The capacity and coverage optimization decision is made by the NM centralized CCO algorithm.

An example for the first option is shown in figure 4.5.4.2-1:

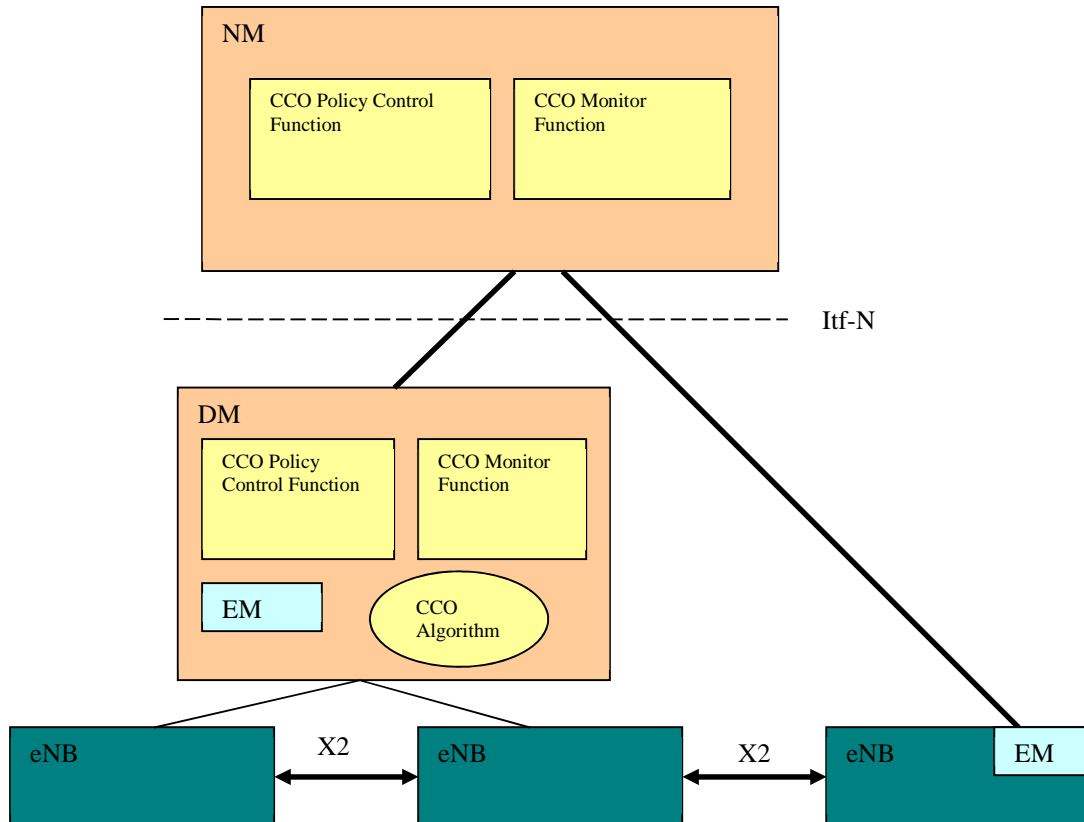

**Figure 4.5.4.2-1: Example when the CCO SON algorithm is located in DM**

An example for the second option is shown in figure 4.5.4.2-2:

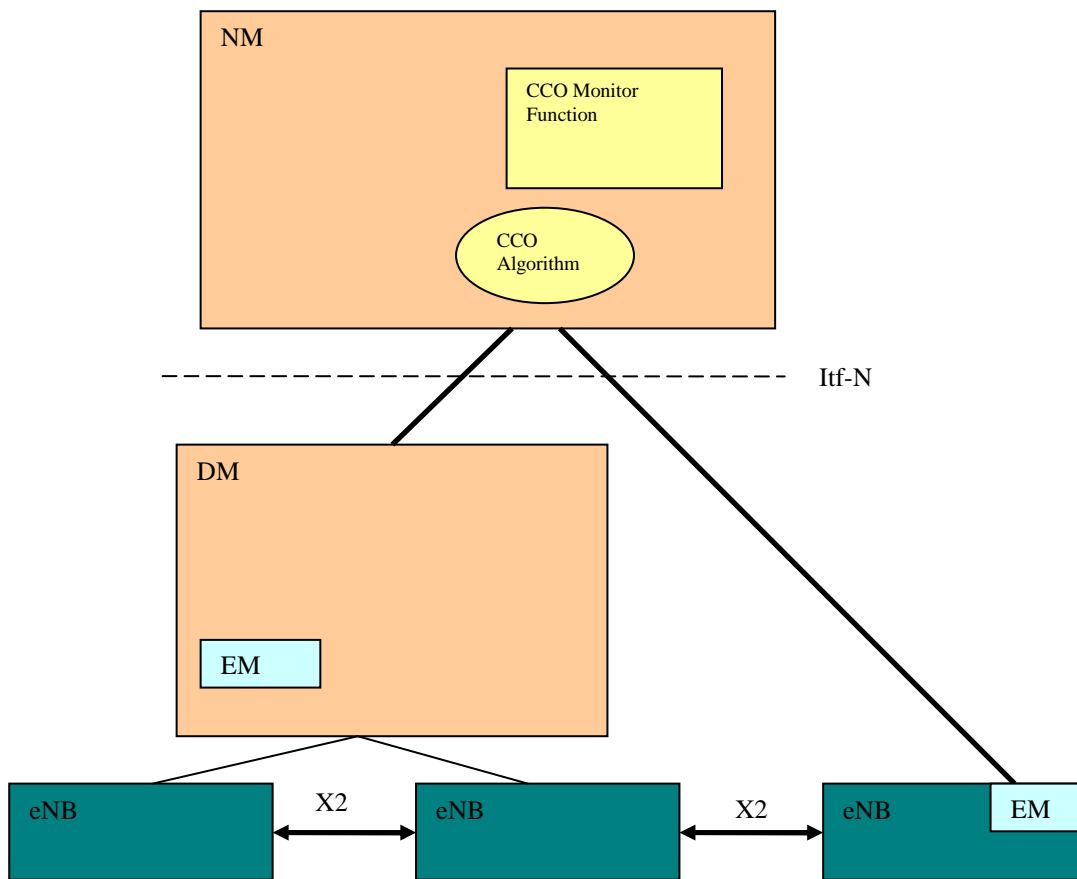

**Figure 4.5.4.2-2: Example when the CCO SON algorithm is located in NM**

The detailed CCO SON algorithm in OAM (NM centralized or EM centralized) is out of scope of this specification.

### 4.5.5 PM

The IRP Agent shall support a capability allowing the IRP Manager to collect CCO related performance measurements to know the situation of coverage or interference which may then trigger corresponding optimization procedures. Performance measurements related with CCO are captured in the tables 4.5.5-1 (E-UTRAN) and 4.5.5-2 (UTRAN) below:

**Table 4.5.5-1: E-UTRAN performance measurements for CCO**

Performance measurement name	Description	Comment
RSRP level	Refer to 3GPP TS 32.425 [8] RSRP related measurements.	
RSRQ level	Refer to 3GPP TS 32.425 [8] RSRQ related measurements.	
RACH usage	Refer to 3GPP TS 32.425 [8] - Mean number of RACH preambles received. - Distribution of RACH preambles sent. - Distribution of RACH access delay. - Percentage of contentious RACH attempts. - Number of UE RACH reports received. - Percentage of time when all dedicated RACH preambles are used.	
Power utilization	Refer to 3GPP TS 32.425 [8] - Maximum carrier transmit power. - Mean carrier transmit power.	
CQI distribution	Refer to 3GPP TS 32.425 [8] - Wideband CQI distribution - Average sub-band CQI.	
UE power headroom	Refer to 3GPP TS 32.425 [8] - UE power headroom related measurements.	
RRC connection related	Refer to 3GPP TS 32.425 [8] - Failed RRC connection establishments. - Attempted RRC connection establishments. - Number of UE CONTEXT Release Request initiated by eNodeB. - Successful UE CONTEXT Release.	
E-RAB related	Refer to 3GPP TS 32.425 [8] -Number of initial SAE Bearers failed to setup. -Number of initial SAE Bearers attempted to setup. -Number of SAE Bearers requested to release initiated by eNodeB per cause. -Number of SAE Bearers successfully released.	
PRB Usage	Refer to 3GPP TS 32.425 [8] - DL Total PRB Usage. - UL Total PRB Usage. - DL PRB full utilisation. - UL PRB full utilisation.	

**Table 4.5.5-2: UTRAN performance measurements for CCO**

Performance measurement name	Description	Comment
Signal strength and quality	Refer to 3GPP TS 32.405 [21] - P-CCPCH RSCP. - UTRAN RSCP.	
Received total wideband power	Refer to 3GPP TS 32.405 [21] - Mean Received Total Wideband Power of an UTRAN Cell. - Maximum Received Total Wideband Power of an UTRAN Cell.	

## 4.5.6 MDT measurements

The IRP Agent shall support a capability allowing the IRP Manager to collect CCO related MDT measurements to know the situation of coverage or interference which may then trigger corresponding optimization procedures. MDT measurements related with CCO are captured in the tables 4.5.6-1 (E-UTRAN) and 4.5.6-2 (UTRAN).

**Table 4.5.6-1: E-UTRAN MDT measurements for CCO**

MDT measurement name	Description	Comment
RLF	- Radio Link Failure events (refer to TS 36.331 [6], TS 32.423 [23]).	
Location	- CellId (refer to TS 36.331 [6], TS 32.422 [22], TS 37.320 [15], TS 32.423 [23]). - GNSS (refer to TS 36.331 [6], TS 32.422 [22], TS 37.320 [15], TS 32.423 [23]) - TA/AoA (refer to TS 36.133 [24], TS 32.422 [22], TS 37.320 [15], TS 32.423 [23]).	
UL Interference power	- M3: Received Interference Power measurement by eNB (Refer to 3GPP TS 32.422 [22], TS 37.320 [15]).	
RSRP and RSRQ level	- M1: RSRP and RSRQ measurement by UE (Refer to TS 32.422 [22]).	

**Table 4.5.6-2: UTRAN MDT measurements for CCO**

MDT measurement name	Description	Comment
Location	- CellId (refer to TS 32.422 [22], TS 37.320 [15]).	
Received total wideband power	- M5: Received total wideband power (RTWP) by Node B (refer to TS 32.422 [22]).	

## 4.6 RACH Optimization Function

### 4.6.1 Objective and targets

The objective of RACH Optimization is to automatically set several parameters related to the performance of RACH. One of the following targets shall be used. The specific target value shall be configured by operators.

Target Name	Definition	Legal Values
Access Probability, <i>AP</i>	The probability that the UE has access after a certain random access attempt number.  The target is met if the actual access probability is higher than the target probability value.	CDF of access attempts. See section 5.5.1
Access Delay Probability, <i>ADP</i>	The probability distribution of Access Delay expected to be experienced by UEs accessing the RACH Channel.  The target is met if the actual access probability is higher than the target probability value.	CDF of delays. See section 5.5.1

### 4.6.2 Parameters to be optimized

To achieve RACH optimization target, RACH optimization function may optimize several parameters defined in TS 36.300 [14] section 22.4.3.

### 4.6.3 Optimization method

#### 4.6.3.1 Problem detection

The problem detection is out of scope of this specification since the RACH optimization entity resides in the eNB.

#### 4.6.3.2 Problem solution

The problem solution is out of scope of this specification since the RACH optimization entity resides in the eNB.

### 4.6.4 PM

The IRPAgent shall support a capability allowing the IRPManager to collect RACH optimization related performance measurements. Performance measurements related with RACH optimization are captured in the table below:

Performance measurement name	Description	Related targets
Distribution of RACH preambles sent	Refer to 3GPP TS 32.425 [8] Cumulative Distribution of RACH preambles sent by UE	Access Probability, AP
Distribution of RACH access delay	Refer to 3GPP TS 32.425 [8] Cumulative Distribution of RACH Access Delay	Access Delay Probability, ADP

## 4.7 SON coordination

### 4.7.1 Introduction

There may be conflicts or dependencies between SON functions; SON coordination means preventing or resolving conflicts or negative influences between SON functions to make SON functions comply with operator’s policy.

As the example shown in figure 4.7.1.1, there is mesh relationship between SON functions and network parameters (or network elements) in which conflicts or negative influences may happen if no SON coordination.

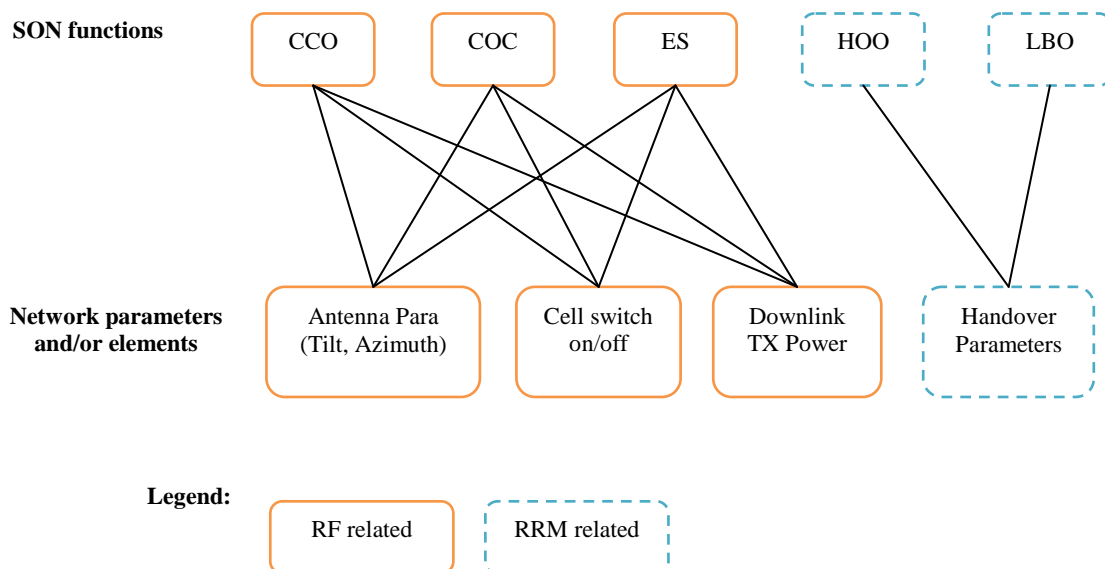

**Figure 4.7.1.1: Mesh relationship between SON functions and network parameters (or network elements)**

## 4.7.2 Coordination between SON functions below Itf-N and non-SON CM operations over itf-N

### 4.7.2.1 Description

Conflict may arise between non-SON CM operation via Itf-N and the SON functions (in particularly self-optimization function) below Itf-N in the following scenario.

The network parameters can be changed by the non-SON CM operations via Itf-N, meanwhile, the SON functions below Itf-N may also require changing the parameters. If these parameters are some (same or associated) parameters of some (same or associated) nodes which will be changed by the non-SON CM operations and the SON functions below Itf-N, conflict arises. (Conflict see clause 4 of 28.627[5])

For example, the non-SON CM operation via Itf-N may try to reduce the CIO (cell individual offset) parameter, it makes the HO trigger between cells (e.g., HO from cell A to cell B) become more difficult. But in the meanwhile, the SON function MRO may try to increase the CIO parameter, it makes the HO easier. In this case, if the conflict is not coordinated, the parameter may be modified twice. Then the failed rate related with handover may rise or ping-pong handover may arise between the two cells.

In case the SON function below Itf-N and non-SON CM operation via Itf-N has conflict, the SON function below Itf-N shall take into account and re-evaluate, if applicable, any non-SON CM operation changes via Itf-N.

As showing in the following example, At Time T3, after Non-SON operation has finished the modification, SON function below Itf-N shall take the non-SON CM operation changes into account for further SON analysis.

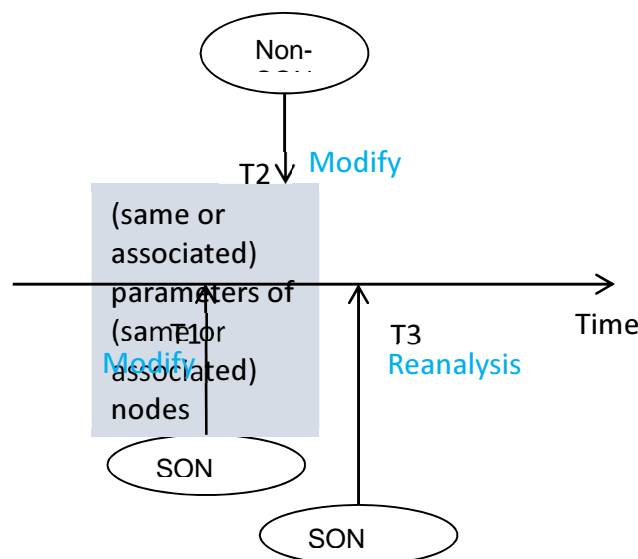

### 4.7.2.2 Prevention

In a real network, it is possible that non-SON CM operations via Itf-N and several SON functions below Itf-N are running at the same time, and they may try to change the same or associated parameters during a short time period. So coordination is needed to prevent this kind of conflicts.

### 4.7.2.3 Resolution

Refer to common coordination solutions part.

## 4.7.3 Coordination between different SON functions

### 4.7.3.0 General

NOTE: The coordination between different SON functions should be decided case by case.

### 4.7.3.1 Coordination between Cell Outage Compensation and Energy Saving Management

#### 4.7.3.1.1 Description

A conflict could arise between energy saving and cell outage compensation in the following scenario.

One or more candidate cells are configured to possibly take coverage of the original cell. The original cell is in energySaving state or is about to enter energySaving state. One or more candidate cells go into outage with the consequence that coverage of the original cell can not be provided any more.

#### 4.7.3.1.2 Prevention

Prevention is hardly possible, except making the cells as outage proof as possible. But cell outages can happen even to the most stable cell in a network.

#### 4.7.3.1.3 Resolution

If the original cell is in energySaving state, it shall leave energySaving state.

If the original cell is about to enter energySaving state, it shall not go into energySaving state until candidate cell outage is recovered and candidate cell is able to provide the coverage.

The original cell may go into the energySaving state after the candidate cell outage is recovered and coverage of the original cell can be taken over by candidate cell again.

### 4.7.3.2 Coordination among Cell Outage Compensation, Capacity and Coverage Optimization, and Energy Saving Management

#### 4.7.3.2.1 Description

Capacity and Coverage Optimization (CCO), Cell Outage Compensation (COC) and Energy Saving Management (ESM) may require changes to the coverage and/or capacity of one or more cells during the same time period, which could lead to the following issue:

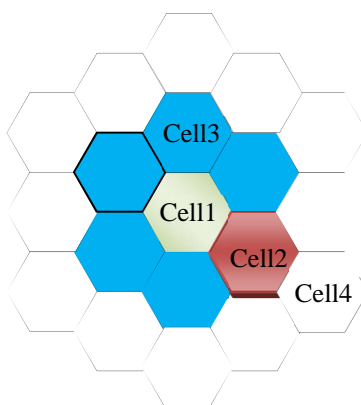

**Figure 4.7.3.2 Coordination among COC, CCO, and ESM**

Figure 4.7.3.2 is a typical scenario for the coordination among COC, CCO and ESM.

Cell 1 is detected in outage, COC will try to compensate the outage Cell 1 by reconfiguring the RF configuration of some compensation candidate cells, e.g., TX power, antenna tilt and antenna azimuth of Cell 2 and Cell 3.

Before the outage Cell 1 is compensated, CCO may detect the degrading of coverage related KPI (e.g., success rate of RRC connection establishments, cell throughput) of Cell 1 and its neighbour cells (Cell 2 and other blue cells) and make a conclusion that there is a coverage problem in this KPI degraded area.

Meanwhile, ESM is operating on Cell 2 to compensate the coverage of its neighboring cell (Cell 4) which is going into energySaving state.



From the time point at which the outage Cell 1 is detected until Cell 1 has been compensated by Cell 2 and Cell 3, during this period, if there is no coordination among COC, CCO and ESM, there will be possibly different settings for adjusting TX power, antenna tilt and antenna azimuth of Cell 2 for COC, CCO or ESM purposes respectively. It's most likely that the adjustment from COC, ESM and optimization from CCO may conflict in the common affected outage compensation candidate cell(s) (Cell 2 in the above example).

It is also possible that ESM is operating on Cell 2 to compensate the coverage of Cell 4 that is in energySaving state, while COC detects that Cell 1 has outage, and requests Cell 2 to compensate the coverage of Cell 1. COC and ESM need to be coordinated to determine if this request can be accepted.

After the outage cell comes back to normal, the COC exits the coordination scenario, while CCO and ESM continue to work and need to be well coordinated. For example, CCO may adjust the antenna tilt of Cell 2 in a downward direction to improve the coverage signal quality, but ESM may adjust the antenna tilt of Cell 2 in an opposite direction to enlarge its coverage area for purpose of ES compensation. Therefore, coordination should be continued between CCO and ESM to resolve the possible configuration conflict on Cell 2.

Other conflict scenarios could be:

Cell A is compensating to provide coverage for Cell B that is in energySaving state. COC detects that Cell A has outage. Since Cell A is not able to provide the coverage for Cell B any more, Cell B needs to be covered by another cell, or to deactivate energy saving.

Cell A is in energySaving state. COC detects Cell B has outage, and requests Cell A to compensate the coverage of Cell B. Cell A may need to terminate energy saving in order to compensate the coverage of Cell B.

Cell A which is compensating Cell B in outage shall not go into energySaving state as long as its compensation for Cell B is needed.

#### 4.7.3.2.2 Prevention

Prevention is hardly possible.

#### 4.7.3.2.3 Resolution

Refer to clause 4.7.4 General SON coordination solutions.

### 4.7.3.3 Coordination between Cell Outage Compensation and Automatic Neighbour Relation

#### 4.7.3.3.1 Description

In case one cell is detected in outage, COC will try to compensate the outage cell by reconfiguring the RF configuration of some compensation candidate cells. As a result of this, there will be new NRs (neighbour relations) which reflect the new topology relations.

For a stable network, ANR could be deactivated for the purpose of system resource saving. If ANR is deactivated, the new NRs cannot be captured in NRT by ANR. Network performance, for example, handover will be impacted negatively by the NRT which lacks of the new NRs.

#### 4.7.3.3.2 Prevention

Prevention is hardly possible, except making the cells as outage proof as possible. But cell outages can happen even to the most stable cell in a network.

#### 4.7.3.3.3 Resolution

The ANR function should monitor if a cell outage or cell outage compensation takes place within its area. If this happens, then the ANR function should check the NRs of the affected cells (for example the outage cell and its neighbours and neighbours' neighbours). In case the ANR function in the the affected area is deactivated, the possible NRs change of the affected cells should be taken as a factor to reactivate the ANR function.

#### 4.7.3.4 Coordination between HandOver parameter Optimization and Load Balancing Optimization

##### 4.7.3.4.1 Description

HOO function and LBO function both optimize network performance by adjusting handover parameters such as CIO, Hysteresis, TTT, etc. Conflicts may happen when HOO function and LBO function are changing the same or associated handover parameters in opposite direction or towards the same direction but on different scales.

For example, HOO function may adjust handover parameters (e.g. *decrease* CIO of source cell A to target cell B) to minimize the number of too early handovers from cell A to cell B whilst LBO function may adjust handover parameters (e.g. *increase* the CIO of source cell A to target cell B) to make the handover from cell A to cell B more easier in case the load of cell B is much less than cell A.

##### 4.7.3.4.2 Prevention

Prevention is hardly possible unless switch off HOO function or LBO function. However, disabling the complete HOO function or LBO function cannot fulfil the requirement that both handover performance and load performance need to be improved at the same time.

##### 4.7.3.4.3 Resolution

For the coordination between HOO and LBO, IRPManager should assign priorities for HOO function and LBO function or weights for targets of HOO function and LBO function according to operator's policy.

The policy should cover different scenarios well:

- Policy may assign higher priority for HOO function than LBO function or higher weight for target of HOO function than targets of LBO function when resolving MRO issues (HO too early/too late/to wrong cell) is the main objective of network optimization, e.g. in handover optimization scenario for better coverage.
- Policy may assign lower priority for HOO function than LBO function or lower weight for target of HOO function than targets of LBO function when enhancing load performance is the main objective of network optimization, e.g. in load optimization scenario for better capacity.

Concrete way of using priority or weights of targets, refers to clause 4.7.4 General SON coordination solutions.

### 4.7.4 General SON coordination solutions

#### 4.7.4.1 Overview

As described in TS 28.627 [5], multiple SON functions may have conflicting demands on network resources. This situation is considered as "SON functions in conflict" and requires conflict prevention or resolution. A SON Coordination Function will be responsible for preventing or resolving conflicts.

Conflict needs to be detected when there is "SON functions in conflict". Policies can be preset by operator to SON Coordination Function to avoid conflict on certain associated resources (network elements and/or parameters) among SON functions.

Conflict prevention is to take some advanced methods to prevent the occurrence of conflict. However, no matter what implementation is chosen, it is impossible to guarantee that 100% of conflicts will be prevented, so conflict detection and resolution are needed. Conflict detection should be taken firstly as the pre-condition of conflict resolution.

The SON Coordination Function is a logical function, which means it can be implemented as a separate function entity or as part of SON function.

When the SON Coordination Function is implemented as a separate function entity, all the SON functions send the necessary information to the SON Coordination Function, the SON Coordination Function coordinate these SON functions as a centralized control point. This centralized coordination approach fulfills the requirements of SON coordination in a large area scope, for example, the coordination between NM centralized SON functions and distributed SON functions.

In some other situations, coordination is only needed in a smaller area, for example, the coordination between distributed SON functions inside one domain. Then the SON Coordination Function can be implemented as part of each SON function. The necessary coordination information can be inter-exchanged between each SON functions to achieve coordination as well.

The SON Coordination Function may reside above or below Itf-N. Figure 4.7.4.1 shows an example of a SON Coordination Function, which is a separate function entity, above Itf-N.

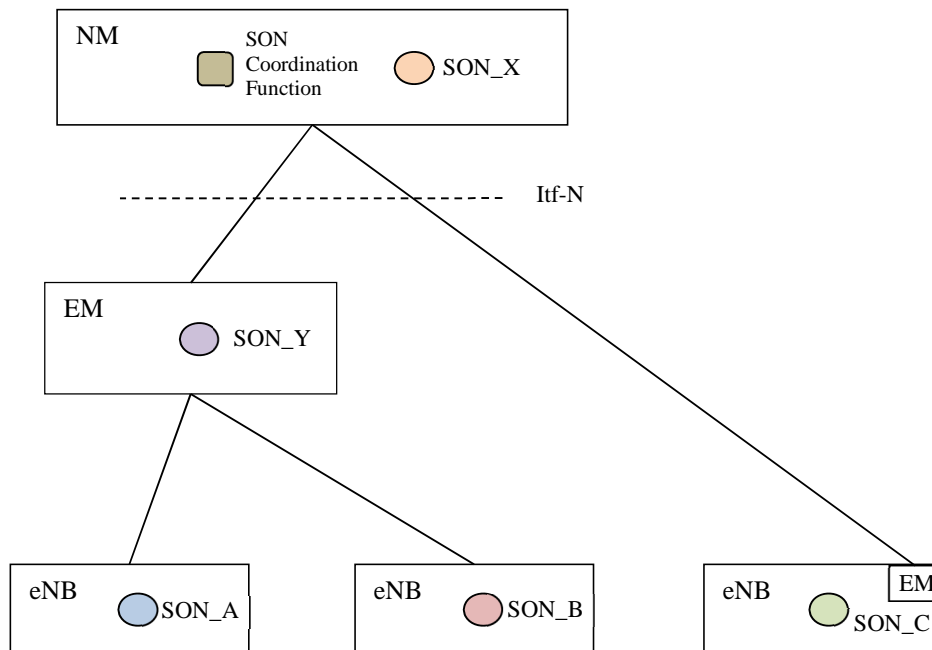

**Figure 4.7.4.1: Example of SON Coordination entity located in NM**

The SON Coordination Function may be responsible for conflict prevention, conflict resolution, or both in parallel.

#### 4.7.4.2 Conflict prevention

To prevent conflicts between the SON functions, the SON functions may ask the SON Coordination function for permission before changing some specific configuration parameters. The SON Coordination Function should check the SON coordination interdependency policy between this requesting SON function and other SON function(s) upon receiving the permission request from the SON function. SON coordination interdependency policy which is pre-configured can help the SON Coordination Function to find which SON function(s) possibly conflict with this requesting SON function.

As a basis for decisions, the SON Coordination Function will typically use one or some of the following inputs received from the SON function(s)

- Which SON functions are modifying configuration parameters (including information about vendor, release etc.)
- Configuration parameters intended to be changed and/or their existing and proposed new values
- The time duration how long the configuration parameter should not be interfered with (“impact time”)
- The state of SON functions
- The SON targets which are the justification for the configuration change.
- Possible impact of a parameter change on other objects (“impact area”)
- The state of certain managed objects
- Possible impact of the parameter change on Key Performance Indicators

- Priority of SON functions, which can be used to determine the execution order of requests from different SON functions in case of conflicts
- SON coordination policies

The SON Coordination Function sends the decision back to the requesting SON function; the decision may be confirmation or suspension or rejection of the SON executing request, or other actions like configuration of specific parameters with specific value.

After SON function executes action, the SON Coordination Function is then informed about the result (successful/unsuccessful, parameters changes) of the executed SON action.

The SON Coordination Function may prevent parameter changes by one or more SON functions for a specified time period after the same parameter has been changed by another SON function.

The SON Coordination Function may inform a SON Function of a managed object state change which may impact calculation of KPIs.

Detailed description of how to use general SON coordination solutions are in Annex B.

#### 4.7.4.3 Conflict resolution

The SON Coordination Function should detect conflicts and attempt to resolve the conflicts.

To detect conflicts, the SON Coordination Function will typically analyse one or some of the following types of data

- Key Performance Indicators which indicate if SON functions are meeting their targets or improving network performance
- Measurements which indicate if SON functions are meeting their targets or improving network performance
- Unacceptable oscillations in configuration parameters

To resolve conflicts, the SON Coordination Function will typically use one or some of following methods

- Enabling/disabling/suspending certain SON functions
- Stopping/suspending/modifying certain SON actions
- Modifying certain configuration parameters

## 4.8 SON for AAS management

### 4.8.1 Objective and targets

The objective of SON for AAS management is to perform AAS operations (i.e. Cell Splitting, Cell Merging, Cell Shaping) in automated manner, and the new split/merged cells or shaped cells can be configured and optimized automatically with no or minimum service interrupt.

One of the following targets or the combination of the following targets shall be used. The specific target value or values shall be configured by operators. Operators should assign weights for targets being used.

Table 4.8.1-1. Targets related to SON for AAS management

Target Name	Definition	Legal Values
PDCP data volume load rate	(DL cell PDCP SDU Data Volume + UL cell PDCP SDU Data Volume) / nominal capacity of PDCP data volume  The target is met if the actual rate is inside the target value range.	Integer [0..100] in unit of percentage
IP throughput load rate	(IP Throughput in DL + IP Throughput in UL) / nominal capacity of IP Throughput  The target is met if the actual rate is inside the target value range	Integer [0..100] in unit of percentage
Active UE amount load rate	(Average number of active UEs on the DL + Average number of active UEs on the UL) / nominal capacity of Active UE amount  The target is met if the actual rate is inside the target value range	Integer [0..100] in unit of percentage
Rate of failures related to handover	(the number of failure events related to handover) / (the total number of handover events)  The target is met if the actual rate is smaller than the target value.	Integer [0..100] in unit of percentage

## 4.8.2 Parameters to be optimized

To reach AAS optimization targets, the following parameters may be considered in SON for AAS algorithm:

- Downlink transmit power
- Antenna downlink tilt and/or beam width
- Reference signal power

## 4.8.3 Optimization method

### 4.8.3.1 Problem detection

The problem detection is out of scope of this specification.

### 4.8.3.2 Problem solution

The problem solution is out of scope of this specification.

## 4.8.4 Architecture

### 4.8.4.1 Definition of logical functions

**AAS Monitor Function:** This function is used for monitoring the AAS optimization (e.g. monitoring related performance counters or alarms).

**AAS Policy Control Function:** This function is used for configuring the AAS optimization policies.

### 4.8.4.2 Location of logical functions

For AAS, there are several options for the location of the SON for AAS algorithm:

- 1) The SON for AAS algorithm is located in the eNB(s).
- 2) The SON for AAS algorithm is located in the EM/DM level, the AAS optimization decision is made by the EM/DM centralized SON for AAS algorithm.
- 3) The SON for AAS algorithm is located in the NM level, the AAS optimization decision is made by the NM centralized SON for AAS algorithm.

An example for the first option is shown in figure 4.8.4.2-1:

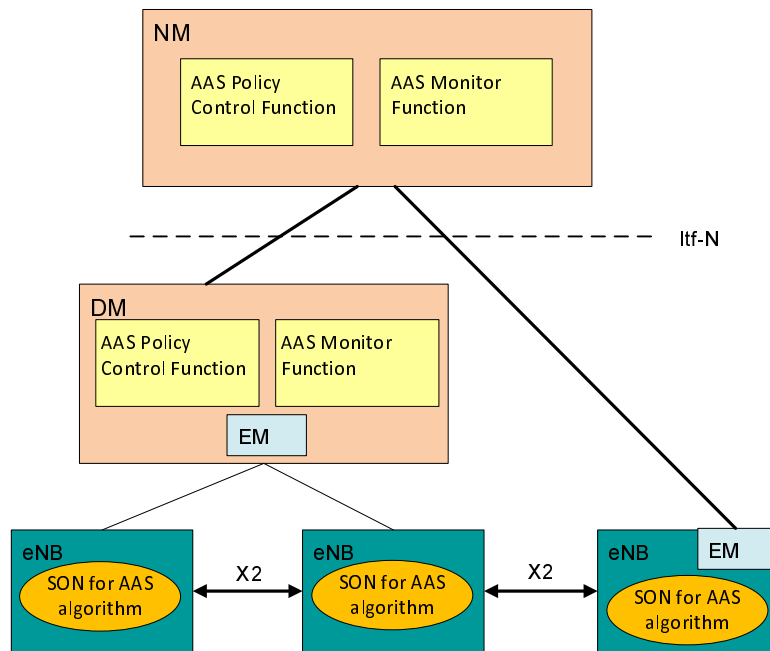

**Figure 4.8.4.2-1: Example when the SON for AAS algorithm is located in the eNB(s)**

The detailed SON functionalities in eNB are out of scope of this specification.

### 4.8.5 PM

The IRPAgent shall support a capability allowing the IRPManager to collect AAS related performance measurements to know the situation of coverage or performance, which may then trigger relevant OAM coordination operations, or corresponding AAS operations (i.e. Cell Splitting, Cell Merging, Cell Shaping) if NM centralized SON for AAS option is used. Performance measurements related with AAS are captured in the table below:

**Table 4.8.5-1. Performance measurements related to SON for AAS management**

<b>Performance measurement name</b>	<b>Description</b>	<b>Related targets</b>
DL cell PDCP SDU Data Volume	Refer to 3GPP TS 32.425 [8] Data volume in the DL delivered from PDCP layer to RLC layer	PDCP data volume load rate
UL cell PDCP SDU Data Volume	Refer to 3GPP TS 32.425 [8] Data volume in the UL delivered from PDCP layer to RLC layer	PDCP data volume load rate
IP Throughput in DL	Refer to 3GPP TS 32.425 [8] IP throughput in downlink	IP Throughput load rate
IP Throughput in UL	Refer to 3GPP TS 32.425 [8] IP throughput in uplink	IP Throughput load rate
Average number of active UEs on the DL	Refer to 3GPP TS 32.425 [8] average number of UEs that have DTCH data queued on the downlink	Active UE amount load rate
Average number of active UEs on the UL	Refer to 3GPP TS 32.425 [8] average number of UEs that have DTCH data queued on the uplink	Active UE amount load rate
Attempted outgoing handovers per handover cause	Refer to 3GPP TS 32.425 [8] number of attempted outgoing handovers per handover cause and LTE target cell specific.	Rate of failures related to handover
Successful outgoing handovers per handover cause	Refer to 3GPP TS 32.425 [8] number of successful outgoing handovers per handover cause and LTE target cell specific	Rate of failures related to handover
Attempted outgoing intra-eNB/RN handovers per handover cause	Refer to 3GPP TS 32.425 [8] number of attempted outgoing intra-eNB/RN handovers per handover cause	Rate of failures related to handover
Successful outgoing intra-eNB/RN handovers per handover cause	Refer to 3GPP TS 32.425 [8] number of successful outgoing intra-eNB/RN handovers per handover cause	Rate of failures related to handover
Attempted outgoing inter-eNB handover preparation	Refer to 3GPP TS 32.425 [8] number of attempted outgoing inter-eNB handover preparations	Rate of failures related to handover
Attempted outgoing inter-eNB handover executions per handover cause	Refer to 3GPP TS 32.425 [8] number of attempted outgoing inter-eNB handovers per handover cause	Rate of failures related to handover
Successful outgoing inter-eNB handover executions per handover cause	Refer to 3GPP TS 32.425 [8] number of successful outgoing inter-eNB handovers per handover cause	Rate of failures related to handover

# 5 Model

## 5.1 Imported information entities and local labels

Label reference	Local label
3GPP TS 28.622 [9], IOC, Top	Top
3GPP TS 28.622 [9], IOC, SubNetwork	SubNetwork
3GPP TS 28.658 [10], IOC, ENBFunction	ENBFunction
3GPP TS 28.658 [10], IOC, EUTRANRelation	EUTRANRelation
3GPP TS 28.658 [10], IOC, EUTRANGenericCell	EUTRANGenericCell

## 5.2 Class diagrams

### 5.2.1 Relationships

This subclause depicts the set of classes (e.g. IOCs) that encapsulates the information relevant for this IRP. This subclause provides the overview of the relationships of relevant classes in UML. Subsequent subclauses provide more detailed specification of various aspects of these classes.

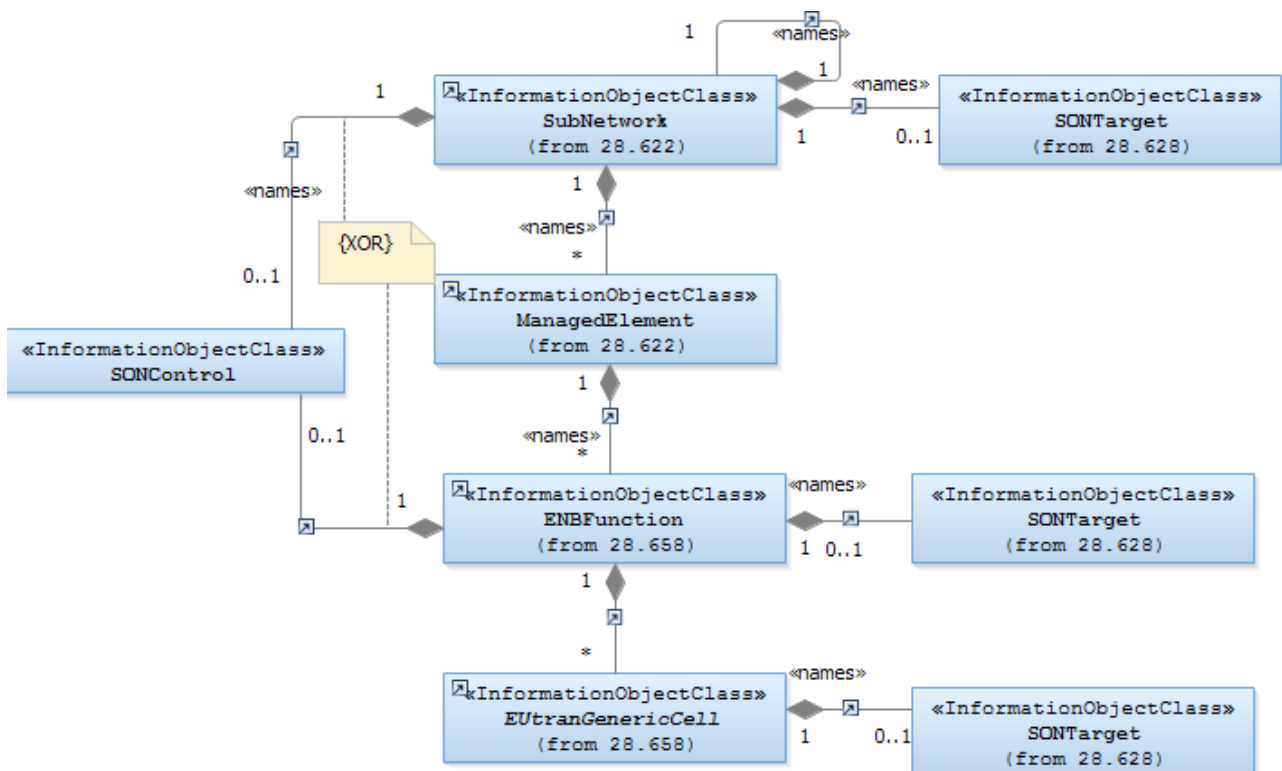

NOTE 1: IOC SONControl shall be instantiated whenever one or more IOC SONTargets are instantiated.

Figure 5.2.1-1: Cell view of SON Policy NRM



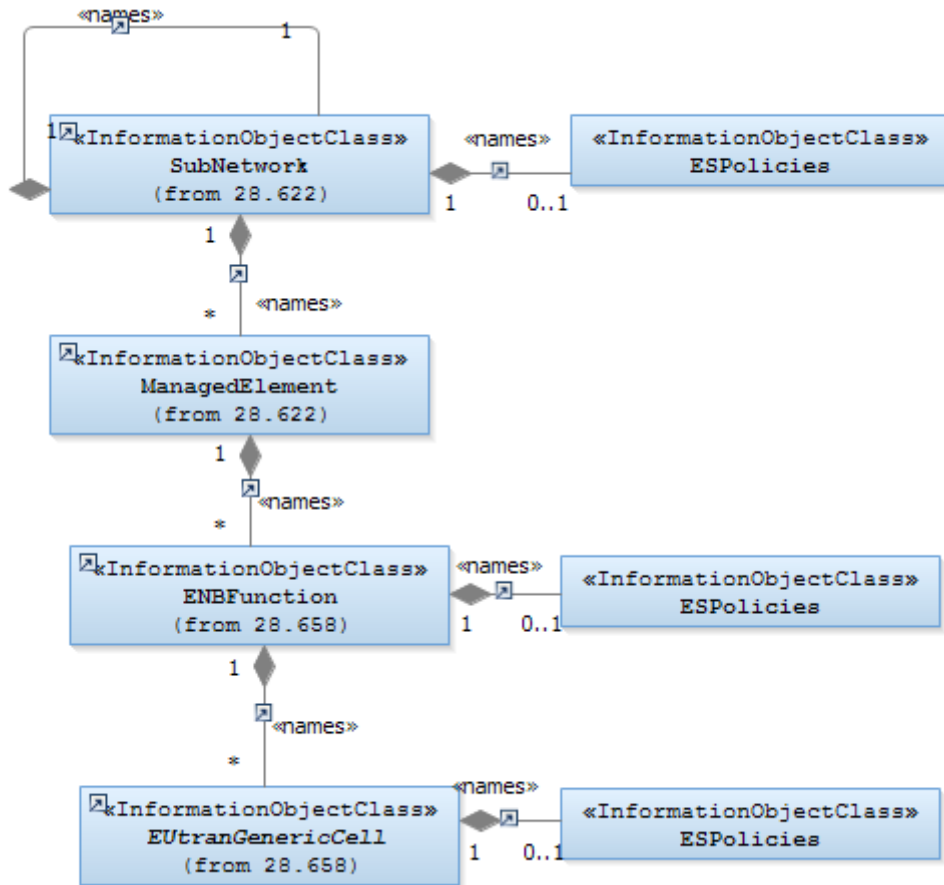

Figure 5.2.1-2: ES Policies NRM IOCs (Containment Relationship)

NOTE 2: Also IOC SONControl is used for intra-LTE ES purposes – see clause 5.3.2.2 – but is not shown in Figure 5.2.1-2 to avoid the impression that there would an additional instance of this IOC be needed for intra-LTE ES.

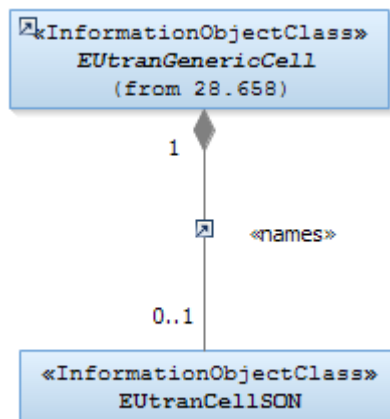

Figure 5.2.1-3: IOCs to control SON on cell level (Containment Relationship)

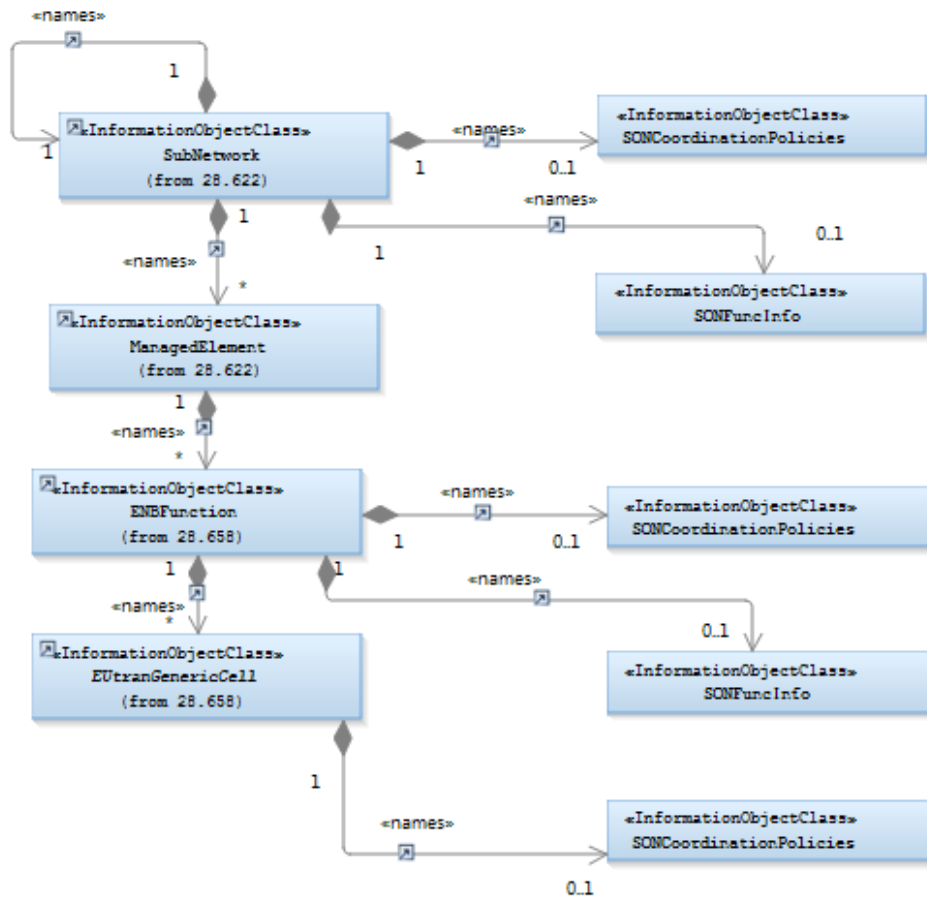
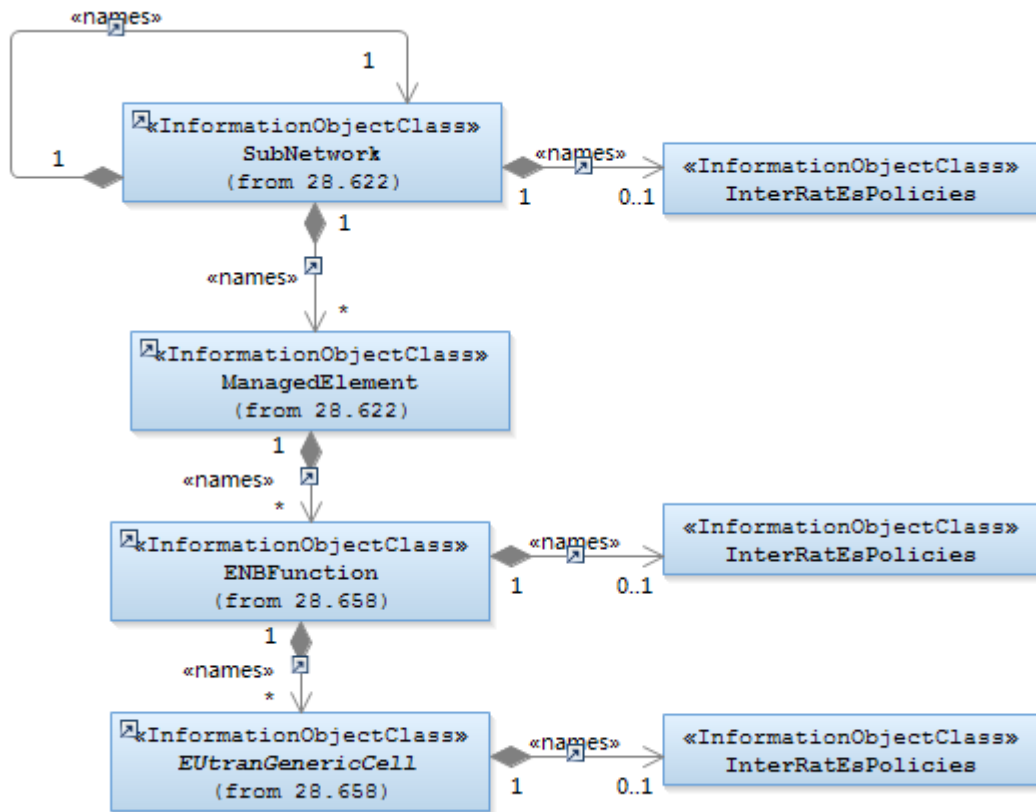

Figure 5.2.1-4: IOCs for SON coordination (Containment Relationship)



**Figure 5.2.1-5: Inter-RAT ES Policies NRM IOCs (Containment Relationship, part 1)**

NOTE 3: Also IOC SONControl is used for inter-RAT ES purposes – see clause 5.3.2.2 – but is not shown in Figure 5.2.1-5 to avoid the impression that there would an additional instance of this IOC be needed for inter-RAT ES.

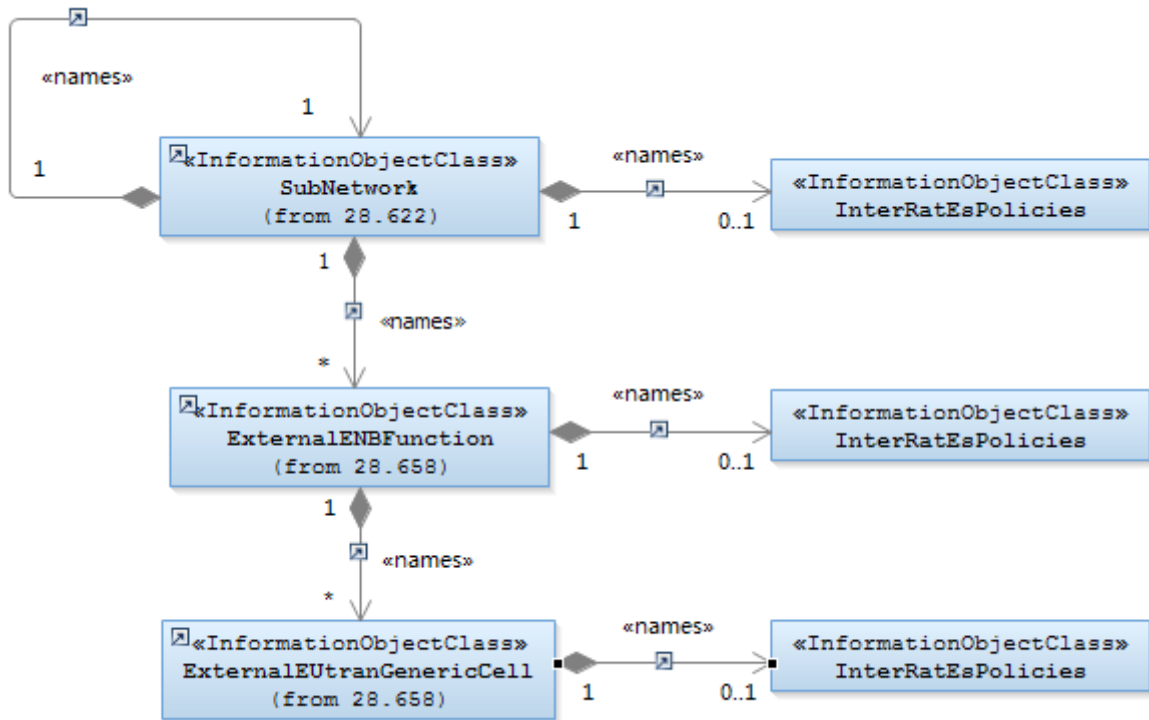

Figure 5.2.1-6: Inter-RAT ES Policies NRM IOCs (Containment Relationship, part 2)

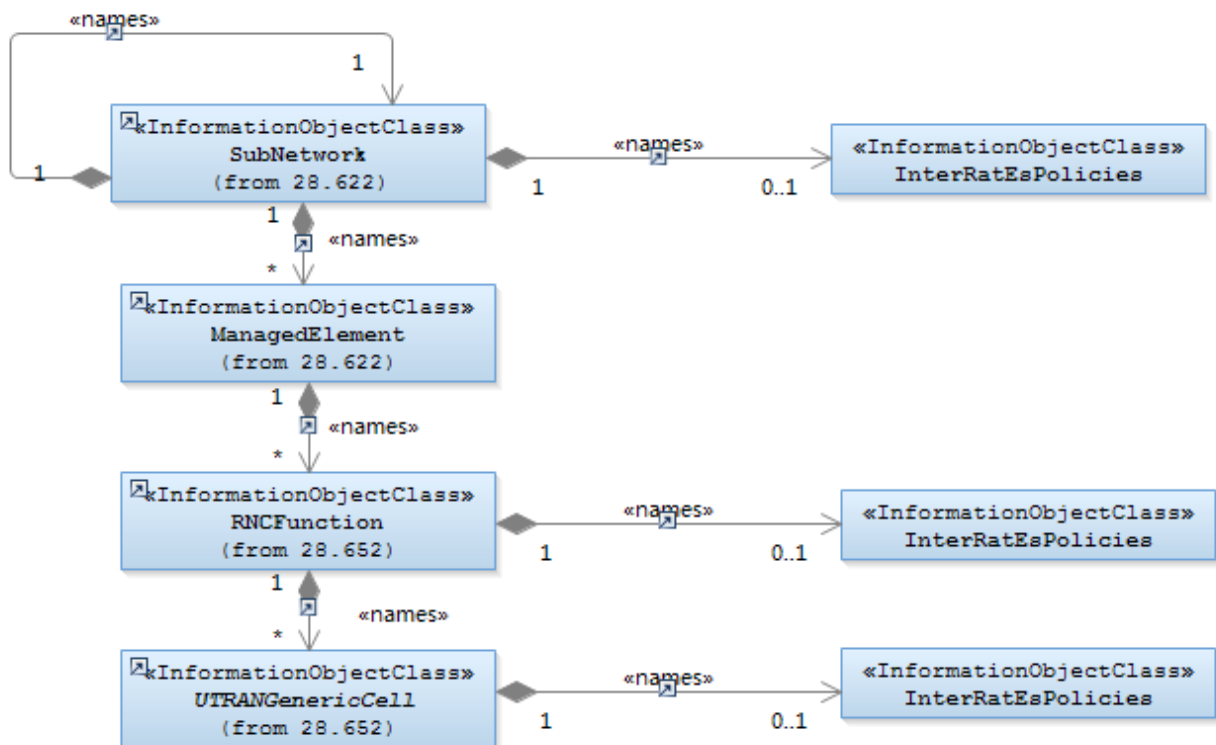

Figure 5.2.1-7: Inter-RAT ES Policies NRM IOCs (Containment Relationship, part 3)

NOTE 4: Also IOC SONControl is used for inter-RAT ES purposes – see clause 5.3.2.2 – but is not shown in Figure 5.2.1-7 to avoid the impression that there would an additional instance of this IOC be needed for inter-RAT ES. SONControl is contained by Subnetwork or RncFunction when esSwitch attribute is applied in SONControl.

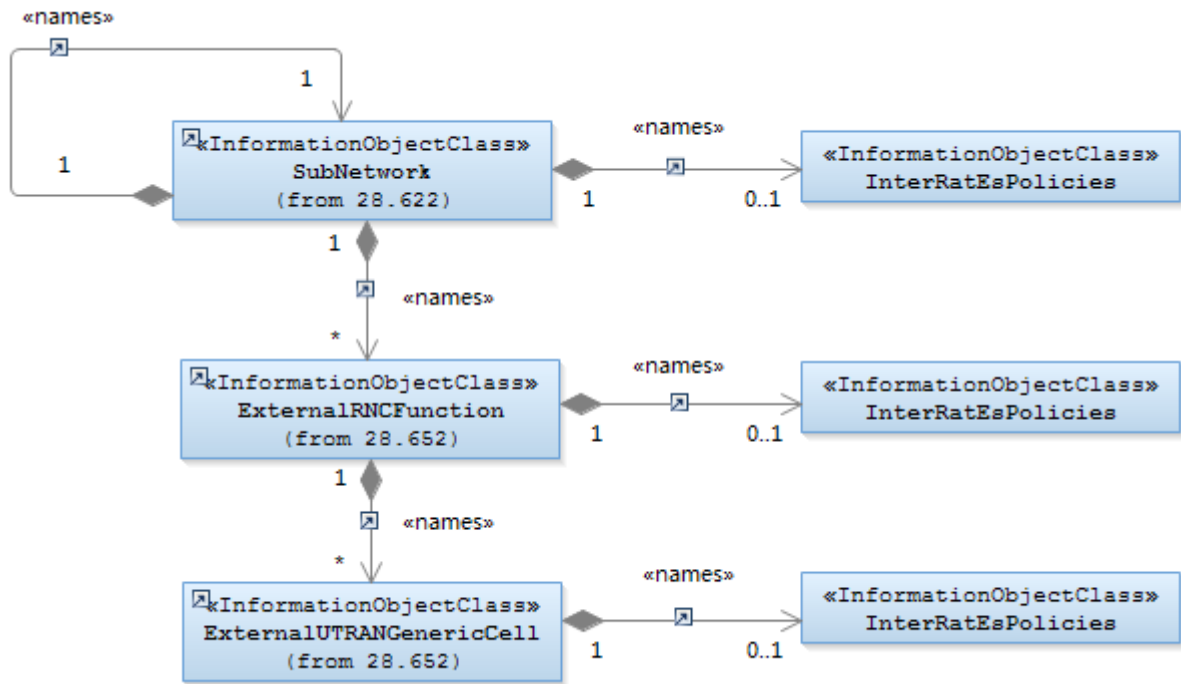

Figure 5.2.1-8: Inter-RAT ES Policies NRM IOCs (Containment Relationship, part 4)

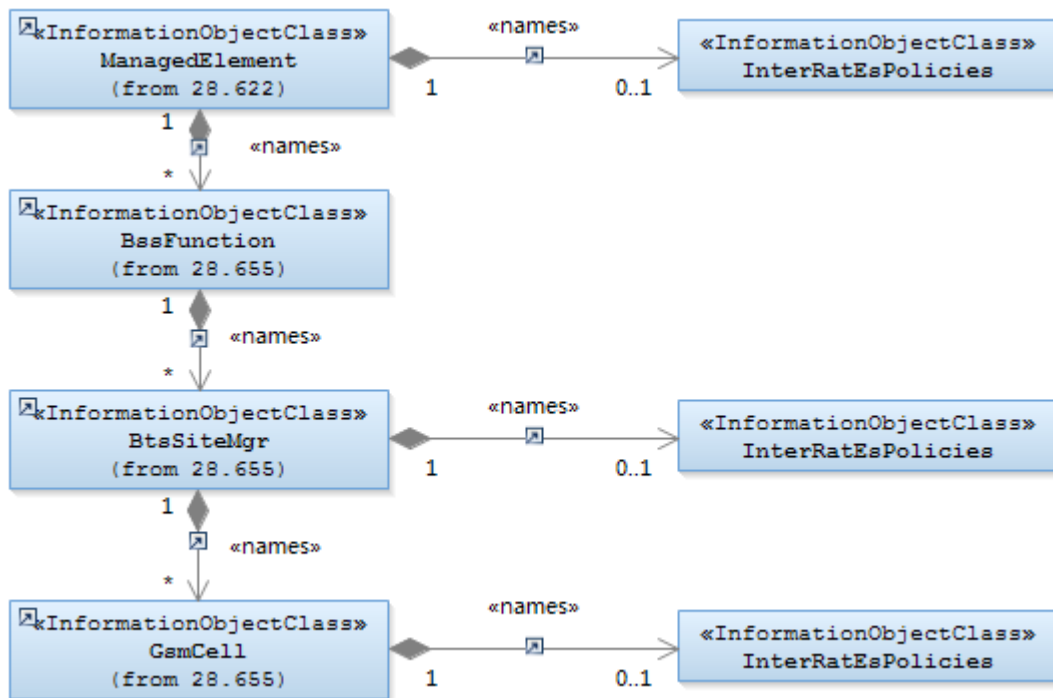

Figure 5.2.1-9: Inter-RAT ES Policies NRM IOCs (Containment Relationship, part 5)

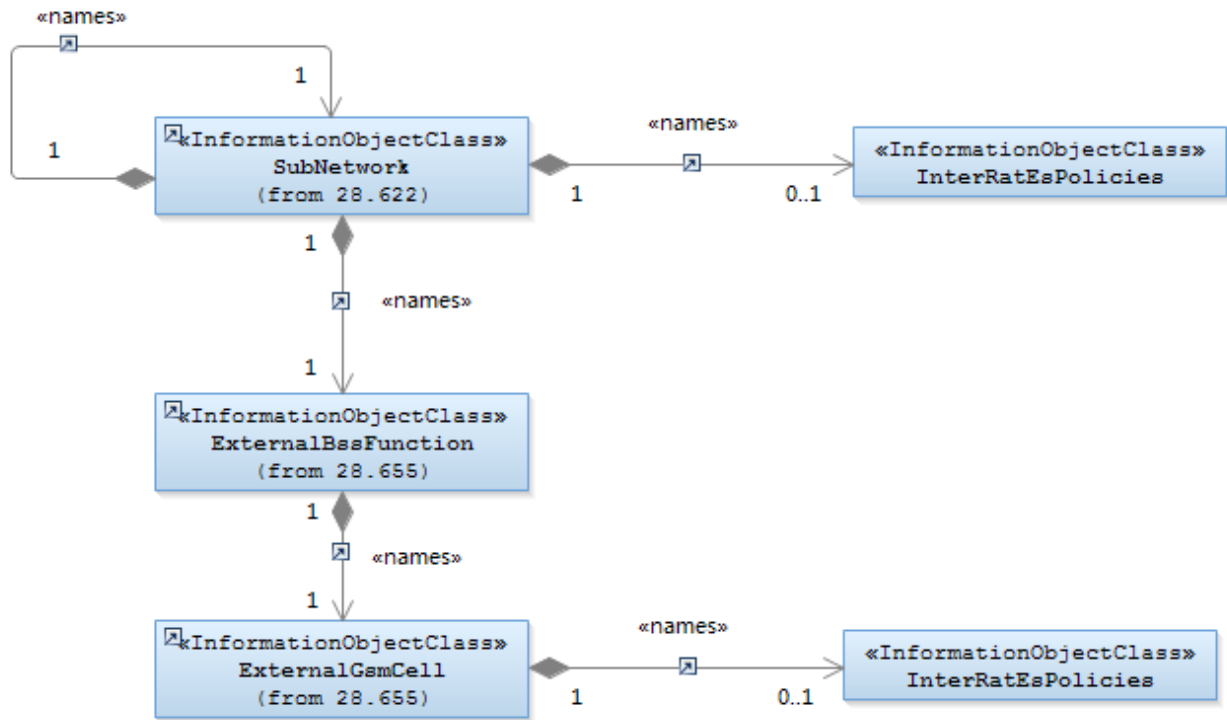

Figure 5.2.1-10: Inter-RAT ES Policies NRM IOCs (Containment Relationship, part 6)

### 5.2.2 Inheritance

This subclause depicts the inheritance relationships.

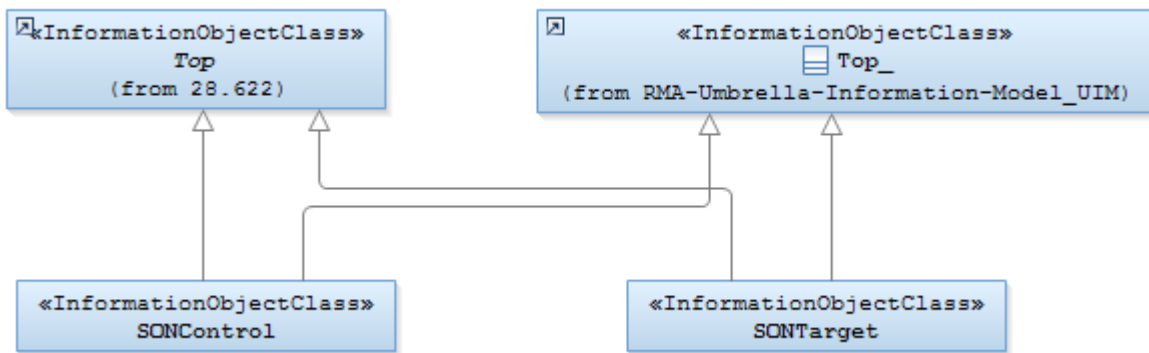

Figure 5.2.2-1: SON Policy NRM Inheritance Hierarchy

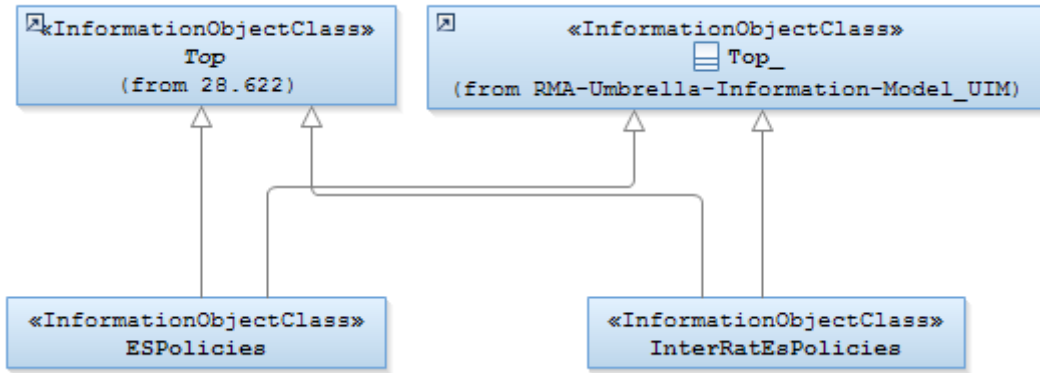

Figure 5.2.2-2: ES Policies NRM IOCs (Inheritance Relationship)

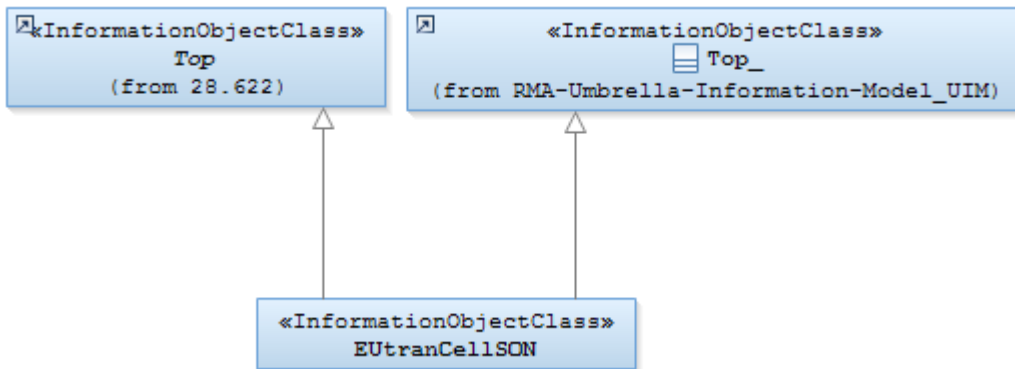

Figure 5.2.2-3: Inheritance for IOC to control SON on cell level

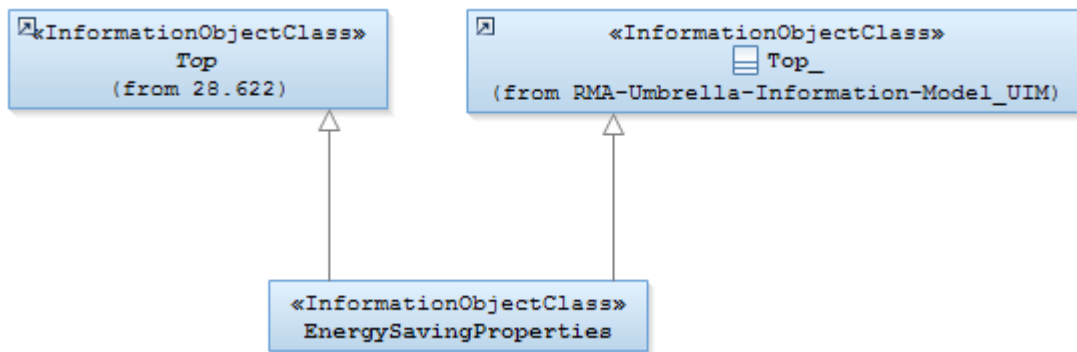

Figure 5.2.2-4: Energy saving properties NRM IOCs (Inheritance Relationship)

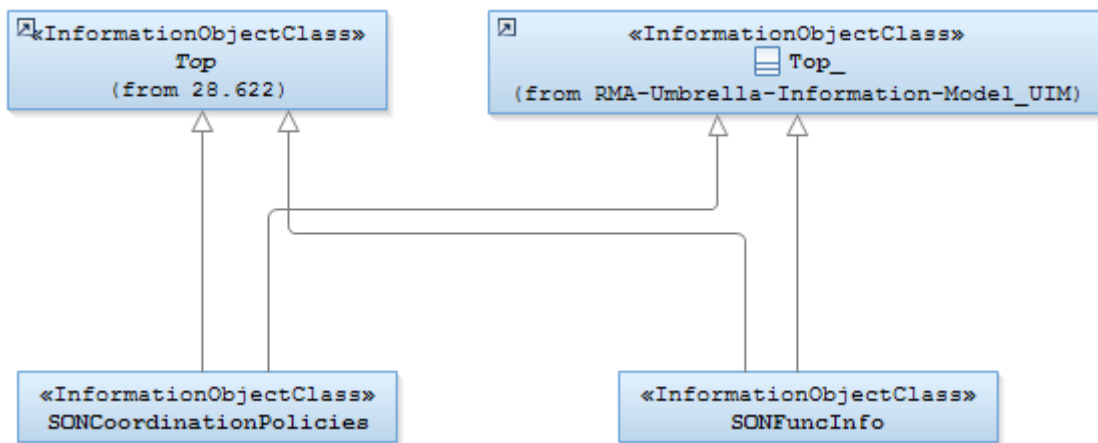

Figure 5.2.2-5: IOCs for SON coordination (Inheritance Relationship)

### 5.3 Class definitions

#### 5.3.1 SONTargets

##### 5.3.1.1 Definition

This IOC represents targets for SON functions and their relative weights.

Target hierarchy rule:

An NRM IOC instance X may name-contain an IOC SONTargets instance T. The rule states that:

- If X name-contains a SONTargets instance T, then T is applicable to X.
- If X and all its superior instances do not name-contain any SONTargets instance, then no SONTargets instance is applicable to X.
- If X does not name-contain any SONTargets instance, but one or more of X’s superior instances name-contain a SONTargets instance, then the SONTargets instance of the superior instance closest to X, in X’s naming tree, is applicable to X.

##### 5.3.1.2 Attributes

Attribute name	Support Qualifier	isReadable	isWritable	isInvariant	isNotifiable
hoFailureRate	O *)	M	M	-	M
rrcConnectionEstablishmentFailureRateCharacteristic	O *)	M	M	-	M
rrcConnectionAbnormalReleaseRateCharacteristic	O *)	M	M	-	M
eRabSetupFailureRateCharacteristic	O *)	M	M	-	M
eRabAbnormalReleaseRateCharacteristic	O *)	M	M	-	M
rachOptAccessProbability	CM **)	M	M	-	M
rachOptAccessDelayProbability	CM **)	M	M	-	M
pDCPDataVolumeLoadRate	O *)	M	M	-	M
iPThroughputLoadRate	O *)	M	M	-	M
activeUEAmountLoadRate	O *)	M	M	-	M

\*) Note 1: At least one of the attributes shall be supported.



\*\*) Note 2: Only one of these attributes shall be present.

### 5.3.1.3 Attribute constraints

Name	Definition
rachOptAccessProbability CM Support Qualifier	RACH Optimization is supported and Access Probability is supported as target.
rachOptAccessDelayProbability CM Support Qualifier	RACH Optimization is supported and Access Delay Probability is supported as target.

### 5.3.1.4 Notifications

The common notifications defined in subclause 5.5 are valid for this IOC, without exceptions or additions.

## 5.3.2 SONControl

### 5.3.2.1 Definition

This IOC represents the possibility to switch on or off SON functions. This is provided for AAS optimization, Handover parameter optimization, Load Balancing optimization, Energy Saving, RACH optimization and Cell Outage Compensation.

### 5.3.2.2 Attributes

Attribute name	Support Qualifier	isReadable	isWritable	isInvariant	isNotifyable
aasSplitSwitch	CM	M	M	-	M
aasMergeSwitch	CM	M	M	-	M
aasShapeSwitch	CM	M	M	-	M
hooSwitch	CM	M	M	-	M
lboSwitch	CM	M	M	-	M
esSwitch	CM	M	M	-	M
roSwitch	CM	M	M	-	M
cocSwitch	CM	M	M	-	M

### 5.3.2.3 Attribute constraints

Name	Definition
aasSplitSwitch CM Support Qualifier	Active Antenna System (AAS) optimization function is supported.
aasMergeSwitch CM Support Qualifier	Active Antenna System (AAS) optimization function is supported.
aasShapeSwitch CM Support Qualifier	Active Antenna System (AAS) optimization function is supported.
hooSwitch CM Support Qualifier	Handover (HO) parameter Optimization function is supported.
lboSwitch CM Support Qualifier	Load Balancing Optimization function is supported.
esSwitch Support Qualifier	The condition is "Distributed or EM-Centralized ESM architecture is supported".
roSwitch CM Support Qualifier	RACH Optimization is supported.
cocSwitch Support Qualifier	The condition is "CoC is supported". Only allowed to be present, if SONControl is contained in subnetwork IOC instance.

### 5.3.2.4 Notifications

The common notifications defined in subclause 5.5 are valid for this IOC, without exceptions or additions.

### 5.3.3 ESPolicies

#### 5.3.3.1 Definition

This IOC represents the energy saving policies information. This object class is valid in a distributed ES architecture or in an EM-centralized ES architecture.

#### 5.3.3.2 Attributes

Attribute name	Support Qualifier	isReadable	isWritable	isInvariant	isNotifiable
esActivationOriginalCellLoadParameters	CM	M	M	-	M
esActivationCandidateCellsLoadParameters	CM	M	M	-	M
esDeactivationCandidateCellsLoadParameters	CM	M	M	-	M
esNotAllowedTimePeriod	O	M	M	-	M

#### 5.3.3.3 Attribute constraints

Name	Definition
esActivationOriginalCellLoadParameters	The condition is "Intra-RAT ESM is supported AND the cell acts as an original cell".
esActivationCandidateCellsLoadParameters	The condition is "Intra-RAT ESM is supported AND the cell acts as a candidate cell".
esDeactivationCandidateCellsLoadParameters	The condition is "Intra-RAT ESM is supported AND the cell acts as a candidate cell".

#### 5.3.3.4 Notifications

The common notifications defined in subclause 5.5 are valid for this IOC, without exceptions or additions.

### 5.3.4 EUtranCellSON

#### 5.3.4.1 Definition

This IOC represents the parameters for control of SON functions on E-UTRAN cell level.

#### 5.3.4.2 Attributes

Attribute name	Support Qualifier	isReadable	isWritable	isInvariant	isNotifiable
alterCovConfig	CM	M	M	-	M
maximumDeviationHoTrigger	CM	M	M	-	M
minimumTimeBetweenHoTriggerChange	CM	M	M	-	M
replacedCells	CM	M	M	-	M

#### 5.3.4.3 Attribute constraints

Name	Definition
alterCovConfig CM Support Qualifier	AAS optimization function is supported.

maximumDeviationHoTrigger Support Qualifier	The condition is "HOO function is supported".
minimumTimeBetweenHoTriggerChange Support Qualifier	The condition is "HOO function is supported".
replacedCells CM Support Qualifier	AAS optimization function is supported.

#### 5.3.4.4 Notifications

The common notifications defined in subclause 5.5 are valid for this IOC, without exceptions or additions.

### 5.3.5 EnergySavingProperties

#### 5.3.5.1 Definition

This IOC represents the energy saving properties of a network element supporting Energy Saving Management functionality.

#### 5.3.5.2 Attributes

Attribute name	Support Qualifier	isReadable	isWritable	isInvariant	isNotifiable
energySavingState	M	M	-	-	M
energySavingControl	CM	M	M	-	M
isProbingCapable	O	M	-	-	M

#### 5.3.5.3 Attribute constraints

Name	Definition
energySavingControl CM Support Qualifier	The condition is "ESM functionality supports and uses NM-Centralized architecture".

#### 5.3.5.4 Notifications

The common notifications defined in subclause 5.5 are valid for this IOC. Notification notifyAttributeValueChange shall be supported for attribute energySavingState.

### 5.3.6 IOC SONFuncInfo

#### 5.3.6.1 Definition

This IOC represents information of SON functions, to support SON coordination. In case of SON coordination function is located below Itf-N, this IOC is used together with SONCoordinationPolicies IOC for SON coordination purpose.

SONFuncInfo hierarchy rule:

An NRM IOC instance X may name-contain an IOC SONFuncInfo instance T. The rule states that:

- If X name-contains a SONFuncInfo instance T, then T is applicable to X.
- If X and all its superior instances do not name-contain any SONFuncInfo instance, then no SONFuncInfo instance is applicable to X.
- If X does not name-contain any SONFuncInfo instance, but one or more of X's superior instances name-contain a SONFuncInfo instance, then the SONFuncInfo instance of the superior instance closest to X, in X's naming tree, is applicable to X.

### 5.3.6.2 Attributes

Attribute Name	Support Qualifier	Read Qualifier	Write Qualifier
sonFuncCapabilityBelowItfN	M	M	-

### 5.3.6.3 Attribute constraints

None.

### 5.3.6.4 Notifications

The common notifications defined in subclause 5.6.1 are valid for this IOC, without exceptions or additions.

## 5.3.7 IOC SONCoordinationPolicies

### 5.3.7.1 Definition

This IOC represents the SON coordination policies that are selected by IRPManagers from the IRPAgent supported policies in the case of a separate SON coordination function is located below Itf-N (i.e., EM centralized SON coordination) or SON coordination function is implemented as part of each SON function (i.e., distributed SON coordination). For EM centralized SON coordination case, the case that the SON function is located above Itf-N and the corresponding SON coordination function is below Itf-N is not in the scope of this release.

This IOC is not intended to be used by IRPManager to create SON coordination policies that are not supported by IRPAgent. The selected SON coordination policies are used by SON coordination function to coordinate the SON functions with potential conflicts, in case no SON coordination policies are selected by IRPManager, the default SON coordination policies are applied to the SON coordination function below Itf-N; the default SON coordination policies are per agreement between IRPManager and IRPAgent, the value of the default SON coordination policies is out of the scope of this specification.

SONCoordinationPolicies hierarchy rule:

An NRM IOC instance X may name-contain an IOC SONCoordinationPolicies instance T. The rule states that:

- If X name-contains a SONCoordinationPolicies instance T, then T is applicable to X.
- If X and all its superior instances do not name-contain any SONCoordinationPolicies instance, then no SONCoordinationPolicies instance is applicable to X.
- If X does not name-contain any SONCoordinationPolicies instance, but one or more of X's superior instances name-contain a SONCoordinationPolicies instance, then the SONCoordinationPolicies instance of the superior instance closest to X, in X's naming tree, is applicable to X.

### 5.3.7.2 Attributes

Attribute Name	Support Qualifier	Read Qualifier	Write Qualifier
selectedSonCoordPolicy	CM	M	M
sonFuncPriorityOrder	CM	M	M

### 5.3.7.3 Attribute constraints

Name	Definition
selectedSonCoordPolicy CM Support Qualifier	SON coordination function below Itf-N supports more than one coordination policy.
sonFuncPriorityOrder CM Support Qualifier	The selectedSonCoordPolicy equals to "BaseOnPriority".

### 5.3.7.4 Notifications

The common notifications defined in subclause 5.6.1 are valid for this IOC, without exceptions or additions.

## 5.3.8 interRatEsPolicies

### 5.3.8.1 Definition

This IOC represents the inter-RAT energy saving policies information. This object class is valid in a distributed ES architecture or in an EM-centralized ES architecture.

### 5.3.8.2 Attributes

Attribute name	Support Qualifier	isReadable	isWritable	isInvariant	isNotifyable
interRatEsActivationOriginalCellParameters	CM	M	M	-	M
interRatEsActivationCandidateCellParameters	CM	M	M	-	M
interRatEsDeactivationCandidateCellParameters	CM	M	M	-	M

### 5.3.8.3 Attribute constraints

Name	Definition
interRatEsActivationOriginalCellParameters CM Support Qualifier	The condition is "The cell acts as an original cell" AND inter-RAT ESM is supported.
interRatEsActivationCandidateCellParameters CM Support Qualifier	The condition is "The cell acts as a candidate cell" AND inter-RAT ESM is supported.
interRatEsDeactivationCandidateCellParameters CM Support Qualifier	The condition is "The cell acts as a candidate cell" AND inter-RAT ESM is supported.

### 5.3.8.4 Notifications

The common notifications defined in subclause 5.6.1 are valid for this IOC, without exceptions or additions.

## 5.4 Attribute definitions

### 5.4.1 Attribute properties

The following table defines the attributes that are present in the Information Object Classes (IOCs) of the present document.

Attribute Name	Documentation and Allowed Values	Properties
aasSplitSwitch	This attribute allows the operator to enable/disable the AAS cell splitting functionality.  allowedValues: on, off	type: <<enumeration>> multiplicity: 1 isOrdered: N/A isUnique: N/A defaultValue: None isNullable: True
aasMergeSwitch	This attribute allows the operator to enable/disable the AAS cell merging functionality.  allowedValues: on, off	type: <<enumeration>> multiplicity: 1 isOrdered: N/A isUnique: N/A defaultValue: None isNullable: True
aasShapeSwitch	This attribute allows the operator to enable/disable the AAS cell shaping functionality.  allowedValues: on, off	type: <<enumeration>> multiplicity: 1 isOrdered: N/A isUnique: N/A defaultValue: None isNullable: True
activeUEAmount LoadRate	This indicates the assigned SON target of the sum number of active UE in DL and UL divided by the nominal capacity of active UE amount, together with its targetWeight.  This target is suitable for AAS.  allowedValues: A set of three numbers:  targetLowerThreshold: Integer 0..100 (representing a percentage)  targetUpperThreshold: Integer 0..100 (representing a percentage)  targetWeight: Integer 1..N. (The higher the number the higher the weight)	type: <<data type>> multiplicity: 1 isOrdered: N/A isUnique: N/A defaultValue: None isNullable: True

alterCovConfig	<p>This holds a list of alternative coverage configurations which are used for AAS optimization function to select and switch between these configurations. Each coverage configuration contains the following entries:</p> <ul style="list-style-type: none"> <li>- StateId, which indicates the identifier of the coverage configuration, see 3GPP TS 36.423 [7];</li> <li>- horizontalHBW, which indicates the horizontal half-power beamwidth (see NOTE 1);</li> <li>- verticalHBW, which indicates the vertical half-power beamwidth (see NOTE 1);</li> <li>- maximumTransmissionPowerRange, which indicates the range of maximumTransmissionPower, see TS 28.658 [10];</li> <li>- referenceSignalPowerRange, which indicates the range of referenceSignalPower, see TS 28.658 [10]</li> </ul> <p>allowedValues: StateId: See 3GPP TS 36.423 [7] subclause 9.1.2.8 for value range of identifier of the coverage configuration.</p> <p>horizontalHBW: Integer 0..360 (representing an angle in degrees)</p> <p>verticalHBW: Integer 0..360 (representing an angle in degrees)</p> <p>maximumTransmissionPowerRange: see 3GPP TS 28.658 [10] subclause 4.4.1 for value range of maximumTransmissionPower.</p> <p>referenceSignalPowerRange: see 3GPP TS 28.658 [10] subclause 4.4.1 for value range of referenceSignalPower.</p>	<p>type: &lt;&lt;data type&gt;&gt; multiplicity: 1..* isOrdered: N/A isUnique: N/A defaultValue: None isNullable: True</p>
cocSwitch	<p>This attribute allows the operator to enable/disable the COC functionality.</p> <p>allowedValues: on, off</p>	<p>type: &lt;&lt;enumeration&gt;&gt; multiplicity: 1 isOrdered: N/A isUnique: N/A defaultValue: None isNullable: True</p>
energySavingControl	<p>This attribute allows the IRPManager to initiate energy saving activation or deactivation. Its value can not be changed by the IRPAgent.</p> <p>allowedValues: toBeEnergySaving, toBeNotEnergySaving</p>	<p>type: &lt;&lt;enumeration&gt;&gt; multiplicity: 1 isOrdered: N/A isUnique: N/A defaultValue: None isNullable: True</p>
energySavingState	<p>Specifies the status regarding the energy saving in the cell.</p> <p>If the value of energySavingControl is toBeEnergySaving, then it shall be tried to achieve the value isEnergySaving for the energySavingState.</p> <p>If the value of energySavingControl is toBeNotEnergySaving, then it shall be tried to achieve the value isNotEnergySaving for the energySavingState.</p> <p>allowedValues: isNotEnergySaving, isEnergySaving.</p>	<p>type: &lt;&lt;enumeration&gt;&gt; multiplicity: 1 isOrdered: N/A isUnique: N/A defaultValue: None isNullable: True</p>



<p>eRabAbnormalReleaseRateCharacteristic</p>	<p>The target is on the number of E-RAB abnormal release related to load divided by the total number of attempted E-RAB setups.</p> <p>This attribute allows to define for a value the composite available capacity (CAC) range in which the target is valid. For this, it contains one characteristic dependent on Uplink CAC, one for Downlink CAC:  eRabAbnormalReleaseRateCharacteristicDownlink and  eRabAbnormalReleaseRateCharacteristicUplink.  At least one of these characteristics must be present. Together with the characteristic its targetWeight as a SON target is defined as part of this attribute. The characteristics have the following structure:  eRabAbnormalReleaseRateCharacteristicDownlink:  List of one or more entries, each consisting of:      lowerEndOfCacRange,      upperEndOfCacRange,      eRabAbnormalReleaseRateTarget  eRabAbnormalReleaseRateCharacteristicUplink:  List of one or more entries, each consisting of:      lowerEndOfCacRange,      upperEndOfCacRange,      eRabAbnormalReleaseRateTarget</p> <p>Remark:  Formula for composite available capacity:  Available Capacity = Cell Capacity Class Value * Capacity Value  For definition of Cell Capacity Class Value and Capacity Value see TS 36.331 [6]. These definitions lead to a value range of a composite available capacity from 0..10000.  36.423 [7] has cell capacity class value as optional parameter in case of intra-LTE load balancing. If cell capacity class value is not present, than 36.423 assumes that bandwidth should be used instead to assess the capacity.</p> <p>This target is suitable for LBO.</p> <p>allowedValues:  lowerEndOfCacRange and upperEndOfCacRange:  Integer 0..10000</p> <p>eRabAbnormalReleaseRateTarget:  Integer 0..100 (representing a percentage)</p> <p>targetWeight:  Integer 1..N. The higher the number the higher the weight.</p>	<p>type: &lt;&lt;data type&gt;&gt;  multiplicity: 1  isOrdered: N/A  isUnique: N/A  defaultValue: None  isNullable: True</p>
--	--	--

<p>eRabSetupFailureRateCharacteristic</p>	<p>The target is on the number of E-RAB setup failures related to load divided by the total number of attempted E-RAB setups.                  For E-RAB setup failure related to load the causes "Reduce load in serving cell" and "Radio resources not available" defined in TS 36.413 are used.                  This attribute allows to define for a value the composite available capacity (CAC) range in which the target is valid. For this, it contains one characteristic dependent on Uplink CAC, one for Downlink CAC:                  eRabSetupFailureRateCharacteristicDownlink and eRabSetupFailureRateCharacteristicUplink.                  At least one of these characteristics must be present. Together with the characteristic its targetWeight as a SON target is defined as part of this attribute. The characteristics have the following structure:                  eRabSetupFailureRateCharacteristicDownlink:                  List of one or more entries, each consisting of:                      LowerEndOfCacRange,                      UpperEndOfCacRange,                      eRabSetupFailureRateTarget                  eRabSetupFailureRateCharacteristicUplink:                  List of one or more entries, each consisting of:                      LowerEndOfCacRange,                      UpperEndOfCacRange,                      eRabSetupFailureRateTarget                  For CAC see eRabAbnormalReleaseRateCharacteristic                    This target is suitable for LBO.                    allowedValues:                  lowerEndOfCacRange and upperEndOfCacRange and targetWeight:                  See eRabAbnormalReleaseRateCharacteristic                    eRabSetupFailureRateTarget:                  Integer 0..100 (representing a percentage)</p>	<p>type: &lt;&lt;data type&gt;&gt;                  multiplicity: 1                  isOrdered: N/A                  isUnique: N/A                  defaultValue: None                  isNullable: True</p>
<p>esActivationOriginalCellLoadParameters</p>	<p>This attributes is relevant, if the cell acts as an original cell.                  This attribute indicates the traffic load threshold and the time duration, which are used by distributed ES algorithms to allow a cell to enter the energySaving state. The time duration indicates how long the load needs to have been below the threshold.                    allowedValues:                  Threshold: Integer 0..100 (Percentage of PRB usage, see 3GPP TS 36.314 [13])                  TimeDuration: Integer (in unit of seconds)</p>	<p>type: &lt;&lt;data type&gt;&gt;                  multiplicity: 1                  isOrdered: N/A                  isUnique: N/A                  defaultValue: None                  isNullable: True</p>

<p>esActivationCandidateCellsLoadParameters</p>	<p>This attribute is relevant, if the cell acts as a candidate cell.</p> <p>This attribute indicates the traffic load threshold and the time duration, which are used by distributed ES algorithms level to allow a n 'original' cell to enter the energySaving state. Threshold and duration are applied to the candidate cell(s) which will provides coverage backup of an original cell when it is in the energySaving state. The threshold applies in the same way for a candidate cell, no matter for which original cell it will provide backup coverage.</p> <p>The time duration indicates how long the traffic in the candidate cell needs to have been below the threshold before any original cells which will be provided backup coverage by the candidate cell enters energy saving state.</p> <p>allowedValues: Threshold: Integer 0..100 (Percentage of PRB usage (see 3GPP TS 36.314 [13]) ) TimeDuration: Integer (in unit of seconds)</p>	<p>type: &lt;&lt;data type&gt;&gt; multiplicity: 1 isOrdered: N/A isUnique: N/A defaultValue: None isNullable: True</p>
<p>esDeactivationCandidateCellsLoadParameters</p>	<p>This attribute is relevant, if the cell acts as a candidate cell.</p> <p>This attribute indicates the traffic load threshold and the time duration which is used by distributed ES algorithms to allow a cell to leave the energySaving state. Threshold and time duration are applied to the candidate cell when it which provides coverage backup for the cell in energySaving state. The threshold applies in the same way for a candidate cell, no matter for which original cell it provides backup coverage.</p> <p>The time duration indicates how long the traffic in the candidate cell needs to have been above the threshold to wake up one or more original cells which have been provided backup coverage by the candidate cell.</p> <p>allowedValues: Threshold: Integer 0..100 (Percentage of PRB usage (see 3GPP TS 36.314 [13]) ) TimeDuration: Integer (in unit of seconds)</p>	<p>type: &lt;&lt;data type&gt;&gt; multiplicity: 1 isOrdered: N/A isUnique: N/A defaultValue: None isNullable: True</p>
<p>esNotAllowedTimePeriod</p>	<p>This attribute can be used to prevent a cell entering energySaving state.</p> <p>This attribute indicates a list of time periods during which inter-RAT energy saving is not allowed.</p> <p>Time period is valid on the specified day and time of every week.</p> <p>allowedValues: The legal values are as follows: startTime and endTime: All values that indicate valid UTC time. endTime should be later than startTime.</p> <p>periodOfDay: structure of startTime and endTime.</p> <p>daysOfWeekList: list of weekday. weekday: Monday, Tuesday, ... Sunday.</p> <p>List of time periods: { { daysOfWeek daysOfWeekList, periodOfDay dailyPeriod } }</p>	<p>type: &lt;&lt;data type&gt;&gt; multiplicity: 0..* isOrdered: N/A isUnique: N/A defaultValue: None isNullable: True</p>

esSwitch	<p>This attribute determines whether the energy saving function is enabled or disabled.</p> <p>allowedValues: On, Off</p>	<p>type: &lt;&lt;enumeration&gt;&gt;  multiplicity: 1  isOrdered: N/A  isUnique: N/A  defaultValue: None  isNullable: True</p>
hoFailureRate	<p>This indicates the assigned HOO target of the number of failure events related to handover divided by the total number of handover events, together with its targetWeight.</p> <p>This target is suitable for HOO or LBO.</p> <p>allowedValues: A set of two numbers: the first indicates a percentage, the second a targetWeight (see eRabAbnormalReleaseRateCharacteristic).</p>	<p>type: &lt;&lt;data type&gt;&gt;  multiplicity: 0..*  isOrdered: N/A  isUnique: N/A  defaultValue: None  isNullable: True</p>
hooSwitch	<p>This attribute determines whether the Handover parameter Optimization Function is activated or deactivated.</p> <p>allowedValues: On, Off</p>	<p>type: &lt;&lt;enumeration&gt;&gt;  multiplicity: 1  isOrdered: N/A  isUnique: N/A  defaultValue: None  isNullable: True</p>
interRatEsActivationOriginalCellParameters	<p>This attribute is relevant, if the cell acts as an original cell.</p> <p>This attribute indicates the traffic load threshold and the time duration, which are used by distributed inter-RAT ES algorithms to allow an original cell to enter the energySaving state. The time duration indicates how long the traffic load (both for UL and DL) needs to have been below the threshold.</p> <p>In case the original cell is an EUTRAN cell, the load information refers to Composite Available Capacity Group IE (see 3GPP TS 36.413 [12] Annex B.1.5) and the following applies:  <math>Load = (100 - 'Capacity Value') * 'Cell Capacity Class Value'</math>, where 'Capacity Value' and 'Cell Capacity Class Value' are defined in 3GPP TS 36.423 [7].</p> <p>In case the original cell is a UTRAN cell, the load information refers to Cell Load Information Group IE (see 3GPP TS 36.413 [12] Annex B.1.5) and the following applies:  <math>Load = 'Load Value' * 'Cell Capacity Class Value'</math>, where 'Load Value' and 'Cell Capacity Class Value' are defined in 3GPP TS 25.413 [19].</p> <p>If the 'Cell Capacity Class Value' is not known, then 'Cell Capacity Class Value' should be set to 1 when calculating the load, and the load threshold should be set in range of 0..100.</p> <p>allowedValues:  LoadThreshold: Integer 0..10000  TimeDuration: Integer 0..900 (in unit of seconds)</p>	<p>type: &lt;&lt;data type&gt;&gt;  multiplicity: 1  isOrdered: N/A  isUnique: N/A  defaultValue: None  isNullable: True</p>

<p>interRatEsActivationCandidateCellParameters</p>	<p>This attribute is relevant, if the cell acts as a candidate cell.</p> <p>This attribute indicates the traffic load threshold and the time duration, which are used by distributed inter-RAT ES algorithms to allow an original cell to enter the energySaving state. Threshold and time duration are applied to the candidate cell(s) which will provides coverage backup of an original cell when it is in the energySaving state.</p> <p>The time duration indicates how long the traffic load (both for UL and DL) in the candidate cell needs to have been below the threshold before any original cells which will be provided backup coverage by the candidate cell enters energySaving state.</p> <p>In case the candidate cell is a UTRAN or GERAN cell, the load information refers to Cell Load Information Group IE(see 3GPP TS 36.413 [12] Annex B.1.5) and the following applies: Load= 'Load Value' * 'Cell Capacity Class Value', where 'Load Value' and 'Cell Capacity Class Value' are defined in 3GPP TS 25.413 [19] (for UTRAN) / TS 48.008 [20] (for GERAN).</p> <p>If the 'Cell Capacity Class Value' is not known, then 'Cell Capacity Class Value' should be set to 1 when calculating the load, and the load threshold should be set in range of 0..100.</p> <p>allowedValues: LoadThreshold: Integer 0..10000 TimeDuration: Integer 0..900 (in unit of seconds)</p>	<p>type: &lt;&lt;data type&gt;&gt; multiplicity: 1 isOrdered: N/A isUnique: N/A defaultValue: None isNullable: True</p>
<p>interRatEsDeactivationCandidateCellParameters</p>	<p>This attribute is relevant, if the cell acts as a candidate cell.</p> <p>This attribute indicates the traffic load threshold and the time duration which is used by distributed inter-RAT ES algorithms to allow an original cell to leave the energySaving state. Threshold and time duration are applied to the candidate cell which provides coverage backup for the cell in energySaving state.</p> <p>The time duration indicates how long the traffic load (either for UL or DL) in the candidate cell needs to have been above the threshold to wake up one or more original cells which have been provided backup coverage by the candidate cell.</p> <p>For the load see the definition of interRatEsActivationCandidateCellParameters.</p> <p>allowedValues: LoadThreshold: Integer 0..10000 TimeDuration: Integer 0..900 (in unit of seconds)</p>	<p>type: &lt;&lt;data type&gt;&gt; multiplicity: 1 isOrdered: N/A isUnique: N/A defaultValue: None isNullable: True</p>

ipThrouputLoadRate	<p>This indicates the assigned SON target of the total IP throughput in DL and UL divided by the nominal capacity of total IP throughput, together with its targetWeight.</p> <p>This target is suitable for AAS.</p> <p>allowedValues: A set of three numbers:</p> <p>targetLowerThreshold: Integer 0..100 (representing a percentage)</p> <p>targetUpperThreshold: Integer 0..100 (representing a percentage)</p> <p>targetWeight: Integer 1..N. (The higher the number the higher the weight).</p>	<p>type: &lt;&lt;data type&gt;&gt; multiplicity: 1 isOrdered: N/A isUnique: N/A defaultValue: None isNullable: True</p>
lboSwitch	<p>This attribute determines whether the Load Balancing Optimization Function is activated or deactivated.</p> <p>allowedValues: On, Off</p>	<p>type: &lt;&lt;enumeration&gt;&gt; multiplicity: 1 isOrdered: N/A isUnique: N/A defaultValue: None isNullable: True</p>
maximumDeviationHoTrigger	<p>This parameter allows the IRPManager to define the maximum allowed absolute deviation of the cell pair specific part of Handover Trigger (as defined in [14] (§22.4.1.4), from the default point of operation</p> <p>allowedValues: Integer (+1..+96) Unit: 0.5 dB</p>	<p>type: Integer multiplicity: 1 isOrdered: N/A isUnique: N/A defaultValue: None isNullable: True</p>
isProbingCapable	<p>This attribute indicates whether this cell is capable of performing the ES probing procedure. During this procedure the eNB owning the cell indicates its presence to UEs for measurement purposes, but prevents idle mode UEs from camping on the cell and prevents incoming handovers to the same cell. If this parameter is absent, then probing is not done.</p> <p>allowedValues: yes, no</p>	<p>type: &lt;&lt;enumeration&gt;&gt; multiplicity: 1 isOrdered: N/A isUnique: N/A defaultValue: None isNullable: True</p>
minimumTimeBetweenHoTriggerChange	<p>This parameter defines the minimum allowed time interval between two changes of the Handover Trigger performed by MRO.</p> <p>allowedValues: Integer (0..1440) Unit: Minutes</p>	<p>type: Integer multiplicity: 1 isOrdered: N/A isUnique: N/A defaultValue: None isNullable: True</p>
pDCPDataVolumeLoadRate	<p>This indicates the assigned SON target of the total PDCP data volume in DL and UL divided by the nominal capacity of total PDCP data volume, together with its targetWeight.</p> <p>This target is suitable for AAS.</p> <p>allowedValues: A set of three numbers:</p> <p>targetLowerThreshold: Integer 0..100 (representing a percentage)</p> <p>targetUpperThreshold: Integer 0..100 (representing a percentage)</p> <p>targetWeight: Integer 1..N. (The higher the number the higher the weight).</p>	<p>type: &lt;&lt;data type&gt;&gt; multiplicity: 1 isOrdered: N/A isUnique: N/A defaultValue: None isNullable: True</p>

rachOptAccessDelayProbability	<p>This is a list of target Access Delay probability (<math>AD_P</math>) for the RACH optimization function.</p> <p>Each instance <math>AD_P</math> of the list is the target time before the UE gets access on the random access channel, for the <math>P</math> percent of the successful RACH Access attempts with lowest access delay, over an unspecified sampling period.</p> <p>This target is suitable for RO.</p> <p>allowedValues: Each element of the list, <math>AD_{Pn}</math>, is a pair (<math>a</math>, <math>b</math>) where <math>a</math> is the targetProbability (in %) and <math>b</math> is the access delay (in milliseconds).</p> <p>The legal values for <math>a</math> are 25, 50, 75, 90. The legal values for <math>b</math> are 10 to 560.</p> <p>If <math>AD_{Px}</math>'s <math>a</math> is larger than that of <math>AD_{Py}</math>, then <math>AD_{Px}</math>'s <math>b</math> must be larger than that of <math>AD_{Py}</math>.</p> <p>The number of elements specified is 4. The number of elements supported is vendor specific. The choice of supported values for <math>a</math> and <math>b</math> is vendor-specific.</p>	<p>type: &lt;&lt;data type&gt;&gt; multiplicity: 0..* isOrdered: N/A isUnique: N/A defaultValue: None isNullable: True</p>
rachOptAccessProbability	<p>This is a list of target Access Probability (<math>AP_n</math>) for the RACH optimization function.</p> <p>Each instance <math>AP_n</math> of the list is the probability that the UE gets access on the random access channel within <math>n</math> number of attempts, over an unspecified sampling period.</p> <p>This target is suitable for RO.</p> <p>allowedValues: Each element of the list, <math>AP_n</math>, is a pair (<math>a</math>, <math>n</math>) where <math>a</math> is the targetProbability (in %) and <math>n</math> is the access attempt number.</p> <p>The legal values for <math>a</math> are 25, 50, 75, 90. The legal values for <math>n</math> are 1 to 200.</p> <p>If <math>AP_x</math>'s <math>a</math> is larger than that of <math>AP_y</math>, then <math>AP_x</math>'s <math>n</math> must be larger than that of <math>AP_y</math>.</p> <p>The number of elements specified is 4. The number of elements supported is vendor specific. The choice of supported values for <math>a</math> and <math>n</math> is vendor-specific.</p>	<p>type: &lt;&lt;data type&gt;&gt; multiplicity: 0..* isOrdered: N/A isUnique: N/A defaultValue: None isNullable: True</p>
replacedCells	<p>This holds a list of local identify of the cells which have been replaced by the subject cell within the eNodeB.</p> <p>allowedValues of each entry: Integer (0..255)</p>	<p>type: &lt;&lt;data type&gt;&gt; multiplicity: 1 isOrdered: N/A isUnique: N/A defaultValue: None isNullable: True</p>
roSwitch	<p>This attribute determines whether the RACH Optimization function is activated or deactivated.</p> <p>allowedValues: On, Off</p>	<p>type: &lt;&lt;enumeration&gt;&gt; multiplicity: 1 isOrdered: N/A isUnique: N/A defaultValue: None isNullable: True</p>

<p>rrcConnectionAbnormalReleaseRateCharacteristic</p>	<p>The target is on the number of abnormal RRC connection releases related to load divided by the total number of RRC connection releases.</p> <p>This attribute allows to define for a value the composite available capacity (CAC) range in which the target is valid. For this, it contains one characteristic dependent on Uplink CAC, one for Downlink CAC:  rrcConnectionAbnormalReleaseRateCharacteristicDownlink and  rrcConnectionAbnormalReleaseRateCharacteristicUplink.</p> <p>At least one of these characteristics must be present. Together with the characteristic its targetWeight as a SON target is defined as part of this attribute. The characteristics have the following structure:  rrcConnectionAbnormalReleaseRateCharacteristicDownlink:  List of one or more entries, each consisting of:      lowerEndOfCacRange,      upperEndOfCacRange,      rrcConnectionAbnormalReleaseRateTarget</p> <p>rrcConnectionAbnormalReleaseRateCharacteristicUplink:  List of one or more entries, each consisting of:      lowerEndOfCacRange,      upperEndOfCacRange,      rrcConnectionAbnormalReleaseRateTarget</p> <p>For CAC see  eRabAbnormalReleaseRateCharacteristic</p> <p>This target is suitable for LBO.</p> <p>allowedValues: lowerEndOfCacRange and upperEndOfCacRange and targetWeight:  See eRabAbnormalReleaseRateCharacteristic</p> <p>rrcConnectionAbnormalReleaseRateTarget:  Integer 0..100 (representing a percentage)</p>	<p>type: &lt;&lt;data type&gt;&gt;  multiplicity: 1  isOrdered: N/A  isUnique: N/A  defaultValue: None  isNullable: True</p>
---	---	--



<p>rrcConnectionEstablishmentFailureRateCharacteristic</p>	<p>The target is on the number of RRC connection establishment failures related to load divided by the total number of attempted RRC connection establishments.</p> <p>This attribute allows to define for a value the composite available capacity (CAC) range in which the target is valid. For this, it contains one characteristic dependent on Uplink CAC, one for Downlink CAC:  rrcConnectionEstablishmentFailureRateCharacteristicDownlink and  rrcConnectionEstablishmentFailureRateCharacteristicUplink.  At least one of these characteristics must be present. Together with the characteristic its targetWeight as a SON target is defined as part of this attribute. The characteristics have the following structure:  rrcConnectionEstablishmentFailureRateCharacteristicDownlink:  List of one or more entries, each consisting of:  lowerEndOfCacRange,  upperEndOfCacRange,  rrcConnectionEstablishmentFailureRateTarget  rrcConnectionEstablishmentFailureRateCharacteristicUplink:  List of one or more entries, each consisting of:  lowerEndOfCacRange,  upperEndOfCacRange,  rrcConnectionEstablishmentFailureRateTarget  For CAC see  eRabAbnormalReleaseRateCharacteristic</p> <p>This target is suitable for LBO.</p> <p>allowedValues: lowerEndOfCacRange and upperEndOfCacRange and targetWeight:  See eRabAbnormalReleaseRateCharacteristic</p> <p>rrcConnectionEstablishmentFailureRateTarget:  Integer 0..100 (representing a percentage)</p>	<p>type: &lt;&lt;data type&gt;&gt;  multiplicity: 1  isOrdered: N/A  isUnique: N/A  defaultValue: None  isNullable: True</p>
<p>selectedSonCoordPolicy</p>	<p>This attribute indicates the SON coordination policy that is selected by IRPManager in case the SON coordination function is located below ltf-N. The selected SON coordination policy is one of the enumerated value from BaseOnPriority and BaseOnState, wherein</p> <ul style="list-style-type: none"> <li>- BaseOnPriority, representing that the coordination is based on the priority order of the SON functions listed in "sonFuncPriorityOrder" attribute;</li> <li>- BaseOnState, representing the coordination is based on the cell state.</li> </ul> <p>allowedValues: BaseOnPriority, BaseOnState</p> <p>The examples of SON coordination for some certain conflicting cases based on priority and state are depicted in Annex B.</p>	<p>type: &lt;&lt; enumeration &gt;&gt;  multiplicity: 0..1  isOrdered: N/A  isUnique: N/A  defaultValue: None  isNullable: False</p>

sonFuncCapabilityBelowItfN	<p>This attribute represents the SON functions supported below Itf-N.</p> <p>It is a list of SON function name. The SON function name is one of the enumerated value from anr, hoo, lbo, es, coc, cco and aas, wherein</p> <ul style="list-style-type: none"> <li>- anr representing automated neighbor relation;</li> <li>- hoo representing handover parameter optimization;</li> <li>- lbo representing load balancing optimization;</li> <li>- es representing energy saving;</li> <li>- coc representing cell outage compensation;</li> <li>- cco representing coverage and capacity optimization.</li> <li>- aas representing active antenna system optimization</li> </ul> <p>allowedValues: List of SON function name. SON function name: Enumerated {anr, hoo, lbo, es, coc, cco, aas}</p>	<p>type: &lt;&lt;dataType&gt;&gt; multiplicity: 1 isOrdered: N/A isUnique: N/A defaultValue: None isNullable: False</p>
sonFuncPriorityOrder	<p>This attribute indicates the priority order of SON functions below Itf-N for SON coordination purpose, in case the selectedSonCoordPolicy equals to "BaseOnPriority".</p> <p>It is a list of SON function name, see the detailed description in "sonFuncCapabilityBelowItfN" attribute.</p> <p>The priority order is indicated by the sequence of the SON function name in the list, i.e., the first element in the list takes the highest priority, and the last element in the list takes the lowest priority.</p> <p>In case of selectedSonCoordPolicy does not equal to "BaseOnPriority", this sequence of the SON function name in the list is not used as priority order for SON coordination.</p> <p>allowedValues: List of SON function name. SON function name: Enumerated {anr, hoo, lbo, es, coc, cco, aas}</p>	<p>type: &lt;&lt;dataType&gt;&gt; multiplicity: 0..1 isOrdered: N/A isUnique: N/A defaultValue: None isNullable: False</p>
<p>NOTE : The half-power beamwidth is, in a radiation pattern cut containing the direction of the maximum of a lobe, the angle between two directions in which the radiation intensity is one-half the maximum value.</p>		

## 5.4.2 Constraints

None.

## 5.5 Common notifications

### 5.5.1 Alarm notifications

None.

### 5.5.2 Configuration notifications

This subclause presents a list of notifications, defined in [17], that IRPManager can receive. The notification header attribute `objectClass/objectInstance`, defined in [16], would capture the DN of an instance of an IOC defined in this IRP specification.

Name	Qualifier	Notes
<code>notifyAttributeValueChange</code>	O	
<code>notifyObjectCreation</code>	O	
<code>notifyObjectDeletion</code>	O	

---

## Annex A (informative): Target Achievement Evaluation

To evaluate the result of the optimization the target achievement needs to be evaluated. This can be done by calculating the Total Target Achievement as follows.

The Total Target Achievement is the sum of the products of the individual target achievement (difference between target and performance) and the individual targetWeights:

$$\begin{aligned} \text{Total Target Achievement} = & \\ & \text{Sum}_{i=1..n} [ (\text{minTarget}_i - \text{performance}_i) \times \text{weight}_i ] \\ & + \text{Sum}_{j=1..n} [ \text{performance}_j - \text{maxTarget}_j ) \times \text{weight}_j ] \end{aligned}$$

where minTarget is a target to be minimized and maxTarget is a target to be maximized.

For targets with a substructure (like \*Characteristic, see §5.5.1) the above formula is applied to each individual substructure target.

The higher the Total Target Achievement, the better is the result of the optimization.

---

## Annex B (informative): Examples of how to use general SON coordination solutions

Examples of how to use general SON coordination solutions are as below:

---

### B.1 Coordination of COC and CCO using priority of SON functions

To prevent conflicting setting as illustrated in clause 4.7.3.2.1, the cell(s) which may need to be coordinated between COC and CCO, i.e., the impact area information, should be known by the SON Coordination Function. By comparing the priorities of COC and CCO, SON Coordination Function will decide to do the high-priority action and suspend the low-priority action on the coordinated cell(s). The priorities of COC and CCO can be preset by operator to SON Coordination Function, or SON Coordination Function inquires the default priority of COC and CCO to each of them.

The cell which needs to be coordinated between COC and CCO is:

- The cell in which there is coverage or capacity problem and CCO action is needed, meanwhile the cell is outage or compensating or going to compensate for outage; or
- The cell which is located in the CCO optimization analysis area for other cell which has coverage or capacity problem, meanwhile the cell is outage or compensating or going to compensating for outage;

After the high-priority SON function executes action, the SON Coordination Function is informed about the result (successful/unsuccessful, parameters changes) of the executed high-priority SON action. Then, SON Coordination Function will analyse the latest network situation to decide how to deal with the suspended low-priority SON action, for example, resuming or rejecting.

---

### B.2 Coordination of COC, CCO and ES using priority of SON functions

To prevent conflicting adjustment from COC, ES and optimization from CCO in the common affected cell(s) (e.g., Cell 2 in the Figure 4.7.3.2), the cell(s) which may need to be coordinated among COC, CCO and ES, i.e., the impact area information, should be known by the SON Coordination Function. By comparing the priorities of COC, CCO and ES, SON Coordination Function will decide to do the highest-priority action and suspend the low-priority actions on the coordinated cell(s). The priorities of COC, CCO and ES can be preset by operator to SON Coordination Function, or SON Coordination Function inquires the default priority of COC, CCO and ES to each of them.

The cell which needs to be coordinated among COC, CCO and ES is:

- The cell in which there is coverage or capacity problem and CCO action is needed, meanwhile the cell is outage or compensating or going to compensate for outage or ES; or
- The cell which is located in the CCO optimization analysis area for other cell which has coverage or capacity problem, meanwhile the cell is outage or compensating or going to compensate for outage or ES;

After the highest-priority SON function executes action, the SON Coordination Function is informed about the result (successful/unsuccessful, parameters changes) of the executed highest-priority SON action. Then, SON Coordination Function will analyse the latest network situation to decide how to deal with the suspended low-priority SON actions, for example, resuming or rejecting.

---

## B.3 Coordination of COC, CCO and ES based on the cell state

The following lists the examples of how SON Coordination Function (SCF) can resolve the conflicts between COC, CCO, and ES functions based on cell state. Although not shown, priority may be used to along with the cell state to resolve the conflicts.

**Possible conflict #1:** COC requests a cell that is compensating an energy saving cell to compensate an outage cell

**Resolution:** When COC requests SCF that cell A is going to compensate an outaged cell, SCF should check whether cell A is compensating an energy saving cell. If so, SCF should check whether cell A can compensate both the outage cell and the energy saving cell concurrently. If not, the SCF may disallow cell A to compensate an energy saving cell.

**Possible conflict #2:** COC requests a cell that is being changed or going to be changed by CCO to compensate an outage cell

**Resolution:** When COC requests SCF that cell A is going to compensate an outaged cell, SCF should check whether CCO is updating parameters to optimize the capacity and coverage of cell A. If so, SCF may not allow cell A to compensate an outaged cell; otherwise SCF should allow cell A to compensate an outage cell.

**Possible conflict #3:** ES requests a candidate cell that is compensating an outage cell to compensate an energy saving cell

**Resolution:** When ES request SCF that cell A is to compensate a cell going to enter energy saving, SCF should check the `cOCStatus.state` of cell A. If `cOCStatus.state = cOCCompensating`, SCF should check whether cell A can compensate both the outage cell and the energy saving cell concurrently. If not, the SCF may disallow cell A to compensate an energy saving cell.

**Possible conflict #4:** ES requests a cell that is being changed or going to be changed by CCO to compensate an energy saving cell

**Resolution:** When ES requests SCF that cell A is going to compensate a cell going to enter energy saving, SCF should check whether CCO is updating parameters to optimize the capacity and coverage of cell A. If so, SCF may not allow cell A to compensate an energy saving cell; otherwise SCF should allow cell A to compensate an outage cell.

**Possible conflict #5:** CCO is going to change the configuration parameter of a cell that is compensating an outage cell

**Resolution:** When CCO requests SCF that cell A is going to change the configuration parameter, SCF should check the `cOCStatus.state` of cell A. If `cOCStatus.state = cOCCompensating`, SCF should disallow cell A to change the configuration parameter.

# Annex C (informative): State diagram for Distributed and EM-centralized Energy Saving Management

Energy Saving Management “state” attributes are available at various levels:

- SubNetwork IOC level, via the attribute esSwitch defined in the IOC SonControl;
- ENBFunction IOC level, via the attribute esSwitch defined in the IOC SonControl;
- EUTranGenericCell IOC level, via the locally defined attribute isChangeForEnergySavingAllowed, and via the attribute energySavingState defined in the IOC EnergySavingProperties.

The following figure provides an overview of Energy Saving Management related IOCs, state attribute names and possible values, for Distributed and EM-centralized Energy Saving Management:

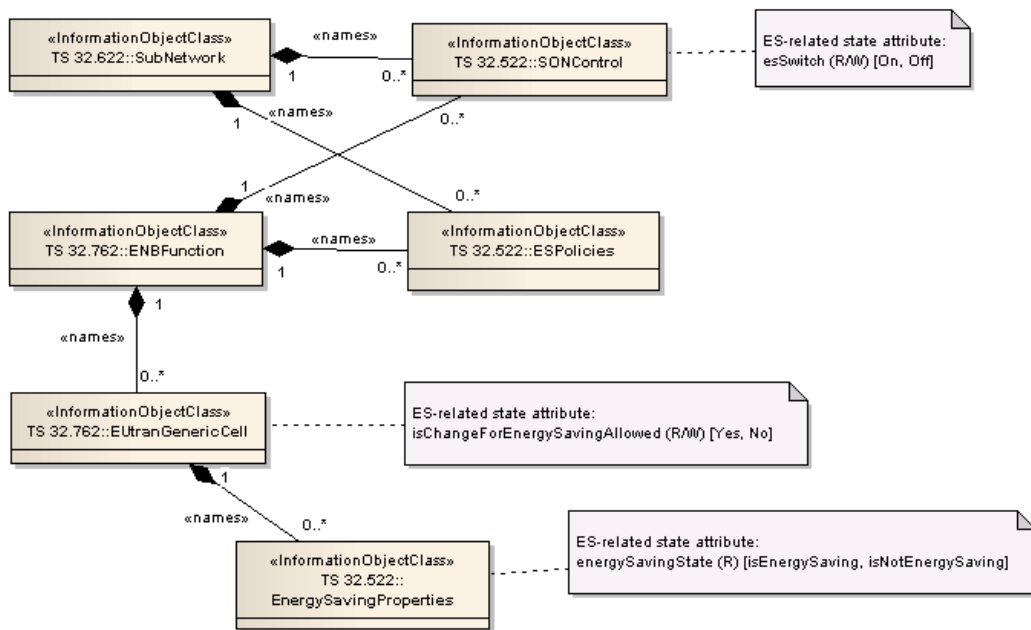

**Figure C-1: IOCs and state attributes for Distributed and EM-centralized ESM**

Dependencies exist between distributed ESM state attributes. The diagram below shows which allowed combinations of attribute state values, and which state transitions, are valid and which are not.

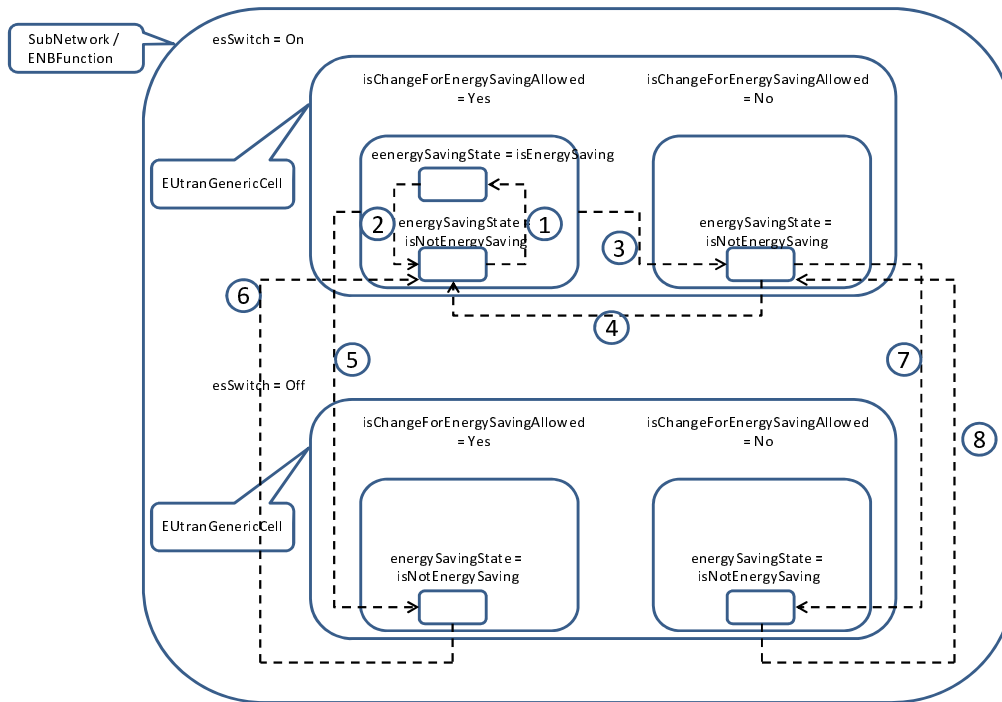

**Figure C-2: State diagram for Distributed and EM-centralized ESM**

**Description:**

- The ESM-related state attribute *esSwitch* is used by IRPManager to switch on / off the ESM functionality, in the distributed and EM-centralized architectures. This attribute has two possible values: On, Off. It can be set at the sub-network level and at the eNodeB level;
- The ESM-related state attribute *isChangeForEnergySavingAllowed* is used by IRPManager to prohibit or allow configuration changes of cells individually, within a eNodeB / sub-network, for ESM purposes by the IRPAgent. This attribute has two possible values: Yes, No.
- The ESM-related state attribute *energySavingState* is used to reflect the actual status of a cell regarding the energy saving. This attribute has two possible values: *isEnergySaving*, *isNotEnergySaving*.

Figure C-2 describes the following state transitions:

- Transition from (*esSwitch* = On and *isChangeForEnergySavingAllowed* = Yes and *energySavingState* = *isNotEnergySaving*) to (*esSwitch* = On and *isChangeForEnergySavingAllowed* = Yes and *energySavingState* = *isEnergySaving*): happens when:

ES Policies attached to the subject cell and to candidate for compensation cells, e.g. threshold and duration, are satisfied and allow entering Energy Saving state.

- Transition from (*esSwitch* = On and *isChangeForEnergySavingAllowed* = Yes and *energySavingState* = *isEnergySaving*) to (*esSwitch* = On and *isChangeForEnergySavingAllowed* = Yes and *energySavingState* = *isNotEnergySaving*): happens when:

ES Policies attached to the subject cell and to candidate for compensation cells, e.g. threshold and duration, are satisfied and allow leaving Energy Saving state.

- Transition from (*esSwitch* = On and *isChangeForEnergySavingAllowed* = Yes) to (*esSwitch* = On and *isChangeForEnergySavingAllowed* = No and *energySavingState* = *isNotEnergySaving*): happens when:

IRP Manager sets the attribute *isChangeForEnergySavingAllowed* to "No".

- 4) Transition from (*esSwitch* = On and *isChangeForEnergySavingAllowed* = No and *energySavingState* = *isNotEnergySaving*) to *isChangeForEnergySavingAllowed* = Yes: happens when:

IRP Manager sets the attribute *isChangeForEnergySavingAllowed* to “Yes”.

- 5) Transition from (*esSwitch* = On and *isChangeForEnergySavingAllowed* = Yes) to (*esSwitch* = Off and *isChangeForEnergySavingAllowed* = Yes and *energySavingState* = *isNotEnergySaving*): happens when:

IRP Manager sets the attribute *esSwitch* to “Off”.

- 6) Transition from (*esSwitch* = Off and *isChangeForEnergySavingAllowed* = Yes and *energySavingState* = *isNotEnergySaving*) to (*esSwitch* = On and *isChangeForEnergySavingAllowed* = Yes and *energySavingState* = *isNotEnergySaving*): happens when:

IRP Manager sets the attribute *esSwitch* to “On”.

- 7) Transition from (*esSwitch* = On and *isChangeForEnergySavingAllowed* = No and *energySavingState* = *isNotEnergySaving*) to (*esSwitch* = Off and *isChangeForEnergySavingAllowed* = No and *energySavingState* = *isNotEnergySaving*): happens when:

IRP Manager sets the attribute *esSwitch* to “Off”.

- 8) Transition from (*esSwitch* = Off and *isChangeForEnergySavingAllowed* = No and *energySavingState* = *isNotEnergySaving*) to (*esSwitch* = On and *isChangeForEnergySavingAllowed* = No and *energySavingState* = *isNotEnergySaving*): happens when:

IRP Manager sets the attribute *esSwitch* to “On”.



## Annex D (informative): Change history

Change history							
Date	TSG #	TSG Doc.	CR	Rev	Subject/Comment	Old	New
2013-03	SA#59	SP-130060	001	-	Rel-11 CR 28.628 SON coordination synchronization with 32.522	11.0.0	11.1.0
2013-06	SA#60	SP-130304	002	1	SON coordination synchronization with 32.522	11.1.0	11.2.0
			003	-	Energy saving synchronization with 32.522		
			004	-	Correction of attribute constraints		
2013-09	SA#61	SP-130441	005	-	Add missing Object class id for SONPolicy IOCs	11.2.0	11.3.0
2014-06	SA#64	SP-140358	007	-	remove the feature support statements	11.3.0	11.4.0
2014-09					Upgrade to Rel-12	11.4.0	12.0.0
2014-12	SA#66	SP-140798	008	1	Change esState in the Annex C text with the correct name of the attribute	12.0.0	12.1.0
2015-03	SA#67	SP-150063	009	1	Add NM centralized Coverage and Capacity Optimization (CCO) logical description	12.1.0	13.0.0
2015-06	SA#68	SP-150320	010	3	Add measurements for NM centralized Coverage and Capacity Optimization (CCO)	13.0.0	13.1.0
2015-09	SA#69	SP-150419	011	1	Add NM-Centralized CCO related measurements and delete redundant ones	13.1.0	13.2.0
			013	1	Correct coverage hole definition for NM centralized Coverage and Capacity Optimization (CCO)		

Change history							
Date	Meeting	TDoc	CR	Rev	Cat	Subject/Comment	New version
2017-03	SA#75					Promotion to Release 14 without technical change	14.0.0
2018-01	SA#78	SP-170968	0016	4	B	Add SON for AAS deployment management description and attributes	15.0.0
2019-03	SA#83	SP-190125	0017	-	F	Correction of AAS IP Throughput load rate definition	15.1.0

---

# History

<b>Document history</b>		
V15.0.0	July 2018	Publication
V15.1.0	May 2019	Publication