

ETSI TS 129 011 V3.0.0 (2000-01)

Technical Specification

**Digital cellular telecommunications system (Phase 2+) (GSM);
Universal Mobile Telecommunications System (UMTS);
Signalling interworking for supplementary services
(3G TS 29.011 version 3.0.0 Release 1999)**



Reference

DTS/TSGN-SS29011U

Keywords

GSM, UMTS

ETSI

Postal address

F-06921 Sophia Antipolis Cedex - FRANCE

Office address

650 Route des Lucioles - Sophia Antipolis
Valbonne - FRANCE
Tel.: +33 4 92 94 42 00 Fax: +33 4 93 65 47 16
Siret N° 348 623 562 00017 - NAF 742 C
Association à but non lucratif enregistrée à la
Sous-Préfecture de Grasse (06) N° 7803/88

Internet

secretariat@etsi.fr
Individual copies of this ETSI deliverable
can be downloaded from
<http://www.etsi.org>
If you find errors in the present document, send your
comment to: editor@etsi.fr

Important notice

This ETSI deliverable may be made available in more than one electronic version or in print. In any case of existing or perceived difference in contents between such versions, the reference version is the Portable Document Format (PDF). In case of dispute, the reference shall be the printing on ETSI printers of the PDF version kept on a specific network drive within ETSI Secretariat.

Copyright Notification

No part may be reproduced except as authorized by written permission.
The copyright and the foregoing restriction extend to reproduction in all media.

© European Telecommunications Standards Institute 2000.
All rights reserved.

Intellectual Property Rights

IPRs essential or potentially essential to the present document may have been declared to ETSI. The information pertaining to these essential IPRs, if any, is publicly available for **ETSI members and non-members**, and can be found in SR 000 314: "*Intellectual Property Rights (IPRs); Essential, or potentially Essential, IPRs notified to ETSI in respect of ETSI standards*", which is available from the ETSI Secretariat. Latest updates are available on the ETSI Web server (<http://www.etsi.org/ipr>).

Pursuant to the ETSI IPR Policy, no investigation, including IPR searches, has been carried out by ETSI. No guarantee can be given as to the existence of other IPRs not referenced in SR 000 314 (or the updates on the ETSI Web server) which are, or may be, or may become, essential to the present document.

Foreword

This Technical Specification (TS) has been produced by the ETSI 3rd Generation Partnership Project (3GPP).

The present document may refer to technical specifications or reports using their 3GPP identities or GSM identities. These should be interpreted as being references to the corresponding ETSI deliverables. The mapping of document identities is as follows:

For 3GPP documents:

3G TS | TR nn.nnn "<title>" (with or without the prefix 3G)

is equivalent to

ETSI TS | TR 1nn nnn "[Digital cellular telecommunications system (Phase 2+) (GSM);] Universal Mobile Telecommunications System; <title>

For GSM document identities of type "GSM xx.yy", e.g. GSM 01.04, the corresponding ETSI document identity may be found in the Cross Reference List on www.etsi.org/key

Contents

Foreword	5
1 Scope.....	6
1.1 Normative references.....	7
1.2 Definitions and abbreviations	8
2 Introduction.....	8
2.1 MSC/VLR procedures for handling supplementary service signalling received over the A-interface	8
2.2 MSC/VLR procedures for handling supplementary service signalling received over the D-interface	9
3 SS version negotiation	9
3.1 Call related supplementary services interworking	9
3.2 Call independent supplementary services interworking.....	9
4 Mapping between TC transaction sublayer messages and layer 3 radio path messages.....	10
4.1 D-interface to A-interface mapping	10
4.2 A-interface to D-interface mapping	10
4.3 Procedures	10
5 Call related supplementary services management	11
5.1 SS management in connection establishment phase	11
5.1.1 Line Identification services	11
5.1.1.1 Calling Line Identification Presentation (CLIP).....	11
5.1.1.2 Calling Line Identification Restriction (CLIR)	12
5.1.1.3 Connected Line Identification Presentation (COLP).....	12
5.1.1.4 Connected Line Identification Restriction (COLR).....	12
5.1.2 Call Forwarding services.....	13
5.1.2.1 Notification to served mobile subscriber.....	13
5.1.3 Call Waiting service (CW).....	13
5.1.3.1 Offering a waiting call.....	13
5.1.3.2 Notification of waiting call to calling subscriber.....	13
5.1.4 Closed User Group service (CUG).....	14
5.1.4.1 Explicit invocation of a CUG call	14
5.1.4.2 Notification of CUG invocation to served MS	14
5.1.4.3 Notification of rejection of CUG invocation to served MS.....	14
5.1.4.4 Notification of CUG invocation to terminating MS	16
5.1.5 Advice of Charge services.....	16
5.1.5.1 Notification of Charging information to served MS, mobile originated call.....	16
5.1.5.2 Notification of Charging information to served MS, mobile terminated call	16
5.1.6 Call Barring services	17
5.1.6.1 Barring of outgoing calls	17
5.1.6.2 Barring of incoming calls	17
5.1.7 CCBS call outcome	18
5.2 SS Management in stable connection state	18
5.2.1 Call Forwarding services.....	18
5.2.1.1 Notification of invocation of CFB to served mobile subscriber	18
5.2.2 Call Hold service (HOLD)	19
5.2.3 Multi Party service (MPTY)	20
5.2.4 Advice of Charge services.....	20
5.2.5 Explicit Call Transfer service (ECT).....	21
5.3 SS Management in disconnecting phase.....	21
5.3.1 Call Forwarding services.....	22
5.3.2 CCBS Request Activation.....	22
5.3.3 Call Deflection service	23
5.3.3.1 Call Deflection Operation Request.....	23
5.3.3.2 Call Deflection Operation Response	23
6 Call independent supplementary services management.....	24
6.1 MS initiated SS Management	24

6.1.1 Connection establishment phase 24

6.1.2 Connection established..... 25

6.1.3 Connection release 26

6.2 Network initiated SS Management 27

6.2.1 Connection establishment phase 27

6.2.2 Connection established..... 27

6.2.3 Connection release 27

6.2.4 ForwardCheckSSIndication 28

6.2.5 CCBS Recall 28

6.2.6 CCBS Monitoring 29

6.3 Mapping of Operation Codes, Error Codes, Parameter Tags and Parameter Contents 29

6.3.1 Operation codes..... 29

6.3.2 Error codes 29

6.3.3 Parameter tags and parameter values 30

Annex A: Change history..... 31

History..... 32

Foreword

This Technical Specification has been produced by the 3GPP.

This TS provides a detailed specification for interworking between the A-interface protocol and the Mobile Application Part (MAP) for handling of supplementary services within the 3GPP system.

The contents of the present document are subject to continuing work within the TSG and may change following formal TSG approval. Should the TSG modify the contents of this TS, it will be re-released by the TSG with an identifying change of release date and an increase in version number as follows:

Version 3.y.z

where:

- x the first digit:
 - 1 presented to TSG for information;
 - 2 presented to TSG for approval;
 - 3 Indicates TSG approved document under change control.
- y the second digit is incremented for all changes of substance, i.e. technical enhancements, corrections, updates, etc.
- z the third digit is incremented when editorial only changes have been incorporated in the specification;

1 Scope

The scope of this Technical Specification is to provide a detailed specification for interworking between the A interface protocol and the Mobile Application Part for handling of supplementary services. The MAP interfaces of interest are the B-, C-, D- and E-interfaces.

The A-, C-, D- and E-interfaces are physical interfaces while the B-interface is an internal interface defined for modelling purposes. Information relating to the modelling interface is not normative in this specification.

Supplementary service signalling may be passed by the MSC/VLR between the A- and E-interfaces after inter-MSC handover. This procedure is transparent as far as supplementary services are concerned therefore interworking concerning this process is not described in this specification.

Clause 2 describes general procedures for interworking between the A- and D- physical interfaces.

Clause 3 describes the general procedures for the SS version negotiation.

Clause 4 describes the mapping of layer 3 radio path messages with Transaction Capabilities (TC) transaction sublayer messages for interworking between the A- and D- physical interfaces.

Clause 5 describes specific interworking procedures for all interfaces relating to call related SS activity.

Clause 6 describes specific interworking procedures for all interfaces relating to call independent SS activity. Clause 6 also covers the interworking between the MAP User (see GSM 09.02) and the SS handling functions of the network entities (see GSM 04.10 and GSM 04.80).

Reference is made to the following Technical Specifications:

- GSM 02.04 and GSM 02.8x and GSM 02.9x-series,
for definition of supplementary services;
- GSM 03.11, GSM 03.8x and GSM 03.9x-series,
for technical realisation of supplementary services;
- GSM 04.10, GSM 04.80, GSM 04.8x and GSM 04.9x-series,
for radio path signalling procedures for supplementary services;
- GSM 09.02 (MAP).

1.1 Normative references

The following documents contain provisions which, through reference in this text, constitute provisions of the present document.

- References are either specific (identified by date of publication, edition number, version number, etc.) or non-specific.
- For a specific reference, subsequent revisions do not apply.
- For a non-specific reference, the latest version applies.
- A non-specific reference to an ETS shall also be taken to refer to later versions published as an EN with the same number.

- [1] GSM 01.04: "Digital cellular telecommunications system (Phase 2+); Abbreviations and acronyms".
- [2] GSM 02.04: "Digital cellular telecommunications system (Phase 2+); General on supplementary services".
- [3] GSM 02.24: "Digital cellular telecommunications system (Phase 2+); Description of Charge Advice Information (CAI)".
- [4] GSM 02.82: "Digital cellular telecommunications system (Phase 2+); Call Forwarding (CF) supplementary services - Stage 1".
- [5] GSM 02.86: "Digital cellular telecommunications system (Phase 2+); Advice of Charge (AoC) supplementary services - Stage 1".
- [6] GSM 02.93: "Digital cellular telecommunications system (Phase 2+); Completion of Calls to Busy Subscriber - Stage 1".
- [7] GSM 03.11: "Digital cellular telecommunications system (Phase 2+); Technical realization of supplementary services".
- [8] GSM 03.86: "Digital cellular telecommunications system (Phase 2+); Advice of Charge (AoC) supplementary services - Stage 2".
- [9] GSM 03.93: "Digital cellular telecommunications system (Phase 2+); Completion of Calls to Busy Subscriber - Stage 2".
- [10] GSM 04.08: "Digital cellular telecommunications system (Phase 2+); Mobile radio interface layer 3 specification".
- [11] GSM 04.10: "Digital cellular telecommunications system (Phase 2+); Mobile radio interface layer 3 Supplementary services specification General aspects".
- [12] GSM 04.72: "Digital cellular telecommunications system (Phase 2+); Call Deflection supplementary service - Stage 3".
- [13] GSM 04.80: "Digital cellular telecommunications system (Phase 2+); Mobile radio interface layer 3 supplementary services specification Formats and coding".
- [14] GSM 04.81: "Digital cellular telecommunications system (Phase 2+); Line identification supplementary services - Stage 3".
- [15] GSM 04.82: "Digital cellular telecommunications system (Phase 2+); Call Forwarding (CF) supplementary services - Stage 3".
- [16] GSM 04.83: "Digital cellular telecommunications system (Phase 2+); Call Waiting (CW) and Call Hold (HOLD) supplementary services - Stage 3".
- [17] GSM 04.84: "Digital cellular telecommunications system (Phase 2+); Multi Party (MPTY) supplementary services - Stage 3".

- [18] GSM 04.85: "Digital cellular telecommunications system (Phase 2+); Closed User Group (CUG) supplementary services - Stage 3".
- [19] GSM 04.86: "Digital cellular telecommunications system (Phase 2+); Advice of Charge (AoC) supplementary services - Stage 3".
- [20] GSM 04.88: "Digital cellular telecommunications system (Phase 2+); Call Barring (CB) supplementary services - Stage 3".
- [21] GSM 04.90: "Digital cellular telecommunications system (Phase 2+); Unstructured supplementary services operation - Stage 3".
- [22] GSM 04.91: "Digital cellular telecommunications system (Phase 2+); Explicit Call Transfer (ECT) supplementary services - Stage 3".
- [23] GSM 04.93: "Digital cellular telecommunications system (Phase 2+); Completion of Calls to Busy Subscriber - Stage 3".
- [24] GSM 09.02: "Digital cellular telecommunications system (Phase 2+); Mobile Application Part (MAP) specification".
- [25] GSM 09.10: "Digital cellular telecommunications system (Phase 2+); Information element mapping between Mobile Station - Base Station System and BSS - Mobile-services Switching Centre (MS - BSS - MSC) Signalling procedures and the Mobile Application Part (MAP)".

1.2 Definitions and abbreviations

Abbreviations used in this specification are listed in GSM 01.04.

2 Introduction

This clause describes general procedure at the MSC/VLR for SS interworking between the A- and D-interfaces.

2.1 MSC/VLR procedures for handling supplementary service signalling received over the A-interface

Upon receipt of supplementary service signalling on the A-interface, the MSC/VLR shall:

- perform any internal SS checks or procedures appropriate to the signal (see clauses 4 and 5);
- if necessary request access to the HLR over the D-interface using the procedures defined in this specification and MAP, GSM 09.02;
- use the version indicator received from the MS to set up the right AC context name towards the HLR (see clause 3). The version indicator is described in GSM 04.10 and GSM 04.80. AC names are defined in GSM 09.02;
- perform mapping between layer 3 messages on the radio path and TC transaction sublayer messages as required (see clause 3).

2.2 MSC/VLR procedures for handling supplementary service signalling received over the D-interface

Upon receipt of supplementary service signalling on the D-interface, the MSC/VLR shall:

- perform any internal SS checks or procedures appropriate to the signal (see clauses 4 and 5);
- handle any information elements according to the screening indicator procedure as described in GSM 04.10;
- perform mapping between TC transaction sublayer messages and layer 3 messages on the radio path as required (see clause 3).

3 SS version negotiation

This clause describes the general procedures for the call related and call independent supplementary services version negotiation.

3.1 Call related supplementary services interworking

No interworking identified.

3.2 Call independent supplementary services interworking

On receipt of the REGISTER message from the MS, the MSC/VLR will include the appropriate AC name in the dialogue control portion of the BEGIN message based on the following rules:

- if no version indicator is present, no AC name is included in the BEGIN message towards the HLR (no AC name indicates "version1");
- if the version indicator is less or equal to the highest AC name the MSC/VLR and HLR both support, the "dialogue" will be handled according to the AC name corresponding to the version indicator and to the SS operation received;
- if the version indicator is greater than the highest commonly supported AC name within the network (MSC/VLR, HLR), the "dialogue" will be handled according to this highest AC name if the request from the MS can also be fulfilled with this version of the "dialogue".

The selection of the highest commonly supported AC name by the network is described in GSM 09.02.

It should be noted that unknown parameters of the extension field within the Facility Information Element shall be forwarded to a phase 2 HLR according to the Extensibility rules as defined in GSM 09.02. They may be discarded when sent to a phase 1 HLR.

According to this version of the standards, the highest AC name is "version3".

The description method employed in the clauses 4 to 6 is tabled showing the mapping of parameter values. The exact values of the parameters and parameter tags can be found in the referenced specifications.

4 Mapping between TC transaction sublayer messages and layer 3 radio path messages

This clause describes the mapping of TC transaction sublayer messages to layer 3 radio path messages over the external interfaces. The precise coding of these messages is given in other technical specifications.

4.1 D-interface to A-interface mapping

Table 4.1 shows the mapping of TC transaction sublayer messages to layer 3 messages on the radio path.

Table 4.1: Mapping of TC transaction sublayer messages to layer 3 radio path messages

TC transaction sublayer message	Layer 3 radio path message
BEGIN	REGISTER (note 1)
CONTINUE (note 2)	FACILITY/REGISTER (note 3)
END (note 2)	RELEASE COMPLETE/REGISTER (note 3)
ABORT (note 2)	RELEASE COMPLETE
NOTE 1: AC name is not mapped to a version indicator.	
NOTE 2: The user information field if present is discarded.	
NOTE 3: A CONTINUE or END is mapped to REGISTER if a new transaction has to be established.	

4.2 A-interface to D-interface mapping

Table 4.2 shows the mapping of layer 3 radio path messages to TC transaction sublayer messages.

Table 4.2: Mapping of layer 3 radio path messages to TC transaction sublayer messages

Layer 3 radio path message	TC transaction sublayer message
REGISTER	BEGIN (note)
FACILITY	CONTINUE
RELEASE COMPLETE	END
NOTE: The right AC name shall be included, see clause 3.	

4.3 Procedures

The mapping from TC Transaction Sublayer messages to Layer 3 radio path messages must include a replacement of the tag and length of the Component Portion in the Transaction Sublayer message with the Information element identifier and length of the Facility Information Element for the Layer 3 message. Similarly for the reverse mapping. However, if a version indicator is received an AC name will be provided in the BEGIN message, see clause 3.

All transaction sublayer messages, except the ABORT message, will normally contain one or more components. If components are included, the conversion algorithm described below applies. If a message does not contain a component, then the corresponding message is also sent without a component: messages shall not be withheld by the interworking function.

For call independent SS operations each message shall only contain a single component. If a message contains more than one component then a RELEASE COMPLETE message with the cause "Facility rejected" (see GSM 04.08) and without any component shall be sent on the radio path (see GSM 04.10).

TC Transaction sublayer messages can also contain a dialogue portion. If a user-information is received within this dialogue portion, it will not be conveyed in a Layer 3 radio path message.

If an ABORT message is received in TC, a RELEASE COMPLETE message is to be sent on the radio path. The RELEASE COMPLETE message shall not contain any component. If a cause is to be provided to the MS, one of the cause codes of GSM 04.08 shall be used.

If an ABORT message with a dialogue portion indicating "version fallback" (e.g. the cause "AC-not-supported") is received in TC then, if the MSC does not re-attempt the "dialogue" (e.g. by using a different AC name), it shall send a RELEASE COMPLETE to the MS with the cause "Facility rejected" (see GSM 04.08) and without any component.

If an END message with a dialogue portion indicating "dialogue refused" is received in TC then the MSC shall send a RELEASE COMPLETE to the MS with the cause "Facility rejected" (see GSM 04.08) and without any component.

If a layer 3 radio path message or a component in the layer 3 radio path message is rejected by the MSC, the MSC shall:

- return a RELEASE COMPLETE message to the MS. If the reject condition is not associated with a component, one of the cause codes of GSM 04.08 shall be inserted, as described below. If it is a component (except a REJECT component), a REJECT component with the appropriate problem code shall be inserted in the RELEASE COMPLETE message, as described below. If the reject condition concerns a REJECT component the RELEASE COMPLETE message may be empty;
- terminate the transaction with the VLR by use of an ABORT message.

If a dialogue cannot be established with the HLR because no common AC name is available then the MSC shall send a RELEASE COMPLETE to the MS with the cause "Facility rejected".

5 Call related supplementary services management

5.1 SS management in connection establishment phase

When a CM connection is being set up between an MS and an MSC, setting up of a connection between the MSC and the VLR to request access proceeds as for normal call set-up (see GSM 09.02). Moreover, the MSC will also assess the capabilities of the MS according to the screening indicator (see GSM 04.10 and GSM 04.80). As the call set-up proceeds, the following supplementary services may apply:

5.1.1 Line Identification services

These supplementary services (described in GSM 04.81) require interworking in the MSC between both GSM 04.08, MAP (GSM 09.02) and the fixed network protocol, see also GSM 09.10.

5.1.1.1 Calling Line Identification Presentation (CLIP)

The signalling at invocation of the CLIP supplementary service is shown in figure 5.1.

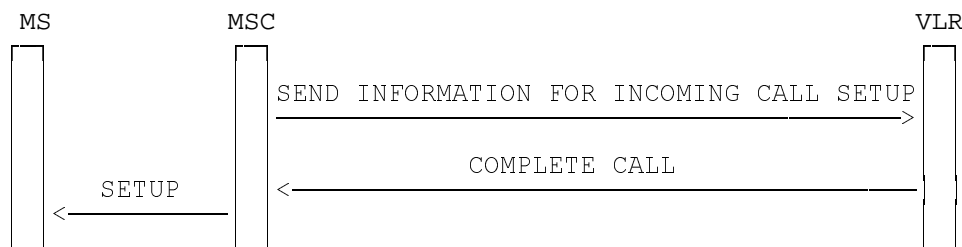

Figure 5.1: Signalling for CLIP supplementary service

When a call terminates at a mobile subscriber, the MSC obtains information on what supplementary services are active by analysing the SS-Data parameter in the MAP_COMPLETE_CALL service primitive on the B-interface. If this parameter indicates that the CLIP service is provided (and CLIR is not indicated in the incoming call set-up message from the PSTN), then the number of the calling subscriber (if received in the incoming call set-up) shall be mapped onto the Calling Party BCD number parameter in the SETUP message sent to the mobile. Exact values of the parameter and parameter tags are indicated in GSM 04.80 and GSM 04.81.

5.1.1.2 Calling Line Identification Restriction (CLIR)

The signalling at invocation of the CLIR supplementary service is shown in figure 5.2.

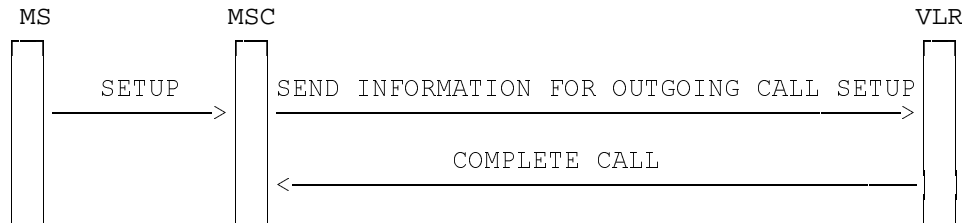

Figure 5.2: Signalling for CLIR supplementary service

When a call originates at a mobile subscriber, the MSC obtains information on what supplementary services are active by analysing the SS-Data parameter in the MAP_COMPLETE_CALL service primitive on the B-interface. If this parameter indicates that the CLIR service is provided and if the CLIR service shall be invoked (according to the presentation mode and possible subscriber request), then this information is indicated in the initial address message sent using the fixed network protocol (if possible).

If this parameter indicates that the CLIR service is not provided and the calling subscriber has attempted to invoke CLIR, then the call set-up shall be rejected as defined in GSM 04.81.

5.1.1.3 Connected Line Identification Presentation (COLP)

The signalling at invocation of the COLP supplementary service is shown in figure 5.3.

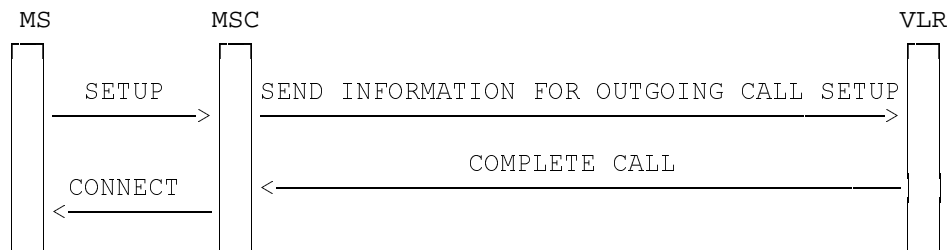

Figure 5.3: Signalling for COLP supplementary service

When a call originates at a mobile subscriber, the MSC obtains information on what supplementary services are active by analysing the SS-Data parameter in the MAP_COMPLETE_CALL service primitive on the B-interface. If this parameter indicates that the COLP service is provided, then if the connected line identity is made available by the terminating network (i.e. no interworking or presentation restrictions apply) then the connected number is passed to the calling mobile subscriber in the ConnectedNumber parameter in the CONNECT message.

5.1.1.4 Connected Line Identification Restriction (COLR)

The signalling at invocation of the COLR supplementary service is shown in figure 5.4.

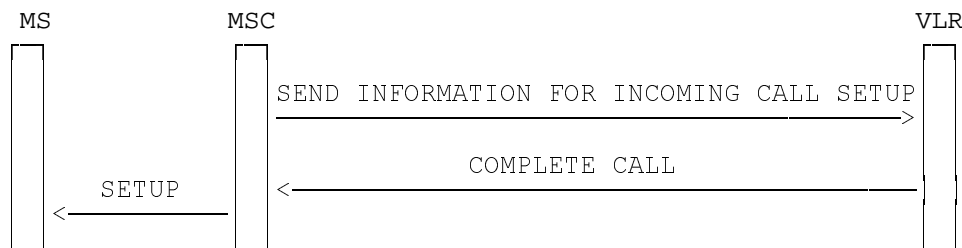

Figure 5.4: Signalling for COLR supplementary service

When a call terminates at a mobile subscriber, the MSC obtains information on what supplementary services are active by analysing the SS-Data parameter in the MAP_COMPLETE_CALL service primitive on the B-interface. If this parameter indicates that the COLR service is provided, then this information is sent to the originating network using the fixed network protocol (if possible).

5.1.2 Call Forwarding services

5.1.2.1 Notification to served mobile subscriber

As described in GSM 02.82, when a subscriber has any (set of) Call Forwarding service(s) active, a notification of this fact is sent to the MS at mobile originated call set-up from the served mobile subscriber. The signalling for this notification is shown in figure 5.5.

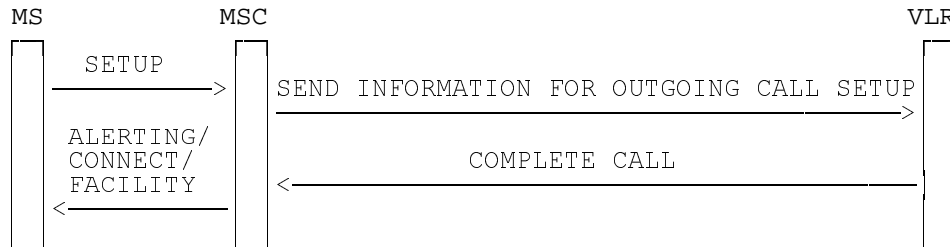

Figure 5.5: Signalling for notification of invocation of Call Forwarding supplementary service

The MSC obtains information on what supplementary services are active by analysing the SS-Data parameter in the MAP_COMPLETE_CALL service primitive on the B-interface. If this parameter indicates that a call forwarding service is active, then any of the ALERTING, CONNECT or FACILITY messages may be used to convey the required NotifySS operation in a Facility information element. Exact values of the parameter and parameter tags are indicated in GSM 04.80 and GSM 04.82.

5.1.3 Call Waiting service (CW)

5.1.3.1 Offering a waiting call

The signalling for this situation is shown in figure 5.6.

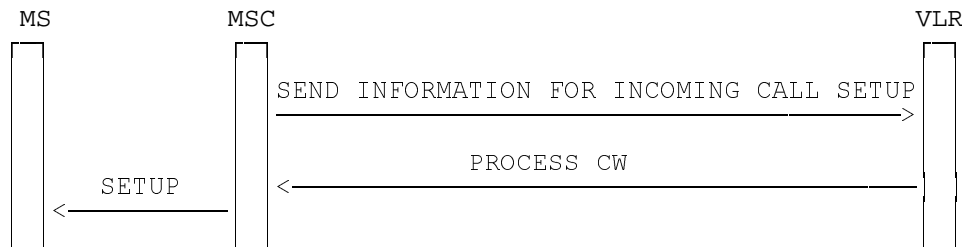

Figure 5.6: Signalling for setting up a waiting call

A waiting call is offered to a busy MS using a normal SETUP message including a "Signal" information element with value #7 (call waiting tone on), as described in GSM 04.83. This is the required MSC behaviour if it has received a MAP_PROCESS_CALL_WAITING service primitive as a response to a MAP_SEND_INFO_FOR_INCOMING_CALL service primitive on the B-interface. Exact values of the parameter and parameter tag are indicated in GSM 04.08.

5.1.3.2 Notification of waiting call to calling subscriber

The signalling for this notification is shown in figure 5.7.



Figure 5.7: Signalling for notification of waiting call to calling subscriber

If there are no network interworking limitations between the originating and destination MSCs, then the calling MS receives notification of his waiting call as follows: A Facility Information element in the ALERTING message includes a NotifySS operation with the following parameters:

- SS-Code parameter indicates "callWaiting";
- CallIsWaitingIndicator parameter indicates "callIsWaiting".

Exact values of the parameter and parameter tags are indicated in GSM 04.80 and GSM 04.83.

5.1.4 Closed User Group service (CUG)

5.1.4.1 Explicit invocation of a CUG call

The signalling for this situation is shown in figure 5.8.



Figure 5.8: Signalling at explicit invocation of a CUG call

When a subscriber to the CUG supplementary service sets up a call, an explicit invocation involves transport of a ForwardCUG-Info operation in a Facility information element in the SETUP message. Parameter mapping between the air-interface SETUP message and the B-interface MAP_SEND_INFO_FOR_OUTGOING_CALL service primitive shall take place in the MSC. Exact values of the parameter and parameter tags are indicated in GSM 04.80 and GSM 04.85. The parameter tags and values are mapped as follows:

Table 5.1: Mapping of parameter names and values for explicit invocation of a CUG call

GSM 04.80 parameter name	GSM 09.02 parameter name
cug-Index	cug-Index
suppressPrefCUG	suppressPrefCUG
suppressOA	suppressOutgoingAccess

5.1.4.2 Notification of CUG invocation to served MS

The signalling for this situation is shown in figure 5.9.

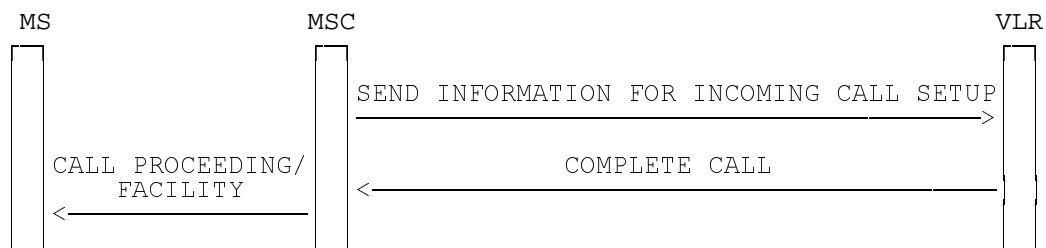

Figure 5.9: Signalling flow for notification of CUG invocation to served MS

The network may indicate to the MS that a CUG has been invoked for the outgoing call by sending a NotifySS operation in the Facility information element in the FACILITY or CALL PROCEEDING message towards MSa. The parameter to be included in this operation (cug-Index) is obtained from the MAP_COMPLETE_CALL service primitive. Exact values of the parameter and parameter tags are indicated in GSM 04.80 and GSM 04.85.

5.1.4.3 Notification of rejection of CUG invocation to served MS

The signalling for this situation is shown in figure 5.10.

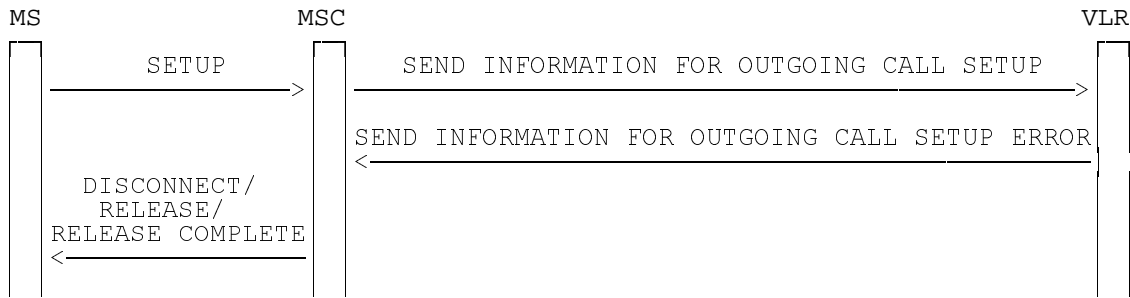

Figure 5.10: Signalling flow for notification of rejection of CUG invocation to served MS

When an attempted CUG call is rejected for CUG related reasons, mapping of parameter values take places in order to inform the MSa of the failure in the DISCONNECT, RELEASE or RELEASE COMPLETE message. If the call is rejected by the serving VLR, a mapping of errors received on the B-interface (as response to MAP_SEND_INFO_FOR_OUTGOING_CALL) to diagnostics (in the diagnostics field of the Facility Rejected cause value) must be performed. The mapping from error code to diagnostic is as follows (detailed values of tags, cause values and diagnostics are found in GSM 09.02, GSM 04.08, and GSM 04.80 respectively):

Table 5.2: Mapping of GSM 09.02 error causes to diagnostics at notification of rejection of CUG invocation to served MS

GSM 09.02 error cause	Facility rejected #29 diagnostic field
outgoingCallsBarredWithinCUG	Outgoing calls barred within the CUG
noCUG-Selected	No CUG selected
unknownCUG-Index	Unknown CUG index
indexIncompatibleWith RequestedBasicService	Index incompatible with requested basic service

If there are no network interworking restrictions (i.e. originating MSC = gateway MSC = terminating MSC), interworking between MAP and the air-interface takes place also for rejection of CUG calls by terminating end. The signalling for this situation is shown in figure 5.11.

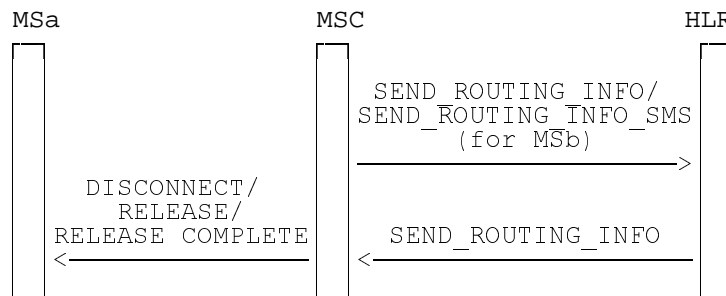

Figure 5.11: Signalling flow for notification of rejection of CUG invocation from terminating end

The mapping from error code to diagnostic is as follows (detailed values of tags, cause values and diagnostics are found in GSM 09.02, GSM 04.08, and GSM 04.80 respectively):

Table 5.3: Mapping of GSM 09.02 error causes to cause values at notification of rejection by terminating end

GSM 09.02 error cause	Cause information element (cause value)
calledPartySSInteractionViolation	Facility Rejected #29, Diagnostic = CUG call failure, unspecified
incomingCallsBarredWithinCUG	Incoming calls barred within the CUG #55
subscriberNotMemberOfCUG	User not a member of CUG #87

requestedBasicServiceViolatesCUG-Constraints	Facility Rejected #29
--	-----------------------

5.1.4.4 Notification of CUG invocation to terminating MS

The signalling for this situation is shown in figure 5.12.

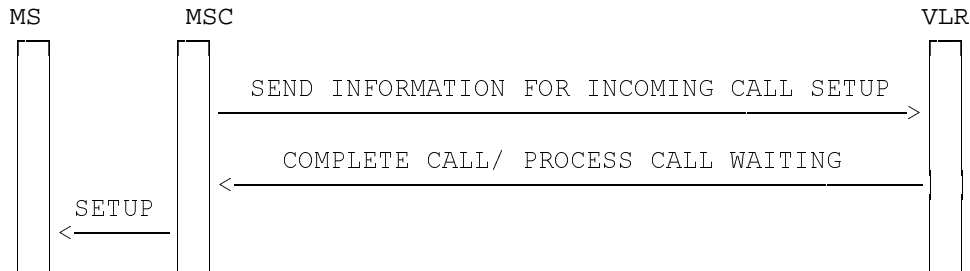

Figure 5.12: Signalling flow for notification of CUG invocation to terminating end

When a CUG call arrives at the terminating end, the CUG index associated with the invoked CUG may be passed to the mobile station. The cug-Index parameter is obtained from the fixed network connection establishment request message, or if no fixed network protocol is involved (i.e. originating = terminating MSC), it is obtained from the MAP_COMPLETE_CALL or MAP_PROCESS_CALL_WAITING service primitive. Its value is mapped onto the cug-Index parameter in the NotifySS operation in the Facility Information element of the SETUP message on the air-interface. Exact values of the parameter and parameter tags are indicated in GSM 04.80 and GSM 04.85.

5.1.5 Advice of Charge services

5.1.5.1 Notification of Charging information to served MS, mobile originated call

The signalling for this situation is shown in figure 5.13.

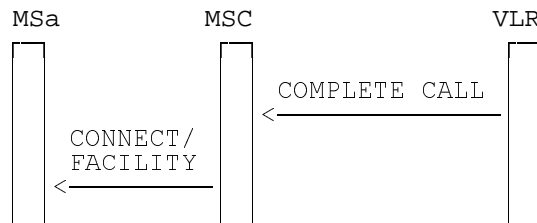

Figure 5.13: Signalling flow for notification of Mobile originated Charging Information to served MS

The network may indicate charging information to the MS at mobile originated call set-up. The MSC knows charging information is applicable due to the inclusion of an SS-Code indicating Advice Of Charge Charging or Advice Of Charge Information in the MAP_COMPLETE_CALL service indication from the VLR. This parameter's value is mapped onto the SS-Code parameter in the ForwardChargeAdvice operation which is to be sent to the MS together with the relevant charging parameters. The ForwardChargeAdvice operation shall be sent in the facility information element of either the CONNECT or the FACILITY message. Exact values of the parameter and parameter tags are indicated in GSM 04.80 and GSM 04.85.

5.1.5.2 Notification of Charging information to served MS, mobile terminated call

The signalling for this situation is shown in figure 5.14.

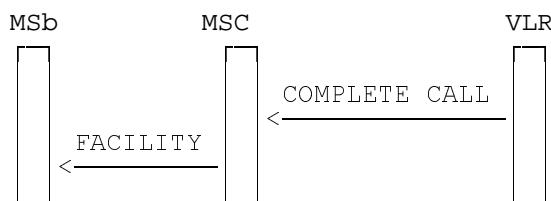

Figure 5.14: Signalling flow for notification of Mobile terminated Charging Information to served MS

The network may indicate charging information to the MS at mobile terminated call set-up. The MSC knows charging information is applicable due to the inclusion of an SS-Code indicating Advice Of Charge Charging or Advice of Charge Information in the SS-Data parameter included in the MAP_COMPLETE_CALL service indication from the VLR. This parameter's value is mapped onto the SS-Code parameter in the ForwardChargeAdvice operation which is to be sent to the MS together with the relevant charging parameters. The ForwardChargeAdvice operation shall be sent in the facility information element of the FACILITY message. Exact values of the parameter and parameter tags are indicated in GSM 04.80 and GSM 04.85.

5.1.6 Call Barring services

These supplementary services (described in GSM 04.88) require the following interworking in the MSC:

5.1.6.1 Barring of outgoing calls

The signalling for this situation is shown in figure 5.15.

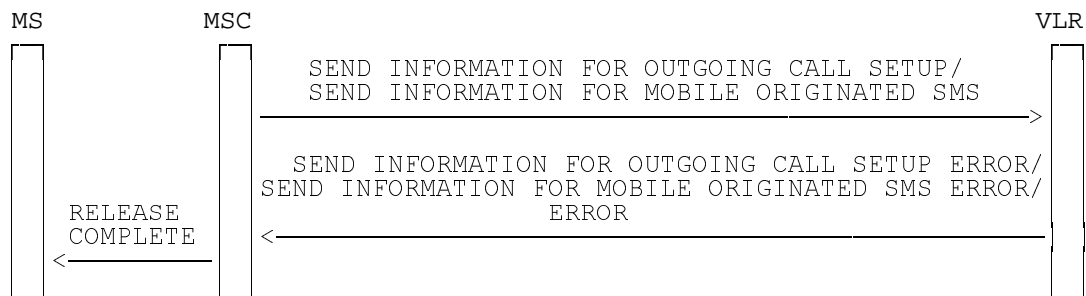

Figure 5.15: Signalling flow for barring of an outgoing call

If the error code "CallBarred" is received as a response to the MAP_SEND_INFO_FOR_OUTGOING_CALL or MAP_SEND_INFO_FOR_MO_SMS service primitives on the B-interface, then a RELEASE COMPLETE message with a NotifySS operation shall be sent to the originating MS, as described in GSM 04.88. The mapping of GSM 09.02 callBarringCause to GSM 04.08 cause values is shown in table 5.4. Exact values of the parameter and parameter tags are indicated in GSM 04.80, GSM 04.88 and GSM 04.08.

Table 5.4: Mapping of GSM 09.02 callBarringCause to GSM 04.08 cause values at barring of outgoing call

GSM 09.02 callBarringCause	GSM 04.08 Cause value
barringServiceActive	#31: Normal Unspecified
operatorBarring	#8: Operator Determined Barring
(None)	#21: Call Rejected

5.1.6.2 Barring of incoming calls

The signalling for this situation is shown in figure 5.16.

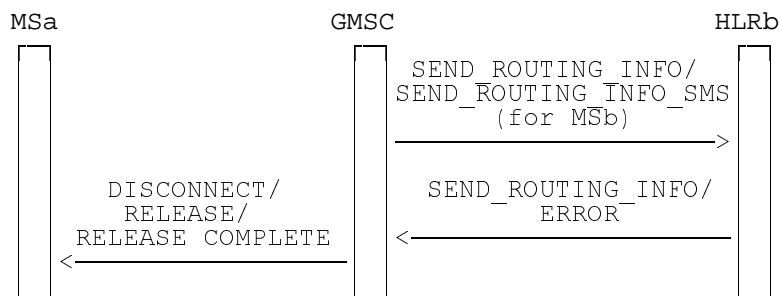

Figure 5.16: Signalling flow for barring of an incoming call

If the error code "CallBarred" is received as a response to the MAP_SEND_ROUTING_INFO or MAP_SEND_ROUTING_INFO_FOR_SM service primitives on the D-interface, then if no network interworking limitations apply, a NotifySS operation shall be sent to the originating MS in the first clearing message, as described in GSM 04.88. The mapping of GSM 09.02 error causes to GSM 04.08 cause values is shown in table 5.5. Exact values of the parameter and parameter tags are indicated in GSM 04.80, GSM 04.88 and GSM 04.08.

Table 5.5: Mapping of GSM 09.02 error causes to cause values at barring of incoming call

GSM 09.02 error cause	Cause value
barringServiceActive	#21: Call Rejected
operatorBarring	#21: Call Rejected
(None)	#21: Call Rejected

5.1.7 CCBS call outcome

For the purpose of monitoring the destination B (the target of a CCBS request activated by subscriber A), the HLR on the B-side needs to know the outcome of a CCBS call. A CCBS call is a call being set-up after acceptance of a recall (indication to subscriber A that B is idle). Thus, in case of a CCBS call, on receipt of call related messages from the MS, the MSC shall send (via the VLR) the MAP_STATUS_REPORT to the HLR.

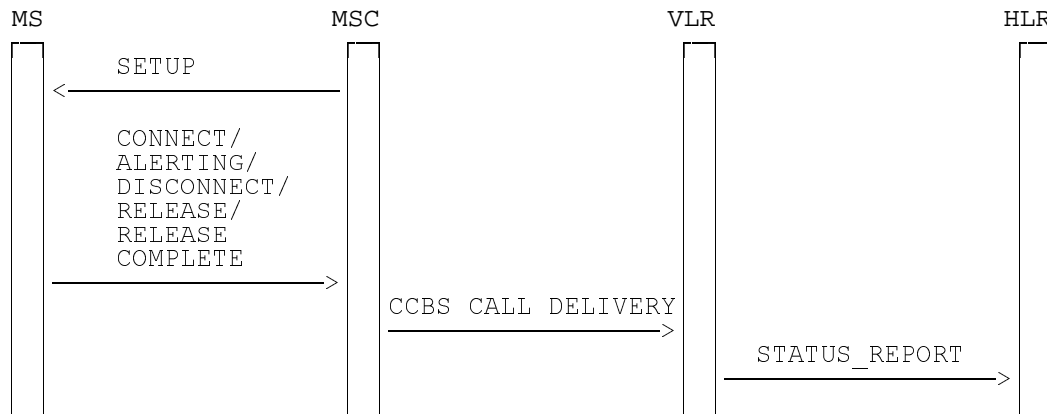

Figure 5.16a: Signalling for CCBS call outcome

The CONNECT or ALERTING messages imply that the call establishment has been successful. Then the value of the Outcome information element in the MAP_STATUS_REPORT is set to success.

The DISCONNECT and RELEASE are, in this case, error messages and can contain different causes (e.g. *Call Rejected* or *User Busy*). The MSC translates the message and/or the cause received into the proper value for the Outcome information element (*Failure* or *Busy*).

Exact coding and values of the messages and parameter tags can be found in GSM 04.08 and GSM 09.02.

5.2 SS Management in stable connection state

When a stable CM connection is set up between a mobile station and the network, the following supplementary services may apply:

5.2.1 Call Forwarding services

5.2.1.1 Notification of invocation of CFB to served mobile subscriber

As described in GSM 02.82, when the Call Forwarding on MS Busy service is invoked by the network, a notification of this fact may be sent to the MS. The signalling for the situation when the user is NDUB is shown in figure 5.17. Note that if the subscriber is not NDUB, this notification does not apply.

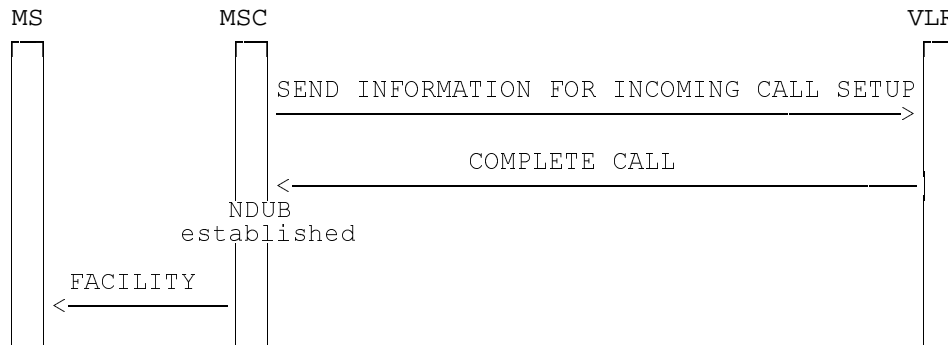

Figure 5.17: Signalling for notification of invocation of CFB supplementary service

The MSC obtains information on what supplementary services are active by analysing the SS-Data parameter in the MAP_COMPLETE_CALL service primitive on the B-interface. If this parameter indicates that CFB is active, then the FACILITY message may be used to convey the required NotifySS operation in a Facility information element. Exact values of the parameter and parameter tags are indicated in GSM 04.80 and GSM 04.82.

5.2.2 Call Hold service (HOLD)

As described in GSM 04.83, an MS can at any time during the active phase of a call signal invocation of the Call Hold supplementary service towards the network. This is done by use of the HOLD message (defined in GSM 04.80). When the MSC receives such a message, it requests access to the VLR and sends the MAP_INVOKE_SS service primitive to the VLR (as described in GSM 09.02). The interworking function triggers this behaviour by sending an internal MAP_INVOKE_SS signal to the MAP Service User of the MSC, indicating the following parameter values:

- SS-Code = Call Hold;
- BS-Code = Basic service of the on-going call.

The signalling for this situation is shown in figure 5.18. Exact values of the parameter and parameter tags are indicated in GSM 04.80, GSM 04.83 and GSM 09.02.

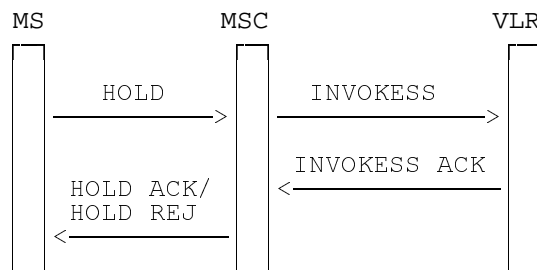

Figure 5.18: Signalling flow at invocation of Call Hold supplementary service

If the A_INVOKE_SS signal from the MAP Service User in the MSC is empty, the HOLD ACKNOWLEDGE message is returned to the MS. If it refers to an error, the mapping of error causes takes place according to table 5.6. Exact values of the parameter tags are indicated in GSM 04.80 and GSM 09.02.

Table 5.6: Mapping of GSM 09.02 operation errors to GSM 04.80 HOLD REJECT causes

GSM 09.02 operation error	GSM 04.80 HOLD REJECT cause
SystemFailure	#63: Service/Option not available
DataMissing	#100: Invalid Information Element contents
UnexpectedDataValue	#100: Invalid Info. element contents
CallBarred	#29: Facility Rejected
IllegalSS-Operation	#50: Requested Facility not subscribed
SS-ErrorStatus	#50: Requested facility not subscribed
SS-NotAvailable	#69: Requested facility not implemented

Note that Call Retrieval requires no communication on the B-interface, and thus no interworking requirements have been identified.

5.2.3 Multi Party service (MPTY)

As described in GSM 04.84, an MS can at any time during the active phase of a call signal invocation of the Multi Party supplementary service towards the network. This is done by including a BuildMPTY operation (defined in GSM 04.80) in a FACILITY message. When the MSC receives such a request, it requests access to the VLR and sends the MAP_INVOKE_SS service primitive to the VLR (as described in GSM 09.02). The interworking function triggers this behaviour by sending an internal MAP_INVOKE_SS signal to the MAP Service User of the MSC, indicating the following parameter values:

- SS-Code = MPTY;
- BS-Code = Basic Service Code of the on-going calls.

Note that the MSC does not allow the MPTY to be invoked if the two calls are not telephony calls.

The signalling for this situation is shown in figure 5.19.

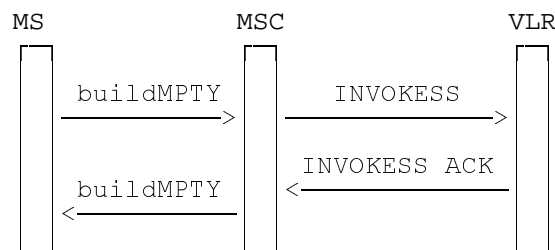

Figure 5.19: Signalling flow at invocation of Multi Party supplementary service

If the A_INVOKE_SS signal from the MAP Service User in the MSC is empty, the BuildMPTY return result is returned to the MS in a FACILITY message. If it refers to an error, the mapping of errors takes place according to table 5.7.

Table 5.7: Mapping of GSM 09.02 operation errors to GSM 04.80 BuildMPTY errors

GSM 09.02 operation error	GSM 04.80 BuildMPTY error
SystemFailure	SystemFailure
DataMissing	SystemFailure
UnexpectedDataValue	SystemFailure
CallBarred	IllegalSS-Operation
IllegalSS-Operation	IllegalSS-Operation
SS-ErrorStatus	SS-ErrorStatus
SS-NotAvailable	SS-NotAvailable

Note that Holding, Retrieving and Splitting a multi party requires no communication on the B-interface, and thus no interworking requirements have been identified.

5.2.4 Advice of Charge services

Notification of Charging information to served MS during the call

The network may indicate revised charging parameters (as required according to GSM 02.24, GSM 02.86, GSM 03.86 and GSM 04.86) to the MS during a call. The parameters are forwarded to MSa using the ForwardChargeAdvice operation in the facility information element of the FACILITY message. Exact values of the parameter and parameter tags are indicated in GSM 04.80 and GSM 04.85.

5.2.5 Explicit Call Transfer service (ECT)

As described in GSM 04.91, an MS can at any time during the active phase of a call signal invocation of the Explicit Call Transfer supplementary service towards the network. This is done by including a ExplicitCT operation (defined in GSM 04.80) in a FACILITY message. When the MSC receives such a request, it requests access to the VLR and sends the MAP_INVOKE_SS service primitive to the VLR (as described in GSM 09.02). The interworking function triggers this behaviour by sending an internal MAP_INVOKE_SS signal to the MAP Service User of the MSC, indicating the following parameter values:

- SS-Code = ect;
- BS-Code = Basic Service Code of the on-going calls.

Note that the MSC does not allow the ECT to be invoked if the two calls are not telephony calls.

The signalling for this situation is shown in the following figure 5.21.

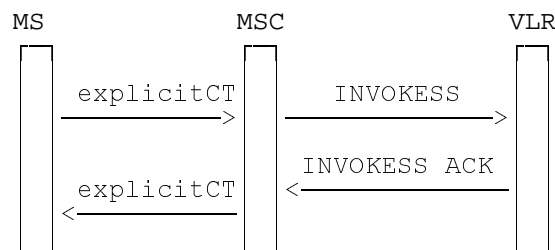

Figure 5.21: Signalling flow at invocation of Explicit Call Transfer supplementary service

If the A_INVOKE_SS signal from the MAP Service User in the MSC is empty, the ExplicitCT return result is returned to the MS in a DISCONNECT/RELEASE/RELEASE COMPLETE message. If it refers to an error, the mapping of errors takes place according to table 5.8.

Table 5.7: Mapping of GSM 09.02 operation errors to GSM 04.80 ExplicitCT errors

GSM 09.02 operation error	GSM 04.80 ExplicitCT error
SystemFailure	SystemFailure
DataMissing	SystemFailure
UnexpectedDataValue	SystemFailure
CallBarred	CallBarred
IllegalSS-Operation	IllegalSS-Operation
SS-ErrorStatus	SS-ErrorStatus
SS-NotAvailable	SS-NotAvailable

5.3 SS Management in disconnecting phase

When a CM connection is being released, the following supplementary services may apply:

5.3.1 Call Forwarding services

Notification of invocation of CFNRy to served mobile subscriber

As described in GSM 02.82, when the Call Forwarding on No Reply service is invoked by the network, a notification of this fact may be sent to the MS as the call attempt is disconnected. The signalling for this situation is shown in figure 5.20.

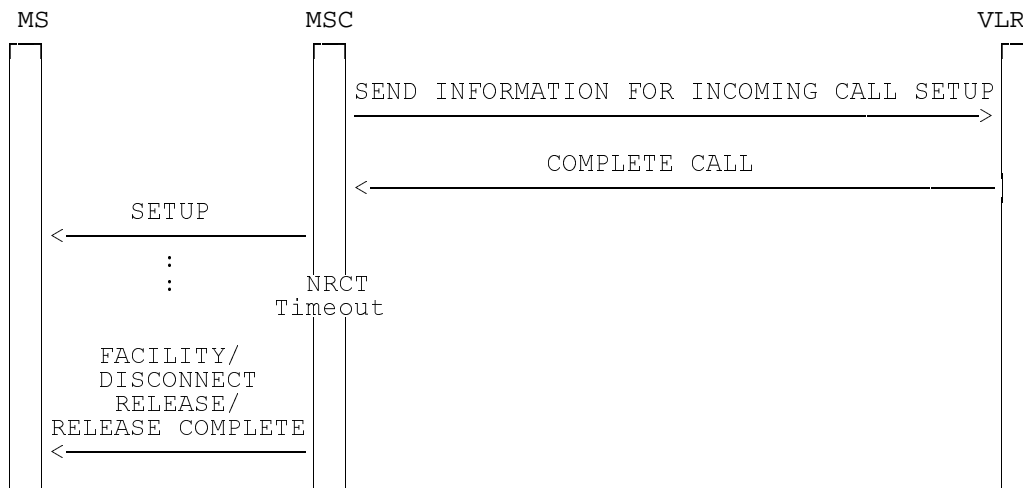

Figure 5.20: Signalling for notification of invocation of CFNRy supplementary service

The MSC obtains information on what supplementary services are active by analysing the SS-Data parameter in the MAP_COMPLETE_CALL service primitive on the B-interface. If this parameter indicates that CFNRy is active, then if required, either one of the DISCONNECT, RELEASE, RELEASE COMPLETE or FACILITY messages may be used to convey the required NotifySS operation in a Facility information element. Exact values of the parameter and parameter tags are indicated in GSM 04.80 and GSM 04.82.

5.3.2 CCBS Request Activation

As described in GSM 02.93, when subscriber A encounters a busy destination B, subscriber A can request the CCBS supplementary service (i.e. activate a CCBS request against destination B).

The signalling for this situation is shown in figure 5.21.

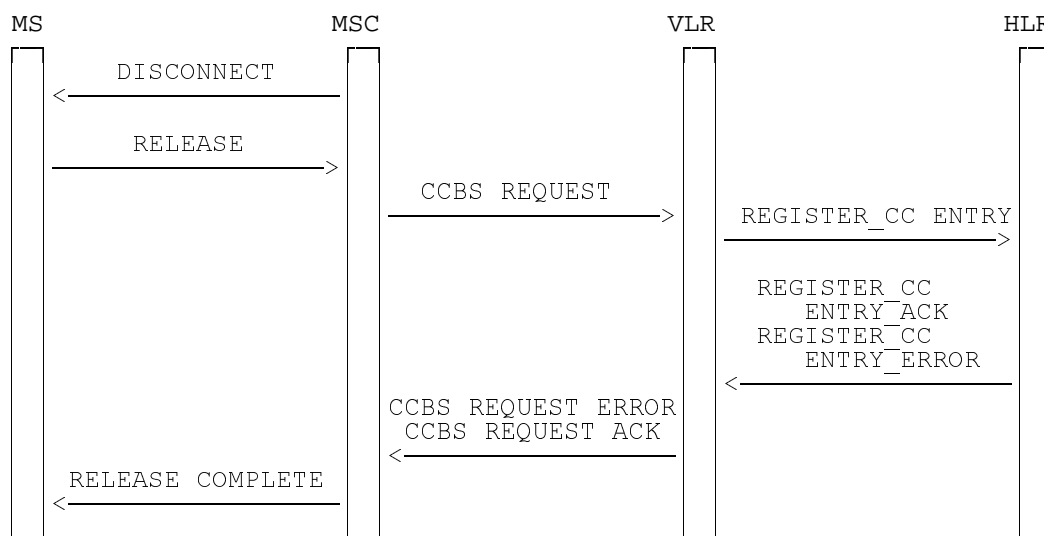

Figure 5.21: Signalling for CCBS Request Activation

The MS request the activation of CCBS in a Facility information element of a RELEASE message in response to a DISCONNECT message containing the diagnostic *CCBS is possible* and the Allowed Actions information element set to *Recall is possible*. Then, the MSC transmits the request in an Invoke component together with the call information towards the VLR in a CCBS_REQUEST message on the B-interface. The VLR forwards it in a MAP_REGISTER_CC_ENTRY on the D-interface.

The outcome of the activation is sent back by the HLR in a MAP_REGISTER_CC_ENTRY_ACK or a MAP_REGISTER_CC_ENTRY_ERROR message. This outcome is subsequently mapped and inserted in the Facility information element of the RELEASE COMPLETE message from the MSC to the MS.

Exact values of the parameters and parameter tags are indicated in GSM 04.08, GSM 04.80, GSM 04.93 and GSM 09.02.

5.3.3 Call Deflection service

5.3.3.1 Call Deflection Operation Request

As described in GSM 04.72, a MS may signal invocation of the Call Deflection supplementary service for a mobile terminated call at any time after call confirmation until the call is accepted.

The signalling for this situation is shown in figure 5.22.



Figure 5.22: Signalling of a Call Deflection Request

The MS requests Invocation of Call Deflection by including a CallDeflection operation (defined in GSM 04.80) in a DISCONNECT message. The parameters of the CallDeflection operation of the DISCONNECT message shall be transferred by the MSC to the VLR with the B-interface COMPLETE_CALL_ERROR or PROCESS_CALL_WAITING_ERROR message.

5.3.3.2 Call Deflection Operation Response

Optimal Routing of late call forwarding is not invoked

The signalling for this situation is shown in figure 5.23.

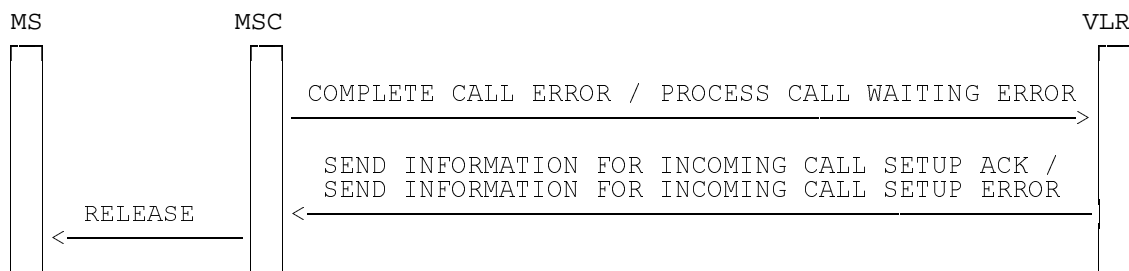

Figure 5.23: Mapping of Call Deflection Response without SOR

The MSC shall send a CallDeflection return result to the MS if the SEND_INFO_FOR_INCOMING_CALL_ACK message is received from the VLR and the invocation of Optimal Routing is not requested. The MSC shall send a CallDeflection return error to the MS if a SEND_INFORMATION_FOR_INCOMING_CALL_SETUP ERROR message is received from the VLR. The MSC shall obtain the value of the CallDeflection error from the error received in the SEND_INFORMATION_FOR_INCOMING_CALL_SETUP ERROR message.

Optimal Routeing of late call forwarding is invoked:

The signalling for this situation is shown in figure 5.24.

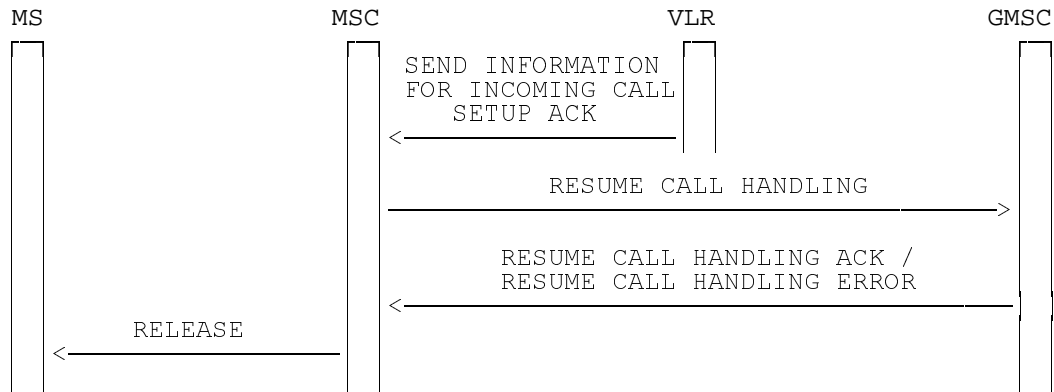

Figure 5.24: Mapping of Call Deflection Response in case of SOR

If for a Call Deflection Request Optimal Routeing of late call forwarding is invoked the MSC shall send a CallDeflection return result to the MS if the MAP_RESUME_CALL_HANDLING_ACK is received from the GMSC. If a MAP_RESUME_CALL_HANDLING_ERROR message with error "ForwardingFailed" is received from the GMSC the MSC shall send a CallDeflection return error "ForwardingFailed" to the MS. Reception of other errors than "ForwardingFailed" in the MAP_RESUME_CALL_HANDLING_ERROR message shall lead to local processing in the MSC.

Exact values of the parameters and parameter tags are indicated in GSM 04.80 and GSM 09.02.

6 Call independent supplementary services management

6.1 MS initiated SS Management

6.1.1 Connection establishment phase

Call independent supplementary service management takes place on a separate, dedicated CM connection between the mobile station and the MSC. When a request to open such a connection arrives at the MSC, the MSC will request access permission from the VLR, as described in GSM 09.02. It will also assess the capabilities of the MS according to the screening indicator, as described in GSM 04.10 and GSM 04.80. The signalling for this situation is shown in figure 6.1.

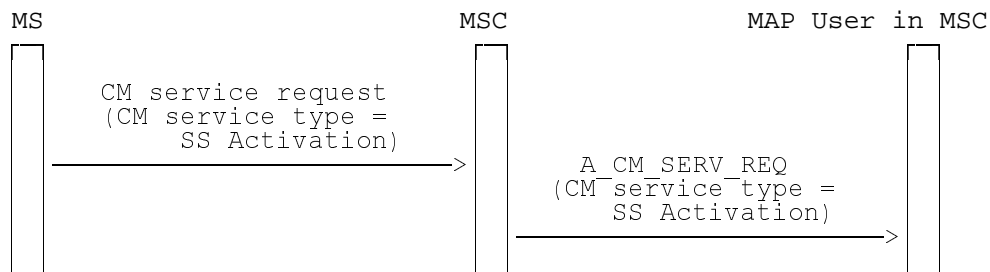

Figure 6.1: Signalling flow for SS connection establishment

6.1.2 Connection established

At this stage of the connection, the version negotiation mechanism will be invoked as described in clause 3. The abstract definition of the protocol used for call independent SS operations is imported directly from GSM 09.02 into GSM 04.80.

The signalling for invocation of a supplementary service operation is shown in figure 6.2, while figure 6.3 shows the signalling for returning the result of the supplementary service operation. Tables 6.1 and 6.2 show the mapping of GSM 04.80 operation codes to MAP service primitives, and vice versa respectively. The detailed mapping of the contents of the facility information elements to the service primitives triggering the MAP user are described in subclause 6.3.

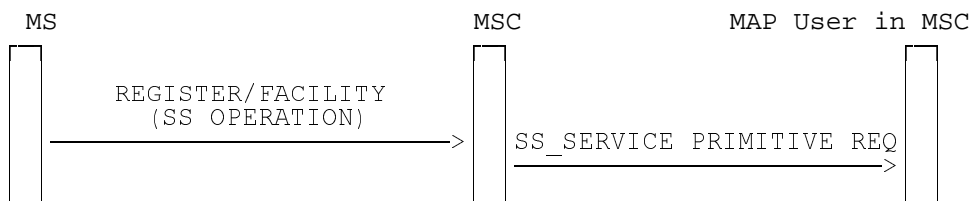

Figure 6.2: Signalling flow for SS operation invocation

Choice of service primitive on the basis of received facility information element is as follows:

Table 6.1: Mapping of GSM 04.80 operations to GSM 09.02 service primitives

Facility information element operation	Service primitive for MAP Service user
RegisterSS	A_REGISTER_SS
EraseSS	A_ERASE_SS
ActivateSS	A_ACTIVATE_SS
DeactivateSS	A_DEACTIVATE_SS
InterrogateSS	A_INTERROGATE_SS
RegisterPassword	A_REGISTER_PASSWORD
ProcessUnstructuredSS-Request	A_PROCESS_UNSTRUCTURED_SS_REQUEST
EraseCC-Entry	A_ERASE_CC_ENTRY

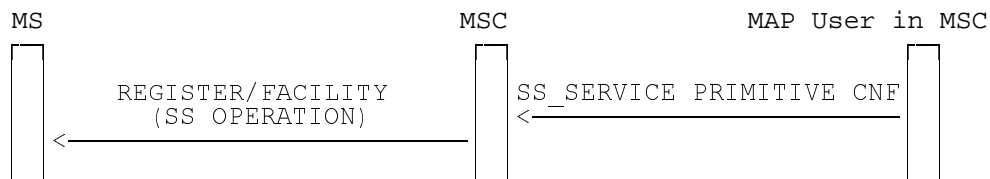

Figure 6.3: Signalling flow for SS operation return result

Choice of facility information element on the basis of received service primitive is as follows:

Table 6.2: Mapping of GSM 09.02 service primitives to GSM 04.80 operations

Service primitive for MAP Service user	Facility information element operation
A_REGISTER_SS	RegisterSS
A_ERASE_SS	EraseSS
A_ACTIVATE_SS	ActivateSS
A_DEACTIVATE_SS	DeactivateSS
A_INTERROGATE_SS	InterrogateSS
A_REGISTER_PASSWORD	RegisterPassword
A_PROCESS_UNSTRUCTURED_SS_REQUEST	ProcessUnstructuredSS-Request
A_UNSTRUCTURED_SS_REQUEST	UnstructuredSS-Request
A_UNSTRUCTURED_SS_NOTIFY	ProcessUnstructuredSS-Notify
A_GET_PASSWORD	GetPassword
A_REGISTER_CC_ENTRY	AccessRegisterCCEntry
A_ERASE_CC_ENTRY	EraseCCEntry

6.1.3 Connection release

A supplementary service control connection is usually released by the network. The signalling for this situation is shown in figure 6.4.

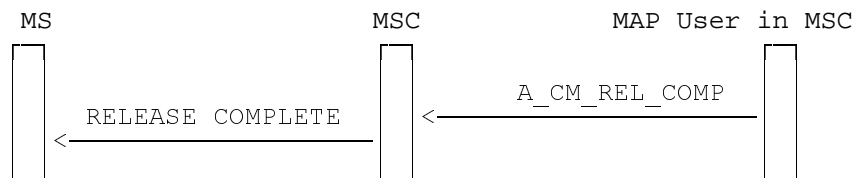

Figure 6.4: Signalling flow for SS connection release by the network

However, in exceptional circumstances, the MS may request release of the connection. The signalling for this situation is shown in figure 6.5.

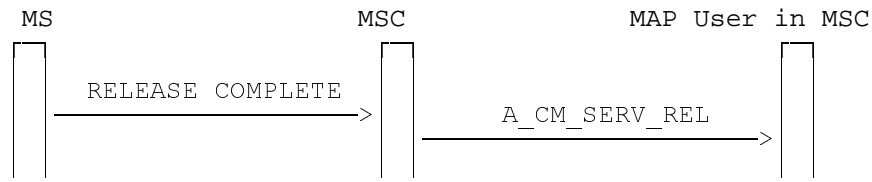

Figure 6.5: Signalling flow for SS connection release by the MS

6.2 Network initiated SS Management

6.2.1 Connection establishment phase

Call independent supplementary service management takes place on a separate, dedicated CM connection between the mobile station and the MSC. The MSC may need to open a connection towards the MS (as described in GSM 04.08) to send the Network initiated SS operation to the MS. Detailed mapping rules are described in subclause 6.3.

6.2.2 Connection established

The abstract definition of the protocol used for call independent SS operations is imported directly from GSM 09.02 into GSM 04.80.

The signalling for invocation of a Network initiated SS operation is shown in figure 6.6, while figure 6.7 shows the signalling for returning the result of supplementary service operation.

Choice of facility information element on the basis of received service primitive is described in table 6.2.

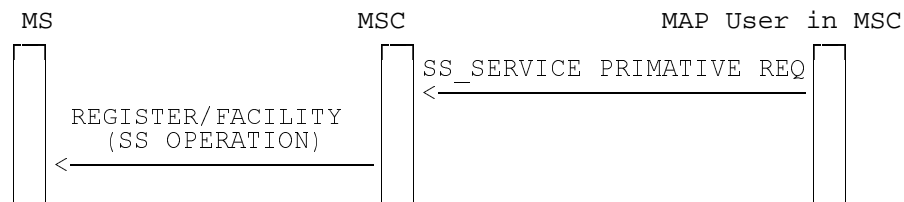

Figure 6.6: Signalling flow for Network Initiated SS operation invocation

Choice of service primitive on the basis of received facility information element is described in table 6.2.

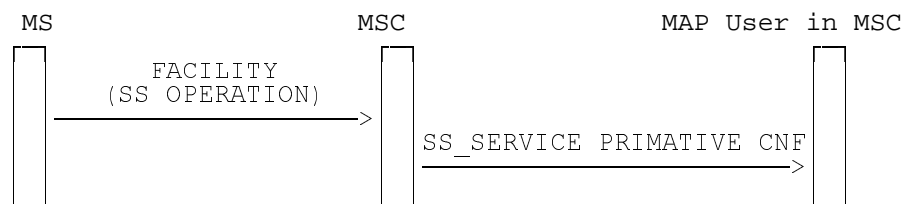

Figure 6.7: Signalling flow for Network Initiated SS operation return result

6.2.3 Connection release

A Network initiated SS connection is usually released by the network. The signalling for this situation is shown in figure 6.4.

However, in exceptional circumstances, the MS may request release of the connection. The signalling for this situation is shown in figure 6.5.

6.2.4 ForwardCheckSSIndication

When a mobile station first makes contact with the network after there has been a HLR restart, an indication may be sent by the HLR to the MS to inform of possible unintended consequences with respect to supplementary services. This indication is a separate service in the MAP (MAP_FORWARD_CHECK_SS_INDICATION service), and the abstract definition of its operation (ForwardCheckSSIndication) is imported into the GSM 04.80 protocol.

Upon receipt of ForwardCheckSSIndication from the VLR, the MSC shall create a new call independent SS transaction and then send ForwardCheckSSIndication (see GSM 04.10).

The MSC is only required to deliver ForwardCheckSSIndication if there is an active RR connection to the MS. The network shall not page the MS in order to deliver ForwardCheckSSIndication.

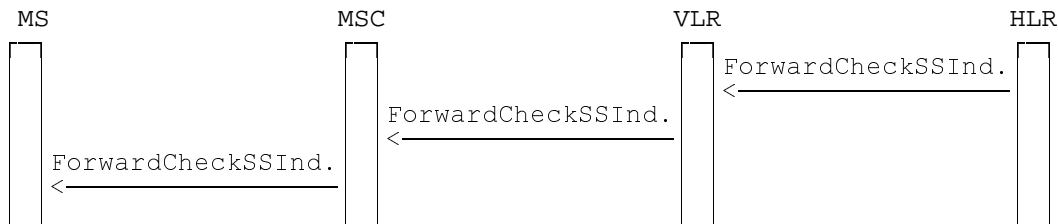

Figure 6.8: ForwardCheckSSIndication

6.2.5 CCBS Recall

As described in GSM 02.93, when destination B, target of a CCBS request activated by subscriber A, becomes idle, the network shall automatically recall subscriber A. When subscriber A accepts the recall, the network will automatically generate a CCBS call to destination B.

The signalling for this situation is shown in figure 6.9.

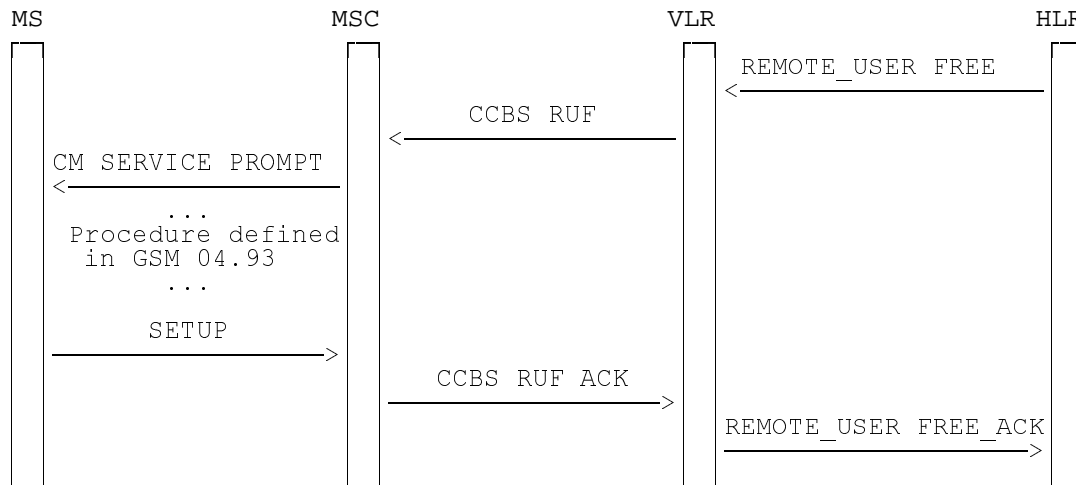

Figure 6.9: Signalling for CCBS Recall

The indication of destination B idle is sent in the MAP_REMOTE_USER_FREE service primitive. It is transmitted on the D-interface and relayed on the B-interface. Then, the recall procedure starts with the establishment of a CC connection initiated by the network with the CM SERVICE PROMPT message. The following exchange of message concerns only the A-interface and is not described here since it is already done in GSM 04.93.

The acceptance of the recall by the user is implicit in the SETUP message sent by the MS to the MSC. This message contains the call information previously sent to the MS and the indication that the call in its establishment phase is a CCBS call. The MSC informs the HLR of this acceptance by sending a MAP_REMOTE_USER_FREE_ACK message on the B-interface and further on the D-interface.

In case an error occurs (e.g. *MS not reachable* or *Incompatible terminal*), at any time of the recall procedure (i.e. just after the error has been received), the MSC shall send the MAP_REMOTE_USER_FREE_ERROR with the appropriate value for the Error information element.

Exact values of the parameters and parameter tags are indicated in GSM 04.08, GSM 04.93 and GSM 09.02.

6.2.6 CCBS Monitoring

The monitoring process is initiated by the network. It is started on the B-side as soon as subscriber B becomes a target of a CCBS request. It is started on the A-side when subscriber A is found to be busy or suspends a request while being offered a recall. Since the status of a subscriber is linked to its activity, a message sent by the MS to the MSC may lead to the transmission of a message containing the new status on the D-interface (i.e. the MAP_STATUS_REPORT service primitive). This message contains a Status information element which can take the value *Idle*, *Not_Reachable* or *Not Idle*.

Several situations might occur, they are described in the figure 6.10.

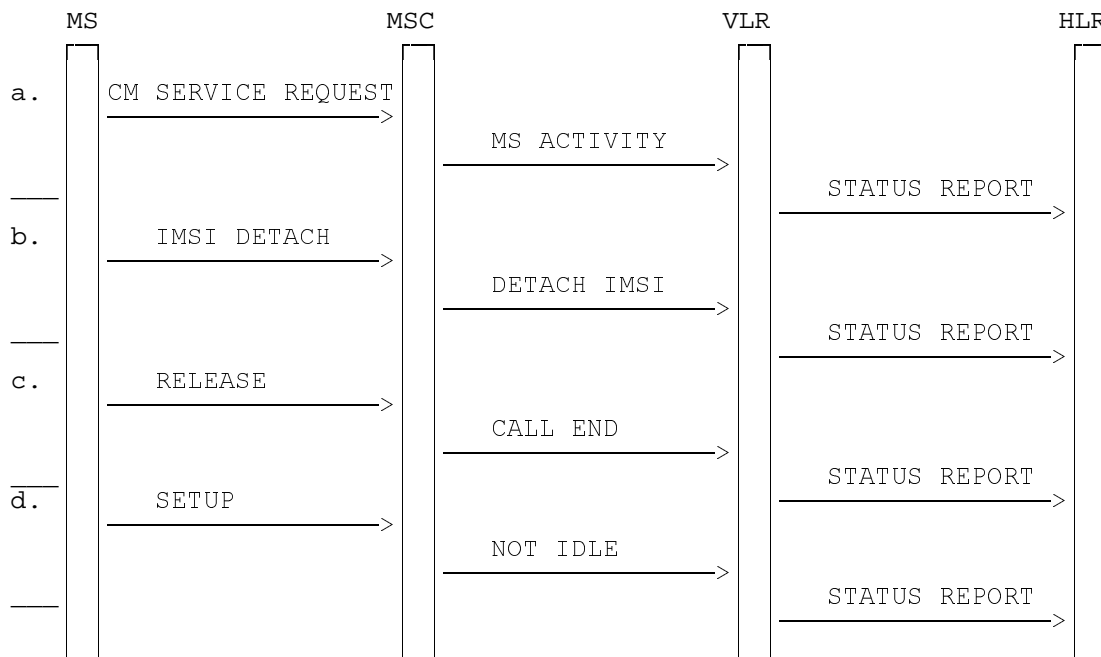

Figure 6.10: Signalling for CCBS Monitoring

For all these situations (from a to d), the transmission of the MAP_STATUS_REPORT service primitive depends on the possible change of status of the MS. The detailed behaviour of this procedure is described in GSM 03.93.

Exact coding and values of the messages are indicated in GSM 04.08 and GSM 09.02.

6.3 Mapping of Operation Codes, Error Codes, Parameter Tags and Parameter Contents

6.3.1 Operation codes

The same operation codes are used for equivalent operations in GSM 04.80 and GSM 09.02 for call independent supplementary service management.

6.3.2 Error codes

For call independent supplementary service management, the same error codes are used for equivalent error types in GSM 04.80 and GSM 09.02.

The RETURN ERROR components are also constructed in the same way on both sides of the interface.

6.3.3 Parameter tags and parameter values

The same parameter tags and parameter values are used for equivalent parameters in GSM 04.80 and GSM 09.02.

Annex A: Change history

Change history						
TSG CN#	Spec	Version	CR	<Phase>	New Version	Subject/Comment
Apr 1999	GSM 09.11	7.0.0				Transferred to 3GPP CN1
CN#03	29.011				3.0.0	Approved at CN#03

History

Document history		
V3.0.0	January 2000	Publication